

Scanning - Shortwave - Ham Radio - Equipment  
Internet Streaming - Computers - Antique Radio



# Monitoring Times

A Publication of Grove Enterprises

Volume 27, No. 3  
March 2008

U.S. \$5.95  
Can. \$5.95  
Printed in the  
United States



# AIRSHOW!

## MT's annual monitoring guide



### *In this issue:*

- Chicagoland's Airports
- High Flying Hams
- GRE's PSR-200 Desktop Scanner

# Watch What Happens!

The SR2000A is an ultra-fast spectrum display monitor that lets you **SEE** received signals in **FULL COLOR**

## AOR SR2000A Frequency Monitor

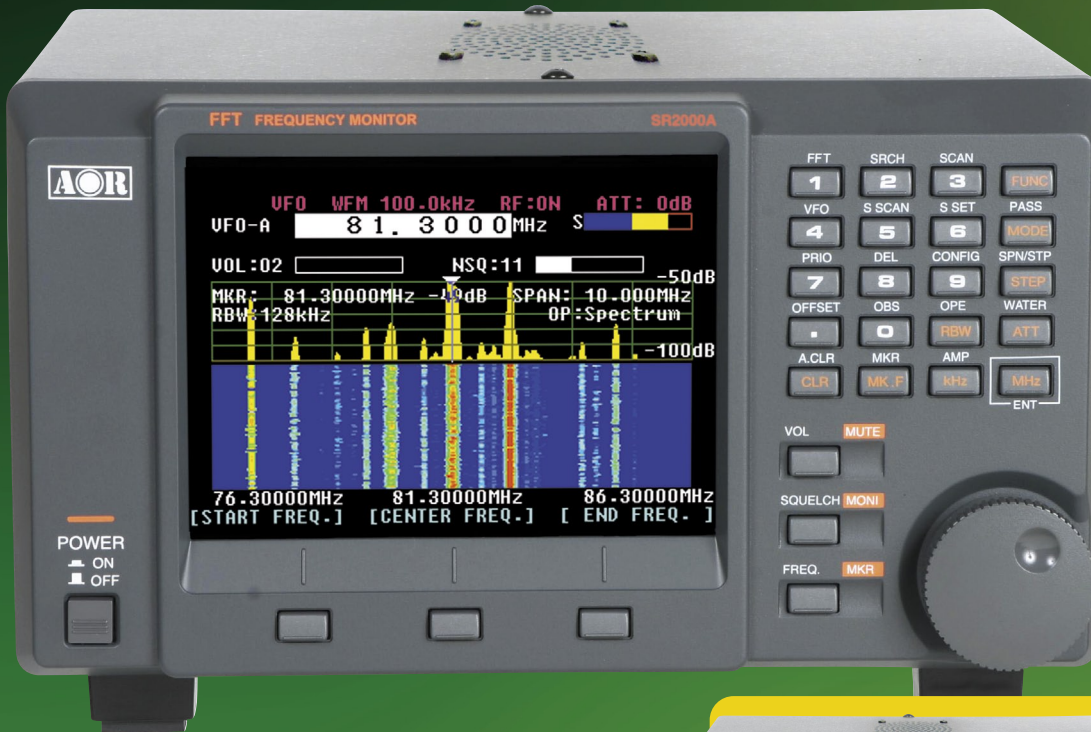

- Frequency coverage: 25MHz ~ 3GHz (no gaps)\*
- Ultra-stable, high-sensitivity triple-conversion receiver
- External video output (composite video)
- AM/NFM/WFM/SFM/TV receive modes
- Displays up to 40MHz of spectrum bandwidth (20MHz or 40MHz selectable)\*\*
- P25 decoding function available with optional P25-8600
- Waterfall (time) display function
- 1000 memory settings (100ch x 10 memory banks)
- Average or peak value readings

Using the power of FFT (Fast Fourier Transform) algorithms with a powerful receiver covering 25MHz ~ 3GHz\*, the SR2000A features a color monitor that displays up to 40MHz spectrum

bandwidth or video display of NTSC, PAL or SECAM signals. Ultra-sensitive, incredibly fast, yet easy to use, with a high quality internal speaker for crisp, clean audio signals.

Scans 10MHz in as little as 0.2 seconds! Instantly detects, captures and displays transmitted signals.



- Video display function (NTSC/PAL/SECAM auto select)\*\*\*
- 5 inch TFT color LCD display
- Versatile color display uses state of the art digital signal processing

- High speed FFT search quickly captures new signal transmissions
- Easy menu-driven operation
- PC control through RS232C serial port or USB interface



Authority on Radio  
Communications

AOR U.S.A., Inc.  
20655 S. Western Ave., Suite 112, Torrance, CA 90501, USA  
Tel: 310-787-8615 Fax: 310-787-8619  
info@aorusa.com http://www.aorusa.com

\*Government version. Cellular blocked for US consumer version.

\*\*No audio is available when the frequency span is set to 20MHz or 40MHz.

\*\*\*No audio available while displaying video signal on the LCD. If both video and audio need to be monitored simultaneously, an optional (external) TV2000 is required.



# A marine receiver like no other.

## At WiNRADiO, the innovation never stops.

The new WR-G33EM Marine Receiver represents a true breakthrough: It is the world's first software-defined marine receiver.

- Frequency range 9kHz to 30MHz
- AM, LSB, USB, DSB, CW standard modes
- DSC, HF Fax, NAVTEX, TELEX marine modes
- Extraordinary sensitivity
- Excellent dynamic range
- Real-time spectrum analyzer
- Spot-on tuning in 1Hz steps
- Continuously variable bandwidth 1Hz - 15kHz
- Automatic scheduling, recording and playback
- GPS option

Most of the radio signal processing with this receiver is performed in software, using computational signal processing methods, rather than using traditional hardware parts, resistors, capacitors, diodes, etc.

The received signal is digitized as early as possible in the signal processing chain, and further processing, demodulation and decoding of the digitized signal is then performed entirely in software.

There are many advantages to this approach, especially the flexibility of demodulation modes - new modes can be added easily by simply upgrading software. The WR-G33EM also performs better than a comparable conventional receiver, thanks to advanced signal processing techniques which make it possible to implement sharper selectivity filters, more accurate demodulators and decoders than conventional hardware.

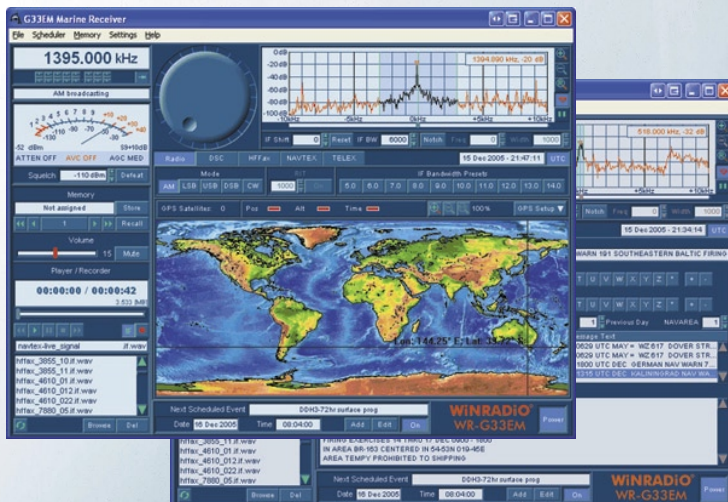

WR-G33EM Marine Receiver on-board

The performance of a Software Defined Radio receiver is also more consistent, stable and reliable because component tolerances and aging do not play such an important role as they do in a conventional receiver.

The WR-G33EM receiver also offers far more features and facilities than a typical marine receiver. For example, the real-time spectrum analyzer with continuously variable bandwidth, graphical notch filter and IF recording are just some of the many features which were previously unavailable on a typical marine radio, in particular at such an affordable price level.

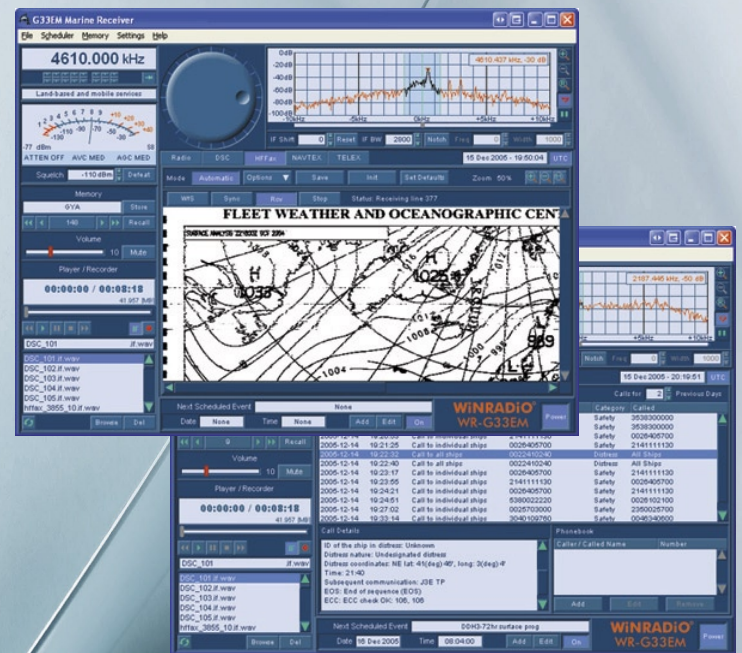

For more information visit

[www.winradio.com](http://www.winradio.com)





## Lead Story

### Ninth Annual MT Air Show Guide By Larry Van Horn

This yearly report is a comprehensive look at frequencies, best monitoring tips, show dates, and recommended equipment. Some of the information changes from year to year, some doesn't.

In addition to military demonstration team performance schedules for 2008, you'll find a listing of older radios as well as new ones which are appropriate for milair scanning, and frequency changes or additions observed during the past season.

Next time you head to a military air show, take along your scanner, tune in, and experience a whole new perspective on the aerial acrobatics!

Cover photo: Sean Tucker Power Acrobatics puts on a show for Kevin Burke's camera ([k\\_burke\\_photoz@verizon.net](mailto:k_burke_photoz@verizon.net)). Inset: The US Air Force Heritage flight

## C O N T E N T S

### Monitoring Chicagoland's Airports ..... 13

By Bruce Ames and Dennis Biagioli

Chicago is an aviation monitor's mecca, with two major airports and numerous municipal fields for your listening pleasure. Our authors provide a comprehensive and up-to-date look at aeronautical frequencies in use, as well as some interesting legends and lore on Midway and O'Hare. Save this article for your next trip through Chicago!

### High Flying Hams In and On the Air ..... 16

By Ken Reitz

What could create better operating conditions for a ham than getting your antenna up high? Raising your entire operating position up there along with it! In essence, that's what three top aviators do every time they fire up their ham rigs while piloting long flights across the globe. All three are crack pilots and long-time amateur operators. See if you can catch one of them transmitting from far above the earth!

### Is Aircraft Monitoring for You? ..... 18

By Iden Rogers

Are you still not quite sure what all the fuss is about? This brief overlook of the aviation monitoring hobby by MT's Planes columnist outlines the attractions and the challenges of aviation monitoring, and introduces some terms that will help you better appreciate what you're hearing.



## Reviews

GRE's new PSR-200 desktop scanner has no trunking, is analog only, and has 200 channels for only \$99.95. "Just what I was looking for!" says reviewer Larry Van Horn. It also comes in handy for the spring storm season, with SAME/FIPS weather alert and one-button monitoring of the ham Skywarn nets. (See page 66.)

John Catalano continues mining software gold from the COAA website: this month he reviews RadioClock to set your computer clock to the audio signal of a time

standard station, and BeaconSee, which provides an accurate, realtime representation of shortwave propagation conditions using amateur radio beacons. (See page 68.)

Are you opening more computer programs and seeing less? Using MaxiVista and two computers, John can enlarge a single display across both monitor screens, or duplicate it on both screens, or run a different display on each screen. See what you've been missing! (See page 72.)





MONITORING TIMES  
(ISSN: 0889-5341;  
Publishers Mail Agree-  
ment #1253492) is  
published monthly  
by Grove Enterprises,  
Inc., Brasstown, North  
Carolina, USA.

Copyright © 2008 Grove Enterprises, Inc.  
Periodicals postage paid at Brasstown,  
NC, and additional mailing offices. Short  
excerpts may be reprinted with appropri-  
ate credit. Complete articles may not be  
reproduced without permission.

Address: 7540 Highway 64 West,  
Brasstown, NC 28902-0098  
Telephone: (828) 837-9200  
Fax: (828) 837-2216 (24 hours)  
Internet Address: [www.grove-ent.com](http://www.grove-ent.com) or  
[www.monitoringtimes.com](http://www.monitoringtimes.com)  
Editorial e-mail: [editor@monitoringtimes.com](mailto:editor@monitoringtimes.com)  
Subscriptions: [order@grove-ent.com](mailto:order@grove-ent.com)

Subscription Rates: \$28.95 in US; \$39.50  
Canada; and \$58.50 foreign elsewhere,  
US funds. Label indicates number of is-  
sues left. Renewal notice is cover sheet 3  
months before expiration. See page 77  
for subscription information.

Postmaster:  
Send address changes to *Monitoring Times*,  
7540 Highway 64 West, Brasstown, NC  
28902-0098.

**Disclaimer:**  
While *Monitoring Times* makes an effort  
to ensure the information it publishes is  
accurate, it cannot be held liable for the  
contents. The reader assumes any risk for  
performing modification or construction  
projects published in *Monitoring Times*.  
Opinion or conclusions expressed are  
not necessarily the view of *Monitoring  
Times* or Grove Enterprises. Unsolicited  
manuscripts are accepted. SASE if material  
is to be returned.

#### Owners

Bob and Judy Grove  
[judy@grove-ent.com](mailto:judy@grove-ent.com)

#### Publisher

Bob Grove, W8JHD  
[bobgrove@monitoringtimes.com](mailto:bobgrove@monitoringtimes.com)

#### Managing Editor

Rachel Baughn, KE4OPD  
[editor@monitoringtimes.com](mailto:editor@monitoringtimes.com)

#### Assistant Editor

Larry Van Horn, N5FPW  
[larryvanhorn@monitoringtimes.com](mailto:larryvanhorn@monitoringtimes.com)

#### Art Director

Bill Grove

#### Advertising Svcs.

Beth Leinbach  
(828) 389-4007  
[bethleinbach@monitoringtimes.com](mailto:bethleinbach@monitoringtimes.com)

## TABLE OF CONTENTS

### Departments:

Communications .....	4
Letters .....	6
Stock Exchange .....	75
Advertisers Index .....	75

### First Departments

Getting Started	
Beginners Corner .....	20
<i>Readers Write</i>	
Ask Bob .....	22
The MT Help Desk .....	23

Scanning Report .....	24
<i>Radio Scanning, Limited</i>	

Utility World .....	28
<i>Get Ready for Cycle 24!</i>	

Digital Digest .....	31
<i>Easy Catches for Beginners</i>	

Global Forum .....	32
<i>VOA Special English Changes</i>	

Broadcast Logs .....	35
Programming Spotlight .....	36
<i>A Trip to Germany</i>	

The QSL Report .....	38
<i>Transmitter Chasing</i>	

English Language SW Guide .....	39
---------------------------------	----

### Second Departments

Milcom .....	52
<i>Milcom Mail Call</i>	
The Fed Files .....	54
<i>To Your Health (DHHS)</i>	
Boats, Planes, TRAINS .....	56
<i>New Safety Provisions/Messages</i>	
Below 500 kHz .....	58
<i>Focus on New England</i>	
Outer Limits .....	59
<i>Pirate Busts Hit All-Time High</i>	
On the Ham Bands .....	60
<i>GRAB and GO!</i>	

### Technical Departments

Antenna Topics .....	62
<i>Antennas and the US Navy</i>	
Radio Restorations .....	64
<i>Aligning the BC-348</i>	
First Look .....	66
<i>The GRE PSR-200</i>	
MT Review .....	68
<i>Radio Clock and BeaconSee</i>	
On the Bench .....	71
<i>Antenna Switch</i>	
Computers & Radio .....	72
<i>MaxiVista - Seeing More</i>	
What's New .....	74

## EDITORIAL STAFF Email [firstlast@monitoringtimes.com](mailto:firstlast@monitoringtimes.com)

TJ "Skip" Arey..... On the Ham Bands  
Rachel Baughn ..... Letters to the Editor  
Kevin Carey ..... Below 500 kHz  
John Catalano ..... Computers & Radio  
Mike Chace..... Digital Digest  
Marc Ellis ..... Radio Restorations  
Bob Grove ..... Ask Bob  
Glenn Hauser ..... Global Forum  
Chris Parris ..... Fed Files  
Ken Reitz..... Beginners Corner  
..... Communications  
Iden Rogers..... Planes  
Clem Small ..... Antenna Topics  
Doug Smith..... American Bandscan

Hugh Stegman ..... Utility World  
Ernest Robl ..... Trains  
Gayle Van Horn ..... Frequency Manager  
..... Broadcast Logs  
..... QSL Corner  
Larry Van Horn..... Milcom  
..... MT Help Desk  
..... Reviews Editor  
..... What's New?  
Dan Veeneman ..... Scanning Report  
Ron Walsh..... Boats  
Fred Waterer..... Programming  
Spotlight  
George Zeller..... Outer Limits



# COMMUNICATIONS

by Ken Reitz

## AMATEUR RADIO/SHORTWAVE

### Cycle 24 Officially Begins (Sort of)

The solar cycle is said to be eleven years old. That's the amount of time it takes to go from the end of one cycle to the beginning of the next. The rise of a cycle brings with it increased propagation on the shortwave and amateur bands and makes hams and SWLers happy.

So, just how do you tell when a cycle has finally begun? David Hathaway, a physicist at the Marshal Space Flight Center, who put the beginning date at December 11, 2007, explained that, "New solar cycles always begin with a high-latitude, reversed polarity sunspot." The sunspot polarity is reversed compared to sunspots from the previous cycle. The old cycle sunspots tend to congregate at the equator of the sun.

According to the NASA news release, Cycle 24 will be intense and peak around 2011 or 2012. While that's good news for hams and shortwave listeners, it's a scary time for the multi-billion dollar electronics industry. Since the last big solar cycle peak, there have been hundreds of new satellites launched and put into operation worldwide. Most countries now depend on satellites for communications such as air traffic control, GPS, broadcasting, TV entertainment, radio, military applications and weather. (See page 28 for more.)

### Oregon Governor Backs Ham Network

Ham radio operators nationwide are used to picking up plaques and citations from public officials for their efforts in emergency communications. But now, according to a report from the Associated Press, the Governor of Oregon is making \$250,000 available to further develop a statewide amateur radio digital communications network.

"In the storms last December amateur radio operators often provided the only communication between county and state governments when landline, cell phone systems and the Internet failed. Digital radio systems proved their value then," the report said.

It will be interesting to see what the Oregon hams do with the money and what effect such a program may have on other states which experience similar severe weather.

## BROADCASTING

### Radio Piracy on the Rise

Citizens around the world are resorting to establishing their own radio stations at a pace that has rules enforcers several steps behind. Pirate stations are cropping up in England,

Hong Kong, and all parts in between. Reports in various publications tell about the seizure of such stations, but there's no way to know just how many are actually operating.

In January, authorities in Winter Haven, Florida, arrested three people and closed down one hip-hop station operating out of a residence. In an effort to combat these operations, which are not uncommon in Florida, the Florida legislature made operating such a station a felony with a possible prison sentence of 5 years in 2005. Also in January, a Milwaukee, Wisconsin man was fined by the FCC \$10,000 for operating a pirate station.

Perhaps the biggest concentration of unauthorized broadcasting is New York City where an article in the December 23, 2007, issue of the *New York Times* reported that many pirate broadcasters are currently operating, some even with commercials for local establishments. "Brooklyn, over the years," the article said, "has been home to dozens of pirate broadcasters, chattering in every language from Spanish to Yiddish."

### Consumers Flock to \$40 DTV Coupon

Congress has acted to speed up the process of converting America to all-digital off-air TV by creating funds, hundreds of millions of dollars in fact, to ensure that all who receive TV via the air-waves can afford to buy a digital converter. Anyone may sign up for the \$40 coupon by going to [www.dtv2009.gov](http://www.dtv2009.gov). The application is available in 7 languages. After applying on-line, up to two coupons will be sent to the address given and the consumer will have 90 days to make the purchase.

Participating retailers will deduct coupons from the cost of the product. The site lists some 24 products which are eligible for the coupon purchase. As of mid-January, no retailers were listed. According to the National Telecommuni-

cations and Information Administration, 725,000 requests for a total of nearly 1.4 million coupons were received in the first few days of the program. Consumers may also apply via telephone at 1-(800)-DTV-2009.

### Satellite Radio/HD-Radio Hype

The annual January Consumer Electronics Show has always been an extravagant love-fest between the overly optimistic cheerleaders of the electronics industry and the seemingly gullible electronics press. Wild claims from industry PR firms of how new, gee-whiz technologies are poised to take off and radically change all of our lives are dutifully reported by every reporter unlucky enough to have been assigned the story.



The latest news on the HD-Radio front is the addition of more iPod docking on new HD-radio sets enabling what's called "i-Tunes tagging." This should more properly be called the "Apple Billion Dollar Subsidy Program." i-Tunes tagging lets consumers electronically tag a song heard on their new HD-Radio through their iPod. When the iPod is connected to an on-line computer, it downloads that song to the owner's iPod, who then is billed at the going dollar/song rate.

Also at CES2008 Samsung announced it intended to make HD-Radio chip-sets for portable reception. But, you can resume breathing because Samsung believes they'll have the chip-sets ready by the third quarter of this year. Add at least a quarter to that prediction. Even if they do, don't expect portable HD-Radio sets much before the middle of 2009. And, even if the units finally see production, don't expect these portable HD-radios to perform any better than desk-top sets. That's a real problem, because portable sets are not likely to be attached to large outdoor antennas to receive a steady lock on the HD-channels.





While XM and Sirius both maintained an unusually low profile at CES2008 because of concerns about their combined futures, a business analyst at Park Associates believes that satellite radio will nearly double from a projected 20 million subscribers in 2008 to 40 million in 2010, according to SkyReport. No doubt this forecast assumes the companies will in fact merge and somehow escape the coming recession.

## PUBLIC SAFETY

### M/A-Com System Wins and Loses

A headline in the Troy, Michigan *Daily Tribune* read, "Police Scanners will be Silenced when County Transition Complete." The \$42 million system is expected to begin operation this month. The article pointed out that, "... residents and reporters won't be able to listen. No scanner manufacturers have products compatible with M/A-Com's Open Sky technology."

According to the piece, the county administrator of the Courts Law Enforcement Management Information System suggested that scanner listeners contact scanner manufacturers. "Start bugging them now... If there's enough demand, I'm sure ...some company will come out with something. I think it will eventually happen when there's a market. This is the same system Pennsylvania uses. New York and Milwaukee also are going to it."

However, according to a newspaper report from Albany, New York, the \$2.1 billion communications system designed by M/A-Com failed recent operational tests. The tests, which were conducted in the summer and fall of last year in the two counties where it's installed, showed training problems and signal gaps. Critics of the system worried about continuing the build-out to the rest of the state.

### Last Ditch Interoperability

A small town in Missouri, peculiarly named Peculiar, has decided it will make Family Radio Service (FRS) channel 5 its last ditch, go-to emergency radio channel. In a report from *The Journal*, which serves Cass County, Missouri, the West Peculiar Emergency Management Department has studied the problems of disaster communications and made a few recommendations.

After recognizing that cordless phones

don't work in a power outage, and that cell phones have limited capability in power outages, "During extended power outages the Emergency Management Department with the assistance of the Citizen Emergency Response Team, will monitor FRS walkie-talkie channel 5, with tone #5 for emergency communications. The police department has 2 of these portable radios and will put them in service during emergencies."

### The Russians are Coming, the Russians are Coming!

According to a report in Russia's Itar-Tass News Agency, the Russian Federal Space Agency (FSA) has entered the multi-billion dollar GPS market. The first 1,000 navigator units, which can receive both Russian Glonass and U.S. GPS signals, sold out in the first twenty minutes they were offered. According to the report, the units are capable of receiving 12 Glonass channels and 20 American GPS channels. The FSA is expected to launch an additional six Glonass GPS satellites this year.

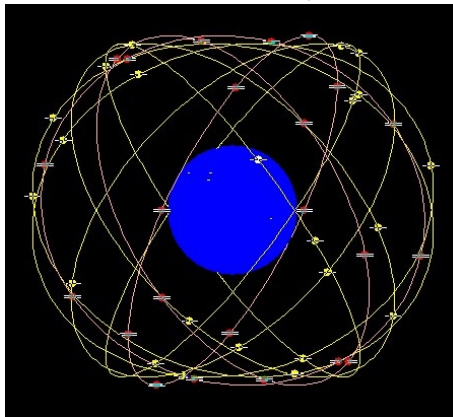

### Not Ready for Evolution

Several sources reported the story of a hapless driver who apparently obeyed his built-in GPS navigation system too quickly when it directed him to turn right as he drove across railway tracks at a crossing. Luckily, the driver got out of the stuck car before it was hit by a commuter train.

Meanwhile, the *Detroit News* reported on two people from Detroit who allegedly sold stolen GPS units on eBay. One person was said to have worked for a GPS unit supplier to one of the car makers in Detroit while the other operated a web site on eBay to sell the units. When police swept in for the arrest they allegedly found 15 more radios.

Connecticut police arrested a trucker for allegedly stabbing a fellow trucker in Arkansas in an apparent road-rage incident. With the help of the trucking company, a GPS unit on-board the truck was used to track the suspect down.

Gang members in L.A. were tracked down after allegedly being involved in a drive-by shooting that resulted in at least one death. It turns out one of the alleged shooters was wearing a court-ordered GPS tracking bracelet which put him exactly at the scene of the crime when the crime was committed. According to an AP report, the city has been using such bracelets on identified gang members since November, 2007. The devices are actually attached at the ankle.

And, finally, an article in New York's *News Day* reports that a man was stopped at 1:00 a.m. while he attempted to ride a bike while holding a GPS unit in his arms. When police stopped the man and pressed the "home" button on the unit it was identified as belonging to someone else just a block away. The unit had been allegedly stolen from a nearby vehicle. According to the article, police charged the man with larceny, criminal possession of stolen property and... riding a bike at night without a light.

## TV TECHNOLOGY

### Plasma, LCD TV Screens Obsolete?

It's no wonder that it's hard to get people excited about the latest digital craze. About the time the average consumer decides to invest in it, it's obsolete. The current struggle between Sony's Blu-Ray HDTV DVD player/recorders and the rival HD-DVD format has consumers waiting on the sidelines.

Similarly, the big screen TV business has been forcing consumers to choose between the less expensive LCD displays and the more spectacular plasma screens.

Now, Organic Light Emitting Diode (OLED) technology could make them all obsolete. Introduced at the CES2008 this January, OLED screens were making a splash in a number of manufacturers' booths. Sony was showing a 3 mm thick OLED screen that was only 11" wide and would sell for \$2,500. Samsung had a 31" OLED prototype screen on display. No price was given on that unit.

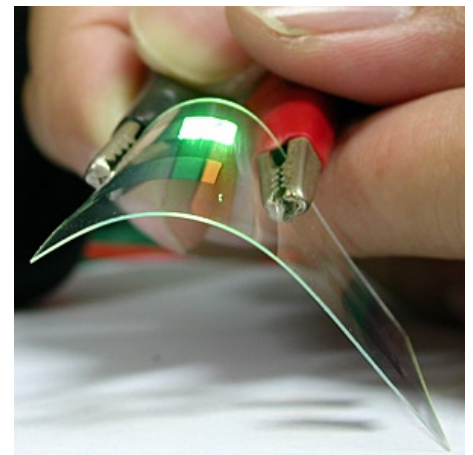

But, don't pitch your new plasma or old-age LCD screen yet, because the most optimistic guess is that TVs and computer screens employing this technology are at least two years away. If previous estimates from company PR firms are calculated correctly, you can add two years to that estimate and five years before it's affordable.

"Communications" is compiled by Ken Reitz KS4ZR ([kenreitz@monitoringtimes.com](mailto:kenreitz@monitoringtimes.com)) from news clippings and links supplied by our readers: Many thanks to this month's fine reporters: Anonymous, Azizul Al-Alam Amin, Rachel Baughn, Michael Colburn, Ira Paul, Doug Robertson, Brian Rogers, Rick Kissel, Larry Margrave, and Larry Van Horn.



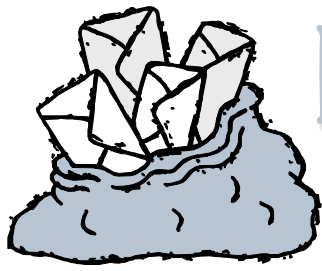

# LETTERS TO THE EDITOR

*This column is open to your considered comments. Opinions expressed here are not necessarily those of Monitoring Times. Your letters may be edited or shortened for clarity and length. Please mail to Letters to the Editor, 7540 Hwy 64 West, Brasstown, NC 28902 or email editor@monitoringtimes.com  
Happy monitoring!  
Rachel Baughn, Editor*

## Rubber-Tired Trains?!

I enjoyed reading about the hi-rail, rubber-tired vehicles in Ernest Robl's column in the March 2007 issue. I wanted to share with you these photographs of a hi-rail vehicle I took in May 2006.

The truck is unique particularly for its length. It is pulling four semi-trailers as can be seen in the last photo.



Being operated by a well-known contractor, Asplundh, I believe the truck is spraying a vegetation killing chemical along the tracks. These tracks parallel U.S. Hwy. 25 in Richwood, Kentucky. There were three operators visible in two separate compartments: one to drive the truck, and two to operate the spray equipment.

— Greg May W2ORO, Union, Kentucky

## Kudos

Just a note to tell you how much I enjoyed your magazine. I am sending you a subscription for *Monitoring Times*. I have also taken the liberty of posting a link to your "free" magazine on a website which is frequented by former members of the US Air Force Security Service. I hope that some other interested members will also subscribe.

— Don Mencl

## Battery Charger Caveat?

MT's review of the LaCrosse BC-900 battery charger in the January 2008 issue provoked my interest to the point that I was ready to purchase one. However, upon looking it up on Amazon.com, I read reviews indicating that a number of people had experienced serious overheating of the charger, and had never gotten a satisfactory

acknowledgement of the problem from LaCrosse, or a response regarding what its cause might have been. There are apparently two different models... but LaCrosse denied that there was ANY difference between the two models...

Here's a link to Amazon's page:

[www.amazon.com/Crosse-Technology-BC-900-AlphaPower-Battery/dp/B00077AA5Q/ref=pd\\_bbs\\_sr\\_1?ie=UTF8&s=home-garden&qid=1198269076&sr=8-1](http://www.amazon.com/Crosse-Technology-BC-900-AlphaPower-Battery/dp/B00077AA5Q/ref=pd_bbs_sr_1?ie=UTF8&s=home-garden&qid=1198269076&sr=8-1)

Scroll down to the graph of different ratings and click on the one-star ratings (I always check these).

... the possibility of overheating is something I can't overlook until LaCrosse comes up with a reasonable answer as to what might have been responsible for these incidents. Meantime, I hesitate to purchase one, and other potential customers should be forewarned.

— Kevin Jones, W7LOZ

Larry Van Horn, MT's reviewer for this model, says, "I have not experienced any overheating issues with the review unit and I have been testing it nearly continuously since I have received it. I have probably charged well over 100 sets of batteries and no overheating has been noted." Reading the referenced Amazon web site, it looks as though the majority of users (248 out of 279 reviewers) were as satisfied as Larry. Obviously, if one experiences serious overheating, the unit should be returned as defective!

## Leave Lights on in Winter

I enjoyed your article on "Use Less Power" (*Beginner's Corner* Jan 2008) and I'm always looking for ideas to cut back on my power. But I have to disagree strongly with you about use of lights in the winter; you write "this is especially true in winter when house lights are on more hours per day."

It makes good sense to turn off any appliance not in use in the summer when the AC has to remove the heat, but if you're having to heat your home in the winter... electrical appliances complement the home heating system... save for any differences in fuel cost (as in gas cost vs. A\$/KWH) the heat is the same.

You need it anyway. If your home is heated electrically, then it is exactly the same on energy cost.

During the summer here in Louisiana where it is real hot, I spend a lot of time turning stuff off. As I write this, it is 55F outside and our house needs the heat. In the winter, I just leave the stuff on (except for light bulbs which wear out and there is a cost to that). I have six radios going in my ham shack as well as a TV. No worries.

— Tom N5OFF

Good points, Tom! This shows that folks have to examine their own situations to determine what they want in order to use less power.

While wall transformers and incandescent bulbs do provide additional heat to the living space, the objective in my own situation is to look for more efficient use of power. My house is self-designed to take advantage of "passive solar," so that in winter if the outside temperature at my location was 55 degrees I'd have to open the windows! Despite the rise in energy costs over the last year, my own expenses for electric power over the last six months dropped by \$150, thanks entirely to the small steps I've taken in managing our home's energy without sacrificing comfort or convenience. It's encouraged me to go further in reducing energy consumption and, why not? It pays!

— Ken Reitz

## New Batteries and Homebrew Tubes

An MT reader pointed us to a couple of interesting web sites. The first touts a newly developed battery from Stanford University using "Buckytubes" (carbon nanotubes). To quote the website: Stanford researchers have found a way to use silicon nanowires to reinvent the rechargeable lithium-ion batteries that power laptops, iPods, video cameras, cell phones, and countless other devices. The new technology produces 10 times the amount of electricity of existing lithium-ion. <http://news-service.stanford.edu/news/2008/january9/nanowire-010908.html>

The same reader also provided the link to a mesmerizing 17-minute video of a French amateur radio operator making vacuum tubes at home: [http://blog.makezine.com/archive/2008/01/make\\_your\\_own\\_vaccum\\_tube.html](http://blog.makezine.com/archive/2008/01/make_your_own_vaccum_tube.html)

It even comes with a sound-track (music, no narration).

## Elusive Interoperability

I read your brief article from *Monitoring Times*, Feb 2006, "Interoperability - The Real Story," with great interest. You really hit the nail on the head. The solution to the so-called non-interoperability problem doesn't need to cost billions of dollars. 2 billion has already spent since 9/11 and, according to almost all the assessments, we're no better off now than we were prior to 9/11.

I always like to point to one example of a government project that was done right, which is the 7 channel VHF NOAA weather radio network. 7 frequencies! And there's hardly a place that you can set foot in this country and not be able to get critical weather information using nothing more than a \$50 radio.

— David Kleber, KB3FXI, Director of Sales and Marketing, RemComm, Inc.



# Monitoring the Air Show Experience

## The Annual MT Air Show Guide

By Larry Van Horn, MT Assistant Editor, N5FPW

DoD photo

### Air Show!

It's our ninth annual Air Show Guide and still nothing stirs up the aircraft enthusiast's juices more than those two magical words. Every year, from March through November, thousands travel all around the country each weekend to watch the action, as military and civilian aero teams put their aircraft through the paces to entertain and perform.

While there is nothing quite as thrilling as going out to one of these public air shows and watching the military or civilian demonstration teams strut their stuff in front of thousands of aircraft fanatics, you can add to the visual experience by monitoring the performing teams' radio communications. With a radio scanner in hand, you will experience a whole new perspective of the show that few attendees will realize or enjoy.

Since the new 2008 air show season starts in the second week of March, we here present our annual *Milcom Air Show Guide*, giving you the frequencies to monitor, the recommended list of air show radio equipment, and the major military flight demonstration team schedules for the upcoming air show season.

### Where do you hear the action?

From time to time, frequencies for air show teams do change, so it's important to know where to search for potential new frequencies. When the Blue Angel team made some major changes back in 2004, seasoned veterans knew the right bands to target to look for the new frequencies being used. Just like the veterans, if you concentrate on the bands listed below, you should be able to locate most air show activity in your area (all frequencies in this article are in MHz).

118.0-137.0 25 kHz search steps (AM mode)  
**Note:** We have reports of a lot of new air show activity in the new portion of the civilian aero band - 136-137 MHz. Be sure to check

122.7-123.575 25 kHz search steps (AM)  
 138.0-144.0 12.5 kHz search steps (AM/Narrowband FM)  
 148.0-150.8 12.5 kHz search steps (AM/NBFM)  
 225.0-390.0 25 kHz search steps (AM)  
 406.1-420.0 12.5 kHz search steps (NBFM)

### U.S. Navy Blue Angels

The U.S. Navy (USN)/Marine Corps (USMC) military team is represented on the air show circuit by the Blue Angels flying their F/A-18 Hornet aircraft.

A Blue Angels flight demonstration exhibits the skills possessed by all naval aviators. It includes the graceful aerobatic maneuvers of the four plane Diamond Formation, in concert with the fast paced, high performance maneuvers of its two Solo Pilots. At the close of every show, the team illustrates the pinnacle of precision flying, performing maneuvers locked as a unit in the renowned, six jet Delta Formation.

The team is stationed at Forrest Sherman Field, Naval Air Station Pensacola, Florida, during the show season. However, the squadron spends January through March training pilots and new team members at Naval Air Facility El Centro, California.

The Blue Angels are scheduled to fly 68 air shows at 35 air show sites in the United

States during the 2008 season, as the team celebrates 22 years of flying the F/A 18 Hornet. Last season, more than 15 million spectators watched the Blue Angels perform. Since its inception in 1946, the Blue Angels have performed for more than 442 million fans.

The other major piece of hardware in the squadron is their C-130 Hercules transport aircraft, affectionately known as "Fat Albert." It is the only Marine Corps aircraft permanently assigned to support a Navy squadron and is flown by an all Marine Corps crew of three pilots and five enlisted personnel. "Fat Albert" flies more than 140,000 miles during the course of a show season.

After coping with all the frequency changes noted during the 2004 season, the 2007 season was relatively stable. The primary AM mode UHF frequencies monitored during last season include:

### Blue Angels Primary Frequencies

Frequency	Usage
—	Pensacola (KNPA) frequencies <Channels 1-7>
—	Show Site frequencies <Channels 11-15>
237.800	Solos <Channel 8>
255.200	Circle and arrivals discrete <Channel 17>
275.350	Diamond <Channel 9>
284.250	Show Box/Delta <Channel 16>
289.800	Aerial Refueling
302.100	Fat Albert <Secondary>
303.000	Occasional air-to-air comms
305.500	Fat Albert "Bert" Primary <Channel 10>
346.500	Ground start/rollout/maintenance <Channel 18>

Some other UHF frequencies that were not widely reported over the last two seasons include: 251.600 302.150 307.700 (AM).

During the 2005 show season, the Blues started using a new ground cart for show communications. Two new narrowband FM splinter frequencies/designators were found in use: 139.8125 <Bravo/Channel 3> and 142.6125 <Alpha/Channel 3A>. Last year another possible new narrowband FM frequency was reported: 141.5625 MHz <Charlie>.

Although we believe that the older



DoD photo

162-174 MHz Blue Angel FM LMR frequencies are no longer being widely used, I have not deleted them from this list, as West Coast monitors claim that some of them are still being used there.

I encourage those of you with Signal Stalker and Close Call capability to watch the LMR spectrum from 138-144 MHz closely for new additional 12.5-kHz splinter frequencies being used by the team's ground crews.

#### Additional Blue Angels Frequencies

##### Cross Country Air-Air

138.250 143.600 237.800 238.150  
275.350 284.250 (AM)

##### Maintenance/Ground communications

[Old communications comcart/ground frequencies]

140.100 142.000 143.600 163.000  
164.900 165.225 167.500 167.800  
168.900 169.400 170.900 (NBFM)

##### Tower-Comm Cart (May no longer be used)

173.825 (NBFM)

##### Tower Observer

143.000 (AM)

##### UHF frequencies not reported in recent seasons

236.450 249.625 254.500 256.250  
262.850 263.350 264.350 264.550  
265.000 273.300 286.000 299.650  
381.000 (AM)

You can learn more about the Blue Angels flight demonstration team on their internet website at [www.blueangels.navy.mil/index.htm](http://www.blueangels.navy.mil/index.htm).

### U.S. Air Force Thunderbirds

The premier U.S. Air Force (USAF)

flight demonstration team is known as the Thunderbirds. This team uses six F-16C Fighting Falcon aircraft, performing formation flying and solo routines. The four aircraft diamond formation demonstrates the training and precision of Air Force pilots, while the solos highlight the maximum capabilities of the F-16. The pilots perform approximately 30 maneuvers in a demonstration. The entire show, including ground and air, runs about an hour and 15 minutes.

The frequency list below has been in use by the team over the last nine air show seasons. It should be noted that at some performances the 143.850 and 235.250 MHz roles are reversed from what is published below.

#### USAF Thunderbirds

##### Frequency Usage

139.8000 Possible New VHF (AM)  
140.4000 Support "T-Bird Ops"/Cross country air-to-air (AM)  
141.8250 Alternate Diamond <Victor 2>  
141.8500 Pre-take/Four ship/Diamond formation linked to PA system/Cross country air-to-air (AM) <Victor 2>  
142.5750 Program audio/Air-Ground communications (NBFM)  
143.8500 Diamond formation/Cross country air-to-air (AM) <Victor 1>  
Retransmission to public through the team PA system.  
235.0250 Unknown usage [Tentative]  
235.2000 Thunderbird Control/ComCart (AM)  
235.2500 Pre-Engine Start and Solo aircraft on/off show center/ linked to PA system (AM) <Uniform 1>  
322.9500 Engine Starts/Solo aircraft (5-6) Air-Air (AM) <Uniform 2>

#### Maintenance/Ground teams (NBFM/P25 digital)

216.725 Announce PA feed - show narration <Channel 55>  
216.775 Announce PA feed - show narration <Channel 56>  
216.975 Team Airshow frequency feeds/mix <Channel 60>  
413.000 Ground Maintenance Digital (P25)  
413.025 Ground Maintenance Analog <Channel 1>  
413.100 Ground Maintenance Analog <Channel 2>  
413.250 Ground Maintenance Analog  
413.275 Ground Maintenance Analog (DCS 431) (Listed in official publications)  
413.325 Ground Maintenance Analog (DCS 503) (Listed in official publications)  
413.350 Ground Maintenance Digital (P25)  
413.375 Ground Maintenance Digital (P25)  
901.500 Comm Cart Headset  
905.350 Comm Cart Headset

Previous VHF maintenance frequencies, including 142.175 and 143.900 MHz, appear to have been replaced by 413 MHz frequencies noted in our list above.

The 216 MHz frequencies are transmitted using Comtek gear and are interesting to monitor from the T-Bird Comm cart. You can get a complete Comtek bandplan for that frequency range at [www.comtek.com/download/AT-](http://www.comtek.com/download/AT-)

**frequency\_chart.pdf**. If you don't hear the cart on the frequencies that I have identified above, do a search using the frequency chart at the Comtek link.

You can learn more about the T-Birds on their website at <http://thunderbirds.airforce.com/>.

### Other US DoD Military Flight Demo Teams

In addition to the two units mentioned above, the Navy and the Air Force also have other flight demonstration units. Other branches of the Department of Defense (DoD) and David Shultz air shows (one of the premier air show companies) use a wide variety of VHF and UHF frequencies during air shows. Some of the frequencies recently reported for these organizations are listed below. (AM mode is used for all the frequencies listed below unless otherwise indicated.)

#### US Military Flight Demo Teams

##### Combat Search and Rescue

40.80 (Air/Air) 251.900 (SAR Coordination)

##### David Shultz airshows (civilian)

118.700 (Ground Ops) 132.950 (Operations) 135.650 (Airboss) 238.150 (Airboss) 350.300

##### Heritage Flight

118.500 (Air/Air) 122.475 123.150  
123.425 123.450 127.150 136.575  
136.675 238.150 282.800 376.025  
384.550

##### Air Force A-10 Thunderbolt demonstration teams

40.800 118.700 122.475 123.150  
123.475 136.575 138.050 138.100  
138.200 138.250 138.300 138.475  
138.500 139.900 139.625 136.675  
139.725 139.800 139.975 140.400  
141.675 142.200 225.500 236.850  
251.200 269.900 283.700 305.400  
327.700 341.500 343.000 343.000  
376.025 384.550

##### Air Force B-1B Bomber Flyover

238.150

##### Air Force B-2 Bomber Flyovers (509BW)

290.225 335.550 370.900 388.850

##### Air Force B-52 Bomber Flyovers

376.025

##### Air Force F-15 Eagle East demonstration team

(Replaced by the USAF F-22 Demo Team)

##### Air Force F-15 Eagle West demonstration team

123.150 376.025 384.550

##### Air Force F-16 Fighting Falcon demonstration teams

136.575 136.675 365.700 376.025  
283.700 384.550

##### Air Force F-117 Stealth Flight Demo

123.150

##### Air Force F-22 Raptor East demonstration team

238.900 290.225 292.700 376.025  
387.200

##### Air Force AETC T-6 Texan East Coast Team

118.900 122.925 123.150 123.400  
127.150 138.400 226.100 283.700  
295.000

##### Air Force Combat search and rescue (SAR) demonstrations

127.150 138.100 139.700 225.450  
236.000 242.000 251.900 252.800  
259.000 278.800 280.500 282.800  
287.500 381.000 384.550

##### Army Blackhawk Demo (National Guard Unit)



DoD Photo



242.400 (Primary)/46.85 (NBFM)  
 Coast Guard aircraft/SAR demonstrations  
 122.900 (SAR)  
 157.050 (Drug Interdiction demo - NBFM)  
 157.075 (Command Post -NBFM)  
 237.900 282.800 326.150 345.000 (Demo) 379.050  
 Coast Guard HITRON interdiction demo  
 157.050 (NBFM)  
 Navy F/A-18 Demo Team  
 123.150 376.025  
 Navy LCAC comms  
 40.400 (NBFM)  
 Navy Light Amphibious Vehicle comms  
 30.000 (NBFM)  
 Navy S-3 Viking aircraft demonstrations  
 263.400 325.400 325.800 342.500  
 Navy SAR demonstrations  
 242.500 282.000 283.100

## DoD Military Parachute Demonstration

### Teams

The premier DoD military parachute team on the air show circuit is the **U.S. Army Golden Knights** based out of Fort Bragg, North Carolina. The team aircraft used during air shows is either the C-31A Friendship or UV-18A Twin Otter.

Look for their communications on the frequently reported frequencies of 122.775 123.400 123.475 and 123.500 MHz. You should also keep the following plugged into your scanner for possible GK team activity: 32.300 32.400 122.575 124.875 126.200 238.000 284.900 and 367.700 MHz. Also watch for a possible new VHF frequency of 142.800 MHz for Golden Knight radio activity in the near future.

You can learn more about the Golden Knights on their official website at [www.usarec.army.mil/hq/goldenknights/Web-page2005\\_content.html](http://www.usarec.army.mil/hq/goldenknights/Web-page2005_content.html).

The U.S. Army actually has more parachute teams than just the Golden Knights. The U.S. Army Special Operations Command parachute team is known as the **Black Daggers** (see *MT Milcom* May 2004). Several frequencies have been uncovered for them during the last four seasons, including: 123.450 136.000 136.500 138.650 237.300 238.150 MHz. The team has a very nice website located at <http://news.soc.mil/blackdaggers/blackdaggers.htm>.

Another Army parachute outfit is the **Silver Wings**. This is the Fort Benning, Georgia, Command Exhibition Parachute Team. They have been monitored on 34.650 and 44.900 MHz. However, both these frequencies were common landing zone frequencies in the area they were performing in, so if neither of the two frequencies above is heard at a performance you attend, I suggest you initiate a rigorous search of the VHF-low band frequencies.

In addition to the VHF low band frequencies mentioned above, ground and safety personnel associated with this team have been heard using 467.6125 MHz (FRS channel 10/GMRS) for communications. There was also one report that the team was using an Intra Squad radio frequency of 397.500 MHz.

See our comments below about programming ISR, GMRS and FRS channels for air show monitoring. The Silver Wings team website is located at [www.infantry.army.mil/silverwings/](http://www.infantry.army.mil/silverwings/).

The U.S. Army has several more teams, but we still do not have frequency information for them. We would appreciate communication reports on the following U.S. Army teams if you catch them performing this air show season:

All American Free Fall Team (82nd Airborne)  
 Fort Bragg, North Carolina  
 Green Beret Parachute Team  
 Fort Bragg, North Carolina  
 Black Knights  
 US Military Academy, West Point, New York

The U.S. Special Operations Command has a team based out of MacDill AFB in Florida. They have been heard on the following frequencies: 122.450 123.450 and (no, this is not a misprint) 151.625 MHz, a nationwide business itinerant frequency.

This year we have two new teams to add to our list. During the 2007 show season, the U.S. Air Force Academy Parachute Team **Wings of Blue** was reported. Two frequencies were reported: air-to-ground jump coordination frequency on 121.950 MHz (AM) and 407.500 MHz (NBFM).

A possible frequency for the **Screaming Eagles** (101st Airborne Division) Parachute Team, based out of Fort Campbell, Kentucky, may have been monitored. That possible frequency is 44.200 MHz (NBFM). Further reports are requested.

And last, but not least, the colorful U.S. Navy Seal Parachute Team, known as the **Leap Frogs**, are frequent visitors around the country at various sporting events and air shows. This team has been regularly reported on 270.000 (AM) and 407.500 MHz (NBFM 131.8-Hz PL tone) nationwide over the last several years.

### GMRS Frequencies

During the 2001 and 2002 seasons I received several reports that the Golden Knights were using GMRS (General Mobile Radio Service) frequencies 462.625, 467.5625, and 467.6125 MHz. In addition to hearing air show demo crews, monitors have found vendors and other military ground units using GMRS frequencies. You should make these frequencies part of your scanner load-out prior to the air show.

A	B	C
462.550	467.550	462.5625
462.575	467.575	462.5875
462.600	467.600	462.6125
462.625	467.625	462.6375
462.650	467.650	462.6625
462.675	467.675	462.6875*
462.700	467.700	462.7125
462.725	467.725	
*(462.675/467.675 National Emergency Frequency pair)		

### Legend:

- A. Base station, Mobile relay, Fixed station, or Mobile station
- B. Mobile station, Control station, Fixed station operating in Duplex mode.
- C. Interstitial frequencies, base and portable simplex

### Family Radio Service/Intra-Squad Radio

We have also received several reports of the ground pyrotechnics personnel from the Tora **Tora Tora** and **Warbirds** flight demonstration team using FRS (Family Radio service) radios for communications during shows. You will also find military monitoring enthusiasts attending an air show using FRS radios to coordinate meeting fellow monitors. Load up FRS frequencies below (NBFM mode) in your scanner or carry an FRS radio to the show, and you might make a new Milcom monitoring friend or two.

462.5625 <Ch 1> 462.5875 <Ch 2>  
 462.6125 <Ch 3> 462.6375 <Ch 4>  
 462.6625 <Ch 5> 462.6875 <Ch 6>  
 462.7125 <Ch 7> 467.5625 <Ch 8>  
 467.5875 <Ch 9> 467.6125 <Ch 10>  
 467.6375 <Ch 11> 467.6625 <Ch 12>  
 467.6875 <Ch 13> 467.7125 <Ch 14>

The government version of the Family Radio Service is known as the Inter-Squad Radio or ISR. As noted above, I have seen several reports over the last few years that these radios might be in use at air shows by military units, including the Civil Air Patrol (CAP), see below. It might be a good idea to program these frequencies in your scanner as part of your air show load out.

396.8750 <Ch 1> 397.1250 <Ch 2>  
 397.1750 <Ch 3> 397.3750 <Ch 4>  
 397.4250 <Ch 5> 397.4750 <Ch 6>  
 397.5500 <Ch 7> 397.9500 <Ch 8>  
 398.0500 <Ch 9> 399.4250 <Ch 10>  
 399.4750 <Ch 11> 399.7250 <Ch 12>  
 399.9250 <Ch 13> 399.9750 <Ch 14>

### U.S. Civil Air Patrol Frequencies

Finally, you should program U.S. Air Force Civil Air Patrol frequencies in your scanner as well. We have received field reports of CAP frequencies (repeater and simplex) being used as ground support at several air shows.

The CAP was in the process of transiting to narrowband allocations/equipment during 2007. Though transition was to have been complete as of October 1, 2007, some regions encountered frequency conflicts. Therefore we have included both the old assignments as well as the new assignments (all found in the public domain).

### CAP Frequencies (variety of modes)

Old assignments:  
 143.750 143.900 148.125 148.1375  
 148.150 148.5375 148.975 149.5375  
 New assignments:  
 138.0125 140.6375 142.2250 143.7250

143.9000 148.1750 148.7750 150.1625  
150.5625 150.6375 MHz

## Civilian/Foreign Air/Parachute

### Demonstration Teams

The Canadian Forces **Snowbird** aircraft demonstration team (431 Air Demonstration Squadron) is another regular on the U.S./Canada air show circuit. The following frequencies have been recently reported for this popular aerial team: 123.325 227.600 242.600 243.400 245.500 245.750 246.500 272.100 (Primary) 284.900 299.500 333.300 340.100 MHz.

A new Snowbird VHF frequency has now been noted in use during the last three seasons: 116.000 MHz (AM); 243.400 and 272.100 are the only two UHF frequencies reported in 2005-7.

The Canadian Forces also have a CF-18 demonstration team. Last year Brian "Check your Six" Topolski in Connecticut passed along these possible frequencies for that team:

128.9750 129.0250 130.0750 245.5000  
263.5000 263.7000 264.6000 (East Ops)  
274.4500 285.9750 312.5500 (Air/Air)  
316.5500 333.3000 335.6000 340.2000  
(West Ops) 341.7000

At most air shows the military flight demonstration units aren't the only performers. Civilian organizations, companies, and individuals sponsor a wide variety of aerobatics teams and parachutists to thrill the crowd. Many different frequencies are used by these teams in the civilian aviation band. Load your scanner with the following frequencies and you shouldn't miss out on communications used by the civilian acts.

122.725 122.750 122.775 122.825  
122.850 122.875 122.925 122.950  
122.975 123.025 123.050 123.075  
123.150 123.175 123.300 123.325  
123.350 123.400 123.425 123.450  
123.475 123.500 129.650 129.925  
136.575 136.975

Some specific frequencies reported to us for other foreign military and US civilian flight demonstration teams are included in the list that follows:

### Civilian Flight Demonstration Teams

Aeroshell Aerobatics Team 123.150  
Aerostars CJ-6/YAK-52 Flight Formation Team  
118.700 122.775  
Air Force Reserve Biplane (Ed Hammil)  
123.150  
All American Firebirds Flight Demonstration  
Team 122.775  
American Four Jets Patriot 127.300  
Bud Light Air Force (ex- Coors Microjet)  
122.925 123.350 123.475  
Chapman/Mancuso Aerobatics  
136.975  
Civilian Air Show Discrete Common  
123.150  
Flight for Diabetes (Michael Hunter)  
123.425  
Firecat (Rich Perkins) 123.500  
Flying Colors Hang Glider Aerobatic (Dan  
Buchanan)  
123.300 123.450 132.950  
French Connection Air Show  
122.925 122.975 129.975

Geiko Extra 300 – Tim Webber  
123.150  
Ian Groom's FedEx Red Bull Aerobatic Team  
122.725 122.775 122.825 122.925  
123.150 123.350  
Iron Eagles Aerobatic Team  
122.925 123.150  
John Klatt 123.475  
Julie Clark's US of Air 118.700  
L39 Patriots 127.300  
Lima Lima Flight Team  
123.150 123.175 123.425 123.575  
Manfred Radius Glider Aerobatics Team  
123.150  
North American Jet Air Show Team  
122.775 122.925 129.650 129.925  
Northern Lights Aerobatic Team  
123.325 136.975  
Oreck Vacuum Cleaners Aerobatic Demo (Frank  
Ryder)  
122.825 123.425 123.450  
Otto the Helicopter 123.150 123.300  
Patty Wagstaff Air Shows Inc 1 2 2 . 7 5 0  
123.475  
Pitts Special U.S. Air Force Reserve  
123.150  
Rayban Gold Aerobatics Team  
122.925  
Red Baron Stearman Squadron  
122.725 122.775 123.150  
Red Bull Air Race-Michael Goulian  
135.075  
Red Eagles Flight Demo Team  
123.150 123.425 123.475  
Sean Tucker Power Aerobatics  
118.700 122.875 122.950 123.150  
123.450 123.475  
SIAI Marchetti SF260 Debbie Gary  
123.150  
Showcopters 123.150 134.700  
Sky Soldiers Demonstration Team (Army Aviation  
Foundation)  
118.700 123.025 234.500 242.400  
Skytypers Team  
122.750 122.775 (Diamond) 123.150  
123.425 123.450 (Solos)  
Swift Magic Aerobatic Team 1 2 2 . 7 7 5  
122.925  
Team Red 123.350  
Tora Tora Tora Warbirds Team (Commemora-  
tive Air Force)  
118.750 122.850 122.875 123.150  
123.450 469.500 469.550

### Foreign Military Flight Demonstration Teams

Asas de Portugal, Esquadra 103 (Wings  
of Portugal 103 Squadron) Flight Team  
262.150  
Blue Eagles Royal Army Air Corps Flight Team  
(UK) 136.975  
Blue Tango Helicopters 123.600  
Brazilian Air Force Team (Brazil)  
130.550 130.650 132.250  
Brazilian Smoke Squadron (Brazil)  
133.450  
British Army Red Devils Parachute Team (UK)  
462.625  
Canadian Forces Skyhawks Parachute Jump  
Team (Canada)  
123.000 294.700  
Falcons Royal Air Force Parachute Jump Team  
(UK) 255.100 465.100  
Frecce Tricolori Military Flight Team (Italy)  
123.475 (Ground Secondary)  
140.600 (Ground Primary)  
362.625 (Primary)  
263.250 (Secondary)  
Grasshopper Helicopter Team (Netherlands)  
281.100  
Halcones Military Flight Team (Chile)  
136.175  
La Patrouille Adecce Air Force Flight Team

(France)  
121.850 123.600 138.450 141.825  
143.100 143.850 242.650  
La Patrulla Aguila Military Flight Team (Spain)  
130.500 252.500  
Le Royal Jordanian Teams (Jordan)  
123.500  
Les Breitling (Switzerland) 127.350  
Les Iskry (Poland) 123.600  
Marche Verte [Green March] (Morocco)  
135.000 135.925 (Ground)  
135.500 (Air-to-Air)  
Military Stars Flight Team (Turkey)  
264.400 279.600  
Patrouille Suisse Military Flight Team (Switzer-  
land) 288.850  
Red Arrows Royal Air Force Flight Team (UK)  
242.200 242.050 243.450 253.450

## In Closing

It is always difficult to predict what a new season will bring, so I strongly encourage readers to watch my *Milcom Blogspot* (<http://mt.milcom.blogspot.com/>) and the *Monitoring Times* home page for any late breaking news and frequency information during the 2008 air show season.

If you attend an air show in 2008 and you find this list useful, please pass along any frequencies that you monitor, whether it is on this list or not. This will greatly aid in the production of next year's listing. You can reach me via e-mail at [larryvanhorn@monitoringtimes.com](mailto:larryvanhorn@monitoringtimes.com) or via our snail mail address: *MT Milcom*, 7540 Highway 64 West, Brasstown, NC 28902.

Finally, I would like to extend a sincere thanks to all of the contributors who took the time last year to share their post-show reports with us. I want to especially thank several overseas reporters who added new material to our foreign teams section. I deeply appreciate the time and effort each of you took to let us know what you have heard at many of the air shows in 2007.

Now, break out those scanners, plug in those frequencies, and get ready for the ride of a lifetime – a front row seat at the air show!

## Monitoring the Air Show Experience – Equipment and Schedules

Now that you know who are the crack military flight demonstration teams and where to find the frequencies they use for air-ground coordination and other communications, we turn to two other important considerations for successful monitoring: where and when you can find an air show in your area and what equipment is required to listen in.

### MT Air Show Equipment List

I am frequently asked which scanner I recommend for air show monitoring. While I don't have a favorite, I have prepared the list in Table 1 as a purchase guide of receivers that meet all the requirements as outlined below.

### Not Just Any Old Scanner Will Do

Some scanners currently being marketed and most older scanners on the used market are *not* suited for air show monitoring. There are certain requirements your air show radio has to meet in order to successfully monitor the two major military aerial demonstration teams – the



Blues and T-Birds.

If you are going to a Thunderbird show, you will need a scanner that can monitor the 138-150 MHz military land mobile band in the AM mode. Most of the older Uniden scanners cannot be used for air show monitoring due to their lack of independent transmission mode selection.

You also need a scanner that has the 225-400 MHz military aeronautical band in it. Most of the action (especially the Blues) will be heard in this military UHF portion of the spectrum. Adding this criterion to the mix of possible radios again narrows down our choice for air show scanners even further.

Information below includes current Grove

Enterprises stock codes/prices (if carried by Grove) for the items indicated, but the price does not include shipping or taxes (if applicable). Prices are subject to change without notice, so be sure to call the Grove order department at 800-438-8155 or visit the Grove website at [www.grove-ent.com](http://www.grove-ent.com) for current pricing.

#### Air Show Listening Tip

If you are going to use a handheld scanner at the air show, there is another purchase you should consider: an extra set of charged batteries. Murphy's Law applies here and nothing is worse than having your batteries die halfway through the show with no replacements.

## TABLE TWO: MILITARY DEMONSTRATION

### TEAMS

### 2008 PERFORMANCE SCHEDULE

Note: If security levels increase in a base to Threat Condition "Bravo" or above, many military installations will not have public air shows. Consequently, demonstration schedules listed below are subject to change or cancellation without notice. You can keep up with the latest schedules on our Milcom Monitoring Post Blog at <http://mt-milcom.blogspot.com/>.

#### Demonstration Group Abbreviations:

BA	US Navy Blue Angels
GK	US Army Golden Knights
SB	Canadian Forces Snowbirds
SW	US Army Silver Wings
TB	US Air Force Thunderbirds

#### Abbreviations

AFB	Air Force Base
ARB	Air Reserve Base
CFB	Canadian Forces Base
EAA	Experimental Aircraft Association
MCAS	Marine Corps Air Station
NAF	Naval Air Facility
NAS	Naval Air Station
TBD	To Be Determined

#### Dates

#### Group: Locations

Mar 8	BA: NAF El Centro, California - NAF El Centro 2008 Air Show
Mar13-16	GK: South Padre Island, Texas
Mar15-16	BA: Sacramento, California - California Capital AirShow TB: San Angelo, Texas
Mar 29	GK/TB: Tyndall AFB, Florida - Gulf Coast Salute 2008, Tyndall Air Force Base Air Show
Mar 29-30	BA: NAS Meridian, Mississippi - Wings Over Meridian 2008 SW: White Sands, New Mexico - Bataan Death March Commemoration
Apr 5	GK: Slidell, Louisiana SW: Columbus, Georgia - Columbus State University 50th Anniversary
Apr 5-6	BA: NAS Kingsville, Texas - Wings Over South Texas GK/TB: Punta Gorda, Florida - Florida International Airshow
Apr12-13	BA: Smyrna, Tennessee - The Great Tennessee Air Show TB: Lakeland, Florida - EAA Sun 'n Fun 2008
Apr 19-20	BA/GK: Peoria, Illinois - Prairie Air Show/River City Air Expo GK/TB: Wilmington, North Carolina - Coastal Carolina Airshow
Apr 26	GK: Jackson, Mississippi TB: Charleston AFB, South Carolina - Charleston Air Expo 2008
Apr 26-27	BA: Vidalia, Georgia - Vidalia Onion Festival Air Show
May 3-4	BA/GK/SB: Ft. Lauderdale, Florida - Fort Lauderdale Air & Sea Show GK/TB: March ARB, California - AirFest 2008
May 7	GK: Myrtle Beach, South Carolina SB: Anderson, South Carolina - Anderson Air Show
May 10-11	BA/GK/SW: Barksdale AFB, Louisiana - Defenders of Liberty Open House and Airshow TB: Langley AFB, Virginia

## TABLE ONE: MILITARY AIR SHOW CAPABLE RECEIVERS

Handheld Unit	Grove Stock No	Price
Alinco DJ-X3T	n/a	\$302.95
Alinco DJ-X7	SCN03	\$169.95
Alinco DJ-X10T	SCN01	\$319.95
Alinco DJ-X2000T	SCN10	\$499.95*
AOR AR-8200 Mk III	SCN51	\$579.95
AOR AR-8600 Mk IIB	RCV11	\$889.95
GRE PSR-300	n/a	\$214.99
GRE PSR-500	SCN18	\$499.95**
Icom IC R-3	SCN07	\$349.95**
Icom IC R-5	SCN02	\$199.95
Icom IC R-20	SCN20	\$509.95
Uniden BCD-396T	SCN47	\$499.95**
Yaesu VR-120D	n/a	\$249.00
Yaesu VR-500	n/a	\$370.00

\* This is a closeout price at Grove Enterprises

Base/Mobile Unit	Grove Stock No.	Price
AOR AR-5000A+3B	RCV44P	\$2569.95
AOR AR-8600 Mk II	SCN11	\$889.95
GRE PSR-400	n/a	\$214.99
GRE PSR-600	SCN19	\$499.95**
Uniden BCT-15	SCN15	\$229.95
Uniden BCD996T	SCN48	\$499.95**
Yaesu VR-5000	n/a	\$754.08

\*\* Includes APCO-digital/trunk capability

Computer Receivers	Grove Stock No.	Price
Icom PCR-1500	RCV15	\$499.95
Icom IC-R1500	RCV25	\$599.95
Icom PCR-2500	RCV35	\$729.95
Icom IC-R2500	RCV52	\$899.95
WinRadio WR-G305e	RCV63	\$619.95
WinRadio WR-G305i	RCV53	\$519.95
WinRadio WR-G305e/PD	RCV63P	\$719.95
WinRadio WR-G305i/PD	RCV53P	\$619.95
WinRadio WR-G315e	RCV64	Contact Grove for pricing
WinRadio WR-G315i	RCV54	Contact Grove for pricing
WinRadio WR-3150e	RCV48-E	\$1849.95
WinRadio WR-3150i-DSP	RCV48-I	\$1849.95
WinRadio WR-3500e	RCV49-E	\$2395.95
WinRadio WR-3500i-DSP	RCV49-I	\$2395.95
WinRadio WR-3700e	RCV50-E	\$2895.95
WinRadio WR-3700i-DSP	RCV50-I	\$2895.95

#### Professional Receiver Grove Stock No. Price

AOR AR-Alpha	Not available in a consumer version at presstime.	
AOR AR-One	Not available in a consumer version	
Icom R-9500	RCV27	\$13,500.00

#### Discontinued radios/scanners that are capable of air show monitoring

Alinco	DJ-X2T
AOR	AR-16B, AR-1000, AR-1500, AR-2515, AR-2700, AR-3000AB, AR-5000+3B, AR-7000B, AR-8000, AR-8200B, AR-8200 Mk-11B, AR-8600B
Icom	IC-R1, IC-R2, R3, R10, R100, R7000, R7100, PCR-100, PCR-1000
Kenwood	RZ-1
Radio Shack	Pro-2004, Pro-2005, Pro-2006, Pro-43
Uniden	BC-296, BR-330T, BC-796
WinRadio	WR-1000i/e, WR-1500i/e, WR-3000i-DSP, WR-3100i-DSP
Yaesu	VR-120

May 14	SB: Pittsburgh, Pennsylvania - Wings Over Pittsburgh SB: Duluth, Minnesota - Duluth Air Show	Jul 4-6	SW: Fort Dix, New Jersey - Ft Dix 4th of July Celebration TB: Battle Creek, Michigan - Battle Creek's Field of Flight Air Show & Balloon Festival	Sep 2	SB: Whitby, Ontario - Captain Michael VandenBos School Flypast
May 16-18	BA: Andrews AFB, Maryland - DoD Joint Services Open House	Jul 5-6	BA/GK: Traverse City, Michigan - National Cherry Festival	Sep 6-7	BA/GK: NAS Brunswick, Maine - The 2008 Great State of Maine Airshow
May 17-18	GK: Andrews AFB, Maryland - DoD Joint Services Open House GK/TB: Ft. Smith, Arkansas - Fort Smith Regional Airshow 2008	Jul 11	GK: Cape Girardeau, Missouri	Sep 10	GK/TB: Westover ARB, Massachusetts - Great New England Air Show
May 21	SB: Malmstrom AFB, Montana - Malstrom AFB Open House BA: US Naval Academy, Annapolis, Maryland SB: Cranbrook, British Columbia - Cranbrook Air Show	Jul 12-13	BA: Pensacola Beach, Florida - Pensacola Beach Air Show	Sep 12-13	SB: Halifax, Nova Scotia - Nova Scotia International Air Show
May 23	BA: US Naval Academy Fly-By, Annapolis, Maryland	Jul 16	TB: Milwaukee, Wisconsin - Milwaukee Air Expo	Sep 13-14	SB: Stephenville, Newfoundland - Stephenville Air Show
May 24	TB: Tinker AFB, Oklahoma - Star Spangled Salute	Jul 19	SB: Thompson, Manitoba - Thompson Air Show	Sep 14	TB: Reno, Nevada - US National Championship Air Races
May 24-25	BA/GK: Jones Beach, New York - New York Air Show GK/SB: Janesville, Wisconsin - Janesville Air Show	Jul 19-20	SB: Yellowknife, North West Territories - Yellowknife International Air Show	Sep 20-21	BA/GK: Eau Claire, Wisconsin - Chippewa Valley Airshow
May 28	TB: U.S. Air Force Academy, Colorado. (Invitation Only)	Jul 20	BA: Duluth, Minnesota - Duluth Airshow	Sep 21	TB: Mountain Home, Idaho - 2008 Mountain Home Air Force Base Air Show
May 31	SB: Portage-la-Prairie, Manitoba - 17 Wing Armed Forces Day	Jul 23	GK: Gary, Indiana TB: McChord AFB, Washington - McChord Air Expo 2008	Sep 22	BA: NAS Oceana, Virginia - NAS Oceana Airshow
May 31-Jun 1	TB: McGuire AFB, New Jersey - McGuire/Fort Dix/Lakehurst Joint Base Open House 2008	Jul 26-27	SB: Edmonton, Alberta - Edmonton Grand Prix Flypast	Sep 24	GK: Midland, Texas SB: Victoria, British Columbia - Victoria Air Show
Jun 1	GK: Danville, Virginia SB: Brandon, Manitoba - Westman Air Show	Jul 30	SB: Prince George, Alberta - Prince George Air Show	Sep 27-28	TB: Scott AFB, Illinois - Scott Air Force Base Open House
Jun 4	SB: Kapuskasing, Ontario - Kapuskasing Air Show	Aug 2-3	TB: Cheyenne, Wyoming BA: Twin Falls, Idaho - Air Magic Valley 2008	Sep 21	GK: Dover, Delaware (NASCAR Sprint Cup Race)
Jun 7-8	BA/GK: MCAS Cherry Point, North Carolina - MCAS Cherry Point 2008 Open House and Air Show	Aug 3	GK: Helena, Montana SB: Wetaskiwin, Alberta - Wetaskiwin Air Show	Sep 24	SB: Tri-Cities, Washington - Tri-Cities Air Show
Jun 10	SB: Montreal, Quebec - Formula 1 Race TB: Rockford, Illinois - 3rd Annual Rockford Air Show	Aug 6	GK/TB: Rochester, New York - Rochester International Air Show 2008	Sep 27-28	BA: Grand Junction, Colorado - Air Show Western Colorado 2008
Jun 14	SB: Magog, Quebec - Magog Fly-past	Aug 8-10	SB: White Rock, British Columbia - Wings Over White Rock	Oct 1	GK: Parkersburg, West Virginia SB: Chico, California - Chico Air Show
Jun 14-15	BA/SB/TB: Quebec City, Quebec Canada - 400th Anniversary of Quebec	Aug 13	BA: Seattle, Washington - Seafair Airshow	Oct 4	TB: Salinas, California
Jun 18	SB: Kingston, Ontario - Kingston Air Show	Aug 16	SB: Dawson Creek, British Columbia - Dawson Creek Air Show	Oct 4-5	SB: Douglas, Arizona - Douglas Air Show
Jun 21	TB: Klamath Falls, Oregon - Klamath Falls Air Show 2008	Aug 16-17	SB: Penticton, British Columbia - Penticton Air Show	Oct 11-12	TB: Vance AFB, Oklahoma BA/GK: MCAS Miramar, California - Marine Corps Air Station Miramar Air Show
Jun 21-22	BA/GK: Davenport, Iowa - Quad City Air Show -A Festival in the Sky	Aug 22	BA: Fairchild AFB, Washington - Skyfest 2008	Oct 11-12	GK/SB: El Paso, Texas - Amigo Air Sho
Jun 24	GK: Sioux City, Iowa SB: CFB Borden, Ontario - Canadian Force Base Borden	Aug 23	SB/TB: Abbotsford, British Columbia Canada - Abbotsford International Airshow	Oct 17	BA/SB: San Francisco, California - San Francisco Fleet Week
Jun 25	TB: Eielson AFB, Alaska	Aug 23-24	SB: Rocky Mountain House, British Columbia - Rocky Mountain House Air Show	Oct 18-19	GK: West Chester, Pennsylvania GK/TB: Ft. Worth (Alliance), Texas - Fort Worth Alliance Air Show
Jun 27-28	SB: Goderich, Ontario - Goderich Air Show	Aug 27	SB: Springbank, Alberta - Springbank Air Show	Oct 17	SB: CFB Moose Jaw, Saskatchewan - End of Year Show
Jun 28-29	TB: Elmendorf AFB, Alaska - Arctic Thunder 2008	Aug 30-31	BA/GK: Chicago, Illinois - 50th Annual Chicago Air and Water Show	Oct 18-19	BA/GK: Little Rock AFB, Arkansas - Little Rock Air Force Base 2008 AirPower Arkansas Air Show
Jul 1	BA/GK: Huntsville, Alabama - Huntsville International Airshow 2008	Aug 30-Sep 1	GK Yankton, South Dakota TB: Offutt AFB, Nebraska - 2008 Offutt AFB Open House and Air Show	Oct 25-26	GK: Huntington Beach, California TB: Dobbins ARB, Georgia BA: NAS Jacksonville, Florida - 2008 NAS Jacksonville Air Show
Jul 3	GK: Evansville, Indiana SB: Ottawa, Ontario - Ottawa Air Show	Aug 30-Sep 1	GK/TB: Atlantic City, New Jersey - 2008 Atlantic City "Thunder Over the Boardwalk" Airshow	Nov 1-2	TB: Houston, Texas - Wings Over Houston Airshow
Jul 4	SB: Ottawa, Ontario - Canada Day Flypast	Aug 30-Sep 1	SW: Lawton, Oklahoma - Cameron University 100th Anniversary	Nov 8-9	BA/GK: Lackland AFB, Texas - Airfest 2008
	GK: Dubuque, Iowa		SB: Moose Jaw, Saskatchewan - 15 Wing Armed Forces Day	Nov 14-15	GK/TB: Lafayette, Louisiana BA: Kennedy Space Center (Shuttle Landing Facility), Florida - World Space Expo - Celebrating NASA's 50th Anniversary
	SB: Calgary, Manitoba - Calgary Stampede Flypast		GK/TB: Kansas City, Missouri - KC Aviation Expo and Airshow		TB: Nellis AFB, Nevada - Aviation Nation 2008
			GK: Indianapolis, Indiana SB: Welland, Ontario - Welland Air Show		BA: NAS Pensacola, Florida - Naval Air Station Pensacola Open House and Blue Angel Homecoming Air Show



# Monitoring Chicagoland's Airports

By Bruce Ames & Dennis Biagioli

Chicago is an aviation monitor's delight. Two major airports – O'Hare and Midway – and numerous other municipal fields offer a wide and diverse aviation monitoring experience. Unleash your scanners and communication receivers for a comprehensive look into the aviation structure of the second largest city in the United States.

## A Little Background History

The namesake of Chicago's premiere aviation facility – O'Hare International Airport (ORD) – is Navy Lt. Cmdr. Edward "Butch" O'Hare, who was awarded the Congressional Medal of Honor in 1942. President Franklin D. Roosevelt termed O'Hare's mission that saved the carrier *U.S.S. Lexington* (CV-2) from enemy bombers "one of the most daring, if not the most daring, single action in the history of combat aviation."

On 20 February 1942, the *U.S.S. Lexington* was approximately 400 miles away from its destination of Rabaul Harbor in the Solomon Islands when the aircraft carrier was spotted by enemy patrols. O'Hare and his wingman picked up the formation of enemy fighters. When O'Hare's

wingman's guns jammed, the intrepid Naval aviator was forced to fight the battle alone. In just a matter of minutes, O'Hare "executed a swift and decisive attack on enemy fighters and saved the *U.S.S. Lexington*."

Later on during the war, Lt. Cmdr O'Hare's plane was lost in enemy action in the vicinity of Tarawa Atoll and was declared missing in action. One year later, on 27 November 1944, he was declared dead. On many occasions, O'Hare risked his life and went above and beyond the call of duty in the many missions he flew.

Long after the war, another facet of his wartime dedication was revealed: O'Hare originally enlisted, not only due to a patriotic desire, but to right the many wrongs that he felt his father caused in an earlier generation. His father was apparently a notorious lawyer for the Chicago mob during the era of prohibition, specifically for the most famous Chicago gangster of the period – Alphonse "Big Al" Capone.

## From Orchard to O'Hare

During World War II, the Douglas C-54 was built at a factory on the current site of ORD. This aircraft was the largest US troop and cargo carrying airplane at the time. This base was known as Orchard Field and was used almost entirely by the military.

Following the war, Chicago became the world's busiest civil aviation operation (although it was the city's municipal airport – today's Midway International Airport – that held the title). The city council at the time saw a huge potential for post-war air travel and decided that a second major facility was required. In 1946, the city purchased Orchard Field from the U.S. government, along with 7,000 adjacent acres. Three years later, more land would be acquired and Orchard Field was renamed O'Hare in honor of the city's young war hero.

A little known piece of O'Hare trivia happened in 1952 when the airport was transitioning from a military field to a commercial airport. Two Vought F7U-1 Cutlass (known by all that flew them as the "Gutless Cutlass") aircraft, flown by the elite U.S. Navy Blue Angels pilots LCdr E.L. Feightner and Lt. Harding MacKnight, were approaching NAS Glenview. Feightner's ship lost an engine and prepared for a no waveoff landing. As he looked over his shoulder, he saw his wingman MacKnight's Cutlass was inverted and on fire. Two simultaneous emergencies! MacKnight had a double

engine failure but he recovered by split-essing to a landing at Glenview. He abandoned his aircraft before the now blazing Cutlass quit rolling.

Air traffic control directed Feightner to O'Hare which was not yet open for traffic. Feightner's ship recovered amid peach baskets (remember, O'Hare was known at the time as Orchard Field) that were strewn about the runway to prevent landings. This is the story behind the Blue Angels logging the first ever landing at what is now O'Hare International Airport.

The airport was officially opened to domestic commercial flights in 1955, but Midway was still the major Chicago airport. In 1959, its busiest year, Midway handled ten million passengers compared to O'Hare's two million. But, by 1962 all scheduled operations had been transferred from Midway to O'Hare. O'Hare's airport code used on tickets and baggage tags is ORD (Orchard). A sense of history still remains.

Prior to 2005, O'Hare was the world's busiest airport in terms of takeoffs and landings. But in 2005, due to limits imposed by the federal government to reduce flight delays, Hartsfield-Jackson Atlanta International Airport (ATL) became the busiest. ORD is the second busiest airport in the United States in terms of traffic, and the second in the world with 76,248,911 passengers passing through the airport in 2006.

ORD currently has flights to more than 60 foreign destinations. In 2005, O'Hare was ranked fourth of the United States' international gateways, with only JFK (John F. Kennedy International Airport in New York City), LAX (Los Angeles International Airport), and MIA (Miami International Airport) serving more foreign destinations.

## O'Hare Left-Right Flip-Flop

On 5 July 2007, former runway 9R-27L was renamed Rwy 10-28. On 30 August, existing runway 9L-27R was renamed 9R-27L. November 2008 will see the new north runway 9L-27R commissioned.

By the end of 2011, ORD will have four parallel east-west runways, two on the north side of the main terminal area and two on the south side of the field. In the future, all runways north of the terminal complex will be referred to as 9-27 Runways and all runways south of the terminals will be 10-28 Runways. The two north side runways will be named 9L-27R and 9R-27L, and the south side runways will be named 10L-28R and 10R-28L.



## Business Travel

Put your scanners into "search" mode. Numerous local corporations are keeping their movements and frequencies off of the flight tracking sites. Therefore we are not listing them and perhaps driving more underground. DuPage is the corporate field for Sears, Menards, Ty (Beanie Babies toys), ConAgra and McDonalds. Gary is the base for Boeing Corporate Flight Operations.

## O'Hare International (ORD)

### O'HARE TERMINALS

Airline	Terminal
Aer Lingus	International (Five)
Air Canada	Two
Air Canada Jazz	Two
Air France	Five
Air India	Five
Air Jamaica	Five
Alaska Airlines	Three
Alitalia	Five
All Nippon	One & Five
American airlines	Three - Domestic & Intl Departure
	Five - International Arrivals
American Eagle	Three
America West	Two
Asiana Airlines	Five
Austrian Airlines	Five
British Airways	Five
BMI British Midland	Five
Cayman Airways	Five
Continental Airlines	Two
Delta Airlines	Three
El Al	Five
Iberia Airlines	Three - Departures Only
	Five - Arrivals Only
Japan Airlines	Five
Jet Blue	Two
KLM	Five
Korean Air	Five
LOT Polish Airlines	Five
Lufthansa	One - Departures Only
	Five - Arrivals Only
Mexicana	Five
Northwest Airlines	Two
Pakistan International	Five
Royal Jordanian	Five
SAS (Scandinavian Airlines)	Five
Spirit Airlines	Three
Swiss	Five
TACA Airlines	Five
Ted	One
Turkish	Five
United Airlines	One - Domestic & Intl. Departures
	Two
	Five - International Arrivals
United Express	One & Two
US Airways	Two
USA 3000	Five
Virgin Atlantic	Five

### FREQUENCIES

ALCP*	252.100
Approach	119.000(360-179)
	128.450(180-359)
	284.000(180-359)
	393.100(360-179)
	121.15 124.350
	125.700(180-359)
ASOS** - Dupage	124.800

ph630-584-2728  
ph 773-462-0118

ASOS - Midway	132.750	ph 773-581-8094
ASOS - ORD		ph 773-462-0118
ASOS - Palwaukee	124.200	ph 847-465-0291
ATIS	135.400 269.9	ph 773-601-8921
Class B	120.550(north)	
	128.450(180-359)	
	133.5(south)	
	284.000(180-359)	
	290.200(north)	
	371.900(south)	
	134.400	
Class B IC	119.000(360-179)	
	393.100(360-179)	
Clearance	121.600 119.250	
Departure:	125.000(340-159)	
	125.400(220-339)	
	127.400(160-219)	
Emergency Ground	121.500 243.000	
	121.675	
	121.750 (outbound)	
	121.900(inbound)	
	348.600	
IC	126.900(north)	
Metering	121.675	
PTC/P	121.600	
PTC/S	119.250	
Tower	120.750 (south)	
	126.900(north)	
	127.925	
	132.700	
	390.900	
	269.500(160-219)	
)	307.200(220-339)	
	337.400(340-159)	
Unicom	122.950	
VFR Advisory	126.800	
* ALCP - Air Logistics Command Post		
** ASOS - Automated Surface Observing System		

### Company Frequencies

Korean Air Cargo and others - O'Hare North Cargo ops	122.950
American Eagle ("Eagle Flight") - Outbound flight ops	128.850
Signature Air Services (FBO)	128.925
United and United Express - Maintenance	128.950
Delta - pre-taxi clearance, "Pushback"	129.200
American - K & L-Branch Maintenance	129.225
United - Hangar Line and Maintenance Line control	129.300
American - H-Branch Maintenance ("Hotel Maintenance")	129.325
United Parcel Service - Ops	129.425
Delta - "Atlanta Dispatch"	129.500
KLM - KLM Ops	129.750
US Air - Ops	129.800
Evergreen Operations (ground services)	129.850
American - Hangar Maintenance	129.875
Alitalia - Ops	129.900
Continental and Continental Express ("Chautauqua")-Ops	129.925
SkyWest Aviation (United Express) - Ops	130.150
Mesa Aviation ("Air Shuttle") (United Express) - Ops	130.200
American - "Fi Worth Dispatch" link	130.250
Northwest - Ops	130.275
Mexicana - Ops	130.325
Gateway ("Go Jet")	130.500
Shuttle America ("Mercury")	130.500
TransWorld Express ("Water Ski") - Ops	130.500
DHL Cargo - Ops	130.550
American - Closeout and Load Control	130.650
American - Changeover and Crew Coordination (sometimes carries simulcasting of 131.875)	130.750
Northwest Cargo - Ops	130.900
United - "Chicago Dispatch"	131.050
British Airways ("Speedbird") - Ops	131.100
Delta - "Atlanta Dispatch" link at O'Hare	131.225
Polar Air Cargo, Martin Air & others - "South Cargo" ramp ops	131.225
United - Security, Passenger Services and Planning	131.400
America West ("Cactus") - Ops	131.500
American Trans Air ("Am Tran") - Charter Ops (no regular service to O'Hare)	131.525
American Eagle - Dispatch and Maintenance (airborne)	131.600
American Eagle - Maintenance (aircraft on the ground)	131.625
American Eagle - Inbound Flight Ops	131.825
Federal Express ("Fed Ex") - Ops	131.925
American Eagle - Deicing and Operations Manager	131.975

### ARINC (Aeronautical Radio Incorporated) enroute frequencies

129.350 (transmitter at O'Hare)
129.400 (transmitter at O'Hare)
129.450 (transmitter at O'Hare)
131.300
131.650
131.800

Note to monitors: The frequencies we used to call ARINC (Aviation Radio Inc.) are now being licensed to ASRI - Aviation Spectrum Resources, Inc. (www.asri.aero/). They have the same mailing address as ARINC (Annapolis, MD).

### O'Hare Gate/Ramp Frequencies

Terminal 1	
All Bravo gates	131.300
Odd-numbered (east) Charlie gates	130.150
Even-numbered (west) Charlie gates	29.075
Terminal 2	
All even-numbered plus E-1 (west) Echo gates (shared with Terminal 1 Bravo gates)	131.300
Odd-numbered Echo gates, all Foxrot gates and even-numbered (west) Golf gates ("Foxrot Alley Ramp")	30.375
Odd-numbered (east) Golf gates and even-numbered (west) Hotel gates	128.975
Odd-numbered Hotel and Even-numbered (east) Kilo gates (except K2 & K-4) ("Hotel-Kilo "Y" Ramp")	129.675
Kilo (north) odd-numbered gates, K-2 and K-4, even-numbered (south) Lima gates in Terminal 3	131.875
Terminal 3	
Lima (south) even-numbered gates	131.875
Lima (north) odd-numbered gates	129.600
Terminal 5 (International Terminal)	
All gates (frequency referred to as "International Ramp Control")	129.050

## Midway International Airport (MDW)

### MIDWAY CONCOURSES

Airline	Concourse
Air Tran	A
Air Midwest	A
ATA	B
ComAir	A
Continental Airlines	C
Delta Airlines	A
Frontier Airlines	A
Northwest Airlines	A
Southwest Airlines	A & B

### FREQUENCIES

App/Dep	118.400	119.350	126.050	127.875	133.500
ATIS	132.750				
Class C Rdr	119.450				
Clearance	121.850				
Ground	121.650				
Helo Tower/Class C	135.200				
Tower	118.700				

### "Company" Frequencies

Air Tran	Ops	130.050
ATA	Dispatch	129.425
	Ops	130.975
Continental Airlines/CO Express		131.200
	Ops	131.025
Delta Airlines (Atlantic Southeast, ComAir)		131.225
	Ops	130.825
Frontier		130.275
Northwest Airlines		130.675
	Dispatch & Maint.	130.675
	Ops	130.675
	Minneapolis Dispatch	131.475
	Ops	129.275
	Dispatch	130.125
Signature Flight Support		122.950
		128.925
Atlantic Aviation		131.425
Million Air Chicago		130.950



## MAJOR FEEDER & RELIEVER AIRPORTS

Usage	Executive (PWK)	Dupage (DPA)	Waukegan (UGN)	Aurora (ARR)	Gary (GYG)
Approach	120.550	133.500	120.550	133.500	133.100
125.500					
ATIS/ASOS	124.200	124.800	132.400	125.850	120.625
Clearance	124.700	119.750		121.700	
CTAF	119.900		120.050	120.600	125.600
Departure	120.550	133.500	120.550	133.500	133.100
125.500					
Ground	121.700	121.800	121.650	121.700	121.900
Emergency			121.500		
Tower	119.900	120.900	120.050	120.600	125.600
124.500					
257.800					
Unicom	122.950	122.950	122.950	122.950	

## ARTCC – Chicago Center Frequencies

City	Frequency	Usage – Altitude Sectors
Chicago Center (ZAU)	125.200	Low
	127.800	Low
Aurora	123.750	Low (Discrete)
	354.000	Low (Discrete)
Burlington	135.600	Low (Discrete)
	316.100	Low (Discrete)
Chicago Heights	132.950	Low (Discrete)
	272.700	Low (Discrete)
Crown Point	127.800	Low
	387.050	Low
Danville	135.750	Low (Discrete)
	353.950	Low (Discrete)
Des Plaines	120.350	Low (Discrete)
	128.650	Low
	133.200	Low
	298.900	Low
	317.400	Low (Discrete)
	360.800	Low
Downers Grove	127.600	Low
	135.750	Low
	338.300	Low
	363.200	Low
	364.800	High
Dubuque	125.225	High
	127.775	High
	133.950	Low (Discrete)
	281.400	Low (Discrete)
	285.500	High
	343.600	High
Fort Wayne	119.850	Low (Discrete)
	126.325	High
	269.100	High
	362.300	Low (Discrete)
Goshen	127.550	Low (Discrete)
	133.900	Low
	135.900	Low
	263.100	Low (Discrete)
	317.600	Low
Grand Rapids	126.125	High
	134.950	Low (Discrete)
	287.900	Low (Discrete)
	319.100	Low
Hampshire	133.350	Low (Discrete)
	134.200	Low
	348.700	Low
	381.400	Low (Discrete)
Horicon	132.225	Low
	132.750	Low
	135.550	Low
	263.000	Low
	327.800	Low
	343.900	Low
Jones	120.225	High
	125.975	High
	254.300	High
	269.350	High
Kankakee	118.225	High
	120.125	Low
	132.500	Low
	256.800	Low
	258.100	Low

Lafayette	123.850	Low (Discrete)
	393.000	Low (Discrete)
Leroy	119.225	Low
	307.250	Low
Lone Rock	133.300	Low (Discrete)
	380.350	Low (Discrete)
Maple Park	127.075	Low (Discrete)
	299.700	Low (Discrete)
Milford	120.175	Low
	125.050	Low
	127.450	Low
	132.500	High
	135.400	High
	284.700	Low
	353.800	High
	377.200	High
Milwaukee	123.825	Low
	125.100	Low (Discrete)
	134.750	Low
	291.700	Low
	323.100	Low
	360.600	Low
	364.800	Low
Moline	118.750	Low
	135.825	High
	351.700	Low
	385.650	High
Monee	133.425	High
	360.750	High
Muskegon	132.275	High
	254.350	High
Oshkosh	127.000	Low (Discrete)
	132.100	Low
	319.250	Low
	387.100	Low (Discrete)
Pullman	128.500	Low (Discrete)
	269.600	Low (Discrete)
Rockford	120.375	High
	279.650	High
Rossville	120.975	High
	125.375	Low (Discrete)
	343.950	High
	350.350	High (Discrete)
	370.850	Low (Discrete)
South Bend	135.350	High (Discrete)
	273.600	High (Discrete)
Volk Field	125.050	Low
	269.650	Low

During periods of bad weather or factors that limit traffic into Chicago, aircraft will normally be diverted to one of three major airports – Milwaukee or Madison (WI) or Indianapolis (IN).

There you have it: one of the most comprehensive and updated views into aviation monitoring in Chicago. Due to space concerns, we have purposely left out the myriad of trunking systems employed at the airports. That is best left for another story.

Happy Monitoring!

### About the Authors

**Bruce Ames:** Prior to retirement, Bruce Ames was a very frequent business traveler to Chicago for over twenty-five years. He is a former feature and column writer for RCMA, *Scanning USA* and was Vice President and newsmagazine Editor for (San Francisco) Bay Area Scanner Enthusiasts (BASE). He currently is a moderator on the Internet user group - Scan Fresno. He is a licensed amateur radio operator KE6HPK and GMRS as KAE9222.

**Dennis Biagioli:** Denny, as he is known to his friends, is a retired music educator and since 1980 has been licensed amateur radio operator KE9VG. For thirteen years he was the federal government and military editor for the Radio Communications Monitoring Association's RCMA *Journal*. He also held a similar position for several years with *Scanning USA* and was aviation editor for the All Ohio Scanner Club's American Scannergram publication. He has lived within direct monitoring distance of Chicago's O'Hare International Airport since 1975.

# High Flying Hams In The Air and On The Air

By Ken Reitz KS4ZR

The first time I ever worked a ham who was operating aeronautical mobile, he was in the gondola of a hot air balloon 400 feet over Albuquerque, NM. Running just four watts into a wire antenna hanging down below the gondola, KF5OW put out a very big signal on 10 meters and was working a pile-up as if he were rare DX. Since then I've been on the lookout for hams who spend their time in the air and on the air, and over the years I've found some remarkable stories.

## Top Aviation Job

Picture yourself in the cockpit of a private jet over the Atlantic Ocean at 47,000 feet with time on your hands. What to do? Why not fire up the built-in, frequency-agile, Rockwell Collins HF rig and work the ensuing pile-up?! That's just what Rick Dougherty, NQ4I of Griffin, Georgia, does routinely as part of his job.

Rick has one of the premiere jobs in avia-

tion as Chief Pilot on a Gulfstream G-V, a 19 passenger craft with one of the longest ranges in its class, up to 6,500 nautical miles (about 15 hours of flight time). That's enough to get you from New York to Tokyo or Los Angeles to Auckland, New Zealand.

According to Rick, the GV cruises at Mach .85, over 600 mph, and can fly up to 51,000 feet. Rick says when the tanks are full, the GV holds 6,000 gallons (20.25 tons) of fuel which, at \$4 gallon, works out to \$24,000 per fill up. With an operating cost of \$5,000/hour, the GV is strictly for Fortune 500 companies and A-list celebrities.

Rick got his start in aviation while a junior in high school. He explains, "By the time I graduated from college I had nearly 2,000 hours, a multi-engine rating, and a commercial license." Rick attended USAF pilot training and went on to fly the F-100 Super Sabre jet fighter, the F4 Phantom II and the F-16 Fighting Falcon during 22 years in the Air National Guard.

"I flew full time for Eastern Airlines for 12 years until they went out of business, then flew another 2 years for Express One International Airlines, and made the transition to corporate aviation in 1994 ... I have been employed the past 11 years by NetJets International, a fractional ownership program that is owned by Warren Buffet's Berkshire Hathaway Company." During that period Rick has flown all the Gulfstream models, including the GII, GIII, GIV, GV and the latest versions, the G450 and G550. He says, "I have over 23,000 hours of flight time in world wide operations from every quadrant of the world ... I am as at home in China as the New England states."

Rick says, "I've made thousands of QSOs from the plane over nearly 12 years ... DXing from 47,000 feet can be fun at times and also frustrating ... I'm not using enough power to break the pileups ... The antenna height makes for some wonderful DXing, though."

Of his on-board HF gear he says the Rockwell Collins rig runs 200 watts PEP and "...they are not very easy to tune the band with ... but if you know where you want to plop down, then they are fine. The antenna is a small wire that is encased in fiberglass on the leading edge of the vertical tail. It's 7 feet or 2 meters in length. There is an antenna tuner in the non-pressurized

tail compartment that matches the antenna for the frequency used."

He says the rig does not interfere with any other avionics. "We have two complete HF systems, but can only use one at a time. The rig will operate on any frequency from 2 to 30 MHz. I have never operated on any of the VHF or UHF bands, I guess if I carried a hand-held I could, but 80% of my flying is over water and who would I talk to?"

At his home QTH in Georgia, Rick has built a world class ham station. There's no doubt that if he wants to be heard on any band at any time he can. He has 9 towers spread over his 13 acres, sporting some 22 Yagi antennas for all bands from 160-10 meters. He even has a 3-element 80 meter Yagi at 175 feet. His home station has 11 operating positions, two stations on each band (though only one on 160 meters). Rigs include Yaesu FT-1000D's and FT-1000MP's with Alpha and Henry linear amplifiers.

## Air Photographer/Ham Operator

Last year I was monitoring 21.070 MHz, the BPSK31 digital mode frequency on 15 meters. There had been very little traffic on the frequency for some time when a fairly strong signal came up, causing the characteristic PSK whine to come out of the speaker. I pulled up the HamScope screen on my computer, clicked on the signal spike showing on the spectrum display, and saw the CQ call of N4GVA/AM. I was amazed to see that the station calling was in fact in the air at 9,000 feet over the Turks and Caicos Islands, a small island group southeast of the Bahamas and due north of the island of Hispanola.

Scott Keating, who is N4GVA, runs his own aero photography business ([www.aerog.com](http://www.aerog.com)) from his twin engine Cessna 310H. He's been around aviation and ham radio all his life. He explains, "[I] soloed when I was 16, been flying pretty much ever since, I'm 38 now. Learned to fly in a 1947 Cessna 140 and got my private pilot's license in a Cessna 152. I've also got a good amount of time in Beechcraft Bonanzas, Piper Cubs, Cessna 310s and Piper Navajos, [I've] flown all over the country, the



QSL card from NQ4I/AM, Rick Dougherty features the Gulfstream G-V he pilots the world over. (Courtesy: Rick Dougherty)





**QSL card from Scott Keating, N4GVA, featuring his Cessna 310H aerial photo plane over Matanzas Inlet, FL. (Courtesy: Scott Keating)**



**Charlie Gyenes, W6HIQ, of Hi-Q Antennas with his Glastar TD plane/aeronautical test bed. (Courtesy: Hi-Q Antennas)**

Bahamas, South America, and the Southeastern U.S.”

Scott also started early in ham radio. “I got my first ham ticket, tech class, with my original callsign N4GVA, when I was 13, 25 years ago. CW was always my favorite mode, but I really enjoy RTTY and the newer modes like PSK, especially in the airplane.”



**N4GVA's on-board digital station consisting of a Yaesu FT-747GX with a data/mic switch box and aviation headset interface for voice. (Courtesy: Scott Keating)**

He says, “DX in the airplane hasn’t proven to be as spectacular as I thought it would be. From the air around Florida I’ve worked quite a few European countries and Japan. Propagation seems to change quite a bit depending on the altitude we’re at.” Scott typically flies from a few thousand to 9,000 feet. He says, “I’ve run 15 and 20 meters from the airplane and I use the wire ADF (Automatic Direction Finding) antenna on the top of the airplane. We tried a short trailing-wire antenna once, but on 20 meters the performance wasn’t much different.”

## The Ham Who Couldn’t Retire

Charlie Gyenes, W6HIQ, left his native Hungary after the revolution in 1957. But before he left he had soloed in a glider at age 13 (he says he had to lie about his age in order to do it). The family then made it to Canada where he flew very little but did get his first ham ticket, VE7BOC. He says, “I got on 2 meters with an old Motorola VHF mobile, it was a two piece

dyno-powered unit approximately 80 pounds in the trunk.”

By 1965 he had made it to the U.S. and joined NCR as a manufacturing engineer. Later, he started his own company making glider avionics. He says, “I got into the glider and sport aircraft importation/distribution business ... All this time ham radio is the second best hobby of mine next to flying. My two sons and my wife are all pilots.”



By 1980 he was out of the glider import business and took a marketing job at McDonnell Douglas Aircraft. But then “...a very attractive position came up at Gulfstream Aircraft, marketing the G-IV Business jets in Europe ... Later McDonnell Douglas lured me [back] to set up a marketing base in Budapest Hungary for the FA-18 fighter aircraft and later all of the Boeing Aircraft products.” Charlie had come full circle.

He retired six years ago as Managing Director of Boeing Aerospace Hungary. Now he has plenty of time for hamming and designing mobile antennas. He first started aeronautical mobile in a Glastar. “It was a fun aircraft to fly and, being a ham, I wanted to take advantage

of the elevated HF antenna to communicate in a real DX mode. I remember my first contact was an LU (Argentina) followed by some ZL’s (New Zealand) and VK’s (Australia). One thing that was annoying was the engine/prop and air-rush noise. That was improved with a headset with noise canceling mike for the Icom 706MKII. Now I fly my Ogar motor-glider and when the engine is off and soaring it is nice and quiet.”

While Charlie claims to be retired, he is still active in his business, Hi-Q Antennas ([www.hiqantennas.com](http://www.hiqantennas.com)) where he designs and manufactures mobile antennas for amateur and military applications. One of his latest projects was designing underwater antennas for special operations for the U.S. Navy. Some retirement!

## Tuning in Aeronautical Mobile Hams

There are no set frequencies for Aeronautical Mobile operations. I’ve run into several hams operating /AM by chance alone.

Rick Dougherty, NQ4I/AM says when he’s in the air he can be found on 14.200, 21.260, and 28.480 MHz. On 80 meters you can find him on 3.799 MHz. If you work Rick, you can receive his QSL card if you send an SASE via his manager K4PK, Don Aldridge, whose address you’ll find on [QRZ.com](http://QRZ.com).

Scott Keating, N4GVA is active on the digital modes and can be found on 14.070 or 21.070 in PSK31. You can contact him directly via [QRZ.com](http://QRZ.com) for a QSL but asks that you include an SASE with your report.

Charlie Gyenes says he’s found almost daily on 14.185 MHz + or – a few kHz.

For the rest of us earthbound mortals, there’s a great fascination with hams who are aeronautical mobile. We envy the skill it takes to fly those planes and the breathtaking views they see. In our minds it’s easy to imagine Scott, N4GVA, flying over the Caribbean Sea at 9,000 feet working DX on his keyboard in digital mode and looking out for traffic in the air thick with building cumulonimbus clouds. Or, Rick, who’s flying so fast that his signal comes and goes more like a Low Earth Orbit satellite and so high that all the clouds are below him.



# Is Aircraft Monitoring for You?

By Iden Rogers

**A**ircraft listening is quite different from listening to police and fire calls. Air Traffic Control communications use quite a different language. Aircraft operate in three dimensions, use lots of navigational terms, and change frequencies often during flights. Although most are not responding to emergencies, note that there are law enforcement and firefighting agents, news and traffic services, search and rescue, and medical airlift aircraft out there, all doing their jobs.

Most of the same publications and aeronautical charts that are intended for pilots and controllers are available to hobby listeners. Some radio hobbyists really enjoy learning all the various details that make it all understandable.

If this subject is mostly unfamiliar to you, let's take a brief look.

## VHF / UHF Aero Bands

The VHF aircraft band spans 118-137 MHz. This band is occupied mostly by civilian aircraft,

but military aircraft can and do appear there, too. Each frequency is allocated for a specific use. This website, [www.jneuhaus.com/fccindex/aviation.html](http://www.jneuhaus.com/fccindex/aviation.html), offers info on the allocations.

Military aircraft, but no civilian aircraft, can be found in the 225-380 MHz band (formerly 225-400 MHz). Not all scanners include the UHF aircraft band and some don't even have the VHF aircraft band. Check the equipment list in this month's lead feature for scanners with the required frequency ranges.

## HF Aero Bands

Aircraft that fly across oceans are beyond the range of VHF and UHF ground stations for much of their flights, so they must rely on shortwave frequencies which travel much further. Some also use satellites. The shortwave aero bands are 2850-3155, 3400-3500, 4650-4750, 5480-5730, 6525-6765, 8815-9040, 10005-10100, 11175-11400, 13200-13360, 15010-15100, 17900-18030, 21870-22000, and 23200-23350 kHz Upper Sideband (USB).

The lower frequencies are favored at night and the higher ones in the daytime, but now at the low end of the 11-year sunspot cycle, the highest bands will produce little. Civilian and military aircraft, and the ground stations they communicate with, as well as aero weather stations, can be found in the HF aero bands.

The URL [www.faa.gov/ats/aat/ifim/ifim0109.htm](http://www.faa.gov/ats/aat/ifim/ifim0109.htm) is a good place to start. ARINC frequencies are for air-ground communications. VOLMET frequencies are for aero weather. For more frequencies, use Google [www.google.com/](http://www.google.com/) and try these searches: "MWARA frequencies," "VOLMET frequencies," and "HFGCS frequencies."

Whatever receiver is selected, it must be capable of receiving single sideband (SSB). A great receiver for the money, if within your budget, is the Icom IC-R75: [www.grove-ent.com/ICR75.html](http://www.grove-ent.com/ICR75.html).

## Airports

Some airports have Control Towers and others do not. At smaller airports without towers, pilots self-announce their intentions for all to hear. Each small airport has a UNICOM frequency assigned to it, which will be among these: 122.7, 122.725, 122.8, 122.975, 123.0, 123.05, and 123.075 MHz.

Larger airports will have Control Towers which, at times, can be fast paced. To find airports near you, go to [www.airnav.com/airports](http://www.airnav.com/airports) and click on "Browse by U.S. State." Click on the desired state and look for ones that you think may be within your receiving radius. Click on the airport identifier links listed on the left to gain airport information and frequencies.

Using a typical airline flight and Fresno International Airport as examples ([www.airnav.com/airport/KFAT](http://www.airnav.com/airport/KFAT)), you will see CLEARANCE DELIVERY 124.35, FRESNO GROUND 121.7, and FRESNO TOWER 118.2. On the first frequency, you will hear airliners soon to depart exchanging information about the details of their routes of flight. On the Ground Control frequency, you will hear a controller in the Tower giving taxi instructions to get the airliner safely to near the end of the runway. Near the time of takeoff, the airliner will switch to the Tower and will receive takeoff instructions. Shortly after liftoff, it will switch to Departure Control.

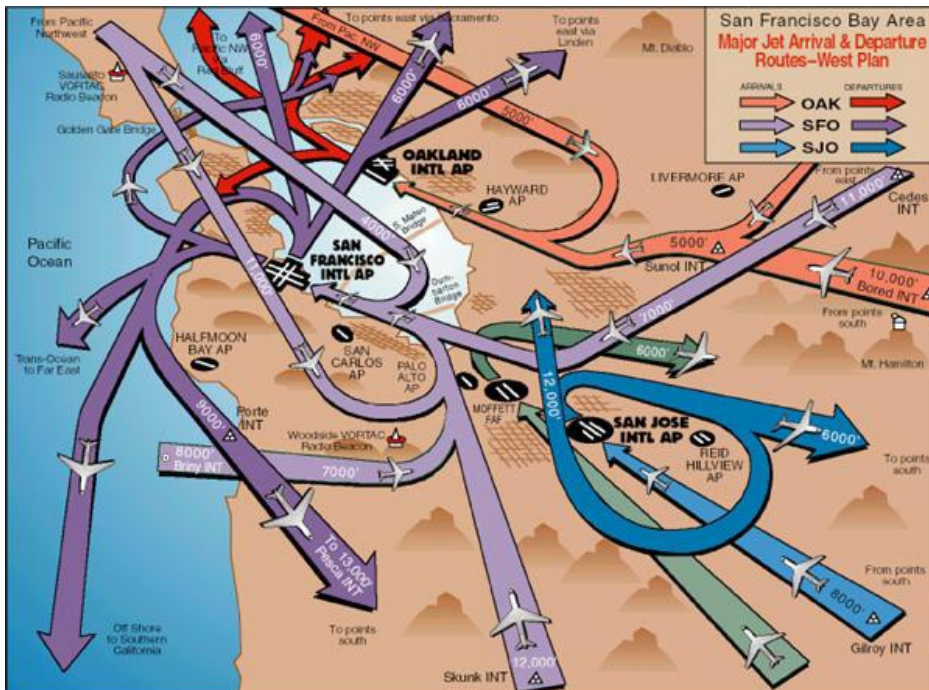

Unlike police and fire calls, aircraft listening adds another whole dimension. Graphic courtesy FAA.



ATIS (Automatic Terminal Information Service) is a periodically-updated, repeating broadcast with information important to departing and arriving aircraft. For Fresno airport, it is listed as ATIS: 121.35.

### ARTCCs

Once at cruising altitude, long distance flights talk to FAA (Federal Aviation Administration) Air Route Traffic Control Center (ARTCC) controllers. ARTCCs blanket the entire U.S. and each is divided into sectors. Each sector has its own controller and frequencies. As an aircraft progresses on its flight, it goes from sector to sector and controller to controller. Controllers "hand off" each plane to the next controller and inform the pilot of the new frequency.

### TRACONS

Pilots talk to ARTCC controllers during the "enroute" phase of flight, but begin and end their flights at airports. TRACON (Terminal Radar Approach Control) controllers perform the intermediate function of organizing aircraft that are departing from airports and getting them to altitude and going in the right directions, while keeping them separated from each other.

TRACON controllers also transition and guide aircraft from altitude and ARTCC controllers back down to airports and their Towers. TRACONS exist at or near large airports and control air traffic in a 30 to 50 mile radius and up to 10,000 feet.

The AirNav information for each airport

includes the "Approach" and "Departure" frequencies – which are TRACON frequencies.

### The Attraction?

Why do people enjoy listening to the variety of aircraft out there? Not easy to answer. It has its own intrigue which can grow on a person. The hobby has many different facets and some listeners focus narrowly on one or a few of those facets, for example, tracking airliners using FlightAware while listening to their communications – <http://flightaware.com/live/airport/>

### Information

Internet forums and Yahoo Groups <http://groups.yahoo.com/> which deal with aircraft communications listening can provide useful information.

Consider acquiring MT Anthologies for previous Planes and related columns and articles. These are in searchable PDF format on CD-ROMs and have helpful info, details, and explanations: [www.grove-ent.com/mtantindividual.html](http://www.grove-ent.com/mtantindividual.html)

[www.faa.gov/airports\\_airtraffic/air\\_traffic/publications/](http://www.faa.gov/airports_airtraffic/air_traffic/publications/) has an enormous amount of free information, but I suggest starting with the *Pilot/Controller Glossary* and the *Aeronautical Information Manual – Official Guide to Basic Flight Information and ATC Procedures*.

You may also email questions to me, the *Planes* column editor. So now, go dial up some airplanes!

CCRadio<sup>plus</sup>



### The Best Long Range AM Radio

- AM, FM, TV Audio, Weather Band and Weather Alert
- Easy To Use
- Rotary 1kHz Fine Tune
- 5 Top Mounted Memory Buttons
- Audio Shaped for Voice
- Lighted Display, Timer, Alarm
- Batteries or Power Cord

~~\$164<sup>95</sup>~~ \$139<sup>95</sup> – New Low Price!

**C.CRANE**

**Free Catalog**

**800-522-8863 • [ccrane.com](http://ccrane.com)**

## Did your Antenna System Survive the Harsh Weather?

Performance and Price...these are the industry leaders!

Grove Enterprises offers these three exclusive products with decades of proven excellence:

### Grove Omni II

Looking for an economical solution for metropolitan monitoring? Look no further: The OMNI II is a low-profile (68"), single-element, 25-1300 MHz receiving antenna with astounding performance for city-wide coverage. Includes balun transformer (with F connector), offset pipe, mounting hardware and full instructions.

Order ANT05  
Only \$ **29<sup>95</sup>**

plus \$3 UPS Ground shipping

### Scantenna

Unsurpassed by any competitive, omnidirectional scanner antenna, the OMNI II provides continuous frequency coverage from 25-1300 MHz an ideal companion for modern scanning receivers. It comes with matching balun transformer, 50 feet of low-loss coaxial cable (with BNC adaptor) and mounting hardware.

Order ANT07  
Only \$ **49<sup>95</sup>**

plus \$6.95 UPS Ground shipping

### Grove Scanner Beam II

With continuous reception from 25-1300 MHz, the Scanner Beam is ideal for directional targeting (100-900 MHz) of specific locations. Gains are 4-6 dBd from 100-200 MHz, 6-8 dBd from 400-500 MHz and 10-12 dBd 800-900 MHz.



Hams can use the Scanner Beam for transmitting up to 25 watts on the amateur 50, 144, 223 and 430 MHz bands as well, with an SWR under 3:1. Balun transformer (with F connector), offset pipe and mounting hardware included.

Order ANT18  
Only \$ **64<sup>95</sup>**

plus \$8.95 UPS Ground shipping

#### Accessories:

50' RG-6U    CBL50    \$19.95  
100' RG-6U    CBL100    \$24.95

plus \$3 shipping each

**GROVE**  
WWW.GROVE-ENT.COM

800-438-8155

828-837-9200

fax: 828-837-2216

7540 Highway 64 West  
Brasstown, NC 28902

## READERS WRITE:

### No-Tower Antenna Tower, HDTV Reception, WX Radio DX

This month I'm looking at antenna solutions for HF, TV, and the weather band. First is how to put up a big HF beam antenna without the use of an expensive tower. Then I'll find solutions to the all-or-nothing of digital TV reception and finally, I'll explore the edges of DX on the weather band.

#### ❖ The No-Tower Antenna Tower

MT reader Lyle Lunsford AB4SG saw my mention of my HF beam antenna in which I described using three lengths of 10 foot long Radio Shack antenna mast and wanted more details.

For many years I've used only an off-center-fed, all-band dipole (described innumerable times in this column over the years) up about 25 feet and fed with 50 ohm coax into the receiver. It's a great performer on the ham bands 80 through 10 meters and works especially well in the international broadcast bands for general shortwave reception. It's a low noise and seemingly omni-directional antenna.



*DIY no-tower tower uses three lengths of 10-foot TV antenna mast attached to a gable end exterior wall. A ground rod and a cement block at the base complete the installation. (Courtesy: Author)*

I had always yearned for a three element tri-band beam, but the cost of the antenna, expense of the tower, rotator and the rest was always prohibitive.

One day a neighbor offered to sell me a new, in-the-box, CushCraft A3S which he didn't need because he had also bought a two-element, five-band quad as part of a whole ham shack purchase from a ham who was headed for the retirement home. He offered to sell the A3S at a price I couldn't refuse. But, I spent the next couple of years trying to figure out how to get it in the air.

Finally, I had the idea to use the side of the house for a mast support. I have a two story addition with a gable-end close to the deck which is just outside the part of the house from where my shack is located. The peak of the second floor roof is about 25 feet above the ground. If I used three 10 foot, 16 gauge steel masts (RS#15-863 \$20/each), I could get the antenna up 30 feet or about 5 feet over the peak of the house.

To hold the mast to the house I bought two sets of 4-inch antenna mast wall-mounts (RS#15-0883 \$13/each) and secured them to the exterior wall near the center of the peak of the roof. I evenly spaced the wall-mounts, leaving the brackets that hold the mast just loose enough to be able to slide the masts up. Once I had the first 10-foot mast threaded through, I slipped the next one into it and so on until all three were joined.

To say it was just a matter of mounting the beam on top of the mast is to miss the life-or-death crawl up a 25-foot aluminum ladder carrying a fully assembled A3S antenna. The boom is 14 feet long and the reflector element is 28 feet long. Carrying the antenna "Flying Wallenda-style" along the peak of the roof was also a little tricky, especially on a windy day. Holding the antenna in place with one hand at the edge of the roof, while tightening the mounting bolts with the other hand was also tricky.

After attaching the lead-in cable and securing it to the mast, I went back to the deck and spun the antenna by hand. With just a little effort I can turn the beam to any global position. Once I get it where I want it, I lock down the lowest wall-mount clamp. It's just that easy.

Of course, it's a little inconvenient to walk out-doors every time I want to turn the antenna, especially when it rains or snows. But, since I do most of my operating toward South America, it can just stay pointed south. If I need to work stations in Africa, Europe or Asia over the North



*Create vertical log periodic dipole array may be the best VHF-DX antenna on the market. But, at \$300 it had better be! (Courtesy: Grove Enterprise)*

Pole, I can pop outside, loosen the nut on the clamp, rotate the antenna and lock it down. It doesn't do too much drifting in heavy wind. And, during tropical storm Isabelle a few years ago, when we had sustained winds of 50 mph and higher gusts, it did just fine.

So, there it is: the no-tower tower that costs less than \$100. No expensive rotors, no control cables, guy wires, or heavy concrete foundations. But, the best part is in the operating. Just being up 30 feet is enough to allow this antenna to perform like it should. Running only 25 to 100 watts from my trusty old Kenwood TS-140s, I've worked 240 DXCC countries in the bottom of the solar cycle on all modes. My advice to new hams is: forget amplifiers. They are a waste of money and electricity. Forget expensive towers and rotors. This simple beam on a simple mast gives you all the power you need and directs it where you want it to go.

#### ❖ The Mysteries of HDTV Reception

MT reader J.J. Owens writes that he lives in a rural area that has no cable TV service and a large stand of tall trees blocks his view to the satellite arc. "For me it is over-the-air TV or no TV. I have a good log-periodic VHF-UHF-TV antenna on my house up about 20 feet with a rotor and a good view of the northern sky (most TV stations are to my north)..."



*The Terrestrial Digital XG91 antenna gives you 22 directors on a boom almost 8 feet long. This corner reflector UHF-TV antenna could help bring in digital off-air TV signals smaller antennas miss. It claims a gain of 16 dB, front-to-back ratio of 28 dB and is \$80 plus shipping from [solidsignal.com](http://solidsignal.com) or call 866-374-4625 (Courtesy: [solidsignal.com](http://solidsignal.com))*

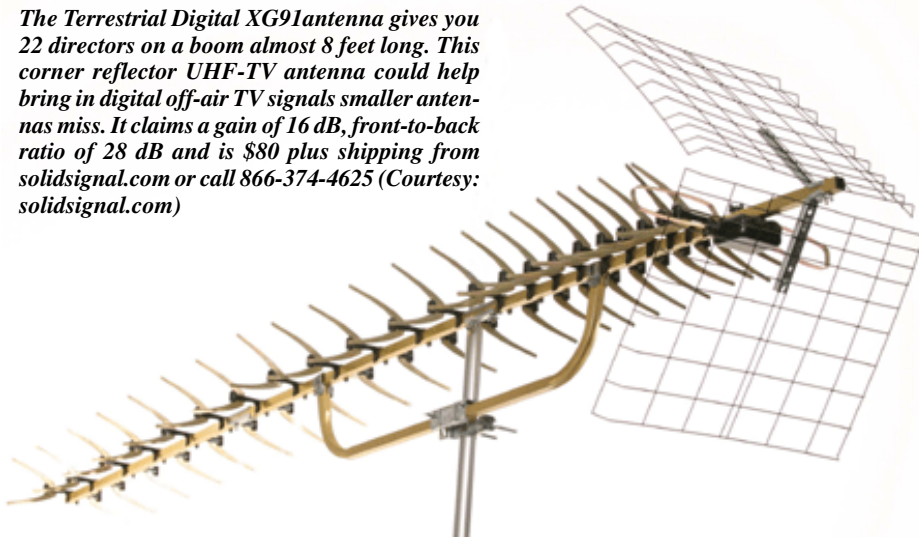

After purchasing a new brand-name HDTV set, he was disappointed to discover that his analog reception had deteriorated and that digital reception was limited to three stations, one of which came in only part-time. To compare, he attached the antenna lead to an older analog set as well as an old VCR and reported perfect reception. He wonders if new digital tuners were designed to just meet specifications and nothing more, since most people get their TV signals from cable or satellite TV. He also wants to know what to do to improve his over-the-air digital reception.

Well J.J., I think you've got it right. A recent TV industry survey reported that only 4% of Americans use over-the-air TV as their sole television source. That would certainly give manufacturers no incentive to produce sensitive off-air receivers. I had the same experience when I switched to an HDTV set five years ago. The built-in analog off-air tuner was rubbish (it had no digital receiver built-in).

My solution was to use an out-board digital/HDTV tuner, the Digital Stream HD-1150. It's a very sensitive digital receiver with excellent features such as on-screen guide, freeze-frame, and setting the output for any analog TV. While that receiver has been discontinued, there are several models on the market that may perform better than the one built-in to your TV. Places to look are any of the major consumer electronic stores. But, you should have an understanding from the store that you can return the unit if it doesn't perform any better than what you have.

In addition, there are a number of things you can try to improve your reception. Do one at a time and, if you're happy, you won't have to go any further, but you may end up needing them all. The biggest improvement I made was up-grading my receiving antenna. You no longer need a big VHF-UHF antenna for TV reception. With very few exceptions virtually all digital TV stations are now transmitting in the UHF band. So, you need to buy the best UHF-TV antenna you can put on your current mast/rotor.

The Channel Master UHF antenna I use is no longer made. But, I've found one that should be comparable from Terrestrial Digital (see photo). It costs about \$80 plus shipping.

Next, replace your RG59 coaxial cable with RG6. After that, add a mast-mounted UHF-only preamplifier; again I recommend the Channel Master CM-7775. If that doesn't do the trick, you'll have to raise the antenna height another 20 feet. The further away from the transmitter you are, the higher you have to have any antenna. While there is some atmospheric refraction of FM and UHF-TV signals, UHF frequencies are line-of-sight and you'll get a stronger signal by increasing the height of your antenna.

### ❖ DXing the Weather Band

MT reader Jorge Hamer wrote, "I was reading the article in MT August 2007 about buying a weather radio and I wanted to know which of the ones mentioned would allow reception of the most distant weather stations using an outdoor antenna." He also wanted to know about a good outdoor antenna and what the limits for weather radio reception would be.

There are a number of factors to consider when thinking about DXing the weather band which is actually channelized into seven frequencies: 162.400, 162.425, 162.450, 162.475, 162.500, 162.525, and 162.550 MHz. First is the distance from the transmitter. With a beam antenna on top of a tower some 30 to 50 feet up, you might pick up signals as far as 90 miles away. Since VHF frequencies require line-of-sight to the transmitting antenna, that's about the limit under normal band propagation. Of course, skip could allow greater distances but would not be reliable. Weather radios themselves are not very sensitive and it may not matter which particular brand you bought.

Adding an external antenna may be a problem, since the ones that have external antenna jacks use RCA jacks. You'll need an adaptor to accommodate BNC, "N," or PL259 antenna connectors, whichever you use. External antennas that are made for these weather radios are little more than a folded dipole or vertical. The best distance reception on the weather band will be had with a multi-element beam. There are several on the market, but I believe the best one for the price is the Grove Scanner Beam II which sells for about \$65. There are better beams that cost considerably more, but would probably not perform any better at these fre-

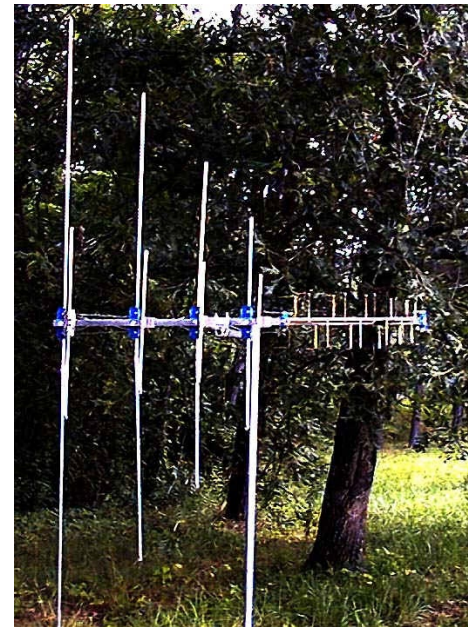

*Grove Scanner Beam Antenna II could be the best performing inexpensive VHF antenna on the market. (Courtesy: Grove Enterprises)*

quencies. It's possible that a very sophisticated scanner receiver such as the AOR AR500A+3B would extend your weather band reception, but at \$2,600 it seems like quite an extravagance. (Also see page 22 for Bob Grove's recommendations - ed.)

## Race Scanning

Experience high speed scanner listening!  
First Edition By Richard Haas, Jr.

**Chapters:**

- History of race comms.
- What you can hear
- Racing terms
- Racing flags
- Choosing a scanner
- Tips and tricks
- Racing frequencies

**By Richard Haas, Jr.** Listening to a scanner radio at the track adds a dramatic new element to the race fan's experience. This book will help you be properly equipped and informed to enjoy the race from a new perspective. Listen to, and understand exciting real-time transmissions from the driver's seat and support communications from behind the scene. Printed September 2003 with up-to-date frequencies. #0031 **Only \$4.95** (+\$2.00 ship)

**Universal Radio**  
6830 Americana Pkwy.  
Reynoldsburg, OH 43068

◆ Orders: 800 431-3939  
◆ Info: 614 866-4267  
[www.universal-radio.com](http://www.universal-radio.com)

**Q.** Can a discone antenna be used as an effective TV antenna to receive distant VHF and UHF channels? (Gary Cernak, Easthampton, MA)

**A.** In a word, no. While discones can cover the majority of the VHF and UHF TV channels, the broadcasters transmit their signals horizontally polarized so that traditional TV beam-style antennas can be used to receive them. Discones are vertically polarized, so you already start with a substantial signal loss from cross polarization.

**Q.** I live in an area that has marginal reception for weather radios – sometimes I get the alerts, sometimes I don't. The radio has a jack for an external antenna. Would it work to just attach a longwire type antenna to it or would something else be more suitable like some sort of homebrew antenna? (Dale Demerest, KC8LZG)

**A.** Since the receiver is frequency-specific (the 162 MHz weather band), you can optimize reception with a simple, center-fed, 32-inch vertical dipole (two in-line 16-inch elements fed at their common "touch" point). Feed it with low-loss coax like TV-type RG-59/U or RG-6/U for best transmission characteristics. If the signal is reasonably strong and you aren't using more than about 50 feet of cable, standard RG-58/U cable will work, too.

Similar "drooping radial" ground-plane antennas have been used by hams on the two-meter band (144-148 MHz) for decades. These use a female, chassis-mount, SO-239 coax connector (Radio Shack #278-201) and five identical lengths of stiff copper wire (17" lengths for the weather band).

One wire is soldered straight out from the center solder pin (it will be facing directly upward when mounted); the other four through the mounting holes (hanging downward when mounted) and flared out at roughly a 45 degree angle from the axis of the connector.

The nice thing about this home-brew antenna is that it can be simply set on a convenient length of mastpipe, with the coax going up through the pipe and screwed onto the SO-239 connector which simply sits on the top of the pipe.

A side benefit of this antenna is that it makes a dandy scanner antenna for the 150 and 450 MHz bands, and if you use 19-inch lengths for the elements, it's a great two-meter (144-148 MHz) and 70 cm. (420-450 MHz) transmitting

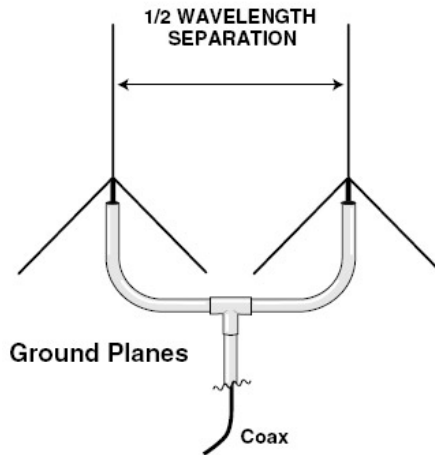

Ground plane illustration from Bob Grove's *Antenna Factbook*, viewable on line at [www.monitoringtimes.com/mtsubscriber/antenna-factbook.pdf](http://www.monitoringtimes.com/mtsubscriber/antenna-factbook.pdf)

antenna!

A random "longwire" shortwave-style antenna will only work if it just happens to be the right length for an appropriate harmonic of its naturally-resonant frequency, and in the vertical plane (which is unlikely in a shortwave wire antenna). If these conditions aren't met, it will only hear VHF signals if they are so strong that they overcome the poor suitability of the random wire length and configuration.

If you aren't up to the task of doing it yourself, the Grove OMNI II does a great job for such applications, works on all the scanner bands as well, and is inexpensive (\$29.95 plus shipping).

**Q.** I have two Grove LAR1F lightning arresters on my ICOM IC-R9500 receiver which is grounded with #6 AWG wire to a 6-ft 3/4-in ground rod. Some of my friends question the LAR1F because it doesn't have a ground lug to connect directly to a bus bar like the Alpha Delta and Polyphaser arresters have. Is that a problem? (Daniel Gillet, Canada)

**A.** In some 25 years of selling these little units, we have never had a report of static electricity from a nearby lightning strike damaging a radio which was protected by an LAR1F device. I have these on all my receivers and scanners and have been using the same ones for more nearly 20 years!

The more expensive units are very well built and offer excellent protection, but nothing

will survive a direct lightning strike to the antenna; the voltage and current are just too high to be redirected to ground by any of these devices. It's always recommended to detach the antenna connectors from radios during stormy weather.

You can easily emulate the grounding used on the more expensive devices by simply attaching a metal hose clamp around the LAR1F and slip the #6 ground wire under it as you tighten the clamp.

**Q.** How do I know if my gas-discharge lightning arrester has been hit by a surge? Do they need periodic replacement? (Ray Clemmer, email)

**A.** I have gas-discharge lightning protectors on all my antennas, and they've been there for well over a decade. They defend against voltage induced on your antenna line by nearby strikes, but, as mentioned above, nothing can survive a direct hit.

If the voltage from a nearby strike was high enough to ionize the gas (electrically charge it so it conducts), it recovers immediately. It can do this nearly indefinitely considering the rarity of such events. If there were a strike close enough to damage the device, you would either notice a reduction in signal levels from metal particles shorting out the device or notice nothing at all because it may have merely released its gas through a crack in the seal (in which case it's no longer protective). If you can see the glass envelope, the appearance of darkness on the glass may indicate vaporized metal in a damaged protector.

It's a good idea to periodically examine all antenna system parts for damage from wind, lightning and squirrels! Outdoor coax should be replaced every five years or so, and antennas should be replaced when their joints and contacts exhibit corrosion unless those joints can be cleaned and weather protected.

If you have an ohmmeter, you can remove the protector from the circuit and measure its correct conductivity and insulation: There should be a dead short (0 ohms) between the input and output center pins, and completely open (infinitely high resistance) across either of the connectors from the center to the shell.

Every so often I simply tune in a local frequency of known signal strength to test my antenna system, like NOAA weather or commercial AM, FM and TV broadcasters.

Questions or tips sent to Ask Bob, c/o MT are printed in this column as space permits. Mail your questions along with a self-addressed stamped envelope in care of MT, or e-mail to [bobgrove@monitoringtimes.com](mailto:bobgrove@monitoringtimes.com). (Please include your name and address.)

**Q.** My problem is programming the BCT 8 in 800 MHz Type II. I am trying to program Gwinnett Co. which is a Motorola Type II Smartnet SysID 2D31. I have everything programmed according to the manual. But I can't get the letter M to appear next to the Trunk in the upper left hand corner of the screen. I tried to look for a Yahoo Group but there is none. And I don't want to buy the computer programming software just yet. I want to program it first by hand. (Bill Black-Buford, Georgia)

**A.** There are three things that immediately come to mind. I have seen this condition before with others who had a problem similar to yours.

First, make sure that you are in the trunk programming mode before you enter any frequency. Press TRUNK for 1.5 seconds and you will then hear two beeps, and "BANK" and "TRUNK" will begin to flash on the display. Then you select the bank you want to store the frequency by using the keypad. Then select the system you want to track by using the Δ or ∇ key, then press E. Make sure you select "E2-800 (Motorola Type II 800 MHz)."

At this point you could enter all the frequencies or do only the control channels and use the "control channel only" mode. I highly recommend you program all the frequencies. Those frequencies include the following (thanks to our friends at Scannerstuff and their Atlanta Frequency Directory: [www.atlantas-canner.com/](http://www.atlantas-canner.com/)):

854.78750	854.81250	854.83750
855.31250	855.48750	855.76250
855.78750	855.81250	856.81250
856.83750	856.91250	857.81250
857.83750	857.91250	858.78750
858.81250	866.13750	866.38750
867.38750	867.96250	868.13750
868.48750	MHz	

Now you should be able to track the system and the "M" should be present. If not, you are either (1) out of range of the system or (2) the current control channel in use has not been programmed or (3) a frequency has not been programmed properly. If you step through each frequency manually in that bank and you don't hear a control channel, you can't trunk the system.

Regrettably, your BCT-8 scanner may not be of much use to you much longer. Reports indicate that Gwinnett County is switching to a nine-site, Project 25 digital trunk radio system. These reports indicate the system is now well under construction. This new digital network will replace the older Motorola Type-II system that I have described above. The project is expected to be complete by the autumn of this year. So you will have to look at purchas-

ing one of the new GRE (500/600) or Uniden (396/996) scanners if you want to monitor this system in the future.

**Q.** While out recently in Corpus Christi, Texas, I took my little trusty BC92XLT and was operating it in Close Call mode. I was downtown and got a hit on 408.325 MHz. It locked up the scanner and it would not move off from there until I left the area. The image or signal was so strong I didn't get a good read on it. It sounded like it was a control channel used for a trunking network.

I am familiar with all of Corpus Christi law enforcement, EMS and fire communications on their Motorola Type 2 system in the 800 MHz band and knew it was not them. It went away a few blocks from the Whataburger restaurant I was in. It seems to be in the government and military band, so I think it might be coming from the Veterans Center located next door to the Whataburger.

Nothing in my files show any listings for that center, so do you have any ideas? I doubt it is a highly used network since there is only a small unit there. There is, however, a cop at the door with a handheld. I can't tell if it's a 800 or 400 MHz radio. Are there any trunked systems in the Corpus area in the 400 MHz band? (Emmitt in Sinton, Texas)

**A.** I do not have any Texas allocations for 408.325 MHz in my database. There are some US Bureau of Prison trunk system allocations in Michigan and Missouri. Fort Bliss also has a trunk radio system allocation on this frequency. But as you know, that is nowhere near Corpus Christi. I agree with your assumption that it is probably not the Vet Center, so my best guess is you are getting an image from one of the 800 MHz Public Safety TRS systems from either Corpus Christi or Nueces County.

**Q.** I live in High Point, North Carolina, and I hear 128.800 (Atlanta Center). I frequently hear commercial airlines telling Atlanta controllers that they "are crossing Magic," or they "just crossed magic." This term is used a great deal of the time and I have no idea what it means. Do you know or maybe have any suggestions on who can help me? (Stuart Smith - High Point, North Carolina)

**A.** Magic is just one of the many intersections that are used by air traffic controllers. Since it is the Atlanta ARTCC that is using this "Magic" intersection, it is most likely an IFR route intersection. These intersections are usually the intersection of two navigation aid radials.

Historically, the name of every intersection makes some reference to something near that location. Originally the words were spelled out. With the advent of computers, all intersections consist of five letters which may phonetically resemble the original. LODI became LODDI, RIO VISTA became REJOY and VISTA. Only an active imagination or an old memory bank makes possible many of the associations.

I looked for your "Magic" intersection on my VFR and IFR charts and could not find it. But sometimes it is a matter of an odd spelling. This triggered a spark of recognition, and a look through the online MT 2007 Index of Articles, I found where Iden Rogers answered this same question in February 2007 *Boats, Planes and Trains*. The intersection being heard in North Carolina is actually MAJIC, and it can be seen, he says, on the map found at <http://204.108.4.16/d-tpp/0612/00078majic.pdf>

If you missed that discussion, check out Iden's column for more information on intersections and aero charts in the February 2007 MT, and also look in the *Planes* column from February 2005 for more on "names and numbers" used in aircraft communications.

**Q.** Excuse me for asking a dumb question (I am a newbie), but what does ALE stand for?? (Michael Smith VK3 VMS)

**A.** ALE = Automatic Link Establishment. You can learn more about ALE on the ARRL website at [www.arrl.org/tis/info/ale.html](http://www.arrl.org/tis/info/ale.html). The page above has weblinks for articles and software to monitor ALE signals (including freeware).

### Longwave Resources

✓ **Sounds of Longwave** CD or Audio Cassette (please specify) featuring WWVB, Omega, Whistlers, Beacons, European Broadcasters, and more!  
\$13.95 postpaid

✓ **The BeaconFinder** A 65-page guide listing Frequency, ID and Location for hundreds of LF beacons and utility stations. Covers 0-530 kHz.  
\$13.95 postpaid

Kevin Carey  
P.O. Box 56, W. Bloomfield, NY 14585



## Radio Scanning, Limited

For those of us who have been interested in radios and electronics for many years, it is sometimes difficult to imagine that there are folks out there who might simply want to use a scanner but not let the monitoring hobby take over their lives. This month we help one such reader choose an appropriate scanner and take a look at some local and state governments who have chosen to purchase public safety radio systems that are currently impossible to monitor.

### ❖ Salem, Oregon

*Dan, I find the subject of scanners to be overwhelming. I live in Salem Oregon, and just want to listen in on the city police. What scanner do you recommend? Thank you, Cathy.*



Salem is the capitol of Oregon and home to just over 150,000 people. Located in the northwest part of the state, Salem resides in two counties, Marion and Polk.

Police radio first came to Salem in 1933 and has evolved into the Communications Division of the Salem Police Department. The Department currently has a total of 85 full-time employees and operates the Willamette Valley Communications Center (WVCC), a regional PSAP (Public Safety Answering Point) for 911 calls. WVCC provides dispatch services for 18 police, fire and emergency medical agencies in Marion and Polk Counties, including Salem.

The City of Salem itself uses a relatively simple analog radio system in the UHF band for Police services. Repeaters at two locations – one at Downs Hill and the other at the Civic Center – provide coverage for Salem officers. There is also a “talkaround” frequency, which can be used by officers to talk directly with each other without needing the repeater. Activity on the talkaround frequency might be more difficult to hear since the transmissions are coming from the relatively

low power mobile and portable radios rather than the high power repeater transmitter.

Frequency	Description
460.0750	Salem Police
460.1750	Salem Police (Talkaround)
460.4750	Salem Police

The City of Salem is also licensed to use a VHF frequency, 159.0300 MHz, which is apparently used as an interoperability channel with the Oregon State Police.

The Marion County Sheriff also operates on several frequencies in the VHF band. There are four repeaters, all in various locations around Salem, including Prospect Hill and the Civic Center.

Frequency	Description
154.7400	Marion County Sheriff (Dispatch)
154.8900	Marion County Sheriff
154.9050	Marion County Sheriff
155.6100	Marion County Jail
155.7000	Marion County Sheriff (Talkaround)
155.8650	Marion County Sheriff

In the Salem area you may also be able to hear the Oregon State Police on 155.9100 MHz.

If you’re interested in activity beyond law enforcement, fire departments in Marion and Polk Counties also operate on VHF frequencies.

Frequency	Description
153.7700	Marion County Fire (Central Operations)
153.8300	Marion County Fire (Training)
154.0100	Marion County Fire (South Operations)
154.1600	Marion County Fire (North Dispatch)
154.2350	Polk County Fire (Dispatch)
154.2500	Marion County Fire (South Operations)
154.2950	Marion County Fire (South Tactical)
154.3850	Marion County Fire (Central Dispatch)
154.4150	Marion County (South Dispatch)
159.3450	Marion County Fire (North Operations)

For other departments besides the police, Salem operates a Motorola Type II analog trunked radio system. It’s actually two separate systems, referred to as “A-Tower” and “B-Tower.”

**A-Tower Site Frequencies:**  
856.7125, 857.7125, 859.4875, 860.4875, 866.1250 and 868.1000  
**B-Tower Site Frequencies:**

856.4875, 857.4875, 858.4875, 867.8125 and 867.5500

Here are a few talkgroups, which may be heard on either tower:

58416	E43	Salem Fire Department (Dispatch)
58448	E45	Salem Fire Department (Operations)
58576	E4D	McNary Field
58640	E51	Salem Fire Department (Operations)

There is also a “C-Tower” pair of frequencies (821.4250 and 866.4250 MHz) which operate in conventional (non-trunked) mode. Fire Department personnel apparently use these frequencies when they’re in the southernmost part of the city and don’t have good coverage from the A-Tower.

### Selecting a Scanner

For conventional (non-trunked) analog radio systems like that used by the Salem Police Department and the Oregon State Police, nearly any scanner made in the past 20 years should be fine. You’ll want to find one that has coverage in the VHF and UHF ranges, covering 150 MHz and 450 MHz frequencies. If all you really want to hear are the local police, a scanner with ten channels would be sufficient. You’ll also need to decide whether a handheld or a base/mobile is better for your listening habits. A handheld is certainly easier to carry around during your daily activities, while the convenience of an AC-powered base relieves you of having to change or recharge batteries.

You can certainly purchase a new scanner from one of the many vendors advertising in this magazine. It will function correctly and come with a warranty, and there will be folks on various Internet interest groups who will have the exact same model and be able to help you with any specific questions you might have. This is probably the easiest way to get up and running.

For instance, the new GRE PSR-100 is a handheld scanner with the ability to scan up to 200 separate frequencies and a tuning range that covers the VHF and UHF frequencies in and around Salem. It also has five pre-programmed bands, including weather and aeronautical, in case you’d like to monitor other activity. It’s available for \$100 or so from Grove Enterprises and various other merchants. (See a review of the PSR-200 base version of this model in this issue - ed.)

As an alternative, if you’d like to save some money and would be happy with an older model,

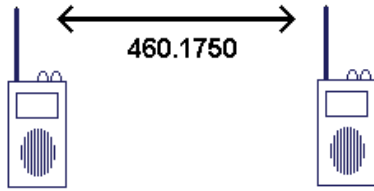

**Simplex Mode  
"Talk Around"**

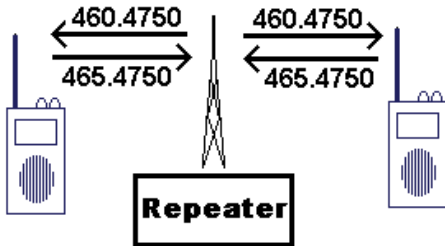

**Repeater Mode**

you might want to consider a used scanner. I'd initially recommend looking for Uniden or Radio Shack branded scanners. Although there are several other manufacturers of quality radios, finding manuals and helpful folks who have an identical model will be easier with either of these common brands.

Table 1 lists some relatively simple and inexpensive models to look for.

**RECOMMENDED "STARTER" SCANNERS**

Radio Shack	Handheld	PRO-43, PRO-46, PRO-51, PRO-60, PRO-62, PRO-64
Uniden	Base/Mobile	PRO-2042
	Handheld	BC100XL, BC100XLT, BC200XL, BC205XL, BC220XL, BC230XL, SC150
	Base/Mobile	BC3000XL, BC760XL, BC895XL, BC9000XL

This list is by no means exhaustive, but will at least give you a starting point to begin looking. Any of these scanners will be more than adequate to monitor the conventional analog transmissions from the Salem Police Department and should be fairly easily to learn to use.

**Finding a Used Scanner**

If you enjoy the "thrill of the hunt," as many radio listeners and collectors do, and are willing to put in some footwork, there are several places you can go to find used scanners.

If you have good thrift shops or second-hand stores in your area, check there first. Most stores have an electronics section where stereos and television sets are displayed. Scanners might also be mixed in with such items as clock-radios and telephones, so be sure to hunt through the shelves with those kinds of things. Weekends are usually the busiest time for these stores, so if you're able to go during a weekday you might

have fewer distractions and interruptions when shopping.

Since the folks working in the back of the thrift shop are typically not familiar with scanners, you may have to check to be sure the device is in good shape and operational. Check that there are no significant cracks or missing pieces (battery doors on handheld radios can easily go missing) and that the antenna is intact and undamaged.

Once you've found the unit to be physically acceptable, you'll need to a way to power it. Base/mobile units typically have some kind of AC adapter, usually a "wall wart" that plugs into the wall and provides DC power. For some reason it's very common for thrift shops to separate an electronic device and its power cord, so you may find that wall warts are in a different location, sometimes hanging from a peg on the wall or mixed in with many others in a plastic tub. Be sure to check not only that the power cord will fit the scanner, but that the voltage and polarity are correct. Wall warts often look alike, and you want to be sure you have one that will work.

Many stores will allow you plug in and test an electronic device before you buy it. If possible, be sure to do this with the scanner. After plugging it in and turning it on, you should see some kind of action take place on the display. Be sure that the display is legible - some liquid crystal displays, for example, may be damaged or won't display digits clearly. To test the audio capability, I would suggest programming in one of the seven NOAA (National Oceanic and Atmospheric Administration) frequencies used for automated weather information:

- 162.400 MHz
- 162.425 MHz
- 162.450 MHz
- 162.475 MHz
- 162.500 MHz
- 162.525 MHz
- 162.550 MHz

These stations broadcast 24 hours a day and are generally strong enough to be heard up to 40 miles from their transmitter site. Programming the scanner may require stopping any scanning that might be occurring (via a [MANUAL] button or similar), the entry of the frequency (including an [ENTER] button), and the adjustment of the squelch and volume knobs.

If the scanner passes these tests and is marked with a reasonable price, go ahead and purchase it. Once you get it home you'll have a good chance of finding an owner's manual on the Internet, either on a web site or from a "vintage" manual vendor. The manual will be useful both for programming instructions and for maintenance information.

If you do have free time on Saturdays, garage sales and estate sales might also be worth checking. The electronic items are generally in better shape than at the thrift shops, and usually the owner has kept the power supply, manual, and other accessories that otherwise get lost.

Locating the right neighborhood is important - I've had good luck in older, more established parts of town where people are cleaning out attics and basements. Garage sales in the newer developments, full of young families with infants and toddlers, haven't yielded much in the way of radio equipment, at least for me. For instance, just last year in my local area where the homes were

**INFORMATION & ORDERING  
WWW.SCANCAT.COM**

**INTERNET DOWNLOADS AVAILABLE  
ORDER TOLL FREE  
888-722-6228**

**COMBO CD SPECIAL**

- Reg. ScanCat-Lite-Plus.....\$29.95
- Mr. Scanner FCC Public Safety .....\$29.95
- Nat-Com's FCC Scancat Files .....\$9.95
- Bonus Disk Of Frequencies.....\$15.00

**NOW \$49.95**

**PLUS FREE** Scanning Magazine(s)  
*(Current Issues While Supplies Last)*

**SCANCAT®**

**Since 1989, The Recognized  
Leader in Computer Control**

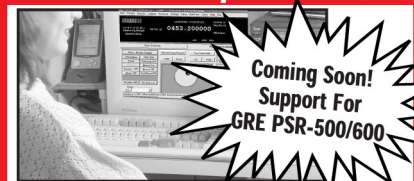

**Once you use SCANCAT with YOUR  
radio, you'll NEVER use your radio  
again WITHOUT SCANCAT!**

**ScanCat-Lite-PLUS**

Reg. \$39.95 - Limited Time Special \$29.95

**Program Your Scanner**

**As Easy As 1-2-3-CLICK!**

SC-Lite Supports PRO-83, PRO-95, PRO-96, BC246 & over 15 more Trunking Scanners

**Scancat-Gold for Windows**

Version 8.50 \$99.95

Supports all radios in ONE program - share files with all radios.

Two Scanning modules:

- A Simple Basic Module - for beginners
- Plus**—An Advanced Scanning System for the "experts".

**Scancat-Gold for Windows-SE -**

**\$159.95**

**All the features of our "Standard Scancat" plus additional functions.**

- Long term logging of frequencies to hard drive.
- Record Audio to hard drive using sound card.
- Improved spectrum analysis with several great graphical analysis screens.

**Skysweep Decoder Software**



**Advanced Digital  
Signal Processing  
Software For  
HF/VHF Applications**

**JUST OUT  
NEW  
VERSION**

All you need is any Windows® soundcard demo on our website



**COMPUTER AIDED  
TECHNOLOGIES**

P.O. Box 18285 Shreveport, LA 71138

ORDERS: (318) 687-4444 FAX: (318) 686-0449

Info/Tech Support: (318) 687-2555

(9 a.m. - 3 p.m. Central M-F)

**INTERNET DOWNLOADS AVAILABLE  
INFORMATION & ORDERING  
WWW.SCANCAT.COM**



built in the 1960s, I purchased a Uniden Bearcat BC560XLT at a garage sale for \$7. It came with a power supply and the original manual, all in plastic bag. The seller didn't know much about it, just they were looking to get rid of their "clutter." So there are scanners out there, you just have to be persistent and be willing to visit a lot of yards and garages on Saturday!

One additional note – be sure to check the classified section of your local paper for a listing of local sales. In some areas of the country it is common to have sales on Thursday or Friday mornings, rather than Saturday.

I've had pretty good luck with thrift shops and with garage sales. I even managed to find a Bearcat 200XLT in the trash, of all places, in front of a house that was undergoing a "spring cleaning." I was in the neighborhood at a nearby garage sale and saw it as I was driving out. So



keep your eyes open and you might find something that works for you and won't cost much!

If all this running around and checking things sounds like too much, the Internet can also serve as an easy way to locate an appropriate scanner. Besides eBay ([www.ebay.com](http://www.ebay.com)), smaller web sites may have an inexpensive, serviceable radio. Check Bob's Bargain Bin ([www.grove-ent.com/bbb scanners.htm](http://www.grove-ent.com/bbb scanners.htm)) and Universal Radio's ([www.universal-radio.com](http://www.universal-radio.com)) used equipment sales. I've used both and have been pleased with the price and the service. You might also want to check your local area via FreeCycle ([www.freecycle.org](http://www.freecycle.org)) and Craig's List ([www.craigslist.org](http://www.craigslist.org)) to see if anyone might be selling or giving away an old scanner.

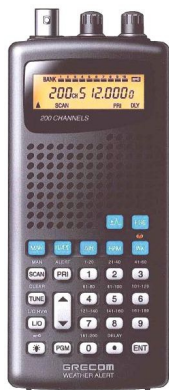

### ❖ Peoria County, Illinois

Although areas like Salem, Oregon, are easily monitored with nearly any consumer scanner, there are several areas of the country where public safety cannot be monitored. Peoria County, in central Illinois, is about to become another.

In December 2007 Peoria County, Illinois, officially awarded an \$11.2 million contract to equipment provider M/A-COM to build a new radio system for their public safety operations. The planned system will use M/A-COM's OpenSky technology, a proprietary digital system used in a number of other jurisdictions in the United States.

Members of Peoria County's Emergency Telephone System Board (ETSB) reviewed proposals from Motorola and M/A-COM and were eventually sold on the M/A-COM promise of Internet Protocol (IP) connectivity and the ability to carry four simultaneous conversations in a single 25 kHz wide radio channel. Motorola, the provider for Illinois' statewide StarCom21 system, proposed a network based on APCO (Association of Public Safety Communications Officers) Project 25 standards. Project 25 (P25) is a set of publicly available standards describing a common digital communications method. P25 is far more common than OpenSky and equipment is available from a number of different manufacturers.

The M/A-COM contract includes the purchase of P7200IP radios, which are capable of operating on StarCom21 using P25 as well as OpenSky. They are also able to operate on EDACS (Enhanced Digital Access Communications System), which is used by Tazewell County to the southeast, and with conventional analog repeaters. M/A-COM markets the P7200 series of radios as "software defined," meaning that their behavior and capabilities can be changed or upgraded via software modules rather than requiring new hardware.

The new Peoria County system will require the construction and installation of OpenSky equipment on more than two dozen repeater sites across the county. It is expected to be up and operational in about three years. It will be interesting to see if that deadline will be met, given the experience of some other OpenSky customers.

### ❖ Pennsylvania

The most visible OpenSky customer is probably the State of Pennsylvania, who began their contract with M/A-COM in 1996 when they approved the expenditure of \$179 million for a statewide system. Since that time the state has spent another \$132 million and is evaluating a request for an additional \$57 million. The system was supposed to be operational in 2001 but continues to experience delays.

According to the Pennsylvania Office of Administration, part of the reason the system is so late and so over budget is that the goals for the new system changed over the years. The initial plan was to replace aging, incompatible radio equipment and provide interoperability between various public safety agencies. After the September 2001 attacks the state expanded the radio plan to include county and local agencies. Additional costs and delays occurred as the network of planned repeater sites ran into land acquisition difficulties and construction setbacks.

### ❖ New York

Next door to Pennsylvania, the State of New York experienced a failure last December with the first major test of their new OpenSky system. Like Pennsylvania, New York originally contracted with M/A-COM to build a statewide radio network to allow police, fire, and other emergency personnel from different agencies to communicate directly with each other. New York's system, awarded to M/A-COM in 2005, came with a \$2.1 billion price tag and is currently in the build-out phase of installation in the western part of the state. The City of Buffalo and surrounding Erie County, along with the adjacent Chatauqua County, were supposed to be operational last June.



The performance on the new system fell far short of expectations, including significant gaps in coverage and poor voice quality. It was so bad that Buffalo appears ready to opt out of joining and intends to simply upgrade their existing radio equipment.

### ❖ Oakland County, Michigan

Scanner listeners in Oakland County, Michigan, just to the northwest of Detroit, are also facing a silent future as the county moves to a new \$42 million OpenSky system.

Oakland County selected M/A-COM in 2002 to install a new public safety radio network and is now ready to begin transitioning municipalities. Troy and Clawson police and fire departments are first in line, after which Royal Oak, Madison Heights, and Ferndale and the rest of the county will join. When the transition is complete, it will have totalled 41 police departments, 35 fire departments and 28 dispatch centers.

Troy has been operating as a test bed with seven vehicle-mounted and 15 portable OpenSky radios and has had a positive experience, with good coverage and clear audio quality.

Unfortunately, there is currently no consumer scanner available for OpenSky, so residents and news reporters are effectively locked out of the system. Because the technical details of the OpenSky network are proprietary and there are relatively few systems in operation, it is not clear if a major manufacturer like Uniden or GRE will take the financial and legal risks to develop a scanner capable of monitoring it. If enough of these OpenSky systems become operational and there is enough demand from consumers, perhaps there will be a product in the not-too-distant future that will satisfy the citizen's desire to keep track of what their public officials are doing.

That's all for this month. Keep sending email to me at [danveeneman@monitoringtimes.com](mailto:danveeneman@monitoringtimes.com) and check my web site at [www.signalharbor.com](http://www.signalharbor.com) for more radio-related information. Until next month, happy scanning!



# Big Savings on Radio Scanners

## Uniden® SCANNERS



### Bearcat® 796DGV Trunk Tracker IV with free scanner headset

Manufacturers suggested list price \$799.95  
**CEI Special Price \$519.95**

1,000 Channels • 10 banks • CTCSS/DCS • S Meter  
**Size: 6 15/16" Wide x 6 9/16" Deep x 2 3/8" High**

**Frequency Coverage:** 25,000-512,000 MHz., 806,000-956,000 MHz. (excluding the cellular & UHF TV band), 1,240,000-1,300,000 MHz.

When you buy your Bearcat 796DGV TrunkTracker package deal from Communications Electronics, you get more. The GV means "Great Value." With your BC796DGV scanner purchase, you also get a **free deluxe scanner headphone** designed for home or race track use. Headset features independent volume controls and 3.5 mm gold right angle plug. The 1,000 channel Bearcat 796DGV is packed with features to track Motorola Type I/II/III Hybrid, EDACS, LTR Analog Trunk Systems and Motorola APCO 25 Phase I digital scanner including 9,600 Baud C4FM and CQPSK. Also features control channel only mode to allow you to automatically trunk many systems by simply programming the control channel, S.A.M.E. weather alert, full-frequency display and backlit controls, built-in CTCSS/DCS to assign analog and digital subaudible tone codes to a specific frequency in memory, PC Control and programming with RS232C 9 pin port (cable not supplied), Beep Alert, Record function, VFO control, menu-driven design, total channel control and much more. Our CEI package deal includes telescopic antenna, AC adapter, cigarette lighter cord, DC cord, mobile mounting bracket with screws, owner's manual, trunking frequency guide and one-year limited Uniden factory warranty. For maximum scanning enjoyment, order magnetic mount antenna part number ANTMMBNC for \$29.95. For complete details, download the owners manual from the [www.usascan.com](http://www.usascan.com) web site. For fastest delivery, order on-line at [www.usascan.com](http://www.usascan.com).

### Bearcat® BCT8 Trunk Tracker III

Manufacturer suggested list price \$299.95  
**CEI Special Price \$169.95**

250 Channels • 5 banks • PC Programmable  
**Size: 7.06" Wide x 6.10" Deep x 2.44" High**

**Frequency Coverage:** 25,000-54,000 MHz., 108,000-174,000 MHz., 400,000-512,000 MHz., 806,000-823,987.5 MHz., 849,0125-868,9950 MHz., 894,0125-956,000 MHz.

The Bearcat BCT8 scanner, licensed by NASCAR, is a superb preprogrammed 800 MHz trunked highway patrol system scanner. Featuring TrunkTracker III, PC Programming, 250 Channels with unique BearTracker warning system to alert you to activity on highway patrol link frequencies. Preprogrammed service searches makes finding interesting active frequencies even easier and include preprogrammed police, fire and emergency medical, news agency, weather, CB band, air band, railroad, marine band and department of transportation service searches. The BCT8 also has preprogrammed highway patrol alert frequencies by state to help you quickly find frequencies likely to be active when you are driving. The BCT8 includes AC adapter, DC power cable, cigarette lighter adapter plug, telescopic antenna, window mount antenna, owner's manual, one year limited Uniden warranty, frequency guide and free mobile mounting bracket. For maximum scanning enjoyment, also order the following optional accessories: External speaker ESP20 with mounting bracket & 10 feet of cable with plug attached \$19.95. Magnetic Mount mobile antenna ANTMMBNC for \$29.95.



### Bearcat® BCD396T Trunk Tracker IV

Suggested list price \$799.95/CEI price \$519.95

APCO 25 9,600 baud compact digital ready handheld TrunkTracker IV scanner featuring Fire Tone Out Paging, Close Call and Dynamically Allocated Channel Memory (up to 6,000 channels), SAME Weather Alert, CTCSS/DCS, Alpha Tagging. **Size: 2.40" Wide x 1.22" Deep x 5.35" High**

#### Frequency Coverage:

25,000-512,000 MHz., 764,000-775,987.5 MHz., 794,000-823,987.5 MHz., 849,0125-868,9765 MHz., 894,0125-956,000 MHz., 1,240,000 MHz.-1,300,000 MHz.

The handheld BCD396T scanner was designed for National Security/Emergency Preparedness (NS/EP) and homeland security use with new features such as **Fire Tone Out Decoder**. This feature lets you set the BCD396T to alert if your selected two-tone sequential paging tones are received. Ideal for on-call firefighters, emergency response staff and for activating individual scanners used for incident management and population attack warning.

**Close Call Radio Frequency Capture** - Bearcat exclusive technology locks onto nearby radio transmissions, even if you haven't programmed anything into your scanner. Useful for intelligence agencies for use at events where you don't have advance notice or knowledge of the radio communications systems and assets you need to intercept. The BCD396T scanner is designed to track Motorola Type I, Type II, Hybrid, SMARTNET, PRIVACY PLUS, LTR and EDACS® analog trunking systems on any band. Now, follow UHF High Band, UHF 800/900 MHz trunked public safety and public service systems just as if conventional two-way communications were used. **Dynamically Allocated Channel**

**Memory** - The BCD396T scanner's memory is organized so that it more closely matches how radio systems actually work. Organize channels any way you want, using Uniden's exclusive dynamic memory management system. 3,000 channels are typical but **over 6,000 channels are possible** depending on the scanner features used. You can also easily determine how much memory you have used and how much memory you have left. **Preprogrammed Systems**

- The BCD396T is preprogrammed with over 400 channels covering police, fire and ambulance operations in the 25 most populated counties in the United States, plus the most popular digital systems. **3 AA NiMH or Alkaline battery operation and Charger** - 3 AA battery operation - The BCD396T includes 3 premium 2,300 mAh Nickel Metal Hydride AA batteries to give you the most economical power option available. You may also operate the BCD396D using 3 AA alkaline batteries. **Unique Data Skip** - Allows your scanner to skip unwanted data transmissions and reduces unwanted birdies. **Memory Backup** - If the battery completely discharges or if power is disconnected, the frequencies programmed in the BCD396T scanner are retained in memory. **Manual Channel Access** - Go directly to any channel. **LCD Back Light** - A blue LCD light remains on when the back light key is pressed. **Autolight** - Automatically turns the blue LCD backlight on when your scanner stops on a transmission. **Battery Save** - In manual mode, the BCD396T automatically reduces its power requirements to extend the battery's charge. **Attenuator** - Reduces the signal strength to help prevent signal overload. The BCD396T also works as a conventional scanner to continuously monitor many radio conversations even though the message is switching frequencies. The BCD396T comes with AC adapter, 3 AA nickel metal hydride batteries, belt clip, flexible rubber antenna, wrist strap, SMA/BNC adapter, RS232C cable, Trunk Tracker frequency guide, owner's manual and one year limited Uniden warranty. Not compatible with AGEIS, ASTRO or ESAS systems. Order on-line at [www.usascan.com](http://www.usascan.com) or call 1-800-USA-SCAN.

## More Radio Products

Save even more on radio scanners when purchased directly from CEI. Price includes delivery in the continental USA excluding Alaska.

Bearcat 8987 500 channel TrunkTracker III base/mobile.....	\$209.95
Bearcat 796DGV 1,000 channel TrunkTracker III base/mobile.....	\$519.95
Bearcat BCD396T APCO 25 Digital scanner with Fire Tone Out.....	\$519.95
Bearcat 246T up to 2,500 ch. TrunkTracker III handheld scanner.....	\$214.95
Bearcat Sportcat 230 alpha display handheld sports scanner.....	\$184.95
Bearcat 278CLT 100 channel AM/FM/SAME WX alert scanner.....	\$129.95
Bearcat 248CLT 50 channel base/AM/FM/weather alert scanner.....	\$104.95
Bearcat 92XLT 200 channel handheld scanner.....	\$109.95
Bearcat 72XLT 100 channel handheld scanner.....	\$99.95
Bearcat BR330T up to 2,500 ch. TrunkTracker III with Tone out \$274.95	
Bearcat BCT8 250 channel information mobile scanner.....	\$169.95
Bearcat 350C 50 channel desktop/mobile scanner.....	\$104.95
AOR AR16BQ Wide Band scanner with quick charger.....	\$199.95
AOR AR3000AB Wide Band base/mobile receiver.....	\$1,079.95
AOR AR5000A+3B Wide Band 10 KHz to 3 GHz receiver.....	\$2,599.95
AOR AR8200 Mark III Wide Band handheld scanner.....	\$594.95
AOR AR8600 Mark III Wide Band receiver.....	\$899.95
AOR AR-ONE Government/Export sales only 10 KHz-3 GHz.....	\$4,489.95
Scancat Gold For Windows Software.....	\$99.95
Scancat Gold For Windows Surveillance Edition.....	\$159.95

### Bearcat® BC246T Trunk Tracker III

Suggested list price \$399.95/CEI price \$214.95

Compact professional handheld TrunkTracker III scanner featuring Close Call and Dynamically Allocated Channel Memory (up to 2,500 channels), SAME Weather Alert, CTCSS/DCS, Alpha Tagging. **Size: 2.72" Wide x 1.26" Deep x 4.6" High**

#### Frequency Coverage:

25,000-54,000 MHz., 108,000-174,000 MHz., 216,000-224,980 MHz., 400,000-512,000 MHz., 806,000-823,987.5 MHz., 849,0125-868,9875 MHz., 894,0125-956,000 MHz., 1,240,000 MHz.-1,300,000 MHz.

The handheld BC246T TrunkTracker scanner has so many features, we recommend you visit our web site at [www.usascan.com](http://www.usascan.com) and download the free owner's manual. Popular features include **Close Call Radio Frequency Capture** - Bearcat exclusive technology locks onto nearby radio transmissions, even if you haven't programmed anything into your scanner. **Dynamically Allocated Channel Memory** - Organize channels any way you want, using Uniden's exclusive dynamic memory management system. 1,600 channels are typical but **over 2,500 channels are possible** depending on the scanner features used. You can also easily determine how much memory is used. **Preprogrammed Service Search (10)** - Makes it easy to find interesting frequencies used by public safety, news media TV broadcast audio, Amateur (ham) radio, CB radio, Family Radio Service, special low power, railroad, aircraft, marine, racing and weather frequencies. **Quick Keys** - allow you to select systems and groups by pressing a single key. **Text Tagging** - Name each system, group, channel, talk group

ID, custom search range, and S.A.M.E. group using 16 characters per name. **Memory Backup** - When power is lost or disconnected, your BC246T retains the frequencies that were programmed in memory. **Unique Data Skip** - Allows the BC246T to skip over unwanted data transmissions and birdies. **Attenuator** - You can set the BC246T attenuator to reduce the input strength of strong signals by about 18 dB. **Duplicate Frequency Alert** - Alerts you if you try to enter a duplicate name or frequency already stored in the scanner. **22 Bands** - with aircraft and 800 MHz. The BC246T comes with AC adapter, 2 AA 1,800 mAh nickel metal hydride batteries, belt clip, flexible rubber antenna, wrist strap, RS232C cable, Trunk Tracker frequency guide, owner's manual and one year limited Uniden warranty. For more fun, order our optional deluxe racing headset part #HF24RS for \$29.95. Order now at [www.usascan.com](http://www.usascan.com) or call 1-800-USA-SCAN.

## Buy with Confidence

### Order on-line and get big savings

For over 36 years, millions of communications specialists and enthusiasts worldwide have trusted Communications Electronics for their mission critical communications needs. It's easy to order. For fastest delivery, order on-line at [www.usascan.com](http://www.usascan.com). Mail orders to: Communications Electronics Inc., P.O. Box 1045, Ann Arbor, Michigan 48106 USA. Price includes \$30.00 UPS Ground shipping/handling/insurance per scanner to a street address in the continental USA excluding Alaska. Add \$20.00 shipping for all accessories. For shipments to Canada, Puerto Rico, Hawaii, Alaska, Guam, P.O. Box, APO/FPO, USPS Priority Mail or UPS 2 business day delivery, add \$30.00. Michigan residents add sales tax. No COD's. For Bearcat scanners your satisfaction is guaranteed or return item in unused condition in original packaging within 61 days for refund, less shipping charges. 10% surcharge for net 10 billing to qualified accounts. All sales are subject to availability, acceptance and verification. Prices, terms and specifications are subject to change without notice. We welcome your Discover, Visa, American Express, MasterCard, IMPAC or Eurocard. Order toll free, call 1-800-USA-SCAN or 1-734-996-8888 if outside Canada or the USA. FAX anytime, dial 1-734-663-8888. Dealer and international inquiries invited. Order your radio scanners from Communications Electronics today.

For credit card orders call  
**1-800-USA-SCAN**

e-mail: [cei@usascan.com](mailto:cei@usascan.com)  
[www.usascan.com](http://www.usascan.com)  
 PO Box 1045, Ann Arbor, Michigan 48106-1045 USA  
 For information call 734-996-8888 or FAX 734-663-8888



Visit [WWW.USASCAN.COM](http://WWW.USASCAN.COM) • 1-800-USA-SCAN



# Get Ready for Solar Cycle 24!

In the past year, it has become obvious that sunspot cycle number 23, as international observing organizations count these things, was nearly over. The solar activity, as measured by sunspot counts and noontime radio flux observations, has been about as low as it ever gets. Since these cycles change at the low point, it was only a matter of time before a new one began, bringing a gradual improvement in shortwave reception.

Now, many scientists believe that Cycle 24 has begun. The evidence came with the observation of a second high-latitude, reverse-polarity sunspot in early 2008. As sunspots go, it was tiny, and lasted only a few days. However, both the latitude and polarity seemed to indicate that it belonged to a new cycle. This makes two such discoveries since late 2006.

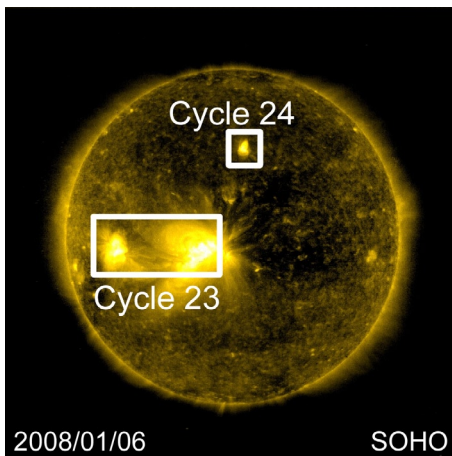

Sunspots, and the active regions that produce them, are relatively cool areas on the solar surface with strong magnetic fields. This activity rises and falls over an approximate 11-year period. It also reverses magnetic polarity each time, creating a 22-year full cycle.

Early in a new cycle, active regions and spots occur at relatively high solar latitudes, overlapping the lower-latitude spots from the previous one. Gradually, the new ones increase, moving southward as the cycle progresses. Since this has now happened twice, the new cycle seems at hand.

Activity won't pick up right away, but when it does, look for high-frequency (HF) radio propagation to improve rather dramatically. One quick measurement to follow is the "solar flux," a daily solar radio observation. Right now the numbers, as broadcast on WWV at minute 18, range between 65 and about 90, higher being better. Any extended period above

90 causes much stronger signals and higher usable frequencies. On weak digital utilities, this often makes the difference between no copy and a whole screen full.

As conditions pick up, newcomers to this hobby will eventually know why manufacturers put frequencies between 20 and 30 megahertz (MHz) in shortwave receivers. In day time, these will become the best places to hear a lot of traffic.

The improvement comes slowly, so next winter might not change in any truly spectacular manner. However, the year after that should be pretty awesome. Unfortunately, all of this depends on whether the increased activity will also bring more days of disturbed propagation, as it tended to do in Cycle 23.

If you've never heard the HF radio effects from these disturbances, you will. It can be quite an experience. These effects range from the sudden fade out of all HF propagation on the daylight side of the Earth to increased fading and flutter on signals.

The fade outs, caused by Sudden Ionospheric Disturbances (SIDs), follow strong x-ray flares. These flares are enormous explosions that occur in the areas around sunspots, when intense magnetic fields rupture and release wide-spectrum bursts of electromagnetic energy.

For now, you can duplicate the effect by removing the antenna from your radio. It's that dramatic. The ionosphere recovers over a period of 40 minutes to an hour, depending on the magnitude of the disturbance.

The more lingering effects come from coronal mass ejection. This mass affects Earth as an enhanced solar wind, usually 36 hours or so after the flare or other event. The first audible effects come from increased aurora.

Aurora is, of course, the same particle flow that produces the northern and southern lights. Auroral flutter is amazing to hear. When it is strong, it can distort the phase of signals so heavily that Morse code dots blend together, and atomically-generated time signals actually waver in pitch. This is the stuff that can really cause trouble for power grids, pipelines, and communication satellites.

Various effects can persist for days, leading to weak and fading signals. Fortunately, bad days are often predictable, since active solar regions rotate around the sun in a period of approximately 28 days. Most of the propagation forecasts in the magazines take advantage of this rotation.

Solar cycles rarely follow the exact rules,

but if everything stays on schedule, the solar maximum should come sometime around 2011. Scientists are currently divided on how strong a peak we can expect. In the past, peak daily solar fluxes have briefly played with the 300 mark, and several months of 200-250 are guaranteed.

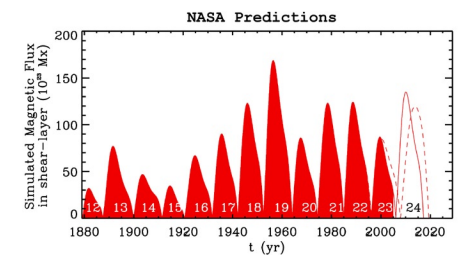

One good web site for following the new cycle is at [spaceweather.com](http://spaceweather.com). Somewhat more technical, but very official information is in the daily bulletins of the US Space Weather Prediction Center, at [www.swpc.noaa.gov/forecast.html](http://www.swpc.noaa.gov/forecast.html).

## ❖ Cuban RDFT is Back

Right as we go to press, Cuban numbers frequencies are buzzing, quite literally, with the Redundant Digital File Transfer (RDFT) mode. Those who've followed all the weird Cuban digital experiments know RDFT as the 8-tone, differential phase modulation mode usually decoded with a free ham program for the PC called DIGTRX (presumably for Digital Transfer). This mode is tuned in upper sideband (USB). Its more common use is by hams sending pictures without analog noise.

For much of December, the daily schedule at 1700 Coordinated Universal Time (UTC) on 17435 kilohertz (kHz) sent text files in RDFT. Right now, though, it has gone back to the voice format called V02a by the ENIGMA 2000 numbers group. Today, however, as we were writing the sunspot explanation, RDFT appeared at 1800, following a series of tones that gave everyone a chance to start DIGTRX.

Today, other ENIGMA members have just heard RDFT on 7887 kHz at 2000 UTC, 8097 at 1800, and 11566 at 1630. Earlier transmissions were copied on 6855 at 2100, and 8097 at 1900. In all cases, the files being transferred have 8-digit names with an extension of .TXT. Indeed, these open as text. They usually have lines of 2's and 3's as delimiters, but the actual messages are some kind of encrypted or compressed binary data. It prints as total garbage.

As always, it's anyone's guess what's really going on here. Buzz away until next month.

## ABBREVIATIONS USED IN THIS COLUMN

AFB.....	Air Force Base
ALE.....	Automatic Link Establishment
AM.....	Amplitude Modulation
CAMSLANT....	Communication Area Master Station, Atlantic
COTHEN.....	US Customs Over-The-Horizon Enforcement Network
CW.....	On-off keyed "Continuous Wave" Morse telegraphy
DEA.....	US Drug Enforcement Administration
E17.....	Russian "KGB," "English Lady" voice, ends 00000
E11.....	"Strich," English "oblique" callup, 5-figure groups
EAM.....	Emergency Action Message
EPA.....	US Environmental Protection Agency
FEMA.....	US Federal Emergency Management Agency
HFDL.....	High-Frequency Data Link
HF-GCS.....	High-Frequency Global Communication System
JSTARS.....	Joint Surveillance Target Attack Radar System
LDOC.....	Long-Distance Operational Control
LSB.....	Lower Sideband
M08a.....	Cuban 3-msg CW/MCW, ANDUWRIGMT = 1-0
MARS.....	Military Affiliate Radio System
MCW.....	Modulated CW or AM tone Morse telegraphy
RDFT.....	Redundant Digital File Transfer, 8-tone mode
Selcal.....	Selective Calling
SHARES.....	SHARed RESources, federal interoperability pool
SITOR-B.....	Simplex Telex Over Radio, Forward Error Correction
SK01.....	Generic for Cuban numbers in ham digital modes
Unid.....	Unidentified
US.....	United States
USS.....	United States Ship
USAF.....	United States Air Force
USCG.....	United States Coast Guard
UK.....	United Kingdom
V02a.....	"Atencion" Spanish numbers, 3-msg format

All transmissions are USB (upper sideband) unless otherwise indicated. All frequencies are in kHz (kilohertz) and all times are UTC (Coordinated Universal Time). "Numbers" stations have their ENIGMA (European Numbers Information Gathering and Monitoring Association) designators in ( ).

- 2040.0 INGEZ-Indiana National Guard, Shelbyville, ALE sounding at 0106. T1Z137-Ohio National Guard, ALE sounding, also on 2540, 3246.5, and 5351.5, at 0107. (Jack Metcalfe-KY)
- 2749.0 Unid-Canadian Coast Guard, probably St. John, NB, maritime weather at 0149. (Metcalfe-KY)
- 2872.0 El Al 107-El Al Israel Airways, position for Gander at 0733. (Allan Stern-FL)
- 2899.0 Gander-Gander Radio, NFD, passing turbulence warning from Northwest Dispatch, at 0711. (Stern-FL)
- 3016.0 American 54-American Airlines, selcal check with Santa Maria at 0517. (Stern-FL)
- 3137.0 INGEZ-Indiana National Guard, ALE sounding, also on 6721, at 1149. (MDMonitor-MD)
- 3193.5 CLS-US Army Special Operations, KY, ALE sounding at 1708. (Metcalfe-KY)
- 3204.0 043MERCAP-US Civil Air Patrol, ALE sounding at 0238. (Metcalfe-KY)
- 3255.5 AAM4INC-US Army MARS, possible multi-service net with Navy/ Marine Corps MARS, at 0236. (Metcalfe-KY)
- 3299.0 AFA2FJ-USAF MARS, net at 0144. (Metcalfe-KY)
- 3325.0 NNN0PBE-US Navy/ Marine Corps MARS net, at 0240. (Metcalfe-KY)
- 3390.0 NNN0IJG-US Navy/ Marine Corps MARS, net with NNN0NIG and NNN0SYH, at 0305. (Metcalfe-KY)
- 3455.0 Ethyl 90-USAF tanker, position for New York at 0642. Ethyl 91, position for New York at 0643. (Stern-FL)
- 3455.0 Speedbird 208-British Airways, position for New York at 0430. (Stern-FL)
- 4017.0 Cuban Spanish female voice "numbers" (V02a), AM but sounded best in LSB, in progress at 0305. (Mike-West Sussex, UK)
- 4068.0 November Whiskey-US Navy, probably USS Nassau air defense

- 4068.0 November Whiskey-US Navy, tracking a Global Hawk unmanned aerial vehicle with Golf, at 1930. (Stern-FL)
- 4079.7 TMP-Pirate CW temperature beacon, CA, identifying with Fahrenheit temperature (42), at 0227. (Tom Severt-KS)
- 4149.0 WBN3013-Crowley Maritime Tug Sentry, check-in with "WPE Jacksonville," FL, at 2321. (Cleary-SC)
- 4331.0 4XZ-Israeli Navy, CW message in 5-letter groups, at 0500. (Severt-KS)
- 4369.0 WLO-Mobile Radio/ Shipcom, AL, offshore weather forecast, simulcasting 4396, at 0600. (Cleary-SC)
- 4445.0 AAM5MI-US Army MARS, net at 1421. (Metcalfe-KY)
- 4536.0 LYN-Virginia National Guard, Lynchburg, sounding in LSB ALE, also on 6766, at 1547. (Metcalfe-KY)
- 4593.5 AFA1BQ-USAF MARS, net at 1419. (Metcalfe-KY)
- 4623.5 NNN0TGQ-US Navy/ Marine Corps MARS, net at 1419. (Metcalfe-KY)
- 4739.0 711-US Navy P-3C, ops-normal for Fiddle, Jacksonville, FL, at 0731. (Cleary-SC)
- 4780.0 Golden Pirate-Indiana Joint Forces Headquarters Emergency Radio Network, working Anderson and Bloomington, LSB at 1400. (Metcalfe-KY)
- 5236.0 AFA1CM-USAF MARS, with a SHARES exercise message at 1607. (Metcalfe-KY)
- 5430.5 MONGO1-Unknown station sounding in ALE with MONGO2, at 2030. (Metcalfe-KY)
- 5541.0 ICL907-Israel Cargo Logistics freighter, company patch in Hebrew via Stockholm LDOC, at 2035. (Patrice Privat-France)
- 5565.0 Angola 742-TAAG Angola Airlines, working Luanda Radio at 0613. (Privat-France)
- 5598.0 Air Mexico 022-AeroMexico, sent to 3455 for selcal check by New York, at 0605. (Stern-FL)
- 5616.0 Reach 285-USAF Air Mobility Command transport, position for Gander, then sent to 4675 for Shanwick, at 0522. (Stern-FL)
- 5634.0 Corsair 910-Corsair Airlines Boeing 747-422 (F-GTUI), answered selcal DS-CE on Indian Ocean net, at 2230. Cathay 749-Cathay Pacific Airways Boeing 747-467 (B-HOX) answered Indian Ocean net selcal AD-JL at 2250. (Privat-France)
- 5711.0 Cape Radio-USAF, Cape Canaveral Air Force Station, FL, testing at 1751. (Cleary-SC)
- 5717.0 Halifax Military-Canadian Forces, NS, setting secondary of 8992 for unheard aircraft, at 1948. (MDMonitor-MD)
- 5732.0 OPB-DEA Operations Bahamas and Tortugas (OPBAT), working helicopter J12, ALE at 0800. (Privat-France) TSC-US Customs Technical Service Center, FL, working 707 (HC-130H Coast Guard 1707), at 1017. (MDMonitor-MD) Coast Guard 1708-USCG, patch via Service Center, FL, to Air Station Clearwater, at 1449. (Cleary-SC)
- 5820.0 KGD825-EPA, MA, ALE sounding at 1341. (Metcalfe-KY)
- 5821.0 WGY901-FEMA Region 1, MA, voice and 39-tone data with WGY931, Vermont State Emergency Operations Center, at 1923. (Metcalfe-KY)
- 6586.0 Continental 31-Continental Airlines, working New York at 0558. (Stern-FL)
- 6628.0 Virgin 30-Virgin Airlines, position and selcal with Santa Maria, at 0656. (Stern-FL)
- 6640.0 Speedbird 204-British Airways, position for Gander, at 0633. (Stern-FL)
- 6746.4 P2B-US Navy, FL, calling C1A, SC, also on 7965, ALE at 1325. (Cleary-SC)
- 6765.0 NNN0EPY-US Navy/ Marine Corps MARS, in SHARES regional net with Civil Air Patrol Starfish 40 and North Central 54, taking check-ins for "Exercise Dark Crystal," at 1921. (Metcalfe-KY)
- 6819.6 KTQ313-EPA, ALE sounding at 2054. (Metcalfe-KY)
- 6855.0 Cuban Spanish AM "numbers" (V02a), callup 91831 88642 41233, at 2100. V02a, callups 36081 32605 77470, 70726 60047 63165, and 45323 12372 04476, all at 2102. V02a,



- started late, no callup, at 2105. (Cam Castillo-Panama) V02a, AM numbers in progress at 2127. (Michael Maher-NJ)
- 6910.0 WNIY791-Southwestern Bell, TX, SHARES regional net with KNY56 and KNY84, at 1613. (Metcalfe-KY)
- 6985.0 T12-US Army 12th Aviation, VA, ALE sounding at 1817. (MD-Monitor-MD)
- 7439.0 Unid-"Strich" numbers (E11), null-message callup "312 oblique 00," at 1230. (Mike-UK)
- 7527.0 08C-DEA, position for Panther, Bahamas, at 1558. (Cleary-SC) KCMSEC-COTHEN remote, Kansas City, MO, calling USCG helicopter J10, ALE at 2141. (MDMonitor-MD)
- 7650.0 T1Z137-Ohio National Guard 1-137th Assault Helicopter Battalion, ALE sounding at 1733. (MDMonitor-MD)
- 7681.0 Cuban AM numbers (V02a), best in LSB, in progress at 1914. (Sevart-KS)
- 7798.0 "Strich" null-message callup "221 oblique 00" (E11), at 0915. (Mike-UK)
- 7811.0 American Forces Network-US Armed Forces Radio/TV Service Interruptible Voice Channel, relay from US Navy comm station Saddlebunch Key, FL, with live National Public Radio news at 2257. (William Hassig-IL) [On 24/7; great signal in California -Hugh]
- 7887.0 Cuban Spanish AM numbers (V02a), callup 03911 26314 57808, at 2000. V02a, late start, only heard 02550, at 2002. V02a, in progress at 2004, 2007, and 2015. (Castillo-Panama)
- 7965.0 P2B-US Navy, FL, calling C1A (USN, Charleston, SC), ALE at 1432. (Cleary-SC)
- 7974.0 Cuban CW "Cut Numbers" station (M08a), in progress at 2108. (Castillo-Panama)
- 7997.0 V02a, AM callup 81884 02734 07220, at 2001. (Castillo-Panama)
- 8026.0 303CDCS48-US National Public Health Radio Network with 453CDCH48, ALE, LSB voice, and digital at 1727. (Metcalfe-KY)
- 8050.0 CLS-US Army, KY, ALE sounding at 1436. FC8FEM-FEMA Region 8, CO, ALE sounding at 1440. IN5FEM-FEMA Indiana State Emergency Operations Center, ALE sounding at 2141. (MDMonitor-MD)
- 8097.0 Cuban MCW "Cut Numbers" (M08a), substituted callups 60121 86504 72404, 52886 02208 83772, 88941 42411 43622, and 81550 47285 70607, at or near 1801. M08a, MCW in progress, at 1818. M08a, callups 70662 36153 26732 and 43455 25742 23421, at 1900. M08a, MCW callups 58310 64531 71142, 33831 67711 81581, 15682 23303 38103, and 88941 42411 43625, at 1901. (Castillo-Panama) M08a, MCW in progress at 1818 and 1904. (Sevart-KS)
- 8156.0 Coral Harbour Base-Royal Bahamas Self-Defence Force, working an unheard station at 1239. (Cleary-SC)
- 8176.0 VMC-Australian Bureau of Meteorology, Charleville, voice weather forecasts at 1242. (MDMonitor-MD)
- 8181.5 T1126-Rhode Island National Guard 1-126th Aviation, ALE sounding, also on 12168, at 1728. (MDMonitor-MD)
- 8188.7 "W"-Pirate CW beacon, CO, at 1605 and 1830. (Sevart-KS)
- 8885.0 THA794-Thai Airways International flight, HF DL position for Bahrain at 1422. 3U8918-Sichuan Airlines, HF DL position for Bahrain at 1440. CCA174-Air China, HF DL position at 1501. MU5619-China Eastern Airlines, HF DL position at 1459. PR0856-Philippine Airlines, HF DL position at 1436. (Privat-France)
- 8912.0 D90-US Customs P-3A, ALE sounding, also on 11494 and 15867, at 1355. EST-COTHEN Eastern Regional Node, calling 706 (a C-130), ALE at 2032. (MDMonitor-MD) Juliet 01-USCG helicopter, ops-normal and position for CAMSLANT, at 1720. (Cleary-SC)
- 8960.0 LTU1674-LTU Lufttransport-Unternehmen flight, working Luanda Radio at 1725. (Privat-France)
- 8971.0 Red Talon 71B-US Navy P-3C, ops-normal for Fiddle, USN Tactical Surveillance Control Center, FL, at 1504. (Cleary-SC) Fiddle-US Navy radio checks with P-3C Quartet 712, at 2030. (MDMonitor-MD)
- 8983.0 CAMSLANT-USCG, VA, working helicopter Coast Guard 2140 at 1907 (Cleary-SC) CAMSLANT, working helicopter Swordfish 28, at 2133. (MDMonitor-MD)
- 8992.0 Real Silk-US military, EAM at 2025. (MDMonitor-MD)
- 9025.0 E30007-USAF E-3B, ALE-initiated patch via McClellan, CA, at 2138. (MDMonitor-MD)
- 9100.0 TC189-US Army, ALE sounding at 1625. (Metcalfe-KY)
- 10000.0 Unid-Spanish speaking males, with typical chatter under WWV, at 1546. (Sevart-KS) [They've been there at least 15 years. Amazing. -Hugh]
- 10081.0 BO0006-Boeing KC-767A tanker (N763TT), test flight for Japan Self-Defense Force, giving HF DL position to San Francisco at 1957. (Hugh Stegman-CA)
- 10200.0 Shark 08-USCG Cutter *Tahoma*, clear and secure with helicopter Falcon 40, at 1916. (Cleary-SC)
- 10242.0 Service Center-US Customs, voice and ALE checks with 2CC, a US Customs Cessna 550, at 2108. (MDMonitor-MD)
- 10445.0 M08a, 5-letter CW in progress at 0302. (Sevart-KS)
- 10780.0 Peach 33-USAF E-8 JSTARS, patch via Cape Radio to Peachtree (Robins AFB, GA) for tanker status, at 1640. (Cleary-SC)
- 10993.6 Sector Key West-USCG, ops-normal from helicopter Dolphin 58, at 2048. (Cleary-SC)
- 11170.0 Russian "English Lady" (E17) callup 674, short 5-figure-group message, then sign 201/5, at 0800. (Mike-UK)
- 11175.0 Offutt-USAF HF-GCS, Offutt AFB, NE, sending Ply Board to 11220 for data, at 1610. Offutt, 6-character EAM "for Sappy," then patch from unheard Team 78 to McGuire Command Post, at 1904. (Jeff Haverlah-TX) U-haul 11-USAF C-5A transport, requesting a patch via Lajes HF-GCS, but too weak, at 1950. (MDMonitor-MD) Marlin 80, patch via Lajes HF-GCS, Azores, to Whidbey Island Naval Air Station, at 2109. Marlin 80, another patch, this time via Andrews HF-GCS, MD, to Whidbey Island, at 2117. (Stern-FL)
- 11220.0 Offutt-USAF Offutt HF-GCS, asking Ply Board (who came from 11175) for data mode, then contact in "async 4-tone" at 1611. (Haverlah-TX)
- 11232.0 Peach 33-USAF E-8 JSTARS, patch via Trenton Military with maintenance writeup at 1801. (Cleary-SC)
- 11309.0 Avianca 011-Avianca, position for New York at 2030. (Stern-FL)
- 11488.0 027CDCS48-US Centers for Disease Control, working 141CDCS48 in LSB ALE, at 2024. (Metcalfe-KY)
- 11494.0 LNT-USCG, VA, ALE and weak voice with USCG helicopter F04, at 1926. TSC, COTHEN, FL working F04 in ALE and voice at 1932. (MDMonitor-MD)
- 12164.0 051CDCS41-US Centers for Disease Control, ALE sounding at 1747. (Metcalfe-KY)
- 12579.0 NMF-USCG, Boston, MA, maritime safety information in SI-TOR-B, at 1630. (Sevart-KS)
- 13354.0 Lufthansa 901-Airliner with position and selcal check for New York, at 1514. (Sevart-KS)
- 13356.0 Dispatch-Air Jamaica LDOC, Kingston, working Jamaica 010 at 1653. (Sevart-KS)
- 13488.0 061CDCS48-National Public Health Radio Network, with 303CDCS48, ALE at 1629. KGD825-EPA, Boston, MA, also on 9414.5, 10202.0, and 12164.0, ALE at 1741. (Metcalfe-KY)
- 13927.0 AFA1YV-USAF MARS, NY, patch to Keesler AFB for arrival of Teal 61, a 53rd Weather Recon WC-130, at 2021. (Stern-FL)
- 15034.0 Trenton Military-Canadian Forces, Trenton, Ontario, aviation weather for Canada, Greenland, and Iceland, at 2024. (Leonard Estorge-LA)
- 15658.0 WGY9030-FEMA, passing "RYRYRYRY" test string to WGY9032 as an ALE text message, at 2037. (Metcalfe-KY) [RY is used on old Baudot circuits because it contains all possible states. Its use on ALE is just old school, I guess. -Hugh]
- 15867.0 715-USCG HC-130H, ALE sounding at 1605. (MDMonitor-MD)
- 17435.0 V02a, repeated "tres" in AM at 1658, then callup 55562 32878 05365 at 1700. V02a, AM callup 83653 38803 84048, at 1700. (Sevart-KS) V02a, AM callup 43856 77162 17558, at 1701, and in progress at 1729. (Castillo-Panama) Cuban RDFT testing (SK01), sent encrypted text files 231109.txt, 231113.txt, and 231114.txt, all with same 8-bit content, at 1720, 1735, and 1745. (Stegman-CA)
- 17515.0 SK01, AM carrier and RDFT at 1600, cut to standard V02a in progress, bad audio, at 1603. V02a, late start with callup 55562 32878 05365, bad audio mixing with an unknown broadcast program, at 1604. (Sevart-KS)

# Easy Catches for Beginners

This column is the result of a New Year's resolution. In line with the *MT* philosophy of providing as many frequencies for you to tune to as possible, I'll be scanning a 200 kHz section of the HF spectrum and noting what digital delights you can hear there, starting this month.

However, before we do that, I thought we'd start off the new year with a few "oldies but goodies": easy things to hear with a minimum of equipment and a good variety of interesting stuff for the beginner.

### Oldie but Goodie #1: Egyptian Diplomatic Service

If it's SITOR-A (otherwise known as AMTOR or ARQ) and the frequency ends in .7, it's probably the Egyptian Diplomatic Service! These guys have been at it on shortwave with the same gear for more than three decades. While the past few years have seen experimentation with a number of different modes (seeming to have settled on the Codan 9000-series 16 tone modems), they still can't resist keeping the SITOR gear warm with a call-up, operator chatter or even the odd message or two. With a bit of patience and tuning around, you're almost guaranteed to hear them on any day.

When using SITOR, the Egyptians use the ATU-80 (Arab Telecommunications Alphabet 80) on most traffic, which looks a bit strange to begin with, but is soon recognizable. Coded traffic is seldom used, messages being mostly in the clear (if you can read ATU-80, of course!).

If not done with the Codan Chirp (see the November 2007 column), call-ups often use SITOR-B and start with the string "fmfmfm-fmfmfmfm" instead of the usual "ryryryryry" signal. In these call-up exchanges, operators usually specify the called embassy and the QSX (reply) frequency, since most operation is done using separate transmit and receive frequencies. Numbers sent in ATU-80 read backwards, so a QSX frequency of 5099 actually means "listen on 9905 kHz." This is the carrier frequency when tuning in Upper Sideband. The center of data is 1.7 kHz higher (9906.7 kHz in this case).

**Frequencies to try:**  
6786.7, 8023.7, 8089.7, 8189.7, 9056.7, 9067.7, 10156.7, 10168.7, 10177.7, 13926.7, 14923.7, 16079.7, 18326.7 and 18716.7 kHz

### Oldie but Goodie #2: German Weather Service

One of the few weather stations still available on shortwave RTTY, the transmitters of the

German Weather Service (DWD) run night and day on a variety of frequencies and can be heard far and wide. The DWD uses a 50bd 425 Hz shift Baudot RTTY signal that can be decoded with the simplest of equipment.

**Frequencies to try:**  
4583, 7646, 10100.8, 14467.3 and 15988 kHz

### Oldie but Goodie #3: Canadian Forces, Halifax

Another long-standing RTTY signal is that from Canforce, Halifax, in Nova Scotia. Most of the time, this station sends a standard "Notice to all warships" (NAWS) channel marker using 75bd/850Hz Baudot RTTY signal. A number of frequencies share their channel with Fax traffic, too.

**Frequencies to try:**  
73.6, 122.5, 4271, 4997, 5097, 6389, 6496, 10536, 10945, 13510 and 15920 kHz

### Oldie but Goodie #4: US Air Force ALE

Just where is Air Force Two, Mr. President? Yes, ALE identifier AF1 probably is the leader of the free world winging his way to the next important meeting. Along with many ground stations and several thousands of other aircraft, you can hear the goings on of the USAF right on your HF radio.

With more than 20 frequencies to choose from and locations around the world, you're bound to hear them just about everywhere testing the ether with soundings, linking with ALE, firing up phone patches, high speed modems and other tasks: all through the wonder of MIL-STD-188-141A Automatic Link Establishment or ALE signals.

**Frequencies to try:**  
2805, 3059, 3068, 3137, 4490, 4721, 4724, 5684, 5708, 6685, 6715, 6721, 6761, 7632, 7840 8965, 8992, 9019, 9025, 9026, 9027, 9057, 11175, 11226, 11250, 13209, 13215, 15016, 15043, 18000, 18003, 20031, 20631, 23337 and 27870 kHz USB

### Oldie but Goodie #5: Royal Naval Fleet Broadcast Fax

There's still a strange fascination watching a weather chart reveal itself slowly over a few minutes, a remnant of a bygone time still alive in the Internet age. The Royal Navy's GYA still broadcasts a regular schedule of weather charts to the world on a number of frequencies that can be heard widely at many times of the day.

**Frequencies to try:**  
2618.5, 4610, 6834, 8040 and 11086.5kHz

### Oldie but Goodie #6: Prefectura Naval Argentina

Although operating on only a few frequencies, the Argentine Coast Guard is a good test for your SITOR-B gear, coming through loud and clear most evenings.

Traffic is in the clear, in Spanish, using NATO style message format. Message origin and destination are denoted by routing indicators like RECAPNA, DIOPPNA, KSTMPNA and SANIPNA that have yet to be clearly associated with stations or facilities.

**Frequencies to try:**  
4521.7 and 7771.7 kHz

### Oldie but Goodie #7: NATO Navy Channel Availability Stations

The Italian, French, Dutch and sometimes Royal Navy still operate a number of stations sending channel availability information to ships at sea. These are usually sent using standard 75bd 850Hz shift Baudot RTTY and thus make an excellent catch for even the simplest of equipment.

**Frequencies to try:**  
Dutch Navy 2474, 12840.5 and 17118 kHz  
Royal Navy 8642.1 kHz  
Italian Navy 4227 and 6333.5 kHz  
French Navy 2780, 2789 and 6348 kHz  
Portuguese Navy 12823.5 kHz

### Digital Bandscan

This month, we look at regular digital signals recently found between 9000 and 9200 kHz.

- 9010.0 NATO with Link-11
- 9011.7 Egyptian Embassy, Rome with 100bd SITOR-A
- 9025.0 US Air Force many stations and aircraft with MIL-188-141A ALE
- 9030.0 US Military with 75bd/850 FSK KG84 encryption
- 9045.1 XNet Yachting Association with 100bd 200Hz PactOR channel free signal
- 9047.0 Many US SHARES stations with MIL-188-141A ALE
- 9050.0 Rockwell Collins modem test frequency
- 9052.0 Venezuelan Army and National Guard with MIL-188-141A ALE
- 9055.0 Egyptian Embassy, Havana with Codan 9000-series 16 tone modem

continued on page 67

## VOA Special English Makes Changes to Word List

VOA has just updated its list of words used in its Special English broadcasts, something it does only once every ten years. The following have been added: abuse, advertise, attention, available, behavior, career, class, collapse, contact, corruption, detain, disaster, discrimination, donate, double, embryo, extraordinary, fan, favorite, generation, genocide, ignore, Internet, justice, militia, neighbor, partner, persuade, predict, promise, rape, register, respect, restaurant, rural, suicide, vacation, vaccine, video, visa, volunteer, website, whether, witness.

The following have been deleted: bell, blanket, capitalism, grandmother, grandfather, grandson, granddaughter, mercy, pan, tears,

vicious (Source: *Columbus Dispatch*)

Andy Sennitt posted this on the Media Network blog and comments: "It's interesting to see the word *embryo* added to the list. I remember many years ago listening to a Special English broadcast which mentioned 'chicken embryos' and being surprised, as I didn't think the word *embryo* was in the list of permitted words. Apparently it wasn't. I wonder how strictly some of the writers adhere to the official list. Studying the complete list of added words is actually quite depressing, as so many of them are clearly related to the less pleasant aspects of human behaviour."

**AFGHANISTAN** [non] The additional frequency of R. Solh, via UK reported last month, 13830, turned out to be only a brief test. Main frequency continued to be 15265 at 1200-1500, playing exactly the same music and talk program day after day into 2008 (gh)

**ALBANIA** The new present web page of Albanian Radio television is [www.rts.al](http://www.rts.al) - Radio Tirana Channel 3 is the foreign service, where you will have the 'Internet' option to listen in the future, I hope beginning this year (Drita Çiço, ARTV-Albanian Radiotelevision, Head of Monitoring Center, *DX LISTENING DIGEST*)

**ARGENTINA** Starting Dec 30, time here was advanced from UT -3 to UT -2, as the government wants to save energy in the summer, until March 16. The exact DST dates will be fixed annually (Arnaldo Slaen, *DXLD*) RAE's English to NAm at 0200 on 11710v changed to French (Steve Wood, MA, *DXLD*) DST caused them to advance all UT scheduling by one hour so English now at 0100-0200 Tue-Sat; also to Eu on 15344.4v, M-F at 1700 instead of 1800. This is totally for RAE's convenience and not for listeners' who have made no such clock change abroad; but RAE does have to integrate relays of domestic service (gh)

**BANGLADESH** After installing a new solid-state 1000 kW MW transmitter this year, Bangladesh Betaar has a further plan to replace the 250 kW SW transmitter near Dhaka at Kabirpur (BB via Alokesh Gupta, New Delhi, India, also via Rachel Baughn) Perhaps it will then start to fulfill the imaginary schedules it has been registering (gh)

**BHUTAN** 6035, Bhutan Broadcasting Service, Sangaygang, checked from 2355: no signal till 0055 when heard weak tone and carrier; suddenly at 0100 started music. Since the SW would not propagate at 0000, they bring up the transmitter at 0100 straight into the program (Victor Goonetilleke, Sri Lanka, *DSWCI DX Window*) New s/on time around \*0100 or \*0050 (Anker Petersen, Denmark, *ibid.*)

**BOLIVIA** José Luis López, director of R. San Miguel, Riberalta, denounced the fact that the first vice-president of the Beni Civic Committee, Marco Jáuregui, had threatened to take over the facilities of R. San Miguel, which is with the ERBOL network, for broadcasting coverage of pro-government sectors of society. López also informed the local police of the threats (AIB via Arnaldo Slaen, *condiglist* yg)

Two weeks later, R. San Miguel still heard, on 4699.35 at 1003-1018 (Scott Barbour, NH, *DXLD*) And another morning on 4699.32 at 1007-1020 fading (Chuck Bolland, FL, *ibid.*)

**BRAZIL** Rede Boa Vontade, 9550 was accompanied by good quality spurs 240 kHz above and below, on 9310 and 9790, ID at 2253 (Adán Mur, Paraguay, *Conexión Digital*)

**CANADA** Following news that CBC's Vancouver flagship on 690, CBU, had applied to move to FM, SWLs were concerned about the future of its SW relay from the same AM site, CKZU on 6160 (gh) The future of CKZU is currently being evaluated. There is a distinct possibility that the operation could close. However, a final decision has yet to be made, and will depend in part on whether the FM application is approved and the new service is implemented. At this point a "wait and see" approach is best. Thank you again (Kim Belle, CBC Audience Relations via Ron Howard, Monterey, CA, *DXLD*) I would hate to see CKZU go, having listened to it over much of western Canada when no other CBC was available (Eric Flodén, BC, *ibid.*) I would be disappointed to have them close their SW operation. Perhaps others who feel the same way should also e-mail Kim Belle [cbcinput@toronto.cbc.ca](mailto:cbcinput@toronto.cbc.ca) (Ron Howard, *ibid.*)

CFRX 6070 - Per a recent phone chat with the engineer, a new solid state transmitter is on order for CFRX, made by a U.S. company, [www.armstrongtx.com](http://www.armstrongtx.com) It's a rebuild of their medium-

wave model X1000B. This should be light-years ahead of the old Elcom Bauer transmitter. Delivery was expected in early January. Antenna adjustments were also still needed. CFRX will be back on the air soon. From e-mail and web buzz, a lot of people are anxiously waiting for its return (CFRB/CFRX QSL Manager Steve Canney, VA3SC, via BC-DX) While they are at it, why in the world not up the power from only 1 kW? It will continue to get hit by CVC and others who pretend CFRX does not exist (gh)

**CHAD** Rdif. Nationale Tchadienne, Ndjamena, which for several weeks last year put an extremely distorted signal varying around 7300 instead of 6165 kHz, unexpectedly reactivated its old 60 meter channel, reversing the usual trend (gh) First noted Dec 20 at 1627 on 4905 in French, 1700 Arabic, strong, blocking China on same (Jari Savolainen, Finland, *DXLD*) Then widely reported, including: 4904.97, closed with trumpet, national anthem from 2228:20 to 2229:23 UT, ex-6165; also heard at 0720 (Wolfgang Büschel, *DXLD*) Quite decent reception of typical African music on 4905 here even in my flat. It's almost like a decade ago, when Chad left 60 metres, but with one exception: They are indeed on 4905, maybe 30 Hz low, but not again on their old 4904.5 frequency which was apparently intentional for some reason (Kai Ludwig, Germany, *ibid.*) The last logging we had of Chad on 60m was over 10 years ago in October 1997 (Dave Kenny, England, *BDXC-UK*)

Still on 6165 in daytime, opening 4905 around 1600 (Carlos Gonçalves, Portugal, *ibid.*) And 4904.97 from \*0427 to 0731\* (Anker Petersen, Denmark, *playdx* yg) Half an hour later on Saturday to 2301\* (Mark Taylor, WI, Mark Schiefelbein, MO, *ibid.*) On later until 0006\* Jan 1 (Brian Alexander, PA, *ibid.*) Best 60m signal by far from outside NAm, at 0605-0620, rivaled only by Mauritania 4845 when it's on, but Chad fades out two hours earlier (gh, OK) Needed lower frequency at night to reduce skip zone (Victor Goonetilleke, Sri Lanka, *BC-DX*)

**CHINA** Offband type Firedragon [or Firedrake] jamming heard at 0215 on 10400, 12160, 13970, 14410, 15050, 16750 and 18180 with Sound of Hope QRM confirmed on 18180. Also Firedragon from 0930 the day before on 9290 blocking Latvia (Sei-ichi Hasegawa, Japan, *NDXC, DXLD*) All of these except 18180 also heard here at 1000 (Wolfgang Büschel, Germany, *ibid.*)

**CUBA** R. Rebelde has a very enjoyable Latin American folk music program on Saturday at 1715-1800, *Al Sur del Rio Bravo*, heard on 17735 (Dan Sheedy, CA, *DXLD*) Also on 11655 15370 15570 17555; probably one UT hour earlier during DST (gh)

From mid-December to mid-January at least, a large grinding / bubbling Cuban-style jammer on 15710 heard daily from before 1400 past 1900; never any sign of its target, surely not R. Marti, never scheduled here, but maybe a daytime low-power frequency for R. República? Or some other unknown clandestine. The off-frequency reported in our January column, 5954.1 carrying R. República, continued on the air until 2359:30\* with nonstop music instead of República, its source still a mystery; and Cuban jamming went away from that (gh, OK) TIQ, ex-5954, Costa Rica, turned over the rights for that frequency to an evangelical group in Alajuela (Raúl Saavedra, CR, *DXLD*)

High-power transmission of R. República heard on 6185 at 0225 in late Dec (Giampiero Bernardini, Italy, *DXLD*) Had started B-07 on 6100 at 0200-0400, forcing Vatican via Canada to move to 6040. 6185 also used by RR in previous seasons; blocking XEPPM again (gh)

**CZECH REPUBLIC** [non] Last month's news about additional R. Prague relays at 01 on 11665 in Spanish via Ascension, and 0200 on 5995 Sackville, was quickly outdated, expiring at yearend (via *DX Mix News*, Bulgaria) Similar

*All times UTC; All frequencies kHz; \* before hr = sign on, \* after hr = sign off; // = parallel programming; + = continuing but not monitored; 2 x freq = 2nd harmonic; sesqui = one and a half; B-07=full/winter season; [non] = Broadcast to or for the listed country, but not necessarily originating there; u.o.s. = unless otherwise stated*



temp relay additions the year before; using up budget excess? (gh)

**EGYPT** 9250, unID in Arabic, first heard Dec 18 at 2205. Mauno Ritola says it's the Wadi el Nil service from MW 1107. Next day heard as early as 1730, conflicting with Lincolnshire Poacher numbers station on 9251 at 1800 (José Miguel Romero, Spain, DXLD)

Also found 9250 at 2020, in Arabic about Sudan, the local network called Nile Valley Radio from Cairo, for Sudanese living in Egypt // MW 1107, first time heard on SW! 9250 has *Sout Al Arab* earlier around 1655 matching // 621 kHz. NVR mentioned no SW frequency at 1700 opening. ID is "Idha'at wadi al-nil min al-qahira wal khartoom" - which means Nile Valley Radio from Cairo and Khartoum (Tarek Zeidan, Cairo, WORLD OF RADIO and DXLD) Wadi el Nil closes with Egyptian anthem at 2300 (Wolfgang Büschel, Germany, BC-DX)

Quite a coincidence that this is yet another Cairo frequency matching or almost matching British and Israeli spy-numbers, others being 6250, 6270, 6290, 7325, 9960, 11540, 11620 (Romero, DXLD) So is Egypt deliberately blocking the numbers, or involved in producing some of them? (gh) The number station from Egypt is using 9450 and 6140 (Tarek Zeidan, DXLD)

Amil El Disuky, of R. Cairo's Brazilian Service, says it will soon launch a webpage where programs may be heard (Célio Romais, Brasil, *Panorama, @trividade DX*) Let's hope they also offer English shows on demand - modulated properly?!?! (gh)

**ETHIOPIA** 6110, Radio Fana, Addis Ababa, \*0258 with IS, 0302 opening ID and into Horn of Africa music to 0315. Good, strong, in the clear; threshold signal on // 7210 (Brian Alexander, PA, DXLD)

[and non] Checking how Eritrea comes through Ethiopian jamming 1600-1700: On 8000, Eritrea was jammed by a distorted radio program, which was best readable on 7999.5 LSB. At times this jammer changed to a "white-noise mode." On 7175 jammer was playing afro-pops and at times western disco music. 7100 was jammed by this same jammer, which hopped from 7175 to 7100 and back again. Maybe Ethiopia was short of jammers at this time block. Sounded like Eritrean program was in parallel on all three frequencies (Jari Savolainen, Finland, WORLD OF RADIO)

A colleague in Nairobi heard Eritrea on 7100 and 7175 being jammed by a relay of Voice of the Tigray Revolution. Definite ID (he speaks Tigrinya). This may have been the same "distorted radio program" that you heard on 8000. This goes some way to confirming the suspicions that the extra SW transmitters Ethiopia has been using in recent months for V. of Tigray Revolution and Radio Fana are mainly intended for jamming purposes (Chris Greenway, England, *ibid.*)

Another day at 16-17 7100, 7175 and 8000 were all covered by a music station. Eritrea 8000 has been on and jammed for weeks, sometimes hopping up and down, sometimes staying on 8000 steadily (Savolainen, *ibid.*)

DW Amharic and jamming situation at 1400-1500 as of early Jan: I could hear both 15620 and 15660, the lower frequency stronger, but no jamming detectable on either. Both 15620 and 15660 are Rwanda, but the latter is non-directional, and not always audible here (gh, OK) Two broadband jammers from Ethiopia with annoying hiss noted only around the two other frequencies 11645 and 15640 (Wolfgang Büschel, Germany, DXLD)

This is sad news and historical irony. Asa Briggs writes in his famous BBC history that Italy was the first country to start radio jamming, in 1936 when Italy occupied Ethiopia. Ethiopian radio began to broadcast messages to get help when Italian forces started their invasion. These broadcasts were jammed by the Italians. Now the Ethiopian government is jamming foreign broadcasts to Ethiopia (Jorma Mantyla, Finland, HCDX)

**FRANCE** RFI B07 English schedule finally posted in mid-Dec, here including changes as of March 2 until 29, all to Africa:

0400-0430	9805 7315
0500-0530	11995 13680
0600-0630	13680 15605 15160 9765
0700-0730	15605
1200-1230	21620
1600-1700	15605

(via Bernie O'Shea, DXLD) 1600 also heard on 15160 via South Africa (Joe Hanlon, NJ, *ibid.*) And the morning broadcasts M-F only (gh)

**GREECE** 6230, ERA Spor, 105.8, spur or mid-product, with ID and sports, talks at 1355 (Zacharias Liangas, Thessaloniki, Greece, DXLD)

Mixing product, 15650 minus 9420 = 6230, analogous to 6210 = 15630 minus 9420. So 6230 is possible whenever both higher frequencies are on the air from Avlis. Are you close enough to be getting this by groundwave? (gh)

**GUATEMALA** Received a 2008 calendar from R. Verdad. Enclosure in English says: We have received reports from more than 441 different places in 49 countries [enumerated, including only 33 US states]... now with 720 watts. Our programming is varied, very spiritual, genuinely evangelical and with service to the community. We are transmitting from 2300 to 0600 UT and achieving a great impact on our listeners from Europe and the United States, especially because of the high musical and spiritual quality of our music. And we are transmitting our signal on Internet at

[www.radioverdad.org](http://www.radioverdad.org) (gh)

**INDIA** Faulty AIR transmitter on 7410 put spurs 345 kHz away on 7065 and

clearly also same signal level on 7755 at 1745-1815. German ham intruder-watchers have complained. Also heard on a terrible distorted spur around 7463.4 (Wolfgang Büschel, *harmonics yg*)

**ISRAEL** IBA has extended shortwave transmissions of Israel Radio for three more months (Doni Rosenzweig, Dec 24, DXLD) Still heard Jan 1 in English at 1030 on both 13855 and 15760 (Erik Koëie, Netherlands, *ibid.*) So another possible termination at March-end (gh) English at 1830 on 9345 and much better on unlisted 9390 with QRM de WWRB 9385 (Jerry Lenamon, TX, *ibid.*) 9390 ex-13630 from at least 1400 in Hebrew, co-channel VOA until 1500; Israel not registered to start until 1600 (Noel R. Green (NW England), *ibid.*) 9390 is ex-15760 at 1400-1725 in Hebrew, Farsi, Hebrew (DX Mix News, Bulgaria)

**KOREA NORTH** [non] New broadcast, since Dec 24: North Korea Reform Radio <http://nkreform.net/> 1200-1230 9630 via Taiwan; another recent addition: CMI, Voice of Wilderness, from Cornerstone Ministries International, Tustin CA, 1300-1330 9940 and 2000-2030 9795, both also via Taiwan (S. Aoki NDXC-HQ via S. Hasegawa, DXLD)

After sending a reception report to CMI, P. O. Box 4002, Tustin, CA 92781, I got a non-detailed verification letter from Cornerstone, Yeong Dong, P. O. Box 8, Seoul 135-660, Korea in 36 days. v/s Hosea, program director of CMI-Voice of Wilderness. His e-mail address is [dirhq2006@hanmail.net](mailto:dirhq2006@hanmail.net)

Info from the letter: "Our broadcasting is a Christian Mission broadcasting which is running from the Republic of Korea with embracing the North Korea, DPRK and targeting the northeast Asian areas" (Patrick Robic, Austria, *ibid.*)

**LIBYA** Voice of Africa, English at 1400-1600 on 17725 - I got a kick out of the man who gave opening announcements. He was speaking in English and using quite flowery language about how great Africa will be once it is a single state and the resources it will have at its disposal. Arabic has a tradition of using flowery language, but it just doesn't sound right in English; it comes off sounding to me as crude propaganda. Heard via DX Tuner Sweden (Hans Johnson, FL, *Cumbre DX*)

**LITHUANIA** The Mighty KBC as of Jan 1, 2008, 2130-2229 on 6265, 100 kW, 259 degrees: Sun, Big L 1395 & the Mighty KBC; M-F The Original Wolfman Jack Radio Show; Sat, Eric van Willegen & Oliver Kujundzic (repeated at 0100 UT Sun on 6255, 310 degrees for NAM) (via Tom Taylor, Ydun Ritz, DXLD)

**MAURITANIA** R. Mauritanie was missing from 4845 for a few weeks, but back in late Dec, sometimes running all night, but not including New Year's Eve when several other West Africans did stay on later than usual (including 4905, 5025, 5030). Around 0625 at roughly same level as Chad 4905. But Nouakchott is 31 degrees of longitude further west than Ndajemma, so 4845 should hold up about two hours longer, later than any other African (gh) 4845 heard closing at 0830, 7245 opening at 0847 (Dan Sheedy, CA, DXLD)

**MÉXICO** As predicted last month, XERTA came back on 4800, ex-4810, in late Dec (gh) Testing at first with non-stop music at 1102-1154 (Dave Valko, PA, HCDX) Even weaker than before, free of 4810 hash, but plenty of CODAR QRM, at 0011-0041; must be counting on Guatemala not resuming 4800 (gh, OK) Also Xmas music at 0747, very weak with CODAR (Ron Howard, CA, DXLD) Identified it at 1248-1315 only by // to delayed live audio feed on website (Mark Schiefelbein, MO, *ibid.*) XERTA says they are back, on new 4800, also with new quarter-wave vertical antenna, which may have reduced local coverage; adjusting modulation and programming, with new personnel who barely understand what they are doing. Power 500 watts, and reports wanted (XE1RCS bulletin via Thierry Fricot, DF, DXLD)

**MICRONESIA** The Cross, 4755, was still unheard in mid-January after some activity in early October (gh) E-mail verie reply Dec 5 for a report with mp3 clip I'd e-mailed them in October said they had been off the air, changing the antenna (Nigel Pimblett, Alberta, DXLD)

P-mail QSLs were received in late Dec for more reports of early Oct reception (Steve Lare, MI, DXLD; Terry Palmersheim, MT, and Steve Price, PA, HCDX)

From the program schedule via [www.pmapacific.org](http://www.pmapacific.org) we finally have a callsign for 4755, V6MP, while FM 88.5 is V6MA. Sked is 06-24 local, i.e. 19-13 UT. Everything in local evening appears to be in English from various distant preachers, some of them well-known aliens, such as Chuck Colson and Billy Graham (gh)

**PAKISTAN** I noted that there had been no English from Pakistan the past few days, so asked them if it had been cancelled. Return e-mail said this service had been cancelled as of January 5: English to Europe 0730-0830 15100 and 17835 (Chris Lewis, England, WORLD OF RADIO) APP reported that PBC would reinforce external broadcasts in Asian languages (gh)

**PERU** New station! Around 1155 heard on 4990.8 which I thought would be R. Andina, but it was Manantial Radio, Huancayo, announcing 960 kHz, website <http://galeon.com/manatial> (Alfredo Cañote, Lima, *condiglist yg*) Note different spelling of the name in URL. But probably same old off-frequency transmitter as Andina. Website says "4985 KW onda corta satelital" [sic]. Another gospel station, "spring" being a codeword for a font of religionism. Bad news for Suriname if not Brasil (gh) Andina was on 4995; the one on 4991v was R. Ancash (Dario Monferini, Italy, *playdx yg*) R. Manantial is a truly new station, no connection whatsoever with R. Ancash. Pastor Leoncio Paco Conce says the 1 kW transmitter was built by Ramón Chang. The transmitter site is in the district of Huancán, in the Huancayo area. The station's website is at [www.radiomanatial.tk](http://www.radiomanatial.tk) The postal address is in care of I.E.P.J. "Templo La Hermosa," Jr. Santa Cecilia

No. 107, Chilca, Huancayo, Perú (Henrik Klemetz, Sweden, DXLD)

Another new Peruvian? Around 2330-0230 heard a R. Superior on 4523.5 with program called Superfiesta, announcing 4523. More info needed; in years past there were stations by this name from Distrito de Bolivar on 5300; and from Naranjos on 6237v kHz (Rafael Rodriguez R., Colombia, playdx yg)

**SAINT HELENA** R. St. Helena Day, Dec 15, 2007, was another success, with reports of 11092.5 from all over the world. If you missed it, Roberto

Scalgione provides audio archives off DX tuners at  [www.bclnews.it/audiobox/africa/africa.htm](http://www.bclnews.it/audiobox/africa/africa.htm) Better reception on the third file than the first (gh)

**SERBIA** [and non] Updating International Radio Serbia's schedule last month: 10 kW Belgrade/Stubline unit is on 7240 at 1100-2230; 250 kW Bijeljina, Bosnia transmitter at 1900-2230 on 6100, 0030-0230 on 7115 (Dragan Lekic, Serbia, DXLD)

The 7115 service, 310 degrees to NAm includes English 0100-0128 Mon-Sat, and 0200-0228 daily, otherwise Serbian except 0130-0158 Italian! (DX Mix News, Bulgaria) Why in the world would Belgrade broadcast in Italian to NAm? Are there Serbo-Italian-Americans they want to reach? Or to compensate for Rome's refusal to do so any more? Program we heard was 30 minutes of Serbian music, interspersed with announcements in Italian (gh)

They have no particular reason to broadcast Italian to NAm, but they know well there is no more non-religious broadcasting to NAm in Italian on shortwave (Roberto Scalgione, Sicily, DXLD) An article on the IRS website indicates the revived SW service is primarily to reach the diaspora (via Jean-Michel Aubier, France, *ibid.*)

IRS plans to buy a new non-directional antenna and a double rhombic in spring/summer 2008 for Stubline and Bijeljina. They're also planning to move Stubline to 7200 as of A08 season (12 hours/day). Bijeljina will stay on 6100 because that is a longtime frequency used by IRS.

In Stubline they have only one dipole antenna; the good antenna was dismantled, because all the copper was stolen by thieves. Their long-range plan is to buy a completely new transmitter for Stubline station which would be broadcasting in AM and DRM mode (Dragan Lekic, Serbia, DXLD)

**SUDAN** [non] Sudan Radio Service in English, M-F at 0300-0330 on 5975 via Rwanda, which was well heard in NAm, moved to another site, UAE at 240 degrees, likely to worsen reception here (gh)

**TUNISIA** [and non] I often listen to RTT 7190 around 0630-0700 for Arab music though it's hardly soporific. I once heard an unID SSB ham zero-beat, doing nothing but test counts at 0643-0650, thinly disguised jamming. Yes, hams in Americas are totally free to use this frequency, but are they totally free to use it in a one-way 5+ minute 'test' without ID? Tunisia is not breaking any rules; this transmission per HFCC at 04-08 is 265 degrees to CIRAF 37, which is Algeria and Morocco; it is just bleeding over here, even though its 500 kW often makes it the best signal inside the 41 mb in OK - Unlike Croatia/Germany, Russia, Slovakia, etc., which really do broadcast to Americas inside our 40m hamband (gh) Sfax sounds like only 100-125 kW now (Wolfgang Büschel, Germany, DXLD)

**UKRAINE** RUI abruptly ceased NAm service Oct 11, but reactivated 7440 via hi-power Lviv transmitter, as a new fiscal year began, Jan 1 at 0000-0500; includes English at 0100-0200 and 0400-0500, which had been off SW for almost two sesquimonths. Glad this is back, since music quality is better here than on their webcast. Not on planned B-07 frequency 7530. The imminent return was emblazoned in red on their website two days before (gh)

[non] New station, R. Svitle, 9885 at 1445-1501 with pop music, IDs, time checks, // their web stream at

 [www.svitle.org/news\\_ru.php](http://www.svitle.org/news_ru.php) (José Miguel Romero, Spain, DXLD) Also heard here after 1505 with talk about Jesus in Ukrainian, also called Radio Emmanuil at 1540 (Zacharias Liangas, Greece, *ibid.*)

After 1500 had Xmas music well into January. It's the new Ukrainian service of CVC via Jülich since Jan 1 at 1400-1800, apparently taking programming from these FM stations, with a stealth-evangelism philosophy akin to CVC, which must have decided they qualified for relay, if there is not already a deeper relationship (gh) Collides with V. of Russia via Tajikistan 9885 in Russian until 1500, then in Hindi; also with YFR relay via Wertachtal from 1600; which one heard in Europe depends on skip distances (Noel Green, England, and Wolfgang Büschel, Germany, DXLD)

Svetly means "shining," so this station is called "Immanuel's Shining Radio." On website in Ukrainian I also see a short reference to "Radiostantsiya Emmanyil." Appears to have a Catholic background; just went on satellite, and partnering with HCJB (Kai Ludwig, Germany, *ibid.*)

**USA** [and non] The IBB Relay station in Kuwait is one of the cheapest stations to operate - guess because of oil costs. So when all the other relay stations have gone, this might still be around or the last to go. Morocco will close after the end of the current B-07 season.

It's a half-hearted effort from IBB. People who are not in touch with the world media situation make decisions. The good engineers are demoralized, find work elsewhere and the journalists are abandoning IBB. Cutting down on HF radio to channel the funds to Internet or satel-

ite is only cutting down your audience. On the Internet even if you have access, people look for info that they want and not what the West wants to tell them. If the West wants to reach people who get on the street, give refuge to terrorists in the border areas, you have to get down to their homes.

IBB is losing. Take South Asia. CRI is transmitting on every frequency that the IBB uses for English, and protests are not even being heard by the Chinese and Iranians at HFCCs. Sadly, America is out of touch with the world (Victor Goonetilleke, Sri Lanka, via BC-DX)

Harris Corporation has been awarded a contract from broadcast systems integrator Communications Engineering Inc. to help modernize the VOA facility in Washington, DC. CEI is designing the facility's new broadcast system. Harris Broadcast Communications will provide master control, routing and quality control systems - including 12 channels of master control playback controlled by a Harris automation system, extensive ingest and record list control, etc. (via Media Network blog)

Steve Redisch is new VOA Executive Editor. He was "most recently CNN's deputy Washington bureau chief and executive producer in charge of the CNN White House unit. At VOA, Redisch will supervise the daily operations and activities of VOA's news, programs, language services, broadcast operations and Internet departments (VOA director Dan Austin, e-mail to staff, via [kimandrewelliott.com](mailto:kimandrewelliott.com)) "Executive editor" is a new job title, and appears to function like an all-purpose deputy director (Kim Elliott, *ibid.*)

VOA has launched *African Music Treasures*, its first blog designed especially for African music fans. Matthew Lavoie, host of *Music Time in Africa*, will moderate the blog featuring music from VOA's extensive and rare African music collection, music commentary, audio clips, bios of interesting musicians, and chats with online participants. "Our archive is overflowing with rare music from every country in Africa," said Lavoie. VOA's African music archive houses more than 10,000 music titles, including the Leo Sarkisian Library of African Music.

 [www.VOAAfrica.com](http://www.VOAAfrica.com) and click on the African Music Blog link (VOA via Media Network)

Due to strife in Kenya, VOA added a morning broadcast in Swahili in January, 0300-0330 on 7380 9440; temporary? (gh)

AFRTS, Saddlebunch Keys, FL, on 12133.522-USB at 0322 during *The Car Show* with very annoying audio clipping out for a split second, every few seconds // parallel excellent 7811-USB, which also suffered from the spasmodically clipping audio (Terry L Krueger, FL, DXLD) This has been the rule rather than exception on these two frequencies for many weeks; no one paying attention. How sad (gh) No such problem on // 5446.5 USB (Pete Costello, NJ, *ibid.*)

WBCQ's Area 51, M-F 2200-2400 on 5110, presumably one UT hour earlier during DST, has variable content, but advance plans are posted in the "broadcaster's forum" at [www.wbcq.com/forum/viewforum.php?f=3](http://www.wbcq.com/forum/viewforum.php?f=3)

The Area 51 webcast is active during the show at [www.johnlightning.com:8024](http://www.johnlightning.com:8024) (Larry Will, Area 51, DXLD)

KAIJ went off the air at the end of November, no longer heard on 9480 or 5755, and still missing in mid-January. GM George McClintock says the owner of Two If By Sea, Mike Parker, had not informed him of his intentions for KAIJ, but was working on higher priority projects. He has not revealed if or when it would return to the air, but frequencies for A-08 have been coordinated (gh) An engineering message board item called for help in dismantling KAIJ's log-periodic antenna (Jerry Kiefer, NM, DXLD) Urban sprawl from the suburbs of Dallas is encroaching, so the land might be worth quite a bit (Stephen Luce, Houston, WORLD OF RADIO)

Dimite Tewahedo, the Ethiopian program Mondays at 1900-2000 on WHRA 11785, started as usual Dec 24 but cut off at 1905, abruptly back to WHRA in English, announcing frequency change to 7520! But stayed on 11785 with WHR English gospel music fill. Some glitch caused the automation to run the QSY announcement at 1905 instead of 1958 (gh)

The other Radio Miami Internacional: a press item via Nicolás Eramo, *condiglist*, referred to Agustín Rangugini as director of RMI. What became of Jeff White? Jeff explains: "This is some Argentine guy who runs a website called Radio Miami Internacional which has been going on for a few years now and has no affiliation whatsoever with us. I'm not sure about the legality of their using that name, but I believe he knows about us because he once inquired about buying airtime from us."

Here's the faux RMI website:

 [www.radiomiami.us/new/](http://www.radiomiami.us/new/) which autolaunches a 24/7 WM webcast, with program sked [www.radiomiami.us/new/programacion.php](http://www.radiomiami.us/new/programacion.php) which did not match what we were hearing, even allowing for the wrong time conversion from Miami to Argentina in our winter, their summer (gh)

A winter sporadic E opening on Jan 8 brought in broadcast auxiliaries from The Metroplex, WBAP on 25910 at 1942, and KSCS on 25990 at 1952; also WIBC Indianapolis on 26130 at 2002. The Texans also heard the next day at 1624 (David Ross, Ont., DXLD and ODXA) WBAP and co-licensed KSCS aux call sign is WQCY434, 100 watts, ERP 265 watts; WIBC's is WQDS396, 100 watts, ERP inefficiently 65 watts (Larry Van Horn, NC, *ibid.*)

Until the Next, Best of DX and 73 de Glenn!



# BROADCAST LOGS

NOTEWORTHY LOGS FROM OUR READERS

Gayle Van Horn, W4GVH  
gaylevanhorn@monitoringtimes.com  
http://mt-shortwave.blogspot.com

## 0000 UTC on 9420

GREECE: Voice of Greece. Greek music program. SIO 353. (Bob Fraser, Belfast, ME) Additional monitoring 7475 with English text this hour; 0100-0105, 7475 // 9420; 0700 on 9420. (Brian Bagwell, St. Louis, MO)  
Internet streaming audio: [www.voiceofgreece.gr/](http://www.voiceofgreece.gr/)

## 0003 UTC on 5910

COLOMBIA: Marfil Estereo. Spanish. Long commercial string for establishments in Puerto Lleras, Puerto Rico and Granada. Back to music tunes at 0011 to occasional ID and EST local time checks. Generally a fair signal. (John Wilkins, Wheat Ridge, CO)

## 0020 UTC on 11935

ROMANIA: Radio Romania International. Spanish service including station comments and programming // 11960 (SIO 444). (Stewart MacKenzie, Huntington Beach, CA) *Business Club* segment on 6115 at 2315, // 9610 fair signal quality. (Fraser).  
Internet streaming audio: [www.rri.ro](http://www.rri.ro)

## 0055 UTC on 5952.50

BOLIVIA: Emisoras Pio XII. Spanish programming comments from announcers extending past 0100 amid poor signal quality.  
Internet streaming AM/FM audio: [www.http://www.radioopio12.org/](http://www.radioopio12.org/) Additional Bolivian's in Spanish; **Radio Loyola** 5996.38, 0937-1030; **Radio Santa Cruz** 6134.81, 1000-1015. **Radio Eco** 4409.70, 2314-2330. (Chuck Bolland, Clewiston, FL) **Radio Tacana** 4781, 2325-2328. (Lucio Otavio Bobrowiec, Brazil/HCDX)

## 0445 UTC on 4770

NIGERIA: Radio Nigeria (via Kaduna). Announcer's English newscast of various national news topics. Mentions of on-going festivals throughout Nigeria to brief signal outage at 0450. Signal resumed and remained active at 0600 recheck. (Joe Wood, Greenback, TN). 4770, 2247-2300. (Bolland). **Voice of Nigeria** (via Ikorodu) 9690, \*0757-0810. Sign-on theme music to ID and vernacular language at 0758. Possible newscast at 0800 to station identification. Very good signal. (Brian Alexander, PA) **VON** 15120, 2208 with public and current affair items. (MacKenzie) Website: [www.voiceofnigeria.org/](http://www.voiceofnigeria.org/)

## 0615 UTC on 9780

YEMEN: Republic of Yemen Radio. Arabic service. Middle-Eastern music from announcer's programming including a friendly discussion with babies laughing in the background. Fair signal, as this station is a rare visitor at my location. (Wood)  
Internet streaming and on-demand audio: [www.yemenradio.net/](http://www.yemenradio.net/)

## 0640 UTC on 4835

MALI: RTV Mali. Afro pops to French/Vernacular announcements of poor signal quality. (Wood) Monitored on 5995, 2315-0001 to national anthem at sign-off. (Alexander) **Mali** relay via **China Radio International** 11975 at 2357. (MacKenzie)

## 1032 UTC on 6193.40

PERU: Radio Cuzco. Spanish programming comments at tune-in to canned program promos. Fair/poor signal with intermittent fading. Additional Peruvians in Spanish: **Radio Tarma** 4775, 1049-1104; **Radio Cultural Amauta** 4955, 1110-1120; **Radio San Nicholas** 5470.73, 1110-1130; **Radio Cultural Amata** 4955, 1110-1120. (Bolland). **Radio Marañón** 4834.93, 1120-1131. (Alexander)  
Internet FM streaming audio: [www.radiomaranon.org.pe/](http://www.radiomaranon.org.pe/) **Radio Manantial** 4990.8, 1155. Station ID and website/email addresses. (Jerry Berg, MA/DX Window)  
Internet streaming audio: [www.galeon.com/manatial/](http://www.galeon.com/manatial/) **Radio del Pacifico** 4974.9, 2335-2348. (GVH, NC)  
Internet on-demand audio, video and podcast: [www.grupopacifico.org/radio.html](http://www.grupopacifico.org/radio.html) **Radio Vision** 4790.1, 2338-2346. (Carlos Goncalves, Portugal/WWDXC Top News)  
Internet on-demand audio and video: [www.iplacosecha.org/sugerenciasadd.php](http://www.iplacosecha.org/sugerenciasadd.php)

## 1145 UTC on 15190

EQUATORIAL GUINEA: Radio Africa. Signal fading in around 1145, slowly improving by 1210, though not beyond a weak level by 1210. English religious programming suffering from distortion and weak modulation. Sign-off as "Radio Africa Network," including multi website URLs for Pan American Broadcasting plus postal and email addresses. (Alexander).  
Internet streaming audio [www.panambc.com/](http://www.panambc.com/) **Radio Nacional** (Bata) 5005, 0625-0632. Spanish programming of 1950's

Doo-Wop classic music. (Wood) 5005, 2245-2256.\* (Alexander)

## 1146 UTC on 9290

LATVIA: Radio SWH relay. Weekend program *Latvia Today*. Lite music instrumentals to segment on local history. Station ID and address for reception reports to Radio SWH. **Radio Casablanca** programming at 1200 with ID and folk music. (Alexander)  
Internet on-demand audio: [www.radioswh.lv/index.php](http://www.radioswh.lv/index.php)<sup>1</sup> SWH Skanstes iela 13, Riga, LV-1013, Latvia.

## 1248 UTC on 3320

NORTH KOREA: Pyongyang BC. Choral and patriot music to Korean text. Fair signal quality. (Wilkins)

## 1400 UTC on 5985

CLANDESTINE: (targeted to North Korea) Shiokaze. English segment *Daily News* on *North Korean Issues* to newspaper editorials. Pretty good signal, observed in Korean on next day Saturday programming. Presumed station is clandestine, **Suab Xaa Moo Zoo** 11655, 2330-2340 under VOA Special English. Too weak for program details. (Wilkins) Religious programming is in Hmong language,  
Internet audio on-demand: [www.hmongdistrict.org/](http://www.hmongdistrict.org/)

## 1405 UTC on 15140

OMAN: Radio Sultanate of Oman. Fair signal strength with low-very low modulation, intermittently inaudible. US pop music at tune-in to English news segment 1430-1440. Station identification to pop music. Subsequent rechecks noted 1430-1500 for fair-poor quality. (Alexander) Website: [www.oman-radio.gov.om/fmeng/default.asp](http://www.oman-radio.gov.om/fmeng/default.asp)

## 1420 UTC on 11690

JORDAN: Radio Jordan. Music program of western pop vocals. SIO 454 with signal flutter. (Fraser) 11690, 1604-1615; 1627-1630.\* (Harold Frogde, Midland, MI).  
Internet on-demand audio: [www.jrtv.jo/jrtv/index.php#](http://www.jrtv.jo/jrtv/index.php#)

## 1425 UTC on 17725

LIBYA: LJBC/Voice of Africa. Report on the *Damahalian Society*, a humanitarian group. SIO 453 // 21695 poor signal quality. Station ID, "Voice of Africa." (Fraser) Multilingual website: [www.ljbc.net/home.php](http://www.ljbc.net/home.php) Voice of Africa website: <http://voiceofafrica.com.ly>

## 1935 UTC on 6985

ISRAEL: Kol Israel. News on the Middle East read by Idele Ross, // 7545. (Fraser). Kol 7545, 2347-2359 Hebrew to 2356, commencing in presumed Russian service at 2358. (Bolland) Israel's **Galei Zahal** in Hebrew 6972.1 at 0625. (Wood)

## 1900 UTC on 11785

USA: Clandestine-Dimitse Tewahedo via WHRI. Abrupt sign-on in mid-program. Horn of Africa music to comments in Amharic from female announcer. Station off the air at 1905 without closedown. WHRI regular English programming resumed for the remainder of the hour. (Edward Kusalik, Alberta, Canada)

## 1909 UTC on 11690

RWANDA: Deutsche Welle relay via Kigali. African news topics via DW correspondents. SIO 3+53, using USB to combat RTTY interference. (Frogde) 13790, 2027 in Arabic; 11690, 2210 German. (MacKenzie)  
Internet on-demand audio, video and podcast [www.dw-world.de/](http://www.dw-world.de/) **Radio Rwanda** 6055, 2040-2101.\* (Alexander)

## 1930 UTC on 6010

IRAN: IRIB/VOIRI. Station identification, intro and *Call to Prayers*, followed by world newscast. SIO 554 // 7320 (SIO 453). (Fraser). VOIRI 11975, 0010. (MacKenzie)  
Internet streaming audio and video: [www2.irib.ir/worldservice/](http://www2.irib.ir/worldservice/)

## 2120 UTC on 4904.97

CHAD: Radiodiffusion Nationale Tchadienne. French service presenting African hi-life music to program sign-off with national anthem at 2228. Fair-good signal quality. Audible on subsequent recheck 2210-2228.\* (Alexander) Monitored 4905, 0515-0520; 2226-2300.\* (Wood)

Thanks to our contributors – Have you sent in YOUR logs?  
Send to Gayle Van Horn, c/o Monitoring Times  
English broadcast unless otherwise noted.

<sup>1</sup> Station address from "World QSL Book," available from Grove Enterprises.

# PROGRAMMING SPOTLIGHT

WHAT'S ON WHEN AND WHERE?

Fred Waterer

fredwaterer@monitoringtimes.com

www.doghousecharlie.com/radio

## A Trip to Germany

This month, we shine the *Programming Spotlight* on Germany and German-speaking Europe.

About 35 years ago, as a youngster, I started a folder with all my plans for a trip to Germany. Maps. Itineraries. Points of interest. I still have the folder, but I never made the trip. That is, I never made the trip physically. But thanks to shortwave radio and the internet, I have made hundreds of trips to this interesting country for the past three decades.

Germany fascinates me. In just a hundred years, it has gone from imperial power, to republic, to dictatorship, to division (with the front line of the Cold War smack dab in the middle), to reunification and a principal in the Union of Europe. Germany has given us great thinkers, theologians and artists. It's given us wonderful foods, music and culture. It also gave us perhaps the most evil regime in history, Oktoberfest, and the Berlin Wall.

Fortunately, at this juncture, the most unsavory aspects of Germany have been pushed onto "the ash heap of history" and a new dynamic modern nation has emerged. Deutsche Welle is one of our windows into this great nation.

As is customary with most radio stations, every broadcast from Deutsche Welle opens with a 5-minute newscast.

### Newslink –

**Newslink** is a daily, in-depth look at stories making news in Germany, Europe and the World. DW News programming has a great reputation for impartiality. (In fact, DW as a whole is not afraid to show the bad as well as the good in its coverage of Germany.)

**Newslink Plus** is a daily 60-minute package of news, current affairs and reports. Hosted by Rick Demarest, John Doyle and Steve Zwick, it is available on the internet, or as a downloadable podcast. More on those later.

Deutsche Welle broadcasts the following feature programs.

### MONDAYS

**World in Progress** – This is DW's look at international development issues. Hosted by Anke Rasper, it looks at globalization, poverty, human rights, and "people making a difference."

**EuroVox** – EuroVox is DW's lifestyle program, featuring reports on society, culture, fashion and everyday life in Germany. It's hosted by Anja Kueppers.

### TUESDAYS

**Spectrum** – is a half hour weekly look at issues of science and technology.

**Hits in Germany** – One of my favorite music

programs, period. Hosted by Deborah Friedman, it brings you some of the music gracing the German pop charts each week. Often there is a theme to the show. As I told the presenters recently in an email, it's great hearing this music; oftentimes they play songs that don't get airplay in North America but should.



### WEDNESDAYS

**Money Talks** – Money Talks is DW's look at business news and trends in Europe. EuroVox presenter Anja Kueppers hosts the program.

**Arts on the Air** – a weekly look at the arts scene in Germany and Europe. Selected in 2007 by *Passport to World Band Radio* as one of the top ten "must hear" programs.

### THURSDAYS

**Living Planet** – a magazine program looking at environmental issues facing the world today. Dr. Irene Quaille, a "dedicated conservationist," and Nina Haase, hosts living Planet.

**Cool** – Hosted by Anke Rasper, this is Deutsche Welle's youth culture program. And a very good one it is. It resists the temptation to "talk down" to young people and tackles some very serious issues. It also looks at youth culture and music. A recent episode featured a metal band from Iraq and the plight of young prostitutes in Germany.

### FRIDAYS

**Inside Europe** – This is a weekly newsmagazine, hosted by award winning presenters Helen Seeney and Barbara Gruber. As the program name implies, it gives the listener news, interviews and reports about happenings in the European Union. "The annual handbook 'Passport to World Band Radio' has named Inside Europe in its top ten in the 2000, 2004 and 2006 editions." (DW Inside Europe website)

Barbara Gruber is also producer of another program "Network Europe" a co-production involving a number of international broadcasters.

**Dialogue** – is a program looking at issues of faith. The program was highlighted in an earlier column. It features "news on religious events, insights into the changing relationships between the world's re-



ligions, and background reports on religious social and cultural movements."

### SATURDAYS

**Sports Report** – A weekend look at all the sports scores from across Europe.

**Radio D** – The newest "German by Radio" course from DW. When I did a column last year on "Language Lessons by Radio," this course hadn't begun and the website was largely blank. Well, it's started, and the website is quite extensive. The course's web page explains: "Here you'll find all the episodes from Radio D, Deutsche Welle's new radio language course. The material is geared towards beginners who have no or very little previous experience with German. Emphasis is placed on listening comprehension and each of the audio episodes is accompanied by a text manuscript. The course was developed in cooperation with the Goethe Institute and covers levels A1 and A2 of the European Framework of Reference for Languages (CEF)."

### SUNDAYS

**Inspired Minds** – 15-minute interviews with some of the world's most talented artists; musicians, authors, directors and painters.

**Concert Hour** – This program is DW's weekly one hour broadcast of concerts, largely classical, recorded at festivals and performances around Germany. (Unless you live in South East Asia or Sarajevo, this is only available via the internet)

**A World of Music** – one will encounter any number of varieties and genres of music in this interesting little program.

I should also note that there are some interesting programs in other languages that I sampled. For instance, there are a couple of good music programs from the Russian Service of

DW... a Jazz program, and a folk music program the likes of which are not found in English. I look forward to poking around these language services some more.

## ❖ Playing Hard to Get

Who would have thought that one would see the day when Deutsche Welle (or BBC or Voice of Russia for that matter) would be considered a "DX target"? Since DW doesn't "officially" broadcast programming to North America, one has to try to hear programs beamed to other parts of the world, which *may* make it this way.

In DW's case they recommend the following frequencies: 0500-0530 UTC on 9755 kHz; 0600-0630 UTC on 12045 kHz; 2000-2057 UTC on 9690 and 9735 kHz, and finally, 21-22 UTC on 11690 kHz.

The DW schedule comes with this disclaimer: "These frequencies are not meant to cover the specified target area. However they *could occasionally* be audible under *favorable* propagation conditions" (italics are mine).

Well, that's handy. Following those recommendations, all four broadcasts would include **News** and **Newslink**. The latter two transmissions would also include the following features:

Monday	World in Progress at 2030 and EuroVox at 2130 UTC
Tuesday	Spectrum at 2030 and Hits in Germany at 2130 UTC
Wednesday	Money Talks at 2030 and Arts on the Air at 2130 UTC
Thursday	Living Planet at 2030 and Cool at 2130 UTC
Friday	Inside Europe at 2030 and Dialogue at 2130 UTC
Saturday	Dialogue at 2030, Sports Report at 2130 and Radio D at 2145 UTC
Sunday	Cool at 2030, Sports Report at 2130 and Inspired Minds at 2145 UTC.

DW is clearly shifting its broadcasting priorities away from shortwave. All DW programs (and a quick, unscientific look around the DW website suggests this is the case for all languages) are available on demand, online for 7 days, or until the next edition is aired/posted. There is also a continuous "live stream"; however, it just plays a particular day's features and newscasts over and over again.

🔊 [www.dw-world.de/dw/0,2142,4703,00.html](http://www.dw-world.de/dw/0,2142,4703,00.html)

Many if not most DW programs are also available for download as podcasts. Consult the DW podcast page for details on how to add them to your favourite "podcatching" program. I find this particularly useful for certain shows I don't want to miss. DW programming is also available via a number of satellite services. Again, check the DW website for details on where and when to tune.

There is a daily helping of DW programs via the CBC Overnight, programming block on CBC Radio One in Canada (and online). DW features can be heard for 30 minutes a day on weekdays and for an hour on weekends in the 4am local hour.

## DW Video

While researching this column, I happened

to check out DW TV online and was blown away. Several years ago I had tried DW video online, but the combination of a minimal internet connection on my end and constant buffering caused me to give up in exasperation. For those who have broadband, you should really check out DW TV online. All DW TV programs are available on demand, or you can watch a continuous live stream that alternates between English and German programming. The quality is fantastic!

## ❖ Austria

Like many international broadcasters, Radio Austria International has cut back on its English language output over the years.

"**Report from Austria**, a 15 minute news and current affairs programme on the air Monday to Friday, keeps you up to date on what's happening in Austria with news bulletins as well as interviews and features from the world of domestic and international politics, business, culture and sports. Across the weekend, the **Week in Review**, provides a round up of the main stories of the week and **Insight Central Europe** presents Reports from Poland, Slovakia, the Czech Republic, Hungary, Slovenia and from Austria." Insight Central Europe has its own website at <http://incentraleurope.radio.cz/ice>

Radio Austria English programming (as well as other languages for that matter) are, like Germany's, available in several different formats.

One can hear RAI via shortwave on the following schedule:  
0000-0030 UTC to Central America on 7325 kHz;  
0030-0100 UTC to Eastern North America on 7325 kHz;  
1600-1700 UTC to Western North America on 13675 kHz; and  
2330-0000 UTC on 9870 kHz to South America.

While RAI may not have a lot of programming in English, what they do have is also available in several forms on the internet. You can hear RAI programming, on demand, as a podcast, and you can read the transcripts online as well. Go to

🔊 [http://oe1.orf.at/service/international\\_en](http://oe1.orf.at/service/international_en) and follow the links.

## ❖ Switzerland

My friend Richard Cuff in Allentown, PA, posted the following information to a number of groups. (Switzerland has four official languages, French, German, Italian and Romansch...for the purposes of this column I am including Switzerland in German-speaking Europe-*sw*)

"Since the end of broadcasts from 'Swiss Radio International' a few years back, the only way to get domestically-produced news about Switzerland has been via the **Swissinfo.org** website. Swissinfo is powered by the state-funded Swiss Broadcasting Corporation, also the parent of SRI when it existed.

"Over the past few months the SBC has gotten back into the business of producing English language 'radio' about Switzerland; a weekly podcast produced for external consumption was recently launched at the **swissinfo** site...

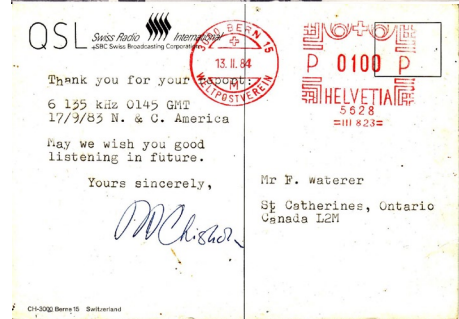

🔊 [www.swissinfo.ch/eng/multi-media/audio\\_podcast/index.html?siteSect=15050](http://www.swissinfo.ch/eng/multi-media/audio_podcast/index.html?siteSect=15050)

"Last November, SBC purchased World Radio Geneva, a commercial, English-language Geneva-based FM station, and has since rebranded the station as World Radio Switzerland, continuing in English, and has expanded its radio presence to the rest of Switzerland via DAB; World Radio Switzerland also webcasts 24/7.

🔊 [www.wrgfm.com/#](http://www.wrgfm.com/#)  
"World Radio Switzerland is both a music and news/talk station; most of the news programming consists of rebroadcasting the BBC World Service. However, WRS produces a 12-minute newscast focusing on news about Switzerland every weekday, calling it *Switzerland Today*. The program airs local time at 630, 730, and 830; this corresponds to 0530, 0630 and 0730 UTC.

"It's a youthful-sounding program, with presenters sporting both British and American English accents. There's a roughly 5-minute newscast, with two longer features rounding out the segment. As WRS has a largely domestic target audience, the news is actually news of interest to people in Switzerland, versus news for consumption by expats.

"In addition to *Switzerland Today*, it appears there are a few other English language spoken-word programs that might be of interest:

Swiss Press Review, airing at 7:45 local time (0645 UTC)

Cover Story, airing at 12:45 local time (1145 UTC)

On The Beat, airing at 10 AM local time (0900 UTC).

"Purists will remind us, that "It ain't shortwave," but it is English language programming from a country that has long been a favorite target of SWLs." Website: [www.wrgfm.com](http://www.wrgfm.com) (Richard Cuff via the *odxa* yahoo group)

Thus concludes our trip around Germany, and German speaking Europe. Perhaps some day I *will* make that trip to Germany in person. At least I've made a start. I have my Passport (to Worldband Radio).



# THE QSL REPORT

VERIFICATIONS RECEIVED BY OUR READERS

Gayle Van Horn, W4GVH

gaylevanhorn@monitoringtimes.com

## Transmitter Chasing

"Congratulations on QSLing Rwanda," I said to the hobby newcomer. He was shocked to discover what he thought was Deutsche Welle from Germany was actually from their Kigali, Rwanda, transmitter relay site.

Location is everything and each transmitter location may count as a new country. In noting location, the collector can verify several countries from one station. A few include: Madagascar and Netherlands Antilles from Radio Netherlands, and Voice of America relays from Ascension Island, Botswana, São Tomé, and Sri Lanka. Verify an extra Canadian site via South Korea's Sackville relay, while Adventist World Radio and Trans World Radio can rake in Guam, South Africa, Swaziland, United Arab Emirates, and more.

The list of transmitter sites continues to expand while broadcasters in the United States and abroad trade relays from multiple locations. Next time you band scan, check the frequency in *Passport to World Band Radio* or the 2008 *Klingenfuss Shortwave Frequency Guide*. Most stations, if requested, will reference the site on your QSL, and you may be surprised at the transmitter location.

Who says there's nothing left to hear on shortwave? The transmitter route is an easy way to add to your country or station totals.



### AMATEUR RADIO

Costa Rica TI5N, 80 meters SSB. Full data color folder card for CQWW 2005 contest operations. Received in 157 days for an SASE to James C. Ebner N8JN-QSL Manager, 5905 N.E. Cubitis Avenue, Box 124, Arcadia, FL 34266 USA. Also verified 2003 CQWW DX Contest on 40/20/15/10 meters with full data two color card in 14 days for a SASE to: Joseph L. Arcure Jr., QSL Manager, 115 Buck Run Road, Lincoln University, PA 19352 USA. (Larry Van Horn, NC)

Croatia 9AA4KF, 20 meters SSB. Full data color photo card. Received in 435 days via ARRL bureau. (Van Horn)

Poland SN7Q, 15/40 meters SSB. Full data two color card. Received in 462 days via ARRL bureau. (Van Horn)

### AUSTRALIA

VL8K, ABC NT Service (Katherine), 2485 kHz. Very nice personal full data verification letter signed by Theresa Regan-Administration Officer, plus station stickers and literature. Received in 28 days for an English report, three IRCs, \$2.00 US (returned), applause card and a souvenir postcard. Station address: Australian Broadcasting Corporation, Business Services, GPO Box 9994, Darwin NT 0801, Australia. (Joe Wood, Greenback, TN). Internet streaming audio for ABC's AM/FW/SW, video and podcast [www.abc.net.au/](http://www.abc.net.au/)

### CANADA

Radio Canada via Sackville, 6100 kHz. Full data *Sackville Transmitter* card, signed by Bill Westenhaven. Received in ten days for an English report and souvenir postcard. Station address: P.O. Box 6000, Montréal, Québec H3A8 Canada.

Internet live audio and podcast [www.radio-canada.ca/rci/](http://www.radio-canada.ca/rci/)

### ERITREA

Radio Bana/Radio Dawn, 5100 kHz. Full data verification letter in Amharic, with illegible signature. Received in 38 days for an English report and \$2.00 US. Station address: Education and Media Department of Ministry of Education, Adult Education and Media, Ministry of

Education, P.O. Box 609, Asmara, Eritrea. (Gayle Van Horn, NC) Station is operated by the Eritrean government, programming produced by the Adult Bana Radio in local languages and English.

### MEDIUM WAVE

KDOW, 1680 kHz AM. Station verification letter signed by Monte Passmore-Chief Engineer. Received in six days for an English AM report. Station address: 2201 Sixth Avenue #1500, Seattle, WA 98121-1840. (Patrick Martin, Seaside, OR)

KNOM, 780 kHz AM. *Alaska Radio Mission*. QSL postcard aerial view of Nome, signed by Ric Schmidt. Received in 13 days for a CD report. Verified via an *Eskimo Girl* card in the early 1980s, but sent in report for a new card. Station address: P.O. Box 988, Nome, AK 99762-0988 USA. (Martin) Station is the oldest Catholic radio station in the United States.

Internet on-demand audio [www.knom.org/](http://www.knom.org/)

KOUU, 1290 kHz AM. Friendly verification letter signed by Paul Anderson-Owner/General Manager. Received in nine days for a CD report. Letter notes station was currently running 30 kW, and scheduled to upgrade to 50 kW. Station address: P.O. Box 97, Poncatello, ID 83204-0097. Idaho QSL # 70. MW # 2977. (Martin)

KUOW, 1340 kHz AM. *Puget Sound Public Radio*. Prepared QSL card returned and signed by April Hokamson. Received in 12 days from second followup. Original report was in 2006. Station address: 458 University Way # 310, Seattle, WA 98105-4535 USA. (Martin)

Internet streaming and on-demand audio: [www.kuow.org/](http://www.kuow.org/)

KXSP, 590 kHz AM. Partial data QSL signed by Kurt Owens-KKCD/KXSP Program Director. Received in 41 days for an AM report to [kowens@journalbroadcastgroup.com](mailto:kowens@journalbroadcastgroup.com) (Patrick Martin N0NNK/WPE9HVV, Westminster, CO)

Internet on-demand audio and podcast [www.bigsports590.com/](http://www.bigsports590.com/)

### PHILIPPINES

Radio Netherlands relay via Tinang, 9795

kHz Full data *A Dutch Morning* (Series #3) card with site noted but unsigned. Received in 62 days for an English report. Station address: P.O. Box 222, 1200 JG Hilversum, Netherlands. (Tom Banks, Dallas, TX)

Internet streaming and on-demand audio [www.rnw.nl](http://www.rnw.nl)

### RUSSIA

WYFR/Family Radio Worldwide via Krasnodar, Russia, 7175 kHz. *Three Decades of Faithful Service* card, plus religious materials and site noted. Received in seven months (3.5 months from email follow-up). Station address: Family Stations, Inc., 290 Hegenberger Road, Oakland, CA 94621-1436 USA. (Ed Kusalik, Alberta, Canada)

Internet streaming and on-demand audio: [www.familyradio.com](http://www.familyradio.com)

### UNITED STATES

WBOH/ Fundamental Broadcasting Network, 5920 kHz. Full data *Lighthouse* card signed by A. Robinson, plus station stickers and schedule. Received in 25 days for an English report to [fbn@radio.com](mailto:fbn@radio.com). (Brian Bagwell, St Louis, MO)

Internet streaming audio [www.fbnradio.com/homepage.htm](http://www.fbnradio.com/homepage.htm)

### UTILITY

Non-Directional Beacon. QT 334 kHz. Thunder Bay, Ontario, Canada. Full data prepared card verified with illegible initials. Received in 42 days for a utility report and \$2.00 US (returned). QSL address: Nav Canada Technical Operations, Thunder Bay TSB, 343Hector Dougall Way, Thunder Bay, ON P7E 6M5 Canada. (H. Tidenberg, Salida, CO).

### VATICAN STATE

Radio Canada International relay via Santa Maria di Galeria. 6030 kHz. Full data *Maple Leaf Mailbag* card from Bill Westenhaven, plus schedule. Received in 13 days for an English report. Station address: (see above Canadian address). (John Wilkins, Wheat Ridge, CO) 13730 kHz received in two months. (Kusalik)

Internet live audio and podcast (see Canada).



## HOW TO USE THE SHORTWAVE GUIDE

0000-0100 twhfa USA, Voice of America 5995am 6130ca 7405am 9455af  
 ① ② ⑤ ③ ④ ⑥ ⑦

### Convert your time to UTC.

Broadcast time on ① and time off ② are expressed in Coordinated Universal Time (UTC) – the time at the 0 meridian near Greenwich, England. To translate your local time into UTC, first convert your local time to 24-hour format, then add (during Standard Time) 5, 6, 7 or 8 hours for Eastern, Central, Mountain or Pacific Times, respectively. Eastern, Central, and Pacific Times are already converted to UTC for you at the top of each hour.

Note that all dates, as well as times, are in UTC; for example, a show which might air at 0030 UTC Sunday will be heard on Saturday evening in America (in other words, 7:30 pm Eastern, 6:30 pm Central, etc.).

### Find the station you want to hear.

Look at the page which corresponds to the time you will be listening. English broadcasts are listed by UTC time on ①, then alphabetically by country ③, followed by the station name ④. (If the station name is the same as the country, we don't repeat it, e.g., "Vanuatu, Radio" [Vanuatu].)

If a broadcast is not daily, the days of broadcast ⑤ will appear in the column following the time of broadcast, using the following codes:

<u>Codes</u>	
s/Sun	Sunday
m/Mon	Monday
t	Tuesday
w	Wednesday
h	Thursday
f	Friday
a/Sat	Saturday
occ:	occasional
DRM:	Digital Radio Mondiale
irreg	Irregular broadcasts
vl	Various languages
USB:	Upper Sideband

### Choose the most promising frequencies for the time, location and conditions.

The frequencies ⑥ follow to the right of the station listing; all frequencies are listed in kilohertz (kHz). Not all listed stations will be heard from your location and virtually none of them will be heard all the time on all frequencies.

Shortwave broadcast stations change some of their frequencies at least twice a year, in April and October, to adapt to seasonal conditions. But they can also change in response to short-term conditions, interference, equipment prob-

lems, etc. Our frequency manager coordinates published station schedules with confirmations and reports from her monitoring team and MT readers to make the Shortwave Guide up-to-date as of one week before print deadline.

To help you find the most promising signal for your location, immediately following each frequency we've included information on the target area ⑦ of the broadcast. Signals beamed toward your area will generally be easier to hear than those beamed elsewhere, even though the latter will often still be audible.

#### Target Areas

- af: Africa
- al: alternate frequency (occasional use only)
- am: The Americas
- as: Asia
- ca: Central America
- do: domestic broadcast
- eu: Europe
- me: Middle East
- na: North America
- pa: Pacific
- sa: South America
- va: various

### Shortwave Broadcast Bands

kHz	Meters
2300-2495	120 meters (Note 1)
3200-3400	90 meters (Note 1)
3900-3950	75 meters (Regional band, used for broadcasting in Asia only)
3950-4000	75 meters (Regional band, used for broadcasting in Asia and Europe)
4750-4995	60 meters (Note 1)
5005-5060	60 meters (Note 1)
5730-5900	49 meter NIB (Note 2)
5900-5950	49 meter WARC-92 band (Note 3)
5950-6200	49 meters
6200-6295	49 meter NIB (Note 2)
6890-6990	41 meter NIB (Note 2)
7100-7300	41 meters (Regional band, not allocated for broadcasting in the western hemisphere) (Note 4)
7300-7350	41 meter WARC-92 band (Note 3)
7350-7600	41 meter NIB (Note 2)
9250-9400	31 meter NIB (Note 2)
9400-9500	31 meter WARC-92 band (Note 3)
9500-9900	31 meters
11500-11600	25 meter NIB (Note 2)
11600-11650	25 meter WARC-92 band (Note 3)
11650-12050	25 meters
12050-12100	25 meter WARC-92 band (Note 3)
12100-12600	25 meter NIB (Note 2)
13570-13600	22 meter WARC-92 band (Note 3)
13600-13800	22 meters
13800-13870	22 meter WARC-92 band (Note 3)
15030-15100	19 meter NIB (Note 2)
15100-15600	19 meters
15600-15800	19 meter WARC-92 band (Note 3)
17480-17550	17 meter WARC-92 band (Note 3)
17550-17900	17 meters
18900-19020	15 meter WARC-92 band (Note 3)
21450-21850	13 meters
25670-26100	11 meters

#### Notes

- Note 1 Tropical bands, 120/90/60 meters are for broadcast use only in designated tropical areas of the world.
- Note 2 Broadcasters can use this frequency range on a (NIB) non-interference basis only.
- Note 3 WARC-92 bands are allocated officially for use by HF broadcasting stations in 2007.
- Note 4 WRC-03 update. After March 29, 2009, the spectrum from 7100-7200 kHz will no longer be available for broadcast purposes and will be turned over to amateur radio operations worldwide.

### MT MONITORING TEAM

**Gayle Van Horn**  
 Frequency Manager

[gaylevanhorn@monitoringtimes.com](mailto:gaylevanhorn@monitoringtimes.com)

**Larry Van Horn, MT Asst. Editor**

[larryvanhorn@monitoringtimes.com](mailto:larryvanhorn@monitoringtimes.com)

## Thank You ...

### Additional Contributors to This Month's Shortwave Guide:

Rich D'Angelo/*NASWA Flash Sheet*; Rachel Baughn/MT; Alokesh Gupta, New Delhi, India; Anker Petersen/*DSWCI-DX Window*; Adrian Sainsbury/R NZ Intl; Tom Taylor, UK; Harold Sellers/*ODXA/DX Ontario*; Wolfgang Büeschel, Germany; Daniel Sampson, WI; Robert Thomas, Bridgeport, CT; Andreas Volk, Germany; *BCL News*; *Cumbre DX*; *BDX Club*; *DX Mix News*, *Bulgaria*; *Hard Core DX*; *NASWA Journal/NASWA Flashsheet*; *World Wide DX Club-Top News*.

**GLENN HAUSER'S  
 WORLD OF RADIO**  
<http://www.worldofradio.com>

For the latest DX and programming news, amateur nets, DX program schedules, audio archives and much more!

**0000 UTC - 7PM EST / 6PM CST / 4PM PST**

0000 0020	Japan, NHK World/Radio Japan	5920eu
	6145na 13650as 17810as	
0000 0030	Australia, HCJB Global	15525as
0000 0030	Egypt, Radio Cairo	9465na
0000 0030	Thailand, Radio	9680af
0000 0030	UK, BBC World Service	7340as 17615as
0000 0030	USA, Voice of America	7405af
0000 0045	India, All India Radio	9705as 9950as
	11620as 11645as 13605as	
0000 0057	Netherlands, Radio	6165na
0000 0100	Anguilla, World University Network	6090am
0000 0100	Australia, ABC NT Alice Springs	2310do
	4835do	
0000 0100	Australia, ABC NT Katherine	5025do
0000 0100	Australia, ABC NT Tennant Creek	4910do
0000 0100	Australia, Radio Australia	9660as 12080as
	13690as 15240pa 17715as 17750va	
0000 0100	Bulgaria, Radio	7400na 9400na
0000 0100	Canada, CFRX Toronto ON	6070na
0000 0100	Canada, CFVP Calgary AB	6030na
0000 0100	Canada, CKZN St John's NF	6160na
0000 0100	Canada, CKZU Vancouver BC	6160na
0000 0100	China, China Radio Intl	6020na 6075as
	7130eu 7180as 9570na 11885as	
	13750as 15115as	
0000 0100	Costa Rica, World University Network	5030va
	6150va 7375va 9725va	
0000 0100	Germany, Deutsche Welle	9785as 15595as
0000 0100	Guyana, Voice of 3291do	
0000 0100	Malaysia, RTM/Trax FM	7295as
0000 0100	New Zealand, Radio NZ Intl	15720pa
0000 0100	New Zealand, Radio NZ Intl	17675pa
0000 0100	Papua New Guinea, Wantok R. Light	7325va
0000 0100	Singapore, MediaCorp Radio	6150do
0000 0100	Spain, Radio Exterior Espana	6055na
0000 0100	UK, BBC World Service	6195as 9740as
	15335as 15360as	
0000 0100	f UK, Bible Voice BC	6140as
0000 0100	USA, American Forces Radio	4319usb
	5446usb 5765usb 6350usb 7811usb	
	10320usb 12133usb 13362usb	
0000 0100	USA, KTBN Salt Lake City UT	7505na
	15590na	
0000 0100	USA, WBCQ Monticello ME	5110am 7415am
	9330am	
0000 0100	h USA, WBCQ Monticello ME	17495am
0000 0100	USA, WBOH Newport NC	5920am
0000 0100	USA, WEWN Vandiver AL	5810am
0000 0100	USA, WHRA Greenbush ME	5890eu
0000 0100	USA, WHRI Cypress Creek SC	7315am
0000 0100	USA, WINB Red Lion PA	9265am
0000 0100	USA, WRMI Miami FL	9955am
0000 0100	USA, WTJC Newport NC	9370na
0000 0100	USA, WWCR Nashville TN	3215na 7465na
	13845na	
0000 0100	USA, WWRB Manchester TN	3185va 5050va
	5745va 6890va	
0000 0100	USA, WYFR/Family Radio FL	6085na
	9505na 9715na 11720am	
0005 0100	Canada, Radio Canada Intl	9755am
0005 0100	Greece, Voice of	7475va 9420va 12105va
0030 0045	Sun Germany, Pan American BC	6165as
0030 0100	Australia, Radio Australia	15415as
0030 0100	mtwhf Austria, Radio Austria Intl	7325am
0030 0100	Lithuania, Radio Vilnius	9875na
0030 0100	Thailand, Radio	12095na
0030 0100	fas UK, Bible Voice BC	6030as
0030 0100	USA, Voice of America	7200va 7405va
	9620va 11695va 11705va 11805va	
	12005va 15185va 15205va	
0043 0100	Sat Austria, Radio Austria Intl	7325am

**0100 UTC - 8PM EST / 7PM CST / 5PM PST**

0100 0105	Greece, Voice of	7475va 9420va 12105va
0100 0127	Czech Rep, Radio Prague	6200na 7345na
0100 0128	Vietnam, Voice of	6175na
0100 0130	Australia, Radio Australia	17775as
0100 0130	mtwhfa Serbia, International Radio Serbia	7115na
0100 0130	Slovakia, Radio Slovakia Int	7230na 9440sa
0100 0156	Romania, Radio Romania Intl	6145na
	9515na	
0100 0157	China, China Radio Intl	6005na 6075eu

		7130eu 7180eu 9570eu 9580na
0100 0157	Netherlands, Radio	6165na
0100 0159	Canada, Radio Canada Intl	5840va 7255va
0100 0200	Anguilla, World University Network	6090am
0100 0200	twhfa Argentina, RAE	11710am
0100 0200	Australia, ABC NT Katherine	5025do
0100 0200	Australia, ABC NT Tennant Creek	4910do
0100 0200	Australia, Radio Australia	9660as 12080as
	13690as 15240pa 15415as 17715as	
	17795va	
0100 0200	Canada, CFRX Toronto ON	6070na
0100 0200	Canada, CFVP Calgary AB	6030na
0100 0200	Canada, CKZN St John's NF	6160na
0100 0200	Canada, CKZU Vancouver BC	6160na
0100 0200	China, China Radio Intl	9535as 11870as
	15115as 15785as	
0100 0200	Costa Rica, World University Network	5030va
	6150va 7375va 9725va	
0100 0200	Cuba, Radio Havana	6000na 6180na
0100 0200	Guyana, Voice of	3291do
0100 0200	Indonesia, Voice of	9525al 11785pa
	15150as	
0100 0200	Malaysia, RTM/Trax FM	7295as
0100 0200	New Zealand, Radio NZ Intl	15720pa
0100 0200	DRM New Zealand, Radio NZ Intl	17675pa
0100 0200	North Korea, Voice of Korea	7140as
	9345as 9730as 11735sa 15180sa	
0100 0200	vi Papua New Guinea, Wantok R. Light	7325va
0100 0200	Singapore, MediaCorp Radio	6150do
0100 0200	Sri Lanka, SLBC	6005as 9770as 15745as
0100 0200	Taiwan, Radio Taiwan Intl	11875as
0100 0200	UK, BBC World Service	6195as 7320as
	11750as 15335as 15360as	
0100 0200	f UK, Bible Voice BC	6140as
0100 0200	Ukraine, Radio Ukraine Intl	7440na
0100 0200	USA, American Forces Radio	4319usb
	5446usb 5765usb 6350usb 7811usb	
	10320usb 12133usb 13362usb	
0100 0200	USA, KTBN Salt Lake City UT	7505na
0100 0200	USA, KWHR Naalehu HI	17525as
0100 0200	USA, Voice of America	7200va 9865va
	11705va	
0100 0200	USA, WBCQ Monticello ME	7415am 9330am
0100 0200	Sat USA, WBCQ Monticello ME	17495am
0100 0200	USA, WBOH Newport NC	5920am
0100 0200	USA, WEWN Vandiver AL	5810am
0100 0200	USA, WHRA Greenbush ME	5890eu
0100 0200	USA, WHRI Cypress Creek SC	7315am
0100 0200	sm USA, WHRI Cypress Creek SC	7490va
0100 0200	USA, WINB Red Lion PA	9265am
0100 0200	USA, WRMI Miami FL	9955am
0100 0200	USA, WTJC Newport NC	9370na
0100 0200	USA, WWCR Nashville TN	3215na 5935na
	7465na	
0100 0200	USA, WWRB Manchester TN	3185va 5050va
	5745va 6890va	
0100 0200	USA, WWRB Manchester TN	3185va 5050va
	5745va 6890va	
0100 0200	USA, WYFR/Family Radio FL	6065na
	9505na 15195as	
0100 0200	Uzbekistan, CVC International	9480as
0105 0200	twhfa Canada, Radio Canada Intl	9755am
0130 0145	twhfas Albania, Radio Tirana	6110na
0130 0200	Iran, Voice of the Islamic Rep	6120na
	7160na	
0130 0200	twhfa USA, Voice of America	5960va 7405va

**0200 UTC - 9PM EST / 8PM CST / 6PM PST**

0200 0205	twhfa Canada, Radio Canada Intl	9755am
0200 0215	Croatia, Croatian Radio	7285na 9470eu
0200 0227	Czech Rep, Radio Prague	5995na 6200na
	7345na	
0200 0230	Iran, Voice of the Islamic Rep	6120na
	7160na	
0200 0230	Serbia, International Radio Serbia	7115na
0200 0230	South Korea, KBS World Radio	15575sa
0200 0230	Thailand, Radio	15275na
0200 0300	Anguilla, World University Network	6090am
0200 0300	Australia, ABC NT Alice Springs	2310do
	4835do	
0200 0300	Australia, ABC NT Katherine	5025do
0200 0300	Australia, ABC NT Tennant Creek	4910do
0200 0300	Australia, Radio Australia	9660as 12080as
	13690as 15240pa 15415as 15515as	
	17750va 21725va	



0200 0300	Canada, CFRX Toronto ON	6070na	
0200 0300	Canada, CFVP Calgary AB	6030na	
0200 0300	Canada, CKZN St John's NF	6160na	
0200 0300	Canada, CKZU Vancouver BC		6160na
0200 0300	China, China Radio Intl	11770as	13640as
0200 0300	Costa Rica, World University Network		5030va
	6150va	7375va	9725va
0200 0300	Cuba, Radio Havana	6000na	6180na
0200 0300	Egypt, Radio Cairo	7270na	
0200 0300	Germany, Deutsche Welle	14665as	
0200 0300	Guyana, Voice of 3291do		
0200 0300	Malaysia, RTM/Trax FM	7295as	
0200 0300	New Zealand, Radio NZ Intl	15720pa	
0200 0300	New Zealand, Radio NZ Intl	17675pa	
0200 0300	North Korea, Voice of Korea		13650as
	15100as		
0200 0300	Papua New Guinea, Wantok R. Light	7325va	
0200 0300	Philippines, Radio Pilipinas	12025va	15285va
	17770va		
0200 0300	Russia, Voice of	6240na	7250na
	13735na	12040na	
0200 0300	Singapore, MediaCorp Radio		6150do
0200 0300	Sri Lanka, SLBC	6005as	9770as
			15745as
0200 0300	Taiwan, Radio Taiwan Intl	5950na	9680na
0200 0300	UK, BBC World Service	6030af	6195me
	6195me	7320va	11750as
	17760as		15360as
0200 0300	USA, American Forces Radio		4319usb
	5446usb	5765usb	6350usb
	10320usb	12133usb	13362usb
0200 0300	USA, KJES Vado NM		7555na
0200 0300	USA, KJES Vado NM		7555na
0200 0300	USA, KTNB Salt Lake City UT		7505na
0200 0300	USA, KWHR Naalehu HI	17525as	
0200 0300	USA, WBCQ Monticello ME	5110am	9330am
0200 0300	USA, WBCQ Monticello ME	7415am	
0200 0300	USA, WBOH Newport NC	5920am	
0200 0300	USA, WEWN Vandiver AL	5810am	
0200 0300	USA, WHRA Greenbush ME	5890eu	
0200 0300	USA, WHRI Cypress Creek SC		7490va
0200 0300	USA, WHRI Cypress Creek SC		5835na
0200 0300	USA, WHRI Cypress Creek SC		7315am
0200 0300	USA, WINB Red Lion PA	9265am	
0200 0300	USA, WRMI Miami FL	9955am	
0200 0300	USA, WRMI Miami FL		7385na
0200 0300	USA, WTJC Newport NC	9370na	
0200 0300	USA, WWCN Nashville TN	3215na	5935na
	7465na		
0200 0300	USA, WWRB Manchester TN	3185va	5050va
	5745va	6890va	
0200 0300	USA, WYFR/Family Radio FL		5985am
	6065na	9505na	9525na
			11855am
0200 0300	Uzbekistan, CVC International		9480as
0215 0230	Nepal, Radio	3230as	5005as
	7165as		6100as
0230 0258	Vietnam, Voice of		6175na
0230 0300	South Korea, KBS World Radio		9560na
0230 0300	Sweden, Radio	6010na	11550as
0245 0300	Albania, Radio Tirana	7425na	
0245 0300	Myanmar, Myanma Radio	9730do	
0250 0300	Vatican City, Vatican Radio	6040na	7305na
0255 0300	Rwanda, Radio		6055do

0300 0400	Canada, CKZU Vancouver BC		6160na
0300 0400	China, China Radio Intl	9690na	9790na
	11770as	13750as	15110as
	15785as		15120as
0300 0400	Costa Rica, World University Network		5030va
	6150va	7375va	9725va
0300 0400	Cuba, Radio Havana	6000na	6180na
0300 0400	Germany, Deutsche Welle	9785as	13790as
0300 0400	Greece, Voice of	7475va	9420va
0300 0400	Guyana, Voice of 3291do		
0300 0400	Malaysia, RTM/Trax FM	7295as	
0300 0400	Malaysia, RTM/Voice of Malaysia		6175as
	9750as	15295as	
0300 0400	New Zealand, Radio NZ Intl	15720pa	
0300 0400	New Zealand, Radio NZ Intl	17675pa	
0300 0400	North Korea, Voice of Korea		7140as
	9345as	9730as	
0300 0400	Oman, Radio Oman		15355as
0300 0400	Papua New Guinea, Wantok R. Light		7325va
0300 0400	Russia, Voice of	6155na	6240na
	12040na	13735na	7350na
0300 0400	Rwanda, Radio		6055do
0300 0400	Singapore, MediaCorp Radio		6150do
0300 0400	South Africa, Channel Africa	3345af	7390as
0300 0400	Sri Lanka, SLBC	6005as	9770as
0300 0400	Taiwan, Radio Taiwan Intl	5950na	15215sa
	15320as		
0300 0400	UK, BBC World Service	3255af	6005af
	6145af	6190af	6195me
	7160af	9510va	975-af
	15335as	15360as	21660as
0300 0400	USA, American Forces Radio		4319usb
	5446usb	5765usb	6350usb
	10320usb	12133usb	13362usb
0300 0400	USA, KTNB Salt Lake City UT		7505na
0300 0400	USA, KWHR Naalehu HI	17525as	
0300 0400	USA, Voice of America	4930af	6080af
	9885af	15580af	
0300 0400	USA, WBCQ Monticello ME	5110am	9330am
0300 0400	USA, WBCQ Monticello ME	7415am	
0300 0400	USA, WBOH Newport NC	5920am	
0300 0400	USA, WEWN Vandiver AL	5810am	
0300 0400	USA, WHRA Greenbush ME	5890eu	
0300 0400	USA, WHRI Cypress Creek SC		7490va
0300 0400	USA, WHRI Cypress Creek SC		5835na
0300 0400	USA, WHRI Cypress Creek SC		7315am
0300 0400	USA, WINB Red Lion PA	9265am	
0300 0400	USA, WRMI Miami FL	9955am	
0300 0400	USA, WRMI Miami FL		7385na
0300 0400	USA, WTJC Newport NC	9370na	
0300 0400	USA, WWCN Nashville TN	3215na	5935na
	7465na		
0300 0400	USA, WWRB Manchester TN	3185va	5050va
	5745va	6890va	
0300 0400	USA, WYFR/Family Radio FL		6065na
	6065na	9505na	9525na
			11855am
0300 0400	Uzbekistan, CVC International		9480as
0300 0400	Nepal, Radio	3230as	5005as
	7165as		6100as
0300 0400	Vietnam, Voice of		6175na
0300 0400	South Korea, KBS World Radio		9560na
0300 0400	Sweden, Radio	6010na	11550as
0300 0400	Albania, Radio Tirana	7425na	
0300 0400	Myanmar, Myanma Radio	9730do	
0300 0400	Vatican City, Vatican Radio	6040na	7305na
0300 0400	Rwanda, Radio		6055do

**0300 UTC - 10PM EST / 9PM CST / 7PM PST**

0300 0320	Vatican City, Vatican Radio	6040na	7305na
0300 0330	Egypt, Radio Cairo	7270na	
0300 0330	Myanmar, Myanma Radio	9730do	
0300 0330	Philippines, Radio Pilipinas	12025va	15285va
	17770va		
0300 0330	UK, Sudan Radio Service	5975af	
0300 0330	USA, KJES Vado NM	7555na	
0300 0330	Vatican City, Vatican Radio	7360af	9660af
0300 0400	Anguilla, World University Network		6090am
0300 0400	Australia, ABC NT Alice Springs		2310do
	4835do		
0300 0400	Australia, ABC NT Katherine	5025do	
0300 0400	Australia, ABC NT Tennant Creek		4910do
0300 0400	Australia, Radio Australia	9660as	12080as
	13690as	15240pa	15415as
	17750va	21725va	15515as
0300 0400	Bulgaria, Radio	7400na	9400na
0300 0400	Canada, CBC NQ SW Service		9625na
0300 0400	Canada, CFRX Toronto ON	6070na	
0300 0400	Canada, CFVP Calgary AB	6030na	
0300 0400	Canada, CKZN St John's NF	6160na	

**0400 UTC - 11PM EST / 10PM CST / 8PM PST**

0400 0427	Czech Rep, Radio Prague	5990na	6200na
	7345na		
0400 0430	France, Radio France Intl	7315af	9805af
0400 0430	Sri Lanka, SLBC	6005as	9770as
0400 0430	USA, Voice of America	4930af	4960af
	6080af	9885af	15580af
0400 0430	USA, WBCQ Monticello ME	5110am	9330am
0400 0430	USA, WWRB Manchester TN	3185va	
0400 0445	USA, WBCQ Monticello ME	7415am	
0400 0455	Turkey, Voice of	6020va	7240va
0400 0456	Romania, Radio Romania Intl		6115va
	9515na	9690va	11895va
0400 0458	New Zealand, Radio NZ Intl	15720pa	
0400 0458	New Zealand, Radio NZ Intl	17675pa	
0400 0459	South Africa, Channel Africa	3345af	
0400 0500	Anguilla, World University Network		6090am
0400 0500	Australia, ABC NT Alice Springs		2310do
	4835do		
0400 0500	Australia, ABC NT Katherine	5025do	
0400 0500	Australia, ABC NT Tennant Creek		4910do
0400 0500	Australia, Radio Australia	9660as	12080as

		13690as	15240pa	15415as	17750va
		21725va			
0400	0500	twhf	Canada, CBC NQ SW Service	9625na	
0400	0500		Canada, CFRX Toronto ON	6070na	
0400	0500		Canada, CKZN St John's NF	6160na	
0400	0500		Canada, CKZU Vancouver BC	6160na	
0400	0500		China, China Radio Intl	6020na	6080as
			13750as	15120as	15785as
			17855as		
0400	0500		Costa Rica, World University Network	5030va	
			6150va	7375va	9725va
0400	0500		Cuba, Radio Havana	6000na	6180na
0400	0500		Germany, Deutsche Welle	5905af	5945af
			6180af	7225af	15455af
0400	0500		Guyana, Voice of 3291do		
0400	0500		Malaysia, RTM/Trax FM	7295as	
0400	0500		Malaysia, RTM/Voice of Malaysia	6175as	
			9750as	15295as	
0400	0500	vl	Papua New Guinea, Wantok R. Light	7325va	
0400	0500		Russia, Voice of	6155na	6240na
			7350na	9550as	9840na
			12010na	12030na	12040na
			13580as	15455as	15530as
			17695as	17840as	15765as
0400	0500	DRM	Russia, Voice of	15735as	
0400	0500	vl	Rwanda, Radio	6055do	
0400	0500		Singapore, MediaCorp Radio	6150do	
0400	0500	vl	Uganda, UBC Radio	4976do	5026do
0400	0500		UK, BBC World Service	3255af	6005af
			6190af	7120af	7160af
			11665af	12095af	15335as
			17760as	21660as	15360as
0400	0500		Ukraine, Radio Ukraine Intl	7440na	
0400	0500		USA, American Forces Radio	4319usb	
			5446usb	5765usb	6350usb
			10320usb	12133usb	13362usb
0400	0500		USA, KTVN Salt Lake City UT	7505na	
0400	0500		USA, KWHR Naalehu HI	17525as	
0400	0500		USA, WBOH Newport NC	5920am	
0400	0500		USA, WEWN Vandiver AL	5810am	
0400	0500		USA, WHRA Greenbush ME	5890eu	
0400	0500		USA, WHRI Cypress Creek SC	7490va	
0400	0500	twhfa	USA, WHRI Cypress Creek SC	5835na	
0400	0500	sm	USA, WHRI Cypress Creek SC	7315am	
0400	0500		USA, WMLK Bethel PA	9265va	
0400	0500		USA, WRMI Miami FL	9955am	
0400	0500		USA, WTJC Newport NC	9370na	
0400	0500		USA, WWCR Nashville TN	3215na	5890na
			5935na		
0400	0500		USA, WWRB Manchester TN	3185va	
0400	0500		USA, WYFR/Family Radio FL	6065na	
			6875na	7780va	9505na
				9715na	13685as
					17600va
0400	0500		Uzbekistan, CVC International	13685as	
0430	0445		Israel, Kol Israel	6280va	7545va
0430	0457		Czech Rep, Radio Prague	9890va	
0430	0500	twhf	Albania, Radio Tirana	7425na	
0430	0500		Australia, Radio Australia	15415as	
0430	0500		Nigeria, Radio/Kaduna	6090do	
0430	0500		Swaziland, TWR 3200af	4775af	
0430	0500		USA, Voice of America	4930af	4960af
			9885af	15580af	
			6005as	9770as	15745as
0430	0500	Sun	New Zealand, Radio NZ Intl	15720pa	
0459	0500		New Zealand, Radio NZ Intl	9870pa	
0459	0500	DRM			

0500	0600		Canada, CKZN St John's NF	6160na	
0500	0600		Canada, CKZU Vancouver BC	6160na	
0500	0600		China, China Radio Intl	11710af	11880as
			15350as	15465as	17505as
			17725as	17855as	17540as
0500	0600		Costa Rica, World University Network	5030va	
			6150va	7375va	9725va
0500	0600		Cuba, Radio Havana	6000na	6060na
			6180na	9550na	11760am
0500	0600		Germany, CVC Intl/Voice Africa	9430af	
0500	0600		Guyana, Voice of 3291do		
0500	0600		Malaysia, RTM/Trax FM	7295as	
0500	0600		Malaysia, RTM/Voice of Malaysia	6175as	
			9750as	15295as	
0500	0600		New Zealand, Radio NZ Intl	15720pa	
0500	0600	DRM	New Zealand, Radio NZ Intl	9870pa	
0500	0600		Nigeria, Radio/Kaduna	4770do	6090al
0500	0600	vl	Papua New Guinea, Wantok R. Light	7325va	
0500	0600		Russia, Voice of	7150na	7350na
			9840na	12040na	12090as
			15455as	15530as	15765as
			17840as		17695as
0500	0600	DRM	Russia, Voice of	15735as	
0500	0600		Singapore, MediaCorp Radio	6150do	
0500	0600		South Africa, Channel Africa	7230af	9685af
0500	0600		Swaziland, TWR 3200af	4775af	9500af
0500	0600		Thailand, Radio	11730va	
0500	0600	vl	Uganda, UBC Radio	4976do	5026do
0500	0600		UK, BBC World Service	3255af	6005af
			6190af	6195va	7160af
			11665af	11695as	11765af
			12095eu	15335as	15360as
			17640af	17760as	21660as
0500	0600	DRM	UK, BBC World Service	5895eu	
0500	0600		USA, American Forces Radio	4319usb	
			5446usb	5765usb	6350usb
			10320usb	12133usb	13362usb
0500	0600		USA, KTVN Salt Lake City UT	7505na	
0500	0600		USA, KWHR Naalehu HI	11565as	15610as
0500	0600		USA, Voice of America	4930af	5855af
			6080af	9885af	15580af
0500	0600		USA, WBCQ Monticello ME	5110am	7415am
0500	0600		USA, WBOH Newport NC	5920am	
0500	0600		USA, WEWN Vandiver AL	5810eu	5850va
0500	0600		USA, WHRA Greenbush ME	7465va	
0500	0600		USA, WHRI Cypress Creek SC	7490va	
0500	0600	twhfa	USA, WHRI Cypress Creek SC	5835na	
0500	0600		USA, WMLK Bethel PA	9265va	
0500	0600		USA, WRMI Miami FL	9955am	
0500	0600		USA, WTJC Newport NC	9370na	
0500	0600		USA, WWCR Nashville TN	3215na	5890na
			5935na		
0500	0600		USA, WWRB Manchester TN	3185va	
0500	0600		USA, WYFR/Family Radio FL	6065na	
			6875na	7780va	9505na
				9715na	13685as
					17600va
0500	0600		Uzbekistan, CVC International	13685as	
0500	0600		Zambia, CVC International	6065af	
0515	0530	vl	Rwanda, Radio	6055do	
0530	0600		Australia, Radio Australia	15415as	
0530	0600	vl	Rwanda, Radio	6055do	
0530	0600	mtwhf	UK, Sudan Radio Service	9525af	9560al
			13720af		

**0600 UTC - 1AM EST / 12AM CST / 10PM PST**

**0500 UTC - 12AM EST / 11PM CST / 9PM PST**

0500	0507	twhf	Canada, CBC NQ SW Service	9625na	
0500	0515	Sun	Sri Lanka, SLBC	6005as	9770as
0500	0530	mtwhf	France, Radio France Intl	11995af	13680af
0500	0530		Germany, Deutsche Welle	7285af	9755af
			12045af	15410af	
0500	0530		Japan, NHK World/Radio Japan	5975eu	
			6110na	9725af	9875af
0500	0530		Vatican City, Vatican Radio	7360af	9660af
			11625af		
0500	0600		Anguilla, World University Network	6090am	
0500	0600		Australia, ABC NT Alice Springs	2310do	
			4835do		
0500	0600		Australia, ABC NT Katherine	5025do	
0500	0600		Australia, ABC NT Tennant Creek	4910do	
0500	0600		Australia, Radio Australia	9660as	12080as
			13630as	13690pa	15160as
			17750va		15240pa
0500	0600		Bhutan, BBS	6035as	
0500	0600		Canada, CFRX Toronto ON	6070na	

0600	0600	sm	USA, WHRI Cypress Creek SC	7315am	
0600	0605		Croatia, Croatian Radio	11690pa	
0600	0615	Sat/Sun	South Africa, TWR	11640af	
0600	0630	Sat/Sun	Australia, Radio Australia	15415as	
0600	0630	mtwhf	France, Radio France Intl	9765af	13680af
			15160af	15605af	
0600	0630		Germany, Deutsche Welle	5945af	7240af
			12045af		
0600	0630		Nigeria, Radio, Natl Svc/Abuja	7275do	
0600	0630		Vatican City, Vatican Radio	4005eu	5965eu
			7250eu		
0600	0645	mtwhf	South Africa, TWR	11640af	
0600	0657		China, China Radio Intl	6115na	
0600	0658		New Zealand, Radio NZ Intl	15720pa	
0600	0658	DRM	New Zealand, Radio NZ Intl	9870pa	
0600	0700		Anguilla, World University Network	6090am	
0600	0700		Australia, ABC NT Alice Springs	2310do	
			4835do		
0600	0700		Australia, ABC NT Katherine	5025do	
0600	0700		Australia, ABC NT Tennant Creek	4910do	
0600	0700		Australia, CVC International	15360as	

0600 0700	Australia, Radio Australia	9660as	12080as
	13630as	13690as	15160as 15240pa
	17750va		
0600 0700 mtwhfa	Austria, Radio Austria Intl	17870me	
0600 0700	Bhutan, BBS	6035as	
0600 0700	Canada, CFRX Toronto ON	6070na	
0600 0700	Canada, CFPV Calgary AB	6030na	
0600 0700	Canada, CKZN St John's NF	6160na	
0600 0700	Canada, CKZU Vancouver BC		6160na
0600 0700	China, China Radio Intl	11870as	11880as
	13660as	15140as	15350as 15465as
	17505as	17540as	17710as
0600 0700	Costa Rica, World University Network		5030va
	6150va	7375va	9725va 11870va
0600 0700	Cuba, Radio Havana	6000na	6060va
	6180na	9550na	11760na
0600 0700	Germany, CVC Intl/Voice Africa		11720af
0600 0700	Guyana, Voice of 3291do		
0600 0700	Malaysia, RTM/Trax FM	7295as	
0600 0700	Malaysia, RTM/Voice of Malaysia		6175as
	9750as	15295as	
0600 0700	Nigeria, Radio/Kaduna	4770do	6090al
0600 0700 vl	Papua New Guinea, Wantok R. Light		7325va
0600 0700	Russia, Voice of	9550as	13580as 15765as
	17665pa	17805pa	
0600 0700	Singapore, MediaCorp Radio		6150do
0600 0700 vl	Solomon Islands, SIBC	5020do	9545al
0600 0700	South Africa, Channel Africa	7230af	15255af
0600 0700	Swaziland, TWR	3200af	4775af 9500af
0600 0700	UK, BBC World Service	6005af	6190af
	7160af	9410va	9825af 11760va
	11765af	11940af	11955as 15335as
	15360as	15420af	17640af 17760as
	21660as		
0600 0700 DRM	UK, BBC World Service	5895eu	
0600 0700	Ukraine, Radio Ukraine Intl	7440eu	
0600 0700	USA, American Forces Radio		4319usb
	5446usb	5765usb	6350usb 7811usb
	10320usb	12133usb	13362usb
0600 0700	USA, KTBN Salt Lake City UT		7505na
0600 0700	USA, KWHR Naalehu HI	11565as	15610as
0600 0700	USA, Voice of America	6080af	9885af
	15580af		
0600 0700	USA, WBCQ Monticello ME	5110am	
0600 0700	USA, WBOH Newport NC	5920am	
0600 0700	USA, WEWN Vandiver AL	5810eu	5850va
0600 0700	USA, WHRA Greenbush ME	7465va	
0600 0700	USA, WHRI Cypress Creek SC		5835va
	7315am		
0600 0700	USA, WMLK Bethel PA	9265va	
0600 0700	USA, WRMI Miami FL	9955am	
0600 0700	USA, WTJC Newport NC	9370na	
0600 0700	USA, WWCR Nashville TN	3215na	5070na
	5890na	5935na	
0600 0700	USA, WWRB Manchester TN	3185va	
0600 0700	USA, WYFR/Family Radio FL		5745va
	6000am	9860na	11530va 11580af
0600 0700 vl	Vanuatu, Radio	4960do	
0600 0700	Yemen, Rep of Yemen Radio	9780me	
0600 0700	Zambia, CVC International	6065af	
0630 0700	Romania, Radio Romania Intl		7180va
	9690va	15135va	17780va
0630 0700	Vatican City, Vatican Radio	7360af	9660af
	11625af		
0659 0700	New Zealand, Radio NZ Intl	9765pa	
0659 0700 DRM	New Zealand, Radio NZ Intl	9870pa	

**0700 UTC - 2AM EST / 1AM CST / 11PM PST**

0700 0706	UK, BBC World Service	6005af	
0700 0730	France, Radio France Intl	15605af	
0700 0730	Slovakia, Radio Slovakia Int	13715pa	15460pa
0700 0730	UK, BBC World Service	15575va	
0700 0800	Anguilla, World University Network		6090am
0700 0800	Australia, ABC NT Alice Springs		2310do
	4835do		
0700 0800	Australia, ABC NT Katherine	5025do	
0700 0800	Australia, ABC NT Tennant Creek		4910do
0700 0800	Australia, CVC International	15360as	
0700 0800	Australia, Radio Australia	9475as	9710as
	11880as	12080as	13630pa 15160as
	15240pa		
0700 0800	Bhutan, BBS	6035as	
0700 0800	Canada, CFRX Toronto ON	6070na	
0700 0800	Canada, CFPV Calgary AB	6030na	
0700 0800	Canada, CKZN St John's NF	6160na	

0700 0800	Canada, CKZU Vancouver BC		6160na
0700 0800	China, China Radio Intl	11785eu	11880as
	13660as	15350as	15465as 17490eu
	17540as	17710as	
0700 0800	Costa Rica, World University Network		5030va
	6150va	7375va	9725va 11870va
0700 0800	Germany, CVC Intl/Voice Africa		15640af
0700 0800	Greece, Voice of	7475va	9420va
0700 0800	Guyana, Voice of	3291do	5950do
0700 0800 Sat	Latvia, Radio SWH		9290eu
0700 0800	Liberia, Star Radio		9525af
0700 0800	Malaysia, RTM/Trax FM		7295as
0700 0800	Malaysia, RTM/Voice of Malaysia		6175as
	9750as	15295as	
0700 0800	Myanmar, Myanma Radio		9730do
0700 0800	New Zealand, Radio NZ Intl	9765pa	
0700 0800 DRM	New Zealand, Radio NZ Intl	9870pa	
0700 0800	Nigeria, Radio/Kaduna	4770do	6090al
0700 0800 vl	Papua New Guinea, Wantok R. Light		7325va
0700 0800	Russia, Voice of	9550as	13580as
0700 0800 DRM	Russia, Voice of	11615eu	11635eu
0700 0800	Singapore, MediaCorp Radio		6150do
0700 0800 vl	Solomon Islands, SIBC	5020do	9545al
0700 0800 vl	South Africa, Channel Africa	9625af	
0700 0800	Swaziland, TWR	4775af	6120af 9500af
0700 0800	Taiwan, Radio Taiwan Intl	5950na	
0700 0800 DRM	UK, BBC World Service	5875eu	
0700 0800	UK, BBC World Service	6190af	6195va
	9410va	11760me	11765af 11940af
	11955as	12095va	13620af 15360as
	15400af	15420af	17760as 21660as
0700 0800	USA, American Forces Radio		4319usb
	5446usb	5765usb	6350usb 7811usb
	10320usb	12133usb	13362usb
0700 0800	USA, KTBN Salt Lake City UT		7505na
0700 0800	USA, KWHR Naalehu HI	11565as	15610as
0700 0800	USA, WBCQ Monticello ME	5110am	
0700 0800	USA, WBOH Newport NC	5920am	
0700 0800	USA, WEWN Vandiver AL	5810eu	5850va
0700 0800	USA, WHRI Cypress Creek SC		5835va
	7315am		
0700 0800	USA, WMLK Bethel PA	9265va	
0700 0800	USA, WRMI Miami FL	9955am	
0700 0800	USA, WTJC Newport NC	9370na	
0700 0800	USA, WWCR Nashville TN	3215na	5070na
	5890na	5935na	
0700 0800	USA, WWRB Manchester TN	3185va	
0700 0800	USA, WYFR/Family Radio FL		6875na
	7455na	9495am	9715na 9985af
0700 0800 vl	Vanuatu, Radio	4960do	
0700 0800	Zambia, CVC International	6065af	
0730 0800	Australia, HCJB Global	11750pa	
0730 0800	Bulgaria, Radio	7400eu	9400eu
0730 0800 Sat/Sun	UK, BBC World Service		15575va
0745 0800 mtwhfa	Australia, HCJB Global	11750pa	
0745 0800 Sun	Germany, TWR Europe	6105eu	
0745 0800 Sun	Monaco, TWR Europe	9800eu	

**0800 UTC - 3AM EST / 2AM CST / 12AM PST**

0800 0825	Malaysia, RTM/Voice of Malaysia		6175as
	9750as	15295as	
0800 0827	Czech Rep, Radio Prague	7345eu	9860eu
0800 0830	Australia, ABC NT Katherine	5025do	
0800 0830	Australia, ABC NT Tennant Creek		4910do
0800 0830	Myanmar, Myanma Radio	9730do	
0800 0830	Pakistan, Radio	15100eu	17835eu
0800 0845 Sat	Guam, TWR/KTWR		11840pa
0800 0850 mtwhf	Germany, TWR Europe	6105eu	
0800 0850 mtwhf	Monaco, TWR Europe	9800eu	
0800 0857	China, China Radio Intl	11785eu	17490eu
0800 0900	Anguilla, World University Network		6090am
0800 0900	Australia, ABC NT Alice Springs		2310do
	4835do		
0800 0900	Australia, CVC International	15360as	
0800 0900	Australia, HCJB Global	11750pa	
0800 0900	Australia, Radio Australia	5995va	9475va
	9580as	9590va	11880as 12080as
	13630as		
0800 0900	Canada, CFRX Toronto ON	6070na	
0800 0900	Canada, CFPV Calgary AB	6030na	
0800 0900	Canada, CKZN St John's NF	6160na	
0800 0900	Canada, CKZU Vancouver BC		6160na
0800 0900	China, China Radio Intl	11620as	11880as
	15350as	15465as	17540as
0800 0900	Costa Rica, World University Network		5030va



0800 0900	6150va	7375va	9725va	11870va
0800 0900 DRM	Germany, CVC Intl/Voice Africa			15640af
0800 0900 Sun	Germany, Deutsche Welle	12005as		
0800 0900 mtwhf	Germany, TWR Europe	6105eu		
0800 0900	Guam, TWR/KTWR	11840pa		
0800 0900	Guyana, Voice of 3291do	5950do		
0800 0900	Indonesia, Voice of	9525al	11785pa	
	15150as			
0800 0900	Malaysia, RTM/Trax FM	7295as		
0800 0900 Sun	Monaco, TWR Europe	9800eu		
0800 0900	New Zealand, Radio NZ Intl	9765pa		
0800 0900 DRM	New Zealand, Radio NZ Intl	9870pa		
0800 0900	Nigeria, Radio/Kaduna	4770do	6090al	
0800 0900	Nigeria, Voice of/Ext. Svc Lagos		9690af	
0800 0900	Papua New Guinea, NBC	4890do		
0800 0900 vl	Papua New Guinea, Wantok R. Light		7325va	
0800 0900	Russia, Voice of	9550as	13580as	13660as
	15195as	17495pa	17665pa	17805pa
0800 0900 DRM	Russia, Voice of	11615eu		
0800 0900	Singapore, MediaCorp Radio		6150do	
0800 0900 vl	Solomon Islands, SIBC	5020do	9545al	
0800 0900 vl	South Africa, Channel Africa	9625af		
0800 0900 Sun	South Africa, DX Amateur League		7205af	
	17570af			
0800 0900	South Korea, KBS World Radio		9570as	
0800 0900	Swaziland, TWR	4775af	6120af	9500af
0800 0900	UK, BBC World Service	6190af	6195as	
	9740as	11760me	11940af	12095va
	15285as	15400af	17640af	17760as
	17830af	21470af	21660as	
0800 0900 Sat/Sun	UK, BBC World Service	15575va		
0800 0900 fas	UK, Bible Voice BC	5945eu		
0800 0900	USA, American Forces Radio		4319usb	
	5446usb	5765usb	6350usb	7811usb
	10320usb	12133usb	13362usb	
0800 0900	USA, KNLS Anchor Point AK	9615as		
0800 0900	USA, KTNB Salt Lake City UT		7505na	
0800 0900	USA, KWHR Naalehu HI	9930as	11565as	
0800 0900	USA, WBCQ Monticello ME	5110am		
0800 0900	USA, WBOH Newport NC	5920am		
0800 0900	USA, WERN Vandiver AL	5850am		
0800 0900	USA, WHRI Cypress Creek SC		5835va	
	7315am			
0800 0900	USA, WMLK Bethel PA	9265va		
0800 0900	USA, WRMI Miami FL	9955am		
0800 0900	USA, WTJC Newport NC	9370na		
0800 0900	USA, WWCR Nashville TN	3215na	5070na	
	5890na	5935na		
0800 0900	USA, WWRB Manchester TN	3185va		
0800 0900	USA, WYFR/Family Radio FL		5950na	
	6875na	7455na	9985af	
0800 0900 vl	Vanuatu, Radio	4960do		
0800 0900	Zambia, CVC International	6065af		
0805 0900 twhf	Guam, TWR/KTWR	15170as		
0815 0850 Sat	Germany, TWR Europe	6105eu		
0815 0850 Sat	Monaco, TWR Europe	9800eu		
0830 0900	Australia, ABC NT Katherine	2485do		
0830 0900	Australia, ABC NT Tennant Creek		2325do	
0830 0900 Mon	Guam, TWR/KTWR	15170as		

**0900 UTC - 4AM EST / 3AM CST / 1AM PST**

0900 0915 Sat	UK, Bible Voice BC	5945eu		
0900 0920 Sun	Germany, TWR Europe	6105eu		
0900 0920 Sun	Monaco, TWR Europe	9800eu		
0900 0930	Australia, HCJB Global	11750pa		
0900 0930	Japan, NHK World/Radio Japan		9825as	
	11815as	12000pa	15590as	
0900 0945 Sun	UK, Bible Voice BC	5945eu		
0900 0957	China, China Radio Intl	15270eu	17490eu	
	17570eu			
0900 1000	Anguilla, World University Network		6090am	
0900 1000	Australia, ABC NT Alice Springs		2310do	
	4835do			
0900 1000	Australia, ABC NT Katherine	2485do		
0900 1000	Australia, ABC NT Tennant Creek		2325do	
0900 1000	Australia, CVC International	15360as		
0900 1000	Australia, Radio Australia	9475va	9580va	
	11880as			
0900 1000	Bhutan, BBS	6035as		
0900 1000	Canada, CFRX Toronto ON	6070na		
0900 1000	Canada, CFPV Calgary AB	6030na		
0900 1000	Canada, CKZN St John's NF	6160na		
0900 1000	Canada, CKZU Vancouver BC		6160na	
0900 1000	China, China Radio Intl	11620as	15210pa	
	15535as	17690pa	17750as	

0900 1000	Costa Rica, World University Network	5030va		
	6150va	7375va	9725va	11870va
	13750va			
0900 1000 DRM	Germany, CVC Intl/Voice Africa		7120as	
0900 1000	Germany, Deutsche Welle	17710as	21840as	
0900 1000	Guyana, Voice of 3291do	5950do		
0900 1000	Malaysia, RTM/Trax FM	7295as		
0900 1000	New Zealand, Radio NZ Intl	9765pa		
0900 1000 DRM	New Zealand, Radio NZ Intl	9870pa		
0900 1000	Nigeria, Radio/Kaduna	4770do	6090al	
0900 1000	Nigeria, Voice of/ Ext. Svc Lagos		9690af	
0900 1000	Papua New Guinea, NBC	4890do		
0900 1000 vl	Papua New Guinea, Wantok R. Light		7325va	
0900 1000	Russia, Voice of	9550as	13580as	13660as
	15195as	17495pa	17665pa	
0900 1000 DRM	Russia, Voice of	11615eu		
0900 1000	Saudi Arabia, BSKSA		15250af	
0900 1000	Singapore, MediaCorp Radio		6150do	
0900 1000 vl	Solomon Islands, SIBC	5020do	9545al	
0900 1000 vl	South Africa, Channel Africa	9625af		
0900 1000	UK, BBC World Service	6190af	6195as	
	9740as	11760me	11895as	11940af
	12095va	15285as	15400af	15575va
	17640af	17760as	17830af	21470af
	21660as			
0900 1000	USA, American Forces Radio		4319usb	
	5446usb	5765usb	6350usb	7811usb
	10320usb	12133usb	13362usb	
0900 1000	USA, KTNB Salt Lake City UT		7505na	
0900 1000	USA, KWHR Naalehu HI	9930as	11565as	
0900 1000	USA, WBCQ Monticello ME	5110am		
0900 1000	USA, WBOH Newport NC	5920am		
0900 1000	USA, WERN Vandiver AL	5850am		
0900 1000	USA, WHRI Cypress Creek SC		5835va	
	7315am			
0900 1000	USA, WRMI Miami FL	9955am		
0900 1000	USA, WTJC Newport NC	9370na		
0900 1000	USA, WWCR Nashville TN	3215na	5070na	
	5890na	5935na		
0900 1000	USA, WWRB Manchester TN	3185va		
0900 1000	USA, WYFR/Family Radio FL		5950na	
	6875na	9460as	9465as	
0900 1000 vl	Vanuatu, Radio	4960do		
0900 1000	Zambia, CVC International	6065af		
0915 0945 Sat	UK, Bible Voice BC	5945eu		
0930 1000	Lithuania, Radio Vilnius	9710na		
0930 1000	Mongolia, Voice of	12085va		

**1000 UTC - 5AM EST / 4AM CST / 2AM PST**

1000 1027	Czech Rep, Radio Prague	9955na	15710as	
	21745af			
1000 1030	Mongolia, Voice of	12085va		
1000 1030	UK, BBC World Service	15285as	17760as	
1000 1030	Vietnam, Voice of	7285as		
1000 1057	Netherlands, Radio	6040as	9795as	
	12065as			
1000 1058	New Zealand, Radio NZ Intl	9765pa		
1000 1058 DRM	New Zealand, Radio NZ Intl	9870pa		
1000 1100	Anguilla, World University Network		11775am	
1000 1100	Australia, ABC NT Alice Springs		2310do	
	4835do			
1000 1100	Australia, ABC NT Katherine	2485do		
1000 1100	Australia, ABC NT Tennant Creek		2325do	
1000 1100	Australia, CVC International	15270as		
1000 1100	Australia, Radio Australia	9475va	9580va	
	11880as			
1000 1100	Canada, CFRX Toronto ON	6070na		
1000 1100	Canada, CFPV Calgary AB	6030na		
1000 1100	Canada, CKZN St John's NF	6160na		
1000 1100	Canada, CKZU Vancouver BC		6160na	
1000 1100	China, China Radio Intl	5995as	6040na	
	11610as	11635as	11650as	11795as
	13590as	13620as	13720as	15190as
	15210as	15350as	17490eu	17690pa
1000 1100	Costa Rica, World University Network	5030va		
	6150va	7375va	9725va	11870va
	13750va			
1000 1100 DRM	Germany, CVC Intl/Voice Africa		7120as	
1000 1100	Guyana, Voice of 3291do	5950do		
1000 1100	India, All India Radio	7270as	13710pa	
	15020as	15235as	15260as	17510pa
	17800as	17895pa		
1000 1100	Italy, IRRS	9510va		
1000 1100	Malaysia, RTM/Trax FM	7295as		
1000 1100	Nigeria, Radio/Kaduna	4770do	6090al	

1000 1100	Nigeria, Voice of/ Ext. Svc Lagos	9690af	
1000 1100	North Korea, Voice of Korea	6185as	
	6285sa 9325sa 9850as		
1000 1100	Papua New Guinea, NBC	4890do	
1000 1100 vl	Papua New Guinea, Wantok R. Light	7325va	
1000 1100	Saudi Arabia, BSKSA	15250af	
1000 1100	Singapore, MediaCorp Radio	6150do	
1000 1100 Sun	Slovakia, European Gospel Radio	9510va	
1000 1100 vl	Solomon Islands, SIBC	5020do	
1000 1100 vl	South Africa, Channel Africa	9625af	
1000 1100	UK, BBC World Service	6190af	6195as
	9740as 11760me 11895as		11940af
	15575va 17640af 21470af		
1000 1100 Sat/Sun	UK, BBC World Service	15400af	17830af
1000 1100	Ukraine, Radio Ukraine Intl	9950eu	
1000 1100	USA, American Forces Radio		4319usb
	5446usb 5765usb 6350usb		7811usb
	10320usb 12133usb 13362usb		
1000 1100	USA, KNLS Anchor Point AK	6150as	
1000 1100	USA, KTBN Salt Lake City UT		7505na
1000 1100	USA, KWHR Naalehu HI	9930as	11565as
1000 1100	USA, WBCQ Monticello ME	5110am	
1000 1100	USA, WBOH Newport NC	5920am	
1000 1100	USA, WEWN Vandiver AL	5850am	
1000 1100	USA, WHRI Cypress Creek SC		5835va
	9865am		
1000 1100	USA, WRMI Miami FL	9955am	
1000 1100	USA, WTJC Newport NC	9370na	
1000 1100	USA, WWCN Nashville TN	5070na	5890na
	5935na 9985na		
1000 1100	USA, WWRB Manchester TN	3185va	
1000 1100	USA, WYFR/Family Radio FL		5950na
	6000am 6875na 6890na		7455na
	9460as 11725am 11830am		
1000 1100	Zambia, CVC International	6065af	
1015 1045 Sun	UK, Bible Voice BC	5985as	
1030 1045	Israel, Kol Israel	13855va	15760va
1030 1100	Iran, Voice of the Islamic Rep		15460as
	17660as		
1059 1100	New Zealand, Radio NZ Intl	13840pa	
1059 1100 DRM	New Zealand, Radio NZ Intl	9870pa	

**1100 UTC - 6AM EST / 5AM CST / 3AM PST**

1100 1128	Vietnam, Voice of	9840as	7220as
	7285as		
1100 1130	Iran, Voice of the Islamic Rep		15460as
	17600as		
1100 1130	UK, BBC World Service	15400af	
1100 1200	Anguilla, World University Network		11775am
1100 1200	Australia, ABC NT Alice Springs		2310do
	4835do		
1100 1200	Australia, ABC NT Katherine	2485do	
1100 1200	Australia, ABC NT Tennant Creek		2325do
1100 1200	Australia, CVC International	13635as	
1100 1200	Australia, Radio Australia	5995va	6020va
	9475va 9560as 9580va		9590va
	11880as 12080as		
1100 1200 Sat/Sun	Canada, CBC NQ SW Service		9625na
1100 1200	Canada, CFRX Toronto ON	6070na	
1100 1200	Canada, CFPV Calgary AB	6030na	
1100 1200	Canada, CKZN St John's NF	6160na	
1100 1200	Canada, CKZU Vancouver BC		6160na
1100 1200	China, China Radio Intl	6040na	11750na
	13655eu 17490eu		
1100 1200	Costa Rica, World University Network		5030va
	6150va 7375va 9725va		11870va
	13750va		
1100 1200 DRM	Germany, CVC Intl/Voice Africa		7120as
1100 1200	Italy, IRRS	9510va	
1100 1200	Malaysia, RTM/Trax FM	7295as	
1100 1200	New Zealand, Radio NZ Intl	13840pa	
1100 1200 DRM	New Zealand, Radio NZ Intl	9870pa	
1100 1200	Nigeria, Radio/Kaduna	4770do	6090al
1100 1200	Nigeria, Voice of/ Ext. Svc Lagos		9690af
1100 1200	Papua New Guinea, NBC	4890do	
1100 1200 vl	Papua New Guinea, Wantok R. Light		7325va
1100 1200	Saudi Arabia, BSKSA	15250af	
1100 1200	Singapore, Radio Singapore Intl		6080as
	6150as		
1100 1200 Sun	Slovakia, European Gospel Radio		9510va
1100 1200 vl	South Africa, Channel Africa	9625af	
1100 1200	Taiwan, Radio Taiwan Intl	7445as	
1100 1200	UK, BBC World Service	5875am	6190af
	6195as 9660am 9740as		9750am
	11760me 11895as 11940af		15575va

		17640af	17830af	21470af	
1100 1200 Sat	UK, Bible Voice BC			5950as	
1100 1200	USA, American Forces Radio				4319usb
	5446usb 5765usb 6350usb				7811usb
	10320usb 12133usb 13362usb				
1100 1200	USA, KTBN Salt Lake City UT				7505na
1100 1200	USA, KWHR Naalehu HI			9930as	
1100 1200	USA, WBOH Newport NC			5920am	
1100 1200	USA, WEWN Vandiver AL			5850am	
1100 1200	USA, WHRI Cypress Creek SC				5875va
	7315na				
1100 1200	USA, WINB Red Lion PA			9265am	
1100 1200	USA, WRMI Miami FL			9955am	
1100 1200	USA, WTJC Newport NC			9370na	
1100 1200	USA, WWCN Nashville TN			5070na	5890na
	5935na 15825na				
1100 1200	USA, WWRB Manchester TN			3185va	
1100 1200	USA, WYFR/Family Radio FL				5950na
	6890na 7780na				
1100 1200	Zambia, CVC International			6065af	
1105 1200	Greece, Voice of	9420va		15650va	
1115 1130 mtwhf	UK, Bible Voice BC			5950as	
1115 1200 Sun	UK, Bible Voice BC			5950as	
1120 1157	Czech Rep, Radio Prague			11640eu	
	175451euva				
1130 1200	Guam, AWR/KSDA			15260as	
1130 1200	Micronesia, PMA/The Cross			4755as	

**1200 UTC - 7AM EST / 6AM CST / 4AM PST**

1200 1215 f	UK, Bible Voice BC		5950as	
1200 1227	Netherlands, Radio		11675na	
1200 1230	Australia, HCJB Global		15400as	
1200 1230	France, Radio France Intl		21620af	
1200 1230	Germany, AWR Europe		15495as	
1200 1230	Japan, NHK World/Radio Japan			6120na
	9625pa 13660as		17585eu	
1200 1230 Sun	UK, Bible Voice BC		5945eu	
1200 1257	China, China Radio Intl		13655eu	13790eu
	17490eu			
1200 1257 DRM/ mtwhf	Netherlands, Radio		5955eu	
1200 1258	New Zealand, Radio NZ Intl		13840pa	
1200 1258 DRM	New Zealand, Radio NZ Intl		9870pa	
1200 1300	Anguilla, World University Network			11775am
1200 1300	Australia, ABC NT Alice Springs			2310do
	4835do			
1200 1300	Australia, ABC NT Katherine	2485do		
1200 1300	Australia, ABC NT Tennant Creek			2325do
1200 1300	Australia, CVC International	13635as		
1200 1300	Australia, Radio Australia	6020va		9475as
	9560pa 9590as 11880as			
1200 1300 DRM	Australia, Radio Australia		5995va	
1200 1300 Sat/Sun	Canada, CBC NQ SW Service			9625na
1200 1300	Canada, CFRX Toronto ON	6070na		
1200 1300	Canada, CFPV Calgary AB	6030na		
1200 1300	Canada, CKZN St John's NF	6160na		
1200 1300	Canada, CKZU Vancouver BC			6160na
1200 1300	China, China Radio Intl	5995as		9460as
	9730as 9760pa 11650as			11660as
	11690as 11760pa 11980as			13645as
1200 1300	Costa Rica, World University Network			9725va
	11870va 13750va			
1200 1300	Italy, IRRS	9510va		
1200 1300 Sun	Latvia, Radio SWH		9290eu	
1200 1300	Malaysia, RTM/Trax FM		7295as	
1200 1300	Nigeria, Radio/Kaduna		4770do	6090al
1200 1300	Nigeria, Voice of/ Ext. Svc Lagos			9690af
1200 1300	Papua New Guinea, NBC	4890do		
1200 1300 vl	Papua New Guinea, Wantok R. Light			7325va
1200 1300	Saudi Arabia, BSKSA	15250af		
1200 1300	Singapore, Radio Singapore Intl			6080as
	6150as			
1200 1300 Sun	Slovakia, European Gospel Radio			9510va
1200 1300	South Korea, KBS World Radio			9650na
1200 1300 DRM/ Fri	Taiwan, Radio Taiwan Intl		9750eu	
1200 1300	UK, BBC World Service		5975as	6190af
	6195as 9660am 9740as			9750am
	11760me 11895as 11940af			15575va
	17640af 17830af 21470af			
1200 1300	Ukraine, Radio Ukraine Intl		9950eu	
1200 1300	USA, American Forces Radio			4319usb
	5446usb 5765usb 6350usb			7811usb
	10320usb 12133usb 13362usb			
1200 1300	USA, KNLS Anchor Point AK	6150as		6915as
1200 1300	USA, KTBN Salt Lake City UT			7505na
1200 1300	USA, KWHR Naalehu HI			12130as

1200 1300	USA, Voice of America	9640va	9760va
	11705va	11730va	15190va
1200 1300	USA, WBOH Newport NC	5920am	
1200 1300	USA, WEWN Vandiver AL	5850am	
1200 1300	USA, WHRA Greenbush ME	13650va	
1200 1300 mtwhf	USA, WHRI Cypress Creek SC		7520na
1200 1300	USA, WHRI Cypress Creek SC		9660am
1200 1300	USA, WINB Red Lion PA	9265am	
1200 1300	USA, WRMI Miami FL	9955am	
1200 1300	USA, WTJC Newport NC	9370na	
1200 1300	USA, WWCR Nashville TN	5070na	5890na
	5935na	15825na	
1200 1300	USA, WWRB Manchester TN	3185va	
1200 1300	USA, WYFR/Family Radio FL		5900as
	6890na	7780na	11530am 11970na
1200 1300	Zambia, CVC International	6065af	
1215 1300	Egypt, Radio Cairo	17835as	
1230 1245 Sun	Australia, HCJB Global	15540as	
1230 1258	Vietnam, Voice of	9840as	12020as
1230 1300	Bangladesh, Bangla Betar	7185as	
1230 1300	Bulgaria, Radio	11700eu	15700eu
1230 1300	Thailand, Radio	9810va	
1245 1300 Sat/Sun	UK, Bible Voice BC	5950as	
1259 1300	New Zealand, Radio NZ Intl	5950pa	

**1300 UTC - 8AM EST / 7AM CST / 5AM PST**

1300 1330	Egypt, Radio Cairo	17835as	
1300 1330 Sun	Italy, IRRS	15750as	
1300 1330 Sun	Slovakia, Universal Life	15750as	
1300 1356	Romania, Radio Romania Intl		15105eu
	17745eu		
1300 1357	China, China Radio Intl	13610eu	13790eu
	15540sa		
1300 1400	Anguilla, World University Network		11775am
1300 1400	Australia, CVC International	13635as	
1300 1400	Australia, Radio Australia	6020va	9560as
	9580va	9590va	
1300 1400 DRM	Australia, Radio Australia	5995va	
1300 1400 mtwhf	Austria, Radio Austria Intl	17715va	
1300 1400 Sat/Sun	Canada, CBC NQ SW Service		9625na
1300 1400	Canada, CFRX Toronto ON	6070na	
1300 1400	Canada, CFVP Calgary AB	6030na	
1300 1400	Canada, CKZN St John's NF	6160na	
1300 1400	Canada, CKZU Vancouver BC		6160na
1300 1400	China, China Radio Intl	5995as	9570na
	9650na	9730as	9760pa 9765as
	9870as	11660as	11760pa 11980as
	13755as	15260na	
1300 1400	Costa Rica, World University Network		9725va
	11870va	13750va	
1300 1400	Malaysia, RTM/Trax FM	7295as	
1300 1400	New Zealand, Radio NZ Intl	5950pa	
1300 1400	Nigeria, Radio/Kaduna	4770do	6090al
1300 1400	Nigeria, Voice of/ Ext. Svc Lagos		9690af
1300 1400	North Korea, Voice of Korea	7570eu	
	9335na	11710na	12015eu
1300 1400	Papua New Guinea, NBC	4890do	
1300 1400 vl	Papua New Guinea, Wantok R. Light		7325va
1300 1400	Poland, Polish Radio	5975eu	9450eu
1300 1400	Singapore, Radio Singapore Intl		6080as
	6150as		
1300 1400	South Korea, KBS World Radio		9570na
	9770as		
1300 1400	UK, BBC World Service	5975as	6190af
	6195as	9740as	11895as 11940af
	15420af	15575va	17640af 17830af
	21470af		
1300 1400	USA, American Forces Radio		4319usb
	5446usb	5765usb	6350usb 7811usb
	10320usb	12133usb	13362usb
1300 1400	USA, KJES Vado NM		11715na
1300 1400	USA, KTBN Salt Lake City UT		7505na
1300 1400	USA, KWHR Naalehu HI	12130as	
1300 1400	USA, Voice of America	9760va	11705va
1300 1400	USA, WBOH Newport NC	5920am	
1300 1400	USA, WEWN Vandiver AL	5850am	
1300 1400	USA, WHRA Greenbush ME	15665va	
1300 1400	USA, WHRI Cypress Creek SC		9840na
1300 1400 Sat/Sun	USA, WHRI Cypress Creek SC		11785na
1300 1400	USA, WINB Red Lion PA	13570am	
1300 1400	USA, WRMI Miami FL	9955am	
1300 1400	USA, WTJC Newport NC	9370na	
1300 1400	USA, WWCR Nashville TN	5890na	9985na
	13845na	15825na	
1300 1400	USA, WWRB Manchester TN	3185va	9385va

1300 1400	USA, WYFR/Family Radio FL		7175as
	7560as	7780na	9485as 11520as
	11562as	11830na	11855na 11930as
	11970na		
1300 1400	Zambia, CVC International	6065af	
1305 1330 Sat	Austria, Radio Austria Intl		17715va
1310 1340	Japan, NHK World/Radio Japan		9875as
1315 1330 mwa	Australia, HCJB Global		15540as
1330 1345 Sun	Austria, Radio Austria Intl		17715va
1330 1357 DRM/Fri-Sat	Czech Rep, Radio Prague		9750eu
1330 1400 mtwhfa	Guam, AWR/KSDA		15660as
1330 1400	India, All India Radio		9690as 11620as
	13710as		
1330 1400	Laos, National Radio		7145as
1330 1400	Sweden, Radio		7420as 15240na
1330 1400	Turkey, Voice of		11735va 12035eu

**1400 UTC - 9AM EST / 8AM CST / 6AM PST**

1400 1415 Sat	Germany, Pan American BC	13645me	
1400 1415	Russia, FEBA	7150eu	
1400 1425	Turkey, Voice of	11735va	12035eu
1400 1429	Czech Rep, Radio Prague	11600as	13580na
1400 1430 w	Germany, Pan American BC	15205as	
1400 1430 mhf	Guam, TWR/KTWR		9975as
1400 1430	Japan, NHK World/Radio Japan		7200as
	9875as	11705na	11780af 17580af
1400 1430	Serbia, International Radio Serbia		7240eu
1400 1430	Thailand, Radio	9725va	
1400 1457	China, China Radio Intl	9700eu	9795eu
1400 1457	Netherlands, Radio	9345as	12080as
	15595as		
1400 1500	Anguilla, World University Network		11775am
1400 1500	Australia, CVC International	13635as	
1400 1500	Australia, Radio Australia	5995va	6080va
	7240va	9590va	
1400 1500	Bhutan, BBS	6035as	
1400 1500 Sat/Sun	Canada, CBC NQ SW Service		9625na
1400 1500	Canada, CFRX Toronto ON	6070na	
1400 1500	Canada, CFVP Calgary AB	6030na	
1400 1500	Canada, CKZN St John's NF	6160na	
1400 1500	Canada, CKZU Vancouver BC		6160na
1400 1500	China, China Radio Intl	5995as	9560as
	9765as	9870as	11675as 11765as
	11775as	13685af	13740na 17630af
1400 1500	Costa Rica, World University Network		9725va
	11870va	13750va	
1400 1500	Germany, Overcomer Ministries		6110va
	13810va	15325va	
1400 1500 tw	Guam, TWR/KTWR		9975as
1400 1500	India, All India Radio		9690as 11620as
	13710as		
1400 1500	Libya, Voice of Africa	17725af	21695af
1400 1500	Malaysia, RTM/Trax FM	7295as	
1400 1500	New Zealand, Radio NZ Intl	5950pa	
1400 1500	Nigeria, Radio/Kaduna	4770do	6090al
1400 1500	Nigeria, Voice of/ Ext. Svc Lagos		9690af
1400 1500 vl	Papua New Guinea, Wantok R. Light		7325va
1400 1500	Singapore, MediaCorp Radio		6150do
1400 1500 vl	South Africa, Channel Africa	9625af	
1400 1500	UK, BBC World Service	5975as	6190af
	6195as	9740as	11760va 11895as
	11920as	11940af	17830af 21470af
	21660af		
1400 1500 Sat	UK, BBC World Service		9410va
1400 1500 Sat/Sun	UK, Bible Voice BC		11695as
1400 1500	USA, American Forces Radio		4319usb
	5446usb	5765usb	6350usb 7811usb
	10320usb	12133usb	13362usb
1400 1500	USA, KJES Vado NM		11715na
1400 1500	USA, KNLS Anchor Point AK	6150as	
1400 1500	USA, KTBN Salt Lake City UT		7505na
	15590na		
1400 1500	USA, KWHR Naalehu HI	9930as	
1400 1500	USA, Voice of America	4930af	6080af
	9760va	9865va	11885va 12150va
	15205va	15580af	17715af 17895af
1400 1500 Sun	USA, WBCQ Monticello ME	17495am	
1400 1500	USA, WBOH Newport NC	5920am	
1400 1500	USA, WEWN Vandiver AL	5850am	
1400 1500	USA, WHRA Greenbush ME	15665va	
1400 1500 mtwhf	USA, WHRI Cypress Creek SC		9495na
1400 1500	USA, WHRI Cypress Creek SC		9840na
1400 1500 Sat/Sun	USA, WHRI Cypress Creek SC		11785na
1400 1500	USA, WINB Red Lion PA	13570am	
1400 1500	USA, WRMI Miami FL	9955am	



1400 1500	USA, WTJC Newport NC	9370na	
1400 1500	USA, WWCR Nashville TN	5890na	9985na
	13845na	15825na	
1400 1500	USA, WWRB Manchester TN	9385va	
1400 1500	USA, WYFR/Family Radio FL	5920as	
	6225as	7175as	7560as 11520as
	11560as	11565na	11855na 13695na
	17760as		
1400 1500	Zambia, CVC International	6065af	
1415 1430 mtwhfa	Germany, Pan American BC	13645as	
1415 1430	Nepal, Radio	3230as	5005as 6100as
	7165as		
1415 1445 Mon	UAE, FEBA	12025eu	
1425 1500	Micronesia, PMA/The Cross	4755as	
1430 1445 Sun	Germany, Pan American BC	13645as	
1430 1445 Fri	UAE, FEBA	12025eu	
1430 1500	Australia, Radio Australia	9475va	11660pa
1430 1500	Ethiopia, Radio	5990af	7110af 9704af
1430 1500 DRM	South Korea, KBS World Radio	9750eu	
1430 1500	Sweden, Radio	9440va	
1430 1500	USA, Voice of America	6105va	7225va
	9715va	15130va	

### 1500 UTC - 10AM EST / 9AM CST / 7AM PST

1500 1510 mtwhfa	Turkmenistan, Turkmen Radio	5015eu	
1500 1527	Czech Rep, Radio Prague	7385na	
1500 1528	Vietnam, Voice of	9550va	9840va
	12020va	13860va	
1500 1530	Guam, AWR/KSDA	12105as	
1500 1530	Nigeria, Radio, Natl Svc/Abuja	7275do	
1500 1530	UK, BBC World Service	11860af	15420af
	17640af		
1500 1530 ta	UK, Bible Voice BC	11895as	
1500 1530 Sat/Sun	UK, Sudan Radio Service	9840af	
1500 1530	USA, Voice of America	6105va	9760va
	15460va		
1500 1545	Sweden, IBRA Radio	7340as	
1500 1557	Canada, Radio Canada Intl	9635va	11975va
1500 1557	China, China Radio Intl	9435eu	9525eu
1500 1557	Netherlands, Radio	9345af	12080as
	15595as		
1500 1600	Anguilla, World University Network	11775am	
1500 1600	Australia, CVC International	13635as	
1500 1600	Australia, Radio Australia	5995va	6080va
	7240as	9475va	9590as 11660pa
1500 1600 Sat/Sun	Canada, CBC NQ SW Service	9625na	
1500 1600	Canada, CFRX Toronto ON	6070na	
1500 1600	Canada, CFVP Calgary AB	6030na	
1500 1600	Canada, CKZN St John's NF	6160na	
1500 1600	Canada, CKZU Vancouver BC	6160na	
1500 1600	China, China Radio Intl	5955as	6100af
	7160as	7325as	9875as 9870as
	11775as	13685af	13740na 17630af
1500 1600	Costa Rica, World University Network	9725va	
	11870va	13750va	
1500 1600	Germany, CVC Intl/Voice Africa	15680af	
1500 1600	Germany, Overcomer Ministries	6110va	
	13810va	15325va	
1500 1600	Italy, IRRS	9825af	
1500 1600	Libya, Voice of Africa	17725af	21695af
1500 1600	Malaysia, RTM/Trax FM	7295as	
1500 1600	Myanmar, Myanma Radio	5985as	
1500 1600	New Zealand, Radio NZ Intl	5950pa	
1500 1600	Nigeria, Radio/Kaduna	4770do	6090al
1500 1600	Nigeria, Voice of/ Ext. Svc Lagos	9690af	
1500 1600	North Korea, Voice of Korea	7570eu	
	9335na	11710na	12015eu
1500 1600 vl	Papua New Guinea, Wantok R. Light	7325va	
1500 1600	Russia, Voice of	7350as	7260as 9660as
1500 1600 DRM	Russia, Voice of	5905eu	
1500 1600	Singapore, MediaCorp Radio	6150do	
1500 1600 vl	Slovakia, Miraya FM	9825af	
1500 1600	South Africa, Channel Africa	17770af	
1500 1600	UK, BBC World Service	6040as	6190af
	6195as	9740as	11920as 11940af
	12095va	15105af	17640af 17830af
	21470af	21660af	
1500 1600 Sat	UK, BBC World Service	9410va	
1500 1600	USA, American Forces Radio	4319usb	
	5446usb	5765usb	6350usb 7811usb
	10320usb	12133usb	13362usb
1500 1600	USA, KTBN Salt Lake City UT	7505na	
	15590na		
1500 1600	USA, KWHR Naalehu HI	9930as	
1500 1600	USA, Voice of America	4930af	6080af

	7125af	9520va	9865va	11510va
	11765va	12150va	13735va	15580af
	17715af	17895af		
1500 1600 Sun	USA, WBCQ Monticello ME	17495am		
1500 1600	USA, WBOH Newport NC	5920am		
1500 1600	USA, WEWN Vandiver AL	11530am		
1500 1600 mtwhfa	USA, WHRA Greenbush ME	15665va		
1500 1600	USA, WHRI Cypress Creek SC		9840na	
1500 1600	USA, WHRI Cypress Creek SC		11785na	
1500 1600	USA, WINB Red Lion PA	13570am		
1500 1600	USA, WRMI Miami FL	7385na		
1500 1600	USA, WTJC Newport NC	9370na		
1500 1600	USA, WWCR Nashville TN	9985na	12160na	
	13845na	15825na		
1500 1600	USA, WWRB Manchester TN	9385va		
1500 1600	USA, WYFR/Family Radio FL	5920as		
	6280as	11565na	11855va	12015as
	13660af	15210am	17760na	17690af
1500 1600	Zambia, CVC International	4965af		
1510 1545	Swaziland, TWR	4760af		
1515 1600 Sat	UK, Bible Voice BC	12035as		
1530 1545	India, All India Radio	7255af	9820af	
	9910af			
1530 1600 mtwhfa	Albania, Radio Tirana	13640na		
1530 1600	Germany, AWR Europe	11675as		
1530 1600	Iran, Voice of the Islamic Rep		6160as	
	7330as			
1530 1600	Sweden, Radio	7440va	15240na	
1530 1600 mh	UK, Bible Voice BC	12035as		
1530 1600	UK, Sudan Radio Service	9840af		
1530 1600	USA, Voice of America	6105va	7175va	
	9760va	15460va		

### 1600 UTC - 11AM EST / 10AM CST / 8AM PST

1600 1615	Pakistan, Radio	6230eu	7520eu	11570eu
1600 1628	Vietnam, Voice of	9730va	11630va	13860va
	9730va	11630va	13860va	
1600 1630	Guam, AWR/KSDA	9585as		11690as
1600 1630	Iran, Voice of the Islamic Rep	7330as		6160as
	7330as			
1600 1630	Myanmar, Myanma Radio	9730do		
1600 1630	Nigeria, Voice of/ Ext. Svc Lagos		9690af	
1600 1630 Sat/Sun	Swaziland, TWR	4760af		
1600 1650	New Zealand, Radio NZ Intl	5950pa		
1600 1657	China, China Radio Intl	7255eu	9435eu	
	9525eu			
1600 1700	Anguilla, World University Network	11775am		
1600 1700	Australia, CVC International	13635as		
1600 1700	Australia, Radio Australia	5995va	6080va	
	7240as	9475va	9710pa	11660pa
1600 1700 mtwhf	Austria, Radio Austria Intl	13675am		
1600 1700 Sat	Canada, CBC NQ SW Service	9625na		
1600 1700	Canada, CFRX Toronto ON	6070na		
1600 1700	Canada, CFVP Calgary AB	6030na		
1600 1700	Canada, CKZN St John's NF	6160na		
1600 1700	Canada, CKZU Vancouver BC	6160na		
1600 1700	China, China Radio Intl	6100af	9570af	
	11800af			
1600 1700	Costa Rica, World University Network	11870va		
	13750va			
1600 1700	Egypt, Radio Cairo	11740af		
1600 1700	Ethiopia, Radio	7165af	9560af	
1600 1700	France, Radio France Intl	15605af		
1600 1700	Germany, CVC Intl/Voice Africa		15680af	
1600 1700	Germany, Deutsche Welle	5965as	9795as	
1600 1700 Sun	Germany, Overcomer Ministries	6110eu		
1600 1700	Italy, IRRS	9825af		
1600 1700	Jordan, Radio	11690na		
1600 1700	Malaysia, RTM/Trax FM	7295as		
1600 1700	Nigeria, Radio/Kaduna	4770do	6090al	
1600 1700	North Korea, Voice of Korea	9990va		
	11545va			
1600 1700 vl	Papua New Guinea, Wantok R. Light	7325va		
1600 1700	Russia, Voice of	4965va	4975va	6130eu
	7260as	7305as	7320eu	9470me
1600 1700 vl	Rwanda, Radio	6055do		
1600 1700 vl	Slovakia, Miraya FM	9825af		
1600 1700	South Korea, KBS World Radio	9515eu		
1600 1700	Taiwan, Radio Taiwan Intl	9785as	11550as	
1600 1700	UK, BBC World Service	3255af	3915as	
	6190af	6195as	11665va	11920as
	11940af	12095va	15105va	15400af
	17830af	21470af	21660af	
1600 1700 Sat	UK, BBC World Service	9410va		
1600 1700	USA, American Forces Radio	4319usb		

		5446usb	5765usb	6350usb	7811usb
		10320usb	12133usb	13362usb	
1600	1700	USA, KJES Vado NM	11715na		
1600	1700	USA, KTBN Salt Lake City UT		15590na	
1600	1700	USA, KWHR Naalehu HI	9930as		
1600	1700	USA, Voice of America	4930af	6080af	
		15580af	13600va	13615va	15445va
		17715af	17895af		
1600	1700	Sun	USA, WBCQ Monticello ME	17495am	
1600	1700		USA, WBOH Newport NC	5920am	
1600	1700		USA, WEWN Vandiver AL	11530am	15785eu
1600	1700		USA, WHRA Greenbush ME	17650af	
1600	1700		USA, WHRI Cypress Creek SC		9840na
			15285am		
1600	1700		USA, WINB Red Lion PA	13570am	
1600	1700	smtwhf	USA, WMLK Bethel PA	9265va	
1600	1700		USA, WRMI Miami FL	7385na	
1600	1700		USA, WTJC Newport NC	9370na	
1600	1700		USA, WWCN Nashville TN	9985na	12160na
			13845na	15825na	
1600	1700	Sun	USA, WWRB Manchester TN	11920af	
1600	1700		USA, WWRB Manchester TN	9385va	12180va
1600	1700		USA, WYFR/Family Radio FL		6085am
			9885af	11565na	11830na
			12010as	13695na	15325af
			17760na	18980va	21455va
1600	1700		Zambia, CVC International	4965af	
1605	1630	Sat/Sun	Austria, Radio Austria Intl	13675am	
1605	1700		Canada, Radio Canada Intl	9610na	
1615	1645	mtwhf	Swaziland, TWR 6130af		
1615	1700	Sat/Sun	UK, BBC World Service	11860af	15420af
			17640af		
1630	1645	Sun	Germany, Pan American BC	9850me	
1630	1700		Guam, AWR/KSDA	11980as	
1630	1700		Nigeria, Voice of/ Ext. Svc Lagos		15120af
1630	1700	Sat/Sun	Swaziland, TWR 6130af		
1630	1700	Sun	UK, Bible Voice BC	9460me	
1640	1650	mtwhfa	Turkmenistan, Turkmen Radio		4930eu
1640	1700	mtwhf	UK, Bible Voice BC	9460me	
1645	1700	f	Sweden, IBRA Radio	9830as	
1645	1700		Tajikistan, Tajik Radio	7245as	
1645	1700	Sat	UK, Bible Voice BC	9460me	
1651	1700	DRM	New Zealand, Radio NZ Intl	9890pa	
1651	1700		New Zealand, Radio NZ Intl	9615pa	

**1700 UTC - 12PM EST / 11AM CST / 9AM PST**

1700	1715		Swaziland, TWR 6130af		
1700	1715	twhfa	UK, Bible Voice BC	9460me	
1700	1720	twhfa	Moldova, Radio PMR/Pridnestrovie	6235eu	
1700	1727		Czech Rep, Radio Prague	5930eu	15710af
1700	1730		Jordan, Radio	11690na	
1700	1740	f	Moldova, Radio PMR/Pridnestrovie	6235eu	
1700	1745		UK, BBC World Service	6005af	9630af
1700	1757		China, China Radio Intl	6100eu	7205eu
			7255eu	7335eu	
1700	1800		Anguilla, World University Network	11775am	
1700	1800	mtwhf	Argentina, RAE	15344eu	
1700	1800		Australia, CVC International	13635as	
1700	1800		Australia, Radio Australia	5995va	6080va
			9475as	9580va	9710as
			11880as		
1700	1800	Sat	Canada, CBC NQ SW Service		9625na
1700	1800		Canada, CFRX Toronto ON	6070na	
1700	1800		Canada, CFVP Calgary AB	6030na	
1700	1800		Canada, CKZN St John's NF	6160na	
1700	1800		Canada, CKZU Vancouver BC		6160na
1700	1800	DRM	Canada, Radio Canada Intl	9800na	
1700	1800		China, China Radio Intl	9570af	11900af
1700	1800		Costa Rica, World University Network	11870va	
			13750va		
1700	1800		Egypt, Radio Cairo	11740af	
1700	1800		Eq. Guinea, Radio Africa	15190af	
1700	1800		Germany, CVC Intl/Voice Africa		15680af
1700	1800		Italy, IRRS	9825va	
1700	1800		Italy, IRRS	9825af	
1700	1800		Malaysia, RTM/Trax FM	7295as	
1700	1800		New Zealand, Radio NZ Intl	9615pa	
1700	1800	DRM	New Zealand, Radio NZ Intl	9890pa	
1700	1800		Nigeria, Radio/Kaduna	4770do	6090af
1700	1800		Nigeria, Voice of/ Ext. Svc Lagos		15120af
1700	1800	vl	Papua New Guinea, Wantok R. Light	7325va	
1700	1800		Russia, Voice of	6125as	7125as
			7270va	7320eu	9470me
1700	1800	vl	Rwanda, Radio	6055do	
1700	1800	vl	Slovakia, Miraya FM	9825af	
1700	1800		South Africa, Channel Africa	15235af	

1700	1800		Swaziland, TWR 3200af		
1700	1800		Taiwan, Radio Taiwan Intl	11850af	
1700	1800	DRM	UK, BBC World Service	5895eu	
1700	1800		UK, BBC World Service	3255af	3915as
			6190af	11665va	11755af
			12095af	15400af	17830af
			21470af		
1700	1800	Sun	UK, Bible Voice BC	9460me	
1700	1800		USA, American Forces Radio		4319usb
			5446usb	5765usb	6350usb
			10320usb	12133usb	13362usb
1700	1800		USA, KTBN Salt Lake City UT		15590na
1700	1800		USA, KWHR Naalehu HI	9930as	
1700	1800		USA, Voice of America	6080af	13710af
			15580af	17895af	
1700	1800	Sun	USA, WBCQ Monticello ME	17495am	
1700	1800		USA, WBOH Newport NC	5920am	
1700	1800		USA, WEWN Vandiver AL	11530am	15785eu
1700	1800		USA, WHRI Cypress Creek SC		15285am
1700	1800		USA, WINB Red Lion PA	13570am	
1700	1800	smtwhf	USA, WMLK Bethel PA	9265va	
1700	1800		USA, WRMI Miami FL	9955am	
1700	1800		USA, WTJC Newport NC	9370na	
1700	1800		USA, WWCN Nashville TN	9985na	12160na
			13845na	15825na	
1700	1800	Sun	USA, WWRB Manchester TN	11920af	
1700	1800		USA, WWRB Manchester TN	9285va	12180va
1700	1800		USA, WYFR/Family Radio FL		3955va
			9885af	13695na	17555na
			21455va	21680af	18980va
1700	1800		Zambia, CVC International	4965af	
1715	1730	h	UK, Bible Voice BC	9460me	
1715	1745	t	UK, Bible Voice BC	9460me	
1730	1745	h	UK, Bible Voice BC	9460me	
1730	1800		Guam, AWR/KSDA	9980me	
1730	1800		Slovakia, Radio Slovakia Int	5915eu	6055eu
1730	1800		Swaziland, TWR 9500af		
1730	1800	Sat	UK, Bible Voice BC	9460me	
1730	1800	Sun	UK, Bible Voice BC	9615me	
1730	1800	mtwhf	UK, Sudan Radio Service	9840af	
1730	1800	Sat/Sun	USA, Voice of America	4930af	12080af
			15775af		
1730	1800		USA, Voice of America	4930af	12080af
			15775af		
1730	1800	mtwhf	USA, Voice of America	4930af	12080af
			15775af		
1730	1800		Vatican City, Vatican Radio	9755af	11625af
			13765af		
1745	1800		Bangladesh, Bangla Betar	7185as	
1745	1800		India, All India Radio	7410eu	9445af
			9950eu	11620eu	11935af
			15075af	15155af	17670af
1745	1800	t	UK, Bible Voice BC	9460me	

**1800 UTC - 1PM EST / 12PM CST / 10AM PST**

1800	1805	DRM	Canada, Radio Canada Intl	9800na	
1800	1809		Tanzania, Voice of	11735af	
1800	1815	t/vl	UK, Bible Voice BC	9460me	
1800	1815	Sat	UK, Bible Voice BC	7210as	
1800	1827		Czech Rep, Radio Prague	5930eu	9400va
1800	1828		Vietnam, Voice of	5955eu	7280va
			9730va		
1800	1830		Nigeria, Radio, Natl Svc/Abuja	7275do	
1800	1830		South Africa, AWR Africa	3215af	3345af
			11830af		
1800	1830		UK, BBC World Service	11955as	
1800	1830	Sat/Sun	UK, Bible Voice BC	9460me	
1800	1830		USA, Voice of America	4930af	6080af
			11975af	13710af	15580af
1800	1856		Romania, Radio Romania Intl	7215eu	
			9640eu		
1800	1857		China, China Radio Intl	6100eu	7110eu
1800	1857		Netherlands, Radio	6020af	11655af
			12050af		
1800	1900		Anguilla, World University Network	11775am	
1800	1900		Australia, Radio Australia	6080va	7240as
			9475va	9580as	9710as
			11880as		
1800	1900		Bangladesh, Bangla Betar	7185eu	
1800	1900		Canada, CFRX Toronto ON	6070na	
1800	1900		Canada, CFVP Calgary AB	6030na	
1800	1900		Canada, CKZN St John's NF	6160na	
1800	1900		Canada, CKZU Vancouver BC		6160na
1800	1900		Canada, Radio Canada Intl	7185af	11875af
			13650af	15365af	17790af
1800	1900		Costa Rica, World University Network	11870va	
			13750va		

1800 1900	Egypt, Radio Cairo	11740af	
1800 1900	Eq. Guinea, Radio Africa	15190af	
1800 1900	Germany, CVC Intl/Voice Africa	9490af	
1800 1900	India, All India Radio	7410eu 9445af	
	9950eu 11620eu 11935af	13605af	
	15075af 15155af 11750af		
1800 1900 fas	Italy, IRRS	7285va	
1800 1900	Kuwait, Radio Kuwait	11990na	
1800 1900	Malaysia, RTM/Trax FM	7295as	
1800 1900	New Zealand, Radio NZ Intl	9615pa	
1800 1900 DRM	New Zealand, Radio NZ Intl	9890pa	
1800 1900	Nigeria, Radio/Kaduna	4770do	6090af
1800 1900	Nigeria, Voice of/ Ext. Svc Lagos		15120af
1800 1900	North Korea, Voice of Korea		7570eu
	12015eu		
1800 1900 vl	Papua New Guinea, Wantok R. Light		7325va
1800 1900	Poland, Polish Radio	6015eu	7130eu
1800 1900	Russia, Voice of	6125as 7105eu	7125as
	7235as 7270af 7320eu	7335va	
	11510af		
1800 1900 Sat/Sun	Russia, Voice of	6055eu	6175eu
1800 1900 vl	Rwanda, Radio	6055do	
1800 1900 fas	Slovakia, European Gospel Radio		7285va
1800 1900	South Korea, KBS World Radio		7275eu
1800 1900	Swaziland, TWR	9500af	
1800 1900	Taiwan, Radio Taiwan Intl	3965eu	
1800 1900	UK, BBC World Service	3255af	5875va
	5955as 6005af 6190af	6195va	
	9410af 9480va 11755af	12095af	
	15400af 17830af		
1800 1900 DRM	UK, BBC World Service	5895eu	
1800 1900 Sat	UK, Bible Voice BC	9615me	
1800 1900	USA, American Forces Radio	4319usb	
	5446usb 5765usb 6350usb	7811usb	
	10320usb 12133usb 13362usb		
1800 1900	USA, KJES Vado NM	15385na	
1800 1900	USA, KTBN Salt Lake City UT		15590na
1800 1900 Sat/Sun	USA, WBCQ Monticello ME	9330am	17495am
1800 1900	USA, WBOH Newport NC	5920am	
1800 1900	USA, WEWN Vandiver AL	11530am	15785eu
1800 1900 mtwhf	USA, WHRI Cypress Creek SC		15670va
1800 1900 Sat/Sun	USA, WHRI Cypress Creek SC		15285va
1800 1900	USA, WINB Red Lion PA	13570am	
1800 1900 smtwhf	USA, WMLK Bethel PA	9265va	
1800 1900	USA, WRMI Miami FL	9955am	
1800 1900	USA, WTJC Newport NC	9370na	
1800 1900	USA, WWCR Nashville TN	9985na	12160na
	13845na 15825na		
1800 1900 Sun	USA, WWRB Manchester TN	11920af	
1800 1900	USA, WWRB Manchester TN	9385va	12180va
1800 1900	USA, WYFR/Family Radio FL		7240eu
	7345va 7395af 9435af	9785eu	
	9895af 9895af 11665af	13695na	
	15115af 17555na 18980va		
1800 1900	Yemen, Rep of Yemen Radio	9780me	
1800 1900	Zambia, CVC International	4965af	
1830 1845	Israel, Kol Israel	6985va 7545va	9345va
	15640af		
1830 1900	Bulgaria, Radio	7400eu	9400eu
1830 1900 whf	Sweden, Radio	6065va	
1830 1900	UK, BBC World Service	6005af	9630af
1830 1900 f	UK, Bible Voice BC	9460me	
1830 1900 Sun	UK, Bible Voice BC	9615me	
1830 1900	USA, Voice of America	4930af	6080af
	6105va 7220va 9650af	11975af	
	13710af 15580af 17895af		
1845 1900 Sun	UK, Bible Voice BC	7260af	

**1900 UTC - 2PM EST / 1PM CST / 11AM PST**

1900 1928	Vietnam, Voice of	7280va	9730va
1900 1930	Germany, Deutsche Welle	9735af	11690af
	13780af 15275af		
1900 1930 Sat	UK, Bible Voice BC	9460me	
1900 1930 Sun	UK, Bible Voice BC	6010eu	7245af
1900 1930	USA, Voice of America	9785va	12020va
1900 1935	New Zealand, Radio NZ Intl	9615pa	
1900 1935 DRM	New Zealand, Radio NZ Intl	9890pa	
1900 1945	India, All India Radio	7410eu	9445af
	9950eu 11620eu 11935af	13605af	
	15075af 15155af 17670af		
1900 1945 Sat	UK, Bible Voice BC	6010eu	
1900 1957	Netherlands, Radio	7120af	11655af
	11805af 12050af	17810af	
1900 1957 Sat/Sun	Netherlands, Radio	15315na	15525na
1900 2000	Anguilla, World University Network		11775am

1900 2000	Australia, Radio Australia	6080va	7240as
	9500va 9580va 9710as		11880as
1900 2000	Canada, CFRX Toronto ON	6070na	
1900 2000	Canada, CFVP Calgary AB	6030na	
1900 2000	Canada, CKZN St John's NF	6160na	
1900 2000	Canada, CKZU Vancouver BC		6160na
1900 2000	Canada, Radio Canada Intl	17790af	
1900 2000	China, China Radio Intl	7295va	9435va
	9440va		
1900 2000	Costa Rica, World University Network	13750va	11870va
1900 2000	Egypt, Radio Cairo	15375af	
1900 2000	Eq. Guinea, Radio Africa	15190af	
1900 2000	Germany, CVC Intl/Voice Africa		9490af
1900 2000 fas	Italy, IRRS	7285va	
1900 2000	Malaysia, RTM/Trax FM	7295as	
1900 2000	Nigeria, Radio/Kaduna	4770do	6090af
1900 2000	Nigeria, Voice of/ Ext. Svc Lagos		15120af
1900 2000	North Korea, Voice of Korea		7100af
	9975va 11910af 11535va		
1900 2000	Papua New Guinea, NBC	4890do	
1900 2000 vl	Papua New Guinea, Wantok R. Light		7325va
1900 2000	Russia, Voice of	5955as 6175eu	7105eu
	7290eu 7335af 11510af		
1900 2000 vl	Rwanda, Radio	6055do	
1900 2000 fas	Slovakia, European Gospel Radio		7285va
1900 2000 vl	Solomon Islands, SIBC	5020do	9545af
1900 2000 vl	South Africa, Channel Africa	3345af	
1900 2000 Mon	South Africa, DX Amateur League		3215af
1900 2000	Thailand, Radio	9805eu	
1900 2000 vl	Uganda, UBC Radio	4976do	5026do
1900 2000	UK, BBC World Service	3255af	5875va
	6005af 6190af 6195va	9410af	
	9480va 9630af 12095af	15400af	
	17830af		
1900 2000 DRM	UK, BBC World Service	5895eu	
1900 2000 Sat/Sun	UK, Bible Voice BC	9470me	
1900 2000 Sun	UK, Bible Voice BC	7260af	
1900 2000	USA, American Forces Radio	4319usb	
	5446usb 5765usb 6350usb	7811usb	
	10320usb 12133usb 13362usb		
1900 2000	USA, KJES Vado NM	15385na	
1900 2000	USA, KTBN Salt Lake City UT		15590na
1900 2000	USA, Voice of America	4930af	6080af
	11975af 13710af 15580af	17895af	
1900 2000 Sat/Sun	USA, WBCQ Monticello ME	9330am	17495am
1900 2000	USA, WBCQ Monticello ME	7415am	
1900 2000	USA, WBOH Newport NC	5920am	
1900 2000	USA, WEWN Vandiver AL	11530am	15785eu
1900 2000	USA, WHRA Greenbush ME	11785va	
1900 2000	USA, WHRI Cypress Creek SC		9840na
	17640am		
1900 2000	USA, WINB Red Lion PA	13570am	
1900 2000 smtwhf	USA, WMLK Bethel PA	9265va	
1900 2000	USA, WRMI Miami FL	9955am	
1900 2000	USA, WTJC Newport NC	9370na	
1900 2000	USA, WWCR Nashville TN	9975na	12160na
	13845na 15825na		
1900 2000 Sun	USA, WWRB Manchester TN	11920va	
1900 2000	USA, WWRB Manchester TN	9385va	12180va
1900 2000	USA, WYFR/Family Radio FL		3230af
	6020af 6085am 7160eu	7345me	
	7395af 9480af 13695na	15115va	
	15565na 17555na 17535va	18980va	
1900 2000	Zambia, CVC International	4965af	
1900 2000	Kuwait, Radio Kuwait	11990na	
1930 2000 Sat/Sun	Germany, Pan American BC	6020va	
1930 2000	Iran, Voice of the Islamic Rep		6010eu
	6225eu 7320eu 9855af	11695af	
1930 2000	Lithuania, Radio Vilnius	6010eu	6225eu
	7320eu		
1930 2000	Serbia, International Radio Serbia		6100eu
	7240eu		
1930 2000	Slovakia, Radio Slovakia Int	5915eu	7345eu
1930 2000	Turkey, Voice of	6055eu	
1930 2000 f	UK, Bible Voice BC	9470me	
1930 2000	USA, Voice of America	6105va	7220va
	9650va 9785va 12020va		
1936 1950 DRM	New Zealand, Radio NZ Intl	11675pa	
1936 2000	New Zealand, Radio NZ Intl	17675pa	
1945 2000 mtwhfa	Albania, Radio Tirana	6135eu	7465eu
1951 2000 DRM	New Zealand, Radio NZ Intl	15720pa	

**2000 UTC - 3PM EST / 2PM CST / 12PM PST**

2000 2015 Sun	Germany, Pan American BC	6020va	
---------------	--------------------------	--------	--



2000 2025	Turkey, Voice of	6055eu	
2000 2028	Lithuania, Radio Vilnius	6010eu	6225eu
	7320eu		
2000 2030	China, China Radio Intl	7160eu	
2000 2030	Egypt, Radio Cairo	15375af	
2000 2030 fa	Germany, Pan American BC	6020me	
2000 2030	Iran, Voice of the Islamic Rep	6010eu	
	6225eu	7320eu	9855af
			11695af
2000 2030	South Africa, AWR Africa	9655af	
2000 2030 Sun	UK, Bible Voice BC	6010eu	
2000 2030	USA, Voice of America	4930af	4940af
	6080af	11975af	13710af
2000 2030	Vatican City, Vatican Radio	7365af	9755af
	11625af		
2000 2057	China, China Radio Intl	7190eu	9600eu
2000 2057	Netherlands, Radio	11655af	18910af
2000 2100	Anguilla, World University Network		11775am
2000 2100	Australia, ABC NT Alice Springs		2310do
	4835do		
2000 2100	Australia, ABC NT Katherine	2485do	
2000 2100	Australia, ABC NT Tennant Creek		2325do
2000 2100 Sat/Sun	Australia, Radio Australia	12080as	
2000 2100	Australia, Radio Australia	6080va	7240as
	9500va	11650as	11660pa
			11880as
2000 2100	Canada, CFRX Toronto ON	6070na	
2000 2100	Canada, CFVP Calgary AB	6030na	
2000 2100	Canada, CKZN St John's NF	6160na	
2000 2100	Canada, CKZU Vancouver BC		6160na
2000 2100	China, China Radio Intl	5960eu	7285eu
	7295af	9440af	11640af
			13630af
2000 2100	Costa Rica, World University Network		13750va
2000 2100	Eqt Guinea, Radio Africa	15190af	
2000 2100	Germany, CVC Intl/Voice Africa		7285af
2000 2100	Germany, Deutsche Welle	9690af	9880af
	12780af		
2000 2100	Indonesia, Voice of	9525al	11785pa
	15150as		
2000 2100	Kuwait, Radio Kuwait	11990na	
2000 2100 vl	Liberia, ELWA	4760do	
2000 2100	Malaysia, RTM/Trax FM	7295as	
2000 2100	New Zealand, Radio NZ Intl	17675pa	
2000 2100 DRM	New Zealand, Radio NZ Intl	15720pa	
2000 2100	Nigeria, Radio/Kaduna	4770do	6090al
2000 2100	Nigeria, Voice of/ Ext. Svc Lagos		15120af
2000 2100	Papua New Guinea, NBC	4890do	
2000 2100 vl	Papua New Guinea, Wantok R. Light		7325va
2000 2100	Russia, Voice of	6145eu	7105eu
2000 2100 vl	Rwanda, Radio	6055do	7330eu
2000 2100 vl	Solomon Islands, SIBC	5020do	9545al
2000 2100 vl	South Africa, Channel Africa	3345af	
2000 2100 mtwhf	Spain, Radio Exterior Espana		9605af
	9690eu		
2000 2100 vl	Uganda, UBC Radio	4976do	5026do
2000 2100	UK, BBC World Service	3255af	6005af
	6190af	6195va	9410af
	12095af	15400af	17830af
2000 2100 DRM	UK, BBC World Service	5875eu	
2000 2100	Ukraine, Radio Ukraine Intl	5840eu	
2000 2100	USA, American Forces Radio		4319usb
	5446usb	5765usb	6350usb
	10320usb	12133usb	13362usb
2000 2100	USA, KJES Vado NM	15385na	
2000 2100	USA, KTVN Salt Lake City UT		15590na
2000 2100	USA, WBCQ Monticello ME	7415am	9330am
2000 2100 Sat/Sun	USA, WBCQ Monticello ME	17495am	
2000 2100	USA, WBOH Newport NC	5920am	
2000 2100	USA, WEWN Vandiver AL	11530am	17595af
2000 2100 mtwhf	USA, WHRA Greenbush ME	7520va	
2000 2100 Sat/Sun	USA, WHRA Greenbush ME	11785af	
2000 2100	USA, WHRI Cypress Creek SC		17640sa
2000 2100 mtwhfa	USA, WHRI Cypress Creek SC		11765na
2000 2100 f	USA, WHRI Cypress Creek SC		15665af
2000 2100	USA, WINB Red Lion PA	13570am	
2000 2100 smtwhf	USA, WMLK Bethel PA	9265va	
2000 2100	USA, WRMI Miami FL	9955am	
2000 2100	USA, WTJC Newport NC	9370na	
2000 2100	USA, WWCR Nashville TN	9975na	13845na
	15825na		
2000 2100 Sun	USA, WWRB Manchester TN	11920af	
2000 2100	USA, WWRB Manchester TN	9385va	12180va
2000 2100	USA, WYFR/Family Radio FL		3230af
	5745va	6020af	6240va
	9480as	15115af	15195af
	17575am		17535na
2000 2100	Zambia, CVC International	4965af	
2005 2100	Syria, Radio Damascus	9330eu	12085eu
2030 2045	Thailand, Radio	9535eu	

2030 2048	Vietnam, Voice of	7220va	7280va
	9550va	9730va	
2030 2058	Sweden, Radio	7420pa	
2030 2100	Cuba, Radio Havana	9505va	11760va
2030 2100	USA, Voice of America	4930af	4940af
	6080af	7595af	11975af
			13710af
2045 2100	India, All India Radio	7410eu	9445eu
	9910pa	9950eu	11620eu
			11715pa
2045 2100 DRM	Vatican City, Vatican Radio	9800am	
2050 2100	Vatican City, Vatican Radio	4005eu	5885eu
	7250eu		

**2100 UTC - 4PM EST / 3PM CST / 1PM PST**

2100 2120	Vatican City, Vatican Radio	4005eu	5885eu
	7250eu		
2100 2127	Czech Rep, Radio Prague	5930va	9430va
2100 2130 mtwhfa	Albania, Radio Tirana	7430eu	9915na
2100 2130	Australia, ABC NT Katherine	2485do	
2100 2130	Australia, ABC NT Tennant Creek		2325do
2100 2130	Austria, AWR Europe	9830af	
2100 2130 Sat	Canada, CBC NQ SW Service		9625na
2100 2130	China, China Radio Intl	11640af	13630af
2100 2130	Cuba, Radio Havana	9505va	11760va
2100 2130	Nigeria, Radio, Natl Svc/Abuja		7275do
2100 2130	South Africa, AWR Africa	9830af	
2100 2130	South Korea, KBS World Radio		3955eu
2100 2157	China, China Radio Intl	5960eu	6135eu
	7190eu	7285eu	9600eu
2100 2159	Canada, Radio Canada Intl	5850eu	9770eu
2100 2200	Anguilla, World University Network		11775am
2100 2200	Australia, ABC NT Alice Springs		2310do
	4835do		
2100 2200	Australia, Radio Australia	9500as	9660as
	11650pa	11660pa	11695as
	13630as	15515as	12080as
2100 2200	Belarus, Radio	6090eu	7360eu
2100 2200	Canada, CFRX Toronto ON	6070na	7390eu
2100 2200	Canada, CFVP Calgary AB	6030na	
2100 2200	Canada, CKZN St John's NF	6160na	
2100 2200	Canada, CKZU Vancouver BC		6160na
2100 2200	Costa Rica, World University Network		13750va
2100 2200	Eqt Guinea, Radio Africa	15190af	
2100 2200	Germany, Deutsche Welle	7280af	9545af
	11690af	13780af	
2100 2200	Guyana, Voice of	3291do	5950do
2100 2200	India, All India Radio	7410eu	9445eu
	9910pa	9950eu	11620eu
			11715pa
2100 2200 vl	Liberia, ELWA	4760do	
2100 2200	Malaysia, RTM/Trax FM	7295as	
2100 2200	New Zealand, Radio NZ Intl	17675pa	
2100 2200	New Zealand, Radio NZ Intl	17675pa	
2100 2200 DRM	New Zealand, Radio NZ Intl	15720pa	
2100 2200	Nigeria, Radio/Kaduna	4770do	6090al
2100 2200	Nigeria, Voice of/ Ext. Svc Lagos		7255af
2100 2200	North Korea, Voice of Korea		7570eu
	12015eu		
2100 2200	Papua New Guinea, NBC	4890do	
2100 2200 vl	Papua New Guinea, Wantok R. Light		7325va
2100 2200	Russia, Voice of	6145eu	7290eu
2100 2200 vl	South Africa, Channel Africa	3345af	7330eu
2100 2200	Syria, Radio Damascus	9330eu	12085eu
2100 2200	UK, BBC World Service	3255af	3915as
	5965as	6005af	6125as
	6195va	9410af	9525am
	15400af		11675am
2100 2200 DRM	UK, BBC World Service	5875eu	
2100 2200	USA, American Forces Radio		4319usb
	5446usb	5765usb	6350usb
	10320usb	12133usb	13362usb
2100 2200	USA, KTVN Salt Lake City UT		15590na
2100 2200	USA, Voice of America	6080af	15580af
2100 2200	USA, WBCQ Monticello ME	7415am	9330am
2100 2200	USA, WBOH Newport NC	5920am	
2100 2200	USA, WEWN Vandiver AL	11530am	17595af
2100 2200	USA, WHRA Greenbush ME	7520af	
2100 2200	USA, WHRI Cypress Creek SC		9575am
2100 2200 mtwhfa	USA, WHRI Cypress Creek SC		11765na
2100 2200	USA, WINB Red Lion PA	13570am	
2100 2200	USA, WRMI Miami FL	9955am	
2100 2200	USA, WTJC Newport NC	9370na	
2100 2200	USA, WWCR Nashville TN	9975na	12160na
	13845na	15825na	
2100 2200 Sun	USA, WWRB Manchester TN	11920af	
2100 2200	USA, WWRB Manchester TN	9385va	12180va
2100 2200	USA, WYFR/Family Radio FL		5745va
	9480as	15115af	15195af
	17575am		17535na
2100 2200	Zambia, CVC International	4965af	
2100 2200	Syria, Radio Damascus	9330eu	12085eu
2100 2200	Thailand, Radio	9535eu	

	6240va	6875eu	9480af	15195af
	15565af	17535na		
2115 2200	Egypt, Radio Cairo	6250eu		
2115 2200	USA, WYFR/Family Radio FL		11875af	
2127 2157	Sweden, Radio 7120af			
2130 2156	Romania, Radio Romania Intl	6055va		
	6155va	7145va	9755va	
2130 2200	Australia, ABC NT Katherine	5025do		
2130 2200	Australia, ABC NT Tennant Creek	4910do		
2130 2200 mtwhfa	Canada, CBC NQ SW Service	9625na		
2130 2200	Guam, AWR/KSDA	9720as		
2130 2200	Turkey, Voice of 7180va			
2130 2200	USA, Voice of America	7405af		

### 2200 UTC - 5PM EST / 4PM CST / 2PM PST

2200 2210	Syria, Radio Damascus	9330eu	12085eu	
2200 2220	Japan, NHK World/Radio Japan		13640pa	
2200 2230	India, All India Radio	7410eu	9445eu	
	9910pa	9950eu	11620eu	11715pa
2200 2230	Papua New Guinea, NBC	4890do		
2200 2230	Serbia, International Radio Serbia	6100eu		
	7240eu			
2200 2230	Turkey, Voice of 7180va			
2200 2235	New Zealand, Radio NZ Intl	17675pa		
2200 2235 DRM	New Zealand, Radio NZ Intl	15720pa		
2200 2245	Egypt, Radio Cairo	6250eu		
2200 2257	China, China Radio Intl	7170eu		
2200 2300	Anguilla, World University Network	6090am		
2200 2300	Australia, ABC NT Alice Springs	2310do		
	4835do			
2200 2300	Australia, ABC NT Katherine	5025do		
2200 2300	Australia, ABC NT Tennant Creek	4910do		
2200 2300	Australia, Radio Australia	9660va	11840va	
	12010va	12080as	13630pa	15230va
	15240pa	15515as	15560pa	
2200 2300	Belarus, Radio	6090eu	7360eu	7390eu
2200 2300	Bulgaria, Radio	7400eu	9400eu	
2200 2300 smtwhf	Canada, CBC NQ SW Service	9625na		
2200 2300	Canada, CFRX Toronto ON	6070na		
2200 2300	Canada, CFVP Calgary AB	6030na		
2200 2300	Canada, CKZN St John's NF	6160na		
2200 2300	Canada, CKZU Vancouver BC	6160na		
2200 2300 DRM	Canada, Radio Canada Intl	9800na		
2200 2300	China, China Radio Intl	9590as		
2200 2300	Costa Rica, World University Network	13750va		
2200 2300	Eq Guinea, Radio Africa	15190af		
2200 2300	Guyana, Voice of 3291do			
2200 2300 vl	Liberia, ELWA	4760do		
2200 2300	Malaysia, RTM/Trax FM	7295as		
2200 2300	Nigeria, Radio/Kaduna	4770do	6090al	
2200 2300	Nigeria, Voice of/ Ext. Svc Lagos	7255af		
2200 2300 vl	Papua New Guinea, Wantok R. Light	7325va		
2200 2300 vl	Solomon Islands, SIBC	5020do	9545al	
2200 2300 Sat/Sun	Spain, Radio Exterior Espana	6125eu		
2200 2300 Sun	Spain, Radio Exterior Espana	9595af		
2200 2300	Taiwan, Radio Taiwan Intl	9355eu		
2200 2300	UK, BBC World Service	5955as	5965as	
	5975am	6195as	9410af	9525am
	9740as	15400af		
2200 2300 DRM	UK, BBC World Service	5875eu		
2200 2300	Ukraine, Radio Ukraine Intl	5830eu		
2200 2300	USA, American Forces Radio	4319usb		
	5446usb	5765usb	6350usb	7811usb
	10320usb	12133usb	13362usb	
2200 2300	USA, KTBN Salt Lake City UT	15590na		
2200 2300	USA, Voice of America	5910va	7120va	
	7220va	7405af	7425va	9490va
	11725va			
2200 2300 Sat	USA, WBCQ Monticello ME	17495am		
2200 2300	USA, WBCQ Monticello ME	7415am	9330am	
2200 2300	USA, WBOH Newport NC	5920am		
2200 2300	USA, WEWN Vandiver AL	7560eu	9975am	
2200 2300	USA, WHRA Greenbush ME	7520af		
2200 2300	USA, WHRI Cypress Creek SC	9575am		
2200 2300 Sun	USA, WHRI Cypress Creek SC	7490na		
2200 2300	USA, WINB Red Lion PA	13570am		
2200 2300 mtwhfa	USA, WRMI Miami FL	9955am		
2200 2300 Sun	USA, WRMI Miami FL	7385na		
2200 2300	USA, WTJC Newport NC	9370na		
2200 2300	USA, WWCR Nashville TN	7465na	9985na	
	12160na	13845na		
2200 2300	USA, WWRB Manchester TN	12180va		
2200 2300	USA, WYFR/Family Radio FL	7305af		
	11740na	11875af	17690af	
2230 2257	Czech Rep, Radio Prague	5930na	9435af	

2230 2300	Guam, AWR/KSDA	15320as		
2230 2300	Papua New Guinea, NBC	9675do		
2230 2300	Sweden, Radio 6065va			
2230 2300	USA, Voice of America	7230va	9780va	
	15445va			
2236 2300	New Zealand, Radio NZ Intl	15720pa		
2236 2300 DRM	New Zealand, Radio NZ Intl	17675pa		
2245 2300	India, All India Radio	9705eu	9950as	
	11620as	11645as	13605as	

### 2300 UTC - 6PM EST / 5PM CST / 3PM PST

2300 0000	Anguilla, World University Network	6090am		
2300 0000	Australia, ABC NT Alice Springs	2310do		
	4835do			
2300 0000	Australia, ABC NT Katherine	5025do		
2300 0000	Australia, ABC NT Tennant Creek	4910do		
2300 0000	Australia, Radio Australia	9660as	11840va	
	12010pa	12080pa	13690pa	15230va
	15240pa	15560va	17795va	
2300 0000 smtwhf	Canada, CBC NQ SW Service	9625na		
2300 0000	Canada, CFRX Toronto ON	6070na		
2300 0000	Canada, CFVP Calgary AB	6030na		
2300 0000	Canada, CKZN St John's NF	6160na		
2300 0000	Canada, CKZU Vancouver BC	6160na		
2300 0000	China, China Radio Intl	5915as	5990va	
	6145na	7180as	11685as	11840na
2300 0000	Costa Rica, World University Network	13750va		
2300 0000	Cuba, Radio Havana	9505am	9550am	
2300 0000	Egypt, Radio Cairo	9465na		
2300 0000	Guyana, Voice of 3291do			
2300 0000	Malaysia, RTM/Trax FM	7295as		
2300 0000	New Zealand, Radio NZ Intl	15720pa		
2300 0000 DRM	New Zealand, Radio NZ Intl	17675pa		
2300 0000	Papua New Guinea, NBC	9675do		
2300 0000 vl	Papua New Guinea, Wantok R. Light	7325va		
2300 0000	Singapore, MediaCorp Radio	6150do		
2300 0000 vl	Solomon Islands, SIBC	5020do	9545al	
2300 0000	UK, BBC World Service	5965as	5985as	
	9740as	11955as		
2300 0000	USA, American Forces Radio	4319usb		
	5446usb	5765usb	6350usb	7811usb
	10320usb	12133usb	13362usb	
2300 0000	USA, KTBN Salt Lake City UT	15590na		
2300 0000	USA, Voice of America	5910va	7120va	
	7405va	9490va	11725va	15185va
2300 0000	USA, WBCQ Monticello ME	7415am	17495am	
2300 0000	USA, WBOH Newport NC	5920am		
2300 0000	USA, WEWN Vandiver AL	7560eu	9975am	
2300 0000	USA, WHRA Greenbush ME	5850eu		
2300 0000 mtwhfa	USA, WHRI Cypress Creek SC	11765na		
2300 0000 Sun	USA, WHRI Cypress Creek SC	7490na		
2300 0000 mtwhfa	USA, WHRI Cypress Creek SC	11765na		
2300 0000	USA, WHRI Cypress Creek SC	7315am		
2300 0000	USA, WINB Red Lion PA	9265am		
2300 0000	USA, WRMI Miami FL	9955am		
2300 0000	USA, WTJC Newport NC	9370na		
2300 0000	USA, WWCR Nashville TN	3215na	7465na	
	9985na	13845na		
2300 0000	USA, WWRB Manchester TN	12180va		
2300 0000	USA, WYFR/Family Radio FL	9430am		
	11740na	15400am		
2300 2305 vl	Liberia, ELWA	4760do		
2300 2310	Croatia, Croatian Radio	7285na		
2300 2315	Nigeria, Radio/Kaduna	4770do	6090al	
2300 2315	USA, WYFR/Family Radio FL		11875af	
2300 2330	USA, Voice of America	6180va	7205va	
	15150va			
2300 2345	USA, WYFR/Family Radio FL	11740na		
2300 2345 DRM	Vatican City, Vatican Radio	7370am		
2300 2355	Turkey, Voice of 5960va			
2300 2356	Romania, Radio Romania Intl	6015va		
	6115va	7105va	9610va	
2330 0000	Australia, Radio Australia	15415as	17750va	
2330 0000 mtwhf	Austria, Radio Austria Intl	9870sa		
2330 0000	Lithuania, Radio Vilnius	7325na		
2330 0000 DRM	Sweden, Radio 9800na			
2330 0000	UK, BBC World Service	3915as	5935as	
	5965as	6170as	6195as	7105as
	7340as			
2330 0000	USA, Voice of America	6180va	7205va	
	11655va	13640va	15150va	
2330 2357	Czech Rep, Radio Prague	5930na	7345na	
2330 2358	Vietnam, Voice of	9840as	12020as	
2335 0000 Sun	Austria, Radio Austria Intl	9870sa		
2343 0000 Sat	Austria, Radio Austria Intl	9870sa		

## Milcom Mail Call

It has been quite some time since I have had Mail Call here in the *Milcom* pages and a good bit of information has been received since then. So without further ado: Mail Call!

### ❖ Fort Campbell KY

Chris Dees was recently in the Fort Campbell, Kentucky, area and during a search of the 380–390 MHz spectrum found they have a new trunk radio system. Details are not complete on all of it, but here is what he has put together so far.

System: Project 25 Standard  
System ID: 1fe WACN: BEE00 NAC: N1FO

#### Frequencies:

Site 1: 386.0750/396.0750c  
Site 2: 388.0000/398.0000c  
Site 3: 386.0375/396.0375c  
Voice Channels - Site Not Determined  
385.0125/395.0125 385.8875/395.8875  
386.2250/396.2250 386.3375/396.3375  
386.3750/396.3750 386.5250/396.5250  
386.6750/396.6750 386.9750/396.9750  
388.3000/398.3000 388.6500/398.6500  
388.8000/398.8000 388.9625/398.9625

#### Talkgroups:

102 101st RAP Team  
108 MP Dispatch "Eagle Control 1"  
133 Ft Campbell Fire Dispatch (some encryption heard)  
134 Ft Campbell Fire Tactical  
303 Unidentified User/usage  
410 Housing Maintenance - Electricians  
414 Housing Maintenance - Plumbing  
617 Welcome Center / 101st Museum  
708 Unidentified User/usage  
720 Unidentified User/usage  
723 Unidentified User/usage

Chris also checked on the older 400 MHz analog system that had been in place since 1998. The old analog system appears to be unused since all the previous users were noted on the new P25 system. Chris did note, however, that the system control channels for the 400 MHz system are still active, but no traffic was monitored on either site.

Here are the complete details of the older system and talkgroups from our *Milcom* files for anyone that wants to verify Fort Campbell communications on the older system or possible talkgroups on the new system.

System: Motorola Type II ASTRO SmartZone (Mixed mode 3600 baud)  
Motorola System ID: 2309

#### Base Frequency:

406.000 MHz, Spacing: 25 kHz; Offset: 380

#### Frequencies:

Site 0 (East Zone) 407.3000 407.9500  
408.1500 408.3500 408.5500 408.7500  
408.9500 409.1500c 409.9500c  
Site 1 (West Zone) 406.3500 406.7500  
407.1500c 407.2500 409.5500c

#### Talkgroups:

16 Unknown user/usage  
32 Unknown user/usage Digital Talkgroup  
48 Unknown user/usage  
64 Unknown user/usage Digital Talkgroup  
80 Unknown user/usage  
112 Unknown user/usage  
144 Unknown user/usage  
160 Unknown user/usage  
192 Unknown user/usage Digital Talkgroup  
208 Unknown user/usage  
224 Unknown user/usage Digital Talkgroup  
240 Unknown user/usage  
256 Unknown user/usage  
272 Unknown user/usage  
288 Unknown user/usage Digital Talkgroup  
304 Unknown user/usage  
336 Ranger Base  
352 Unknown user/usage Digital Talkgroup  
368 Unknown user/usage  
384 Unknown user/usage Digital Talkgroup  
400 Staff Duty  
432 Unknown user/usage  
496 Unknown user/usage  
512 Unknown user/usage Digital Talkgroup  
528 Unknown user/usage  
544 Unknown user/usage  
560 Unknown user/usage  
576 Unknown user/usage  
656 Unknown user/usage  
720 Unknown user/usage  
752 Unknown user/usage  
768 Unknown user/usage  
784 Unknown user/usage  
800 Unknown user/usage Digital Talkgroup  
816 Unknown user/usage  
832 Unknown user/usage Digital Talkgroup  
848 Range Control  
864 Unknown user/usage  
880 Unknown user/usage  
896 Unknown user/usage Digital Talkgroup  
912 Small Arms Range Control  
928 Unknown user/usage  
944 Range Control  
960 Unknown user/usage  
976 Unknown user/usage  
992 Unknown user/usage  
1136 Unknown user/usage  
1232 Motor Pool  
1312 Unknown user/usage  
1328 Base Public Works  
1360 Unknown user/usage  
1424 Unknown user/usage  
1456 Unknown user/usage  
1488 Unknown user/usage  
1504 Unknown user/usage Digital Talkgroup  
1520 Unknown user/usage  
1584 Public Works/Maintenance  
1648 Unknown user/usage  
1712 Unknown user/usage

1808 Military Police "Eagle Base" <Channel 1>  
1840 Military Police "Eagle Base" <Channel 2>  
1872 Military Police "Eagle Base" <Channel 3>  
1904 Military Police Base Events "Eagle Base" <Channel 4>  
1936 Military Police "Eagle Base" <Channel 5>  
1968 Unknown user/usage  
2000 Military Police  
2032 Criminal Investigation Division (Investigators)  
2064 Unknown user/usage  
2160 Base EMS Dispatch  
2416 Unknown user/usage  
2896 Unknown user/usage  
2992 Base Fire Department Dispatch  
3088 Unknown user/usage  
3664 Range MOC  
3792 Base Taxi  
3888 Cobra/Dragon Operations  
4096 Unknown user/usage  
6144 Unknown user/usage Digital Talkgroup  
8960 Unknown user/usage Digital Talkgroup  
12816 Unknown user/usage  
13840 Unknown user/usage  
20048 Unknown user/usage  
20064 Unknown user/usage  
21008 Unknown user/usage  
30208 Unknown user/usage  
30352 Unknown user/usage  
30368 Unknown user/usage Digital Talkgroup  
33024 Unknown user/usage Digital Talkgroup  
40000 Unknown user/usage  
40080 Unknown user/usage  
40096 Unknown user/usage  
40128 Unknown user/usage  
53760 Unknown user/usage Digital Talkgroup

### ❖ Hill Air Force Base, Utah

Gary Davis, KE7MQF, has been monitoring the Hill Air Force Base, Utah, trunk radio communications and passes along the following update on their 400 MHz Motorola system.

#### Site 1: HAFB

Used by the base for most Operations. Mostly P25 digital.

406.9625/415.9625  
407.3625/416.3625  
407.7625/416.7625  
408.1625/417.1625  
408.5625/417.5625  
408.9625/417.9625  
409.3625/418.3625  
409.7625/418.7625  
410.1625/419.1625c

#### Site 2:

Part of the Utah Test and Training Range complex. Gary did not have any information on the part of the system other than he believes it is a rebroadcast of site 4.

#### Site 3: location unknown.

Gary has no other info on it other than a control channel of 410.3625/419.3625 MHz.



Site 4:

Located on the Federal Building, downtown Salt Lake City. Primary user is Utah Air National Guard located at the Salt Lake International Airport. Another user of this system is the Federal Building Security services. Some communications are P25 digital (indicating that this is a mixed mode 3600 baud system with a little encryption.

Frequencies:

406.7625/415.7625 407.1625/416.1625
4 0 7 . 5 6 2 5 / 4 1 6 . 5 6 2 5
4 0 7 . 9 6 2 5 / 4 1 6 . 9 6 2 5 c
408.3625/417.3625

Below is a list of talkgroups for Hill AFB from my personal Milcom files:

Talkgroups:

- 128 HAFB Phone 2 (phone patch)
160 HAFB Phone 1 (phone patch from radios)
1280 HAFB Command Phone (phone patch)
1600 HAFB LAO (Aircraft Maintenance Division)
2560 HAFB Fire Department Dispatch
2656 HAFB Hill User C
2688 HAFB Hill User D
4000 HAFB Phone 5 (phone patch)
5136 HAFB Hill User 3
5568 HAFB Range Phone
8000 HAFB AGE (Aerospace Ground Equipment, Contractor)
8032 HAFB Flightline Maintenance Specialist (flight testing)
8064 HAFB AST (Aerospace Support Technologies, contractor)
8640 HAFB 388FW <Channel A>
8672 HAFB 388FW <Channel B>
8688 HAFB 421TFS Flightline Mechanics, A-4 Maintenance 'Spiders'
8704 HAFB 388FW MOC (Maintenance Operations Center) <Channel C>
9024 HAFB Phone 6 (phone patch)
9216 HAFB Hill User 18
9280 HAFB Civil Engineering Squadron
9472 HAFB Explosive Ordnance Disposal (EOD)
9600 HAFB Security Forces "Trunk Channel"
9696 HAFB Fire Department Dispatch
9760 HAFB Flightline Operations "Hill Ground" (Ground Control, Tower to vehicles)
9792 HAFB Transient aircraft (Follow Me trucks escort visiting aircraft)
10080 HAFB BIO (Bio-Environmental Division)
10112 HAFB Medical, when the base uses it's own ambulance
10208 HAFB OSI Surveillance
10240 DLA Delivery (Defense Logistics Agency) Transportation
10278 HAFB Engineering/Utilities
10400 HAFB Mobility (mobilization of equip & troops for deployment)
10720 HAFB Crash Crews
10784 HAFB Fire Department Structural Fire Fireground
10816 HAFB Fire Department Alarm and sprinkler maintenance
10880 HAFB Base Taxi (Transportation)
11040 HAFB Hill User 9
11072 HAFB Hill User M
11104 HAFB Munitions
11120 HAFB Munitions/Ordnance Ops
11136 HAFB Munitions
11168 HAFB Hill User P
11200 HAFB Surveyor
11296 HAFB Eagle Range Photo
11328 HAFB Eagle Range Ops South
11360 HAFB Eagle Range "Badger"
11424 HAFB Eagle Range User 16
11456 HAFB Eagle Range Control Romeo A "Phoenix 4"
11520 HAFB Phone 14
11872 HAFB 388th Q (inspections?)
12000 HAFB Hill User 13
12064 HAFB Fuel POL (Petroleum, Oils, Lubricants)
12080 HAFB Fuel POL (Petroleum, Oils, Lubricants)
12160 HAFB Command Post
12320 HAFB Hill User 12
12800 HAFB COM Communications squadron "Wizzard"

- 12832 HAFB Plating Shop
12960 HAFB Inspector General
13920 HAFB Hill User 8
14080 HAFB Hill User U
14400 HAFB Visiting Squadron
14432 HAFB Visiting Squadron
16416 HAFB Range EOC (Emergency Ops Center?)
16480 HAFB Range Security
16512 HAFB Hill User W (security of some kind)
16640 HAFB Range Support X
16832 HAFB Hill User 15
25936 HAFB Hill User 11
30432 HAFB Hill User 17
32448 HAFB Livestock
46816 HAFB Hill User Y
49280 HAFB Range User Z
49440 HAFB Range Maintenance
49760 HAFB Range South
52256 HAFB Phone 7 (phone patch)

❖ New Boston Gone Digital

John B. on the Scan New Hampshire newsgroup has monitored P25 digital communications from the US Air Force Tracking Station in New Boston, New Hampshire.

New Boston Air Force Station is a United States Air Force facility located in Hillsborough County in south central New Hampshire. It occupies more than 2,800 acres in three towns: New Boston, Amherst, and Mont Vernon. It was established in 1942 as a practice area for bombers and fighter planes from nearby Manchester. Starting in 1960, it was turned into a satellite-tracking station.

New Boston AFS is operated by the 23d Space Operations Squadron (23 SOPS), a geographically separated unit (GSU) of the 50th Network Operations Group, 50th Space Wing, Schriever Air Force Base, Colorado.

John reports APCO P25 digital communications on two of their VHF conventional frequencies: 170.125 and 170.600 MHz. These have been reported as Civil Engineers and Fire Department frequencies respectively.

Other frequencies that have been reported for this base include:

- 163.4875 Command Net F-1
165.0625 Law Enforcement Net D
165.1375 Maintenance
165.4125 Fire Department
173.4375 Maintenance
173.4875 Law Enforcement

❖ Milair Spectrum Hole Identified

Tracy at www.freqofnature.com has identified one of my long time spectrum hole frequencies. 371.4 MHz in Arizona is controlled by Luke Air Force Base and is used on the Barry M Goldwater Range, North Tactical. This range is in the SELLS MOA. The frequency is very active and used daily for training missions for F-16s out of Luke AFB and A-10s out of Davis-Monthan AFB.

❖ McChord AFB TRS

MT's Chris Parris passes along that McChord AFB in Washington has put up a narrowband trunk radio system. McChord has abandoned their old 25 kHz channels for a new 12.5-kHz spaced system. The system parameters are:

System: Motorola Type II Smartnet 9600 baud (P25)
Motorola System ID: 842a
Base Frequency: 406.3625 MHz, Spacing: 12.5-kHz, Offset: 380
Frequencies:
407.1625/416.1625c 407.7625/416.7625c
407.7750/416.7750 409.5625/418.5625c
409.7625/418.7625 409.9625/418.9625
4 1 0 . 3 6 2 5 / 4 1 9 . 3 6 2 5
410.7625/419.7625

Talkgroups:

- 41008 Command Post
41232 ATOC
41552 Security Police
41744 Airfield Ops
41808 Airfield Maintenance
42064 POL
42128 Crew Transportation
42192 Fire/Crash Net
42384 EOD
43216 Aircraft Maintenance "Alpha Net"
43248 Aircraft Maintenance "Bravo Net" (BLUE Team)
43280 Aircraft Maintenance "Charlie Net"
43312 Maintenance (Silver?)
43344 Airfield Operations (Tower, etc)
57360 Maintenance Squadron
57456 Maintenance Squadron
57488 Maintenance Squadron
57520 Aircraft Generation Squadron "Blue"
57648 Maintenance Squadron
57712 EOD Teams
57808 Security Police F-1
57840 Security Police F-2
57872 Security Police F-3
57904 Passenger Operation (PAX units)
57936 Aircraft movers (Pushback units)
58000 Base Transportation net
58032 Runway Control "Trombone"
58096 Unknown user/usage

❖ Unknown DoD EDACS System in Louisiana

I have received several reports from monitors in southeast Texas and southwest Louisiana of a possible EDACS trunk system operating in the VHF government band. This system is probably being heard during tropospheric ducting conditions by these monitors, so the exact location of this system is unknown. I checked my database and one possible operator of this system could be the U.S Army at the Fort Polk Joint Readiness Center.

Three frequencies have been reported: 163.5625, 164.5000 and 165.0875 MHz. All of these frequencies are Fort Polk assignments. It is also interesting to note that Fort Polk operates a three-site 400 MHz EDACS trunk radio system, so a VHF EDACS TRS would not be out of the realm of possibility. If we have any readers in the Fort Polk area, I would appreciate some monitor reports on the three frequencies noted above.

Well, that does it for this month. If you have monitored one of the military trunk radio systems, any conventional LMR frequencies, or HF/VHF/UHF aero freqs, how about dropping us a line and letting our Milcom family of readers know what you have heard? Until next time, 73 and good hunting.

## To Your Health! Monitoring Health & Human Services

**A**n agency that we haven't touched on previously is the Department of Health and Human Services, or DHHS. A look at their web site shows that there is a lot to this agency and some potential for federal radio communications, [www.hhs.gov/](http://www.hhs.gov/).

The DHHS has many departments and offices under its control. Some of the agencies under DHHS include the Indian Health Service, the National Institutes of Health (NIH) and the Center for Disease Control (CDC).

What about radios and frequencies? The DHHS has many frequency allocations across the federal bands, but I have seen very few, if any, loggings of DHHS activity. I have put together a listing of all the potential DHHS frequencies that you can use as a guideline. I have included VHF low band channels, even though reports of federal activity in this band are nearly non-existent.

### Department of Health & Human Services

(All frequencies are in MHz)

30.420  
30.430  
34.050  
36.180  
36.220  
36.250  
36.270  
36.350  
36.750  
38.830  
40.370  
41.350  
41.390  
41.430 (Nationwide)  
41.470 (Nationwide)  
41.530 (Nationwide)  
41.650 (Nationwide)  
41.690 (Nationwide)  
41.790 (Nationwide)  
41.830

163.0000  
163.0750  
163.1750  
163.2500 (Nationwide Medical Paging Allocation)

163.3000  
163.3750  
163.7000  
164.3000 (Nationwide)  
164.5250  
164.7000  
164.8000  
164.9625  
164.9875 (Nationwide)  
165.0625  
165.2625  
165.3125  
165.3375

166.1000  
166.8250  
168.0000  
168.3250  
168.5250  
169.6250  
170.1250  
171.2375 (Nationwide – shared)  
171.7250  
172.3000  
172.7750

407.7000 / 416.7000  
408.0500 / 417.0500  
409.0000 / 418.0000  
410.0250 / 419.0250  
410.2000 / 419.2000  
410.2250 / 419.2250  
410.4000 / 419.4000  
410.4250 / 419.4250  
411.2250 – Simplex  
411.4500 – Simplex  
411.8250 – Simplex  
413.4500 – Simplex  
413.8750 – Simplex  
415.4000 / 406.4000  
415.8250 / 406.8250  
415.9250 / 406.9250  
416.9750 / 407.9750  
417.6500 / 408.6500  
417.7000 / 408.7000  
419.1500 / 410.1500  
419.6000 / 410.6000  
419.6250 / 410.6250  
419.8000 / 410.8000

A potential monitoring target within the DHHS is the National Disaster Medical System, or NDMS. They are charged with managing the federal government's medical response to a major disaster or emergency. You can find out more at their web site, [www.hhs.gov/aspr/opeo/ndms/index.html](http://www.hhs.gov/aspr/opeo/ndms/index.html). The NDMS has several UHF frequencies that may be used at emergencies or training events. These frequencies may have changed since the federal UHF narrowband requirements have taken place, but these are probably still in use.

### National Disaster Medical System (NDMS)

408.0500  
408.4000  
409.0000  
413.4250  
418.0500  
419.6000

Within the NDMS are the Disaster Medical Assistance Teams, or DMAT. These groups of professional and volunteer health care providers are trained to provide rapid-response medical care at disasters or emergencies anywhere they

are needed: [www.hhs.gov/aspr/opeo/ndms/teams/dmat.html](http://www.hhs.gov/aspr/opeo/ndms/teams/dmat.html).

There are 55 DMAT teams staged around the country, usually associated with local and state government emergency services. They will often have access to medical emergency and public safety radio communications as needed. But the DMAT teams also have federal frequencies that can be used. These have been monitored in the last couple of years during exercises and have been active with P-25 digital mode, sometimes using encryption.

### Disaster Medical Assistance Teams (DMAT)

407.2625  
407.4625  
408.8625  
409.0750  
409.3375  
412.8375  
412.8750  
412.8875  
412.9000  
412.9125  
415.8625  
418.4625

A *Fed Files* reader recently sent along some photos of a DHHS mobile command unit. The vehicle appears to be equipped with multiple VHF and UHF land-mobile radios as well as an MSAT G2 push-to-talk satellite system. It's not clear what office or part of the DHHS this vehicle is used by, but it makes sense that in a



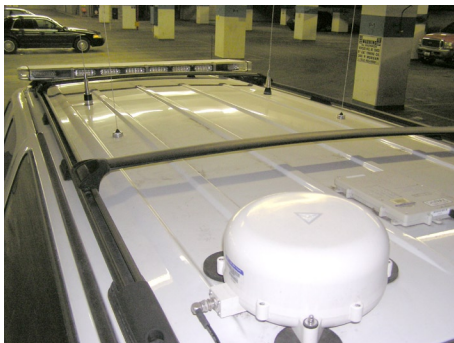

major disaster this vehicle would be used for emergency communications with multiple agencies.

## ❖ Chicago Federal Scanning Update

Some recent changes have started to show up on some federal frequencies in the Chicago area. Here are some new and unknown frequencies that listeners have been sending in to the *Fed Files* (all freqs MHz):

- 166.7125 – P-25, Unknown agency
- 168.1250 – Possible FBI
- 168.3250 – FBI
- 168.6250 – P-25, Possibly FBI or ICE
- 168.7250 – FBI
- 169.9500 – P-25, Possibly FBI or ICE
- 170.3250 – Unknown agency (this is actually a hydrologic data channel)
- 170.7250 – Possibly FBI or ICE
- 406.7000 – P-25, Federal Protective Service (moved from 415.2000)

Here is an update to the US Postal Inspectors frequencies that are in use in the Chicago area that was passed along by an anonymous source:

- 406.3375 – P-25 Postal Inspectors
- 414.7500 – Postal Inspectors Red Channel
- 415.0500 – Postal Police (former Blue Channel)
- 417.7750 – Postal Inspectors Green North Channel
- 419.6500 – Postal Inspectors Green South Channel

And I recently received an email from a Chicago listener who has identified these frequencies as part of the Justice Department's "25 Cities" federal interoperability program. Apparently he was able to identify these as they were being tested over a period of time:

- 168.8875 - P-25 repeater
- 168.9125 - P-25 repeater
- 170.8125 - P-25 repeater
- 171.4375 - P-25 repeater
- 171.6875 - P-25 repeater
- 172.2125 - P-25 repeater

For more information about the Justice Department's federal interoperability project, check out this link; [www.search.org/conferences/2006interop/DOJ\\_25\\_Cities\\_Fact\\_Sheets.pdf](http://www.search.org/conferences/2006interop/DOJ_25_Cities_Fact_Sheets.pdf).

Do you have some new or unknown federal frequencies for your area? Send them along to us at the *Fed Files*!

## ❖ Federal NAC Information

In the January *Fed Files*, I talked about the use of Network Access Codes, or NACs,

on federal P-25 digital radio systems. Since then, some information has started to surface on various web sites and news groups about what NAC codes are being used by federal agencies. It has been hoped that by noting what NAC values are used by different agencies, you might be able to identify what agency is using a particular frequency by the NAC, much as we used to be able to note the CTCSS squelch tone to identify users.

Remember that, besides professional P-25 radio equipment, the only hobby radios that can currently utilize this NAC information are the new line of GRE digital scanners, the PSR-500 and PSR-600. You can also monitor NAC's by using a dedicated scanner and software.

Here are some federal NAC's that I have received from monitors across the country, broken down by agency:

### BATF –

The Bureau of Alcohol Tobacco and Firearms has been one of the lead agencies to switch over to P-25 digital radios, and they seem to be pretty consistently using a NAC of 650 on their radio systems, both simplex and repeaters. They are using various NACs from 650 to 660 on the repeater inputs to select what repeater they are talking in to.

### CBP –

The Customs and Border Protection division of the Department of Homeland Security operates the nationwide legacy Customs VHF radio network. This network is being upgraded in some regions to be P-25 digital, but many areas continue to operate in the analog mode. In areas that have moved to P-25 digital, their use of NACs has been very inconsistent. The CBP appears to be using different NACs to select different repeater networks. Here are some examples that have been monitored in Texas:

- 162.8500 - CBP NET 18, NAC 264
- 163.6250 - CBP NET 18/20/21, NAC 056 and NAC 300
- 163.6750 - CBP NET 19/22/23, NAC 268
- 165.9750 - CBP NET 16, NAC 269
- 168.9750 - CBP, NAC 277

### DEA –

The DEA has been slowly moving to P-25 in many parts of the country, and offices that have switched over to P-25 digital are seen to be using a NAC of 156, a reference to their old analog CTCSS squelch tone of 156.7Hz.

### FBI –

Although the FBI is just now starting to get serious about switching from analog with encryption to P-25, those field offices using P-25 are consistently seen using a NAC of 167. This is simply an easy step from their analog CTCSS squelch tone of 167.9 Hz. They may use different NAC values to control repeaters, but input NAC information hasn't been confirmed yet.

### Secret Service –

Several listeners have reported that the P-25 transmission on Secret Service frequencies, both simplex and repeater, have been using

a NAC of 001. They may be using different NACs to control repeaters, but I haven't been able to confirm that yet.

### TSA –

The Transportation and Security Administration was one of the first agencies to start out with P-25 digital radios. When the agency first began operations in 2002, their radio band plan was quickly circulated around the Internet. The channel plan showed multiple channels on their radios with the same frequencies on each channel. It was assumed then that they were using some sort of digital coding to allow different users on these same frequencies to operate without hearing each other. We now know they are using the P-25 NAC for that purpose. Here's a review of the TSA channel plan and the NACs I have been able to confirm:

- 01 172.1500 = S1 simplex, NAC 001
- 02 172.1500 = S1 simplex, NAC 002
- 03 172.1500 = S1 simplex, NAC 003
- 04 172.1500 = S1 simplex, NAC 004
- 05 172.9000 = S2 simplex, NAC 002
- 06 169.3000 = S3 simplex, NAC 009
- 07 172.9000 = R1 repeater (169.300 input, NAC unknown), NAC 001
- 08 172.9000 = R1 repeater (169.300 input, NAC unknown)
- 09 172.9000 = R1 repeater (169.300 input, NAC unknown)
- 10 172.9000 = S2 simplex
- 11 172.9000 = S2 simplex
- 12 166.4625 = F1 simplex, analog with 103.5 CTCSS
- 13 166.4625 = F1 simplex, NAC unknown, possibly 293

Other agencies seem to be using a mix of NAC codes, including the "default" NAC of 293. This NAC code, in a professional P-25 radio, will un-mute with any valid NAC received. However, this "universal" un-mute NAC does not appear to function this way in the GRE radios. Perhaps in future firmware revisions this function will become operational.

Keep in mind that you do not need these NAC codes to listen to unencrypted P-25 digital transmissions. These codes are simply an additional tool in the listener's arsenal that might help identify unknown federal frequencies that you might come across.

The above information is preliminary and much was developed from listeners' observations. There may be some agencies or offices that are not following these patterns of NAC use, so keep an eye out for some NAC values that don't follow what we've seen so far.

Thanks to all the *Fed Files* readers that helped contribute this federal NAC information. If you have the capability of decoding the NAC data from P-25 signals in your area, please feel free pass them along to us at the *Fed Files* and *Monitoring Times*.

## ❖ Coming Up in May

I am preparing to head to Super Bowl XLII in Phoenix for my "other job." I will be back in the May *Fed Files* with a complete look at federal communications at this major sporting event. Until then, keep checking the *Fed Files Blog* for updates!



## New Safety Provisions = New Radio Messages

**A**n old railroad adage says that all railroad rulebooks are written in blood. What that means, of course, is that behind every rule, there's some terrible accident that the rule now attempts to prevent from happening again.

While the basics of railroad operation have not changed much over the past few decades, a rash of specific types of accidents often adds new emphasis on particular aspects of operational safety.

Though it's been around for a few years, a relatively new term is asking for "three step protection." Some railroads have slightly different terms for this, but this particular request is aimed at making sure nothing moves when a trainman has to go between cars to couple up air hoses or do other work.

The request is made by a trainman on the ground and acknowledged by the engineer of a particular train or yard switcher when it is effect. The three steps consist of having air brakes applied, the reverser handle in neutral, and the generator field switch in the off position. The latter step ensures that no current will go to the locomotive's traction motors which could cause them to move.

The three-step protection remains in effect until the requesting crewman cancels it, usually with a radio call such as "Conductor on train 249 releasing three-step protection."

### ❖ Main line switches

An even newer procedure is now used by most railroads in territories where main line

switches are not operated remotely by dispatchers through the signal system or are not electrically interlocked with the signal systems.

(In centralized traffic control systems, you can still have manually operated switches, but these are usually equipped with a timing circuit and connected to the signal system. To move such a turnout to the diverging route – for example, for a stored engine to enter the main line – a crewman first has to activate the timer, which sets signals at the ends of the block to stop, the same as if the block were occupied by a train. After the timer has run its specified duration period, it unlocks the switch, which can then be moved by the crewman.)

But in track warrant (TW) or direct traffic control (DTC) territory, you don't have such protection, as you either don't have signals at all or only automatic block signals (ABS) that don't give movement authority by themselves. (We covered signal systems in the September 2006 column.)

In TW or DTC territories – which includes most secondary lines of major railroads and almost all main lines of shortlines – main line switches are simply equipped with a switch lock (a railroad provided padlock) to which crewmen have keys.

During the past decade, several accidents with substantial damages and even casualties resulted from crewmen leaving a switch aligned for a siding or spur when a train departed a location after switching cars there.

A through train approaching a misaligned switch will not spot it until it is too late and will not be able to react in time. That misaligned switch either sends the train into a short stub track, where it crashes into an obstruction before



*After the switch was functioning again and the CSX train was able to get a signal to proceed, it passes the sign marking D&S Junction. Behind the sign is the metal housing for the logic and safety circuits controlling the junction.*

being able to stop, or it sends the train through a curving route that is too fast for the train's speed, where it will likely derail. Remember, a heavy 100-car train operating at a modest 35-40 miles per hour may take half a mile or more to stop, even after emergency braking is applied.

So, now you will hear railroad crews paying more attention to the position of switches in their radio conversations.

A through train "giving back" track authority to a dispatcher will report "no main line switches handled," indicating that following trains need not worry about encountering switches left in the wrong position.

When trains do "handle" switches in the field, you may hear the engineer asking the conductor or other trainman on the ground to "double check" the position of the switch prior to departure. At that point, the trainman visually checks again the position of the switch before reporting back that it is indeed in the correct position. In some cases, this is logged on paper.

There are a few locations where train crews can leave a switch in the field (not in switching yards) in the position that it was last used. But those locations are specifically noted in employee timetables and are only at locations where trains operate at very slow speeds.

### ❖ Derails

While it may appear illogical for railroads to have devices designed to derail equipment, the device by that name – the derail – is actually a common railroad appliance. And the same "double check" standard is usually applied to derails, too.



*A CSX local freight, headed by a former Conrail engine, waits at a signal to enter a series of cross-overs that will take the train over two parallel Norfolk Southern tracks into a small CSX yard in Durham, N.C. The train is waiting because ... (see next photo)*



*... a Norfolk Southern signal maintainer is working on a balky switch machine motor on one of the cross-over switches.*





*A permanently installed derail on an industrial spur has been moved to its off position allowing the industry's tracks to be switched. The photo was made from the cab of one of the engines that was still on the main line at that point.*

What is a derail? It's a wedge-shaped device that is clamped over the track and locked in place. Permanently installed derails are hinged, so that when unlocked, the part that fits over the track can be swung out of the way so that the track can be used normally. You can also have portable derails that are applied in the field in special situations, but then are removed when they are no longer needed.

Why have a derail? To prevent an even worse situation from happening than having a single car or engine derail. Derails are normally used only on sidings – either industrial sidings or passing sidings – if these sidings are also used to store cars.

The derail is an additional safety measure against equipment moving unintentionally. Yes, equipment that is parked on a siding should have hand brakes applied, but, if for any reason those brakes fail or are not properly set, you don't want cars rolling out onto the main line. So, it's better to have a runaway car derail – at low speed it won't do much damage – than to have the car roll out onto the main line where it could be struck by a fast-moving train.

Similarly, you don't want runaway cars going into an industry where people are working. So, a bi-directional derail on an industrial spur not only keeps cars from the industry from getting out onto the main, but also keeps cars from rolling into the industry by accident.

In late 2007, a derail actually made national news, though only those familiar with railroads probably understood what happened.

A train carrying spent nuclear fuel (in heavy protective casks) was being switched at the Shearon Harris nuclear generating plant in central North Carolina (near Raleigh). It backed over a derail that was still in place, derailling a

caboose and another spacer car, though not the cars actually carrying the nuclear fuel. (Though no longer used on most trains, special trains such as those carrying nuclear fuel or other high value loads still uses cabooses for security staff.)

Though this was a minor incident in terms of normal railroad operations, because the train was carrying nuclear fuel, the incident had to be reported to both the Nuclear Regulatory Commission and local authorities. And, so it was reported both in newspapers and on television.

The news release from the company owning the generating plant said something along the lines that someone had failed to “properly prepare the track” for the train movement. In other words, they failed to unlock the derail and move it to its off position.

### ❖ **Named control points**

I've mentioned before that railroads need to have unambiguous ways of referring to locations, such as junctions or crossovers. (A crossover is a location in multi-track territory where a set or series of switches allows a train to cross from one main track to another.)

Sometimes a milepost location is sufficient. For example, a train may call a dispatcher, saying “I'm at the milepost 14.7 crossovers, waiting for a signal to proceed.”

But at other times, control points are given names that are not directly related to the geographic location. And, often these names honor a specific individual.

In non-signaled territory, an entire siding will have a name, and that name is often the same as that of a nearby community. But in signaled territory, each end of the siding is considered a control point and has a specific name.

In exploring railroads and delving into railroad history, it's fun to dig back and find out where those names came from. And, with track improvements being made and new signal systems being installed, new control points are being designated all the time.

Recently, in North Carolina where I live, I was pleased to find that two new control points were named after people I knew. In my home town of Durham, a new siding was installed at Norfolk Southern's East Durham Yard, both to allow trains to meet and pass and to avoid trains switching the yard fouling the main line during switching. What happened was that the existing main line was designated as the siding, and a new parallel track was built that became the main line.

The new track was tied back into the existing track on the west side at an existing junction, so no new name had to be applied there. But the location of the switch and signal at the east end of the new track was designated Sullivan, honoring Mark Sullivan, a now-retired long-time staff member of the state of North Carolina's Rail Division. Sullivan had worked for many years as a transportation planner and had been responsible for many railroad improvements in North Carolina that were jointly funded by the state and the operating railroad. Sullivan was also a tireless advocate of both passenger and freight railroading and explained aspects of railroading to civic groups and anyone who would listen.

Similarly, when Norfolk Southern (NS) rebuilt its yard and added a new siding at Selma, N.C., the location at the east end of the new siding needed a name. In Selma, there's a passenger station at the location where NS crosses CSX, and both railroads call that location Selma. On NS, there's also a location where a connecting track from CSX, used by Amtrak passenger trains, joins the NS H line. NS calls that location Selma Junction.

So the new control point east of CSX and the passenger station was called Saylor. That location honors Scott Saylor, president of the North Carolina Railroad Co. (NCR).

North Carolina is in an unusual situation in that the state owns a railroad corridor stretching from Morehead City on the coast to Charlotte in the southwestern part of the state. That corridor is managed by the NCR, a state owned corporation. Though the NCR is under long-term lease to NS and is dispatched by the NS, the NCR maintains a strong hand in long-term planning and infrastructure improvements. The NCR reinvests much of the money it gets from NS in lease payments back into infrastructure improvements – as an investment in the economic future of the state.

So, now when I hear an NS train calling on the radio “Clear at Sullivan” or “Diverging Clear at Saylor” I think not just of the location in question, but the people behind that location name.

I've encountered both Sullivan and Saylor at Operation Lifesaver meetings and other functions. Operation Lifesaver is a national non-profit organization promoting railroad safety, focusing on grade crossing and trespasser incidents.

So, next time, we'll look at Operation Lifesaver and related railroad safety issues.

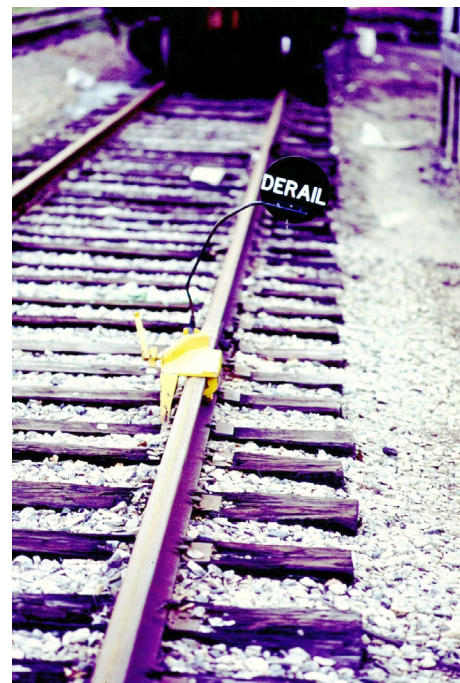

*A temporary derail on a siding protects occupied railroad work cars. The derail is also equipped with a “blue flag” plate, which we'll discuss next time.*

## Focus on New England

New England doesn't seem to get a lot of press in longwave circles. With the exception of some active listeners who live there, I don't receive many loggings of New England beacons, even from listeners in adjoining states. We've written about the possible reasons for this before, and it is believed that two factors come into play. First, the ground conductivity in much of New England is poor due to the rocky terrain found there. This could reduce the efficiency of transmitting antennas used at the beacon sites.

Second, and probably more important, is the fact there are comparatively few beacons operating in New England. The FAA's *Airport/Facility Directory* makes this point clear, as it lists only four beacons in Rhode Island, five in Connecticut and eight in Vermont. (Massachusetts and Maine have considerably more beacons, but their numbers are still well below the statistics of many other states.)

This month, we'll focus on New England beacons as worthy DX targets. (Remember that a station needn't be far away to be considered DX – only rare.) The beacons listed below were taken from a past issue of the *Airport/Facility Directory*. These booklets can be obtained from the pilot shops at many airports, and can be a useful resource for longwave monitoring. Sectional maps are also good (and interesting to look at), although they may not have all beacons marked and do not list them in a directory-style format.

Each *Airport/Facility Directory* covers a specific region of the USA and is updated several times per year as changes warrant. You might want to see if a pilot shop in your area has any obsolete copies they can part with, although purchasing a new one at \$4.55 will not set you back too far. One source for online ordering of this publication is [www.sportys.com/pilotshop/charts/afd.cfm](http://www.sportys.com/pilotshop/charts/afd.cfm).

How many of the stations listed below can you hear? I would be interested in receiving logs from as many listeners as possible, and will present them in a future issue of *Below 500 kHz*.

### Connecticut

238	MMK	Meridan
244	HF	Hartford
257	TBY	Waterbury
362	OX	Oxford/Waterbury
388	BD	Windsor Locks

### Maine

216	LRG	Lincoln/Millinocket
221	RQM	Rangeley
227	BG	Bangor
236	XQA	Squaw/Greenville
240	LE	Lewiston
251	MVM	Machias
257	FVE	Frenchville
260	EPM	Eastport

260	ESG	Eliot
272	OLD	Oldtown
278	BST	Belfast
278	PQ	Presque Isle
330	BH	Bar Harbor
334	RM	Rockland
344	LNT	Milnot/Millinocket
348	BUP	Burnham/Pittsfield
349	SF	Sanford
356	SUH	Spruce Head/Rockland
366	AU	Augusta
394	PW	Portland
399	RL	Waterville

### Massachusetts

194	TUK	Nantucket
205	ORE	Orange
220	IHM	Mansfield
227	TAN	Taunton
230	BA	Westfield
248	AC	Nantucket
251	SKR	Shaker Hill/Woburn
257	FFF	Plymouth
269	TOF	Topsfield
274	EW	New Bedford
279	CQX	Chatham
279	RS	Dunca/Worcester
332	BE	Bedford/Stow
342	HY	Hyannis-Barnstable
346	LI	Hull (Logan)
365	FIT	Fitchburg
368	IMR	Marshfield
370	DXT	Dalton
375	BO	Milton (Logan)
382	LQ	Lynn (Logan)
389	PVC	Provincetown
395	GBR	Great Barrington
397	OW	Norwood
402	LW	Lawrence
417	EK	Gozzr/Worcester

### New Hampshire

216	CO	Concord
233	CNH	Claremont
260	ESG	Rollins/Rochester
276	LAH	Hanover/Lebanon
281	HXX	Hornbrook/Berlin
338	DRY	Derry
359	AS	Chern/Nashua
379	IVV	White River/Lebanon
386	GMA	Mt. Washington/Whitefield

### Rhode Island

216	BID	Block Island
241	SFZ	Central/Pawtucket
335	PV	Rench/Providence
356	AR	Armin/Providence

### Vermont

221	DYO	Smuto/Rutland
224	VWD	Mt. Snow/West Dover
242	EFK	Newport
265	SXD	Springfield
268	VKN	Mt. Mansfield/Montpelier
353	LLX	Lyndonville
375	JRV	Morrisville
382	BT	Burlington

### Locating Your Catch

Often, FAA beacons will be identified with only a "name," not the actual town or city of the station. A case in point is OGY/414 kHz. It is listed in some publications as "Bridge NDB, NY,

NY." The name "Bridge" does not give you much useful information, but the listing also includes geographic coordinates, which are useful if you know how to use them.

In the old days (i.e., pre-Internet/pre-GPS) you'd need to obtain a U.S. Geologic Survey map of the area and cross-reference the coordinates to get an exact fix for the station. Now, several online tools can do the job for you. One especially useful site may be found at: [www.artscipub.com/repeaters/maplatlong.asp](http://www.artscipub.com/repeaters/maplatlong.asp). After entering the coordinates, a detailed map appears, and it allows you to zoom in on the image to pinpoint the location. You can even get an aerial view of the location in many cases. The information on the site is primarily geared toward U.S. and Canadian locations, and can be a very useful tool for serious DXers.

### BeaconFinder II Update

I've noticed an upswing of requests for the *BeaconFinder II* directory, which I began publishing in 1998. At first, it may seem surprising that someone would still want a printed directory when there are so many online sources available. It turns out, many listeners seem to value a resource that does not require turning on a computer, which may generate RF interference – a real problem when listening for weak signals.

A printed directory is also convenient to take with you on the road or to a DXpedition, where light packing is the order of the day. Copies of the *BeaconFinder II* are still available with no increase in price for 2008. You will find an advertisement for the directory elsewhere in this issue under the banner of "Longwave Resources."

Those who already have the directory may want to make note of a correction that has been made. Beacon FZ/219 kHz was incorrectly listed as being in Syracuse, NY. This station is actually located in Fulton, NY, and operates on a frequency of 220 kHz, serving the Oswego County Airport. This correction has been made in the latest printing of the book.

While on the topic of the *BeaconFinder*, I have learned that a small number of copies went out a while ago with "clipped" text at the bottom edge of some pages. If you experience this problem, simply send me a copy of one of these pages, and your directory will be replaced free of charge. I apologize for this production problem.

I had planned to continue the beacon listings from last month, but we are out of room once again. To view this list, please go to the *Below 500 kHz* homepage at [www.monitoringtimes.com/html/below\\_500\\_khz.html](http://www.monitoringtimes.com/html/below_500_khz.html)

See you next month!



Beacon  
LLX/353 kHz  
in Lyndonville, VT



## Pirate Busts Hit All-Time High

According to *DIY Media* (<http://diymedia.net>) via Artie Bigley, FCC pirate enforcement actions reached a ten year record peak during 2007. In a database that they maintain, *DIY Media* notes that since they began to track FCC pirate enforcement actions in 1997, the volume of FCC actions against pirate radio stations soared from 42 in 1997 to 354 in 2007. Their count during the prior 2006 year had been 292.

These figures caught many pirate radio observers by surprise. Even though the figures include more than one FCC enforcement action against some pirates, the same methods were used to count FCC actions in all years. So, overall, the figures do indicate a rising trend of FCC enforcement actions against U.S. pirate radio stations.

The data consist almost entirely of enforcement actions against local FM pirate broadcasters, which constitute more than 99.3% of the actions. Clearly, a robust FM pirate scene has attracted the attention of the Federal Communications Commission.

In the *DIY Media* database, there actually are two instances of FCC action taken against pirates who operated on AM frequency bands. Neither of the two tiny exceptions to the FM domination of FCC enforcement had been officially resolved by press time for this column.

### Who Were They?

Since the two FCC busts outside the FM bands have failed to attract much attention in the radio monitoring hobby, we'll take a look at both of them.

During the 1980s and 1990s there were scattered FCC busts against shortwave pirate stations in the United States. But, since then, it has been hard to find even one instance when the FCC cracked down on a shortwave pirate. Of course, this can happen at any time, as confirmed in 2007.

On October 16, W. Riley Hollingsworth, the FCC Special Counsel at the FCC's Gettysburg, PA office, issued a Warning Notice and Request for Information against Todd E. Daugherty of Taylorville, IL. The FCC indicated that Daugherty holds amateur license N9OGL. The FCC alleged that Daugherty was operating an unlicensed broadcast station on 6950 kHz, 13556 kHz, and other shortwave frequencies with power exceeding allowable levels under Part 15 of the FCC rules. The notice is available on the FCC web site at: [www.fcc.gov/eb/AmateurActions/files/Daugh07\\_11\\_01\\_1161.html](http://www.fcc.gov/eb/AmateurActions/files/Daugh07_11_01_1161.html)

Daugherty quickly denied the FCC's allegations. In fact his reply to the FCC warning notice is posted on the Omega One web site at <http://n9ogl.blogspot.com/>. Daugherty said, "The frequency

**Omega One Radio** was operated on was 13.556.00 MHz. The power level we were operating at is found under 47 CFR 15.225 (The field strength of any emission within the band 13.553 to 13.567 MHz. shall not exceed 15,848 uV/m @ 30 meters) and NOT the field strength in your letter of 30 microvolts/meter at 30 meters. (47 CFR 15.209)." Daugherty claims that his **Omega One** operation was at a power level permitted under FCC rules.

In the second case, on December 11, District Director Gene Stanbro of the FCC Philadelphia office in Langhorne, PA, issued a Notice of Unlicensed Operation to Williard Buttner of Phillipsburg, NJ, whom he claimed was allegedly engaged in unlicensed broadcasting on 1700 kHz at the high end of the expanded United States medium wave band. The FCC said that this station's field strength at 265 meters was 1200 milliwatts, a figure in excess of the 100 milliwatts that is permitted under Part 15 of the FCC rules. The disposition of this unlicensed operating notice was not complete at press time for *Monitoring Times*.

The FCC notice did not describe any programming or station identification that this MW station was allegedly utilizing. Therefore, this FCC action remains somewhat of a mystery. *MT* has been unable to confirm any loggings of this alleged pirate from any DX source. The Notice of Unlicensed Operation is available at [www.fcc.gov/eb/Field-Notices/2003/DOC-278979A1.html](http://www.fcc.gov/eb/Field-Notices/2003/DOC-278979A1.html)

The two instances of FCC pirate "busts" on AM – one mediumwave and one shortwave – currently remain unresolved and under dispute. The Daugherty situation has been exacerbated by claims from some amateur radio operators on forums such as [rec.radio.shortwave](http://rec.radio.shortwave) that **Omega One** was an illegal pirate operation and that they would be reporting it to the FCC. Similar commentary unfavorable to Daugherty appeared on the comments section of the Free Radio Network pirate radio web site. This level of antagonism between amateur radio operators and even among pirate radio operators was highly unusual in 2007.

### ❖ What We Are Hearing

*Monitoring Times* readers heard thirty different pirate radio stations this month. You can hear them, too, if you use some simple techniques. Pirate radio stations never use regularly announced schedules, but shortwave pirate broadcasting increases noticeably on weekends and major holidays. You sometimes have to tune your dial up and down through the pirate radio band to find the stations, but more than 95% of all North American shortwave pirate broadcasts are heard on **6925 kHz**, plus or minus 30 or 40 kHz.

**Allan Weiner Worldwide Parody**- This new one popped up with audio clips of Alan Weiner from **WBCQ**. (None)

**Alice's Restaurant**- An unknown pirate has been broadcasting this classic Arlo Guthrie story. (None known)

**Captain Morgan**- Twilight Zone TV audio and rock "from the pirate zone," is the Captain's normal program content. (None, says to send loggings to the Free Radio Network web site)

**Channel Z Radio**- Their classic rock music is designed as a replica of old "free form" FM radio. They occasionally also relay Europirate programs. (Blue Ridge Summit and [channelzradio@gmail.com](mailto:channelzradio@gmail.com))

**Family Radio Inc. Shortwave**- A pirate has been producing a comedy parody version of WYFR's religious programs with host Brother Levi. Some have heard an ID of Sound of New Life Radio. (None)

**Grasscutter Radio**- The grasscutter guy plays rock music and almost never discusses mowing the lawn. ([grasscutterradio@yahoo.com](mailto:grasscutterradio@yahoo.com))

**Johnny Cash Radio**- Somebody appeared on 3910 kHz in the 90 meter ham band with a collection of Johnny Cash songs, and on subsequent days with holiday music. Most pirates frown on operations within the Amateur Radio bands, but this outlier was an exception to that sound operating practice. (None)

**KPRX**- This odd new operation is creating some confusion. Their ID may be **KPRS** or something similar like **KCRF**. The programs consist largely of confusing discussions and groaning. (Announced their call letters at gmail.com, but e-mails have been bouncing pending the correct call identification)

**KIPM**- Alan Maxwell's elaborate existential dramas are still appearing on the pirate bands occasionally. It is unclear if these are new productions or relays by other pirates. (Elkhorn probably defunct)

**Kracker Radio**- When not running for Vice President of the USA on the Commander Bunny ticket, Kracker normally broadcasts rock music. ([krackerradio@pmlol.com](mailto:krackerradio@pmlol.com))

**Liquid Radio**- Their format varies from show to show. Recent loggings noticed disco, techno, and jazz music. (None, but has replied via the FRN)

**Long Range Radio**- Their diverse productions include rock music, comedy, and dramas. (None)

**MAC Shortwave**- Paul Star's entertaining replica of old top 40 commercial radio formats is among the best produced pirates in North America today. He still uses variable frequencies including 3275, 6850, and 6925 kHz. ([macshortwave@yahoo.com](mailto:macshortwave@yahoo.com))

**Northwoods Radio**- Jack Pine Savage's pirate "from the Great Lakes" normally features rock music mixed with educational discussions. We see their logo this month. ([northwoodsradio@yahoo.com](mailto:northwoodsradio@yahoo.com))

**Oxygen Channel Parody**- This new operation is dominated by sexually explicit stories and jokes. (None)

**Radio Jamba International**- There is speculation that this one may be the origin of The Bowling League. (Unknown, but try Belfast)

**Random Radio**- As the station name implies, their musical style and even the language used by their announcers varies during every broadcast. (None; asks for reports via the FRN web site)

**Sunshine Radio**- It is rare to see female announcers on North American pirates, but this one's rock music sometimes is on with a joint broadcast with **Grasscutter Radio**. ([grasscutterradio@yahoo.com](mailto:grasscutterradio@yahoo.com))

**The Crystal Ship**- The Poet's "Voice of the Blue States Republic," still programs leftist politics and music is evident in his music. Frequencies vary widely,

*Continued on page 61*

## GRAB and GO!

**W**inter is almost gone and spring is around the corner. By the time you read this I hope to be spending some quality time with many of my radio hobby friends at this year's annual Winter SWL Fest in Kulpsville, PA. (<http://swlfest.com/>) Always a good time.

There are a few other things I do around the same time that I pack for the SWL Fest. I overhaul my warm weather road and mountain bicycles. I change out the cold weather gear in my kayaks. I repack my first aid and survival kits for land and water use. And, most relevant to this month's column, I reevaluate and repack my ham radio "Go Bag."

Go Bags are common in the Military and Public Service worlds, but they can also be useful for the ham radio operator, who is on the move more often than not. Even someone who works out of their car or has a long commute to work each day qualifies.

I have discussed general and specific radio hobby emergency setups in the past in this column. Emergency readiness is always at the back of our minds in these days of "the new normal." However, a basic Go Bag filled with ... well... the basics of ham radio can be both fun and, if the going does get tough, assure you can stay on the air and be useful to the world around you. You can also have a lot of fun designing your set-up to meet your own needs. To get you started on this spring project, I will give you a peek inside Old Uncle Skip's personal ham radio Go Bag.

### ❖ The Case

The "Bag" for my Go Bag has been with me for quite a few years. I use a small soft-sided fishing reel/gear bag made by the Shakespeare Company, a major name in the sport fishing world. Or so I am told; I haven't dropped a line in a pond with a worm on it since I was about 6 years old. I bought it because it had a large central compartment and three outboard zippered compartments for carrying the goodies I felt I needed to keep with me when I play radio.

But most of all, I chose this bag because it was on sale! This does not need to be an expensive hobby if you are willing to keep an eye out for bargains. Poke around outdoor stores that cater to camping or fishing (especially at the end of the season) and you will find dozens of possible choices. Repurposing non-ham items to ham radio use is always a great (and money saving) option.

Picking out a good Go Bag is a lot like the story of the Three Bears. Too big and you won't

want to lug it around. Too small and you won't be able to fit anything of use inside. You want a bag that is just right. You want a bag that can hold your equipment but also will be easy to reach into and pull out what you want without a lot of fumbling. Go for something around the size of a 35mm SLR camera bag and you will be in the ball park.

So now that you have your Go Bag picked out, you want to think about what to carry with you. Let's start with the radios themselves.

### ❖ The Radios

I usually carry a full featured dual band handheld and a public service scanning receiver with me wherever I go. My dual band rig of choice for many years now remains the Yaesu FT-50. Newer rigs have come on the market, but this workhorse keeps on ticking. I like the fact that it is rugged and has proven weatherproof construction.

I also carry a Radio Shack Pro-96 Digital Scanning Receiver. My reason for picking this particular rig is that its frequency and mode coverage suits the activities in my area of residence. You may find a different scanner works better for you in your region.

Both of these radios have the ability to operate using their own rechargeable battery pack, an automotive power outlet (alias cigarette lighter) cable, a replacement pack that accepts standard alkaline AA cells, or by connection to other forms of external power. The more ways you can bring power to your equipment, the more likely you will remain up and running under even the most difficult conditions.

These two handheld units reside in the large central compartment of my go bag with a few other items.

### ❖ Accessories

I have developed the habit of carrying two other gadgets wherever I go. These have been added to my bag over the years because they have become small and inexpensive enough to make them worth having around. Don't feel obliged to follow my lead on this. I just find these to be fun and useful toys when I play radio. You will certainly come up with better ideas based upon your

amateur radio techniques and needs.

I carry a Garmin Geko 101 handheld GPS receiver. I have other more sophisticated GPS rigs around the shack and in with my outdoor gear. The diminutive Geko gives me just the basics of location and waypoint marking. Nothing fancy needed for amateur radio operation at this level. It is waterproof and lives for many hours on a couple of AAA batteries.

I also carry an inexpensive digital camera. 3.2 megapixel cameras can be had for well under \$75 new. You are not looking to become the next Ansel Adams here. You just want something basic that can record events as they happen for future reference. It also helps to choose a camera that uses AA or AAA cells for the same reasons listed above for the radios.

If you are in the habit of carrying a cell phone that has a built in camera, you may forego this item, but I find that even low cost cameras have better features and optics than most cell phone photo rigs.

### ❖ More Power

As I mentioned earlier, the rigs I carry have self-contained rechargeable battery packs that can be easily swapped to more common alkaline "store bought" disposable cells. So it is a no-brainer to add the spare cells (in AA or AAA form factors as equipment dictates) to one of the side pockets on my Go Bag.

I have also made up cables that will take 12 to 13.8 volts DC via Power Pole or Molex connectors. In addition, I have a cable made up that works by clipping directly to an automotive battery's terminals. These roll up tightly into one of the other side pockets on my Go Bag.

*Wires down, torrential rain, gale force winds. Are you ready to roll?*



By the way, when I took the time to make up these cables, I used appropriate fuses and diode protection to assure that inattention on either my part or that of the person donating power to me doesn't cause any bad news to my radios. A couple of dollars worth of parts and about an hour's time is all it should take you to keep from frying any gear you plug into unknown power sources. Cheap insurance in my book!

### ❖ Other Useful Items

The front side pouch on my Go Bag carries a lot of useful stuff. I carry a couple of pens and a small notebook. It is always useful to have something to jot down those things that you might forget.

I also carry a small LED flashlight. How did we ever live in a world without these things?! You can have a reasonable source of light that lasts for 10 hours or so in a smaller space than almost any traditional flashlight would fit. Also, that traditional flashlight would start to dim about 5 minutes after you turned it on, thanks to power drain and, of course, Murphy's law. I carry an LED flashlight as part of my work and use it daily, and it has always lasted more than 6 months before requiring new cells. I picked an LED flashlight that uses the same AA size cells that I keep in the side pouch for the radios in the unlikely case the flashlight cells give up the ghost during normal use.

Another must-carry item for me is a multi-tool. There are many brands out there now that can meet all sorts of needs. If you are a traditionalist, you may choose instead to carry a Swiss Army style multiplex knife. While this is a useful tool, hams need pliers! Only a few high end Swiss Army knives have pliers, and they are all too small to get the job done compared to the units sold by companies such as Leatherman or Gerber. Keep in mind that you aren't trying to replace your toolbox here. You just want to be able to perform the occasional quick fix until you can get back to where a broader array of tools and supplies can be found.

Something I found in a local automotive store also fits in the front side pocket: It's called a document wallet. It is a small folding case originally intended to carry car or motorcycle registration documents. Mine is thick plastic with clear plastic inner pockets. I keep mine filled with copies of my amateur radio license, ARES/RACES identification, and about twenty dollars in small bills. It's nice to have this sort of stuff where you can find it fast.

I still have a bit more room, so I add a state and county map to help me keep sorted out as I move through the area. Remember that GPS unit I mentioned earlier? If you take the time to calculate and note the coordinates for major points of concern on your maps for quick reference, you can put both map and GPS unit to much better use in an active environment. Yes, I know all that coordinate stuff resides in the margins of a good map. But when you are in a hurry, seeing that the nearest firehouse is located at a specific point marked in red on your map is faster.

If you are of a mind to carry a more sophisticated GPS unit, you may want to pre-enter all these emergency locations into the unit, but don't forget the map. Maps do not require batteries!

### ❖ Can You Adapt?

The two rigs I mentioned carrying have different antenna connectors. The FT-50 has an "SMA" type antenna connector and the Pro-96 uses a "BNC" style connector. I make a point of carrying SMA to BNC, SMA to SO-239, BNC to SMA and BNC to SO-239 adapters with me in a large, clear plastic pharmacy pill bottle. In this way, I can easily connect either radio to alternate antennas, either mounted on my vehicle, or those that present themselves for use in any emergency situation. You might also want to consider a 10 to 25 foot length of RG8x coaxial cable with appropriate cable ends as a way of putting your radios to use in alternative situations. A short length of 8x doesn't take up a lot of room.

Another thing I make a point of carrying is a well folded 30 gallon trash bag and a couple of equally well folded one quart resealable plastic food bags. Face it, things always get wet at the least opportune times. Being able to put any non-waterproof gear into a dry bag when the weather kicks up is worth the weight of a couple of ounces of plastic. Further, that 30 gallon trash bag can double as a makeshift poncho in case you forgot to weatherproof yourself when the weather turns foul.

One last thing: I toss in a couple of chemical light sources (you know them as glow sticks).

*continued from page 59*

including 1710, 3238, 3275, 5385, 6700, 6875, 6899, 6925, 7575, and 9057 kHz. (Belfast and [tcsshortwave@yahoo.com](mailto:tcsshortwave@yahoo.com))

**Undercover Radio-** Dr. Benway still broadcasts rock music and anecdotes about his adventures "from the middle of nowhere." (Merlin and [undercoverradio@gmail.com](mailto:undercoverradio@gmail.com))

**Voice of the Bowling League-** Comedy and novelty music is their specialty. (Try Belfast)

**WAIR-** Their call letters and their "All Indie Radio" slogan are consistent. They are among the pirates who have relayed Allan Weiner's **WBCQ** remarks about pirate radio amid their new age and folk music. (Elkhorn; probably not valid)

**WBNY-** Commander Bunny's presidential campaign still sells bumper stickers and t-shirts on e-bay. Rock music, **WBCQ** recordings of Allan Weiner, and his advice to monkeys who are listening are his staple format. He wants a debate with Hillary Clinton and John McCain. (Belfast and [rodentrevolutionhq@yahoo.com](mailto:rodentrevolutionhq@yahoo.com))

**WEMR-** They have been specializing in rock music and various seasonal fare. (Unknown)

**WHYP-** James Brownard announces that his station will be relaying other pirates from North East, PA in 2008. (Belfast and [whypradio@gmail.com](mailto:whypradio@gmail.com))

**WMPR-** The call letters stand for Micro Power Radio, and their techno rock "dance music" format is easy to spot. (None, QSLs only rarely at the Winter SWL Festival in Kulpville, PA)

**Wolverine Radio-** Like many pirates, rock music and comedy dominate their broadcasts. (None announced)

**WMPR-** This well known "dance party" station plays techno rock music that is normally played in dance clubs. (None, has QSLed only rarely at the Kulpville Winterfest)

**WTCR-** "Twentieth Century Radio" plays classic rock music, but sometimes they branch out and feature pop tunes from much earlier in the century. (Belfast)

### ❖ QSLing Pirates

Reception reports to pirate stations require three first class stamps for USA maildrops or \$2 US to foreign locations. The cash defrays postage for mail forwarding and a souvenir QSL to your mailbox. Letters go to these addresses, identified above in parentheses:

### UNCLE SKIP'S CONTEST CALENDAR

#### ARRL International DX Contest (SSB)

Mar 1 0000 UTC - Mar 2 2400 UTC

#### North American Sprint (RTTY)

Mar 9 0000 UTC - 0400 UTC

#### Wisconsin QSO Party

Mar 9 1800UTC - Mar 10 0100 UTC

#### 10-10 International Mobile Contest

Mar 15 0001UTC - 2359 UTC

#### Virginia QSO Party

Mar 15 1800 UTC - Mar 17 0200 UTC

#### CQ WW WPX Contest (SSB)

Mar 29 0000 UTC - Mar 30 2359 UTC

#### QCWA QSO Party

Mar 29 1800 UTC - Mar 30 1800 UTC

They can come in handy for marking locations and yes, even providing light if your LED flashlight is otherwise occupied.

I am sure you folks will have lots of great ideas on how to improve upon my humble efforts. Have fun building your Go Bag. We can talk about your designs on the bottom end of 40 meters.

- PO Box 1, Belfast, NY 14711;
- PO Box 109, Blue Ridge Summit, PA 17214;
- PO Box 146, Stoneham, MA 02180; and
- PO Box 293, Merlin, Ontario N0P 1W0.

Unfortunately, PO Box 69, Elkhorn, NE 68022 is no longer a valid address, although a few pirates announce it, and some claim to still be getting replies through it. Some pirates prefer e-mail, bulletin logs or internet web site reports. The best bulletin for submitting pirate loggings is now the e-mailed Free Radio Weekly newsletter, still free to contributors via [freeradioweekly@gmail.com](mailto:freeradioweekly@gmail.com). A few pirates will sometimes QSL reports left on the outstanding Free Radio Network web site, at [www.frn.net](http://www.frn.net). The ACE, a formerly widely read print bulletin, can no longer be used in order to notify pirates that a listener heard a broadcast, but it does have a loggings section and a valuable archive of *Free Radio Weekly* issues on its web site at the [www.theaceonline.com/](http://www.theaceonline.com/) URL.

### ❖ Thanks

Your loggings and news about unlicensed broadcasting stations are always welcome via 7540 Highway 64 W, Brasstown, NC 28902, or via the e-mail address atop the column. We thank this month's valuable contributors: Brian Alexander, Mechanicsburg, PA; John T. Arthur, Belfast, NY; Kirk Baxter, North Canton, OH; Artie Bigley, Columbus, OH; Commander Bunny, Belfast, NY; Ross Comeau, Andover, MA; Richard Cuff, Allentown, PA; Rich D'Angelo, Wyomissing, PA; Gerry Dexter, Lake Geneva, WI; Bill Finn, Philadelphia, PA; John Figliossi, Halfmoon, NY; Harold Frodge, Midland, MI; Vince Havrilko, Mountain Home, ID; Harry Helms, Smithville, TX; Bill Hensel, Denver, CO; Ed Ininger, Summit, NJ; Ed Kusalik, Coaldale, Alberta; Chris Lobdell, Tewksbury, MA; Michael W. Maher, Hillsborough, NJ; Greg Majewski, Oakdale, CT; A. J. Michaels, Blue Ridge Summit, PA; Adrian Peterson, Indianapolis, IN; John Poet, Belfast, NY; Jari Savolainen, Kuusankoski, Finland; Chuck Sayers, Harrisburg, PA; Martin Schoech, Eisenach, Germany; Lee Silvi, Mentor, OH; Bob Wilkner, Pompano Beach, FL; Joe Wood, Greenbriar, TN; Bob Zanotti, Langnau, Switzerland; and an anonymous contributor.



## Antennas and the U. S. Navy

**D**esigning the overall set of antenna systems for a large U. S. Navy ship is not a task for the faint hearted. Large aircraft carriers have as many as 130 antennas installed in the topside! Imagine that many antennas on one ship, and each hopefully functioning without significantly blocking signals from, or causing undue interference to the others!

Impediments to operation of any antenna may include gun emplacements, smoke funnels, loading booms, masts, cables, various parts of the ship's superstructure, and other antennas that are needed to support the ship's missions. The intense competition for space generated by fitting so many antennas into such cramped quarters has given birth to a specialized field: the art and science of shipboard antenna placement.

Obviously the need for satisfactory performance by each antenna requires that a very detailed overall antenna-placement plan be designed and evaluated by a group of experienced engineers. After taking into consideration all the factors that will affect each antenna's operation, a tentative placement plan is produced. In the past a metal, scale-model of the ship, complete with model antennas would be constructed and placed on an electrically-conductive model of the sea! Signals used with the scaled-down model antennas on the ship model used wavelengths correspondingly shorter than those used by the full-size antenna.

Today, computer-modeling programs for designing shipboard-antenna placement plans have replaced most of this tedious model-building.

### ❖ One Cable and One Antenna

An ex-navy man I know was once aboard a U. S. Navy ship sailing off the coast of Japan. He could see the masts and cables of a large rhombic antenna on the shore. As the ship sailed through the major lobe of the antenna's radiation pattern, my friend noticed sparks jumping from one of the cables on the ship to the metal structure of the ship.

Although the radiation was not coming from the ship, this was quite a convincing illustration of the reality of non-intended interaction between radio-frequency radiation and metal objects aboard ships. Multiply this by the number of cables and antennas on a ship, and the potential for problems is obvious.

### ❖ Applications

Aboard a navy ship, antennas are needed to support a variety of important activities. These activities include: communications such as ship to ship, ship to shore, ship to plane and ship to satellite; navigation; radar (surface search, air search, weapons control); electronic warfare (jamming, confusion of signals, false-information signals); IFF (identification as friend or foe); and meteorological antennas (got to know what the weather will be if you're gonna fight in it).

### ❖ Antenna Design Types

Antennas designs employed to support

these activities include, but are not limited to: single wire-rope; vertical, base-loaded HF whips; VHF whips; whip monopoles, helical monopoles; multi-element, wire-rope fan; disc-cone; inverted-cone; discage; biconical dipoles; log-periodic beam; conical spiral; dual-helix; cavity-backed slot; groundplane; dish and other reflector types; horn; loop; magnetic loop; crossed-loop; Adcock; planar-spiral and quadrifilar designs. Whew!

Many of these antennas, especially those that must cover a broad range of frequencies, include an impedance-matching unit. Some include preamplifiers or filters. Some of the antenna assemblies include steering motors and are capable of remote control. Others have electrical-steering for directional orientation of their patterns. Electrical steering can shift the antenna's radiation pattern while the antenna itself remains stationary. Some antennas even have automatic correction for orientation as the ship rolls and pitches.

Due to the extremes of weather that these antennas must survive, many of them, especially the dishes, are fitted with sturdy radomes (protective covers), and additional weight is also added by heavy-duty mounting and support fixtures. It's not completely surprising then that the weight of a few of the more complex of these antenna systems is in the thousands of pounds. Not a misprint: that's *thousands* of pounds!

### ❖ Let's Build a Landlubber's Whip Monopole

A quarter-wavelength vertical antenna with its bottom placed on a groundplane, such as Earth, is known as a "monopole." Another name is a "Marconi grounded quarterwave vertical."

This antenna (fig. 1A) is non-directional and has a fairly low, vertical radiation pattern which is useful for long-distance (DX) communications. Aboard ship, the metal of the ship's decking can serve as the groundplane for the antenna. For landlubbers, however, the groundplane (fig. 1B) is a series of wires (radials) running out from the base of the antenna like spokes from the hub of a wheel.

Radial wires can be buried a few inches below the earth's surface or just laid on the earth's surface. The ideal number of radials is 120, each .4 wavelength long. Few of us will use that many radials or radials of that length.

Their length is not critical. The *ARRL Antenna Book*\* suggests that if only 16 radials

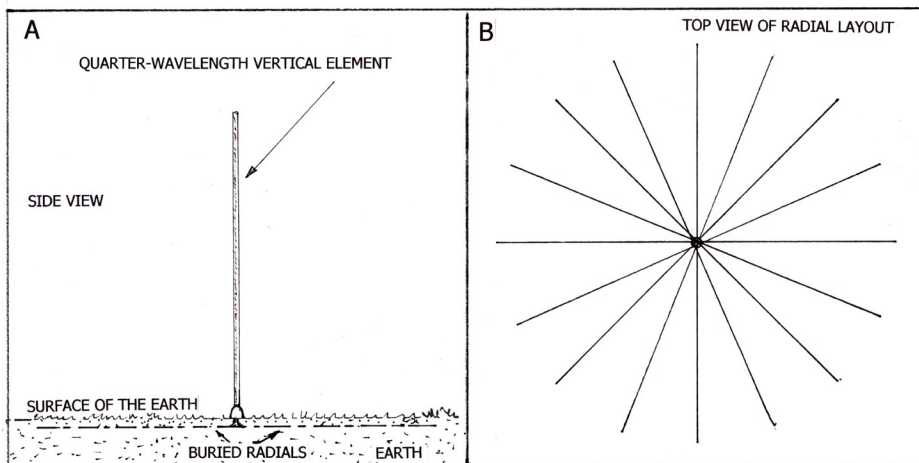

Fig. 1. A MARCONI, GROUNDED, QUARTER-WAVELENGTH, VERTICAL ANTENNA (A), AND A TOP VIEW OF SUCH AN ANTENNA SHOWING THE PATTERNING OF ITS RADIALS.

**This Month's Interesting Antenna-Related Web site:**

Interesting shipboard antennas:  
[www.de220.com/Electronics/Antennas/Antennas.htm](http://www.de220.com/Electronics/Antennas/Antennas.htm)

This next site has a Navy Electronic Warfare Manual with links to antenna info including radiation patterns, typical gain figures, bandwidths for lots of antennas. It also has some heavy math, but you don't need math to understand the patterns:

<http://jacquesricher.com/EWhdbk/>  
 History of radio at sea:  
<http://earlyradiohistory.us/sec005.htm>  
 Understandably, the Navy wants to reduce the number of shipboard antennas:  
[www.onr.navy.mil/media/article.asp?ID=18](http://www.onr.navy.mil/media/article.asp?ID=18)

are used, there is a 3-dB loss of signal strength as compared to 120-radials. If compromises in radial length are made, then many short radials are better than a few longer radials.

A connection to a rod driven into the earth is a poor substitute for actual radials. In wet soil near bodies of water, this may be reasonably effective, but it is not recommended for most installations. If the radials are raised a significant distance above ground, the antenna tends to become a groundplane antenna, which has different design considerations.

The monopole's vertical element should be a quarter wavelength long at the operating frequency. This length in wire is:

$$L(\text{in ft}) = 234/\text{frequency}(\text{MHz}), \text{ or}$$

$$L(\text{in meters}) = 71.3/\text{frequency}(\text{MHz})$$

## RADIO RIDDLES

**Last month:**

I asked: "How did natural radio waves from lightning bolts figure in the pioneering work of Joseph Henry, Alexander Popov, and Nicola Tesla?"

Well, these men were all early pioneers in the study of electromagnetic waves. Henry was the first person to set up a rudimentary receiver and detect the presence of the electromagnetic waves launched by lightning bolts. This was before wireless (radio) was a reality. Popov developed a receiving system which monitored

weather by responding to the waves launched by lightning bolts. And Tesla developed a system by which he reported that he could roughly track a storm's progress by receiving the waves launched by its lightning bolts.

**This Month:**

Navigators of sea-going ships can plot the shortest distance for their courses by using something called a "great-circle map." Does such a map have anything to offer a radio operator?

You'll find an answer to this month's riddle, another riddle, another antenna-related web site or so, and much more, in next month's issue of *Monitoring Times*. 'Til then Peace, DX, and 73.

This means that an element for 10 MHz would be 23.4 ft tall. Note that for lower frequencies the element may be so tall as to be impractical for most of us to construct. For instance, at 4 MHz the element would be almost 60 ft tall.

The vertical element can be made from a wire supported from a tall tie point such as a tree; it can be a guyed metal pole; or it can be a self-supporting metal tower. The antenna can be fed with 50 or 75-ohm coaxial cable.

\* *There's much more about monopole antennas, many other antennas, and practical antenna theory, in the ARRL Antenna Book. (American Radio Relay League, 225 Main Street, Newington, CT 06111-1494;*

*www.arrl.org or call 860-594-0200) It's one you should get if you are interested in antennas. It's a bit pricey, but used copies are available on eBay, and they change only slightly from year to year. Sometimes local libraries have a copy.*

### Antenna Designer

New Version 2.1 for Microsoft Windows 95 and 98  
 Computer program helps you design and build 17 different antennas from common materials. Based on Antenna Handbook by W. Clem Small.

**Only \$39.95**

\$5 S/H on all orders  
 CA residents add 8.5%  
 Shipped on CD ROM

Send check or money order to:  
 Small Planet Systems  
 623 Mangels Avenue  
 San Francisco, CA 94127

[www.smallplanetssystems.com](http://www.smallplanetssystems.com) 415-337-9394



# Listening is only half the fun... POPULAR COMMUNICATIONS is the other half!

If you enjoy radio communications in all its variety, you'll love

## POPULAR COMMUNICATIONS

Since 1982 Pop'Comm has delivered thousands of pages of great reading for both the radio enthusiast and the professional communicator.

Every month Pop'Comm is crammed with scanner frequencies, shortwave listings, broadcast and utility loggings, radio nostalgia, and technical information. Plus you'll find great features on amateur radio, public service communications, DXing, pirates, clandestines, and much, much more.

**YES! Enter my subscription to Popular Communications today!**

Name \_\_\_\_\_  
 Address \_\_\_\_\_  
 City \_\_\_\_\_ State \_\_\_\_\_ Zip \_\_\_\_\_  
 Check    MasterCard    VISA    AMEX    Discover  
 Card No. \_\_\_\_\_ Expires \_\_\_\_\_  
 Signature \_\_\_\_\_

	USA	Canada/Mexico	Foreign
1 Year	<input type="checkbox"/> 32.95	<input type="checkbox"/> 42.95	<input type="checkbox"/> 52.95
2 Years	<input type="checkbox"/> 58.95	<input type="checkbox"/> 78.95	<input type="checkbox"/> 98.95
3 Years	<input type="checkbox"/> 85.95	<input type="checkbox"/> 115.95	<input type="checkbox"/> 145.95

Popular Communications, 25 Newbridge Road, Hicksville, NY11801 • Phone: 516-681-2922 • Fax 516-681-2926

Visit our web site: [www.popular-communications.com](http://www.popular-communications.com)



## Aligning the BC-348

**A**t the close of the last work session, I was trying to discover the reason for the very poor audio quality of our project set. Through voltage checks, I had been able to pin-point a leaky coupling capacitor. I hadn't included it in my earlier recapping because it was a mica – and micas so rarely go bad. Wondering about other micas in the radio, some of which were buried within the r.f. coil compartments, I checked the parts list.

It turned out that this particular mica was one of two identical units that were the largest (capacity wise) in the set. I thought I should at least check the sister capacitor, which the schematic informed me was connected across the primary of the output transformer. Apparently it was there to control the audio tone.

### ❖ The Audio Fix

When I went looking for the capacitor, I found that it was supposed to be occupying a terminal board spot right next to the one I had just replaced – but it was missing! Once again, I was following in the footsteps of the previous owner. Apparently that capacitor had also gone leaky and he decided to do without it. However, I decided to maintain the original configuration and replace the unit.

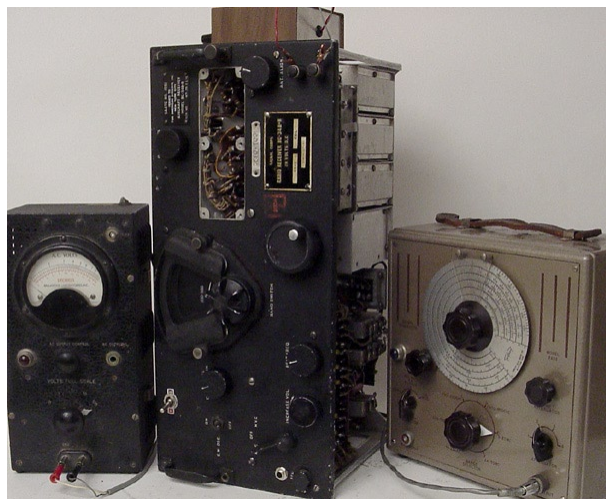

The BC-348 with instruments used for alignment. AC VTVM at left, dummy antenna atop receiver, service generator at right.

Now I was ready to turn the set on for another test. And, as I've been careful to do so far during this restoration, I immediately made a quick check of the plate voltage. Readers who have been following the story will remember

that, last month, I had to readjust the series dropping resistor in the supply to compensate for a value that, unaccountably, had become about 50 volts too low. Something I had changed had increased the current drain on the supply, which of course increased the voltage drop across the series resistor.

This time, the voltage was perhaps 80 volts too high – quite possibly the result of my having corrected the coupling capacitor problem, thereby reducing the current drawn by the output tube. So once again I had to adjust the power supply series resistor. Next time I need to find a power transformer for a radio, I'm going to work a lot harder to find one much closer to the correct voltage so I can do without a series resistor. Another disadvantage is the large initial plate voltage – in this case over 300 volts – that hits the radio before the tubes warm up and begin drawing current through the resistor.

At any rate, the receiver audio was now reasonably clean. However, sensitivity was still questionable and I wasn't able to hear a single aircraft beacon or other signal on the 200-500 kHz band.

### ❖ I.F. Alignment

The most obvious next move was to check the receiver's alignment, readjusting as necessary. As usual I began with the i.f. channel. Instead of the more usual 455 kHz frequency, this radio's i.f. is at 915 kHz. The lower frequency had to be avoided as it would have fallen within the 200-500 kHz band's tuning range.

A modulated 915 kHz signal from the service generator, kept at as low a level as possible, was injected, via a small capacitor, into the grid cap of the first detector tube. For a gain indicator I used an a.c. vtvm (vacuum tube volt meter). clip-leaded to the radio's intercom output terminals (located on the interface plug at the back of the receiver).

The avc was turned off to avoid the possibility of volume peaks being smoothed out.

Beginning with the fourth i.f. transformer, I worked my way back to the first one, peaking all adjustments. The top tuned circuit of each transformer is adjusted via a hollow slotted screw. The gap between the slots is bridged nicely by a

RMA DUMMY ANTENNA  
20 uh choke is 49 turns No. 30 enameled wire close-wound (1/2" long) on 1/2"-diameter plastic tube.

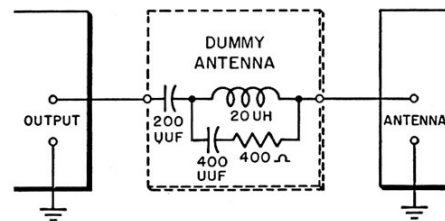

Fig. 1. Specifications for dummy antenna as originally recommended by the Radio Manufacturers' Association.

wide-bladed screwdriver. The screw turns easily and a metal blade is ok – not affecting the gain of the circuit as it is inserted or withdrawn.

The lower tuned circuit requires a screwdriver thin enough to pass through the hollow upper screw so it can engage the lower adjusting screw. This screwdriver must be non-metallic, which created a problem because none of my plastic screwdriver-tip alignment tools was long enough to reach that bottom screw.

Here's where my collection of oddball alignment tools came in handy. (I pick those things up at flea markets whenever I have a chance, and I advise you to do the same!) I did have a tool long enough, but it had a rectangular cross-section tip for who-knows-what-purpose. A few strokes of the file on each side of the flat converted it into a screwdriver tip that performed the adjustments very nicely.

It's a tribute to the quality of the components built into this radio, as well as the previous owner's sophistication, or perhaps his lack of meddling, that most of these adjustments were already either spot on or not very far off. Once I had a working screwdriver, it took only a few minutes to go through the entire i.f. channel.

### ❖ Front End Alignment

The r.f. (front end) adjustments aren't too difficult as long as one works carefully and methodically. The test signal (a different frequency for each of the six bands – two for the 200-500 kHz band) is fed into the antenna and ground terminals of the receiver from the signal generator via a dummy antenna. The latter gadget is used whenever aligning sets intended for use with an outside wire antenna – especially high-performance communications receivers.

The dummy antenna is simply an electrical



Band No.	Freq. Range	Alignment Frequency	Osc.	Trimmers* Det.	R.F.	Ant.
1	200-500 kc.	(500 kc. 200 kc.)	6-1 10	3-5	3-3	2**
2	1.5-3.5 mc.	3.5 mc.	6-2	5-5	5-3	5-1
3	3.5-6.0 mc.	6.0 mc.	6-3	3-6	3-4	3-1
4	6.0-9.5 mc.	9.5 mc.	6-4	5-6	5-4	5-2
5	9.5-18.5 mc.	18.5 mc.	3-7	7-2	7-1	3-2
6	13.5-18.0 mc.	18.0 mc.	3-8	4-3	4-2	4-1

**Fig. 2. Chart of alignment data from service manual showing front-end test frequencies for each band as well as designations for trimmer locations.**

network that simulates the electrical characteristics of an actual antenna. I discussed the device in this column a few years ago during another restoration, and am repeating the schematic here as Figure 1.

With the signal generator and dummy antenna hooked up to the receiver and the a.c. vtvm connected as before, I went through all of the adjustments as outlined in the service manual. The table of Figure 2 shows the test frequencies for each band and the locations of each of the trimmers to be adjusted for that band. Figure 3 shows how the codes in the table are used to find various adjustment locations.

For each band, one first sets the signal generator to the specified frequency – using as low a level as possible and with the receiver avc turned off – and checks to see that the signal is coming in at the proper place on the dial. If not, the oscillator trimmer is carefully adjusted until the signal peaks at the proper dial calibration. After that, the detector, r.f., and antenna trimmers are peaked.

Each of the coded openings in Figure 3 gives access to a screwdriver-adjusted trimmer. Metal screwdrivers are ok here – which is just

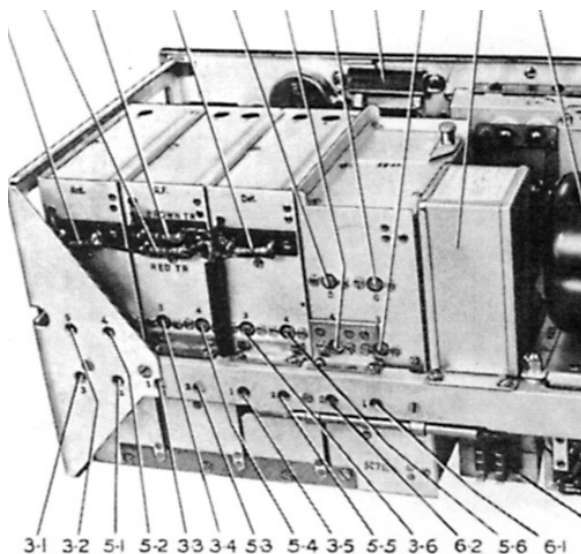

**Fig. 3. Section from manual illustration showing how trimmer locations are identified by designations from alignment data chart.**

as well because some of the adjustments were hard to break loose after decades of disuse.

Though almost all of the adjustments were reasonably close to their proper positions, they were far enough off that I was able to make significant improvements in receiver sensitivity. During several adjustments, I had to reduce the signal generator gain several times to avoid pinning the vtvm.

Only one set of adjustments was really far off – the one for band 2 (1.5 - 3.5 MHz). In fact, I had to move the oscillator trimmer so far that I wondered if perhaps I had the oscillator frequency on the wrong side of the received frequency. On bands 1 through 4 (see Figure 3), the oscillator runs at 915 kHz above the received frequency; on bands 5 and 6, it runs at 915 kHz below the received frequency.

Either arrangement results in a 915 kHz signal that can be amplified by the i.f. channel. But (without going into the reasons why), the tuning of this receiver is optimized for the configurations as stated. I was concerned enough to check on the possibility of an incorrect oscillator setting, but I don't happen to own a frequency counter.

It took me a moment, but I finally thought of using my navy LM frequency meter (the army version of this instrument is known as the BC-221). Using an internal crystal for reference, the LM can generate fundamental and harmonic frequencies of high accuracy in the range of 125 kHz-20,000 kHz. It can also measure frequencies anywhere in that range by zero-beating them against the accurate signal being produced within the instrument. Perhaps we'll cover the LM, or BC-221, in a future series of articles.

In measuring mode, The LM is really intended to work with emissions generated by a radio transmitter. I had no idea if it would be sensitive enough to pick up the tiny signal from the BC-348's oscillator. If the oscillator were running, correctly, at 915 kHz above the received signal on band 2, it would be at 4415 kHz with the dial set at 3.5. If running the same amount below the received signal, it would be at 2585 kHz with the receiver dial set at the same position.

I wrapped several turns of stiff insulated wire around the 6C5 oscillator tube and connected the free end to the input binding post of the LM (which is also the output binding post when it is used as a signal generator). Setting the '348's tuning dial to 3.5 MHz, I set the LM's vernier for 4415 kHz and rotated it in both directions from that point to see if I could pick up a heterodyne.

Sure enough, I heard a tiny but definite zero beat in the LM's headphones after just a few rotations away from the set position. It corresponded to a measured frequency of 4443 kHz. The LM has an accuracy of .01 percent at this frequency, so I felt that I was close enough to feel reassured. Of course, to check that I was really picking up the receiver oscillator, I moved the receiver's tuning dial back and forth to make sure that the zero beat in the LM also moved.

### ❖ More Problems!

With the alignment completed, I could now hear a reasonable number of DX signals on most bands, but still nothing on the 200-500 kHz band. Doing a little testing on the receiver's front end,

it was quickly apparent that the first two r.f. stages – though working – were not working properly. Signals were as strong, or stronger, with the antenna connected directly to the grid of the first detector than when connected to the set's antenna terminal.

I had earlier checked the operating voltages on the pins of these r.f. tubes and found them to be ok; now I checked them again with the same result. I also rechecked the tubes themselves and found them to be still healthy. In addition to typical voltages, the service manual provides data on the resistance to ground expected at each of the tube pins – and here I found some anomalous results that might hold the key to the problem.

And so, though I had hoped to button up the BC-348 at the end of this work session, it has come up with yet another hurdle to be overcome. I hope you readers aren't becoming impatient with my devoting so many columns to the problems of one receiver. Personally, I've been quite fascinated by the challenges presented by this long-neglected shed-stored radio.

So often, when working with a vintage set that was treated with respect during its useful life and then stored under reasonable environmental conditions, a careful recapping and alignment touch-up is all that is needed to re-establish satisfactory operation. However, such restorations don't make the most interesting reading – and a difficult case like this makes an excellent laboratory for illustrating troubleshooting techniques that might be used to restore better equipment!

## JOIN THE AWA

### Antique Wireless Association

*The original and largest historical radio-collector group*

• Publishes *The AWA Journal*, Marc Ellis, Editor, with:

- Battery and AC receiver restoration
- Vacuum-tube history and collecting
- Old-time amateur-radio contests
- Communications receivers
- Free want-sell-swap ads
- Early television
- Horn loudspeakers
- News of U.S. and foreign clubs



• Produces the famous annual Rochester meet

• Maintains unique radio-TV museum

Membership is only \$20 per year in U.S.; \$25.00 elsewhere.

Mail check to:

AWA Membership - P.O. Box 421, Dept. 2 Bloomfield, NY 14469-0421

<http://www.antiquewireless.org>

[awamembership@rochester.rr.com](mailto:awamembership@rochester.rr.com) (585) 392-3088



## FREE SAMPLE COPY!

# ANTIQUE RADIO CLASSIFIED

*Antique Radio's Largest-Circulation Monthly Magazine*

Articles - Classifieds - Ads for Parts & Services  
Also: Early TV, Ham Equip., Books, Telegraph, 40's & 50's Radios & more...

Free 20-word ad each month. Don't miss out!

 1-Year: \$39.49 (\$57.95 by 1st Class)  6-Month Trial - \$19.95. Foreign - Write.

A.R.C., P.O. Box 802-P14, Carlisle, MA 01741

Phone: (978) 371-0512; Fax: (978) 371-7129

Web: [www.antiqueradio.com](http://www.antiqueradio.com)

## The GRE PSR-200

By Larry Van Horn, N5FPW  
Assistant Editor *Monitoring Times*

**M**any years ago when I first started in the radio/scanner hobby, an old media friend of mine gave me some interesting advice, "you can never have enough scanners." He worked on the news desk in a major market news desk and monitoring scanners was his business. I was always amazed how he could cut through all the chatter from a dozen or more scanners and never miss the really important communications that ended up being important news stories.

Well, I have also learned over the years how to use the various scanners in my shack to their maximum potential in monitoring my local radio spectrum. As he told me back in the old days, it is a balance of what frequencies you program into a scanner, how much and what kind of traffic each of those frequencies carries.

Until recently, around here in Brasstown we didn't have a single trunk radio system serving our area. All of our communications consisted of simplex and conventional repeater communications. The only 800 MHz communication systems we had until last year were cellular telephones (put up just prior to the 1996 Atlanta Olympics).

Our scanner requirements up here in the mountains were simple. A basic scanner with as many channels that I could get fits the bill for public safety, with additional scanners for federal, military and civilian air here in the mountains of southwest North Carolina.

Twelve years after moving to NC, I still have a lot of communications in my area that are not digital or trunked that I like to monitor. I really don't like the thought of spending nearly \$500 a unit to load up my shack with scanners that will only be used to monitor analog, non-trunked VHF/UHF public safety communications.

Then last year GRE released their new line of scanners including the PSR-200 desktop. It has no trunking, it is analog only and has 200 channels for only \$99.95. Now that scanner is just what I was looking for! I can afford to buy one for civilian air monitoring, one for my local area public safety communications, and one for federal communication systems - 600 channels for around \$300 bucks. What a neat receive capability this new GRE-200 scanners offers me in my monitoring post.

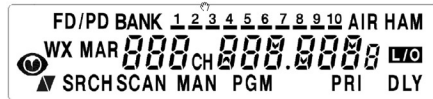

### ❖ Case and Controls

The GRE PSR-200 case measures 8-1/4 (W) x 6-7/8 (D) x 2-3/8 (H) inches (210 x 175 x 60 mm) and weighs in at approximately 24.3 oz (690 g).

Front panel controls/switches on the PSR-200 include an on/off switch; volume control; a separate squelch control; and a keypad. Screen is an amber-colored liquid crystal display.

### ❖ It's what is under the hood that counts

Looking inside the radio, we found a world of scanning capability for a scanner selling for under \$100. Here are some of the PSR-200 features.

- One-touch service search banks: preset search frequencies in separate marine, fire/police, aircraft, ham, and weather banks.
- Quick program when receiving signals up to 200 channels.
- Scan delay: delays scanning for about two seconds before moving to another channel. This will let the owner hear more replies that are transmitted on the active channel.
- Priority channel: sets the scanner to check one channel every two seconds for increased surveillance of a channel of interest.
- Lockout function: skip over specified chan-

nels or frequencies when scanning or searching.

- Keypad for direct frequency entry and SAME/FIPS codes entry.
- Tune: tune for new and unlisted frequencies starting from a specified frequency.
- GRE's "Zeromatic" tuning system: Zeromatic tuning stops the scanner on the correct center frequency of a received signal when the PSR-200 is in the search mode.
- Display back light of the liquid crystal display that makes the display easy to read in low-light situations. 10 digit channel and frequency display with all function indicators (seven segment).
- Memory backup: keeps the frequencies stored in memory for an extended time during a power loss.
- Data cloning: transfer the programmed data to another PSR-200/100 scanner via and 1/8 inch patchcord (not included). You can also use the PC/IF jack for computer control with third party software and a PC (not included).
- Supplied telescoping antenna: Screw-in BNC telescoping antenna provides reception of strong local signals.
- External antenna connector: connect an external antenna (not supplied) with a BNC connector to the scanner for improved reception of distant/weaker signals.
- SAME/FIPS Weather alert: displays the weather event for the specific cities or counties. Will set off a tone if an alert is sounded from the monitored NOAA weather station. Weather alert and SAME programming with 10 FIPS area code memories. There is also a ham Skywarn receive function.

### ❖ Frequency Coverage

The PSR-200 can monitor signals in the following frequency ranges:

29.0-54.0	10-Meter Ham, VHF Lo, 6-Meter Ham (5 kHz steps)
108.0-136.9875	Aircraft (12.5 kHz steps)
137.0-148.0	Military Land Mobile, 2-Meter Ham (5 kHz steps)
148.0-150.8	VHF Hi (12.5 kHz steps)
150.8-162.0	VHF Hi (5 kHz steps)
162.0-174.0	VHF Hi (12.5 kHz steps)
380.0-512.0	UHF Aircraft, Federal Government, 70-cm Ham, UHF Standard, UHF "T" (12.5 kHz)

This scanner is analog (AM/FM modes) only. It does not cover the 700/800 MHz public safety band and does not have a trunk tracking capability.



MT Rating [three stars]





## TABLE ONE: SPECIFICATIONS

### Ten Channel-Storage Banks:

20 channels in each bank (200 total channels)

### Operating temperature:

Normal 32° to 110°F (0° to 43°C)

### Scan rate: Up to 40 channels per second

### Search rate:

Up to 80 steps per second (5 kHz step only) maximum

### Delay Time: 2 Seconds

### IF Frequencies:

1st IF 10.7 MHz; 2nd IF 455 kHz

### IF Interference Ratio (10.7 MHz):

70 dB at 150 MHz

### Spurious Rejection: (FM @154 MHz) 50 dB

### Selectivity: ±8 kHz -6 dB, ±17 kHz -50 dB

### Squelch Sensitivity:

Threshold Less than 0.5 μV

Tight (FM) (S+N)/N 25 dB

Tight (AM) (S+N)/N 20 dB

### Audio output:

3 Inches (77 mm), 8 Ohms; (10% THD) 0.7 W Nominal;

### Power Requirements:

9 Volts DC (Supplied 9V AC or Optional 9V DC Adaptor), 50 mA (squelched)

### External Jacks:

Antenna Jack - BNC Type 50-ohm nominal impedance

Phone/External Speaker Jack - 3.5-mm (1/8-inch) (if a speaker is used it needs to be an amplified speaker).

PC/IF Jack - Cable with 3.5-mm (1/8-inch) TRS phone plugs on each end (not included)

DC Power Jack - 9VDC jack, 4.75mm outer/1.7mm inner plug, center tip must be set to positive.

### Dimensions (HWD):

8-1/4(W) x 6-7/8(D) x 2-3/8(H) inches (210 x 175 x 60 mm)

### Weight (without antenna):

Approximately 24.3 oz (690 g)

**Note:** Features, specifications, and availability of optional accessories are all subject to change without notice by the manufacturer. Information presented above was based on the test unit provided by the manufacturer. Specifications certified accordance with FCC Rules and Regulations Part 15 Subpart C as of date of manufacture.

## MT FIRST LOOK RATING (0-10 SCALE)

Audio Quality .....	7
Audio Levels .....	7
Backlight/Display .....	7
Ease of Use.....	8
Feature Set .....	6
Keyboard/Control Layout .....	8
Overall Construction .....	9
Overall Reception .....	7
Owners Manual.....	8
Sensitivity .....	8
Selectivity .....	7
Spectrum Usability .....	4

ham, marine, train, aircraft, business and public safety communications, I can turn this scanner into a weather radio at the push of a button. When weather was threatening us here in the Brasstown area, I coded two area counties with their SAME codes, pushed the weather button and waited for NOAA to issue an alert. The scanner worked perfectly.

While this scanner is considered a desktop only scanner and it does not have a mobile mounting bracket, if you have access to a 9 VDC or 120 VAC power source, it is really small enough to take it with you. I can see this little desktop in use in a RV or boat.

But those of you who have read this column in the past know that no scanner is perfect. Right off the top: it has no digital decoding or trunking capability. On the other hand, at \$99.95 I didn't expect it to. I was a little disappointed that this was a double conversion scanner. I am sure that if I took it into a metropolitan environment I would have quite a few images that would have interfered with in-band radio signals.

Bottom line, this is a very nice scanner. So if you are looking for a great bargain, these new PSR-200 desktops are just the ticket. It is a very affordable scanner with some nice innovative features. I consider this scanner is one of the best undiscovered treasures in the radio marketplace today.

*The GRE PSR-200 (SCN 17) is available from Grove Enterprises (1-800-438-8155 or [www.grove-enterprises.com](http://www.grove-enterprises.com)) for \$99.95 plus shipping.*

*Digital Digest continued from page 31*

9060.0	Mexican Army with MIL-188-141A ALE
9064.0	Globe Wireless ships with Globedata modem
9067.0	Egyptian Embassy, Havana with Codan 9000-series 16 tone modem
9080.0	Mexican Army with MIL-188-141A ALE
9081.4	Algerian Embassy, Havana with Co-quelet-8
9081.5	US Army and National Guard deployed in Iraq with MIL-188-141A ALE
9082.0	US Civil Air Patrol with MIL-188-141A ALE
9098.6	FUG French Navy, La Regine with 600bd/L STANAG4285 modem
9106.0	Russian Diplomatic Service with CROWD-36
9106.0	Many US SHARES and MARS stations with MIL-188-141A ALE
9115.6	XNet Yachting Association with 100bd PactOR channel free signal
9118.7	Unknown Egyptian Embassy with 100bd SITOR-A
9119.5	Many Virginia National Guard stations with MIL-188-141A ALE
9122.5	Many US Army Corps of Engineers stations with MIL-188-141A ALE
9126.5	Canadian Army Reserve with USB Voice and MIL-188-141A ALE
9136.6	Unidentified station with 250bd/170Hz CHP-200 ARQ
9157.0	HEC Globe Wireless, Berne Switzerland with Globedata modem
9166.0	US Coast Guard HF email network with MIL-188-110A modem
9183.5	Many US FBI stations with MIL-188-141A ALE
9200.0	NATO Military with 75bd/850Hz KG84 encrypted RTTY

That's it for this month. Enjoy your digital listening and please keep the letters and emails coming.

## Books by Ernest H. Robl:

*THE BASIC RAILFAN BOOK*

*UNDERSTANDING INTERMODAL*

*THE POWDER RIVER BASIN*

Detailed descriptions at

<http://www.robl.w1.com>

## ❖ What's in the box?

In addition to the PSR-200 desktop scanner, accessories in the box include an AC adapter, a BNC telescopic antenna, and owners manual. The manual is well written and should be studied to get the most out of the PSR-200 and understand all of its operations.

## ❖ Overall Rating and Final Thoughts

This is a very nice, inexpensive scanner. Audio was excellent and sensitivity/selectivity was good. Even though this is a double conversion scanner, image rejection was good even on an external outdoor antenna.

The one feature I really like is the SAME/FIPS weather function. Not only can I monitor

# FREE SPEECH RADIO WBCQ Shortwave

7.415 - 9.330 - 5.110 - 18.910

[wbcq.com](http://wbcq.com)

[spacetransmissions.com](http://spacetransmissions.com)



*We are the only free speech  
shortwave station on the planet*







## COAA Software Gold Mine Part II: Radio Clock and BeaconSee

By John Catalano

As I wrote last month, I have found the Centro de Observação Astronómico no Algarve (COAA) website to be a “gold mine” filled with many interesting and unique radio programs. Last time, we explored just two COAA “veins”: OrbcommPlotter and PlanePlotter.

OrbcommPlotter easily qualifies as a unique label. It is the only program I know of that tracks and decodes signals from low earth orbiting satellites (LEO). And, if it has to do with tracking and plotting commercial aircraft, PlanePlotter is up to the job with its decoding and plotting of VHF ACARS and HF ACARS signals. Selcal decoding and direction finding and plotting are also part of the PlanePlotter package.

There is much more gold to be had on the COAA site ... if we keep digging.

### ❖ Simultaneity just a Phantom

Setting our PC clock to the “correct” time can be very important. It’s the difference between catching that rare scheduled DX or just hearing hiss. But one of the conclusions drawn from Einstein’s theory of relativity is that there is no such thing as an event occurring exactly simultaneously for two separated observers. Not even setting two clocks.

Why? Well, to start with, there is no preferred frame of reference. Wherever each of the observers is in space (x,y,z) and time(t) is the “correct” location, and light will have a constant speed at each location. That’s just the starting point for evolving the concept. But suffice it to say, simultaneity does not exist, and setting two clocks to exactly the same time is not possible.

The key word is “exactly.” In the space-parameter tolerances of our everyday lives, we can neglect the extremely small difference and call an event simultaneous. But remember, we are defining our own “reality,” which is different from the reality of the universe. (Perhaps you can use this fact of Einstein relativity on your boss next time you are late to a meeting ... that is, if he is not a physicist.)

Now having said all that, how would you like to have a free program that sets your PC’s clock to the “exact” time of a cesium atomic clock? OK, so it’s not quite exact, but it is really for free!

### A Radio Timepiece

Most of us remember, with nostalgia, our early days of radio monitoring when we first heard the rhythmic pips of a time standard station. In the USA it was WWV and its sister stations, although CHU Canada was my first logging. In Europe you probably listened to MSF from Rugby, England, or DCF77 Germany on longwave. In Asia you had RWM from Moscow and in Australia VNG. Just about anywhere on the globe you can receive a time standard station.

Feeding the audio signal from any of these time stations into COAA’s Radio Clock program will guarantee that your PC’s clock will be synchronized to an atomic time standard. Then all PC time-sensitive applications will be “on-the-money.”

### Tempus Fugit

Let’s get right into it. Download the free 500kB program from the COAA website [www.coaa.co.uk/radioclock.htm](http://www.coaa.co.uk/radioclock.htm). Running this self-extracting program will lead you through the simple and quick setup procedure. Connect the audio output of the receiver to the PC’s soundcard’s mic or line input. Using the soundcard mixer screen, ensure that the input is not muted and is set to mid level. The mixer screen can be accessed from the Control Panel or via a right mouse click of the speaker icon in the lower right program tray.

Soundcard calibration is a major part of the setup program. It all happens automatically with just a mouse click or two. One more setting and we’re done with set-up.

Time stations use Universal Time Coordinated (UTC) or Greenwich Mean Time (GMT) standard for their time “zone.” GMT is defined as the time at 0 degrees longitude, called the Prime Meridian. UTC is a similar standard, but uses terrestrial and celestial co-ordinates. For our purposes the two are equal.

Radio Clock automatically converts UTC/GMT to the PC’s local time zone once we enter how many hours our time zone is offset from GMT. We are now ready to go about the business of radio monitoring.

### Time to Tune

For our first attempt we’ll tune to a time station with a strong signal and minimal signal fading. From the Command menu under the “Transmitter” menu, select the time station you are monitoring. This automatically selects a decoder mode to match the station’s digital time encoding method.

Now look at the top right of Figure 1. There you will see a broken vertical line. Tune the receiver so that the horizontal white dashes pass through the line break. Radio Clock makes Setup and tuning very simple.

Going back to my listening roots, I used CHU Canada on 3330 kHz. Figure 1 shows Radio Clock displaying CHU audio. Using the PC’s mixer screen and receiver output (if variable), adjust the level of the source until it appears as in Figure 1. Too high a level and the pulse will not be cleanly formed and noise will fill the spaces between the pulses.

Once correctly tuned and the level set properly, allow the program to run for a minute or two. When the program synchronizes to the station’s data, the small windows at the bottom of Figure 1 will display some interesting data. First, the program’s last reset time, in our case, 10:03. Next are the synchronized time and our GMT offset, 10:03:30 [UT-05]. And finally we see our PC’s clock time, 10:03:28. Comparing the last two windows shows that the PC clock is 2 seconds behind real time.

We can use this info to manually set the PC’s clock to the “exact” second. If you want (or need) continuous automatic PC clock setting, you’ll have to pay 25 euros to register the program. This will enable the automatic PC clock setting function.

The program’s excellent Help file has a wealth of information. Here is what it says about CHU, “Unlike the other signals decoded by Radio Clock, CHU (Canada) uses a single sideband transmission with re-inserted carrier. As such, it can be received in AM mode as well as SSB. If SSB or CW mode is used, the tuning does not need to be offset in order to recover the correct data tones, which encode the time information. The date time code is contained within a 300 bps asynchronous data stream transmitted following

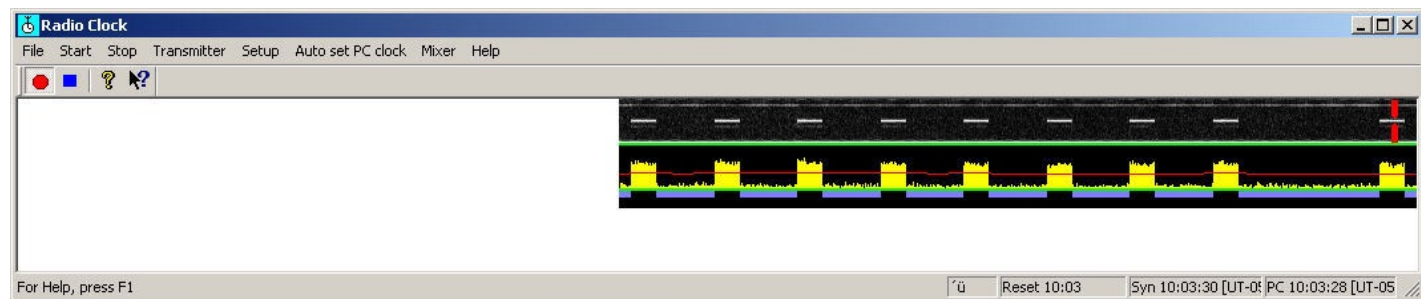

Figure 1 - Radio Clock’s one and only display.

the 1 kHz seconds pulses for each of the 31 to 39 seconds in each minute. The minute marker is a full second of 1 kHz tone.”

Don't miss exploring Radio Clock's Help file.

### Time's Up

I enjoyed using Radio Clock and decoding different time signals on short and long wave. The only problem I encountered was a displaced display as seen in Figure 1. No matter what program or PC display setting I tried, the result was the same. The spectrum display was pulled to the right and the lower right operation windows were not fully open. This was just a minor irritation in an excellent program.

Radio Clock is free, so give it a try. It's a nice meld of radio monitoring and useful computer application. Now let's dig for another nugget.

### ❖ “Seeing” Propagation in Real-time

The Northern California DX Foundation, NCDXF and the International Amateur Radio Union, IARU, have set up eighteen shortwave beacons at various locations around the Earth. The

purpose of these volunteer operated beacons is to “... help amateur and commercial high frequency radio users assess the current condition of the ionosphere.”

The NCDXF website [www.ncdxf.org/Beacon/BeaconSchedule.html](http://www.ncdxf.org/Beacon/BeaconSchedule.html) provides location, callsigns, sample audio files and current operational status for each beacon. This is their description of a beacon transmission, “A transmission consists of the callsign of the beacon sent at 22

words per minute followed by four one-second dashes. The callsign and the first dash are sent at 100 watts. The remaining dashes are sent at 10 watts, 1 watt and 100 milliwatts.” The decreasing power levels add another dimension to the resulting propagation information.

Each beacon transmits every three minutes, twenty-four hours a day on an exacting time schedule. However, this is done in a pre-determined sequential pattern with one beacon starting immediately after the other has finished. Each transmits for ten seconds during its allocated time period.

The beacons use four frequencies, 14.100, 18.110, 21.150 and 28.200 MHz, but not at the same time. For example, once all beacons have had their 10 second transmission on 14.100 MHz, they all move up to the next frequency, 18.110 MHz, and again start their sequential transmissions.

The key to utilizing this methodology is accurate timing. The PC which is controlling your receiver's frequency must have its time set accurately. If it is off, it will be “looking” on frequencies for transmissions that have long ago ended.

Hummm, accurate timing. Sound familiar? This is where COAA's Radio Clock can set your PC's time accurately so you will be on the right frequency at the right time.

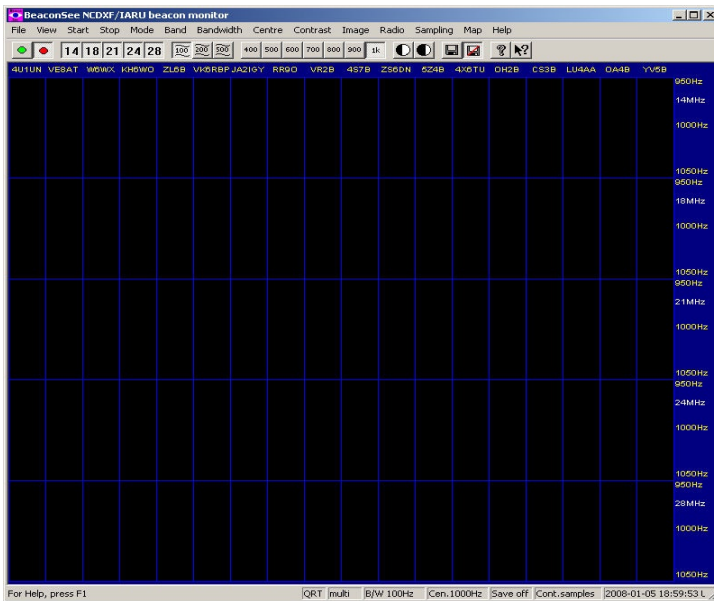

Figure 2 – BeaconSee's full screen during set-up.

# Let's Make a Deal!

Your favorite communications company doesn't just **SELL** radios, we **BUY** them as well!

Grove trade-ins are a **win-win program!** You receive an excellent allowance for your used receiver or scanner, and when you buy a trade-in from Grove, you're assured of a **fully-tested and guaranteed** radio at a **bargain-basement price!**

Why go through the hassle and delay of trying to sell your radio and buy another all on your own when you can depend on Grove's **legendary customer service?** We've bought and sold thousands of radios, making us the country's **number one choice for trade-ins!** With such activity, our inventory changes daily, so stop by our web site right now at [www.grove-ent.com/hmpgbbb.html](http://www.grove-ent.com/hmpgbbb.html), and visit us often!

*All of our previously-owned equipment is tested and guaranteed against defects for 90 days. This list is updated frequently, visit often to catch outstanding bargains!*

[www.grove-ent.com/hmpgbbb.html](http://www.grove-ent.com/hmpgbbb.html)

**GROVE**

Visit our website **TODAY!**

7540 Highway 64 West  
Brasstown, N.C. 28902  
800-438-8155 US & Can.  
828-837-9200  
Fax 828-837-2216  
e-mail: [order@grove-ent.com](mailto:order@grove-ent.com)  
web: [www.grove-ent.com](http://www.grove-ent.com)

Grove is **Always** your **Best Value.**





## Beacon Hopping

If you have one of the listed controllable receivers, COAA's program BeaconSee will keep step – in frequency and time – as the beacons “do their thing.” Using the receiver's audio and some fancy calculations (fast Fourier transforms), the program produces a spectrum display for each beacon. The received signal strengths are plotted for each beacon versus frequency and time. This gives the user an accurate, real-time, visual representation of ionospheric propagation conditions over the entire shortwave spectrum. Now what SWLer or ham couldn't use that? Let's see more about BeaconSee.

## “PSee” Requirements

As with other COAA programs, BeaconSee requires very little in the way of a PC. A PC running Windows 95/98/2000/XP, a free serial port and a 16-bit SoundBlaster-compatible sound card that supports audio capture at 8k samples is all the PC that you need.

For automatic operation, a serially controlled receiver is required. In my opinion, this is only way you should consider using this program. BeaconSee works with many serially controlled radios including: Icom, Kenwood, Winradio and Yaesu and the TenTec RX-320.

If your receiver can be controlled via a serial port but is not on the list, it would probably work using the “Generic” radio set-up menus. The details of the receiver's control command structure and some patience will be needed.

Even using listed receivers, you may be required to manually enter a few of the radio's interface parameters, such as baudrate, word-width, stop bits and parity setting, and for some models the radio's digital address may be required.

After downloading this 700kB program,

unzip and then install it. While you are at it, also download BeaconMap from the COAA website. This program produces a world map displaying the location of the beacon stations. Install it in the BeaconSee directory.

Trying to run the program on a Windows Vista PC gave me problems. (Thank you, Vista, yet again!) If you are using Vista, I suggest that you run the program under the Windows XP compatibility. Do this by right clicking on the BeaconSee, BeaconMap and Help files. Then choose “Compatibility,” Windows XP (Service Pack 2) and select “Apply.” After performing this, the programs worked fine under Vista.

## Seeing More

When BeaconSee is run, you'll be presented with the screen seen in Figure 2. As in Radio Clock, all program functions are accessed from one screen. The layout is also similar, with Command menus at the top, spectrum display in the middle, and small function indicators (telling us what the program is doing) at the bottom.

From the indicators in Figure 2, we can see that we have selected all frequencies sampled continuously, with a bandwidth of 100 Hz and a center frequency of 1000 kHz.

The spectrum display in the center of the screen looks like a checkerboard. Each of the eighteen vertical columns represents a beacon location. The four horizontal rows are the four transmit frequencies. This is where the signal strengths of the beacons will be displayed.

Using the excellent figure from the Help file, Figure 3, we focus on just the transmissions on 14 and 21 MHz from the last nine beacons in the chain.

Look at the column labeled OH2B, the Finland beacon. We can see that its 14 MHz signal is a visible bar of good size. However, OH2B's 21 MHz signal is almost nonexistent

as seen by the blank area. The Sri Lanka 4S7B beacon shows similar propagation conditions for these two bands.

This means that at this time, from this receiver location, frequencies around 14 MHz are the place to look for transmissions from Finland (Scandinavia) and Sri Lanka (South Asia). Conversely, right now, forget about 21 MHz for monitoring these areas of the world.

Now look under the LU4AA column. This Argentine beacon has just the opposite propagation results. LU4AA's 21 MHz signal is much stronger than its 14 MHz. Remember, propagation results will always be unique to the locations of the transmitters and receiver.

## Seeing the Difference

Over the years I've used quite a number of propagation prediction programs. The difference with BeaconSee is that it is the real thing, in real-time, not a prediction or guessimate.

Assimilating all the information on BeaconSee's spectrum screen takes a bit of finesse. There is a lot here. But after an hour or so of use you'll be surprised how much propagation information you can glean just from a quick look at BeaconSee.

BeaconSee is available for free at [www.coaa.co.uk/beaconsee.htm](http://www.coaa.co.uk/beaconsee.htm). If you register the program for US \$29, a number of added functions are enabled including sampling beacons at periodic interval to get a full 24 hours of history and unattended screen savings at user-defined times. These features will allow you to automatically build and save a history of actual propagation conditions from transmitter points around the Earth. Just sitting and watching BeaconSee is a fascinating activity.

## ❖ More Plotting

No, I'm not referring to plotting against Julius Caesar on the Ides of March. I'm talking about yet another COAA program, ShipPlotter. Made in the form of the other COAA plotter programs, ShipPlotter decodes and plots maritime AIS, automatic identification system transmissions. All it takes is the program and a radio capable of receiving 161.975 and 162.025 MHz.

## ❖ More Decoding

The DSCdecoder program decodes digital selective calling (DSC) signals used by ships in the MF, HF and VHF bands for distress, ship-to-ship and ship-to-coast station communications. It can also decode Navtex and Vessel Traffic Service (VTS) messages.

As for this article, we are out of time. But watch for coverage of COAA's ShipPlotter and DSCDecoder in future *Computers & Radio* columns.

I hope you'll now agree, the COAA site is a gold mine of unique radio programs. Try some of them and let me know what you think.

## CONTACT INFORMATION

Centro de Observação Astronômico no Algarve  
[www.coaa.co.uk/software.htm](http://www.coaa.co.uk/software.htm)  
+ 351 282 471180; [info@coaa.co.uk](mailto:info@coaa.co.uk)

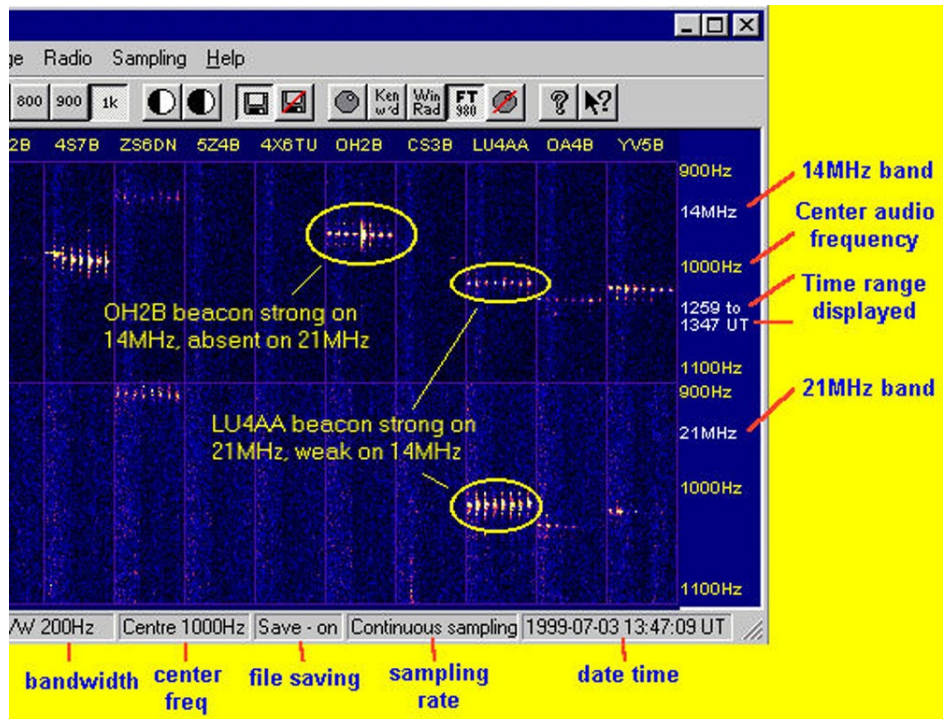

Figure 3 – Zooming in on part of a working BeaconSee spectrum screen



## ANTENNA SWITCH

### A weekend project that won't tax your budget

By Carl Herbert AA2JZ

**A**fter spending years as a radio amateur, with second hand transmitters and receivers, I finally broke down and purchased a new rig! It's an Icom IC-7000, and has more "bells and whistles" than I ever imagined.



Now that I've had operating time to become accustomed to the unit, I've found only one design item that I find slightly annoying. I say slightly, because the rig functions just as the specifications say it should, and the device I describe here is used solely to make my operating time more enjoyable.

This transceiver's coverage is from 160 meters through 440 meters. To accomplish this, the manufacturer has provided two RF output connections on the rear of the unit, one for 160 through 6 meters, and one for 2 meters and 440. This isn't a bad setup if I had only two antennas, but I have several, some for HF work and some

for VHF operation. I often experiment with antennas: some for the CW end of the band, and some for the high end where Single Side Band voice communications are. Changing the coaxial cable attached to the rear of the transceiver to select the required antenna becomes an annoying chore.

To change antennas, amateurs often use enclosed rotary switches often available at hamfests. The price of these units is approximately \$25 each, and I would need two of them. Well, price wasn't detrimental, but I wanted something that would enhance the appearance of my operating space and yet be functional.

#### ❖ For best results, homebrew!

Attached is a photo of the completed antenna switch I built to meet my needs. The enclosure is a previously used aluminum chassis, measuring 1-1/2 by 6 by 9 inches, and it needed only a new base plate that would become the face of the unit. The rotary switches came from my junk box, and are the ceramic type. The SO-239 connectors (chassis mount RF connectors) on the top and bottom of the unit are also salvage items. The two mounted on the bottom feed the selected antenna to the proper input of the transceiver.

The schematic, if you can call it one, shows the simple wiring needed to complete the project. There isn't a need for technical wiring skills here. I used RG-58 sections to wire from the switch to each SO-239. The outer sheath and ground braid were trimmed flush and were not used. The stranded inner conductor of the small coaxial cable is a flexible, insulated wire that can handle RF power up to about 100 watts without a problem.

Once you've wired the switches and

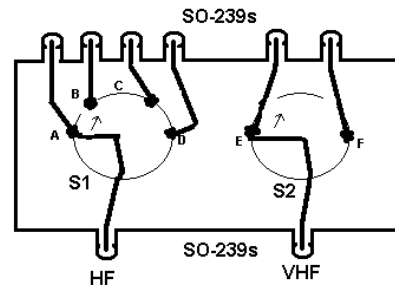

Metal chassis provides common ground for all parts

run the connection to the appropriate SO-239, you'll appreciate the flexibility of the cable and its insulating property.

#### ❖ Success

Being able to reach up and switch antennas without having to connect and reconnect coaxial cables has been a great enhancement to my operating position. It isn't the most technical of projects, but it does provide a convenient way to change antennas. I think that it looks pretty good, too, and it's painted black to match my other gear.

It's a very simple project to complete, awakens your latent building talents and it keeps your soldering iron from gathering dust in your tool box! Mine was built from junk box parts and an old chassis from a hamfest somewhere. I estimate that you should be able to build one for under \$20 or so.

Oh yes, and don't forget to label those coaxial cables coming into your shack. They all look alike after a while, and I guarantee that in a very short time, you'll question which one feeds which antenna.

Happy building, and see you on 20.

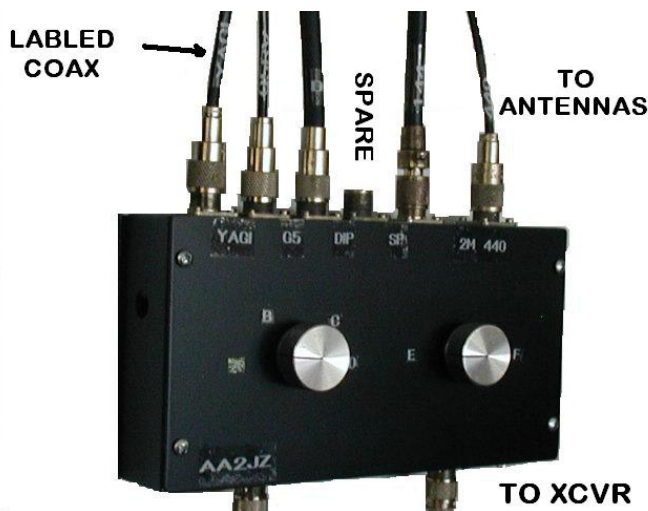

#### MT READERS ONLY

To access the restricted website for the month of March, go to [www.monitoring-times.com](http://www.monitoring-times.com), click on the key, and when prompted, enter "mreader" under the user name. Your password for March is "noaawx"—Check in each month for new material!



## Seeing More & Spending Less MaxiVista

I don't know about you, but I *never* have enough space on my computer's screen. This is especially true when running multiple applications, such as logging, receiver control, satellite tracking, "Hot-Spot" servers and digital signal decoders. It would be nice to have the ability to display a few radio applications simultaneously.

Add to this list your everyday applications; instant messaging screen and email. And finally, do you want to know the status of your eBay items? Watching the progress of the auction for that radio you have been lusting after for many years may top the list!

Just displaying the screens for two radio programs, Nova, a satellite tracking program, and TalkPCR, a receiver control and logging program, illustrates my point clearly. That is, not clearly: see what I mean in Figure 1? There is never enough room on my monitor.

### ❖ Max-Min-Max → ∞

The usual solution is to open each application on a different Window. Then using the Minimize, Reduced and Maximize icons on the top right of the screen, each application is accessed and displayed one at a time. But this leads to constant mouse/keyboard manipulations based on the application's relative importance. And of course, this is ever changing with time. Talk about a pain.

What if you had enough monitor space to leave your application screens open? Multiple monitors are one possibility. Some video cards are capable of driving two monitors. Two-monitor capability is quite common on the current batch of laptops/notebooks. Additional software is sometimes needed to move the application windows between monitors. However, in all



Figure 1 – What a mess! Trying to display screens from just two programs – Nova and TalkPCR.

of these solutions you'll need to buy another monitor.

But, if you are like me, you have one old laptop lying around your house. Yes, it's old and a bit slow. But it has a beautiful color LCD screen, runs Windows 98 or XP and you can remember (with a wince) how much you paid for this now out-dated computer. You just can't part with it, but now it has no use. Except as a target for your wife's "throw-it-out" wrath.

### If Only ...

If only we could use our old laptops as monitors. Well, with the MaxiVista program we can, and without adding costly PC cards. This program bypasses the need for video inputs or additional hardware. Instead, it utilizes the PC's ethernet network connection, USB port, or wireless LAN to send video between the primary PC and other PCs. "Other PCs" equals "that old laptop that's doing nothing in your attic." In fact, it can connect up to three PCs to act as monitors.

MaxiVista comes in three or four versions. We will use MaxVista Pro 3.0.20.0.

### ❖ What's Not In a Name

From the program's name, MaxiVista, you probably thought it was for Windows Vista operating systems. Well, that's **NOT** true. The program's instructions advise that if you are using Windows Vista, you *MUST* convert your Vista system's WDDM display drivers to XP Display Driver Model (XPDM). What does that mean?

It is again glibly stated on the MaxiVista website. This reminds me of a phrase from many of my old physics textbooks: "It is left to the reader to prove this result ..." I always read this as, "If you were smart enough you would easily see ..." Not exactly a user-friendly attitude, especially for a software application. But that's where MaxiVista drops you off.

I tried to get MaxiVista to work for a number of days using various Windows Vista computers, to no avail. Checking a number of chat sites on the subject of using MaxiVista with Windows Vista proved that I was not the only user who felt abandoned.

### ❖ Now What?

An email to the program's author brought back this message, "We are working on v4 which will provide a work around for that limitation introduced by Windows Vista..."



Figure 2 – Extended Mode - TalkPCR on the left primary monitor while the laptop (right) displays Nova.

So the bottom line is, it's best not to try using MaxiVista with Windows Vista.

Having said that, I can attest that MaxiVista works GREAT with Windows XP. So let's go from there.

### ❖ PC Requirements

The PC actually running the program applications is designated the Primary PC. In most cases, the applications that you wish to run will determine the system requirements. MaxiVista's hardware needs are modest for the Primary PC:

- Microsoft Windows 2000/2003/XP/or XP/2003 x64
- 5 MB hard-disk space
- LAN or Wireless LAN capability
- Local TCP/IP network connection
- Optional: Internet access to download future product updates

The secondary PC's requirements are even less:

- Windows 98/ME/2000/2003/XP/ or Windows XP/2003 x64
- VGA card with 16 bit color depth
- LAN or Wireless LAN capability
- Local TCP/IP network connection
- 1 MB hard-disk space

Notice that the Secondary PC requirements fit right in with our old Windows 98/XP laptops. Yes!

### ❖ A Wealth of Info

The MaxiVista website [www.maxivista.com/](http://www.maxivista.com/) contains lots of helpful information that will get you up and running within an hour or less. Watch the video on this site for an excellent introduction to all the capabilities of MaxiVista. It actually took me only 15 minutes from down-



load to operation. That is, once I moved to a primary PC using an XP operating system. My advice is to take your time, read and follow the instructions very carefully.

For my Primary PC I used a Gateway Desktop with a 2.2 GHz Dual Core Pentium CPU, 2 GB of RAM running Windows XP.

As my Secondary I used a long-in-the-tooth, 6-year old Compaq Presario 700. The processor is a 1000 MHz AMD Duron with 750Meg of RAM running Windows XP. In some of the figures, you'll notice that this laptop is missing a hinge cover, among other plastic pieces. These two PCs represent quite a spread in condition, age, technologies and capabilities.

Both PCs were connected to my wireless LAN. Other connection methods supported by MaxiVista include wired LAN and USB to USB, via a special cable.

### ❖ Installing the Software

Start by running the MaxiVista download on the Primary PC. The program will ask you how many Secondary PCs you want to install. Each installed secondary steals processor power from the Primary PC. So only install what you are going to use. We will just use one Secondary.

Now the program will create two new programs. The first is a "Server" program. This must be run and installed on the Primary PC. Next copy the other resulting program, "Viewer," to each of the Secondary PCs. A USB jump drive is perfect for this job.

Use your normal method to connect both PCs to your wireless router. If you are using a Firewall, make sure that you allow the Firewall to pass the MaxiVista application.

Once the Primary software is up and running, run the "Viewer" program on the Secondary(s). Notice that the Viewer does not require installation. This makes the Viewer program very portable and leaving no trace on the Secondary computer. You should now see a small monitor icon in the lower right task tray of each PC. If all the icons are all yellow, they are connected and ready to perform your bidding.

### ❖ Seeing is Believing

One MaxiVista monitor mode is Extended View. This mode allows the user to move displays between all connected PC screens. Start by selecting "Activate Extended Screen" from the Server Program pop-up menu on the Primary PC. All monitor icons should be glowing green.

Now an application window can be dragged from the Primary PC to the display of the Secondary PCs, in our case, our old laptop. It's very interesting to see the cursor disappear from one monitor and appear on the other, as you move the cursor across the screens.

### ❖ Radio Applications

Let's try the Extended mode with the same programs we saw on screen in Figure 1, Nova and TalkPCR. Start Nova on the Primary PC and then drag its window to the secondary PC screen.

Now open the PCRTalker application on the Primary PC. Now we have both applications that we saw in Figure 1, running clearly and simply on two screens. Pretty nifty. Windows from both applications can be seen in full views on the two monitors in Figure 2. MaxiVista makes simultaneous use of programs so much quicker and easier!

There is a noticeable lag when selecting and activating functions of the program being displayed on the Secondary display. When running programs I observed a lag of 0.25 to 1 seconds. Most were less than 0.5 seconds. Not bad at all. Running Nova and tracking and displaying 20 satellites simultaneously really taxes PC resources and makes this lag a noticeable 1 to 2 seconds – for me, still acceptable.

### ❖ A Really BIG Display

The Extended mode has another interesting use. Open an application window on the Primary screen. Then "grab" the side of the display adjacent to the Secondary display. Drag and stretch the display on to the Secondary screen. Now you have the program window really large and displayed over two screens! In Figure 3 you can see that we have done this with the Nova program. The two displays now have the world map with the tracked satellites spread over them. Move over, NASA!

I was spoiled by MaxiVista's Extended feature and didn't want to use my PC without it. MaxiVista was used to write this column. On one screen my word processor was displayed, while on the other screen I surfed the MaxiVista website running its support and help files. No more min-max-min frustration.



Figure 3 – A really BIG display. Nova's tracking map spread over two monitors.

### ❖ Mirror, Mirror

In the Mirror display mode, the Primary PC display is replicated on the Secondary screen. In Figure 4 we can see the TalkPCR program running on the Primary PC, but mirrored on the Secondary display. This mode could be very useful when making presentations to a group without crowding around the Primary PC monitor.

### ❖ Take Control

In addition to its display capabilities, MaxiVista Pro also has PC control functions. This means you can control up to three Secondary PCs via the Primary PC's keyboard and the mouse. When the Remote Control mode is

selected, the program automatically goes into the extended screen mode. The remote control mode is not available while in the mirror mode.

### ❖ Keep it in Synch

While in the Remote Control mode, the Windows clipboard text and files contents (text and files) of all PCs can be synchronized. Copying a file to any one of the MaxiVista-connected clipboards automatically transfers the file to all PC clipboards. This is a convenient and quick file sharing method.

But be careful! If the Synch mode is selected and you change one PC's clipboard it will *overwrite* the clipboard contents of *all* other PCs. Alternatively, the synch feature can be totally disabled or it can be disabled after a user-set time period. Synchronization is disabled in the Extended Screen and Mirror mode.



Figure 4 – Primary PC running TalkPCR and being mirrored on the good o'le laptop

### ❖ My Re-View

In my opinion, MaxiVista is a program that you will find very useful in your radio monitoring. But it will also be very useful in your word processing, financial, and web surfing efforts. If you are running Windows XP or 98, have one or more old laptops around the house, and a wireless or wired LAN, you should get MaxiVista!

With Windows Vista being pushed so hard by Microsoft, a new version of MaxiVista must be released with *direct\_Vista* compatibility. I will anxiously await the release of MaxiVista Version 4 with its promised Vista compatibility.

MaxiVista Mirror Pro costs 69.95 euros and is available from [www.maxivista.com/](http://www.maxivista.com/) (99.95 when discount expires). The Professional version, which omits the mirroring feature, costs 39.9 euros. For 29.95 euros, the Standard version just gives you the Extended Mode. And finally, a free trial version provides the user with a time/use-limited version.

I discovered MaxiVista while surfing flight simulator sites. Here the idea is to have the cockpit view panoramically spread over screens. Or to have the instrument panel on one screen and the Cockpit views on the others. As an ex-pilot with over 2000 hours of flight time (no longer current) I'm very anxious to try this ...as soon as I get this column completed and in to the editor at *MT!* Till next time...keep widening your Vistas.



# What's NEW

Tell them you saw it in Monitoring Times

## Klingenfuss Annual References

### Shortwave Frequency Guide

The 12<sup>th</sup> Edition of the *Klingenfuss Shortwave Guide* for 2008 has been released to the world listening hobby in the midst of this year's DX season. As with last year's volume, the latest edition combines worldwide broadcast and utility stations into one reference aid.

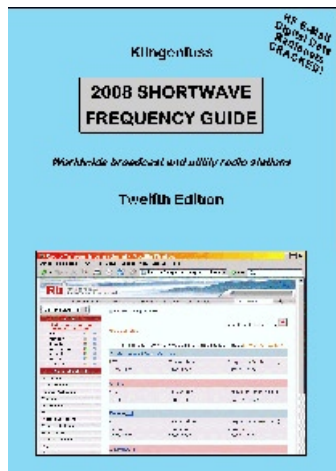

The 474 page, 12<sup>th</sup> Edition begins with *Monitoring utility stations*, an introductory how-to guide, and a by-frequency utility radio station guide arranged with call signs, station name, mode and details.

*Frequency list of broadcast radio stations* introduces the worldwide broadcast scene, DRM (Digital Radio Mondiale), and a start/end DRM schedule. Stations are listed by frequency (2310-26045 kHz), station name, country, start/end times, language, target areas and remarks.

DXers who would rather focus on a particular country will enjoy the by-country section, *Alphabetical List of Broadcast Radio Stations*, which uses the same easy to follow format.

Frequency information, as well as parallel frequencies, appears to be as accurate as possible, considering seasonal frequency adjustments. As with other hobby publications, the *Shortwave Frequency Guide* uses a respected

staff of leading radio contributors, providing the latest information on the broadcast scene.

The *Klingenfuss Shortwave Guide* remains a favorite reference aid in the Van Horn DX Cabin. The modern layout for quick information access is easy to use. Whether monitoring a utility or a broadcast station, this basic, no frills method of radio reference remains an asset to every listener.

For ordering information on the *2008 Klingenfuss Shortwave Frequency Guide* book, refer to: [www.klingenfuss.org](http://www.klingenfuss.org) or Universal Radio [www.universal-radio.com](http://www.universal-radio.com) Book # 5055, \$ 39.95 + S/H. Phone: 1-800-431-3939; FAX 1 614 866-2339. Universal Radio, Inc., 6830 Americana Parkway, Reynoldsburg, OH 43068-4113 USA.

- Review by Gayle Van Horn

### Super Frequency List on CD

This latest, global compilation of shortwave radio signals and stations contains updated records of some 8500 international broadcasters, clandestine and domestic services. Another 10,000 frequency listings of utilities, along with 20,700 formerly-active frequencies for reference, accompany this information-packed database which covers the continuous spectrum from 18 kHz through 28 MHz.

Services include broadcasting, military, government, International Red Cross, press, air to ground, Coast Guard, maritime, meteorological, embassy, and time/frequency standards.

Search parameters include frequency, call sign, identification, location, schedule, language, mode, target country, and other details as applicable. Key words can be combined for instant access to records.

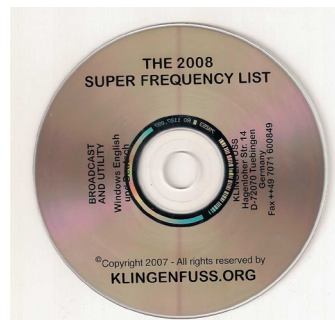

For example, entering "BC2008 bbc en 12:34" immediately uploads to your screen all BBC Worldwide frequencies that were currently on the air in English language at 1234 UTC. Similarly, "UT2008 br ssb" brings the response of all single-sideband transmissions originating in Brazil.

Using similar field entries in the OLDFREQ database, the screen will display records of former users on specific frequencies.

A sub-directory allows viewing of hundreds of recent digital-decoded screenshots for reference.

For the serious shortwave utilities hunter or broadcast listener, Klingenfuss's *Super Frequency List* on CD is the ultimate disk database.

2008 Super Frequency List on CD (BOK-26-08) is available from Grove Enterprises [www.grove-ent.com](http://www.grove-ent.com) for \$34.95 plus S/H, at 1-800-438-8155; 7540 Hwy 64 West, Brasstown, NC 28902.

- Review by Bob Grove

## World Radio TV Handbook 2008

The 62nd edition of *World Radio TV Handbook* for 2008 has recently been released to the worldwide listening audience.

This year's edition begins with *WRTH Receiver Reviews* that include semi-pro receivers from ICOM, Flex Radio, and DRM receivers.

Readers will enjoy feature articles taking a closer look at broadcasting from the *Falklands Radio* and a *Digital Update*. In recent months, Radio Voice of the People, a Zimbabwean clandestine station, has been a focus in the hobby press. This year's *WRTH* feature delves into the station's past and plans for the future.

George Jacobs focuses on *HF Broadcast Reception* and propagation conditions to expect during 2008 with *Most Suitable Frequencies* to complement your bandscanning for the year.

*National Radio* and *International Radio* provide detailed listings that include station name, personnel heads, postal addresses, and website URLs. AM/FM/SW

frequencies, power, and programming complete each country's listings. *Clandestine and Other Target Broadcasters* shows station listings for politically motivated stations from Afghanistan to Zimbabwe.

Derived from active monitoring by an international contributing staff, the *National* and *International* radio sections appear to be as accurate as possible. Information on seasonal frequency adjustments may be viewed and downloaded at [www.wrth.com](http://www.wrth.com). Posting station frequency updating information between the annual issues continues to be a successful solution for hobbyists seeking current frequencies as they become available.

The *Frequency List* contains mediumwave listings worldwide, followed by the by-frequency *Shortwave Stations of the World, Broadcasts in English, DRM International Broadcasters* and world television. An extensive *Reference* section will assist the radio listener through many hours of listening and viewing sessions.

*WRTH 2008* continues to set radio hobby standards. It remains the most respected and authoritative radio reference book in the world and should be in every hobbyist listening post. Mr. Hardyman and his dedicated staff have once again provided the radio listener with the ultimate guide.

*WRTH 2008* (BOK-03-08) is available from Grove Enterprises [www.grove-ent.com](http://www.grove-ent.com) for \$26.95 plus S/H, at 1-800-438-8155; 7540 Hwy 64 West, Brasstown, NC 28902.

- Review by Gayle Van Horn

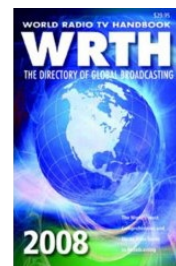

Books and equipment for announcement or review should be sent to What's New, c/o Monitoring Times, 7540 Highway 64 West, Brasstown, NC 28902. Press releases may be faxed to 828-837-2216 or emailed to Larry Van Horn, [larryvanhorn@monitoringtimes.com](mailto:larryvanhorn@monitoringtimes.com).



## Air Show Specials!

Handheld Unit	Stock No	Price
Alinco DJ-X7	SCN03	\$169.95
Alinco DJ-X10T	SCN01	\$319.95
Alinco DJ-X2000T	SCN10	\$499.95
AOR AR-8200 Mk III	SCN51	\$579.95
GRE PSR-500	SCN18	\$499.95
Icom IC R-5	SCN02	\$199.95
Icom IC R-20	SCN20	\$509.95
Uniden BCD-396T	SCN47	\$499.95

Base/Mobile Unit	Stock No.	Price
AOR AR-5000A+3B	RCV44P	\$2569.95
AOR AR-8600 Mk IIB	RCV11	\$889.95
GRE PSR-600	SCN19	\$499.95
Uniden BCT-15	SCN15	\$229.95
Uniden BCD996T	SCN48	\$499.95

Computer Receivers	Stock No.	Price
Icom PCR-1500	RCV15	\$499.95
Icom IC-R1500	RCV25	\$599.95
Icom PCR-2500	RCV35	\$729.95
Icom IC-R2500	RCV52	\$899.95
WinRadio WR-G305e	RCV63	\$619.95
WinRadio WR-G305i	RCV53	\$519.95
WinRadio WR-G305e/PD	RCV63P	\$719.95
WinRadio WR-G305i/PD	RCV53P	\$619.95
WinRadio WR-G315e	RCV64	Call for pricing
WinRadio WR-G315i	RCV54	Call for pricing
WinRadio WR-3500e	RCV49-E	\$2395.95
WinRadio WR-3500i-DSP	RCV49-I	\$2395.95
WinRadio WR-3700e	RCV50-E	\$2895.95
WinRadio WR-3700i-DSP	RCV50-I	\$2895.95

### Professional Receiver

AOR AR-Alpha Not available in a consumer version.

AOR AR-One Not available in a consumer version

Shipping/ Handling Charges	
Total Order	Shipping Charges
\$1-\$29.99	\$3.00
\$30-\$49.99	\$6.95
\$50-\$99.99	\$8.95
\$100-\$399.99	\$12.95
\$400-\$899.99	\$16.95
\$900-\$1499.99	\$20.95
\$1500-\$1999.99	\$24.95
\$2000-\$2499.99	\$28.95
\$2500+	\$32.95



Established in 1979 by well-known communications expert Bob Grove, Grove Enterprises has become a world leader in radio monitoring equipment, accessories, and publications.

If you decide you don't like a product, Grove Enterprises doesn't penalize you for it. There is NO restocking fee so long as you call our toll free number for a return authorization within fifteen days of shipment and the item is returned in new condition. Once the item is received we will give you credit toward another item or issue a full refund (less shipping charges). Software cannot be returned if opened.

That's it! No hassle! No negotiations! Just call 1-800-438-8155 and our friendly staff will assist you with a return authorization number.

**Grove means service and quality. You won't find better customer service anywhere.**

### ANTENNAS & CABLES

Grove Hidden Flex-tenna	ANT49	\$19.95
Austin Condor	ANT 14	\$29.95
Grove Scanner Beam II	ANT 18	\$64.95
Procomm CD144M/BN mag mount antenna	ANT50	\$19.95
AOR DS3000A DISCONE ANTENNA	ANT 52	\$124.95
800 MHz for handhelds	ANT 22	\$29.95
800 MHz base w/ right-angle conn.	ANT 23	\$34.95
OMNI II Scanner	ANT 5	\$29.95
Grove Flex-tenna HVU	ANT45	\$14.95
Grove Flex-tenna VU	ANT46	\$9.95
Professional Wideband Discone	ANT 9	\$94.95
Scantenna + 50' coax	ANT 7	\$49.95
Nil-jon Multiband base antenna	ANT10MBS	\$94.95
Nil-jon Mobile antenna w/ NMO mount	ANT10NMO	\$74.95
AOR DA3000 Aerial Discone	ANT 11	\$139.00
AOR MA500 Wide Range	ANT 12	\$99.00
AOR SA7000 super-wide receiving	ANT 39	\$199.95
Range Extending Mobile Mag Mount	ANT 3	\$24.95
WINRADIO AX-31B Active UHF Ant.	ANT 4	\$119.95
Grove Universal Telescoping Whip	ANT 6	\$14.95
Nil-Jon Super-M Superior Mobile Ant.	ANT 10	\$79.95
Create CLP51301N Log-Periodic Ant.	ANT 16	\$409.95
Create CLP51302N Log-Periodic An.	ANT 17	\$299.95
50' of RG-6U cable	CBL 50	\$19.95
100' of RG-6U cable	CBL 100	\$24.95

### MISCELLANEOUS ACCESSORIES

UNIDEN UA-72 DC CORD	DCC 19	\$19.95
Universal Cigarette Adaptor	DCC 3	\$12.95
Ramsey Broadband Preamp	PRE 2	\$59.95
Scantcat Gold for Windows	SFT 2W	\$99.95
Scantcat Gold for Windows SE Upgrade	SFT 2SE	\$59.95
Scantcat-Lite Plus	SFT 19	\$29.95
PAR VHF Intermod Filter 152MHz	FTR 152DS	\$69.95
PAR VHF Intermod Filter 158MHz	FTR 158DS	\$69.95
PAR VHF Intermod Filter 462MHz	FTR 462DS	\$69.95
FM Trap Filter 88-108MHz	FTR-FMDS	\$69.95
PAR NOAA Weather Filter 162 MHz	FTR 162DS	\$69.95
Yaesu SP-8 Speaker	SPK 4	\$159.95
GRE Superamplifier	PRE 1	\$59.95
VS6 Mobile Speaker	SPK 7	\$14.95
Speco DMS-3P Extension Speaker	SPK 3	\$49.95

**(800) 438-8155**  
**www.grove-ent.com**



(800) 438-8155; (828) 837-9200; fax: (828) 837-2216  
 7540 Hwy 64 W; Brasstown, NC 28902 - email: order@grove-ent.com



# AR5000A+3 Wide Coverage Desktop Communications Receiver

## Discover the Choice of Professionals



**Available in a professional and consumer version,  
the AR5000A+3 is a proven performer!**

*From aircraft and public safety, to broadcast and shortwave, no wonder so many Federal and State law enforcement, military units, surveillance agencies, government users, hospitals, RF labs, news media and monitoring professionals rely on the AR5000A+3 for accuracy, sensitivity and speed!*

*The AR5000A+3 advances the frontiers of performance with coverage from 10 KHz to 3 GHz!\**

*This professional grade receiver with tuning accuracy to 1 Hz delivers automatic electronic front end preselection and precision stability from its built-in TCXO. Other features include:*

- All analog mode reception AM, FM, USB, LSB & CW (APCO 25 accessory optional)
- Excellent strong signal handling
- Synchronous AM detector, Automatic Frequency Control & Noise Blanker
- NCO (Numeric Controlled Oscillator) with tuning stops down to 1 Hz
- Multiple I.F. bandwidths 3 KHz, 6 KHz, 15 KHz, 30 KHz, 110 KHz, & 220 KHz
- Rear panel 10.7 MHz IF output
- Auto mode bandplan selection
- Multi-function LCD with 7 character alpha-text comments
- Extensive search & scan facilities
- CyberScan® fast search & scan facilities
- Analog S-meter
- 2,000 memory channels
- 40 search banks with EEPROM storage
- Computer controllable
- Multiple antenna ports
- Auto memory store
- Extensive RS-232C command list
- Sleep timer/alarm
- Fully compatible with AOR SDU5600 Spectrum Display Unit

**Add to the capabilities of the AR5000A+3 with options:**

- The ARD25 APCO 25 conversion unit
- Collins® Mechanical Filters (500Hz, 2.5 KHz, 4KHz or 6KHz)
- TV5000A NTSC video unit for monitoring TV video
- CT5000 CTCSS decoder module
- DS5000 Analog Voice Descrambler Unit (for Government Use Only.)



**AOR U.S.A., Inc.**  
20655 S. Western Ave., Suite 112, Torrance, CA 90501, USA  
Tel: 310-787-8615 Fax: 310-787-8619  
info@aorusa.com http://www.aorusa.com

**The Serious Choice in Advanced Technology Receivers**

**The AR5000A+3 is another example of why AOR is the Authority On Radio!**

Specifications subject to change without notice or obligation.  
\*Cellular blocked. Unblocked version available for qualified users.  
Documentation required.



# Stock Exchange

**LINE ADS**

NON-COMMERCIAL SUBSCRIBER RATES: \$.25 per word. All merchandise must be personal and radio-related.  
 COMMERCIAL, NON-SUBSCRIBER, AND MULTIPLE SALES RATES: \$1.00 per word. Commercial line ads printed in bold type.

Ads for Stock Exchange must be received 45 days prior to publication date. All ads must be paid in advance to Monitoring Times.  
 Ad copy must be typed for legibility.

**1-3/4" SQUARE DISPLAY AD:**

\$50 per issue if camera-ready copy or, \$85 if copy to be typeset. Photo-reduction \$5 additional charge. For more information on commercial ads, contact Beth Leinbach, 828-389-4007.

**Subscribe to MT for as little as \$15.50 (U.S. Second Class Mail)**

7540 Hwy. 64 W.; Brasstown, NC 28902  
 1-800-438-8155 US and Can.; 828-837-9200; Fax 828- 837-2216  
 e-mail order@grove-ent.com

	6 months	One Year	Two Years	Three Years
US Rates	<input type="checkbox"/> \$15.50	<input type="checkbox"/> \$28.95	<input type="checkbox"/> \$51.95	<input type="checkbox"/> \$76.95
US 1st Class	<input type="checkbox"/> \$30.00	<input type="checkbox"/> \$57.95	<input type="checkbox"/> \$112.00	<input type="checkbox"/> \$168.00
Canada Surface*	<input type="checkbox"/> \$20.50*	<input type="checkbox"/> \$39.50*	<input type="checkbox"/> \$75.95*	<input type="checkbox"/> \$112.95*
Foreign International*	<input type="checkbox"/> \$30.75*	<input type="checkbox"/> \$58.50*	<input type="checkbox"/> \$114.95*	<input type="checkbox"/> \$171.50*
Electronic Subscription		<input type="checkbox"/> \$19.95	<input type="checkbox"/> \$38.90	<input type="checkbox"/> \$57.85

\*All payments must be in U.S. Funds drawn on a U.S. Bank!

Attention all those wanting to know what's going on with ham radio in the New Orleans area, check out: <http://groups.yahoo.com/group/GNOAmateurRadio/>

**MT BLOGS**

Blogs offer an opportunity for columnists to share information that does not make their columns. The news might be too timely for deadline, too short, confined to a small geographical area, too far away to be heard in North America, or even off the columnist's regular "beat." Bookmark these blogs for frequent visits!

MT: AMERICAN BANDSCAN  
<http://americanbandscan.blogspot.com/> - by Doug Smith

MT: EDITOR'S DESK (Corrections posted here as well as on MT website)  
<http://mt-editor.blogspot.com/> - by Rachel Baughn

MT: FED FILES  
<http://mt-fedfiles.blogspot.com/> - by Chris Parris

MT: MILCOM  
<http://mt-milcom.blogspot.com/> - by Larry Van Horn

Larry's Monitoring Post  
<http://monitor-post.blogspot.com/> - by Larry Van Horn

MT: SHORTWAVE  
<http://mt-shortwave.blogspot.com/> - by Gayle Van Horn

MT: UTILITY WORLD  
<http://mt-utility.blogspot.com/> - by Hugh Stegman

Antique Radio ..... 65  
 Antique Wireless ..... 65  
 AOR..... Cover 2, 75  
 C Crane..... 19  
 Carey, Kevin ..... 23  
 CIDX..... Cover 3  
 Communications Electronics ..... 27  
 Computer Aided Technology ..... 25  
 Cumbre DX..... Cover 3  
 Dave's Hobby Shop ..... Cover 3  
 Grove Enterprises..... 19, 69, 75  
 Hauser, Glenn..... 39  
 ICOM ..... Cover 4  
 ODXA ..... Cover 3  
 Popular Communications ..... 63  
 Robl, Ernest..... 67  
 Skyvision..... Cover 3  
 Small Planet Systems ..... 63  
 Universal Radio..... 21, Cover 3  
 WBCQ ..... 67  
 WiNRADiO..... 1

**C Ku Satellite Equipment**  
 Big Dish • FTA Dish • Parts  
 LNBs • Switches • Feeds  
 Shortwave • Ham Gear  
 CB Radios • Scanners  
 Antennas • Cables • Accessories  
 Books • Electronic Parts  
**Dave's Hobby Shop**  
 600 Main • Van Buren, AR  
 479-471-0751  
[www.daveswebshop.com](http://www.daveswebshop.com)

**Listening In**  
 That's what we do and who we are!  
 Since 1974  
 Acclaimed worldwide as one of the top publications for radio listeners. Get a free sample of our electronic monthly magazine and see for yourself.  
 E-mail us and mention this ad  
**Ontario DX Association**  
 155 Main St.N., Apt. 313  
 Newmarket, Ontario L3Y 8C2 Canada  
 E-mail: [listeningin@rogers.com](mailto:listeningin@rogers.com)  
[www.odxa.on.ca](http://www.odxa.on.ca)

**Join the Club!**  
 Open to hobbyists worldwide, the **CANADIAN INTERNATIONAL DX CLUB** is Canada's national, general coverage radio club serving members since 1962.  
 For a free sample of our monthly electronic newsletter, **Messenger**, please e-mail CIDX at:  
**[cidxclub@yahoo.com](mailto:cidxclub@yahoo.com)**  
**Web: [www.cidx.ca](http://www.cidx.ca)**

**HUGE 100 PAGE CATALOG**  
 ➤ Shortwave & Ham Gear  
 ➤ Scanners & RTTY/FAX  
 ➤ Antennas & Accessories  
 ➤ Radio Books & CDs.  
**Send \$1 to**  
**Universal Radio**  
 6830 Americana Pkwy.  
 Reynoldsburg, OH 43068  
 Tel. 800 431-3939  
[www.universal-radio.com](http://www.universal-radio.com)

**Satellite Dish Parts**  
 Residential and Commercial  
 Get it all with just one call!  
  
**Melts snow and ice!**  
 Simply attach to your existing dish—works on metal dishes up to 1.2m!  
[www.icezapper.com](http://www.icezapper.com)  
[www.skyvision.com](http://www.skyvision.com)  
**800-500-9275**

Cumbre DX is the world's best shortwave DX publication. We feature news and loggings that you just won't find elsewhere. But the best part about Cumbre DX is that it is absolutely  
**FREE!**  
 Send and email to  
**[cumbredx@yahoo.com](mailto:cumbredx@yahoo.com)**  
 or visit our  
 website at **[www.cumbredx.org](http://www.cumbredx.org)**  
 to subscribe.

# Expanding your world of possibilities!



## IC-R9500 Icom's Ultimate Wide Band Receiver

We've raised the bar with our super performance, multiple function wide band "measuring" receiver. The IC-R9500 has normal and wide spectrum scope functions. With five roofing filters before the first amp, two independent 32 bit floating point DSP processors, and 7-inch wide color TFT LCD, this is something to get excited about!

### Features:

- 0.005 - 3335.000 MHz\*
- USB, LSB, CW, FSK, FM, WFM, AM
- 1020 Alphanumeric Memories
- P25 (Option UT-122)
- Five Roofing Filters
- Dual DSP
- Digital IF Filter
- Multi-function Spectrum Scope
- 7-inch TFT LCD Display
- Noise Blanker
- Noise Reduction
- Multi-scan Functions
- Voice Synthesizer
- Digital Voice Recorder
- USB Connector
- Receive Assist Functions



### IC-R20 ADVANCED WIDE-BAND RECEIVER

0.150 - 3304.0 MHz\*  
AM, FM, WFM, SSB, CW  
1000 Memory Channels  
Dual Watch Receiver  
4 Hour Digital Recorder



### IC-R5 COMPACT WIDE-BAND RECEIVER

0.5 - 1300.0 MHz\*  
AM, FM, WFM  
1250 Memory Channels  
CTCSS/DTCS Decode  
Weather Alert



### IC-R1500 MOBILE OR PC CONTROLLED WIDE BAND RECEIVERS

0.01 - 3299.99 MHz\*  
AM, FM, WFM, USB, LSB, CW  
Fast Scan  
Optional DSP  
1000 Memory Channels  
PCR Upgradeable



### IC-R2500 MOBILE OR PC CONTROLLED WIDE BAND RECEIVERS

0.01 - 3299.99 MHz\*  
AM, FM, WFM, SSB, CW (Main)  
AM, FM and WFM (Sub)  
1000 Memory Channels  
D-STAR Compatible (Option UT-118)  
P25 (Option UT-122)



### IC-R75 WIDE-BAND RECEIVER

0.03 - 60.0 MHz\*  
Triple Conversion  
Twin Passband Tuning  
Digital Signal Processing (DSP)