

Monitoring Times

A Publication of
Grove Enterprises, Inc.

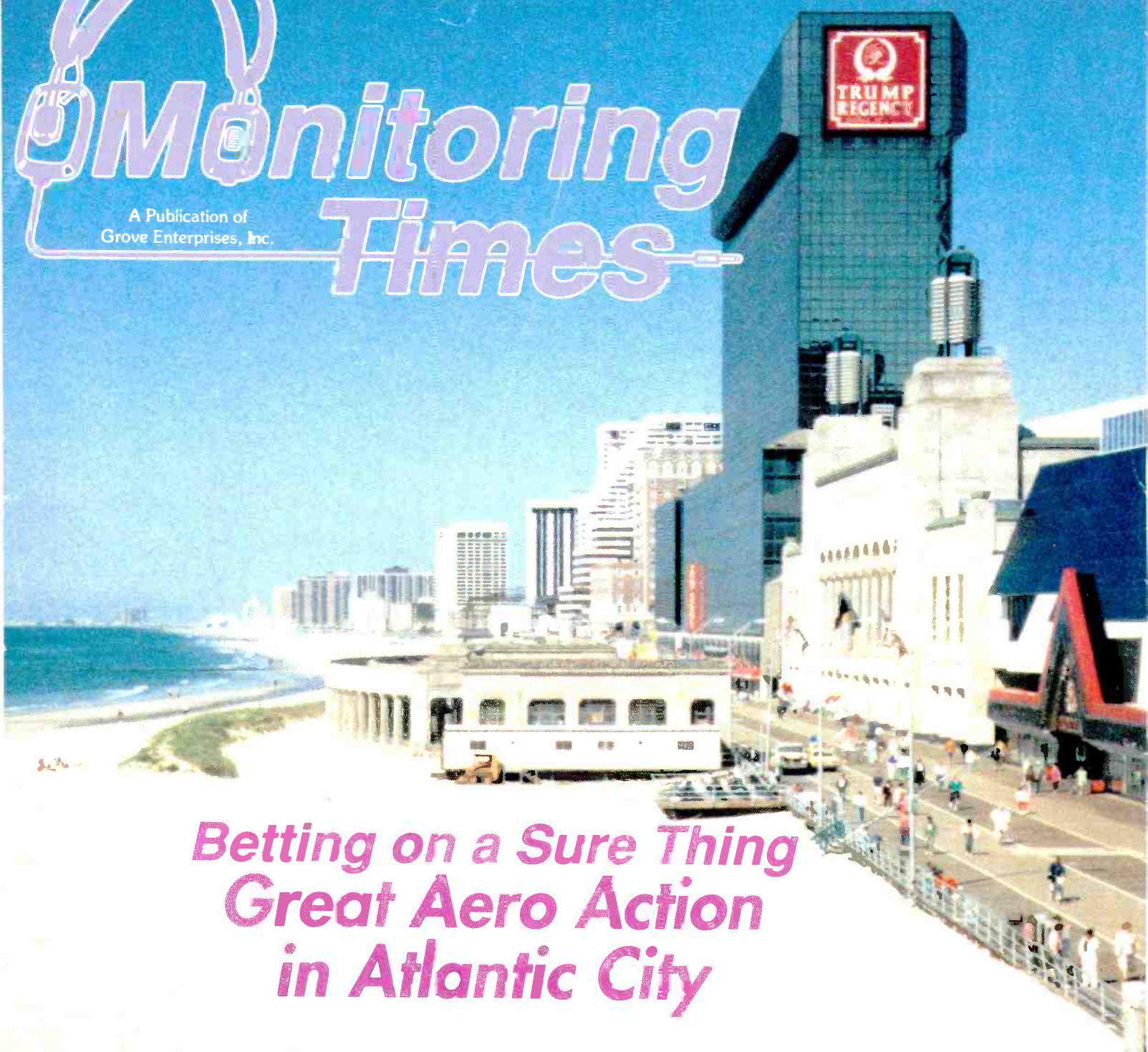

Betting on a Sure Thing Great Aero Action in Atlantic City

- *The Inside Track--Scanner/Shortwave Networking*
- *Listening in the Dark--Tips for the Visually Impaired Hobbyist*
- *See What You Can Hear with a Spectrum Display Unit*



No Matter What Scanner You Have It's Not Complete Without a DC440



With the DC440 We bring you a Complete Scanning System

Scanning the busy VHF/UHF communications bands has always been exciting. Now monitoring enthusiasts are discovering that adding a DC440 to their Scanner or Communications Receiver* adds a new dimension to listening. Virtually all commercial, industrial, business and governmental two-way radios are now using sub-audible tones or codes and being able to display them provides valuable insight into who is talking or being called. Keep tabs on individuals and monitor repeater access codes.

Computer Aided Scanning

Use the DC440 with Scan-Star™ Software to monitor 50 CTCSS Sub-Audible Tones & DCS Codes and the TouchTone™ (DTMF)

The DC440 is small in size and has an exceptional back lit 2x16 character LCD display. In addition to it's all mode decode, there are 5 other operating modes and convenient front panel controls.

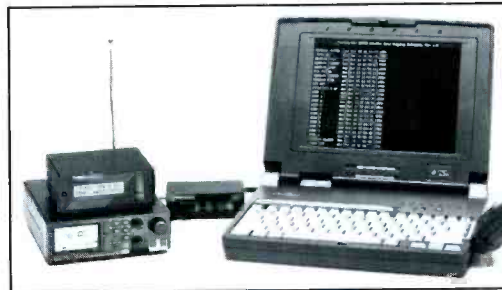

Ideal For Testing Two Way Radios can be directly connected to the Model R10 Interceptor™ for checking CTCSS, DTMS, Deviation, Signal Strength and Audio. **Update older service monitors.**

Unique features such as an actively decoding indicator, squelch connection, a serial communications interface and ToneLog™ software data logging for PC. There is a scrollable 126 character DTMF display of actual characters to prevent lost data.

For Communications Monitoring, Two Way Radio Test, Security & Surveillance, the DC440 is the Most Capable Decoder available today.

**Will likely require internal connection to scanner or receiver.*

DC440 - 3.1 Decoder	\$259.
CX12 RS-232C Interface Converter	\$ 89.
ToneLog™ Software for the PC	\$ 49.
NiCad 44 Battery Pack	\$ 39.

Order Line **1-800-327-5912**
Fax 305-771-2052

OPTOELECTRONICS

305-771-2050 • 5821 NE 14th Avenue., Ft. Lauderdale, FL 33334

5% Ship/Handling (Max \$10) U.S. & Canada. 15% outside continental U.S. Visa, Master Card, C.O.D., Cash or Money Order only
All specifications and prices are subject to change without notice or obligation.



Monitoring Times



Harry Baughn

Listening in the Dark

10

By Paul Shallbetter

If you have ever struggled to operate your radio's sleep switch or the slew controls in the dark, you may have wondered how hobbyists with visual or other handicaps have managed to become so proficient with radios. Shallbetter provides some insight into the adaptations required, both of the listener and of the equipment. Read this article to a person who thinks he can't listen in the dark, or who, like the woman in this picture, lives in a limited world.

Atlantic City Aero Monitoring

16

By Jack Sullivan

It may be the gambling capitol of the East, but Atlantic City has another attraction for aviation buffs. Civilian and military air strips alike provide continuous scanner action, and at the weapons range you can watch it as well. Bring your earplugs!

Scanner/Shortwave Networking

20

By Ed Hesse



Why do some folks always seem to know the latest hobby news, always seem to monitor the latest public safety crisis, and be right on top of frequency changes? Maybe they have an inside track by sharing information with other monitors. Maybe they have reduced the lead time and the effort of a club newsletter by forming a listeners' net. Here's how it works . . .

A Journey to Morocco

24

By Colin Miller

Shortwave broadcasting comes and goes in Morocco, but it has always been significant as an outpost from which both Europe and the African continent can be reached. If you can't visit as a tourist, travel by radio.

COVER PHOTO: Atlantic City is host to more high flyers than just those who frequent the casinos! Photo by Harry Baughn.



The Spectrum Analyzer

26

By Bob Grove

Long considered too expensive for any but the richest or most fanatic of radio hobbyists, spectrum analyzers were thought to be very peripheral to mainstream monitoring. Times have changed. This accessory is becoming a necessity rather than a luxury in monitoring today's sophisticated communications, and, thankfully, some adaptations are making it more affordable.

Radio Gambia

28

By David Gilden

If you want to listen to Gambia, you have to go there. David Gilden did, and found this small West African country to be a haven of delightful sounds, much of it played over Radio Gambia on 648 kHz.

And More ...

It's that time of year again that makes a monkey out of most monitors. I'm talking about climbing trees, clambering over the roof, scaling towers—yes, antenna season! This month several columns get into the act. The Scanning Report, Magne, DeMaw, On the Ham Bands, and Antenna Topics all give you plenty of antenna ideas to work on. Just be sure to observe all safety cautions, especially around power lines.

Below 500 kHz takes you even lower than beacons this month. But how do you get there? Some simple converters may do the trick; Carey tells you where to find them and what you can expect to hear.

Federal File provides more great examples of how a spectrum analyzer can help you track down and identify federal transmissions, even if you can't understand the scrambled communications. You don't have to find it *all* on your own, though; Fulford provides lot of great frequencies for diplomatic security, postal security, and more!

DEPARTMENTS

Letters	3	On the Ham Bands	90
Communications	6	Outer Limits	92
Utility World	32	What's New	94
The Scanning Report	36	Scanner Equipment	98
The Beginner's Corner	40	Magne Tests	100
Shortwave Broadcasting	42	Computers & Radio	102
QSL Corner	46	Demaw's Workbench	106
Shortwave Guide	47	Experimenter's Workshop	108
Propagation Charts	74	Antenna Topics	110
Radio Reflections	78	Ask Bob	112
American Bandscan	80	Club Circuit	116
Federal File	82	Special Events Calendar	117
High Seas	84	Stock Exchange	118
Satellite TV	86	Closing Comments	120
Below 500 kHz	88		

MONITORING TIMES (ISSN: 0889-5341) is published monthly by Grove Enterprises, Inc. Brasstown, North Carolina, USA.

Address: P.O. Box 98, 300 S. Highway 64 West Brasstown, NC 28902-0098

Telephone: (704) 837-9200

Fax: (704) 837-2216 (24 hours)

BBS: (704) 837-9200 (M-F 6:30 pm-8 am; 24 hours on weekends)

Subscription Rates: \$21.95 in US and \$32.00 US funds elsewhere; Label indicates last issue of subscription.

STAFF

Owners

Bob and Judy Grove

Publisher

Bob Grove, WA4PYQ

Editor

Rachel Baughn

Subscription Svcs.

Chanel Cordell

Advertising

Beth Leinbach (704) 389-4007

Editorial Assistant

Beverly Berrong

Dealerships

Kelly Davis

Editorial Staff

Frequency Manager	Gayle Van Horn
Frequency Monitors	B.W. Battin
	David Datko
Program Manager	Jim Frimmel
Beginner's Corner	T.J. Arey, WB2GHA
Plane Talk	Jean Baker, KIN9DD
Computers and Radio	John Catalano
Below 500 kHz	Kevin Carey, WB2QMY
Experimenter's Wkshp	Bill Cheek
DeMaw's Workbench	Doug DeMaw, W1FB
American Bandscan	Joe Eisenberg, WA0WRI
Federal File	John Fulford, WA4VPY
Digital Digest	Bob Evans
Ham DX Tips	Rob Gerardi, N9LAG
SW Broadcasting	Glenn Hauser
High Seas	James R. Hay
Scanning Report	Bob Kay
On the Ham Bands	Ike Kerschner, N3IK
Propagation	Jacques d'Avignon
Magne Tests	Lawrence Magne
Communications	Larry Miller
What's New?	Larry Miller
Satellite TV	Ken Reitz, KC4GQA
Antenna Topics	W. Clem Small, KR6A
SW Broadcast Logs	Gayle Van Horn
QSL Corner	Gayle Van Horn
Utility World	Larry Van Horn, N5FPW
Outer Limits	George Zeller

Correspondence to columnists should be mailed c/o Monitoring Times. Any request for a personal reply should be accompanied by an SASE.

Copyright © 1994.

Short excerpts may be reprinted with appropriate credit. Complete articles may not be reproduced without permission.

Second class postage paid at Brasstown, NC, and additional mailing offices.

POSTMASTER:

Send address changes to Monitoring Times, P.O. Box 98, Brasstown, NC 28902-0098.

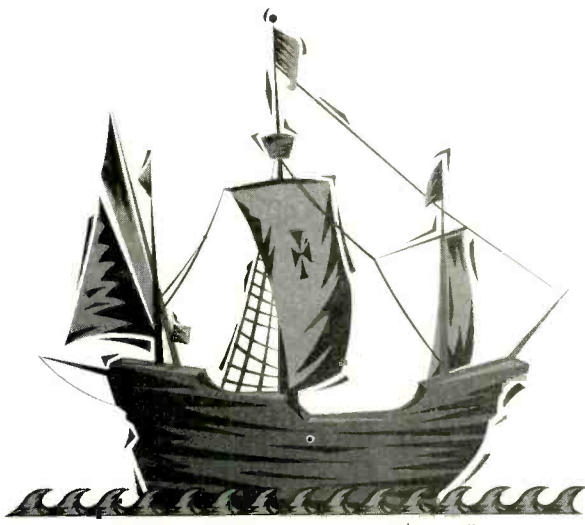

"THE WORLD IS FLAT"

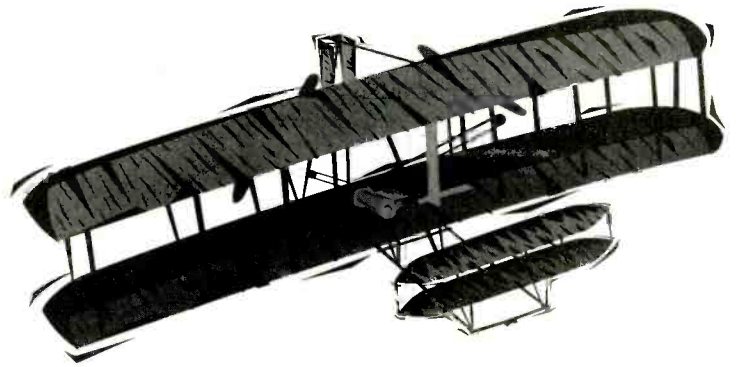

"THAT THING WILL NEVER FLY"



"THAT ANTENNA IS TOO SMALL TO WORK"

There's one in every crowd—one that pushes the limits and proves the skeptics wrong. The world sailed into a new era of discovery with Columbus. The Wright brothers propelled us into the age of air travel. AEA advances into the ranks of these distinguished pioneers with the IsoLoop 10-30 HF antenna—a 35" loop antenna with low-angle performance that is better than many full-size HF antennas.

One IsoLoop 10-30 HF pioneer offers this: "Big-gun DXers will tell you nothing *that* small can work. They will continue to tell you this after you work a couple hundred countries with it. Ignore them. In 24 months, I have worked 213 countries and confirmed 198."

The reason you get such a big performance in a small package is the efficiency of the IsoLoop 10-30 HF; it's 72% on 20m, rising to 96% on 10m. The main loop serves as an inductor, tuned with a 10,000 volt variable capacitor. Frequency range is 10 MHz to 30 MHz with continuous coverage. The unique

compact design is also ideal if you're facing space limitations—mount it in your attic, on a balcony, or go mobile.

With the optional IT-1 Automatic Antenna Tuner (below), tuning your IsoLoop 10-30 HF becomes an adventure in speed—2 or 3 seconds is typically all the time it takes before you're tuned and ready to go. (Antenna comes standard with a manual tuner.)

Discover the world of big antenna performance in a small antenna. Call our literature request line at (800) 432-8873 and request the "Inside Story" on the IsoLoop 10-30 HF or call us direct at (206) 774-5554. For best pricing,

see your favorite amateur radio equipment dealer.



Connect with us

LETTERS



Nimbus Springs to Life

The satellite, Nimbus 4 (Cat #4362) that was the topic of an article last month by Theo Pappan, is now in an orbital position which provides more solar power to its cells. Says Dr. Pappan, "It is simple to find by listening about 1-1/2 hours before and after local noon, wherever you are. Readers might be interested in hearing this seasonal phenomena. Of course, there are many such old satellites and several are becoming more active. This is a good time to listen for them. The hard to find TLEs (orbital elements) can be found on our CNESS (Center for Near Earth Satellite Studies) computer BBS at 517-743-5077 (2400-14, 400bps)."

Ham Radio & More

"America's only ham radio show on the broadcast bands" featured Bob Grove WA4PYQ, publisher of *Monitoring Times*, in an interview on April 10. Even if you didn't catch it, co-hosts Len Winkler and John Moore have more good programs planned for Sunday nights at 6pm. May 8th will feature an interview with Gary Hembree, N7IR, who has confirmed over 250 countries using low power operation, and May 15th includes a visit with Dick Daniels, W4PUJ, Project Manager of the Phase 3D satellite for AMSAT.

Ham Radio & More is available on satellite, Spacenet 3, transponder 9, 6.8 audio, or call the originating station, KFNN at 602-241-1510 for a broadcast station near you that airs the program.

Reader Response

Magne Tests (Feb. 94)

Jeff Lund of Forest Lake, MN, writes, "The section of the review titled 'Possible microprocessor hangup' caught my eye. I had purchased a Sangean model ATS 818 short-wave receiver and it has bombed out three times with similar symptoms as described in the article [about the Realistic® DX-375]."

"After the first episode of sudden death syndrome "SRDS," I stormed back to the dealer. Fortunately for me they had a sharp technician on duty that prescribed the same cure used to revive the Realistic® back to health.

"I'm not certain what event(s) led up to the first failure, but I do know that the second and third attacks of SRDS occurred following my

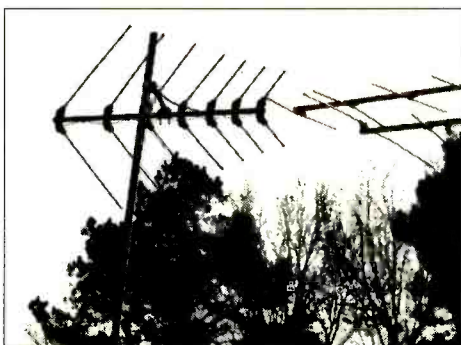

David Montgomery, KA5SKU, says, "I have used this Scanner Beam to listen to many Space Shuttles from STS-9 in 1983 until now. Have also copied MIR on FM voice and packet radio. It is used daily on 146.071.67 two-meter repeater in Little Rock, AR, with an ICOM IC-22U."

disconnecting then reconnecting an external antenna between listening sessions. Perhaps I inadvertently zapped the radio with static electricity, too."

For those who may not have the February issue, Magne's "cure" was to remove the batteries for a couple of days, then reinsert.

Bob Fraser of Cohasset, MA, says microprocessor lockup caused by static electricity isn't limited to the DX-375. "I have heard that it may also happen to the most expensive receivers. Years ago, I was warned not to shuffle my feet on a rug, then touch the antenna of my Barlow Wadley XCR-30, else the static electricity would blow a transistor.

"My Sony ICF-2003 manual states that static electricity will cause a strange readout on the LCD screens. It says this is harmless and just to remove the batteries for a while to correct it (to bleed off the static charge)."

Radiobrás (March 1994)

Bob Fraser also shares a bit of trivia regarding Radio Brazil's logo: "When Radiobrás first came on in English to North America, I quickly earned one of their QSL cards. It pictured a green parrot smoking a cigar. It was quite familiar, so I wrote back and asked if the design had been copied from the Walt Disney character Jose Carioca, a green, cigar-smoking parrot depicting Brazil in the 1943 movie, *Three Caballeros*. (Donald Duck, by the way, was the American tourist, while a rooster depicted Mexico.) Radiobrás replied that, yes, that is where they got the idea for their design."

Bob recalls that there were two or three movies around the same time that featured Latin America, and reminds us that their purpose was not only to entertain, but also to "bring about friendly relations with South America to prevent them from helping the Axis." They were enjoyable, nonetheless.

See the "Shortwave Broadcasting" column for a correction to Radiobrás' address and broadcast schedule.

Monitoring the Space Shuttle (March)

George Speck of Ft. Worth, TX, checks in with some information gleaned from an excellent edition



of *Shortwave Magazine* (November 93), the British shortwave magazine often found on US newsstands. Here is part of the info George culled for us: "You can get info on the date of the next space launch by calling 407-867-4636. You can also write for a Space Shuttle launch pass (good for your collection, whether you use it or not). When they send you the pass, you also get a NASA fact sheet and guest info. The address is: Kennedy Space Center, Public Relations Dept., Kennedy Space Center, FL 32899.

"A souvenir merchandise catalog is available by calling 1-800-621-9826, or write: TW Recreational Services, Inc, Space Sport USA, Mail Code TWRS, Kennedy Space Center, FL 32899. A good book to read is *Shuttle 3*. The book was 'written on location at Cape Canaveral by Nigel Macknight.' The cost is \$9.95, and I highly recommend it."

Donald Kidder of Ashland, ME, feels the same way about shuttle flights. "In recent years whenever another space shuttle mission is launched, people yawn and shrug their shoulders, 'Oh, another one of those space flights?' Maybe their lack of enthusiasm stems from the fact that since the first shuttle in 1981 there have been over 50 space shuttle launches. Maybe support for NASA is low due to past disasters and cost overruns, or perhaps it's the political debate over whether we should be sharing such technological info.

"From a monitoring point of view, listening in on the lift-off of the Discovery mission on Feb. 3rd was exciting [the first mission to include a Russian cosmonaut on the team]. Listening to those transmissions brought back memories of the televised 'moon-walk' when I was a kid, or the time when I was living in Florida, back around 1973, and witnessed the first nighttime launching of a manned space

Continued on page 114

5th Anniversary

1994 MONITORING TIMES CONVENTION

October 21, 22, 23, 1994

Airport Hilton
Atlanta, Georgia

REGISTER NOW!

**OVER \$8000
IN ICOM
PRODUCTS TO BE
GIVEN AWAY!**

Must be convention registrant
in attendance to be eligible.

Enjoy accommodations at the *Atlanta Airport Hilton* and receive the special nightly rate of only \$71 (save 50% off the regular \$140 per night rate!) which includes the following:

- Same rate single or double!
- Free parking!
- Complimentary airport shuttle!
- Baggage check-out for Delta!

Call the Hilton TODAY
at 1-800-HILTONS
to make your room reservation—
SPACE IS LIMITED!
Be sure to mention *Monitoring Times*
when making your reservation to receive
the special room rate. Reservations must
be made by September 21, 1994!

This three day weekend is full of activities for the radio enthusiast—for only \$50 registration:

- **Dozens of exhibitors** with the latest equipment and accessories for radio monitoring, including: Christian Science Monitor, Grove Enterprises, ICOM America, Optoelectronics, Sony, and many more!
- Join your fellow monitors at a **professional listening post** featuring the Grove SDU-100 Spectrum Display Unit as well as other products designed to enhance your radio monitoring.
- A **two hour international broadcasters forum** starts off the weekend Friday evening and is hosted by moderator Ian McFarland.
- Attend any of **over 20 seminars** covering such topics as the future of shortwave broadcasting, choosing a scanner or shortwave radio, LOWFER monitoring, digital communications, spy numbers stations, surveillance, clandestine and pirate broadcasting, antenna theory, military and aero monitoring, and much more!
- Saturday evening's banquet will feature **guest speaker international broadcaster Ian McFarland**.
- Get your scanner charged and ready for the **"Bug Hunt"**—a highlight at each convention!
- Visit **Delta Airline's Communication Center** and **Delta's Maintenance and Flight Operations Division**. Tours will be conducted on Friday.

SCHEDULE

Friday, October 21

- 11:00 am to 5:00 pm
Registration Open
- 12:00 to 5:00 pm
Exhibits and Listening Post
- Open
- 7:00 to 9:15 pm
"International Broadcasters Forum"

Saturday, October 22

- 8:00am to 3:00 pm
Registration Open
- 9:00 am to 12:30 pm
Exhibits Open and
Morning Seminars
- 12:30 to 3:00 pm
Exhibits Open/Lunch Break

Saturday cont'd

- 3:00 pm
Exhibits Close
- 3:00 to 5:15 pm
Afternoon Seminars
- 7:00 to 9:00 pm
Banquet—Served at table
- 9:30 pm
Transmitter Bug Hunt

Sunday, October 23

- 9:00 am to 12:30 pm
Morning Seminars

MT

PRE-REGISTRATION FORM

MT

Deadline 9-21-94

Enclosed is my \$50 registration fee!

Enclosed is my \$21.95 banquet fee!

Name: _____

Address: _____

City: _____ State: _____ Zip: _____ Phone #: _____

Method of Payment: Check/MO Visa/Mastercard/Discover Card

Card # _____

Exp Date: _____

Signature: _____

MONITORING TIMES CONVENTION

P.O. Box 98
Brasstown, NC 28902
1-800-438-8155



Cops Can't Eavesdrop

Plantation, Florida, police detectives Mike Kago and Patrick McGowan were listening to random cordless

phone calls on their scanner when they heard snippets of something that sounded like a drug deal in progress. A woman named Joyce was telling an unidentified man that the supplier "just has powder, no rocks."

After determining what apartment the call was coming from, they staked it out. After monitoring the home of Joyce and Edgardo Mozo for two more days, the two detectives got a search warrant and raided the home. The Mozos were arrested after cocaine, marijuana and drug paraphenalia were confiscated.

At the trial, defense lawyers argued that the evidence should be thrown out because the police violated the Mozos' constitutional privacy rights by listening to a phone call made in the privacy of their own home. Prosecutors in Broward County argued that state privacy laws specifically exempt cordless phones because they transmit over radio waves and therefore have no reasonable expectation of privacy. Circuit Judge Robert Tyson agreed with the state saying that the Mozos should have known that cordless phones can be picked up by practically anyone, making them anything but private.

The Mozos pleaded no contest to possession of cocaine and marijuana and were sentenced to three years probation. Then they appealed. Last month the Florida Fourth District Court of Appeal agreed that cordless phone calls were specifically excluded from the state's privacy and wiretap laws because they were so easy to monitor. But, under the state Constitution, any conversations made within one's home are considered private—even though they were using a cordless phone which is not private.

The end result: Police in Florida cannot randomly intercept cordless phone calls made at home even though the purpose is to curb crime. Such methods, wrote the court, are "the hallmark of a totalitarian society. It is the very antithesis of a free society."

Government Punishes Radio

On 20 February, 1994, "security forces" were dispatched by the government of Gabon

to the radio station in Libreville. Arriving at dawn, the troops systematically destroyed the station's equipment, sparking a wave of violence that ended when an official of the opposition party was burned to death in his home.

Government officials justified the destruction of the station as a "punitive measure." Radio Liberte, they said, had broadcast editorial policy that the government found offensive and that, said Idriss Ngari, chief of the general crisis staff, brought about the military operation against the radio station.

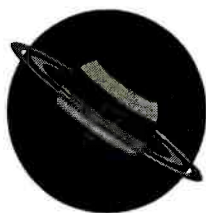

A Ring Around the Earth

Will the Earth someday look like Saturn from the vantage point of Outer Space? Motorola's Iridium satellite telephone project,

which makes use of 66 satellites, pales in comparison to the most recently announced system, which utilizes a staggering 840 satellites!

Edmund L. Andrews, in a report to the *New York Times*, says, "the project ... might be dismissed as an idle fantasy were it not for the two people behind it." Those two people are Craig McCaw, who founded McCaw Cellular Communications, and William Gates, chairman of Microsoft Corporation.

These entrepreneurs have collaborated to form the Teledesic Corporation with the intent of creating a satellite system whose services and quality will rival that of fiber optic lines, but on a worldwide scale. Their obstacles will also be on a world-wide scale: international coordination of frequencies will require the involvement of the International Telecommunications Union, and they will have to obtain permission from every country in the world to beam signals in and out of their borders.

The system would be of greatest benefit to those areas of the world that can least support it financially—third world and rural districts not served by other means. The system plans to utilize frequencies in the 28 gigahertz range, recently opened up by the FCC for wireless video transmissions. It remains to be seen whether the surprising new proposal gets the green light from the FCC, however.

Independent Hawaii Station Signs On

Federal Communication Commission officials paid a visit to KNAC in Naalehu, Hawaii. The 10-watt station broadcasts a pro-sovereignty message over a four mile radius. The problem is

that it has no license. No matter, says station operator George Gali; the FCC "said they just came to look [and] then they went on their way. They didn't say to shut down or anything."

That wasn't the message that the government wanted to get across, of course. Says FCC spokesman Jack Shedletsky, "At this point we're figuring out what our next step would be."

KNAC, which operates with donated equipment and a volunteer staff, says they're standing firm. "If the FCC can prove that they own the air that I breathe, then OK, [I'll sign off]," says Gali. Meanwhile, Gali and crew continue their mix of contemporary music and political programming.

New Towers for Iraq

Officials with the Iraqi military industry commission, charged with repairing the country's damaged infrastructure, have announced the construction of a new 203-meter high communications tower in central Baghdad. At an official dedication ceremony, the tower was christened the... Saddam Hussein Tower (round of warm applause).

The commission also announced the completion of the 350-meter high Saddam Hussein tower in Mosul (polite applause) and 550-meter high Saddam Hussein tower in Um Qasr (applause).

Hussein's interest in improving government broadcast facilities may well be related to the appearance of three opposition radio stations now sharing a transmitter on 1530 kHz.

Cell Phone Rescues Crippled Plane

An unidentified commercial pilot, writing in *Callback*, NASA's Aviation Reporting System, says that he used a passenger's cellular telephone to guide the plane to safety when the plane's radios went out. "All the radios were dead. I was making transmissions in the blind and reporting our intentions. Meanwhile, I decided to fly a wide pattern to insure we cleared all traffic.

"I asked the flight attendant to inquire if any passenger had a cellular phone and she brought one to the cockpit. I had the phone number for the tower and was able to [call on the phone and] get clearance to cross the intersecting runway and taxi to parking without further incident. I returned the phone to the passenger with my gratitude."

COMMUNICATIONS



The Beeb vs. CNN

The BBC is launching a 24-hour news and information cable TV service in America. The channel, which *The Times* of London says will "rival" Ted Turner's all-powerful Cable News Network, is part of the Beeb's ambitious expansion plan. The new station will reportedly hit the airwaves by early 1995 at the latest. It will broadcast a mix of news and current affairs programs as well as light factual shows such as *The Clothes Show* and *Film 94*.

The BBC, says Bob Phillis, BBC deputy director general, "should...become a major world player in the new international multimedia markets." The station will reportedly be funded by the BBC's own commercial activities.

Saving Lives Not a Priority

Richard Wright, for all intents and appearances, seems to be a member of that increasingly rare breed—the all-American young man. An Explorer Scout with a penchant for public safety, he's made a name for himself locally in Orange County, CA, with documented cases of personal bravery, one time entering a burning building to search for occupants. Recently, Wright, using his CB radio, helped save six people aboard a boat stranded off Dana Point.

Through questions and communication relays, he guided a Coast Guard helicopter and an Orange County sheriff's patrol boat to the stricken vessel five miles offshore. Wright's good deed had a very short afterglow.

"The president of the [homeowner's] association called our manager and he notified my mom that they want to fine me \$150 for using my CB radio inside the association grounds," said the 20-year old Wright.

Sure enough, Ron Meixell, president of the 124-member Moulton Parkway Assn. No. 1, confirmed that the association's board would be deciding at its next meeting whether to fine Wright. According to Meixell, the youth promised months ago to stop using his CB radio after several condo owners complained that it interfered with their cordless telephones and televisions.

"I think he and his mother are simply using this rescue thing to help them out," Meixell said. The Coast Guard, however, is on Wright's side, saying in a letter to the association that it is "ludicrous to fine the boy for saving lives."

According to Coast Guard Petty Officer Randolph Reid, "It could have ended up in serious injury or loss of life to the boater and his family."

Scanner Listeners + Police = Success

Scott Township, Pennsylvania, police chief Doyle Winn is crediting scanner listeners with helping police nab a 16-year-old fugitive. According to police, the juvenile eluded police in a successful game of cat-and-mouse for most of the day. During that time, alert citizens with scanners kept track of the action and called police with tips that kept them close on his tail.

The boy, who was identified as a youth that had escaped from a Carbon county juvenile detention center, became the subject of the search after being stopped for driving a stolen car. After ramming several patrol cars, he fled on foot, attracting the attention of seven different police departments who cooperated in the search.

Still, it was the scanner listeners who did the job. "If it hadn't been for the people listening on their scanners, we wouldn't have gotten him," said Chief Winn.

League Tops 170,000 Members

The American Radio Relay League has announced that last year's membership was the highest ever, topping out at more than 170,000. The record high reflects all categories of membership.

According to Steve Mansfield, Manager of Legislative Affairs and Public Information at ARRL, figures show that 24.5% of the membership holds Extra class licenses, 28% hold Advanced, 19% hold general, 25.5% hold either Technician or Technician-plus licenses. Only 3% are Novices.

The new total also includes approximately 3,000 former Canadian Radio Relay League members who have been converted over to ARRL membership. **MT**

"Communications" is edited by Larry Miller with contributions of the following fine people: Brian Cathcart, West Palm Beach, FL; M.L. Cauthon, Bremerton, WA; Rich Helmick, Los Angeles, CA; Steve Marshall; Ricardo Molinar, Fort Lee, NJ; Bruce Ripeteau, Columbia, SC; Kannon Shanmugam, Oxford, England; Robert Thomas, Bridgeport, CT; Jerry Witham, Keaau, HI; Ken Wuschke, Vancouver, BC; *BBC Summary of World Broadcasts*; *National Scanning*.

1-800-666-0908

New Equipment Orders & Prices Only, Please

Shortwave Radios

Sony® • All Popular Models Including The ICF2010, SW55, And The New SW77 • Philips DC777 AM/FM/CASS/Shortwave Car Radio • Sangean • ICOM • JRC • Panasonic • Yaesu, **New FRG-100** • And the Superb

Drake R8

Yacht Boy 400



Call For Special Pricing

Grundig Satellit 700

Scanning Radios

Featuring AOR Models AR1000XL and AR1500 • AR3000A • ICOM R1, R100, and R7100 • Uniden Bearcat - All Models

Amateur Radio Equipment

Factory Authorized Dealer For:

ALINCO **STANDARD** **KENWOOD**

COMET **YAESU** **NO**

DIAMOND **ANTENNA**

ICOM

cashcraft

Accessories, etc.

• Call For Our Low Discount Prices •

For info and tech help call (203) 666-6227

Out-of-State Sales Call 1-800-666-0908

Conn. Sales Call (203) 667-9479



LENTINI

COMMUNICATIONS, INC.

21 Garfield St. Newington, CT 06111

C.O.D.'S OK - SAME DAY SHIPPING

America's #1 Scanning Magazine is

NATIONAL SCANNING REPORT



But don't take our word for it. Check it out yourself. \$3.00 cash will get you a sample copy rushed to you by First Class Mail.

Or subscribe for just \$17.50 and you'll get a free custom frequency print-out for your country. **1 800-423-1331**

P.O. Box 360, Wagontown, PA 19376

Interested in writing?

Send a self-addressed, stamped envelope for your copy of the **MT Writer's Guidelines** to:



WRITER'S GUIDELINES

c/o Monitoring Times

P.O. Box 98

Brasstown, NC 28902

OPTOELECTRONICS

Setting New Standards

IN THE WORLD OF

Communications, Test & Surveillance

Further • Better • Faster



Model 3000A \$329.

- World's most highly advanced hand held counter.
- Digital Filter: Reduces false counts - no loss of sensitivity
 - Digital Auto Capture - auto hold & store; works even near strong RF Fields
 - Stores and recalls frequencies
 - 5-6 hour battery operation
 - Fast - 250 million counts per second for high resolution - 250 MHz direct count
 - 10 Hz to 3 GHz
 - Ultra sensitive bargraph w/ 16 segment display
 - Multi-Function Counter with Frequency, Period, Ratio and Time Interval
 - Optional $\pm .2$ PPM TCXO- \$100.

Model M1 \$229.

- Full Range Pocket Sized Counter
- Digital Filter
 - Digital Auto Capture - Auto Hold
 - Stores & Recalls Frequencies
 - 4-5 hr. battery operation
 - 10 Hz to 2.8 GHz
 - 10 digit LCD with EL backlight

Model 8040 \$679.

- Multi-Function Bench/Portable Counter Measures Frequency Period, Ratio, Time Interval and Average.
- Digital Filtering to eliminate false counts
 - Auto Capture/Auto Hold
 - 16 Segment Signal Strength Bargraph
 - Dual 50 Ohm and 1 Meg Ohm input amplifiers with AC/DC Coupling, \pm Polarity, Triggers Level Adj., Low Pass Filter and Attenuator
 - .05PPM, 0-50°C Oversized Time Base Option
 - Internal/External Clock Input
 - RS-232 Serial Computer Interface

800 • 327 • 5912

(305) 771-2050 • FAX (305) 771-2052 • 5821 NE 14th Ave, Ft. Lauderdale FL 33334



Model DC440 Decoder \$259.

- 50 Sub-Audible (CTCSS) tones
- 106 Digital (DCS) Codes
- 16 Touch Tone (DTMF) characters/126 character recall
- Serial Data Interface
- Update older service monitors
- Ideal for testing two way radios
- Tone log software available
- Exceptional 2x16 character backlit display
- Small size - 1.8" x 4.5" x 4" deep



Model 3300 MiniCounter \$129.

- Super Compact
- 10 digit LCD - longer battery life
- 1 MHz to 250 MHz direct count for high resolution (1 Hz/Second)
- Maximized Sensitivity
- Hold Switch to lock display
- Ni-Cad plugs into board - no soldering to change outpack

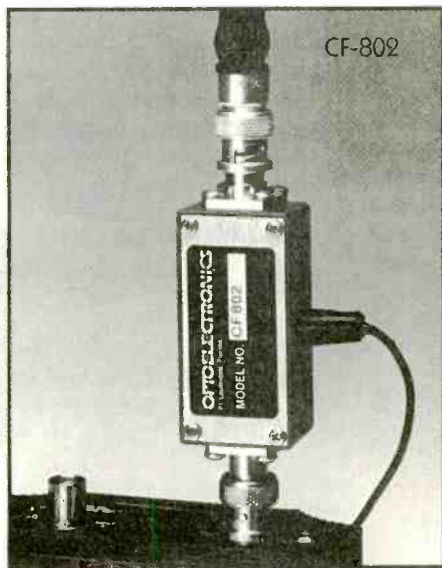

Model CF-802 \$149.

835 MHz ± 10 MHz filter/amplifier. 10 times the pick-up distance when used with our counters or R-10.

Model R-10 \$359.

The R-10 is a unique FM Communication Test Receiver with security and surveillance applications. 30 MHz to 2 GHz. Measures deviation and relative signal strength. Demodulates FM

Model APS104 \$995.

Tunable band pass filter covers 10 MHz to 1,000 MHz. Tunes continuously over more than 5 octaves. Increase pickup distance 10 times. Ultimate Security Sweeper.



5% Ship/Handling (Max \$10) U.S. & Canada. 15% outside continental U.S. Visa Master Card, C.O.D., Cash or Money Orders only. All specifications and prices are subject to change without notice or obligation.

MADE IN THE U.S.A

OPTOELECTRONICS

Listening in the Dark

Adapting Communications Monitoring Gear for Use by the Blind and Visually-Impaired

By Paul Shallbetter

You, like I, may find this article a fascinating glimpse into the amazing adjustments and adaptations of which the human spirit is capable when challenged. This feature was written to be shared. Please put this story to good use: read it to a blind friend; leave a photocopy at the nursing home, the local hospital or vocational rehabilitation center; share it with your radio club; distribute the list of resources found on page 14. The main handicap some people have is simply a lack of information.

Rachel Baughn, Editor

I am often asked by friends and associates how I am able to use the variety of receivers and transceivers in my "shack." Even though the questions now seem a little silly, in retrospect it has taken me time, creativity and some expense to make my setup "blind-friendly." And I'm still working at making things even more usable.

In this article we'll look at the currently available technology, most of it computer-based, which allows blind and visually-impaired persons to enjoy the monitoring hobby. We'll also talk about some common-sense strategies for modifying the radio to the listener...and vice-versa.

To my sighted friends, operating a complex panel of controls without being able to read them

is mystifying and a bit miraculous. There is nothing miraculous about it; operating communications gear without the use of eyesight can be as simple as finding the light switch in your own bathroom in the middle of the night...difficult at first, but automatic once you've learned the location of the switch!

My current setup includes an ICOM IC-751A HF transceiver, a Pro-2006 scanner, a Realistic® HTX-202 handheld 2-meter rig and a Sangean ATS-803A AM-FM-SW portable. Each radio has a unique control panel layout; each functions a bit differently from the others. No problem! Well, these days it's no problem... I had to adapt myself to using each radio.

Adapt myself? Yes. (And you thought this was going to be an article about high-tech toys

and equipment modifications.) In fact, there are many such goodies available, thanks for the most part to advances in computers and software. We'll get to the high tech stuff in just a minute.

Look, Learn and Listen

Before you start shopping for the latest speech output technology, before you get out the Braille stylus and the Dymo tape, before you do *anything*, take a moment to assess what you know about your gear.

Most sighted people don't think twice about where the key for the ignition goes, where the keys on the remote control for the TV are located, or where the light switches are found in their homes. With practice and learning, they eventually know by rote where every device and mechanism they use is located. They learn how to turn on the coffee pot and enter telephone numbers without looking.

Blind and visually-impaired people can and do learn things in much the same way. Once oriented, a visually-impaired person has no more difficulty using a telephone than anyone else.

The point is this: Before sweating the adaptation and modification of your monitoring setup, figure out what you already know. Then determine what you want to do with your gear. It sounds simple...and it is. If you already know how to do what you want to do with your radio, go out and take a walk in the park, or something. You no longer need to read this article; you're excused.

If simply memorizing your most-often used dials and buttons isn't enough, then labelling and/or diagraming might be the next step. Blind and visually-impaired people use large print, Braille or any other mode of printing that suits each individual's needs.

Braille: In Touch with Monitoring?

I am often asked why more radio manufacturers don't mold Braille characters into the control panels of their products. It seems that it would be relatively inexpensive to Braille radio controls; certainly the Braille would not be a distraction to the sighted user, and everyone would benefit. Unfortunately the Braille route is bumpy....

Braille is a writing system which uses combinations of raised dots, two vertical columns of three dots each (a "cell") to represent different letters, combinations of letters, words and punctuation marks. Braille cells are produced in only two uniform sizes, and the larger of the two is used principally by people with tactual difficulties (i.e. diabetics who have lost sensation in their fingertips). Unfortunately, even the smaller of the two standard Braille sizes is too large to fit on the keys of say, a Pro-2006.

Surprisingly, the majority of blind persons in this country are Braille-illiterate, relying instead on "talking books," speech synthesizers and other technological aids. It's not a question of economy; it would be relatively inexpensive to re-tool for Braille marking. However, in terms of space and accessibility, it's not practical. This leaves the task of adaptation to the user rather than the manufacturer.

What I have done with my Realistic® Pro-2006 is to create a Braille "matrix" diagram using a raised-line drawing kit and a Braille slate-and-stylus. Making the matrix was easy since each button has only one function. I also made the same diagram in large print using my computer; I then taped the two back-to-back; my wife uses the Braille side, and I use the other.

Those hobbyists who use larger rigs may be able to label certain controls with Braille Dymo tape or even clear Contact brand self-adhesive paper. But many blind users may find this method unacceptable, especially when attempting to mark hand-held scanners and other smaller devices.

Despite the universal lack of tactile markings on communications gear, not all manufacturers have been totally unresponsive to the needs of blind/visually-impaired users of their products.



Harry Baughn

Can we fathom the impact a scanner, CB, AM/FM, shortwave radio or even amateur radio can make in the life of a person who is otherwise physically restricted?

Built-in Adaptations: What Some Manufacturers Have Already Done

Two Japanese manufacturers, ICOM and Kenwood have long had speech synthesizers available for their shortwave and HF ham gear. Not inexpensive, the speech option boards are typically priced in the US\$50.00-75.00 range, and must be installed by a qualified technician at extra cost. They offer spoken readout of the frequency only. (When are these guys going to realize that we want information on mode, tuning steps, time of day, signal strength and everything else you sighted folks get from your front panel displays?)

Keypad tuning, particularly if it's in the "standard" telephone format, is easier for many people to use, regardless of visual acuity. Direct entry keypads are available as retrofits for many digitally-tuned radios that came without keypads. Georgia's Stone Mountain Engineering offers a terrific keypad setup for ICOM, Kenwood and Yaesu radios for under a hundred bucks (Box 1573, Stone Mountain, GA 30086; 404-879-5756).

I use an ICOM RC-10 keypad (purchased used from a friendly fellow "ham" for thirty-five dollars) with my '751A; the keypad allows me

Isn't that what you want from shortwave and mediumwave listening? Well, then, to get excellent reception and the most DX while reducing noise you need the **NXL-250**, the most unique and advanced indoor active antenna on the market! The **NXL-250** uses a special Faraday-Shielded loop to actually reduce man-made noise, such as power line noise and noise from light dimmers, motors, TVs, computers, etc. This loop can be tilted and turned to further "knock out" stronger noise sources. This loop, in combination with the internal high-gain amplifier and tunable bandswitched front end, gives the **NXL-250** the capability to provide reception equal to or better than a 100-foot outdoor antenna! All this for a price lower than many inferior active antennas: Just **\$99.95!**

SPECS: Tunable from 540 kHz to 29 MHz. Comes with output cable terminated in phono plug. Shipping/tax: Add \$4 shipping (\$8 Canada), Florida residents add 6% tax. **Options:** AC power supply: \$9.95. PL-259, 1/8" phone and BNC adaptors: \$2.99 each. Extra high-sensitivity LW/MW plug-in loop (60 kHz to 2 MHz): \$97.95.

We also offer modifications and upgrades for many SW portables such as internal antenna boosters, tape activators, narrow filters, "Soup-up" specials and more. Send a 29-cent stamp for our full catalog.

WORLDCOM TECHNOLOGY
P.O. Box 3364
Ft. Pierce, FL 34948
(407) 466-4640

The Ultimate Radio Tool!

Sit back and let **SCORPIO** step your *Icom* or *Kenwood Radio* through frequencies based on type of Service, Location or other criteria. It will even shift a **Data Terminal's** mode on the fly - displaying and capturing to disk RTTY, CW, AMTOR and other digital signals as it scans! Easy to expand database includes 100 HF frequencies. Can automatically log "hits" - has Memory Write. **Many other features!**

Optional Databases available for only \$19.95 include:
SW Broadcasters - Military(HF) - VHF - Others

\$89.95 (+ S&H)

ashtron INC

Fax: (615) 397-0466 Compuserve # 72557,3560
PO Box 1206 - Dandridge, TN 37725 - (615-397-0742)

**DO YOU HAVE AN
IDEA FOR A RADIO
RELATED BOOK?**

Grove Enterprises, publisher of books for the radio hobbyist, is looking for new ideas from interested writers. Send your **outline only** (no manuscripts, please) to:
Grove Enterprises, Attn: New Publications
P.O. Box 98
Brasstown, NC 28902

Dave Marthouse, host of "Spectrum" (Sat. nights on WWCR) knows his way around broadcasting like a pro — because he is a pro. He's also blind, but that didn't hold him back from broadcasting "Spectrum" live from the recent Winter SWL Festival in Kulpsville.



Skip Arey

to switch between the two VFOs, activate the speech synthesizer and directly enter frequency. More handy for the handicapped? You bet!

The next level of adaptation takes us further into the digital domain. Thanks to recent advances in communications and computer technology, a variety of monitoring aids are available, and (wonder of wonders!) some are even applicable to visual handicaps.

A Minor Glitch (or two) with Computers

Thanks to the foresight of radio design engineers, many of today's popular scanners and HF receivers come equipped with RS-232 (serial) interface capability. And thanks to speech synthesis technology, even the most humble computer sound card can produce intelligible speech output from text.

The use of these two technologies together would seem to provide the perfect answer to the needs of the visually-impaired scannist or DXer. In fact, they often do. There are, however, minor problems:

Most radios (especially older or less expensive ones) still do not come equipped with RS-232 ports as standard equipment. In fact, most don't even offer it as an option. Secondly, "talking" screen review software can only handle ASCII text. Microsoft Windows-type graphics, even simple ANSI graphics, will "confuse" the current speech output systems. Many of the available radio software applications use a text-based interface, such as the control software available for the Drake R8, but some software titles simply are not "speech friendly."

Jim Springer from Computer Aided Technologies assured me during a telephone interview that ScanCat for DOS does indeed work well with speech output, providing that the screen review ("talking") software leaves a minimum of 600 kilobytes of conventional PC memory for

use by ScanCat. An added bonus is the software's ability to display frequency and partial description of a cataloged station in two-inch high letters on the computer monitor. Intended to be a convenience feature (I suppose) for the 20/20 crowd, this really is a boon to radio hobbyists with low vision (or misplaced eyeglasses!).

Incidentally, Jim told me that he is willing to devote some of his time to developing interfaces for radios which are not currently supported by ScanCat. He will require use of the radio in question for his research and development work (see sidebar for his telephone numbers if you'd like to volunteer your rig).

John Hoot of Software Systems Consulting of San Clemente, California, said that their PC-SWL, PC-HF Facsimile and PC-GOES WEFAX may be very suitable for persons with vision impairments, since the fax products feature real-time zoom features which enlarge portions of the screen. He added that the PC-SWL product also featured a printer-dump feature, making it suitable for output to inexpensive speech devices such as the Covox Speech Thing, a \$99.00 external "talk-box."

DeltaComm from Wisconsin's Delta Research provides software for ICOM radios, and does indeed work with currently available screen review software and speech output devices. Jerry Kraczek tells me that his software is used by at least one blind customer of the company.

Although both availability and affordability of digital radio control packages may make radio control prohibitive for most users, there are positive developments. The type of data that is sent to a computer screen from digital decoding devices is probably quite speech friendly, providing the text is output as ASCII text and does not depend on a graphics display adaptor. It may be quite possible to monitor digital utility communications without much customizing.

The cost of the spoken word is also dropping. Speech output hardware/software systems,

tailored specifically for use by the blind, were initially quite costly. Today more common computer sound cards incorporate speech synthesis. As more software is written to be used by less expensive hardware, more people will have access to talking computers. In fact, a mid-priced card from Creative Labs' SoundBlaster series includes software to read text from both DOS and Windows. The card retails for under US\$170.00.

Since I can neither afford the \$400.00 retrofit to allow computer control of my Pro-2006 scanner nor the CI-V setup for my ICOM, I can only rely on hearsay concerning the suitability of available software for computing control by the visually disabled. But I can always hope!

Other Resources

I have confined this article to discussing adaptations of radios to the needs of visually-impaired people, because this is the area with which I am most familiar. What if you have another type of disability, such as a motor impairment, cerebral palsy or other disability that makes it difficult for you to operate the controls of your radio?

Each year Minneapolis hosts the "Closing the Gap" conference on technology for the disabled. The conference is held in conjunction with the annual convention of the Minnesota Education Association in October, and features numerous displays and workshops on adaptive technology. All the major players show up, including IBM and (until recently) Apple Computer. You won't find anything specifically tailored to radio monitoring, but you may find alternative switches, voice-activated computer interfaces and other devices which could enhance your enjoyment of the hobby (see sidebar).

Many college and university engineering departments are on the lookout for new and interesting projects for their students. Visit your nearest university and chat with the faculty in the engineering or computer science departments. Many will be willing to offer your needs to their students as a class project, and you may end up with a unique adaptation that suits your monitoring goals.

As much as possible I've tried to rely on human rather than technological resources when adapting my own shack to my particular needs. I first assessed my needs, strengths and weaknesses, and figured out what I could do with neither physical modifications to my gear nor expensive outboard devices.

I then assessed what was available in terms of assistance from friends in setting up my shack and the available gear to make my job easier. I still don't control my Pro-2006 by computer, nor

See page 14 to contact agencies and businesses mentioned in this article.

Any blind or visually-impaired reader who cannot access this article otherwise may send Paul Shallbetter a blank cassette to have it read, or an MS-DOS 3.5" floppy for the text file. Send to Paul Shallbetter, 604 SW First St., Faribault, MN 55021-5806.

do I monitor the digital "utes." I can, however, tune in my favorite shortwave stations via direct keypad entry and verify that I've entered the correct frequency with the speech synthesizer. My shack prominently features a variety of magnifiers and clip-on lights so that I can maximize my remaining vision. And of course, I keep the current issue of *MT* handy.

To paraphrase Milton: "No monitor is an island." Get involved with a local DX or scanner club. If you're an aspiring amateur radio operator or a seasoned ham, get in touch with your local amateur radio club. Offer help to others by sharing your knowledge, and others will help you.

None of my friends are "professional" radio announcers, but many of them have been willing to read for me. A willing friend and a portable tape recorder may be all the adaptation you need. I advise my friends who can neither read *MT* with their own eyes nor find a volunteer reader to use their shortwave receivers to get information. Programs such as Glenn Hauser's *World of Radio* and DX-oriented programs from a variety of stations are a huge help. Just keep that tape recorder handy: these programs provide a great deal of information in a very short time!

Realistically, your best path to making your gear usable will be by using your own creativity and ability to learn and adapt. Technologically speaking, until computer control of communications gear "comes of age," I'm afraid we're somewhat stuck, depending on our budgets, the type and age of radios we own, and the availability of a computer.

So what's the answer? The answer is not in "what" but in "whom." You will find that you're the best resource you have for adaptation and creative solutions to your monitoring needs. Have a little faith in yourself, be creative, and you'll soon take better control of your monitoring post and increase your enjoyment of the monitoring hobby!

My Suggestions to the Communications Industry

I would like to see the availability of owners' manuals in Braille, large print and on cassette. There are plenty of resources for the production of such materials at reasonable cost;

most manufacturers, I am sure, are unaware of them. In the meantime, if you are a Braille user, you may want to contact your local state agency serving the blind for information about the availability of Braille transcription services.

Since we're now in the midst of the digital revolution, let's see more radios featuring serial communications ports for interfacing with computers! The advantages to the able-bodied and disabled alike would be many.

Where possible, it would also help if such markers as slew controls (up/down arrows) and pointers on volume/tonesquelch controls were raised to be discernable by touch.

IBM PC-compatible and Apple computer keyboards have long been tactually marked. The "F" and "J" keys on the "home row" of the keyboard typically have a raised marker dot for easy location when touch typing, as does the "5" key on the numeric keypad. Why not do the same thing on radios, making it easier for all users to locate the center of the data entry keypad? For instance, it would be easy and inexpensive to mark the "5," "enter" and decimal point keys on the '2006. Such marks could be used by a visually-disabled radio enthusiast to quickly orient oneself to the keypad or other push-button controls.

But you don't have to wait until manufacturers see the light; it is easy to add such a marker with hobby ("airplane") glue or a commercially-available product called Hi-Marks.

Speech output ICs are very inexpensive. How about making speech output a standard feature? Even sighted users would find such features as speech readout of frequencies and marked "home" keys to be valuable. After all, sightless monitors aren't the only ones who find enjoyment from listening in the dark. **MT**

About the Author:

Paul Shallbetter, N0YPS, is employed part-time at a local Radio Shack store and works evenings as a keyboard player in a rockband. He also writes, produces radio commercials and jingles, and does audio consulting work.

Paul has worked in broadcasting and related fields since 1976, when he earned his FCC First Class

SPECIAL ANNOUNCEMENT

FROM THE COMPANY THAT BRINGS YOU SCANCAT

INTRODUCING...

COPYCAT

Computer Control of the Universal M-7000 & M-8000

And, AEA's PK-232 and the MFJ-1278

FINALLY, an IBM-compatible COMPUTER CONTROL PROGRAM for the M-7000 and M-8000. Let COPYCAT free you FOREVER from remembering all those buttons and keys. COPYCAT does it all! Simple "PULL-DOWN" menus control all functions. No more looking through complicated manuals or searching for buttons. ALL commands are in plain English. *PLUS* COPYCAT has a fully editable text buffer, with cut & paste. Save/load/edit/print files. PROGRAMMABLE macros and much more. COPYCAT supports ALL the above units within ONE program. Simply select your unit from COPYCAT's EASY-TO-USE menu and GO!

COPYCAT \$69.95 (DEMO DISK \$5.00 Refundable with purchase)

(Be sure and order our serial adapter if you do not have the specially wired cable for the M-7000/8000)

SERIAL CABLE ADAPTERS FOR M-7000 AND M-8000 \$24.95.

SHIPPING/HANDLING \$5.00 (\$7.50 Foreign)

COMPUTER AIDED TECHNOLOGIES

P.O. Box 18292 Shreveport, LA 71138

Order Desk (318)636-1234 (9 a.m. - 5 p.m. Central) - FAX (318) 686-0449 (24 hrs)

(See ad on page 33 & 51)

MAGNETIC LONGWIRE BALUN™



- New! For SWLs using longwire antennas.
- Use coaxial cable from antenna to receiver.
- Low noise reception from 500 KHz to 30 MHz.

Your longwire may be up in the clear but the wire to the radio comes down near the computers, light dimmers, TV sets, fluorescent lights and other sources of noise. This noise is added to the signals you are trying to hear.

Add Palomar's MLB-1 balun to your antenna and use coaxial cable to your radio. Coax doesn't pick up noise. Reception is clearer and quieter. There is no loss of signal because the balun matches the antenna to the coax. Static charges go to ground, not through the radio.

Model MLB-1 \$39.95 + \$6 shipping/handling in U.S. & Canada. California residents add sales tax.



Send for FREE catalog that shows our complete line of antennas, preamplifiers, filters and more.

PALOMAR ENGINEERS

BOX 462222, ESCONDIDO, CA 92046

Phone (619) 747-3343

FAX (619) 747-3346

ORDER
TODAY!

And tell them you
read about it in
Monitoring Times!

Radiotelephone license. He believes his "underemployment" to be a direct result of his vision impairment; he points out that blind Americans have a higher per capita level of education than most Americans, yet suffer a 72% unemployment rate.

Paul welcomes the opportunity to field test communications gear, computer software and hardware, and communications accessories.

Where To Go For More

There are numerous organizations, businesses and publications which serve the special needs of disabled people. The following list is by no means exhaustive, but it is hoped that it will give the interested reader a good place to start.

Nearly every state has a Department of Vocational Rehabilitation; some states also have Services for the Blind, Commissions for the Disabled and so on. Many states maintain libraries for the disabled and SCA-FM "reading services" as well. Look in your White Pages under State Government.

Also write or call these organizations and companies:

American Foundation for the Blind (AFB)

15 W. 16th Street
New York NY 10011

One of the oldest and largest organizations for the blind, the AFB produces numerous informative publications to aid blind and visually-impaired people, including *The AFB Directory of Services for Blind and Visually Impaired Persons in the U.S. and Canada*, now in its 24th edition.

This very complete guide gives addresses and phone numbers of dozens of businesses which produce aids, appliances and technology for the blind, as well as addresses of every major library, nonprofit organization and educational center in the U.S. and Canada.

A copy of this book will be available through your state department serving the blind or regional library for the blind, listed in the white pages of your phone directory.

American Printing House for the Blind

1839 Frankfort Ave.
Louisville KY 40206
502-895-2405

APH produces hundreds of books and publications in Braille, large print and on cassette tape for the Library of Congress. They also produce (with General Electric and other manufacturers) special tape recorders for "talking books" on cassette.

Closing the Gap, Inc.

Box 68
Henderson MN 56044
(612) 248-3294

CTG publishes a massive (11" X 14", 200-plus pages) newsletter six times a year. They are absolutely THE source for current information on adapting technology for the disabled. Although concerned primarily with educational issues and applications, CTG offers tremendous benefits to the radio monitoring enthusiast as well. A sample copy of the newsletter is available for \$8.00 in the U.S.

Courage HANDI-HAM System

Courage Center
3915 Golden Valley Road
Golden Valley MN 55422
(612) 520-0511

Primarily intended to help persons with

disabilities earn and upgrade Amateur Radio licenses, the Handi-Ham system may also be able to provide information of interest to disabled radio monitoring enthusiasts as well. Student membership (for disabled persons) is \$10.00 per year and includes a subscription to *Handi-Ham World* newsletter. Thanks to the Handi-Ham system, I was able to get vital material on earning my Amateur license on tape.

Computer Aided Technologies

PO Box 18292
Shreveport LA 71138
Orders: (318) 636-1234
FAX: (318) 686-0779
Tech: (318) 687-4444

Publisher/creator of ScanCat series of radio control software. ScanCat will allow the user to control a variety of popular receivers from a PC; it will set up a database of frequencies, automatically log intercepted frequencies, etc. Speech-friendly. Reviewed in *MT* 4/94.

Henter-Joyce, Inc.

Orders/info: (800) 336-5658
BBS: (813) 821-8099 (2400, 8, n, 1)

Vendors of the the JAWS II software (Job Access with Speech). The extraordinarily popular screen review software works with many popular speech cards and applications. It may be the most widely-used speech synthesis/screen review product in use by the blind in the U.S.

Delta Research

Box 13677
Wauwatosa WI 53213
(414) 353-4567

Producers of the DeltaComm line of software and interfaces which allow computer-assisted scanning by the ICOM line of receivers. The company's ads in *Monitoring Times* state that the control package will (among other things) automatically log "birdies" and help the monitor nail down frequency groups for services using "frequency-hopping" technology. I have not yet tested this package, but Delta assures me that it is "speech friendly."

MicroTalk

BBS: (903) 832-3722

MicroTalk was founded by a totally blind computer expert who has designed a very good

screen review program for use with a wide variety of speech synthesizers (but, alas, not for SoundBlaster or some of the less-expensive sound boards). The software, titled A.S.A.P. works flawlessly with a wide variety of applications. Since this is a TSR (terminate-and-stay-resident) program, it continues to work in the background while you use your word processing software, your database or your radio control logging software. An evaluation copy is available via the BBS at no cost.

MoTron Electronics

310 Garfield St. Suite 4
PO Box 2748
Eugene OR 97402

I mention Don Moser's MoTron here, only because it offers a prime example of how relatively easy it is to convert data output from an electronic device to speech, *providing the device has a digital interface*. Since his TM-16 Plus DTMF decoder has such an interface and outputs in ASCII, conversion to speech is no problem. More manufacturers could take Don's example to heart.

The National Federation of the Blind

1800 Johnson Street
Baltimore MD 21230

The "of" in the name is important to note. The NFB claims to be the only organization of the blind speaking for themselves as lobbyists, advocates and activists. Unabashedly political, the NFB boasts the largest membership of any national organization of or for the blind. The NFB has affiliates in every state.

I mention them here because I know a number of blind "technoids" who belong to the NFB. They'll usually help the uninitiated with solutions to technical adaptation questions. Incidentally, the NFB is one of the best organizations available to help the newly-blinded.

Other computer-aided scanning systems producers who advertise in this magazine could not be reached via telephone so that we could discuss the suitability of their products for use by the handicapped. For this reason they are not included in the above list. If they will contact me, I will be happy to evaluate what they have to offer.

Scanners/Shortwave/GMRS/Ham

COMMUNICATIONS ELECTRONICS INC. Emergency Operations Center

We're introducing new Uniden Bearcat scanners that are just what you've been searching for. Order your Bearcat scanner today.

25th Anniversary Special Save \$25.00

on Uniden Bearcat® 8500XLT, 2500XLT, 890XLT, LRD9000W1.

Celebrate our 25th anniversary with special savings on the scanners and radar detector found in this ad. This coupon must be included with your prepaid order. Credit cards and quantity discounts are excluded from this offer. Offer valid only on orders mailed directly to Communications Electronics Inc., P.O. Box 1045 - Dept. MTO494, Ann Arbor, Michigan 48106-1045 U.S.A. Coupon expires June 30, 1994. Limit one coupon per item. Coupon may not be used in conjunction with any other offer. Coupon may be photocopied.

Radio Scanners

Bearcat® 2500XLT-H

List price \$649.95/CE price \$339.95/SPECIAL
400 Channels - 20 Banks - Turbo Scan
Rotary tuner feature - Auto Store - Auto Sort
Size: 2-3/4" Wide x 1-1/2" Deep x 7-1/2" High
Frequency Coverage: 25,0000 - 549,9950, 760,0000 - 823,9950, 849,0125 - 868,9950, 894,0125 - 1,300,0000 MHz.

Signal intelligence experts, public safety agencies and people with inquiring minds that want to know, have asked us for a world class handheld scanner that can intercept just about any radio transmission. The new Bearcat 2500XLT has what you want. You can program frequencies such as police, fire, emergency, race cars, marine, military aircraft, weather, and other broadcasts into 20 banks of 20 channels each. The new rotary tuner feature enables rapid and easy selection of channels and frequencies. With the AUTO STORE feature, you can automatically program any channel. You can also scan all 400 channels at 100 channels-per-second speed because the Bearcat 2500XLT has TURBO SCAN built-in. To make this scanner even better, the BC2500XLT has AUTO SORT - an automatic frequency sorting feature for faster scanning within each bank. Order your scanner from CEI.

For more information on Bearcat radio scanners or to join the Bearcat Radio Club, call Mr. Scanner at 1-800-423-1331. To order any Bearcat radio product from Communications Electronics Inc. call 1-800-USA-SCAN.

Great Deals on Bearcat Scanners

- Bearcat 8500XLT-H base/mobile \$369.95
- Bearcat 890XLT-H base/mobile . \$244.95
- Bearcat 2500XLT-H handheld ... \$339.95
- Sportcat 150-H handheld \$199.95
- Bearcat 760XLT-H base/mobile. \$199.95
- Bearcat 700A-H info mobile \$149.95
- Bearcat 560XLA-H base/mobile ... \$84.95
- Bearcat 220XLT-H handheld \$229.95
- Bearcat 200XLT-H handheld \$199.95
- Bearcat 148XLT-H base/WX alert \$88.95
- Bearcat 120XLT-H handheld \$159.95
- Bearcat BCT2-H info mobile \$139.95

NEW! RELM® WHS150-H1

List price \$481.67/CE price \$339.95/SPECIAL
16 Channel - 5 Watt VHF scanning transceiver
Size: 2.45" Wide x 1.38" Deep x 6.4" High
Frequency range: 148.000 to 174.000 MHz. continuous coverage.
Will also work 144.000-148.000 MHz. with reduced performance.

The RELM WHS150 is our most popular programmable five watt, 16 channel handheld transceiver. Weighing only 15.5 oz., it features dealer programmable synthesized frequencies either simplex or half duplex in both 5.0 and 6.25 KHz. increments. Other features include scan list, priority channel, selectable scan delay, selectable 5 watt/1 watt power levels, liquid crystal display, time-out timer and much more. When you order the WHS150 from Communications Electronics Inc., you'll get a complete package deal including antenna, battery, belt clip and user operating instructions. The radio technician maintaining your radio system must order programming instructions part #P1150 for \$18.00 to activate this radio.

Bearcat® 8500XLT-H

List price \$689.95/CE price \$369.95/SPECIAL
500 Channels - 20 banks - Alphanumeric display
Turbo Scan - VFO Control - Priority channels
Auto Store - Auto Recording - Reception counter
Frequency step resolution 5, 12.5, 25 & 50 KHz.
Size: 10-1/2" Wide x 7-1/2" Deep x 3-3/8" High

Frequency Coverage:
25,000 - 28,995 MHz. (AM), 29,000 - 54,000 MHz. (NFM),
54,000 - 71,995 MHz. (WFM), 72,000 - 75,995 MHz. (NFM),
76,000 - 107,995 MHz. (WFM), 108,000 - 136,995 MHz. (AM)
137,000 - 173,995 MHz. (NFM), 174,000 - 215,995 MHz. (WFM),
216,000 - 224,995 MHz. (NFM), 225,000 - 399,995 MHz. (AM)
400,000 - 511,995 MHz. (NFM), 512,000 - 549,995 MHz. (WFM)
760,000 - 823,9875 MHz. (NFM), 849,0125 - 868,9875 MHz. (NFM)
894,0125 - 1,300,000 MHz. (NFM).

The new Bearcat 8500XLT gives you pure scanning satisfaction with amazing features like Turbo Scan. This lightning-fast technology featuring a triple conversion RF system, enables Uniden's best scanner to scan and search up to 100 channels per second. Because the frequency coverage is so large, a very fast scanning system is essential to keep up with the action. Other features include VFO Control - (Variable Frequency Oscillator) which allows you to adjust the large rotary tuner to select the desired frequency or channel. Counter Display - Lets you count and record each channel while scanning. Auto Store - Automatically stores all active frequencies within the specified bank(s). Auto Recording - This feature lets you record channel activity from the scanner onto a tape recorder. You can even get an optional CTCSS Tone Board (Continuous Tone Control Squelch System) which allows the squelch to be broken during scanning only when a correct CTCSS tone is received. 20 banks - Each bank contains 25 channels, useful for storing similar frequencies in order to maintain faster scanning cycles. For maximum scanning enjoyment, order the following optional accessories: PS001 Cigarette lighter power cord for temporary operation from your vehicle's cigarette lighter \$14.95; PS002 DC power cord - enables permanent operation from your vehicle's fuse box \$14.95; MB001 Mobile mounting bracket \$14.95; BC005 CTCSS Tone Board \$54.95; EX711 External speaker with mounting bracket & 10 feet of cable with plug attached \$19.95. The BC8500XLT comes with AC adapter, telescopic antenna, owner's manual and one year limited warranty from Uniden. Order your BC8500XLT from Communications Electronics Inc. today.

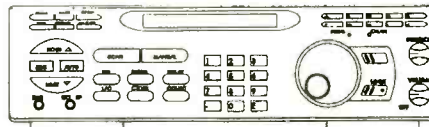

CB/GMRS Radios

The Uniden GMR100 is a handheld GMRS UHF 2-way radio transceiver that has these eight frequencies installed: 462.550, 462.725, 462.5875, 462.6125, 462.6375, 462.675, 462.6625 and 462.6875 MHz. This one watt radio comes with flexible rubber antenna, rechargeable ni-cad battery, AC adapter/charger, belt clip, F.C.C. license application and more.

- Cobra 2000GTL-H SSB Deluxe CB Base \$419.95
- Uniden GMR100-H GMRS Handheld ... \$169.95
- Uniden WASHINGTON-H SSB CB Base \$189.95
- Uniden GRANTXL-H SSB CB Mobile \$149.95
- Uniden PC76XL-H CB Mobile \$99.95
- Uniden PC122XL-H SSB CB Mobile \$107.95
- Uniden PRO510XL-H CB Mobile \$36.95
- Uniden PRO520XL-H CB Mobile \$49.95
- Uniden PRO538W-H CB & Weather \$69.95

Shortwave

- ICOM RI-H ultra compact handheld wideband receiver \$469.95
- ICOM R100-H superwide band mobile/121 memory \$649.95
- ICOM R7100-H base with 900 memory (add \$49.00 shipping) \$1,289.95
- ICOM R9000-H base 30 kHz.-2 GHz. (add \$149.00 shipping) \$1,999.95
- ICOM AH7000-H super wideband discone type antenna \$109.95
- Grundig Satellit 700-H1 portable with 512 memory & AC adapt. \$389.95
- Grundig Yacht Boy 400-H digital portable shortwave \$199.95
- Grundig Yacht Boy 230-H portable shortwave \$139.95
- Sangean ATS202-H ultra compact 20 memory shortwave \$79.95
- Sangean ATS606-H ultra compact 45 memory shortwave \$149.95
- Sangean ATS606P-H shortwave with antenna & AC adapter \$169.95
- Sangean ATS800-H1 portable 20 memory shortwave \$69.95
- Sangean ATS803A-H portable with SSB reception & AC adapter \$159.95
- Sangean ATS808-H portable 45 memory shortwave \$159.95
- Sangean ATS818-H portable without cassette recorder \$189.95
- Sangean ATS18CS-H with cassette recorder \$209.95
- Sangean ANT60-H portable shortwave antenna \$9.95

Weather Stations

Public safety agencies responding to hazardous materials incidents must have accurate, up-to-date weather information. The Davis Weather Monitor II is our top-of-the-line weather station which combines essential weather monitoring functions into one incredible package. Glance at the display, and see wind direction and wind speed on the compass rose. Check the barometric trend arrow to see if the pressure is rising or falling. Our package deal includes the new high resolution 1/100 inch rain collector part #7852-H, and the external temperature/humidity sensor, part #7859-H. The package deal is order #DAVI-H for \$524.95 plus \$15.00 shipping. If you have a personal computer, when you order the optional WeatherLink computer software for \$149.95, you'll have a powerful computerized weather station at an incredible price. For the IBM PC or equivalent order part #7862-H. For Apple Mac Plus or higher including Quadra or PowerBook, order part #7866-H.

Other neat stuff

- Uniden EXP9200-H 900 MHz. 2 line cordless phone \$329.95
- Uniden EXP9100-H 900 MHz. 1 line cordless phone \$299.95
- Cobra CP910-H 900 MHz. spread spectrum cordless phone \$269.95
- ICOM GP22-H handheld global positioning system \$699.95
- WR200-H weather radio with storm alert \$39.95
- RELM WHS150-H VHF handheld 5 watt, 16 ch. transceiver \$339.95
- RELM RH256NB-H VHF 25 watt synthesized transceiver \$289.95
- Ranger RC12950-H 25 watt 10 meter ham radio \$244.95
- Ranger RC12970-H 100 watt 10 meter ham radio \$369.95
- Uniden LRI9000W1-H Super Wideband Laser/Radar Detector \$169.95
- PWB-H Passport to Worldband Radio by IBS \$10.95
- POL1-H Police Call for CT, ME, MA, NH, NY, RI, VT \$5.95
- POL2-H Police Call for DE, MD, NJ, PA \$5.95
- POL3-H Police Call for Michigan & Ohio \$5.95
- POL4-H Police Call for IL, IN, KY, WI \$5.95
- POL5-H Police Call for IA, KS, MN, MO, NE, ND, SD \$5.95
- POL6-H Police Call for DC, FL, GA, NC, PR, SC, VA, WV \$5.95
- POL7-H Police Call for AL, AR, LA, MS, OK, TN, TX \$5.95
- POL8-H Police Call for AZ, CO, ID, MT, NM, NV, UT, WY \$5.95
- POL9-H Police Call for California, Oregon & Washington \$5.95
- USAMMOT-H magnet mount scan antenna w/Motorola plug \$29.95
- USAMMPL-H magnet mount scan antenna with PL259 connector. \$29.95
- USAMMBCN-H magnet mount scanner antenna w/BNC connector \$29.95
- USAK-H VHF scanner/VHF transmitting antenna PL259 connector \$29.95
- USASGMBN-H glass mount scanner antenna with BNC connector \$29.95
- USASGMM-H glass mount scanner antenna with Motorola jack \$29.95

Buy with confidence

It's easy to order from CEI. Mail orders to: Communications Electronics Inc., Emergency Operations Center, P.O. Box 1045, Ann Arbor, Michigan 48106 U.S.A. Add \$15.00 per radio for U.P.S. ground shipping and handling in the continental U.S.A unless otherwise stated. Add \$8.00 shipping for all accessories and publications. Add \$8.00 shipping per antenna. For Canada, Puerto Rico, Hawaii, Alaska, P.O. Box, or APO/FPO delivery, shipping charges are two times continental U.S. rates. Michigan residents add state sales tax. No COD's. 10% surcharge for net 10 billing to qualified accounts. All sales are subject to availability, acceptance and verification. Prices, terms and specifications are subject to change without notice. We welcome your Discover, Visa, American Express or MasterCard. Call 1-800-USA-SCAN to order toll-free. Call 313-996-8888 if outside the U.S.A. FAX anytime, dial 313-663-8888. For technical assistance to solve your communications problem, call the Communications Electronics technical support hotline for \$2.00 per minute at 1-900-555-SCAN. Order your new electronic equipment from Communications Electronics Inc. today.

Scanner Distribution Center and CEI logos are trademarks of Communications Electronics Inc. Sale dates 4/1/94 AD #030494/GEN Copyright © 1994 Communications Electronics Inc.

For credit card orders call 1-800-USA-SCAN

Communications Electronics Inc.
Emergency Operations Center
P.O. Box 1045, Ann Arbor, Michigan 48106-1045 U.S.A.
For information call 313-996-8888 or FAX 313-663-8888



Atlantic City, New Jersey

Great Aero Monitoring from the Gambling Capitol of the East

By Jack Sullivan

Most of us usually associate Atlantic City, New Jersey, with gambling casinos and little white-haired ladies playing nickel slot machines. Although these establishments have their own allure, Atlantic City means something much different to the monitoring enthusiast who is interested in a wide variety of aviation communications. This area of southeastern New Jersey probably provides some of the most interesting and exciting aircraft communications to be heard in the northeast United States.

Here is a brief listing of the major monitoring (and viewing) attractions in Atlantic City and its environs:

Atlantic City International Airport

Located in Pomona, a few miles west of Atlantic City, ACY (its FAA location designator) is an airport with a number of unique distinctions. Once a Naval Air Station, ACY is now a major airport with two runways, one 10,000 feet in length. It is home to the New Jersey Air National Guard's 177th Fighter Interceptor Group, a front line air defense unit that frequently scrambles its F-16s to intercept Russian BEAR turboprop reconnaissance bombers.

On constant alert to defend America's air frontier from Massachusetts to Virginia, the 177th (nickname: The Jersey Devils) is tied by hotlines to the Northeast and Southeast Air Defense Sector command centers (callsigns HUNTRESS and OAK GROVE, respectively). They fly frequent training missions off the New Jersey coast, practicing intercepts and dog fights almost daily in the Warning (or WHISKEY) areas just offshore from New Jersey, New York and Delaware.

This airspace is controlled by the navy's Fleet Area Control and Surveillance Facility at Virginia Beach, VA (callsign GIANT KILLER). Usual callsigns are ACES, DOG, SNAKE, DEVIL and ZORRO. (Despite frequent reports in various publications, JERSEY is not used as a callsign here.) Guided tours are available, which include films, F-16 simulator check outs, and an F-16 static display where you can crawl over the entire aircraft and cockpit and have your questions answered. (Expect the amount of information you're given to decrease in proportion to how much you let on that you might know, especially on topics such as communications, operations, etc.) Contact Master Sergeant Jerry Grasso at 609-645-6295.

The Atlantic City airport, with over 5,000 acres of land, has another important distinction: it is the only airport both owned and operated by the Federal Aviation Administration (FAA). It is also the home of the FAA's Technical Center, which is located on the other side of the terminal building from the Air National Guard complex. Abbreviated ACT, the Technical Center contains over 1,200 employees and over 1,000 contractors working on over 150 different projects, ranging from the development of new state of the art air traffic control systems to research into improved airport security techniques.



A bit of history: an F-106B supersonic interceptor flown by the New Jersey Air National Guard until recently.

There is an FAA ramp connecting several hangars full of FAA flight test and flight inspection aircraft of all descriptions. Guided tours are available of both the control tower and the Tech Center, on request. Contact their Public Affairs office at 609-484-4000.

Table 1 has the frequency lineup for scanning the aircraft radio activity at ACY. UHF-AM channels are given next to their VHF-AM complement, where applicable. The "Button" references the frequencies that are preset into the UHF radios in the F-16s.

Frequencies also listed in government publications for the Air National Guard and FAA at ACY, but not verified during my visit are: ANG: 163.375, 163.4875, 163.5125, 165.0375, 311.0 and 321.0. The VHF-FM channels are probably in use by base security police (one or more channels), refueling trucks, motor pool, etc. The UHF-AM channels were not heard. FAA: 165.75, 166.10, 166.175, 172.125, 172.1875, 172.85, 172.9125 and 172.95. These are used by their Security Police, etc.

Warren Grove Range

Located in Warren Grove, New Jersey, about 25 miles north of Atlantic City, the Warren Grove Range is one of only about eight "Class A" Air Force weapons ranges in the United States. Class A ranges are those that are manned and maintained during operating hours. Other ranges of this type are at Camp Drum, New York, Fort Indiantown Gap in Annville, Pennsylvania, and Dare County, North Carolina.

From Atlantic City, drive north on the Garden State Parkway and get off at Exit 58 (Route 539). Drive north on 539 about fifteen miles and you will be in the middle of the very scenic part of New Jersey known as the Pine Barrens. A sign on the left marks the road to the range. Go through the gate and drive around to the south end of the quonset hut with the two discone antennas. Park where indicated and check in with the staff in the trailer.

Aircraft departing ACY to the north are informed by the controller if Restricted Area 5002 is "hot" or "active." To be sure the range will open when you arrive, call first on 609-698-3815. The Warren Grove Range is closed on Sundays and Mondays.

The Warren Grove Range consists of about a square mile of impact area situated within R-5002. There is a short airstrip and two 100 foot observation towers. The tower closest to the entrance is where the Range Control Officer (RCO) is stationed with his frequency programmable AN/GRC-171 UHF-AM trans-

Touch-Tone Decoder Display



From
MoTron Electronics

The **Tone-Master™** Line of Hand Held Tone Decoder Display Products. Decode Touch-Tones from a telephone, scanner, tape recorder, or nearly any audio source.



- ✓ 16 digit LCD display with 80 character scrollable memory
- ✓ Portable 9 volt battery or external power operation
- ✓ Completely stand-alone, no computer necessary
- ✓ Metal enclosure with built-in monitor speaker, only 2.75" x 6.1" x 1.2"
- ✓ TM-16 Plus includes RS-232 output and Software for optional automatic date/time/number logging using your computer
- ✓ 1 year Warranty on parts and labor
- ✓ 30 day Money Back Guarantee (less shipping and handling)

\$60 Off!

TM-16 Standard Model	\$169.00	PS-12 AC Power Adaptor	\$10.00
TM-16-PLUS RS-232 Model	\$239.00	C-904 Laptop Computer Cable	\$10.00
(IBM Compatible logging Software included)		C-905 Desktop Computer Cable	\$10.00

S/H \$5 USA/Canada, \$15 Foreign. Visa, MasterCard & American Express Accepted

MoTron Electronics • 310 Garfield Street Suite 4 • Eugene OR 97402
Orders: (800) 338-9058 • Info: (503) 687-2118 • Fax: (503) 687-2492

Table 1

Freq MHz	
261.0	177th FIG Operations Control (Atlantic City Ops) (Button 1)
396.0/127.85	ACY Clearance Delivery (Button 2)
284.6/121.9	ACY Ground Control (Button 3) (VHF aircraft, ground service vehicles and tower are also repeated on 172.8125 FM)
239.0/120.3	ACY Control Tower (Button 4)
385.5/124.6	ACY Approach/Departure North Sector (Button 5)
263.6/134.25	ACY Approach/Departure South Sector (Button 6)
285.4	Washington Center at Sea Isle, New Jersey (local low altitude sector) (Button 7)
249.8	GIANT KILLER (remote site located at Lakehurst Naval Air Engineering Center) (Button 8)
255.0	GIANT KILLER (Button 9)
290.4/134.65	ACY Approach/Departure West Sector (Button 10)
288.7	Tactical Discrete (Button 11)
228.7	HUNTRESS Operations Discrete (remote site located at McGuire AFB) (Button 12)
364.2	HUNTRESS Dispatch (Air Intercept Control Common, or AICC) (Button 13)
233.6	HUNTRESS Operations Discrete (Button 14) (Buttons 15-20 are used for the HAVE QUICK anti-jam frequency hopping system.)
273.4	HUNTRESS Operations Discrete (manual setting of UHF radio on F-16 static display.)

Other frequencies of interest at ACY are as follows:

121.7	ACY Clearance Delivery Remote Sites at nearby Bader Field and Wildwood Airports
133.6	ACY Clearance Delivery Remote Site at Barnegat, New Jersey
119.55	ACY Final Approach Control
123.4	FAA Tech Center Flight Operations Control (FAA Ops)
122.95	UNICOM (Butler Aviation)
108.6	ATIS broadcast (ACY VORTAC)
172.725	FAA base (function not determined)
165.1375	ANG Base Engineers (base and mobile)
123.15, 118.15	FAA Flight Test Assignments (plus other channels between 123.00 and 124.00)



The entrance to Warren Grove range; the control tower is in the center.

ceiver. From the tower, he has a clear view of the entire range area with its variety of targets, including junked military vehicles and a simulated aircraft in a revetment.

During my visit, two missions were scheduled for that afternoon: two flights of A-10 Thunderbolt IIs (Warhogs) were expected. Just as the RCO and the range staff were finishing up lunch in their house trailer operations base, a radio speaker came alive with a call from SHARK 51, a flight of three A-10s from Martin State Airport near Baltimore.

We climbed the range control tower and checked out the equipment. The range control secondary frequency of 296.2 was set on the thumbwheels of the GRC-171. Primary range frequency is 286.2 MHz. They also monitor GUARD, or 243.0. Equipment with gauges set into the operating desk spelled out wind speed, direction and barometric pressure. An observer with a special surveying transit stood by to triangulate bomb impacts by intercom with a second observer in the other range tower.



F-16s on the flight line at Atlantic City International.



While sitting in your Atlantic City hotel room at night, you may still want to check out a different kind of action from some high flyers. Here are some frequencies for the casinos courtesy of the latest *Sports and Entertainment Frequencies* pocket guide from Grove Enterprises:

Atlantic City Convention Ctr	453.3500	453.6750	Holiday Inn	35.90	462.8000
Bally Grand	154.540	461.000		463.4250	464.4750
	461.6125	462.825	Local 54, Casino Union	816.8375	
	463.800	464.100	NJ Casino Control Comm	460.1750	460.2500
	464.200	464.2125	Resorts International	154.5700	461.1125
	464.9500			463.6500	464.0750
Bally's Park Place	464.3250	464.1000		464.2750	465.0000
	462.800	464.5750	Sands Hotel	462.050	467.050
Boardwalk Regency Hotel	160.760			461.225	463.325
Atlantic City Casino Security	464.675			463.500	
Caesar's Palace	461.9250	461.950	Showboat Casino	461.2250	461.6250
	461.8625	463.400		461.7000	
	464.6250	816.3375	Tropicana Ramada	464.7250	464.8250
Claridge Casino	461.5500	462.8750		466.925	461.925
	463.7500	464.350	Trump Castle	816.5875	
Golden Nugget	462.000	464.125	Trump Plaza	461.5125	462.7500
	464.200	464.3750	Trump Taj Mahal	809.7875	809.8125
Great Bay Hotel	463.5000			810.7625	810.8125
Harrah's Marina	461.3250	461.6750		811.8125	
	463.3250	463.5500			
	463.7500	464.3250			

standard attack maneuvers: 30 and 45 degree dive bombing and strafing from various angles. The flight of aircraft announce their planned sequence of maneuvers over the radio, and then are cleared one at a time into the range "hot" by the RCO. The range tower gives the visitor a front row seat for some exciting action!

The bombs dropped are dummy practice units that carry only a small charge of explosive to create a puff of smoke for marking the impact point. Each impact was rapidly scored by the observer and the results immediately radioed back to the aircraft. From my point of view, these pilots were great shots, scoring a number of direct hits.

The strafing runs were the high point of the visit. Firing practice ammunition from their 30 mm "Gatling Gun" cannon, the impacts on the targets are scored via microphones on the ground beneath the targets. Impacts then register on an electronic counter in the range tower. Firing only 10-round bursts, the smoke could be seen in front of the A-10's nose several seconds before the sound arrived. BRRAAPPP! The very loud cannon report echoed around the range area.

Aircraft from all over the northeastern United States come to Warren Grove. The last mission of the day was two A-10s from Barnes Airport in Westfield, MA, callsigns DANNO 1-2. Earlier that day an attack helicopter had started a fire on the range, which they put out with their fire truck. Other visitors include OA-10s from Willow Grove NAS (SANDY), A-4s from Marine Corps Air Reserve (MAG49), F/A-18s (COMBAT) from Andrews NAF, F-16s from Richmond and many others.

Although being in the range tower and being part of the excitement was a thrilling experience, on my next visit I will definitely come prepared with my portable scanner programmed with the VHF-FM channels that these aircraft use for interplane communications during the range exercises. Here are those frequencies that I have monitored during periods of activity at Warren Grove: 34.15, 34.40, 34.60, 34.75, 36.35, 40.15, 41.45, 46.65, 49.75, 51.50 and 52.50 MHz. Being able to listen to all of the radio activity while sitting in the front row would make for a *MT* very exciting visit!





Now The Company That Takes You Around The World Lets You Take The World Around With You.

The Drake SW8 – Finally, Professional Desktop Performance In An Affordable, Portable World Band Shortwave.

The company that has been setting the standards in premium-quality world band shortwave performance now puts top-of-the-line features and technology at your fingertips with the SW8... wherever you want to take it. Designed for both desktop use and easy portability, the

Drake SW8 includes many of the same features that have made Drake a perennial favorite of experts – superb audio, versatility, and the unique combination of professional quality and functional simplicity. So tune in the world and get the best of all worlds – quality and affordability, desktop

technology and portability.
The Drake SW8.

To order your SW8 direct,
for more information, or for
the dealer nearest you call:

1-800-968-7795

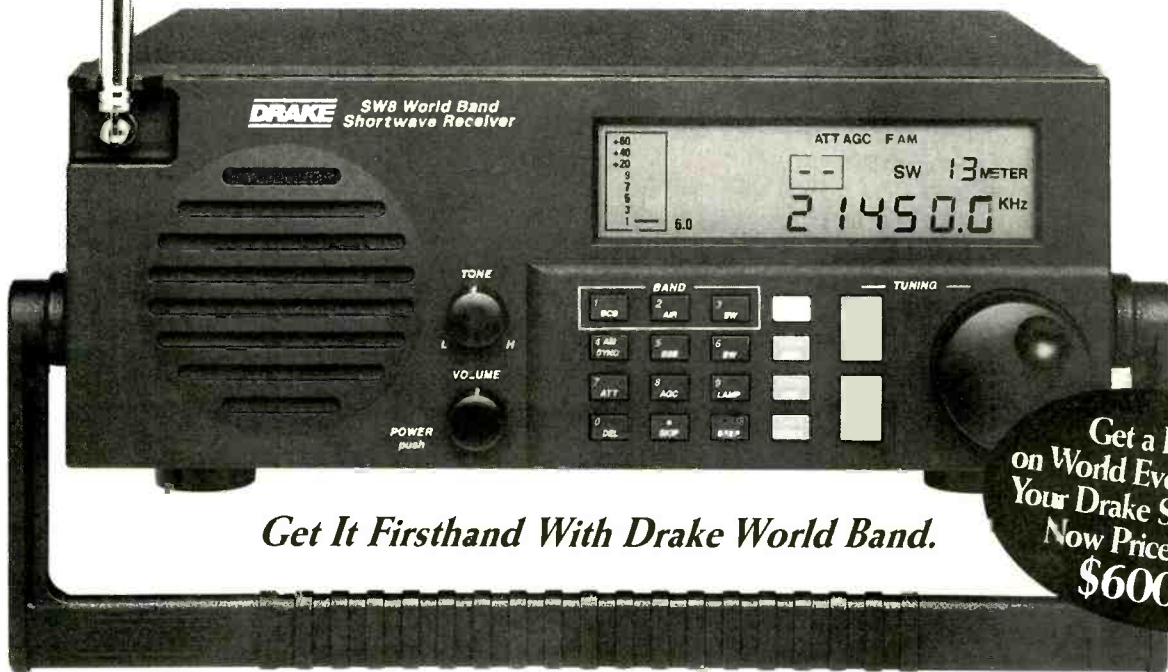

Get It Firsthand With Drake World Band.

**Get a Handle
on World Events... Order
Your Drake SW8 Today.
Now Priced under
\$600.00**

CREATING AN INSIDE TRACK: Scanner/SWL "Networking"

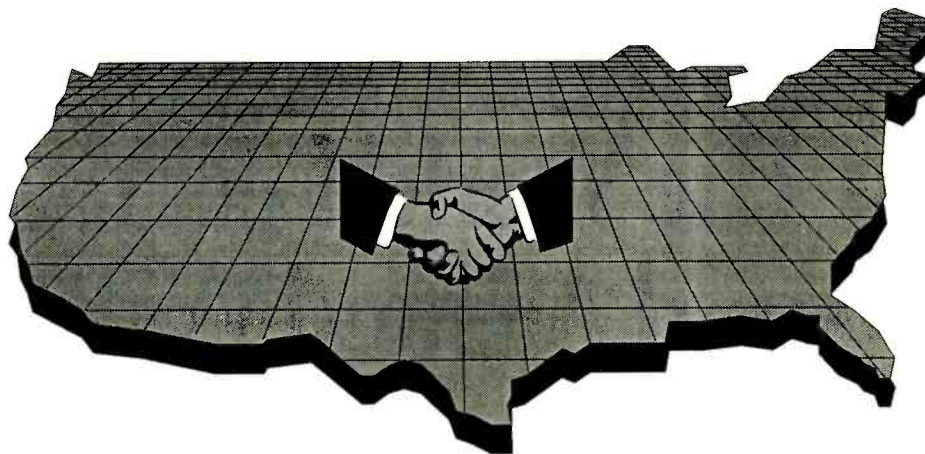

By Ed Hesse, WB2RVA

It's Tuesday evening, just a few minutes shy of 8 o'clock on Long Island, New York. Scanner monitors in the tri-state area are getting ready to listen to the Scanner/Shortwave Listener net on 146.805 MHz. Those who are ham radio operators have already tuned to that frequency, ready to "check in" when directed by net control.

Net control has been getting ready all week, reading the mail he's received and selecting items which can be used on the air for the audience which the net attracts each week.

It's 8 PM, and net control starts the net.

WB2RVA calling CQ, CQ, CQ... Scanner Monitor and Shortwave Listeners' Net. This net meets every Tuesday night on 146.805. The input is 146.205 (600 down), and you need no PL to access the repeater. For those in New York City and New Jersey, we ask that you check in on 147.405 (600 up) so that you don't cause interference with the .805 repeater in New Jersey. We thank Steve, WB2WAK, the trustee of the repeater for the use of his equipment each week when we run the net. When you check in, please give us your call letters, your first name, and let us know if you're just listening, have information, or have a query. Anyone who'd like to check in, please come now.

From that point on, the net starts to roll.

N2NXT, Kevin, just listening... N2LAK, Dave, with info ... N2RSO, Frank, good evening, Ed, just listening... N2RZG, Dick,

with a query... Ron, WA2WBM, just listening, Ed... Mark, N2QAI, just listening, good evening, Ed... Ron, N2TJE, with info, Ed...

That's the initial call-up. There'll be many more during the evening (most nights, the net runs up to two hours). As the callers check-in, net control keeps track of those who have a query and those who have information. The "rule" of the net is that those who check-in in this fashion are regarded as priority traffic. Scanning the check-in sheet, net control calls Dave, N2LAK, who has information.

"Good evening, Ed, and everyone else on the net." Dave then runs through a list of SW and Ute frequencies that he's monitored during the week, giving the UTC times as well.

Net control thanks Dave and asks if anyone needs "a fill" or has any questions for Dave on what he's monitored.

Although Frank, N2RSO, has no "traffic" for the net, net control thanks Frank for the "overlays" for a modified PRO-2004 which Frank has prepared and sent a quantity to net control. If anyone on the net wants an overlay, just send an SASE to net control and it will be sent.

Next in line is Dick, N2RZG, with a query. "Hello, Ed, and everyone else on the net. I heard that TRACON (the local Air Traffic Control facility) will be holding an 'open house' again this year. Does anyone know the date of this?"

Before net control can respond, there's another call: "KB2KMM with info." Net control calls Dave, KB2KMM.

"Ed, it's scheduled for Saturday, September 18. It starts at 10 am and, of course, everyone is welcome."

Net control reviews the 1992 TRACON Open House and suggests that all listeners make sure

NOTICE:

Listeners' nets will be included as an experimental feature of the Monitoring Times' Club Circuit. To be listed, send in the name of the net, geographic region covered, operating frequency and schedule, topics covered, and any other information needed by participants.

that they attend the 1993 function. In a few moments of dialogue between net control and check-ins, it's decided that the group will certainly attend the Open House.

Net control then calls on the others who have information or queries, and these are taken care of. Following this, there's another call-up for check-ins — which is repeated throughout the evening until everyone who wants to check in with a question or information has been heard.

Now it's time for the listeners who don't have an amateur radio license to be heard, those individuals who have sent queries or info to net control.

"We've had a fair amount of 'fan mail' during the week. Let's look at what Brad from Fairfield has to say." Brad sent in a list of frequencies for professional football teams, and net control reviews those which are appropriate for the area. He also has a query: While searching, Brad found 858.8375 to be very active. He knows it's a cable company, but he doesn't know which one it is. Can anyone help?

After a pause of several moments, net control moves on. He knows that someone may check in later with a response to Brad's request, or that during the week, the mail may bring such an answer.

Another letter: Ed from Point Lookout, Long Island, has noticed that the NOAA weather broadcasts in this area, especially those from Rockefeller Center, have been difficult to receive. Does anyone know why? Several stations check in, echoing Ed's complaint, and suggesting other frequencies — such as 162.4 — as a more viable alternative.

A nice note from Michael in Flushing, New York. He's been able to monitor the tennis matches at the National Tennis Center, and shares his experiences with the net. He notices that there's a "blimp" that hovers above the matches. Does anyone have the frequencies for this blimp?

There's a horde of responses, those with frequencies for blimps, and those who take the discussion off into the use of "450" frequencies

Dallas Remote Imaging Group

Satellite Image Consulting

Jeff Wallach Ph.D., President

P.O. Box 117088, Carrollton Texas
75011 - 7088



ON-LINE SINCE
1985

The DRIG BBS is the premier source of information on Satellite Tracking, Satellite Imagery, Telemetry Analysis, Tracking Programs, Satellite Databases, NASA, Space Communications AND MORE!

Over 7 GIGABYTES of files related to Astronomy, Remote Imaging, Amateur Radio, Digital Image/Signal Processing, NASA, AMSAT, and Space!

10 Lines with USR
Dual Standard 16.8K Modems

Internet - info@drig.com

Fidonet - 1:124/6509

- Online VISA/MC/AMEX Registration
- Internet/Fidonet via Ku Band Satellite
- Real Time Weather Satellite Images
- NASA/AMSAT Satellite Tracking Elements
- Boardwatch/Connect/USA Today Doors
- Astronomy Databases
- Weather Information Door
- Internet FTP/Telnet in 1994

1 Year Membership - Full Downloading - No Ratios \$35.00

1 Year Membership - Full Downloading - Internet \$65.00

2 Year Membership - Full Downloading - Internet \$95.00

BBS: (214) 394-7438

Voice: (214) 394-7325
Fax: (214) 492-7747

*Just like a club,
a net provides
several ways of
participating. Here
is the Monitoring
the Long Island
Sounds gang who
enjoyed the Air
Traffic Control
open house
discussed on
the net.*



by airborne vehicles, such as police helicopters in the area. Amazing what you can learn on the net!

The net continues in this fashion, and soon it's 10 pm. The net has run for two hours, and approximately 30 stations have checked in. One can only wonder how many scanner monitors have listened.

Net control (who has to get up and go to work in the morning) asks for one last round of check-ins. And then the net is over.

The net described above has run for 2-1/2 years in the New York metropolitan area. Its coverage ranges throughout Long Island (Nassau and Suffolk counties), New York City, New Jersey, and Connecticut. The number of stations



Setup for the MLIS (Monitoring the Long Island Sounds) Tuesday night net.

checking-in approaches 30 on a weekly average, and the "fan mail" runs close to 20 pieces each week. In addition, the information generated by the net provides the basis for a monthly six-page newsletter (which also has been running for 2-1/2 years), distributed to members of the net.

The net has attracted a group of sophisticated scanner monitors and SWLs. Just about every question raised on the air (or asked through the mail) is answered, and is done so by an expert in his field. In order for the net to be so successful, a few simple rules have been followed:

- No "sensitive" or "confidential" frequencies are ever discussed. If someone wants these frequencies, he's advised to look elsewhere.
- First names only (and location) are used. And sometimes, only an initial and no location are used. "Frank from Wantagh" may be used, or "P" from Long Island may be the source.
- Since the net — and the monthly newsletter — are a joint effort, those who receive the newsletter (at no cost except a stamped-self-addressed envelope) must participate in the net or send information for the newsletter. There is no free lunch.

As noted, the Monitoring the Long Island Sounds net and the newsletter have run consistently for 2-1/2 years. If this works in the metropolitan New York area, it can work in YOUR area. Once you get such a net up-and-running, you'll wonder how you ever did without it. Here are some suggestions for conducting a Scanner Monitor/SWL Net:

- Recognize that many amateur radio operators are also "scanner freqs." Conversely, our experience shows that once a monitor starts to listen to the net, he invariably becomes a ham (No-Code Tech in most cases).
- As good as scanner books and magazines are, there is no substitute for that vast "listening audience" out there who listen hour-by-hour, day-by-day to their scanners and SW radios.

Here are three frequency listings of the Long Island area confirmed by MLIS members. Thanks to the following contributors: Rick, KA2PBO; Warren, N2KDS; and Art, WA2KXE. All frequencies are in MHz.

Monitoring the Long Island Railroad

- 160.38 Train Channel One (Block Frequency One)
- 161.445 Train Channel Two (Dispatcher to Train)
- 161.265 Train Channel Three (Yardmaster, Block Frequency Two, Freight) West
- 161.535 Train Channel Four (Car Inspectors, Babylon Yard, and low power Wayside transmitters)
- 161.385 Maintenance of Way (Signal, Communication, Third Rail, Power Departments)
- 160.455 Police HQ (Railroad-Wide)
- 161.49 Police Repeater Output (Penn Station and Flatbush Avenue)
- 160.785 Maintenance of Way (truck to truck)
- 160.605 Police (car to car)
- 452.9125 Police (mobile repeater)
- 452.7625 Police (handhelds)
- 452.8625 Police (handhelds)

Selected Long Island Maritime Frequencies

- 156.8 Channel 16 VHF Marine Distress Frequency
- 157.1 USCG Channel 22A
- 156.3 USCG Channel 6
- 156.6 USCG Channel 12
- 157.15 USCG Channel 23 (Coast Guard South Shore)
- 157.175 USCG Channel 83 (Long Island Sound)
- 157.075 Channel 81 (Marine Environmental Operations)
- 156.65 Channel 13 (Vessel bridge to bridge)
- 123.1 Search and Rescue, on scene working
- 121.5 Aero distress
- 243.0 Military aircraft distress
- 156.55 Channel 11 (Seatow Moriches/Shinnecock)
- 156.9 Channel 18A (Seatow Great South Bay)

Nassau County Fire Department UHF Frequencies

- | | | | |
|------------------|---------------------|--------------------|----------------|
| 456.6, 465.625 | East Meadow | 465.6125 | Mineola |
| 465.6, 465.625 | Elmont | 458.6125 | New Hyde Park |
| 477.1625 | Glenwood | 465.5625 | North Bellmore |
| 465.6125 | Hewlett | 465.625 | Oceanside |
| 460.5625 | Lakeview | 460.6375, 465.6375 | Oyster Bay |
| 453.7125 | Lawrence/Cedarhurst | 460.6125 | Uniondale |
| 460.58, 465.5875 | Levittown | 453.8125 | Valley Stream |
| 465.5875 | Long Beach | | |
| 465.6375 | Malverne | | |

• In addition to that audience, there is a group of "professionals" whose business is radio and who have access to a tremendous amount of inside information. These people know where the action is and, when cultivated, will share that information with the net.

A net should be run on an amateur radio repeater. Our net is fortunate to have WB2WAK "repeat" at our disposal on Tuesday evenings. Its coverage is great throughout the tri-state metropolitan area.

• Net control should be an enthusiastic scanner "freq"/SWL who is prepared to do his homework before and during the net. The net has to be fun for all concerned, especially net control.

• Start small. A net that runs a half-hour and attracts 10 check-ins eventually will run two hours and attract 30 check-ins (most of whom

are pros who could fill two hours on their own). Be patient, and do your homework.

• If possible, try to have a monthly newsletter. It will help to build an audience and provide a stream of information.

It's important to read magazines like *Monitoring Times*. It's important, too, to listen to your scanner/SWL radio every day. It's important to refer to reliable scanner and shortwave publications and directories to learn and to cross-check what you monitor.

If you really want to get on the fast-track to becoming a world-class monitor, there's nothing like the stimulation of an amateur radio net which, week after week, informs you what's being heard in your area, answers your questions, and gives you the desire to become one of the real "pros" yourself.



Computer Aided Scanning

a new dimension in communications from Datametrics



Now Radio Shack PRO 2006 owners for the first time have access to the exciting world of Computer Aided Scanning with the highly acclaimed Datametrics Communications Manager system. Computer Aided Scanning is as significant as the digital scanner was five years ago and is changing the way people think about radio communications.

- The Datametrics Communications Manager provides computer control over the Radio Shack PRO2006 receiver.
- Comprehensive manual includes step by step instructions, screen displays, and reference information.
- Powerful menu driven software includes full monitoring display, digital spectrum analyzer and system editor.
- Extends receiver capabilities including autolog recording facilities, 1000 channel capacity per file, and much more.
- Uses innovative Machine State Virtualizer technology (patent pending) hardware interface by Datametrics.
- Simple 4 step installation - no soldering or modification to normal receiver operations.

Datametrics, Inc

- Computer Aided Scanning system \$ 349
 - PRO2006 receiver w/interface installed and CAS system \$ 749
 - Manual and demo disk \$15
 - Requires Radio Shack PRO 2006 receiver and IBM PC with 300K memory (640K for full channel capacity) and parallel (printer) port.
- Send check or money order to Datametrics, Inc., 2575 South Bayshore Dr, Suite 8A, Coconut Grove, FL 33133. 30 day return privileges apply.

PC HF FACSIMILE 7.0 \$99

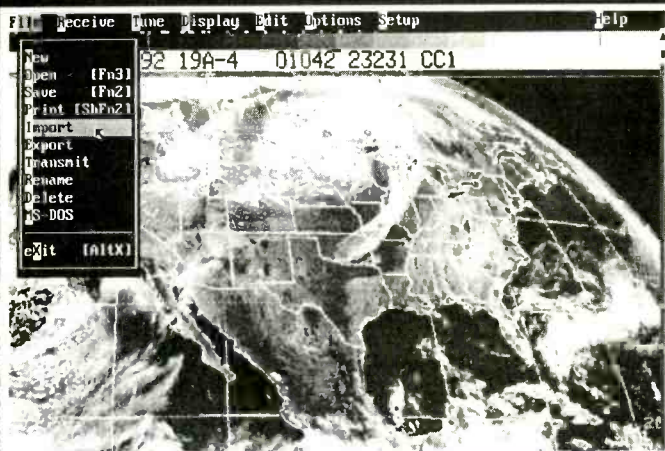

Now under Windows or DOS

PC HF Facsimile is a simple, yet comprehensive shortwave fax system for the IBM PC and compatibles. It includes an FSK demodulator, advanced signal processing software, tutorial cassette, and complete reference manual. With your PC and SSB receiver getting FAX is a snap. Here are just some of the features:

- Mouse or Menu Driven Unattended Operation
- Easy Tuning Oscilloscope
- Start/Stop Tone Recognition
- Up to 256 Levels
- Single Scan per Line with EMS Memory
- Programmable Colorization
- Brightness and Contrast Control
- Transmit Option Available
- Image Zoom, Scroll, Pan, Rotation
- Grayscale on all Popular Printers
- Worldwide Broadcast Schedule
- Worldwide Frequency Listing
- CGA, HGA, EGA, VGA & Super VGA
- Time Lapse Frame Looping
- Slide Shows
- Programmable IOC & Line Rates
- Image Cropping
- Automatic Radio Control
- NAVTEXT & RTTY Option Available

Call or write for our free catalog of products. Visa & MasterCard welcome.

Software Systems Consulting
615 S. El Camino Real, San Clemente, CA 92672
Tel. (714) 498-5784 Fax. (714) 498-0568



Now, hear 225-400 MHz military aircraft on your scanner's 118-136 MHz band! Ideal for monitoring Thunderbirds and Blue Angels air show stunt coordination, military flights, combat training, midair refueling and more!

The **CVR-4 Scanverter** comes with a universal adaptor kit so that it can be connected directly to a handheld scanner for portability, or to the rear of a base or mobile scanner (BNC and Motorola adaptors included).

- Frequency Range:** 216-406 MHz
- Sensitivity:** 1 microvolt
- Power Required:** Alkaline battery; 9 volt @ 13 mA
- Connectors:** BNC
- Dimensions:** 4"H x 1-1/2"W x 2"D
- Weight:** 6 oz.
- Bypass Loss:** 2 dB @ 400 MHz, 6 dB @ 800 MHz

For Airshows, this is what you need;
plane and simple!

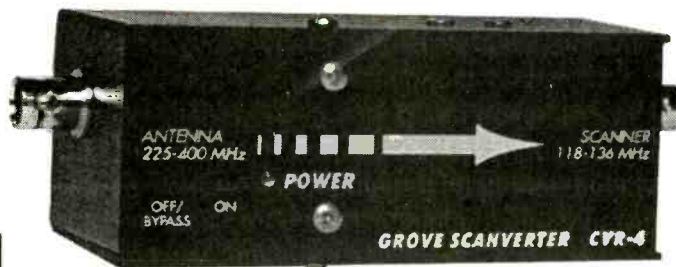

only \$99^{95*}

* plus 5% UPS Ground Shipping

(800) 438-8155

300 South Highway 64 West
Brasstown, NC 28902

(704) 837-9200 (business office)



**GROVE
ENTERPRISES**

"When you know it's Grove, you know it's good"

A JOURNEY TO MOROCCO



El Housseima

By Colin Miller

Morocco is a unique blend of old and new, mountain and sea, east and west. Somewhat larger than California, it is a bridge between Black Africa and Europe. The westernmost of the Maghreb (Morocco, Algeria and Tunisia), Morocco borders the Mediterranean Sea on the north and the Atlantic Ocean on the west. Algeria is its eastern neighbor, with Mauritania to the south. It is separated from Spain only by the narrow Straits of Gibraltar.

Man's origin in Morocco dates back to the earliest prehistoric times. The first inhabitants known in the area were the Berbers, who originally came from the Eastern Mediterranean before 2000 B.C. They settled in a wide area of Northwest Africa, as far west as the Canary Islands. In a northward push, the Berbers helped the Arabs invade Spain in the 8th century. Today they are mostly found in the mountainous regions and deserts of Africa.

In the 12th century B.C. came the Phoenicians, who were followed by numerous other tribes, ethnic groups and dynasties such as the Vandals, Byzantines and Arabs. The Alawites (a Shiite Muslim group) emerged in the 17th century, and their dynasty has been reigning over Morocco up to the present time.

Morocco has struggled for its independence from Britain, France and Spain at various times during the past two centuries. On March 2, 1956, it became an independent Sultanate, and Tangier became a part of the country. The following year a kingdom was established with Muhammad V as sovereign. He was succeeded by his son Hassan, who is the present king.

The population in 1987 was estimated at 23,376,000, 45.1% being located in urban areas. The official language is Arabic, but French, Spanish and English are also spoken.

invading Portuguese; some rampart remains hide the old medina, or old quarter of the city. Beyond the walls, luxury hotels, restaurants and shops abound. Casablanca is where President Roosevelt met with Winston Churchill in 1943. About that time the city was also the setting for the movie "Casablanca," starring Humphrey Bogart and Ingrid Bergman.

Rabat, with nearby Salé, is the administrative capital with nearly a million inhabitants. Gently sloping hills lead to tranquil plains covered with cork oaks. The Bou Regreg river inlet offers a fine view of the city. On the river banks two different towns developed: Rabat and Salé, designated by the Arab chroniclers as "the town of the two river banks." The city was named after the ancient Ribat (fortified camp). The administrative district was founded in 1912, when Rabat became the capital of the then French Morocco.

The royal palace, the offices of the Prime Minister, Royal Guard, Ministry of Endowments and Islamic Affairs, and other institutions are located in a district known as the "Mechouar." Rabat and Salé are undergoing extensive development nowadays, especially building; luxury villas and high rise apartments flourish everywhere, in keeping with careful town planning.

Tangier, the ancient Phoenician trading post of Tingis, is strategically located on the Straits of Gibraltar. As Africa's closest port to Europe, Tangier has always been an outpost of both continents. In 1923 it became a neutral and demilitarized international zone, set up by France, Spain and Britain. The town retains that feeling of adventure and dream which attracts large numbers of tourists. It's also the royal summer residence.

The Cities of Morocco

Everybody knows the name of the famous Moroccan metropolis known as Casablanca, but there are few who know its history. It was Punic, Roman and Berber, and was formerly called Anfa. The Portuguese occupied it in 1575 and gave it the name of Casa Branca, i.e. "white house." The Spanish later named it Casablanca, and it is known to Moroccans as Dar Beida.

In modern times the city has astonishingly extended from 20,000 inhabitants in 1900 to more than three million today. It is the economic capital of Morocco, and its chief trading and industrial center, as well as one of the greatest ports of Africa.

Some of its districts still cling to the one-story architectural tradition. The city preserves some traces of its heroic defense against the



Modern day Casablanca.

Other major cities include the imperial cities of Marrekech, Fez and Meknez, and also Oujda, Agadir and Kenitra. Oujda is a major railroad center near the Algerian border. Agadir, on the Atlantic coast, suffered a devastating earthquake in 1960. Kenitra, 30 miles from Rabat, was the site of a US military base for many years.

The Role of Radio

Broadcasting in Morocco dates back to 1927, when Radio Casablanca inaugurated a 2.5 kW transmitter at Rabat on 305 meters, which was later upgraded to 6 kW. During the 1930's, Radio Maroc came on the air, and operated on shortwave using an out of band frequency of 12830 kHz, a common occurrence among shortwave broadcasters back then.

Another early station of the 1930's was actually operated by a ham, EA9AH, who made experimental transmissions from Tetuan in the then Spanish Morocco. La Estación Experimental Nacionalista had regular news broadcasts in English and Spanish three times a day on 14004 kHz using a 500 watt transmitter.

In November 1942 US forces landed at Kenitra, and later set up a network of AFRTS stations for the Navy and Air Force.

A number of private stations also came on the air over the years, broadcasting from Tangier. According to an early *World Radio Handbook*, these included Radio Africa Maghreb, Radio Africa Tangier, Radio Inter Africa, Pan American Radio, Pan American Radio Intercontinental, Radio Tangier Commercial Broadcaster, and the Voice of Tangier. The last mentioned, incidentally, was the

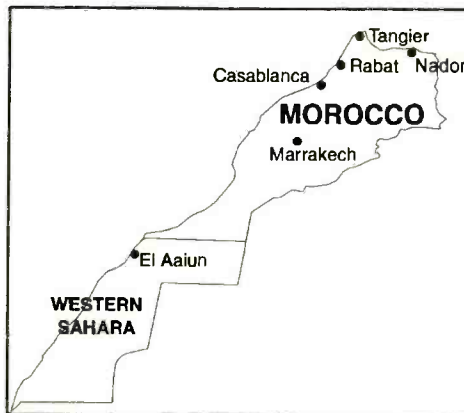

forerunner of Trans World Radio. In 1956 the International Zone was abolished, and by 1960 all these stations had been nationalized.

On December 19, 1949, the Voice of America inaugurated its first 50 kW shortwave transmitter from a 622 acre relay site near Tangier. This station was constructed by RCA and became fully operational in 1953. It is still on the air today, serving North Africa, the Middle East, and parts of Europe. It consists of four 100 kW, two 50 kW and four 35 kW shortwave transmitters. The station is on the air for two periods each day — from 0300-0800 and again from 1500-2400 UTC on about 20 frequencies. More than a dozen languages are used, and English relays can be heard on 15205 kHz from 1700-2200 UTC to Europe, and on 21625 kHz from 1600-2200 UTC to Africa.

Radiodiffusion Télévision Marocaine is the Government-run station, with studios in Rabat. It operates three national networks on long, medium and short wave, with relays on FM. Owing to the mountainous terrain, FM is confined to the main cities. Network A broadcasts in Arabic; Network B in French, English and Spanish; and Network C in Berber and Arabic. The shortwave transmitters are located near the VOA Tangier site. There are three 50 kW and one 100 kW units. The station can be heard in English as follows: 1400-1500 UTC Monday to Friday on 17595 kHz, 1700 to 1800 on Saturday; on 17815 kHz also Sunday from 1900-2000 on 11920 kHz. Radiodiffusion Télévision Marocaine has been noted in the past until midnight UTC sign off on 15335 kHz.

A station that has been operating from Morocco since 1960 is Radio Méditerranée Internationale, or Medi-1, a joint government and private commercial operation. It originates from studios in Tangier, and transmits on long, medium and short wave, as well as FM. The shortwave transmitter is at Nador, a town about 10 miles south of the Spanish Mediterranean enclave of Melilla, and operates on 9575 kHz with 250 kW in French and Arabic. RMI can sometimes be heard until sign off at 0100 UTC. For the DXer who likes more of a challenge, try logging the station's 1,200 kW longwave transmitter on 171 kHz, which can sometimes be heard during winter on the East Coast.

ROYAUME DU MAROC
MINISTÈRE DE L'INFORMATION
RADIODIFFUSION TÉLÉVISION
MOROCCAINE

المملكة المغربية
وزارة الإعلام
الإذاعة والتلفزة المغربية

Q. S. L.

M: R. S. ROSS
F (KHZ): 12595
Date: 31.10.1992
Heure (GMT): 14:12 - 14:40

الإذاعة والتلفزة المغربية تشكركم على تذكركم وتنتسى ان تكون يومها عند حسن ظنكم بها ولكم الشكر جالسا

La RTM vous remercie pour votre rapport d'écoute et espère que ses programmes vous satisfait.
The Moroccan Broadcasting System Thanks you for your reception report and hopes that you enjoy its programs, yours faithfully,
Discueur Technique PJ
Chef de la Division de l'Équipement

Signé: Youssef El-Mouhamed Jemal Edde

Why buy a TNC?

PC HF FAX + PC SWL \$179.00

SPECIAL COMBINATION OFFER

For a limited time, if you order PC HF FAX \$99 (see our other ad in this issue), you can add our new and improved PC SWL 3.0 for \$80.00 instead of our regular low price of \$99.00.

PC SWL contains the hardware, software, instructions and frequency lists needed to allow you to receive a vast variety of digital broadcasts transmitted over shortwave radio. All you need is any IBM PC or compatible computer and an SSB shortwave receiver. The product consists of:

Demodulator
Digital Signal Processing Software
200 Page Tutorial Reference Manual
World wide Utility Frequency List
Tutorial Audio Cassette with Samples

PC SWL automatically decodes Morse code, RTTY, AMTOR, SITOR, NAVTEX and ASCII.

PC SWL lets you tune in on world press services, meteorological broadcasts, ham radio operators, coastal shore stations, aviation telex and much more digital action on the shortwave bands. Why pay for another expensive box when a simple interface and your PC can do the job?

ADVANCED FEATURES:

Tuning Oscilloscope
Digital Waveform Presentations
Auto Calibration and Code Recognition
Continuously Tunable Filter Frequencies
Variable Shift
Adjustable CW Filter Sensitivity
Unattended Capture and Printing
Integrated Text Editor
Integrated Log and Database
Shell to DOS applications
Seamless Integration with PC HF Facsimile

Call or write for our complete catalog of products. Visa & MasterCard welcome.

Software Systems Consulting
615 S. El Camino Real, San Clemente, CA 92672
Tel: (714) 498-5784 Fax: (714) 498-0568

MARRY YOUR RADIO!

*Hear More! Log More!
Store More! Control More!*

Computerized Radio Monitoring - Introduces the wild world of the radio/computer combo. Covers planning, software choices, techniques, radios, automated logging, even remote monitoring!.....\$22.95

See your radio book dealer or order direct

\$ U.S. only • Add \$2 s/h (\$3 foreign),
\$1 each additional book • VISA/Mastercard welcome
Catalog \$1 (free with order)

Order now from

Tiare Publications
P.O. Box 493 • Lake Geneva, WI 53147

NEW ADDRESS!

To serve you better,
MIL-SPEC COMMUNICATIONS
has moved to a newer larger facility. See our new address and telephone number below.

Call us today for Bearcat, AOR and Realistic® scanners and the best shortwave listening equipment.

MIL-SPEC COMMUNICATIONS

P.O. Box 633
Englewood, FL 34295-0633
(813) 474-6818

THE SPECTRUM ANALYZER

High Tech For Your Listening Post

By Bob Grove

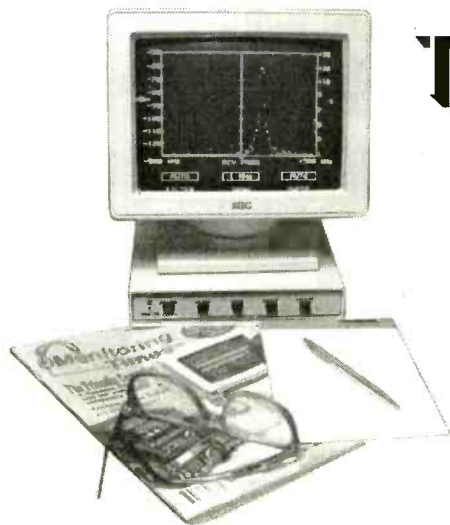

For many listeners, a monitoring setup consists of a scanner and/or short-wave receiver, and appropriate antenna(s). We may indulge ourselves further with a clock, tape recorder and other accessories as well. But there is one accessory that places monitoring power a quantum leap above the average.

Probably the most useful test instrument in any communications shop is the spectrum analyzer. It is used to troubleshoot transmitting and receiving equipment and systems, tune filters and duplexers, adjust cable and satellite TV systems, identify and isolate interference, detect and locate "bugs," catalog less-used frequencies for new licensees, and more.

Radio hobbyists can find new signals, check out local sources of interference, analyze filters and antenna performance, check preamps and other accessories, detect undercover communications, track propagation changes, profile local spectrum usage, identify sources of strong-signal overload, track repeater jammers, and many more imaginative applications!

But just what is a spectrum analyzer anyway, and how does it work? While a spectrum analyzer may look like an oscilloscope—a test instrument with a screen—the resemblance is only skin deep.

An oscilloscope operates in the "time domain"; that is, the display represents the behavior of an electrical signal during a fraction of a second. As shown in the accompanying illustration, the time interval begins at the left of the screen and ends at the right.

A spectrum analyzer, on the other hand, operates in the "frequency domain"; the screen shows a portion of the radio spectrum, often several megahertz wide. Each radio signal on the air shows up as a "spike," its height proportional to the signal strength.

While a scanner in its search mode may eventually reveal the presence of unknown signals, it does it by hit and miss; while it is laboriously sampling each frequency one at a time to see if it is active, the spectrum analyzer shows the entire spectrum at once. If a signal

comes on—even briefly—the spectrum analyzer nabs it.

But laboratory spectrum analyzers may or may not have audio detectors; and those that have them are generally of poor quality since they are used visually to analyze the characteristics of the signal, not to derive audio content. With one or two exceptions, they are also very expensive—typically well above ten thousand dollars!

At the present time, only one low-cost spectrum analyzer with audio recovery is widely advertised: the AVCOMP SA-65A (\$2855 from AVCOM, 500 Southlake Blvd., Richmond, VA 23236; ph. 804-794-2500).

At this low price (compared to other spectrum analyzers), some compromise in performance must be expected. The AVCOM has wide frequency coverage (1000 MHz) and includes a battery for brief portable operation (although it weighs a hefty 16 pounds); but it has poor adjacent-channel selectivity (it isn't a communications receiver), FM-only audio recovery, severe frequency drift, and it cannot display and hear a signal at the same time.

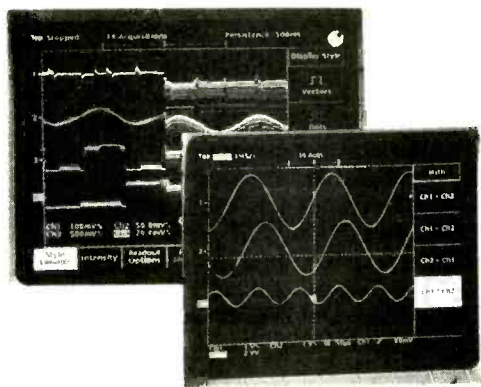

Oscilloscope screens reflect frequencies in the "time domain."

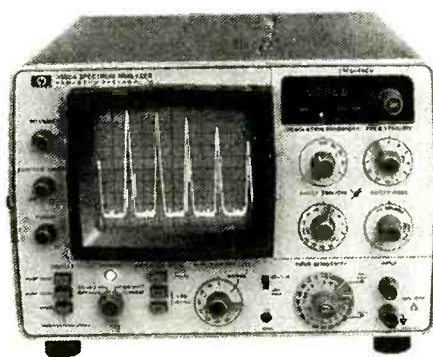

A spectrum analyzer screen, like the one shown on the Hewlett Packard 3580A, operates in the "frequency domain."

Enter the SDU

In the 1930s, the Panoramic Corporation introduced their Panadaptor, a spectrum display unit (SDU) that could be attached to a receiver, creating a makeshift spectrum analyzer.

A powerful spectrum surveillance tool, the SDU is the low-cost alternative for visually detecting signals on the air. Of course, it's only low cost if you already have a receiver with which to use it!

But SDUs are very choosy about their host receivers; they must be internally connected to the receiver's intermediate frequency (IF) stage, and are frequency-specific.

SEE WHAT YOU'RE MISSING

Turn your ICOM R7000, R7100, or R9000 into a powerful spectrum analyzer! Plugs into any receiver or transceiver that has an IF output jack!

Enjoy the high-tech advantage of counter-surveillance professionals who depend upon spectrum analyzers to find eavesdropping transmitters ("bugs").

As the spikes appear on the screen you can tune them in quickly; no need to wait for the slow, hit-and-miss search of a scanner. A "freeze" function allows you to hold and examine all of the signals present at any moment in time.

Your receiver's tuned signal is the center of the screen, with up to 10 MHz (or as narrow as 100 kHz) of the spectrum displayed simultaneously! Nail those unknowns as soon as they transmit!

Ideal for locating jammers, identifying sources of radio interference, studying signal propagation, testing antennas, aligning receivers and transmitters, and much more!

Connect the SDU-100 to any TTL monochrome monitor, or to the matching VID-100 9" CRT monitor. 12 VDC powered for mobile or field environments; AC adapter included (the VID-100 is AC powered).

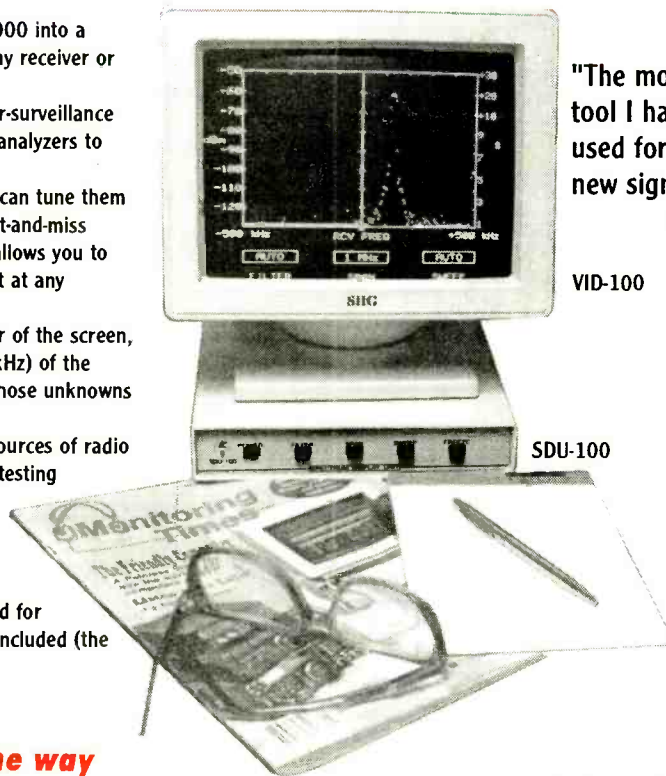

"The most powerful tool I have ever used for discovering new signals."

-Bob Grove

VID-100

SDU-100

ORDER SDU-100

TODAY

Only \$ **499⁹⁵!**

plus \$8 UPS ground shipping

(800) 438-8155

VID-100 - \$149⁹⁵ plus \$8⁵⁰
UPS ground shipping.

**Call today to change the way
you view radio!**

**GROVE
ENTERPRISES**



300 South Highway 64 West
Brasstown, NC 28902
(704) 837-9200

At the present time, most consumer-affordable SDUs are designed to be used with the 10.7 MHz IF of the Icom R7000/R7100. If an IF jack is not present on a receiver, internal modification is necessary to provide one.

The lowest cost SDU presently on the market is the Grove SDU-100 (\$499.95 plus \$149.95 for the matching CRT monitor). Plugged into the rear panel of the host ICOM R7000 or R7100 receiver, the combination makes a very powerful spectrum surveillance tool, displaying up to 10 megahertz of spectrum.

Such add-on accessories are, of course, bulkier than fully-integrated spectrum analyzers, but that is usually an agreeable tradeoff for the reduced cost, especially for fixed installations.

Putting the SDU To Work

One of my long-time fantasies was to go to Las Vegas and hear what really went on in the casinos where security is rampant. The January Consumer Electronics Show (CES) was the perfect excuse! Packing a special portable version of the SDU-100, a tunable receiver, and a Grove No-Tenna, I checked into a Las Vegas hotel.

The Grove SDU-100 Spectrum Display Unit

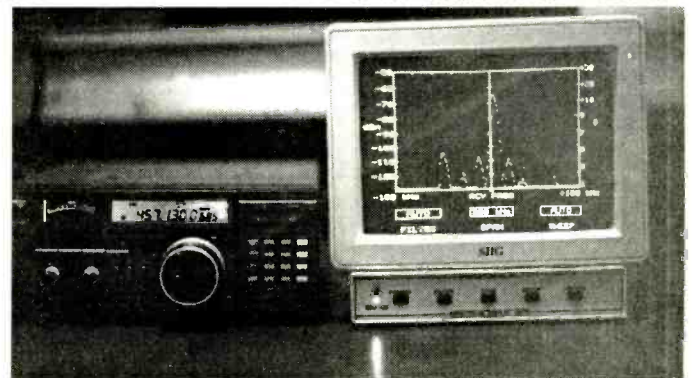

In a matter of seconds the No-Tenna was hooked between the aluminum window frame and the surveillance setup. It didn't take long to identify which signals were the strongest, nor where they came from—they were the casinos!

Within moments I heard on 451.225 MHz, "Casino One to Control—is she going to comply?" "She is now!" came the curt reply. Shortly, an alarm tone on 451.600 MHz was followed by, "10-33, we have a 482; we're on our way down." Then on 451.700 MHz, "He's a local; could be a repeat offender. We're surrounding him now. Here come the troops."

Such intrigue is much easier to spot using an SDU—or a spectrum analyzer—because the visual pattern shows frequently-used channels;

signal strengths of the spikes provide an indication of the signals' relative distances, and whether they come from base, mobile or handheld radios.

Imagine using a spectrum-displaying receiver at an air show; spotting discrete stunt frequencies is a snap. Similarly, an SDU flags wireless mikes at entertainment events, strategic communications at disaster scenes, intercommunication in military convoys and exercises, and so on.

As listeners search for new accessories improve their monitoring capabilities, the spectrum analyzer or spectrum display unit should not be overlooked. They enhance the senses by adding vision to hearing and eliminating **M** the guesswork.

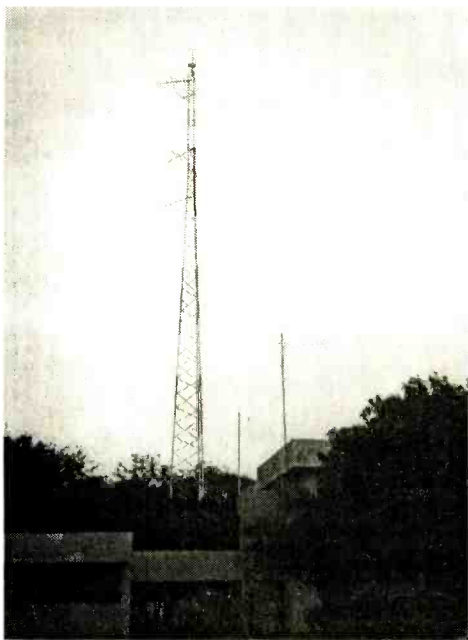

Escape to West Africa

Radio Gambia

By David Gilden

When it comes to finding a way to escape the cold temperatures of Boston, I'm no dummy. I learned a few years ago that January is the best time to say hello to the warm tropical weather of West Africa and good-bye to the harsh northeast winter.

The Gambia is a small country jutting into the middle of coastal West Africa's Senegal and spread out along either side of the River Gambia which extends 295 miles. With a land area of approximately 4000 square miles (smaller than Connecticut!), this former English colony has sometimes been called "the Smiling Coast," an apparent reference to its smile-like shape in the map of West Africa.

In 1965 The Gambia was granted its independence with Sir Dawda Jawara as its President. The official language is English, and it is home to only one million people. This is in contrast to most West Africa countries which are much larger and are francophone (French speaking). Everyone lives together here in peace following the religious teachings of Islam.

Tourism brings people from all over Europe, especially from Scandinavia. With approximately 50 miles of coastline—a good part of it being beautiful unspoiled beaches—it is a popular destination for sunbathers! Today there are several places to stay in the capitol Banjul (formerly known as "Bathurst"). The fancy tourist hotels are in Bakau which is along the Atlantic Ocean. With superb weather and friendly people the Gambia offers the tourist all he or she could wish for a holiday. Many American people of African origin have been coming here to visit "Juffure." This little Gambian village, located upriver, is

where Alex Haley's ancestors came from (portrayed in the movie *Roots*).

That's all well and good, but that's not the reason why I traveled here. My interest is in the local music of the Mandinka people which features a novel combination of the harp and lute called the "Kora." The first known reference to the Kora is by Mungo Park in his book *Travels in the Interior Districts of Africa* (1799), where he describes it as "a large harp with 18 strings." The Kora is made from a large gourd covered with cow skin and has 21 strings of fishing line! It has a sound like that of a harp, and with its intricate playing style is reminiscent of the flamenco guitar! Gambia is home to many excellent musicians who have performed at folk festivals throughout North America. The very famous UK "Womad" world music festival has also played host to many West African musicians. Peter Gabriel and his record company "Real World" have recorded some of these artists.



Life in Gambia is depicted in this photo of a West African market.





A tape recorder patched into my Sony 2010 makes "air checks" for the record — and brings home a taste of Gambia.

While most visitors stay along the Atlantic coast in the nice hotels, I stay several miles inland in the old town of Brikama. As I travel through the small villages and flat, hot countryside of the Gambia, I always hear sounds. Some of these sounds are women working, drummers practicing or someone checking out the local news on their battery powered radio. The electrical utility company, GUC ("Gambian useless corporation") provides power at best intermittently and with frequent brown outs.

Village life is often quiet and slow; there is usually the sound of a radio somewhere along the unpaved side streets. The radios are on all day, and for hours at a time there is a background of "Afro-Pop" music to every conversation. Nevertheless, traditional folk music is still holding its own, despite the wave of new music and styles from the west.

Radio Gambia is located a few miles from the Atlantic Ocean at "Mile Seven" on the road to Banjul. The station and its antennas are surrounded by a tall fence with security guards wielding machine guns! During an attempted coup in 1981 while President Sir Dawda Jawar was in London at the royal wedding of Prince Charles, the radio station was one of the first places to be taken over. From London, Sir Dawda Jawara appealed to Senegalese government for troops to help regain his power. The Senegalese troops have remained there ever since. Because of this action, a year later the "Senegambia" confederation came into effect.

Since there is no regional TV station, radio plays a very important part in everyday life. Radio Gambia broadcasts in English as well as five local languages: Mandinka, Fula, Jola, Wollof and Sarahulay. Programming consists of music and news and includes educational shows, as well (see sidebar 1).

Near the end of a recent stay I had a chance to visit the national service of "Radio Gambia." I had been invited to copy some Kora music from their large tape library. They maintain a large

Sidebar 1 A typical broadcast day schedule on Radio Gambia:

648 kHz medium wave; 91:0 FM
Local time is the same as GMT:

Time

- 06:25 Callsign, National Anthem
- 06:27 Program Parade
- 06:30 Recitations of the Holy Koran
- 06:55 Upcoming programs/sports news
- 07:00 National news (English, Mandinka, Fula, Wollof)
- 07:45 Announcements/sports
- 08:00 Close Down
- 09:55 Callsign (Interval Signal)
- 09:57 Program Parade
- 10:00 English/Social Studies lesson (For Primary One school)
- 10:20 Interlude of music
- 10:30 English/Social Studies lesson (For Primary Two school)
- 10:50 Interlude of music
- 11:00 English/Social Studies lesson (For Primary Three school)
- 11:20 Interlude of music
- 11:30 Educational programming
- 12:00 National news (Jola, Sarahulay)
- 12:30 English/Social Studies lesson (For Primary Four school)
- 12:50 Interlude of music
- 13:00 National and International news: (English, Mandinka, Fula, Wollof)
- 13:45 Announcements
- 14:00 Close Down
- 16:55 Callsign
- 16:57 Upcoming programs
- 17:00 Local programming
- 18:00 National and International news
- 18:45 Public notices
- 19:30 Literary corner
- 19:45 Letter box
- 20:00 Musical requests
- 20:30 Educational forum
- 21:00 National and International news
- 21:30 Songs and composers
- 22:00 Local news
- 22:30 Golden Oldies
- 23:00 Recitations of the Holy Koran
- 23:45 News summary
- 00:00 National Anthem, Close down

archive of traditional folk music indigenous to the Gambia. These tapes contain not only folk music, but also family anecdotes and historical events. When I arrived, Madi Juwara, who is the studio engineer, said he would be happy to give me a tour of the station. He also gave me permission to take a few photos. (It helped to

Save on **ALL** Radio Shack Scanners & Radios WITH MANUFACTURERS WARRANTY IN U.S. (copy available on req.)

3 WAYS TO SAVE

1 **FREE**
SHIPPING & HANDLING
48 STATES

2 **BIG**
PRICE REDUCTION

3 **NO TAX**
COLLECTED
49 STATES

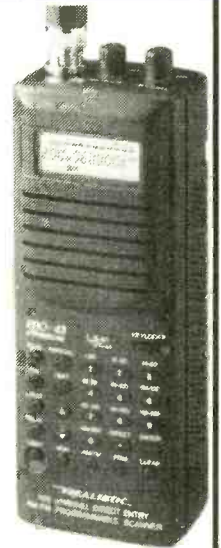

PRO 43, S298 WITH BATT'S

CALL FREE: 1-800-433-SAVE Since 1981 9-5 Central Mon.-Fri.

The Difference Is The Price

USRADIO®

USRadio 377 Plaza, Granbury, TX. 76048

NEW: TONE READER SUPPORT!

ScanStar™
Scanning & Monitoring Software

Professional Edition Features

- o Tone controlled scanning & logging with Optoelectronics DC440.
- o Spectrum analysis on R7100, R9000, AR3000 and NRD535.
- o HF Monitoring Assistant & much more!

Standard Edition Features

- o Scan multiple groups, banks and search ranges all at the same time.
- o Comprehensive data management.
- o Print reports, log activity to disk/printer.

Supports These Radios

R7100, R7000, R9000, FRG9600, AR3000, NRD535, NRD525, R8, MR8100.

System Requirements

IBM/ISA PC with 2 MEG RAM, hard disk, VGA or MONO, serial port and cable for each radio and tone reader. RS232 to TTL interface for Yaesu/Icom. 286 or faster, 386 recommended.

Standard Edition \$49⁹⁷

Professional Edition \$79⁹⁷

Plus shipping, handling and taxes. Visa/MC accepted.

1-408-296-4224

FREE DEMO COPY

Download from BBS, 2400-9600 N81, login as "guest".

1-408-258-6462

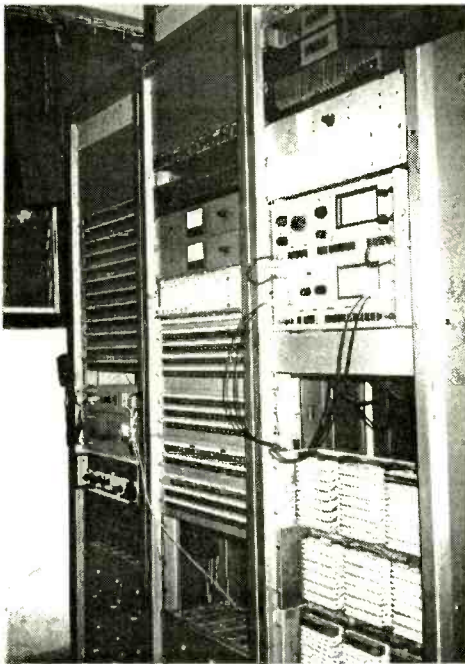

Radio Gambia's studio control.

mention that I would send the staff copies of their photographs!)

Radio Gambia transmits on both medium wave (AM) and FM band. The medium wave programming is broadcast via two main transmitters, each 10 kilowatts. These transmitters are located at "Bonto," some 30 km (18 miles) from the studios.

The transmitters, made by Marconi (based in the U.K.), were originally installed in 1974, and because of their age they are constantly having breakdowns. This service does not cover the whole country, so reception upriver at the town of Basse is always very poor. To address this problem, a regional radio station at Basse was added. This station simulcasts the news and educational programs to the rural people in the "provinces."

The Gambian government has long sought help from the French to rehabilitate Radio Gambia, and has requested a more powerful transmitter for nationwide coverage. In 1989 the British Government, through the "Overseas Development Assistance" program, donated an Eddystone FM transmitter. The FM transmitter is situated at the Mile 7 studio, with a power of 500 kilowatts.

Originally, this was to be a link to the MW transmitter at Bonto. It now serves a dual purpose, as the FM provides better reception for listeners in the capitol Banjul and the bustling market district of Serekunda. In the production studio I noticed that there were no turntables, which are commonplace in radio studios. In their place were several reel to reel tape machines.

Sidebar II African Shortwave Loggings from Brikama, The Gambia

All times GMT. "/" = Parallel

Time	Station	Frequency (kHz)
01.33	Gambia R.Syd	910
02.53	South Africa	15220
08.53	Liberia ELBC	7275
04.00	Swaziland	5055
09.00	Mali	11960/9635/ 7285
09.20	Morocco	9575
14.45	Mauritania	9610
15.00	Guinea	7215/9650
15.40	Senegal	4890/765
21.59	Sierra Leone	3315
22.34	Mali	4835
22.40	Gambia	648
23.00	Ghana	3366/4915

Sidebar III International loggings from my location in Brikama:

Time	Station	Frequency (kHz)
01.00	Iraq	9022
01.10	HCJB	21455
01.14	VOA	15205/9455
02.10	Moscow	13670/15420
02.11	BBC	15310
02.30	Germany	3995
02.35	Albania	11820
03.46	BBC	3955
03.48	Switzerland	13635
04.00	Turkey	9445
09.20	Vietnam	15010
09.30	WHRI	11705
09.36	Moscow	15340/17765/ 15595
15.49	KFBS Saipan!	9465
15.50	UAE	11795
16.20	VOA	17800
16.22	France	17620
16.35	WYFR	21525
22.52	Syria	12085
22.54	Australia	13605
23.18	New York Radio	6603.8 USB (aviation weather)

During the tour, Mr. Lamin Ceesay (who is an announcer and newscaster) noticed I was traveling with my new Kora. Naturally, he asked, "Can you play the Kora?" After he heard me play for a few minutes, he asked if I would like to be interviewed for a Radio Gambia program, and of course I said, "Yes"!

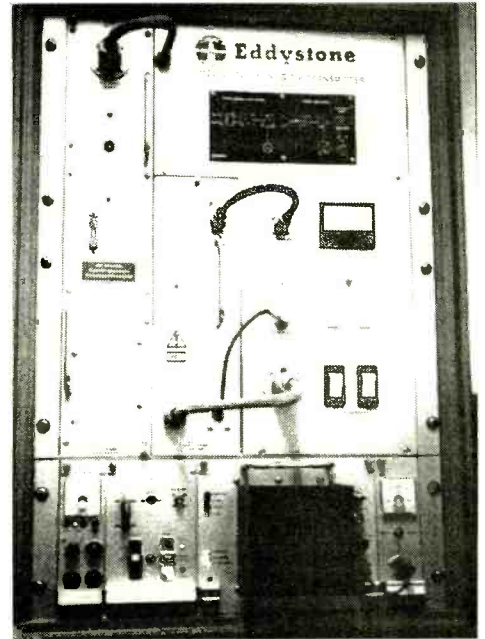

Radio Gambia's FM transmitter.

There are two other radio stations in the Gambia. Radio "Syd" is found on medium wave, playing a mixture of pop music and news. In addition to broadcasting in English and local languages, they also have programming in German, French, and Swedish. After all, this a radio station for the sunbathing tourist!

The relatively new FM broadcaster "Radio One" (102.1 FM) is a privately owned commercial station. The "voice over" heard on most of the advertisements features the owner's wife. It surprised me to see that they had a compact disc player and two turntables! While I was visiting, their main transmitter was down and they were using an old aircraft transmitter until their main transmitter was fixed.

After over two months in the hot West African sun, it is hard to return to the tail end of winter in the USA. On one trip I was granted a reprieve when the left engine stalled, and our "airbus" was forced to make an emergency landing in Dakar, Senegal. We found out that we would be here for a day and a half staying in a big western-style hotel situated right by the ocean! This was "Most Excellent"! I had more time to DX and make airchecks of the local FM radio stations in Dakar with my trusty Sony 2010, patched to my Pro-Walkman. At the Hotel N'gore I even met two more Kora musicians and made arrangements to record their performances.

Such tapes make great memories, and working in Boston with Afro-Pop in the background, I feel like I managed to stay in Gambia just a little longer.

MT

FINALLY - NOW AVAILABLE IN THE USA

The Decoder that is the STANDARD of the European Continent.
The

HOKA CODE-3 USA Version

Many radio amateurs and SWLs are puzzled! Just what are all those strange signals you can hear but not identify on the Short Wave Bands? A few of them such as CW, RTTY, Packet and Amtor you'll know - but what about the many other signals?

There are some well known CW/RTTY Decoders with limited abilities and high prices, complete with expensive PROMS for upgrading, but then there is CODE-3. It's up to you to make the choice, but it will be easy once you know more about CODE-3. CODE-3 works on any IBM-compatible computer with MS-DOS with at least 640kb of RAM, and a CGA monitor. CODE-3 hardware includes a complete audio to digital FSK converter with built-in 115V ac power supply and RS-232 cable, ready to use.

CODE-3 is the most sophisticated decoder available for ANY amount of money, and the best news of all, is that it is available from a United States dealer.

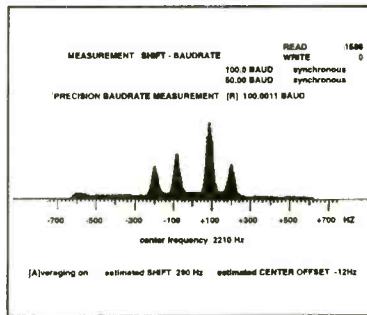

Simulated Speed Measurement Module

26 Modes included in standard package include:

- | | | |
|---|------------------------|--|
| • Morse | • ARQ6-90/98 | • FEC-A FEC100A/FEC101 |
| • RTTY/Baudot/Murray | • SI-ARQ/ARQ-S | • FEC-S • FEC1000 |
| • Sitor CCIR 625/476-4 | • SWED-ARQ-ARQ-SWE | • Simplex |
| • ARQ - Navtex | • ARQ-E/ARQ1000 Duplex | • Sports info 300 baud |
| • AX25 Packet | • ARQ-N-ARQ1000 | • ASCII |
| • Facsimile all RPM (up to 16 gray shades at 1024 x 768 pixels) | • Duplex Variant | • Hellsreiber - |
| • Autospec - Mk's I and II | • ARQ-E3-CCIR519 | • Synch/Asynch |
| • DUP-ARQ Artrac | • Variant | • Sitor • RAW (Normal Sitor but without Synch. |
| • Twinplex | • POL-ARQ 100 Baud | • ARQ6-70 |
| • ASCII | • Duplex ARQ | • Baudot F788N |
| | • TDM242/ARQ-M2/4-242 | • Pactor |
| | • TDM342/ARQ-M2/4 | |

Available as extra options

- Option 3 Piccolo\$85.00
- Option 4 Coquelet.....\$85.00
- Option 5 4 special
- ARQ & FEC systems
- TORG-10/11,
- ROU-FEC/ RUM-FEC,
- HC-ARQ (ICRC) and
- HNG-FEC\$115.00
- Option 8
- SYNOP decoder..\$85.00

- All models in typical baud rates with possibility of changing to any desired value of speed and shift.
- All options are available from the main menu, saving or loading to and from hard/floppy drive in bit form, means no loss of unknown signals!
- HURRY! For a limited time the Standard CODE-3 package includes FOUR options: 1. OSCILLOSCOPE 2. ASCII STORAGE 6. AUTO CLASSIFY 7. PACTOR
- Support after the sale. Computer Aided Technologies is dedicated to customer support!

STANDARD CODE-3 PACKAGE \$595.00 ADD'L OPTIONS \$85.00 - \$115.00 EA
(Shipping/Handling \$7.50)

ORDER NOW!

COMPUTER AIDED TECHNOLOGIES

P.O. BOX 18292 - SHREVEPORT, LA 71138

ORDER DESK - (318) 636-1234 (9 a.m. - 5 p.m. Central)

FAX (318) 686-0449 (24 Hrs)

Technical support line (318-687-4444) - 2 p.m. to 5 p.m. Central (M-F)

(See our ad on page 31 & 57)

MOVING?



Let us know four to six weeks before you move and we will make sure your MT arrives on schedule. Just remove the mailing label and affix below. Then complete your new address (or any other corrections) in the space provided.

My new address:

Monitoring Times

P.O. Box 98
Brasstown
NC 28902

AFFIX OLD LABEL HERE

It's time you found out...

What over 185,000 people already know.

NOW YOU'RE TALKING!

was written with you, the reader, in mind.

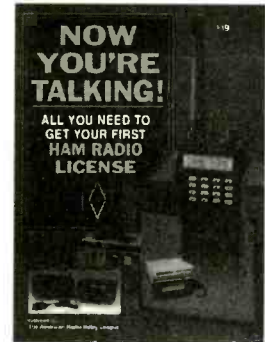

There's never been a more exciting time to get your Ham license. You can use Amateur Radio as a fun, friendly method of local communication, an invaluable tool in emergencies, or even experience the thrill of talking to Astronauts and Cosmonauts in orbit.

Whether you want to enter Amateur Radio as a Technician and choose to skip the code, or as a Novice licensee, *Now You're Talking* will provide you with the information you need in bite-size, easy-to-understand diagrams, photos and sketches, you'll be familiar with all the questions used to make up the FCC test...and you'll be ready for it.

In addition to study material that won't let you down, you'll find invaluable operating hints and tips you'll use once you pass your test. *Now You're Talking: All You Need to Get Your First Ham License* is the book you'll use even after you've passed your exam.

You can shop around for bargains, or you can join the thousands of licensed amateurs who have used *Now You're Talking* to pass their exam. Order your copy today:

Enclosed is \$19 plus \$4 for shipping (a total of \$23) or charge \$23 to my
() VISA () Mastercard
() Discover () American Express

For more Information Call
1-800-326-3942

Signature _____

Acct. No. _____

Expiration Date _____

Name _____

Address _____

City _____ State _____ Zip _____ MT

THE AMERICAN RADIO RELAY LEAGUE
225 MAIN STREET
NEWINGTON, CT 06111

Utility World

Larry Van Horn
c/o MT, P.O. Box 98
Brasstown, NC 28902

A Visit with the Russian Navy

Henry Brown, in Massachusetts, recently had the chance to visit two Russian Naval vessels during their port visit in Boston. The ships had been operating with the US Navy doing joint exercises in the Atlantic.

Henry visited the *Marshall Ustinov* and the *Admiral Kharlamov*. He said these vessels were loaded with antennas. The Russian vessels were strung with cage-like horizontal dipoles, which appeared to be about 40 feet on each pole. The lead wires also used this cage-type construction. Each side of the antenna was apparently insulated from the other.

Henry said these ships were also festooned with discone-like antennas, some of which resembled the type commonly used by scanner monitors. Others of this same type resembled upside down dicons with unusual elements added. All of these antennas, in addition to some huge search radar, satellite communications and missile guidance antennas were clearly visible on both Russian ships.

This description by Henry would add a considerable amount of credibility to the general consensus that the Russian Navy relies heavily on HF radio for its communications networks.

Use Table 1 to update your *Grove Shortwave Directory* on those stations involved with Russian Navy communications. Other possible Russian naval frequencies include:

5137.0	5173.0	5385.0	5428.0	5445.0	6735.0	6765.0	6770.0
6778.0	6780.0	6967.0	10680.0	10750.0	10796.0	14792.0	

Ship to ship: 5808.0 14492.0

Russian Submarine broadcast frequency CW: 17.1 kHz

Stations in this network include:

RIW - Khiva
RJS - Vladivostok
ROD9 - Severmorsk
UDK - Severmorsk
UFD - Arkhangelsk
URD - St. Petersburg
Other calls noted include: RES RYA RYD UDI

Many thanks to Henry Brown of East Falmouth, MA, for his contribution to this month's column.

Tors Cove Revisited

When Len Merkoske, up in Thunder Bay, Ontario, recently logged "Rainbow Radio" on 13285 kHz, he sent a reception report to the station. In return they sent him some background on the station.

The station is divided into two sections for communications purposes: marine and aviation. On the marine side of things, the station IDs as *Tors Cove Radio* and can be found on the following frequencies: 2487.0 and 7460.0 kHz (both frequencies are calling channels).

On the aviation side of the house, the station IDs as *Rainbow Radio* and can be heard using the following calling channels: 3458.0, 5604.0, 8819.0, and 13285.0 kHz.

Len also sent the station's mailing address for those monitors interested in QSLing the station. Correct reception reports should be sent to:

Tors Cove Radio or Rainbow Radio
P.O. Box 5754
St. John's, NFLD Canada A1C 5X3

Thanks for the information, Len, and please check in again.

**Table 1: Commonwealth of Independent States
Russian Navy Communications System**

All frequencies kHz

Possible long range naval broadcast frequency: 6775.0

C9CB - Maputo, Mozambique

CW: 8642.0

CMU967 - Santiago, Cuba

CW: 5198.0	5258.0	6562.0	6690.0	6868.0	7692.5	8120.0	8569.0
9512.0	10435.0	10644.0	10725.0	10796.0	11114.0	11278.0	11555.0
14492.0	14792.0	14968.0	15384.0	15497.0	17424.0	18167.0	29936.0

COY851 - Havana, Cuba

CW: 13390.0

COY895 - Havana, Cuba

CW: 7935.0 9169.0 10536.0 11406.0 14697.0

COZ67 - Havana, Cuba

CW: 5058.0

RCV - Moscow, Russia (DE Marker)

CW: 3222.0	3889.0	4264.0	5174.0	5322.0	6352.0	6376.0	6456.0
6904.0	7574.0	8045.0	8048.0	8084.0	8576.0	9456.0	9476.0
10894.0	1202.0	12716.0	12723.0	12744.0	12757.0	13042.0	13465.0
16296.0	16952.0	16948.0	19098.0	19584.0	21764.0	21812.0	

RIT - Vaygach, Russia

CW: 4244.0	4526.0	4802.5	4807.0	4851.0	4971.0	5783.0	6776.0
6934.0	6940.0	6961.0	8596.0	8600.0	9218.0	10508.0	10888.0
12064.0	12692.0	12745.7	12752.0	15656.0	16936.0	18876.0	20084.0
20484.0	20968.0						

RIW - Khiva, Uzbekistan

CW: 5128.0	5184.0	6394.0	7577.0	7779.0	7836.0	7965.0	8508.0
8523.0	8569.0	9145.0	9236.0	9370.5	10435.0	10510.0	10690.0
10798.0	10912.0	11000.0	11531.0	11592.0	12056.0	12675.0	12731.0
12782.5	12872.0	13064.0	13425.0	13828.0	14141.0	14405.0	14446.0
14468.0	14505.0	14509.0	14541.0	14545.0	14556.0	14559.0	14644.0
14792.0	15648.0	15656.0	16338.0	16392.0	16397.0	17088.0	17110.0
17148.0	17468.0	17504.0	18264.0	18504.0	18560.0	18664.0	18696.0
18808.0	18952.0	19090.0	19098.0	19210.0	19985.0	19993.0	20072.0
20328.0	21380.0	21764.0	21784.0	22568.0	22710.0		

RMP - Kaliningrad, Russia

CW: 3212.0	3181.0	4163.0	4524.5	5194.0	5881.0	6330.0	6500.0
6968.0	6972.0	8680.0	9082.0	10118.0	10888.0	10908.0	11132.0
12720.0	12833.0	13633.0	14397.0	16016.0	16176.0	16934.0	18720.0

RMT - Chelyuskin, Russia

CW: 14221.9

RNO - Moscow, Russia

CW: 12793.0 17163.0

ROD2 - Severmorsk, Russia (CQ Marker)

CW: 8450.5

ROT/RTMS - Moscow, Russia

CW: 6345.0	8450.5	8456.0	8458.0	8500.0	12995.0	13045.0	17045.0
17130.0	17155.0	22450.0	22454.0	25130.0	25175.0		

ROT2 - Moscow, Russia

CW: 6445.0 17045.0

UJE - Moscow, Russia

CW: 12967.0

UMS - Moscow, Russia

(Note: This station has been DF'ed by the FCC to two sites - Petropavlovsk and Murmansk)

17.1	6849.0	7564.0	8478.0	10490.0	11430.0	13449.0	14140.9
19029.0	19517.0						
Murmansk -	7007.0	14171.0	18152.0	21285.0			
Petropavlovsk -	7007.0	14140.9	21032.0				

UIT - Lazo, Russia

CW: 11326.3

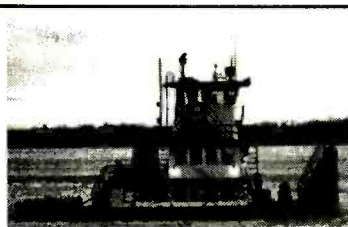

Ron Seymour

Mississippi River Station off-the-air?

Thomas McKee likes to listen to towboat communications on the Mississippi and connecting rivers in the HF spectrum. He has sent some information on Mississippi River marine stations that support towboat operations on the big river.

During extensive monitoring sessions, Tom noticed that morning schedules are no longer being maintained by WGK in Saint Louis and WJG in Memphis. His call to the WGK telephone number yielded a "disconnected" message. My check with telephone information in Granite City and Saint Louis also came up negative. It appears that the WGK frequencies of 4408.0 and 6212.0 kHz can be scratched from our list.

A similar phone call to WJG in Memphis by Tom did produce some answers. WJG still has their capability on 4098.0 kHz but does not maintain any schedules on that frequency which is not used often. Most of their traffic is handled on VHF-FM frequencies.

Tom says that your best bet for towboat communications is now WCM in Cincinnati, Ohio, on 4065.0, 6510.0, 8213.0, and occasionally 12362.0 kHz. Try them from 1200-1300 UTC on 4065.0 and at 1815-2000 on 6510.0 and 8213.0. The marine utility frequencies of 4125.0, 4146.0, 4149.0, 6224.0, 6227.0, 6230.0, 8294.0, and 8297.0 kHz are also very active with this type of traffic early in the morning here in the United States.

Thanks, Tom, for the update. If anybody has additional information on the fate of WGK in Saint Louis, drop me a line at the Brasstown address.

May Mailbag

Norman Talley in neighboring Georgia saw my query in the March issue about Ary Boender's acronym STANAFORMED. Norman says Ary didn't have it exactly right: it should be STANAVFORMED, or Standing Naval Force, Mediterranean. This is a naval group made up of ships of the NATO (North Atlantic Treaty Organization) nations of the Mediterranean (Italian, Greek, Turkish, U.S. and U.K. navies, and probably Spain by now). This task force was formerly known as NAVOCFORMED, or Naval On-Call Force, Mediterranean.

According to Norman, there is also another naval force called STANAVFORLANT, or Standing Naval Force, Atlantic. This force is composed of U.S., U.K., Belgian, Dutch, Portuguese and probably Danish naval units active on the Atlantic side of NATO. Thanks for the insight, Norman; I have now added that one to my master abbreviation file.

Robert Hall in Capetown, RSA, recently faxed in some answers to a few queries I had about terminology in some of his recent logs. "Boustane" means "Egyptian Embassy," which can be anywhere. For instance, "Boustane Lome" indicates that the originator is the Egyptian Embassy in Lome. The term "Khargia Cairo" means the MFA (Ministry of Foreign Affairs) in Cairo.

I also asked about the term, "Redbus," in the December 93 logs (page 41 under entry 19756.8). Robert believes that "Redbus" is the Indonesian description of what we know as the FEC-S mode.

Thanks for the input, Robert, and especially for faxing it to the office; it sure speeds things up.



Pot Luck Frequencies

For several months now, I have been working on a growing list of frequencies and/or intercepts I have

Table 2: Can you help identify these transmissions?

w=working; all freqs kHz

2010.0	Control KT & KM (USB), 13236.5 might be associated freq T1J calling Tango/Echo (USB)
2063.0	J9K w D9T mentioned Fort Raleigh/Fort Ord (USB)
2095.0	CA (NCS) wBC,GH,MT,PB (USB) Poss Alligator net in ARS
2273.5	3J w 6T (USB)
2285.0	A6DX/SXGZ (CW)
2515.0	MK60 w 3V1W (USB/RTTY)
2586.2	1X4 w B8Q (USB) Poss trng net
2854.0	JVD2 (CW)
3000.0	Advance 21 w Advance 30, Advance 01, King Coal (USB)
3207.0	CJDJ5 w KAQ5 (SITOR-A)
3314.0	TPYI clg K9F9 (CW)
4017.0	KM/V/T w control in RTTY/USB
4267.0	Blasting Cap w Pinhole (USB)
4277.0	Spector Ops (USB)
4415.0	Juliet 33 with coded msg (USB)
4545.0	Bravo Echo conducting net chk-in with other LL stns (USB)
4555.0	Vesper/Thunder discussing switchboards (USB/LSB)
4567.0	Crossbow 1 w Silver Armor USB f/4667.0
4596.0	White Lightning w Tropical (USB) said QSY Tac command net night frequency
4640.0	XO5 Headquarters element X23 (USB)
4666.3	Crossbow calling Blackboard, went green (USB)
4667.0	Crossbow 1 w Silver Armor with auth codes USB, QSY to 4567.0
4711.0	V3O/1MM re RTTY/Scrambled comms (USB)
4783.0	STRATCOM EAM at H+50 (USB)
4845.0	Billboard calling Mellow (LSB)
4850.0	V3X-Y7S (LSB)/OM-2U (Possible Army), see 4900.0
4900.0	CHM 7211 w CHM 7231 w training exercise msg (USB) SUB: Microwave Popcorn. V3X-Y7S (LSB)/OM-2U (Possible Army), see 4850.0

listed as "unknowns." Tracking down unknowns can be a lot of fun, so I thought I would share some of these with you from time to time. Together we might be able to ID the users of some of these frequencies. If you have any additional intercepts or insight on any of the frequencies in Table 2, drop me a note at the address in the masthead.

• Here an interesting callsign identification: For years on HF many folks have reported the callsign "S4JG" on US military voice circuits. This callsign has long been associated with the US Navy TACAMO (Take Charge and Move Out) aircraft. Not so fast, Bunky. One reader says that callsign is used as a general voice callsign by all HF equipped aircraft on non-Naval communication circuits. Thanks to this anonymous contributor for that information.

• A new US Strategic Command HF designator has surfaced. Brian Scott in Ft. Worth has identified W-110 with the frequency 15449 kHz. Slowly, but surely, *MT* readers are helping fill out the list of such designators. To all helping in the project, many thanks. I will run an update of the complete list very soon in an upcoming Utility World column.

Speaking of US Stratcom frequencies and the USAF, 11243.0 kHz is definitely part of the Global system, but to quote the words of one operator at Offutt, "11243 is a GHFS discrete." Based on traffic, it would appear that ACC (Air Combat Command) aircraft on US Stratcom missions are authorized to use this frequency for operational relays and voice message traffic. The old SAC night time primary 6761 is also still in use, but it doesn't have the same mission it once did, nor the traffic. It would appear that 6761 is now definitely a discrete channel for ACC US Stratcom mission aircraft.

As I close this month's column, I would like to dedicate this Utility World column to the memory of Dave White, a long time radio hobbyist, contributor and friend of *Monitoring Times*. Dave was also a brother Chief Petty Officer in the United States Navy. My condolences to Dave's family. Poco, you will be missed. *MT*

Utility World

Utility Loggings

Abbreviations used in this column

ACC	Air Combat Command (USAF)	MFA	Ministry of Foreign Affairs
AFB	Air Force Base	MHz	Megahertz
AFTN	Aeronautical Fixed Telecommunications Network	MOI	Ministry of Information
AM	Amplitude Modulation	M/V	Motor Vessel
AMC	Air Mobility Command (USAF)	Nav	Navigation
ANG	Air National Guard (USAF)	NBDP	Narrow Band Direct Printing
ARQ	Automatic Repetition on Request	NORAD	North American Air Defense Command (USAF)
ARQ-E3	Single channel ARQ teleprinter system	NOTAM	Notice to Airmen
ATC	Air Traffic Control	PAP	Polska Agencja Prasowa
CAP	Civil Air Patrol (USAF)	QSX	I am listening to... (frequency)
Comms	Communications	RAF	Royal Air Force (British)
CG	Coast Guard	RCC	Rescue Coordination Center
CQ	General call for any radio station	RTTY	Radioteletype
CW	Continuous Wave	SAM	Special Air Mission (USAF)
DE	Morse code abbreviation for 'From'	SAR	Search and Rescue
EAM	Emergency Action Message	SATCOM	Satellite Communications
Fax	Facsimile	SIGMET	Significant Meteorology
FEC	Forward Error Correcting	SITOR-A	Simplex teleprinting over radio system, Mode A
FEC-A	One-way traffic FEC teleprinter system	SITOR-B	Simplex teleprinting over radio system, Mode B
FEMA	Federal Emergency Management Agency	Unid	Unidentified
FT	Fox Tango	US	United States
FW	Fox Whiskey	USAF	US Air Force
GHFS	Global HF System (JCS Network)	USB	Upper Sideband
HF	High Frequency	V	Letter commonly used in CW markers, (i.e.-VVV DE CFH)
JCS	Joint Chiefs of Staff	VFT	Voice Frequency Telegraphy system
LDOC	Long Distance Operational Control		
MARS	Military Affiliate Radio System		
Meteo	Meteorology		

All frequencies in kilohertz (kHz), all times in UTC. All voice transmissions in English unless otherwise noted.

- 2182.0 LFO-Orlandet Radio, Norway, with USB traffic at 2155. (Ary Boender-The Netherlands)
- 2765.0 Vancouver Military, BC Canada, talking to port Quebec about equipment maintenance in USB at 0700. (David Bashaw-Manteca, CA via Internet) *Welcome to the column, David, appreciate the Internet logs-Larry.*
- 3013.0 Delta 232 working Los Angeles in USB at 1245 in USB. (John D. Linton-Dallas, Texas)
- 3331.0 HEP-Unid station sending V CW marker at 0729. (Boender-Neth) *I believe this station is Bern Radio, Switzerland. Wonder what its function is?-Larry*
- 4002.0 Bucharest Meteo, Romania, with 50 baud RTTY at 2246. (Boender-Neth)
- 4032.0 US Army MARS net, 9th District in USB at 0512. (Gordon Levine-Anaheim, CA)
- 4090.0 Foxy working Echo in USB at 1018. Sounded like an Alligator Playground net. (Harry Riddell-Rochester, NY) *Actually it is an FW net-Larry.*
- 4255.0 SUZ-Serapeum Radio, Egypt, with nav messages in CW at 1850. (Robin Hood-UK)
- 4275.0 SAA-Karlskrona Radio with traffic list in CW at 2320. (Hood-UK)
- 4372.0 US Navy FT network in USB at 0614. (Milan Prokes-Rexburg, ID)
- 4384.0 Halifax CG Radio working various call signs in USB at 0534. (Prokes-ID)
- 4442.5 RGC72-Kiev Meteo, Ukraine, with 50 baud RTTY at 2215. (Boender-Neth)
- 4469.0 Georgia CAP net identifying with Red Star numbers in USB at 0245. (Bob Pettengill-Blanchard, OK) *This the CAP Southeast Region primary freq-Larry.*
- 4570.0 DHJ51-Grengel Meteo, Germany, with weather fax charts at 1330. (Boender-Neth)
- 4600.5 DER-MOI Bonn, Germany, with V CW marker at 0850. (Boender-Neth) OLX-Prague, Czech Republic, with V CW marker at 0900. (Boender-Neth)
- 4610.0 GFA22-Bracknell Meteo, England, with fax weather charts at 1400. (Boender-Neth)
- 4721.0 US Navy FT net noted here in USB at 0609. (Prokes-ID)
- 4900.0 MFA Prague, Czech Republic, with plain language messages in 100 baud RTTY at 0845. (Hood-UK)

- 5211.0 Racetrack working 2278, routine traffic in USB at 0055. Asked 2278 if they had any traffic, then stated WGY992 terminates this call. (Barry Williams-Enterprise, AL, via Grove BBS)
- 5252.0 Unid station WFHP calling KCAV in CW at 2342. (Jack Dix-Yonkers, NY)
- 5258.0 RMJF-Unid Russian Naval calling CMU967-Havana, Cuba, with CW V marker at 2347. (Dix-NY)
- 5282.0 Stockholm Radio working CONDOR flight "Uniform Echo" in USB at 2316. Initial contact was on 5541 but QSY to 5282. (Hood-UK)
- 5422.5 CG Rescue 2130 and 1500 on SAR with cutter *Spence* in USB at 1600. Also used 383.9 MHz. (Fowler-MA)
- 5462.0 RAF Buchan, Scotland, working 8BV and 5ID in USB at 2311. (Hood-UK)
- 5506.0 Shannon VOLMET Radio, Ireland, with aviation weather in USB at 2321. (Glenham Duffy-Durban, South Africa) *Welcome to the column, Glenham; appreciate the telephone call and the fax'ed logs-Larry.*
- 5658.0 Bombay ATC Radio, India, working Air India 982 and Emirates 083 in USB at 2327. (Duffy-RSA)
- 5680.0 Edinburgh calling 1522, 1523 in USB at 1040. (Riddell-NY)
- 5688.0 Australian Air Force Townsville working Air Force Striker 111 reporting condition Bravo Sierra 2. Also briefly joined by Air Force Sydney in USB at 1134. (Lonnie Bunn-Raleigh, NC)
- 5696.0 Tango 1 Echo 3 working COMSTA Boston with flight ops in USB. (Henry Brown-MA via Internet) *Welcome to Ute World, Henry; thanks for the utility logs via Internet-Larry. CAMSLANT Chesapeake working various CG aircraft in USB at various times. (Levine-CA) See this month's content section for an explanation regarding this log-Larry.*
- 5806.4 ZKLF-Auckland Meteo, New Zealand, with weather forecast in CW at 0841. (Hood-UK)
- 5912.0 GXQ-British Military with foxes and RY tape in 50 baud VFT RTTY at 0846. (Hood-UK)
- 6224.0 ZLD-Auckland Radio with weather forecasts in USB at 0735. (Hood-UK)
- 6230.0 WFL-Memphis, TN, working *M/V Dorothy* in USB at 2100. (Neil Perdue-Madisonville, AL)
- 6375.0 PWZ33-Brazilian Naval Radio calling PWDO in CW at 2251. (Hood-UK)
- 6510.0 Australian type accents with weak comms and mentions of 'go green' followed by long periods of scrambling in USB at 1145. (Riddell-NY)
- 6524.0 Zoomer 1/2/3/4 on a practice bombing run in USB at 0030. (Paul Roales-Tulsa, OK) *Welcome, Paul, nice place for ACC bombers to hide-Larry.*
- 6535.0 Dakar ATC, Senegal, working various Air France aircraft in USB at 0450. Gave alternate frequency as 3452. (Williams-AL)
- 6683.0 SAM 27000 working Andrews AFB with phone patch to Andrew Ops sit room in USB at 0210. (Desert Commuter-Nevada) Same conversation between 0210 - 0220. (Henry D. Spearman-Los Angeles, CA)
- 6693.0 Couteney calling Halifax Military in USB at 0453. (Prokes-ID)
- 6710.0 US Navy Link 11 channel noted at 0419. (Jeff Haverlah-Houston, TX)
- 6723.0 US Navy FT network noted here in USB at 0424. (Prokes-ID)
- 6730.0 Personified working WAR46 in USB at 1228 in USB. (Riddell-NY) Reach7003 on X-903 working MacDill in USB at 0518 in USB. Sent him to 11176. (Prokes-ID)
- 6735.0 US Navy FT network noted here in USB at 2200-2230. Alpha Team calling Bravo Team in USB at 1320. Sierra Pete working Blue Crab in USB at 0408 then moved to 6750, 18027 and finally 9023. (Haverlah-TX)
- 6738.0 Delf 45 (Self ID'ed C-130) working MacDill with phone patch to Barksdale in USB at 0456. Tiger 3 working Tiger Base via phone patch, ID'ed himself as LC811 in USB at various times. (Haverlah-TX)
- 6756.0 Air Force One working Crown while enroute to JFK in USB at 1545. (R.W. Fogle-Cheektowaga, NY) *Congrats on your first logging, RW, nice catch. Be sure to join us often-Larry.*
- 6761.0 Rat 63 calling 85, with no response in USB at 0305. (Haverlah-TX)
- 6776.0 401 calling Scorpion Base for a radio check on unsecure HF in USB at 1315. (Riddell-NY) *Ah, one of my favorite frequencies, thanks, Harry-Larry.*
- 6817.0 Teaser Test working Highground 200 in USB. (Fowler-MA) *USAF channel-Larry.*
- 6989.0 SAM 202 working Andrews on F775 in USB at 2035. (Jeffrey Jones-Tracy, CA)
- 7813.0 Acclimate working various Air Force Rescue aircraft in USB at 0015. Also heard aircraft on 5696 and 11201, mentioned 381.0 MHz. (Jones-CA)
- 7918.0 Obvious Israeli Mossad number station with 5 character alpha message in USB at 0510. (Haverlah-TX)

7964.2	Portuguese Military, Azores, with messages to "COMGERPS OP" in SITOR-A at 1928. (Hood-UK)	11159.0	Concourse working McClellan in USB at 0212. They then moved to 7997.0 for voice and data transmissions. (Haverlah-TX)
8039.0	SAM 202 working Andrews with phone patch traffic in USB at 0237. (Jones-CA)	11176.0	Muroc 13 working Elemendorf GHFS, AK, with phone patch to Eielson. This is one of the new C-17 Globemaster III aircraft having major mechanical problems. In USB at 2120. (McDonald-Canada)
8040.0	Andrews AFB working Packass 01 with radio checks on F205 in USB at 0110. (Jones-CA)	11186.0	Rescue 111 working Halifax military with phone patch to RCC Halifax in USB at 1917. (Lewallyn-TX)
8048.5	Charlie 10 working Tango 27 on channel 4. Charlie 10 warned Tango 27 twice not to give frequencies out over the air. Frequencies given were 5063.5 and 6900.0. In USB at 0015. (Jones-CA) <i>Good one, Jeff, got them in the database. 6900 and this one have popped before. Staburst Ops has been heard here working aircraft 118 and on 6900.0 Possum was working Groundhog on frequency hotel, Jay Hawk has also worked Coyote/Mongoose in USB. My best guess is a USAF ANG operation-Larry.</i>	11214.0	Darkstar Mike (Sentry 50) working Darkstar Ops in USB at 1838. (Fowler-MA)
8297.0	KVR451-Miami Beach, FL, with short test transmission in USB at 2230. WFZ-Morgan City, LA, working <i>M/V Parchtide</i> (WV9250) in USB at 2248. (Perdue-AL)	11217.0	Bayonne GHFS working PAT 140 in USB at 2057. Also tried 8993/15015. Thule GHFS working Reach 2M8PH in USB at 2058. (Fowler-MA)
8308.0	US Navy FT network noted here at USB at 0055. (Haverlah-TX)	11220.0	Head Dancer working Andrews with position report in USB at 1535. (Lewallyn-TX)
8515.0	UFL-Vladivostok Radio, Russia, with CQ CW marker at 1200. (Dix-NY)	11226.0	WAR46 working Activated and Phosphate in USB at 2021. (Lewallyn-TX)
8540.0	UTW/USU-Unid Russian marine coastal station with V CW marker for 4KE at 1922, switched to 50 baud RTTY at 1925. (Dix-NY)	11243.0	Hawk 8861 calling Utah 51 on GHFS discrete frequency in USB at 0307. (Williams-AL) Ghost 81 working Sylvia 1 and Coyote in USB at 2347. (Haverlah-TX)
8720.0	HJN2, listed as being in Bogota, Colombia, at 1234 with SITOR-B traffic list. (Richard Baker-Austintown, OH)	11253.5	Habitat working G1J with crossband HF-SATCOM link in USB at 1628. (Lewallyn-TX)
8776.0	GTV with self described "Yankee Bravo" with EAM with now standard 6 character preamble in USB at 1655. (Haverlah-TX)	11447.0	Durkee working Rotator in red/green voice/data comms in USB at 2224. (Jones-CA)
8855.0	Argentina 161 working Canaries Radio	11628.0	2X and 2A passing number codes in USB at 0124. (Jones-CA)
8903.0	Kisangani ATC Radio, Zaire, working GNB036 in USB at 1839. N'djamena, Chad, working KLM 593 in USB at 2325. (Duffey-RSA)	11668.5	CSY-Santa Maria Air Radio with ID/RY tape in 50 baud at 0830. (Hood-UK)
8924.0	KLM Amsterdam LDOC, Netherlands, working aircraft in USB at 0108. (Pettengill-OK)	12107.0	Aria 1 (EC-18 Advanced Range Instrumentation Aircraft) working Aria Control (4950th TW Ops Center, Wright Patterson AFB, OH) and Hotel 4 coordinating data circuit with Cape Radio at 1952 in USB. (Baker-OH)
8933.0	Springbok, Johannesburg LDOC, RSA, working several aircraft in USB at 0100. (Pettengill-OK)	12729.0	UVA-Gelendzhik Radio, Russia, with message to <i>M/V NEFTAGZ 56</i> in CW at 0830. (Note the Russian Morse spells out Gelendvik, but the "V" character is transliterated to "ZH". Message headers were for Gelendzhik. I do not believe that UVA is Batumi as stated in the Klengenfuss book). (Robin Hood-UK)
8967.0	Alabaster 379 working Offutt with frequency request, given X-908 17992 and W-109 13247. (Prokes-ID)	12952.5	VIP-Perth Radio, Australia, with CW marker at 0939. This frequency used to be for VIS-Sidney Radio, now used by Perth. (Hood-UK)
8972.0	Echo working Bluestar and Picker 02 in USB at 0019. (Bunn-NC)	13201.0	Army 030 working Hickam in USB at 0128. (Bunn-NC)
8984.0	Packass 01 working Andrews via phone patch thru COMSTA Ports mouth in USB at 1345. (Riddell-NY) <i>Air Force patching to Air Force via the Coast Guard, very interesting-Larry.</i>	13207.0	Blue Crab working Huntress in USB at 2110. Strong interference from Air Force Sydney/Darwin, Australian Air Force. Talent 92 working Plantation (also on 5732) in USB at 1715. Dragnet Tango working Spirit passing track information in USB at 1715. (Haverlah-TX)
8992.0	Demon 86 working Great Wood in USB at 2214. Military? (Fowler-MA) <i>Probably USAF ACC aircraft-Larry.</i>	13217.0	SAM 27000 working Andrews in USB at 2127. Draft Beer working Sign Post on X-906 in USB at 2254. (Prokes-ID)
8997.0	McMurdo Base (ID's as MAC Center) working XD02 and XD03 in USB at 0617. Gave secondary frequency as 5726.0 (J.S. McDonald-Port Coquitlam, BC, Canada)	13367.1	5YD-AFTN Nairobi, Kenya, believe this is the 50 Baud RTTY carrying SIGMET-NOTAMS at 1845. (Dix-NY)
9002.0	Miniature working R6F with discussion regarding number codes in USB at 0330-0345. Anything to do with number stations? (Randy Miller-Tuallatin, OR) <i>This has nothing to do with numbers, Randy, just the US Navy doing its thing-Larry.</i>	13446.0	WGY908 FEMA District 8, Denver, CO, attempting to work WGY911-FEMA Headquarters, Washington, DC, for phone patch at 1847 in USB. (Baker-OH)
9014.0	Black 1 working a maybe German accented Black 2. Also on frequency Macho 1 working Macho 2 in USB at 2352. Some chatter about what sounded like Amarillo attack and maybe something that sounded like "return to Luke." (Haverlah-TX)	13927.0	Sentry 51 working Air Force MARS stations AFA2RU and AFA2TL at 1805 in USB for phone patch traffic. (Baker-OH)
9017.0	Heartland working Halloween in USB at 1833. (Fowler-MA) Sierra 91 working Mike 25 in red/green in USB at 1404. In past, these alpha ## call signs have called 9017 Fox 4, 5732 Fox 2, 13207 Fox 1. I still do not know what service or maybe agency they belonged to. (Haverlah-TX)	14736.3	Unid station sending 5 letter groups using 75 baud RTTY at 1524. (Dix-NY)
9023.0	Northern Lights working Charlie Charlie in USB at 0530. Talked about going to a SATCOM channel. (Miller-OR)	15015.0	Reach 92S6D (KC10) inbound Dover with explosives in USB. (Fowler-MA)
9032.0	Ascot 3200 working Haven enroute Ascension Island in USB at 0400. (Bob Lewallyn-The Woodlands, TX)	15026.0	US Navy Link 11 channel noted here at 1623. (Haverlah-TX)
9057.0	Uncle Sam working Golf Club on Sierra 309, moved here from 11226 in USB at 1647. (Haverlah-TX)	16013.8	DFQ21-Bonn Press and Information channel with German news summary using 96 baud FEC-A at 0855. (Hood-UK)
9106.0	ZHF44-Faraday Base working Halley Base. VSD-Halley Base working Faraday Base with weather info. Both in USB at 2356. (McDonald-Canada)	16813.0	UAT-Moscow Radiopassing mailbox traffic to UTDX-NIS Kosmonaut Pavel Belyayev in SITOR-A at 1255. (Hood-UK) <i>NBDP Channel 1613-Larry.</i>
9121.0	19 Romeo working Delta, Hardrock 19. Active throughout the day. Mentions of PI location, AAR and DBST Team. (Riddell-NY) <i>I have an indication of that Hardrock callsign on 8056.0. This is possible Army but not positive. Anyone understand Army lingo on some of the terms above that can help me ID these frequencies?-Larry</i>	17458.5	OZ working 3Y for mine field coordinates in USB at 1647. (Jones-CA) <i>The Army is my best guess-Larry.</i>
9251.0	English female 5-digit group "Lincolnshire Poacher" number station in AM at 2103. (Dix-NY)	17975.0	Periodic SELCAL activity on this frequency in USB at 1413-1500. (Haverlah-TX)
10279.7	RFLI-French Forces Fort de France, Martinique, in ARQ-E3/96 baud idling at 0314. Later "non-protege" messages. (Baker-OH)	18027.0	MFA Sofia, Bulgaria, with plain language message in 75 baud RTTY at 1605. (Hood-UK)
10493.0	912 heard working unknown station in USB. Also heard 9114. (Brown-MA)	18175.0	SAM 971 working Andrews AFB on F052 for WWV time hack in USB at 2139. (Jones-CA) <i>Weird, a plane full of HF gear and they need Andy for a time hack?-Larry</i>
10873.7	RFVI-French Forces Le Port, Reunion Island, in ARQ-E3/100 baud idling at 2028. (Baker-OH)	18195.0	German female 3/2-digit number station in AM at 1612. (Dix-NY)
11153.0	SAM 205 working Andrews AFB on F619 with phone patch traffic in USB at 1815. (Jones-CA)	18648.5	SPW-Warsaw Radio, Poland, PAP Polish news bulletin at 1829 using SITOR-B. (Dix-NY)
		18993.5	SPW-Warsaw Radio, Poland, with CW DE marker QSX on 16302.5. (Dix-NY)
		20498.5	Bonn Press and Information channel with German news summary in 96 baud FEC-A at 0858. (Hood-UK)
		22527.0	USU-Mariupol Radio working <i>M/V Rubezhnoye</i> in 50 baud cyrillic RTTY at 1121. Note ship name prints Rubevnoe in normal RTTY.
		22587.0	3BM7-Mauritius Radio with PAN relay from FFD-St. Denis Radio and weather bulletin in CW at 0830. (Hood-UK)

The Scanning Report

Bob Kay

c/o MT, P.O. Box 98
Brasstown, NC 28902

Homemade Scanning Antennas

Ham operators are constantly experimenting with antenna designs. Rocky Adams, K3PAQ, for example, mounted a metal trash can on his vehicle's roof and used it as an effective antenna on several Ham bands. Other Hams have used rain gutters and down spouts to receive and transmit radio signals.

As scanner buffs we can also enjoy experimenting with a large variety of antenna designs and ideas. And since our scanner radios don't transmit a radio signal, our antenna ideas are practically limitless. I've used the metal frame of sliding glass doors to effectively monitor between 30.00 and 150.00 megahertz. Another antenna that worked well was a 30 foot length of wire that was tied to a rock, and thrown over a tree branch. The result was an "inverted V" antenna that provided good results between 30.00 and 500.00 megahertz.

To calculate the length of your experimental antenna, the most popular method is to divide 468 by the frequency to be monitored. If the cordless phone band was the monitoring target, 468.00 divided by 46.00 megahertz indicates that the antenna should be approximately 10 feet long. As you probably know, the formula provides a half-wave dipole antenna. If you're interested in monitoring a specific frequency, divide 468.00 by the exact frequency in megahertz. The finished antenna will be a half-wave dipole that has been cut to resonate (receive), on the frequency of your choice.

Don't be afraid to place an antenna in the attic, behind a door, or above a dropped ceiling. Antennas can be placed behind paneling, under your bed, or temporarily hung from your window. In many situations, the antenna may need to be slightly modified to fit the space. Again, don't hesitate to bend an element or to make similar adjustments. If the antenna is a home brew, it can be specifically designed to fit into a restricted space.

With the arrival of spring and the resurgence of local flea markets and garage sales, keep your eyes open for used antennas. CB radio antennas, antenna mounts, and television antennas can usually be purchased for just a few dollars. And with a little creative ingenuity, you can modify a used antenna to receive the scanning bands. The old 102 inch, CB whip antenna can be used to monitor the cordless phone band. Indoor and outdoor UHF television antennas are excellent choices for monitoring the UHF scanning frequencies.

If you can't find antenna bargains at your local flea market, don't get discouraged. Visit your local Radio Shack store and modify a new antenna! Do you need a base antenna for the UHF and 800 megahertz Bands? No problem. Choose Radio Shack's low priced "U-75," catalog #15-1660. Converting the antenna is easy: (1) Remove the two reflector elements by drilling out the rivets. (2) Rotate the antenna to a vertical position and drill two mounting holes through the boom. Use the hardware provided to mount the antenna to a non-metallic mast.

After the conversion, the U-75 becomes an 8 element beam that can be used to monitor between 400 and 900 megahertz. Die-hard scanner buffs will argue that the elements should be trimmed for maximum efficiency, but unless you live near a television broadcast tower, the antenna will provide excellent results without further modifications. The U-75 can be mounted in a fixed position, or aimed with a standard TV rotor. To feed the antenna with coax, add a balun to the connection points. At \$16.99, the U-75 is a low cost antenna conversion that is affordable and available to everyone.

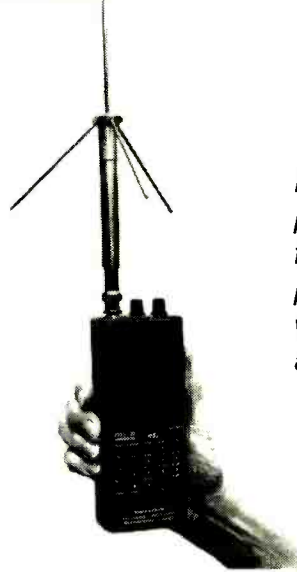

Edwin C. Wade made this portable, 800 MHz antenna from scraps of brass, plexiglass, coat hanger wire and a radio Shack adapter.

Another easy conversion is Radio Shack's "UHF Double Bow Tie," catalog #15-623. The Bow Tie antenna is a handy, indoor antenna for the 800 megahertz band. Again, the modification is simple: Turn the antenna vertically on its side and add a balun to the connection points. That's it! I've also used this antenna outside, on the roof, and it works quite well. For outdoor use, you'll need to make a custom mount and weatherproof the connection points with Radio Shack's, "Coax Sealant," catalog #278-1645. Radio Shack's Bow Tie antenna retails for \$15.99.

As already mentioned, beam antennas should be mounted to a non-metallic mast. Plastic or PVC plumbing pipe will work, but my personal choice is a solid wood, closet clothes pole. Cut the pole to length, use paint or urethane to protect the wood, and mount the antenna. Since the wooden pole is nearly identical to the diameter of a metal antenna mast, your mast hardware will fit and hold nicely.

In your search for antennas to modify, don't neglect your existing scanning antenna. Scanning antennas that have been exposed to the weather for five years or more should be checked for rust and corrosion. To restore the antenna's performance, drill out the rivets on the elements and use brass nuts and bolts to hold the antenna together. Prior to re-assembly, lightly sand the element connection points and apply a coat of shellac or similar sealer to the assembled antenna.

Repairs to aluminum antennas can be made with "Kool-it" aluminum solder paste. The paste is sold in tubes and is simply squeezed out as needed. The paste is heated with a torch or soldering gun and provides a relatively strong, low heat solder joint. The paste can be used to join aluminum to aluminum or aluminum to other metals. Kool-it aluminum solder paste can be found in your local hobby shop and/or department store.

Building, modifying or repairing scanning antennas doesn't require a degree in electronic theory. It's easy, inexpensive and if you haven't tried it, you're missing out on a lot of fun and experimentation!

Treasure Hunt

Roll down the car window, rest your arm on the door and cruise along the highway. The sound and feel of warm air, the road noise, the sound of passing cars—it's all part of the arrival of spring. But if you're trying to listen to your scanner radio, an open window on a warm day can almost make you wish for the cold winds of winter.

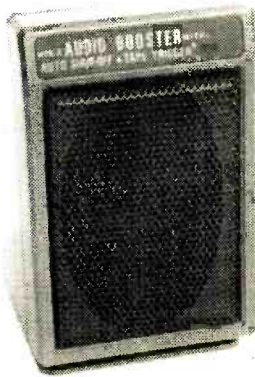

Before you decide to move to Alaska, check out the HTS-2 amplified speaker, by Naval Electronics. The HTS-2 features a tape trigger, external power jack, low stand-by current drain, a level control and a whopping 12 dB of audio gain. Best of all, the HTS-2 isn't large and bulky. The unit will easily fit into your hand and it's completely portable. Four AA batteries fit into the case, or the unit can be powered via your vehicle's 12 volt battery.

To win the HTS-2, here are the clues:

The HTS-2 amplified speaker from Naval Electronics could be a great addition to your shack—enter the Treasure Hunt today!

1. In the March '94 issue of *MT*, what page features the HTS-2?
2. The HTS-2 features automatic shut-off. True or False?
3. Is the Pro-2027 cellular restorable? Yes or No?

4. I purchased the new ANT-20 from Grove. How much did I pay, including UPS ground shipping?
5. Refer to March '94 issue of *MT*. What is a DC440?

The HTS-2 is available from Naval Electronics Inc., 5417 Jet View Circle, Tampa, Florida 33634. Retail price is \$29.95 plus shipping and handling. For more information, give them a call: (813) 885-6091, FAX: (813) 885-3789.

Frequency Exchange

The *North Carolina* highway patrol has realigned its frequencies. The new frequency assignments were downloaded to Grove's BBS and appear as follows:

Channel	Transmit	Receive	Channel	Transmit	Receive
1	42.78	42.62	10	42.50	42.50
2	42.62	42.62	11	42.86	42.82
3	42.80	42.52	12	42.82	42.82
4	42.52	42.52	13	42.58	42.38
5	42.66	42.60	14	42.38	42.38
6	42.60	42.60	15	42.68	42.94
7	42.76	42.64	16	42.94	42.94
8	42.64	42.64	17	42.72	42.92
9	42.70	42.50	18	42.92	42.92

The complete list contains the city and towns that are assigned to specific frequencies. If you want the complete list, it's free. Send a #10 SASE to the Frequency Exchange, P.O. Box 98, Brasstown, NC 28902.

Dropping just south of the North Carolina border, we can listen to the Air Force Base in *Charleston, South Carolina*. The following frequencies were sent in by an anonymous reader.

130.65	Command Post	165.0125	Maintenance A Net
138.075	OSI (Office of Special Investigations)	165.1125	Maintenance B Net
		165.1625	Maintenance C Net
138.175	OSI	173.025	Disaster Preparedness
141.525	OSI		
150.225	Base paging system	173.5375	Crash Crews
163.5375	Maintenance D Net	173.5625	Crash Crews
163.5625	Munitions Transport		
163.5875	Aircraft Refueling		

CD RECORDING OF MODULATION TYPES

71 emissions • 2½ hours • \$ 73

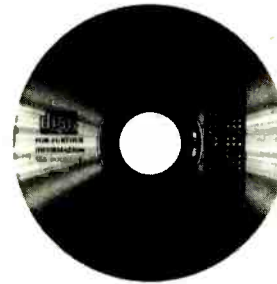

This unequalled product is based on 25 years of experience in the radio monitoring and publishing field. Two standard audio compact discs include 71 different recordings with superior digital quality. These CDs allow rapid access to the typical sound of all conventional and exotic radio communication systems found nowadays on HF. Connect your audio CD player to state-of-the-art decoding hard- and software and practice tuning these professional teleprinter and radio paging systems for easy analysis and display. Synchronization is perfect as a result of digital recording techniques that prevent any play-back speed deviations. The price includes worldwide registered airmail! Credit cards accepted - please fax or mail your order to ☺

Klingenfuss Publications
Hagenloher Str. 14
D-72070 Tuebingen
Germany

Phone 01149 7071 62830
Fax 01149 7071 600849

Heading back North, our next stop is *Cleveland, Ohio*. Here are the frequencies that are monitored by John Parks.

33.72	Fire Dispatch, secondary	460.15	Foot patrol
33.90	Fire Dispatch	460.225	First district
153.89	Fire ground #1	460.35	Detectives
154.145	Fire ground #2	460.40	Second district
155.22	Medical	460.45	Sixth district
155.385	Life flight	460.475	Fourth district
460.125	Traffic police	460.50	Tactical

Livonia, Michigan, is our next stop and it's also the home town of L. M. Clair. L.M.'s invitation included the following:

Detroit			
42.02	Freeway patrol	156.15	Livonia police, car to car
151.25	Parks	455.75	WJR traffic copter
154.665	Detectives	464.55	Wonderland Mall security
154.92	Detectives	469.55	Wonderland Mall security
155.505	Detectives		

Ready for a stop in Indiana? Bob Powell lives in *Marion County, Indiana*, and here are his favorite frequencies.

State Police	City & County Workers	
856.9625	854.4375	857.4375
857.9625	854.9875	857.9875
858.9625	855.9875	858.4375
859.9625	856.4375	858.9875
860.9625	856.9875	859.9875

Not all mountain passes are open, yet, but Mike Lehmpuhl lives near *Colorado Springs, Colorado*, and he has invited us to join him on a scanning adventure.

- 154.665 State Police
- 154.68 State Police
- 154.695 State Police
- 154.725 El Paso Co. Sheriff
- 154.755 Woodland Park Police
- 154.86 El Paso Co. Sheriff #2
- 154.965 Cripple Creek ambulance
- 155.16 Search & Rescue
- 155.175 Teller Co. search & rescue
- 155.23 El Paso search & rescue
- 155.535 Manitou Police
- 173.225 *The Gazette* newspaper
- 412.875 Fort Carson military police
- 450.15 TV channel 13, news remote
- 453.50 Airport police

Are you hungry? If so, let's stop in and visit with Roger Cravens. Roger hasn't volunteered to feed us, but he has provided a list of fast food frequencies for *Atlanta, Georgia*, and other locations throughout the U.S.

<u>Arby's</u>	<u>Jack in the Box</u>	<u>Taco Bell</u>
30.84	33.40	30.84
31.00	154.54	154.57
154.57	469.025	465.8875
457.55	30.82	
	30.84	<u>Wendy's</u>
<u>Burger King</u>		30.84
30.84	<u>Kentucky Fried Chicken</u>	31.00
31.00	31.00	49.83
170.305	33.40	49.89
457.55	170.3050	
457.5625	467.8125	<u>White Castle</u>
		461.8125
<u>Hardee's</u>	<u>McDonald's</u>	466.8125
30.84	30.84	170.245
31.00	31.00	170.305
35.02	33.14	
151.685	71.105	
151.805		
460.8875		

Roger's complete list contains more than 120 fast food frequencies mostly accumulated through his BBS contacts. If you want 'em, they're free for a #10 SASE. Send your request to the Frequency Exchange, P.O. Box 98, Brasstown, NC 28902.

Tired of scanning alone? Here's your chance to invite thousands of readers to your scanning shack. Send your favorite frequencies to the Frequency Exchange, P.O. Box 98, Brasstown, NC 28902.



Computer Corner

This is your last chance to receive a computer disk that contains more than 140 pages of nationwide railroad frequencies. The frequencies are written in ASCII format and can be converted into most word processors.

There are two identical files. One file is sorted by frequency and the second is sorted alphabetically. I retrieved both files into Word Perfect 5.1 and printed the

And The Winners Are ...

1993 Treasure Hunt Winners		
Month	Prize	Winner
JAN/FEB	Minolta Camera	A.W. Spier, Omaha, NE
MAR/APR	MAX System Antenna	Mark Spat, Swanzey, NH
MAY/JUN	Amplified Speaker	Scott Menke, Elgin, IL
JUL/AUG	Weather Station	Homer Ramby, Waynesville, OH
SEPT/OCT	Frequency Books	Michael Reeb, Lehigh, FL
NOV/DEC	Frequency Cards	All entrants received cards

information with ease. If you're a railroad fan, and are looking to start a data base of rail frequencies, this is the disk for you!

As in past offers, you can obtain the disk absolutely free by sending an IBM formatted disk (disk size and density is your choice), with return postage and the proper mailer to: Bob Kay, P.O. Box 173, Prospect Park, PA 19076. If you don't care to provide the disk, mailer and return postage, send \$5.00 dollars to the above address and I'll provide everything that's needed. Lastly, I ask for your patience. As most of you know, copying disks is a time consuming process. Please allow 5 weeks for delivery.

Cancer Gun

A California Jury has ruled that a California police officer's cancer was not caused by constant use of a hand held radar gun. Officer Eric Bendure died three weeks after the jury's decision. Approximately 50 medical experts testified at the trial, including a number of authorities on the health effects of microwave radiation.

The jury was apparently influenced by the testimony of Doctor Saul Rosenberg. Dr. Rosenberg testified that the officer's cancer pre-dated his exposure to radar.

The dangers of hand held radar is a hot issue throughout the country. In Connecticut at least 10 police officers have filed claims against radar gun manufacturers. A few police departments have banned hand held radar devices and/or have moved stationary radar units to the patrol car's roof.

Scanning Wal-Mart

Jeff Seale claims to have monitored Wal-Mart store managers on 154.60 megahertz. As most of you know, 154.60 is referred to as a "colored dot" frequency. The appropriate designations are as follows:

151.625	Red Dot	154.57	Blue Dot
154.60	Green Dot	167.73	Black Dot
464.50	BrownDot	464.55	Yellow Dot

If there's a Wal-Mart in your neck of the woods, punch in the colored dot frequencies and let us know what you hear.

Wash & Wear TV's

Replies to the question, "Have you ever washed your scanner radio?" are still coming in. Here's an excerpt from a recent letter.

"I never washed my scanner radio, but I did wash a 25" color TV. The TV set was totally submerged during a basement flood. After washing the chassis with a paint brush and soapy water, I let the unit dry for two weeks. It's been working for nearly 13 years!" (Howard Lash, Lynwood, IL).

Next Month

June is vacation month. Don't leave home without your scanner!

This is IT.



The cellular-capable ICOM R7100 production has been **STOPPED** in the United States. This is your last chance to get this powerful general coverage receiver!* Grove is down to the last few in stock, and after that, we can get **NO MORE!** Call today while supplies last!

* with continuous frequency coverage.

The R7100 offers continuous frequency coverage (no gaps) from 25 to 2000 MHz on a brilliant LCD readout, selectable tuning steps, USB/LSB/AM/FM modes with wide and narrow selectivity switching.

900 scannable memory locations store frequency, channel number, mode and search steps; ten search banks with memory channel lockout, 5 or 12 channel-per-second scan speed and scan-resume delay are also found on this model.

High sensitivity and stable SSB reception are additional perks, as are sensitive, all-mode squelch and easy pushbutton function selection.

OPTIONAL ACCESSORIES

ACC36 UT36 Voice Synthesizer	\$55.95
ACC71 SP20 Speaker	\$164.95
ACC72 TVR7100 Video Adaptor	\$218.95
ACC74 CT17 Computer Interface	\$109.95
ACC78 Service Manual	\$40.95
ACC83 MB5 Mounting Bracket	\$39.95
ACC138 MB23 Carrying Handle	\$11.95
ANT8N 46" Extendable Whip Antenna	\$23.95
Installation of one or more accessories	\$20.00

* Plus \$15.50 UPS Ground Shipping

CALL NOW!

(800) 438-8155

(704) 837-9200 (Outside Canada and US)

\$ 1349^{95*}



**GROVE
ENTERPRISES**

300 South Highway 64 West
Brasstown, NC 28902

The Beginner's Corner

"Uncle Skip" Arey, WB2GHA
Genie T. AREYI

Uncle Skip Opens His Mailbag

This month I think I'll try something a little different. Don't worry, Boss; anybody who has ever met me at the *Monitoring Times* conventions knows me to be a bastion of decorum. (NOT!)

Actually this critical shift will be relatively mild for me. Instead of writing a whole column on a single topic, I thought I might just dip into the mailbag and answer some of the more common questions that are thrown in my direction.

Hey, Uncle Skip, What is UTC?

In the movie *The Adventures of Buckaroo Banzai* (rumors that this is a biographical account of Uncle Skip's life are slightly exaggerated), Buckaroo reminds us of that basic concept of time: "No matter where you go, there you are." Wherever you are in the world, when the sun is over your head it is Noon. This worked out just fine until people started communicating over long distances. People are eating lunch in France just about the time the first light of the sun is peeking in my windows in New Jersey.

Shortwave radio allows a broadcaster to sling a signal across many time zones. To reduce the confusion this could cause, common practice in the shortwave broadcasting community is to report time in terms of UTC. UTC means UNIVERSAL TIME COORDINATED.

The old name for UTC was GMT for GREENWICH MERIDIAN TIME (also called Greenwich Mean Time) and was actually more explanatory of just what UTC is. If you look on a world globe or map you will see that the 0 degree longitude line (the ones that run from north to south) runs through the town of Greenwich in the United Kingdom. (It's a suburb of London, if you look really close.) The time computed at this 0 longitude line (sometimes referred to as the Prime Meridian or Greenwich Meridian) is the standard for UTC.

All other world time zones are computed from this point by international conventions and agreements. It's one of the few things just about every country can agree on! For example, the time zone we refer to as Eastern Standard Time (EST) is five hours behind the 0 longitude time zone.

To further avoid confusion UTC is usually stated in terms of a 24-hour clock. So when it's midnight or 00:00 in Greenwich, UK, it is 7:00 PM or 19:00 in New Jersey. Likewise it would be 6:00 PM or 18:00 Central Standard Time (CST), 5:00 or 17:00 Mountain Standard Time and 4:00 PM or 16:00 Pacific Standard Time.

Where most beginners get confused is when the US switches over to daylight saving time (DST). Our local time moves ahead an hour but UTC remains the same. That means that, during daylight saving time, at midnight 00:00 UTC, EDT time would be 8:00 PM or 20:00 (EDT) and so on back across the country. The easiest way to keep yourself from being confused about UTC is to keep reading *MT* every month. UTC and the domestic time conversions for Eastern and Pacific Time appear on the top of each page of *The Shortwave Guide*.

Want to know the current UTC? Tune into 5000, 10000, 15000 or 20000 kHz. WWV, Fort Collins, Colorado, will report the current COORDINATED UNIVERSAL TIME, which is what they call UTC. How come nobody ever thought to call it CUT? Probably because it would make so much sense that you couldn't get all those countries to agree on it.

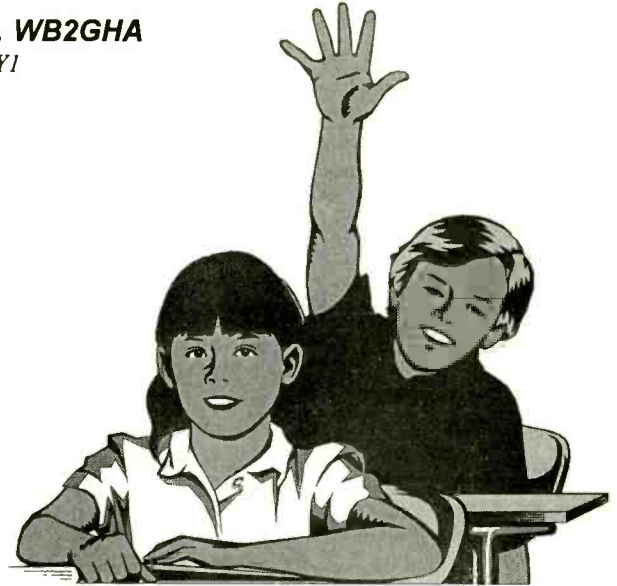

Hey, Uncle Skip, What's the Best Shortwave Receiver I Can Buy?

Well, I think you could probably persuade the Rohde & Schwarz Company in Germany to whip you up a custom rig for around 25 thousand dollars or so. Next best thing would probably be the Watkins Johnson HF1000 for about four grand, give or take the preselector option.

GET REAL, PEOPLE! Most of us dream about Maserattis but drive Mazdas! The best receiver you can buy is the one you can AFFORD that has the best performance characteristics for the money.

Purchasing a receiver should involve a bit of study before you lay down your hard earned dollars. First, keep an eye on Larry Magne's "Magne Tests" column. You will not only get a look at the latest equipment offered, you will also get a good education about the kind of things that are important about any receiver. You will learn to pay attention to frequency coverage, sensitivity, and selectivity. Magne's annual publication *Passport to World Band Radio* always includes extensive coverage of current receivers and their suitability to the task of monitoring. Similar information can often be found in the back pages of the *World Radio TV Handbook*, or in the *WRTH's 1993 Equipment Buyer's Guide*.

Old Uncle Skip has a few ideas about how a beginner should use the above information. First, consider buying a high quality portable as your first receiver. A receiver in this class will give you a lot of performance for your dollar. These radios also will allow you to learn about the differences between shortwave monitoring and tuning in a regular AM kitchen table radio. After spending a year or so tuning around on your portable and reading *Monitoring Times*, you will have a ton of knowledge and experience that will guide you in purchasing a high performance desktop receiver. Your portable will still see service later as you travel and as a backup to your big rig.

If you have already paid your dues listening to your portable and are ready to go the route of a high zoot receiver, take all the above information and stir in one more ingredient. Larry Magne's company, International Broadcasting Services, Ltd., PO Box 300, Penns Park, PA 18943, produces a series of in-depth receiver reviews called "Radio Database International White Papers." For a few dollars you will get all the information you need to seriously examine any of the popular high performance receivers you are likely to consider as your radio monitoring career flourishes.

Another way to make maximum use of your money is to shop the used equipment market. Old Uncle Skip buys 80% of his gear on the used market. However, I usually do not recommend this route for beginners, because you need to know your way around. If you happen to have a couple of friends who have a bit more knowledge under their caps, they can help you kick the tires on the used radio lots. You may need to live without a few of the latest and greatest bells and whistles but you can mine gold on the used equipment market.

Having said all this, a surprising amount of my incoming mail indicates that folks are happy as clams with their current equipment and want to know if they are missing something by not having a multi-thousand dollar receiver. Of course, the ultrahigh performance gear will give you more features, mostly in the area of signal processing. However, that custom Rohde & Schwarz rig will still be just as subject to propagation, environmental noise and solar flares as any bargain basement radio.

In other words, paying twice as much for a receiver will not necessarily bring about twice as much performance. You have to take into account the practical realities of shortwave monitoring, including the limitations of the frequency spectrum. If you're happy, relax and enjoy your listening. It ain't nobody's business but your own, Bunkey.

Hey, Uncle Skip, What's the Best Antenna I Can Use?

This question is almost as loaded as the one I just answered. Actually the answer itself is easy. The best antenna is the one that WORKS! The problem is that this generates a few hundred additional questions. There are half a dozen books on shortwave listening antenna design out there in the market. Any one of them can help you understand how to construct any of the popular antenna designs. The problem with any text on the subject you may read is that the authors, excellent as they may be, don't know about the water tower next to your house. They don't know if you have galvanized steel siding or aluminum. They don't know if your plumbing is copper or plastic. And they surely don't know if you have a 50 kilowatt clear channel AM broadcaster half a block from your house or if you live in the easement of a power company's high voltage lines. All of the metal and signals in your immediate environment are going to have a direct effect on any antenna you may use. That's the bad news.

The good news is that antenna wire is cheap and antennas are fun to play with. Pick a basic design out of any one of those antenna texts and give it a try. Take some notes on its performance. Then give another design a try, and then another, and another. Get to the point that your neighbors begin to wonder of you are a human fly because you are always climbing up on your roof. Experiment and have fun, Compadre!

You can toss a wire out of your window and let it dangle on the ground and you may receive plenty of signals. Tuning an antenna to a desired band of frequencies and tweaking it to take advantage of your local environment will yield many more signals. The learning needed here can't come from any book. They can only serve as a guide to point you in the right direction.

If you start hanging antenna wire, you must pay attention to safety. Do your climbing in a safe manner. Always have a friend or two to help you. Use ladders designed for the height you are climbing. Keep all your antenna wires and ladders away from any power, phone, and CATV lines that are coming into your house. You simply do not want to tangle with electricity.

Live somewhere that won't allow outside antennas? No problem, pal. Most antenna designs can be adopted to indoor use. Try running the antenna around the ceiling or up in the attic. Maybe you can demonstrate your patriotism by hanging a flagpole off the balcony. I know a few hams who have "worked the world" using just such an antenna. A little tenacity goes along way when you are living in a condo.

ATTENTION SHORTWAVE LISTENERS

NEW SERVICE NOW AVAILABLE

24 hours a day • 7 days a week

DX-DAILY

The Shortwave Information Line

UPDATED EVERY 24 HOURS

by noted shortwave authority,

Monitoring Times columnist

and host of the weekly

"World of Radio" program

GLENN HAUSER

1-900-656-5455

95¢ per minute • Average call 4 minutes

Must be 18 years of age or have parental permission

Sponsored by TelePartners 900 • Louisville KY • (502) 478-7845

Hey, Uncle Skip, Who's Responsible for this Stuff Anyway?

Most people have heard that Guglielmo Marconi was credited with inventing the wireless telegraph in 1895. Two other folks were experimenting in relative obscurity back then, too. Mahlon Loomis's experiments predated Marconi's by thirty years. Nathan Stubblefield patented his "Vibrating Telephone" in 1888 when Marconi was still in short pants.

Marconi had the right patents and public relations. He became a household name after the first transatlantic wireless broadcast in 1901. It was R.A. Fessenden who sent the first music over the airwaves in 1902. Of course all these folks operated in the shadow of Nikola Tesla who discovered the practical uses of alternating current in the first place. Later, Lee DeForest would be credited with developing the vacuum tube, bringing radio into the modern world. Many of the real exciting developments in the early days of radio can be credited to Edwin H. Armstrong who developed Frequency Modulation before his untimely death.

These are the folks who are most often lifted up as the "saints" of radio. However, there is one guy who almost never gets mentioned on the history books but who is most definitely the godfather of radio monitors everywhere. In 1906 H.H.C. Dunwoody patented the crystal radio receiver. He is the man who put inexpensive receivers in the hands of the first DXers and for this he deserves a special place in the hearts of every radio hobbyist. Give old man Dunwoody a passing thought the next time you twist those dials. And keep those cards and letters coming, **MT** folks.

Shortwave Broadcasting

Glenn Hauser

P.O. Box 1684-MT
Enid, OK 73702

ANGUILLA Dr. Gene Scott SW project is on again, target July 17 (George Thurman)

ASCENSION RAI began relay via BBC 250 kW, Italian at 0130-0230 on 11765 to S. America, 15390 to C. Am. (R. Netherlands Media Network and Carlo Avogaro, CA) See also ITALY

BELGIUM R. Vlaanderen Internationaal has 12 brilliant QSLs for 1994, historical photos of the royal family, available only to International Listeners' Club members, which requires two reception reports per month; write for application (Dominique Wittevrongel, RVI, P.O. Box 26, 1000 Brussels; via Gigi Lytle, TX) RVO Z-94: 1300 (Sun. 1230) on 15545, and S.E. Asia on 17775; 2330 on 11740, and S. America on 13655 (Steven Cline, IN)

BENIN SIM Radio not only reviving ELWA in Liberia, but plans to add a SW station here; already has French and two vernaculars over government stations (HCJB *DX-Partyline*) see BOLIVIA

BOLIVIA With help from HCJB, SIM Radio is also putting new 10 kW SW station in Sucre, Bible in Quechua, with Bolivian National Church, Bible Institute San Guanillo, director Benedicto Ibarra; now in final stages, license application into La Paz (*SIM Now* via HCJB DXPL)

BOSNIA-HERCEGOVINA R. B-H, 2255-0300+ on 6890 suppressed carrier-USB, never on AM; light music, folk, time pips and ID at each hourtop (Brian Alexander, PA, *World of Radio*)

BOUGAINVILLE In addition to R. North Solomons, PNG government is setting up a propaganda station, R. Bougainville with \$A75K, at Loloho, central Bougainville, not far from areas controlled by Bougainville Revolutionary Army (R. Australia via BBC Monitoring) 1 kW to counter R. Free Bougainville with "awareness" programs. RNS is on 3385, RFB on 3870 at 0800-1000 or 1100. RFB says PNG plans "genocide" of Bougainville people (IARN via John Norfolk) R. United Bougainville is name of new station heard at 2245 on 6020, by 0140 switched to 6010; changes from 6 to 3 MHz around 0730, one day on 3975 at 0900, another on 3880 at 0830, in Tok Pisin, testing erratically (BBCM) R. Unity, from a PNG military base, heard at 0915 on 3880. RFB's old frequency (Sam Voron, IARN via Norfolk)

BRAZIL RNB, 6180 out of commission for many weeks due to burnt out tube from Germany. They claim 500 kW but *WRTH* lists 250; which is it? Updating Valter Aguiar's fine article in March *MT*, international services have been 80 minutes, not 50 for over a year, and address is P.O. Box 08840, Brasilia 70912-790 (Arsenio Fornaro, NY)

CANADA Senate inquiry now underway into drastic RCI cuts three years ago; supporters should write to Sen. Don Oliver, Senate of Canada, Ottawa (Wojtek Gwiazda, PQ)

CHINA CRI announced new contest for a trip to Tibet; answers given in broadcasts into July or August (Gigi Lytle, TX) Winning last year's contest was a lot of work for Gigi, monitoring for obscure facts not easily accessible elsewhere; winners of new contest must decide if they can accept a trip to Tibet from its genocidal masters (gh) First feature program on CRI Sundays renamed *China Scrapbook ex-Anthology* (gh) Heilongjiang PBS, Harbin, First Program 2055-0540, 0840-1500 on 4840; Economic Station 0400-1300 on 5950; Korean service Sun.-Fri. 2100-2300, Mon.-Sat. 0200-0400, Sun. 0000-0400 on 5950 (BBCM)

COLOMBIA Emisora Claridad, Medellin, at 1025 on 3059.7 = 3 x 1020; at 1030 Todelar and station ID (Hans Johnson, MD, *Fine Tuning*) R. Patria Libre, clandestine "from encampments in the new Colombia," 0030-0110 daily on 6530v, repeat at 1130-1210 on 6260v; Sat. 1330-1410 on 15050v, Sun. 1500-1540v on 6660v announced (BBCM) unID Latin American clandestine on 6530, marimba and

All times UTC; all frequencies kHz.

*asterisk before/after time signifies station sign-on/sign-off;

// means parallel; + means continuing but not monitored;

= 2 x indicates 2nd harmonic of following frequency.

Mexican music, 0043-0106*, another day 0103-0118 fade, maybe Zapatistas? (George Schnabel, NY) Most likely RPL

COSTA RICA RFPI did move from 9375 to 9400 USB, mostly clear except around 1300 when FEBC Manila is on 9400.1; RFPI in AM weekdays 1400-1700 in Spanish 120° toward S. America, rest of 24h USB, 1700-2400 due north, 0000-0800 345°, 0800-1400 240°. *Far Right Radio Review* airs Fri. 1830, Sat. 0230, 1030, Sun. 2230, Mon. 0630 every other week. *The Secret Side of Free Trade*, a series exposing GATT, runs through June Tues, 2000, Sats. 1830, repeating 8 and 16 hours later. *CounterSpin* retimed to Sats. 1900, Mons. 2200; *Focus on Haiti*, Sats. 2100, Tues. 2030. E-mail on Internet via Peacenet: rfpic@nicarao.apc.org. *World of Radio* times remain: Fri. 2000, Sat. 1800, Sun. 2300, Tue. 1900 plus repeats (RFPI *VISTA, Mailbags*)

DNESTROVIA R. Dnestr International, English at 2130-2200 Mon., Wed., Sat., "repeated the following respective days," so every day but Fri.; but 9620 clashing with Spain except on Sundays (Brian Alexander, PA) As of March, but now maybe 2030 and/or higher frequency (gh) 9620 registered with ITU for D-93 as 1000 kW from Kishinev, actually near Grigoriopol, in separatist-controlled Pridnestrovye region of Moldova (BBCM)

ECUADOR From April, HCJB *DX Partyline* cut from 50 to 36 mins. on Sats., but adds mid-week 10-minute update, name decided by contest, Weds. 0700 Europe, 0705 S. Pacific, 2130 Europe, Thurs. 0400 N. America (*DXPL*) R. Ecos del Pueblo, Saquisilí, tentatively heard on 2110.4 = 2 x 1055 at 0130 (Gayle Van Horn, NC, *FT*)

FINLAND YLE R. Finland Z-94: 1130, 1230, 1330 on 11900, 15400 (YLE)

FRANCE RFI to us at 1200-1300 in English on new 15530 ex-13640 (Joe Hanlon and George Thurman, *W.O.R.*) Presumably still "All-Iss" rotary curtain antenna (gh)

GERMANY DW has restructured its German service from 4-hour blocks repeated six times each day to 8-hour blocks aired thrice; *DX Programm* moved to third Mondays at 1037, 1837, 0237. Daily cycle starts at 0500 (DW *Auf kurzer Welle*) /non?/ R. Piraña Internacional, Europirate, but which has also operated from S. America during visits there, plans to resume monthly broadcasts April-October on last Sunday of month at 2000 and 2100 on 13950 LSB; report to P.O. Box 220342, D-42373 Wuppertal, Germany (Jorge R. Garcia, RPI, via Fernando Vilorio, Venezuela)

GUINEA RTVG at 2330-2400* on 7125.7, French news at 2350, R. Conakry ID (Brian Alexander, PA) often heard also on 14250.88 = 2x (Martin Potter, Ont., *CIDX Messenger*)

HAWAII KWHR Z-94: 0000 on 17510, 0800 on 9930, 1600 on 7425, 1800 on 13625, 2000 on 15405, 2200 on 17645 (George Jacobs & Associates) That means *World of Radio* would be on 17510 Sat. & Sun. 0600; still 9930 Sat. 0900. *Sounds of Aloha*, Sun. 0800 is also simulcast on WHRI 7315 and 7355 (*DX Radio Show*) And 7275 mixing product (Noel Green, DSWCI SW News) N. Korea warble-jamming Korean at 1300 on 9930 (Don Rhodes, Australia, *RNMN*)

INDIA AIR Shillong on new 4970.0 at 1515 ID for Northeastern Service, tnx to director for tip with QSL for old 4791.5, signed C. Lalrosanga (Ron Howard, CA) AIR Aizawl, 5050, heard after more than 10 years trying, Feb. 5 geomag storm, K-index 5, arriving on skewed path from west, 1230-1250 over Chinese and another station; believe much less signal than rated 50 kW (David Clark, Ont., *FT*)

INDONESIA RRI Scrui, 7173.2, 1243-1405*, bet it's a new 5-10 kW transmitter, just too consistent and good for listed 500 W (David Clark, Ont., *FT*) On 3578.4 unID, believed RPD, really nice with pops,

listener greeting, but no location, 1232, another day in by 1030. RRI Manado, 5987.7 at 0928 temporarily replacing 3215; short term replacements have happened with others recently: 4607/7173, 4789/7231, 4875/9742. RRI Samarinda on 6590.8 = 2 x 3295.4, insipid old western pops at 1344 just up from Beijing feeder on 6590 also in Indonesian (David Foster, Australia, *OzDX*) RRI Banda Aceh transmitter on 3905 out of service since Aug. 1993, no money to buy new tube; 4955 transmitter is damaged, but still active with 1 kW on 2432. At Lhokseumawe—between Banda Aceh and Medan—a new regional RRI is under construction to be completed in 1995 (Jürgen Lohuis, Sumatra, DSWCI *SW News*)

IRAN VVIRI on new 7100.4 ex-9022 in English to us at 0030 (Ed Rausch, NJ, *W.O.R.*) Traces here amid heavy ham CW QRM and other noises (gh, OK) 11790 and 15260 replaced by 6175, also under BBC! (Bob Thomas, CT)

IRAQ (non) V. of Rebellious Iraq (Arabic: *Sawt al-Iraq al-Tha'ir*; Kurdish: *Dangi Iraqi Shurashgar*), supporting uprising against Saddam, and supporting the Iran-sponsored Shi'i Supreme Assembly of the Islamic Revolution in Iraq, at 1600-1830 with news around 1725 and 1810, repeated at 0330-0600, 1200-1430, on 5555v, one hour earlier in summer; address: Iran, Tehran, P.O. Box 1959/14155 (BBCM)

ITALY RAI moved English to us 10 mins. earlier, 0050-0110, and French 0110 on 6005, 9725, 11800, so Italian starts at 0130 instead of 0140 in coordination with new Ascension relay, *qv* (Joe Hanlon, PA)

JAPAN R. Japan Z-94 relays via RCI: 0957-1159 on 6120, 1259:30-1459 on 11705, 0100-0259 on 5960, 0357-0559 on 9725, each on a slightly different heading, 268, 285, 240, 277° respectively (RCI via Westenhaver) Keeping direct 9535 at 1400, 1500, 1700, 1900 (via John Norfolk)

KIRIBATI R. Kiribati, 9825, has 1 kW, 17-element log-periodic, *0558v-0800 or 1000, 1800-2000, 0000-0130; 0600 has BBC news, 0610 national news, 0615 different features: Sun., *London This Week*, 0630 *Hymns for Sunday* (Nobuyoshi Aoi, Japan, R. Japan MR)

KOREA NORTH V. of National Salvation, clandestine to the South, changed interval signal and theme music, at 1954-0030, 0300-0700, 1000-1700 on 1053, 3480, 4000, 4450, 4557; also on 4120 at 1000-1700. 6010 at 1000-1400; plus English at 0030-0100 on same morning frequencies (Tooru Yamashita, Japan, RJMR)

KOREA SOUTH R. Korea dropped Portuguese April 1 due to budget, and other languages may go later (*SW Feedback*) One 250 kW transmitter off until Aug. 1, used mainly on 7275 general service, to replace it with a new one (*SWF* via George Thurman)

KUWAIT R. Kuwait, English at 1800-2100* on new 11990 ex-13620, fair until 2000 when Egypt is also on 11990 (Brian Alexander)

LIBERIA Former Taylor frequency 6090 is back as ELLR, Liberia Communications Network, Gbargna, heard at 1053 and 1500 (BBCM)

LITHUANIA R. Centras claims a large audience on FM and cable radio networks; also SW on 9400 LSB, 5 kW, Mon.-Fri. 1600-0700 UT, Sat., Sun. 24 hours; fax +370-2-429490 (via Arunas Silickas, Vilnius) Never heard here; in Europe, this heard on LSB, RFPI on USB? (gh)

MALI RTVM at 0703-0745 on 11960.1, 9634.37 and 7284.88; French at 0730 (Brian Alexander, PA, *W.O.R.*)

MEXICO Contrary to info last month, *DX-6185* show heard UT. Thu. starting at 0433, not 0400, during one week scanning the Mexico City MW dial with latest station names and formats (gh, OK)

MONACO TWR does not use 9480 but stays on 7385 in English at 0640-0820, Sats. to 0835, Suns. to 0845 (TWR via Gigi Lytle)

NETHERLANDS R. Netherlands, Z-94 in English: 0030-0325 on C-12025 and 9860; 0730 on B-9720 and 9630, 0830 on 9895, B-9720, 0930 on 9895, B-9810 and 9720; 0930-1125 C-15470 and 12065; 1130-1330 5955 and 9650; 1330-1630 M-15150 and 9890, 13700; 1730-1925 M-6020 and 7120, B-21590 and 17655; 1930-2030 B-17655 and 17605; 2330 6020 and B-6165; 0030 6020, B-9840 and 6165; 0330-B-9590 and 6165 (RNMN via Daryl Rocker, Ed Rausch, Steven Cline)

B=Bonaire, M=Madagascar, C=CIS; see also TAJIKISTAN

NEW ZEALAND RNZI until 1 May: 1650-1849 Mon.-Fri. on 7125, 1850-2137 on 11735, 2138-0715 (Sat. 0643, Sun. 0728), then 9700 until 1206; occasionally until 1307 on 9700, 1307-1649 on 9655 (Adrian Sainsbury, RNZI) Hinted earlier 6035 might replace 9700 during southern winter. If 4-week rotation pattern holds, *Calling Pitcairn and Norfolk* should appear UT Fris. 0430 on May 6, June 3, July 1, 29, Aug. 26...; *Around the World with Rudy Hill*, UT Tues. 0900 or 0930 and Fris. 0430 on May 17/20, June 14/17, July 12/15, Aug. 9/12... (gh)

NORWAY Outlook for J94 is not promising; must use long route to reach Far East, NZ, Australia, and western N. America; E. N. America normally no problem in mornings, but now there are problems; best times will be 2300-0200. At 0100 and 0200, 11 MHz expected to be weak in April, but improving in May (Olav Mo Grimdalen, NRK via Robert Thomas, CT) Longpath to W.N. Am., at 1500 on 17895, 1600 on 21705, beamed 135° (via Joe Hanlon, PA) Check to see if those work; I doubt it (gh)

PAKISTAN R. Pakistan, M-94 and tentative J-94 in English: 0230-0245 on 21730, 17725, 17705, 15190, 7290; 0800-0850 and 1100-1120 on 17900, 21520; 1600-1630 on 17660, 15675, 15555, 13590, 11570, 9470; 1700-1750 on 9855, 7485 (via Gigi Lytle, TX)

PALAU KHBN, Z-94: 9830 at 0700-1600, 2000-0100; 9965 at 1200-1900, 2100-2400; 17630 at 0000-1200; alternate 15140 at 2000-0600 (George Jacobs & Associates)

PAPUA NEW GUINEA New station is being built in North Solomons replacing Kieta 3325; 10 kW on Buka island at Hutjeno, per NBC Port Moresby (Arthur Cushen, NZ, *OzDX*) A new station is planned for 49 m at Radio Morobo (John Kecskes, Australia, DSWCI *SW News*) see also BOUGAINVILLE

PARAGUAY R. Encarnación heard on 11939.35 all day and various times around 0230, 0943, in Spanish and Guaraní, good bet to QSL this country, as R. Nacional, 9735 missing (Gabriel Iván Barrera, Argentina, RN *Radio-Enlace*)

PERU R. Centinela, Bambamarca, Piura, new on 6544.5, announced as 6540, testing at 0030-0415* but not heard in the morning (Pedro F. Arrunategui, *Chasqui DX* via *Play-DX*) R. La Hora, Cusco, on 4862.5 ex-4855.2 at 1000 (Emilio Pedro Povrzenic, *Latinoamérica DX*) R. Ilucán on new 5422.2 (Henrik Klemetz, Colombia, *Play-DX*) La Voz de la Selva, 4824.3, begins the day at 1000-1100 with a program called *Baila baila tanrillita, moviéndose la colita*. The *tanrillita* is an Amazonian bird like the flamingo, but also refers to Loretan girls wiggling their behinds. R. Oriente, 6190, says other stations in Yurimaguas have left SW for FM—Estación X on 4593.5, and Estación Yurimaguas on 5046.3 (Henrik Klemetz, Colombia) Estación Tarapoto has transmitter problems, different frequency almost every day, as low as 5014.8, as high as 5020 (Hans Johnson, MD, *FT*) Baptists starting new station for Cuzco area, 6090 in Quechua and Spanish; bought R. Universal SW facility, renaming it R. Luz Universal. Another new 49m station is R. Sol Naciente, Paucartambo, Cuzco dept. (HCJB *DXPL*)

QATAR QBS in Arabic: 0245-0700 and 1320-2130 on 7160,

DX Listening Digest

— Much more info in the style of Hauser's column.

Review of International Broadcasting

— SW programming, opinion, equipment, satellite monitoring.

Samples \$2.50 each (outside North America US\$3 or 7 IRCs)

10 issue subscriptions \$25 in USA, or both for \$47

Glenn Hauser, Box 1684-MT, Enid, OK 73702

SEE PAGE 41 FOR NEW PHONE SERVICE!

0730-1300 on 15285 (QBS via Hans-Peter Tillman, British DX Club *Communication*) Totally different from *WRTH-94*

RUSSIA Yerevan is relayed on 7440 winter, 9450 summer via Chkalovskaya facility cast of Moscow. Baku on 15240, 9840 or 6175 via Balashikha east of Moscow, daytime 7300 and on 11930 or 7160 via Samara. Recent sked of Golos Rossii confirms 7440 as Moscow, 7160 as Samara (Olle Alm, *World DX Bulletin* via DSWCI *SW News*) R. Saha Yakutii (R. Republic of Sakha, Yakutsk), 7215 at 0800-1000 and 2000-2200 in eastern languages and Russian (*Weltweit Hören* via DSWCI) Also in Yakutsk, R. Lena, independent station in Russian, 0300-1000 on 5920, 6155 (D. Anisimov, *ASK-DX* via Klepov, *OzDX*) R. Stantsiya Tsentr, Moscow, daily 0630-0700 on 12010; and with R. *Novyye Nivy* at 1630-1700 on 7170; mainly religious programs, fax +7 095 956 75 46. R. Radonezh, Moscow, 1600-1700 on 9795, one hour earlier in summer; belongs to Russian Orthodox Church (BBCM) "We offer specially endorsed QSLs for reports on AWR programming via SSB feeders as mentioned in this column, Feb. Report to AWR Special Projects, 903 Tanninger Dr., Indianapolis, IN 46239" (Adrian Peterson, AWR) That info dated November, so probably different now, or at least one hour earlier; only AWR segment BBCM mentioned was *Voice of Hope* from Tula, then at 1705-1720 on Weds. when 12175, 11575 and 8040 were in use, along with AM on 7345, 6040, 5980, 5910, 5905, 4895, 4820, 4485, 261 (gh)

SCOTLAND (non?) R Stella International is selling airtime for \$10 an hour; will use 3902 and 6810 starting in May via new 150-W AM transmitter; report to 82 Pentland Place, Kirkcaldy, Fife, Scotland (Chris Lobdell, *NU*, via *NASWA Journal*)

SEYCHELLES FEBA M94 until 30 April showed different frequencies in 1500/1600 period, presumably still for two different English programs: 7170 Mon.-Sat. 1458-1543; 9810 Mon.-Sat. 1458-1600; 11870 1458-1555 (Sat.-1550, Sun.-1558) (gh) *Network* program at 1500 exc. Sun. never mentions it's from FEBA, though taped at FEBA studios in India, with live news from Seychelles (Victor Goonetilleke, Shri Lanka, *RNMN*)

SWEDEN R. Sweden, Z-94 in English: to us at 1230 and 1330 on 15240, 17870; 0230 and 0330 on 6040, 9850; Latin America 0030 on 6065, 9850; Asia/Pacific 1130 on 13775, 15120, 15240; 2330 on 11910; 0130 on 9695, 11695; Europe at 1615, 1730, 2130 and 2230, plus weekends 2030 on 6065; at 1730 also on 9655, 15390, 2130 on 9655 (*SCDX/Mediascan*)

TAJIKISTAN R. Netherlands, Z-94 at 0030-0330 to S. Asia on 12025 and 9860 are via Dushanbé, giving us a good shot at logging and QSLing this country (Ben Krepp, *FT*) (non) V. of Free Tajikistan, supporting opposition groups based in Afghanistan, announced different times: 0200, 0500, 0900, 1300 on 7080, 3540, but still heard on 7090v (BBCM) Note harmonic relationship

TANZANIA R. Tanzania, 5050, continues with one clandestine program for S. Africa, V. of the *Pan-Africanist Congress*, Mon./Wed./Fri. 0415-0430 and 1830-1900, Tue./Thu./Sat. 1815-1830; its own English broadcast starts at 0330, news at 0400 (BBCM)

TURKEY VOT Z-94 in English: 1230-1300 9675; 2000-2050 9900; 2200-2250 11710, 9445, 7185; 0300-0350 9445 (TRT)

UKOGBANI BBC WS will split into six regional services in 1995, with specific programming (BBC *Write On*) That should make it easier to cave in to American Public Radio demanding DST shifts for convenience of relayers (gh) 5 megapound budget cut requires reduced SW hours to N. America, not a priority target; *Waveguide* now Sat. 0715, 1030, Thu. 0130 (*Waveguide*)

URUGUAY Oriental y Cristal, 6140 heard some mornings at 0930 with sports (Emilio Pedro Povrzenic, *Latinoamérica DX*) A MW station in Montevideo, CX-48, has applied for SW: 9650, 10 kW non-directional at 1000-2100, and 15230, 5 kW, directional 348° to North America with 14 dB gain. Deadline was March 28 to act on this (*Radioactivades*, SODRE, via Rubén Guillermo Margenet, Argentina)

CX-48 not in the *WRTH-94*.

USA VOA ended SW April 1 for Portuguese to Brazil (Bill Whitacre, VOA, *RNMN*) Ceasing all SW to Latin America after World Cup later this year, and VOA will later give up this antique, sentimental technology everywhere (Brian Penn, US Embassy, Quito, HCJB, *DXPL*)

WHRI again carries the *Indianapolis 500*, live May 29 starting at 1500 UT on 9465, 15105, also on KWHR 9930; also for the first time, NASCAR's *Backyard 400* Sat., Aug. 6 at 1630, *DX Radio Show*. UT Sun. 0200 on 7315, is repeated Mon. 0400 on 9495, both also on KWHR 17510. Additional time for *World of Radio*: Fri. 2300 on 7315. Dropped 17830, extended 9485 to 1800-2300, with *For the People* live all three hours at 1800 weekdays, RMI's Haitian clandestine at 2100. See HAWAII.

WWCR has new exclusive *Old Record Shop*, even Edison cylinders from teens, 20's, 30's, Fri. 1200 on 15685, UT Sun. 0400 on 7435, 0630 on 5810.

World Voice of Historic Adventism has May 16 deadline to make final payment for purchase of WCSN; per announcements, followers had contributed \$2.5M worth of antique furniture, jewelry, stamp and coin collections, silver flatware to be turned into cash. Plans to change call sign to WVHA, which seems to be available; first priority to get log-periodic antenna; admits on air that primary purpose is to reach followers within the U.S.; reliable time for such news was Sats. 1550-1605 on 15665, also with frequent references to home churches, personal ministries, and three-angels messages, Rev. XIV: 6-12 (gh) Evenings, 90° to Africa with intent that the back-lobe, about 50 kW ERP, covers U.S. for our supporters; same for Sabbath transmissions, both shifting with DST for domestic audience, but Sun.-Fri. mornings are 60° to Europe at unchanged time 1500. Evenings from 0000 on 9850 ex-7465 (Gordon Simkin, *Prophecy Countdown*, via Jim Frimmel)

Monitor Radio International as of Dec. 6 planned these changes for May 3: WCSN at 0600 on 9870, 1800 and 1900 on 17510. WSHB-1 at 0600 and 0700 on 9840, 1400 on 11900, 2200 and 2300 on 13770 (WSHB) Financially troubled Christian Science Church plans more cutbacks; MRI to stop producing daily international broadcast in May; most SW programming will be relays of Monitor Radio's domestic news (Laurence Kranich, *FIDONET SW Echo* via George Thurman)

WEWN has eliminated the 5-8 am ET gap in N. American broadcast to expand to 24 hours; also dropped 13740 so during the day, 7425, 9350 and 13615 (*Gabriel's Horn* via Diane Mauer, Bob Thomas)

More on the *Fury* bust aftermath: on his broadcasts, Bro. Stair reported that the feds finally served papers on him at his request so that he could proceed with claiming the equipment seized; Stair is representing himself, since lawyer too expensive. Stair named Scott Becker as the person put off the ship for drinking; says a man in anger or drunken state took a ham radio on *Fury* and sent a signal for several hours. Scott Becker, from his ch. 13 LPTV in Hawthorne, NV, denies any broadcasts from on board, or that Stair expelled him, since Becker owned the ship. Becker thinks the Brothers a strange bunch, not only forbidden to eat sweets, but required to scavenge in dumpsters. Allan Weiner continues to rebut 100% the FCC claim that there were broadcasts from the ship Jan. 14 between 12:50 and 3:21 am; says they had no right to loot and pillage the *Fury* (Diane Mauer, Becker and Weiner)

More than 50 remote units of U.S. broadcast stations have been heard the last few years on 11 meters, predominantly NBFM on 26150, 26250, 26350 and 26450 kHz. Two more are on 26250, WESH-TV, ch. 2 in Florida at 1700; a week later, KOCO-TV, ch. 5 in Oklahoma at 1830 (Alan Roberts, PQ, *CIDX Messenger*)

ZAMBIA R. Zambia audio now as strong as the carrier, vernaculars on 4909.8 from 0245, English on 7234 from 0300 (Hans Johnson, MD, *NASWA Journal*)

Until the next, best of DX and 73 de Glenn!

Broadcast Loggings

Thanks to our contributors — Have you sent in YOUR logs?
Send to **Gayle Van Horn**, c/o Monitoring Times.
English broadcast unless otherwise noted.

0003 UTC on 6005

ITALY: RAI. News item on Italy's many political parties. Station IDs between each news story. (Bob Fraser, Cohasset, MA)

0103 UTC on 6010

CUBA: Radio Havana. News on Cuba Qatar economic pact. (Fraser, MA) *DXers Unlimited* on collecting antique radios, 9510 at 0439. (John Carson, Norman, OK)

0125 UTC on 7195

UKRAINE: Radio Ukraine Intl. *Hello From Kiev* mailbag program. Audible on //7240 //9860. (Dan Smith-N2PTF, Morrisville, NY)

0200 UTC on 6116.5

COLOMBIA: La Voz del Llano. Spanish. "Super Radio" ID to chat and Latin tunes. (Smith, NY) Colombia's Radio Macarena heard on 5975 at 0600. (Sam Wright, Biloxi, MS)

0215 UTC on 11950

UNITED STATES: WINB. Pete Peters on *Scriptures For America*. (John Carson, OK) Religious programming monitored on 15715 at 1600. (Jean Lafaurie, Bourdeaux, France)

0217 UTC on 7375

COSTA RICA: Radio For Peace Int'l. *China & Human Rights*. James and Deborah Latham's *Mailbag* show this frequency at 0344, monitored to 0430. (Carson, OK) *World of Radio* heard on 15030 at 1228. (Steve Hunter, Drexel Hill, PA)

0224 UTC on 6025

DOMINICAN REPUBLIC: Radio Amanacer Int'l. Canned ID in English "this is 1570 HIAJ, Radio Amenacer International." Local time check to *Your Story Hour*. (Garland Thomas, Cleveland, OH)

0230 UTC on 9705

PORTUGAL: Radio Portugal. Fair to good most evenings. Newscast, national weather and *Collector's Corner*. // 9570. (Hunter, PA; Carson, OK)

0240 UTC on 4845

GUATEMALA: Radio Ke'kchi. Presumed Ke'kchi. Conversations mixed with Spanish and Indian dialect. "Radio Ke'kchi" ID with frequency quote. (Randy Stewart, Springfield, MO)

0250 UTC on 4909.8

ZAMBIA: Zambia National Broadcasting Corp. Fish-Eagle interval signal to sign-on national anthem. Station ID and program feature in vernacular language. (Stewart, MO) ZBC monitored this frequency 0430-0445 with music and IDs. (Tom Banks, Dallas, TX)

0255 UTC on 4925

BOLIVIA: Radio San Miguel. Spanish. Sign-off routine in progress at tune-in. Station ID with frequency quote. (Stewart, MO)

0257 UTC on 5010

PERU: Radio Cora. Spanish. Peruvian vocals to "Radio Cora del Peru" at 0300. (Stewart, MO) Peru's Radio Eco audible at 0415 on 5097. Regional ads to time check and ID. (Banks, TX) Tentative logging of Peru's Radio Villa Rica at 0315 on 4804.5. Spanish music, to sign-off routine at 0330. (Witham, HI)

0300 UTC on 6000

CANADA: Radio Canada Int'l. *Double Exposure* to ID and *Royal Canadian Air Farce*. RCI news, sports, weather and ID into Canadian Forces Network discussion on NATO, 0610 on 6150. (Carson, OK)

0319 UTC on 7020

ERITREA: Voice of the Broad Masses of Eritrea. Kunama. Intermittent signal tones to melody interval signal. Male announcer with sign-on and ID. News to African Sahara style music. CW interference under announcer duo chat. Pop music to "Eritrea" ID. Newscast in presumed Tigrigna language at 0400. Feature and African music monitored to 0410. No //7380. (GVH/NC)

0330 UTC on 6040

SWEDEN: Radio Sweden. *Sounds Nordic* show, featuring Sweden's first all female music show. Music included contemporary and soul music from Swedish songwriters and artist. (Don Kidder, Ashland, ME)

0335 UTC on 4835

GUATEMALA: Radio Tezulutlan. Presumed Quecha. Marimba melody to special announcement on an upcoming transmission. Musical selection, fading to carrier only. Sign-off 0404. (Jerry Witham, Keauau, HI) Station audible this frequency at 1115. Very good signal past 1230. (Williams, AL)

0410 UTC on 7460

SOMALIA: Voice of Free Somalia. Male/female announcer duo in Somalian. Extended speech about Somalia. (Witham, HI)

0415 on 3300

GUATEMALA: TGNA-Radio Cultural. *Insight For Living* to 0428. "TGNA" ID/frequency quote to Spanish program. (Carson, OK) Radio Maya de Barillas heard on 3324.8 at 1030. Numerous IDs to pop/folk music program. Fair signal quality. (David Williams, Pinson, AL)

0430 UTC on 7225

RWANDA: Deutsche Welle relay. Good signal for *Africa This Week* program. Parallel frequencies 7275//6015. (Stewart, MO)

0447 UTC on 9550

CLANDESTINE-ANGOLA: A Voz da Resistencia do Galo Negro. Portuguese. Cock crow signal to guitar melody. ID to national anthem at 0448. Lady announcer to men's chorus. Easy-listening tune to program preview. Portuguese vocals to "VORGAN" IDs at 0501 and 0510. (GVH/NC)

0518 UTC on 4800

LESOTHO: Lesotho National BS. Sesotho. Hymn by African chorus. Sermon text to piano instrumental. (Hillton, SC)

0540 UTC on 9550

CLANDESTINE-ANGOLA: Voice of the Resistance of the Black Cockeral. Male announcer in unidentified language to pop music. Bell tone, ID and news at 0600. Station audible at 1630 on 7290 kHz with similar format in Portuguese. (Witham, HI)

0645 UTC on 9675

PAPUA NEW GUINEA: NBC. Pop tunes and station promo for *Sports World*. Station ID and warning announcement about trespassing at transmitter sites. Children and adult vocals to ID and news. (Witham, HI)

0958 UTC on 5049

ECUADOR: Radio Jesus del Gran Poder. Spanish. Religious music to 1000 station ID. Ecuador's Radio Luz y Vida heard on 4851 1030-1045. (Frank Hillton, Charleston, SC)

1000 UTC on 6160

CANADA: CKZN-St. John's, Newfoundland. Regional news from Newfoundland and Labrador. Local time checks, frequent weather forecast and marine coastal conditions. Sports roundup to classic pop tune from the Carpenters. (Hunter, PA)

1015 UTC on 6185

MEXICO: Radio Educacion. Spanish/English. Multilingual IDs to Spanish music. QSL address P.O. Box 21940-04021, Mexico City DF, Mexico. Poetry readings to radio play of "La Historia de la Conquista del Espana." Address repeat to continued cultural programming. (Hunter, PA)

1130 UTC on 9650

SOUTH KOREA: Radio Korea. Good signal for newscast and *Shortwave Feedback*. Listener's letters and chat to anthem sign-off. (Hunter, PA)

1150 UTC on 3215

INDONESIA: RRI-Manado. Indonesian. Fair signal for audio level. Announcer's talk and regional tune. Indo's RRI-Manokwari heard on 3987.3 at 1205 with Jakarta news relay. (Hillton, SC)

1443 UTC on 15630

GREECE: Voice of Greece. World newscast followed by discussion on Bosnia. (Smith, NY)

1620 UTC on 3250

NEPAL: Radio Nepal. Regional music and programming announcements in Nepalese. Station audible on // 5005. (Witham, HI)

1650 UTC on 3358.9

MADAGASCAR: Radio Madagascar. Malagasy. Smooth easy-listening tune to past the hour. ID at 1702 followed by short radio drama with sound effects. Abrupt shut down at 1713, continuing on parallel 5009. (Witham, HI)

1705 UTC on 4820

INDIA: All India Radio. Twenty-five minutes of Indian music. Vivaldi's music *The Four Seasons* performed by London's. (Witham, HI)

1920 UTC on 9746

BAHRAIN: Radio Bahrain. Arabic. Middle Eastern music to station pips to ID at 1930. Regional news. (Witham, HI)

1935 UTC on 17605

NETHERLANDS ANTILLES: Radio Netherlands relay. *Happy Station* with a salute to the Year of the Family with family pop singers. (Fraser, MA)

1935 UTC on 7465

ISRAEL: Kol Israel. *DX Corner* discussing types of noise limiting circuits. (Fraser, MA) Israel audible on 15640 at 1406. *Calling All Listeners* and *DX Corner*. (Smith, NY)

2005 UTC on 15095

SYRIA: Radio Damascus. Station ID and world newscast. Audible on // 12085. (Smith, NY)

2030 UTC on 15400

ASCENSION ISLANDS: BBC relay. *It's a Funny Old World* comedy music program. BBC's relay in Antigua hear on 5975 at 2215, with *Seeing Stars* featuring galaxies and city stargazing. (Fraser, MA) Relay monitored on 15220 at 1158. (Smith, NY)

2035 UTC on 11990

KUWAIT: Radio Kuwait. U.S. pop and R&B music at tune-in. News update to station ID. Anthem to 2100 sign-off. (Banks, TX)

2200 UTC on 9900

EGYPT: Radio Cairo. Usual poor modulation for station ID, address quote. Egyptian music program. (Virgil Carlson, Kirkland, WA) Station heard on 11600 at 0210. English prayers and translation to station ID. (Witham, HI)

2255 UTC on 9860

PHILIPPINES: Radio Veritas Asia. Indonesian. Pop music at tune-in. Station ID to interval signal. Program preview for Southeast Asia and Indonesian service. (Carlson, WA)

Is DXing India your forte? ...

We have good news for you! *India BroadBase '94* is out, and is the most comprehensive review of the Indian broadcasting scene. *IBB '94* covers longwave through satellites, medium wave, VHF-FM, television and time signal stations. Check out the addresses, frequency schedules, charts, maps and future plans. The price of *India BroadBase '94* is (postpaid): Canada \$7.00 First Class Mail, U.S. \$6.50 Air Mail, other countries US \$8.00 Air Mail or 10 International Reply Coupons. Order from: Ontario DX Association, P.O. Box 161, Station A, Willowdale, Ontario M2N 5S8 Canada.

Ready to QSL Radio Singapore International? Send two IRCs to Farrer Road, P.O. Box 5300, Singapore 9128.

Radio Estonia has reactivated on 5925 kHz. Reception reports should go to Estonian Radio External Service, 21 Gonsiori Street, EE-0100 Tallinn, Estonia.

Deutsche Welle has a toll free telephone "hotline" in the United States. The number is 1-800-392-3248.

AIRCRAFT TRAFFIC

Speedbird 293, 13306 kHz USB. Full data prepared QSL card signed by Mark Preston-Capt. Received in 47 days for an English utility report. QSL address: c/o British Airways, Miami International Airport, Miami, FL 33152. (Steve McDonald, Port Coquitlam, B.C. Canada)

Calm Air 1573, 5680 kHz USB. Full data prepared QSL card signed by J. St. Pierre. Received in 32 days for an English utility report. QSL address: c/o Calm Air Int'l Ltd., 60 Seal Rd., Thompson, Manitoba, Canada. (McDonald, CAN)

ANTARCTICA

VNJ-Australian Antarctic Division, 11553 kHz USB. Full data prepared QSL card and personal letter signed by Patrick Haddock-Network Supervisor. Received in 22 days for an English utility report. QSL address: c/o Australian Antarctic Division, Channel Highway, Kingston, Tasmania 7050. (McDonald, CAN)



Radio Portugal worldmap card QSL sent in to us by Douglas Markel.

Send us your prize QSL or a good photocopy when you send in your report. Maybe yours will be the featured card! (originals are returned).

AUSTRALIA

VLW6-6140, VLW9-9610, VLW15-15425 kHz. Full data map cards for three frequencies. Received in two months for an English report. Station address: Box 9994, Perth, WA 6001, Australia. (Dr. Adrian M. Peterson, Indianapolis, IN)

BAHRAIN

Radio Bahrain, 9745 kHz. Full data map card signed by A. Suliman. Received in 17 days for an English report, one U.S. dollar, and N.C. souvenir postcard. Station address: P.O. Box 702, Manama, State of Bahrain. (GVH/NC)

BRAZIL

Radiobras, 15445 kHz. Full data QSL sheet signed by Gaby Hertha Einstoss. Program schedule, reception report forms, and souvenir postcard of Brasilia. Received in 53 days for an English report, and postcard. Station address: c/o Radiobras External Service, Caixa Postal 08840, CEP70912-790, Brasilia-DF, Brazil. (Stephen Hunter, Drexel Hills, PA)

CUBA

Radio Havana, 9815 USB kHz. Two full data QSL cards, signed by Rolando Pelaez-Head of Correspondence Dept. Received in 60/107 days for an English report, short note, and souvenir postcards. Station address: Apartado 6240, La Habana, Cuba. (LeRoy Long, Edmond, OK)

HONDURAS

Radio Copan International, 15675 kHz. Full data "rock carving" card signed by Jeff White. Station schedule and info sheet included. Received in 20 days for an English report. QSL address: 8500 SW 8th St., Suite 252, Miami, FL 33144. (Charles Washburn, Robbinston, ME)

IRAN

VOIRI, 9022 kHz. Full data Ghazel QSL card. Received in 64 days for an English report. Station address: Voice of the Islamic Republic of Iran, P.O. Box 3333, Tehran, Iran. (Long, OK)

KUWAIT

Radio Kuwait, 13620 kHz. Full data yellow QSL folder card with illegible Arabic signature. Wallet calendar, and program schedule included. Received in 120 days for an English report and 2 IRCs. Station address: c/o Engineering Communications Dept., Controller of

Frequency Management, P.O. Box 397 Safat, 13004 Safat, Kuwait. (Randy Stewart, Springfield, MO)

PORTUGAL

Radio Portugal, 9570 kHz. Full data "world map" card and road map of Portugal. Received in 27 days for an English report. Station address: Av. Eng. Duarte Pacheco 6, 1000 Lisboa, Portugal. (Washburn, ME; Frank Hillton, Charleston, SC)

SEYCHELLES

BBC Indian Ocean Relay, 11730 kHz. Full data letter on BBC letterhead, signed by Peter Lee-Resident Engineer. Received in 18 days for an English report and 2 IRCs. Station address: BBC Indian Ocean Relay Station, Grand Anse, Mahe, Seychelles. (Stewart, MO)

SHIP TRAFFIC

SS ARCO ALASKA-KSBK-2182 kHz (Tanker). Full data prepared QSL card stamped with ship's seal, signed by Richard C. Devir-Master. Received in 17 days for an English utility report. Ship address: c/o Arco Marine Inc., 300 Oceangate, Long Beach, CA 90802-4341. (McDonald, CAN)

ISLAND KING-HO9893, 8240 kHz (Motor Tanker). Full data prepared QSL card stamped with ship's seal, signed by Capt. F. Henry and friendly note from company president. Received in 60 days for an English utility report, one U.S. dollar, and an SASE. Ship address: c/o Island Shipping, 2101 S. Andrews Ave., Suite 201, Ft. Lauderdale, FL 33316. (Russ Hill, Oak Park, MI)

SENTINEL II-ELBY4, 8240 kHz (Bulk Carrier). Full data prepared QSL card stamped with ship's seal. Received in 150 days for an English utility report, one IRC, and an SASE. Ship address: c/o Alcoa Steamship Co., Suite 1501, 24th Floor, Alcoa Bldg., Pittsburgh, PA 15219. (Hill, Oak Park, MI)

UNITED STATES

USCG Comsta NMA21, 2670 kHz. Full data NME station folder card, signed by RM1 David L. Smith, USCG. Received in 48 days for an English utility report, mint stamp, prepared card (not used) and address label (not used). Station info sheet included. Station address: Coast Guard Group St. Petersburg, FL 600 8th Ave., St. Petersburg, FL 33701-5099. (Mike Hardester, Jacksonville, NC)

WXTK-94.9 MHz FM. Full data QSL letter signed by Vern Coleman-Chief Engineer. Received in 66 days for an English FM report, and mint postage. Veri signer was CE for WOCM in 1943! Station address: 278 South Sea Ave., West Yarmouth, MA 02673. (Hank Holbrook, Dunkirk, MD)

WHRO-90.3 MHz FM. Full data letter signed by Herman Wood-Chief Engineer. Received in 9 days for an English FM report, and mint stamps. Station address: 5200 Hampton Blvd., Norfolk, VA 23508-9476. (Holbrook, MD)

WETH-89.1 MHz FM/WETA-90.9 MHz FM. Full data QSL letter signed by Joseph M. Davis-P.E. WETA-FM/WETH Chief Engineer. Received in 10 days for an English FM report, and mint stamps. Station address: P.O. Box 2626, Washington, DC. (Holbrook, MD)

VANUATU

Radio Vanuatu, 3945 kHz. Full data black & white Tam-Tam card signed with illegible signature. Received in 6/10 months for an English report. Station address: Box 49, Port Vila, Rep. of Vanuatu. (Jeff Hambright, Sparta, NJ; Peterson, IN)

RADIO PORTUGAL INTERNATIONAL
Rua de S. Marcel, 1-B - 1209 LISBOA - PORTUGAL
Telex: 347 50 85/6/7/8 - Telex: 42247 - Telex: 3474475

Date: 10 September 1991
Hour (UTC): 0230 - 0300
FREQUENCY (KHZ): 9.702 (31 m)

QSL

To: Douglas D. Markel
Your report is hereby verified as fully correct.
We would be glad to hear from you again.

How to Use the Shortwave Guide

1: Convert your time to UTC.

Eastern and Pacific Times are already converted to Coordinated Universal Time (UTC) at the top of each page. The rule is: convert your local time to 24-hour format; add (during Daylight Savings Time) 4, 5, 6 or 7 hours for Eastern, Central, Mountain or Pacific Time, respectively.

Note that all dates, as well as times, are in UTC; for example, the BBC's "John Dunn Show" (0030 UTC Sunday) will be heard on Saturday evening (8:30 pm Eastern, 5:30 PM Pacific) in North America, not on Sunday.

2: Choose a program or station you want to hear.

Some selected programs appear on the lower half of the page for prime listening hours—space does not permit 24-hour listings except for the "Newslines" listing, which begins on the next page.

Occasionally program listings will be followed by "See X 0000." This information indicates that the program is a rerun, and refers to a previous summary of the program's content. The letter stands for a day of the week, as indicated below, and the four digits represent a time in UTC.

S: Sunday T: Tuesday H: Thursday A: Saturday
M: Monday W: Wednesday F: Friday

3: Find the frequencies for the program or station you want to hear.

Look at the page which corresponds to the time you will be listening. Comprehensive frequency information for English broadcasts can be found at the top half of the page. All frequencies are in kHz.

The frequency listing uses the same day codes as the program listings; if a broadcast is not daily, those day codes will appear before the station

name. Irregular broadcasts are indicated "tent" and programming which includes languages besides English are coded "vl" (various languages).

4: Choose the most promising frequencies for the time, location and conditions.

Not all stations can be heard and none all the time on all frequencies. To help you find the most promising frequency, we've included information on the target area of each broadcast. Frequencies beamed toward your area will generally be easier to hear than those beamed elsewhere, even though the latter will often still be audible. Every frequency is followed by one of these target codes:

am: The Americas	as: Asia
na: North America	au: Australia
ca: Central America	pa: Pacific
sa: South America	va: various
eu: Europe	do: domestic broadcast
af: Africa	om: omnidirectional
me: Middle East	

Consult the propagation charts. To further help you find the right frequency, we've included charts at the back of this section which take into account conditions affecting the audibility of shortwave broadcasts. Simply pick out the region in which you live and find the chart for the region in which the station you want to hear is located. The chart indicates the optimum frequencies for a given time in UTC.

Programs for Shortwave Listeners: This section, published quarterly, lists programs with news and information about shortwave radio for listeners. For brevity, only programs at certain peak listening times are included. Corrections and additions are appreciated.

Sundays	2235 Radio Korea: "Shortwave Feedback"	0349 Radio Sweden: "Media Scan"	0130 WHRI (7315): "World of Radio"
0015 Spanish National Radio: "DX Spot"	2253 Vatican Radio: "Vatican On-the-Air"	0435 Radio Havana Cuba: "DXers Unlimited"	0210 Radio Australia: "Feedback"
0039 HCJB: "DX Partyline"	2300 Radio For Peace Int'l: "World of Radio"	0535 Radio Havana Cuba: "DXers Unlimited"	0235 RAE Argentina: "DXers Special"
0110 Radio Prague: "Calling All Listeners"	2300 WWCR (7435): "World of Radio"	0800 HCJB: "Ham Radio Today"	0246 Radio Portugal Int'l: "Radio Portugal DX"
0110 Voice of America (am/ca): "Communications World"		1030 HCJB: "Ham Radio Today"	0400 Radio For Peace Int'l: "World of Radio"
	Mondays	1100 Radio For Peace Int'l: "World of Radio"	0600 KWHR (Hawaii): "World of Radio"
0115 Spanish National Radio: "DX Spot"	0045 Radio Bulgaria: "Radio Bulgaria Calling"	1235 Polish Radio: "DX Program"	0600 WHRI (9495): "World of Radio"
0118 Swiss Radio Int'l: "SW Merry-Go-Round"	0100 WHRI (9495): "World of Radio"	1315 FEBC (Philippines): "DX Report"	0600 WHRI (7315): "World of Radio"
0130 Radio Havana Cuba: "DXers Unlimited"	0130 Radio Japan: "Media Roundup"	1505 Polish Radio: "DX Program"	0618 Swiss Radio Int'l: "SW Merry-Go-Round"
0130 WHRI (7315): "World of Radio"	0300 WWCR (7435): "Spectrum"	1611 Radio Prague: "Calling All Listeners"	0630 WWCR #1: "World of Radio"
0200 Radio For Peace Int'l: "World of Radio"	0400 WHRI (9495): "The DX Radio Show"	1730 HCJB: "Ham Radio Today"	0639 Radio Vlaanderen Int'l: "Radio World"
0200 WHRI (7315): "The DX Radio Show"	0430 Radio New Zealand Int'l: "RNZI Mailbox"	1810 Radio Prague: "Calling All Listeners"	0715 BBC: "Waveguide"
0200 WWCR (5810): "Spectrum"	0639 Radio Vlaanderen Int'l: "Radio World"	1920 RAE Argentina: "DXers Special"	0739 HCJB: "DX Partyline"
0215 KSDA (Guam): "DX Asiawaves"	0640 Radio Korea: "Shortwave Feedback"	1930 HCJB: "Ham Radio Today"	0915 Swiss Radio Int'l: "SW Merry-Go-Round"
0245 Radio Romania Int'l: "DX Mailbag"	0700 Radio For Peace Int'l: "World of Radio"	2015 Polish Radio: "DX Program"	0940 FEBC (Philippines): "DX Dial"
0258 Vatican Radio: "Vatican On-the-Air"	0900 Radio Vlaanderen Int'l: "Radio World"	2110 Radio Prague: "Calling All Listeners"	1009 HCJB: "DX Partyline"
0309 HCJB: "DX Partyline"	1308 Radio Vlaanderen Int'l: "Radio World"		1010 Voice of America (as): "Communications World"
0311 Radio Prague: "Calling All Listeners"	1500 Radio For Peace Int'l: "World of Radio"	Thursdays	1030 BBC: "Waveguide"
0313 Voice of Turkey: "DX Corner"	2010 Voice of Israel: "Calling All Listeners"	0011 Radio Prague: "Calling All Listeners"	1115 Swiss Radio Int'l: "SW Merry-Go-Round"
0315 WWCR (7435): "World of Radio"	2045 Radio Bulgaria: "Radio Bulgaria Calling"	0100 HCJB: "Ham Radio Today"	1125 Radio Bulgaria: "Radio Bulgaria Calling"
0330 Radio Havana Cuba: "DXers Unlimited"	2150 Radio Vilnius: "DX Program"	0130 BBC: "Waveguide"	1200 Radio For Peace Int'l: "World of Radio"
0410 Radio Australia: "Feedback"	2230 WHRI (13760): "World of Radio"	0152 Radio Netherlands Int'l: "Media Network"	1210 Voice of America (as): "Communications World"
0418 Swiss Radio Int'l: "SW Merry-Go-Round"	2241 Voice of Israel: "Calling All Listeners"	0311 Radio Prague: "Calling All Listeners"	1245 Voice of Turkey: "DX Corner"
0503 HCJB: "DX Partyline"	2251 Voice of Israel: "DX Corner"	0330 HCJB: "Ham Radio Today"	1309 Radio Vlaanderen Int'l: "Radio World"
0515 Spanish National Radio: "DX Spot"		0530 HCJB: "Ham Radio Today"	1319 Swiss Radio Int'l: "SW Merry-Go-Round"
0530 Radio Japan: "Media Roundup"	Tuesdays	0752 Radio Netherlands Int'l: "Media Network"	1344 Radio Romania Int'l: "DX Mailbag"
0600 KWHR (Hawaii): "World of Radio"	0045 Radio Bulgaria: "Radio Bulgaria Calling"	0830 Radio New Zealand Int'l: "RNZI Mailbox"	1345 Radio Bulgaria: "Radio Bulgaria Calling"
0600 WWCR (5810): "World of Radio"	1147 Radio Sweden: "Media Scan"	0952 Radio Netherlands Int'l: "Media Network"	1345 Radio Tashkent: "DX Program"
0610 Radio Australia: "Feedback"	1230 WWCR (15685): "World of Radio"	1152 Radio Netherlands Int'l: "Media Network"	1440 FEBC (Philippines): "DX Dial"
0630 Radio Havana Cuba: "DXers Unlimited"	1249 Radio Sweden: "Media Scan"	1352 Radio Netherlands Int'l: "Media Network"	1518 Swiss Radio Int'l: "SW Merry-Go-Round"
0810 Radio Australia: "Feedback"	1349 Radio Romania Int'l: "For Radio Amateurs"	1552 Radio Netherlands Int'l: "Media Network"	1610 Voice of America (as/me): "Communications World"
0835 Radio Korea: "Shortwave Feedback"	1349 Radio Sweden: "Media Scan"	1752 Radio Netherlands Int'l: "Media Network"	1615 KSDA (Guam): "DX Asiawaves"
0940 FEBC (Philippines): "DX Report"	1505 Polish Radio: "DX Program"	1952 Radio Netherlands Int'l: "Media Network"	1718 Swiss Radio Int'l: "SW Merry-Go-Round"
1000 Radio For Peace Int'l: "World of Radio"	1634 Radio Sweden: "Media Scan"	2110 Radio Prague: "Calling All Listeners"	1800 Radio For Peace Int'l: "World of Radio"
1037 Radio Korea: "Shortwave Feedback"	1749 Radio Sweden: "Media Scan"		1809 Radio Vlaanderen Int'l: "Radio World"
1236 Radio Korea: "Shortwave Feedback"	1840 Radio Bulgaria: "Radio Bulgaria Calling"	Fridays	1909 HCJB: "DX Partyline"
1307 Radio Korea: "Shortwave Feedback"	1900 Radio For Peace Int'l: "World of Radio"	0052 Radio Netherlands Int'l: "Media Network"	1945 Radio Romania Int'l: "DX Mailbag"
1353 Vatican Radio: "Vatican On-the-Air"	2049 Radio Sweden: "Media Scan"	0052 Radio Netherlands Int'l: "Media Network"	2018 Swiss Radio Int'l: "SW Merry-Go-Round"
1407 Voice of Israel: "Calling All Listeners"	2135 Radio Havana Cuba: "DXers Unlimited"	0115 Radio Tashkent: "DX Program"	2030 Voice of Turkey: "DX Corner"
1419 Voice of Israel: "DX Corner"	2149 Radio Sweden: "Media Scan"	0252 Radio Netherlands Int'l: "Media Network"	2039 HCJB: "DX Partyline"
1430 Radio Japan: "Media Roundup"	2235 Radio Havana Cuba: "DXers Unlimited"	0352 Radio Netherlands Int'l: "Media Network"	2105 Radio Vlaanderen Int'l: "Radio World"
1436 Radio Korea: "Shortwave Feedback"	2249 Radio Sweden: "Media Scan"	1530 Radio Bulgaria: "Radio Bulgaria Calling"	2110 Voice of America (af/me): "Communications World"
1615 KSDA (Guam): "DX Asiawaves"	2300 Radio Bulgaria: "Radio Bulgaria Calling"	1546 Radio Portugal Int'l: "Radio Portugal DX"	2135 Radio Havana Cuba: "DXers Unlimited"
1635 Radio Korea: "Shortwave Feedback"	2349 Radio Sweden: "Media Scan"	1845 Radio Bulgaria: "Radio Bulgaria Calling"	2213 Voice of Turkey: "DX Corner"
1730 Radio Japan: "Media Roundup"		1916 Radio Portugal Int'l: "Radio Portugal DX"	2235 Radio Havana Cuba: "DXers Unlimited"
1815 KSDA (Guam): "DX Asiawaves"	Wednesdays	1930 Radio New Zealand Int'l: "RNZI Mailbox"	2300 Radio Bulgaria: "Radio Bulgaria Calling"
2011 Voice of Israel: "Calling All Listeners"	0035 Radio Havana Cuba: "DXers Unlimited"	2000 Radio For Peace Int'l: "World of Radio"	2315 KSDA (Guam): "DX Asiawaves"
2023 Voice of Israel: "DX Corner"	0049 Radio Sweden: "Media Scan"	2016 Radio Portugal Int'l: "Radio Portugal DX"	2338 Radio Vlaanderen Int'l: "Radio World"
2040 Radio Korea: "Shortwave Feedback"	0149 Radio Sweden: "Media Scan"	2115 WWCR (15685): "World of Radio"	
2045 Radio Bulgaria: "Radio Bulgaria Calling"	0220 RAE Argentina: "DXers Special"	2210 Radio Australia: "Feedback"	
2110 Voice of America (as): "Communications World"	0235 Radio Havana Cuba: "DXers Unlimited"		
2130 Radio Japan: "Media Roundup"	0249 Radio Sweden: "Media Scan"		
	0300 Radio For Peace Int'l: "World of Radio"		

MT Monitoring Team

Gayle Van Horn, Frequency Manager
North Carolina

Next Reporting Deadline
May 23, 1994

Jim Frimmel, Program Manager
Texas

Dave Datko B.W. Battin
California New Mexico

Jacques d'Avignon
Propagation Forecasts
Ontario, Canada

newsline

"Newsline" is your guide to news broadcasts on the air. • All broadcasts are world news reports unless followed by an asterisk, which means the broadcast is primarily national news. • All broadcasts are daily unless otherwise noted by the day codes.

0000 UTC (8:00 PM EDT, 5:00 PM PDT)

BBC
China Radio Int'l
Radio Prague
Monitor Radio Int'l [T-F]
Radio Australia
Radio Havana Cuba [T-S]
Radio Moscow
Radio New Zealand Int'l [M-A]
Radio Norway Int'l [M]
Radio Thailand
Radio Ukraine Int'l
Radio Yugoslavia
Spanish National Radio
Voice of America (am/as/ca)
WWCR (5810) [S]

0003

Radio Bulgaria
Radio Pyongyang

0008

China Radio Int'l*
0010
Radio Havana Cuba [S-F]*
Voice of America (ca) [T-A]*

0022

Radio Ukraine Int'l [W]*

0030

HCJB
Radio Havana Cuba [T-A]
Radio Moscow

Radio Nacional de Venezuela
[T-S]

Radio Netherlands Int'l
Radio Sweden [T-A]
Voice of America (am) [T-S]
(Special English)
Voice of America (as) (Special
English)

0045

Korean World News Service

0050

RAI Italy
0055
Vatican Radio [S-W-F]

0057

Spanish National Radio [F]

0100 UTC

(9:00 PM EDT, 6:00 PM PDT)

All India Radio
BBC
Radio Prague
Deutsche Welle
FEBC (Philippines)
Monitor Radio Int'l [T-F]
R Slovakia Int'l
Radio Australia
Radio Budapest Int'l
Radio Canada Int'l

Radio Havana Cuba
Radio Japan
Radio Korea
Radio Moscow
Radio New Zealand Int'l [M-A]
Radio Tashkent
Radio Thailand
Radio Yugoslavia [S-F]
Spanish National Radio
Swiss Radio Int'l
Voice of America (am/as/ca)
Voice of Indonesia

0110

Radio Australia [M-F]*
Radio Havana Cuba [S-F]*

0130

BBC (as)*
Radio Austria Int'l
Radio Havana Cuba [T-A]
Radio Moscow [T-A]
Radio Netherlands Int'l
Radio Sweden [T-A]
Radio Tirana
Voice of Greece [M-A]

0145

BBC (ca) [T-A]*

0155

Voice of Indonesia

0157

Spanish National Radio [F]

0200 UTC

(10:00 PM EDT, 7:00 PM PDT)

BBC ("Newsdesk")
Christian Science Sentinel [A]
Deutsche Welle
KVOH [T-A]
Monitor Radio Int'l [T-F]
Radio Australia
Radio Canada Int'l
Radio Havana Cuba [T-S]
Radio Moscow
Radio New Zealand Int'l [M-A]
Radio Norway Int'l [M]
Radio Romania Int'l
Radio Thailand
Voice of America (am) [T-A]
Voice of America (as)
Voice of Myanmar (Burma)
WWCR (7435) [S]
WWCR (5810) [T-A]

0203

Voice of Free China

0210

Radio Havana Cuba [S-F]*

0215

Radio Cairo

Radio Nepal

0230

Radio Budapest Int'l

Radio Havana Cuba [T-A]
Radio Moscow
Radio Netherlands Int'l
Radio Pakistan
Radio Portugal Int'l [T-A]
Radio Sweden [T-A]
Radio Tirana
0245
Korean World News Service
Radio Yerevan

0300 UTC

(11:00 PM EDT, 8:00 PM PDT)

BBC
China Radio Int'l
Radio Prague
Deutsche Welle
HCJB
KVOH [T-A]
Monitor Radio Int'l [T-F]
Radio Australia
Radio Havana Cuba
Radio Japan
Radio Moscow

Radio New Zealand Int'l [M-A]
Radio Norway Int'l [M]
Radio Thailand
Voice of America (af)
Voice of Turkey
WHRI (7315) [T-A]
WWCR (7435) [T-S]
WWCR (5810) [M-A]

0303

Voice of Free China

0308

China Radio Int'l*

0309

BBC*

0310

Radio Havana Cuba [S-F]*

0315

BBC (as) [S]*

0320

Radio Philippines [M-A]

0330

BBC (af)*

Radio Austria Int'l

Radio Dubai

Radio Havana Cuba [T-A]

Radio Nacional de Venezuela

[T-S]

Radio Netherlands Int'l

Radio Sweden [T-A]

0340

Voice of Greece [M-A]

0355

Radio Japan [M-W]

0400 UTC

(12:00 AM EDT, 9:00 PM PDT)

BBC ("Newsdesk")
BBC (af)
Channel Africa
China Radio Int'l
Christian Science Sentinel [A]
Deutsche Welle
Monitor Radio Int'l [T-F]
Radio Australia
Radio Canada Int'l
Radio Havana Cuba [T-S]
Radio Moscow
Radio New Zealand Int'l*
Radio Romania Int'l
Radio Tanzania
Radio Thailand
Swiss Radio Int'l
Voice of America (af/me)
WHRI (7315) [T-A]
WWCR (7435) [T-A]

0403

Radio Bulgaria
Radio Pyongyang

0408

China Radio Int'l*

0409

BBC (af) [T-S]*

0410

Radio Havana Cuba [S-F]*

0411

Channel Africa [T]

0415

RAI Italy

0430

Channel Africa [A]
Radio Havana Cuba [T-A]
Radio Moscow
Voice of America (af) [M-F]*

0431

Channel Africa [T/H/F]

0445

BBC (af) [T-F]*

0500 UTC

(1:00 AM EDT, 10:00 PM PDT)

BBC ("Newshour")
Channel Africa
Christian Science Sentinel [S]
Deutsche Welle
HCJB
Monitor Radio Int'l [T-F]
Radio Australia
Radio Canada Int'l [M-F]
Radio Havana Cuba [S-F]
Radio Japan
Radio Moscow
Radio New Zealand Int'l
Radio Thailand

Spanish National Radio
Swiss Radio Int'l (eu)
Vatican Radio [T/F]
Voice of America (af/me)
Voice of Israel
WWCR (7435) [W-H]

0501

Channel Africa [A-S]
0510
Radio Australia [M-F]*
Radio Havana Cuba [S-F]*

0530

Channel Africa [F-M/W]
Radio Austria Int'l
Radio Dubai
Radio Finland [M-A]
Radio Havana Cuba [T-F]
Radio Moscow
Radio Romania Int'l
Radio Thailand
Voice of Nigeria

0550

Radio Finland [S]

0600 UTC

(2:00 AM EDT, 11:00 PM PDT)

BBC
BBC (af) [A-S]*
BBC (af) [M-F]
Channel Africa
Deutsche Welle
Monitor Radio Int'l [T-F]
Radio Australia
Radio Havana Cuba
Radio Korea
Radio Moscow
Radio New Zealand Int'l
Radio Prague
Swiss Radio Int'l
Voice of America (af) [A-S]
Voice of America (af) [M-F]*
Voice of America (me)
Voice of Kenya
Voice of Malaysia
WWCR (7435) [S]

0603

Radio Pyongyang

0609

BBC*

0610

Radio Havana Cuba [S-F]*

0627

BBC (af) [M-F]*

0630

Channel Africa [W]
Radio Austria Int'l [T-S]
Radio Havana Cuba [T-A]
Radio Moscow
Radio Vlaanderen Int'l

- Vatican Radio [H]
Voice of Nigeria [M-F]
0632
Radio Romania Int'l
0640
Vatican Radio [T]
0645
Radio Romania Int'l
Voice of Nigeria [M-F]*
0650
Radio New Zealand Int'l [M-F]*
Voice of Med. (Malta) [M-F]
- 0700 UTC**
(3:00 AM EDT, 12:00 AM PDT)
BBC
Monitor Radio Int'l [T-F]
Papua New Guinea
Radio Australia
Radio Ghana
Radio Japan
Radio Moscow
Radio New Zealand Int'l*
Swiss Radio Int'l (eu)
Voice of Myanmar (Burma)
0703
Radio Pyongyang
Voice of Free China
0710
Radio Australia [W]*
0730
BBC (af) [A]*
Radio Prague
HCJB
Radio Moscow [M-A]
Radio Netherlands Int'l
0740
Voice of Greece
0745
Radio Finland [M-A]
0755
Radio Japan [M-F]
- 0800 UTC**
(4:00 AM EDT, 1:00 AM PDT)
BBC
Christian Science Sentinel [T/F]
KNLS
Monitor Radio Int'l [T-F]
Radio Australia
Radio Korea
Radio Moscow
Radio New Zealand Int'l*
Radio Norway Int'l [S]
Voice of Indonesia [A-H]
Voice of Malaysia
0803
Radio Pyongyang
0830
R Slovakia Int'l
Radio Austria Int'l
Radio Moscow
Radio Netherlands Int'l
0845
Radio Yerevan [S]
0855
Voice of Indonesia [A-H]
- 0900 UTC**
(5:00 AM EDT, 2:00 AM PDT)
BBC
China Radio Int'l
Christian Science Sentinel [T/F]
Deutsche Welle
Monitor Radio Int'l [M-F]
Papua New Guinea
Radio Australia
Radio Ghana [A-S]
Radio Japan
Radio Jordan
Radio Moscow
Radio Mozambique
Radio New Zealand Int'l ("BBC
Newsdesk")
Radio Pakistan
- Radio Finland [M-A]
Radio Japan
Radio Moscow
Radio New Zealand Int'l*
Radio Vlaanderen Int'l [T-A]
Swiss Radio Int'l
0908
China Radio Int'l*
0915
Korean World News Service
0930
FEBC (Philippines)
Radio Moscow
Radio Netherlands Int'l
Radio New Zealand Int'l [T]
0933
Radio New Zealand Int'l [M]
0940
Voice of Greece
0945
Deutsche Welle [M-F]*
0955
Radio Japan [M-W]
- 1000 UTC**
(6:00 AM EDT, 3:00 AM PDT)
BBC
China Radio Int'l
Christian Science Sentinel [A]
FEBC (Philippines) [M-F]*
HCJB
Monitor Radio Int'l [M-F]
Papua New Guinea
Radio Australia
Radio Moscow
Radio New Zealand Int'l*
Radio Norway Int'l [S]
Radio Tanzania
Vatican Radio [M-A]
Voice of America (as/ca)
Voice of Kenya
WYFR (Satellite Network) [M-A]
1008
China Radio Int'l*
1030
Radio Austria Int'l [M-A]
Radio Dubai
Radio Korea
Radio Moscow
Radio Netherlands Int'l
Radio New Zealand Int'l [M-F]*
Radio Prague
Voice of Nigeria
1033
Radio Bulgaria
1040
Voice of Greece
1045
Voice of Nigeria [A-S]*
- 1100 UTC**
(7:00 AM EDT, 4:00 AM PDT)
BBC ("Newsdesk")
Channel Africa
Christian Science Sentinel [A]
Deutsche Welle
Monitor Radio Int'l [M-F]
Papua New Guinea
Radio Australia
Radio Ghana [A-S]
Radio Japan
Radio Jordan
Radio Moscow
Radio Mozambique
Radio New Zealand Int'l ("BBC
Newsdesk")
Radio Pakistan
- Radio Singapore Int'l
Swiss Radio Int'l
Voice of America (as/ca)
Voice of Israel
WWCR (15685) [M-F]
1103
Radio Pyongyang
1110
Radio Australia*
1115
Korean World News Service
1130
Radio Moscow
Radio Nacional de Venezuela
[M-A]
Radio Netherlands Int'l
Radio Singapore Int'l [M-A]
Radio Sweden [M-F]
Voice of Asia
WYFR (Satellite Network) [M-A]
1135
Radio Thailand
1145
Deutsche Welle [S-F]*
- 1200 UTC**
(8:00 AM EDT, 5:00 AM PDT)
BBC
China Radio Int'l
Christian Science Sentinel [A]
Monitor Radio Int'l [M-F]
Papua New Guinea [M-A]
Radio Australia
Radio Canada Int'l [M-F]
Radio France Int'l
Radio Moscow
Radio New Zealand Int'l
Radio Norway Int'l [S]
Radio Singapore Int'l [S-F]
Radio Tashkent
Radio Thailand
Voice of America (as)
WYFR (Satellite Network) [M-A]
1203
HCJB [M-F]
Radio Korea
1208
China Radio Int'l*
1209
BBC [W]*
1224
HCJB [M-F]
1230
Radio Austria Int'l
Radio Bangladesh [S-M]
Radio Cairo
Radio Canada Int'l
Radio Finland [M-A]
Radio Moscow [M-A]
Radio Netherlands Int'l
Radio Sweden [M-F]
Radio Vlaanderen Int'l [S]
Radio Yugoslavia
Voice of Turkey
Voice of Vietnam
WYFR (Satellite Network) [M-A]
1233
Radio Bulgaria
1240
Voice of Greece
1254
Radio France Int'l
- 1300 UTC**
(9:00 AM EDT, 6:00 AM PDT)
BBC ("Newshour")
China Radio Int'l
- Christian Science Sentinel [A]
KNLS
Monitor Radio Int'l [M-F]
Radio Australia
Radio Canada Int'l [S]
Radio Ghana
Radio Korea
Radio Moscow
Radio Romania Int'l [M-A]
Radio Tanzania [A-S]
Radio Tashkent [S]
Radio Vlaanderen Int'l [M-A]
Swiss Radio Int'l
Voice of America (as)
Voice of Kenya
WWCR (15685) [M-F]
WYFR (Satellite Network) [M-A]
1301
Radio Romania Int'l [S]
1303
Radio Pyongyang
1308
China Radio Int'l*
1310
Radiobrçs [M-F]
1315
Radio Nepal
1324
HCJB [M-F]
1328
Radio Cairo
1330
All India Radio
FEBC (Philippines)
Korean World News Service
Radio Austria Int'l
Radio Canada Int'l
Radio Dubai
Radio Finland [M-A]
Radio Moscow
Radio Netherlands Int'l
Radio Sweden [M-F]
Radio Tashkent [M-A]
Voice of America (as) (Special
English)
Voice of Vietnam
- 1400 UTC**
(10:00 AM EDT, 7:00 AM PDT)
All India Radio [M/W/F]
BBC
BBC (as) [M-F]*
China Radio Int'l
Christian Science Sentinel [A]
Monitor Radio Int'l [M-F]
Radio Australia
Radio Canada Int'l [S-F]
Radio France Int'l
Radio Ghana
Radio Japan
Radio Jordan [A]
Radio Korea
Radio Moscow
Voice of America (as)
Voice of Israel [S-H]
WWCR (15685) [M-F]
1408
China Radio Int'l*
1418
Radio Bulgaria
1423
Voice of Israel [S-H]
1424
HCJB [M-F]
1430
FEBC (Philippines)
Radio Canada Int'l [S]
- Radio Finland
Radio Moscow
Radio Nacional de Venezuela
[M-A]
Radio Netherlands Int'l
Radio Romania Int'l [T-S]
Radio Tirana
RTM Morocco [S]
Voice of Myanmar (Burma)
WYFR (Satellite Network) [M-F]
1431
Radio France Int'l [T]*
Radio Romania Int'l [M]
1435
Voice of Greece
1440
FEBC (Philippines) [S-F]*
1445
BBC (as) [M-F] (Special English)
Voice of Myanmar (Burma)
1450
All India Radio
Voice of Med. (Malta) [M-F]
1453
Radio France Int'l [M-H/A]
1455
All India Radio
- 1500 UTC**
(11:00 AM EDT, 8:00 AM PDT)
BBC
BBC (af) [M-F]
Channel Africa
China Radio Int'l
Christian Science Sentinel [A]
Deutsche Welle
Monitor Radio Int'l [M-F]
Radio Australia
Radio Canada Int'l [S]
Radio Japan
Radio Jordan
Radio Moscow
Radio Omdurman
Radio Tallinn
Swiss Radio Int'l
Voice of America (as/me)
WHRI (9465) [A]
WWCR (15610) [A]
WYFR (Satellite Network) [A]
1503
Radio Pyongyang
1505
Radio Algiers [M]
1508
China Radio Int'l*
1525
BBC (af) [S]*
Radio Veritas [T-F]
1530
All India Radio
Deutsche Welle [M-F]*
FEBC (Philippines)
Radio Austria Int'l
Radio Moscow
Radio Netherlands Int'l
Radio Portugal Int'l [M-F]
Voice of Greece [M-A]
Voice of Nigeria [M-H]
1540
Radio Veritas [A-M]
1545
Korean World News Service
1555
Radio Japan [M-W]
Radio Veritas [A-M]

1600 UTC
(12:00 PM EDT, 9:00 AM PDT)

BBC
Channel Africa
China Radio Int'l
Christian Science Sentinel [A]
Radio Prague
Deutsche Welle
Monitor Radio Int'l [M-F]
Radio Australia
Radio France Int'l
Radio Jordan
Radio Korea
Radio Moscow
Radio Pakistan
Radio Tanzania
Voice of America (af) [A-S]
Voice of America (as/me)
Voice of Kenya
Voice of Nigeria [M-F]
WRNO [M-F]
WWCR (15685) [M-F]
1605
Radio Yemen
1608
China Radio Int'l*
1609
BBC*
1611
Radio France Int'l [T]*
1612
Vatican Radio [S-F]
1615
Radio Sweden [M-F]
1630
Radio Austria Int'l
Radio Canada Int'l
Radio Dubai
Radio Moscow [S-F]
Voice of America (af) [M-F]
Voice of America (as/me)
(Special English)
1645
BBC (as)*
1652
Radio France Int'l [M-F]

1700 UTC
(1:00 PM EDT, 10:00 AM PDT)

BBC
BBC (af)
Channel Africa
China Radio Int'l
Christian Science Sentinel [A]
HCJB [M-F]
Monitor Radio Int'l [M-F]
Polish Radio
Radio Australia
Radio Japan

Radio Moscow
Radio New Zealand Int'l [M-F]*
Radio Pakistan
RTM Morocco [A]
Swiss Radio Int'l
Voice of America (af/as/me)
WWCR (15685) [M-F]
WWCR (15610) [M-F]
1703
Radio Pyongyang
1708
China Radio Int'l*
1710
Radio Australia*
1715
Korean World News Service
1725
Radio New Zealand Int'l [M-F]*
1730
Radio Moscow
Radio Netherlands Int'l
Radio Romania Int'l
Radio Sweden [M-F]
Vatican Radio [F]
Voice of America (af) [S]
1733
Radio Bulgaria
1740
BBC (af)*
1745
All India Radio

1800 UTC
(2:00 PM EDT, 11:00 AM PDT)

All India Radio
BBC ("Newsdesk")
Christian Science Sentinel [A]
Monitor Radio Int'l [M-F]
Radio Australia
Radio Moscow
Radio Mozambique
Radio New Zealand Int'l [M-F]*
Radio Norway Int'l [S]
Radio Omdurman
Radio Prague
Radio Tanzania
Radio Vlaanderen Int'l
Voice of America (af/me)
Voice of Israel
Voice of Kenya
WWCR (15685) [M-F]
WWCR (15610) [M-F]
1805
Radio New Zealand Int'l [M-F]*
1830
R Slovakia Int'l
Radio Kuwait
Radio Moscow
Radio Nacional de Venezuela [M-A]

Radio Netherlands Int'l
Radio Yugoslavia
Voice of America (af) [A-S]
(Special English)
Voice of America (me) (Special English)
1835
Radio New Zealand Int'l [F]*
1840
Voice of Greece [M-A]
1845
Radio Yerevan
1850
Africa No. 1 (Gabon)*
1855
Radio New Zealand Int'l [M-H]*
1857
BBC (af) [M-F]*

1900 UTC
(3:00 PM EDT, 12:00 PM PDT)

All India Radio [W]
BBC
China Radio Int'l
Christian Science Sentinel [A]
Deutsche Welle
HCJB
Monitor Radio Int'l [M-F]
Radio Australia
Radio Budapest Int'l
Radio Japan
Radio Moscow
Radio New Zealand Int'l [S-F]
Radio Portugal Int'l [M-F]
Radio Romania Int'l [T-S]
Spanish National Radio
Voice of America (af/as/me)
Voice of Greece [M-A]
WHRI (9485) [M-F]
WWCR (15610) [M-A]
1901
Radio Romania Int'l [M]
1908
China Radio Int'l*
1910
All India Radio [W]
Radio Australia [M-F]*
1930
BBC (af) [S]*
Deutsche Welle [T-F]*
Polish Radio
Radio Austria Int'l
Radio Finland [S-F]
Radio Moscow [A-S]
Radio Netherlands Int'l
Voice of America (af) [S]
1933
Deutsche Welle [M]*
1935
RAI Italy
1955
Radio Japan [M-W]

2000 UTC
(4:00 PM EDT, 1:00 PM PDT)

BBC
China Radio Int'l
Deutsche Welle
KVOH [A-S]
Monitor Radio Int'l [M-F]
Radio Australia
Radio Moscow
Radio New Zealand Int'l [S-F]
Radio Norway Int'l [S]
Radio Portugal Int'l [M-F]
Swiss Radio Int'l
Voice of America (af/me)
Voice of Indonesia

Voice of Israel
Voice of Nigeria [M-F]
Voice of Turkey
WHRI (9485) [M-W/F]
WWCR (15610) [M-A]
2003
Radio Bulgaria
Radio Pyongyang
2008
China Radio Int'l*
2010
Radio New Zealand Int'l [S-H]*
2011
Voice of Israel [W]*
2025
RAI Italy
2030
HCJB [M-A]
Radio Canada Int'l
Radio Korea
Radio Moscow
Radio Riga Int'l [M-F]
Radio Sweden [M-F]
2031
HCJB [S]
2045
All India Radio [A]
Korean World News Service
2055
Voice of Indonesia [M]

2100 UTC
(5:00 PM EDT, 5:00 PM PDT)

All India Radio
BBC ("Newshour")
China Radio Int'l
Deutsche Welle
KVOH [S]
Monitor Radio Int'l [M-F]
Radio Australia
Radio Budapest Int'l
Radio Canada Int'l [A-S]
Radio Damascus [F]
Radio Havana Cuba [M-A]
Radio Japan
Radio Moscow
Radio New Zealand Int'l [S-H]
Radio Prague
Radio Romania Int'l
Radio Ukraine Int'l
Radio Vlaanderen Int'l [M-F]
Radio Yugoslavia
Spanish National Radio
Voice of America (af/as/me)
WWCR (12160) [M-F]
2105
Radio Yemen
2108
China Radio Int'l*
2110
Radio Damascus [S-M]
Radio New Zealand Int'l [S-W]*
2112
Radio Damascus [F]
2115
BBC (ca) [M-F]*
2120
Radio Cairo
2130
Radio Havana Cuba [M-A]*
Radio Havana Cuba [W/F]
Radio Moscow [S-F]
Radio Nacional de Venezuela [M-A]
Radio Sweden [M-F]
2145
Radio Damascus [W]
Radio Korea

Radio Yerevan
2148
Radio Bulgaria

2200 UTC
(6:00 PM EDT, 3:00 PM PDT)

All India Radio
BBC
China Radio Int'l
Christian Science Sentinel [A]
Radio Prague
Monitor Radio Int'l [M-F]
Radio Australia
Radio Canada Int'l
Radio Havana Cuba [M-A]
Radio Korea
Radio Moscow
Radio New Zealand Int'l
Radio Tirana
RAI Italy
Voice of America (as)
Voice of Turkey
WWCR (12160) [M-A]
2203
Voice of Free China
2208
China Radio Int'l*
2215
All India Radio [M/F]
Radio Cairo
2230
Radio Canada Int'l [A-S]
Radio Finland [S-F]
Radio Havana Cuba [M-A]*
Radio Moscow
Radio Sweden [M-F]
Voice of America (as) (Special English)
Voice of Israel
2240
Radio Cairo
Voice of Greece [S-F]
2242
Voice of Israel [H]*
2245
Radio Yerevan

2300 UTC
(7:00 PM EDT, 4:00 PM PDT)

BBC ("Newsdesk")
Christian Science Sentinel [A]
Monitor Radio Int'l [M-F]
Radio Australia
Radio Canada Int'l [A-S]
Radio Japan
Radio Moscow
Radio New Zealand Int'l
Radio Norway Int'l [S]
Radio Singapore Int'l
Radio Vilnius [M-A]
Radio Vlaanderen Int'l
Voice of America (as)
WWCR (5810) [A-S]
WYFR (Satellite Network) [M-H/A]
2303
Radio Pyongyang
2330
Radio Austria Int'l
Radio Moscow
Radio Netherlands Int'l
Radio New Zealand Int'l [S-H]
Radio Sweden [M-F]
SLBC (Sri Lanka) [M]
2335
Voice of Greece [S-F]
2355
Radio Japan [M-W]



This tempting seashore is depicted on a QSL from Radio Cairo.

A KEYNOTE SPEAKER *from Grove!*

NEW!



Why pay over \$400 for these separate accessories:

- Speaker
- Adjustable Filter
- Recorder Activator
- Audio Amplifier
- Audio Activated Squelch
- Noise Limiter



When you can have it all in the new Grove

SP-200!

SOUND ENHANCER ●

The Grove engineering team has created the most revolutionary audio accessory on the communication market: the **SP200 Sound Enhancer**.

Housed in a stylish, solid oak cabinet hand crafted in the mountains of North Carolina, the **SP200** is sure to enhance any room and radio receiver. The control panel, constructed of sturdy, black aluminum, has been designed for optimum ease and convenience when tuning and refining signals.

The **SP200** combines a powerful audio amplifier, top-of-the-line speaker, and an adjustable filter system in one to create the most versatile and precise listening environment ever available to radio enthusiasts. The keen peak/notch filter system and advanced noise limiter allow the listener to pull clear and distinct signals out of the haze of interference and background noise, while the

adjustable bass and treble provide the flexibility to create just the sound you want. FSK, RTTY, packet, FAX, CW and all other data systems are enhanced while interference and electrical noise are reduced or even eliminated by the analog audio processor.

The **SP200** also comes equipped with a stereo/mono headphone jack, for private listening, and an automatic tape activator so that you never have to miss anything.

Try the new Grove **SP200** Sound Enhancer with your receiver, scanner, or transceiver and enjoy the latest in speaker sophistication; you'll agree this is truly a keynote speaker!

SPECIFICATIONS:

Power Required: 12 to 14 VDC @500 mA; 120 VAC adaptor incl.
Audio Power Output: 2.5 W @ 10% THD (8 ohms)
Audio Selectivity: Peak/notch 30 dB or greater, 0.3-6 kHz
Squelch Hold: 0-10 seconds
Noise Limiter: Adjustable-threshold pulse noise clamp
Tape Activator: Audio activated (VOX), 3 second hold
Tape Output: 500 mV P-P @ 600 ohms (nom.)
Headphone Jack: Universal mono-wired stereo jack
Dimensions: 10-7/8"W x 6-7/8"H x 7-1/4"D

CALL NOW! **(800) 438-8155**
(704) 837-9200

\$ Order SPK13
199^{95*}

 **GROVE ENTERPRISES**

*Changing the way you to
hear the world*

* Plus \$7⁵⁰ UPS Ground Shipping

FREQUENCIES

0000-0100	Australia, Radio	13605as	15320pa	15365pa	15510as	0000-0100	Spain, Spanish Natl Radio	9540na			
		17750as				0000-0100	Thailand, Radio	9655as	11905as		
0000-0100 vl	Australia, VL8A Alice Spg	4835do				0000-0100	United Kingdom, BBC London	5975na	6175na	6180na	7180eu
0000-0100 vl	Australia, VL8K Katherine	5025do						7325na	9580na	9590na	9915na
0000-0100 vl	Australia, VL8T Tent Crk	4910do						11750sa	11955sa	12095sa	15260sa
0000-0015	Cambodia, Natl Voice of	11938as						15310as	15360as		
0000-0100	Canada, CFCX Montreal	6005do				0000-0100	USA, KCBI Dallas TX	13740na			
0000-0100	Canada, CFRX Toronto	6070do				0000-0100	USA, KTBN Salt Lk City UT	7510am			
0000-0100	Canada, CFVP Calgary	6030do				0000-0100	USA, KVOH Los Angeles CA	17775am			
0000-0100	Canada, CHNX Halifax	6130do				0000-0100	USA, KWHR Naalehu HI	17510as			
0000-0100	Canada, CKZN St John's	6160do				0000-0100	USA, Monitor Radio Intl	5850na	9430ca		
0000-0100	Canada, CKZU Vancouver	6160do				0000-0100	USA, VOA Washington DC	5995am	6130am	7215au	7405am
0000-0100	China, China Radio Intl	9780na	11715na					9455am	9770au	9775am	11580am
0000-0100	Costa Rica, AWR Alajuela	9725ca	11870ca					11695am	11760as	15120am	15185as
0000-0100	Cuba, Radio Havana Cuba	6010na	9815na					15205am	15290as	17735as	17820as
0000-0027	Czech Rep, Radio Prague	5930na	7345na			0000-0100	USA, WCSN Scotts Cor ME	7465am			
0000-0045	India, All India Radio	9910as	11745as	11785as	15110as	0000-0100	USA, WEWN Birmingham AL	7425am	9350am		
		15145as				0000-0100 vl	USA, WHRI Noblesville IN	7315am			
0000-0030	Lithuania, Radio Vilnius	7150am				0000-0100	USA, WINB Red Lion PA	11950am			
0000-0100 vl	Malaysia, RTM Kota Kinaba	5980do				0000-0100	USA, WJCR Upton KY	7490na	13595na		
0000-0100 vl	Malaysia, RTM Sarawak	4950do	7160do			0000-0100	USA, WRNO New Orleans LA	7355am			
0000-0030	Netherlands, Radio	6020na	6165na			0000-0100	USA, WWCN Nashville TN	5810am	7435am	13845am	
0000-0100	New Zealand, R NZ Intl	15115pa				0000-0100	USA, WYFR Okeechobee FL	6085am			
0000-0050	North Korea, R Pyongyang	11335na	13760na	15130na		0030-0100	Australia, Radio	11720pa	11880pa	13605as	15240pa
0000-0100 mtwhfa	Palau, KHBN Voice of Hope	11980as						15365pa	15510as	17795pa	17860pa
0000-0100 vl	Papua New Guinea, NBC	9675do						17880as			
0000-0100	Philippines, FEBC Manila	15450as				0030-0100	Ecuador, HCJB Quito	9745am	15155am	17490am	21455am
0000-0100	Russia, Radio Moscow Intl	7165na	7180af	7195am	7210af	0030-0100	Iran, VOIRI Tehran	6175na	7100na		
		7295am	9480na	9620na	9885am	0030-0100	Netherlands, Radio	6020na	6165na	9840na	
		10344as	11675am	11790am	11970as	0030-0100	Sri Lanka, SLBC Colombo	6005as	9720as	15425as	
		12050na	15425am	17570as	17610as	0030-0100	Sweden, Radio	6065sa	9850sa		
		17690na	17890as	21480na	21690na	0050-0100	Italy, RAI Rome	6005na	9725na	11800na	

SELECTED PROGRAMS

Sundays

- 0000 BBC: World News. Broadcast on the hour.
- 0000 Radio New Zealand Int'l: National Radio. Programming from New Zealand's domestic radio.
- 0009 BBC: British News. Also during Newsdesk (:20) and Newshour (:40).
- 0010 Radio New Zealand Int'l: Focus on Politics. Developments on the New Zealand political scene.
- 0015 BBC: Good Books. Recommendation of a book to read.
- 0025 R New Zealand Int'l: NZ Long Range Weather Forecast. Five-day weather forecast with warnings for mariners.
- 0030 BBC: Play of the Week. *Racing Demon* (29th, 90 min). The struggles of four clergymen in south London are detailed.
- 0030 BBC: The John Dunn Show. A melodic mix of songs old and new.
- 0030 Radio New Zealand Int'l: Insight '94. New Zealand's relationships with other countries of the Asia/Pacific region (Natl Radio).

Mondays

- 0000 BBC: World News. See S 0000.
- 0000 Radio New Zealand Int'l: News and Midday Report. News

- and information from NZ's National Radio.
- 0009 BBC: British News. See S 0009.
- 0015 BBC: Feature. A Step Too Far (16th, 23rd, 30th). See S 0445.
- 0015 BBC: Music Feature. Rock 'N Rice (2nd, 9th). See S 0445.
- 0030 BBC: In Praise of God. Weekly programme of worship and meditation.
- 0030 Radio New Zealand Int'l: RNZ News. See S 0600.
- 0035 Radio New Zealand Int'l: NZ Long Range Weather Forecast. See S 0025.
- 0040 Radio New Zealand Int'l: Rural Report. Farming and agricultural news.
- 0055 Radio New Zealand Int'l: International Business News. Five minutes of commercial news.

Tuesdays

- 0000 BBC: World News. See S 0000.
- 0000 Radio New Zealand Int'l: News and Midday Report. See M 0000.
- 0009 BBC: British News. See S 0009.
- 0015 BBC: A Jolly Good Show. Dave Lee Travis presents your record requests and dedications in his own unique way.
- 0030 Radio New Zealand Int'l: RNZ News. See S 0600.
- 0035 Radio New Zealand Int'l: NZ Long Range Weather Forecast. See S 0025.
- 0040 Radio New Zealand Int'l: Rural Report. See M 0040.
- 0055 Radio New Zealand Int'l: International Business News. See M 0055.

Wednesdays

- 0000 BBC: World News. See S 0000.
- 0000 R New Zealand Int'l: News and Midday Report. See M 0000.
- 0009 BBC: British News. See S 0009.
- 0015 BBC: Concert Hall. See S 1515.
- 0030 Radio New Zealand Int'l: RNZ News. See S 0600.

- 0035 Radio New Zealand Int'l: NZ Long Range Weather Forecast. See S 0025.
- 0040 Radio New Zealand Int'l: Rural Report. See M 0040.
- 0055 Radio New Zealand Int'l: International Business News. See M 0055.

Thursdays

- 0000 BBC: World News. See S 0000.
- 0000 Radio New Zealand Int'l: News and Midday Report. See M 0000.
- 0009 BBC: British News. See S 0009.
- 0015 BBC: Ray on Record. Robin Ray presents some of the best in classical music.
- 0030 Radio New Zealand Int'l: RNZ News. See S 0600.
- 0035 Radio New Zealand Int'l: NZ Long Range Weather Forecast. See S 0025.
- 0040 Radio New Zealand Int'l: Rural Report. See M 0040.
- 0055 Radio New Zealand Int'l: International Business News. See M 0055.

Fridays

- 0000 BBC: World News. See S 0000.
- 0000 R New Zealand Int'l: News and Midday Report. See M 0000.
- 0009 BBC: British News. See S 0009.
- 0015 BBC: Music Review. News and views from the world of music.
- 0030 Radio New Zealand Int'l: RNZ News. See S 0600.
- 0035 Radio New Zealand Int'l: NZ Long Range Weather Forecast. See S 0025.
- 0040 Radio New Zealand Int'l: Rural Report. See M 0040.
- 0055 Radio New Zealand Int'l: International Business News. See M 0055.

Saturdays

- 0000 BBC: World News. See S 0000.
- 0000 Radio New Zealand Int'l: RNZ News. See S 0600.
- 0009 BBC: British News. See S 0009.
- 0012 Radio New Zealand Int'l: Money Matters. See S 0630.
- 0015 BBC: Feature. Writing Time (7th, 14th, 21st). Advice on the technique of fiction writing. Marriage and the Throne (28th). Dramatic stories of marriage and divorce from the history of the British royal family.
- 0015 BBC: Feature.
- 0025 Radio New Zealand Int'l: NZ Long Range Weather Forecast. See S 0025.
- 0030 BBC: From the Weeklies. Review of the British weekly press.
- 0045 BBC: The Learning World. See M 0615.

Thank You...

Additional contributors to this month's Shortwave Guide:

John Babbis, Silver Spring, MD; Bob Fraser, Cohasset, MA; Clyde Harmon, Anniston, AL; Stephen Hunter, Drexel Hill, PA; Robert E. Thomas, Bridgeport, CT; Alden Wires, East Point, GA; Grove Enterprises BBS; Internet Shortwave Newsgroup via Larry Van Horn. NASWA Journal, Speedx, BBC Summary of World Broadcasters, Internet.

**Guide to Shortwave Programs
1994 Edition**

Updated this year with over 20,000 program listings from more than 100 worldwide broadcasters, you can now enjoy a complete 24-hour a day listing of English language short-wave programs!

Grove Enterprises
1-800-438-8155

Only
\$16⁹⁵
plus \$5 UPS

FREQUENCIES

Table with columns for frequency ranges (e.g., 0200-0300), call letters (e.g., twhfa), and country/region names (e.g., Argentina, RAE). Includes various international stations and their broadcast times.

Table with columns for frequency ranges, call letters, and country/region names. Includes stations from Serbia, Sri Lanka, Taiwan, Thailand, USA, and Vatican State.

SELECTED PROGRAMS

Sundays

- 0200 BBC: Newsdesk. World News and dispatches from overseas and UK correspondents.
0200 KSDA (Guam): AWR Magazine.
0200 Radio Canada Int'l: CBC News. See S 0100.

Mondays

- 0200 BBC: Newsdesk. See S 0200.
0200 Radio Canada Int'l: CBC News. See S 0100.
0200 Radio New Zealand Int'l: RNZ News. See S 0600.

Tuesdays

- 0200 BBC: Newsdesk. See S 0200.
0200 Radio Canada Int'l: CBC News. See S 0100.
0200 Radio New Zealand Int'l: RNZ News. See S 0600.

Wednesdays

- 0200 BBC: Newsdesk. See S 0200.
0200 Radio Canada Int'l: CBC News. See S 0100.
0200 Radio New Zealand Int'l: RNZ News. See S 0600.

Thursdays

- 0200 BBC: Newsdesk. See S 0200.
0200 Radio Canada Int'l: CBC News. See S 0100.
0200 Radio New Zealand Int'l: RNZ News. See S 0600.

Fridays

- 0200 BBC: Newsdesk. See S 0200.
0200 Radio Canada Int'l: CBC News. See S 0100.
0200 Radio New Zealand Int'l: RNZ News. See S 0600.

Saturdays

- 0200 BBC: Newsdesk. See S 0200.
0200 KSDA (Guam): Digging Up the Past.
0200 Radio Canada Int'l: CBC News. See S 0100.

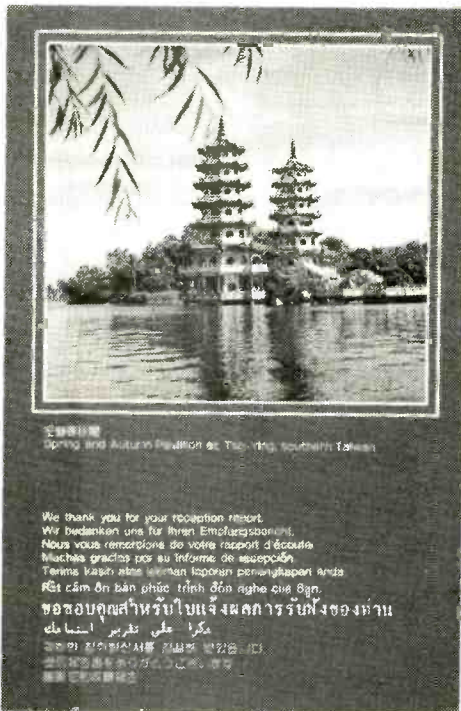

Donald Choleva of Ohio shares this QSL from Radio Free China.

FREQUENCIES

0300-0400	Australia, Radio	11720pa	11880pa	15240pa	15320pa
		15365pa	15510as	17750as	17795pa
		17860pa	17880as	21525as	21595as
0300-0400 vl	Australia, VL8A Alice Spg	4835do			
0300-0400 vl	Australia, VL8K Katherine	5025do			
0300-0400 vl	Australia, VL8T Tent Crk	4910do			
0300-0400	Bahrain, Radio	6010do			
0300-0330 mtwtf	Canada, CanForce Network	6000eu	9725eu		
0300-0400	Canada, CFCX Montreal	6005do			
0300-0400	Canada, CFRX Toronto	6070do			
0300-0400	Canada, CFVP Calgary	6030do			
0300-0400	Canada, CHNX Halifax	6130do			
0300-0400	Canada, CKZN St John's	6160do			
0300-0400	Canada, CKZU Vancouver	6160do			
0300-0400	China, China Radio Intl	9690na	9780na	11715na	
0300-0400	Costa Rica, R Peace Intl	7375am	9400am	15030am	21465am
0300-0400	Costa Rica, Faro del Carib	5055do			
0300-0400	Cuba, Radio Havana Cuba	6010na	9510na		
0300-0327	Czech Rep, Radio Prague	5930na	7345na		
0300-0400	Ecuador, HCJB Quito	9745am	15155am	17490am	21455am
0300-0330	Egypt, Radio Cairo	9475na	11600na		
0300-0350	Germany, Deutsche Welle	6085na	6185na	9535na	9640na
		9700na	11715na		
0300-0400	Guatemala, Radio Cultural	3300do			
0300-0400	Japan, NHK/Radio	5960am	11875am	11885am	15210am
		15230am	15325am	17810am	21610am
0300-0400	Kenya, Kenya BC Corp	4935do			
0300-0400 smtwh	Malaysia, RTM Radio 4	7295do			
0300-0325	Netherlands, Radio	9845as	9860as	11655as	
0300-0400	New Zealand, R NZ Intl	15115pa			
0300-0400 vl	Papua New Guinea, NBC	9675do			
0300-0400	Russia, Radio Moscow Intl	5940am	7130na	7150na	7165na
		7180na	7295na	9675me	9755me
		11675na	12050na	15425na	17570as
		17605na	17655as	17690na	
0300-0400	S Africa, Channel Africa	3220af	5955af		
0300-0400	Sri Lanka, SLBC Colombo	9720as	15425as		

0300-0400	Taiwan, VO Free China	5950na	9680na	9765au	11740as
		15345na			
0300-0400	Thailand, Radio	9655as	11905as		
0300-0350	Turkey, Voice of	9445na			
0300-0400 vl	Uganda, Radio	4976do			
0300-0330	United Kingdom, BBC London	11750sa	15260sa	15310as	15380as
0300-0400	United Kingdom, BBC London	3955af	5975na	6005af	6175na
		6180eu	6195eu	7230eu	7325na
		9410eu	9600af	9630af	9915am
		11730af	11760me	11955me	12095ca
		15310me	15420af	21715as	
0300-0400	USA, KCBI Dallas TX	9815am			
0300-0400	USA, KTNB Salt Lk City UT	7510am			
0300-0400	USA, KVOH Los Angeles CA	9785am			
0300-0400	USA, KWHR Naalehu HI	17510as			
0300-0400	USA, Monitor Radio Intl	5850na			
0300-0400	USA, VOA Washington DC	7105af	7265af	7280af	7405af
		9575af	9885af	11965af	
0300-0400	USA, WCSN Scotts Cor ME	7465am			
0300-0400	USA, WEWN Birmingham AL	7425am	9350am	13615am	
0300-0400 vl	USA, WHRI Noblesville IN	7315am	9495am		
0300-0400	USA, WINB Red Lion PA	11950eu			
0300-0400	USA, WJCR Upton KY	7490na	13595na		
0300-0400	USA, WRNO New Orleans LA	7355am			
0300-0400 vl	USA, WWCR Nashville TN	5810am	5935am	7435am	
0300-0400	USA, WYFR Okeechobee FL	6065am	9505am		
0315-0330 sh	Greece, Voice of	5970na	9380na	9420na	
0315-0345	Vatican State, Vatican R	7360af	9695af		
0330-0400	Austria, R Austria Intl	9870sa	13730sa		
0330-0357	Czech Rep, Radio Prague	5930eu	7345eu	9440eu	
0330-0400	Netherlands, Radio	6165na	9590na		
0330-0400	Sweden, Radio	6040na	9850na		
0330-0400	Tanzania, Radio	5050af			
0330-0400	UAE, Radio Dubai	11945na	13675na	15400eu	17890eu
		21485na			
0340-0350	Greece, Voice of	5970na	9380na	9420na	
0345-0400	Armenia, Radio Yerevan	7105na	10344na	17605na	17650na
0345-0400	Tajikistan, Radio	7245as			

SELECTED PROGRAMS

Sundays

- 0300 BBC: World News. See S 0000.
- 0300 R New Zealand Int'l: National Radio or Sport. See S 0100.
- 0309 BBC: British News. See S 0009.
- 0315 BBC: Sports Roundup. The latest sports news.
- 0330 BBC (af): African News. Five minutes of news about Africa.
- 0330 BBC: From Our Own Correspondent. BBC correspondents comment on the background to the news.
- 0335 BBC (af): Postmark Africa. Expert answers to any question under the sun.
- 0350 BBC: Write On. Air your views about World Service: write to PO Box 76, Bush House, Strand, London WC2B 4PH.

Mondays

- 0300 BBC: World News. See S 0000.
- 0300 Radio New Zealand Int'l: RNZ News. See S 0600.
- 0305 Radio New Zealand Int'l: In Touch with New Zealand. See M 0205.
- 0309 BBC: British News. See S 0009.
- 0315 BBC: Sports Roundup. See S 0315.
- 0330 BBC (af): African News. See S 0330.
- 0330 BBC (eu): Europe Today. News, features, profiles and trends for the new Europe.
- 0330 BBC: Anything Goes. See S 1430.
- 0333 BBC (af): Network Africa. Breakfast show of news, sport, personalities, music, and listener's comments.

Tuesdays

- 0300 BBC: World News. See S 0000.
- 0300 Radio New Zealand Int'l: RNZ News. See S 0600.
- 0305 Radio New Zealand Int'l: In Touch with New Zealand. See M 0205.
- 0309 BBC: British News. See S 0009.
- 0315 BBC: Sports Roundup. See S 0315.
- 0330 BBC (af): African News. See S 0330.
- 0330 BBC (eu): Europe Today. See M 0330.
- 0330 BBC: John Peel. Tracks from newly released albums and singles from the contemporary music scene.
- 0333 BBC (af): Network Africa. See M 0333.

Wednesdays

- 0300 BBC: World News. See S 0000.
- 0300 Radio New Zealand Int'l: RNZ News. See S 0600.
- 0305 Radio New Zealand Int'l: In Touch with New Zealand. See M 0205.
- 0309 BBC: British News. See S 0009.
- 0315 BBC: Sports Roundup. See S 0315.
- 0330 BBC (af): African News. See S 0330.
- 0330 BBC (eu): Europe Today. See M 0330.
- 0330 BBC: Discovery. In-depth look at scientific research.
- 0333 BBC (af): Network Africa. See M 0333.

Thursdays

- 0300 BBC: World News. See S 0000.
- 0300 Radio New Zealand Int'l: RNZ News. See S 0600.
- 0305 Radio New Zealand Int'l: In Touch with New Zealand. See M 0205.



- 0309 BBC: British News. See S 0009.
- 0315 BBC: Sports Roundup. See S 0315.
- 0330 BBC (af): African News. See S 0330.
- 0330 BBC (eu): Europe Today. See M 0330.
- 0330 BBC: Assignment. A weekly examination of a topical issue.
- 0333 BBC (af): Network Africa. See M 0333.

Fridays

- 0300 BBC: World News. See S 0000.
- 0300 Radio New Zealand Int'l: RNZ News. See S 0600.
- 0305 Radio New Zealand Int'l: In Touch with New Zealand. See M 0205.
- 0309 BBC: British News. See S 0009.
- 0315 BBC: Sports Roundup. See S 0315.
- 0330 BBC (af): African News. See S 0330.
- 0330 BBC (eu): Europe Today. See M 0330.
- 0330 BBC: Focus on Faith. Comment and discussion on the major issues in the worlds of faith.
- 0333 BBC (af): Network Africa. See M 0333.

Saturdays

- 0300 BBC: World News. See S 0000.
- 0300 Radio New Zealand Int'l: RNZ News. See S 0600.
- 0305 R New Zealand Int'l: National Radio or Sport. See S 0100.
- 0309 BBC: British News. See S 0009.
- 0315 BBC: Sports Roundup. See S 0315.
- 0330 BBC (af): African News. See S 0330.
- 0330 BBC (eu): Europe Today. See M 0330.
- 0330 BBC: The Vintage Chart Show. Each week a classic Top 20 from the past with Paul Burnett.

Gigi Lytle, Lubbock, TX, and two new friends she made on her recent trip as a Hainan cup winner to China.

FREQUENCIES

0400-0500	Australia, Radio	11720pa	11800pa	15240pa	15320pa	0400-0500	S Africa, Channel Africa	3220af	5955af			
		15365pa	17630pa	17700pa	17750as	0400-0430	Sri Lanka, SLBC Colombo	9720as	15425as			
		17795pa	17860pa	21525as	21595as	0400-0500	Swaziland, Swazi Radio	6155af				
0400-0500 vl	Australia, VL8A Alice Spg	4835do				0400-0430	Switzerland, Swiss R Intl	6135na	9860na	9885na	12035na	
0400-0500 vl	Australia, VL8K Katherine	5025do				0400-0430	Tanzania, Radio	5050af				
0400-0500 vl	Australia, VL8T Tent Crk	4910do				0400-0430	Thailand, Radio	9655na	11905na			
0400-0500	Bahrain, Radio	6010do				0400-0500 vl	Uganda, Radio	4976do				
0400-0500	Canada, CFCX Montreal	6005do				0400-0430	United Kingdom, BBC London	6175na	6180na	7105na	7325na	
0400-0500	Canada, CFRX Toronto	6070do						9630af	9915am	11760me	11955me	
0400-0500	Canada, CFVP Calgary	6030do						12095eu	15310as	15575me	21725as	
0400-0500	Canada, CHNX Halifax	6130do				0400-0500	United Kingdom, BBC London	3255af	3955eu	5975na	6005af	
0400-0500	Canada, CKZN St John's	6160do						6180af	6195eu	9410af	9600af	
0400-0500	Canada, CKZU Vancouver	6160do						11760af	11820af	21470af	21715as	
0400-0430	Canada, RCI Montreal	9650me	11905me	11925me	15276me	0400-0500	USA, KCBI Dallas TX	9815am				
0400-0500	China, China Radio Intl	11680na	11840na			0400-0500	USA, KTVB Salt Lk City UT	7510am				
0400-0500	Costa Rica, R Peace Intl	7375am	9400am	15030am	21465am	0400-0500	USA, KVOH Los Angeles CA	9785am				
0400-0500	Cuba, Radio Havana Cuba	6010na	6180na	9510na		0400-0500	USA, KWHR Naalehu HI	17510as				
0400-0430	Ecuador, HCJB Quito	9745am	15155am	17490am	21455am	0400-0500	USA, Monitor Radio Intl	7465eu	9840af			
0400-0450	Germany, Deutsche Welle	5980af	6015af	6185af	7150af	0400-0500	USA, VOA Washington DC	5995me	6040me	6140eu	6873eu	
		7225af	7275af	9565af	9765af			7170eu	7265af	7280af	7405af	
0400-0500	Guatemala, Radio Cultural	3300do				0400-0500	USA, WEWN Birmingham AL	7425am	9350am	13615am		
0400-0500	Kenya, Kenya BC Corp	4935do				0400-0500 vl	USA, WHRI Noblesville IN	7315am	9495am			
0400-0500 mtwhf	Lebanon, Wings of Hope	9960me				0400-0500	USA, WINB Red Lion PA	11950eu				
0400-0500 smtwh	Malaysia, RTM Radio 4	7295do				0400-0500	USA, WJCR Upton KY	7490na	13595na			
0400-0425	Netherlands, Radio	6165na	9590na			0400-0500 smtwhf	USA, WMLK Bethel PA	9465eu				
0400-0500	New Zealand, R NZ Intl	15115pa				0400-0500	USA, WRNO New Orleans LA	7395am				
0400-0450	North Korea, R Pyongyang	15180as	15230as	17765as		0400-0500	USA, WWCR Nashville TN	5810am	5935am	7435am		
0400-0500 vl	Papua New Guinea, NBC	9675do				0400-0500	USA, WYFR Okeechobee FL	6065am	9505am	11825eu		
0400-0430	Romania, R Romania Intl	6155na	9510na	9570na	11830na	0415-0440	Italy, RAI Rome	7275eu	9575eu			
0400-0500	Russia, Radio Moscow Intl	5940eu	7105na	7130eu	7165eu	0430-0500	Australia, AAF Radio	13525as				
		7180eu	7270na	7295eu	9465na	0430-0457	Czech Rep, Radio Prague	5930na	7345af	9440me		
		9480na	9580na	9865na	11765af	0430-0500	Nigeria, Radio	3326do	4770do	4990do		
		12050af	15320me	15375me	15385me	0430-0500	Swaziland, Trans World R	5055af	7200af	7215af		
		15425me	17590af	17610af	17655af	0445-0500 t	Sri Lanka, SLBC Colombo	9720na	15425na			
		21585af										

SELECTED PROGRAMS

Sundays

- 0400 BBC: Newsdesk. See S 0200.
 0400 Radio Canada Int'l: RCI News. News, weather, and sports from Radio Canada International.
 0400 R New Zealand Int'l: National Radio or Sport. See S 0100.
 0407 Radio Canada Int'l: Innovation Canada. See S 0106.
 0409 BBC (af): African News. See S 0330.
 0415 BBC (af): African Perspective. Feature or discussion analyzing a major issue.
 0430 BBC: Seeing Stars (1). A discussion of astronomical observations and special events for the near future.
 0430 BBC: Short Story. *The Outdoor Life* (8th). An apparently normal bachelor has a secret eccentricity. *Ben* (15th). Ben's wife dies and he feels completely alone. *Blue Forever* (22nd). Finding something to do while alone on a boat in the ocean. *Listening to The Blind Teacher* (29th). The young German teacher just lost his job but is not depressed.
 0445 BBC: Feature. A Step Too Far (15th, 22nd, 29th). How many advances in science and technology are made at immense human and financial cost.
 0445 BBC: Music Feature. Rock 'N Rice (1st, 8th). The continuing story of the popular music of the Far east, featuring Malaysia and China.

Mondays

- 0400 BBC: Newsdesk. See S 0200.
 0400 Radio Canada Int'l: RCI News. See S 0400.
 0405 Radio New Zealand Int'l: Calling Cook Islands. Birthday Calls, dedications, and requests for Cook Islands listeners.
 0407 Radio Canada Int'l: The Mailbag. See M 0128.
 0415 BBC (af): Network Africa. See M 0333.
 0430 BBC: Off the Shelf. Daily readings from the best of world literature.
 0430 Radio New Zealand Int'l: Mailbox (biweekly). Transmission developments, letters from listeners, and DX news from Arthur Cushen.
 0445 BBC: Feature. Sounds of Gospel (2nd, 9th). A look at gospel music from around the world. All the World's a Football Pitch (16th, 23rd, 30th). A five-part series on the social and economic background of soccer.

Tuesdays

- 0400 BBC: Newsdesk. See S 0200.
 0400 Radio Canada Int'l: RCI News. See S 0400.

- 0405 Radio New Zealand Int'l: Calling Tonga. Regional news and topical programming for Tonga.
 0409 BBC (af): African News. See S 0330.
 0411 Radio Canada Int'l: Spectrum. See M 1341.
 0415 BBC (af): Network Africa. See M 0333.
 0430 BBC: Off the Shelf. See M 0430.
 0430 Radio New Zealand Int'l: Tagata Atua Motu. See S 0530.
 0445 BBC (af): African News. See S 0330.
 0445 BBC: On Screen. Film reviews and movie news from around the world.

Wednesdays

- 0400 BBC: Newsdesk. See S 0200.
 0400 Radio Canada Int'l: RCI News. See S 0400.
 0405 Radio New Zealand Int'l: Pacific Beat Entertainment. Keep up with developments in NZ's entertainment arena.
 0409 BBC (af): African News. See S 0330.
 0411 Radio Canada Int'l: Spectrum. See M 1341.
 0415 BBC (af): Network Africa. See M 0333.
 0430 BBC: Off the Shelf. See M 0430.
 0430 Radio New Zealand Int'l: Te Puna Wai Korero. See S 0530.
 0445 BBC (af): African News. See S 0330.
 0445 BBC: Country Style. See W 0145.

Thursdays

- 0400 BBC: Newsdesk. See S 0200.
 0400 Radio Canada Int'l: RCI News. See S 0400.
 0405 Radio New Zealand Int'l: Calling the Solomon Islands (biweekly). A program for the Solomon Islands.

- 0405 Radio New Zealand Int'l: In Touch with New Zealand. See M 0205.
 0409 BBC (af): African News. See S 0330.
 0411 Radio Canada Int'l: Spectrum. See M 1341.
 0415 BBC (af): Network Africa. See M 0333.
 0430 BBC: Off the Shelf. See M 0430.
 0445 BBC (af): African News. See S 0330.
 0445 BBC: From Our Own Correspondent. See S 0330.

Fridays

- 0400 BBC: Newsdesk. See S 0200.
 0400 Radio Canada Int'l: RCI News. See S 0400.
 0405 Radio New Zealand Int'l: Calling Niue. Regional news and topical programming for Niue.
 0409 BBC (af): African News. See S 0330.
 0411 Radio Canada Int'l: Spectrum. See M 1341.
 0415 BBC (af): Network Africa. See M 0333.
 0430 BBC: Off the Shelf. See M 0430.
 0430 Radio New Zealand Int'l: Around the world (in rotation). International broadcaster Rudi Hill provides topical comment and a Pacific viewpoint.
 0430 Radio New Zealand Int'l: Calling Pitcairn and Norfolk (in rotation). A program for Pitcairn and Norfolk Islands listeners.
 0430 Radio New Zealand Int'l: Calling Tokelau (in rotation). A program for Tokelau listeners.
 0430 Radio New Zealand Int'l: Feature (in rotation). Variable feature program.
 0445 BBC (af): African News. See S 0330.
 0445 BBC: Folk Routes. See T 0130.

Saturdays

- 0400 BBC: Newsdesk. See S 0200.
 0400 Radio Canada Int'l: RCI News. See S 0400.
 0400 Radio New Zealand Int'l: RNZ News. See S 0600.
 0405 R New Zealand Int'l: National Radio or Sport. See S 0100.
 0409 BBC (af): African News. See S 0330.
 0411 Radio Canada Int'l: Spectrum. See M 1341.
 0415 BBC (af): TalkAbout Africa. Telephone conversations with BBC correspondents on late-breaking African events.
 0430 BBC: Jazz Now and Then. See A 0145.
 0445 BBC: Worldbrief. Roundup of the week's news headlines, plus everything from sport and finance to best-sellers and weather.

PROPAGATION FORECASTING

JACQUES d'AVIGNON

965 LINCOLN DRIVE
KINGSTON, ON
K7M 4Z3 CANADA

Distributor for ASAPS propagation software
Compuserve: 70531,140

FREQUENCIES

0500-0530	Australia, Radio	17750as			
0500-0600	Australia, Radio	11720pa	11800pa	15240pa	15320pa
		15365pa	17630pa	17795pa	21525as
		21595as			
0500-0600 vl	Australia, VL8A Alice Spg	4835do			
0500-0600 vl	Australia, VL8K Katherine	5025do			
0500-0600 vl	Australia, VLBT Tent Crk	4910do			
0500-0600	Bahrain, Radio	6010do			
0500-0600	Bulgaria, Radio	9700na	11720eu		
0500-0600	Canada, CFCX Montreal	6005do			
0500-0600	Canada, CFRX Toronto	6070do			
0500-0600	Canada, CFVP Calgary	6030do			
0500-0600	Canada, CHNX Halifax	6130do			
0500-0600	Canada, CKZU Vancouver	6160do			
0500-0530 mtwhf	Canada, RCI Montreal	6050eu	6150eu	7296eu	15430af
		17840AF			
0500-0600	Costa Rica, R Peace Intl	7375am	9400am	15030am	21465am
0500-0600	Cuba, Radio Havana Cuba	9510na			
0500-0600	Ecuador, HCJB Quito	11925am	21455am		
0500-0600 as	Eqt Guinea, R East Africa	9585af			
0500-0550	Germany, Deutsche Welle	5960na	9515na	9670na	11705na
0500-0600	Guatemala, Radio Cultural	3300do			
0500-0515	Israel, Kol Israel	7465eu	9435na	11605na	17545na
0500-0600 vl	Italy, IRRS Milano	7125eu			
0500-0600	Japan, NHK/Radio	6025na	6085me	7230eu	9610as
		11740as	15410as	17810as	
0500-0600	Kenya, Kenya BC Corp	4935do			
0500-0600 mtwhf	Lebanon, Wings of Hope	9960me			
0500-0600	Malaysia, RTM Radio 4	7295do			
0500-0600	New Zealand, R NZ Intl	15115pa			
0500-0600	Nigeria, Radio	3326do	4770do	4930do	
0500-0600	Nigeria, Voice of	7255af			
0500-0530 m	Norway, Radio Norway Intl	7165eu	9560na	9590eu	11865na
0500-0600 vl	Papua New Guinea, NBC	9675do			
0500-0600	Russia, Radio Moscow Intl	5940na	7105na	7130af	7150na
		7165na	7180na	7330na	9890eu
		11675af	12050me	15465af	17570af
		17590af	17610me	17555af	17835af
		21690af			
0500-0600	S Africa, Channel Africa	5955af	9695af		

0500-0553 f	Seychelles, FEBA Radio	17750me			
0500-0600	Spain, Spanish Natl Radio	9540na			
0500-0515 t	Sri Lanka, SLBC Colombo	9720na	15425na		
0500-0600	Swaziland, Swazi Radio	6155af			
0500-0530	Swaziland, Trans World R	5055af	7200af	7215af	
0500-0530 mtwhf	Switzerland, Swiss R Intl	3985eu	6165eu		
0500-0600	Thailand, Radio	9655as	11905as		
0500-0600 vl	Uganda, Radio	4976do			
0500-0600	United Kingdom, BBC London	3955eu	5975na	6005af	6180eu
		6195eu	7325af	9410af	9640ca
		11735eu	11760me	11820as	12095af
		15070me	15310as	15400af	15420af
		15575me	17830as	21470af	21715as
0500-0600	USA, KCBI Dallas TX	9815am			
0500-0600	USA, KTVN Salt Lk City UT	7510am			
0500-0600	USA, KVOH Los Angeles CA	9785am			
0500-0600	USA, KWHR Naalehu HI	17510as			
0500-0600	USA, Monitor Radio Intl	9840af			
0500-0600	USA, VOA Washington DC	6035af	7405af	9665af	12080af
		15600af			
0500-0530	USA, VOA Washington DC	5995eu	6140eu	6873eu	7170eu
		9530eu	9700eu	11825me	15205me
0500-0600	USA, WEWN Birmingham AL	7425am	9350am	13615am	
0500-0600 vl	USA, WHRI Noblesville IN	7315am	9495am		
0500-0600 vl	USA, WINB Red Lion PA	11950am			
0500-0600	USA, WJCR Upton KY	7490na	13595na		
0500-0600 mtwhfa	USA, WMLK Bethel PA	9465eu			
0500-0600	USA, WRNO New Orleans LA	7395am			
0500-0600	USA, WWCR Nashville TN	5810am	5935am	7435am	
0500-0600	USA, WYFR Okeechobee FL	5985am	9850eu	11580af	
0500-0530	Vatican State, Vatican R	9695af	11625af	15090af	
0510-0520	Botswana, Radio	3356af	4830af	7255af	
0525-0600	Ghana, GBC Radio 2	3366do			
0530-0600	Austria, R Austria Intl	6015na	6155eu	13730eu	15410me
		17870me			
0530-0600	Romania, R Romania Intl	15340af	15380af	17720af	17745af
		17790af			
0530-0600	Swaziland, Trans World R	7200af	11740af		
0530-0600	UAE, Radio Dubai	15435as	17830as	21700as	

SELECTED PROGRAMS

Sundays

- 0500 BBC: Newshour. A comprehensive look at the major topics of the day, plus up-to-the-minute international and British news.
- 0500 R New Zealand Int'l: National Radio or Sport. See S 0100.
- 0500 Trans World Radio Swaziland: Radio Bible Class.
- 0530 Radio New Zealand Int'l: Te Reo o Te Pipiwharauroa. No details available.
- 0530 Trans World Radio Swaziland: Kerygma.

Mondays

- 0500 BBC: Newshour. See S 0500.
- 0500 Radio New Zealand Int'l: Checkpoint. NZ current affairs, sports news, business news, news about Australia, and English language Maori news (Nat'l Radio-90 min).
- 0500 Radio Norway Int'l: Norway Now. See S 1200.
- 0500 Trans World Radio Swaziland: Back to the Bible.
- 0514 Radio Canada Int'l: Report to the Peacekeepers. Information about Canada for Canadian Forces overseas.
- 0530 BBC (eu): Europe Today. See M 0330.
- 0530 Trans World Radio Swaziland: Family Bible Hour.

Tuesdays

- 0500 BBC: Newshour. See S 0500.
- 0500 Radio New Zealand Int'l: Checkpoint. See M 0500.
- 0500 Trans World Radio Swaziland: Back to the Bible.
- 0514 R Canada Int'l: Report to the Peacekeepers. See M 0514.
- 0530 BBC (eu): Europe Today. See M 0330.
- 0530 Trans World Radio Swaziland: Gospel Tide Hour.

Wednesdays

- 0500 BBC: Newshour. See S 0500.
- 0500 Radio New Zealand Int'l: Checkpoint. See M 0500.
- 0500 Trans World Radio Swaziland: Back to the Bible.
- 0514 R Canada Int'l: Report to the Peacekeepers. See M 0514.
- 0530 BBC (eu): Europe Today. See M 0330.
- 0530 Trans World Radio Swaziland: Bringing Christ to the Nations.

Thursdays

- 0500 BBC: Newshour. See S 0500.
- 0500 Radio New Zealand Int'l: Checkpoint. See M 0500.
- 0500 Trans World Radio Swaziland: Back to the Bible.
- 0514 R Canada Int'l: Report to the Peacekeepers. See M 0514.
- 0530 BBC (eu): Europe Today. See M 0330.
- 0530 Trans World Radio Swaziland: The Haven of Rest.

Fridays

- 0500 BBC: Newshour. See S 0500.
- 0500 Radio New Zealand Int'l: Checkpoint. See M 0500.
- 0500 Trans World Radio Swaziland: Back to the Bible.

- 0514 R Canada Int'l: Report to the Peacekeepers. See M 0514.
- 0530 BBC (eu): Europe Today. See M 0330.
- 0530 Trans World Radio Swaziland: The Wesleyan Hour.

Saturdays

- 0500 BBC: Newshour. See S 0500.
- 0500 Radio New Zealand Int'l: Change of Pace. A light mixture of jazz, polka, and other musical forms.
- 0500 Trans World Radio Swaziland: Young Life.
- 0515 Trans World Radio Swaziland: Visit with Mrs. G.
- 0530 BBC (eu): Europe Today. See M 0330.
- 0530 Radio New Zealand Int'l: Tagata Atu Motu. See S 0530.
- 0530 Trans World Radio Swaziland: We kids.

*This Voice of
the
Organization of
American
States (OAS)
QSL was sent
to us by
Ray Labrie of
Portsmouth, NH.*



FREQUENCIES

0600-0700	Australia, Radio	6020pa	11720pa	11800pa	15240pa	0600-0700	Russia, Radio Moscow Intl	5905eu	5940eu	7165eu	7180eu
		15320pa	15365pa	17630pa	17670as			7270eu	7330eu	9890eu	11765eu
		17880as	21525as	21595as				13650eu	15190eu	15480me	15550me
0600-0700 vl	Australia, VL8A Alice Spg	4835do				0600-0700	S Africa, Channel Africa	5955af	15220af		
0600-0700 vl	Australia, VL8K Katherine	5025do				0600-0630 vl	Solomon Islands, SIBC	5020do	9545do		
0600-0700 vl	Australia, VL8T Tent Crk	4910do				0600-0700	South Korea, Radio Korea	7275na	11945na	15155as	
0600-0700	Bahrain, Radio	6010do				0600-0700	Swaziland, Swazi Radio	6155af			
0600-0630	Bulgaria, Radio	9700na	11720eu			0600-0700	Swaziland, Trans World R	5055af	7200af	11740af	
0600-0700	Canada, CFCX Montreal	6005do				0600-0630	Switzerland, Swiss R Intl	9885af	13635af	15430af	
0600-0700	Canada, CFRX Toronto	6070do				0600-0615 mtwtf	Switzerland, Swiss R Intl	3985eu	6165eu		
0600-0700	Canada, CFPV Calgary	6030do				0600-0700	United Kingdom, BBC London	3955eu	5975ca	6180af	6195af
0600-0700	Canada, CHNX Halifax	6130do						7325af	9410eu	9600af	9640na
0600-0700	Canada, CKZU Vancouver	6160do						11780eu	11820af	11940af	12095eu
0600-0700	Costa Rica, R Peace Intl	7375am	9400am	15030am	21465am			15360as	15420af	15575eu	17790as
0600-0700	Cuba, Radio Havana Cuba	9510na						17830as	17885af	21470me	
0600-0700	Ecuador, HCJB Quito	11925am	15155am	21455am				9815am			
0600-0700 as	Eqt Guinea, R East Africa	9585af				0600-0700	USA, KCBI Dallas TX	9815am			
0600-0650	Germany, Deutsche Welle	11915af	13790af	15185af	15205af	0600-0700	USA, KTBN Salt Lk City UT	7510na			
		17820af	17875af	21680af		0600-0700	USA, KVOH Los Angeles CA	9785am			
		4915do				0600-0700	USA, KWHR Naalehu HI	9930as			
0600-0630	Ghana, GBC Radio 1	3366do				0600-0700	USA, Monitor Radio Intl	7520eu	7535eu		
0600-0615	Ghana, GBC Radio 2	7125eu				0600-0700	USA, VOA Washington DC	6035af	7120af	7405af	9530af
0600-0700 vl	Italy, IRRS Milano	11860as	21610as					9665af	11950af	12080af	15080af
0600-0700	Japan, NHK/Radio	4935do						15600af			
0600-0625	Kenya, Kenya BC Corp	9825do				0600-0630	USA, VOA Washington DC	3980eu	5995eu	6040eu	6060eu
0600-0700 vl	Kiribati, Radio	7116as						6140eu	6873eu	7120eu	7170eu
0600-0630	Laos, National Radio of	9960me						7325eu	11805me	11825me	15205me
0600-0700 mtwhf	Lebanon, Wings of Hope	4760do				0600-0700 vl	USA, WHRI Noblesville IN	7315am	9495am		
0600-0700	Liberia, Radio ELWA	7295do				0600-0700 vl	USA, WINB Red Lion PA	11950na			
0600-0700 smtwha	Malaysia, RTM Radio 4	6175as	9750as	15295as		0600-0700	USA, WJCR Upton KY	7490na	13595na		
0600-0700	Malaysia, Voice of	9765me				0600-0700 smtwhf	USA, WMLK Bethel PA	9465eu			
0600-0700	Malta, V of Mediterranean	15115pa				0600-0700	USA, WWCR Nashville TN	5810am	5935am	7435am	
0600-0700	New Zealand, R NZ Intl	3970do	4770do	4990do		0600-0700	USA, WYFR Okeechobee FL	5985am	7355eu	9680am	11580af
0600-0700	Nigeria, Radio	7255af				0625-0700	Kenya, Kenya BC Corp	4935do			
0600-0700	Nigeria, Voice of	15180as	15230as			0630-0700	Australia, Radio	9580pa	9860pa	11910pa	
0600-0650	North Korea, R Pyongyang	9675do				0630-0700	Austria, R Austria Intl	6015na			
0600-0700 vl	Papua New Guinea, NBC	7225eu	9510eu	9665eu	11810eu	0630-0700 mtwtf	Belgium, R Vlaanderen Int	9925eu			
0600-0630	Romania, R Romania Intl					0630-0645	Vatican State, Vatican R	9695af	11625af	15090af	
						0632-0641	Romania, R Romania Intl	7225eu	9510eu	9665eu	11810eu
						0640-0700	Monaco, Trans World Radio	7385eu			
						0645-0700	Romania, R Romania Intl	11775pa	15250pa	15335pa	17720pa
								17805pa			

SELECTED PROGRAMS

Sundays

- 0600 BBC (af): African News. See S 0330.
- 0600 BBC: World News. See S 0000.
- 0600 Radio New Zealand Int'l: RNZ News. News from New Zealand's National Radio.
- 0605 BBC (af): Postmark Africa. See S 0335.
- 0608 Radio New Zealand Int'l: Kupu Korokori. Maori Comment.
- 0609 BBC: British News. See S 0009.
- 0615 BBC: Letter from America. Alistair Cooke shares his inimitable view of contemporary American life.
- 0619 Radio New Zealand Int'l: Te Karere O Rongo. See S 0530.
- 0630 BBC (af): African Perspective. See S 0415.
- 0630 BBC: Jazz for the Asking. Record requests with Malcolm Laylock.
- 0630 Radio New Zealand Int'l: Pacifika Style. No information available.
- 0645 Radio New Zealand Int'l: Storytime. Tales for children.

Mondays

- 0600 BBC: World News. See S 0000.
- 0600 Radio New Zealand Int'l: Checkpoint. See M 0500.
- 0602 BBC (af): Network Africa. See M 0333.
- 0609 BBC: British News. See S 0009.
- 0615 BBC: The Learning World. News and views about world-wide education.
- 0627 BBC (af): African News. See S 0330.
- 0630 BBC (af): Network Africa. See M 0333.
- 0630 BBC: Feature. Frogs and Rosbits (2nd). See S 1401.
- 0630 BBC: Feature. Extraordinary And Plenipotentiary (9th, 16th, 23rd). See S 1401.
- 0630 BBC: Feature. Between Russia and the Reich (30th). See S 2330.
- 0630 BBC: Feature.
- 0630 Radio New Zealand Int'l: Ears. Children's stories.

Tuesdays

- 0600 BBC: World News. See S 0000.
- 0600 Radio New Zealand Int'l: Checkpoint. See M 0500.

- 0602 BBC (af): Network Africa. See M 0333.
- 0609 BBC: British News. See S 0009.
- 0615 BBC: The World Today. See M 1645.
- 0627 BBC (af): African News. See S 0330.
- 0630 BBC (af): Network Africa. See M 0333.
- 0630 BBC: Music Feature. Showtime for Shakespeare (3rd, 10th). Some music produced for film and theater inspired by a Shakespearean work. Duke Ellington—Jazz Genius (17th, 24th, 31st). Tracing the Duke's career from the Cotton Club days.
- 0630 BBC: Music Feature.
- 0630 Radio New Zealand Int'l: Ears. See M 0630.

Wednesdays

- 0600 BBC: World News. See S 0000.
- 0600 Radio New Zealand Int'l: Checkpoint. See M 0500.
- 0602 BBC (af): Network Africa. See M 0333.
- 0609 BBC: British News. See S 0009.
- 0615 BBC: The World Today. See M 1645.
- 0627 BBC (af): African News. See S 0330.
- 0630 BBC (af): Network Africa. See M 0333.

GROVE SHORTWAVE DIRECTORY 8TH EDITION

Completely revised and updated, this book is your guide to HF global communications. Over 250 pages of frequency information in a three-hole punched, loose-leaf format for easy accessibility.

Grove Enterprises
1-800-438-8155

Only
\$29.95
plus \$5 UPS
(price includes binder)

- 0630 BBC: Meridian Documentary. One of three topical programmes weekly about the world of the arts.
- 0630 Radio New Zealand Int'l: Ears. See M 0630.

Thursdays

- 0600 BBC: World News. See S 0000.
- 0600 Radio New Zealand Int'l: Checkpoint. See M 0500.
- 0602 BBC (af): Network Africa. See M 0333.
- 0609 BBC: British News. See S 0009.
- 0615 BBC: The World Today. See M 1645.
- 0627 BBC (af): African News. See S 0330.
- 0630 BBC (af): Network Africa. See M 0333.
- 0630 BBC: Assignment. See H 0330.
- 0630 Radio New Zealand Int'l: Ears. See M 0630.

Fridays

- 0600 BBC: World News. See S 0000.
- 0600 Radio New Zealand Int'l: Checkpoint. See M 0500.
- 0602 BBC (af): Network Africa. See M 0333.
- 0609 BBC: British News. See S 0009.
- 0615 BBC: The World Today. See M 1645.
- 0627 BBC (af): African News. See S 0330.
- 0630 BBC (af): Network Africa. See M 0333.
- 0630 BBC: Meridian Books. See W 0630.
- 0630 R for Peace Int'l: The Far Right Radio Review. See A 0230.
- 0630 Radio New Zealand Int'l: Ears. See M 0630.

Saturdays

- 0600 BBC (af): African News. See S 0330.
- 0600 BBC: World News. See S 0000.
- 0600 Radio New Zealand Int'l: RNZ News. See S 0600.
- 0609 BBC: British News. See S 0009.
- 0615 BBC: The World Today. See M 1645.
- 0617 Radio New Zealand Int'l: Pacific Requests. Music request and dedications.
- 0630 BBC (af): Spice Taxi. A sideways look at African culture, from presidential style to cult films.
- 0630 BBC: Meridian Reports. See W 0630.

0700-0730	Australia, Radio	15320pa			
0700-0800	Australia, Radio	6020pa	9580pa	9710pa	9860pa
		11720pa	11880pa	11910pa	15240pa
		15365pa	17695as	17790as	21525as
		21595as			
0700-0800 vl	Australia, VLBA Alice Spg	4835do			
0700-0800 vl	Australia, VL8K Katherine	5025do			
0700-0800 vl	Australia, VL8T Tent Crk	4910do			
0700-0800	Bahrain, Radio	6010do			
0700-0800	Canada, CFCX Montreal	6005do			
0700-0800	Canada, CFRX Toronto	6070do			
0700-0800	Canada, CFPV Calgary	6030do			
0700-0800	Canada, CHNX Halifax	6130do			
0700-0800	Canada, CKZU Vancouver	6160do			
0700-0800	Costa Rica, R Peace Intl	7375am	9400am	15030am	21465am
0700-0727	Czech Rep, Radio Prague	5930do	7345do	9505do	
0700-0800	Ecuador, HCJB Quito	6205eu	9600eu	9745au	11835eu
		21455eu			
0700-0800 as	Eqt Guinea, R East Africa	9585af			
0700-0715	Ghana, GBC Radio 1	4915do			
0700-0715	Ghana, GBC Radio 2	3366do			
0700-0800	Italy, AWR Europe	7230eu			
0700-0800 vl	Italy, IRRS Milano	7125eu			
0700-0800	Japan, NHK/Radio	6050as	7230au	11740au	15170as
		15325au	15410au	17765as	17810as
		17860as	21575me	21610me	
0700-0800	Kenya, Kenya BC Corp	4935do			
0700-0800 vl	Kiribati, Radio	9825do			
0700-0800 mtwhf	Lebanon, Wings of Hope	9960me			
0700-0800	Liberia, Radio ELWA	4760do			
0700-0800 smtwha	Malaysia, RTM Radio 4	7295do			
0700-0800	Malaysia, Voice of	6175as	9750as	15295as	
0700-0800 mtwfta	Monaco, Trans World Radio	7385eu			
0700-0730	Myanmar, Radio	9730do			
0700-0758	New Zealand, R NZ Intl	15115pa			
0700-0800	Nigeria, Radio	3326do	4770do	4990sk	
0700-0800	Nigeria, Voice of	7255af			
0700-0750	North Korea, R Pyongyang	15340as	17765as		
0700-0800 vl	Papua New Guinea, NBC	9675do			
0700-0715	Romania, R Romania Intl	11775pa	15250pa	15335pa	17720pa
		17805pa			
0700-0800	Russia, Radio Moscow Intl	5905eu	5930eu	7130af	7165eu
		7180na	7270na	7345na	7370eu
		9890eu	11765me	13650eu	15190eu
		15480me	15550me	17725af	17835af
		21610af			
0700-0715 vl	Sierra Leone, SLBS	3316do			
0700-0800 vl	Solomon Islands, SIBC	5020do	9545do		
0700-0800	Swaziland, Swazi Radio	6155af			
0700-0800	Swaziland, Trans World R	7200af	11740af		
0700-0715 as	Switzerland, Swiss R Intl	3985eu	6165eu		
0700-0800	Taiwan, VO Free China	5950na			
0700-0800	United Kingdom, BBC London	3955eu	5975ca	6190af	6195eu
		7150af	7325eu	9410eu	9600af
		9640na	9660eu	9760eu	11760me
		11780ca	11940af	12095eu	15070eu
		15310as	15400af	15575me	17790af
		17885af	21470af		
0700-0800	USA, KCBI Dallas TX	9815na			
0700-0800	USA, KTNB Salt Lk City UT	7510na			
0700-0800	USA, KVOH Los Angeles CA	9785am			
0700-0800	USA, KWHR Naalehu HI	9930as			
0700-0800	USA, Monitor Radio Intl	7520eu			
0700-0800	USA, WEWN Birmingham AL	7425am	9350am	13615am	
0700-0800 vl	USA, WHRI Noblesville IN	7315am	9495am		
0700-0800 vl	USA, WINB Red Lion PA	11950na			
0700-0800	USA, WJCR Upton KY	7490na	13595na		
0700-0800 smtwhf	USA, WMLK Bethel PA	9465eu			
0700-0800	USA, WWCR Nashville TN	5810am	5935am	7435am	
0700-0800	USA, WYFR Okeechobee FL	7355eu	9680am	11580af	
0730-0800	Australia, Radio	9580pa	17750as		
0730-0757	Czech Rep, Radio Prague	17535as	21705af		
0730-0745 sh	Greece, Voice of	7450eu	9425eu	11645eu	15650eu
0730-0745 mtwhf	Iceland, Natl BC Service	9265am			
0730-0800	Netherlands, Radio	9630pa	9715pa		
0745-0800	Guam, KTWR Agana	15200as			

0800-0900	Canada, CHNX Halifax	6130do			
0800-0900	Canada, CKZU Vancouver	6160do			
0800-0900	Costa Rica, R Peace Intl	7375am	9400am	15030am	21465am
0800-0830	Ecuador, HCJB Quito	6205eu	9600eu	9745pa	11835eu
		11925pa	17490au	21455eu	
0800-0900 as	Eqt Guinea, R East Africa	9585af			
0800-0805 s	Ghana, GBC Radio 1	4915do			
0800-0805 s	Ghana, GBC Radio 2	3366do			
0800-0900	Guam, KTWR Agana	15200as			
0800-0900	Indonesia, Voice of	9675as	11752as		
0800-0900 vl	Italy, IRRS Milano	7125eu			
0800-0900	Kenya, Kenya BC Corp	4935do			
0800-0900 mtwhf	Lebanon, Wings of Hope	9960me			
0800-0830	Liberia, Radio ELWA	4760do			
0800-0900 smtwha	Malaysia, RTM Radio 4	7295do			
0800-0825	Malaysia, Voice of	6175as	9750as	15295as	
0800-0820 mtwfta	Monaco, Trans World Radio	7385eu			
0800-0825	Netherlands, Radio	9630pa	9715pa		
0800-0900	New Zealand, R NZ Intl	9700pa			
0800-0900	Nigeria, Radio	3326do	4990do		
0800-0850	North Korea, R Pyongyang	15180as	15230as		
0800-0850	Pakistan, Radio	17900eu	21520eu		
0800-0900 vl	Papua New Guinea, NBC	9675do			
0800-0900	Russia, Radio Moscow Intl	7130af	7165eu	9680eu	11690eu
		12010eu	12055af	12070eu	13650eu
		15190eu	15210eu	15485eu	15540eu
		17595eu	21515eu		
0800-0815 vl	Sierra Leone, SLBS	3316do			
0800-0900 vl	Solomon Islands, SIBC	5020do	9545do		
0800-0900	South Korea, Radio Korea	7550af	13670me	15155eu	
0800-0900	United Kingdom, BBC London	3955eu	6195eu	7150au	7325eu
		9410eu	9640na	9660eu	9760eu
		11760me	11940af	15070eu	15400eu
		15575me	17790as	17885af	21470af
		21660af			
0800-0900	USA, KCBI Dallas TX	9815am			
0800-0900 vl	USA, KNLS Anchor Point AK	7365as	9615as		
0800-0900	USA, KTNB Salt Lk City UT	7510am			
0800-0900	USA, KWHR Naalehu HI	9930as			
0800-0900	USA, Monitor Radio Intl	13615pa			
0800-0900	USA, WEWN Birmingham AL	7425am	9350am	13615am	
0800-0900 vl	USA, WHRI Noblesville IN	7315am	7355am		
0800-0900 vl	USA, WINB Red Lion PA	11950na			
0800-0900	USA, WJCR Upton KY	7490na	13595na		
0800-0900 smtwhf	USA, WMLK Bethel PA	9465eu			
0800-0900	USA, WWCR Nashville TN	5810am	5935am	7435am	
0830-0900 vl	Australia, VLBA Alice Spg	4835do			
0830-0900 vl	Australia, VL8K Katherine	5025do			
0830-0900 vl	Australia, VL8T Tent Crk	4910do			
0830-0900	Australia, R Austria Intl	6155eu	13730eu	15450as	17870au
0830-0900	Ecuador, HCJB Quito	9745pa	11925pa	21455pa	
0830-0900	Netherlands, Radio	9720pa			
0835-0845 s	Monaco, Trans World Radio	7385eu			

If you have a hard time picturing the path taken by radio waves to or from your spot on the globe, the maps shown on this and following pages should help. Each map's center is printed in the lower left hand corner. Prepared by Jacques d'Avignon.

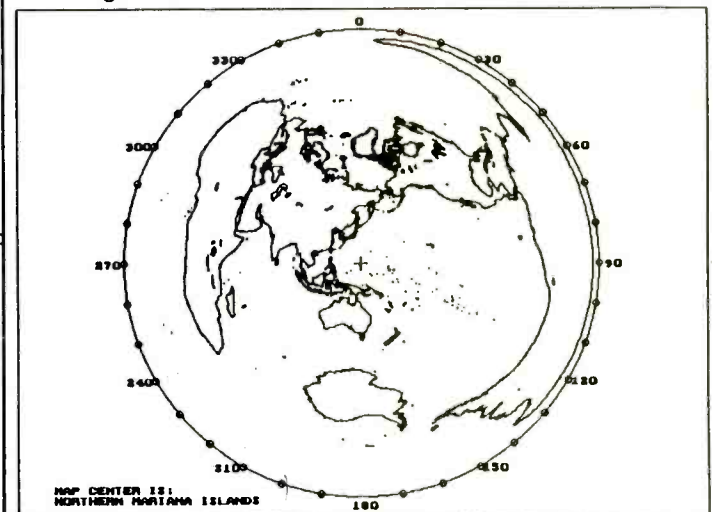



The Savings are almost **GONE!**



GROVE has offered you, our valued customer, the opportunity to purchase this great **ICOM** receiver at a great **GROVE** price. However, there are still a few of you who are holding out to the last minute...

THE TIME HAS ARRIVED!

These radios are selling fast--our stock is getting low. Once these **R72s** are gone, **THAT'S IT!**

Call **TODAY** before this fantastic deal *disappears...*

Freq Range: 100 kHz-30 MHz
Tuning Steps: 10Hz/1kHz/10kHz
Receiving Modes: AM, SSB, CW; FM optional
Memory: 101 channels
Sensitivity: 100 kHz-1.8 MHz 2uV SSB/12.6uV AM; 1.8-30 MHz (preamp on) 0.16 SSB/2uV AM; optional FM 0.5uV
Selectable Attenuator: 10/20/30 dB
Selectivity: (-6/-60dB): AM wide 6/20 kHz; AM narrow/SSB 2.3/8 kHz; optional FM 15/30 kHz
Image rejection: 70 dB
Dynamic Range: 100 dB

ICOM R-72

only \$ **695⁹⁵**

plus \$15⁵⁰ UPS ground shipping

CALL TODAY!

GROVE ENTERPRISES, INC.



1-800-438-8155

300 South Highway 64 West
Brasstown, NC 28902
(704) 837-9200 (business office)
(704) 837-2216 (fax)
(704) 837-7081 (technical assistance)

Join us at the
Dayton Hamvention,
April 29-May 1, 1994!
Stop by booth 514

GROVE -- It's not just a name, it's a guarantee.

AR-33B VHF FM RECEIVER

THE AR-33B IS A LIGHTWEIGHT, MINIATURE VHF FM RECEIVER. IT INCLUDES MANY PROFESSIONAL COMMUNICATION QUALITY FEATURES FOR THE SERIOUS USER.

- Runs on 2 "AA" batteries.
- 140-170MHz coverage in 5kHz steps.
- Easy to use digital thumbwheel tuning.
- Microprocessor controlled solid state design.
- 2 memory channels for instant frequency recall.
- 4 varactor tuned stages in front end that track with frequency selection.
- .22uv sensitivity, 12db SINAD.
- Adjacent channel rejection 65db at ± 25 kHz.
- Spurious rejection is better than 60db in band, and 70db out of band.
- No birdies 140-170MHz.
- Size 5.2" x 2.5" x 1.0" - Weighs 7.3 oz.
- Supplied with batteries, earphone, rubber flex antenna, antenna adapter, and manual.
- F.C.C. approved.
- Full 1 year warranty.
- Same day delivery.



COMMUNICATIONS SPECIALISTS, INC.
426 WEST TAFT AVENUE • ORANGE, CA 92665-4296
(714) 998-3021 • FAX (714) 974-3420
Entire U.S.A. (800) 854-0547 • FAX (800) 424-3420



FCC MASTER FREQUENCY DATABASE CDROM

All frequencies within the FCC Master Frequency Database for the entire US on CDROMS, Floppy Disk and Printouts

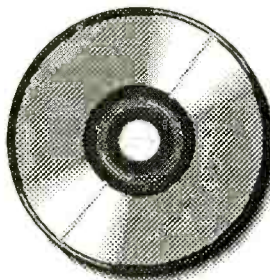

Dbase File Structure (ASCII Avail)
Exporting Available
Frequency, Callsign, DBA Name,
Licensee, City, State, Zip
Transmitter Lat & Long,
Elevation, Antenna Height
Address and County
Radio Service Code, Issue &
Expiration Dates and more
Data Access Program available...
Custom Databases and Services
are also available ...

PerCon is the official contractor to the FCC for the Master Frequency Database on CDROM

Full Master Frequency Database Available on CDROM
Call for more information and pricing on our complete product line.
Single State on CD \$99.95. Single State on Floppy Disk \$35.00

PerCon Corporation

Bemus Point, NY 14712
4906 Maple Springs / Ellery Road
(716) 386-6015 (716) 386-6013 FAX



IF YOU LISTEN TO BBC WORLD SERVICE, YOU SHOULD READ THIS.



To get the very best out of BBC World Service, you need new BBC Worldwide magazine. It's not only a comprehensive monthly guide to World Service Radio and Television programmes but also a well written blend of in-depth previews and special features.

For your subscription of just £24 p.a., you'll also pick up a free

BBC World Service World Time alarm clock, with a dual time facility to help you tune in wherever you go.

To take advantage of this very special offer, which will only last for a limited period, please complete the coupon now.



Please send my free gift of BBC World Service World Time alarm clock and start my BBC Worldwide subscription immediately. Annual subscription £24. You can pay by cheque or postal order made payable to BBC Worldwide alternatively by credit card.

Barclaycard Visa Mastercard Europcard

AMEX Card No.

Expiry date Initials

Mr/Mrs/Ms/Miss

Address

Postcode
Date Signature

MT/AD/93

Please allow 6-10 weeks for your gift to arrive. This offer is only available to persons 18 years and over. Return coupon to:- BBC Worldwide, BBC World Service, PO Box 76, Bush House, Strand, London WC2B 4PH.

BBC WORLD SERVICE

0900-1000	Australia, Radio	6020pa	9510as	9580pa	9710pa	
		9860pa	13605as	15170as	21745as	
0900-1000 vl	Australia, VL8A Alice Spg	2310do				
0900-1000 vl	Australia, VL8K Katherine	2485do				
0900-1000 vl	Australia, VL8T Tent Crk	2325do				
0900-1000	Bahrain, Radio	6010do				
0900-0930 mtwff	Belgium, R Vlaanderen Int	6035eu				
0900-1000	Canada, CFCX Montreal	6005do				
0900-1000	Canada, CFRX Toronto	6070do				
0900-1000	Canada, CFVP Calgary	6030do				
0900-1000	Canada, CHNX Halifax	6130do				
0900-1000	Canada, CKZU Vancouver	6160do				
0900-1000	China, China Radio Intl	11755pa	15440pa	17710pa		
0900-1000	Costa Rica, R Peace Intl	7375am	9400am	15030am	21465am	
0900-1000	Ecuador, HCJB Quito	9745pa	11925pa	17490pa	21455pa	
0900-1000 as	Eqt Guinea, R East Africa	9585af				
0900-0950	Germany, Deutsche Welle	6160as	9565af	11715as	12055as	
		15410af	15435as	17715as	17780as	
		17800af	21600af	21680as		
0900-0915 mtwff	Ghana, GBC Radio 1	4915do				
0900-0915	Ghana, GBC Radio 2	3366do				
0900-1000	Guam, KTWR Agana	11805au				
0900-0915	Guam, KTWR Agana	15200as				
0900-1000 vl	Italy, IRRS Milano	7125eu				
0900-1000	Japan, NHK/Radio	9610as	9750as	11740as	11815as	
		15190as				
0900-1000 mtwhf	Lebanon, Wings of Hope	9960me				
0900-1000	Malaysia, RTM Radio 4	7295do				
0900-0930	Netherlands, Radio	9715pa				
0900-1000	New Zealand, R NZ Intl	9700pa				
0900-1000	Nigeria, Radio	3326do	4990do			
0900-1000 mtwfta	Palau, KHBN Voice of Hope	9830as				
0900-1000 vl	Papua New Guinea, NBC	9675do				

0900-1000	Russia, Radio Moscow Intl	9680eu	12070eu	13650eu	15190eu	
		15210eu	15345eu	15380eu	15440eu	
		15495eu	15540eu	17595eu	17605eu	
		17760eu	21515eu	21540eu		
0900-1000 vl	Solomon Islands, SIBC	5020do	9545do			
0900-0930	Switzerland, Swiss R Intl	9885au	13685au	21820au		
0900-1000	United Kingdom, BBC London	6190af	6195eu	7180as	9410eu	
		9660eu	9740eu	9750eu	9760eu	
		11760me	11940af	12095eu	15070eu	
		15190sa	15310as	15400af	15575me	
		17640eu	17705eu	17790af	17885af	
		21470af	21660af			
0900-1000	USA, KCBI Dallas TX	9815am				
0900-1000	USA, KTBN Salt Lk City UT	7510am				
0900-1000	USA, KWHR Naalehu HI	9930as				
0900-1000	USA, Monitor Radio Intl	7395ca	9840pa	13615pa	17555as	
0900-1000	USA, WEWN Birmingham AL	7425am	9350am	13615am		
0900-1000 vl	USA, WHRI Noblesville IN	7315am	7355am			
0900-1000 vl	USA, WINB Red Lion PA	11950na				
0900-1000	USA, WJCR Upton KY	7490na	13595na			
0900-1000 smtwhf	USA, WMLK Bethel PA	9465eu				
0900-1000	USA, WWCN Nashville TN	5935am				
0910-0940 smha	Mongolia, R Ulaanbaatar	11850as	12015as			
0915-1000	Ghana, GBC Radio 2	6130do	7295do			
0920-0935 sh	Greece, Voice of	15650au	17525au			
0930-1000	Australia, AAF Radio	11465as				
0930-1000	Canada, CKZN St John's	6160do				
0930-1000	Netherlands, Radio	7260as	9715pa	9810as	9865pa	
0930-1000	Philippines, FEBC Manila	11690as				
0940-0950	Greece, Voice of	15650au	17525au			
0945-1000 s	Armenia, Radio Yerevan	15455eu	15485eu	15510eu		

1000-1100	Australia, Radio	9580pa	9860pa	15170as	21745as	
1000-1100 vl	Australia, VL8A Alice Spg	2310do				
1000-1100 vl	Australia, VL8K Katherine	2485do				
1000-1100 vl	Australia, VL8T Tent Crk	2325do				
1000-1100	Bahrain, Radio	6010do				
1000-1100	Canada, CFCX Montreal	6005do				
1000-1100	Canada, CFRX Toronto	6070do				
1000-1100	Canada, CFVP Calgary	6030do				
1000-1100	Canada, CHNX Halifax	6130do				
1000-1100	Canada, CKZN St John's	6160do				
1000-1100	Canada, CKZU Vancouver	6160do				
1000-1100	China, China Radio Intl	11755pa	15440pa	17710pa		
1000-1100	Costa Rica, AWR Alajuela	9725ca				
1000-1100	Costa Rica, R Peace Intl	7375am	9400am	15030am	21465am	
1000-1100	Ecuador, HCJB Quito	9745pa	11925pa	17490pa	21455pa	
1000-1100 as	Eqt Guinea, R East Africa	9585af				
1000-1100	Ghana, GBC Radio 2	6130do	7295do			
1000-1100	India, All India Radio	15050as	17387au	17895as	21735au	
1000-1100	Italy, AWR Europe	7230eu				
1000-1100 vl	Italy, IRRS Milano	7125eu				
1000-1100 mtwhf	Lebanon, Wings of Hope	9960me				
1000-1100 vl	Malaysia, RTM Kota Kinaba	5980do				
1000-1100 mtwh	Malaysia, RTM Radio 4	7295do				
1000-1100	Netherlands, Radio	7260as	9810as			
1000-1030	Netherlands, Radio	9715pa	9865pa			
1000-1100	New Zealand, R NZ Intl	9700pa				
1000-1100 mtwhfa	Palau, KHBN Voice of Hope	9830as				
1000-1100 vl	Papua New Guinea, NBC	9675do				
1000-1100	Philippines, FEBC Manila	11690as				
1000-1100	Russia, Radio Moscow Intl	7205eu	9750eu	11675na	12015eu	
		12020eu	12070eu	13650eu	15175eu	
		15210eu	15320na	15380eu	15435na	
		15465na	15470na	17710na	17760eu	
		21515eu	21540eu			
1000-1100	S Africa, Channel Africa	17810af				
1000-1100	United Kingdom, BBC London	6190af	6195af	9410eu	9660eu	
		9750eu	9760eu	11750me	11940af	
		12095eu	15070eu	15190sa	15310as	
		15400af	15575me	17640eu	17705eu	
		17790af	17885af	21470af	21660af	
1000-1100	USA, KCBI Dallas TX	9815am				
1000-1100	USA, KTBN Salt Lk City UT	7510am				
1000-1100	USA, KWHR Naalehu HI	9930as				
1000-1100	USA, Monitor Radio Intl	7395ca	7465am	9430as	13625pa	
1000-1100	USA, VOA Washington DC	5985as	7405am	9590am	11915am	
		15120am				
1000-1100 vl	USA, WHRI Noblesville IN	7315am	7355am			
1000-1100 vl	USA, WINB Red Lion PA	11950na				
1000-1100	USA, WJCR Upton KY	7490na	13595na			
1000-1100	USA, WWCN Nashville TN	5935am				
1000-1100	USA, WYFR Okeechobee FL	5950am				
1000-1030	Vietnam, Voice of	9840as	12020as	15010as		
1030-1100 mtwfta	Austria, R Austria Intl	6155eu	13730eu	15450au	17870as	
1030-1100 vl	Malaysia, RTM Sarawak	4950do	7160do			
1030-1100	South Korea, Radio Korea	9650na	11715na			
1030-1100	Sri Lanka, SLBC Colombo	11835au	15120as	17850as		
1030-1100	UAE, Radio Dubai	13675eu	15320eu	15395eu	21605eu	
1040-1050	Greece, Voice of	15650as	17525as			

GUIDE TO UTILITY STATIONS 1994

12th edition • 534 pages • \$ 50 or DM 70

5000 new coastal and fixed station frequencies!

Our bestseller covers the complete frequency range between 0 and 30 MHz. We control the radio spectrum continuously by means of sophisticated operating methods and regular overseas monitoring missions (1993 for months in Alaska, Canada, Djibuti, Malaysia, Mauritius, Réunion and Singapore). The conflicts on the Balkan and in Africa and Asia are perfectly covered. We are the only non-governmental radio monitoring service applying latest technology such as the revolutionary new WAVECOM W4100 teleprinter systems decoder.

The frequency list now includes more than 20,000 entries. A new index covers 2,000 stations in country order with all frequencies for rapid access. Up-to-date schedules of weatherfax stations and teletype press agencies are listed both alphabetically and chronologically. Abbreviations, addresses, call signs, codes, definitions, explanations, frequency band plans, international regulations, modulation types, NAVTEX schedules, Q and Z codes, station classes, telex codes, etc. - this reference book lists everything. Thus, it is the ideal addition to the World Radio TV Handbook for the "special" stations on SW!

Further publications available are *Guide to Facsimile Stations, Air and Meteo Code Manual* (13th editions) and *Radioteletype Code Manual* (12th edition). We have published our international radio books for 24 years. They are in daily use with equipment manufacturers, monitoring services, radio amateurs, shortwave listeners and telecommunication administrations worldwide. Please ask for our free catalogue, including recommendations from all over the world. For recent book reviews see Larry Miller in *MT 9/93* pages 90/92 and Bob Evans in *MT 10/93* page 57. All manuals are published in the handy 17 x 24 cm format, and of course in English.

Do you want to get the **total information** immediately? For the special price of \$ 180 / DM 270 (you save \$ 40 / DM 55) you will receive all our manuals and supplements (altogether more than 1800 pages!) plus our new *Cassette Tape Recording of Modulation Types*.

Our prices include surface mail postage worldwide (for airmail please add \$ 7 or DM 10). Payment can be by \$ or DM check or cash. We accept American Express, Eurocard, Mastercard and Visa credit cards. Dealer inquiries welcome - discount rates on request. Please fax or mail your order to ☺

Klingenfuss Publications
Hagenloer Str. 14
D-72070 Tuebingen
Germany

Fax 01149 7071 600849 • Phone 01149 7071 62830

FREQUENCIES

1100-1200	Australia, Radio	5995pa	6020pa	6080as	7240pa	1100-1200	S Africa, Channel Africa	9730af			
		9510as	9580pa	9710as	9860pa	1100-1200	Singapore, R Singapore Int	9530as			
		13605as	15170as	17910as		1100-1130	Sri Lanka, SLBC Colombo	11835au	15120as	17850as	
1100-1200 vl	Australia, VL8A Alice Spg	2310do				1100-1145	Switzerland, Swiss R Intl	9535as	9885as	13635as	15505as
1100-1200 vl	Australia, VL8K Katherine	2485do				1100-1200	United Kingdom, BBC London	5965na	5975na	6190af	6195na
1100-1200 vl	Australia, VL8T Tent Crk	2325do						9410eu	9515na	9660eu	9740na
1100-1200	Bahrain, Radio	6010do						9750eu	9760eu	11770me	11940af
1100-1200	Canada, CFCX Montreal	6005do						12095eu	15070eu	15220na	15310as
1100-1200	Canada, CFRX Toronto	6070do						15400af	17640eu	17705eu	17790sa
1100-1200	Canada, CFVP Calgary	6030do						17885me	21470af	21660af	
1100-1200	Canada, CHNX Halifax	6130do				1100-1200	USA, KCBI Dallas TX	9815am			
1100-1200	Canada, CKZN St John's	6160do				1100-1200	USA, KTVN Salt Lk City UT	7510na			
1100-1200	Canada, CKZU Vancouver	6160do				1100-1200	USA, KWHR Naalehu HI	9930as			
1100-1200	Costa Rica, AWR Alajuela	9725ca	11870ca			1100-1200	USA, Monitor Radio Intl	7395am	7465am	9425pa	
1100-1200	Costa Rica, R Peace Intl	7375am	9400am	15030am	21465am	1100-1200	USA, VOA Washington DC	5985as	6110as	7405am	9590am
1100-1130	Ecuador, HCJB Quito	9745pa	11925pa	21455pa				9760as	11720au	15120am	15160au
1100-1150	Germany, Deutsche Welle	15370af	15410af	17715af	17765af			15425as			
		17800af	17860af	21600af		1100-1200 vl	USA, WHRI Noblesville IN	7315am	9850am		
1100-1115	Ghana, GBC Radio 1	4915do				1100-1200	USA, WJCR Upton KY	7490na	13595na		
1100-1130	Israel, Kol Israel	15640eu	15650as	17575eu		1100-1200	USA, WWCR Nashville TN	5935am	15685am		
1100-1200 vl	Italy, IRRS Milano	7125eu				1100-1200	USA, WYFR Okeechobee FL	5950am	7355am		
1100-1200	Japan, NHK/Radio	6120na	9610as	15445as		1130-1200	Bulgaria, Radio	11645na	13645me		
1100-1200 mtwhf	Lebanon, Wings of Hope	9960me				1130-1157	Czech Rep, Radio Prague	7345eu	11990eu	15355eu	
1100-1200 vl	Malaysia, RTM Kota Kinaba	5980do				1130-1200	Ecuador, HCJB Quito	11925am	15115am	17890am	21455am
1100-1200	Malaysia, RTM Radio 4	4950do	7295do			1130-1200	Finland, YLE/Radio	11900na			
1100-1200 vl	Malaysia, RTM Sarawak	4950do	7160do			1130-1200	Iran, VOIRI Tehran	9525me	11715me	11790as	11910as
1100-1200	New Zealand, R NZ Intl	9700pa						11930as			
1100-1150	North Korea, R Pyongyang	6576na	9977na	11335na		1130-1200	Netherlands, Radio	5955eu	9850eu		
1100-1120	Pakistan, Radio	17900as	21520as			1130-1200	Sweden, Radio	13775au	15240as		
1100-1200 mtwhf	Palau, KHBN Voice of Hope	9830as				1130-1200	Thailand, Radio	9655as	11905as		
1100-1200 vl	Papua New Guinea, NBC	9675do				1130-1200	Vietnam, Voice of	6115as	10059as	12025as	15010as
1100-1200	Russia, Radio Moscow Intl	7205eu	9705eu	11675eu	12015eu						
		12020eu	12055eu	12070eu	15150as						
		15175as	15210eu	15280as	15320as						
		15345eu	15380eu	15435as	15480as						
		15585eu	17605eu	17690eu	17710as						
		17760eu	17805as	17880eu	21515eu						

SELECTED PROGRAMS

Sundays

- 1100 BBC: Newsdesk. See S 0200.
- 1100 Papua New Guinea. News.
- 1100 Radio New Zealand Int'l: Newsdesk. Rebroadcast of the BBC World Service's quality news program.
- 1105 Papua New Guinea. Top of the Pops.
- 1130 BBC: Play of the Week. *Racing Demon* (29th). See S 0030.
- 1130 BBC: The John Dunn Show. See S 0030.
- 1130 Radio New Zealand Int'l: Good Night from Wellington. National Radio.

Mondays

- 1100 BBC: Newsdesk. See S 0200.
- 1100 Papua New Guinea. News.
- 1100 Radio New Zealand Int'l: Newsdesk. See S 1100.

- 1105 Papua New Guinea. Top of the Pops.
- 1120 Radio Singapore Int'l. Business and Market Report.
- 1130 BBC: Composer of the Month. In depth looks at classical composers and their music.
- 1130 Radio New Zealand Int'l: Good Night from Wellington. See S 1130.

Tuesdays

- 1100 BBC: Newsdesk. See S 0200.
- 1100 Papua New Guinea. News.
- 1100 Radio New Zealand Int'l: Newsdesk. See S 1100.
- 1105 Papua New Guinea. Top of the Pops.
- 1120 Radio Singapore Int'l. Business and Market Report.
- 1130 BBC: Megamix. Compendium of music, sport, fashion, health, travel, news and views for young people.
- 1130 Radio New Zealand Int'l: Good Night from Wellington. See S 1130.

Wednesdays

- 1100 BBC: Newsdesk. See S 0200.
- 1100 Papua New Guinea. News.
- 1100 Radio New Zealand Int'l: Newsdesk. See S 1100.
- 1105 Papua New Guinea. Top of the Pops.
- 1120 Radio Singapore Int'l. Business and Market Report.
- 1130 BBC: Meridian Documentary. See W 0630.
- 1130 Radio New Zealand Int'l: Good Night from Wellington. See S 1130.

Thursdays

- 1100 BBC: Newsdesk. See S 0200.
- 1100 Papua New Guinea. News.
- 1100 Radio New Zealand Int'l: Newsdesk. See S 1100.
- 1105 Papua New Guinea. Top of the Pops.
- 1120 Radio Singapore Int'l. Business and Market Report.
- 1130 BBC: Feature. Shakespeare's Globe (5th, 12th). Continuing the worldwide survey of Shakespeare in performance around the globe. *Lord Edgware Dies* (19th, 26th). A dramatization of the Agatha Christie novel.
- 1130 Radio New Zealand Int'l: Good Night from Wellington. See S 1130.

Fridays

- 1100 BBC: Newsdesk. See S 0200.
- 1100 Papua New Guinea. News.
- 1100 Radio New Zealand Int'l: Newsdesk. See S 1100.
- 1105 Papua New Guinea. Top of the Pops.
- 1120 Radio Singapore Int'l. Business and Market Report.
- 1130 BBC: Meridian Books. See W 0630.
- 1130 Radio New Zealand Int'l: Good Night from Wellington. See S 1130.

Saturdays

- 1100 BBC: Newsdesk. See S 0200.
- 1100 Papua New Guinea. News.
- 1100 Radio New Zealand Int'l: Newsdesk. See S 1100.
- 1105 Papua New Guinea. Top of the Pops.
- 1130 BBC: Meridian Reports. See W 0630.
- 1130 Radio New Zealand Int'l: Good Night from Wellington. See S 1130.

The transmitting antennas for Swedish Telecom Radio are highlighted on their QSL.

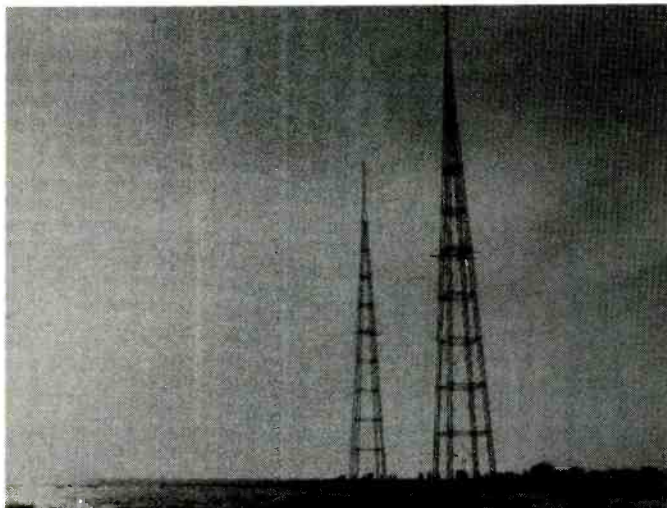

FREQUENCIES

1300-1400	Australia, Radio	5995pa	7240pa	11800pa
1300-1400 vl	Australia, VL8A Alice Spg	2310do		
1300-1400 vl	Australia, VL8K Katherine	2485do		
1300-1400 vl	Australia, VL8T Tent Crk	2325do		
1300-1400	Bahrain, Radio	6010do		
1300-1330 mtwtf	Belgium, R Vlaanderen Int	17775as		
1300-1320	Brazil, Radiobras	15445na		
1300-1400	Canada, CFCX Montreal	6005do		
1300-1400	Canada, CFRX Toronto	6070do		
1300-1400	Canada, CFVP Calgary	6030do		
1300-1400	Canada, CHNX Halifax	6130do		
1300-1400	Canada, CKZN St John's	6160do		
1300-1400	Canada, CKZU Vancouver	6160do		
1300-1400	Canada, RCI Montreal	9535as	11796as	15315eu
		17820eu	17895af	21455me
1300-1400 s	Canada, RCI Montreal	11955na	17820na	
1300-1400	China, China Radio Intl	9715as	11660as	15440pa
1300-1400 vl	Costa Rica, R Peace Intl	7375am	9400am	15030am
1300-1400	Ecuador, HCJB Quito	11925am	15115am	17490am
		21455am		
1300-1330	Egypt, Radio Cairo	17595as		
1300-1330	Ghana, GBC Radio 1	4915do		
1300-1400 vl	Italy, IRRS Milano	7125eu		
1300-1400 mtwhf	Lebanon, Wings of Hope	9960me		
1300-1400 vl	Malaysia, RTM Kota Kinaba	5980do		
1300-1400	Malaysia, RTM Radio 4	7295do		
1300-1400 ocasnal	New Zealand, R NZ Intl	9700pa		
1300-1350	North Korea, R Pyongyang	13760as	15230as	
1300-1330 s	Norway, Radio Norway Intl	9590eu		
1300-1400 mtwhf	Palau, KHBN Voice of Hope	9830as		
1300-1400 vl	Papua New Guinea, NBC	9675do		
1300-1400	Philippines, FEBC Manila	11995as		
1300-1400	Romania, R Romania Intl	11940eu	15365eu	17720eu
1300-1400	Russia, Radio Moscow Intl	7205as	7295as	9560as
		9830af	9890eu	11675eu
		12030eu	12065eu	15150eu
		15345eu	15380eu	15440eu
		15480me	15495eu	15540eu
				17760eu

1300-1330	South Korea, Radio Korea	17880eu	21540eu	21610af	21785af
1300-1400	Sri Lanka, SLBC Colombo	9570as	13670as		
1300-1330	Switzerland, Swiss R Intl	6075as	9720as	15425as	
1300-1400	United Kingdom, BBC London	7480as	11690as	13635as	15505as
		5965af	6190af	6195am	7180as
		9410eu	9515na	9580as	9660eu
		9740na	9760eu	11750as	11760me
		11820na	11940af	12095eu	15070eu
		15220na	15310as	15400af	15420af
		15575me	17640eu	17705eu	17790af
		17885af	21470af	21660af	
1300-1400	USA, KCBI Dallas TX	9815am			
1300-1400	USA, KJES Mesquite NM	11715am			
1300-1400 vl	USA, KNLS Anchor Point AK	7355as	7365as		
1300-1400	USA, KTBN Salt Lk City UT	7510am			
1300-1400 vl	USA, KWHR Naalehu HI	9930as			
1300-1400 mtwhf	USA, Monitor Radio Intl	7465am	13625as		
1300-1400	USA, VOA Washington DC	6110as	9560as	9760as	11715au
		15160as	15425as		
1300-1400	USA, WEWN Birmingham AL	7425am	9350am	13615am	
1300-1400 vl	USA, WHRI Noblesville IN	9465am	15105am		
1300-1400	USA, WJCR Upton KY	7490na	13595na		
1300-1400	USA, WWCR Nashville TN	5935am	15685am		
1300-1400	USA, WYFR Okeechobee FL	5950am	9705am	11550as	11830am
		11970am	13695am		
1300-1330	Vietnam, Voice of	6115as	10059as	12025as	15010as
1330-1400	Austria, R Austria Intl	15450as			
1330-1400	Bulgaria, Radio	11630as			
1330-1400	Canada, RCI Montreal	6150as	9535as		
1330-1400	Finland, YLE/Radio	15400na			
1330-1400 tw	Ghana, GBC Radio 1	4915do			
1330-1400	India, All India Radio	5950am	15120as		
1330-1400	Laos, National Radio of	7116as			
1330-1400	Netherlands, Radio	9895as	13700as	15150as	15530as
1330-1400	Sweden, Radio	15240na	17870na		
1330-1400	UAE, Radio Dubai	13675eu	15320eu	15435as	21605as
1330-1400	Uzbekistan, R Tashkent	7285as	9715as	15295as	17745as
1335-1345	Greece, Voice of	15630na	17535na		
1345-1400 vl	Myanmar, Radio	7185do			
1345-1400	Vatican State, Vatican R	11640as	15090as	17525au	

SELECTED PROGRAMS

Sundays

- 1300 BBC: Newshour. See S 0500.
- 1300 Radio Canada Int'l: CBC News. See S 0100.
- 1300 Radio Norway Int'l: Norway Now. See S 1200.
- 1311 Radio Canada Int'l: Sunday Morning. A magazine program covering virtually everything under the sun.
- 1330 Radio Canada Int'l: RCI News. See S 0400.
- 1336 Radio Canada Int'l: Arts in Canada. A look at the Canadian arts scene.
- 1346 All India Radio: Musical Interlude.

Mondays

- 1300 BBC: Newshour. See S 0500.
- 1300 Radio Vlaanderen Int'l: Brussels Calling.
- 1301 Radio Vlaanderen Int'l: News.
- 1306 Radio Vlaanderen Int'l: Press Review.
- 1308 Radio Vlaanderen Int'l: Radio World.
- 1320 Radio Vlaanderen Int'l: Tourism.
- 1330 Radio Canada Int'l: RCI News. See S 0400.
- 1341 Radio Canada Int'l: Spectrum. A weekday magazine program of current affairs, features, and a business report.
- 1346 All India Radio: Indian Music.

Tuesdays

- 1300 BBC: Newshour. See S 0500.
- 1300 Radio Vlaanderen Int'l: Brussels Calling.
- 1301 Radio Vlaanderen Int'l: News.
- 1304 Radio Vlaanderen Int'l: Press Review.
- 1308 Radio Vlaanderen Int'l: Belgium Today.
- 1313 Radio Vlaanderen Int'l: Focus on Europe.
- 1318 Radio Vlaanderen Int'l: Sports Report.
- 1330 Radio Canada Int'l: RCI News. See S 0400.
- 1341 Radio Canada Int'l: Spectrum. See M 1341.
- 1346 All India Radio: Indian Music.

Wednesdays

- 1300 BBC: Newshour. See S 0500.
- 1300 Radio Vlaanderen Int'l: Brussels Calling.
- 1301 Radio Vlaanderen Int'l: News.
- 1306 Radio Vlaanderen Int'l: Press Review.

- 1310 Radio Vlaanderen Int'l: Belgium Today.
- 1314 Radio Vlaanderen Int'l: Living in Belgium.
- 1320 Radio Vlaanderen Int'l: PO Box 26.
- 1330 Radio Canada Int'l: RCI News. See S 0400.
- 1341 Radio Canada Int'l: Spectrum. See M 1341.
- 1346 All India Radio: Indian Music.

Thursdays

- 1300 BBC: Newshour. See S 0500.
- 1300 Radio Vlaanderen Int'l: Brussels Calling.
- 1301 Radio Vlaanderen Int'l: News.
- 1306 Radio Vlaanderen Int'l: Press Review.
- 1308 Radio Vlaanderen Int'l: Belgium Today.
- 1314 Radio Vlaanderen Int'l: The Arts.
- 1319 Radio Vlaanderen Int'l: Green Society.
- 1330 Radio Canada Int'l: RCI News. See S 0400.
- 1341 Radio Canada Int'l: Spectrum. See M 1341.
- 1346 All India Radio: Listeners' Choice.

Fridays

- 1300 BBC: Newshour. See S 0500.

- 1300 Radio Vlaanderen Int'l: Brussels Calling.
- 1301 Radio Vlaanderen Int'l: News.
- 1306 Radio Vlaanderen Int'l: Press Review.
- 1310 Radio Vlaanderen Int'l: Belgium Today.
- 1314 Radio Vlaanderen Int'l: North-South.
- 1320 Radio Vlaanderen Int'l: Economics.
- 1330 Radio Canada Int'l: RCI News. See S 0400.
- 1341 Radio Canada Int'l: Spectrum. See M 1341.
- 1346 All India Radio: Indian Music.

Saturdays

- 1300 BBC: Newshour. See S 0500.
- 1300 Radio Vlaanderen Int'l: Brussels Calling.
- 1301 Radio Vlaanderen Int'l: News.
- 1306 Radio Vlaanderen Int'l: Press Review.
- 1309 Radio Vlaanderen Int'l: Radio World.
- 1319 Radio Vlaanderen Int'l: Tourism.
- 1330 Radio Canada Int'l: RCI News. See S 0400.
- 1337 Radio Canada Int'l: Innovation Canada. See S 0100.
- 1346 All India Radio: UN News Magazine.

**Radio for Peace
International, Costa Rica,
has new phone and fax
numbers as follows:
506/249-1821 voice
506/249-1095 fax**

Give.



**American Heart
Association**

FREQUENCIES

1400-1500	Australia, Radio	5995pa	7240pa	9580pa	9710pa	9890eu	12030eu	15210na	15320na
		11660pa	11695pa	11800pa		15345af	15380na	15440eu	15455eu
1400-1500 vl	Australia, VL8A Alice Spg	2310do				15540eu	17595eu	17685eu	17760eu
1400-1500 vl	Australia, VL8K Katherine	2485do				21610eu			
1400-1500 vl	Australia, VL8T Tent Crk	2325do				1400-1500 vl	Rwanda, Radio Rwanda		
1400-1500	Bahrain, Radio	6010do				1400-1500	Slovakia, AWR Europe	13790as	
1400-1500	Canada, CFCX Montreal	6005do				1400-1500	South Korea, Radio Korea	5975as	6135as
1400-1500	Canada, CFRX Toronto	6070do				1400-1500	Sri Lanka, SLBC Colomb	6075as	9720as
1400-1500	Canada, CFVP Calgary	6030do				1400-1500	United Kingdom, BBC London	6195as	7180as
1400-1500	Canada, CHNX Halifax	6130do						9410eu	9515na
1400-1500	Canada, CKZN St John's	6160do						9660eu	9750eu
1400-1500	Canada, CKZU Vancouver	6160do						9760eu	9760af
1400-1500 s	Canada, RCI Montreal	11955na	17820am					12095eu	15070eu
1400-1500	China, China Radio Intl	7405na	9785na	11815as	15165as			15400af	15575me
1400-1500 vl	Costa Rica, R Peace Intl	7375am	9400am	15030am				17790af	17840af
1400-1430	Ecuador, HCJB Quito	21455am				1400-1500	USA, KCBI Dallas TX	17725am	17880af
		11910as	12035as	17650me		1400-1500	USA, KJES Mesquite NM	11715na	
1400-1500	France, Radio France Intl	4915do				1400-1500	USA, KTNB Salt Lk City UT	7510na	
1400-1420	Ghana, GBC Radio 1	6130do	7295do			1400-1500	USA, KWHR Naalehu HI	9930as	
1400-1500	Ghana, GBC Radio 2	11760as	15120as			1400-1500 mtwhf	USA, Monitor Radio Intl	9355as	9455am
1400-1500	India, All India Radio	15250as				1400-1500	USA, VOA Washington DC	6110as	7125as
1400-1500	Iraq, Radio Iraq Intl	15640na	15650as					11705au	15160as
1400-1425 mtwh	Israel, Kol Israel	7125eu						15425as	
1400-1500 vl	Italy, IRRS Milano	9535na	9750as	11705as	11735am	1400-1500	USA, WENW Birmingham AL	7425am	9350am
1400-1500	Japan, NHK/Radio	11815as				1400-1500 vl	USA, WHRI Noblesville IN	9465am	15105am
		9960me				1400-1500	USA, WJCR Upton KY	7490na	13595na
1400-1500 mtwhf	Lebanon, Wings of Hope	5980do				1400-1500	USA, WWCR Nashville TN	13845am	15685am
1400-1500 vl	Malaysia, RTM Kota Kinaba	7295do				1400-1500	USA, WYFR Okeechobee FL	11550as	11830am
1400-1500	Malaysia, RTM Radio 4	4950do				1400-1415	Vatican State, Vatican R	11640as	15090as
1400-1500 vl	Malaysia, RTM Sarawak	11925eu				1415-1425	Nepal, Radio	3230do	5005do
1400-1500	Malta, V of Mediterranean	11925eu				1430-1500	Australia, Radio	5995pa	6060pa
1400-1500 mtwhf	Morocco, RTV Marocaine	17595af						9510as	9580pa
1400-1500 vl	Myanmar, Radio	7185do						11695pa	11800pa
1400-1500	Netherlands, Radio	9895as	13700as	15530as		1430-1500	Canada, RCI Montreal	9555eu	11915af
1400-1500 ocasnal	New Zealand, R NZ Intl	9700pa						15325me	17820af
1400-1430 mtwhf	Palau, KHBN Voice of Hope	9830as				1430-1500	Ecuador, HCJB Quito	11925am	17490am
1400-1500	Philippines, FEBC Manila	11995as				1430-1500	Myanmar, Radio	5990do	
1400-1500	Russia, Radio Moscow Intl	5905as	5960as	6055eu	6065eu	1430-1500	Netherlands, Radio	15150as	
		7105na	7135na	7195af	7205as	1445-1500	Romania, R Romania Intl	11775as	15335as
		7250na	7345as	9550na	9560as	1445-1500 smha	Guam, KTWR Agana	15610as	17720as
							Mongolia, R Ulaanbaatar	7260as	7780as

SELECTED PROGRAMS

Sundays

- 1400 BBC: News Summary. See S 0100.
- 1400 Radio Canada Int'l: CBC News. See S 0100.
- 1401 BBC: Feature. Frogs and Rosbits (2nd). NEW. The opening of the Channel Tunnel this month recalls the debate about why the English and the French do not like each other. Extraordinary And Plenipotentiary (8th, 15th, 22nd). NEW. An examination of how the international network of embassies evolved and became established.
- 1405 Radio Canada Int'l: Sunday Morning (Centerpoint). A feature program segment of the CBC Sunday Morning program.
- 1430 BBC: Anything Goes. A variety of music and much more with Bob Holness.
- 1430 Radio Canada Int'l: RCI News. See S 0400.
- 1437 Radio Canada Int'l: Arts in Canada. See S 1336.

Mondays

- 1400 BBC (as): Dateline East Asia. Magazine program dealing with political and economic affairs of SE/NE Asia.
- 1400 BBC: World News. See S 0000.
- 1405 BBC: Outlook. An up-to-the-minute mix of conversation, controversy and color from around the world.
- 1430 BBC (as): Special Programs for Asia. English-teaching followed by world news at slow speed.
- 1430 BBC: Off the Shelf. See M 0430.
- 1430 Radio for Peace Int'l: The Far Right Radio Review. See A 0230.
- 1445 BBC: Feature. Rock 'N Rice (2nd, 9th). See S 0445. A Step Too Far (16th, 23rd, 30th). See S 0445.

Tuesdays

- 1400 BBC (as): Dateline East Asia. Magazine program dealing with political and economic affairs of SE/NE Asia.
- 1400 BBC: World News. See S 0000.
- 405 BBC: Outlook. See M 1405.

- 1430 BBC (as): Special Programs for Asia. English-teaching followed by world news at slow speed.
- 1430 BBC: Off the Shelf. See M 0430.
- 1445 BBC: Music Feature. Mastersingers (3rd, 10th). See M 0145. Crossing the Border (17th, 24th, 31st). See M 0145.

Wednesdays

- 1400 BBC (as): Dateline East Asia. Magazine program dealing with political and economic affairs of SE/NE Asia.
- 1400 BBC: World News. See S 0000.
- 1405 BBC: Outlook. See M 1405.
- 1430 BBC (as): Special Programs for Asia. English-teaching followed by world news at slow speed.
- 1430 BBC: Off the Shelf. See M 0430.
- 1445 BBC: Good Books. See S 0015.

Thursdays

- 1400 BBC (as): Dateline East Asia. Magazine program dealing with political and economic affairs of SE/NE Asia.
- 1400 BBC: World News. See S 0000.

- 1405 BBC: Outlook. See M 1405.
- 1430 BBC (as): Special Programs for Asia. English-teaching followed by world news at slow speed.
- 1430 BBC: Off the Shelf. See M 0430.
- 1445 BBC: The Learning World. See M 0615.

Fridays

- 1400 BBC (as): Dateline East Asia. Magazine program dealing with political and economic affairs of SE/NE Asia.
- 1400 BBC: World News. See S 0000.
- 1405 BBC: Outlook. See M 1405.
- 1430 BBC (as): Special Programs for Asia. English-teaching followed by world news at slow speed.
- 1430 BBC: Off the Shelf. See M 0430.
- 1445 BBC: Global Concerns. See F 0145.

Saturdays

- 1400 BBC: World News. See S 0000.
- 1401 BBC: Sportsworld. The weekly sports magazine.

See our ad on
page 5 for
details or call
1-800-438-8155
and pre-register
TODAY!

Come celebrate our
5th Anniversary!
1994 Monitoring Times Convention
October 21-23 Atlanta Airport Hilton

FREQUENCIES

1500-1600	Algeria, R Algiers Intl	11715af	15205me	17745eu	
1500-1600	Australia, Radio	5995pa	6060pa	6080pa	7240pa
		7260as	9510as	9580pa	9710pa
		9770as	11660as	11680as	11695pa
		11800pa			
1500-1600 vl	Australia, VL8A Alice Spg	2310do			
1500-1600 vl	Australia, VL8K Katherine	2485do			
1500-1600 vl	Australia, VL8T Tent Crk	2325do			
1500-1600	Bahrain, Radio	6010do			
1500-1600	Canada, CFCX Montreal	6005do			
1500-1600	Canada, CFRX Toronto	6070do			
1500-1600	Canada, CFVP Calgary	6030do			
1500-1600	Canada, CHNX Halifax	6130do			
1500-1600	Canada, CKZN St John's	6160do			
1500-1600	Canada, CKZU Vancouver	6160do			
1500-1600 s	Canada, RCI Montreal	11955na			
1500-1600	China, China Radio Intl	7405na	9785na	11815as	15165as
1500-1600 vl	Costa Rica, R Peace Intl	7375am	9400am	15030am	21465am
1500-1600	Ecuador, HCJB Quito	11925am	17490am	17890am	21455am
1500-1600	Ethiopia, Voice of	7165do	9560do		
1500-1550	Germany, Deutsche Welle	7185af	9735af	11965af	21600af
1500-1500	Guam, KTWB Agana	15610as			
1500-1600	Iraq, Radio Iraq Intl	15250as			
1500-1600 vl	Italy, IRRS Milano	7125eu			
1500-1600	Japan, NHK/Radio	9535na	9750as	11915na	15355af
1500-1600	Jordan, Radio	9560eu			
1500-1600 mtwhf	Lebanon, Wings of Hope	9960me			
1500-1600 vl	Malaysia, RTM Kota Kinaba	5980do			
1500-1600	Malaysia, RTM Radio 4	7295do			
1500-1600	Malaysia, RTM Sarawak	4950do	7160do		
1500-1600	Malta, V of Mediterranean	11925eu			
1500-1513 smha	Mongolia, R Ulaanbaatar	13780as			
1500-1600	Netherlands, Radio	9895as	13700as	15150as	
1500-1600 ocasnal	New Zealand, R NZ Intl	9700pa			
1500-1600	North Korea, R Pyongyang	9325eu	9640af	9977af	13785eu
1500-1600	Philippines, FEBC Manila	11995as			
1500-1555	Poland, Polish R Warsaw	7285eu	9525eu		
1500-1530	Romania, R Romania Intl	11775as	15335as	17720as	

1500-1600	Russia, Radio Moscow Intl	5930as	6055eu	6065eu	7105na
		7115na	7195na	7260na	7345na
		9735eu	9890eu	11965eu	12045as
		12065eu	15320as	15345eu	15380as
		15440eu	15465as	15540eu	15550eu
		17760eu	17780eu		
1500-1600 vl	Rwanda, Radio Rwanda	9610do			
1500-1600	S Africa, Channel Africa	4945af	11770af		
1500-1543 mtwhfa	Seychelles, FEBA Radio	7170as	11870as		
1500-1600	Slovakia, AWR Europe	9455as			
1500-1600	Sri Lanka, SLBC Colombo	6075as	9720as	15425as	
1500-1530	Switzerland, Swiss R Intl	9420af	9455as	13635as	15505as
1500-1600	United Kingdom, BBC London	6190af	6195eu	7180as	9410eu
		9515na	9660na	9740me	9750eu
		9760eu	11750as	11940af	12095eu
		15070af	15260na	15310as	15400af
		17640af	17705eu	17760na	17840na
		17880af	21470af	21490af	21660af
1500-1600	USA, KCBI Dallas TX	15725am			
1500-1600	USA, KTBN Salt Lk City UT	7510na			
1500-1600	USA, KWHR Naalehu HI	9930as			
1500-1600 mtwhf	USA, Monitor Radio Intl	9355as			
1500-1600	USA, VOA Washington DC	6110as	7125as	9645as	9700as
		9760as	11705as	15205as	15395as
		19379me			
1500-1600	USA, WCSN Scotts Cor ME	15665eu			
1500-1600	USA, WEWN Birmingham AL	7425am	9350am	13615am	
1500-1600 vl	USA, WHRI Noblesville IN	9465am	15105am		
1500-1600	USA, WJCR Upton KY	7490na	13595na		
1500-1600	USA, WRNO New Orleans LA	15420na			
1500-1600	USA, WWCR Nashville TN	13845am	15685am		
1500-1600	USA, WYFR Okeechobee FL	11830am	15215am	17760am	
1515-1600	Bulgaria, Radio	12085as			
1530-1600	Albania, R Tirana Intl	7155eu	9760eu		
1530-1600	Austria, R Austria Intl	6155eu	9880me	11780as	13730eu
1530-1545	India, All India Radio	7412as	9910as	11740as	
1530-1600 mtwhf	Portugal, Radio	21515me			

SELECTED PROGRAMS

Sundays

- 1500 BBC (af): Postmark Africa. See S 0335.
- 1500 BBC: World News. See S 0000.
- 1500 Radio Canada Intl: CBC News. See S 0100.
- 1505 Radio Canada Intl: Sunday Morning. See S 1311.
- 1505 Swiss Radio Intl: Rhythmmakers (4). The whole scale of Swiss music from classical to pop to rock to folk.
- 1505 Swiss Radio Intl: Roundabout Switzerland (2). Go off the beaten track or behind the facades of the well-known regions.
- 1505 Swiss Radio Intl: Sunday Supplement (1). An in-depth look at issues, events and people. Sunday Supplement (3). See S 1505.
- 1505 Swiss Radio Intl: The Name Game (5). A chance for you to test your knowledge of Switzerland and win prizes.
- 1515 BBC: Concert Hall. Classical music concerts.
- 1525 BBC (af): African News. See S 0330.

Mondays

- 1500 BBC: World News. See S 0000.
- 1505 Swiss Radio Intl: Dateline. Analysis on world events and a closer look at the Swiss national fabric.
- 1515 BBC (af): Focus on Africa. Up-to-the-minute reports on the day's events from all over the continent.
- 1515 BBC: Feature. Shakespeare and the Idea of England (2nd). See M 0101. Shakespeare on Screen (9th). See M 0101. Mind and Body (16th). See M 0101. Children Under the Skin (23rd, 30th). See M 0101.
- 1515 Swiss Radio Intl: Future Watch. SRI's science and technology program.

Tuesdays

- 1500 BBC: World News. See S 0000.
- 1505 Swiss Radio Intl: Dateline. See M 1505.
- 1515 BBC (af): Focus on Africa. See M 1515.
- 1515 BBC: A Jolly Good Show. See T 0015.
- 1515 Swiss Radio Intl: Future Watch. See M 1515.

Wednesdays

- 1500 BBC: World News. See S 0000.
- 1505 Swiss Radio Intl: Dateline. See M 1505.
- 1515 BBC (af): Focus on Africa. See M 1515.
- 1515 BBC: From Our Own Correspondent. See S 0330.
- 1515 Swiss Radio Intl: Taking Stock. Reports on business, finance and economics.
- 1530 BBC: Feature. Stories in Verse (4th). Leading actors read narrative classics. The Reduced Shakespeare Radio Show (11th, 18th, 25th). An irreverent, abbreviated, crash-course in Shakespeare.

Thursdays

- 1500 BBC: World News. See S 0000.
- 1505 Swiss Radio Intl: Dateline. See M 1505.
- 1515 BBC (af): Focus on Africa. See M 1515.
- 1515 BBC: Ray on Record. See H 0015.
- 1515 Swiss Radio Intl: Red Cross Review (4). Activities of the International Red Cross are described.
- 1515 Swiss Radio Intl: Taking Stock. See W 1515.

Fridays

- 1500 BBC: World News. See S 0000.
- 1505 Swiss Radio Intl: Dateline. See M 1505.
- 1515 BBC (af): Focus on Africa. See M 1515.
- 1515 BBC: Music Review. See F 0015.

Saturdays

- 1500 BBC (af): Spice Taxi. See A 0630.
- 1500 BBC: World News. See S 0000.
- 1505 Swiss Radio Intl: The Saturday Magazine. Includes The Week in Switzerland, The Grapevine, and Swiss Shortwave Merry-Go-Round.
- 1509 Swiss Radio Intl: The Grapevine. Listener's letters and comment.
- 1515 BBC: Sportsworld. See A 1401.
- 1518 Swiss Radio Intl: Shortwave Merry-Go-Round. Bob Thomann and Bob Zanotti present shortwave radio news and advice.



John Flake of Charlotte, NC, contributed this Radio Cairo QSL.

FREQUENCIES

1600-1700	Australia, Radio	5995pa 9580pa 11695pa	7240pa 9710pa 11800pa	7260as 9770as	9510as 11660pa				
1600-1700 vl	Australia, VL8A Alice Spg	2310do							
1600-1700 vl	Australia, VL8K Katherine	2485do							
1600-1700 vl	Australia, VL8T Tent Crk	2325do							
1600-1700	Bahrain, Radio	6010do							
1600-1700	Canada, CFCX Montreal	6005do							
1600-1700	Canada, CFRX Toronto	6070do							
1600-1700	Canada, CFVP Calgary	6030do							
1600-1700	Canada, CHNX Halifax	6130do							
1600-1700	Canada, CKZN St John's	6160do							
1600-1700	Canada, CKZU Vancouver	6160do							
1600-1700 s	Canada, RCI Montreal	11955na	17820am						
1600-1700	China, China Radio Intl	11575af	15110af	15130af					
1600-1700 vl	Costa Rica, R Peace Intl	7375am	9400am	15030am	21465am				
1600-1627	Czech Rep, Radio Prague	5930as	7345me	11630eu					
1600-1700	Ecuador, HCJB Quito	21455am							
1600-1700	France, Radio France Intl	6175eu 17620af	11705af 17795af	11975me 17850af	12015af				
1600-1650	Germany, Deutsche Welle	6170as 17810as	7225as 21680as	9875as	15595as				
1600-1700	Guam, KSDA AWR Agat	7455as							
1600-1700	Guam, KTVR Agana	15610as							
1600-1627	Iran, VOIRI Tehran	11790eu							
1600-1700	Iraq, Radio Iraq Intl	15250as							
1600-1700 vl	Italy, IRRS Milano	7125eu							
1600-1700	Jordan, Radio	9560eu							
1600-1630 mtwhf	Lebanon, Wings of Hope	9960me							
1600-1615 mha	Mongolia, R Ulaanbaatar	7560as	7780as						
1600-1700	Netherlands, Radio	9895as	13700as	15150as					
1600-1649 ocasnal	New Zealand, R NZ Intl	9700pa							
1600-1630	Pakistan, Radio	9470as 15675as	11570as 17660as	13590as	15555as				
1600-1700	Russia, Radio Moscow Intl	6055eu 7205eu 9540na 12045eu	7105na 7250na 9550na 15320na	7115eu 7345na 9560eu 15380eu	7150eu 7345na 9890eu 17760eu				
1600-1700 vl	Rwanda, Radio Rwanda	9610do							
1600-1700	S Africa, Channel Africa	4945af	11770af						
1600-1700	Saudi Arabia, BSKSA	9705eu	9720eu						
1600-1700	South Korea, Radio Korea	5975as							
1600-1700	Sri Lanka, SLBC Colombo	6075as	9720as	15425as					
1600-1700	Swaziland, Trans World R	9500af							
1600-1645	UAE, Radio Dubai	11795af	13675eu	15435eu	21605eu				
1600-1700	United Kingdom, BBC London	6190af 9515na 9760eu 15070af 17705eu 21660af	6195eu 9630af 11750as 15260na 17860af	7180as 9740me 11940af 15400af 17880af	9410eu 9750eu 12095eu 17640af 21470af				
1600-1700	USA, KCBI Dallas TX	15725am							
1600-1700	USA, KTVN Salt Lk City UT	15590am							
1600-1700	USA, KWHR Naalehu HI	7425as							
1600-1700 mtwhf	USA, Monitor Radio Intl	13625af							
1600-1700	USA, VOA Washington DC	6110as 9700as 12040af 15320af 17790af	6180eu 9760as 13710af 15395as	7125as 11855eu 15205as 15410af	9645as 11930af 15255af 15445af				
1600-1700	USA, WCSN Scotts Cor ME	15665eu							
1600-1700	USA, WEWN Birmingham AL	7425am	13615am	13615am					
1600-1700 vl	USA, WHRI Noblesville IN	9465am	15105am						
1600-1700	USA, WINB Red Lion PA	15715eu							
1600-1700	USA, WJCR Upton KY	7490na	13595na						
1600-1700	USA, WRNO New Orleans LA	15420am							
1600-1700	USA, WWCR Nashville TN	13845am	15610am	15685am					
1600-1700	USA, WYFR Okeechobee FL	11830am	15215am	15355eu	17760am				
1600-1630	Vietnam, Voice of	9840af	12020af	15010af					
1615-1645	Sweden, Radio	6065eu							
1620-1630 mtwtf	Estonia, Estonian Radio	5925eu							
1630-1700	Australia, Radio	6060pa	11660pa	11880pa					
1630-1700	Austria, R Austria Intl	11780as							
1630-1700	Canada, RCI Montreal	7150as	9550as						
1630-1700	Ecuador, HCJB Quito	15270me	17790me	21455me					
1630-1700	Egypt, Radio Cairo	15255af							
1630-1700	Liberia, Radio ELWA	4760do							
1645-1700	Afghanistan, Radio	9635as							
1645-1700	Tajikistan, Radio	7245as							
1650-1700 mtwtf	New Zealand, R NZ Intl	6035pa							

SELECTED PROGRAMS

Sundays

- 1600 BBC: World News. See S 0000.
- 1600 KSDA (Guam): AWR Magazine.
- 1609 BBC: British News. See S 0009.
- 1615 BBC: Feature. Discursive Excursions (1st, 8th, 15th). See S 0230. Cannabis—Weed or Wonderdrug? (22nd). See S 0230. Nansen—Explorer and Statesman (29th). See S 0230.
- 1615 KSDA (Guam): AWR DX Asiawaves.
- 1630 KSDA (Guam): Power to Cope.
- 1645 BBC (as): South Asia Report. Regional daily current affairs program.
- 1645 BBC: Letter from America. See S 0615.

Mondays

- 1600 BBC: World News. See S 0000.
- 1600 KSDA (Guam): The Music Scrapbook.
- 1609 BBC: British News. See S 0009.
- 1615 BBC: New Ideas. Window on the world of technology, innovation and new products.
- 1615 KSDA (Guam): The Bible in Living Sound.
- 1630 KSDA (Guam): Discovering the Bible.
- 1635 BBC: Feature. Shakespeare's sonnets. Contemporary poets read and evaluate their favorites.
- 1645 BBC (as): South Asia Report. Regional daily current affairs program.
- 1645 BBC: The World Today. Examines thoroughly a topical aspect of the international scene.
- 1645 KSDA (Guam): Voice of Prophecy.
- 1650 Radio New Zealand Int'l: Bellbird. RNZI's famous interval signal.
- 1655 Radio New Zealand Int'l: Karanga/Reading/Hymn. Vespers at the beginning of transmission.

Tuesdays

- 1600 BBC: World News. See S 0000.
- 1600 KSDA (Guam): The Music Scrapbook.

- 1609 BBC: British News. See S 0009.
- 1615 BBC: Megamix. See T 1130.
- 1615 KSDA (Guam): The Bible in Living Sound.
- 1630 KSDA (Guam): Discovering the Bible.
- 1645 BBC (as): South Asia Report. Regional daily current affairs program.
- 1645 BBC: The World Today. See M 1645.
- 1645 KSDA (Guam): Voice of Prophecy.
- 1650 Radio New Zealand Int'l: Bellbird. See M 1650.
- 1655 Radio New Zealand Int'l: Karanga/Reading/Hymn. See M 1655.

Wednesdays

- 1600 BBC: World News. See S 0000.
- 1600 KSDA (Guam): The Music Scrapbook.
- 1609 BBC: British News. See S 0009.
- 1615 BBC: Music Feature. Showtime for shakespeare (4th, 11th). See T 0630. Duke Ellington—Jazz Genius (18th, 25th). See T 0630.
- 1615 KSDA (Guam): The Bible in Living Sound.
- 1630 KSDA (Guam): Discovering the Bible.
- 1645 BBC (as): South Asia Report. Regional daily current affairs program.
- 1645 BBC: The World Today. See M 1645.
- 1645 KSDA (Guam): Voice of Prophecy.
- 1650 Radio New Zealand Int'l: Bellbird. See M 1650.
- 1655 Radio New Zealand Int'l: Karanga/Reading/Hymn. See M 1655.

Thursdays

- 1600 BBC: World News. See S 0000.
- 1600 KSDA (Guam): The Music Scrapbook.
- 1609 BBC: British News. See S 0009.
- 1615 BBC: Network UK. Issues and events affecting the lives of people throughout the UK.
- 1615 KSDA (Guam): The Bible in Living Sound.
- 1630 KSDA (Guam): Discovering the Bible.

- 1645 BBC (as): South Asia Report. Regional daily current affairs program.
- 1645 BBC: The World Today. See M 1645.
- 1645 KSDA (Guam): Voice of Prophecy.
- 1650 Radio New Zealand Int'l: Bellbird. See M 1650.
- 1655 Radio New Zealand Int'l: Karanga/Reading/Hymn. See M 1655.

Fridays

- 1600 BBC: World News. See S 0000.
- 1600 KSDA (Guam): The Music Scrapbook.
- 1609 BBC: British News. See S 0009.
- 1615 BBC: Science in Action. The latest in science and technology.
- 1615 KSDA (Guam): The Bible in Living Sound.
- 1630 KSDA (Guam): Discovering the Bible.
- 1645 BBC (as): South Asia Report. Regional daily current affairs program.
- 1645 BBC: The World Today. See M 1645.
- 1645 KSDA (Guam): Voice of Prophecy.
- 1650 Radio New Zealand Int'l: Bellbird. See M 1650.
- 1655 Radio New Zealand Int'l: Karanga/Reading/Hymn. See M 1655.

Saturdays

- 1600 BBC: World News. See S 0000.
- 1600 KSDA (Guam): Pacific Island Journal.
- 1609 BBC: British News. See S 0009.
- 1615 BBC: Sportsworld. See A 1401.
- 1615 KSDA (Guam): AWR DX Asiawaves.
- 1630 KSDA (Guam): Digging Up the Past.
- 1645 BBC (as): South Asia Report. Regional daily current affairs program.
- 1645 KSDA (Guam): Inspirations.

1700-1800	Algeria, R Algiers Intl	7155eu			
1700-1800	Australia, Radio	6060pa	6080as	7240pa	7260as
		9510as	9580pa	9860pa	11660pa
		11695pa	11880pa		
1700-1800 vl	Australia, VLBA Alice Spg	2310do			
1700-1800 vl	Australia, VLBK Katherine	2485do			
1700-1800 vl	Australia, VLBT Tent Crk	2325do			
1700-1800	Bahrain, Radio	6010do			
1700-1800	Canada, CFCX Montreal	6005do			
1700-1800	Canada, CFRX Toronto	6070do			
1700-1800	Canada, CFVP Calgary	6030do			
1700-1800	Canada, CHNX Halifax	6130do			
1700-1800	Canada, CKZN St John's	6160do			
1700-1800	Canada, CKZU Vancouver	6160do			
1700-1800	China, China Radio Intl	7405af	9570af	11575af	
1700-1800	Costa Rica, R Peace Intl	7375am	9400am	15030am	21465am
1700-1800	Ecuador, HCJB Quito	15270me	17790me	21455me	
1700-1800	Egypt, Radio Cairo	15255af			
1700-1800 vl	Eq Guinea, Radio Africa	7200af			
1700-1800 as	Guam, KSDA AWR Agat	13720as			
1700-1800 vl	Italy, IRRS Milano	7125eu			
1700-1800	Japan, NHK/Radio	9535na	9750as	11915as	17870af
1700-1730	Jordan, Radio	9560eu			
1700-1713 mtwhfa	Lebanon, Voice of	6550eu			
1700-1800	Liberia, Radio ELWA	4760do			
1700-1800 a	Morocco, RTV Marocaine	17815af			
1700-1800 mtwtf	New Zealand, R NZ Intl	6035pa			
1700-1750	North Korea, R Pyongyang	9325eu	9640af	9977af	13785af
1700-1750	Pakistan, Radio	7485eu	9855eu		
1700-1755	Poland, Polish R Warsaw	5995eu	7270eu	7285eu	
1700-1800	Russia, Radio Moscow Intl	7105na	7170eu	7205eu	7260na
		7330eu	7340eu	7345na	9540na
		9890eu	13670eu	15380eu	17760eu
1700-1800 vl	Rwanda, Radio Rwanda	9610do			
1700-1800	S Africa, Channel Africa	4945af	11770af		
1700-1800	Saudi Arabia, BSKSA	9705eu	9720eu		
1700-1730	Sri Lanka, SLBC Colombo	6075as	9720as	15425as	
1700-1715	Swaziland, Trans World R	7120af			
1700-1730	Switzerland, Swiss R Intl	9885af	13635me	17635af	
1700-1730	United Kingdom, BBC London	6005af	17860af		
1700-1800	United Kingdom, BBC London	3955eu	6180eu	6190af	6195eu
		7160me	9410eu	9515eu	9630af
		9740me	11940af	12095af	15070af
		15260af	15400af	15420af	17860af
		17880af	21470af	21660af	
1700-1800	USA, KCBI Dallas TX	15725am			
1700-1800	USA, KTBN Salt Lk City UT	15590am			
1700-1800	USA, KWHR Naalehu HI	7425as			
1700-1800 mtwhf	USA, Monitor Radio Intl	13625af			
1700-1800	USA, VOA Washington DC	6040eu	6110as	7125as	9645as
		9700eu	9760eu	11855as	11920af
		12040af	13710af	15205eu	15320af
		15395as	15410af	15445af	17790af
		19379me			
1700-1800	USA, WEWN Birmingham AL	7425am	9350am	13615am	
1700-1800 vl	USA, WHRI Noblesville IN	13760am	15105am		
1700-1800	USA, WINB Red Lion PA	15715eu			
1700-1800	USA, WJCR Upton KY	7490na	13595na		
1700-1800 smtwhf	USA, WMLK Bethel PA	9465eu			
1700-1800	USA, WRNO New Orleans LA	15420am			
1700-1800	USA, WWCR Nashville TN	13845am	15685am		
1700-1800	USA, WYFR Okeechobee FL	21500af			
1700-1800	Swaziland, Trans World R	7120af			
1730-1800	Netherlands, Radio	6020af	9605af	21515af	21590af
1730-1800	Romania, R Romania Intl	15340af	15365af	17745af	17805af
1730-1800	Sweden, Radio	6065af	9655eu	15390me	
1730-1800	Vatican State, Vatican R	11625af	15090af		
1745-1800	India, All India Radio	7412eu	9950me	11620eu	11860eu
		11935af	15080af		

1800-1900	Argentina, RAE	15345eu			
1800-1900	Australia, Radio	5960as	6060pa	6080as	7240pa
		7260as	9580pa	9860pa	11660pa
		11695pa	11855as	11880pa	
1800-1900 vl	Australia, VLBA Alice Spg	2310do			
1800-1900 vl	Australia, VLBT Tent Crk	2325do			
1800-1900	Bahrain, Radio	6010do			
1800-1830 mtwtf	Belgium, R Vlaanderen Int	5910eu			
1800-1900	Brazil, Radiobras	15268eu			
1800-1900	Canada, CFCX Montreal	6005do			
1800-1900	Canada, CFRX Toronto	6070do			
1800-1900	Canada, CFVP Calgary	6030do			
1800-1900	Canada, CHNX Halifax	6130do			
1800-1900	Canada, CKZN St John's	6160do			
1800-1900	Canada, CKZU Vancouver	6160do			
1800-1900	Costa Rica, R Peace Intl	7375am	9400am	15030am	21465am
1800-1827	Czech Rep, Radio Prague	5930af	7345me	9420eu	
1800-1900	Ecuador, HCJB Quito	21455am			
1800-1830	Egypt, Radio Cairo	15255af			
1800-1900 vl	Eq Guinea, Radio Africa	7200af			
1800-1815	Ghana, GBC Radio 1	4915do			
1800-1815	Ghana, GBC Radio 2	3316do			
1800-1915 as	Guam, KSDA AWR Agat	13720as			
1800-1900	India, All India Radio	7412eu	9950me	11620eu	11860eu
		11935af	15080af		
1800-1815	Israel, Kol Israel	7465eu	11587na	11675na	
1800-1900 vl	Italy, IRRS Milano	7125eu			
1800-1900	Kuwait, Radio	11990na			
1800-1900	Liberia, Radio ELWA	4760do			
1800-1900	Netherlands, Radio	6020af	9605af	21515af	21590af
1800-1900 mtwtf	New Zealand, R NZ Intl	6035pa			
1800-1830 s	Norway, Radio Norway Intl	5960eu	9590af	15220af	
1800-1830 mtwhf	Portugal, Radio	9780eu			
1800-1900	Russia, Radio Moscow Intl	7105eu	7170na	7190eu	7205eu
		7250na	7260na	9540eu	9550eu
		9890eu	12050na	13670eu	15380eu
		17760eu			
1800-1900	Saudi Arabia, BSKSA	9705eu	9720eu		
1800-1900	Sudan, Radio Omdurman	9170af			
1800-1900	Swaziland, Trans World R	3200af	9500af		
1800-1900	United Kingdom, BBC London	3255af	3955eu	6005af	6180eu
		6190af	6195eu	7160me	9410eu
		9630af	9740me	11940af	11955as
		12095af	15070af	15400af	15420af
		17880af			
1800-1900	USA, KCBI Dallas TX	15725am			
1800-1900	USA, KJES Mesquite NM	9510na			
1800-1900	USA, KTBN Salt Lk City UT	15590am			
1800-1900	USA, KWHR Naalehu HI	13625as			
1800-1900 mtwhf	USA, Monitor Radio Intl	9355pa	21640af		
1800-1900	USA, VOA Washington DC	6040eu	9700eu	9760eu	11920af
		12040af	13675af	13710af	15410af
		15580af	17800af	19379me	
		17425am	9350am	13615am	
1800-1900 vl	USA, WHRI Noblesville IN	9485am	13760am		
1800-1900	USA, WINB Red Lion PA	15715eu			
1800-1900	USA, WJCR Upton KY	7490na	13595na		
1800-1900	USA, WMLK Bethel PA	9465eu			
1800-1900	USA, WRNO New Orleans LA	15420am			
1800-1900	USA, WWCR Nashville TN	13845am	15610am	15685am	
1800-1900	USA, WYFR Okeechobee FL	21500eu			
1800-1830	Vietnam, Voice of	9840eu	12020eu		
1815-1900	Bangladesh, Radio	9570me	12030eu		
1830-1900	Bulgaria, Radio	7455eu	9700na		
1840-1850 mtwhfa	Greece, Voice of	15630af	15650af	17525af	
1845-1900 irreg s	Mail, RDTV Malienne	4783do	4835do	5995do	
1850-1900	New Zealand, R NZ Intl	11735pa			

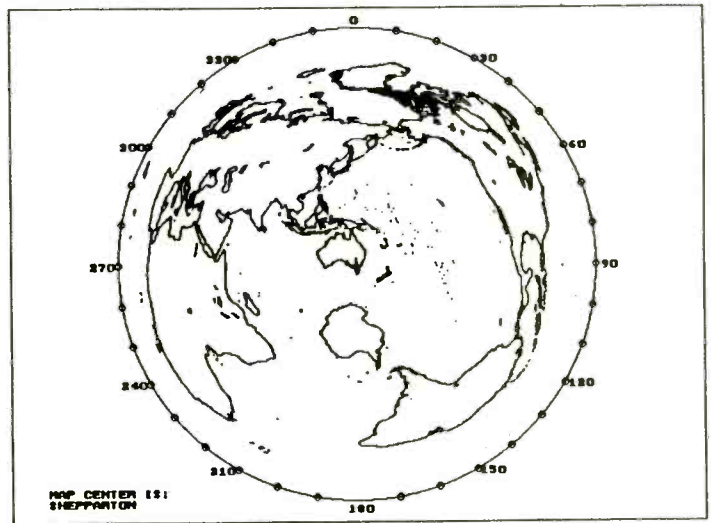
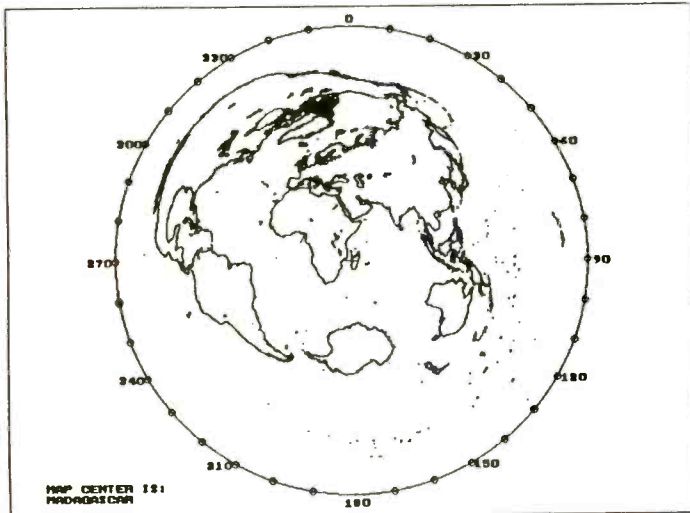

1900-2000	Australia, Radio	5960as 7240pa 11695pa	5995pa 7260as 11720pa	6060pa 9580pa 11880pa	6080as 11680pa
1900-2000 vl	Australia, VL8A Alice Spg	2310do			
1900-2000 vl	Australia, VL8K Katherine	2485do			
1900-2000 vl	Australia, VL8T Tent Crk	2325do			
1900-2000	Bahrain, Radio	6010do			
1900-1918	Brazil, Radiobras	15268eu			
1900-2000	Bulgaria, Radio	7455eu	9700na		
1900-2000	Canada, CFCX Montreal	6005do			
1900-2000	Canada, CFRX Toronto	6070do			
1900-2000	Canada, CFVP Calgary	6030do			
1900-2000	Canada, CHNX Halifax	6130do			
1900-2000	Canada, CKZN St John's	6160do			
1900-2000	Canada, CKZU Vancouver	6160do			
1900-2000	China, China Radio Intl	9440af	11515af		
1900-2000	Costa Rica, R Peace Intl	7375am	9400am	15030am	21465am
1900-2000	Ecuador, HCJB Quito	15270eu	17490eu	17790eu	21455eu
1900-2000 vl	Eqt Guinea, Radio Africa	7200af			
1900-1930	Georgia, Radio Georgia	6080eu			
1900-1950	Germany, Deutsche Welle	7285eu 11740af 13790af	9615eu 11785af 15350af	9640af 11810af	9735af 13690af
1900-1930	Hungary, Radio Budapest	6110eu	7220eu	9835eu	11910eu
1900-1945	India, All India Radio	7412eu 11935af	9950me 15080af	11620eu	11860eu
1900-2000 vl	Italy, IRRS Milano	7125eu			
1900-2000	Japan, NHK/Radio	6150as 11815pa	9535as 11865pa	9640am 11875pa	9750as 11915pa
1900-2000	Kuwait, Radio	11990na			
1900-2000	Liberia, Radio ELWA	4760do			
1900-2000 s	Morocco, RTV Marocaine	11920as			
1900-1925	Netherlands, Radio	6020af 21590af	9605af	17605af	21515af
1900-2000	New Zealand, R NZ Intl	11735pa			
1900-2000	Nigeria, Radio	3326do	4770do	4990do	
1900-2000	Nigeria, Voice of	7255af			
1900-2000 vl	Papua New Guinea, NBC	9675do			
1900-2000	Romania, R Romania Intl	9750eu	11810eu	11940eu	15365eu
1900-2000	Russia, Radio Moscow Intl	7170na 9550eu 12055eu 17760eu	7180na 9685eu 13670eu	7205eu 10344eu 15580af	9470na 12045eu 17710na
1900-2000	Saudi Arabia, BSKSA	9705eu	9720eu		
1900-2000	Spain, Spanish Natl Radio	11775af			
1900-2000	Swaziland, Trans World R	3200af	3240af		
1900-2000 vl	Uganda, Radio	4976do			
1900-2000	United Kingdom, BBC London	3255af 6190af 9630af 15070af	3955eu 6195eu 9740me 15400af	6005af 7160me 11955as 17880af	6180eu 9410eu 12095af
1900-2000	USA, KCBI Dallas TX	15725am			
1900-2000	USA, KTVN Salt Lk City UT	15590am			
1900-2000	USA, KWHR Naalehu HI	13625as			
1900-2000 mtwhf	USA, Monitor Radio Intl	9355eu	15665eu	21640af	
1900-2000	USA, VOA Washington DC	3980eu 9760eu 13710af 17800af	6040eu 11870as 15180au	9525as 11920af 15410af	9700eu 12040af 15580af
1900-2000	USA, WCSN Scotts Cor ME	15665am			
1900-2000	USA, WEWN Birmingham AL	7425am	9350am	13615am	
1900-2000 vl	USA, WHRI Noblesville IN	9485am	9590am		
1900-2000	USA, WINB Red Lion PA	15715eu			
1900-2000	USA, WJCR Upton KY	7490na	13595na		
1900-2000	USA, WMLK Bethel PA	9465eu			
1900-2000	USA, WRNO New Orleans LA	15420am			
1900-2000	USA, WWCR Nashville TN	13845am	15610am	15685am	
1900-2000	USA, WYFR Okeechobee FL	15355af	21615af		
1900-1930	Vietnam, Voice of	9840eu	12020eu	15010eu	
1910-1920	Botswana, Radio	3356af	4830af	7255af	
1930-2000	Austria, R Austria Intl	5945eu	6155eu	9880eu	13730af
1930-2000	Iran, VOIRI Tehran	9022me	9745me		
1930-2000	Netherlands, Radio	17605af	21590af		
1930-2000	Poland, Polish R Warsaw	5995eu	6135eu	7285eu	
1930-2000	Slovakia, R Slovakia Intl	5915eu	7345eu	9440eu	
1935-1955	Italy, RAI Rome	7275eu	11800eu		
1940-2000 mha	Mongolia, R Ulaanbaatar	11790eu	11850eu		
1945-2000	Armenia, Radio Yerevan	4810me	4990me	6065me	

2000-2100	Australia, Radio	5960as 7260as 11880pa	6060pa 9580pa 11695pa	6080as 11695pa	7240pa 11720pa
2000-2100 vl	Australia, VL8A Alice Spg	2310do			
2000-2100 vl	Australia, VL8K Katherine	2485do			
2000-2100 vl	Australia, VL8T Tent Crk	2325do			
2000-2100	Bahrain, Radio	6010do			
2000-2100	Canada, CFCX Montreal	6005do			
2000-2100	Canada, CFRX Toronto	6070do			
2000-2100	Canada, CFVP Calgary	6030do			
2000-2100	Canada, CHNX Halifax	6130do			
2000-2100	Canada, CKZN St John's	6160do			
2000-2100	Canada, CKZU Vancouver	6160do			
2000-2100	China, China Radio Intl	9440af	9920eu	11500eu	11715af
2000-2100	Costa Rica, R Peace Intl	7375am	9400am	15030am	21465am
2000-2100	Ecuador, HCJB Quito	15270eu			
2000-2100 vl	Eqt Guinea, Radio Africa	7200af			
2000-2030 mt	Estonia, Estonian Radio	5925eu			
2000-2030	Ghana, GBC Radio 1	4915do			
2000-2030	Ghana, GBC Radio 2	3366do			
2000-2010 mtwhfa	Greece, Voice of	9375eu			
2000-2100	Indonesia, Voice of	9675as	11752as		
2000-2030	Israel, Kol Israel	7465eu 11675na	9435eu 17575af	11585na	11603na
2000-2100 vl	Italy, IRRS Milano	7125eu			
2000-2010 mtwhf	Kenya, Kenya BC Corp	4935do			
2000-2100	Kuwait, Radio	11990na			
2000-2030 as	Latvia, Radio	5935eu			
2000-2100	Liberia, Radio ELWA	4760do			
2000-2030	Lithuania, Radio Vilnius	9400eu	9710eu		
2000-2010 smwha	Mongolia, R Ulaanbaatar	11790eu	11850eu		
2000-2025	Netherlands, Radio	17605af	21590af		
2000-2100	New Zealand, R NZ Intl	11735pa			
2000-2100	Nigeria, Radio	3326do	4770do	4990do	
2000-2100	Nigeria, Voice of	7255af			
2000-2100	North Korea, R Pyongyang	6576eu	9345eu	9640af	9977af
2000-2030 s	Norway, Radio Norway Intl	9590eu	15220af		
2000-2100 vl	Papua New Guinea, NBC	9675do			
2000-2015	Poland, Polish R Warsaw	5955eu	6135eu	7285eu	
2000-2100	Russia, AWR Europe	7140eu			
2000-2100	Russia, Radio Moscow Intl	7170eu 9450na 9890eu 15425na	7180na 9470na 10344eu 17605na	7205eu 9550na 12050na	7250na 9685na 12055na
2000-2100	Saudi Arabia, BSKSA	9705eu	9720eu		
2000-2100 vl	Solomon Islands, SIBC	5020do	9545do		
2000-2100	Sri Lanka, SLBC Colombo	9720eu	15120eu		
2000-2045	Swaziland, Trans World R	3200af	3240af		
2000-2030	Switzerland, Swiss R Intl	6110af 15505af	9885af	12035af	13635af
2000-2050	Turkey, Voice of	9900eu			
2000-2100 vl	Uganda, Radio	4976do			
2000-2030	United Kingdom, BBC London	6190af 9740me	6195eu 15070af	7160me 17880af	9630af
2000-2100	United Kingdom, BBC London	3255af 6005af 6180eu 9410eu	3255af 3955eu 6180eu 12095af	4570af 5975am 6195af 15070af	5975am 7325eu 15260sa
2000-2100	USA, KCBI Dallas TX	15725am			
2000-2100	USA, KJES Mesquite NM	15545am			
2000-2100	USA, KTVN Salt Lk City UT	15590am			
2000-2100 as	USA, KVOH Los Angeles CA	17775am			
2000-2100	USA, KWHR Naalehu HI	15405as			
2000-2100 mtwhf	USA, Monitor Radio Intl	13770af	15665eu		
2000-2100	USA, VOA Washington DC	3980eu 9760na 15410af 21485af	6040eu 11820af 15580af	7415af 13710af 17800af	9700eu 15160af 19379me
2000-2100	USA, WEWN Birmingham AL	7425am	9350am	13615am	
2000-2100 vl	USA, WHRI Noblesville IN	9485am	9590am		
2000-2100	USA, WINB Red Lion PA	15715eu			
2000-2100	USA, WJCR Upton KY	7490na	13595na		
2000-2100	USA, WMLK Bethel PA	9465eu			
2000-2100	USA, WRNO New Orleans LA	15420am			
2000-2100	USA, WWCR Nashville TN	13845am	15610eu	15685am	
2000-2100	USA, WYFR Okeechobee FL	15355af	21555af	15566eu	17750af
2000-2030	Vatican State, Vatican R	9645af	11625af	15090af	
2005-2100	Syria, Radio Damascus	12085eu	15095eu		
2010-2100 sa	Kenya, Kenya BC Corp	4935do			
2015-2045 s	Swaziland, Trans World R	3200af			
2025-2045	Italy, RAI Rome	7235me	9575me	11800me	
2030-2100	Canada, RCI Montreal	6995me 15325eu	7236me 17020af	13660af 17875eu	13670af 17875eu
2030-2100	Egypt, Radio Cairo	15375af			
2030-2100 mtwhfa	Palau, KHBN Voice of Hope	11980as			
2030-2100	South Korea, Radio Korea	5975as	6035af	9640me	9870eu
2030-2100	Sweden, Radio	6065af	9655me		
2030-2100	Vietnam, Voice of	9840eu	12020eu	15010eu	
2045-2100	India, All India Radio	7412eu 11715pa	9910au 11880pa	9950eu 15265pa	11620eu



David Letterman is a supporter of shortwave broadcast listening. In a show last fall, he repeatedly urged viewers to "buy a shortwave radio...you can thank me later."

ORDER NOW 1-800 4 HOBBY KITS

- 2 Meters
- 223 MHz
- 440 MHz
- 6 Meters

FANTASTIC FM TRANSCEIVERS

Ramsey breaks the price barrier on FM rigs! The FX is ideal for shack, portable or mobile. The wide frequency coverage and programmable repeater splits makes the FX the perfect rig for Amateur, CAP or MARS applications. Packeteers really appreciate the dedicated packet port, "TRUE-FM" signal and almost instant T/R switching. High speed packet? ...No problem. Twelve diode programmed channels. 5W RF output, sensitive dual conversion receiver and proven EASY assembly. Why pay more for a used foreign rig when you can have one AMERICAN MADE (by you) for less. Comes complete less case and speaker mike. Order our matching case and knob set for that pro look.

- | | | | |
|---------------------------------|----------|--|----------|
| FX-50 kit (6 Meters) | \$149.95 | FX-146 kit (2 Meters) | \$149.95 |
| FX-223 kit (1 1/4 Meters) | \$149.95 | FX-440 kit (3/4 Meters) | \$169.96 |
| CFX matching case set | \$29.95 | FXM-1, ICOM/Yaesu style speaker mike | \$24.95 |

2 MTR & 220 BOOSTER AMPS



Here's a great booster for any 2 meter or 220 MHz hand-held unit. These power boosters deliver over 30 watts of output, allowing you to hit the repeater's full quieting while the low noise preamp remarkably improves reception. Ramsey Electronics has sold thousands of 2 meter amp kits, but now we offer completely wired and tested 2 meter, as well as 220 MHz units. Both have all the features of the high-priced boosters at a fraction of the cost.

- | | |
|---|---------|
| PA-10 2 MTR POWER BOOSTER (10 X power gain) Fully wired & tested | \$99.95 |
| PA-20 220 MHz POWER BOOSTER (8 X power gain) Fully wired & tested | \$99.95 |

QRP TRANSMITTERS/HAM RECEIVERS

20, 30, 40, 80M
CW TRANSMITTERS

Join the fun on QRP! Thousands of these mini-rigs have been sold and tons of DX contacts have been made. Imagine working Eastern Europe with a \$30 transmitter—that's ham radio at its best! These CW rigs are ideal mates to the receivers at right. They have two-position variable crystal control (one popular QRP XTAL included), one watt output and built-in antenna switch. Runs on 12VDC. Add our matching case and knob set for a handsome finished look.



20, 30, 40, 80M
All Mode RECEIVERS

Build your own mini ham station! Sensitive all-mode AM, CW, SSB receivers use direct conversion design with NE602, IC as featured in QST and ARRL handbooks. Very sensitive varactor tuned over entire band. Plenty of speaker volume. Runs on 9V battery. Very EASY to build, lots of fun and educational—ideal for beginner or old pro. New 30-page manual. Add the case set for well-fitted professional look.

- | | | | |
|---|---------|--|---------|
| Your choice of bands
(Specify band: QRP-20, 30, 40, or 80) | \$29.95 | (Specify band: HR-20, HR-30, HR-40, HR-80) | \$29.95 |
| Matching case knob set. CQRP | \$14.95 | CHR, Matching case | \$14.95 |

Miniature SPEAKER-MIKE



Fits Icom, Yaesu, Alinco, Ramsey and Radio Shack rigs! Looking for a handy little speaker-mike to complement your FX transmitter or other ICOM style handie-talkie? The Ramsey

SM-1 speaker-mike is a beauty. It's only 1 1/2" wide by 2 1/2" inches high and has a handy clip on the back so you can easily clip it to your lapel or shirt. Its small internal speaker isn't going to break any eardrums but is very clear and has plenty of pop to be heard when worn. There's even a jack on the mike so when you plug it in, you still have the use of the speaker jack from your radio. Fits all Radio Shack, ICOM, Yaesu, Alinco and Ramsey rigs.

- | | |
|---|---------|
| SM-1 Mini-Speaker mike, Fully assembled | \$24.95 |
|---|---------|

SHORTWAVE RECEIVER



Fantastic receiver that captures the world with just a 12" antenna! Can receive any 2 MHz portion from 4-11 MHz. True superhet, has smooth varactor tuning, AGC, RF gain control, plenty of speaker volume and runs on a 9V battery. Fascinating Scout, school or club project, provides hours of fun for even the most serious DXer. For the car, consider our shortwave converter. Two switchable bands (in 3-22 MHz range), each 1 MHz wide—tunable on your car radio dial. Add some interest to your drive home!

- | | |
|--------------------------------------|---------|
| Shortwave receiver kit, SR1 | \$29.95 |
| Shortwave converter kit, SC1 | \$27.95 |
| Matching case set for SR1, CSR | \$14.95 |
| Matching case set for SCI, CSC | \$14.95 |

CW KEYS

Send perfect CW. Microprocessor keyer features 4 programmable memories of up to 26 words each, lmbic keying, dot-dash memory, variable speed from 3-60 WPM, adjustable sidetone, keying to any rig and fully RFI proof. EPROM memory keeps messages up to 100 years - you'll go silent before the key! Includes built-in touch paddles or use your own. Easy assembly and matching case set available for a nice station look.

- | | | | |
|---|----------|----------------------------|---------|
| CW-700 Micro keyer kit | \$69.95 | MK Matching case set | \$14.95 |
| CW-700WT Assembled CW-700and case | \$119.95 | | |

ACTIVE ANTENNA

Cramped for space? Get longwire performance with this desktop antenna. Properly designed unit has dual HF and VHF circuitry and built-in whip antenna, as well as external jack. RF gain control and 9V operation makes unit ideal for SWLs, traveling hams or scanner buffs who need hotter reception. The matching case and knob set gives the unit a hundred dollar look!

- | | | | |
|---------------|---------|------------------------------------|---------|
| AA-7Kit | \$28.95 | Matching case & knobset, CAA | \$14.95 |
|---------------|---------|------------------------------------|---------|

AIRCRAFT RECEIVER



Hear exciting aircraft communications—pick up planes up to 100 miles away! Receives 110-136 MHz AM air band, smooth varactor tuning superhet

with AGC, ceramic filter, adjustable squelch, excellent sensitivity and lots of speaker volume. Runs on 9V battery. Great for air shows or just hanging around the airport! New 30-page manual details pilot talk, too. Add case set for "pro" look.

- | | |
|------------------------------|---------|
| AR-1 kit | \$29.95 |
| Matching case set, CAR | \$14.95 |

2M POWER AMP

Easy to build power amp has 8 times power gain, 1W in, 8W out, 2W in, 16W out, 5W is for 40W out. Same amp as featured in many ham magazine articles. Complete with all parts, less case and T-R relay.

- | | |
|-------------------------------------|---------|
| PA-1, 40W pwr amp kit | \$34.95 |
| TR-1, RF sensed T-R relay kit | \$14.95 |

MINI KITS

Ramsey carries a complete line of low cost, easy to build, easy to use functional kits that can be used alone or as building blocks in larger more complex designs. Mini-kits include audio amps, tone decoders, VOX switches, timers, audio alarms, noise-makers and even shocking kits! Call for our free catalogue!

QRP AMPLIFIER

For a slick little QRP boost, use one of the 20 Watt amplifiers. Needs only 1/2-2 watts of drive for full output, linear for SSB, AM or CW operation, power MOSFETs for high efficiency and multistage low pass filter for a clean signal. Built-in T/R relay for automatic switching, runs on 12-15 VDC at 2-4 amps. Add our matching case set for a complete station look.

- | | |
|---|---------|
| Your choice of bands | \$49.95 |
| Specify band: (QAMP-20, 30, 40, 80) | \$49.95 |
| CQAMP Matching case set | \$14.95 |

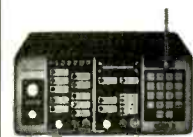

2WAY RADIO SERVICE MONITOR

COM-3, the world's most popular low-cost service monitor. For shops big or small, the COM-3 delivers advanced capabilities for a fantastic price—and our new lease program allows you to own a COM-3 for less than \$3.00 a day. Features • Direct entry keyboard with programmable memory • Audio & transmitter frequency counter • LED bar graph frequency/error deviation display • 0.1-10.0 kHz output levels • High receive sensitivity, less than 5 µV • 100 kHz to 999.9995 MHz • Continuous frequency coverage • Transmit protection, up to 100 watts • CTS tone encoder • 1 KHz and external modulation. COM-3 2 Way Radio Service Monitor

FOXHUNT HEADQUARTERS



Locate hidden or unknown transmitters fast. The Foxhound direction finder connects to the antenna and speaker jack on any radio receiver, AM or FM from 1 MHz to 1 GHz. The antenna (a pair of dipole telescopic whips) is rotated until the Null meter shows a minimum. A pair of LEDs indicate to turn Left or Right. The Foxhound is ideal to use with a walkie-talkie, if you wish to transmit, go ahead, a built-in T/R switch senses any transmitted RF and switches itself out of circuit while you talk. It doesn't get any easier than this! We provide all parts except for a few feet of 1/2 inch PVC pipe available at any hardware store for a dollar or two. Add our matching case set for a complete finished unit. Be the one with the answers, win those transmitter hunts and track down those jammers, you'll do it all with your Foxhound.

Add some fun to your club events by having a transmitter hunt! Foxhunting is a craze sweeping the nation, but many clubs are missing out on the action because they lack the expertise or time to develop their own foxhunt transmitter. We set one of our most devious and sneaky engineers to the task of designing an easy to build and use, yet highly capable Foxhound transmitter. A snazzy microprocessor controller has both preset and programmable transmission characteristics allowing you to easily set the difficulty level from "beginner" to "know-it-all"! The SlyFox, FHT-1, is crystal controlled in the 2 meter band (crystal for 146.52 included) with a power output of 5 watts that is adjustable by the controller. The transmitter is programmed to ID in CW or add our voice option if you really want to aggravate the troops - "Ha ha, you can't find me!" Join the fun, get rid of those stuffy old meetings and picnics, have a foxhunt!

- | | | | |
|--|----------|--------------------------------------|---------|
| DF-1 Foxhound direction finder kit | \$59.95 | CDF Matching case set for DF-1 | \$14.95 |
| FHT-1 SlyFox Foxhound transmitter kit | \$129.95 | FHID-1 Voice ID option | \$29.95 |
| CFHT Heavy duty metal matching case set for FH T-1 | \$29.95 | | |

PACKET RADIO

Two new versions are available for the Commodore 64 (P-64A) and IBM (P-IBM). Easy assembly NO TUNING. Includes FREE disk software, PC Board and Full Documentation. Kit form.

- | | | | | | |
|-------------|---------|-------------|---------|----------------|---------|
| P-64A | \$59.95 | P-IBM | \$59.95 | CASE CPK | \$12.95 |
|-------------|---------|-------------|---------|----------------|---------|

STEREO FM TRANSMITTER

Run your own Stereo FM radio station! Transmits a stable signal in the 88-108 MHz FM broadcast band up to 1 mile. Detailed manual provides helpful info on FCC regs, antenna ideas and range to expect. Latest design features adjustable line level inputs, pre-emphasis and crystal controlled subcarrier. Connects to any CD or tape player, mike mixer or radio. Includes free tuning tool too! For a pro look add our matching case set with on-board whip antenna.

- | | |
|-------------------------------------|---------|
| FM-10A Stereo transmitter kit | \$34.95 |
| CFM Case, whip ant set | \$14.95 |

SPEECH SCRAMBLER

Descramble most scramble systems heard on your scanner radio or set up your own scrambled communication system over the phone or radio. Latest 3rd generation IC is used for fantastic audio quality - equivalent to over 30 op-amps and mixers! Crystal controlled for crystal clear sound with a built-in 2 watt audio amp for direct radio hook-up. For scramble systems, each user has a unit for full duplex operation. Communicate in privacy with the SS-70. Add our case set for a fine professional finish.

- | | |
|--|---------|
| SS-70 Scrambler /descrambler kit | \$39.95 |
| CSSD matching case set | \$14.95 |
| SS-70WT Assembled | \$79.95 |

MICRO-MIKE

World's smallest FM wireless mike. Smaller than a sugar cube - including battery and mike. Two sets of SMT parts supplied in case you are clumsy! Terrific audio pick-up (pin drop at 5 ft) and transmit range of 300 ft. We include the battery (watch style), electret mike and even a tuning tool! Be a James Bond and learn SMT too!

- | | |
|---------------------------|---------|
| FM-5 Micro mike kit | \$19.95 |
|---------------------------|---------|

CRYSTAL RADIO

Relive the radio past with a crystal set like your grandfather built. Uses genuine Galena crystal and catwhisker. Several different types of radios are built, including standard AM broadcast, shortwave and even WW II foxhole style. To compare modern semiconductor detectors, we include a diode for comparison. No soldering required and we even give antenna ideas. Radio for free, get it now before Clinton taxes it!

- | | |
|----------------------------|---------|
| CS-1 Crystal set kit | \$19.95 |
|----------------------------|---------|

DR. NI-CAD CONDITIONER/FAST CHARGER

Quit spending big bucks for replacement battery packs, rejuvenate and condition your batteries for peak capacity. Advanced circuitry has optimized discharge before charge to eliminate memory effect and to condition batteries that have been poorly cared for in the past. Quick charge rapidly brings battery to full charge in less than an hour—just 15 minutes for some types! And "top-off" charge mode squeezes every last bit of energy into each cell for the absolute most capacity. Switch-mode regulator controls constant current charge while being monitored by a negative delta-V system that cuts off the fast charge at the exact point of full charge—batteries are charged, not cooked! Charges NiCads or NiMH packs from 2 to 10 cells (easily expanded) and current capacities up to 10 Amp-hours. Runs on 12 to 15 VDC. Quit cooking your batteries, buying new packs, waiting hours for recharge, get a Dr. Ni-Cad today! Available in money saving kit form or wired and tested with case at a special price. Kit builders: add our matching case set for a snazzy finish.

- | | |
|--|---------|
| DN-1 Dr. Ni-Cad conditioner/fast charger kit | \$49.95 |
| CDN Matching case set | \$12.95 |
| DN-1WT Fully assembled Dr. Ni-Cad with case | \$89.95 |

ORDERS CALL 1-800-4 HOBBY KITS (446-2295) ORDERS ONLY
TECH/ORDER/INFO (716)924-4560 FAX (716)924-4555



RAMSEY ELECTRONICS, INC 793 CANNING PARKWAY VICTOR NY 14564

2100-2200	Australia, Radio	9645as	11720pa	11855as			
2100-2130 vl	Australia, VL8A Alice Spg	2310do					
2100-2130 vl	Australia, VL8K Katherine	2485do					
2100-2130 vl	Australia, VL8T Tent Crk	2325do					
2100-2106	Bahrain, Radio	6010do					
2100-2130 mtwtf	Belgium, R Vlaanderen Int	5910eu					
2100-2200	Bulgaria, Radio	6085eu	9700eu				
2100-2200	Canada, CFCX Montreal	6005do					
2100-2200	Canada, CFRX Toronto	6070do					
2100-2200	Canada, CFVP Calgary	6030do					
2100-2200	Canada, CHNX Halifax	6130do					
2100-2200	Canada, CKZN St John's	6160do					
2100-2200	Canada, CKZU Vancouver	6160do					
2100-2130	Canada, RCI Montreal	6995me	7236me	13660eu	13670af		
		15325eu	17020af	17850af	17875eu		
2100-2200	China, China Radio Intl	9920eu	11500eu				
2100-2130	China, China Radio Intl	11715af	15110af				
2100-2200	Costa Rica, R Peace Intl	7375am	9400am	15030am	21465am		
2100-2200	Cuba, Radio Havana Cuba	15165eu					
2100-2127	Czech Rep, Radio Prague	5930na	7345na	9420au			
2100-2130	Ecuador, HCJB Quito	21455am					
2100-2200	Egypt, Radio Cairo	15375af					
2100-2150	Germany, Deutsche Welle	9670as	9715af	9735af	9765as		
		11785as	13690as	15135af	15350af		
		15435af					
2100-2130	Hungary, Radio Budapest	6110eu	7220eu	9835eu	11910eu		
2100-2200	India, All India Radio	7412eu	9910au	9950eu	11620eu		
		11715pa	15265pa				
2100-2200	Japan, NHK/Radio	6035as	6185as	9640pa	9660as		
		11915as	11925eu				
2100-2200	Liberia, Radio ELWA	4760do					
2100-2137	New Zealand, R NZ Intl	11735pa					
2100-2200	Nigeria, Radio	3326do	4770do	4990do			
2100-2200	Nigeria, Voice of	7255af					
2100-2200 mtwhfa	Palau, KHBN Voice of Hope	11980as					
2100-2200 vl	Papua New Guinea, NBC	9675do					
2100-2130 mtwhf	Portugal, Radio	15250af					
2100-2200	Romania, R Romania Intl	7195eu	7225eu	9690eu	9750eu		
		11940eu					
2100-2200	Russia, Radio Moscow Intl	4795eu	4860eu	5950eu	6055eu		
		7150na	7170eu	7180eu	7205eu		
		7330eu	7390eu	9470eu	9550eu		
		9620eu	9685eu	9750na	9795eu		
		9885eu	12050na	15425na	17605na		
		17690na					
2100-2115 vl	Sierra Leone, SLBS	3316do					
2100-2200 vl	Solomon Islands, SIBC	5020do	9545do				
2100-2200	Spain, Spanish Natl Radio	6125eu					
2100-2130	Sri Lanka, SLBC Colombo	9720eu	15120eu				
2100-2105	Syria, Radio Damascus	12085eu	15095eu				
2100-2200	United Kingdom, BBC London	3255af	3955eu	5975am	6005af		
		6180eu	6195eu	7325eu	9410eu		
		9590na	11955as	12095na	15260sa		
		15400af	15575eu				
2100-2200	USA, KCBI Dallas TX	15725am					
2100-2200	USA, KTVN Salt Lk City UT	15590na					
2100-2200	USA, KWHR Naalehu HI	13720as					
2100-2200 mtwhf	USA, Monitor Radio Intl	13770eu	13840pa	15665eu			
2100-2200	USA, VOA Washington DC	6040eu	6095eu	9760eu	11870as		
		15185au	15410af	17735as	19379me		
2100-2200	USA, WEWN Birmingham AL	7425am	9350am	13615am			
2100-2200 vl	USA, WHRI Noblesville IN	13760am	17830am				
2100-2200	USA, WINB Red Lion PA	15715eu					
2100-2200	USA, WJCR Upton KY	7490na	13595na				
2100-2200	USA, WMLK Bethel PA	9465eu					
2100-2200	USA, WRNO New Orleans LA	15420am					
2100-2200	USA, WWCR Nashville TN	13845am	15610am	15685am			
2100-2200	USA, WYFR Okeechobee FL	7355eu	15355eu	15566eu	17750af		
		21525af					
2110-2200	Syria, Radio Damascus	12085na	15095na				
2115-2200	Egypt, Radio Cairo	9900eu					
2115-2130 mtwhf	United Kingdom, BBC Carib	6110am	15390am	17715am			
2130-2200	Australia, Radio	15240pa	15320pa	15365pa	17795pa		
		17860pa					
2130-2200 vl	Australia, VL8A Alice Spg	4835do					
2130-2200 vl	Australia, VL8K Katherine	5025do					
2130-2200 vl	Australia, VL8T Tent Crk	4910do					
2130-2200	Canada, RCI Montreal	5995eu	7260eu	11945eu	13650eu		
		13690af	15140af	15325af	17820af		
2130-2200	Ecuador, HCJB Quito	11835eu	15270eu	17490eu	17790eu		
		21455eu					
2130-2140 mtwhf	Latvia, Radio	5935eu					
2130-2200 mwa	Moldova, R Dnestr Intl	9620eu					
2130-2200	Sweden, Radio	6065eu	9655eu				
2138-2200	New Zealand, R NZ Intl	15115pa					
2145-2200	South Korea, Radio Korea	6480eu	15575eu				

2200-2300	Australia, Radio	9645as	11720pa	11855as	15240pa
		15320pa	15365pa	17795pa	17860pa
2200-2300 vl	Australia, VL8A Alice Spg	4835do			
2200-2300 vl	Australia, VL8K Katherine	5025do			
2200-2300 vl	Australia, VL8T Tent Crk	4910do			
2200-2300	Canada, CFCX Montreal	6005do			
2200-2300	Canada, CFRX Toronto	6070do			
2200-2300	Canada, CFVP Calgary	6030do			
2200-2300	Canada, CHNX Halifax	6130do			
2200-2300	Canada, CKZN St John's	6160do			
2200-2300	Canada, CKZU Vancouver	6160do			
2200-2300	Canada, RCI Montreal	5960na	9755na	13670am	
2200-2300	China, China Radio Intl	7170eu			
2200-2230	China, China Radio Intl	3985eu			
2200-2300	Costa Rica, R Peace Intl	7375am	9400am	15030am	21465am
2200-2300	Cuba, Radio Havana Cuba	6180na			
2200-2230	Czech Rep, Radio Prague	5930na	7345af	9420eu	
2200-2245	Egypt, Radio Cairo	9900eu			
2200-2300 vl	Eq Guinea, Radio Africa	7200af			
2200-2230	India, All India Radio	7412eu	9910au	9950eu	11620eu
		11715pa	15265eu		
2200-2225	Italy, RAI Rome	5990as	9710as	11800as	
2200-2300 vl	Malaysia, RTM Kota Kinaba	5980do			
2200-2300 smtwha	Malaysia, RTM Radio 4	7295do			
2200-2300	New Zealand, R NZ Intl	15115pa			
2200-2300	Nigeria, Radio	3326do	4770do	4990do	
2200-2300	Nigeria, Voice of	7255af			
2200-2300 mtwhfa	Palau, KHBN Voice of Hope	11980as			
2200-2300 vl	Papua New Guinea, NBC	9675do			
2200-2300	Russia, Radio Moscow Intl	7115eu	7150eu	7180eu	7185eu
		7205eu	7295eu	7380eu	9550eu
		9620na	9695eu	9725eu	9750na
		9885eu	10344eu	12050na	15425na
		17605na	17655na	17690na	21655na
2200-2215 vl	Sierra Leone, SLBS	3316do			
2200-2235 vl	Solomon Islands, SIBC	5020do	9545do		
2200-2245	South Korea, Radio Korea	6480eu	15575eu		
2200-2230	South Korea, Radio Korea	7275as	9640as		
2200-2210	Syria, Radio Damascus	12085na	15095na		
2200-2300	Taiwan, VO Free China	9850eu	11915eu		
2200-2250	Turkey, Voice of	7185me	9445na	11710eu	
2200-2300	UAE, Radio Abu Dhabi	9605na	9770na	11885na	
2200-2300	United Kingdom, BBC London	3955eu	5975am	6195eu	7325eu
		9410eu	9590na	9915am	11750sa
		11955as	12095af	15260sa	15400af
		15575eu			
2200-2300	USA, KCBI Dallas TX	15725am			
2200-2230 s	USA, KGEI San Fran CA	15280sa			
2200-2300	USA, KTVN Salt Lk City UT	15590am			
2200-2300	USA, KWHR Naalehu HI	17645as			
2200-2300 mtwhf	USA, Monitor Radio Intl	9355na	9430as	13625as	17555ca
2200-2300	USA, VOA Washington DC	6035as	7215as	9770as	11760as
		15185au	15290as	15305as	17735au
		17820as			
2200-2300	USA, WEWN Birmingham AL	7425am	9350am	13615am	
2200-2300 vl	USA, WHRI Noblesville IN	13760am	17830am		
2200-2300 vl	USA, WINB Red Lion PA	15715eu			
2200-2300	USA, WJCR Upton KY	7490na	13595na		
2200-2300	USA, WRNO New Orleans LA	15420am			
2200-2300 vl	USA, WWCR Nashville TN	12160am	13845am	15685am	
2200-2300	USA, WYFR Okeechobee FL	17750eu	21525af		
2230-2300	Israel, Kol Israel	7465eu	9435eu	11585na	11603na
		11675na	17575sa		
2230-2300	Lithuania, Radio Vilnius	9710eu			
2230-2300	Sweden, Radio	6065eu			
2240-2250 smtwhf	Greece, Voice of	11645au			
2245-2300	Armenia, Radio Yerevan	7440eu	9480eu	9705eu	10344eu
		11920eu			
2245-2300	Bulgaria, Radio	7455eu	9700na		
2245-2300	Ghana, GBC Radio 1	4915do			
2245-2300	Ghana, GBC Radio 2	3366do			
2245-2300	India, All India Radio	9910as	11745as	11785as	15110as
2245-2300 mtwtf	USA, Voice of the OAS	9670am	11835am	15160am	
2245-2300	Vatican State, Vatican R	9600au	11830pa		

If you have any changes or corrections to the Shortwave Guide, send them to Gayle Van Horn, Frequency Manager, c/o Monitoring Times, P.O. Box 98, Brasstown, NC 28902.

FREQUENCIES

2300-2315	Albania, R Tirana Intl	9760eu	11825eu			2300-2400	Russia, Radio Moscow Intl	7110eu	7170eu	7210na	7295na
2300-2400	Australia, Radio	11720pa	11855as	15240pa	15320pa			9450na	9480na	9620na	9695na
		15365pa	17795pa	17860pa				9750na	11675as	12050na	15425na
2300-2400 vl	Australia, VL8A Alice Spg	4835do				2300-2400	Singapore, R Singapore Int	9530as			
2300-2400 vl	Australia, VL8K Katherine	5025do				2300-2400	Thailand, Radio	9655as	11905as		
2300-2400 vl	Australia, VL8T Tent Crk	4910do				2300-2400	UAE, Radio Abu Dhabi	9605na	9770na	11885na	
2300-2345	Bulgaria, Radio	7405na	9700na	11720na		2300-2400	United Kingdom, BBC London	3955eu	5975na	6175na	6195na
2300-2400	Canada, CFCX Montreal	6005do						7180eu	7325na	9410eu	9590na
2300-2400	Canada, CFRX Toronto	6070do						9915am	11750sa	11955as	15260sa
2300-2400	Canada, CFVP Calgary	6030do						15280as	15370as	15400af	
2300-2400	Canada, CHNX Halifax	6130do				2300-2400	USA, KCBI Dallas TX	15725am			
2300-2400	Canada, CKZN St John's	6160do				2300-2400	USA, KTBN Salt Lk City UT	15590na			
2300-2400	Canada, CKZU Vancouver	6160do				2300-2400	USA, KWHR Naalehu HI	17510as			
2300-2330 mtwhf	Canada, RCI Montreal	5960na	9755na	11940am	13670am	2300-2400 mtwhf	USA, Monitor Radio Intl	9355na	9430as	13625pa	17555ca
		15235am				2300-2400	USA, VOA Washington DC	7215as	9770as	11760as	15185as
2300-0000 as	Canada, RCI Montreal	5960na	5995eu	7250eu	9535am			15290as	15305as	17735as	17820as
		9755na	11845na	11940am		2300-2400	USA, WEWN Birmingham AL	7425am	9350am	13615am	
2300-2400	Costa Rica, AWR Alajuela	5030ca	9725ca	11870ca		2300-2400 vl	USA, WHRI Noblesville IN	7315am	9495am		
2300-2400	Costa Rica, R Peace Intl	7375am	9400am	15030am	21465am	2300-2400	USA, WINB Red Lion PA	15715eu			
2300-2400	Ecuador, HCBJ Quito	9745am	21455am			2300-2400	USA, WJCR Upton KY	7490na	13595na		
2300-2400	Guam, KSDA AWR Agat	15610as				2300-2400	USA, WRNO New Orleans LA	7355am			
2300-2400	India, All India Radio	9910as	11745as	11785as	15110as	2300-2400	USA, WWCR Nashville TN	12160am	13845am		
		15145as				2300-2315	Vatican State, Vatican R	9600au	11830as		
2300-2400	Japan, NHK/Radio	6060eu	6125eu	7140eu	9660eu	2300-2400	Austria, R Austria Intl	9870sa	13730sa		
		15430as	17810as			2330-2400 mtwhf	Belgium, R Vlaanderen Int	5910eu			
2300-2400 vl	Malaysia, RTM Kota Kinaba	5980do				2330-2400	Canada, RCI Montreal	5960na	9755na		
2300-2400 smtwha	Malaysia, RTM Radio 4	7295do				2330-2400	Netherlands, Radio	6020na	6165na		
2300-2400	New Zealand, R NZ Intl	15115pa				2330-2400 m	Sri Lanka, SLBC Colombo	15425na			
2300-2350	North Korea, R Pyongyang	11700am	13650am			2330-2400	Sweden, Radio	11910as			
2300-2330 s	Norway, Radio Norway Intl	9655sa	11860na			2330-2400 vl	USA, R Bosnia via WHRI	7315am	9495am		
2300-2400 mtwhfa	Palau, KHBN Voice of Hope	11980as				2330-2400	Vietnam, Voice of	9840as	12020as	15010as	
2300-2400 vl	Papua New Guinea, NBC	9675do				2335-2345 smtwhf	Greece, Voice of	9425sa	11595sa	11645sa	
						2345-2400	Armenia, Radio Yerevan	9480eu	11920eu	12010eu	

SELECTED PROGRAMS

Sundays

- 2300 BBC: Newsdesk. See S 0200.
- 2300 KSDA (Guam): AWR Magazine.
- 2300 Radio Canada Int'l: CBC News. See S 0100.
- 2300 R New Zealand Int'l: National Radio or Sport. See S 0100.
- 2300 Radio Norway Int'l: Norway Now. See S 1200.
- 2315 Radio Canada Int'l: Open House. Conversations on religion, politics, social justice, and personal relations.
- 2315 KSDA (Guam): The Bible in Living Sound.
- 2330 BBC: Feature. Frogs and Rosbits (1st). See S 1401. Extraordinary And Plenipotentiary (8th, 15th, 22nd). See S 1401. Between Russia and the Reich (29th). An examination of the atrocities committed in Latvia during World War II.
- 2330 KSDA (Guam): Voice of Prophecy.

Mondays

- 2300 BBC: Newsdesk. See S 0200.
- 2300 KSDA (Guam): The Music Scrapbook.
- 2300 Radio Canada Int'l: As It Happens. Live telephone interviews with newsmakers around the world.
- 2315 KSDA (Guam): The Bible in Living Sound.
- 2330 BBC: Multitrack 1: Top 20. World Service Top 20.
- 2330 KSDA (Guam): Discovering the Bible.
- 2345 KSDA (Guam): Voice of Prophecy.

Tuesdays

- 2300 BBC: Newsdesk. See S 0200.
- 2300 KSDA (Guam): The Music Scrapbook.
- 2300 Radio Canada Int'l: As It Happens. See M 2300.
- 2300 R New Zealand Int'l: National Radio or Sport. See S 0100.
- 2315 KSDA (Guam): The Bible in Living Sound.
- 2330 BBC: Omnibus. Each week a half-hour programme on practically any topic under the sun.
- 2330 KSDA (Guam): Discovering the Bible.
- 2345 KSDA (Guam): Voice of Prophecy.

Wednesdays

- 2300 BBC: Newsdesk. See S 0200.
- 2300 KSDA (Guam): The Music Scrapbook.
- 2300 Radio Canada Int'l: As It Happens. See M 2300.
- 2300 R New Zealand Int'l: National Radio or Sport. See S 0100.
- 2315 KSDA (Guam): The Bible in Living Sound.
- 2330 BBC: Multitrack 2. New pop records, interviews, news and competitions.

- 2330 KSDA (Guam): Discovering the Bible.
- 2345 KSDA (Guam): Voice of Prophecy.

Thursdays

- 2300 BBC: Newsdesk. See S 0200.
- 2300 KSDA (Guam): The Music Scrapbook.
- 2300 Radio Canada Int'l: As It Happens. See M 2300.
- 2300 R New Zealand Int'l: National Radio or Sport. See S 0100.
- 2315 KSDA (Guam): The Bible in Living Sound.
- 2330 BBC: Feature. The Reduced Shakespeare Radio Show (12th, 19th, 26th). See W 1530.
- 2330 KSDA (Guam): Discovering the Bible.
- 2345 KSDA (Guam): Voice of Prophecy.

Fridays

- 2300 BBC: Newsdesk. See S 0200.
- 2300 KSDA (Guam): The Music Scrapbook.
- 2300 Radio Canada Int'l: As It Happens. See M 2300.
- 2300 Radio New Zealand Int'l: National Radio. See S 0000.

- 2315 KSDA (Guam): The Bible in Living Sound.
- 2330 BBC: Multitrack 3. Latest developments on the British music scene.
- 2330 KSDA (Guam): Discovering the Bible.
- 2345 KSDA (Guam): Voice of Prophecy.

Saturdays

- 2300 BBC: Newsdesk. See S 0200.
- 2300 KSDA (Guam): Pacific Island Journal.
- 2300 Radio Canada Int'l: CBC News. See S 0100.
- 2300 Radio New Zealand Int'l: RNZ News. See S 0600.
- 2305 Radio New Zealand Int'l: Connexions. See S 0630.
- 2307 Radio Canada Int'l: The Inside Track. A sports feature magazine.
- 2315 KSDA (Guam): AWR DX Asiawaves.
- 2330 BBC: Music Feature. The Musician's Musician (21st, 28th). Talks with some of today's accomplished performers about the great musicians of the past.
- 2330 KSDA (Guam): Digging Up the Past.

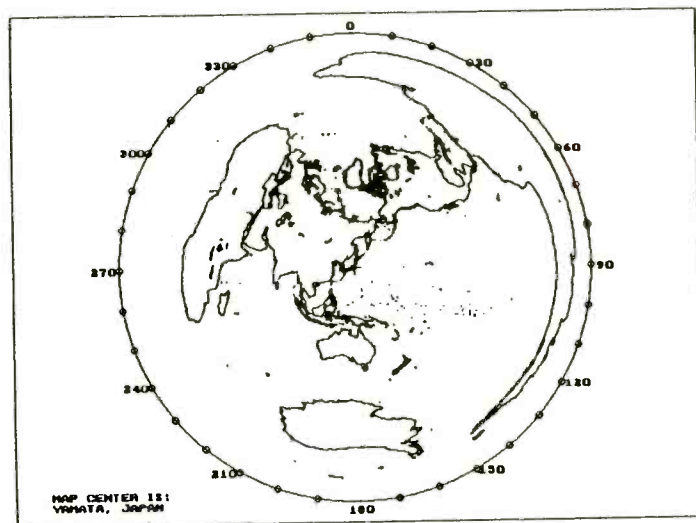

Propagation conditions: Eastern United States

How to use the propagation charts: Propagation charts can be an invaluable aid to the DXer in determining which frequencies are likely to be open at a given time. To use the propagation charts, choose those for your location. Then look for the one most closely describing the geographic location of the station you want to hear.

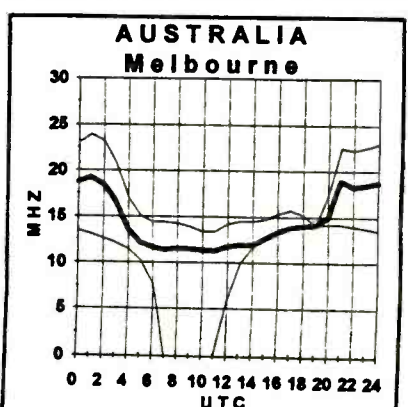
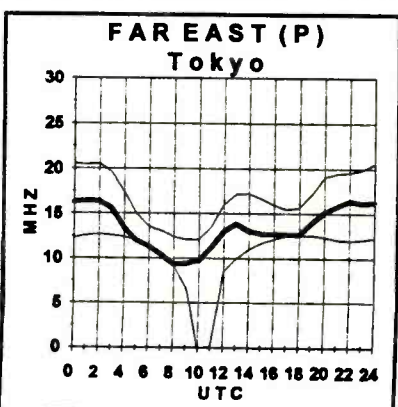
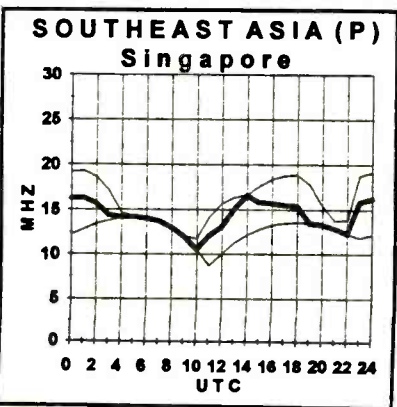
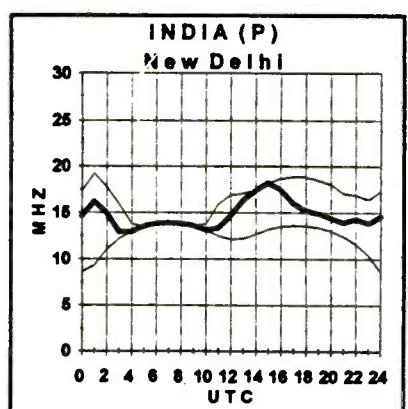
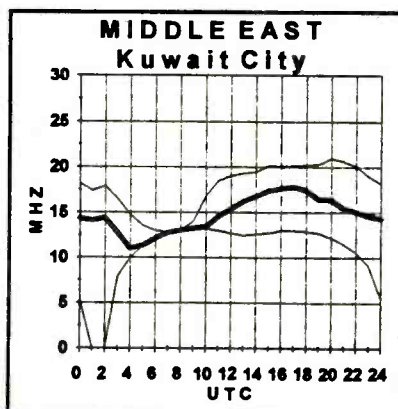
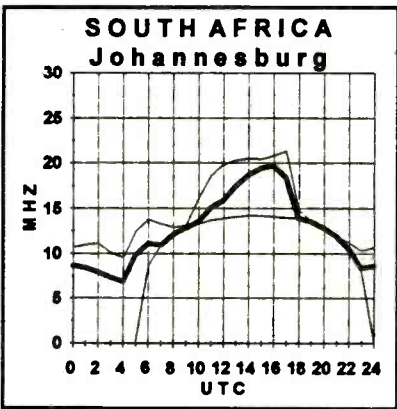
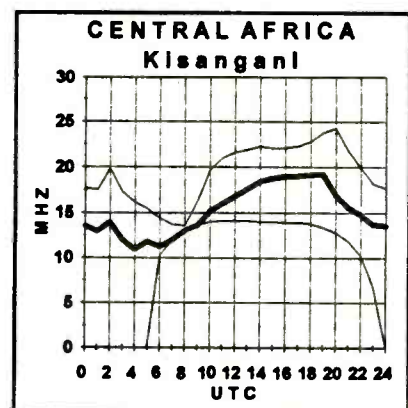
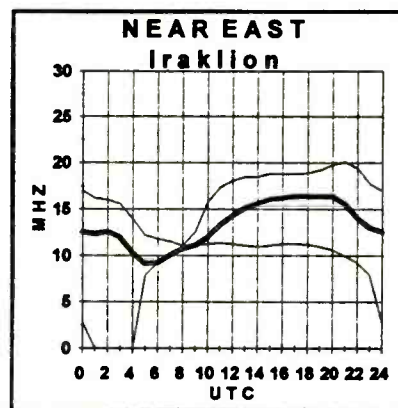
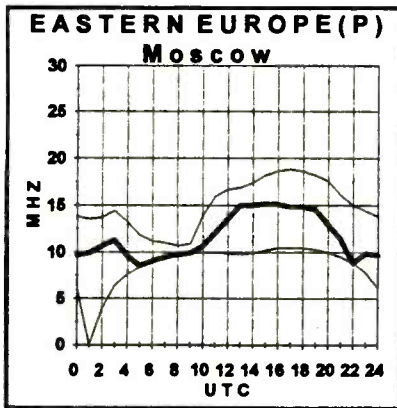
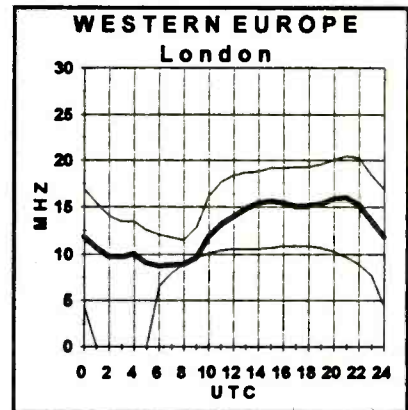
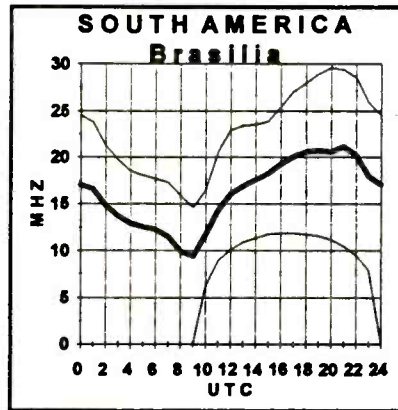
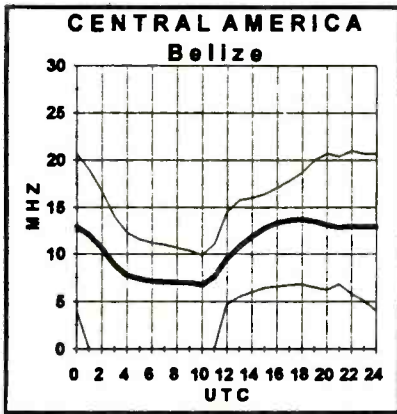

Propagation Conditions: Western United States

Once you've located the correct charts, look along the horizontal axis of the graph for the time you are listening. The top line of the graph shows the maximum usable frequency (MUF), the heavy middle line is the frequency for best reception, or optimum working frequency (OWF), and finally, the bottom line is the lowest usable frequency (LUF). You will find the best reception along the heavy middle line. Circuits labeled (P) cross the polar auroral zone. Expect poor reception on these circuits during ionospheric disturbances.

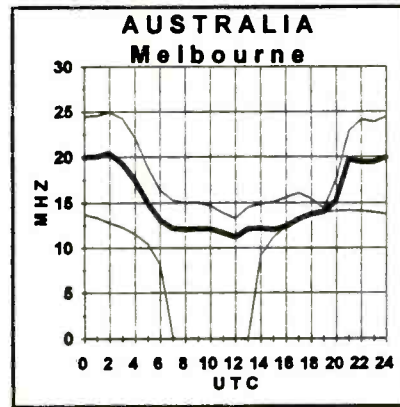
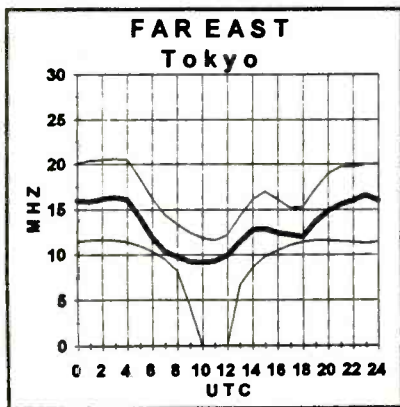
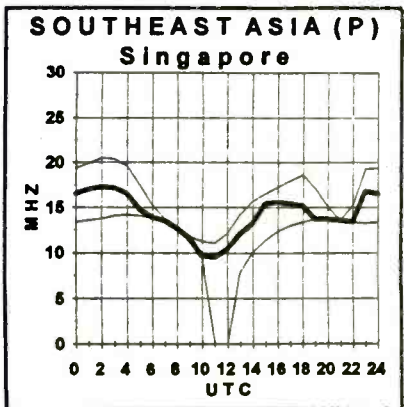
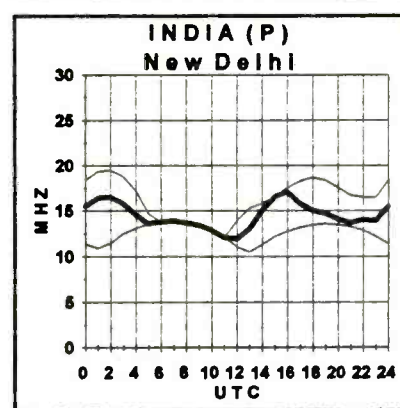
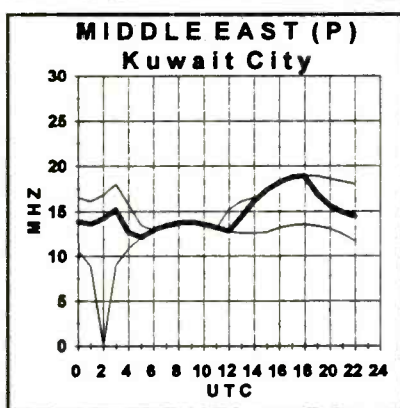
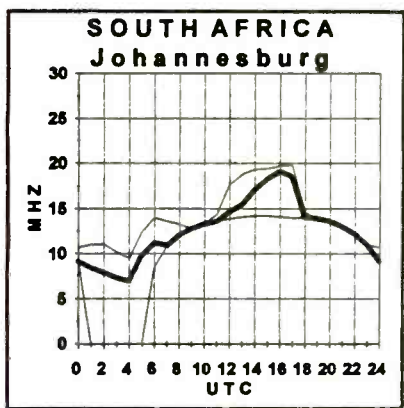
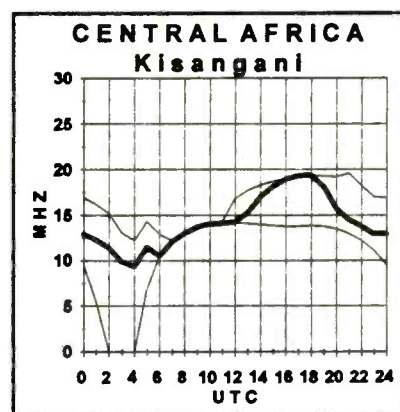
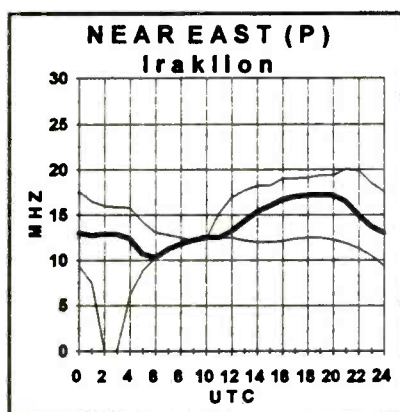
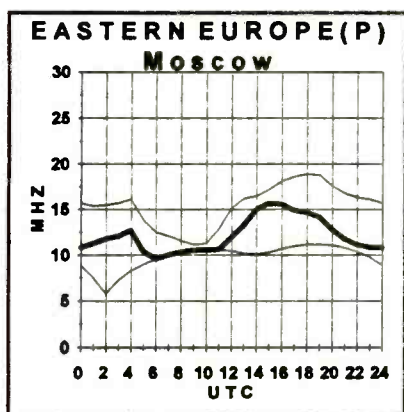
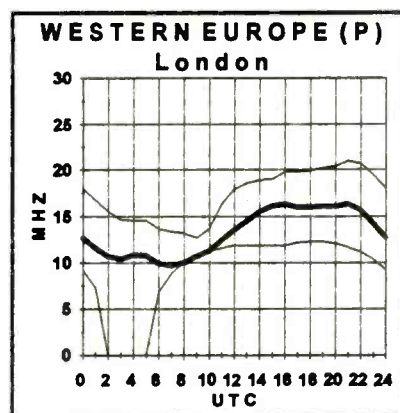
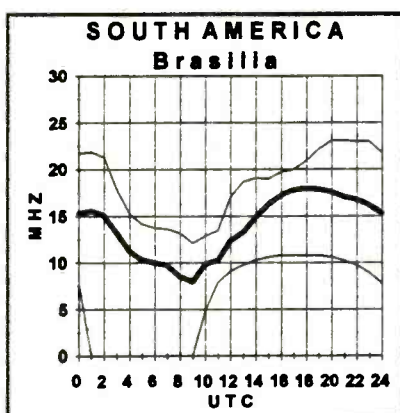
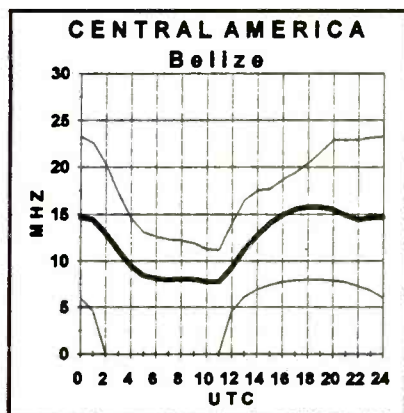



Impressions of a First Year Radio Listener



By Andy Maslowski

I well remember the first year I became a bona fide radio enthusiast.

Like many more before me, I realize a world of information and entertainment has literally been opened up for the gray matter between my ears. And, like for so many others, it was the Persian Gulf crisis that served as the catalyst, encouraging me to become one of the newest HF listeners on the planet.

I now realize some of the limitations of the DX-440 I purchased from Radio Shack, but you have to start somewhere. For example, the tiny BFO pitch and RF gain dials on this receiver are better suited for a small Lilliputian! But I have enjoyed tuning into broadcasts of the BBC, VOA, Radio Canada International, Radio Moscow and many others that even this radio can bring in loud and clear.

The first thing a new DXer is confronted with is the enormity of the radio spectrum. Frequency allocation is a strange bird. I'm sure there is some logic to the spacing of the different bands, but I can't figure out what that might be. Everybody wants their own piece of the frequency pie and will take it wherever possible.

Program scheduling on the international bands makes Amtrak railroad scheduling look like a precision instrument. Broadcast frequencies change by the time of day, time of the year, and without previous announcement. This mercurial condition of HF listening, however, is what makes it unique. It also makes my "scan" button the most popular on the radio, looking for both old and new programming. You just never know what you are going to tune into accidentally.

Besides listening to the international and ham bands, I enjoy experimenting with long distance AM broadcasts, shortwave tropical bands and even regular citizen band. I asked (begged?) my wife to drive around in our pick-up truck talking into our CB radio just to find the frequencies and range of the 40 CB channels. I know these figures are published in many places, but I wanted to discover 27.185 MHz is Channel 19 and 27.065 MHz is Channel 9 for *myself*.

I have found myself reading more about radio wave propagation, even reviewing my high school physics book and other books from the library. I have lot to learn and relearn, but I think an understanding of radio science can certainly improve your listening hobby. Will another solar magnetic storm erupt this month? How will the ionosphere be reflecting tonight? I may not always comprehend these concepts, but the occasional flashes of insight are very valuable.

I am still in the pupil or "egg stage" of my shortwave hobby, yet my radio itself often serves as a teacher. Sometimes I tape-record radio programs, and even these programs can educate. One BBC broadcast talked about the unpredictable nature of radio wave reflection on the ionosphere and how it is tied to the sun spot cycle. Higher frequencies reflect better during periods of higher ionization, it said, and during lower periods of ionization, lower frequencies. BBC relies on its worldwide "reception reporters" to inform it about bad reception or about what frequencies are

working well. This is accomplished with the SIO (signal strength/interference/overall) forms these listeners send in, rating these characteristics on a 0 to 5 chart, with 5 being excellent.

Of course other programming and conversations have informed me about less scientific but sometimes more entertaining topics. Regularly scheduled programs such as Alistair Cooke's *Letter from America* on the BBC or the CBC's *As It Happens* are always well produced. Or I might tune into Radio Habana Cuba discussing recent sugar production techniques or find an amateur talking about his problems with moles in his lawn. Variety is the spice of shortwave listening. But if I'm bored or not interested, I can always change the channel or turn it off.

The sky is full of radio waves, so the sky is also naturally the limit when it comes to channel selection. And even if my radio is off, there are plenty of opportunities to learn about what to listen to by reading various newsletters or publications such as *Monitoring Times*. I have also called a few bulletin board services via a computer modem for other listening tips and shortwave information. It seems you can never be too prepared for shortwave listening.

It's been almost 100 years since Mr. Marconi, the Father of Radio, sent a wireless dot-and-dash message nine miles across a plain in England. It took me almost 40 years to grasp the shortwave listening hobby. Time has a way of getting away from you. But in my case anyway, I think it's better late than never and I'm happy to be aboard.



**REMEMBER WHEN
A ROOM FULL OF
COMPUTERS
COULDN'T DO WHAT
YOUR PC COULD DO
TODAY...**



**THE SAME THING
JUST HAPPENED TO
SHORTWAVE.**

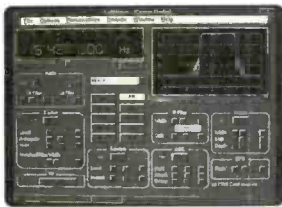

The Communications Radio. One of SoftWave's six different radio "Personalities." Tune continuously, in 1 Hz precision, in HF and VHF and see the signal in real time on the Spectrum Analyzer. Tune the IF Filter to one of 46 settings from 11 kHz to 56 Hz. Because you see the signal, you can adjust the notch filter and view the results!



The VHF Radio. A separate "Personality" for the VHF enthusiast. Continuous coverage from 108 to 174 MHz. Name your own scanning group or use one provided by SoftWave. Customize and set priority frequencies for each scanning group. SoftWave is incredibly flexible.

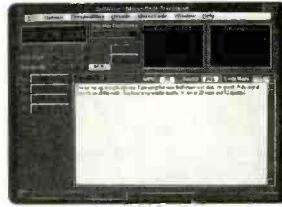

Using SoftWave's proprietary Digital Decoding Techniques, the Morse Code Translator displays the decoded text right on the screen! "Zoom" the filter in to 56 Hz. Save the text to a disk or print a copy at your convenience. No thresholds to adjust or lessons to learn. SoftWave makes it easy.



Click on the World Radio to "Hear the world at a glance." Fully digital controls tune up to 100 stations per second while indicating reception quality for each. No need for propagation tables. Sort by region, country, frequency, program type or your own list of preferred stations.

Announcing the first Receiver, Digital Signal Processor, Spectrum Analyzer, Multi-Mode Demodulator, Decoder, Database and Windows Program in a single product.

Not long ago you'd fill a room with all these components. Now, you just need your desktop. The future of digital receivers is here, and it's called **SoftWave™**

SoftWave is a fully integrated digital receiver for Microsoft

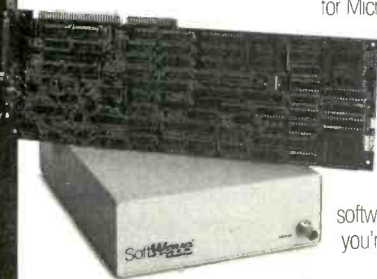

Windows. Slide the DSP card in your PC and connect the receiver, load the software and you're off! Select

from one of 6 "personalities" (Shortwave Communication, VHF, World Map, etc...) and let SoftWave go to work. Select a station from the database or just click on the World Map to "hear the world at a glance."

We made the impossible possible by implementing the digital signal processing at the IF instead of baseband frequency — giving you near limitless capabilities.

SoftWave has: two receive bands: 0.5 to 30 MHz and 108 to 174 MHz (performance characteristics matched by only the most expensive receivers); 7 demodulator selections; a spectrum analyzer; 46 standard filter bandwidths; a tunable notch filter; fully automatic decoding of Morse Code; completely digital AGC; digital blanking; synchronous AM demodulation; "Tone-Tag™" narrowband processing; and many features not even available

on receivers costing thousands of dollars more. And because it's on the Windows platform, you don't pay for any knobs or buttons.

If you spend too many hours searching the air waves, or fine tuning that distant station, SoftWave will change your life. And through July 31, 1994, SoftWave can change your life at a discount. You'll get the complete SoftWave package — Receiver, DSP Card & Software for \$1495.

Still can't believe it? Try SoftWave for two weeks, and if you don't like it, and bought it direct from us, return it for a full refund.*

Be a part of radio history.
CALL 1-800-SOFT-WAVE (763-8983)

SoftWave™
By ComFocus

BRINGING THE WORLD TO YOUR DESKTOP™

ComFocus Corporation, 6160 Lusk Blvd., San Diego, CA 92121

* Domestic sales only. Less shipping & handling of approximately \$30.00. System Requirements: IBM Compatible 386 or 486 and Microsoft Windows Version 3.1 or higher. Windows is a registered trademark of Microsoft Corporation.

Making Your Own Radio Parts

By Doug DeMaw, W1FB

I was surprised a few months ago when *MT* Editor Rachel Baughn suggested I prepare an article that described how to build radio components from scratch. I have made a number of radio parts from raw materials over the years, and concluded wrongly, perhaps, that every builder of equipment engaged in a similar practice. Certainly, constructing components at home was a necessary way of life in the early days of amateur radio and it became a challenge that was met gladly by most early-day experimenters.

Although we are here addressing an older practice, you may enjoy tinkering with home-

made parts while restoring or building old circuits. The topic is also timely, in light of the soaring cost for certain "bread and butter" parts that we experimenters use.

Fixed-Value Capacitors

Waxed paper and what was once known as tin foil were the ingredients for constructing tubular fixed-value capacitors in the old days of radio. It's still a viable practice from an experimenter's point of view, at least. The waxed paper was used as the insulating (dielectric) material and strips of foil served as the two conductors in the capacitor.

The foil strips were offset slightly from one another (see Fig. 1A) to allow attachment of the wire pigtails that were used for connecting the part to a circuit. Meat-wrapping paper was often used as the outer protective layer for the completed capacitor. The more tightly wrapped the foil and paper turns are, the greater the developed capacitance.

Modern materials are available for creating much better tubular capacitors than in the past. Thin mylar or teflon sheeting would replace the waxed paper and Reynolds or equivalent aluminum foil would replace the tin foil.

Low values of capacitance are obtained easily, as in Fig. 1B, by utilizing strips of double-clad (copper on both sides) glass epoxy PC board material. A strip that is 1/4 inch wide and 1 inch long yields approximately 10 pF of capacitance. Larger, square or rectangular pieces of PC board may be used to create capacitors with values up to, say, 100 pF.

In the past, we amateurs often made low-value capacitors that were known as "gimmicks." These consisted of short lengths of insulated hookup wire that were twisted together to obtain a few pF of capacitance for use in coupling two VHF or UHF circuits.

Variable Capacitors

All manner of ordinary materials are available for constructing home-made variable capacitors. A length of brass or aluminum rod may be used as the shaft for the rotor (movable) portion of the capacitor. Two more of these rods

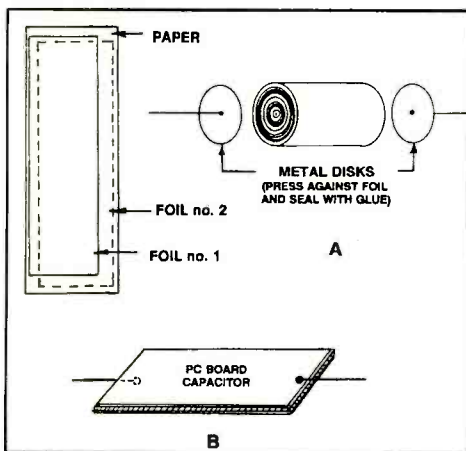

Figure 1: Examples of two types of home-made capacitors. At the upper left are two layers of foil with insulating paper between them. These long strips are rolled tightly to form the capacitor at the upper right. Paper or cardboard is used to enclose the rolled capacitor and the cover projects beyond the ends of the roll approximately 3/16 inch to permit inseting the two metal disks before they are glued to the outer covering. Illustration B shows how to make a low-value capacitor from double-sided PC board stock. It can be snipped at one end to obtain a precise capacitance value while checking it with a capacitance meter.

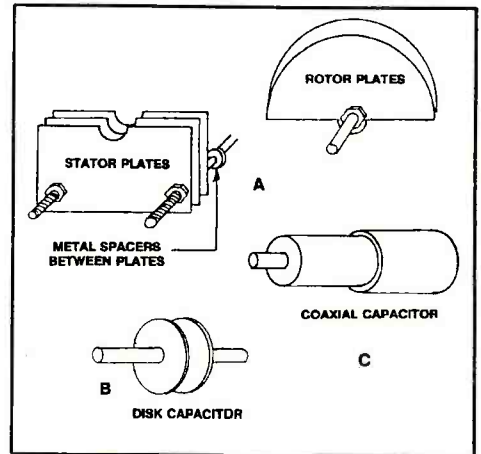

Figure 2: Home made variable-capacitor plates are seen at A. Details for an adjustable disc capacitor are provided at B. One of the shafts should be threaded to permit easy adjustment of the disk spacing. Drawing C is for a coaxial variable capacitor made from telescoping sections of metal tubing. Plastic or teflon sheeting is glued to the outer surface of the smaller tubing section to provide insulation and a snug fit between the pieces. The section with the shaft is the rotor.

can be used to support the stator (unmovable) plates of the variable capacitor. The end plates for the assembly can be made from insulating material, such as Plexiglass or some other high dielectric plastic. Metal washers will serve as the spacers between the plates of the capacitor. Sheet aluminum, such as that used for cookie tins, can be used for the plates of the capacitor.

I once knew a ham who made two large variable capacitors for his antenna tuner by using tin snips to cut the capacitor plates from scrap pieces of aluminum house siding. Fig. 2A shows

how such a variable capacitor would be constructed. A simple two-plate disc type of capacitor is illustrated in Fig. 2B.

Coaxial Variable Capacitors

Telescoping sections of brass, copper or aluminum tubing work nicely for building a trombone type of variable capacitor. The larger the diameter and the longer the tubing sections, the greater the maximum capacitance.

I once constructed a 1500-pF variable capacitor from telescoping aluminum tubing three feet long and 1-1/2 inch in diameter. Polyethylene sheeting was wrapped three times around the inner section of tubing to serve as dielectric material and to ensure a snug fit between the two pieces of tubing. This unit was needed as a reactance cancelling capacitor for a 160-meter vertical antenna that used a gamma match.

A good high voltage trombone capacitor can be fashioned by using 10-mil teflon sheeting around the movable inner tubing section. I built a 100-pF capacitor of this style while using an 8-inch length of 2 inch OD aluminum tubing as the outer (stator) part of the capacitor. The rotor (inner section of tubing) was adjusted by means of a threaded brass rod that extended from the front panel of the transmitter.

The capacitance of a coaxial capacitor can be determined by the equation in Fig. 3, which gives the capacitance per foot of tubing. The dielectric factor (ϵ_r) must be known in order to make this calculation. The dielectric constant for polyethylene is 2.26. For teflon it is 2.1 and for glass epoxy resin it is 3.62.

Persons with mechanical aptitude can develop unique ways to control coaxial capacitors by using a rack and pinion technique. We used coaxial capacitors extensively in bygone days as neutralizing capacitors in medium- and high-power transmitters.

Resistors

It is a simple task to fashion home-made resistors from nichrome wire that is wound on a ceramic insulating form. Low-value resistors of this variety can be made from the wire in hot-plate heating elements. I have also made low-value resistors (i.e., for meter shunts) from numerous turns of no. 30 or smaller gauge magnet wire wound over the body of a high-value carbon resistor or some other insulating material. I like using resistors as foundations because the pig-tails are available for anchoring the ends of the winding.

Magnet wire exhibits a specific number of ohms per 100 feet, and this data can be used for calculating how many feet of wire are needed to obtain a specified resistance.

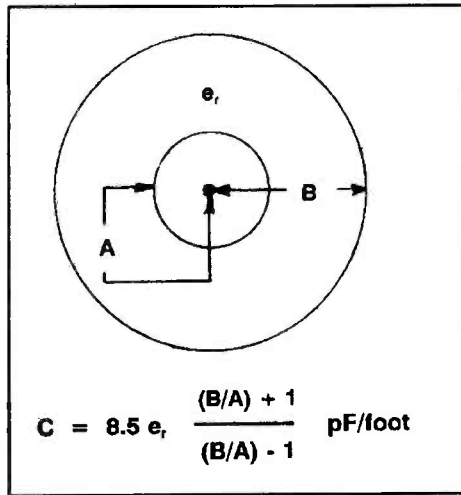

Figure 3: Method for determining the capacitance per foot when designing a coaxial capacitor of the type shown in Figure 2C.

In the old days of radio it was not uncommon to use pencil lead to draw a line on heavy paper or some other insulating material in order to create a high value of resistance (megohm or greater). These resistors were used in detector grid-leak circuits for regenerative receivers. The wider the pencil line, the lower the developed resistance. Innovation was necessary in those days, and it saved a substantial amount of money!

Dummy Antennas of Old

Very few resistive dummy antennas, such as the Heath Antenna, existed years ago. We amateurs used incandescent light bulbs as dummy antennas for our transmitters. Normally, the pi network tank circuits had sufficient adjustment range to match the transmitter final amplifier to the light-bulb load. Light bulbs can still be used for this purpose by connecting a sufficient number of bulbs (to accommodate the transmitter power) in series, in parallel or in series parallel. Matching to the transmitter may be done by means of an antenna tuner. Ten 100-W bulbs can be used for a 1000-W transmitter, and this is considerably less expensive than a comparable-power resistive load immersed in oil. The light bulbs are not messy and they provide a visual indication of the output power.

Some Final Thoughts

Numerous other radio parts can be fashioned by hand, but space in this article does not permit in-depth coverage of so broad a subject. Perhaps you will become innovative and develop a transmitter or receiver around home-made parts. It certainly would present an interesting challenge and could be a lot of fun.

Both of these cars are picking up the same frequencies and the same signals.

Only one has the new Grove **NO-TENNA.**



Typical Radio Enthusiast's Car



Typical Radio Enthusiast's Car with the new **NO-TENNA.**

Imagine; strong, clear, continuous frequency coverage of shortwave and scanner signals without having to mount an antenna anywhere on your car! No invitation to theft, suspicion, breakage, low overhangs, hole drilling, scraped paint, or cables through doors or windows. **No visible antenna whatsoever!** Mounts in seconds, using your entire car body as a giant, efficient, 1-1000 MHz all-band antenna!

The unique **No-Tenna** was developed exclusively in Grove's laboratory and extensively road tested under all signal conditions. Ideal for city dwellers, travelers, reporters, investigators--anyone who doesn't want a visible receiving antenna on his vehicle.

Connected to a single upholstery screw already in the vehicle; use either the upper, right-hand moulding screw or the adjacent sun visor screw. Spring dip provided for temporary connection to motel or apartment metal window frames, curtain rods and other emergency, makeshift antennas. Full instructions and universal connectors for RCA, BNC and 1/8" (3.5mm) miniplug included.



NEW ANT-20
NO-TENNA
from
GROVE

ONLY \$19.95!

plus \$4 UPS Ground shipping.

ACC134: Motorola Adaptor Kit: \$5⁹⁵



GROVE ENTERPRISES, INC.

(800) 438-8155 (orders only)

(704) 837-9200 (business and orders)

(704) 837-7081 (product information)

(704) 837-2216 (fax)

300 South Highway 64 West
Brasstown, NC 28902

The Summer Sporadic-E Season is Here!

With the change of seasons, AM DXers curse the increased static levels that are the harbingers of spring. FM and TV DXers, on the other hand, look forward to what is another season of Sporadic-E DX.

It seems appropriate that I begin my tenure at the helm of this column at the change of the propagation seasons. I hope to build upon the great work of my predecessor, Karl Zuk, and continue to bring the world of AM, FM and TV broadcasting to *MT* readers.

I have been a licensed ham, WA0WRI, for over 25 years, and I have been DXing even longer on all bands. Living in the heartland of the country in Lincoln, Nebraska, I have found the central location to be valuable in being able to DX all areas of North America on the broadcast bands. I look forward to reading all of your stories and news about broadcasting from your part of the country and most of all, hearing your DX reports.

A new feature of this column will be a listing of DX reports by our readers. Send me your *best* DX catches of the month for listing in the new area of the column, which will be called "Skipping In." I will try to publish as many reports as possible each month, so we can all share in the excitement of getting that tough DX. A simple logging format would include the DX station heard, the time of day in UTC, the format of the station, and a brief description of the programming, such as commercials, type of music played, etc. Also be sure to include what state you are in.

Here's an example:

KTGL 92.9 Beatrice, NE. Classic rock, ID "KTGL, Beatrice-Lincoln. Lincoln's Classic Rock, the Eagle-92.9" Heard commercials for Runza and Wanek's of Crete.

The most fun for FM and TV DXers is certainly the Sporadic-E season, or "E-skip" for short. E-skip can bring in DX from approximately 800 to 2500 miles away. It has been hotly debated what exactly causes E-skip; we do know it happens more at certain times of the year and certain times of the day. From Mother's Day in May to the end of July, the E-skip season has its

Each month we'll enjoy a brief visit with a different radio station. Paul Mundt of Lombard, IL, took this picture on his recent trip to Greece. This radio station, FM Stereo 92.4, was located on the road between Kavalla and Komotini.

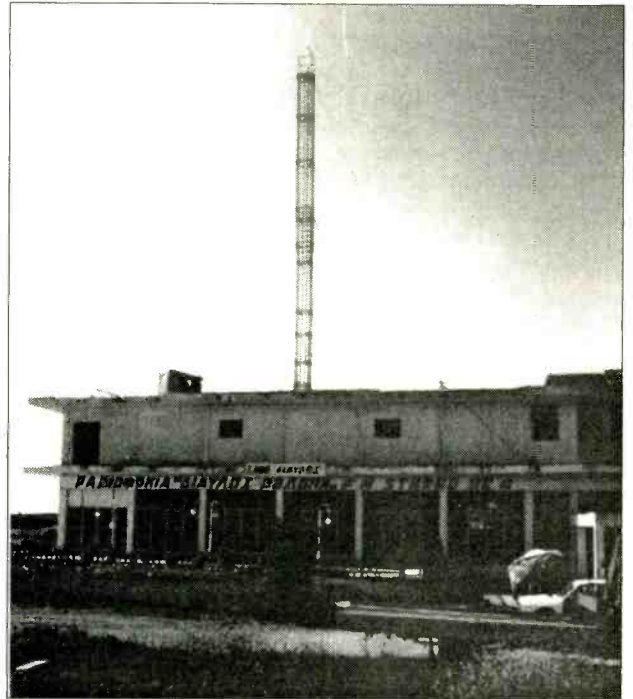

peak. A much smaller peak also happens between Christmas and New Year's Day. The hours just before noon and in the late afternoon and early evening are the best times to catch the fun!

How do you know when the skip is "in"? I have found that simply tuning a TV set that is connected to an outside antenna (or even to rabbit ears) to an unused low channel (2-6) is the best means to see what is up. I also tune my stereo receiver with the MUTE switch on to an unused FM channel in my area and wait for the action. The MUTE simply acts as a squelch and when the speakers come alive, there is DX! More advanced TV and FM DXers use a scanner, listening to the 30-50 MHz frequencies for strange signals. If that band has too much traffic, they may watch the 6 meter ham band (50-54 MHz) for signs of unusual activity. Because, just above 6 meter is TV channel 2 at 54 MHz.

What TV DXers look for is a station on a channel that normally is vacant in their local viewing area. Also, looking for horizontal grey lines and a buzzing sound in a weak fringe area station indicates another station coming through. This phenomenon is called "beats." In strong E-

skip openings, these "beats" can almost completely obliterate a near-local station. Here in Lincoln, it can be nearly impossible to view channels 3 and 6 from nearby Omaha (50 miles) during periods of strong skip, even on cable! Since cable companies use antennas on high towers to receive these stations off the air, they, too can be the recipient of DX!

If signs of skip can be seen on TV channel 6, FM DX is at hand. The FM band is just above the TV band, going from the top of TV channel 6 at 88 MHz to 108 MHz. Starting with the lower frequencies of the FM band, you can watch the DX as the maximum usable frequency moves up the band. You can gauge the intensity of the openings not only by the strength of the signals, but by how high in frequency they go. Remember that E-skip signals fade rapidly and violently. They can be full scale, and yet can fade completely away only a second or two later. The openings can last a few minutes or hours long.

In future columns, we will look into various ways of enhancing your DX setup for all of the broadcast bands. For the FM DX season, however, I recommend a publication I have found

invaluable both to the FM DXer and to the traveler. I always have my current copy of Bruce Elving's *FM ATLAS* with me while DXing or traveling for work or pleasure. With its listings by frequency and geographic location, and excellent locator maps, I can find stations with the music format I want or quickly identify new catches. The slogan, such as "The Eagle" or "Z-92," is listed right next to the station name, so you can instantly know who you are listening to without having to wait for the full legal ID.

You can order the *FM ATLAS* through the Grove Enterprises Catalog or directly from FM Atlas Publishing, 241 Anderson Rd., Esko, MN 55733. Bruce Elving also publishes a monthly newsletter which has all of the current changes in the FM band, such as call signs, locations, power, formats and new station. The newsletter *FMedia* is also available from the Esko, MN, address.

Up and Coming

With the increasing popularity of talk radio, AM radio has checked its slide into obsolescence. While we may all be familiar with Rush Limbaugh and other national talk show hosts, there are many local hosts that we enjoy as well. Tell this column who and where they are, so as we travel or DX the bands, we can look for these new talents. Also, if you hear any unusual formats, let us know, too, so we can pass the information along.

With the growth of "duopoly" ownership, there have been a large number of stations merging facilities of up to three stations under one roof. We will profile a group of such stations in the near future as well as look at joint use towers in which multiple AM and FM stations share the same tower. These multiple use towers can be both a benefit and a problem to serious DXers who live near them.

Bits and Pieces

In my travels for work, I sometimes get the opportunity to visit a few radio stations. In a recent visit to Sioux Center, IA, I had the privilege of touring the fine studio facilities of KVDB AM 1090 and KTSB FM 93.9. The FM is normally a mixed music format and the AM is country, but from 4-5 PM Central time, *MT* reader Tom Aldrich, program director, takes the helm and does an oldies show.

His show features many long forgotten hits of the rock era and many novelty tunes. It is simulcast on both FM and AM for the one-hour Monday

through Friday show. The stations cover a good portion of northeast Iowa and are not trying to penetrate a major market. They serve this mainly rural part of Iowa with locally produced news, weather and sports. With trivia quizzes and other contests, this hour seemed to be a favorite of listeners in the area. I, too, enjoyed listening to the rest of the show as I drove home from my work trip to Sioux Center.

A detailed summary of broadcast stations in the Orlando, FL, area by Marc Manis was forwarded to the Grove BBS. Marc's station histories and descriptions will be an aid to any traveler to the most popular tourist destination in America. Marc is available via Compuserve at 70402,1426, or you may send an SASE to American Bandscan for a copy.

Kevin Klein sends an article from *Radio World* about WUST AM 1120 in Washington, D.C. WUST sells time in blocks to international broadcasters wanting non-shortwave entry into the radio market of our nation's capital. Listening to WUST can bring broadcasts from VOA, Radio China International and many other popular stations around the world. Some of these shows are carried live by WUST using satellite delivery or a dial-up telephone line using a Comrex.

The Comrex is a device commonly used by stations for things like remote broadcasts of sports events and news and other programming away from the main studios. By using the frequency response extension feature of the Comrex, a station can get very high quality audio from ordinary phone lines at low cost.

With severe weather season being at hand in the Midwest, many radio stations have special tones they transmit periodically to remind listeners that the area covered by the station may be in a tornado or severe thunderstorm watch or warning. The reminder may be a series of short beeps or a short tone repeated about every two minutes or so. Remember when DXing this spring and summer to listen for these indicators of pending severe weather and the tropo DX these conditions can bring on FM.

Remember to send your news of radio happenings in your area and your best DX catches for listing in this column. You can send it several ways: by mail to American Bandscan, by e-mail via the Prodigy network at JPGC40A, via Internet at jpgc40a@prodigy.com, or via the Grove/MT BBS. See you next month!

MT

NEW!

Interference ~~ELIMINATORS~~ for scanners and shortwave receivers!

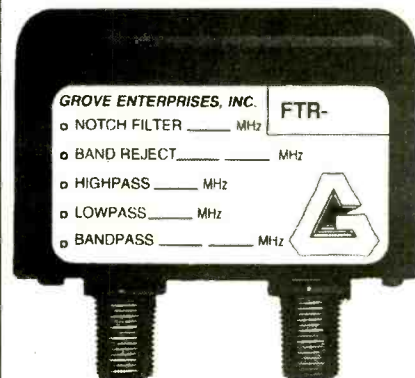

Reduce or even ELIMINATE strong signal overload from your scanner or general coverage receiver. Increase reception range with these new wavetraps, notch filters and bandpass filters designed exclusively by Grove Enterprises! Attach directly to your antenna cable, no modification required!

Ideal for suppressing overload interference from nearby paging, weather, broadcasters, dispatchers, hams, aircraft and more. Reject unwanted signals by 40 dB or more; reduce intermod interference by at least 120 dB! Filters can be combined for deeper rejection or multiple frequencies. Simply choose your filter(s) from the list below and specify your antenna connectors.

FTR6 - 30-2000 MHz Bandpass Filter - Removes AM broadcast, CB and shortwave interference from scanners - \$19⁹⁵

FTR7 - 540-1700 kHz Band Reject Filter - Removes AM broadcast interference from shortwave/longer wave receivers - \$29⁹⁵

FTR8 - 118-137 MHz Band Reject Filter - Removes aircraft interference from scanners - \$19⁹⁵

Connector Kits:

ACC124: PL-259 (UHF) - \$9⁹⁵

ACC125: 1/8" Miniplug - \$9⁹⁵

ACC126: BNC - \$9⁹⁵

ACC127: Motorola - \$12⁹⁵

ACC128: RCA - \$9⁹⁵



GROVE ENTERPRISES, INC.

(800) 438-8155 (Orders Only)

(704) 837-9200 (Business and Orders)

(704) 837-2216 (Fax)

(704) 837-7081 (Product Information)

**GROVE -- A name that
you know with quality
you can trust.**

Maybe Your Next Radio Shouldn't Be a Scanner

One of the most useful additions you can make to your receiving equipment is not a radio in the true sense of the word. It is a spectrum analyzer. A spectrum analyzer is just that—it analyzes and gives you a visual indication of what is out there in the radio spectrum.

With practice, you will be able to differentiate between the types of signals found to be active, and it can even encourage you to find signals in frequency ranges not normally monitored. For example—in the Miami area there has been a signal in the 824-825 MHz band which sounds like a video carrier. Without even listening to it, one can tell by analyzing the signal pattern on the spectrum analyzer that it is a Time Domain Multiple Access carrier related to the cellular industry.

In the November 1993 issue of *Monitoring Times*, the Product Review section did a complete review of the Grove Spectrum Analyzer, Model SDU-100. For those not familiar with the operation of the unit, see that review, as well as a general article by Bob Grove on using it on page 26 of this month's issue.

I use a fifteen year old Cushman Model CE-15B Spectrum Analyzer designed for the two-way radio shops. It covers approximately 30-900 MHz. It can be found as used equipment at a reasonable price. When it comes time for a replacement, I will spend the extra money and get a new unit that covers up to 1.8 or 2.0 GHz for the monitoring of the low end microwave bands and the PCS (Personal Communications Services) frequencies.

When it comes time to open the pocketbook for your purchase, remember that you get what you pay for. Look to pay between one and two thousand dollars for either a good used one, such as the Cushman, or a new unit, such as the AVCOM units. The Grove SDU is excellent, but it requires a supplementary radio receiver. The Cushman and other units have the receiver built in.

A 10 MHz wide spectrum display is useful for finding hidden links or frequencies in the 162-174 MHz or the 406-420 MHz government allocations. A much wider display, such as 50 MHz, is useful for the examination of the 240-270 MHz military satellite downlink band. Once a signal is located, the spread can be narrowed to focus down to the exact frequency. By looking at the "signature" the signal leaves on the S/A

display, it can be determined if the signal is AM, FM, or has subcarriers, and if the subcarriers are AM/FM, FM/FM, or even spread spectrum modulation.

Okay, you say, how is this going to help me in the real world? Well, here is one example that may seem "far fetched," but it's not. For those of you that do electronic countermeasures, there are some "strange" carriers out there. Listening to them on the average bug detector or the scanner will give you just that—a carrier. Examination of the signal on a S/A, however, just might reveal the presence of a hidden subcarrier carrying the intercepted audio. Had I not have seen this in operation, with the discovery of a "subcarrier bug," I would have passed it off as James Bond propaganda. The bug was in the 169 MHz region, with a 67 kHz subcarrier carrying the audio.

When you start listening, tuning, and viewing, you will find monitoring with a spectrum analyzer to be very addictive. The spectrum analyzer takes a majority of the guesswork out of frequency exploration—and it's the way the real professionals do it.

Digital Decoder

While we are spending money, let's go ahead and purchase a communications decoder for our receiver. This type of unit, such as the Connect Systems, Inc. unit advertised here in *MT*, decodes and displays digital and analog subaudible tones. How is this going to help us in our scanning?

In the South Florida area in the past few months, the frequency of 418.2 MHz has come into use. It is a repeater output carrying tactical and administrative traffic. My digital decoder displayed the subaudible tone of 123.0 Hz, which I knew to be the common tone used by the Internal Revenue Service's Criminal Investigative Division. Further analysis showed that this was the new repeater channel to supplement their existing 418.225 MHz repeater channel.

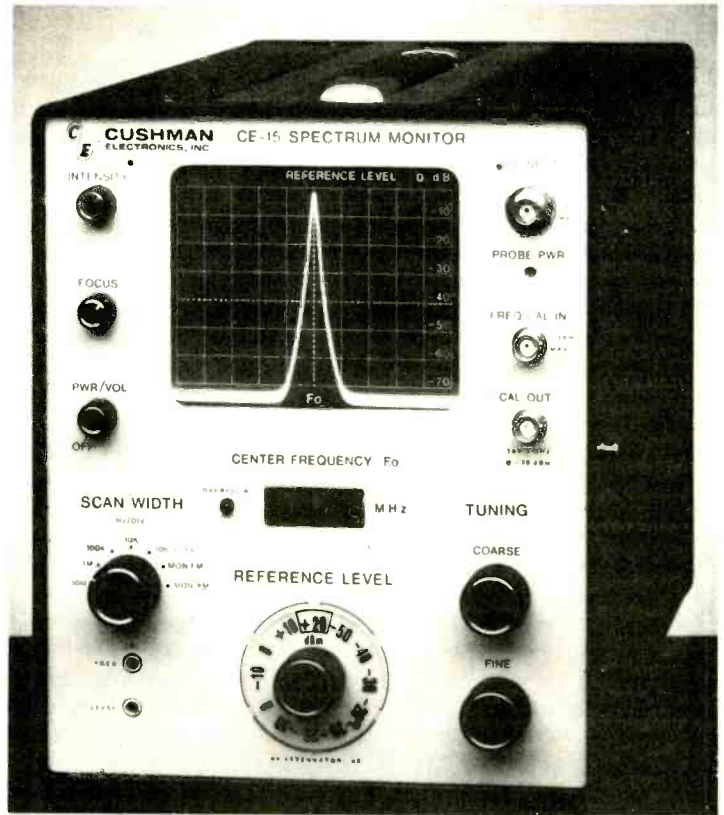

As another example, let's say you find a new frequency in use in the 150-151 MHz range carrying encrypted digital traffic. The subaudible tone is 167.9 Hz. A check of the records shows that this is the nationwide tone frequency used by the FBI. If you happen to be in the New York City area, then you have found one of the new "secret" FBI channels for that region. Likewise, a tone of 156.7 Hz is used by the Drug Enforcement Administration nationwide, so a new frequency in the 416-420 range with a 156.7 Hz subaudible tone gives it away as most likely being one of theirs.

Putting Them to the Test

Using both of the above tools together can speed up the discovery process enormously. Recently, in the South Florida area, the DEA was monitored, as usual, without their speech encryption units turned on. Most of the traffic was run on the simplex channels. For the real secret stuff, they switched to Channel 15—which does not fit in their normal frequency assignments.

I hooked up the spectrum analyzer to an outside antenna and found them operating on a totally different frequency. A check with the tone decoder showed the 156.7 Hz tone, which verified I had found their new secret frequency. They were using 419.650 MHz—which is assigned to the United States mint. A check with someone who would know, affirmed that for their "most secret" tactical traffic they will program their radios with frequencies not normally used by their agency.

Where Have All of the Links Gone?

For years the Border Patrol and Immigration and Naturalization Service (INS) have had numerous links in the 406-420 band crisscrossing the state of Florida. Recently I had my scanner in the search mode sweeping the 406-420 band when it hit me that it was not locking up on the point-to-point carriers. Had my scanner died? A check with the spectrum analyzer did not show the normally distinctive pips of the links. They were gone... Has the Department of Justice done away with their point-to-point links? Let me know what you are hearing (or not hearing!) in your area.

Frequency Lists United States Postal Service

Postal Inspectors National Radio System

Channel	Freq	Use
01	407.775	C/M
	414.750	Rptr Out
02	414.750	Simplex
03	407.725	C/M
	415.050	Rptr Out
04	415.050	Simplex
05	408.050	C/M
	413.600	Rptr Out
06	413.600	Simplex

The subaudible tone of 82.5 Hz is used nationwide by the Postal Service. Recently, digital scrambling has been heard in the South Florida area, although most of the traffic is still run in the clear. You will hear stakeouts, surveillance, and other neat stuff on these channels. Recently a murder was committed on Post Office property. I got to hear the entire stakeout, chase, and capture by the Postal Inspector's "SWAT Team."

The Postal Security Force has a national radio system they use in providing protection to the property and personnel at Post Office Facilities.

Postal Security Force

Channel	Freq	Use
01	418.300	Simplex
02	416.775	C/M
	418.300	Rptr Out

Again, the tone of 82.5 Hz is used.

All government agencies have use of the following frequencies on a wide area (itinerant) use:

Simplex	C/M	Rptr/Simplex
418.575	168.350	163.100
418.075	408.400	418.050

Table 1
Department of State Security

Channel	Freq	Use	PL Tone
01	407.200	control/mobile	151.4 HZ
	409.625	repeater out	151.4 HZ
02	409.625	simplex	151.4 HZ
03	407.600	simplex	151.4 HZ
04	408.600	simplex	151.4 HZ
Boston Field Office			
	411.150	simplex	151.4 HZ
National Assignments			
	165.6125	simplex	
	165.7125	simp/rptr out	
	166.1000	control/mobile	
	169.0500	control/mobile	
	169.8000	simplex	
	170.4500	simplex	
Foreign Mission Security			
	148.1000	simplex	
United Nations Command Ctr			
Alpha Net	409.7000	rptr out	
	408.1000	control/mobile	
United Nations Command Post			
Channel 1	409.7000	rptr out	151.4 HZ
	408.1000	rptr in	151.4 HZ
Channel 2	409.7000	simplex	151.4 HZ
Channel 3	407.6000	simplex	151.4 HZ
Channel 4	408.6000	simplex	151.4 HZ
Paging	170.5750	paging	
Motor Pool			
Channel 1	164.1250	duplex base side	
Channel 2	166.6126	duplex mobile side	
State Department Building			
Channel 1	168.2250	rptr out/security	151.4 HZ
	163.1500	rptr in	
Channel 2	168.2250	simplex	

Diplomatic Security

The Department of State Security Service is the State Department's version of the Secret Service. The head of state gets Secret Service; everybody else gets DSS protection. For example, when HRH Queen Elizabeth II visited this country several years ago, she was protected by Secret Service agents, but Prince Philip and Prince Charles got DSS protection.

Recently the Israeli Foreign Minister was in the U.S. to kick off the Israeli Bond drive. The State Department channels were in full force. Table 1 is the breakdown of their UHF system:

Here in South Florida, the 409.625 MHz frequency is constantly in use—as it was during the Foreign Minister's visit. There is a repeater in Miami with a land line up to the Palm Beaches with a duplicate repeater up here. When the FM was in his hotel for dinner, channel 3 (407.6000) was in use.

Because he was staying on the ocean, the Coast Guard had a cutter directly off the coastline using 157.050 MHz to maintain surveillance with unseen land-based mobiles. Watch your local news for foreign dignitaries coming to visit, so you can try some of these frequencies for activity.

Well, that's it for this month. Good **MT** scanning and 73's.

SPRING ANTENNA SETUP SPECIAL from GROVE!

SUPERCARGE YOUR SCANNER!

ANT1: Scanner Beam Antenna

World-renowned for providing unexcelled 30-50 MHz low band reception, 108-136 MHz aircraft, 136-174 MHz high band, 225-400 MHz military aircraft and satellites, 406-512 MHz UHF, and 806-960 MHz microwave mobile.

'59⁹⁵ plus '7 UPS ground shipping



ANT7: Scantenna

This full-frequency, omnidirectional scanner antenna will equal or outperform any competitor on the market. Its dipole-cluster design utilizes broadband techniques to provide continuous frequency coverage from 25-1300 MHz, offering superb reception of public safety, civilian and military aircraft, hams, personal communication devices, maritime, CB -- anything in its frequency range!

'39⁹⁵ plus '7 UPS ground shipping



LA1: Lightning Arrestors

Responds in one ten-millionth of a second to short-circuit bursts of 250,000 volts at currents of 5000 amps, while allowing normal signal voltages (and even control voltages up to 50 volts AC or DC) to pass undisturbed! Extremely low signal loss--0.2 dB at 1500 MHz! Ideal for protecting scanners, shortwave receivers, CB and ham equipment, VCRs, TVs, satellite receivers, FM stereo systems and more!

LA1F (F connector) '19⁹⁵

LA1B (BNC connector) '24⁹⁵

LA1P (PL-259 UHF connector) '24⁹⁵

LA1M (Motorola connector) '29⁹⁵

plus \$4 UPS ground shipping



Call **TODAY** for these and other great deals from:



GROVE ENTERPRISES, INC.

1-800-438-8155

300 South Highway 64 West

Brasstown, NC 28902

(704) 837-9200 (business office)

(704) 837-2216 (fax)

**GROVE--known for price,
quality and service... all
GUARANTEED!**

Cruisin'

Table 1

Carnival Cruise Lines, Miami, FL

Callsign	Freq			
KD49973	468.325 MHz			
KD50603	151.925 MHz			
KD51553	462.175 MHz			
KMD254	kHz: 4125	4146	4149	
	6224	6227	6230	
	8294	8297	12353	
	12376	12359	16528	
	16531	16534	22159	
	22162	22165		
	MHz: 156.275	156.800	156.900	
	156.950			

WNXH 245154.540 MHz
 WNXH 248154.515 MHz
 WNZH 665151.745 MHz

Commodore Cruise Lines

Callsign	Freq
KD 53054	464.500 MHz

Crown Cruise Line, Riviera Beach, FL

Callsign	Freq			
WXZ 280	kHz: 4125	4146	4149	
	8291.2	8297	12353	
	12356	12359	16528	
	16531	16534	22165	
	22171			
	MHz: 156.450	156.800		

Holland America Cruise Lines, Fort Lauderdale, FL

Callsign	Freq
WNYE 594	896.000 MHz

Premier Cruise Lines, Cape Canaveral, FL

Callsign	Freq
WNED 407	464.325 MHz

Princess Cruises, Fort Lauderdale, FL

Callsign	Freq
WNFN 830	896.000 MHz

Royal Caribbean Cruises, Miami, FL

Callsign	Freq			
WNQW 423	463.350	468.350	468.350	MHz
WNXM 729	896.000	MHz		

Windjammer Barefoot Cruises, Miami Beach, FL

Callsign	Freq			
KVR 451	kHz: 4146	8297	12353	
	12356	12359	16528	
	16531	16534	22162	
	22165	22168		



Summer is approaching and pleasure boat activity will be picking up for the season. British Columbia Ferries Corporation is planning to resume their Victoria-Seattle run this spring and are refitting the *Queen of Burnaby* for that purpose. The ferry service will begin May 21 and make one round trip daily until September 18.

Princess Cruises, home of the "love boat," is continuing its program to expand its fleet. The *Sun Princess* is scheduled to enter service in January of 1996. Two new ships have been commissioned, one to be 77,000 tons, designed to carry 1,950 passengers and entering service in the spring of 1997. The other is to be in the 90,000 ton range, built to carry 2,500 passengers. The latter vessel will enter service in the fall of 1997 and will be specifically designed for the Caribbean market. In fact, this ship will have too broad a beam to pass through the Panama Canal. When these new ships enter service, the Princess fleet will consist of 12 ships.

P&O, the company which owns Princess Cruises, is building another new ship which will enter service in the spring of 1995. This 67,000 ton ship, the *Oriana*, is being built in Germany and will be used for the European market.

Not to be outdone, Carnival Cruises is also busy building new ships to help bolster their business. In late July, the *Fascination* will enter service from New York before being moved to San Juan in October, where she will be offering year 'round seven day cruises in the southern Caribbean. *Imagination* is due to be delivered to the line in the fall of 1995.

The next in the series of 70,000 ton cruise ships to be added to Carnival's fleet will be the

Inspiration, which is scheduled for delivery in March 1996. These ships are in addition to the *Fantasy*, *Ecstasy* and *Sensation*, which entered service over the past few years and whose success led Carnival to order the building of these three additional ships.

To top it off, Carnival is also scheduled to receive delivery of a 95,000 ton ship in late 1996, which will carry approximately 3,400 passengers! The vessel, which is yet to be named, is claimed by Carnival to be the largest passenger ship ever built.

We'll look more in a later column at cruise ships and where to hear them, but meanwhile, you might want to try some of the VHF-FM and HF-USB frequencies listed in Table 1.

These frequencies are used for communications between the ships and their home offices. Many of the cruise lines have set up company radio stations at their offices to communicate with their ships without having to incur the costs of High Seas communications stations. Most of the communications will be relatively routine, dealing with location of the ship, needed supplies, equipment or parts, etc. Many shipping companies arrange daily scheduled calls to their ships to handle routine daily reports, and cruise lines may follow the same practice.

The VHF frequencies are used for local communications between ship and office, when sitting in the harbor, or during arrival and departure. They are usually used by the company's maintenance and supply staffs for arranging maintenance work, ordering supplies, and taking care of all the many details involved in preparing the ship for its next cruise.

SANGEAN

ATS-803A



SALE
\$149.95
 (+\$6 UPS)

sale ends
 7/1/94

Passport to World Band Radio 1993 calls the Sangean ATS-803A An outstanding buy ... a dollar cigar for 75 cents. The famous "803A" does indeed provide exceptional value, combining strong performance with all the features you want. Full coverage of LW, AM, SW and FM is provided. Excellent CW-SSB performance is achieved via a smooth tuning BFO. The large illuminated digital display indicates SW frequencies to 1 kHz. Nine memories store your favorite stations. Five tuning methods are available: manual tuning, keypad, auto scan, manual scan and memory recall. A wide-narrow selectivity button helps you separate stations. Pleasant audio results from the large 4" speaker plus Bass and Treble controls. Jacks are provided for external antenna, stereo headphones, record out and external power. Includes: AC adapter, stereo headset, Wave Guide and one year limited warranty. There is simply no better value in this price class!

Universal Radio
 6830 Americana Pkwy.
 Reynoldsburg, OH 43068
 ♦ Orders: 800 431-3939
 ♦ Info.: 614 866-4267

FREE CATALOG
 This huge 100 page catalog covers everything for the shortwave, amateur and scanner enthusiasts.
Request it today!

SERIOUS EAVESDROPPING

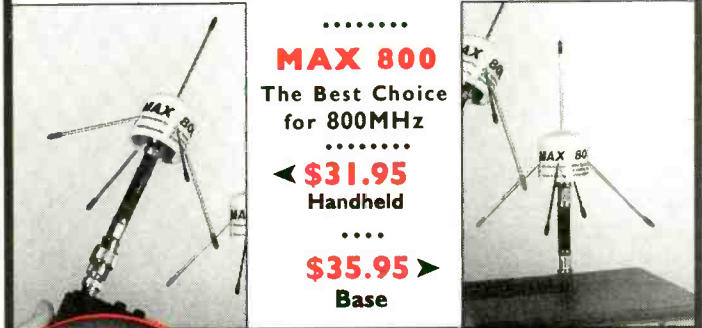

.....
MAX 800
 The Best Choice
 for 800MHz

 ◀ **\$31.95**
 Handheld

\$35.95 ▶
 Base



**FREE
 CELLULAR &
 CORDLESS
 FREQ CHARTS**
 w/PURCHASE

.....
MAX 46-49
 Cordless Phones
 & Baby Monitors

 ◀ Portable Halfwave
\$29.95
 High Performance Dipole
\$49.95 (not shown)

Cellular Security Group
MAX System Antennas.

508-281-8892 (questions)
4 Gerring Road, Ste. 30 • Gloucester, MA 01930
1-800-487-7539 (orders only) • **508 768-7486** (FAX)
 SASE for Free Catalog • \$4.00 S&H • Ck/MO/MC/VISA (MA 5%)

Norfolk Facsimile Broadcasts

If you are interested in radiofacsimile, then the schedule in Table 2 for NAM, Norfolk, which recently arrived in the mail, may be of interest to you.

The broadcasts offer various satellite pictures, wave height, temperature and wind prognoses for various barometric pressure levels, and various other predictions of use to those who might be on, above or even under the ocean. Perhaps the most interesting broadcasts will be those from the GOES satellite. These provide considerable information on what the weather is like over quite a large area. For anyone who makes meteorology one of their hobbies, these broadcasts can offer some useful information to hone one's skills.

Many similar broadcasts are also offered by other stations, including CFH in Halifax and CKN in Victoria, BC. The Canadian broadcasts will also include maps of ice conditions during the winter when icebergs can threaten navigation. In fact, in the North Atlantic, icebergs can be a problem any time of year, depending on the latitude at which a ship is sailing.

That's about it for this time, as the weather gets warmer in the north, maritime activity will be increasing for both commercial and private **MT** traffic. Stay tuned!

Table 2
 All times UTC

0000	NFAX schedule	0815/2015	SFC pres/wind 48hr prog
1200	NMC boundary layer anal	0830/2030	NMC 24hr sig wx
0015/1215	850mb ht/temp/wind 36 hr prog	0840/2040	NMC 36/48hr sig wx
0030/1230	500mb ht/temp/wind 48 hr prog	0850/2050	200mb ht/temp/wind 24hr prog
0100/1300	SFC pres 36 hr. prog (S. Atl)	0905/2105	sig wave ht 24hr prog
0115/1315	SFC pres 48 hr. prog (S. Atl)	0920/2120	SFC pres anal prelim (06 & 18 UTC)
0130/1330	500mb pres 36 hr. prog (S. Atl)	0935/2135	Open period (Tropical warnings)
0145/1345	500mb pres 48 hr. prog (S. Atl)	0945	Bracknell 28hr sig wave
0200/1400	GOES satellite ch 2 (Full disk)	2145	NEOC 48hr prog blend
0215	NMC extended SFC U/A prog	1000/2200	NMC 12hr high wind/sea warnings
1415	NMC 200mb ht anal	1015/2215	850mb ht/temp/wind 24hr prog
0230/1430	Open period	1030/2230	700mb ht/temp/wind 24hr prog
0240/1440	RAFC stg wx 12hr prog (FL 250-600)	1045/2245	520mb ht/temp/wind 24hr prog
0250/1450	NMC 36hr 500mb ht/isotach prog	1100/2300	400mb ht/temp/wind 24hr prog
0300	NEOC Gulf stream anal	1115/2315	GOES satellite ch 15 (N. Atl)
1500	FNOG SST anal	1130/2330	300mb ht/temp/wind 24 hr prog
0315/1515	NEOC 36hr prog blend	1145/2345	Freezing lvl 24hr prog
0330/1530	NWS radar summary		
0345/1545	Open period (Tropical warnings)		
0400/1600	500mb pres anal (S. Atl)		
0415/1615	FNOG prelim SFC anal (N. Atl)		
0430/1630	SFC Trop/pres/wind anal	3357	Continuous
0445/1645	SFC pres anal (S. Atl)	10865	Continuous
0500/1700	NMC NGM 24hr prog	15959	0900-2100 UTC
0515/1715	GOES satellite ch 14 (GoMex)	20015	1200-2100 UTC
0530/1730	Bracknell SFC 24hr prog	8080	on call via commspot
0545/1745	GOES satellite ch 15 (N. Atl)		
0600/1800	NMC NGM 48hr prog		
0615	NMC radar summary		
1815	NEOC sea ht anal		
0630/1830	850mb ht/temp/wind anal	9318	Continuous
0645/1845	700mb ht/temp/wind anal	3620.5	Continuous
0700/1900	300mb ht/temp/wind anal	18486	0900-2100 UTC
0730/1930	SFC pres/wind 12hr prog		
0745/1945	GOES satellite ch 14 (GoMex)		
0800/2000	SFC pres/wind 24hr prog		

These broadcasts can be heard from Norfolk as follows (all freqs kHz):

The broadcasts can also be heard from Keflavik as follows (all freqs kHz):

Satellite Broadcasting Guide

If there is one thing that satellite TV enthusiasts always seem to lack, it is accurate, timely, and inexpensive information. All publications currently in print fall short in one or more of the above requirements. My finding is that the most useful reference books carry a reference price tag, often in excess of \$100. The cheapest publications usually have the least amount of information. Even the most current ones are out of date in more than one critical area.

Why is this? First of all, the subject of satellite broadcasting is so broad that the inclusion of all pertinent information makes for massive texts resulting in equally massive cost. Secondly, the process of publishing is so time consuming that the trip from the author's word processor to the bookstore shelf can take six months to a year, resulting in inaccurate or out of date information. And, finally, the pace of satellite technology is so rapid that it is a struggle to keep current.

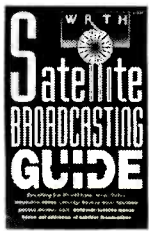

A New Satellite Annual

From the publishers of *World Radio TV Handbook (WRTH)*, *Satellite Broadcasting Guide 1994 Edition* by Bart Kuperus is the latest entry in the satellite publishing field. This

5-3/4 by 9 inch, 366 page book features over 160 satellite "footprint" maps; introductory chapters on satellite basics, receiving installations, and available equipment; chapters listing what's on each transponder of each satellite in each ITU (International Telecommunications Union) region and much more. Excellent photos and line drawings support the very readable text. It is, indeed, the stand-alone satellite version of the *WRTH*. The \$20 retail price tag makes it one of the more reasonable buys in this field.

Still, *Satellite Broadcasting Guide* is not without its shortcomings. As stated in my opening paragraph, it's impossible to publish this type of book and get it all right. To begin with, this book is of interest primarily to the European market. The "Equipment Test Bench" chapter, roughly forty pages long, covers receivers and equipment marketed to Europe exclusively and is of no use to the North American reader. Dozens more pages list information of marginal use at best to those of us in ITU region 2. Even the chapter on ITU 2 transponder loading is considerably out of date (as is every other similar book on the subject).

Frankly, a reference book this ambitious without an index is unfair to the reader. Asking

readers to wade through the entire book in search of a particular item is asking too much. A well designed index is easy to do, takes only a few extra pages and is a major asset to a reference work.

I recommend this book to European TVRO enthusiasts for whom it was largely intended and look forward to the positive changes which are bound to be made in the 1995 edition.

In The Meantime

Don't want to wait for the 1995 edition of the *Satellite Broadcasting Guide*? Then do it yourself. For a small amount of money you can piece together all the information you need about satellite television:

"Satellite TV and You" is a magazine format booklet on the basics of Satellite TV. Produced by the publishers of *Onsat*, a weekly satellite TV guide, it covers the basics of this hobby. In excellent photos and line drawings, satellite concepts are explained in easy to understand terms complete with a thorough glossary. "Satellite TV and You" is free and it's available from many local satellite TV dealers. It's designed as a sales tool to bring in new customers and it does a great job. Look in the phone book and call around; a dealer in your area carries it.

"Satellite TV Buyer's Guide 1994" is a similar publication with a similar objective in mind. The idea is to get you into the showroom of your local dealer and introduce you to satellite TV. Again, this publication is produced by a weekly satellite TV guide; this time it's *Satellite TV Week*. If your local dealer doesn't have a copy you can get one through the publisher. It's not free, though. Call Fortuna Communications (707) 725-1185 and ask for details. This publication compares receivers and other TVRO equipment made for the North American market.

"Satellite Channel Chart" is published by Westsat Communications, Inc. and is as complete and up to date a list of satellites and their transponders as you can find. This chart consists of 42 8-1/2 x 11 inch pages, and lists every broadcaster on every channel of every satellite in ITU 2. It also contains a frequency chart for all domestic C and Ku satellites for North America as well as a lengthy update on recent and upcoming changes in our skies. Subscriptions are \$75/year (6 issues per year). Send \$5 for a sample back copy to Westsat Communications, P.O. Box 434, Pleasanton, CA 94566, or call them at 510-846-7200.

"The DXers Guide To The Galaxy" by George Wood is a 50 page 5-1/2 x 8-1/2 inch booklet featuring a concise discussion of the world's

broadcast satellite situation. Not content with that, he also covers weather, amateur and military satellites as well as the Space Shuttle, MIR and more. And hold on to your wallet; it's free. Send your request to Radio Sweden, S-105 10 Stockholm, Sweden.

Now, the one thing not covered in the above periodicals, but which is done so admirably in the *Satellite Broadcasting Guide*, is the extensive collection of satellite "footprint" maps. These are not necessary items for those just getting started in TVRO, but are most interesting as you delve into the hobby a little more.

These maps give you a good idea of what reception is possible in your area for any given satellite (assuming lack of serious obstructions such as forests and buildings). Of course, it's obvious that most satellites in the ITU 1 and 3 regions will not be viewable from most of North America. However, the coastal regions of our continent may provide quite a bit of good viewing of satellites supposedly out of our "range." With a big enough dish it's possible to move that viewing area further inland.

SCOLA, the university oriented learning channel, has its large 10 meter dishes parked in Iowa and receives some remarkable pictures from very distant birds. The only other publications of which I am aware that feature such footprints are the more expensive books aimed at the satellite industry. Examples are books such as Frank Baylin's *World Satellite Yearly*, or Mark Long's *World Satellite Almanac*. But these books are \$100 and up! This collection of footprint maps in "Satellite Broadcasting Guide" might well be worth the \$20 to the advanced TVRO hobbyist, even if the rest of the publication is not.

TVRO NewsBites

- China's Xinhua news agency has announced that the next two high powered American DBS satellites will be launched by the China Great Wall Industry Corporation in late summer 1995. Echostar Satellite Corporation hopes to be a major DBS (Direct Broadcast Satellite) player by then with the launch of its Echostar 1 and 2 satellites built by Martin Marietta. Both satellites will feature 16 transponders and be co-located at 119 degrees West. This will provide an apparent single satellite with 32 degrees which, with as little as 3:1 video compression, will yield nearly 100 channels receivable on an 18 inch dish.

Echostar's market strength will be tested against the by-then one year old DirecTV and United States Satellite Broadcasting DBS players. Look for lower than ever hardware prices as



John Locker's PC with sattracker, dumb terminal for Packet and scanners to tune satellite baseband signals.



The Echostar receiver and Philips monitor to check incoming satellite signals.

these companies slug it out. The theory of DBS is this: The hardware is a loss-leader. Do whatever it takes to get the consumer to spring for a system (they may not all be compatible). As decades of watching America's cable industry has told us: 1. The real profits are in the programming. 2. Nothing succeeds like excess.

- NBO (Name Brands Only) has a new satellite TV/home theater catalog available. The 52 page, magazine format catalog features various systems from "basic" to "deluxe." One interesting aspect to the sales pitch is that systems can be completely financed through NBO. Write or call for your catalog at NBO Distributors, Inc., 5631 Palmer Way, Carlsbad, CA 92008. Phone: 619-931-1800 or FAX: 619-931-6999.

- National Aeronautics and Space Administration News: "The U.S. component of the Global Geospace Science (GGS) program, the Wind and Polar spacecraft, will experience launch delays of several months to give NASA an opportunity to examine the materials and process used to build two power subsystem electronic boxes on each spacecraft which are similar in design to those determined to be the cause of the NOAA-13 spacecraft failure last year." (*NASA News*)

And speaking of disasters, "...after conducting extensive analyses, the (independent investigation) board reported that the most probable cause of the loss of communications with the (Mars Observer) spacecraft on Aug. 21, 1993, was a rupture of the fuel propulsion system, resulting in a pressurized leak of both helium and liquid MMH (monomethyl hydrazine) under the spacecraft's thermal blanket. The gas and liquid would most likely have leaked out from under the blanket in an unsymmetrical manner, resulting in a net spin rate. This high spin rate would cause the spacecraft to enter into the 'contingency mode,' which interrupted the stored command sequence and thus, did not turn the transmitter on." (*NASA News*)

- More Catalog News: Baylin Publications has just released their latest catalog of satellite re-

lated titles. New editions of *World Satellite TV and Scrambling Methods*, *1994 World Satellite Yearly* and the *1994 International Satellite Directory* are featured among the other staples such as *Home Satellite TV Installation & Troubleshooting Manual* and *Install, Aim and Repair Your Satellite TV System*. To get your copy of the catalog write: Baylin Publications, 1905 Mariposa, Boulder, CO 80302 or call: 303-449-4551 or FAX 303-939-8720.

MAILBAG

- John Locker of Merseyside, England, checks in regularly with photos of interesting items he's seen with his Ku gear in the U.K. This time he checks in with excellent photos of the gear itself! Photo #1 shows his satellite receiver and monitor screens and photo #2 his multi-mode UHF gear with which he is active on the AMSATs (amateur satellites).

- Patrick Paventa of Hawthorne, NJ, wants to know if there will be SCPC (single channel per carrier) services available on the new DBS birds on which USSB and DirecTV will transmit. It's a good question. The non-video capabilities of these satellites are rarely discussed. However, I believe that both companies have designs on future data and audio services. These services will likely be transmitted in the same digitally compressed signals as the video (available on a subscription basis) and thus unavailable to analog receivers of any kind.

And, speaking of SCPC, there are reports that the future of analog SCPC reception could be in doubt. It appears that NPR is looking into digital transmission techniques which will drastically improve audio quality. Even so, it's also likely that several analog transmissions will remain as a backup to the inevitable breakdowns in the new technology. Strangely, this rumor comes at the same time that other reports have Uniden about to bring to market a new IRD (Integrated Receiver/Descrambler) with built-in SCPC. *M*
Most interesting.

Satellite-TV FREE

100% Satisfaction Guarantee

56 Page Catalog/Buyer's Guide

- All Major Brands
- Complete Systems
- Accessories
- Huge Savings
- Easy Installation
- Complete Instruct.

Systems from \$479

Let Us Help You Select Your New Satellite TV Entertainment System

Over 40,000 Satisfied Customers

1-800-334-6455
Int'l 218-739-5231 Fax 218-739-4879

SKYVISION INC.®
1050 FRONTIER DRIVE
FERGUS FALLS, MN 56537

INSTALL OR UPDATE YOURSELF!

PORTABLE SATELLITE ANTENNA

Complete 3' KU Band System

For Free Information Package and Pricing

• Call 219-236-5776 •

R.C. Distributing • PO Box 552 • South Bend, IN 46624

SATELLITE TV

NAME BRANDS AT 50% DISCOUNT

This FREE 24 page Consumer Buying Guide tells all about Satellite TV and lists guaranteed lowest prices.

Salman, Inc.
6310 N. University No. 3798 • Peoria, IL 61612

1-800-472-8626

HamCall CD-ROM

U.S. and International Callsign Lookup

Nearly 1,000,000 Listings
Thousands of Public Domain Programs

Includes Clubs & Military
Still \$50. + \$5 Shipping & Handling per Order
Works on PC and Mac

Buckmaster's HamCall CD-ROM looks up calls in seconds. U.S. calls can be searched by any element, including name, city, state, etc. A TSR is included to look up callsigns from almost any text application. Prints labels. No hard disk required, everything is on one CD-ROM! New CD-ROM disc every April and October, with updated listings and dozens of new programs!

BUCKMASTER Publishing
Rt. 4, Box 1630-Mineral, VA 23117
703-894-5777 800-282-5628

ORDER TODAY!

Beyond Beacons

Ready for something new? This month we'll discuss two easy ways of getting into the sub-basement below 100 kHz and explore some of the signals to be heard.

It's a shame that more receivers don't tune below 100 kHz. I believe this is due mostly to economics, not technical limitations. Since relatively few listeners go below 150 kHz (the lower limit of the LW broadcast band), manufacturers are hard pressed to justify the added cost for VLF circuitry.

For the utility listener, there are ways around this problem. If your receiver stops at 100 kHz, it is still possible to tune the low end of the band using an inexpensive **LF converter**. (See Figure 1.) A converter works by "moving" the longwave band to a frequency range that can be tuned by your shortwave receiver (such as the 80 meter ham band). Many converters will provide reception from 5 to 500 kHz.

Two well known firms that manufacture converters are LF Engineering, 17 Jeffry Rd., Dept. MT, East Haven, CT 06512 and Palomar Engineers, Box 455, Dept. MT, Escondido, CA 92025. Both companies offer catalogs that list many items of interest to the LF enthusiast.

Another way to tune radio's rock bottom is with surplus gear. The military has long understood the value of the longwaves, and as a result, many of Uncle Sam's leftovers are available on the surplus market. This gear typically provides coverage to at least 10 kHz. One well known unit, the R-1401-A/G, goes all the way down to 1 kHz! Some other models worth looking for are the R-389, R-2174, and the RBL/RBA series.

Remember that the surplus route isn't for everyone. Typically, these sets have been out of service for some time and may need work ranging from a minor tune up to fairly involved component-level repair. Still, if you're technically inclined, operating vintage gear can be lots of fun. Fair Radio Sales offers a catalog filled with surplus gear. Write them at 1016 E. Eureka St., Dept. MT, Lima, OH 45802.

Table 1. Frequency Chart

Freq Range	Freq Classification	Abbreviation
0-3 kHz	Extremely Low Frequency	ELF
3-30 kHz	Very Low Frequency	VLF
30-300 kHz	Low Frequency	LF

0 to 100 kHz — A Profile

The face of radio begins to change below 100 kHz (3,000 meters). For one thing, you won't hear voice signals down here. The signals you

Figure 1:
LF Converter Hookup

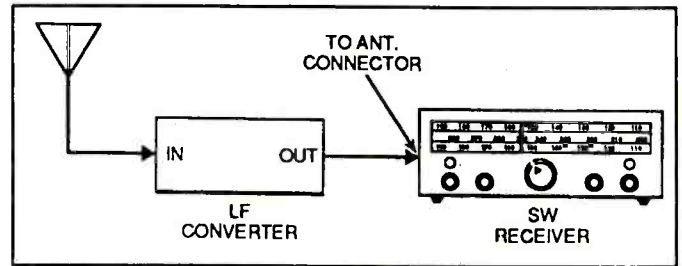

can hear include specially coded Time and Frequency standards, high power military RTTY stations, worldwide radionavigation stations (like OMEGA), and even some sounds generated by the Earth itself.

The frequencies below 100 kHz are divided into three segments as shown in Table 1.

The spectrum from 0 to 3 kHz (ELF) is essentially uncharted territory. This is where much of the research work is being done with "natural radio"—the study of signals emanating from the Earth and the atmosphere. There is strong evidence that some types of ELF and VLF signals may be precursors to seismic events. Someday, this could lead to accurate prediction of earthquakes.

Probably the lowest frequency *man-made* signal is from Project ELF. This is a U.S. Navy program that uses powerful 76 Hertz transmitters at Clam Lake, WI, and Republic, MI, to signal submerged submarines. It is believed that the signal can be heard to a depth of at least 400 feet.

From 3 to 30 kHz (VLF) we start to see more man-made signals appearing. One of the best known is the OMEGA system at 10-14 kHz. This is a global radiolocation system that consists of seven transmitters scattered around the globe. They take turns sending a brief signal that can be used by a special receiver to determine one's position. It's not as accurate as GPS, but OMEGA is internationally accepted and continues to be used by many pilots and mariners.

OMEGA transmitters are located in the USA (North Dakota and Hawaii), Argentina, Japan, Liberia, Norway, and on Reunion Island in the Indian Ocean. Tune to 12 kHz or so and you may be able to hear the slow melody of OMEGA tones. Each tone is from a different transmitter site.

From 15 kHz to 30 kHz the military dominates the VLF band, with encrypted RTTY being the mode of choice. Occasionally you may hear some CW as well. A few kingpins to look for are NSS-Annapolis, MD (21.4 kHz), NAA-Cutler, ME (24 kHz) and NLK-Jim Creek, WA (24.8 kHz). Another frequency to check out is 20.27 kHz. This frequency has been known to light up during military operations.

From 30 to 100 kHz (LF) there is a mix of military stations, time and frequency stations, and radiolocation services. Military/RTTY stations include FXL-Silver Creek, NE (48.5 kHz), NPG-California (56.5 kHz), CFH-Halifax, NS (73.6 kHz) and NAM-Virginia (77.2 kHz).

At exactly 60 kHz you should be able to hear the pulsating carrier of time and frequency station WWVB—the longwave counterpart to WWV (Ft. Collins, CO). The longwave outlet provides an extremely stable signal that is unaffected by propagation shifts that can sometimes wipe out SW reception. You won't hear voice or time ticks on this frequency. WWVB uses a modulation scheme which uses carrier reductions to produce an automated time code.

At the top end of the sub-basement (100 kHz) are the clicking sounds of LORAN (Long Range Aid to Navigation). This radiolocation service is operated by the US Coast Guard to provide automated positioning data to mariners and pilots. You should have no trouble hearing LORAN signals if you live near navigable U.S. waters.

Identifying What You Hear

Stations operating below 100 kHz don't give away their IDs as readily as beacons do. Down here, you have to depend on a reliable frequency directory and an accurate tuning dial to identify what you hear. The *Grove Shortwave Directory* contains an extensive list of stations operating in this range. Also, the *World Radio TV Handbook* is a good reference for LF time and frequency stations. Both of these books are available from Grove Enterprises Inc., P.O. Box 98, Brasstown, NC 28902.

The best way to become familiar with the sub-basement is to scan the band each day. By doing this, you'll get a feel for its profile and be able to quickly spot any new or unusual signals that pop up. You never know what you'll find rumbling in the basement!

That wraps up another month. Remember that your questions, comments and loggings are always welcome at Below 500 kHz. Why not write today in care of this column? An M T SASE guarantees a response.

ORDER YOUR

STATE NOW!

CALL

1-800-890-6999

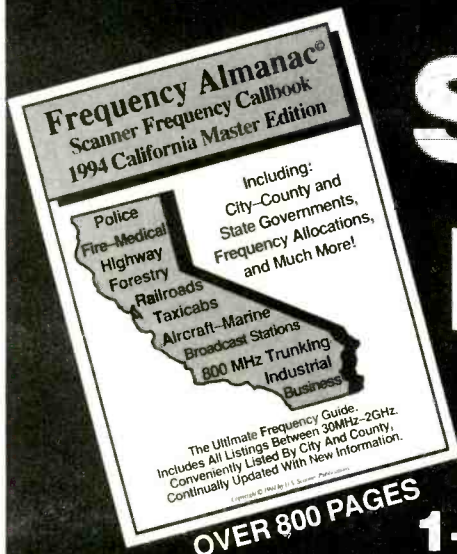

OVER 800 PAGES

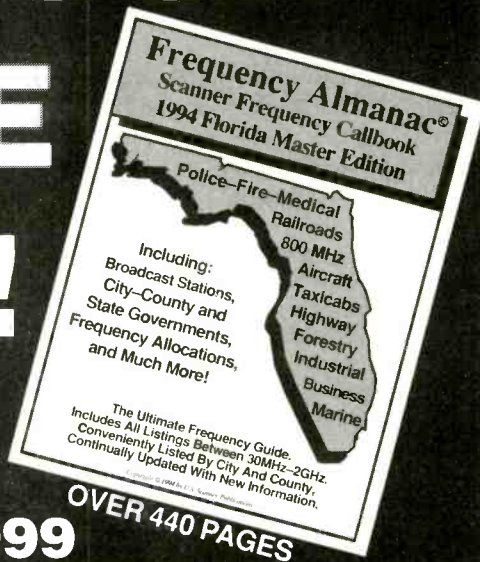

OVER 440 PAGES

OWN THE EASIEST TO USE AND MOST COMPLETE FREQUENCY DIRECTORY!!!

Simplified Frequency format lists county then city.
Each county lists public safety by state, county and city,
including 800MHz, followed by business and ***all other services.***

CA, FL, IL, NY, TX \$24.95 ea + S&H
AK, AL, AR, AZ, CO, CT, GA, ID, IN, IA, KS, KY, LA,
MA, MD, MI, MN, MO, MS, MT, NC, ND, NE, NJ, NM,
NV, OH, OK, OR, PA, SC, TN, UT, VA, WA, WI \$19.95 ea + S&H
DC, DE, HI, ME, NH, PR, RI, SD, VI, VT, WV, WY \$9.95 ea + S&H

S&H: 4TH CLASS MAIL \$3.95, UPS BROWN \$5.95, UPS BLUE \$9.95



ALSO RIGHT OFF THE PRESS!

38X26 Full Color World Map Surrounded By A Complete Frequency Allocation Chart.
Beautifully Lithographed On 100lb Paper. Shipped Rolled In a Tube.

\$19.95 + \$3.95 S&H

"THIS IS FANTASTIC!!
GOTTA HAVE IT"

"WAY TO GO!!
BEAUTIFUL
WORK"

US SCANNER PUBLICATIONS
PO BOX 14923
PORTLAND OR 97214-4923

FAX (503) 233-5176 (503) 230-6999 1-800-890-6999

A New Old Antenna

Take a look at figure one. This is the basic W8JK antenna invented by John Kraus, PhD., back in the 1930's, I think. Anyhow, this particular antenna has been featured in every ARRL Antenna manual and early handbook that I own. When I received my General class license at the age of 13, I hoped that somehow I might be able to put up a rotary beam antenna. After a full summer of farm and orchard work, however, the required cash for a beam, rotor and tower just was not there.

In desperation I decided to try this simple antenna. (I really did not expect it to work.) The only wire I had was a copper clad steel wire that was left over after a highway crew blasted a new roadbed out of the hill behind our home. It was only 20 gauge or so, but rather tough, so that's what I used to build my first 8JK. The feedline on that first antenna was some old 300 ohm twinlead a neighbor threw on the dump.

The directions specified using 12 gauge wire and open wire feeders to a transmatch. Well, I had a transmatch, but everything else was pretty much hit or miss.

With the antenna coupled to a 15 watt homebrew CW rig I worked an LU (Argentina) on twenty meters on my first try. Needless to say, I was hooked on the 8JK and over the years have built and used many of them.

The basic antenna of figure one will work from 20 to 10 meters and provide about four dB of gain over a dipole. The antenna is bi-directional and will provide 4 dBd or more on the frequency of design (20 meters). Gain will vary on the other bands but will never be less than 3 dB. The beam width of the 8JK is about 75 degrees, so two of them placed at right angles will pretty much cover the earth.

What is so nice about the 8JK is that it only requires approximately 30 feet to produce a really good signal. The antenna can be installed vertically, too. Install this wire beam at 25 feet or higher for best results. Of the many 8JK antennas I have built, none have ever disappointed me (and I never did use 12 gauge wire).

Basically, the 8JK is two dipole antennas fed out of phase. Spacing is $\frac{1}{8}$ th wave. Nothing is real critical! If the length falls out to only 30 feet, or stretches to 40 feet, it's okay; the thing will work! Knowing this, you may want to design one to fit into your particular lot; just remember the antenna will work OK on higher bands, but will not function too well at lower frequencies. For 40 meters just double the space and length. Try it: you'll love it!

In fact, why not try your new 8JK on...

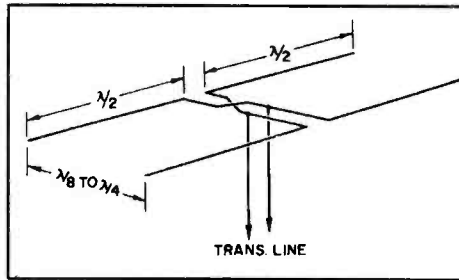

Figure 1 Courtesy ARRL Antenna Handbook

15 Meters

Fifteen is perhaps the best all around DX band for the Novice amateur. Lots of DX stations hang out in the Novice band just waiting to give the new DXer the thrill of working them.

The 15 meter band extends from 21000 to 21450 kHz. The band is divided as follows in the USA: 21000 to 21200 is CW only with Novice operation permitted between 21100 to 21200. Extra class may work from 21000 to 21200 CW while General and Advanced are permitted CW in the section from 21025 to 21200. Extra class phone extends from 21200 to 21450, Advanced privileges extend from 21225 to 21450 and Generals are allowed 21300 to 21450 phone.

More and more PACKTOR and AMTOR stations are showing up in the 21060 kHz region daily and lots of nice contacts can be made in the digital modes. The most popular modes on 15 are, of course, SSB and CW.

In addition, some of the Radio Sputnik satellites use 15 meters, enabling a new ham to get into the exciting field of space communications.

A half wave on 15 meters is only 21 feet long, and beams are easily erected even on small lots. Vertical antennas work well on this band.

Normal range will be 1500 plus miles under normal conditions. On a good weekend it is possible to work all continents; during contest weekends working 100 countries is easily achieved even with modest equipment.

15 is a truly superior DX band!

SSTV

I know you are tired of hearing me yapping about SSTV, but I just have to tell you about a chance for hams and non-hams alike to see what SSTV is all about.

If you own a computer, a new product on the market will allow you to view SSTV pictures for only \$49.95 plus five bucks for shipping!

I recommend you take advantage of this new setup from Absolute Value Systems, 115 Stedman St., Chelmsford, MA 01824-1823. You can phone them at (508) 256-6907.

The SSTV Explorer Version 2 is a fantastic value. Remember, this is a receive only system. At this price you can see if SSTV is for you, or if you are a SWL, it will allow you to eavesdrop on all of the good stuff being sent on SSTV. The new system covers all of the popular modes in both black and white and color.

Places of Natural Beauty

Let me apologize to all of you who were looking for N3IK/3 from Lehigh Gap State Park on March 20. Even two days later there was still a foot of snow in my backyard. It was impossible to reach the site on the 20th except by cross country skis, since several feet of snow blocked the trails to the proposed operating site.

I still intend to make it, however, and the new date will be May 15th. Again, frequencies will be 3695, 7040, 14040, 21140 \pm 10 kHz. I will attempt to be active for most of the day. All contacts will be QSLed.

As before, if you care to join me on an expedition of your own, use the same frequencies and see how many stations you can work; receive an award if you work N3IK/3. Note that if you did set up on the March date, you will still receive the award if you work me in May.

ARRL June VHF Contest

Those of you who have participated in the ARRL June VHF contest know it is the premier VHF activity of the year. If you have never given it a try before, why not this year? It starts at 1800 hours UTC June 4 and ends at 0400 UTC June 6. Rules are in the May issue of *QST*. Try roving, or portable operation to a rare grid square.

It is truly surprising how many stations operate during this activity. Many operators make VUCC (100 Grid Squares) during this contest.

N3IK is planning on being on six and two meters SSB, and CW QRP from grid square 11 and/or 01 for the contest, so hope to see you then. Also see N9LAG from grid square EM-57.

Dayton!

The top amateur convention of the year is, of course, the Dayton hamfest, April 29 through May 1. I hope you make it to this one; you can always count on bargains galore. Look for me at flea market spot 320; mediumwave columnist Joe Eisenberg can be found in spot #2076. Bob Grove and Grove Enterprises will also be there at Booth 514.

See Ya, 73, de Ike, N3IK

MT

Rob Secord's

Ham DX Tips

May is an interesting month in the ham world. Not only are there many DXpeditions and special events stations on the HF bands, but this is the Season when DX starts to happen on VHF, particularly 50 MHz. It is also the start of what I like to refer to as the "third season of ham DX"; that is, the get-togethers. This month's tips represent a little bit of each of these:

ANTARCTICA Stations operating from the Russian bases here have been assigned new prefixes, which will form the block R1ANA to R1ANZ. **BRAZIL** PY2AMI is the callsign of a 12 meter CW beacon on 24931.5 kHz. The beacon will be a good indication when propagation is good to S America on this band. If you wish to report reception of this beacon, send your reports to: Sub Diretoria Secc Labre, Box 31, 13470 Americana, SP, Brazil. PP5LL will operate from Santa Catarina Island (for IOTA hunters this is SA-026) 1 to 4 June. Look for him to probably operate on the IOTA net, 14220 kHz SSB, and the following SSB freqs: 14260, 21260, 28460 kHz, all noted for their IOTA activity **CANADA** The British Columbia DX Club and the Fraiser Valley DX Club will host the 42nd annual Northwest DX Convention May 23 and 24th in Richmond, British Columbia. If you are wanting to attend, please contact Earl Dery, VE7IN, 16969 20th Avenue, South Surrey, BC, Canada, V4B 5A8. **CUBA** The name Arnie Corro is familiar to many SWLs from Arnie's work at Radio Habana Cuba. It is also a familiar name as well to many VHF/UHF DXers in North America, the Caribbean, and Central America. Arnie, C02KK, along with several other Cuban hams, will once gain be active in the ARRL June VHF QSO Party, 4-6 June. Arnie's group, possibly using a special callsign or maybe Arnie's, will be the only CO/CM prefixed station on these bands operating from one of the highest points in Cuba on or about the following frequencies: 50.110, 144.200, 222.100, 432.100 MHz \pm 10 kHz for QRM. Just because the frequencies are VHF and UHF, do not let that discourage you. If propagation conditions are good, Arnie's group's operation could possibly be worked and heard from DXers from all over N America, the Caribbean, and Central America. **FERNANDO DE NORONHA** PY0FF (whose QSL manager is W9VA, William B. Smith, 1345 Linden Ave, Deerfield, IL 60015) has been appearing on 24945 kHz SSB Saturdays and Sundays at 1600 UTC. He is also active from time to time on 50 MHz, and it is a good bet that he, too, will be active during the ARRL June VHF QSO Party (see Ike's column for times) on the international calling frequency of 50-110 MHz. In past June contests, PY0FF was worked in Nova Scotia and Washington State! **FRANZ JOSEPH LAND** Another area of Russian Territory, though considered a separate DXCC country, that has a new series of amateur callsigns from R1FJA to R1FJZ. **JUAN FERNANDEZ ISLAND** Eliazar Rojas (P.O. Box 1, Juan Fernandez Island, Chile, South America), who is CE0ZIS, is on 14250 kHz SSB daily starting at 0400 UTC. **KAMPUCHEA** XU0HW will be activated May 5th to 20th by HA0HW who will be visiting and HA7VK who works in the Hungarian Embassy here. The two plan to operate CW, SSB, and RTTY on 20 to 10 meters, with possibly some operation on 40 and 80. Sometime during the operation the two plan to make a trip to the Kampuchean island of Rong, located in the Gulf of Thailand, to operate for four days as XU9HA. QSL requests should be sent to: Laci Szabo, HA0HW, P.O. Box 24, Puspoklandany H-4551, Hungary. **MALYJ VYSTOKIJ ISLAND** Russians operating from this island and DXCC country located near Finland, will be assigned callsigns from the block: R1MVA to R1MVZ. **RUWANDA** 9X5DX offers this tiny African nation to the amateur world daily on either 14190 to 14210 kHz or 21290 kHz, whichever offers the best propagation, starting at 1330 UTC. QSL to his manager F2X, Gerard DeBelle, 4 Le Haut d Yvrac, F-33370 Tresses C3, France. **USA** During the annual ARRL VHF QSO Party, this writer along with the other "Bald Knob DX Hogs" will be active, using my callsign N9LAG from atop Bald Knob Mt in Maiden Head Grid Square EM-57. Look for us at the top of each hour on 50.165, 144.207, 222.115, and 432.115 MHz SSB. We also plan to operate CW on 144 and 432 MHz, as well as FM at the bottom of each hour on the following frequencies: 146.580, 223.5, and 446.000 MHz. For those not familiar with the contest, the exchange is callsign and grid square locator identifier. Last year we made contacts in 46 states and three countries on 50 MHz, and we hope to contact many of you this year. A colorful QSL will be issued to those worked us or who sent reception reports. Please QSL to P.O. Box 91, Benton, IL 62812 USA.

That's it for this month; enjoy the DX and until next time 73 de Rob, N9LAG

SHOCKING MANUALS!

Survival Electronics, Computers, Phones, Security, Weapons, Rocketry, Energy, Financial, Medical, 150+ others also include Special Projects, Research Services and Hardware. By John Williams, former Senior Electronic Design Engineer (Lockheed), Professor of Computer Science (NMSU). As seen on CBS "60 Minutes," Forbes, etc. Since 1971. New Catalog \$4. Add \$5 total SH, VISA, MC OK. No CODs, P.O.s. Educational purposes only.

CELLULAR & CORDLESS PHREAKING: Describes how cellphones are reprogrammed and scanned, forcing AOX, Test Mode, control data formats, operating systems, computing encoded MINs, ESNS, SIDis - much more! Keypad mods of 100+ cellphones detailed. Plus cordless hacking; scanner mods. \$69.

PBX HACKING: Average loss to PBX hacking is \$90,000! Step-by-step descriptions on how they are hacked; countermeasures. \$39.

PHONE COLOR BOXES: As designed by phone phreakers: Plans for 15 phone color boxes - Red, Blue, Black, Silver, Cheese - more! \$29.

BEYOND VAN ECK PHREAKING: Plans for surveillance systems used to eavesdrop on the emanations from computer monitors and TVs. \$29.

SECRET & SURVIVAL RADIO: Describes the optimum freqs, equipment, modes and circuits for secret, survival and security situations: Includes small transmitters and receivers; ultrasonic, infrared and fiberoptic commo, improvising and optimizing antennas. 70+ circuit diagrams. \$29.

COMPUTER PHREAKING: Describes both computer infections and how computers are penetrated. Includes 2 PC disks: [1] FLUSHOT+ - protection system. [2] Disk loaded with hacker files. \$39.

Also, VOICE MAIL HACKING (\$29), STEALTH TECHNOLOGY (\$29), STOPPING POWER METERS (\$29), RADIONICS MANUAL (\$29), EM BRAINBLASTER (\$29), UNDER ATTACK! (\$29), HIGH VOLTAGE DEVICES (\$29), ATM (\$29), COIN & SCAMS (\$29), PHREAKING CALLER ID & ANI (\$29), HACKER FILES (\$29), ROBOPHONE (\$29) - more!

CONSUMER TRONICS: 2011 Crescent Dr., P. D. Drawer 537, Alamogordo, NM 88310. Voice: 505-434-0234, 505-434-1778 (8AM-8PM MST, Mon-Sat) Fax: 434-0234 (for orders only, 24-hour, 7-days/wk. If you get answering machine press "#", then "1" any time).

Personal Code Explorer™



★ Novices
★ SWLs
★ Veterans

Receive Digital Signals
Copies FAX, RTTY, MORSE, SITOR, PACKET, and more from receiver to IBM/PC CGA, EGA, VGA screen. Easy to use and install. Extensive manual.

On-Screen Scope

Personal Code Explorer - \$129 S&H \$4

Free Brochure. Call-Write-Order. MC/VISA.
Phone (414) 241-8144

Microcraft Box 513M, Thiensville, WI 53092

PAY TV AND SATELLITE DESCRAMBLING

Our Best Yet.....1994 EDITION.....Our Best Yet

Includes the latest cable box and satellite (PLUS B-MAC) files. Lots of schematics and chip files (all new), bullets, ECM's, etc. ONLY \$19.95. Out best yet. Other Pay TV editions, volumes 1-5 (all different). \$15.95 each. The complete Wizard. VCII PLUS hacking. \$15.95. Satellite Systems Under \$600. \$12.95. Wireless Cable Hacking \$12.95. Hacker Video \$19.95. Any 3/\$34.95 or 5/\$52.95. Scrambling News monthly \$29.95. Scrambling News Year One (176 pages) \$39.95. Everything listed here and more \$129.95. Includes all our information. Catalog \$1. C.O.D.'s are OK. Add \$6

SCRAMBLING NEWS
1552 HERTEL AVE., #123
BUFFALO, NY 14216 Voice/FAX (716) 874-2088

The World of Ham Radio

CALLSIGN 94 Database

The World of Ham Radio CD-ROM which is dedicated to amateur radio software, now includes the FCC ham call sign database. Scan over 750,000 US ham calls in just seconds with CALLSIGN. You will have the latest releases in ham radio software from all over the world at your fingertips, using CDVIEW to guide you while viewing over 7,000 IBM files, over 1,000 radio mods, and thousands of SWL frequencies. USA shipping \$3, Foreign air mail \$5, AmSoft PO Box 666 New Cumberland PA 17070-0666 USA Facsimile orders 24 hours: 717-938-6767

\$40
CD-ROM

VISA
MasterCard

AmSoft 717-938-8249



FCC Visits WPIG Studios

Multiple sources close to the situation report that the FCC paid a February 19 visit to the alleged pirate studios of WPIG. Numerous *MT* readers have heard this station's frequent broadcasts, which began on January 8.

WPIG easily holds the distinction of the most frequently active North American pirate during the first six weeks of 1994. Following the "visit" by New York FCC personnel and the Woodbridge, NJ, police, the station suddenly became inactive.

A consistent programming format at WPIG produced mixed reviews in the DX hobby. Announcer "Ira" transmitted news, weather, and entertainment features for pigs. This inevitably included a cappella "singing" about pigs riding in the "BunndyMobile" through the slums of New Jersey. Somewhat contradictory adjectives have been used to describe the overall effect of this, including juvenile, bizarre, creative, stupid, amusing, and annoying. Take your pick.

A reliable source in a position to know says that the FCC inspected a Kenwood TS450S transmitter during the visit, but did not confiscate any equipment. The alleged station operator was warned to cease broadcasting on 7415 kHz, since this frequency is allocated to the "aero band."

Actually, the International Telecommunications Union allocates frequencies between 7350-8100 kHz to Fixed and Land Mobile utility services. Joerg Klingenfuss' excellent *Guide to Utility Stations: Twelfth Edition* lists no active aero, fixed, or land mobile stations on 7415 kHz. The eighth edition of Gilfer's *Confidential Frequency List* also comes up empty on 7415.

The FCC has a history of amusing claims in its press releases that pirates are dangerous because they emit interference to utility services like aircraft, ambulances, police, etc. But, it does not seem likely that the FAA will be visiting officials at the **Voice of America** in Washington to curtail the VOA's dangerous daily interference to aircraft in the "aero band" from their powerful Botswana relay site on 7415 kHz.

The Achilles heel at WPIG was its regular schedule of Saturday afternoon broadcasts on consecutive weekends. Most pirates maintain an erratic transmission schedule, hoping to minimize the odds of a knock on the door from the FCC.

WRMI

Jeff White says that **Radio Miami International's** new Florida transmitter has remained in the testing phase. He hopes to begin relays of clandestine broadcasts soon on 9955 kHz. You should check this frequency regularly, since they could be on the air already by the time that you read this. *MT* reader Leslie Edwards of Doylestown, PA, is pleased to report that she is among those who received a WRMI QSL card for their first day of testing on November 11, 1993. Congrats!

Radio Pretoria

Although its FM broadcasting band signal is inaudible in North America, **Radio Pretoria** has been the most interesting new clandestine of 1994. The station, located 20 miles from Pretoria, South Africa, is the voice of the far-right Afrikaner People's Front. The *New York Times* characterizes the station as an "alliance of right wing groups headed by retired generals."

Radio Pretoria produces flagrantly racist programming in opposition to the spread of Communism in South Africa. Despite a January 20 judicial order to cease broadcasting, the station continued its transmissions. Military defenses, including sandbags, trenches, and razor wire, were installed around the station's perimeter.

A confrontation was avoided on February 4 when the South African government issued temporary broadcast licenses to 15 stations, including Radio Pretoria. According to UPI, African National Congress President Nelson Mandela said that the incident "proves President Frederik de Klerk has no fighting spirit."

Several *MT* readers sent in material on this station, including Dave Alpert of New York City, Scott Edwards of Los Alamitos, CA, and Thomas Risher of Whittier, CA.

Radio Piraña QSL's

We have a follow-up to our March coverage of this unique Europirate that features a Latin American format, usually near 13950 kHz. More QSL's have poured in to North American

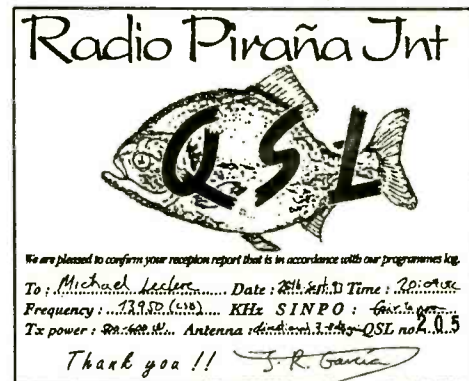

Note proper spelling on Mike LeClerc's verie.

mailboxes, including those of Michael LeClerc of Somers, CT, and Dave Gasque of Orangeburg, SC. As our photo of Michael's verie indicates, the official spelling includes a tilde over the ñ. The Wuppertal address is producing these results.

Lytle Publicizes DXing

Longtime *MT* supporter Gigi Lytle of Lubbock, Texas, recently generated a full page article about shortwave radio in the Lubbock *Avalanche Journal* newspaper. The article featured a large color photo of Gigi at the dials in her shack, with her copy of *Passport to World Band Radio* clearly visible. Her published description of pirates is worth reprinting, "The stations broadcast a mix of rock 'n' roll, comedy sketches, and irreverent political and social satire. 'These guys are hilarious,' she said."

Part 15

Although the FCC generally prohibits unlicensed broadcasting, a "Part 15" regulations loophole permits extremely low power transmissions by the general public under restricted circumstances. This allows everything from "Mr. Microphone" to elaborate low power television transmitters. ACE President Rob Keeney has announced that *The ACE* now includes a monthly column on this rarely

publicized facet of the radio hobby, written by veteran DXer Bud Stacey. For a sample copy of the bulletin, send \$2 to PO Box 11201, Shawnee Mission, KS 66207.

What We Are Hearing

Maildrop addresses used by pirate stations that we report this month include: PO Box 452, Wellsville, NY 14895; PO Box 109, Blue Ridge Summit, PA 17214; PO Box 493, Boys Town, NE 68010; PO Box 293, Merlin, Ontario N0P 1W0; Kammarsvagen 133:220, 22646 Lund, Sweden; and PO Box 220342, 5600 Wuppertal 22, Germany. You should include three first class postage stamps with reports to domestic addresses. International Reply Coupons or \$1 US should be sent to foreign maildrops.

Action Radio- 7416 at 2300. A. J. Michaels ended his layoff from the pirate bands in spectacular fashion with the best program that he has ever produced. Comedy, rock, country, folk, and slick promo ID's were featured. "Conan the Librarian" was a nice touch, and Michaels generated a big signal that rivaled nearby **WEWN**. Addr: Boys Town. (Keeney)

CRSM- 7470 at 0015. Rob Roy covers Scottish ethnic events in detail. This always includes a schedule of upcoming Scottish events in Quebec, but the station's cultural emphasis is international. Addr: Blue Ridge Summit. (Adam Andrews, Clarkston, WA; Skip Arey, Waterford Works, NJ)

East Coast Beer Drinker- 7465 at 0345. Rock music is mixed with beverage consumption commentary on this one, which has resumed activity lately. Addr: Blue Ridge Summit. (Robert Ross, London, Ontario)

Ground Level Network- 7415 at 1645. "Just Bob's" calm medical tips remind many pirate fans of similar fare that used to come from "Joe" at the dormant **One Voice Radio**. Addr: Wellsville. (George Zeller, Cleveland, OH)

Heavy Dude Radio- 7415 at 2245. Here's an example of a recent NAPRS relay of a Europirate rocker that would otherwise be a difficult DX catch in the Western Hemisphere. Addr: Lund. (Ross)

Liberty- 7416 at 1530. Tom Paine's new station mixes rock, comedy, seasonal fare, and commentary on individual freedoms. It has quickly established a good QSL record. Addr: Wellsville. (Ross)

North American Pirate Relay Service- 7412 at 2230. A real deluge of Europirate relays has come from Richard T. Pistek's transmitter lately. Scott reports a QSL for the Titanic relay (see below) in only 12 days. Addr: Wellsville. (Scott Krauss, Cleveland, OH)

Radio Airplane- 7480 at 0000. Captain Eddy mixes rock and comedy, a typical pirate format. He is distinctive because he says that all broadcasts are transmitted from a moving aircraft. Addr: Wellsville. (Rick Havner, Charlotte, NC; Andrews)

Radio Cambodia- 7412 at 1815. The coughing announcer on this one was widely heard, but it remains to be seen if he will be continually active. He said that he was awaiting a new 100 kW transmitter that is being donated by Radio Moscow. Addr: Merlin. (Max Syko, Gaylord, MI)

Radio Doomsday- 7405 at 2315. Nemesis produces entertaining shows that mix rock music, comedy, and commentary, sometimes from an announced mobile location. Note that pirates will use 41 meter frequencies when not in use by powerful international broadcasters, such as this instance on a VOA channel. Addr: Wellsville. (David Bland, Columbia, SC; Andrews; Havner)

Radio Earth Relay- 7465 at 0100. Somebody recently aired an old Radio Earth show, including the usual Chicago address of PO Box 321, Chicago, IL 60666. But, it's unclear if regular broadcasters will respond to correspondence about pirate relays of their shows. Addr: Uncertain. (Andrews)

Radio Freedom- 7465 at 2300. They have been around since late 1990, but few DXers have ever heard them east of the Mississippi. On the west coast they are occasionally audible with a classic 1960's rock format. Addr: None. (Andrews)

Radio Free Euphoria- 7413 at 2300. Dozens of us heard their "Voice of the Runaway Maharishi" program hosted by the East Indian swami. But, it's somewhat unclear if the "Maharishi" identifications really represent a new pirate station, or just a program segment on Radio Free Euphoria. Addr: Wellsville. (Ross; Havner; Syko; Andrews)

Radio Garbanzo- 7420 at 2000. Longtime pirate Fearless Fred has come out of hiding. A good example of his original comedy is his "Drunks Against Mad Mothers" segment. Look for their interval signal: "Shave and a Haircut, Two Bits," performed by barking dogs. Addr: Wellsville. (Syko)

Radio Gumby International- 7465 at 0015. Master Gumby's pirate broadcasts mix rock music with songs from television shows. On some occasions the station gives out a Canadian voice mail telephone number for communication with its listeners. After Rick left a message on their answering machine, the station played his message over the air! Addr: Merlin. (David Ditlow, Los Angeles, CA; Havner)

NOW HEAR THIS!

FINALLY!

High-Powered Sound from your HT.

- 12 DB of Audio Gain
- 3.5 inch Oval Speaker
- Automatic Shut-Off
- Internal NiCad Charger
- External Power 5-15 VDC

NEW FEATURES

- *Tapè Trigger*® (automatic logging)
- Auto Polarity Switch
- Input Level Adjustment
- Even Lower Battery Drain

\$29.95 Plus S&H

Naval electronics inc.

Model HTS-2

5417 Jet View Circle, Tampa, Florida 33634
Phone: (813) 885-6091 Telex: 289-237 (NAVL UR)
Fax: (813) 885-3789

Radio Lollipop- 7415 at 2300. This strange Europirate has developed a relay relationship with the North American Pirate Relay Service. Its programming mixes songs about lollipops and other rock music mixed with slick jingles, some of which feature small children. Addr: Wuppertal. (Krauss)

Radio New York International- 7415 at 0830. Although the log is slightly old now, Adam Andrews was the only *MT* reader who actually submitted a logging of Johnny Lightning's shows that precipitated the FCC bust of the *m/v Fury* in Charleston, SC. The signal clearly got out to the west coast. Addr: Not verifying reports. (Andrews)

Radio Titanic International- 7412 at 2230. This Europirate rocker is among several stations that produce special programming for relay via North American pirate transmitters. Their slogan is "from Germany to the world." They have been on the air since 1975, and claim to be Germany's oldest free radio station. Addr: Wuppertal. (William Hassig, Mt. Prospect, IL; Krauss; Syko)

Radio USA- 7413 at 2330. Mr. Blue Sky is still with us after more than ten years on the air. His punk rock and originally produced comedy stands out among the best active pirates. Addr: Wellsville. (Bland)

Solid Rock Radio- 7415 at 2200. The station name at this one is accurately descriptive. Sometimes Dr. Love adds commentary, but this is basically a music programmer. This was Rick's first afternoon pirate log, but as you see elsewhere this month, it wasn't his last! Addr: Wellsville. (Havner, Syko, Andrews)

WCCC (tentative)- 7465 at 0130. David didn't get a clear ID, but he heard a station transmitting blatant Nazi propaganda that was attracting jamming from other pirates. Is it possible that WCCC has reactivated? Addr: Unclear. (Bland)

WJLR- 7413 at 2200. They still mix John Lennon songs with a variety of other rock in a pleasantly produced format. The announcer has asked for program comments to motivate him to stay on the air. Note Adam's west coast location. Given the low sunspot counts, pirates have been audible out west at a surprisingly early hour. Addr: Blue Ridge Summit. (Andrews)

Wire Line Radio- 7436 at 2130. This one programs a well produced blend of rock, comedy, and slick ID promos with cameos from Phil Muzik of **KNBS**. The station recently asked for comments on its productions so that it can be motivated to stay on the air. Addr: Blue Ridge Summit. (Zeller)

WPIG- 7415 at 2230. Plenty of DXers heard Ira's hyperactive station while it was still maintaining a regular schedule. The BunndyMobile currently seems to be parked in the garage while the station lies dormant. Addr: Wellsville. (Arey; Bland; Syko; Havner; Hassig)

MT

what's new?

Larry Miller

A New PRO-43?

Among the many who mourned the passing of the Radio Shack PRO-43 handheld scanner was Bob Grove. So when the new PRO-51 handheld came out, it was only natural to think that it was, maybe, the replacement for the honored '43.

After all, the PRO-51 is a hot little radio with 29-54, 108-174, 406-512 and 806-956 MHz coverage (minus cellular, don't you know). There's room for 200 of your favorite frequencies which it scans at a rate of 50 per second. When searching, this baby can hit 100 CPS (channels per second). There's also a separate 10 channel monitoring bank, automatic air/fire-emergency, marine, and weather service search plus all of the features you've come to expect from Radio Shack.

So what does Grove say about the PRO-51? He says it's a great little scanner. But is it the awaited replacement for the PRO-43? You'll have to turn to page 98 to find out.

Another Ace

Ace Communications (10707 E. 106th St., Indianapolis, IN 46256; 800-445-7717) is trying to fill the gap left by the no-longer-importable Yupiter MVT-7100 scanner with a version of its own. The new radio, actually a Camnis HSC-050, which is not sold in the U.S., is being private-labeled as the TR2400.



The HSC-050/TR2400, according to those who have seen the unit, appears to have been developed from the previous generation of AOR scanners. The speaker, display and keyboard are mounted on the front, the controls are on the top and an integral battery compartment is accessible through a cover on the rear panel.

Construction, both internally and externally, is for all practical purposes the same as the AR-1500, (which is still being sold by AOR dealers, contrary to rumors that it had been discontinued).

Frequency coverage runs from from 0.1 MHz to 2060 MHz (although there's not much to listen to over 960 MHz) and can operate in FM, AM, WFM and SSB. There's room for 1000 memories and it scans/searches at 20 steps/channels per second.

The TR2400 sells for \$499 plus shipping.

900 Phone DX

Just when I was complaining (and complaining and complaining) that there was nothing new going on in the radio hobby, I got a press release from Tom Kennedy. Tom runs TelePartners 900, which is one of those companies that markets telephone "900" numbers.

Now, it seems, you can call a 900 number and, for a buck a minute (actually, 95 cents a minute), get the latest DX news from *Monitoring Times*' own Glenn Hauser!

The average call runs about four minutes (\$3.80) and begins with a preview of the information contained in that recording. There could be a listing of DX programs of the day, timely listening tips, or even a schedule for Glenn's own *World of Radio* program. If a caller isn't interested in the topics of the day, they can hang up and only pay for the initial minute (95 cents).

Will the average hobbyist pay for information that can be found elsewhere for free? TelePartners 900's Kennedy says, "Today, information is power and convenience is king. People will call..." So confident is Kennedy that he is predicting that the average listener might call once or twice a week.

OK. So let's take a minute to figure this out — hypothetically, of course. Each call is \$.95 a minute and lasts four minutes. So that's \$3.80 per call. Do that twice a week for a month and your phone bill will show a \$30.40 charge when it comes. In a year that's \$364.80.

Now, if every *Monitoring Times* subscriber (30,000) called Glenn Hauser at 900-656-5455 at the rate predicted by Mr. Kennedy for one year, the project would generate ten million, nine hundred forty-four thousand dollars (\$10,944,000.00)! All of which is to say that this could be a very lucrative venture for Mssrs. Kennedy and Hauser — and a very expensive, albeit helpful, one for you.

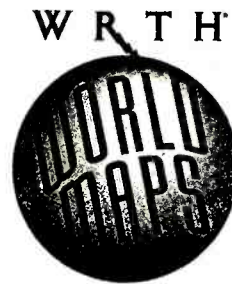

It's A Small, Small World

Last month we got a package of the new 1993 WRTH World Maps. Inside a small sandwich-size zip-lock bag was a slip of paper announcing "12 all new world and regional maps in full color..."

Inside, I found only a single sheet of paper, just a little bigger than 12 inches. Thinking that the rest of the contents of the package had become lost in the mail, I requested a replacement. No, I was told. That's all you get. Yes, there are 12 maps but they're all

printed on that one sheet of paper. And they bear a striking resemblance to the maps you'll find in the *World Radio TV Handbook*. In fact, it's possible that they are the same maps, just all put in one place and illustrated in color.

So how much will you pay for new *World Radio TV Handbook* sandwich bag 'o map(s)? \$9.95 plus shipping.

Repeater Mapbook

Scanner listeners and hams alike who wish frequency listings for amateur radio repeaters are out of luck with official FCC sources — they don't list them.

But all is not lost; the *U.S. Repeater Mapbook*, 1994-95 Edition, by Bob Martin, shows the locations and frequency pairs for many popular amateur repeaters from 29 through 1200 MHz in the United States, Canada, Mexico, Central America and the Caribbean!

Alphabetized by state, province and country, illustrations include PL tones as well, making it especially useful for traveling hams. The *U.S. Repeater Mapbook* gives you a bargain 170 pages of maps for \$9.95 plus shipping from ARTSCI Inc., PO Box 1428, Burbank, CA 91507.

Scan the Apple

Last year we reviewed a Metro New York scanner directory called *Metro Concepts*. It was a scanner frequency directory for the Big Apple but with an interesting twist. The *Metro Concepts* book contained primarily active frequencies, confirmed by the author. Missing from the book were tons of those odd frequencies that fill the pages of other books but are never heard. Instead, you got a book full of guaranteed action.

This year, Dave Garofalo and his wife have produced an all new

Be sure to mention *MT* when you contact the companies mentioned in "What's New."

second edition, this time called *Scanner Planner*. Scan the pages of this hefty book and you'll find police, fire and emergency medical, plus business, military, sports, and much more. In addition, there are frequencies from New Jersey and Metro Philadelphia plus portions of Delaware and Connecticut — all of it red-hot active.

The book is divided into two sections. The first is a listing of frequencies by name. You'll find the user's name, the type of service, the frequency, call letter, PL tone, state, and helpful remarks. The second section is arranged by frequency and contains the same information.

We really like the new *Metro Concepts Scanner Planner*. Whether you're in the Big Apple, The Big Scrapple (Philly), suburban NJ or anywhere close enough to tune them in, you'll want a copy. It's \$19.95 plus \$3.50 shipping from Metro Concepts, 189 Berdan Avenue, Suite 155, Wayne, New Jersey 07474.

Rhode Island Scanner Directory

Rhode Islanders can now pick up a copy of the *Official Scanner Guide's* frequency directory for their state. The new 3rd edition includes a complete update of all public safety and business licenses, channel numbers, and PL codes and contains over 5,000 listings — that's up 1,200 from the last edition.

The new edition also covers the new 220 MHz channel plan, the new emergency radio service, and has extended coverage of aeronautical and notification systems.

The price is just \$21.95 plus \$3.05 book rate shipping. The address is Official Scanner Guide,

P.O. Box 525, Londonderry, NH 03053.

Scanning North Carolina

The *North Carolina Frequency Directory* is only one of 17 different directories available from DBK Research. The directories put out by this small publisher center on cities as well as complete states (NC, SC, TN, GA, VA, MD). Cost varies between \$15.95 and \$24.95 depending upon size of publication.

Arranged by service (air, amateur, business, city/county government, federal government, public safety, schools, utilities), each section is alphabetized by licensee name, followed by location and frequency(ies).

A "Nationwide" section provides a large sampling of common VHF/UHF frequencies used by a wide variety of federal government agencies. While definitely not comprehensive nor completely up to date, the directory does provide some good listening clues throughout the state.

At 200 pages, the North Carolina edition is \$24.95 plus \$3 shipping. Order from DBK Research, 120 E. Mary St., Bristol, VA 24201; ph 703-466-8912.

Ohio Directory

The *Scanner Frequency Directory* for Northwestern Ohio, Southeastern Michigan is authored by Darryl Symington, a long-time member of the All Ohio Scanner Club, and well-known as a consummate frequency collector. This edition concentrates on public safety, local and federal government, business, aircraft and marine, and other scanning targets as well.

ASLEEP...AWAY...ON-THE-JOB... DON'T MISS ANYTHING ON YOUR SCANNER

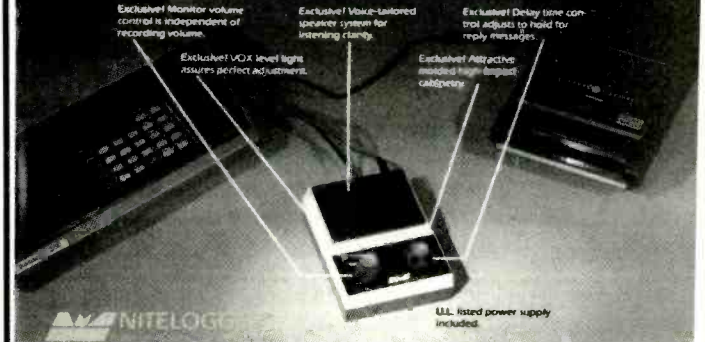

A permanent record even when you're not there!

"Before I installed NiteLogger I always seemed to miss the big stories..." Now solve the biggest frustration of scanner enthusiasts: NiteLogger makes sure you'll hear it all, even if it happens at 3:47 a.m.!

Foolproof operation...works every time!

"I've tried rigging up recorders before only to be frustrated...I was amazed how well NiteLogger worked." Bulky relays, transistor switch polarities, hump pick-up, distortion and more are all problems most scanner users have faced trying to match recorders to various model scanners. NiteLogger works with any scanner every time...guaranteed! Just plug into the scanner's external speaker jack and any standard cassette recorder.

VOX operation saves up to 7 days or more on a single C-90 cassette.

"I came back from vacation and could review the entire week's operation of my (police) department on tape." Depending upon the amount of activity on the channel, one cassette tape can hold many days—even weeks—of communications. And NiteLogger's exclusive VOX delay control adjusts to minimize dead time on the tape, while still capturing reply messages without annoying tape start/stop noise.

Hear while you record.

"What used to drive me crazy was that anytime the recorder was plugged into the scanner, the speaker would cut off so I couldn't hear what was going on!" NiteLogger's built-in monitor speaker and Monitor Level control solves the problem. You control the volume from off to full on, independent of recording levels.

Buy with absolute confidence.

In 1980 BMI introduced the first commercially available military time format clock independent of power lines...now used in hospitals, airports, police and fire departments worldwide. BMI also designed and produced the Mission Time Clock used on the Space Shuttle and the contingency timer for Mission Control. You can purchase BMI-engineered products with confidence!

MONEY BACK GUARANTEE

If you're dissatisfied in any way with NiteLogger, just return it to us prepaid within 25 days for a prompt, courteous refund. For One-Full Year NiteLogger is guaranteed to be free of defects in workmanship and materials. Simply send prepaid to BMI for warranty repair.

Introductory price just \$69.95 (Plus \$4.50 shipping and handling). Complete with U.L. listed power supply, all cables, and easy step-by-step instructions.



9445 Seven Mile Road
Caledonia, WI 53108
Phone: (414) 835-4299
FAX: (414) 835-4298

©Copyright 1992, BMI, Inc.

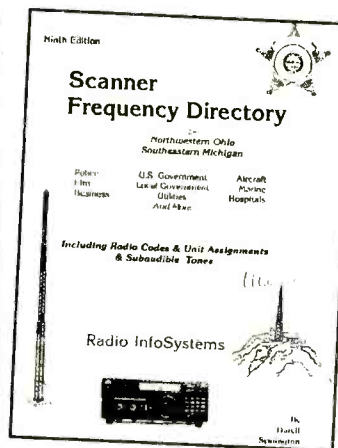

Counties covered include: (Ohio) Defiance, Erie, Fulton, Hancock, Henry, Lucas, Ottawa, Paulding, Putnam, Sandusky, Van Wert, Williams, Wood; (Michigan) Hillsdale, Lenawee, Monroe, Washtenaw, Wayne, Macomb, Oakland; (Ontario) Windsor area.

Arranged initially alphabetically, and cross-referenced by frequency, data fields include

location, repeater pairs, service, squelch tone, and callsign. Dozens of lists of dispatch ("ten") codes are also listed.

For your copy, send \$11.95 plus \$3 shipping to Radio Infosystems, PO Box 399, Holland, OH 43528.

SWLing: Clean Up Your Act

JPS Communications says their new NTR-1 Noise Reduction unit is now available for short-wave listeners and "discriminating" amateurs. The NTR-1 Wide Band Noise and Tone Remover has two front panel-selectable bandwidths that is designed to work on both wide band (6.6 kHz) as well as narrow band (3.4 kHz) signals — good for removing heterodynes.

Dynamic Peaking is very effective at reducing white atmospheric noise; the notch filter



automatically removes tones, whistles or heterodynes — and does it in a reported 3 to 5 milliseconds. There is no delay between input audio and output audio.

The NTR-1 operates on 12VDC and measures just 1.7" high, 6.5" wide and 5.1" deep. It's \$169.00 and can be purchased from your local dealer or direct from the factory at 919-790-1011, or write P.O. Box 97757, Raleigh, NC 27624.

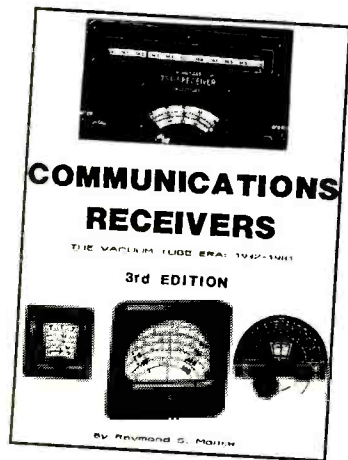

Radio Receiver Nostalgia

Communications Receivers is the third edition of Raymond Moore's 125 page book on the vacuum tube era. Over 400 photographs featuring 68 manufacturers illustrate what many consider one of the most exciting, romantic, eras of radio listening: 1932-1981. A collector's bonanza, the new 3rd edition even includes military receivers.

Alphabetized by make, each listing includes the year(s) of manufacture, list price, frequency coverage, tubes used and a brief anecdotal history of the company.

Many feel *Communications Receivers* is the flea marketer's bible. Others find solice browsing through its pages into the past.

Your copy is available for \$19.95 plus \$2.50 shipping from RSM Communications, P.O. Box 1046-MT, Key Largo, FL 33037-1046.

Modern Receiver Reviews

You'll find no warm, orange glow of vacuum tubes to bask in when you read Larry Magne's in-depth reviews. Tubes have long ago been replaced by the cold efficiency of the super high-tech world of today's shortwave receivers. In fact, so fast has technology advanced — not to mention prices — that making a decision about a new radio can be a nerve and wallet wracking experience.

Magne's latest "White Paper" report is on the FRG-100, a receiver with an excellent reputation but a \$669.00 list. That's a lot of money. Is it the right receiver for you? You'll know after you read this 24 page report. It's available for \$5.95 from IBS, Box 300, Penn's Park, PA 18943, or from Grove Enterprises (add \$2.50 shipping). You can also get a complete list of all the White Paper reports by sending a self-addressed, stamped envelope to the IBS address.

Space Satellite Handbook

More than 22,000 satellites, platforms, payloads, rockets and debris from all space-capable countries are listed in this unique reference. Although this material is a reprint of a recent NASA satellite situation report, it is only one part of the *Space Satellite Handbook*, which is written by

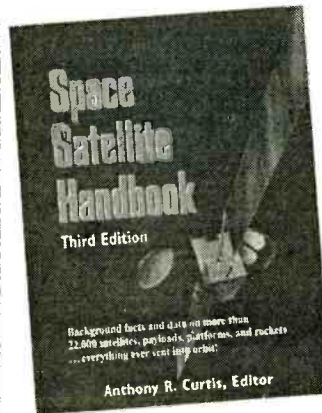

Anthony Curtis, editor of *Space Today* magazine, president of ARCsoft publishers, and author of the *Space Almanac*.

Beginning with a chronology of worldwide space efforts following the 1947 launch of the Soviet satellite Sputnik, the book evolves into a categorized chapter-by-chapter treatment of satellites by mission: search and rescue, weather, earth-observing, navigation, military, science and technology, and manned space stations.

The *Handbook* is not a frequency compendium; frequencies are few and far between, and are confined primarily to those transmissions intended for wide reception, such as weather satellites. Rather, it is a journalist's description of the satellites, their purposes and their anecdotal histories. In this regard it excels.

Space Satellite Handbook, Third Edition, is a \$39 hard cover available from Gulf Publishing Company, P.O. Box 2608, Houston, TX 77252-2608. Call (713) 520-4444. Be sure to add \$7.75 shipping.

Satellite Companion

An interesting companion to the non-frequency *Space Satellite Handbook* is Mr. Curtis' *The Outer Space Frequency Directory*. Billed as "the radio monitor's guide to eavesdropping on satellites, space shuttles, space stations, interplanetary space probes, and non-human signals," it covers from 1.8 to 30,000 MHz.

In all, there are listings for over 2,200 space and space-related sources.

Indeed, the goal of the book is ambitious, perhaps too much so. The list is interspersed with a considerable number of terrestrial frequencies and allocations, including ham radio, maritime, international broadcasting, FM and TV broadcasting and time standard stations. Worse, many of the listed frequencies are inactive or invalid and, according to *MT*'s Larry Van Horn, at least one set of frequencies is completely fictional — the FLTSATCOM "delta" channels.



Because a reference source for satellite frequencies is so badly needed, this directory may be useful to some hobbyists. However, as a monitoring tool, we'll hope for a more definitive and better constructed work next time around.

The *Outer Space Frequency Directory* is 69 pages and sells for \$17.95 plus \$2.00 book rate shipping from Tiare Publications, P.O. Box 493, Lake Geneva, WI 53147.

Electronic Access Denied

Several *MT* readers have contacted our office in Brasstown with news that Electronic Access, who advertised in previous issues of *MT*, has not been answering their BBS or voice phone numbers listed in their ad.

Monitoring Times has pulled their ad from the magazine until the problem is resolved.

Review

By Bob Grove



Grove SP-200 Sound Enhancer

There is a growing number of audio accessories on the market designed to improve receiver audio. Most of these audio processors are restricted to one or two functions and have no internal speaker, but the new Grove SP-200 Sound Enhancer overcomes those former limitations.

Housed in a handsome, custom, wood-crafted enclosure, the SP-200 incorporates an extended range, four-inch, 15-watt capacity speaker driven by a two-watt amplifier. A 120 VAC/12 VDC power supply is included.

The Grove Sound Enhancer includes separate bass and treble controls for up to +/-15 dB equalization; a 300-6000 Hz notch/peak filter with adjustable bandwidth; a continuously adjustable noise limiter; an audio squelch with variable hold; a tape recorder activator; and audio output jacks for tape recorder, demodulator, or other accessory.



Our Lab Test

Measuring approximately 11 inches wide and 7 inches high as well as deep, the Grove SP-200 nestles comfortably alongside—or even on top of or under—a receiver, transceiver or scanner. The solid wood cabinet is visually elegant and acoustically pleasant. The black-finished aluminum panel features bold, easy-to-read lettering, and the knobs are large and roomy.

The instructions suggest various combinations of settings for different modes of reception. Music is best reproduced without filtering, of course, because of its wide frequency range. The bass and treble controls produced far more sound range and dynamics than possible from the radio's internal speaker or even competitive \$170-\$180 accessory speakers without all the SP-200's features.

On CW, the SP-200 can be used as a "scrubber," completely eliminating background noise and even off-frequency interference by adjusting the filter and the squelch controls. RTTY, TOR, packet, slow scan, and even voice were similarly isolated, although background noises were not as fully eliminated as on CW due to their wider bandwidths.

Even narrow-shift FSK interference could be reduced by slightly widening the bandwidth of the notch filter.

While digital signal processing (DSP) designs are capable of much sharper bandpass characteristics and deeper unwanted signal rejection, they don't offer continuously variable frequency or bandpass settings like the analog SP-200.

No audio accessory can ever replace a well-designed receiver. If the receiver's poor selectivity allows adjacent-frequency interference to be detected, it will still be present in the audio passband, often sharing the same audio range as the desired signal.

With this limitation understood, the Grove SP-200 Sound Enhancer offers considerable flexibility to improve the audio of any communications receiving system.

The SP-200 Sound Enhancer is \$199.95 plus \$7.50 from Grove Enterprises, P.O. Box 98, Brasstown, NC 28902; 1-800-438-8155.

MARYMAC®

The New Realistic® PRO-43 Scanner

Radio Shack®

PHONES

Our 17th Year of DISCOUNTS

Toll Free 800-231-3680

PRO-43 List \$349.95

Our Delivered Price \$288⁰⁰

"We discount everything in the RS catalog"

22511 Katy Fwy.

Katy (Houston), TX 77450

1-713-392-0747 FAX 713-574-4567

DON'T MISS OUT ON THE OVERNIGHT ACTION !!
CAN'T TAKE A SICK DAY FOR THE SHUTTLE LAUNCH ?!

Listen to it ALL when YOU want to with ...
MESSAGE CATCHER

It lets your tape recorder monitor when YOU can't
Connect to your receiver's or scanner's speaker jack.
Recorder turns on only when MessageCatcher "hears" activity
Includes: - MessageCatcher Unit
- Power Supply, Cables & Plugs

.. All this and a good night's sleep for ..
only \$19.95 (plus \$3.86 for S&H in USA)

To order, send check to: RADIO ACCESSORIES,
P.O. Box 168, Melvin Village, NH 03850

Ever wish you had a radar gun in your car?

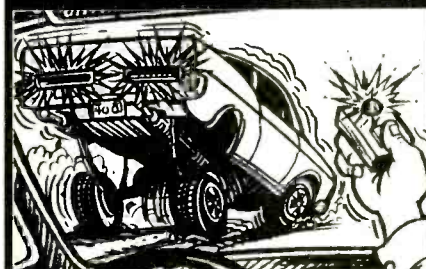

The ZAPPER is an awesome Answer!

This magic-like little box activates any radar detector within 3/4 of a mile. Watch the brake lights come on the speeding sports car that just flew by. Keep those speeding big trucks from eating your bumper. The ZAPPER is a 10GHz amateur transmitter the size of a cigarette pack, operates on a 9v battery. Complete with road game "Trolling for Tailights".

Built & tuned only **\$49⁹⁵** Plus \$5.00 S&H

TRANSEL
TECHNOLOGIES
MADE IN USA

123 East South Street
Harveysburg, Oh 45032
1-800-829-8321

Realistic® PRO-51 Handheld Scanner

With the discontinuation of the popular Realistic® PRO-43 hand-held scanner, many listening enthusiasts have been waiting for its replacement. The recently-released PRO-51 may be the closest contender, but it isn't closely comparable.

Manufactured by Uniden for Radio Shack, the PRO-51 is similarly contour-styled to the upcoming Bearcat BC220XLT, and measures a similar 6-1/16"H x 2-7/16"W x 1-11/16"D; it weighs roughly 8 ounces. Its frequency range is also a remarkably similar 29-54, 108-174, 406-512 and 806-960 MHz (less cellular, unrestorable).

The PRO-51 comes with a sturdy belt clip and six-inch flex antenna, but no other accessories. It can be powered optionally by 4 AA cells: alkaline or rechargeable NiCd. The instruction manual is well written and comprehensive.

The 50-channel-per-second scan rate ("HyperScan") is the same as Uniden's "TurboScan", as is the 100-step-per-second search speed.

Even though it has cellular frequencies blocked, the radio's down conversion design (10.8 MHz/450 kHz) assures easy (and illegal) reception of cellular phone calls 21.6 MHz higher than their actual frequencies.

Ten 20-channel memory banks hold 200 frequencies; additionally, 10 search-uncovered channels may be temporarily stored in scratchpad memory for review before committing them to primary memory. Any one channel may be selected for priority, sampled every two seconds for activity regardless of any other function in progress.

A direct search up or down from any channel frequency is accomplished by pressing an arrow



key; single-stepping from the channel is not possible, however, without opening the squelch, a rather noisy alternative.

Factory pre-programmed search ranges are available for marine, air, fire and weather, but curiously not police, the most popular listening target.

Any of the 200 channels can be individually locked out temporarily from the scanning sequence; channels may also be individually delayed two seconds before scan resume to await replies. A keyboard lock protects scanner settings from being accidentally altered.

The contents of all memory channels may be erased by holding down the 2 and 9 keys, then switching the radio on. A bank of factory test frequencies may be entered by holding down the 2, 9, and MANUAL keys, then switching the radio on.

The 15-second-backlit LCD is readily viewable at night, and is seen best--highly contrasty--from straight on or slightly below; viewing from above is dim to impossible.

The tiny (1-7/16") internal speaker gives surprisingly strong audio from the PRO's 250 milliwatt audio amplifier. Sensitivity averages a respectable 0.5-0.7 microvolts.

The Bottom Line

The PRO-51 should prove to be a popular hand-held scanner. Its small size, pre-eminently simple programming, rapid scan and search, and reasonable price are an attractive combination.

The PRO-51 scanner is \$299.95 from Radio Shack outlets nationwide.



Cellular Censorship:

What Are the Manufacturers Doing?

Now that it is illegal to manufacture or bring into the United States any scanner with cellular frequencies, how are the makers responding to the edict?

ICOM, manufacturer of the top-rated R7100, has announced that it will remove not only the 825-849 MHz (mobile) and 869-894 MHz (base) cellular telephone frequencies, but it will remove the entire 800-900 MHz portion of the R7100, R100 and R1 scanning receivers.

While this may be a manufacturing expedient for ICOM, it severely emasculates the radios, preventing reception of 800 MHz police, fire, medical, business, industrial, land transportation, and Airphone as well.

All new Uniden (Bearcat) and Radio Shack (Realistic®) scanners have non-cellular-restorable microprocessors, as must all legally-marketed but lesser-known brands like AOR, Camnis (Ace), and Yupiteru.

Some manufacturers have indicated that they will continue to import cellular-restorable scanners which are difficult to modify, testing whether that criterion satisfies the FCC's ban on scanners which can be "readily altered to receive cellular."

At this writing there are still some full-coverage scanners in dealers' warehouses, but when they are gone there will be no more.



STARTEK INTERNATIONAL INC. FREQUENCY COUNTERS

Made
in
USA

WARRANTY

5 YEARS all parts
1 YEAR labor
ALL MODELS

FIND FREQUENCIES FAST

With the new, high sensitivity, ultra-fast, Auto Trigger & Hold STARTEK frequency counters. Increase readability distance with the new Band Pass Filters. All products made in USA.

AUTO TRIGGER & HOLD

Now, for the first time, available on inexpensive, portable counters with our new ATH™ Series. This feature is the most significant improvement ever made to the pocket sized counters! It allows "Hands Free" operation to automatically read & hold a signal as quick as 80ms or 8% of a second.

New ATH™ Series

Say goodbye to random counting & false readings with the ATH™ Series

TA-90 Antenna
(priced separately)



ATH-50
5 Hz to 2800 MHz
One-Shot Feature

Signal
Strength
Bar Graph
Works
on Every
Range

Low
Battery
Indicator

Ultra Bright
Display



ATH-15
1-1500 MHz

Size 4" h x
3.5" w x 1" d
Aluminum
Cabinets

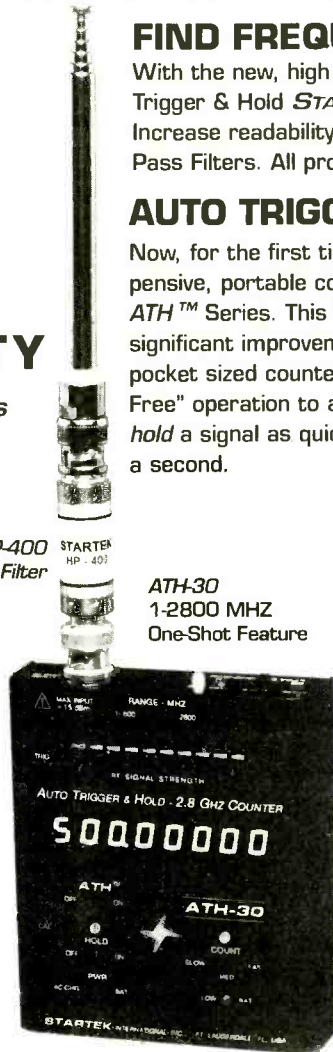

HP-400
Band Pass Filter

ATH-30
1-2800 MHz
One-Shot Feature



ATH™ SERIES FEATURES:

- Easy to use - simple controls
- Ultra fast response time
- Extra BRIGHT LED digits
- 3-5 hour battery operation
- Automatic clean dropout
- Maximized sensitivity, <1mV typical
- Signal strength Bar Graph
- 2 ranges - 6 fast gate times
- 9-12V auto-polarity power jack
- StarCab™ aluminum cabinet



Ni-Cads
and A/C Charger
INCLUDED
with ALL Models



In Stock... Same Day Shipment!

Ultra High Sensitivity Frequency Counters

ATH-15	1-1500 MHz, High speed	\$199.	\$235.
ATH-30	1-2800 MHz, High speed, one shot	259.	289.
ATH-50	5 Hz to 2800 MHz, one shot	289.	329.
HST-15	Optional 0.2 PPM TCXO High Accuracy Timebase (installed)	100.	125.

Economy Frequency Counter

1350	1-1300 MHz, 10 HZ Res. 3 gate times, Hold switch	\$119.	129.
------	---	--------	-----------------

Band Pass Filters

Increase range or distance from a transmitter with a Band Pass Filter: <1 dB pass band insertion loss.

LP-60	DC-60 MHz Usage	\$69.
HP-400	400-1500 MHz Usage	69.
HP-800	800-2000 MHz Usage	69.
BP-3	Above 3 filters (SAVE \$30)	\$177. 207.

Accessories

A CC-90	Case for all models	12.
B TA-90	Telescope BNC antenna	12.
C TA-90-L	Telescope elbow antenna	16.
D RD-150	150 MHz rubber duck	16.
E RD-2750	27-50 MHz rubber duck	28.
F RD-800	800 MHz rubber duck	29.
G M-207-IC	Interface cable for MFJ-207	10.
H P-110	200 MHz, 1x, 10x probe	39.
J LP-22	Lo-Pass, audio usage probe	25.
K DC-10	Direct, 50 OHM probe	20.

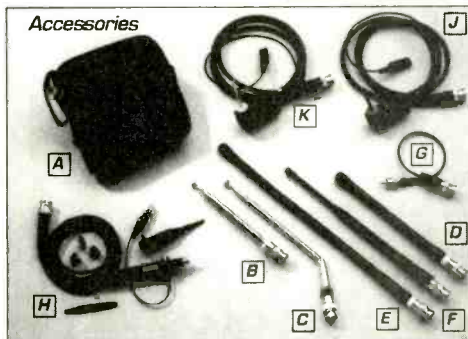

Factory Direct Order Lines
SAME DAY SHIPMENT
Orders Only Orders & Information
800-638-8050 305-561-2211
FAX 305-561-9133



STARTEK INTERNATIONAL INC.
398 NE 38th St., Ft. Lauderdale, FL 33334

Terms: Ship/Hand charges for US & Can \$10, others add 15%. FL residents add tax. C.O.D. \$5. VISA, MC, Discover accepted. Prices and specifications subject to change without notice or obligation.

• An External Antenna for Shortwave Listening

• Another Keypad for the Yaesu FRG-100

Do you need a separate antenna for shortwave listening? If you have an inexpensive little shortwave portable, the chances are that its built-in antenna is perfectly adequate. With tabletop models, though, a good external antenna is *de rigueur*.

Stations that already come in well probably won't come in audibly better if your receiver is connected to a good external antenna. The signal-strength indicator may read higher, but your receiver's automatic-gain control (AGC) regulates things so that what you hear probably won't sound much different than it does without that external antenna.

Where a worthy antenna helps is with weaker signals—especially weaker signals that are intermixed with local electrical noises or noise from your receiver's circuitry. The goal is to hear more signal, and less noise. This is known as improving the "signal-to-noise ratio," and it's like speaking louder to be heard over noises surrounding you.

That's why antenna evaluations that rely only on signal-strength indication don't mean much. You can have a powerful amplified antenna that makes your signal meter quiver, or a passive antenna that provides a much lower meter reading. Yet, the latter may actually perform better than the former.

Which antenna is best? With radios, the model you buy is the most important thing, but with antennas, it's where you live and how you

erect the antenna. While some are indeed better than others, our tests over the years have shown that the design of an antenna itself is secondary to where and how it is erected.

The most common shortwave wire antenna in use worldwide is the simple inverted-L, sometimes referred to (usually incorrectly) as a "longwire." It's called an inverted-L, because with the antenna wire end-fed to a downlead wire, it looks like an "L" cocked on its side. The inverted-L is cheap, simple, covers all shortwave bands...and it's about the only thing left in radio that you can still make yourself!

As a rule of thumb, if you have less than 100 feet of space for an antenna, you'll be better off with something like a trapped-dipole design. However, if you have room for an antenna of at least 150 feet, a long inverted-L has the virtue of capturing more wavelengths of radio signal. This ability results in improved signal-to-noise. Remember, those distances are in a straight line. You can't run antennas zigzag and expect full-quality results.

You can buy simple inverted-L antenna kits from Radio Shack, shortwave specialty firms and other vendors. The quality varies enormously, usually with the price. You can also "roll your own" inverted-L easily enough, and construct it to last for years and years. Here's how, step-by-step.

Build Your Own Inverted-L

1. Parts needed

- Stranded or solid copper wire, not spliced, preferably 16, 14 or 12 gauge, for the antenna itself. "Enameled" wire, being lightweight yet protected, is best.
- Insulated downlead wire, not spliced, of about the same thickness as the antenna wire.
- Coax-Seal, Duxseal or silicone caulk.
- Two 3" to 6" sausage-shaped insulators, preferably ceramic, with a hole at each end.
- RF connector for antenna input into the receiver.
- A length of strong weather-resistant rope, such as nylon (avoid polypropylene).
- Two strong marine or other weatherproof pulleys capable of turning freely after years of exposure to the elements.
- Three strong, weather-resistant screw-type eye hooks—threaded for wood or nuts, or bracketed for flush mounting. (Use brass or stainless steel nuts, if required.)
- Bricks or cinder blocks for ballast.

2. Tools needed:

- A sturdy ladder.
- A long, flat-blade screwdriver.
- Wire-cutting pliers.
- A soldering iron or gun, preferably of at least 200 watts. Alternative: a propane torch.
- A hank of rosin-flux solder.
- A pocket knife.

3. Important safety tips:

- Have a partner to hold the ladder, pass up tools and such.
- Do not erect any antenna or downlead where, if any part of the mounting system fails, it can fall on an electrical wire, or vice versa. *Remember: All electrical wires are, or can be, live and lethal.*

4. Erecting the antenna:

- Pick the two points—one near your listening room—at which the ends of the antenna are to be affixed. These and the line-of-sight between them

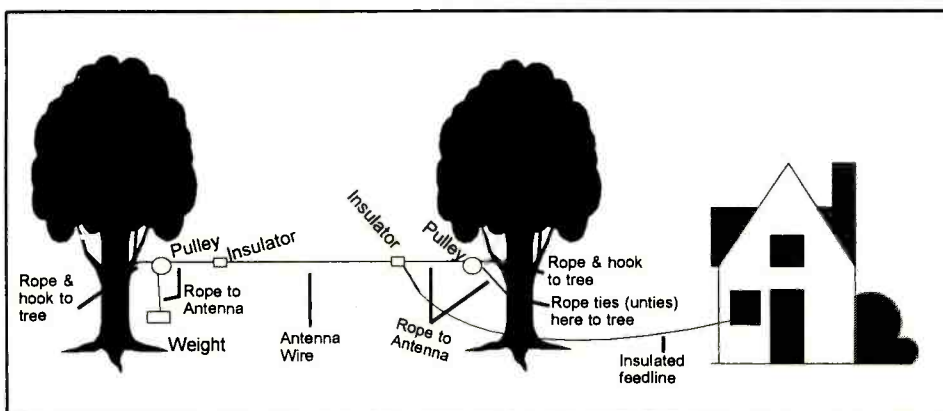

should be as far as possible from electrical power lines and other sources of noise.

- Soap your hands clean of dirt and body oils. With your knife, scrape off all traces of protective varnish or enamel from one inch of one end of the antenna wire. Also scrape shiny one inch of one end of the downlead wire.

- Line up the cleaned ends in parallel, with the wire tips facing in the same direction. Twist together the two cleaned ends to form a pigtail.
- Solder (Place the hot iron or gun at one end of the cleaned pigtail, then hold the solder against the other end of the pigtail about one inch away. When the solder melts, it will flow smoothly throughout the entire hot pigtail.) Keep the joint rock steady until it cools down naturally.

- Stick this pigtail, plus another few inches of parallel wiring, through a hole in an insulator. Wrap and twist to the insulator, or back over to the antenna wire itself such that any tugging will not disturb the soldered pigtail.

- Using Coax-Seal, Duxseal or silicon caulk, cover the pigtail to protect it from the weather.
- At the mounting point near your listening room, affix a screw eye hook as high as possible.
- Attach a second screw eye hook to a point about one yard above the ground and directly below the first hook.

- Either: Connect the upper screw eye hook directly to the eye of the pulley, or: Tie together with a piece of weather-resistant rope, as shown in the illustration.

- Mount the second pulley on the opposite support structure in the same way.

- Tie a substantial length of weather-resistant rope to the remaining hole of the insulator. Pass the rope through the pulley nearest your monitoring post. Total length of the rope needs to be long enough to allow the antenna to clear any obstructions, such as tree branches, plus twice the height of the antenna (to lower the antenna for maintenance.)

- Run rope end through the lower screw eye and screw eye and tie the rope off at a point such that the antenna will be close to its desired position.

- Pass the other end of the antenna wire through one end of the remaining insulator. Determine where you want the antenna to terminate, ensuring it will be well away from tree-branch tips even in the years to come. Tighten the wire around the insulator and/or twist it over the antenna wire coming into the insulator.

- Tie a substantial length of weatherproof rope to the remaining hole in the insulator.

- Pass that rope through the pulley, then down to the ground.

- Pull the rope until the antenna is fairly taut—not real tight, yet not sagging unduly.

- Tie your ballast to the rope about one yard from the ground. Add ballast until the antenna remains in this taut position.

- The addition of a lightning protector is recommended. At the least, disconnect and ground the antenna when lightning is nearby. See DeMaw's Workbench for some basic advice on grounding.

If you have suitable equipment to get high up into trees, you can substitute bungee straps for the rope, ballast and pulley arrangement described above. Bungee straps provide the recommended "give," in a simpler installation, but whenever maintenance is necessary you will have to get up into the tree to be able to lower the antenna.



Another Outboard Keypad for FRG-100

Recently, I reported on an outboard keypad, the Stone Mountain QSYer, for the Yaesu FRG-100, which comes equipped with no keypad. There was a typo in that report; their correct phone number is (404) 879-5756.

While preparing the just-issued RDI White Paper on the "Frog 100," we tested yet another outboard keypad. This one, made by the French firm of Brodier EEI, works comparably to the Stone Mountain offering, but has the additional virtue of accessing frequency presets—a major improvement. Unlike the Stone Mountain pad, however, it doesn't "beep" when the keys are pressed, and there are no rubber feet.

It sells for 420 French Francs plus FF49 registered airmail shipping to North America—about \$80 total via credit card—direct from the manufacturer: Brodier EEI, 3 Place de la Fontaine, F-57420 Curvy, France; fax 011 33 87 525 567. You can also check with your favorite radio supplier before ordering. Universal Radio, for example, has expressed an interest in possibly carrying the Brodier keypad, and there already are dealers in Holland and Luxembourg.

This equipment review is performed independently in accordance with the policies and procedures of International Broadcasting Services, Ltd. Reprints of "Magne Tests" are not available.

FREE SAMPLE COPY!

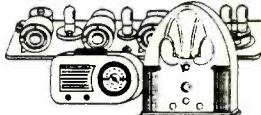

ANTIQUE RADIO CLASSIFIED
Antique Radio's Largest-Circulation Monthly Magazine

Articles - Classifieds - Ads for Parts & Services
 Also: Early TV, Ham Equip., Books, Telegraph, 40's & 50's Radios & more...
 Free 20-word ad each month. Don't miss out!
 1-Year: \$29.95 (\$47.95 by 1st Class)
 6-Month Trial - \$16.95. Foreign - Write.
 A.R.C., P.O. Box 802-P9, Carlisle, MA 01741
 Or Call: (508) 371-0512

GREAT SWBC SOFTWARE!

NEW! SWBC Database and Logging Utility
 Contains thousands of changeable records for SWBC radio stations with their frequencies, schedules, languages, countries. This program prints logging reports for submission to your favorite clubs. With the data entered only once, logging reports can be printed in different formats with only a keystroke. Specify IBM compatible 3.5 or 5.25 disks.
Only \$29⁹⁵

SWBC Station Database
 Contains thousands of changeable radio station records. Sorts by station, frequency, schedule, language, country or continent.
Only \$19⁹⁵

DX-SWL Program Database
 Radio station schedules and frequencies for all SWL programs on shortwave. Don't miss your favorite shows!
Only \$9⁹⁵

Working demo disks available (3-1/2" only) \$3⁰⁰ Each. Specify program(s) when ordering.

Orchid City Software
 P.O. Box 18402
 West Palm Beach, FL 33416
 All payments in US funds only.

PASSPORT® TO WORLD BAND RADIO'S Radio Database International White Paper® equipment reports contain virtually everything found during IBS' exhaustive tests of premium receivers and outdoor antennas. These are available in the U.S. from Universal Radio, EEB, Grove Enterprises and DX Radio Supply; in Canada from Sheldon Harvey (Radio Books), 79 rue Kippis Street, Greenfield Park PQ, J4V 3B1; in the United Kingdom from Lowe Electronics Limited, Chesterfield Road, Matlock, Derbyshire DE4 5LE, England; and in Japan from IBS Japan, 5-31-6 Tamanawa, Kamakura 247. For a complete list of available reports, please send a self-addressed stamped envelope to RDI White Papers, Box 300M, Penn's Park PA 18943 USA.

Award Winning Filters

Japan Radio
 NRD 535 Sony ICF-2010
 NRD 525 Yaesu FRG-100
 NRD 515

Winner of the 93/94 WRTH award for the design of the most innovative accessory equipment. High performance filter kits to improve the above receivers and more. The new Premium Grade filters for the Japan Radio NRD receivers offer outstanding narrowband selectivity.

Kiwa Electronics
 612 South 14th Ave., Yakima WA 98902
 ☎ 509-453-KIWA or 1-800-398-1146

Research works.



American Heart Association

They Are Out There Listening To Us!

By the fact that you are reading *MT*, it is evident that you find listening to other people communicate interesting. But how do we feel when someone listens in on *our* communications?! This month we'll talk about computer generated radio frequency interference, RFI. Al Gill, of New Jersey, wrote and called it the "hiss wash out." Gerald Busch, of Saskatchewan, Canada, who uses his computer for logging databases, has to "put his computer to bed for a while" so it doesn't "wipe out the stations" it was meant to catalog! But what does this bothersome RFI have to do with us being listened to?!

We'll see in a while, but first, here's an overview of a receiver control and logging database from an English company who WAS listening. In fact, that is how Richard McLachlan of Lowe Communications in Derbyshire, England began his letter to me, "YES - somebody here is listening!" Holy Cow!

Multiscan 1.81

Lowe's Multiscan was brought to our attention by a letter from William Briley of Minnesota. I asked in a previous column if the people at Lowe "were listening" and would send me a copy of Multiscan for review. They were. They have. So let's go.

Multiscan, version 1.81, runs on just about any PC compatible with a minimum of 490K bytes of RAM memory available for programs. (On any PC, to see how much memory you have for programs go to the DOS directory and run the program "MEM"; you will be shown your amount of total memory, how your system is using it and a line which indicates the "largest executable program size." This is the number which, for Multiscan, must be greater than 490000.) Other minimum requirements are: one serial port and either 1 MByte of hard drive space or two 720K floppy drives. Hercules, CGA, EGA or VGA displays are all supported.

"What does Multiscan do? And how well?" you ask. In its very, very disjointed thirty-two page manual you'll discover that it is a receiver control and logging program. My first impression was that for a program in the \$100 range, not having an internal method of displaying decoded data from a PK-232 or other TNC, was a serious omission. On the other hand, the program does have some very nice features and a uniquely convenient operational layout.

The program comes on four 720K, 3.5 inch disks (5.25 available on request) which are carefully packaged in a reusable plastic disk holder, a nice touch. Once loaded, using simple instructions which take about five minutes, we're

ready to put Multiscan through its paces. Typing "CONFIG" (not your computer's config.sys file; this one is in Multiscan as CONFIG.EXE) allows us to set up some basic parameters such as what radio we wish to control. I found it strange that I had to go outside of the main program manually to change these basic parameters. However, I am pleased to report that this is not another "throw out the program and your log" if you change radios. Multiscan currently comes with eleven different radios it can control: AR2500, 3000, 3000A; FRG8800, 9600, 100; NRD535; R7000, 7100, 72; and R5000 (Lowe also offers a second group of drivers for ham transceivers at an additional cost). From the set-up it looks like Lowe is planning to add more as required.

Typing MS brings up the main screen which controls almost all program functions. The screen is divided into four sections: the top shows time and date, the very bottom contains eight secondary command choices controlled by the tab key (including access to the Logbook database). Two sections take up the majority of the screen: one of these shows channels which you have set, their frequency and space for comments. You can scroll through these and send them to the receiver if yours is one of those the program can control. (My good old Icom R-71 is not one that Multiscan supports, but my FRG-9600 is.) The other middle section is the heart of the program from where all the receiver control functions are displayed and controlled.

Having one clearly labelled screen is a strong point of this program, which I wish other programs would emulate. It is a relief not to have to guess what screen contains what function. Multiscan has avoided the multi-screen approach while keeping a high level of capability.

Frequencies and modes loaded easily into the FRG-9600 on the first try. The on-line help is superb, highly detailed and only one keystroke away at any time. Similar praise-worthy comments can be made for the Logbook and scanning modes setup. And now for some scanning.

Putting it to the "Smoke" Test

Well, scanning with the FRG-9600 has never been a problem with any other control program before, so here Multiscan scores its first unfortunate milestone. No matter how many times I read the manual, accessed the Help file or just tried anything, Multiscan would not stop its scanning. Frequencies and modes were being loaded to the radio and signals were being received, but there was no stopping, which made Multiscan useless for the scanning function. I'm

sure it has to do with the wiring of the RS-232 port and the squelch output. But a customer should not have to speculate on how to use a \$100 piece of software. After two hours of trying I gave up. Should I have made an expensive call to England? Perhaps, but "Joe User" shouldn't even run into such a basic problem.

I discovered many interesting screens and capabilities in my two hours of blind traveling through Multiscan. Most, however, have little or no "how to use" details. I must have eventually done something very wrong, because after the journey the program would not run or load any longer, either from MS or Multi command. This required me to re-install the entire program from the floppies with a loss of all stored data. Fortunately, I hadn't stored a large amount.

Great Start...But No Cigar!

From the feel of the screen operation one can sense the high potential of this program. But for now it remains a *potential*. I'm sure that the majority of the problems encountered with Multiscan version 1.81 was due to its non-user oriented instructions. Although thirty-two pages long, it has no "hand-holding" examples of use and it reads like a collection of definitions. But a tremendous amount of effort has gone into the programming. This is a well presented, well thought-out, well laid-out, potentially powerful program. But, in my opinion, it's being let down badly by its lack of detailed instructions and user examples.

A second area which needs work is the integration of all the program's sub-programs into one program environment. Exiting the program to change a parameter is not modern programming technique. Requiring the user to determine how to start/re-start the main program after exiting is more than inconvenient. The wrong choices may result in loss of all your new data, as I experienced.

These problems, although very real, can be changed with relatively little effort by the talented programmer who put Multiscan together. If these are changed, a TNC decode screen added, and the price brought down to a competitive level, this will be a real market winner. For now, I can only offer it to the experienced software hackers among you who want to explore. I'll anxiously await the next version of Multiscan and hope it won't be long in coming.

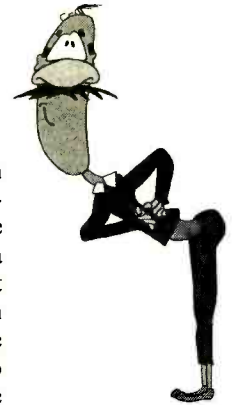

Multiscan version 1.81 is available from Lowe Electronics Limited, Chesterfield Road, Matlock, Derbyshire DE4 5LE England, Tel (0629) 580800. The price is 75 pounds sterling which is approximately \$110. There was no mention of shipping costs.

What Unwanted Guests Do We All Have in our Shacks?

(No! Not wives, husbands, kids or parents...try again.)



Now to the fiend (not friend) of all monitors. The topic that made the usually cool Bob Grove vow, a number of years ago, to "never have a computer in his shack...!" We're talking about computer generated radio frequency interference, RFI! Heaven save us.

Where does it come from?... From the clock in your computer that keeps all the chips synchronized. From the many, many resulting data pulses that are used for communications between logic chips. From the video data that is sent to your display. From the high voltage scan pulses of your CRT circuits. From your printer's internal microchips. From the data being sent back and forth from your parallel and serial ports. From the switch mode power supplies in your computer and peripherals. And the list goes on and on!

Each one of these signals is very different. Some mix with each other to form yet other types. Complex? You bet. Capable of being summed up in any "one-size-fits-all" book? I don't think so. The problem is not new to the world, only to consumers since the age of PCs. Professional and military electronics has been dealing with it, and using it, for quite a while.

"Using it?!" you ask. Sure. I know you have heard of the recent CIA spy case where a high level mole was uncovered after years of "surveillance." More than one news account has mentioned that the CIA used passive reception and decoding of the alleged spy's computer's signals: in other words, they were listening to and decoding the RFI from his computer!

Concern about such occurrences has required me in my commercial life to construct RF shielded screen rooms when working on government projects and manipulating possibly "sensitive" project data. Governments have always been worried about their computers being listened to. Even decades ago one embassy found an inductively coupled transmitter bug on their FAX/Telex line.

While hopefully none of us are being spied upon, one thing we definitely don't want to do is to listen to our own RFI! First, the good news. Since some of the RFI ingredients "look" like radio waves, good shielding practices will do some good. Keep all cables to a minimum number and length, shielded and of the highest quality. Locate your computer, monitor and peripherals in a location (relative to your receiver and antenna) which yields the least RFI. Shut off all unnecessary peripherals, such as printers, when monitoring. Put your antenna as far away from the computer as possible. Use a tuned, or balanced, antenna instead of a long wire or active antenna. Try plugging the radio and computer into different AC outlets. Try grounding all equipment together. Try ungrounding some equipment. Finally, use RFI inductors on all cables. Radio Shack or ham flea markets are good sources.

If you do all this I'll guarantee you: you'll still hear RFI on your receiver. (Sorry.) However, it should be at a reduced level. You might even get lucky on your favorite shortwave or scanner frequencies.

Why can't we fix RFI if we can send men to the moon? Because of the number, strength and complexity of the sources in a digital computer, and due to the many physical factors which affect near field propagation (RFI). Of course, if we wanted to pay tens of thousands of dollars for our equipment, as the military does, the problem could be greatly reduced. Any takers?

Computer Control Your Radio With SCANCAT 5.0 and SCANCAT-PRO!

Once you use the newest version of the SCANCAT 5.0 or SCANCAT-PRO computer program with your radio, you will never operate your radio again without it! SCANCAT controls the following radios:

- AOR 2500, 3000, 3000A
- DRAKE R-8
- ICOM R-71, R-7000, R-7100, R-9000
- JRC NRD-525, NRD-535
- KENWOOD R-5000, TS-50, TS-440, TS-450, TS-850
- YAESU FT-757GX, FRG-100, FRG-9600
- REALISTIC PRO-2004/5/6 for HB-232 Interface



Most ICOM and Kenwood radios - consult your radio's owners manual.

SCANCAT 5.0 FEATURES

- Create frequency databases
- Scan between ANY frequencies
- Up to 400 frequencies per file (unlimited with SCANCAT-PRO)
- Scan by ANY increment and delay
- Share any radio's file
- Faster Performance
- QUICKTERM built-in TNC comm program with programmable macros

AOR / KENWOOD 450-850 / DRAKE / YAESU / ICOM / NRD535

* Must have squelch detect cables for ICOM and YAESU (not required for R-7100, R-9000 ICOM OR YAESU FRG-100)

- Auto signal detection/scan stop
- Auto logging to disk files
- Spectrum analysis with spectacular graphics
- Save/load radio's memories to disk

SCANCAT-PRO ADDITIONAL FEATURES

- Multiple scanning banks
- Comma delimited conversion
- D-Base file support
- Unlimited file sizes
- Dual radio simultaneous scanning with ICOM radios

SCANCAT comes ready to run ALL supported radios within only ONE program. SCANCAT makes your listening hobby a breeze! Plus, the included SCANPORT allows you to convert your favorite BBS, D Base files, or columnar frequency lists to a running SCANCAT file.

Requires a 640K MS-DOS computer w/RS-232C serial port - hard disk recommended for SCANCAT-PRO. **Manufacturer's interface not included.**

CALL or WRITE for FREE information or our \$5.00 FULLY OPERATIONAL DEMO DISK (includes shipping/handling). DEMO price refunded with purchase. FOR A LIMITED TIME, if you ORDER NOW, we'll include as a BONUS, FOUR SCANCAT FREQUENCY FILES!

SCANCAT 5.0	\$49.95	UPGRADE	\$24.95
SCANCAT-PRO	\$79.95	from any version	
SQUELCH DETECT CABLES	\$24.95		



Charge Cards and COD Welcome - Please Call

PLUS \$5.00 SHIPPING & HANDLING \$7.50 FOREIGN

COMPUTER AIDED TECHNOLOGIES

P.O. Box 18292, Shreveport, LA 71138

Order Desk Phone: (318) 636-1234 (9 a.m. to 5 p.m.) FAX (318) 686-0449 (24 hours)

BBS (SCANCAT File Area) (318) 631-3082 (6 p.m. - 9 a.m. Central)

Technical support line (318) 687-4444 2 p.m. to 5 p.m. Central (M-F)

(See our ad on page 51 & 57)

More bad news: The computer's mechanical housing will have a major effect. In my experience running a company which manufactured and sold microprocessor CPU chips to computer manufacturers, I found out a frightening fact: ALL personal computers put out lots of RFI, some less than others in certain bands. The difference can be traced to the Motherboard's layout and materials.

Since most manufacturers are constantly re-designing their computers to update and reduce their costs, you can never predict what RFI will be generated from what manufacturer. Sure, federal standards supposedly apply to allowable emitted radiation. But, a walk through the streets of Korea or Taiwan, where most of the PC component parts are being made, will give you an idea of the impossible task that faces federal regulators and enforcers. Now can you see why I put little faith in "Cure Your Computer RFI" books or columns.

Sometimes I think that Bob was right. But then my wife refuses to read any more "of those #@\$* frequencies," for punching into the memories and I know he isn't. The computer is evolving before our eyes, much in the same way the spark-gap transmitter of the 1900's became the 2 meter, palm held walkie-talkie of the 90's. But it's happening in years, not decades.

For now, we can try to minimize RFI as in the above suggestions and live with the rest. Also, when buying a computer for the shack, made sure you can return the computer for a full refund, and then try a few out in your shack.

Meanwhile, hold on. The future of computer miniaturization and standardization is near. Credit card size 386s are showing up in the professional electronic trade mags! Can the fully shielded computer be far behind? Now, I bet I could design an RF screened credit card enclosure... Nah. Dumb idea. I hope no one was listening.

MT

THE FAMED 2 METER

Also the ultimate for scanner (1B C) to 1300 MHz.

A. S. A. 9209

+9 db Co-Linear "MultiWave" Base Station Double 5/8 over 1/4 wave delivers up to +9 db gain. All fiberglass & solid aluminum construction. Fits masts up to 1-1/2". 2 Meter Base Station 10' length.

+15dB scanner

Made in USA

\$36.73

+ \$5.00 S&H

(SC RES. 5% SALES TAX)

CHECK IN ADVANCE OR C.O.D.

ALSO AVAILABLE IN 220 & 440

ASA

"Service is the Reason For Our Success"

Model 9209
+9db

Tel: (803)293-7888

P.O. Box 3461

Watts: 1-800-722-2681 Myrtle Beach, SC 29578

Ref. "MT" Oct. '93 Pg. 94

Write On!

MT columnists welcome your response to their columns. It's the way to keep MT lively and up-to-date.

Please address your letter to the author
c/o Monitoring Times
P.O. Box 98
Brasstown, NC 28902.



If you request a personal reply, you should always enclose a self-addressed, stamped envelope.

THE ANT FARM

Quality, High performance antennas at reasonable price for the Ham and SWL. Our 47 foot long MB-2A covers all bands, fully assembled, not a kit. Only \$40 ppd in 48 states. SASE for catalog.

P.O. Box 3196
Wescosville, PA 18106

GALAXY ELECTRONICS

67 EBER AVE. BOX-1202

AKRON, OHIO-44309

216-376-2402

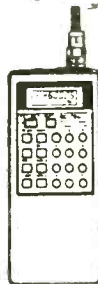

AR-1000XLT

1000ch, covers
500KHZ-1,300 MHZ, 10
Search Banks, LCD
Display, Priority, AC/DC, All
Accessories

\$415

New Ar-1500
W/SSB! Call!

FREE
CELLULAR
MODS!!!

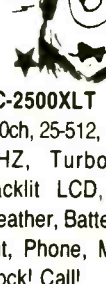

BC-2500XLT

400ch, 25-512, 760-1300
MHZ, Turbo Scan,
Backlit LCD, Instant
Weather, Battery Pack,
Ant, Phone, More!! In
Stock! Call!

AR-2500

2016ch, 1-1,500 MHZ, LCD
Display, AC/DC, Search, Priority,
All Accessories

\$465

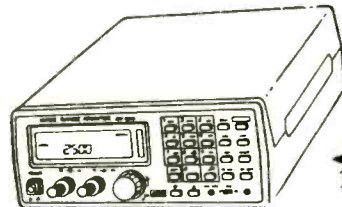

BC-890XLT

200ch, Turbo Scan, 29-54,
108-174, 216-512, 806-956 MHZ,
Backlit, Delay, Priority, More! In
Stock! Call!

SHORTWAVE RADIO

R-5000 100KHZ-30MHZ, 100 Memories	925.00
R-2000 150KHZ-30MHZ, 10 Memories	669.00
ICR-71A 1 TO 30MHZ, 32 Memories	1015.00
ICR-72A 1 TO 30MHZ, 99 Memories	939.00
ICR-7000 25 TO 1300MHZ, 99 Memories	1225.00
ICR-7100 25 TO 2000MHZ, 900 Memories	1250.00
ORAKE R8 100KHZ TO 30MHZ, 100 Memories	995.00
FRG-8800 150KHZ TO 30 MHZ, 12 Memories	699.00
FRG-100 10 TO 30MHZ, Memories	549.00
NRD-535D 1 TO 30MHZ, Memories, Digital	1715.00

POLICE/FIRE SCANNERS

BC-200XLT, 200ch, 29-54, 118-174, 406-512, 806-952	249.00
BC-2500XLT, 400ch, 29 TO 1.3ghz & FM, Turbo Scan	CALL!
BC-760XLT, 100 ch, 29-54, 118-174, 406-512, 806-956	279.00
BC-855XLT, 100 ch, 29-54, 108-174, 406-512, 806-956	225.00
BC-8500XLT, 500ch, 29 TO 1.3ghz & FM, Turbo Scan	CALL!
AR-1000XLT, 1000ch, 500KHZ TO 1300 MHZ	415.00
AR-1500XLT, 1000ch, 500KHZ TO 1300MHZ, PLUS SSB	469.00
AR-2500, 1 TO 1500MHZ, 2000ch, LCD DISPLAY	449.00
AR-3000A 100KHZ TO 2000MHZ, 400ch, LCD DISPLAY	995.00
ICR-100 100KHZ TO 1800MHZ, 121ch, LCD DISPLAY	625.00

PRICES SUBJECT TO CHANGE

USED
GEAR

Price Sheets \$1.00

AIR/POLICE/800 MHZ

BUY
SELL
TRADE

SAME DAY C.O.D. SHIPPING
FREE SHIPPING & INSURANCE!!!
WE TAKE TRADES!!!

Research saves lives.



American Heart
Association

Full 800MHz coverage!

We have scanners with full
800MHz coverage!

Models available include:

ICOM R9000, R7100, R7000, R1,
R100, IC-2SRA; Kenwood RZ-1;
Yupiteru MVT-7100, MVT-7000,
MVT-8000; Shinwa SR-001;
Bearcat BC200XLT, BC2500XLT,
BC700A, BC760XLT, & BC890XLT.

ATLANTIC HAM RADIO LTD.

(416) 636-3636

(416) 631-0747 (fax)

All U.S. orders shipped UPS Air

368 Wilson Ave

Downsview, ON

Canada M3H 1S9

DELTACOMM™ DSS

Digital Signal Strength Option For Your ICOM™ R7000

DELTACOMM™ I-7000 and your MS-DOS computer integrated with the Delta Research custom CI-V interface and optimized software will not just control but will maximize the potential of your ICOM™ IC-R7000's monitoring capability.

- CYBERSCAN function allows scan file tracking control of systems employing frequency hopping techniques.
- Spectrum log at speeds in excess of 1300 channels a minute, generate a real time histogram of activity and create scan database file automatically.
- Birdie log during frequency search automatically characterizes your R7000, then locks out those frequencies.
- Activity log function continuously monitors and logs all frequencies of a scan database while displaying active, was active and never active channels.



Optional DELTACOMM™ DSS (Digital Signal Strength) upgrade for your DELTACOMM™ I-7000 communication manager.

- Innovative interface design allows digitizing and storing the R7000 signal level information with 8-bit accuracy via your computer's game/joystick port.
- DSS allows user programmable upper and/or lower signal level detection limits during DELTACOMM™ I-7000's spectrum log, scan and search functions.
- Log signal strength information to printer or delimited log file while DELTACOMM™ I-7000 is scanning or activity logging the selected database file.

DELTACOMM™ I-7000 communication manager program includes all cabling, manual, UL listed power supply and Delta Research custom CI-V interface for \$299.00 + \$8.00 (U.S.) or \$25.00 (foreign) S&H. The DELTACOMM™ DSS interface upgrade comes complete with easy to follow NO SOLDER installation instructions, all cabling and 8-bit DSS A/D converter module (game port required) for \$99.00 + \$8.00 (U.S.) or \$25.00 (foreign) S&H and is available as an upgrade option to registered I-7000 users. Contact us for additional information on DELTACOMM™ communication managers for ICOM™ R7100, R71A, R72 and IC735.



Delta Research



Box 13677 • Wauwatosa, WI 53213 • FAX/Phone (414) 353-4567

UNLOCK FULL 800 MHZ

\$40

FREE
CELLULAR
FREQUENCY
CHARTS

- 100s of satisfied customers
- Warranty & Service Plan Protection
- Same-day Service — FREE insured UPS return

PRO	BC
34,37	200
39	205
43	700A
46	760
2004,5,6	855
2022	890
2026	950
2030	2500

FOR DETAILS CALL:
508-768-7486

SHIP TO:

Cellular Security Group
106 Western Avenue,
Essex, MA 01929

See our ad on page 85

Improve Your Scanning Coverage!

GRE America is proud to introduce a new family of products to enhance your scanning pleasure! First, GRE has designed the new **Super Converter 9001** for base model scanners. The 9001 converts 810 MHz - 950 MHz down to 410 MHz - 550 MHz. The 9001 is the perfect alternative to buying a new, expensive scanner covering the 800 MHz band. Next, GRE announces the new **Super Amplifier 3001** for base model scanners. The 3001 will increase gain by as much as 20 dB, and is engineered to help scanners with low sensitivity pull in weak signals. Both products use BNC connectors, (1) 9 volt battery and have an off/pass switch for returning to normal operation.



Super Converter 9001 & Super Amplifier 3001



Super Converter II



Super Amplifier



All-Band Antenna

U.S. & International Distributorship inquiries welcome. Please call GRE for further information!

Let GRE Manufacture Your Radio Products!

GRE America, Inc. is a leading OEM developer and manufacturer of radio telecommunications products such as:

- Cordless Telephones
- CB & Marine Radios
- Spread Spectrum "engines"
- Remote Monitoring Systems

If you need a high quality, cost competitive, reliable manufacturer, GRE will provide you with a free production quotation.

For more information, please call GRE at (800) 233-5973. GRE is a subsidiary of General Research of Electronics, Inc.

GRE

GRE America, Inc.

GRE America, Inc.
425 Harbor Blvd., Belmont, California 94002
(415) 591-1400 Outside California: (800) 233-5973

Effective Earth and Radio Ground Systems

Some misconceptions exist concerning DC (earth) and AC (RF) ground systems. I have seen a number of SWL and amateur stations that were equipped with antennas that are dependent upon a quality ground screen or radial wires in order to function efficiently with minimum ground losses. Unfortunately, some of these stations had only a metal rod driven into the soil, from which a wire was routed to the station equipment. Others depended upon the cold-water pipes in their homes for the antenna ground system. Let's explore the characteristics and minimum requirements for these two types of grounding methods.

Ground Rods and Water Pipes

The primary importance of a station earth ground is operator safety. The electronics equipment on your desk or table should always be connected to a first rate earth ground. This will protect you from electrical shocks in the event the chassis of your gear should become "hot" because of a circuit malfunction.

It should be noted that a lot of radio equipment has bypass capacitors connected between each side of the AC-input line and the equipment chassis. If you do not have the various pieces of equipment grounded, you can get a nonlethal jolt when you touch the cabinet and a damp floor, water faucet or some other item that *is* grounded. When you have an earth ground attached to your station apparatus you will not feel this annoying tingle when you touch the equipment. Remember always that capacitors can pass AC current, and

that's why some of the 120-V primary current can flow to the chassis through the capacitors.

In many instances the cold-water pipes in your home (assuming they are copper and not PVC!) can provide an excellent earth ground. Iron pipes may also serve this purpose if the pipe sections are not insulated from one another by means of pipejoint compound or teflon pipe-thread tape. You can check the joints with an ohmmeter if you are in doubt.

Measure across each pipe joint while using the low ohms scale of your meter. The resistance should be finite rather than a few ohms. If you find a resistive joint you can bridge it with two small hose clamps and a piece of copper braid from some RG-58 coax. Recheck the resistance to ensure that it is finite.

Figure 1 illustrates a proper method for creating a quality earth ground outside your home. It should be located as close to your radio room as practicable. This will eliminate the need to have a long piece of wire between the ground rods and your radio equipment. The longer the wire the more resistive it becomes and the less effective the grounding. Use a large conductor, such as the shield braid from RG-8 or RG-11 coax for joining your ground rods to the station equipment. As Figure 1 indicates, four 8-foot ground rods are driven into the soil. The rods are six feet apart. They are joined electrically by means of copper braid that has been soldered to each rod by means of a propane torch.

It is important to remember that *this ground system is not sufficient for use as an antenna*

ground system, even though it may be better than no ground at all. Likewise for the water pipes in your house.

Ground Systems for Antennas

You will hear references to "ground-screen" and "radial" types of ground systems. Both of these are commonly employed for providing an efficient ground system for use with antennas that are 1/4 wavelength long, or multiples of 1/4 wavelength, such as a 3/4-wavelength antenna. The earth thereby represents what is known as the "image half" of the antenna. You can think of the image as being the missing half of a dipole. Ground screens, radials or counterpoise wires may be used with horizontal or vertical 1/4-wave antennas. The worse the quality of the ground system, the more lossy the antenna becomes, and this spoils its effectiveness for transmitting or receiving signals.

Physical Traits of Ground Systems

Radial wires may be buried in the soil or they can be above ground and suspended on insulators. Generally, only four radial wires are required for above-ground installations. If the wires are laid on the ground or buried, you will need a large number of them. In either situation the wires should be 1/4 wavelength long at the operating frequency of the antenna.

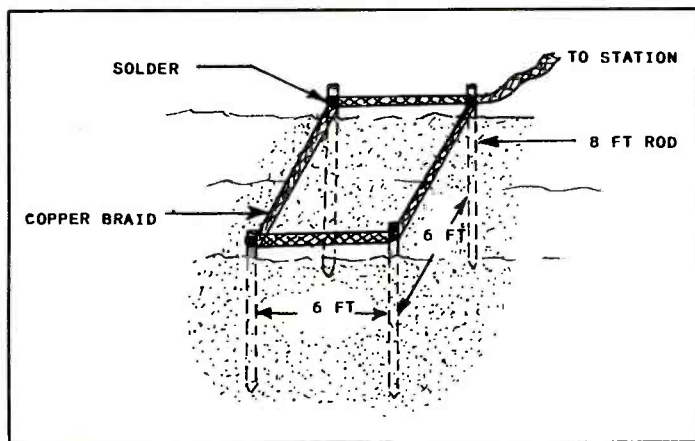

Figure 1: Details for constructing a quality DC earth ground. When it is connected to your station equipment it will protect you from hazardous electrical shocks.

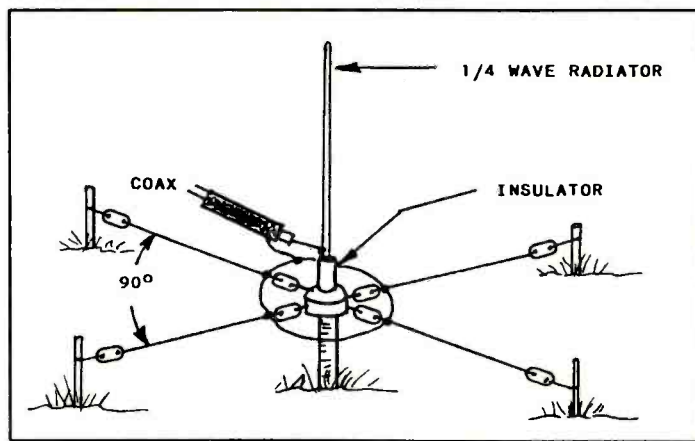

Figure 2: An example of four above-ground radials as they are used with a 1/4-wavelength vertical antenna.

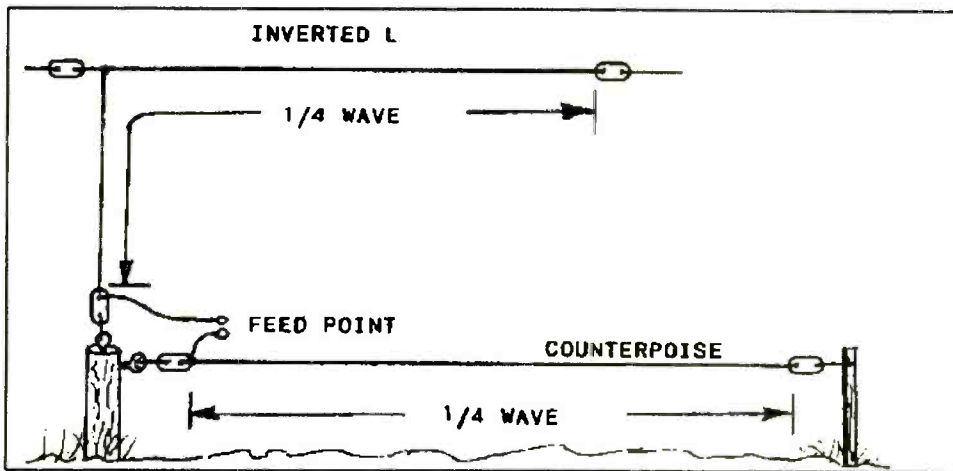

Figure 3: Shown here is a 1/4-wavelength inverted-L antenna that uses a single 1/4-wavelength counterpoise wire for its ground system.

Most designers use above-ground radials that are approximately 5% longer than the antenna driven element if it is a full-size radiator (not with loading coils or traps). If the antenna is physically short because of loading coils or traps, then cut the radials 5% longer than the calculated length for a 1/4-wave radiator ($L_r = 234/f_{MHz}$).

The actual number of on-ground or buried radials is arbitrary. I have read engineering papers that specify 120 radial wires. Beyond that number the engineers observed no improvement in antenna efficiency. I have used as few as eight buried radials and had excellent results. Some of them were less than 1/4 wavelength long. An acceptable rule of thumb is to use as many radials as you can manage—the more the better. Ideally, they would be deployed linearly from the base of the antenna, but that is not always possible. The main thing is to get them in the ground in as many directions as possible.

The radials are soldered together at the point where they converge (base of the antenna) and are connected to the shield braid of the coaxial feed line. The center conductor of the coax is attached to the driven element or radiator if no impedance matching network is used at the antenna feed point. An impedance matching network (coils and capacitors) is preferred to ensure that the 50-ohm coax feed line is matched to the antenna (generally less than 20 ohms for verticals with buried radials). But, for reception only it is okay to skip the matching network. Figure 2 shows how above-ground radials are used with a 1/4-wave vertical.

A Counterpoise Ground

A popular practice among amateurs many years ago was to employ a single 1/4-wavelength, above-ground wire (counterpoise) for use with an end-fed quarter-wave antenna. In effect, this would be the same as using one radial wire. In this situation the single counterpoise wire func-

tions as the missing half of a dipole. SWLs and amateurs who live on small pieces of property may find the counterpoise their best choice for an antenna ground. The counterpoise can be any convenient height above ground, but the greater the spacing between it and a horizontal 1/4-wave antenna the better the antenna performance. This is because the effective height (and height is important) of the antenna is dependent upon the spacing between it and the counterpoise. Figure 3 depicts a 1/4-wave inverted-L antenna that has a counterpoise.

Improving a Mediocre Antenna Ground

If you lack the room for a large number of buried or onground radials you can enhance the ground system by connecting it to chain-link fences, if you have them around your yard. In this situation the cold-water pipes may be added as well, since they usually occupy a fair amount of real estate in the earth. Metal fencing other than the chain-like variety is useful also for enhancing the ground system.

Closing Remarks

The main purpose of this article is to clear up any doubts you may have had about ground systems and to point out that ground rods are not a substitute for an antenna ground system. At best, they can only serve as a reference point for the shield conductor of your coaxial feeder.

You need not use large diameter wire for on-ground or buried radials. Even wire as small as no. 30 will work, but it is too fragile to work with. Also, the smaller wire will be eaten away quickly by soil acids and alkalis. Wire with plastic insulation will last a long time, but bare aluminum wire (such as electric fence wire) may turn to powder in a few months.

M_T

TIRED OF PLAYING GAMES?
**Finally, a practical use
for your sound card!**

Passband monitoring

Signal identification and tuning

Notch filter adjustment

3-D surface plots & color spectrogram track frequency changes over time

Multiple open windows

Spectra Vision & Spectra Plus.

Real-time audio spectrum analyzers. Full control over FFT size, sampling rate, scaling, gain, and averaging. Requires 386 or better, Windows 3.1 and any Windows compatible 8 or 16 bit soundcard.

"—Knock-your-socks-off quality!"—Harold Price, QEX Magazine, Dec. '93

	Spectra Vision	Spectra Plus
Modes		
Real time	●	●
Recorder		●
Post process		●
Price	\$89 ⁰⁰	\$179 ⁰⁰

All display formats included with either package. 60 day money-back guarantee.

800-401-3472 fax/voice 206-697-3472

Visa, MasterCard, Check or Money Order

Pioneer Hill Software

24460 Mason Rd., Poulsbo, WA 98370

S & H included, foreign delivery add \$10.00

Demo disk \$4.00 (credit toward purchase)

• R-7100 Speedup • Home-Brew Signal Generator

Steve Morehouse of Fargo, North Dakota, contributes this hot mod:

The ICOM R-7100 is an excellent receiver, but it can be made magnificent with one modification. Given the versatile and well thought out programming of the microprocessor, the unit lacks one thing: SPEED. Luckily, this progeny of ICOM has the same genes as its older brother (R-7000), and will accept a little parental encouragement to get off its sluggish duff.

The microprocessor speed can be doubled, with the same results as the speed modification of the R-7000 (see *MT*, June 1990), only this modification is even easier, because there's no separate scan speed oscillator with which to be concerned.

The crystal that controls the R-7100's CPU speed can be exchanged fairly easily. (Keeping track of which screws and connectors secure which boards is the worst part of the task.) The original crystal (X-1) is 9.83 MHz. Replace it with a 20 MHz crystal to increase memory

scanning from 10.3 to 22 channels/second, and speed of searching ("Program Scanning") from 11.5 to 24 increments/second.

X-1 is located on the Logic Board just behind the front panel and just below the mullet-function LCD readout. Since a 20 MHz microprocessor crystal is twice the size of the original, be on your toes: the new crystal must be carefully positioned. DO NOT try to get by with a junk or surplus crystal nor anything of the CB-type. These kinds of crystals usually operate at twice or three times the fundamental frequency and could pose a danger of blowing out the CPU.

Obtain ONLY the kind of crystal referred to as a microprocessor crystal, and don't be tempted to go for something faster than 20 MHz. The faster a CPU's gates open and close, the more current it drains and the hotter it runs. All CPUs have a redline, beyond which they like to turn belly up. Fortunately, there is some latitude, but don't go hog-wild, please.

Most of the side effects of the original R-7000 modification apply: doubled baud rate for serial computer control, halved scan-resume delay times, and you have to group frequencies together when entering them into the memory channels. You DON'T have to worry about searching too fast for the circuitry to recognize a signal, as on the R-7000.

Also, because the R-7100 is designed with its heat-producing components away from the logic board, heat buildup is not the problem that it was on the R-7000 (causing loss of memory).

A Cheap Signal Generator for Hidden Transmitter Hunts, Antenna and Receiver Tests

Signal generators are EXPENSIVE, large, heavy and cumbersome to lug around. You can, however, roll your own into a cubic inch or less for next to nothing provided you don't mind a decided dearth of frills, razor-edged quality, and good looks. The gizmo I have in mind for this month is a basic crystal controlled oscillator that will accept almost any type of quartz crystal over a very wide range of frequencies. A handful of the desired crystals will yield a perfectly functional signal generator which can be used to evaluate the performance of shortwave and scanning receivers, as well as antennas. The oscillator can be used as the emitting device for hidden transmitter hunts. Add only a few extras for a nice wireless microphone.

An oscillator does the same thing as a guitar string when plucked, or a piano string when struck: it oscillates or vibrates at a precise and relatively consistent rate. Like musical strings, an oscillator can be tuned or adjusted. Unlike musical strings which vibrate at audio rates, our oscillator vibrates at radio frequencies, from maybe as low as a few hundred kHz to 100-MHz or higher. Our oscillator will be coarse-tuned or "adjusted" by the choice of crystal. Each crystal can be "trimmed" or finely tuned by means of a small trimmer capacitor.

There's really nothing to it; a crystal, a transistor and a few parts. One benefit of this cheap oscillator is that not only will it put out a healthy signal on the fundamental frequency, but also plenty of even and odd order harmonics up to the 8th to 10th order or thereabouts. Normally this is not good; oscillators are supposed to generate just the frequency for which they are designed, but ours is so simple (on purpose) that it puts out eight or more odd and even multiples of the crystal frequency.

ALL PURPOSE TEST OSCILLATOR

NOTES:

1. The crystal is not critical, but probably should not be lower than 1 MHz, nor higher than 50 MHz.
2. An optimum value may be as high as 1100-ohms. Use of a 2-k trimpot is suggested to determine best value.
3. An optimum value may be as low as 4000 ohms. Use of a 100-k trimpot is suggested to determine best value.
4. The trimmer capacitor should have as wide a "swing" or tuning ratio, max to min, as possible. The high end will not adversely affect the oscillator's operation, but oscillations may stop as the trimmer is adjusted toward the minimum end of the range.
5. Ground traces and connections are shown in heavy black lines. All grounds are interconnected.

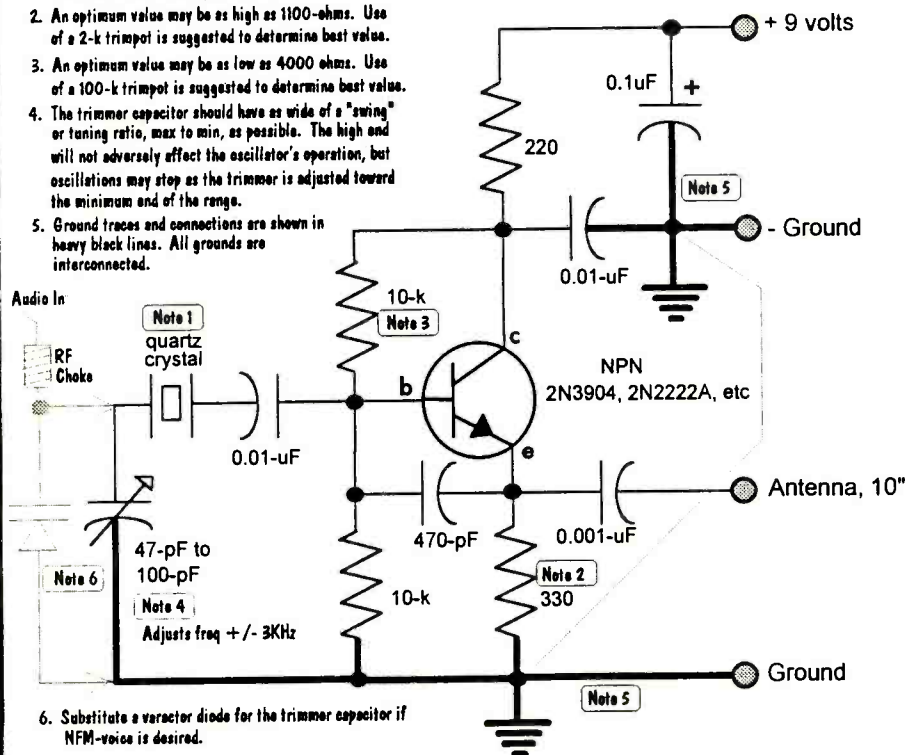

6. Substitute a varactor diode for the trimmer capacitor if NFM-voice is desired.

Depending on the type of crystal, it might put out subharmonics of the crystal frequency as well! Again, this "shoddy" operation normally is not considered good, but for our purposes, it means a number of test signals are available in the output at the same time. You can test your shortwave receiver and your VHF-UHF scanner without having to change crystals.

Construction of the test oscillator is not critical, but for best operation with the most harmonics, all components should be close together with short interconnecting wiring. The test oscillator is powered by 9-volts, DC, but probably can vary from as low as 5 volts to as high as 12 volts or a little more. Just be aware that the frequency will change as the voltage changes, which is not good, even for our test purposes. For portable operations and transmitter hunts, I prefer to power my test oscillators with two 9-v batteries, wired in series for 18-volts, and fed to a 78L09 or LM-317T regulator to set the voltage to a regulated 9 volts. I'll leave the oscillator's power up to you, but this design is for 9-volts.

WARNING: Depending on how you configure and use the test oscillator, its operation could conceivably be illegal. The FCC imposes a limit on the length of the antenna and on the maximum power that can be radiated from the antenna. I'm not up on the latest regulations, so check first before you go hog wild with sophisticated antennas and power-increasing design techniques. The transistor can self-destruct if you draw too much power off the oscillator. Caveats out of the way, let's build it and have some fun.

Perfboard assembly with point-to-point wiring and soldered connections are fine. A crystal socket facilitates easy replacement of crystals as desired. A socket for the transistor is nice in the event you destroy one during setups and alignment. The assembled board should be installed in a small metal box for shielding and isolation from sudden temperature changes. The metal box can and should be grounded to the ground traces on the board.

A BNC jack can be installed on the box somewhere to facilitate the connection of an antenna which should not be longer than about 10" to keep operation legal. Use a phono jack as a receptacle for power from a DC adapter. Install battery clips to hold the one or two 9-v batteries for portable operations. The trimmer capacitor can be almost any mini-tunable type with a maximum of not more than 100-200 pF and a minimum of 10-15 pF or less.

If you need a low power voice transmitter, the trimmer capacitor can be substituted with a varactor diode. It is beyond the scope of this article to dwell on how to choose the best varactor diode, but they are cheap enough that a few trials will produce a nice sounding voice transmitter. Add a 470-uH RF choke to the junction of the crystal and the varactor diode and feed a

preamplified audio signal to the other end of the choke. The output will be narrow-band FM, so this unit might make a nice wireless mic if you use a little ingenuity in the mechanical packaging. The peak-to-peak value of the modulating audio signal will determine the FM deviation of the carrier, and something on the order of 1-v, p-p, will probably be required. This means the audio signal should come from a gain-adjustable preamplifier so you can set the FM deviation to about ± 3 kHz.

Other Uses

The oscillator is great for testing and evaluating antennas, too! A portable version pitched out into the field a hundred feet from the antenna under test will produce a real-life signal without bothering a soul anywhere else. The antenna can then be trimmed, tuned and adjusted for optimum performance on the desired frequency using your receiver and S-meter as visual/aural feedback instruments.

The All Purpose Oscillator emits a range of signals as multiples of the crystal frequency. For example, if you select a 20 MHz crystal, you can expect to find signals at 20, 40, 60, 80, 100, 120, 140 and possibly 160 MHz and above at 20 MHz intervals. You might also find subharmonics at 10, 5 and 2.5 MHz. "Overtone" crystals like those used in older CB radios are especially useful in this oscillator. The popular 23 MHz and 37 MHz series work great. So, you see, the All Purpose Test Oscillator need not cost much and it will make a handy little instrument for your growing electronic bench.

Not to give ideas to anybody, but I've heard stories from the golden days of CB how "good guy" vigilantes whipped up one of these oscillators and carefully tuned it to a "bad guy's" home channel. The gizmo was sealed into a jar with a fistful of batteries to last several weeks and a 2-3 ft antenna wire fed through the lid. The jar was buried near the victim's house, 50-100 yards, and the antenna snaked under leaves and grass so that for weeks, the poor fellow was unable to hear anything on his favorite channel, thanks to the 30-dB/S9 dead carrier.

It is said that "Leon" (R.I.P.) of San Diego, California, referred to a similar trick pulled on him as having "stainless steel earplugs." I'm told that the perpetrators of this incident used such an oscillator wired to a large 12-v gel cell and hung it in a neighborhood pine tree where it plugged "Leon's" receiver for months until the wind finally blew it out of the tree and the case came to light.

March Correction

No sooner did I print a correction to the diode bridge in November's project, than I turned around

PC Software by W2XQ



NEW for HF-150!

THREE new programs for this award-winning receiver: (1) Windows' front end to set VFO and memories. (2) SWBC Schedules v3.02 loads data into VFO or memories. (3) "Memory Management" to load "lists" of frequencies into 60 memories.

Send SASE or download complete catalog from Pics OnLine BBS 609-753-2540.

TRS Consultants

PO Box 2275-MT
Vincentown, NJ 08088-2275
609-859-2447 | Fax 609-859-3226

ATTENTION ICOM OWNERS!

THE WILLCO ICM-1024 NO FAIL MEMORY NOW INCLUDES LARRY VAN HORN'S 250 "HOT" H.F. FREQUENCIES. USING YOUR ICOM R71 OR IC-751 FRONT PANEL CONTROLS SELECT 1024 MEMORIES. (The IC-745 REQUIRES EXTERNAL SWITCHES).

SPECIAL LOW PRICE! \$99.95 + \$3.00 S&H
ILLINOIS RESIDENCE INCLUDE 6.75% TAX
OFFER GOOD UNTIL MAY 31 1994

WE ALSO SELL BOWTIE FILTERS MODS FOR THE M7000, M8000 & PK232

FOR MORE DETAILS WRITE TO

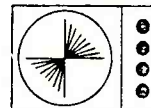

WILLCO Electronics
P.O. Box 788
New Lenox, IL
U.S.A. 60451

If you stutter, you're not alone.

The National Stuttering Project

2151 Irving St., #208
San Francisco, CA 94122-1609
Tel: (415) 566-5324, FAX: 415-644-3721

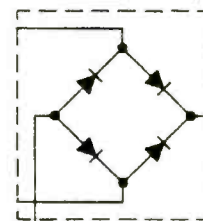

and did the exact same thing in March! Thanks to S. Hatchikian for noticing. The correction to Fig. 2 of the DC power supply project is above. (Although the error is of no consequence if a full-wave bridge rectifier is used, if discrete diodes are used in a full-wave configuration, it is significant.)

Well, that's it for this month, folks. Keep **M** your feedback coming! 73/Bill

The T2FD Antenna

Some readers have asked about the terminated, tilted, folded dipole (T2FD) or W3HH antenna first described by Countryman in 1949. This antenna is moderately nondirectional and, as it is oriented somewhat vertically, it will perform well for DX. Being a sloper it requires relatively little mounting space compared to many wire antennas. Some reports indicate that it exhibits gain over a dipole across its bandwidth; however, other reports (including my own experience) indicate that its performance is somewhat below that of a halfwave dipole's within the dipole's bandwidth. On the other hand, the T2FD has a bandwidth that far exceeds that of the dipole: about 5 or 6 times its design frequency.

Perhaps more pertinent to receive-only applications is the fact that broadbandness in an HF antenna is of more interest when one uses an antenna for transmitting as well as receiving. This is due to the fact that signal-to-received-noise level, rather than simply signal level delivered by the antenna, will determine reception success over most, or usually all, of the HF band as well as for frequencies below HF. Thus, even random-length wires can give considerable "apparent broadbandness" in HF and lower-frequency receive-only applications.

The T2FD (fig. 1) should ideally be slanted 30 degrees (20 to 40 degrees acceptable) from the vertical. At this tilt the antenna is moderately nondirectional but it does have a number of lobes and nodes in its directivity pattern, at least when mounted near a conductive structure.

The resistor (fig. 1) is noninductive and, for receive-only installations, its power rating can be 1/2 watt or larger; for transmitting installations it

should be rated to handle 35 percent of the transmitter's final-stage input power. Carbon film resistors are noninductive at HF. High-power noninductive resistors are sometimes available through surplus outlets such as Fair Radio Sales, 1016 E. Eureka St., Lima, OH 45802..

The antenna's length is determined by the formula:

$$\text{Length (in feet)} = \frac{328}{\text{lowest operating frequency in MHz}}$$

$$\text{Length (in meters)} = \frac{100}{\text{lowest operating frequency in MHz}}$$

For example, the length of a T2FD cut to cover from 7 MHz to 35-42 MHz length would be 46.9 ft.

Let's Make One

1. Determine the length of your antenna from the formula above. Add 2 inches to this length.
2. Get enough 300-ohm TV twinlead to equal the length found in step 1, plus enough to go from the antenna to wherever you mount the balun or antenna tuner mentioned below.
3. Cut a piece of twinlead to the length found in step 1. Find its middle and cut each wire conductor there. Don't cut the center part of the insulation.
4. Make a center insulator as shown in fig. 1 from a sheet of plastic. I used the side of a plastic

milk jug folded double. Thread the antenna into the insulator and add the nylon nuts and bolts (your hardware store has them) as indicated in fig. 1.

5. Trim the insulation from both ends of the antenna for about 1-1/2 in. At each end add an insulator (fig. 1), twist the wire ends together and solder them to hold the insulator in place.

6. At one of the middle cuts you made in step 3 remove insulation from both ends of the cut wire and solder a 390-ohm resistor (375 to 400 ohms acceptable) between these ends (fig. 1). Leave a bit of slack in the resistor leads.

7. Clean the insulation from the ends of the other middle-cut wire and from the conductors at one end of the twinlead lead-in. Thread the lead-in into the insulator as in fig. 1 and add the nylon nut and bolt as shown. Twist and solder the two twinlead wires to the two antenna wires.

8. Attach one end of the antenna to a high point and the other end to an anchor point nearer the ground. Remember the 30° angle you are striving to achieve.

9. Run the lead-in cable to a balun or to an antenna tuner that can handle balanced lead-in. If a balun is used, attach the twinlead lead-in to its high-impedance terminals. A 4-to-1 ratio balun is correct for 75 ohm coax and a 6-to-1 ratio balun (to be covered in next month's column) would be correct for 50-ohm coax; however, the 4-to-1 should be acceptable in most applications. Run coax from the low-impedance terminals of the balun, or from the tuner, to your rig.

For receive-only HF installations you can usually omit the tuner or balun and still have satisfactory results by connecting one twinlead wire to the center of your antenna input and one to the outer shell of the connector.

10. If you live in lightning country don't forget lightning protection. The minimum here is to disconnect and ground the antenna when it is not in use and never use the antenna in weather likely to produce lightning.

Your antenna is now ready to use, Happy monitoring!

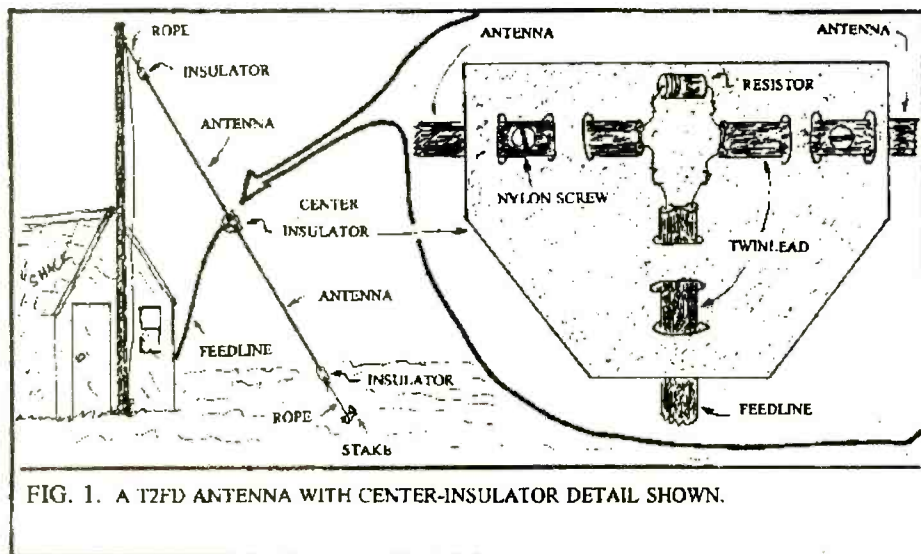
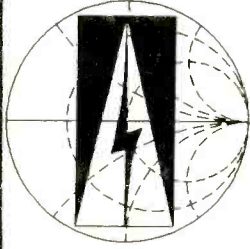

FIG. 1. A T2FD ANTENNA WITH CENTER-INSULATOR DETAIL SHOWN.



Austin Antenna

"The World Leader in Multiband Technology"

Manufacturers of multi-band Land Mobile, Microwave, and Scanner Antennas for Government Agency operations, Drug and Law Enforcement operations, Communications at the Kennedy Space Center and major networks such as NBC and ESPN.



The Ultimate Omnidirectional Multiband Station Antenna



CONDOR
New Innovation brings New Dimensions for Portables!

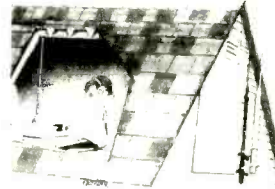
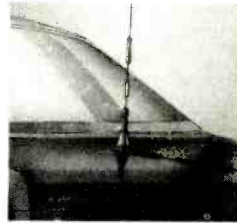

Superb Performance!
with Maximum Versatility for Mobile and Base Station



Send \$1.00 for an Austin Scanner Antenna User's Guide [a regular \$3.95 value]

Austin Antenna 10 Main Street, Gonic, N.H. 03839 (603) 335-6339

A Handy Test Accessory

Advanced Electronics Applications (AEA) has developed a series of Graphical Antenna Analyzers for the HF, VHF and UHF bands. These instruments can be used to indicate the SWR (standing wave ratio) for the match between any RF (radio frequency) device (usually an antenna) and its intended 50-ohm or 75-ohm source or load (usually a transmission line or transmitter output). The series covers from 1-31.999 MHz (model SWR-121 HF), 120-175, 200-225, and 400-475 MHz (model SWR-121 V/U).

Battery operated and microprocessor controlled, these RF Analyzers present you with a graphic LCD readout of SWR across their frequency range as well as a digital readout of the SWR at the center frequency of the graph. I found it both a pleasure and a feeling of power to be able to see immediately how SWR varies across frequencies for an antenna. You get in mere minutes what once took a technician hours to measure and graph.

Antenna bandwidth and return loss for a feedline can also be measured with these devices. And they have a serial interface with software available allowing use of a PC-compatible computer for remote control and display of their SWR graphics.

It takes a few minutes with the instruction manual to master operation of these devices, but it is time well spent; this is an excellent instrument for the ham, CBER or anyone who is concerned with determining the match of antenna and feedline, receiver and feedline, transmitter and feedline, or between any other 50-ohm or 75-ohm source and load. More information is available on the SWR-121 series by calling AEA's literature request line: 1-800-432-8873.

RADIO RIDDLES

Last Month

Last month I asked you: "If you were an earthworm under the surface of the ground very near the base of the antenna tower," which was a tall metal tube transmitting 100 kw of RF power, "would the radiation from the tower have any effect on your little body?"

Well, if the tower had a good set of 120 radials, as BC stations do, and you were well below the level of the radials, you might be OK. The radials are the return path for the RF which reaches the ground near the antenna. Fishermen sometimes use AC current passed through the ground surface to cause earthworms to come to

Looking for a Good Antenna Handbook?

If you'd like a good source of information about antennas you will be interested in **THE ANTENNA HANDBOOK** by Clem Small. Within its 200-plus, 8 1/2" by 11" pages, there is much material from past "Antenna Topics" columns plus a considerable amount of new material.

It is an excellent source of information for selecting, constructing, understanding, and utilizing your antenna system. Also covered are subjects like the history of antennas, odd and unusual antennas, signal propagation, factors affecting antenna performance, antenna accessories, and antenna troubleshooting.

THE ANTENNA HANDBOOK is available from Grove Enterprises, P.O. Box 98, Brasstown, NC, 28902 for \$12.95 plus \$2.00 book rate postage (\$4.50 UPS).

the top of the soil where they are easily gathered for use as fish bait. If you were above the radials you would likely feel the RF as a tingling (or worse!) and try to escape.

This Month

Which will cause more loss in HF receiving capability (signal-to-noise ratio): a certain amount of loss (10 dB) in transmitted power due to transmission line losses at the transmitter or the same amount of loss (10 dB) in received power due to transmission line losses at the receiver? Would the answer to this be different for VHF, UHF or microwave?

We'll have the answer to this month's riddle, and much more, in next month's issue of *Monitoring Times*. 'Til then, Peace, DX, **M** and 73.

Q. *Electrical noise in the long, medium and short wave bands is getting worse and worse. Are these devices in compliance with FCC rules and regulations? (Richard Phoenix, Plainfield, NJ)*

A. Yes and no. Keep in mind that receivers are more sensitive than they used to be, and there are more electrical devices in use. The FCC Rules and Regulations specify under Part 15 certain limits for unintentional radiations. Manufacturers, however, are not required to submit samples to the Commission, only to depose that they meet the certification levels.

The FCC is terribly under-budgeted to enforce their regulations; that is why CB was deregulated and now sounds the way it does. Unless multiple reports are made to the Commission regarding an offensive device, little action can be expected. And it will get worse.

Q. *As a newcomer to shortwave, I am curious about the significance of the number "73"; what does it mean? (Brian Neggemann, Milwaukee, WI)*

Questions or tips sent to "Ask Bob," c/o MT, are printed in this column as space permits. If you desire a prompt, personal reply, mail your questions along with a self-addressed stamped envelope (no telephone calls, please) in care of MT.

A. In the early days of radio, all two-way communications were conducted by Morse code. In order to expedite message handling, abbreviated forms and prosigns were used. Two popular signatures were "Love and Kisses" (88) and "Best Regards" (73).

Q. *I rarely use my handheld CB transceiver; which type of rechargeable batteries would be best, nickel-cadmium or the new alkalines? (Jim Clifton, Cedar Rapids, IA)*

A. Since NiCds discharge rapidly, generally useless within a month, I would opt for the new rechargeable alkalines. They hold their charge for years.

Q. *Why is it that when I am experiencing S-meter flutter on a shortwave AM station, if I switch to single-sideband mode, the flutter goes away and the audio stops fluttering? (Bob McPherson, Etowah, NC)*

A. Signal flutter is caused by an unstable ionosphere, the solar-influenced, electrically-charged upper atmosphere that reflects radio signals. When you select single sideband, the narrower bandwidth and slower AGC (automatic gain control) timing (depending upon the receiver model), make audio fluttering less pronounced.

Q. *I would like to cut down an old trap-coil CB whip to make a 25-1000 MHz scanner antenna; how long should the whip be? (Brian Gaskamp, Brenham, TX)*

A. You can't do it. In the case of the CB whip, the coil is to make up for the missing portion of a physical length of about nine feet for 27 MHz resonance (easiest to match to the transceiver for optimum coupling of power).

Coils in scanner antennas, however, are designed to isolate different sections from each other so that each becomes resonant at its own frequency range for optimum signal coupling to the receiver.

A whip antenna is normally resonant over roughly ten percent of its design frequency, and even "hears" well for another ten or more percent outside that range, and at odd multiples (3 times, 5 times, etc.) of its design frequency for receiving purposes.

But as you listen higher and higher in frequency beyond the resonant frequency of an antenna, the "look" angle rises, so it is better for hearing aircraft flying overhead than a police car down the block!

Q. *Is there any way to disconnect the automatic low-battery shutoff on my Realistic(C) DX-380 portable radio? (Mike Oreskovic, 2231 Silverbirch Court, Burlington, Ont. Canada, L7M 3H3)*

A. Sure, but without a schematic I don't know how to do it! Anyone out there who can help Mike? Write to him directly.

Bob's Tip of the Month

PRO-2030 Cellular Frequency Restoration

NOTE: It is not lawful to monitor cellular or conventional mobile telephone conversations. The following procedure may violate your warranty. *Monitoring Times* assumes no liability resulting from its attempt, nor will accept the modified scanner for return under any condition.

The Realistic® PRO-2030 has cellular frequencies deleted at the factory, but restoration is one of the easiest we have ever seen—clip one marked wire! All you need is a Philips screwdriver and wire cutters.

- (1) Turn the scanner upside-down and remove the screws holding the bottom cover in place; pull the cover loose and set it back about two inches out of the way.
- (2) Locate the small circuit board at the lower right-hand corner and find jumper L201. Cut it and slightly separate the break.
- (3) Reassemble the radio which now has continuous 806-956 MHz coverage and 30 kHz search increments in the cellular band.

Q. I have a typical stereo receiver with an attachable loop antenna; it has connections for an external antenna as well. Is there any way I can improve reception? (Don Chism, Camarillo, CA)

A. There is an excellent product on the market called "Select-A-Tenna"; it is a tunable 11" loop which is simply set adjacent to the radio. It has provisions for an external antenna as well, and can be connected to the receiver if desired. It is available from Grove enterprises and a number of other MT advertisers.

Q. What would be the difference in using a tunable preselector versus an interference filter on my shortwave receiver to remove overload from nearby AM, FM and TV stations? (Richard Dailey, Pittsburgh, PA)

A. Filters are designed either to remove or to pass certain frequency ranges; they are not designed to be retuned. Preselectors are adjustable to pass the particular frequency that you are monitoring at the time, rejecting all off-frequency signals.

Filters are preferred so that you don't have to keep retuning. In your case you would need a combination of two filters: a 1.7 MHz high-pass filter to eliminate the AM broadcast band, and a 30 MHz low-pass filter to get rid of TV and FM signals.

But what about strong shortwave signals? Do they overload your radio as well? If so, you would be better off with the tunable preselector which can be peaked on each signal frequency you select to monitor, rejecting other shortwave, AM and VHF/UHF (FM and TV) signals as well.

Q. Does anyone know when the unit "cycles per second" became "hertz"? My instructor said, "12 October, 1960." Wasn't it earlier than that? (Clarence W. Patton, St. Cloud, FL)

A. According to the Time and Frequency Division of the National Institute of Science and Technology (NIST), your instructor was right! But for decades before that, hertz was the common European unit and is commonly seen on German World War II surplus **M_T** equipment.

Mac
IBM

OSO Tutor[®] Study Aid for the Amateur Radio Exams



- Runs on IBM compatibles or Macintoshes
- Programs are available for Novice, Technician, No-Code Technician, General, Advanced and Extra Amateur classes, Commercial Radiotelephone and Radar Endorsement. Each sold separately.
- Work with the entire question pool or questions automatically selected from your weakest areas.
- Current Questions. Future updates: \$10
- Includes full screen graphics, explanations on appropriate questions and, on the IBM version, a pop-up calculator.
- Logs multiple study sessions and allows resuming at a later time.
- Creates random sample tests on-line or printed with graphics, suitable for VEC testing, on Epson/IBM or Mac printers.
- PD Morse code tutor included on request.

1 800 483-3973

(1 800 GUD DX 73)

Ordering info only please!

PA residents add 6%. Price includes shipping.

The new "No-Code Technician" license is now available. You can become an amateur operator with VHF and UHF voice privileges without passing a Morse Code test. All you need to pass the exam is included in our No-Code Package. You can be a ham easily and quickly.

"Great Programs - I passed the advanced and extra licenses both in one morning! After 12 years as a general. The sample test portion really got me going! See you in the pileups! After 12 WBYIF"

"As far as I am concerned, there is nothing like the OSO Tutor program. I have tried another and believe me, there is no comparison" KA3ZBE

"The most advanced program I've tried... Graphics are extraordinary... This program should be your first consideration." Gordon West - Worldradio

"Do I recommend the OSO Tutor? Heavily. Yes! It really motivated me and it's a great way to test my progress. The learning is a natural by-product of the fun I am having." Jim Ball - 73 Magazine Review

Also Available: OSO Controller[®] \$99.95

- The ultimate companion for controlling late model Kenwood rigs.
- Full mouse driven graphical user interface.
- Controls all functions of TS-950, 940, 850, 811, 711, 450, 440 and 140.
- Includes integrated logging, custom scanning, extended memories with annotation, real time S & multi-meters on screen, GMT, in/out-of band conditions by license class, and much more.
- Available for Macintoshes and IBM compatible (EGA or VGA only)

\$29.95

per class for Novice thru Extra and Commercial Radiotelephone

\$39.95

per class for No-Code Tech (Novice and Tech programs) and Commercial Radiotelephone

OSO Software

Specialist in Software for the Micro by W3JF
208 Partridge Way
Kennett Square, PA 19348
610-347-2109 (Voice or FAX)

PRO-2006

Hyperscan

Base & Mobile Scanner

\$359 Reg. \$399

UPS Shipping Included

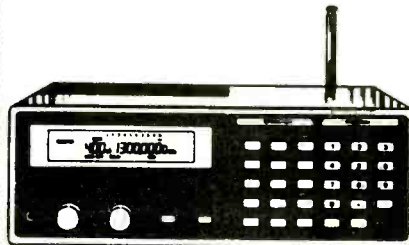

PRO-43 \$269

Pioneer Data, Inc.

1515 N. Pacific Hiway

Woodburn, OR 97071

(503) 982-5115

Go SPECTRA

4-Band Scanner Antenna

Austin's 4-band, patented, Spectra scanner antenna brings you unparalleled reception performance on VHF-Low, VHF-High, UHF, and 800 to 1000 MHz Cellular. You can even replace your Cellular phone antenna with the Spectra and receive the other bands to boot!

only \$81

Plus \$5.95 S&H

Optional Magnet Mount \$21.49

Spectra with optional pole mount for base station with improved VHF-Low band performance ... only ~~\$138~~ plus \$6.95 S&H

1-800-950-WARE

Write for your FREE 64 page catalog

RADIOWARE



PO Box 1478 Westford MA 01886

(508) 688-4433

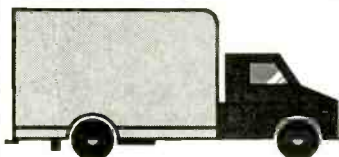

Moving?

Send us notification of your new address as soon as possible so you won't miss a single issue of **Monitoring Times** — or have your second class mail forwarded!

mission. I still find excitement in space launchings, especially when I can listen to it as it happens!"

Radio Reflections

• William Rhodes of Phoenix, AZ, author of "Pioneer Days and Broadcast Thrills" (Feb 94) reports his article got him a lunch date with former Arizona governor Jack Williams, who asked for permission to use it in a speech. A note from Governor Williams to Rhodes says, "Your recent description of the early appearance of KOY in *Monitoring Times* was excellent. It captured the appearance, ambiance and 'flavor' of the old studio in which I cut my 'Eye Teeth' as an announcer. How true 'the choking cigarette stench' and the 'beat up Schiller Grand Piano.' You caught it all—even the old improvised 'tower' falling down."

• Wes Witten of Boalsburg, PA, has some words of advice for owners of the old Zenith Trans-Oceanics. When he bought his G500 at an auction "The oil cloth exterior was rather drab, and this lack of luster was no doubt caused by terminal barn storage. Some corners had the oil cloth covering abraded away revealing the wood beneath.

"I cleaned it initially with glass cleaner fortified with two fingers of household ammonia (also works great to clean old wooden radio cabinets). After drying overnight I dyed the entire exterior with Fiebings solvent-based leather dye in USMC black. Never, ever use latex based dyes—it will turn to a rubbery glop. Then I used a product from Constantine's (a wood worker supply store) called Pad-Lac. This is a lacquer that may be rubbed on with a lint free cloth, and its chemical base is compatible with the Fiebings dye. (Don't use polyurethane; this will produce a Godzilla effect—not what you want!)

"The coatings are intended to be extremely thin and do not leave a thick and unsightly finish if they are applied correctly. The first coat will leave the cloth fuzzies surrounding the abraded areas stiff and therefore sandable. I sanded them off with 220 grit paper. I then retouched these abraded areas with the dye and after allowing it to dry for an hour I applied another coat (three coats of lacquer in all).

"Constantine's is located at 2050 East Chester Road, Bronx, NY 10461; 1-800-223-8087. Fiebings solvent-based leather dye should be available at most shoe shops."

Wes says only a few minor problems remain, such as "how to read those funny little brown capacitors," and solving some alignment problems.

Continued on page 119

MT From the Pen to You: The MT Production Story

Copy for *Monitoring Times* is generated, of course, by our writers who are located all across the U.S. and Canada: sometimes, from all over the world. It is edited and put into magazine format by Rachel Baughn and Beverly Berrong in Brasstown. The print-ready copy and the mailing labels (generated by Chanel Cordell), are then sent to Ripon Community Printers in Ripon, Wisconsin! The covers are designed by Robin Miller in Pennsylvania.

The dependable crew at Ripon then works with us to ensure the best quality production in the shortest possible turnaround time. After bagging and labeling, *Monitoring Times* is shipped to you from Wisconsin by 2nd Class mail exactly ten days before the end of each month.

While the polybagging has brought almost unanimous approval from U.S. readers, the experience of foreign subscribers has not been as good. To respond to complaints of damaged and delayed delivery, we are reverting to shipping *MT* in an envelope to fulfill the 1300 subscriptions outside the U.S. Around 300 more get their subscriptions through Interbooks in Scotland.

An ever-increasing number of issues are being sold on newsstands and in bookstores, such as Barnes & Noble; we hope to add military bases to that list soon. These dealers pay for 2nd day UPS shipping, so some of them will get their issues out on the shelves before you receive yours. However, most dealers service many stores, so they need this extra time for distribution.

The ten days for delivery *should* allow enough time for each U.S. subscriber to receive his or her issue by the first day of the cover month. However, we all know this isn't a perfect world. What should you do if your *MT* does not arrive? We ask you to wait until the 10th of the month before calling us, to ensure it is not a normal delay. However, do not wait *too* long before notifying us that your issue did not arrive; we stock very few extra copies due to space constraints. If you wait more than a month to let us know you are missing an issue, you may be out of luck!

There are a few unresolvable delivery problems. Foreign subscriptions, of course,

take the longest to arrive and suffer the most damage. And we often cannot replace their issues, because there are none left by the time it is certain the issue is lost. On the other hand, the cost of Air Mail for foreign subscriptions is almost prohibitive. Even in the U.S., first class delivery is an extra \$25 per year.

How do you know when to renew? Your expiration date is printed on your label (date shown is the last issue you will receive). However, since we began attaching labels to the mailer, it gets discarded. For this reason, we may go back to attaching labels to the magazine cover, but even if we don't, you are sent *three* renewal notices, so there should be little reason for your subscription to lapse without you knowing it.

To avoid missing an issue, you need to be prompt in responding to the green renewal card enclosed in your last two issues. Your subscription only pays for 2nd class delivery, and must be renewed before labels are printed for the next month. If we have not received your payment, a yellow reminder will be mailed to you separately by first class mail after your final issue has been delivered. However, if you wait for the yellow card to send in your renewal, you will probably miss an issue.

Suppose your expiration date is May 1994, for example: you will receive your second green notice with the May issue. If you don't renew before May 5th, you'll miss the June issue! (This is slightly different from the information on the card, which gives you until the 10th of the month; the decision to polybag changed the schedule after the cards had been printed!) As long as it is in stock, you can still replace a missing issue by purchasing the single copy for \$4.50, which includes first class postage.

If you run into problems with your mail delivery or your subscription that have not been answered by this short excursion "from the pen to you," write or call us and we'll do our best to make sure you keep receiving your favorite monitoring magazine!

VLF CONVERTER



- Receives the entire 10 KHz to 500 KHz VLF band.
- Converts VLF to shortwave.
- Works with any shortwave receiver that has external antenna terminals.

Now you can hear the 1750 meter band, navigation beacon band, WWVB standard frequency broadcasts, ship-to-shore communications, and the European low frequency broadcast band just by tuning across 80 meters shortwave.

Connects between antenna and receiver. Turn it on and hear VLF; turn it off and hear normal shortwave signals.

Model VLF-A converts to 3510-4000 KHz or Model VLF-S converts to 4010-4500 KHz \$79.95 + \$6 shipping/handling U.S. & Canada. Requires 9-v battery (not supplied). Calif residents add sales tax.



Send for FREE catalog that shows our complete line of antennas, filters, preamplifiers and converters.

PALOMAR ENGINEERS

BOX 462222, ESCONDIDO, CA 92046
Phone: (619) 747-3343
FAX: (619) 747-3346



AVIATION MONITORS:

Hear the action with genuine U.S. Defense Department Aeronautical Charts and Frequency Directories for Military and civilian aviation... **WORLDWIDE!**

Call or write for a **FREE BROCHURE:**
Aerial Development of New England
PO Box 563 Bangor, ME 04402-0663
24 HRS 207-223-2255

CABLE X-PERTS, INC.

	COAX	100 ft./UP	500FT
FLEXIBLE 9913 DIRECT BURIAL JACKET	62¢/ft		.57¢/ft
9913 EQUAL UV RESISTANT JACKET	44¢/ft		.40¢/ft
RG 213/U MIL-SPEC DIRECT BURIAL JACKET	34¢/ft		.32¢/ft
RG 8/U FOAM 95%	30¢/ft		.28¢/ft
RG MINI 8X BLK or CLR UV JACKET	16¢/ft		.14¢/ft
RG 11U FOAM MIL-SPEC	42¢/ft		.40¢/ft
RG 214/U-MIL-SPEC	1.50¢/ft		1.30¢/ft
RG-142B/U-MIL-SPEC	1.30¢/ft		1.10¢/ft

ANTENNA WIRE

14GA 168 STR SUPER-FLEX UNINSULATED	12¢/ft	10¢/ft
14GA 7/22 H.D.B.C UNINSULATED	08¢/ft	07¢/ft
14GA SOLID "COPPERWELD" UNINSULATED	07¢/ft	06¢/ft
12GA 19 STR FLEXIBLE BC UNINSULATED	11¢/ft	10¢/ft

MORE ITEMS STOCKED INCLUDING CONNECTORS & ANTENNAS
CABLE & WIRE CUT TO YOUR SPECIFIC LENGTH

ORDERS ONLY: 800-828-3340

TECH INFO: 708-506-1886

113 McHenry Rd., Suite 240
Buffalo Grove, IL 60089-1797

For Complete Literature Mail SASE



Monitoring Times

P.O. Box 98, Brassstown, NC 28902

SUBSCRIBE TODAY!

Order your subscription today before another issue goes by!

Yes, Begin my subscription to Monitoring Times. I've enclosed a check. For MC/VISA/ Discover Card orders, call 1-800-438-8155 (outside US and Canada call 704-837-9200)

U.S. SUBSCRIPTION

- One Year \$21⁹⁵
- Two Years \$42⁰⁰
- Three Years \$62⁰⁰

CANADIAN/FOREIGN

(US Funds/Surface Mail)

- One Year \$32⁰⁰
- Two Years \$62⁰⁰
- Three Years \$91⁵⁰

METHOD OF PAYMENT

- Check/Money Order
- Mastercard
- Visa
- Discover Card

Name _____

Address _____

City _____ State _____ Zip _____ Country _____

Credit Card Number _____ Exp Date _____

Need a GREAT-sounding, ULTRA-RELIABLE, SOLIDLY-made long play recorder? TIRED of POOR-sounding, FLIMSY recorders?

Why spend well over \$100 for a long play recorder "improvised" from a plastic "consumer-type"? Spend a few more \$\$ and get the BEST!

PROFESSIONAL 10 HOUR RECORDER. Built like a **BATTLESHIP.**



- Special Monitoring Times price \$149
- BUILT-IN voice activation (NO box dangling outboard) add \$25
- Also available: 12, 14 and 16 hour models
- Dialed number decoder, reads numbers from tape \$59



VIKING INTERNATIONAL

SINCE 1971

150 Executive Park Blvd. #4600
San Francisco, CA 94134

Phone: (415) 468-2066

Fax: (415) 468-2067

No shipping charges on prepaid orders. COD's OK. Cal. residents add tax. Sorry, no credit cards (all they "do" is increase prices--)

FREE 32 page catalog!

©1994 EDF



Buy recycled. It would mean the world to them.

Thanks to you, all sorts of everyday products are being made from materials you've recycled. But to keep recycling working for the future, you need to look for these products and buy them. For a free brochure, call 1-800-CALL-EDF.



Club Circuit

Club Listings A-L

All Ohio Scanner Club: Dave Marshall, 50 Villa Rd., Springfield, OH 45503-1036. Ohio and surrounding states; VHF/UHF/HF utilities. Net Mon 9:30pm 146.940. *American Scannergram*. \$18 U.S., \$21 Can/Mex, \$28 ww. \$3 sample. Annual summer meeting.

American SW Listener's Club: Stewart MacKenzie, WDX6AA, 16182 Ballad Lane, Huntington Beach, CA 92649, (714) 846-1685. Western US, Pacific, Asia. SWBC, utilities, longwave, clandestine. SWL \$20 US, \$22 Can/Mex. \$1 sample (\$2 ww). Meets 1st Sats 10am address above.

Association of Clandestine Enthusiasts (A.C.E.): Kirk Baxter, P.O. Box 11201, Shawnee Mission, KS 66207. US, Europe and Middle East; Pirate and clandestine. *The A.C.E.* \$18 US, \$19 Can/Mex, \$25 ww.

Association of DX Reporters (ADXR): Reuben Dagold, 7008 Plymouth Rd., Baltimore, MD 21208. International; Utilities, ham band, QSLing, MW, LW, and SWBC. *DX Reporter*. \$19 US, \$29 Can/Mex, \$22ww. \$1 or 5 IRC's sample.

Networking

In response to reader requests, we offer this bi-monthly space for listing amateur radio nets primarily devoted to the radio monitoring hobby, whether shortwave, scanning, utilities, or other. Your listing should include the following information:

Name of Net	Frequency
Day of Week	Time of Day UTC
Region covered	Topics of Interest
Net Manager	Who may participate

Modes of participation:
 Address for contributions/questions by mail
 BBS number for participation by computer
 Phone number for phone patch
 Club address and membership fee (if required for participation)

Capitol Hill Monitors
 146.91 MHz 1st & 3rd Mon 7:30pm ET; Scanning

Central Florida Listeners Group
 146.730 MHz, Sun 8pm ET, Central Florida;
 any radio communications outside amateur bands
 Net Mgr: N4EF
 Telephone gateways announced; CFLG BBS conference on LASER BBS 407-647-0031
 Call Mark Kuziv, KC4ZVK, 407-933-7163 for info

Monitoring the Long Island Sounds Net
 146.805 Tues 8pm ET, Long Island, NY;
 Primarily scanning
 Net Mgr: WB2RVA, 2134 Decker Ave, North Merrick, NY 11566

Shortwave Listeners Net, Association of North American Radio Clubs
 7.240 MHz LSB, Sun 10am ET, Eastern US; Shortwave broadcasts and utilities
 Net Mgr: KW3F, 238 Cricklewood Circle, Lansdale, PA 19446
 Telephone gateways announced

Larkfield Net
 147.21 MHz, Fri 8pm ET, Long Island, NY;
 Shortwave and scanning

Association of Manitoba DX'ers (AMANDX): Shawn Axelrod, 30 Becontree Bay, Winnipeg, Manitoba, R2N 2X9 Canada, (204) 253-8644. Manitoba; LW, MW, SW, and VHF/UHF. Meets monthly. \$2.

Bay Area Scanner Enthusiasts: Bruce Ames, P.A.O., 105 Serra Way #363, Milpitas, CA 95035, (408)267-3244. Western U.S.; 25+ MHz. *Listening Post* (bi-monthly). Meets 2nd Mons. 7:30 Milpitas Police Admin Bldg. \$25 US, \$2 sample, or SASE for info.

Bayonne Emergency Radio Network (BERN): Ray Baron/Bob Frasca, P.O. Box 1203, Bayonne, NJ 07002-6203, 1-800-286-2876. Metro NJ, NY; Fire/disaster, pub safety.

Bearcat Radio Club: Larry Miller, Box 360, Wagontown, PA 19376, 1-800-423-1331. National. Scanning only. *National Scanning Report* (bi-monthly). \$17.50 or \$29.90, \$5 more Can. \$3 sample.

Boston Area DXers: Paul Graveline, 9 Stirling St., Andover, MA 01810-1408, (508)470-1971, 50 mile radius Boston; 3-30 MHz. Meets 3rd Fri 7:30pm, Bull Billerica Facility, 300 Concord Rd., Billerica.

British Columbia Shortwave Listening Club (BCDX): Box 500, 2245 Eton St., Vancouver, BC Canada V5L 1C9, (609) 255-8987 fax. Shortwave. *LOG/AM*. Meets 3rd Thurs. 7pm at 920 Davie St.

British DX Club: Colin Wright, 54 Birkhall Road, Catford, London, SE6 1TE, United Kingdom. UK and international. SW, MW, AM, FM DXing, pirate and clandestine. *Communication*. £10 UK, £12 Eur, £16 ww. Sample 3 IRCs or \$2 US cash. Meets monthly in Twickenham (London).

Canadian Int'l DX Club: Sheldon Harvey, 79 Kippis St., Greenfield Park., Quebec, Canada J4V 3B1, (514)462-1459. Canada nationwide/membership open to all; General coverage. *The Messenger*. \$26 Can, \$25 US, \$US28/\$Can35 ww. \$2 sample. Meets 2nd Tues 7pm Montreal; several annual events.

Capitol Hill Monitors: Alan Henney, 6912 Prince Georges Ave, Takoma Park, MD 20912-5414, (301) 270-2531/5774 fax. DC, MD, No.VA, So.DE. Scanner bands. Frequency Forum BBS 703-207-9622 (8-N-1) Net 1st & 3rd Mons 7:30pm 146.91. *Capitol Hill Monitor*. \$8. Meets irregularly.

Central Florida Listeners Group: David Grubbs N4EF, 956 Woodrose Court, Altamonte Springs, FL 32714-1261; (407) 296-2055 Andy Fountain. Central Florida; All bands. Net on 146.73 MHz Sun 8 pm. Meets 2nd Sats 12 noon. Conf#10 on Laser BBS (407)647-0031.

Central Indiana Shortwave Club: Steve Hammer, 2517 E. DePauw Road, Indianapolis, IN 46227-4404. Central Indiana; SW broadcasting, pirates, and the offbeat. *Shortwave Oddities*.

Central VA Radio Enthusiasts: Richard Rowland, POB 34832, Richmond, VA 23234-0832. Metro Richmond and vicinity. VHF/UHF. SASE. No newsletter, no dues. Meets quarterly in Richmond.

Chicago Area DX Club: Edward G. Stroh, 53 Arrowhead Dr., Thornton, IL 60476. 300 mile radius of Chicago; DXing all bands. *DX Chicago*. \$17, \$1 sample. Meets irregularly.

Chicago Area Radio Monitoring Association (CARMA): Ted & Kim Moran, 6219 N. Greenvew, Chicago, IL 60660-1815. Chicago & midwest. Public safety & general coverage. SCUG/CARMA BBS (708)852-1292. *CARMA Newsletter*. Meetings (Sats) and newsletter bi-monthly on alternate months.

Communications Research Group: Scott Miller, 122, Greenbriar Drive, Sun Prairie, WI 53590-1706. Wisconsin area. Scanning.

DecalcoMania: Paul Richards, P.O. Box 126, Lincroft, NJ 07738, (908)591-2522. Worldwide AM, FM and collecting radio related items. *DecalcoMania*. \$10 US, \$11 Can/Mex, \$16 Eur, \$17.50 Asia/Pac.

Drake SPR4 Int'l Club: Bill Swiger, Route 1, Box 142A, Bridgeport, WV 26330. Worldwide; Drake SPR4 owners.

DX Audio Service (NRC): NRC Publications Center, P.O. Box 164, Mannsville, NY 13661-0164. Worldwide; AM/FM; DXAS Cassette 90-min monthly audio magazine. Sample \$3 to above address.

DX Australia: P.O. Box 422, Moonee Ponds, Victoria 3039, Australia. MW, SW. *DXers Calling*.

DX Club of India: Navin Patel, 1-Dutt Niwas, 809 - M.G. Road, Mulund, Bombay-400 080, India. India; MW/SW/Ham. *DX World* (quarterly) Rs 50/-, 30 IRCs outside India. 3 IRCs sample.

DX Club Paulista: Marcelo Toniolo Dos Anjos, C. Postal 592, Sao Carlos - SP (Brasil), 13560-970. South America. Shortwave, including utilities. *Actividade DX* (in Portuguese).

Finnish DX Association: Mr. Arto Mujunen, Suomen DX-Liitto, P.O. Box 454, FIN-00101 Helsinki, Finland; +358-0-8512410 fax. Finland and worldwide. SW and BCB. *Radiomailma*.

Fire Net: Tom Kravitz, Box 1307, Culver City, CA 90232, 310-838-1436, internet mpag@netcom.com. All of California; fire, EMS, tied in with nationwide notification net.

Friendship DXers Club: Ing. Santiago San Gil Gonzalez, C.DX.A - International, P.O. Box 202, Barinas 5201-a, Estado Barinas, Venezuela. International. DXing all bands. Cadena DX, YV-2-FSW, Sunday 1130-1330 UTC on 7113 and 14113 kHz. Membership free.

Houston Area Scanners & Monitoring Club: Glen Dingley, 909 Michael, Alvin, TX 77511, (713) 388-1941. 75 mile radius of Houston, TX; scanning & SW. Paging network. *HASMC Newsletter*. Meets Jan & June.

Hudson Valley Monitors Association (HVMA): Patrick Libretti, P.O. Box 706, Highland, NY 12528; Mid-Hudson valley and surrounding counties; VHF/UHF, public safety. *The Hudson Valley Monitor*.

International 11 Meter Alliance: Allen Newton, Rt. 1 Box 187-A, Whitney, TX 76692, (817) 694-4047. Public safety, traffic handling, all bands, esp. 11 meters.

International Listeners Organization: Mohsin Abbas, St. Nisar Ali Shah Ahamed Pura, Sheikhpura, Pakistan, 1-(50359) 2-(50561). South Asia. Broadcasting. *Listener Times*.

Int'l Radio Club of America (IRCA): Ralph Sanserino, P.O. Box 70223, Riverside, CA 92513-0223. Worldwide; BCB/AM DX. *DX Monitor* (34 x) \$25 US, \$27 Can/Mex, \$28.50 ww. \$.29 or 2 IRCs sample.

Longwave Club of America: Bill Oliver, 45 Wildflower Rd., Levittown, PA 19057, (215) 945-0543. Worldwide; Longwave only. *The Lowdown*. \$18 US, \$19 Can/Mex, \$26 ww.

New Listings:

Global DX Club: David Williams, P.O. Box 1176, Pinson, AL 35126-1176. Worldwide; all bands. *Radio Waves* (bi-monthly). \$10 US; \$1 sample. Meets monthly.

Shortwave Radio Communications Club: Atiqur Rehman, Dawood Street, Khalid Road, Sheikhpura, P.C. 39350 Pakistan. South Asia; MW/SW. *The Amateur* (Urdu language). Meets 1st Fri on SW Complex, S.K.P.

SPECIAL EVENT CALENDAR

Date	Location	Club/Contact Person
May 1	Burlington, IA	Burlington Hamfest/Valley Emergency Communications Assoc., P.O. Box 911, Burlington, IA 52601-0911; (319) 752-3000. Location: Burlington Drive-In Theatre, 7:30 am to 3 pm, \$4 admission, talk-in on 146.790 and 146.520 simplex.
May 7	Cedarburg, WI	Ozaukee Radio Club Swapfest/Chairman, W70N1018 Hampton Ct., Cedarburg, WI 53012; (414) 377-7468. Location: Circle-B Recreation Center, Hwy 60 and County I, 8am to 1 pm, \$3 admission, talk-in on 146.37/97 and 146.52.
May 14-15	Birmingham, AL	BirminghamFest/Birmingham ARC, P.O. Box 10521, Birmingham, AL, 35202-0521; (205) 979-7039. Location: South Exhibition Hall of the Birmingham-Jefferson Civic Center, \$6 admission, doors open 9 am both days.
May 15	Cambridge, MA	MIT Radio Society and Harvard Wireless Club Flea Market, 9am-2pm, Albany and Main Sts., \$2 admission.
May 15	Wheeling, WV	Wheeling Hamfest and Computer Show/Triple States RAC, Box 240, RR #1, Adena, OH 43901; (614) 546-3930. Location: Wheeling Park, 8 am to 3 pm, \$3 admission, talk-in on 146.910 and 146.715.
May 20-23	Paris, France	European DX Council Conference
May 21-22	New Ulm, MN	New Ulm ARC will operate KB0IWW 1600Z-0400Z May 21 and 1600Z-2300Z May 22 celebrating Hanska's 10th annual Syttende Mai, check 7.250, 14.250 MHz and repeater at 147.33+. QSL w/9x12 SASE and two first class stamps or #10 SASE for folded certificate to KB0IWW, NUARC, Pat Mathiowetz, RR4 Box 14-A, New Ulm, MN 56073.
May 22	Hagerstown, MD	Great Hagerstown Hamfest/Antietam Radio Assoc, W3CWC, P.O. Box 52, Hagerstown, MD 21741. Location: Hagerstown Jr. College Rec. Ctr., 8 am to 3:30 pm, \$5 admission, talk-in on 146.34/146.94 repeater.
May 22	Sun Prairie, WI	The Communications Research Group will be holding its spring meeting from 12 pm to 5 pm. For more information contact Scott Miller at (608) 837-7666 evenings.
May 22	Wheaton, IL	GMRS of Illinois May Fest '94/2077 W. Roosevelt Road, Wheaton, IL 60187; (708) 690-1492. Location: DuPage County Fairgrounds, 8 am to 1 pm, \$5 admission, talk-in on 146.52.
May 28	Springhill, LA	Springhill and Arkla ARC Hamfest/David Smith, KF5BF, P.O. Box 812, Springhill, LA 71075; (318) 539-3226. Location: Springhill Civic Center.
May 28-29	Poughkeepsie, NY	Poughkeepsie ARC/Donald Stein, W2PTF, 3 Little Road, Wappingers Falls, NY 12590; (914) 297-9608. Location: Young/Morse House, South Road, free admission to Special Event station. See May QST for callsign, times and frequencies of operation.
May 29	Chicago, IL	Chicago ARC Hamfest/5631 W. Irving Park Road, Chicago, IL 60634; (312) 666-1606 or (312) 545-3622. Location: DeVry Institute of Technology, 3300 N. Campbell, 8am-3pm, \$4 admission, talk-in on 147.255.
June 4	Wilmington, NC	Seafest/Azalea Coast ARC, P.O. Box 4044, Wilmington, NC 28406; (919) 675-6180 or (919) 799-4195. Location: Trask Coliseum-UNC, 9 am-3 pm, \$5 admission, talk-in on 147.180+.
June 5	Princeton, IL	Princeton Hamfest and Computer Show/Starved Rock RC, KU9A, 1153 Union Street, Marseilles, IL 61341; (815) 795-2201. Location: Bureau County Fairgrounds, \$5 admission, talk-in on 146.355/955.
June 5	Manassas, VA	Hamfest & Computer Show/Virginia Hams ARC, P.O. Box 1255, Manassas, VA; (703) 368-5180. Location: Prince William County Fairgrounds, \$5 admission.
June 11	Loveland, CO	Northern CO ARC Superfest/Musser Moore, AA0PB, (303) 221-3698. Location: Larimer Co Fairgrounds, 8am-3pm, \$3 admission, \$8 tables, talk-in on 144.515/145.115.
June 11	Winston-Salem, NC	Hamfest and Computer Fair/Forsythe ARC, Don Edwards, WB4KQN, P.O. Box 11361, W-S, NC, 27116; (910) 723-7388. Location: Dixie Classic Fairgrounds, 9am-5pm, \$7 admission, talk-in on 146.04/64.
June 12	Pleasant Hill, MD	Computer and Hamfest/Hanover Area Hamming Association Location: Pleasant Hill Fire Co. carnival grounds, \$5 admission, opens 8 am, talk-in on 145.41/146.895.
June 12	Lancaster, NY	Lancaster ARC Hamfest/Nick, WA2CJJ, 5645 Genesee St., Lancaster, NY 14086; (716) 681-6410. Location: Darien Center Fire Co. on Rt. 77 at Rt. 20, \$5 admission, talk-in on 147.266/146.550/443.850.
June 12	Willow Springs, IL	Six Meter Club of Chicago, Inc. Hamfest/Joseph Gutwein, WA9RIJ 7109 Blackburn Avenue, Downers Grove, IL 60516; (708) 963-4922. Location: Santa Fe Park, \$5 admission, gates open 6 am, talk-in on 146.52 or 146.37/97.
June 18	Nashville, TN	Hamfest Nashville/Nashville ARC, Bob Malone, WB5ZDS, 62 The Arcade, Nashville, TN 37219; (615) 256-6994. Location: Tennessee State Fairgrounds, 7am-5pm, \$5 admission, talk-in on 145.47.
June 18	Cortland, NY	Cortland International Hamfest/SARC, P.O. Box 5241, Cortland, NY 13045; (607) 756-6550. Location: Cortland Co Fairgrounds, 7am-3pm, \$5 admission, talk-in on 147.780/180.
June 18	Dunellen, NJ	Raritan Valley RC '94 Hamfest/John Manna, WA2F, (908) 722-9045. Location: Columbia Park, 7am-2pm, \$5 admission, talk-in on 146.625.
June 19	Cambridge, MA	MIT Radio Society and Harvard Wireless Club Flea Market-see May 15

Monitoring Times is happy to run brief announcements of radio events open to our readers. Send your announcements at least 60 days before the event to: **Monitoring Times Special Event Calendar**, P.O. Box 98, Brasstown NC 28902-0098.

INDEX OF ADVERTISERS

Advanced Electronics Applications	3
Aerial Dev. of New England	115
Amsoft	91
The Antenna Handbook	111
The Ant Farm	104
Antique Radio Classified	101
ARRL	31
ASA	104
Ashton ITC	11
Atlantic Ham Radio	104
Austin Antenna	111
BBC World Service	61
BMI, Inc.	95
Buckmaster Publishing	87
Cable X-perts, Inc.	115
Cellular Security Group	85,105
ComFocus	77
Communications Electronics	15
Communications Specialists	61
Computer Aided Technologies	13,31,103
Consumertronics	91
Dallas Remote Imaging	21
Datametrics	23
Jacques d'Avignon	56
Delta Research	105
R.L. Drake, Company	19
DX Daily	41
Galaxy Electronics	104
GRE America	105
Grove Enterprises	23,27,39,51,52,53, 58,60,79,81,83
Glenn Hauser	43
ICOM America	Cover IV
J&J Enterprises	13,31,103
Japan Radio Company	Cover III
KIWA	101
Klingenfuss	37,62
Lentini Communications	7
Marymac Industries	97
Microcraft Corporation	91
MilSpec Communications	25
Monitoring Times	5,115
Motron Electronics	17
National Scanning	7
Naval Electronics	93
OptoElectronics	8,9 Cover II
Orchid City Software	101
Palomar Engineering	13,115
Percon	61
Pioneer Data	113
Pioneer Hill Software	107
QSO Software	113
Radio Accessories	97
Radioware Corp.	113
Ramsey Electronics	71
R.C. Distributing	87
RDI White Papers	101
Satman	87
Scrambling News	91
Skyvision	87
Software Systems Consulting	23,25
Startek International	99
Tiare Publications	25
TranSel Technologies	97
TRS Consultants	109
Universal Radio	85
US Radio	29
US Scanner Publications	89
V-Comm (ScanStar)	29
Viking International	115
Willco Electronics	109
Worldcom Technology	11

STOCK EXCHANGE

Ads for **Stock Exchange** must be received 45 days prior to publication date. All ads must be paid in advance to *Monitoring Times*. **Ad copy must be typed for legibility.**

Monitoring Times assumes no responsibility for misrepresented merchandise.

NON-COMMERCIAL SUBSCRIBER RATES: \$.25 per word — *Subscribers only!* All merchandise must be personal and radio-related.

COMMERCIAL RATES: \$1.00 per word. Commercial line ads printed in bold type.

1-3/4" SQUARE DISPLAY AD: \$50 per issue. Send camera-ready copy or copy to be typeset. Photo-reduction \$5 additional charge. For more information on commercial ads, contact Beth Leinbach, 704-389-4007.

Lightning Rods—FREE! Information mailed 1-800-532-0990.

GE SUPERADIO III, custom designed with up to four noise-free SCA channels. Performance guaranteed. Credit Card orders accepted. (800) 944-0630.

R-390-A SALES & SERVICE P.O. Box 3541, Toledo, OH 43608.

R-390-A TOP AND BOTTOM COVERS (419) 726-2249.

Scan Illinois — Never before released! Illinois State Police Activity Codes...A must have! Now you too can know what these codes mean. Send check or money order for \$5.95 plus \$2.25 s/h to: Scan Illinois, P.O. Box 58, Mascoutah, IL 62258.

MONITOR: AIRFORCE 1, 2, SECRETARY OF STATE AND OTHER VIP PHONE COMMUNICATIONS. Complete list of HF, VHF, UHF, SATCOMM frequencies and designators. Over 50 pages. \$15 includes same day shipping. Check or money order to: G. Cook, P.O. Box 3511, La Mesa, CA 91944.

VACATIONING in SE FLORIDA coastal areas? Latest, up-to-date Police, Fire, Emergency frequencies. All of Broward County (Ft. Lauderdale areas), Southernmost Palm Beach County, Disneyworld. Details/comments with frequencies not found in any other publication! Send \$8 m.o. for lists; \$12 m.o. w/letter for "special" requests: Radio Co., P.O. Box 50006, Lighthouse Point, FL 33074.

ROCKY TOP SATELLITE PARTS New, used, order by calling (704) 837-6430 or send SASE to 208 Fleming St., Murphy, NC 28906 for a price list.

SCANNERS & SECRET FREQUENCIES. Bestselling new 320 page book covers scanning from A to Z. "Useful, knowledgeable, and readable" (*Popular Communications*). "Wry, cynical, and immensely entertaining" (*Paladin Press*). "An enormous collection of information...plenty of great reading" (*Monitoring Times*). "You can't miss" (*American Survival Guide*). "A high point of scanner

publication" (*RCMA*). Only \$19.95 plus \$3 s/h. Check/MO to Index, 3368 Governor Dr., Ste. 273-T, San Diego, CA 92122. Credit Cards only 800-546-6707. Free catalog of "insider" books on scanners, cellular, eavesdropping, cable, much more.

SHORTWAVE AND SCANNER Computer Service. ShortWave Paradise—1019 Cambridge Drive, #2, Kalamazoo, MI 49001. 6 mo \$15, 1 yr \$25. Call our Computer System today! (616) 383-4979.

THE ANARCHIST'S BBS is a resource for anarchists, investigators, researchers, computer hackers and phone phreaks. Categories include: Computer hacking, Investigation techniques, Telecommunications technology and Surveillance. Call (214)289-8328 for free trial access.

Take heed **SHORTWAVE LISTENERS.** Are you planning to deal with Mike Papagorgio's coin show "Money Makes Money"? Please contact me before you buy from him. George DiPrinzio, 837 E 232 St., Bronx, NY 10466; or call collect (718) 231-5638.

Highest price paid for used scanners! (614) 544-5842.

HQ180A-DRAKE R8, both mint, 601-825-8108.

MONITORING TIMES: May/June '83-'93, complete. **POPULAR COMMUNICATIONS** 11/83-'93, complete. \$250. Call Maury (504) 866-3042, evenings.

WANTED: MONITORING TIMES issues 8/86, 5/85, 6/85, 7/85; 1975 WRTH. **FOR SALE:** 250 Hz and 4.0 kHz R5000 filters; Seiko GMT/Local Watch \$45. P.O. Box 4854, Wheaton, IL 60189-4854; 1-800-225-0256/pin=14733.

FOR SALE: JRC NRD-525, \$675; BEARCAT 200XLT with Metrowest longlife battery and Pro Power II charger, \$175. Original boxes. Tom (603) 225-2115.

WANTED: BEARCAT 250 manual, will pay photocopy plus mailing cost. Carl (516) 427-7782.

WANTED: HAMMARLUND MODEL SPC-10 SSB IF CONVERTER and complete service manual. Harry A. Weber, 4845 W. 107th St., Oak Lawn, IL 60453-5252.

DTMF DECODER, EMCOM T-2000, paid \$175, will sell for \$95. Decodes telephone touch tones. (407) 898-4152.

ICOMR-71 SHORTWAVE RECEIVER Has passband tuning, FM option board, International Crystal 2.1 kHz SSB filter and 400 Hz CW filter. Near mint condition, \$675. H. Lash, 2679 Glenwood-Dyer Road, Lynwood, IL 60411.

NEW IN BOX NEVER USED AOR 1500 MULTIBAND RECEIVER w/SSB and manual, \$450. Fred (312) 467-9810.

WANTED: Copy of service manual for Bearcat Monitor Model 300, call (508) 481-6817 collect.

WANTED: KENWOOD R-600 RECEIVER, Rick (510) 687-2719.

FOR SALE: SONY ICF-SW7600, REALISTIC® AMPLIFIED ANTENNA, new condition, \$175 firm. I pay insured shipping, (708) 241-4231.

SONY SHORTWAVE SW-7600 with MFJ TUNER, \$95; BEARCAT BC300 50 channel, \$75. (407) 260-8392.

PRO-2006 SCANNER with cellular and manual, \$300. Jim (916) 682-5665.

WANTED: ANTIQUE RADIOS Hallicrafters DD-1, Zenith Stratosphere, E.H. Scott, McMurdo Silver, Crosley WLW Super Power Receivers, (301) 774-3203.

SURVEILLANCE
& COUNTERSURVEILLANCE Electronic Devices

Bugging/Phone Tapping Detectors • Caller ID • Covert Video
• Phone Scramblers • Voice Changers • Shotgun Mics • Vehicle
Tracking • Transmitter Kits • Locksmithing • AND MORE!

7-Hour Telephone Recording System
Tapes phone calls automatically. \$125.00

FOR CATALOG SEND \$5.00 TO...

POB P.O. Box 337, Buffalo, NY 14226 (718) 691-3478

WIDEBAND PREAMPS & CLASS A PWR AMPS

- WLA24T (mast), 5-1000MHz, NF=3dB, G=21dB, \$139
- WLA24M, 5-1000MHz, NF=3dB, G=23dB, \$99
- WLA97AC, 1-1300MHz, NF=3dB, G=24dB, \$
- WLA81M, 1-50MHz, NF=2.4dB, G=17dB, \$69
- LPA11M, 10-900MHz, P (1dB)=1 W, G=22dB, \$289
- LPA12M, 10-900MHz, P (1dB)=2 W, G=21dB, \$447
- 4 o/p coupler for sig. monitoring RC24-4: NF=3dB, G=12dB, Isol.=20dB, 115VAC, 19" rack

Send SASE for more info • S&H \$5

WI-COMM Box 5174 • Massena, NY 13662
(315) 769-8334

Weiner Defends the *Fury*

In one day the broadcast ship *Fury* was stripped of everything that makes up a radio station (March '94). Radio engineer Allan Weiner, who built the radio station, protests, "No arrests, no hearings, nothing! The reason? The FCC claims to have identified unlicensed radio transmissions from 12:10am EST on January 14, 1994, which they claim were pinpointed to the location of the ship. I was on board the vessel at the time and I observed no such transmissions and none were technically possible with the existing equipment.

"Only two of her four transmitters were partially restored. Of these two, only one could be applied primary filament power. None of the transmitters were ready to broadcast. Furthermore, there was no available source of transmitter power. Both transmitter generators were down for final installation and repairs. The main generator was inoperative due to a fuel leak and the backup generator had a burned out regulator.

"So the question remains: why was an entirely legal radio station destroyed without a hearing and due process? I think it is time to take a hard look at the Federal Communications Commission and their policies which disregard law and due process; especially the seizure laws in which they legally 'steal' personal property.

"The ship owners plan to seek restitution from the government. Many questions remain. A radio station, a printing press of the air, has been smashed. Please protest this illegal action by the FCC to your Congressperson."

See this month's "Shortwave Broadcasting" column and future issues of *MT* for more. Although Bro. Stair has decided not to pursue shortwave as a means of broadcasting, this story is not yet over.

Short Subjects

- Via Internet, we read an assurance from Jonathan Clough of UK-based Javation that cellular-capable scanners, such as the MVT-7100 many US customers purchased from them, can be returned for repair. All that is required is that both the customer and the company provide documentation that the radio was originally imported before April 26, 1994.

- "The February 94 *MT* item on page 6 entitled 'Hoarse but Hamming' seems to question the fact that Patty Loveless has obtained her ham license. She has! Her real name is Patty Ramey, her call is KD4WUJ (Novice). Her husband Emory Gordy is also a ham, callsign W4WRO (Extra). Those stage names will get you every time."

Richard Newbould, Pittsburgh, PA

Here's hoping your radio brings you a May basket (remember those?) filled with spring's infinite array of ever-changing signals and ever-challenging monitoring times.

Rachel Baughn, Editor

LesComm LSCM2006 with LED S'Meter, 45CPS, Continuous 800, Beep & S'Meter ON/OFF. \$499.95 while supplies last. Say you saw it in *MT* and get another \$10 off. Data Tone squelch installed \$69.95/kit \$54.95 LC180 installed \$89.95/kit \$64.95 GEScan installed \$59.95/kit \$49.95 GEScanII installed \$89.95 Commtronics HB232 installed, internal \$299.95, external \$359.95 6,400 Channels with Keyboard Bank Control installed \$249.95 For more information send a Self Addressed Stamped Envelope to: **LesComm** P.O. Box 81294 Corpus Christi, TX 78468-1294

YOU AIN'T HEARD NOTHIN...YET!

Largest selection of scanner frequency guides (federal, military, police, aero, etc.); AM/FM/TV broadcast directories; HF "ute" directories; Books on espionage, covert ops., bugging, wiretapping, surveillance, clandestine radio, & more! **BIG FREE CATALOG!**

CRB RESEARCH
P.O. Box 56-MT
Cammock NY 11725

CUSTOM F.C.C. REPORTS
printouts & diskettes

This is not the same old "Official Spy" junk you see everywhere-This is Real FCC data reported in formats you select — NOT just Public Safety
WE HAVE IT ALL!
Your County or Monitoring Radius
Bus/Ind/Aircraft/RR/SMR/Pagers/Media
2-Way/Taxi Forestry/Mfg/Marine/800 Police-Fire-Bus. Trunking/GMRS/Hospitals & more

FREQUENCY PRINTOUT SERVICE
P.O. Box 1239
Charleston, SC 29402
(803) 766-5144

PAN-COM INTERNATIONAL CATALOG

From Amplifiers to Zappers!
Over 350 Kits, Plans & Books about Licensed/Unlicensed AM/FM/Cable broadcasting, Ham/CB/SW/lowfer/medfer, surveillance, phone devices, software, MORE. Send \$1.00!

**PO Box 130-T
Paradise CA 95967**

Take a look at the **Ontario DX Association**

DX Ontario magazine.
\$2.00 for sample

Call our DX-Change news service (416)444-3526

Ontario DX Association
Box 161, Station A
Willowdale, Ontario M2N 5S8
Phone/Fax (905)853-3169

MONITORING WITH HIGH TECHNOLOGY

-World Scanner Report-

published 10/yr for the casual hobbyist, follows avant-garde technology of monitoring the radio frequency spectrum from DC-to-daylight, consumer & hobby electronics; do-it-yourself scanner/receiver projects. SASE or 2 IRC for info, or \$15/half-yr. \$25/yr. \$45/two-yr. Canada +15%; other foreign +25% surface or +50% air. US Funds Only. MCVISA ok

COMMtronics Engineering
PO Box 262478; San Diego, CA 92196

HUGE 100 PAGE CATALOG

- Shortwave Receivers
- Amateur Radio Gear
- Scanners
- RTTY & FAX Equipment
- Books & Accessories

Send \$1 to **Universal Radio**
6830 Americana Pkwy. MT
Reynoldsburg, OH 43068
Tel. 614 866-4267

DEVICE ELIMINATES ANTI-SCANNER TRUNKING TONES

GE trunked systems play a series of tones at the end of every transmission. This device eliminates those tones and restarts the scan. Easy to install in PRO-2005/2006 (other models soon). \$29.95 user installed + \$3.50 shipping. CA add sales tax. Dealer inquiries invited.

COMSEC ASSOCIATES, INC.
2219 W. Olive Ave., Burbank, CA 91506

Join The Club!

Open to hobbyists worldwide, the **CANADIAN INTERNATIONAL DX CLUB** is an active promoter of the radio hobby through its monthly newsletter and local chapters.

The Messenger is packed with general coverage information including the broadcast band, shortwave, utilities, scanning, amateur radio and more. Send \$2 for a sample bulletin and membership information to:

CIDX
79 Kipps St., Greenfield Park,
Quebec, CANADA J4V 3B1

RADIO

C. CRANE COMPANY

Radio receivers and antennas of all kinds. Exemplary service.

AM, FM, SW, Scanner, & Auto
Custom cable and receiver modifications
Many exclusive radio products

FREE CATALOG 558 - 10th Street
Fortuna, CA 95540-2350
(707) 725-9000 Fax (707) 725-9060
Orders: 800-522-(TUNE)8863

HAND-HELD SCANNERS!
MetroWest is your source for:

Bearcat Hand-Helds
Double-Life Battery Packs
Drop-In Chargers
Specialty Antennas
Books and more

Send for our free catalog
MetroWest, Inc.
822 N. Spring
LaGrange Park, IL 60525
(708) 354-2125
(800) 657-1475

FULL DISCLOSURE

The Nation's #1 Surveillance Magazine

Only \$29.95/12 issues. Single issue by First Class mail: \$3.50
Full Disclosure, P.O. Box 67
Lowell, MI 49331
Phone: 1-800-NEED-A-PI
Fax: 616-897-0705

Restructuring the Spectrum

Two major shufflings of the communications spectrum will impact future technologies and future monitoring as well. The first is reassignment of 200 megahertz of government allocations to the civilian sector; the second is refarming (narrowing channel spacing).

Both of these major decisions have caused a ripple of nervous speculation throughout the hobby as well as the industry. In fact, both changes simply improve spectrum efficiency and will not immediately impact on equipment or techniques of monitoring.

Over the next decade, we will see the use of microwave spectrum growing considerably — wireless computer LANs (local area networks), Personal Communications Service (PCS) devices, and many other emerging technologies.

Reallocation

To provide spectrum for new and growing services, the Federal Communications Commission (FCC) has received 200 megahertz of former government and military bands slated for implementation over the next five years; details were in the April 1994 issue (page 6).



Reassigned primarily for civilian mobile/base communications, radiolocation systems, and even satellites, approval of the plan affects 1390-1400, 1427-1432, 1670-1675, 1710-1755, 2300-2310, 2390-2400, 2402-2417, 3650-3700, and 4635-4685 MHz.

Obviously, these 200 additional megahertz of microwave spectrum will have little impact on most present-generation scanners which cut off above 960 or 1300 MHz, but there will be some profound changes in the scanner bands over the next few years as well.

Refarming

The (FCC) refers to the compressing of frequency allocations as “refarming”; modern equipment is capable of much tighter frequency tolerances and much narrower modulation techniques, allowing more signals to be squeezed into existing spectrum.

For example, in the present 460-512 MHz UHF land mobile spectrum former 25 kHz spacing has already been reduced to 12.5 kHz; but the Commission proposes even narrower 6.25 MHz spacing, allowing four users for every former one. At 150 MHz VHF, 5 kHz increments will replace the current 15 kHz spacing.

Along with the new technologies, we will see new modes as well, with digital signals abounding as well as some inevitable encryption.

But this is not foreboding. There will be a need for conventional, unscrambled voice communications well into the future. The changes will be healthful for the industry, and challenging for the listener.

Bob Grove
Publisher



NRD-535D

"Best Communications Receiver"

World Radio TV Handbook 1992



"Unsurpassed DX Performance"

Passport to World Band Radio 1992

Setting the industry standard once again for shortwave receivers, the NRD-535D is the most advanced HF communications receiver ever designed for the serious DXer and shortwave listener. Its unparalleled performance in all modes makes it the ultimate receiver for diversified monitoring applications.

Designed for DXers by DXers! The NRD-535D (shown above with optional NVA-319 speaker) strikes the perfect balance between form and function with its professional-grade design and critically acclaimed ergonomics. The NRD-535D is the recipient of the prestigious World Radio TV Handbook Industry Award for "Best Communications Receiver."



Japan Radio Co., Ltd.

Japan Radio Company, Ltd., New York Branch Office - 430 Park Avenue (2nd Floor), New York, NY 10022, USA Tel: (212) 355-1180 / Fax: 212 319-5227

Japan Radio Company, Ltd. - Akasaka Twin Tower (Main), 17-22, Akasaka 2-chome, Minato-ku, Tokyo 107, JAPAN Tel: (03) 3584-8836, Fax: (03) 3584-8373

- Phase-lock ECSS system for selectable-sideband AM reception.
- Maximum IF bandwidth flexibility! The Variable Bandwidth Control (BWC) adjusts the wide and intermediate IF filter bandwidths from 5.5 to 2.0 kHz and 2.0 to 0.5 kHz—continuously.
- Stock fixed-width IF filters include a 5.5 kHz (wide), a 2.0 kHz (intermediate), and a 1.0 kHz (narrow). Optional JRC filters include 2.4 kHz, 300 Hz, and 500 Hz crystal type.
- All mode 100 kHz - 30 MHz coverage. Tuning accuracy to 1 Hz, using JRC's advanced Direct Digital Synthesis (DDS) PLL system and a high-precision magnetic rotary encoder. The tuning is so smooth you will swear it's analog! An optional high-stability crystal oscillator kit is also available for ± 0.5 ppm stability.
- A superior front-end variable double tuning circuit is continuously controlled by the CPU to vary with the receive frequency automatically. The result: Outstanding 106 dB Dynamic Range and +20 dBm Third-Order Intercept Point.
- Memory capacity of 200 channels, each storing frequency, mode, filter, AGC and ATT settings. Scan and sweep functions built in. All memory channels are tunable, making "MEM to VFO" switching unnecessary.
- A state-of-the-art RS-232C computer interface is built into every NRD-535D receiver.
- Fully modular design, featuring plug-in circuit boards and high-quality surface-mount components. No other manufacturer can offer such professional-quality design and construction at so affordable a price.

WHY ICOM?

QUALITY COMPONENTS

Uncompromising standards; no "short cuts" to reduce costs. Only the highest quality components are good enough for an ICOM radio.

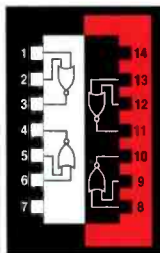

HIGH PERFORMANCE

ICOM's reputation is built on crystal-clear reception; levels of dynamic range, sensitivity and selectivity unobtainable just a few years ago. Circuitry, filtering and operating features designed to give you top performance.



INNOVATION

ICOM means technological leadership! Every new product advances the hobby, sets new standards for others to reach.



PRODUCT TESTING

Every new ICOM product is extensively tested by real hams before it's released. You get superior performance and reliability, right out of the box.



DESIGN PURPOSE

ICOM offers many different models, each designed for a specific purpose. No need to compromise—choose the ICOM that meets your particular needs.



COMPATIBILITY

Once you learn one ICOM, you can operate them all. We planned it that way to make upgrading a snap. The same idea is behind the extraordinary interchangeability of ICOM products. You're not buying a radio—you're building a system!



SOLID CONSTRUCTION

We never cut corners on materials. Our rigorous design and assembly standards are the reason behind those legendary ICOM "tough radio" stories you hear at any hamfest.



SERVICE

You'll probably never need it, but it's good to know that ICOM service is the "pride of the industry." We get you back on the air in days instead of weeks.



VALUE

All this adds up to VALUE. Years of reliable operation and "top dollar" resale value.



CUSTOMER SUPPORT

ICOM has the best customer support "hotline" in the industry. Expert assistance is only a phone call away.



HERITAGE

ICOM's heritage is amateur radio. We built the very first solid state HF transceiver, and have set industry standards ever since. Your investment in ICOM is an investment in the heritage of amateur radio.



ICOM America, Inc., 2380-116th Ave. N.E., Bellevue, WA 98004
Customer Service Hotline (206) 454-7619

All stated specifications are subject to change without notice or obligation. All ICOM radios significantly exceed FCC regulations limiting spurious emissions. The ICOM logo is a registered trademark of ICOM, Inc. VIC793IC

For information about ICOM products, call the ICOM Brochure Hotline: 1-206-450-6088

Experience the Quality®

ICOM®