

POPULAR SCIENCE

RADIO ANNUAL

35¢



**How to Build *and* Service
RADIOS *at Home***

POPULAR SCIENCE
RADIO ANNUAL

•

POPULAR SCIENCE
RADIO ANNUAL

PREPARED BY THE EDITORIAL STAFF
OF POPULAR SCIENCE MONTHLY

POPULAR SCIENCE PUBLISHING CO., INC.
353 FOURTH AVENUE, NEW YORK 10, N.Y.

COPYRIGHT, 1943
BY POPULAR SCIENCE PUBLISHING CO., INC.
All Rights Reserved

Printed in United States of America
Second Printing—May, 1944

I N T R O D U C T I O N

Radio building has a way of doubly repaying those who take it up. For in addition to being a hobby that provides more fun and educational entertainment than is likely to be expected, it very often becomes a highly profitable spare-time business.

But for whatever reason it is that you now enter the fascinating realm of radio, you are sure to find what you are looking for in these pages. Here is contained a wide variety of sets, ranging sufficiently in power, size, and design to satisfy anyone who wants to get an all-around education in how to be a radio builder. Whatever parts may be needed to build a particular set are listed in detail. The text explains just how the set is to be constructed, and for what purpose it is best suited. Complete diagrams show clearly the method of wiring, and operational details. Both text and diagrams are presented so that even the amateur builder can understand them. But let no one think that the material contained in this book is confined to the narrow horizons of the beginner. The very latest developments in radio building are to be found within these covers—and even those who may consider themselves builders of long experience will find answers and explanations to problems which may have long baffled them.

The editors take this opportunity to acknowledge their indebtedness to Arthur C. Miller, of New York, for much of the material contained in this volume.

Here, then, is your book. Good luck—and good hunting among the ether waves.

THE EDITORS

TABLE OF CONTENTS

One-Control Beginner's Radio	9
Get Started in Radio	10
Three-Tube TRF Receiver	13
One-Tube Loudspeaker Set	14
Four-Tube Speaker Receiver	16
Four Dollars Builds This Set	18
More Power for Your Two-Tube Radio	20
Homemade "Audio" Telegraph	22
Three-Tube Phonograph Receiver	24
Four-Tube TRF Receiver	27
Inexpensive Dual-Turntable Phonograph	28
Kitchen Radio	32
Two-Tube Set Gets Foreign Stations	35
Two-Way Radio Station	36
Combination Receiver and Amplifier	40
"Letter" Radio Can Be Mailed	43
Build an FM Receiver for \$22	44
A Tuner for Any Broadcast Set	48
World's Smallest P. A. Units	51
Twin-Bed Radio	54
Floor-Lamp Radio	58
Practice Code Sender and Receiver	61

Pocket Receiver for Sports	63
Tiny Portable Operates Anywhere	64
Low-Cost Power Supply	67
Three-Tube Superhet	68
Compact All-Wave Set	71
Two-Tube AC-DC Receiver	72
Portable Radio-Phonograph	76
One-Tube Short-Wave Set	79
Sliding Panel Tunes Novel Receiver	80
All-Wave Bands on Two Tubes	82
Compact Radio-Tube Tester	84
Europe on One Tube	87
Bicycle Radio	88
"B" Supply for Portables	91
Priority Receiver Uses New Tuning	92
Compact Rectifier Unit	95

SERVICING YOUR RADIO

Pilot Lights, Rectifier Tube, Squealing, Paper Tubular Condenser . . .	26
Various Causes of Humming	42
Bring Your Radio Up to Date	57
Reception, Volume Control, Dead Speaker, Connecting a Pickup . . .	75
How to Build a Loop Antenna	86
Line-Cord Breaks, Dial Pointers, Fuzzy Operation, Ballast Tubes . . .	96

ONE CONTROL

operates this beginner's

RADIO

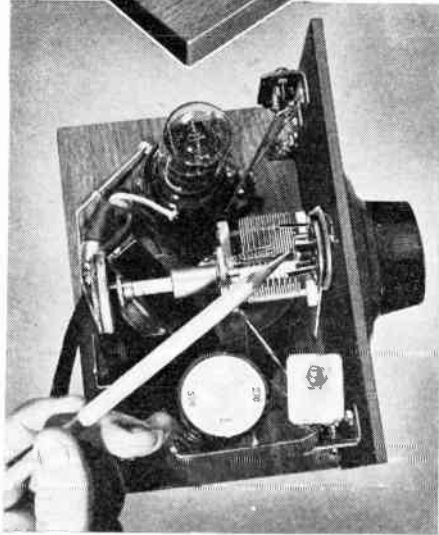

Follow this rear view of the set when placing the parts. Below, the crystal detector with cap removed

A SINGLE dial operates this novel one-tube battery radio; turning the set on when it is rotated to tune in stations and turning it off when moved to its minimum setting. This automatic switching is accomplished by coupling the condenser shaft to an inexpensive rheostat which has been altered by flowing solder over the winding as shown in the sketch.

The circuit is easily wired.

A crystal detector is followed by a single stage of audio amplification. One 45-volt "B" battery provides the plate voltage and a single 1.5 volt dry cell serves the filament. Of the three antenna connections, Terminal A₃ is the most selective, while A₂ provides the greatest volume. Terminal A₁ connects a trimmer condenser into the lead for a short antenna.



The single knob that controls the receiver

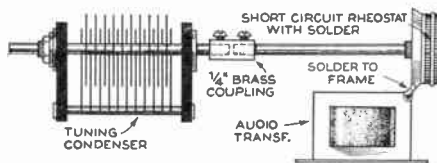
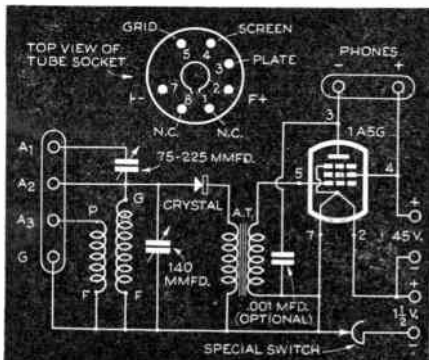

How the automatic switch is fashioned from a rheostat

Get Started in

WITH A FEW
INEXPENSIVE PARTS
YOU CAN BUILD SIX
CIRCUITS DESIGNED
TO TEACH THE TRICKS
OF SET BUILDING
AND REPAIR



Any well equipped radio store is likely to have all the parts that you will need. The prices shown at the right are approximately what you will have to pay for the various items. With these parts you can build this circuit—and then go on to build five other circuits merely by reassembling the parts. Thus you can give yourself a course in the theory and building of radios

IF YOU have always wanted to experiment with radio, here's your chance. With the parts listed at the right, costing about \$8.95, you can build six modern radio circuits—six different radio hook-ups specially designed not only to use the same parts but to provide a good course in general radio construction and theory.

The first circuit, described in this article, is a simple two-tube all-electric earphone receiver. On the following pages, details will be given on how to build a three-tube tuned radio-frequency circuit (page 13), a four-tube speaker receiver (page 16), a three-tube loudspeaker set (page 18), a three-tube phonograph amplifier (page 24), and a four-tube TRF receiver (page 27).

After purchasing the parts listed, together with the necessary connecting wire, fuse clips,

WHAT TO BUY

Line-cord, 135 or 160 ohm....	.29
Filter choke, 20 h., 500 ohm..	.29
Coils, plug-in, 100-570 meters	
(2)85
Variable condenser, .00014	
mfd.55
Mica condensers (2), .002	
mfd.42
Mica condenser, .0002 mfd....	.15
Mico condenser, .0005 mfd....	.15
Dual electrolytic condenser,	
16-16 mfd., 250 v.....	.97
Shielded paper by-pass con-	
denser, .1 mfd., 200 v.....	.13
Tubular paper condenser,	
.006 mfd., 600 v.....	.07
Electrolytic condenser, 10	
mfd., 25 v.....	.24
Pentode-triode tube, 25B8GT	.75
Pentode-rectifier tube,	
70L7GT75
Carbon resistors (4), ½ watt,	
1 meg.40
Carbon resistor, ½ watt,	
200,000 ohm10
Carbon resistor, ½ watt,	
150,000 ohm10
Carbon resistor, ½ watt, 600	
ohm10
Variable resistor, 25,000 ohm	.28
Variable resistor, 250,000	
ohms28
Six-inch magnetic speaker....	.88
Four-inch diol26
Octal molded sockets (2)....	.48
Six-prong molded socket.....	.18
Rotary S.P.S.T. switch.....	.16
R. F. choke, 2.5 mh.....	.12
	\$8.95

◆ TWO-TUBE ELECTRIC ◆ THREE-TUBE ELECTRIC ◆ FOUR-TUBE ELECTRIC

Radio for \$8.95



A few of the items you need. At right, assembling a two-tube, all-electric broadcast-receiving set, the first in a series of six

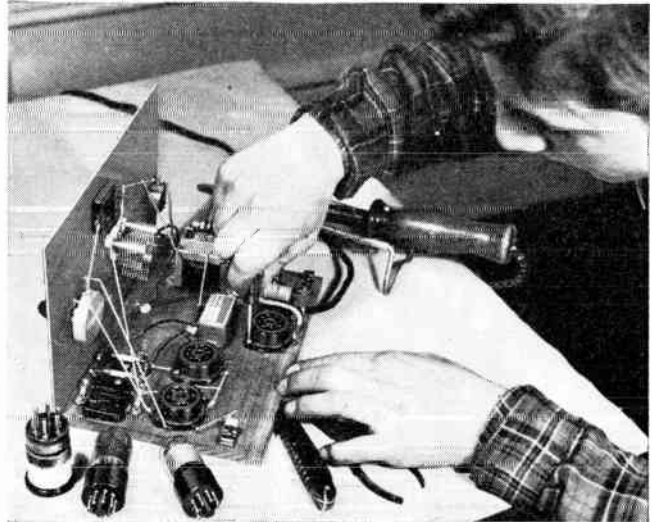

metal panel, wood base-board, and solder, you will have nothing more to buy.

Two tubes of the latest dual-purpose design provide all the tube elements needed in any one of the six circuits. The 25B8GT provides a high-frequency pentode and a high-amplification triode. The 70L7GT provides a half-wave rectifier and an output pentode. Both tubes have octal bases with eight pins or prongs.

Before going on to the construction of the first receiver, it will be well to review a few pointers on radio construction in general:

First of all, use only high-grade parts and make sure that they match the specifications. Second, don't manhandle the parts—remember they have to last for six different circuits. Third, always keep your soldering iron clean and use a solder with a resin core.

The first receiver in this series of six is a two-tube outfit designed to operate on either alternating or direct current of 110 or 115 volts. For these voltages a line cord hav-

ing a built-in resistance of 135 ohms is used and is the right value for all six circuits. If the line voltage in your home is 120 volts, a 160-ohm line cord must be used.

In this circuit, the pentode section of the 25B8GT is used as a regenerative detector (the triode is not used) while half-wave rectifier in the 70L7GT supplies the rectified current for the receiver. (See next page).

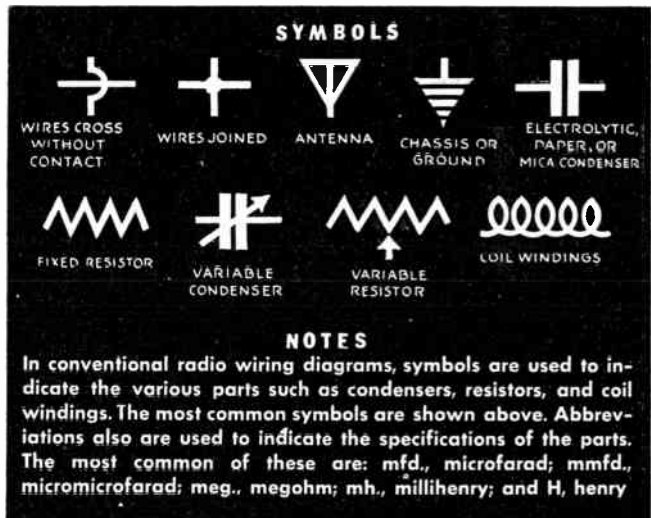

◆ PHONO AMPLIFIER ◆ THREE-TUBE TRF ◆ FOUR-TUBE TRF ◆

Three holes drilled in the metal panel receive the 25,000-ohm variable resistor (used for controlling the regeneration), the .00014-mfd. tuning condenser, and the rotary-type switch. All other parts, with the exception of the .0005-mfd. fixed mica condenser (shown mounted above the tuning condenser), are placed on the wooden baseboard.

As all the parts will be used over and over again, take care in mounting the resistors and condensers. Also, when buying the parts remember that fixed resistors and condensers with "pigtailed" cannot be used.

The electrolytic condensers can have flexible leads since they can be mounted in the same place in each circuit, but the resistors should be mounted in clips, like those used for small fuses.

As this is an A.C.-D.C. receiver, no ground is needed, the circuit being grounded through the house lighting system. Any type of antenna up to 80' in length can be used. For the reception of local stations an indoor antenna approximately 25' long will be found sufficient. It is not advisable to use a long antenna for receiving short-wave signals.

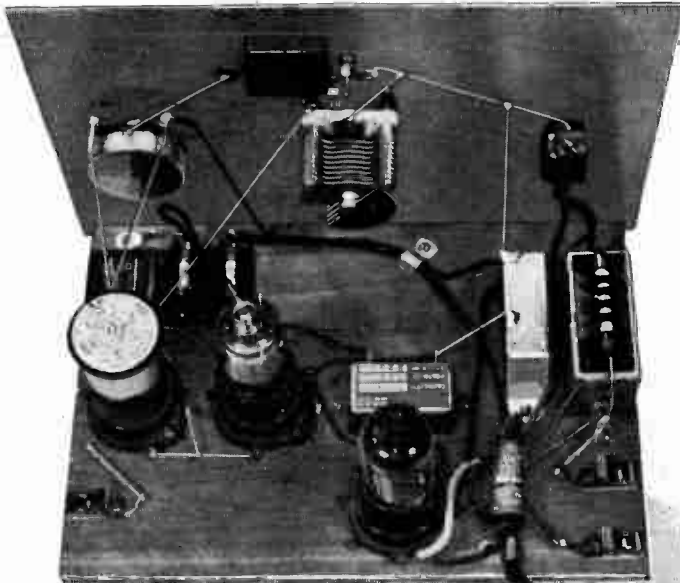

The finished set. The wiring diagram shows the parts used

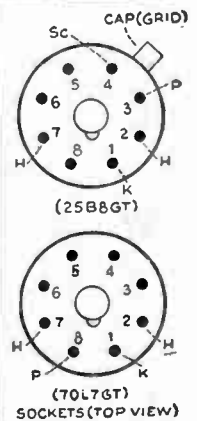
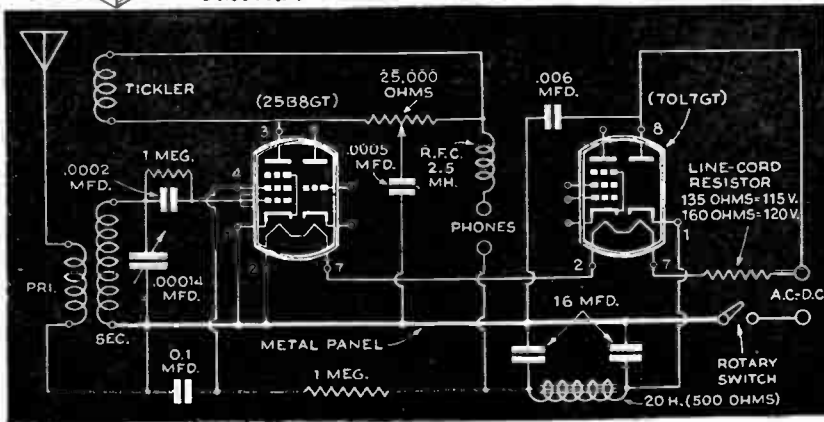
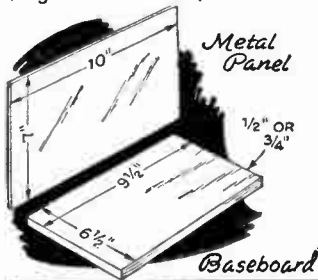

A Three-Tube TRF Receiver

The Get-Started-in-Radio
Series

THE three-tube, tuned radio-frequency receiver for the broadcast band described here, second unit in the series to be built from the parts listed on page 10, will give excellent results. It uses an untuned stage of radio-frequency amplification, a regenerative detector, and a half-wave rectifier, the first two actually one dual-purpose tube. The detector stage is tuned. Regeneration is controlled by a 25,000-ohm variable resistor in the detector's plate circuit. A coil having primary, secondary, and tickler windings couples the detector to the radio-frequency stage. Detection uses the grid-leak-and-condenser method. The grid leak here is a 1 meg., $\frac{1}{2}$ -watt resistor in the grid circuit of the triode (detector), across which is connected a .0002-mfd. fixed mica condenser. The rectifier stage is extremely simple, consisting of one 16-and-16 mfd., 150-volt electrolytic block, one 20-henry choke, and the rectifier portion of the 70L7GT tube.

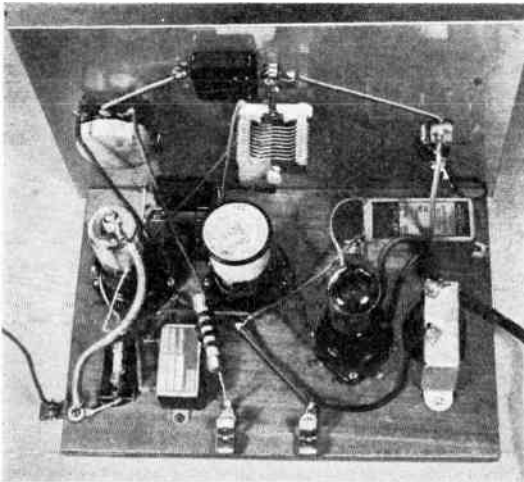

How the parts are arranged on the base and panel

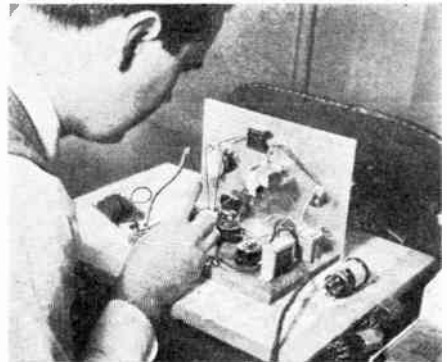

Sockets are easily screwed to the wooden base

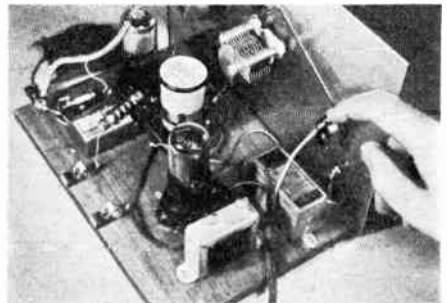

An S.P.S.T. rotary switch turns on the power

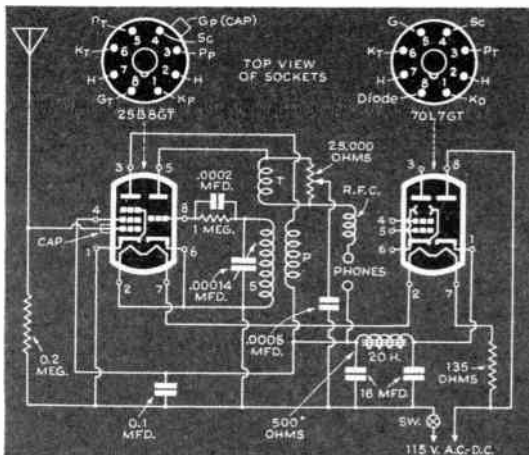

This wiring diagram shows all parts and connections

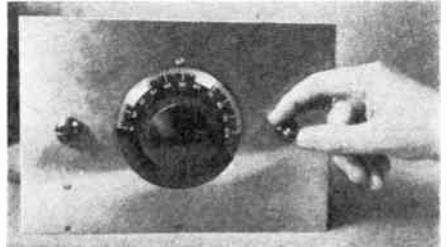

The volume control is right of the tuning dial

One-Tube Set Gives

WITHOUT the use of a tricky reflex circuit or hard-to-get parts this one-tube tuned-radio-frequency set will give full loudspeaker results on all local stations when a good outdoor antenna is used. Within ten miles of local stations, even an indoor antenna can be used, and its selectivity is such that powerful local stations only 30 kilocycles apart can be easily separated.

This remarkable performance is due chiefly to the fact that iron-core coils are used in the antenna and radio-frequency stages. Also, in order to get the most out of each stage, and to allow greater flexibility of control, two separate tuning condensers are used.

A double pentode power amplifier (1E7G) is the single tube used. One section serves as the radio-frequency amplifier, while the other provides the detector and output stages of the receiver.

Grid-leak detection is used on the second "tube" and its plate is connected directly to the speaker without any additional audio-frequency amplification. Sufficient power is obtained with this hook-up to work a 6"

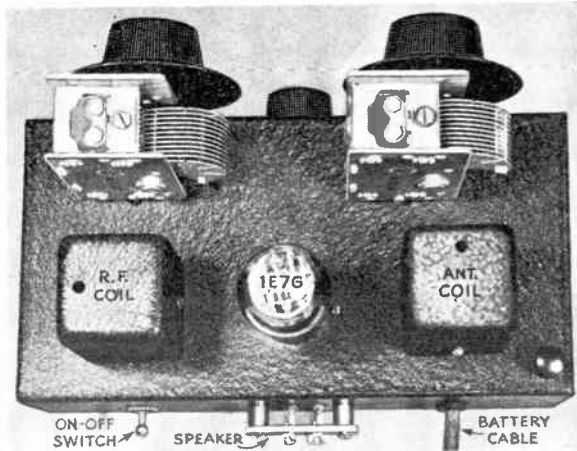

These views of the top and underside of the chassis will serve as a guide in placing the various parts. Below, the set in operation. Note the batteries and separate speaker unit

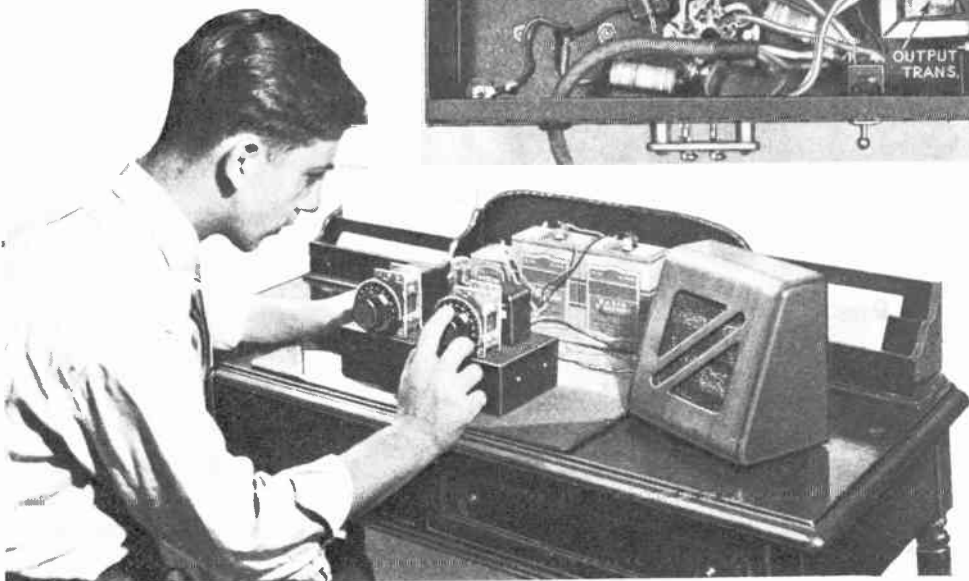
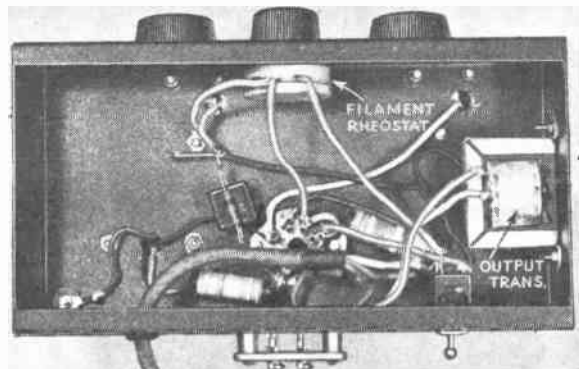

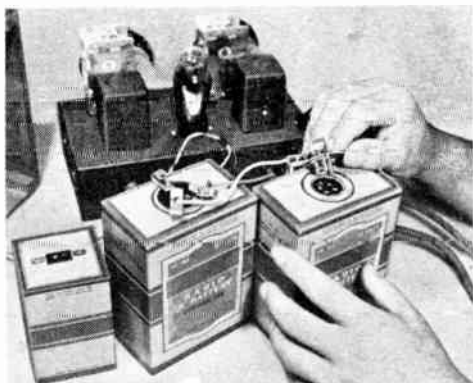

Three new-style batteries are used to power the receiver. The plug-in-type connectors save time

rheostat knob should never under any circumstances be turned.

In tuning the set, remember that both tuning condensers must be operated. The two readings will be just about the same, provided the dials are mounted on their shafts in the same relation. As a matter of fact, these two condensers can be ganged if desired, but the double control does provide greater flexibility and makes it possible to make minor adjustments in any one condenser in order that maximum volume may be obtained.

No ground is necessary with the circuit, and as pointed out earlier the type of antenna, indoor or outdoor, will depend entirely on your geographical location with respect to strong local stations.

LIST OF PARTS

Shielded antenna coil, iron-core.
 Shielded RF coil, iron-core.
 Condensers, tuning, two, .00036 mfd.
 Condenser, tubular, paper, .05 mfd., 600 v.
 Condenser, tubular, paper, .005 mfd., 600 v.
 Condenser, mica, .0002 mfd.
 Resistor, carbon, 1 meg., $\frac{1}{2}$ watt.
 Rheostat, 15 ohms, 4 watts.
Miscellaneous: Tube (1E7G), octal wafer socket, universal output transformer, chassis ($2\frac{1}{2}$ " by 5" by $9\frac{1}{2}$ "), cabinet ($4\frac{1}{2}$ " by $7\frac{1}{2}$ " by $8\frac{1}{2}$ "), two dials, D.P.-S.T. toggle switch, two 45-volt "B" batteries, one 3-volt "A" battery, PM speaker, wire, solder, etc.

A Four-Tube Speaker Receiver

BY ADDING only a half-dozen parts to the all-electric receiver described on page 21 as part of this series, you can provide a final stage of amplification. For this stage, the power pentode in the 70L7GT tube is used, and with this additional power there will be sufficient volume to operate a loudspeaker. The speaker, included in the original list of parts that appears on page 10, is a 5" magnetic unit which can be mounted in a small homemade wooden cabinet. If you do not wish to go to the trouble of making up a special cabinet, the speaker can be mounted on a small baffle about a foot square. Two Fahnestock clips can be used to connect the speaker to the set. These are mounted just inside the cabi-

ADDITIONAL PARTS

Mica condenser, .002 mfd.
 Electrolytic condenser, 10 mfd.
 Fixed resistor, 150,000 ohm.
 Fixed resistor, 1 megohm.
 Fixed resistor, 600 ohm.
 Loudspeaker.

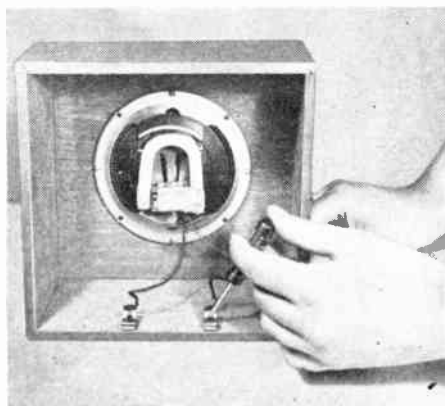

Two spring clips serve as speaker connectors

The Get-Started-in-Radio Series

net, along the bottom (see photo).

The additional parts required from the original parts list are: one .002-mfd. mica condenser, one 10-mfd. electrolytic condenser, and three fixed resistors (150,000 ohm, 1 megohm, and 600 ohm).

When making the various changes, note that some fixed resistors used originally have been juggled around a bit. For instance, the 200,000-ohm resistor used in the plate circuit of the three-tube circuit has been replaced by a 150,000-ohm resistor and the 200,000-ohm resistor used in the grid circuit of the power pentode (70L7GT). The original .006-mfd. paper tubular condenser is used this time as a bypass condenser between the plate of the triode (25B8GT) and the ground (or chassis). No ground connection is needed with this "four-tube" circuit.

Any type of antenna may be used.

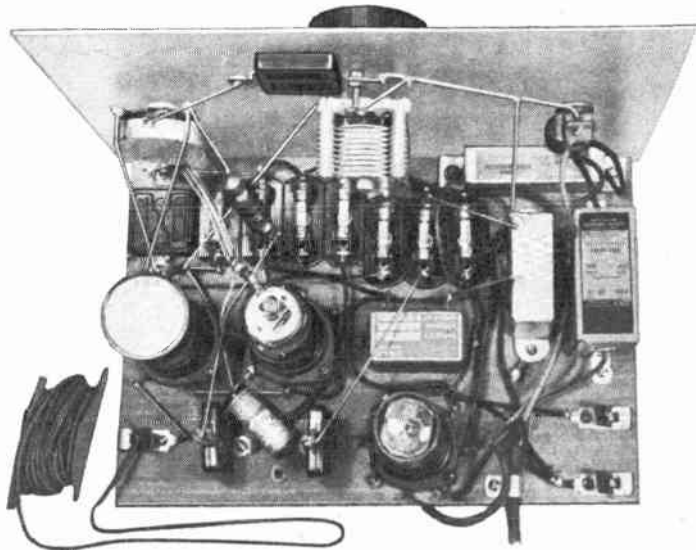

The circuit as it appears wired as a "four-tube" receiver. The antenna wire is coiled on the left. The clips at the right are for the speaker

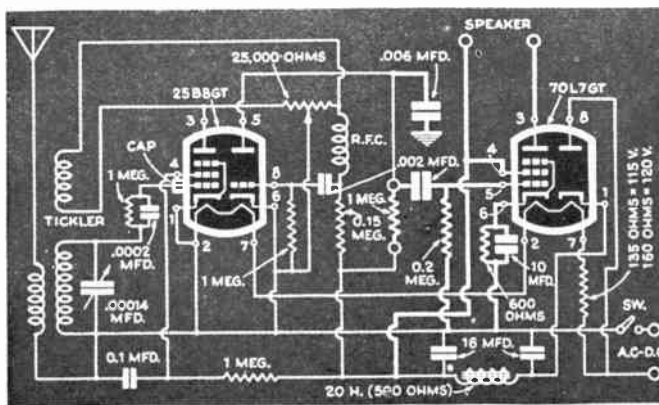

In wiring the circuit be sure to follow the diagram carefully. The new portion of the circuit is indicated by the heavy lines. Socket connections are shown below

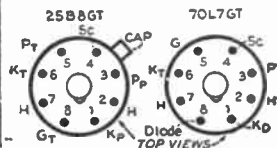

Four Dollars Builds

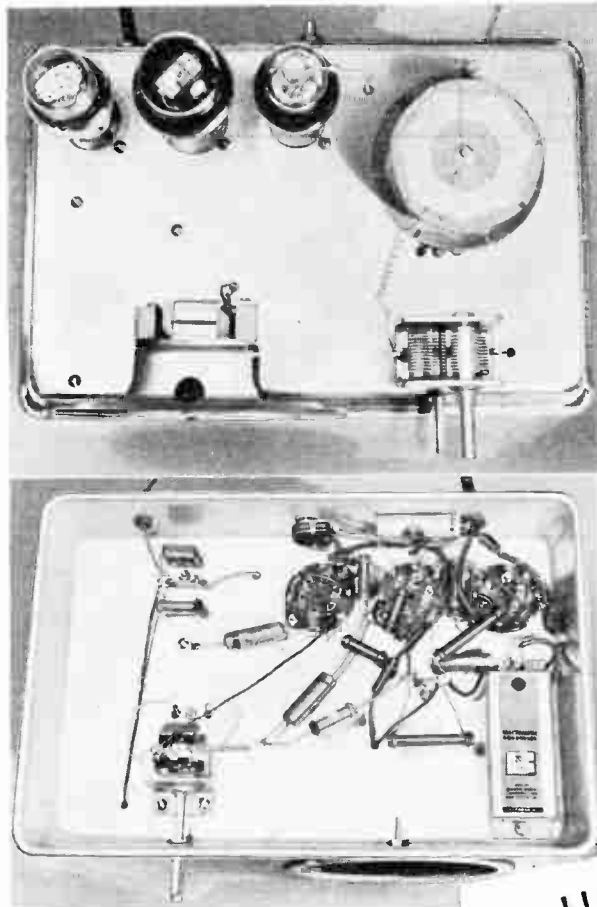

WHEN I finished building the receiver shown, I dubbed it the "Economy Three," for it had cost me only \$4.06, not including the cost of the wood for the cabinet, which I salvaged from my workshop scrap pile. It was an easy receiver to build; the hand-wound coils were easy to make, and the parts fitted nicely into the chassis with plenty of room to spare.

The chassis I purchased for ten cents at my neighborhood "five-and-ten." It's simply an inverted aluminum cake pan 10" long and 6½" wide. Being made of thin aluminum sheeting it was easier to work than most chassis materials. In fact, although I used a regular chassis punch to cut the three holes for the tube sockets, they could

Top and bottom views of the receiver showing the placement of the parts on the ten-cent cake-pan chassis. The regeneration control, set back from the edge, is mounted on a small bracket



A drill saves time, but holes can be cut with scissors

LIST OF PARTS

- Condenser, variable, .000365 mfd.
 - Condenser, mica, .00015 mfd.
 - Condenser, tubular, .005 mfd., 400v.
 - Condensers, tubular, three, .01mfd., 400v.
 - Condenser, electrolytic, 20 mfd., 200 v.
 - Condenser, electrolytic, 5 mfd., 25v.
 - Resistor, carbon, 1,000 ohm, 1 watt.
 - Resistor, carbon, 2,000 ohm, 1 watt.
 - Resistor, carbon, 600 ohm, ½ watt.
 - Resistor, carbon, 300,000 ohm, ½ watt.
 - Resistors, carbon, two, 1 meg., ½ watt.
 - Regeneration control, 25,000 ohm.
- Miscellaneous: Tubes, coil wire, cake-pan chassis, five-inch magnetic speaker, 200 ohm line-cord resistor, on-off switch, six-prong wafer sockets, wire, solder, etc.

This Loudspeaker Set

Get-Started-in-Radio Series

have been cut with an ordinary pair of scissors. Because of the pan's sloping sides, however, the 25,000-ohm regeneration control had to be mounted on a small aluminum bracket behind the front edge as shown at the extreme left. The same screws that hold the variable tuning condenser can be used to support the bracket.

The A. C.-D. C. circuit is simplicity itself. It uses three tubes—a 43, a 6C6, and a 25Z5 rectifier—and provides sufficient pep to operate a loudspeaker. Because magnetic speakers are generally sensitive to weak signals, I chose one of that type. It cost me 93c.

The homemade coils are quite easy to wind. Before going into the actual construction details, however, there is one important point that must be remembered: In making the coils, adhere strictly to the



The completed outfit gives loudspeaker volume with a short antenna

specifications, such as the size of the wire, the length of the antenna attached to the antenna coil, the distance between coils, etc.

First cut out two round cardboard disks, one 2 3/4" in diameter and another 3 1/4". Then divide each form into seven equal sections and cut a slot down each line about 1/16" wide to within 5/8" of the center. On

the smaller form wind 55 turns of No. 30 double-cotton-covered magnet wire. Pass the wire first over one section and then under the next—alternating as you go round. When finished, this will be the antenna coil. The larger coil is the tickler coil and consists of 60 turns of the same wire. In checking the number of turns, add the turns on two adjacent sections. In other words, a coil of 55 turns will have twenty-seven windings on one "rib" and twenty-eight on the next.

The coils are mounted on the chassis by means

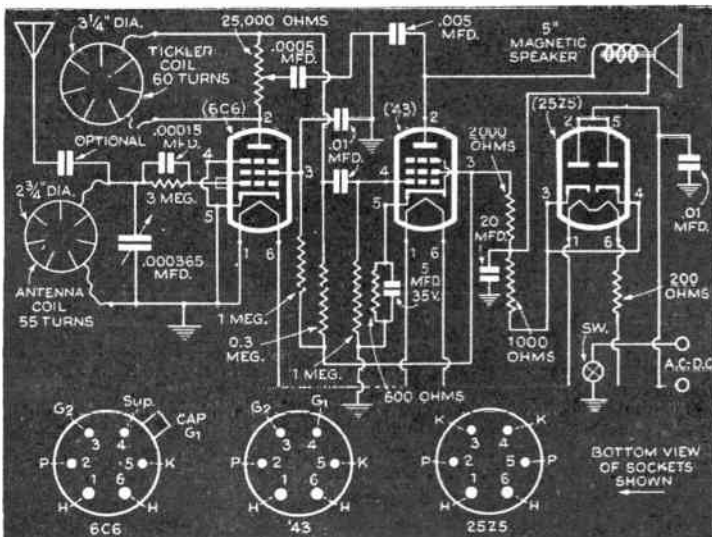

Specifications for the circuit and the hand-wound pancake-type coils

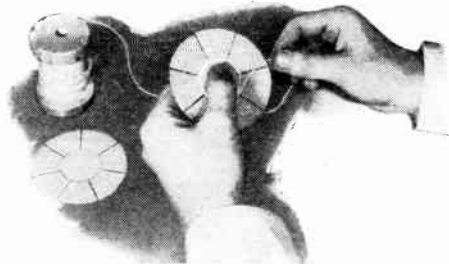

The wire goes over and under the form ribs

of a brass machine screw $2\frac{1}{2}$ " long and two brass-tubing spacers, $\frac{1}{4}$ " in diameter. The tickler coil should be placed nearest the chassis and 1" from it. The antenna coil should be placed $\frac{3}{4}$ " above the tickler coil. Refer to the drawing below for details.

The cabinet, whose dimensions also appear in the drawing below, can be made of any wood that you may have in your scrap pile. It has an open back, and the chassis can be conveniently held in place with two screws driven into the baseboard.

A 25' antenna should be used and it can be left on the floor or hung out of a window. On my version of the set I used rubber-insulated stranded wire and it worked particularly well. If a longer antenna is desired, a .00005-mfd. fixed mica condenser must be inserted in the antenna lead.

By adding to or reducing the number of turns on the antenna coil, the set's range can be varied to receive stations just below or just above the broadcast band.

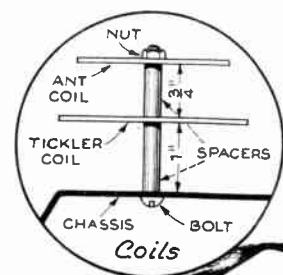

Dimensions for the cabinet and the cake-pan chassis, and mounting details for the two flat-wound coils

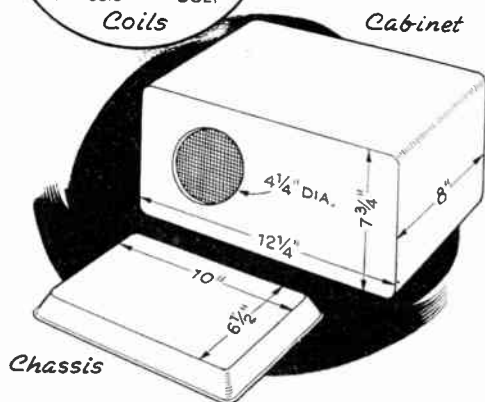

Chassis

More Power

ON PAGE 10, as the first in a series of six articles on easily built circuits for radio experimenters, a two-tube all-electric receiver is described. On these pages a stage of resistance-coupled audio-amplification is shown to give the set more power.

For the additional stage we will use the triode section of the 25B8GT tube used in the original design and six new items from the original list of parts. The new parts consist of a .002-mfd. mica condenser, a 200,000-ohm, $\frac{1}{2}$ watt resistor, a 1-megohm, $\frac{1}{2}$ watt resistor, a Fahnestock clip for the ground connection, and two fuse mounts to hold the resistors. The .002-mfd. mica condenser is used for coupling the detector stage to the audio stage and is mounted on the baseboard in a vertical position. In the photographs, it can be seen next to the antenna clip. The two $\frac{1}{2}$ -watt resistors are also mounted on the baseboard, next to the other resistors.

In order to avoid feed-back and undesirable oscillation, the grid lead to the

LIST OF PARTS

(Included in list on page 10)

- Condenser, mica, .002 mfd.
- Resistor, Carbon, 200,000 ohm, $\frac{1}{2}$ watt.
- Resistor, carbon, 1 meg., $\frac{1}{2}$ watt.
- Fahnestock clip.
- Two fuse mounts.

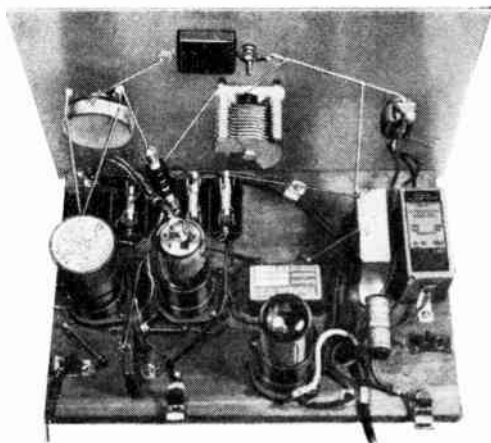

How the two-tube set on page 10 should look after adding a stage of audio amplification

H O M E M A D E "Audio" Telegraph

NEEDS NO WIRES

WITH a few inexpensive standard radio parts you can experiment with a new and novel type of communication system. Dubbed an "audio" telegraph because it uses waves that are more than 30,000 meters long, the easily built hook-up makes it possible to send and receive dot-and-dash messages over distances of more than 200 feet without the use of wires.

In the "audio" telegraph the ground serves as the connecting link between stations, the receiver and transmitter being connected to the ground by means of 30" copper or steel rods driven deep into the soil as shown in the photograph below. The transmitter consists simply of an eighty-cent telegraph key, a house buzzer, a battery, and a bell transformer. The receiver is an easily wired conventional two-stage audio-frequency amplifier connected to an ordinary pair of earphones.

In the original transmitter circuit shown,

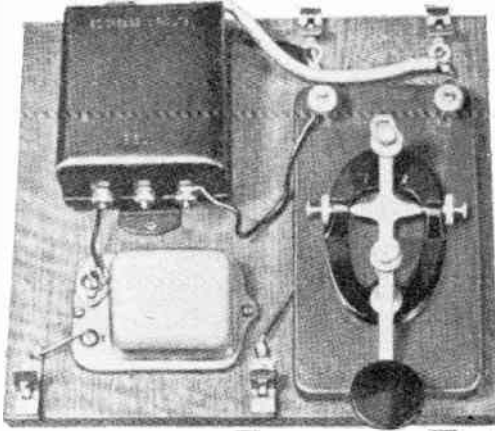

Above, the transmitter, and at the right, the receiver, both mounted upon boards with Fahnestock clips used as terminals

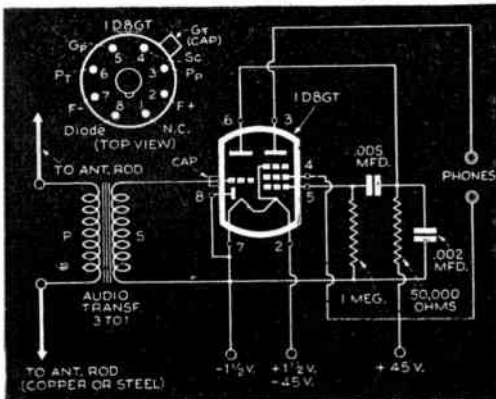
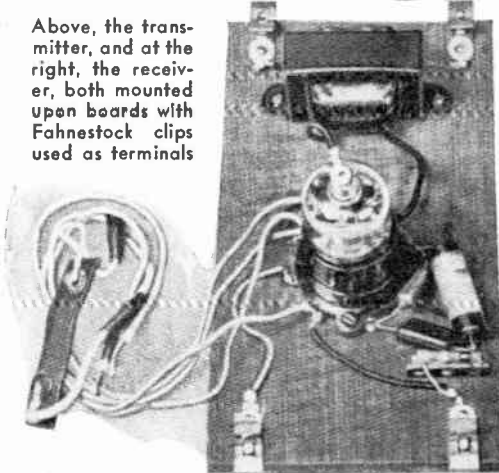

All connections are shown and all parts are represented in the wiring diagram of the receiver above. At right, sender and receiver are set up for use

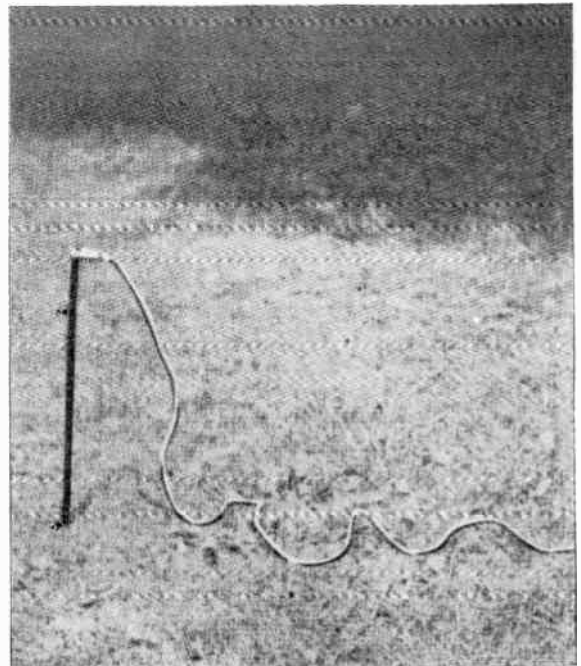

I mounted the parts on a 7" by 8" baseboard. It can, of course, be placed in a cabinet or it and the receiver can be housed together in a compact portable carrying case. When buying the bell transformer, which is the only critical part in the transmitter circuit, make sure that it provides a 110-volt primary and a 12-volt secondary. In the actual hook-up, the windings are used in reverse—the 12-volt winding serving as the primary and the 110-volt winding as the secondary. Connections to the copper antenna rods and to the 7½-volt battery can be made through Fahnestock clips screwed to the baseboard. (See next page.)

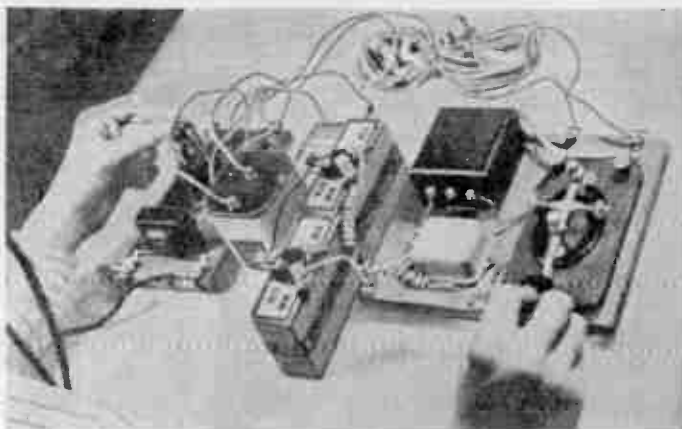

Follow this arrangement in mounting the parts of the two units on their baseboards. Below, how transmitter, receiver, and ground rods are set up

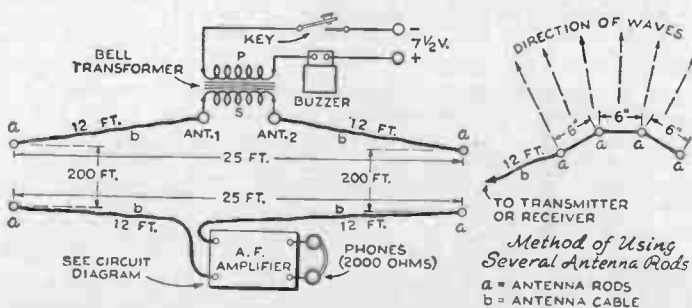

**Sends Messages
Over 200 Feet**

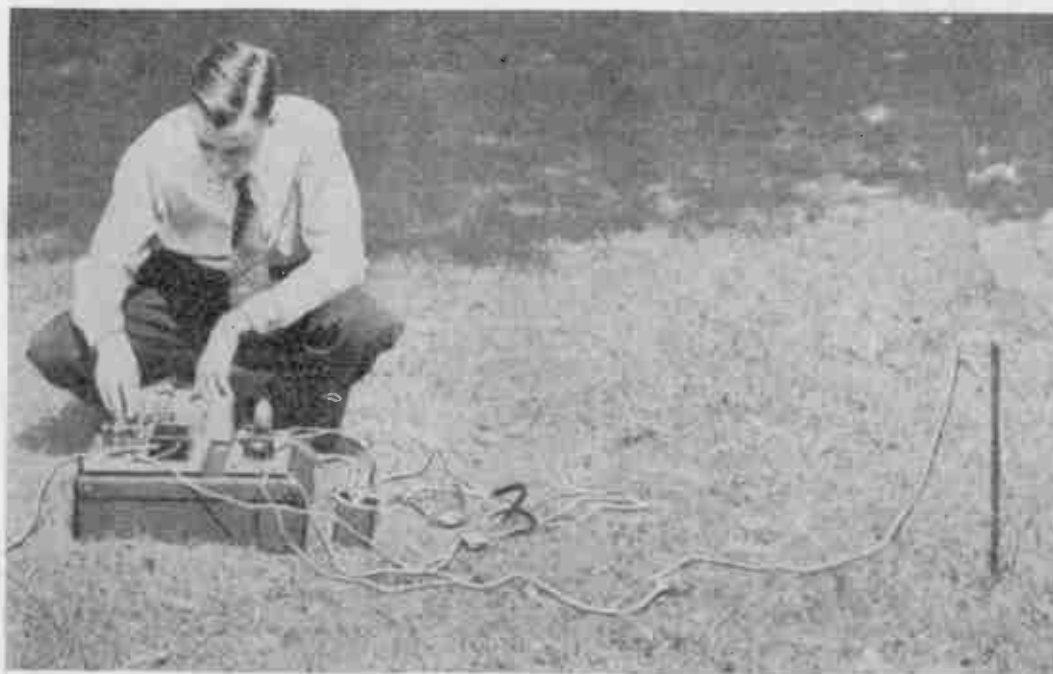



A small suitcase provides a handy carrier for the outfit, its batteries, and the necessary wires

For the audio-amplifier receiver, a dual-purpose 1D8GT tube is used. The diode portion of the tube provides the first or input stage, the pentode the second or output stage. Notice that an audio transformer is used in the first stage and resistance coupling is used in the second.

A small 1½-volt flash-light cell or an ordinary dry cell, and one 45-volt "B" battery, provide the current necessary to power the receiver circuit. These batteries are indicated on the wiring diagram together with the socket connections.

In setting up the receiver and transmitter, be sure to follow the directions given in the drawing. The antenna rods must be placed approximately 25' apart and in a line parallel to the line of the rods connected to the receiver. If a greater distance of transmission is desired, use additional antenna rods in the transmitter circuit and place them in open curves facing toward the receiver.

PARTS FOR "AUDIO" TELEGRAPH

Amateur transmitting key.
 Bell transformer (see text).
 House buzzer.
 Audio transformer, 3-to-1 ratio.
 Baseboard octal socket.
 Tube (1D8GT).
 Fahnestock clips (eight).
 Headphones, 2,000 ohm.
 Antenna rods (four, see text).
 Mica condenser, .005 mfd.
 Tubular paper condenser, .002 mfd., 600 v.
 Carbon resistor, ½ watt, 1 meg.
 Carbon resistor, ½ watt, 50,000 ohm.
Miscellaneous: Flash-light batteries, "B" batteries, wire, baseboards, etc.

A Three-Tube Phonograph Receiver

ALTHOUGH designed primarily as a phonograph amplifier for use with either a crystal or a magnetic pick-up, this three-tube set of the "Get Started in Radio" series which begins on page 10, is so versatile that it can be used for other purposes as well. Connected to a simple crystal receiver through a 3-to-1-ratio transformer, for instance, it can be used to provide loud-speaker volume on near-by broadcasting stations. Used with a microphone, it can be made to serve as a small public-address system.

The parts for the amplifier were all included in the main list of parts given in the first article. If you bought the list complete you have nothing more to buy, for even the baseboard can be used again by turning it bottom side up to conceal the holes that were made in mounting



An earphone can be used as a public-address mike

The Get-Started-In-Radio Series

the parts for the first three circuits.

Your first job will be to take apart the four-tube receiver constructed on page 16. Be careful in removing the parts, as many of them will be used again.

Both tubes (25B8GT and 70L7GT) are used in the amplifier circuit. The 25B8GT, not using its triode section, serves as the input stage and the 70L7GT provides the output. As shown in the diagram, resistance coupling is used and offers sufficient volume for ordinary use.

In placing the parts, follow the photographs. Mount the 25,000-ohm tone control, the 250,000-ohm volume control, and the on-off switch on the front panel. The volume control fits conveniently in the space vacated by the variable tuning condenser used in the previous receiver circuits.

When used as a phonograph amplifier, the unit should be connected to a high-impedance pick-up with a rating of approximately 18,000 ohms.

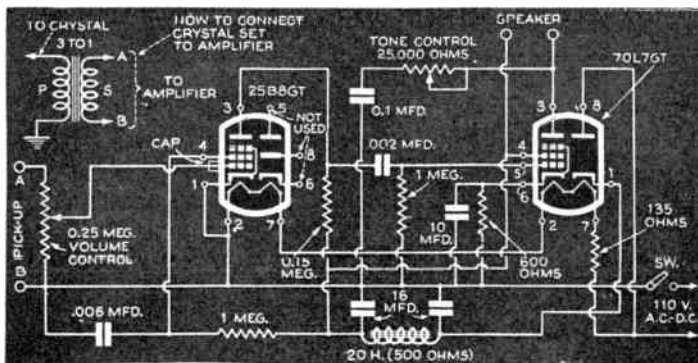
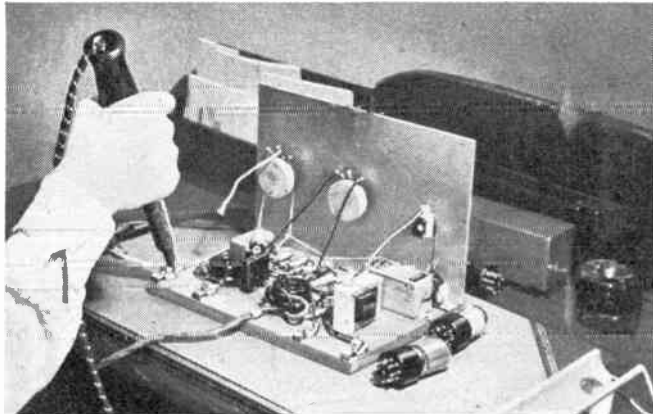
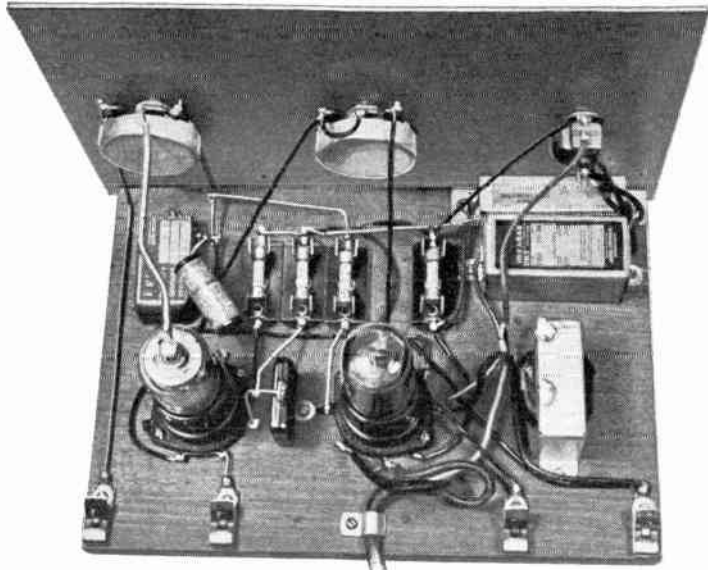

Soldering iron and pliers are the only tools needed to assemble the inexpensive amplifier

How the parts are wired. Below are the two socket wiring diagrams

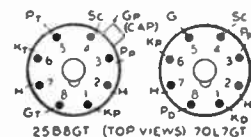

Servicing Your Radio

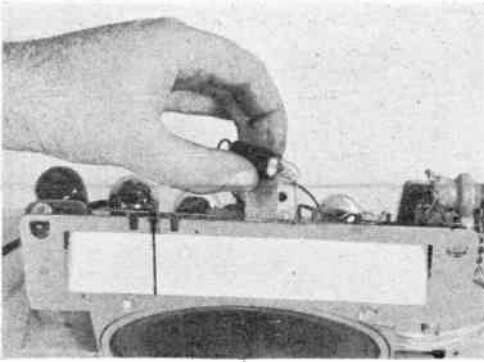

CHANGING PILOT LIGHTS is a simple operation in servicing a small A.C.-D.C. receiver, but be sure that you disconnect the radio at the wall socket—don't just turn off the switch. A serious short can occur if the pilot-light bracket and holder drop on the tuning condenser or chassis.

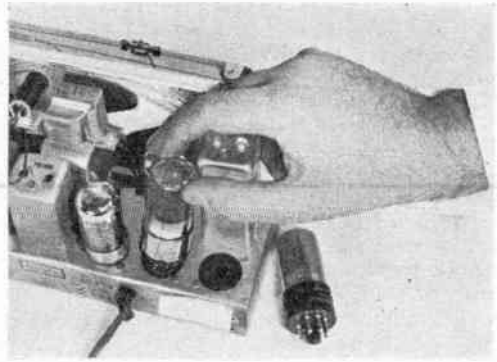

INCREASED HEATER VOLTAGE may be necessary if the rectifier tube burns out quickly on an A.C.-D.C. radio having a new high-voltage heater tube and no line-cord resistor. Try replacing the 3525-GT/G rectifier tube with a 45-volt rectifier, such as a 42Z5-GT/G, to increase the heater voltage to 120 volts.

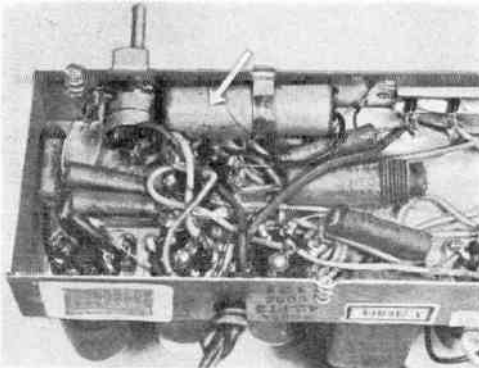

THE PAPER TUBULAR CONDENSER connected between the power pentode tube and chassis, as shown in the diagram below, may be shorted if an A.C.-D.C. radio has gone dead except for the heater glow inside its tubes. This is especially true if, upon testing, the D.C. voltage to the tubes shows only about 20 volts. Remove the power pentode tube (a 43, 25L6, 50L6, or similar tube) from its socket, and test the condenser by placing an ohmmeter across it. If the needle on the meter swings over, the condenser is shorted and a new one must be installed.

SQUEALING AND WHISTLING that make it impossible to tune in a station clearly on a small A.C.-D.C. receiver may mean failure of one or both of the filter condensers shown in the photograph above and the diagram below. The noise is usually accompanied by a noticeable loss in volume. If defective, the condensers must be replaced.

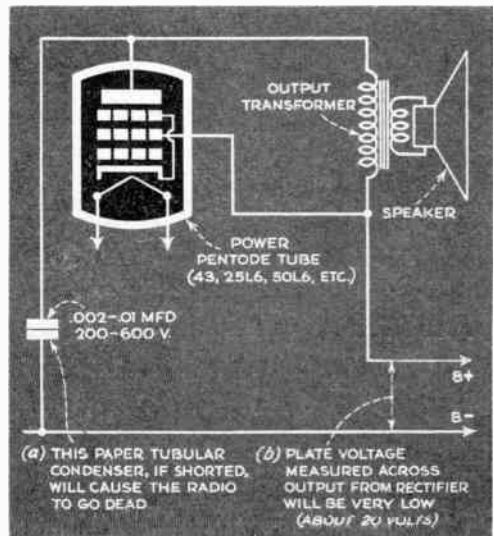
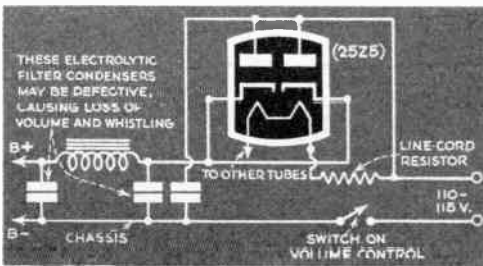

A Four-Tube TRF Receiver

The Get-Started-in-Radio Series

THIS radio is the sixth and last in our "Getting Started for \$8.95" series. The set is a four-tube, tuned-radio-frequency receiver with an untuned stage of radio-frequency coupled to a tuned detector stage with regeneration. Only one coil and one tuning condenser are required, instead of a ganged condenser and a pair of matched antenna and radio-frequency coils. The antenna coil has been replaced by a 200,000-ohm, 1/2-watt resistor between the grid of the 25B8GT (pentode section) and the chassis.

The radio-frequency portion of the set remains the same as in the previous article, except that an audio stage has been added. The audio stage is resistance-coupled. Bias for the pentode portion of the 70L7GT tube is obtained by means of the 600-ohm resistor and 10-mfd. electrolytic condenser.

The antenna should be from 20' to 100' long. No ground should be used unless it is attached to the chassis through a .1-mfd., 600-volt condenser.

The dual-purpose 70L7GT tube with its glass bulb removed to show the cylindrical arrangement of the elements

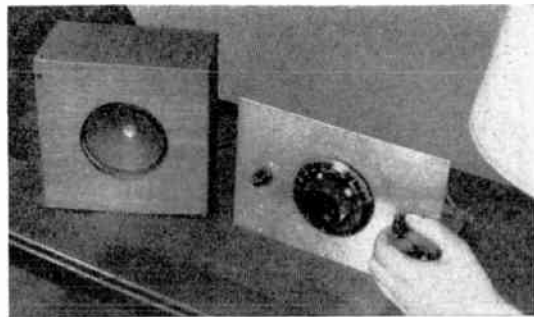

Two tubes serving as four power this loudspeaker radio



The same chassis and panel used before can be used again

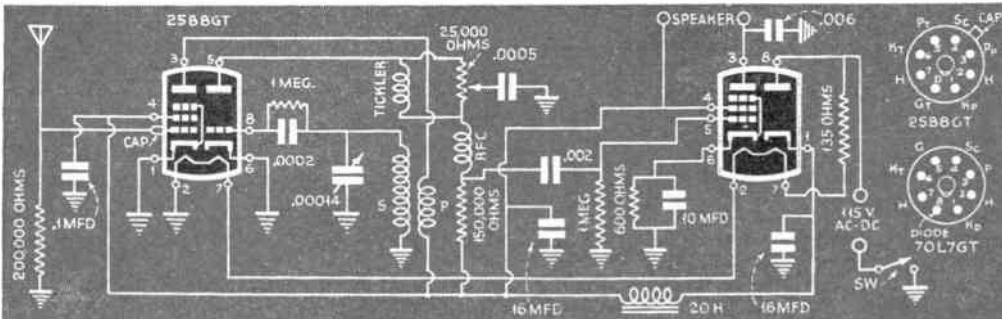
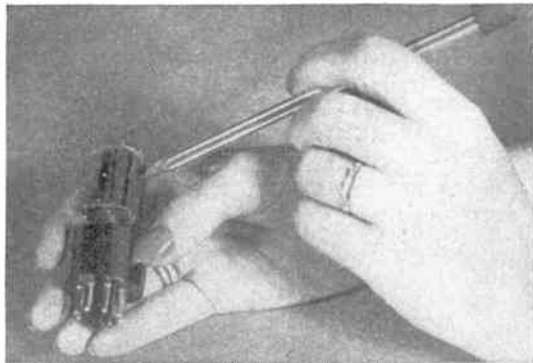

A 200,000-ohm resistor between the pentode grid and the chassis replaces an antenna coil in the hook-up

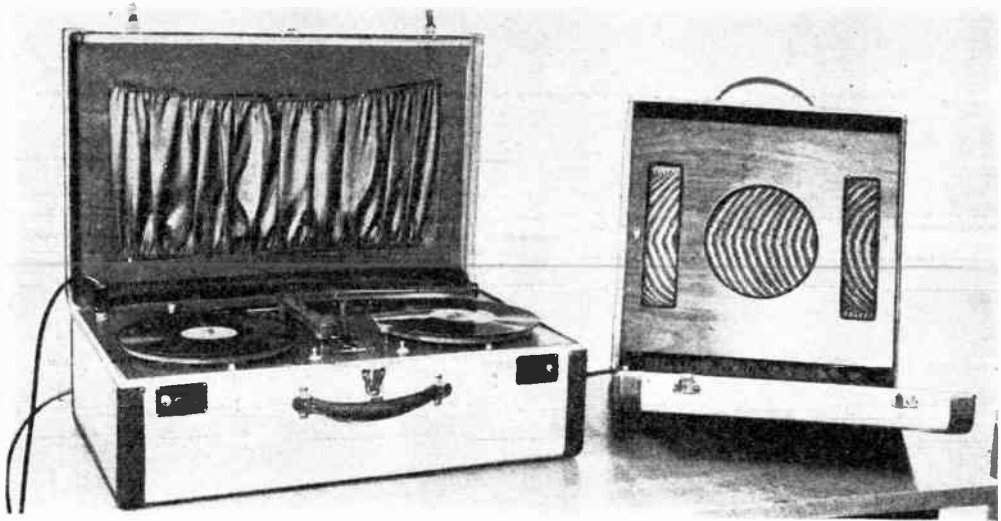

The twin phonographs and amplifier are installed in a 26" suitcase, the speaker in a matching hatbox

INEXPENSIVE DUAL-TURNTABLE PHONOGRAPH

Portable and Easy to Build, It
Provides Sound Accompaniment
for Your Own Home-Movie Films

ALL SORTS of entertainment possibilities are opened with this easily built twin-turntable phonograph. If you are a music lover, it will allow continuous reproduction of your favorite symphonies and operas. If you like nonstop music for dancing, it will supply that. And if your hobby is home movies, it can be used to provide realistic fade-in and fade-out accompaniments and sound effects for your favorite films. Complete and housed in two pieces of luggage for easy carrying, the outfit can be built for \$35.

The containers for the equipment consist of a standard 26" week-end bag and a standard hatbox, matching in color and design. Into the larger bag go the two self-starting, A.C. motors with 9" turntables,



Close-up of the motor panel showing the two turntables and pick-up arms, and the tone and fader controls. The switches next to the turntables operate the phone motors. While one unit plays music, the other may provide the incidental sounds



How the two units are set up for use. The phonographs are beside the movie projector where the operator can put on and change records and regulate the volume. The speaker unit, connected by a 25' cable, is placed near the screen

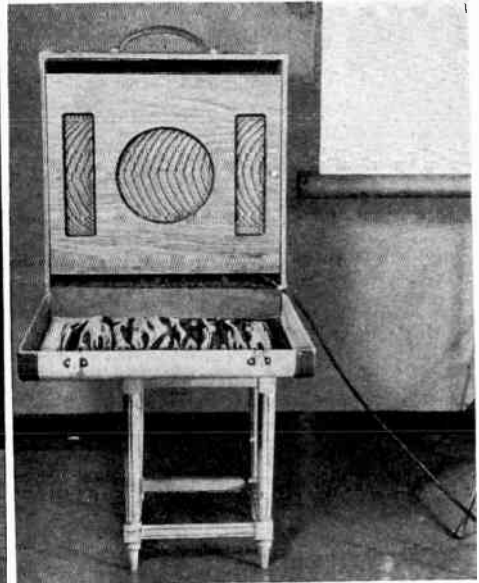

two crystal pick-ups, and the 4-watt amplifier system with fader and tone control. In the hatbox is the 8" permanent-magnet speaker, provided with a 25' length of heavy, rubber-covered cable so that the speaker can be placed beside a movie screen. At one end of the table is a microphone-type plug which fits into the jack at the motor panel.

On the motor panel, which is a $\frac{1}{2}$ " by $15\frac{1}{8}$ " by $24\frac{7}{8}$ " sheet of plywood, are mounted two S.P.S.T. toggle switches for starting or stopping the two phonograph motors. The motors should maintain a constant speed of 78 revolutions per minute at all times. Those used by the author have large bearings and laminated-bakelite helical-cut gears completely inclosed and protected.

Above the three-tube amplifier is an opening $3\frac{1}{2}$ " by 10" and protected by a piece of cane sheeting $4\frac{1}{2}$ " by 11". The cane sheeting may be obtained at any large hardware store. It should have a coating of black enamel paint to prevent rust and enhance the general appearance of the equipment.

On a small black-crackle aluminum panel, $2\frac{1}{2}$ " by 6", are mounted the two fader controls regulating the output of each pick-up, the tone control, and the amplifier on-and-off switch which is mounted on the 250,000-ohm tone control.

The fader controls are two 100,000-ohm

variable resistors connected in series between the control grid of the input triode and ground. Across these is a 1-meg., 1-watt carbon resistor.

The 6C5 is resistance-coupled to the 6F6 pentode by means of the 50,000-ohm, 1-watt resistor, the .1-mfd. coupling condenser, and the 500,000-ohm, 1-watt grid resistor. Amplification is ample with the crystal pick-ups used to operate the 6F6 at its maximum output of $3\frac{1}{2}$ to 4 watts.

The power transformer has three secondary windings—300+300 volts at 60 milliamperes, 5 volts at 2 amperes, and 6.3 volts at 2.5 amperes. A 30-henrys choke, rated to pass 75 milliamperes, and two 12-mfd. electrolytic condensers constitute the filtering circuit. A 10,000-ohm, 1-watt resistor in the plate circuit of the 6C5 and by-passed by an 8-mfd. electrolytic condenser stabilizes the amplifier and prevents feed-back.

A high- μ triode (the 6F5) may be substituted for the 6C5 if greater volume is desired. However, the output of this amplifier, with the 6C5, is ample even for a small dance hall. If needle scratch is noticeable, an inexpensive scratch filter may be connected in the output of each pick-up unit. The filters can be mounted beside the motors under the motor panel.

Instantaneous changing of the records is

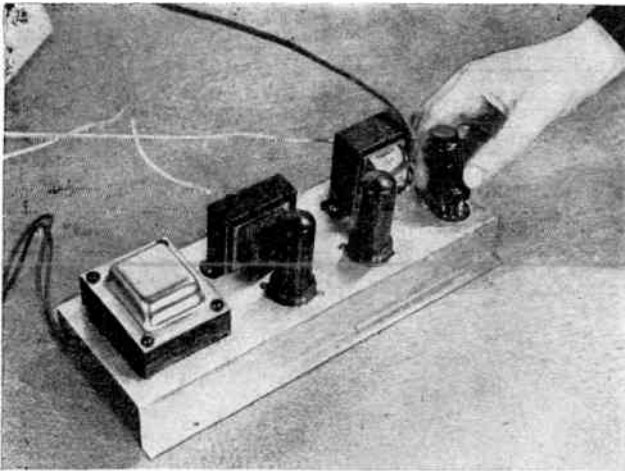

Top and bottom views of the amplifier chassis which should be bolted to the bottom of the suitcase under the motor-panel grill. Metal tubes are used—an important advantage in portable units

possible with the twin pick-up units, one record being readied while another is playing. For home-movie work, records or parts of them can be faded in or out at will. And, if desired, a sound-effects recording may be played simultaneously with an instrumental recording.

Ilya Laskoff, composer and conductor for the Columbia Broadcasting Company, suggests the following records for use with home-movie scenes:

For ocean scenes, Debussy's "La Mer" and Mendelssohn's "Fingal's Cave." For western scenery, Ferde Grofe's "Grand Canyon Suite" and "The Plains" by Bernard Rogers. For pictures of children, Debussy's "Children's Corner." For country scenes, "Pastoral Symphony" by Beethoven.

For industrial scenes of ship-yards, railroad terminals, or factories, Mr. Laskoff's choice is either "Ironworks" by Mos-solow, or "Steel Mills" by Ferde Grofe.

Pictorial diagram of parts under the motor panel. Needle-scratch filters may be added if necessary

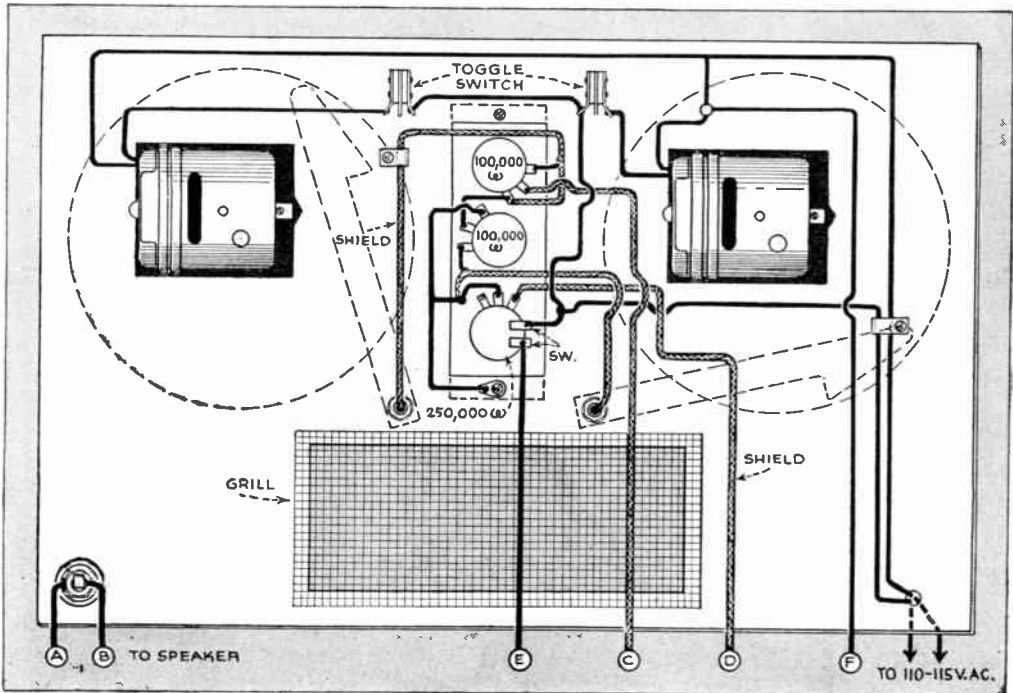

LIST OF PARTS

- Power transformer, 600 volt, 50 ma.; 5 volt, 2 amp; 6.3 volt, 2½ amp.
 Filter choke, 30 henrys, 400 ohm.
 Universal output transformer.
 Tubes, 6C5, 6F6, and 5W4.
 Crystal pick-ups (2).
 Phonograph motors (2) with 9" turntables.
 P.M. speaker, 8".
 Suitcase (26" size).
 Hatbox.
 Chassis, 1½" by 4" by 12".
 Octal wafer sockets (3).
 Shielded hook-up wire.
 S.P.S.T. toggle switches (2).
 Volume controls, 100,000 ohm (2).
 Tone control, 250,000 ohm
 S.P.S.T.-switch cover plate (for above).
 Electrolytic condensers, 12 mfd., 450 volts (2); 25 mfd., 50 volt; 5 mfd., 50 volt; and 8 mfd., 450 volt.
 Tubular condensers, .05 mfd., 400 volt, and .1 mfd., 400 volt.
 Carbon resistors, 500 ohm, 5 watt; 2,500 ohm, 1 watt; 10,000 ohm, 1 watt; 50,000 ohm, 1 watt; 500,000 ohm, 1 watt; and 1 meg., 1 watt.

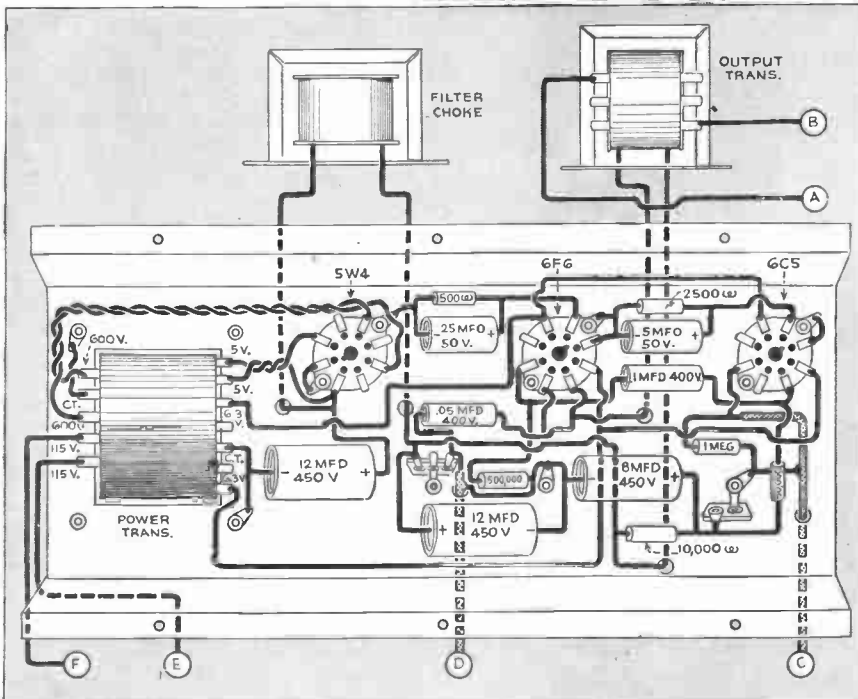
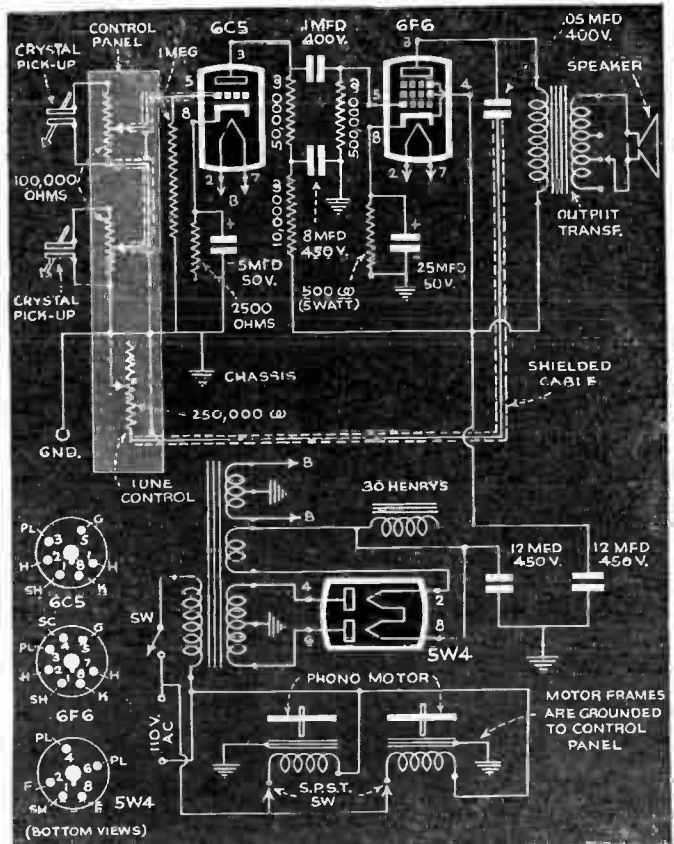

Above is a complete wiring diagram for the amplifier and loudspeaker circuit. The motor frames are grounded to the control panel.

In this pictorial diagram, the placing of the ports of the amplifier circuit above and below its chassis are shown in detail. In making all connections, use solder.



KITCHEN RADIO

RESEMBLES FLOUR CONTAINER

Matching kitchen bins, the radio is both decorative and handy. The lettering and trim are in black on an ivory background

An A.C.-D.C. Three-Tube Receiver

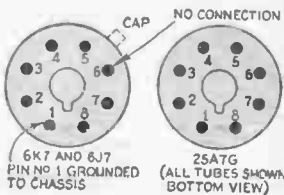

Follow the numbers in the circuit diagram for making the tube-base connections

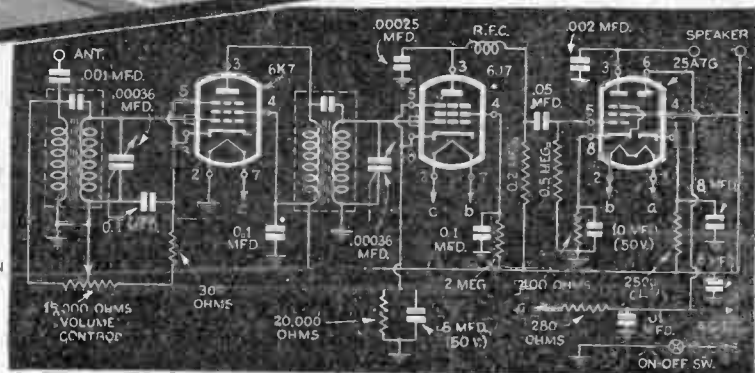

DESIGNED specially for use in a kitchen or kitchenette, this compact three-tube broadcast receiver is built to match the conventional canisters used by housewives to store flour, sugar, and other dry groceries. Operating on either alternating or direct current, the set can be plugged into any house-wiring outlet and requires only a short antenna and no ground.

To match the set of canisters already in the writer's kitchen, the wooden receiver cabinet was finished in ivory enamel with black lettering and trim. The word "FLOUR," which appears on the front just above the tuning dial, was painted on free-hand. However, if the reader prefers, he may cut the letters from a strip of black electrician's tape, and then press each letter in place. As electrician's tape is already adhesive, no glue will be required. Black paper letters, available at most large stationery or art-supply stores, also can be used, if desired.

Since most kitchen containers have some sort of handle on the top, the writer placed the volume control on the top of the cabinet. The knob makes the general appearance of the receiver more realistic. The speaker was mounted on the right side in order to leave room on the front for the word "FLOUR."

In designing the circuit, one of the new ultra-midget combined pentode and rectifier tubes was chosen as a combination rectifier and power tube to save space and make the chassis as compact as possible.

Two all-metal tubes are used in the radio-frequency and detector stages and are coupled through shielding iron-core coils. This provides maximum efficiency and results in an increase in sensitivity with the result that a greater number of stations can be heard with this set than with most standard A.C.-D.C.

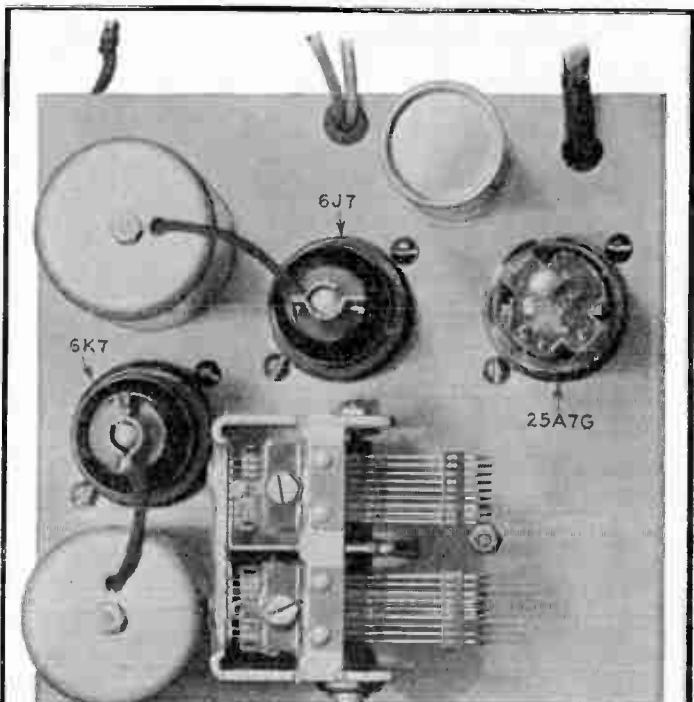

Note the arrangement of the tubes, coils, and condenser on top the chassis

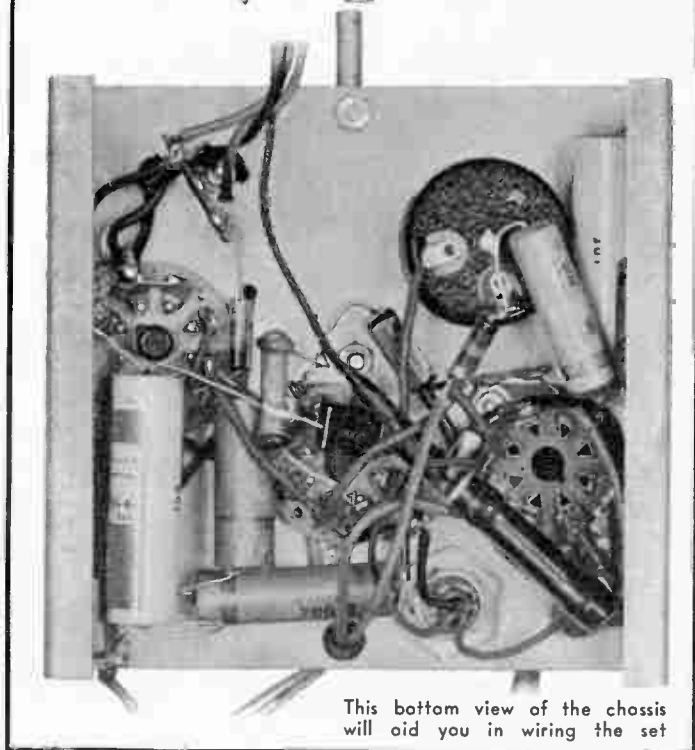

This bottom view of the chassis will aid you in wiring the set

tuned-radio-frequency receivers. Adequate filtering in the plate circuit of the detector tube avoids instability caused by feed-back between the audio and detector stages.

The chassis, which can be cut and bent to shape easily from sheet aluminum, measures 1½" by 5" by 5½". The front and back should be left open to provide ventilation for the 2,500-ohm filter resistor. In order to provide plenty of room for mounting the resistors and by-pass condensers, the dual electrolytic condenser should be placed above the chassis. As shown in the photographs, it will fit under the output transformer of the five-inch, permanent-magnet loudspeaker. Before installing the speaker, a piece of metallic cloth, which can be obtained from a radio-supply house, should be cut to shape and glued over the speaker opening on the inside surface of the cabinet.

As with all radio circuits, caution should be exercised in making the various connections, particularly those to the tube sockets. Remember that filament voltages are low, plate and grid voltages are high by comparison, and that one slip may destroy a radio tube. All connections should be made carefully with solder, and connecting wires should be made

LIST OF PARTS

Tuning condenser, two-gang, .00036 mfd.	Resistor, 2,500 ohm, 10 watt.
Tubular condensers (three), .1 mfd.	Resistor, 400 ohm, 1 watt.
Tubular condenser, .05 mfd.	Half-watt resistors, ½ meg., 20,000 ohm, 2 meg., 200,000 ohm, and 300 ohm.
Tubular condenser, .01 mfd.	Antenna and radio-frequency coils, shielded, iron-core.
Fixed condenser, mica, .002 mfd.	Volume control and switch, 15,000 ohms.
Fixed condenser, mica, .001 mfd.	Radio-frequency plate choke, shielded 30 mh.
Fixed condenser, mica, .00025 mfd.	Miscellaneous — Midget wafer 8-prong sockets, tubes (see diagram), speaker.
Electrolytic condensers, 50 volt, 5 mfd.; ultramidget, ultrathin, 8 and 8; and 50 volt, 10 mfd.	
Line-cord resistor, 280 ohms.	

as short as possible to insure low losses and good performance.

The reader will find that the wiring of the tubes will be greatly simplified if he will compare the numbering of the terminals on the tube-socket diagrams with those appearing in the circuit diagram.

In operating the receiver, thirty or forty feet of flexible insulated wire strung around the molding or baseboard will provide good reception. As with all A.C.-D.C. receivers, no ground connection should be used, since the circuit is already grounded through the power plug.



Putting finishing touches on the cabinet. At the right is a rear view of the completed set. The knob on the top is the receiver's volume control

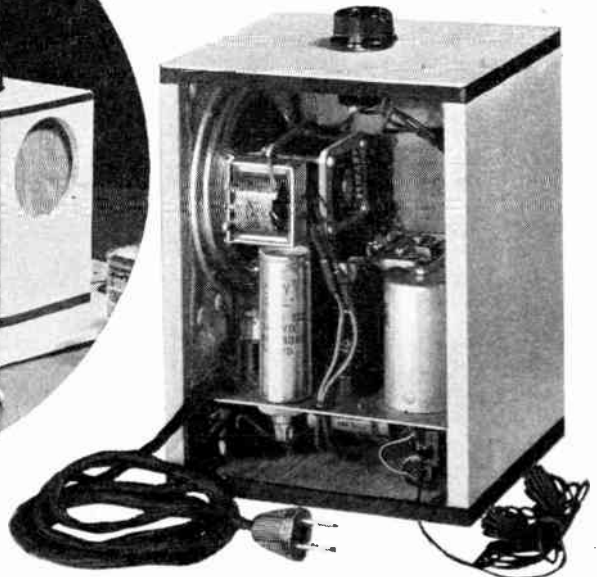

Two-Tube Receiver

BRINGS IN FOREIGN STATIONS

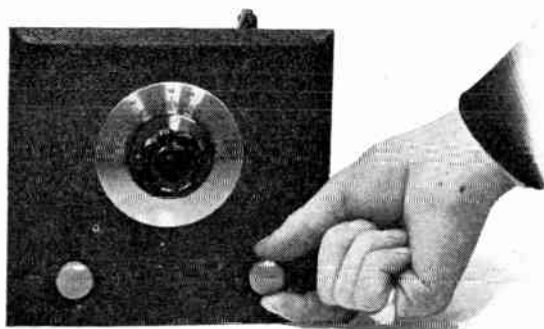

Three controls operate the long-range receiver



Mount tubes, tuning condenser, transformer, and plug-in coil atop the chassis; other ports below it

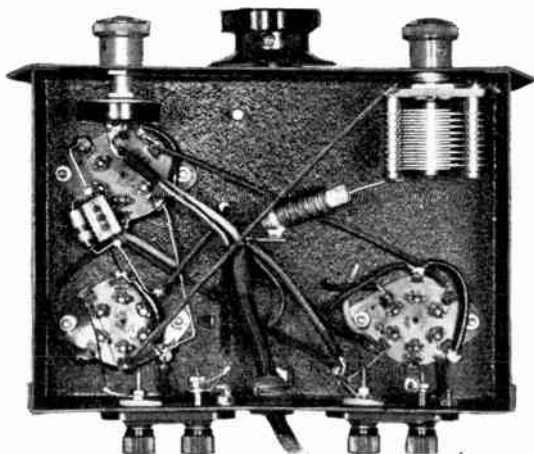

ALTHOUGH it operates without high-voltage "B" batteries, the two-tube, all-wave receiver illustrated will bring in London, Rome, and Berlin as easily as local broadcasts. Using two 6C6 tubes, the circuit is basically an improvement over the original "B" batteryless set. The secret of the hook-up lies in a reversal of the grids in the tubes. In this receiver, the suppresser grid (4) in each tube becomes the control grid, while the two grids nearest the cathode (3 and cap) are connected to the positive side of the three-volt "B" supply. This arrangement causes an unusually large number of electrons to flow from the cathode toward the plate, and results

in increased power at low voltages.

For short-wave reception, a "B" supply of 3 volts is used, but for the broadcast band this may be reduced to 1½ volts. With a short aerial, no antenna trimmer condenser is used. For longer aeriels, use either a .001-mfd. or a .00025-mfd. condenser. The filament rheostat must deliver from 3.4 to 3.8 volts to the tube heaters.

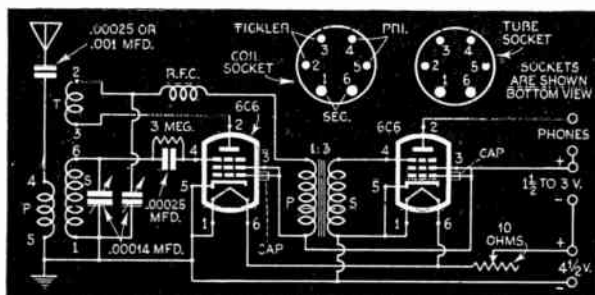

Specifications for the ports are given in this wiring diagram

Two-way Radio Station

COSTS \$18 TO BUILD

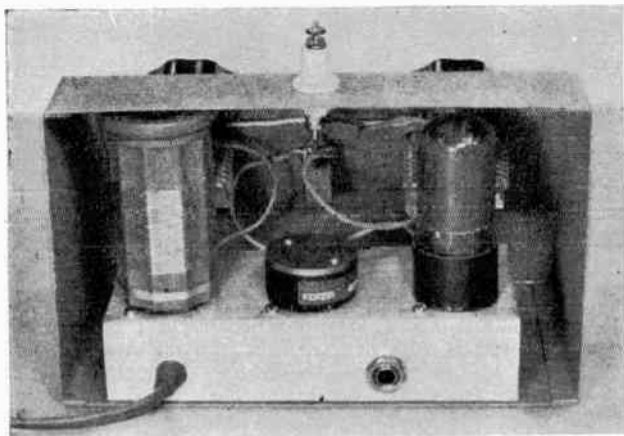

Adjusting the midget transmitter described in this article. Left, the receiver, and right, the sending key

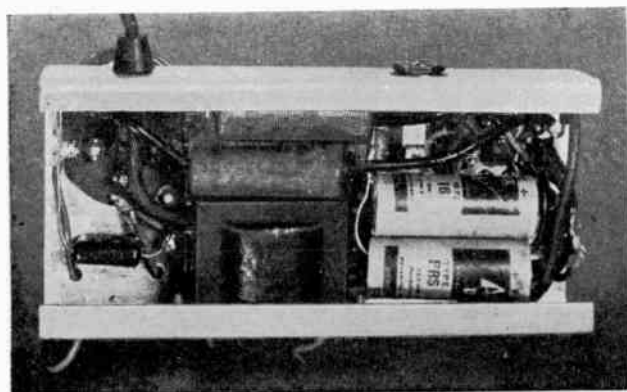

FOR the amateurs specially authorized by the Government to use transmitters for specified emergencies, a complete sending and receiving station is detailed on these pages. Inexpensive and compact, as well as easy to build, the efficient short-wave receiver and "punchy" little transmitter will provide an excellent stand-by station in case of trouble in regular equipment.

A choice of two circuits is given for the receiver. As a straight one-tube plus rectifier tube, the set will pull in South American stations and several amateurs—final results depending, of course, on the locality and position of the antenna. As a two-tube plus

On the transmitter chassis, left, are a four-prong 80-meter plug-in coil, crystal, and 117N7GT tube. Shown in the view from underneath are the filter choke, two 16-mfd. electrolytic and two paper tubular condensers

the rectifier, it should bring in the European stations and several more amateurs in the United States and possibly South America.

A few simple alterations change the receiver to a three-tube set, so we will describe only the two-tube version. This circuit calls for a 6J7 as a pentode detector and a 25Z6 as a half-wave rectifier. Both tubes are metal and require no external shielding. A six-prong coil is used and on it are three windings—a primary or antenna, a secondary or grid, and a tickler winding.

There are two antenna connections at the back of the chassis—one leading straight to the primary winding, the other through a .0001-mfd. mica condenser to the grid winding. The first is used when an outside antenna longer than 50' is employed, while the other is for short indoor antennas up to 30' or 40'. Tuning is accomplished with the .00014-mfd. condenser (the small dial to the left of the center dial in photo). When a band such as the 80-meter amateur band is tuned in, it is spread out over a 180-degree by means of the band-spread condenser (the large center dial). This system aids tuning on short waves.

Regeneration is controlled by the 50,000-ohm variable resistor in the screen circuit of the 6J7. This type of regeneration is extremely smooth and eliminates the loud "plop" as the receiver goes into oscillation. Any type of magnetic phones may be used if the resistance is between 2,000 and 4,000 ohms.

Ample filtering is provided by the 20,000-ohm, 5-watt wire-wound resistor and the two 20-mfd. electrolytic condensers. No hum should be heard, even at the point of oscillation, but if it is, try increasing the .01-mfd. tubular condenser in the plate circuit of the rectifier (25Z6) to about .1 mfd.

The transmitter uses the new 117N7GT, which is a combined power pentode and rectifier tube. It has a 117-volt heater, does not need a

line-cord resistor, and operates directly off a 115-volt AC or DC line. Tuning is done with the .0001-mfd. variable condenser across the four-prong plug-in coil. The antenna coupling is adjusted by the other .0001-mfd. variable condenser in the antenna lead. A crystal in the grid circuit of the pentode stabilizes the signal and prevents transmitter drift. The key is inserted in the cathode and by-passed by a .1-mfd. tubular condenser. Another .1-mfd. tubular condenser across the 115-volt line smooths out any remaining "ripple" in the signal sent.

Tuning a transmitter correctly involves patience, but can be done easily with the aid of a 0-50 milliammeter. With the antenna disconnected and both variable condensers in mesh, the 0-50 milliammeter (which is connected across the key terminals) should read 35 milliamperes. Gradual reduction of the capacity of the tank or tuning condenser will dip the needle to about 18 milliamperes. Further reduction will cause the needle to jump back to about 23 milliamperes and stop there. Regulate the tuning condenser so that it reads about

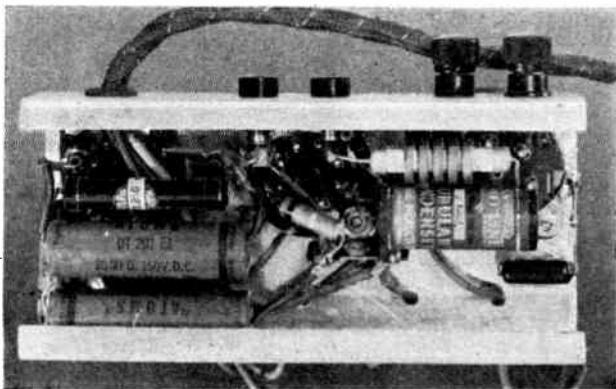
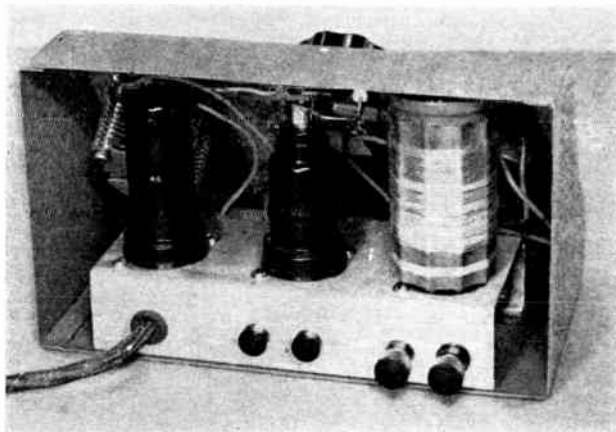

Amateur-band tuning is done with the coil (right) on the receiver chassis. The tubes are 6J7 and 25Z6. Above the two electrolytic condensers, at left in the bottom view, is the wire-wound resistor. The RF choke is shown at right

LISTS OF PARTS

TRANSMITTER

Cabinet, 7½" by 4½" by 4¼".
 Four-prong 80-meter plug-in coil.
 Rubber line cord and plug.
 Octal wafer socket.
 Four-prong wafer socket.
 Mounted crystal, 80 meters.
 Five-prong socket for crystal.
 Pentode-rectifier tube, 117N7GT.
 Filter choke, 12 Henrys, 250 ohms.
 Toggle switch, S. P. S. T.
 Condensers: Mica, .001 mfd.; electrolytic (2), 16 mfd., 150 volts; paper tubular (2), .1 mfd., 600 volts; tuning (2), .0001 mfd.
 Carbon resistor, ½ watt, 50,000 ohm.
 Ceramic antenna binding post.
 Transmitting key.

RECEIVER

Cabinet, 7½" by 4½" by 4¼".
 Six-prong 80-meter plug-in coil.
 Midget RF choke, 2.5 millihenrys.
 Resistor line cord, 290 ohms.
 Octal wafer sockets (two).
 Six-prong wafer socket.
 6J7 triple-grid detector tube.
 25Z6 half-wave rectifier.
 Variable resistor, 50,000 ohms.
 Attachable switch, S. P. S. T.
 Condensers: Electrolytic (2), 20 mfd., 150 volts; mica (3), .0001 mfd., .00025 mfd., and .0002 mfd.; tubular paper (2), .1 mfd., 600 volts, and .01 mfd., 600 volts; tuning (2), .00014 and .00002 mfd.
 Resistors: Carbon (2), 100,000 ohms, ½ watt, and 1 megohm, ½ watt; wire-wound, 20,000 ohms, 5 watts.

EXTRAS FOR THREE-TUBE RECEIVER

Resistor line cord, 260 ohms.
 Pentode-rectifier tube, 32L7GT.
 Condensers: Electrolytic, 5 mfd., 25 volts; paper tubular (2), .002 mfd., 600 volts, and .05 mfd., 600 volts.
 Resistors: Carbon (3), 1 watt, 600 ohms; ½ watt, 500,000 ohms, and ½ watt, 250,000 ohms.

20 milliamperes or at a degree on the dial where it is slightly more out of mesh than at the maximum dip of the needle.

Now connect the antenna. The needle will instantly jump back to 35 milliamperes. Turn this time the antenna condenser until the needle dips to about 30 milliamperes. Turning the condenser further out of mesh will cause the needle to dip to about 25 milliamperes. However, the antenna is correctly loaded at the 30 milliampere reading, so turn the condenser back until the reading is again 30 milliamperes.

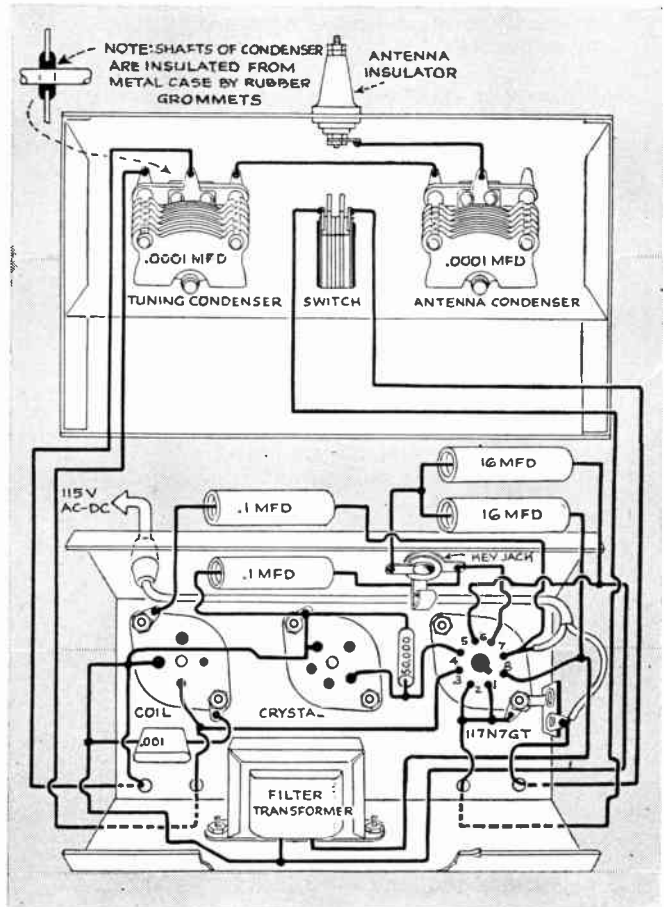

Pictorial diagram of the midget radio transmitter using the new 117N7GT combination power pentode and rectifier tube

Below, complete wiring diagram of the transmitter. About 3 watts are fed into the antenna by this little sending outfit

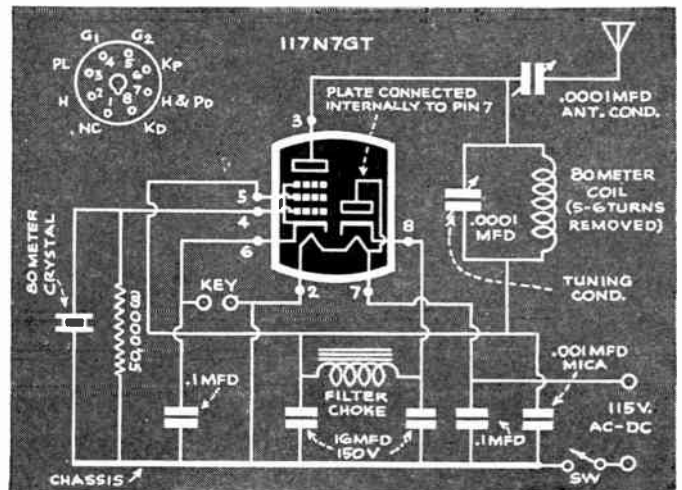

COMBINATION RADIO RECEIVER AND AMPLIFIER

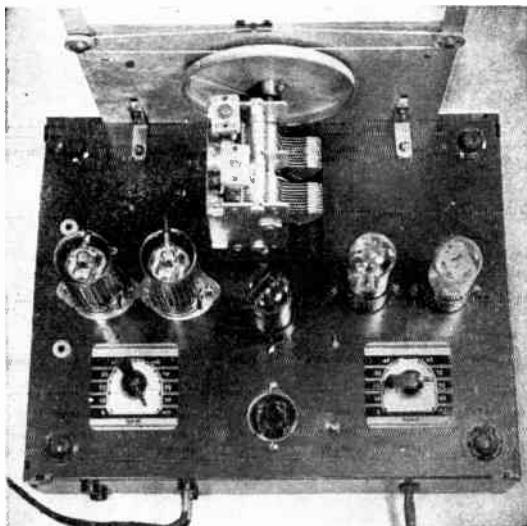

Top and bottom views of the receiver and amplifier. The condenser is raised to be in line with the center of the dial. In the tube bank, those unshielded are 35Z5-GT/G's. The unshielded coils are shown below

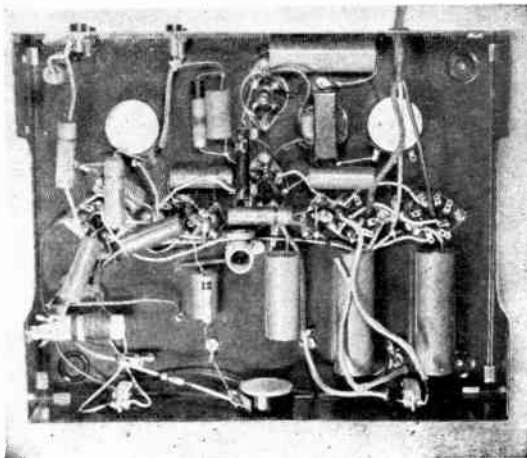

USING an inverted metal letter holder, found in most stationery stores, instead of the usual steel radio chassis, this instrument combines into one unit a TRF broadcast receiver and high fidelity P.A. amplifier. By an unusual circuit arrangement all five tubes are in operation when the instrument is in use either as a radio receiver or as a Public Address amplifier, that is, the radio frequency stage and detector stage double as the first two stages of the P.A. amplifier.

An analysis of the circuit shows at once that no power transformer is employed. The circuit is operated only on straight AC current. In spite of the lack of a power transformer, the output from the rectifier circuit is still higher than the line—200 volts to be exact—and the maximum power output of the 25L6-GT/G tube, about 5 watts, can be obtained. The high plate voltage is obtained by using a voltage doubler circuit with two 35Z5-GT/G's.

When the upper feed line in the diagram is positive, current flows through the lower tube and the 30 mfd. condenser and charges the condenser. When the reverse condition occurs on the other half of the cycle, the power line lead to the cathode is positive and no current can then

LIST OF PARTS

Metal letter holder.
Dial, 8". Octal sockets (5).
Socket and plug, 4-prong.
Electrodynamic speaker, 6",
field 450-500 watts.
Output transformer, 2,000 ohms.
Toggle switches: S.P.S.T. on-off,
S.P.D.T. radio-phono.
Volume control (2): 250,000
ohms, 750,000 ohms.
Tone control, 50,000 ohms.
Coils, unshielded: RF, antenna.
Tubes: (2) pentode-triode 12B8-
GT; beam power 25L6-GT/G;
(2) half-wave rectifier 35Z5-
GT/G.
Condensers: Tuning, 2-gang.
Paper tubular, 400 volts, (3)
.05 mfd., (2) .06 mfd., (3) .1
mfd. Electrolytic, 50 volts, 5
mfd., (2) 10 mfd.; 250 volts, 12
mfd.; (2) 450 volts, 30 mfd.
Resistors: Carbon, ½ watt,
3,000 ohms, 125,000 ohms, 150,-
000 ohms, 200,000 ohms, 400,000
ohms, (2) 750,000 ohms, 1.5
megohms; 1 watt, 3,000 ohms,
30,000 ohms; 2 watts, 600
ohms. Line-cord, 140 ohms.
Wire-wound, 10 watts, 2,000
ohms.

Servicing Your Radio-

SOME of the most annoying experiences with old-model receivers or new models that have been in use for some time are caused by humming. This can be traced to several sources, most of them within the scope of the amateur repair man. Among

the most frequent are hum in the phonograph of a combination set or in an older-type electrodynamic speaker, or that caused by a broken filament resistor, weak or gassy tube, or faulty electrolytic condenser. The pictures below illustrate the cures.

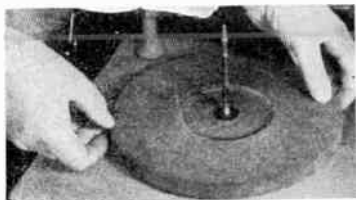

WHEN the hum occurs in the speaker only when the phonograph is being used, ground the pick-up arm and motor frame to the radio chassis, both leads from the pick-up being grounded with braided shield covering. If the hum persists, a 1/16" metal plate, 8" to 12" in diameter, will act as a magnetic shield if screwed to the motor board between the motor and turntable.

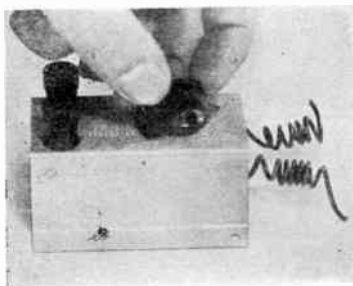

SHOULD an old-type electrodynamic speaker lack a "hum-bucking" winding on the voice coil, connect a 30-ohm, 10-watt, center-tapped potentiometer across the power transformer's 2.5-volt or 6.3-volt heater winding in series with the voice-coil winding. A short, soldered wire serves as a center tap.

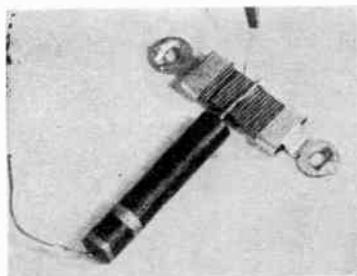
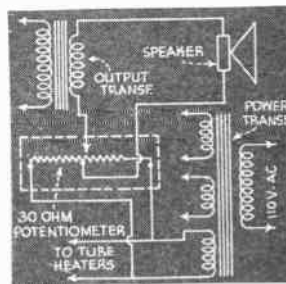

FILAMENT resistors, used in earlier models before indirectly heated tubes were perfected, must be replaced if they are broken. They are connected across the filaments of RF and other tubes to supply grid bias current and balance out hum from the power transformer's AC filament winding.

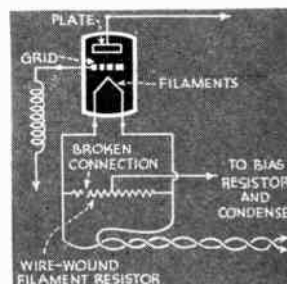

Often hum can be corrected by replacing a weak or gassy rectifier tube. If hum increases after the set has been on for a while, a power tube may be at fault, especially an old 47 power pentode tube

Electrolytic condensers go bad for many reasons—they may have open or short circuits, or the wet type may dry out and lose effective capacity. In any case, the best bet is to get a new condenser

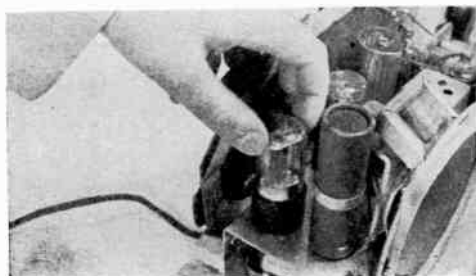

"LETTER" RADIO

CAN BE MAILED

HERE is a novelty radio receiver that you can slip into an ordinary envelope and mail to one of your radio-minded friends as an amusing birthday or holiday greeting. Mounted on a conventional scenic post card and covered with a second post card so that all wiring is concealed, the set consists of a simplified tuning coil and a crystal detector. With earphones clipped to two of its paper-fastener terminals and a ground and antenna attached to the two remaining terminals, the set is ready to bring in near-by broadcasting stations. Tuning is accomplished by fastening a small spring clip to the various taps on the homemade "spider-web" tuning coil, while a sensitive spot on the crystal can be found by shifting the cat whisker from one point to another until a station is heard in the earphones. The tuning coil is made by interlacing 100 turns of No. 30 double-cotton-covered wire around seven "spokes" cut in a $3\frac{1}{4}$ " diameter cardboard disk, as shown in the drawing below. The coil should be tapped every twenty turns by removing the insulation and applying a blob of solder. The two post cards, which

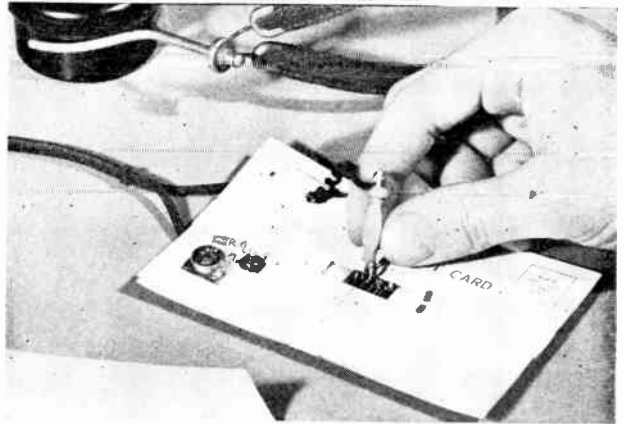
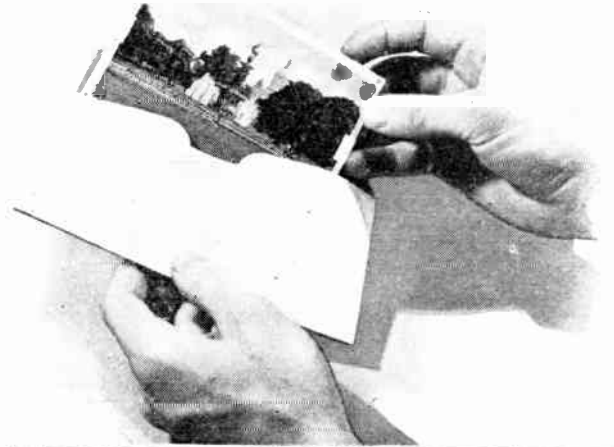

The letter radio can be mailed out of town for six cents. It is tuned by moving a spring clip from one coil tap to another

form the "chassis" and "cabinet" of the tiny receiver are held together by the paper-fastener terminals. To save space, flat copper ribbon was used in making the various connections.

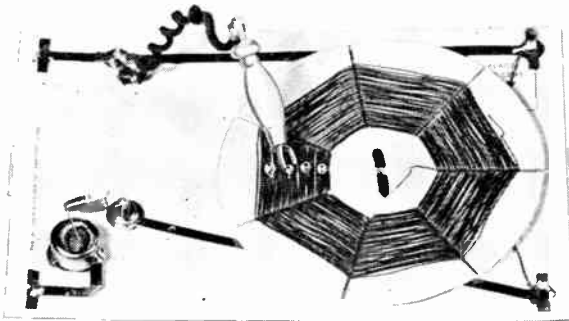

The tiny receiver with its post-card "cabinet" removed to show the wiring. Circuit and coil are shown at right

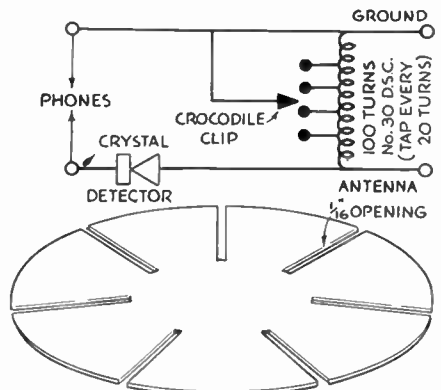

You Can Build— **FM RECEIVER FOR \$22**

A Complete Eight-Tube Set

THIS unit is not just another FM converter, but a complete eight-tube FM receiver, and it can be built for only \$22. Extremely compact, it is mounted in a cabinet usually sold for four-tube receivers.

A simplified version of the original FM circuit is used, a circuit so rapidly becoming standard that a kit of low-cost components has been put on the market. These parts, used in this design, are a set of three FM coils (antenna, RF, and oscillator), three special FM I.F. transformers peaked at 4,300 kilocycles, a discriminator transformer, also peaked at 4,300 kilocycles, and a three-gang tuning condenser, each section having a capacity of 7-22 mmfd.

The main difference between a standard broadcast superhet and an FM superhet is the use of a limiter tube and a "discriminator" stage. Otherwise this FM receiver consists of the usual R.F. stage (converter stage) and two I.F. stages (second detector and audio stage). The "discriminator" stage makes possible the detection of FM impulses and discriminates against standard or amplitude-modulated impulses.

In an FM receiver all grid and plate leads must be as short as possible, especially in the RF and converter stages. The layout here allows short leads between the tube prongs, condensers, coils, etc. The 10,000-ohm, 1-watt loading resistors across the secondary windings of the coils stabilize and balance the I.F. circuits. An elaborate decoupling system in each plate and screen lead of the first five tubes eliminates feedback between the circuits which would cause oscillation. The rectifier tube and circuit deliver 250 volts at about 60 milliamperes.

Front panel of the FM receiver described in this article

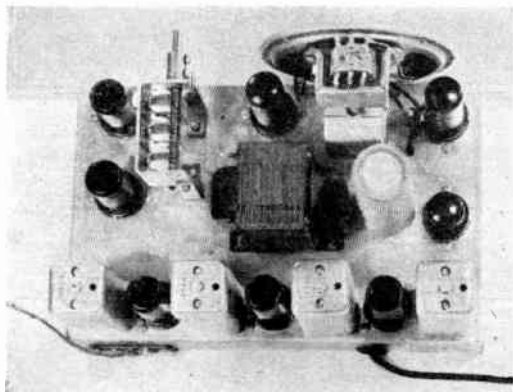

Top view of chassis, showing the compact layout of tubes, transformers, condensers, and speaker, which permits installation in a small, four-tube cabinet

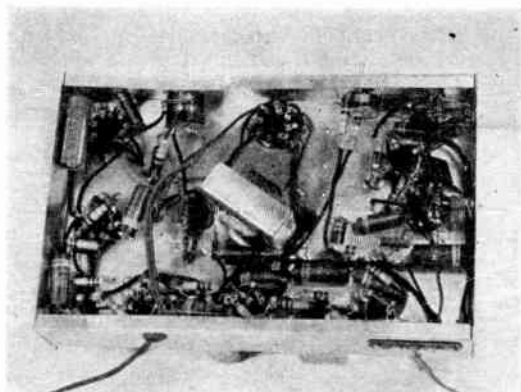

Bottom of chassis. Note filter choke in center and the special FM coils on extreme right. A phone jack indicated in diagram is not shown

It is difficult to align an FM receiver, and a dependable dealer will do it for you. Those who are ambitious, however, and can obtain a signal generator can do it at home. Align the discriminator transformer by applying a signal of 4,300 kilocycles to the grid of the 6SJ7 and connecting an O-1 ma. meter with a 100,000-ohm resistor in series with the meter across the 6H6 cathode. Adjust the secondary trimmer of the discriminator until a movement of the meter's needle is noted. As the trimmer is tuned, the meter will go plus or minus, either side of the resonant frequency. Set the trimmer so the meter reads zero voltage. The primary trimmer of the discriminator transformer is adjusted to the maximum reading when it is connected between the center tap of the transformer and ground.

To align the I.F.'s the same O-1 ma. is connected in series with the grounded side of the 50,000-ohm variable resistor (sensitivity control). By-pass the meter with a .02-mfd condenser, and apply a 4,300-kilocycle signal to the grid of the preceding 6SK7. Tune the transformer for a maximum reading on the meter. Apply a signal to the next 6SK7 and repeat the procedure. To align the trimmer condensers on the three-gang tuning condenser, tune in a station and adjust each trimmer, by ear, until the station is received at maximum volume.



Adjusting the trimmer condensers. The steel cabinet has a hinged lid

If the set is located within ten to 15 miles of an FM broadcasting station, a short piece of wire (about ten feet) connected to point "b" on the antenna binding post will suffice, but for best results a special doublet FM antenna should be connected to "a" and "c" on the binding post.

There are two important points about FM reception to keep in mind. First, the discriminator stage will not operate satisfactorily unless a sufficiently strong signal reaches the grid of the 6SJ7. Secondly, the range of FM is limited to about 50 miles.

The five-inch permanent magnet speaker does not do justice to high-fidelity FM reception. It is better to buy one of the high-fidelity speakers now sold for FM reception and use the small speaker just for speech or for monitoring the reception.

(CONTINUED)

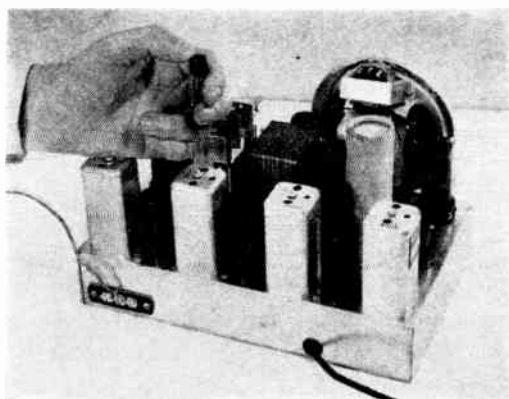

Making final adjustments. Since the tubes and power transformer generate heat, two four-inch ventilation holes should be cut in cabinet's back

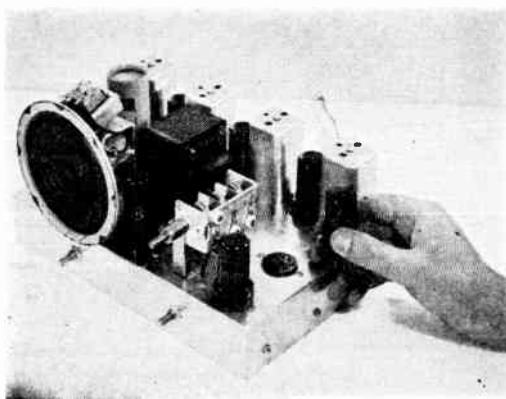

View of the RF portion of the FM chassis, showing the three-gang tuning condenser, the 6SK7 RF tube at front, and the 6SA7 mixer tube held in the hand

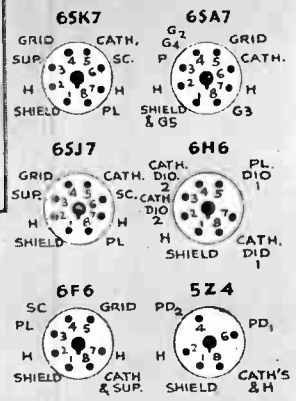
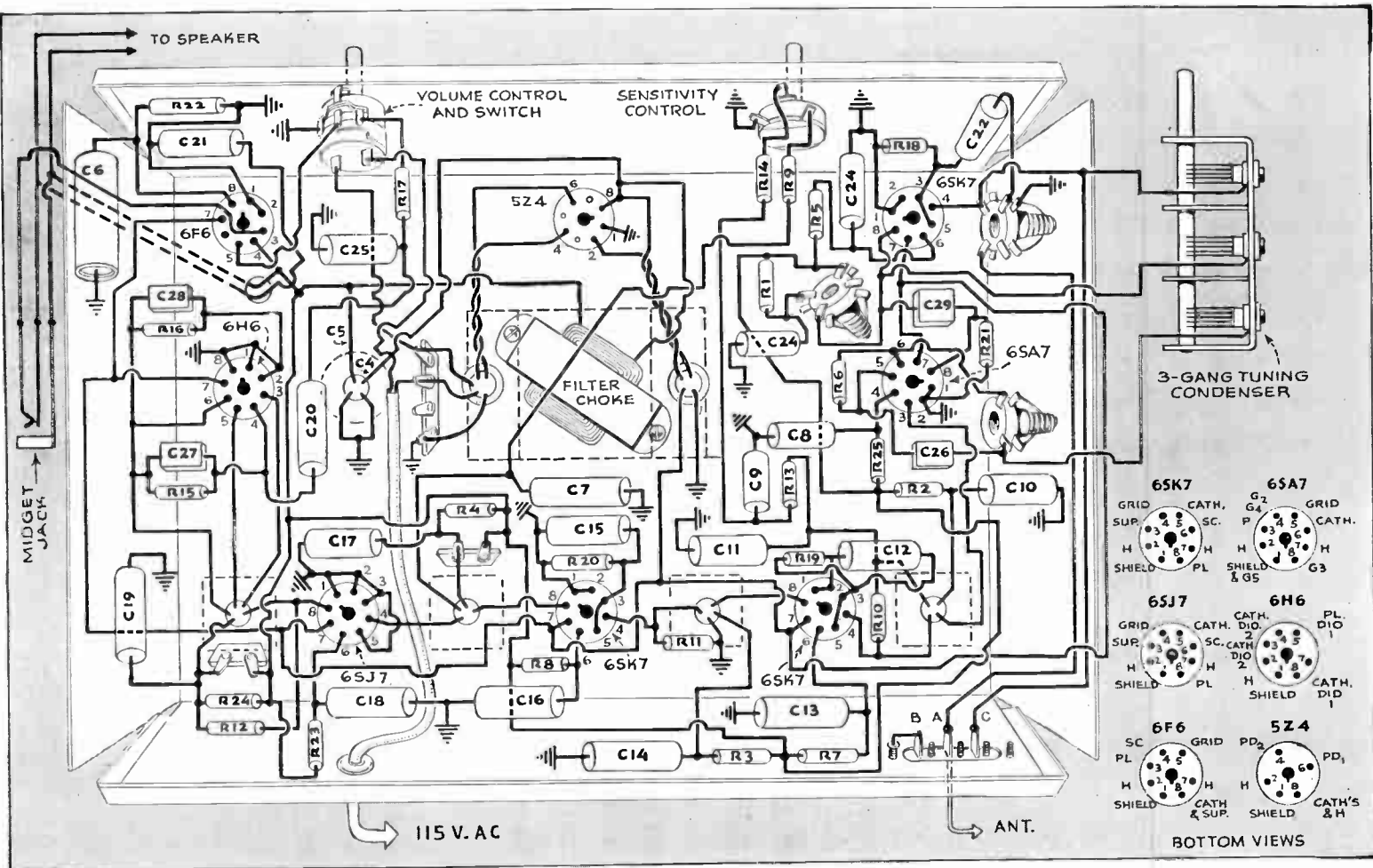

BOTTOM VIEWS

The diagrams above and on the facing page make it easy to follow the wiring connections. Above, lower right corner, are bottom views of tubes in the layout

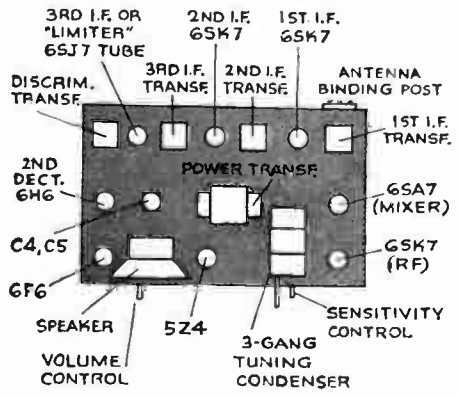
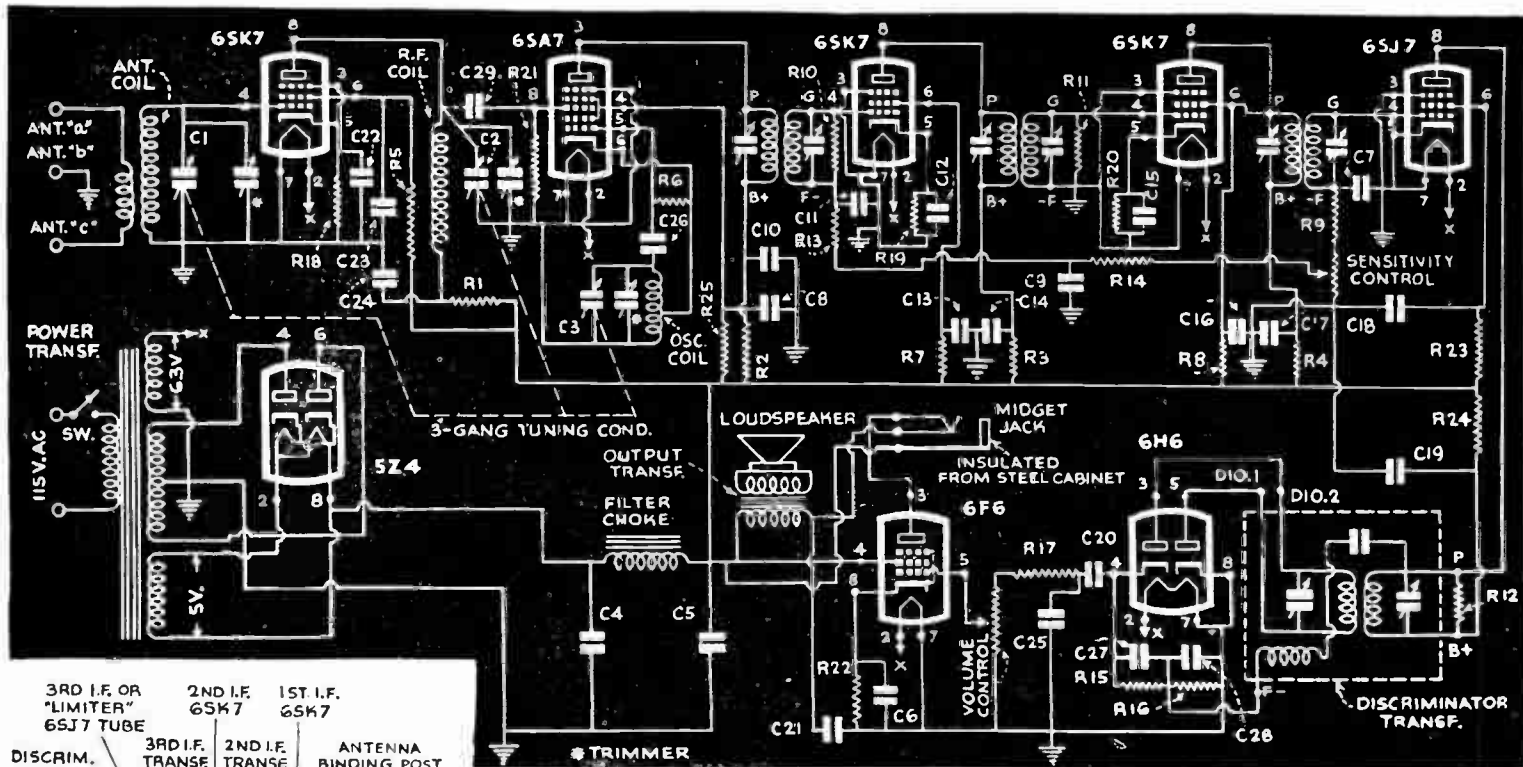

3-gang tuning condenser, 7-22 mmfd. C1 to 3.
 Electrolytic capacitors: dual 8-16 mfd., 25 volts. C4-C5; 50, 25, C6.
 Tubular condensers: .1 mfd., 400 volts, C7; (2) .01, 400, C8-C9; (11) .05, 400, C10 to C20; .006, 600, C21; (4) .001, 600, C22 to C25.
 Mica condensers: (3) .00005

mfd., C26 to C28; .004, C29.
 Carbon resistors: (4) 1,500 ohms, 1 watt, R1 to R4; (5) 50,000, 1, R5 to R9; (3) 10,000, 1, R10 to R12; (5) 100,000, 1, R13 to R17; (3) 150, 1, R18 to R20; 250,000, 1, R21; 400, 2, R22; 75,000, 1, R23; (2) 20,000, 1, R24-R25.
 FM coils: antenna; RF; oscillator.

Transformers: output; power, 680CT-70, 5 volts-2 amp. 6.3-2.5 amp.; discriminator, 4,300 kc.; (3) FM I.F., 4,300 kc.
 Filter choke, 11 henrys, 300 ohms.
 Variable resistors (2); 50,000 ohms; with switch, 500,000.
 Speaker; octal sockets; steel chassis; cabinet; tubes, etc.

Lazy-Man's Tuner

SIMPLIFIED PUSH-BUTTON REMOTE-CONTROL



IF YOU have always wanted a simplified remote-control tuner for your broadcast receiver here is an easily built unit that needs neither motors nor expensive equipment and requires only a minimum of connections to your receiver circuit. With it, you can turn your set on or off, select any one of six stations merely by pushing a button, and control the volume; all without budging from your armchair. Provided with a long cable, the small remote-control box can be carried to any room in your house.

Basically, the unit operates by automatically connecting into the receiver preset padding condensers that tune the circuit in place of the usual tuning condenser. Operating one of the buttons on the push-button tuner switch panel in the remote-control box energizes a corresponding relay at the receiver which serves to connect the desired condensers into the circuit. In the unit shown, six tuning buttons are em-

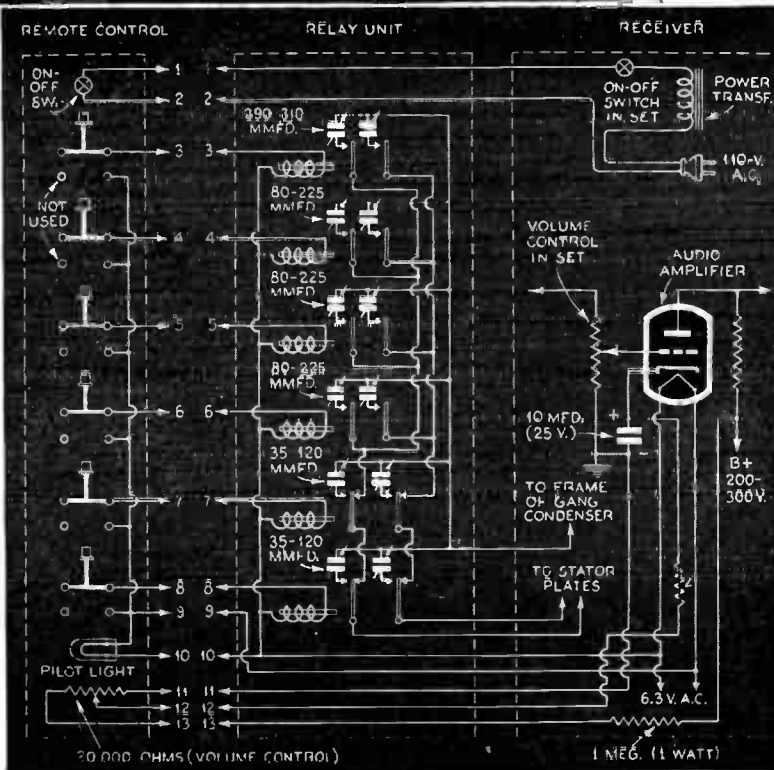

This comprehensive diagram shows the wiring of the remote-control tuner, the relay system which tunes the radio circuit, and the receiver connections



Fits Any Broadcast Set

UNIT IS EASILY ASSEMBLED FROM INEXPENSIVE PARTS

ployed to operate six relays, which in turn make the condenser connections and provide a selection of six stations. Volume control is obtained by a potentiometer built into the control box.

Designed for use with the conventional broadcast superheterodyne or tuned radio-frequency set employing a two-section tuning condenser, the unit makes use of twelve padding condensers, two for each relay circuit. When a relay is operated, one of these pre-tuned condensers is connected across each section of the two-section condenser. In receivers employing three-section condensers, three padding condensers must be used with each circuit, and three-pole relays will be required to make the necessary connections.

The actual details of construction should



Placed beside your chair, the tuner lets you adjust your radio with ease

not cause the set builder any great difficulty. The box for the remote-control unit is a standard wooden card-file case, 3" by 5", trimmed off until it stands 3 1/4" high, outside measurement. A 1/8"-thick composition panel holds the push-button controls, a pilot light, and an on-off switch. A slot is cut in one end for the cable. Incidentally, the cable may be of any length and of any type so long as it has the necessary number of conductors.

However, since it must carry 110 volts A.C., the insulation must be good.

(Continued)

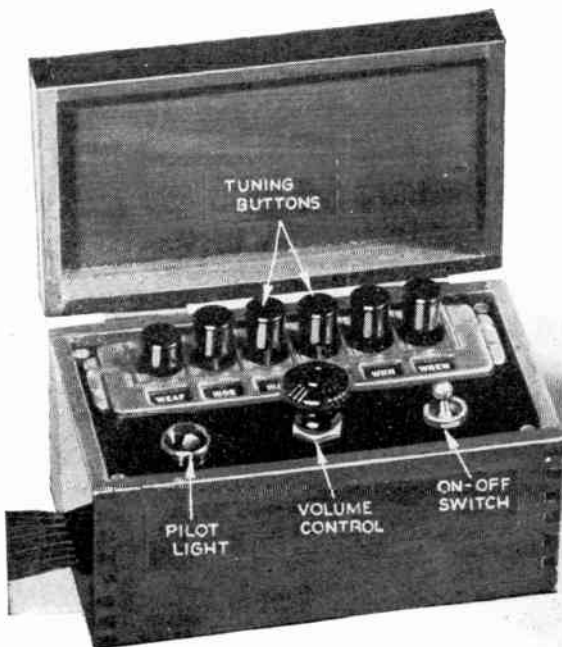

The push-button case also houses a volume control, an on-off switch, and a pilot light. Brackets aid in mounting the relay unit

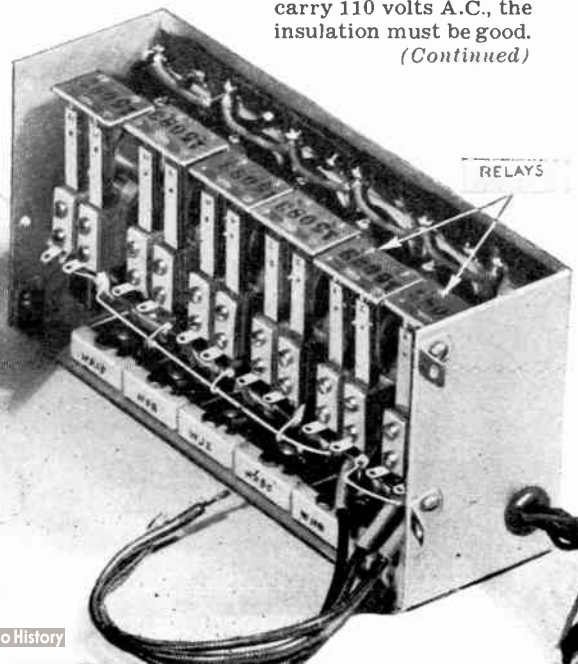

LIST OF PARTS

One double padding condenser, 290-310 mmfd.

Two double padding condensers, 35-120 mmfd.

Three double padding condensers, 80-225 mmfd.

Electrolytic condenser, 10 mfd., 25 volt.

Variable resistor, 20,000 ohms.

Resistor, 1 watt, 1 meg.

Two relays, 6 volt, A.C., double-pole, double-throw.

Four relays, 6 volt, A.C., double-pole, single-throw.

Push-button tuning unit, six buttons.

Thirteen-wire cable.

Fifteen-connection plug and socket.

Miscellaneous:—Pilot lamp and socket, control box and panel, single-pole, single-throw toggle switch, wire, etc.

The relay unit can be fastened directly to the receiver chassis. It measures $2\frac{1}{4}$ " by $3\frac{3}{4}$ " by $7\frac{1}{2}$ ". Here the six relays, controlled by the remote-control buttons, make the necessary connections between the padding condensers across each section of the receiver's tuning condenser. In this unit, the standard fifteen-connection socket for the control cable is also mounted.

Should the cable be removed at any time, the receiver will not operate unless a wire jumper is connected between the plug terminals 11 and 12, and 1 and 2 (see diagram).

It will be noted that relays 1 and 2 have their contacts connected somewhat differently from the others. When either of these operates, all connections

to the following relays are automatically opened. This is necessary to eliminate the unavoidable stray capacity in the relay connections. The four other relays may be of the double-pole, single-throw type, with contacts closed when the relay is in the "make" position.

The initial tuning of the padding condensers can be accomplished easily. They should be adjusted, section by section, until the loudest response for each desired station is obtained. Any type of tuning indicator on the receiver is a great help at this stage. The condenser values shown allow full coverage over the band.

Care must be exercised in setting the remote volume control. With the latter set at full volume, turn the receiver volume control up until the receiver output is louder than normal. Then reduce it to the desired level with the remote volume control.

When using the remote control, make sure that the receiver's tuning condenser is turned all the way out (to the high-frequency end of the dial). This procedure must, of course, also be followed during the initial tuning of the padding condensers.

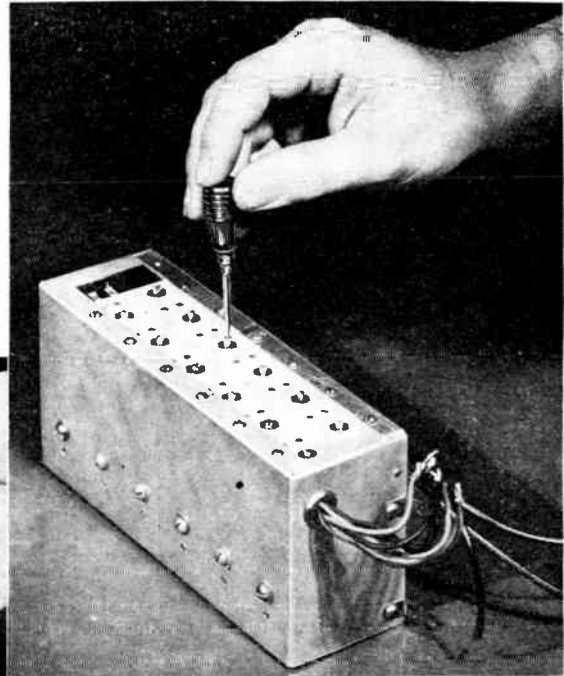
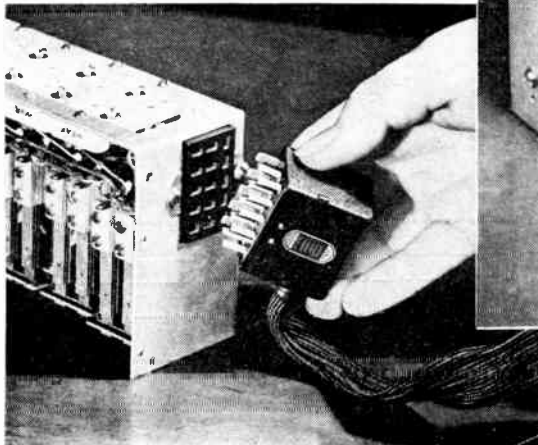

In pretuning the padding condensers, they should be adjusted with a screw driver to give maximum volume on the desired stations. A multiple plug makes the relay connections



The public-address amplifier in use. With the radio-frequency tuner, it will rival in performance many larger sets

TUNER AND AMPLIFIER MAKE WORLD'S SMALLEST Public-Address Units

SMALL enough to fit into the palm of one's hand, these midget public-address amplifier and radio-frequency tuner units will perform as well as many larger battery or A.C.-D.C. sets. Only $3\frac{3}{8}$ " long, $2\frac{7}{8}$ " wide and $2\frac{3}{8}$ " high, they are completely self-contained, even to batteries.

In the tuner there is a $1\frac{1}{2}$ -volt "C" bat-

tery, used as a bias for the 1T4 detector tube, and two flashlight batteries (in parallel), supplying $1\frac{1}{2}$ -volt "A" current to the two 1T4 tubes. Inside the amplifier is a $67\frac{1}{2}$ -volt "B" battery which supplies plate current to all the tubes in both units, and a large-size flashlight cell for lighting the filaments of the three amplifier tubes (HY123—1Q4—1Q4).

The tuner consists of a radio-frequency stage using a pentode r.f. amplifier coupled to a detector stage using the same type of tube. Coupling is accomplished with an iron-core r.f. coil with a shielding can of $1\frac{1}{8}$ " diameter. The antenna coil, of the same size, also has an iron core.

The amplifier unit consists of a triode

At the left is the tuner unit. It may be used individually as a headphone receiver or with the amplifier as a broadcast set



When the amplifier is connected with the tuner, the triode tube is removed and the grid and plate terminals of the socket are joined by a piece of insulated wire

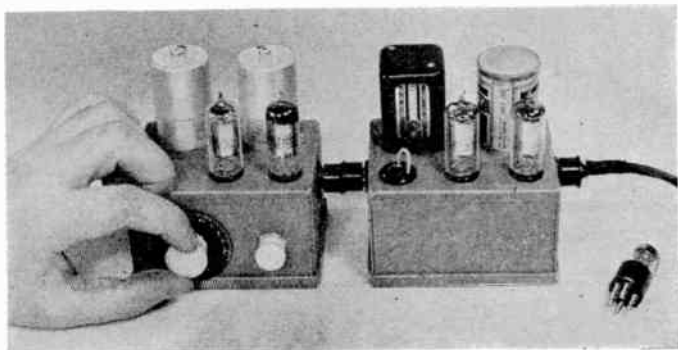

The tuner is a radio-frequency stage using a pentode r.f. amplifier coupled to a detector stage using a tube of the same type. Coupling is accomplished by means of an iron-core r.f. coil

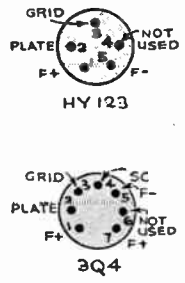
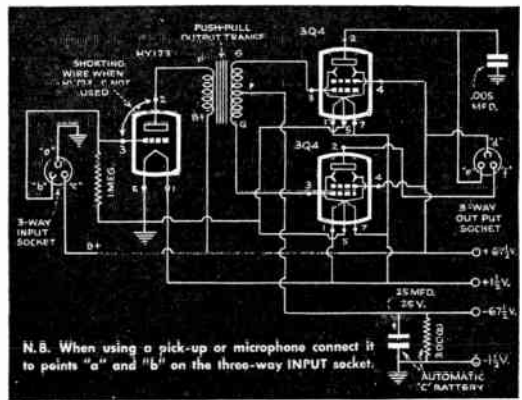
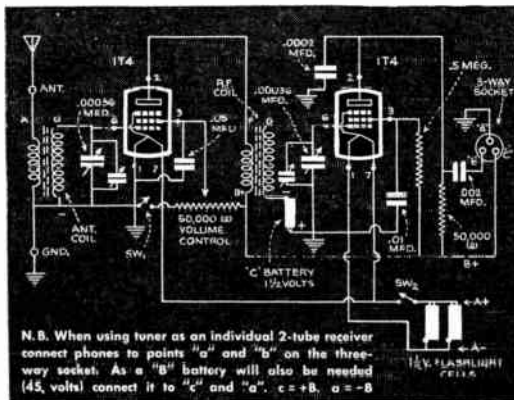
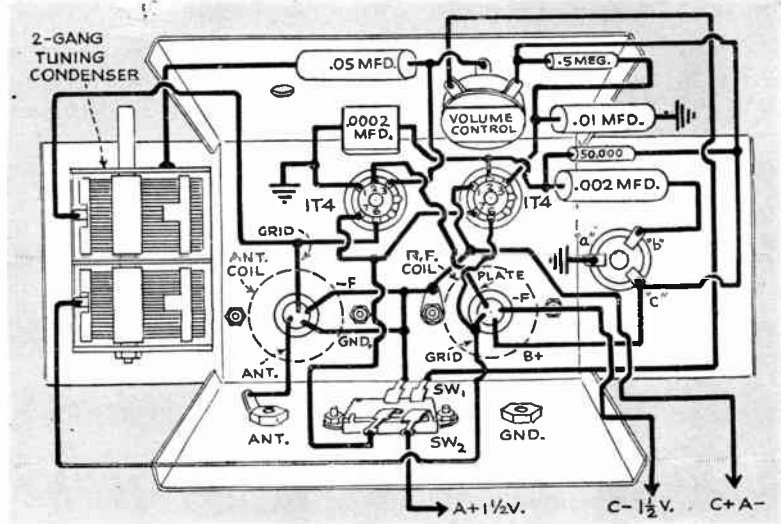
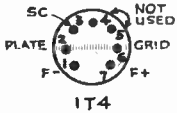

The amplifier unit consists of a triode input stage, transformer-coupled to a pentode push-pull output stage. Small three-prong plugs are used to connect the units together

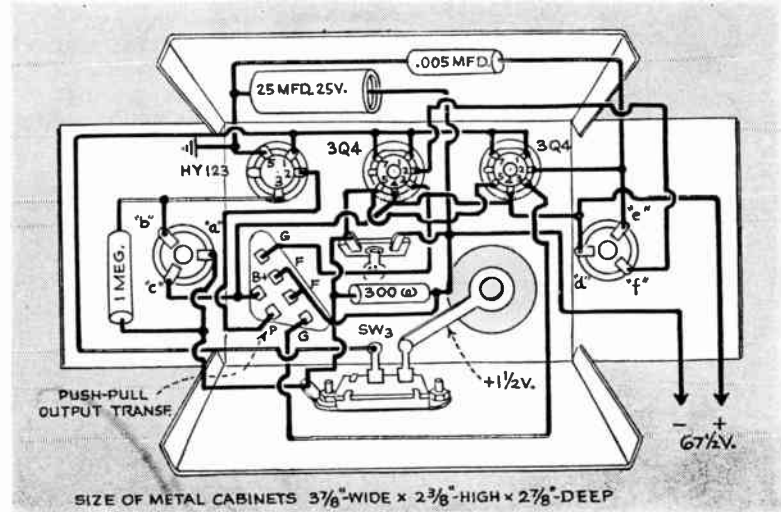

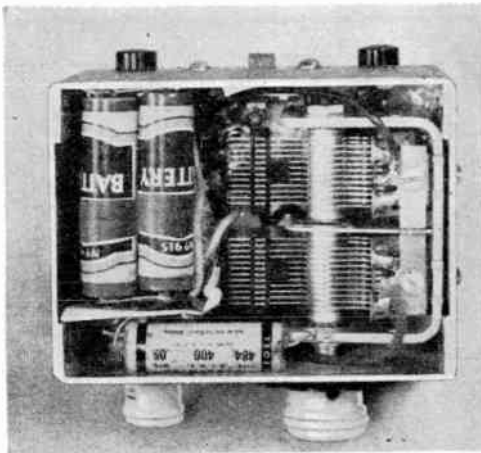

This is the underside of the tuner cabinet, showing the midget two-gang condenser and the batteries

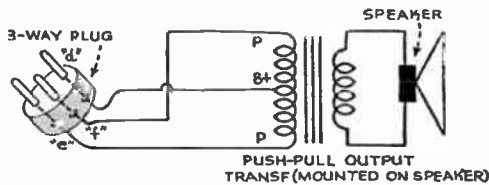

input stage transformer-coupled to a pentode push-pull output stage. When the amplifier is connected to the tuner, remove the triode tube (HY123) and join the grid and plate terminals of the socket as shown.

Small three-prong plugs are used to connect the units, and a similar plug joins the output transformer to the speaker, which may be any type of p. m. speaker.

The tuner may be used individually as a sensitive headphone receiver, or it may be connected to the amplifier to form a powerful broadcast set. Either a combination of antenna and ground, or just a short antenna, may be used with the tuner.

Since the amplifier "A" battery lasts only eight to ten hours, its replacement is simplified by mounting it above the chassis as pictured below

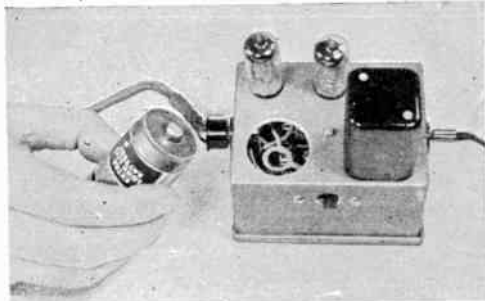

Positive contact of the "A" battery is made to a lug soldered to one of the lugs on the switch. The minus connection is made by contact with cabinet

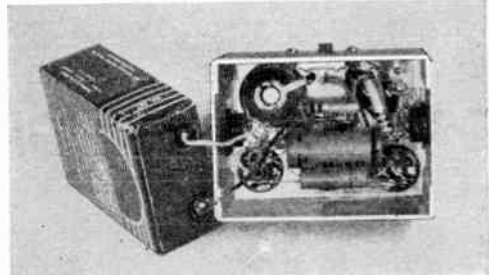

The 67 1/2-volt "B" battery that supplies plate current to all the tubes in the two units fits snugly in the bottom of the gray wrinkle amplifier cabinet

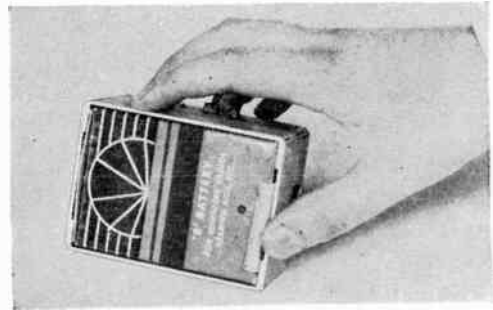

PARTS FOR TUNER

- Iron-core antenna and r.f. coils (shielded).
- Volume control, 50,000 ohms.
- Miniature 7-prong tube sockets (2).
- Midget two-gang tuning condenser.
- Miniature r.f. pentode tubes (2) 1T4.
- Miniature slide switch d.p.s.t.
- Three-way miniature plug and socket.
- Insulated banana plug and jack.
- Small 1 1/2-volt flashlight cells (3).
- Tubular condenser, .05 mfd., 200 volts.
- Tubular condenser, .01 mfd., 200 volts.
- Mica condenser, .0002 mfd.
- Carbon resistors, 1/2 watt, .5 megohm; 1/2 watt, 50,000 ohms.
- Tubular condenser, .002 m. d., 200 volts.

PARTS FOR AMPLIFIER

- Midget push-pull audio transformer (1.15:1).
- Miniature 5-prong tube socket.
- Miniature 7-prong tube sockets (2).
- Miniature s.p.s.t. slide switch.
- Three-way miniature plugs and sockets.
- Standard p.m. speaker with transformer.
- Miniature detector tube, HY123.
- Miniature beam-power pentodes, 3Q4.
- Flashlight battery, 1.5 volts.
- Miniature 67 1/2-volt "B" battery.
- Electrolytic condenser, 25 mfd., 25 volts.
- Carbon resistor, 1 watt, 300 ohms.
- Carbon resistor, 1/2 watt, 1 megohm.
- Tubular condenser, .005 mfd., 200 volts.

Twin-Bed Radio

**CAN BE TUNED
FROM EITHER SIDE**

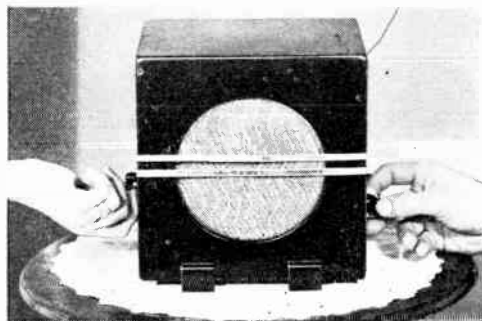
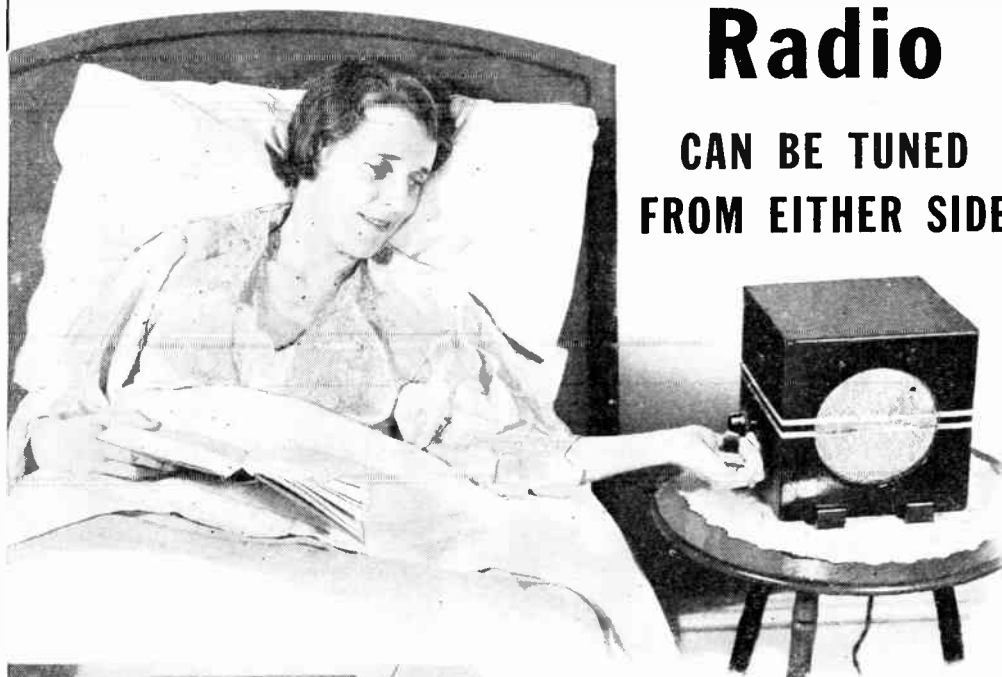

At the flip of a switch, either of two pairs of controls on opposite sides of this twin-bed radio will tune and regulate the receiver

WITH two independent sets of controls, mounted on opposite ends of its cabinet, this novel bedside receiver can be operated easily by either occupant of twin beds. A flick of a conveniently located switch instantly changes the operation of the set from one side to the other.

The circuit makes use of four all-electric tubes of the octal type. The filaments of twin beds. A flick of a conveniently located switch instantly changes the operation of the set from one side to the other.

the detector stage through a high-impedance radio-frequency choke, a .0005-microfarad mica condenser, and a one-megohm resistor, instead of the more conventional radio-frequency coil and tuning condenser. This method was chosen in order to simplify the connections for switching from one set of controls to the other. Two separate tuning stages would have resulted in the circuit being too unstable because of the feed-back through the switch wiring, unless careful shielding were employed.

However, choke-coupling of the radio-frequency stage has its disadvantages, the main ones being a slight loss in volume, and broader tuning. To eliminate the latter, an iron-core, radio-frequency choke should be used, together with a well-designed antenna coil. If the reader desires still greater selectivity, he may obtain it by using a shielded, iron-core antenna coil with a low-impedance primary.

The second disadvantage, namely, loss of volume, is eliminated by using impedance-coupling between the detector and audio stages, instead of resistance-coupling. A center-tapped impedance choke is employed for this. It is connected into the grid circuit of the output tube. Since such chokes are hard to find in radio-parts catalogues, a good substitute may be made by using a standardized transformer with a one-to-two or one-to-three ratio.

To change the audio transformer into a center-tapped impedance choke, simply connect the *out* wire of the primary winding to the *in* wire of the secondary winding, and then ground them directly to the chassis. The start of the primary winding then goes to the grid-coupling condenser, while the other end of the secondary winding goes to the grid of the 25A6G output tube. If the reader is unable to determine the correct connections beforehand, all he needs do is try the leads from the transformer first one way and then the other, retaining the connections that give the best results. The output pentode, which is a 25A6G, will easily handle a two-watt output without over-

The circuit's four octal tubes are grouped on the top of the chassis. All other parts but the speaker are below it. Note the two volume-control units and tuning condensers, and the handy selector switch at the back

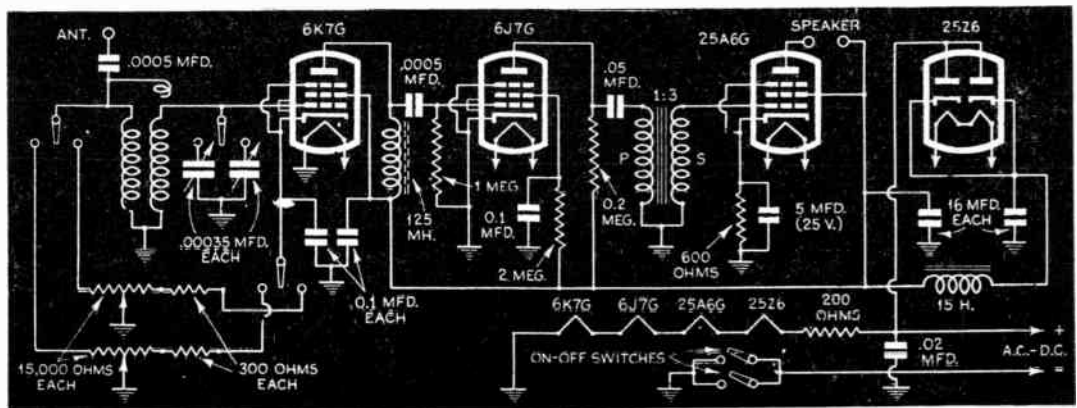
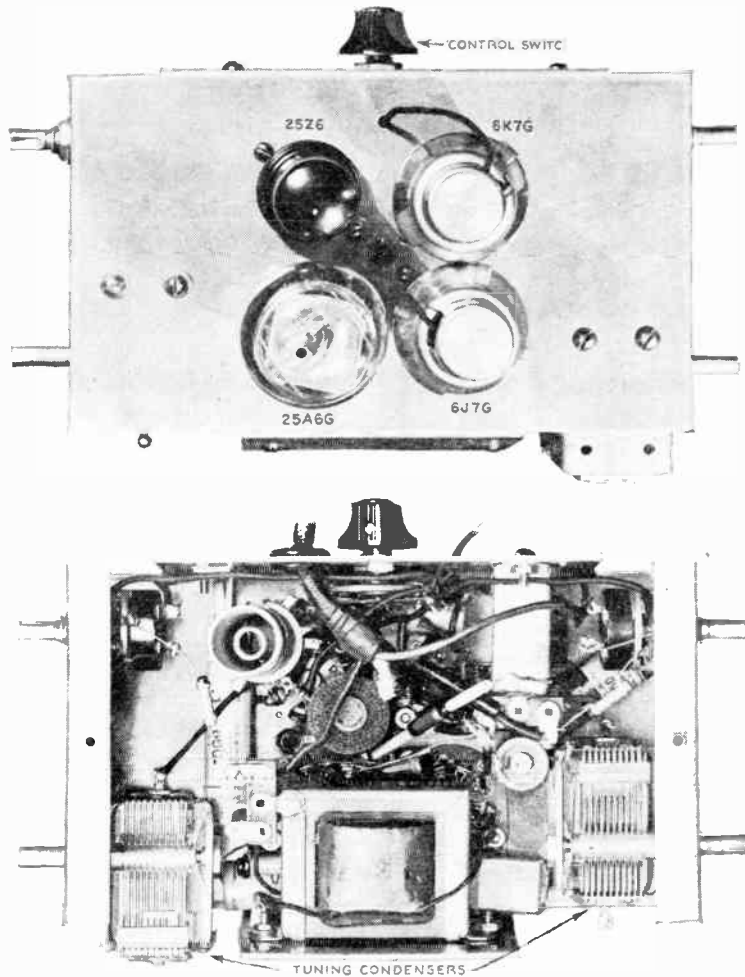



The chassis is placed well to the rear of the cabinet, to leave room for the speaker mounted behind the front panel

loading, which is ample for most purposes.

In the interests of compactness, a special, six-inch orthodynamic speaker is used to handle the output from the set. Its total depth is only $2\frac{1}{4}$ " , which is considerably less than the depth of a conventional six-inch electrodynamic speaker. The magnets of the orthodynamic speaker, mounted directly above the center of the cone, make this saving of space possible.

The switch used in the bedside radio to change the tuning controls from one side to the other is of the three-pole, double-throw type. Since it is impossible to obtain a toggle

through the house wiring. For an antenna, either an outdoor or an indoor aerial can be used. In the original, a twenty foot length of silk-covered wire strung around the molding gives excellent results.

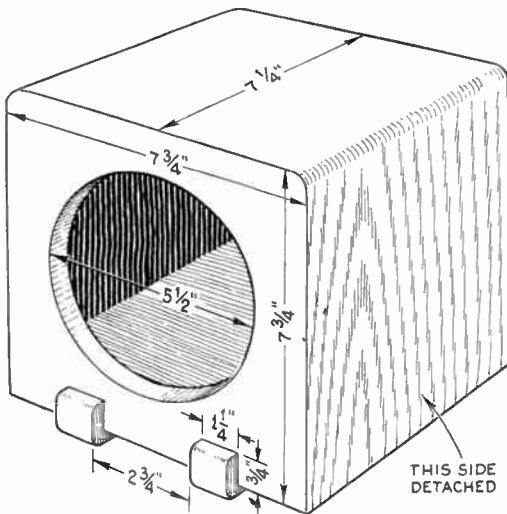

How the modernistic wooden cabinet is constructed

switch of this kind, a rotary switch such as that used in tube analyzers was chosen instead.

The cabinet, measuring $7\frac{1}{4}$ " by $7\frac{1}{4}$ " by $7\frac{3}{4}$ " , is constructed of wood, as shown in the drawing below. Because of the projecting shafts for the dual controls, one side of the cabinet must be made detachable so that the chassis can be slipped into place. To complete the modernistic appearance of the general design, the writer enamelled the cabinet black and applied strips of decorative silver banding. Although this can be thin metal, the same effect can be obtained with sections of metal-foil ribbon of the type sold for indoor antennas. These can be cemented in place after the finish has been applied.

Like all A.C.-D.C. receivers, this set requires no ground, the circuit being grounded internally

LIST OF PARTS

- 6K7G tube.
- 6J7G tube.
- 25A6G tube.
- 25Z6 tube.
- Two .00035-mfd. midget condensers.
- Two 16-mfd. electrolytic condensers.
- One 5-mfd., 25-volt electrolytic condenser.
- Three .1-mfd. tubular condensers.
- One .05-mfd. tubular condenser.
- One .02-mfd. tubular condenser.
- Two .0005-mfd. mica condensers.
- One line-cord resistor.
- Two 300-ohm, $\frac{1}{2}$ -watt resistors.
- One 1-meg., $\frac{1}{2}$ -watt resistor.
- One 2-meg., $\frac{1}{2}$ -watt resistor.
- One 200,000-ohm, $\frac{1}{2}$ -watt resistor.
- One 600-ohm, 1-watt resistor.
- Unshielded antenna coil.
- Iron-core, radio-frequency choke.
- Three-pole, double-throw switch.
- Two 15,000-ohm volume controls with switches.
- Audio transformer, 1 to 3 ratio.
- Filter choke.

Miscellaneous:—Aluminum chassis, $7\frac{1}{2}$ " by $4\frac{1}{2}$ " by 3"; four octal tube sockets, four dials, two aluminum shields, two insulated grid-clip leads, speaker, etc.

Servicing Your Radio

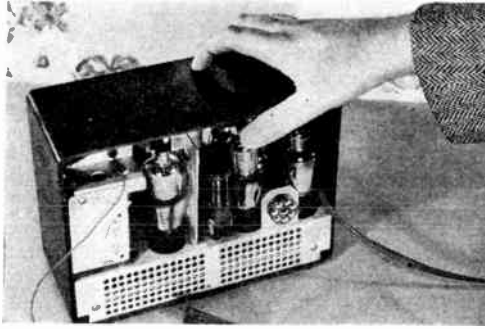

THIS OUT-OF-DATE SET is not hard to fix up

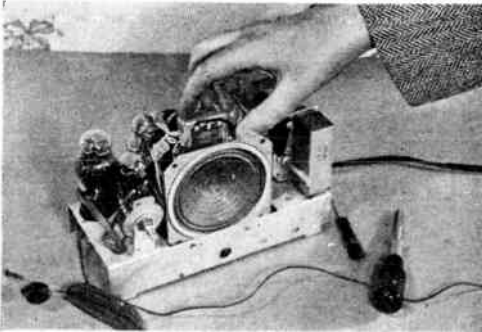

NEW SPEAKER will require an output transformer

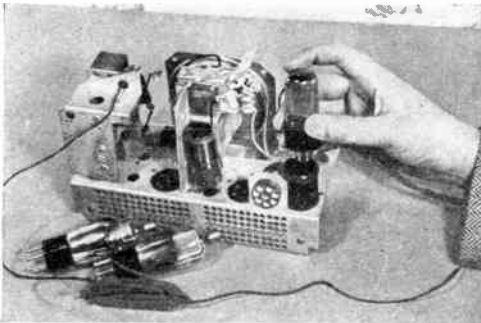

ADAPTER SOCKETS are essential for new tubes

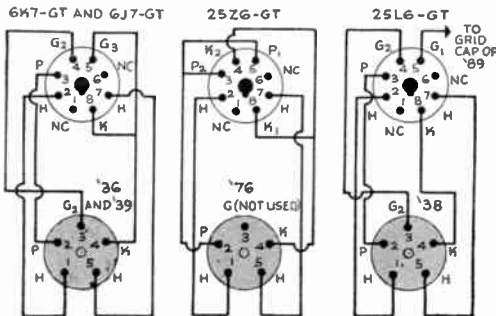

BOTTOM VIEWS SHOWN (N.B. - N C MEANS NO CONNECTION)

IF YOU HAVE an old radio set whose reception is not up to 1942 standards, you can modernize it yourself. The receiver illustrated here was one of the first AC-DC radios to use a plastic cabinet, and had no line-cord resistor, no 25Z5 or similar-type rectifier, and had a magnetic speaker.

The first thing to do, of course, is to remove the chassis from its plastic cabinet. Before starting to work on the chassis, be sure to dust and clean it thoroughly. The magnetic speaker is removed from the chassis and replaced by a four-inch permanent-magnet speaker. Since no output transformer is required with a magnetic speaker, one will have to be purchased. It is mounted directly to the four-inch speaker, on top, and may be seen clearly in the picture.

The set originally used a 39 tube as RF amplifier, a 36 tube as detector, an 89 tube as power amplifier, and a 37 tube as half-wave rectifier. Since those tubes first appeared several improvements have been made, and the new tubes now have greater sensitivity and clarity. Sockets and tube bases, however, have changed also, and it is not a simple matter of plugging a new tube into the old socket in order to use the new tubes. Adapter sockets have to be purchased. To replace the 39 RF amplifier tube use a 6K7-GT, instead of the 36 detector tube use a 6J7-GT, instead of the 38 power tube use a 25L6 or 25L6-GT, and instead of the 37 half-wave rectifier tube use a 25Z6 or 25Z6-GT. In using the 25L6 power tube, the bias resistor in the set will have to be changed to one having a value of approximately 600 ohms.

In the original set, a built-in heater resistor was used. It should be replaced by a line-cord resistor of 180 ohms. This is the correct value for the tubes listed above.

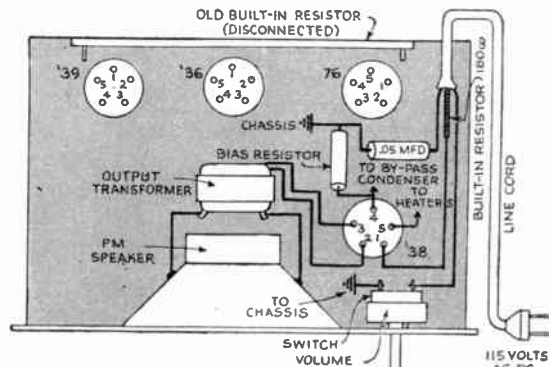

Tube wirings, left; general wiring diagram, above

A Radio for Your Floor

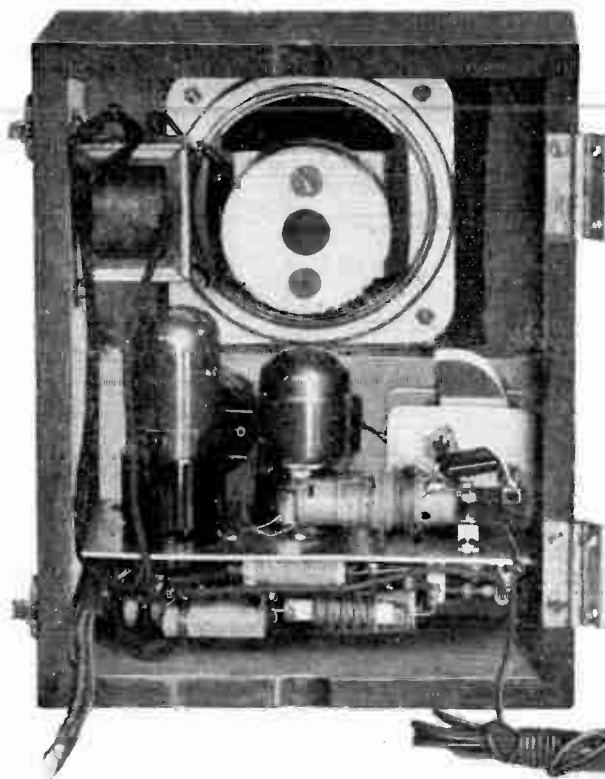

DESIGNED so that it can be attached to the standard of any floor lamp, the radio set illustrated forms a handy auxiliary receiver for living room, bedroom, or den. Mounted on a bridge lamp it provides a radio for card games; attached to a floor lamp beside your favorite chair it puts the evening's programs at your finger tips; and fastened to a standing lamp in your bedroom it serves as a convenient bedside set. Since the receiver's cabinet simply is clamped around the lamp's standard, the absence of exterior fittings or brackets also makes it possible to use the unit as a conventional table radio. The compact receiver requires no external ground, and can be operated with nothing more than a short indoor antenna.

There is nothing particularly complicated about the A.C.-D.C.

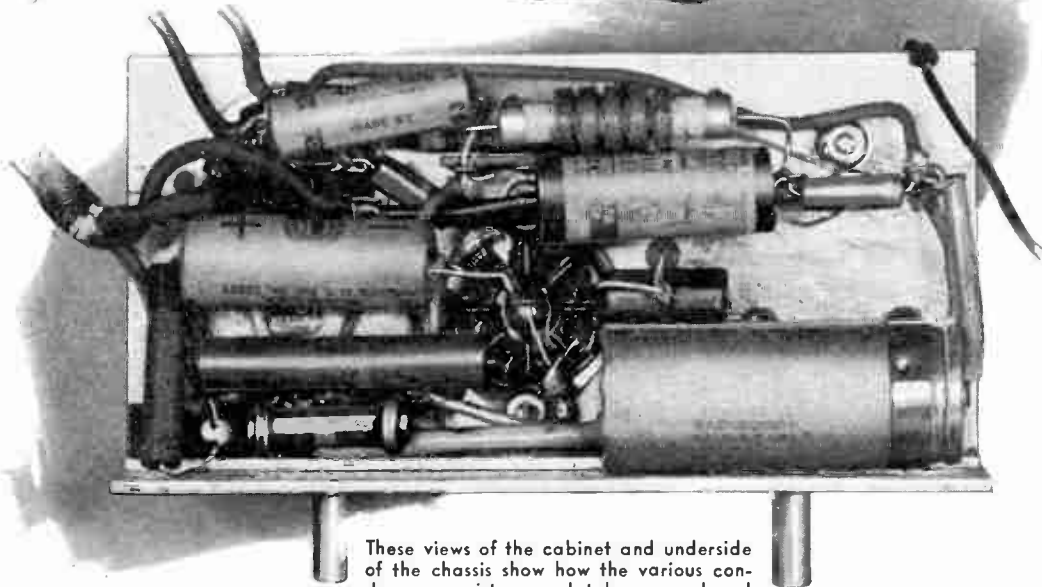

These views of the cabinet and underside of the chassis show how the various condensers, resistors, and tubes are placed

Lamp

circuit, which is unusually sensitive and free from hum. Only two tubes are used. One of the new locking-type-base pentode tubes (7A7) was chosen as the detector. It is resistance-coupled to a combination output pentode and half-wave rectifier (32L7). No grid cap is provided on the detector, as these new tubes are of the single-end construction, the grid connection being brought out at the base. Because the rated heater voltage of the 7A7 is slightly higher than that of the 32L7, a 2-watt resistor of approximately 1,500 ohms must be placed across the heater connections on the base of the 32L7. The resistor can be soldered directly to the lugs of the socket.

To save space, no filter choke is used. Instead, a 1,000-ohm, 1-watt resistor is connected between the dual electrolytic condenser (16-24 mfd.). This provides adequate filtering and allows the necessary voltage to get through to the plate of the tubes. A larger resistance cannot be used without an appreciable loss in volume.

The .00025-mfd. mica condenser indicated in the antenna lead is *extremely important*, since it eliminates any possibility of blowing out the tubes or burning the primary of the antenna coil (which could start a fire) should the antenna wire or antenna lead accidentally come in contact with a ground pipe or radiator.

The hinged mahogany cabinet measures 4¼" by 6¼" by 8", the lid being 1¼" deep (this is included in the overall depth of 4¾"). The sides are constructed of ¾" wood, while the front and sides were cut from ¼" wood. When completed the whole box was stained a deep mahogany, waxed, and then polished. The

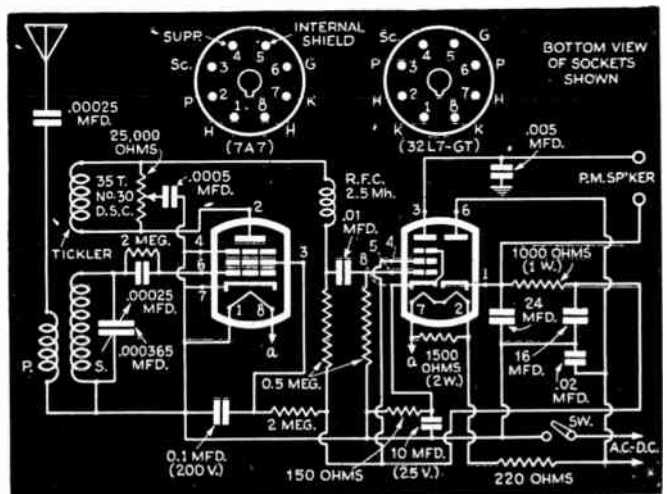

Easily built, the set can be clamped to the upright of any floor lamp

sides of the 3¼" diameter opening for the speaker are beveled outward to give a more finished appearance to the cabinet, and a square of gold silk glued in place behind

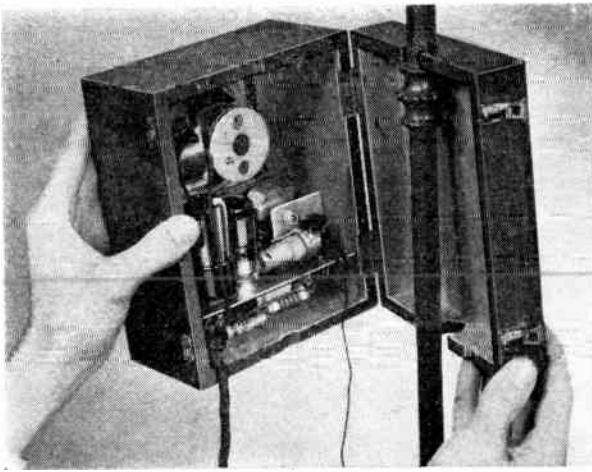

Either a decorative "bead" on the standard or a hose clamp can be used to support the mahogany cabinet shown in the drawings below, right

the opening serves as an attractive grille.

As indicated in the photographs and drawings, the parts, with the exception of the speaker and output transformer, are mounted on a small aluminum chassis and panel. The output transformer, separate from the speaker, can be fastened with screws to the side wall of the cabinet. In wiring the tubes, pay close attention to the accompanying socket diagrams, particularly the diagram for the new 7A7 tube. Watch the power connections to the resistor line cord. The 220-ohm resistance must be wired into the heater circuit to reduce the full 110-volt house current to the value required for the two heaters. A wrong connection at this point can blow out both tubes.

Holes cut in the top and bottom edges of the hinged lid and main cabinet serve to take the lamp standard. Naturally, the diameter of these holes will be governed by the size of the standard.

When using the receiver with direct current, remember that the house-wiring receptacle has a positive and a negative terminal. For this reason, it may be necessary to reverse the power plug to obtain the proper polarity.

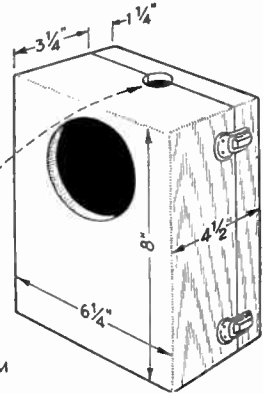
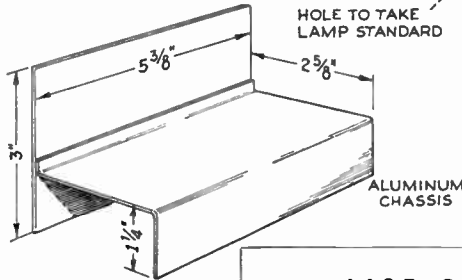
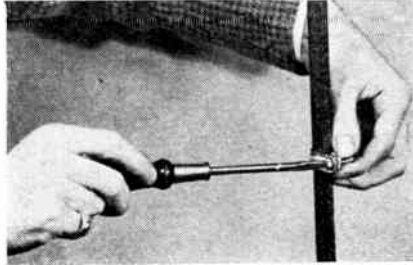

LIST OF PARTS

Midget tuning condenser, .000365 mfd.
 Midget antenna coil.
 Radio-frequency choke, 2.5 mh.
 Resistor, 1,000 ohm, 1 watt.
 Resistor, 1,500 ohm, 2 watt.
 Resistors, two, 500,000 ohm, 1/2 watt.
 Resistors, two, 2 megohm, 1/2 watt.
 Resistor, 150 ohm, 1 watt.
 Condenser, tubular, .1 mfd., 200 volt.
 Condenser, tubular, .02 mfd., 200 volt.
 Condenser, tubular, .01 mfd., 200 volt.
 Condenser, tubular, .005 mfd., 200 volt.
 Condensers, two, mica, .00025 mfd.
 Condenser, mica, .0005 mfd.
 Electrolytic condenser, dual, 16-24 mfd.
 Loudspeaker, 3" permanent-magnet type.
 Output transformer for speaker.
 Line cord and resistor, 220 ohms.
 Volume control and switch, 25,000 ohms.

Miscellaneous: Cabinet, chassis, 7A7 tube, 32L7-GT tube, sockets, wire, lugs, solder, knobs, grille cloth, etc.

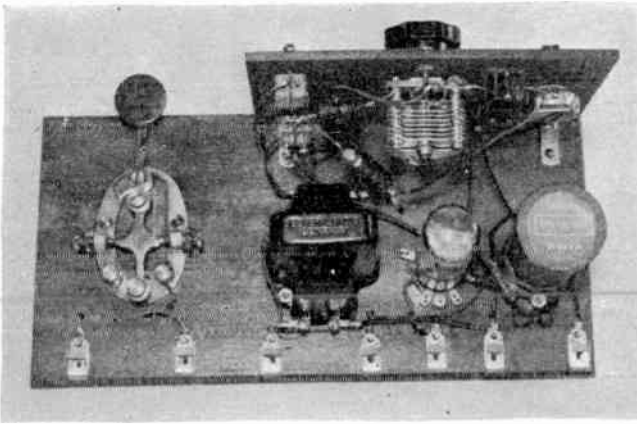

All parts have been mounted and connections made in this view of the top of the baseboard and rear of the panel. Below, the bottom view of the baseboard shows some of the simplified wiring

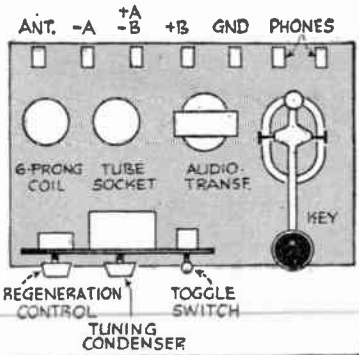
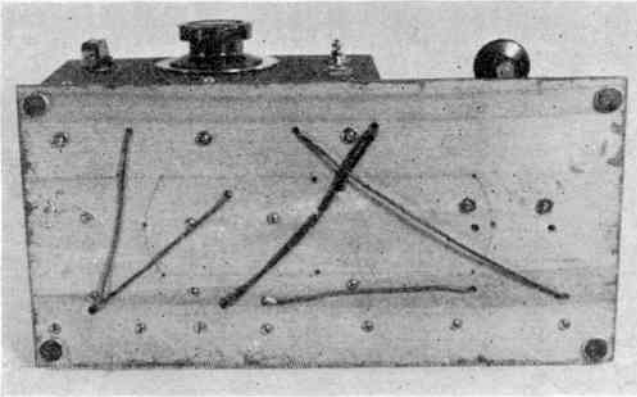

LIST OF PARTS

- Wooden baseboard, 6" x 12".
- Composition panel, 5" x 7".
- Toggle switches (2), D.P.-D.T. and S.P.S.T.
- Practice key.
- Potentiometer, 25,000-50,000 ohms.
- Audio transformer, any type, any ratio.
- Six-prong plug-in coil.
- Six-prong coil base.
- Eight-prong octal socket.
- Triode amplifier tube, 1G4-GT/G.
- Tuning condenser, .00014 mfd.
- Mica condensers (2), .0001 mfd. to .0005 mfd. and .0004 mfd. to .0005 mfd.
- Carbon resistor, 1/2 watt, 2 to 5 megohms.
- RF choke (optional), 2.5 to 8 millihenrys.

tuning condenser with a 2 3/4" dial and pointer, a 25,000-ohm regeneration control, and two toggle switches. One of these switches is of the double-pole, double-throw type and changes the circuit over for use either as a radio receiver or a code-practice oscillator. The other is an ordinary single-pole, single-throw switch and cuts off the filament supply whenever the unit is not being used.

The sending key and radio-oscillator unit are both mounted on the base. The latter unit includes a six-prong plug-in coil, octal wafer socket, and audio transformer. Connections to phones and batteries are made by means of Fahnestock clips arranged along the back of the baseboard.

For the audio transformer, take one out of the junk box, if possible, because the older it is the better it will work as an oscillator. A new audio transformer has too much inductance for this purpose, making it impossible to obtain a high-pitched note. If no oscillation is obtained when the oscillator is tested, reverse the leads to the primary of the transformer. It is important that cor-

rect polarity be observed. If desired, the pitch of the tone may be varied by placing a fixed condenser across the secondary of the audio transformer, using one of from .02-mfd. to .002-mfd. capacity. The higher the capacity (.02 mfd.) the lower the pitch will be.

When the instrument is used as a radio receiver, the plate supply ("B" battery) is usually about 45 volts, but when it is used as a code oscillator, the plate supply must be reduced to 4 1/2 volts. An ordinary 4 1/2-volt "C" battery will do for this purpose. In either case, whether the instrument is used for reception or for code practice, the filament voltage remains the same—1 1/2 volts.

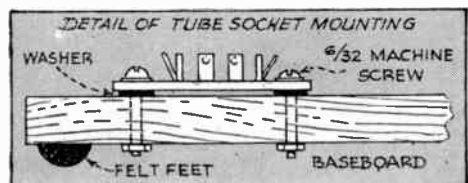

Pocket Receiver

FOR SPORTS FANS



LITTLE larger than a tobacco tin, the pocket receiver pictured below is ideal for sports fans who want to hear the play-by-play broadcasts while watching a game or meet from the stands. The set employs a super-regenerative circuit, using a 958 tube that operates successfully on very low plate voltage. Around the cigar-box-wood case, a loop antenna is wound, consisting of thirty-five turns each side of center, with both sections wound in the same direction. Use No. 40 D.S.C. wire. The two 140-mmfd. variable condensers, of the air-padder type, should be mounted with screws before the loop is wound. A brass bushing $\frac{1}{4}$ " in diameter and $\frac{3}{8}$ " long is soldered to the stub shaft of each condenser.

A medium-size flash-light cell serves as an "A" battery, while the "B" is composed of four "fountain-pen" cells in series. The latter should last almost indefinitely as the drain is very small. Although the set is decidedly not a distance getter, since it has limited voltage and only a tiny directional loop, it should give good results up to fifty miles on the bands between 650 and 1260 kc.

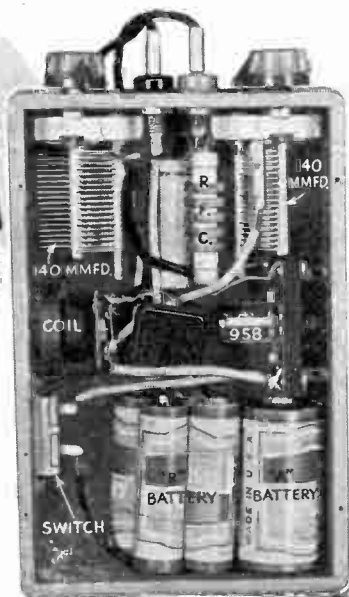

You can stow this midget receiver in a coat pocket. Note the parts arrangement at the right. Cigar-box wood forms the cabinet, and a loop antenna is wrapped around it, while flash-light cells to power the set are carried in the base

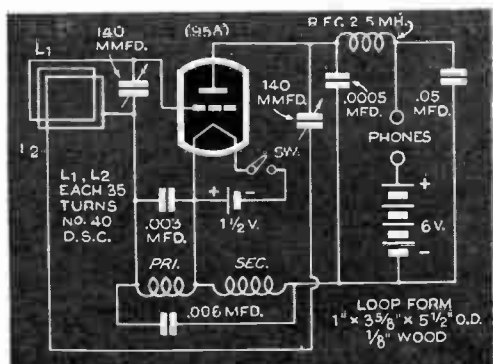

Wiring diagram also gives full parts specifications



Tiny Portable

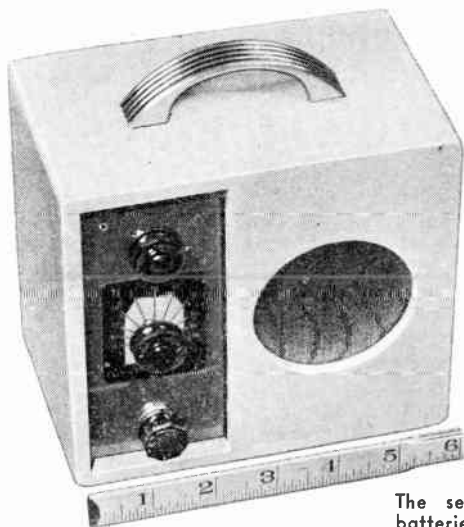

The set, complete with batteries, is little larger than a dollar box camera

POWERED by its own built-in battery supply, this compact portable receiver is a handy companion for use on picnics, at summer camps, on your garden terrace, or anywhere that a 110-volt house-lighting circuit is not available. Complete with loud-speaker, it weighs but a few pounds and is little larger than the average dollar box camera.

To cram as much radio into as little space as possible, the tuned radio-frequency circuit was designed around three of the newest $1\frac{1}{2}$ -volt midget tubes. Operating on plate voltages from

50 to 60 volts and having an extremely low current drain, the midget tubes make it possible to cut the battery supply to the minimum. Although the tubes are manufactured in England, they are available in the United States and can be obtained from any of the larger radio-parts supply houses.

All three tubes are of the pentode type and must be used with the special midget sockets designed for them. As shown in the diagram, the third grids, or suppressors, of the radio-frequency pentode and detector are brought out to pins in the bases of the tubes (pin No. 3) and should be connected to the minus lead of the "A" battery or to the aluminum chassis. The suppressor grid of the output tube (XY) is connected internally so that no external connection is required.

The antenna and radio-frequency coils are of the standard broadcast type used in commercial A.C.-D.C. receivers. As sold, they are mounted in square aluminum cans. Because of the limited space, these shields must be removed. As shown in the photographs, the radio-frequency coil is mounted vertically at the rear of the chassis, and the antenna coil is placed directly behind the antenna tuning condenser.

To conserve space, variable condensers of the "solid-dielectric" type are used for tuning the antenna and radio-frequency coils. These condensers, unlike

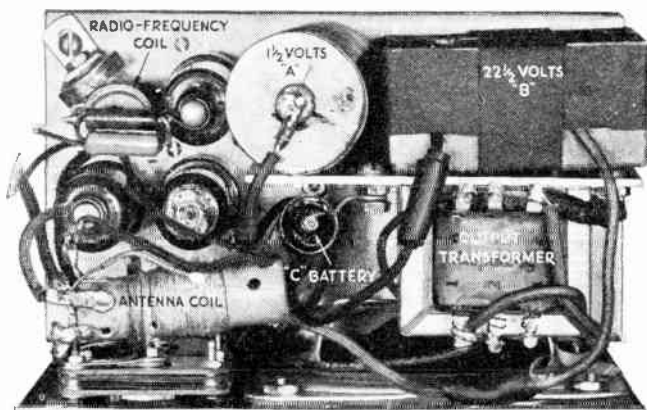

How the parts are arranged above and below the chassis. The three midget tubes are mounted at the left of the chassis

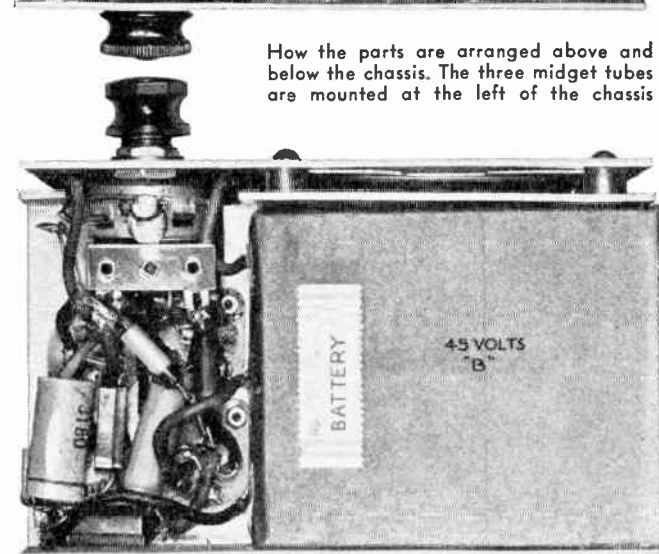

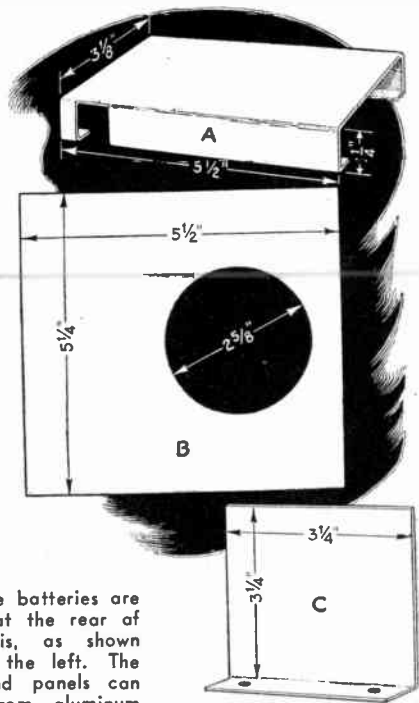
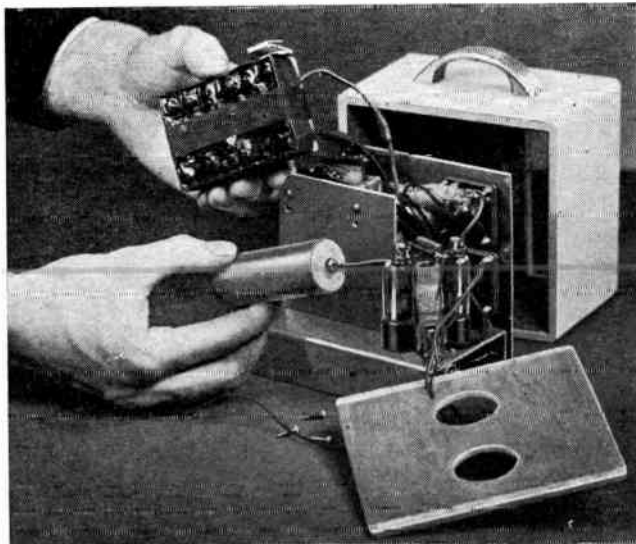

half to provide a $22\frac{1}{2}$ -volt source. The $22\frac{1}{2}$ -volt unit and the $1\frac{1}{2}$ -volt dry cell can be held in place on the transformer panel (C) with rubber bands or string. The 45-volt unit can be mounted conveniently under the chassis. A tiny $1\frac{1}{2}$ -volt flash-light cell of the type used in fountain-pen flash lights serves as the "C" battery and, being light enough to be supported by its own wiring, can be placed at the left of the speaker.

Two of the batteries are mounted at the rear of the chassis, as shown above at the left. The chassis and panels can be cut from aluminum

To provide maximum portability, the set is designed for use with two antennas—a long one about 40' in length and a shorter one approximately 25' long—instead of with an antenna and an actual connection to the ground. The long antenna is connected to the ground terminal on the receiver and the shorter one serves as the actual aerial. An actual ground can be used, of course, if desired.

The cabinet, measuring 6" square and $3\frac{1}{2}$ " deep outside, is made of $\frac{3}{8}$ " thick hard wood finished with quick-drying enamel in the desired color. The original shown is white. The modernistic handle is a silver and black metal drawer pull of the type available at most five-and-ten-cent stores for a dime. It blends in with the general modernistic design of the cabinet.

Two holes, one rectangular and the other circular, cut in the front of the cabinet provide openings for the aluminum control panel and the speaker. The speaker opening should be covered on the inside with silver and black speaker-grill cloth, to match the silver handle and the aluminum panel. Small black knobs should be used for the two tuning controls and the potentiometer. A dial need only be provided for the radio-frequency condenser, since the antenna circuit is not

- ### LIST OF PARTS
- Three-inch permanent-magnet speaker.
 - Output transformer.
 - Tubes, XW (two), XY.
 - Midget antenna coil.
 - Midget radio-frequency coil.
 - Snap-on switch (D. P. S. T.).
 - Resistors, 1 meg., $\frac{1}{2}$ watt (two).
 - Resistor, 400,000 ohm, $\frac{1}{2}$ watt.
 - Volume control, 100,000 ohm.
 - Special tuning condensers, .0005 mfd. (two).
 - Mica condensers, .0003 mfd. (two).
 - Mica condenser, .002 mfd.
 - Tubular condensers, .02 mfd. (three).
 - Midget "B" batteries, 45 volt (two, see text).
 - Midget "C" battery, $1\frac{1}{2}$ volt.
 - Small "A" battery, $1\frac{1}{2}$ volt.
 - Miscellaneous*:—Three special sockets, cabinet, chassis, panels, wire, etc.

critical in tuning. As in the making of all radio receivers, much of the success of your efforts depends upon careful workmanship. Make sure that all wire connections are soldered well. One loose connection or one that is not made with clean contacts can destroy a receiver's performance. Careful workmanship on the cabinet will reward the builder with a portable set that is sturdy.

LOW-COST POWER SUPPLY

HERE is an "A" and "B" power supply that can be built for less than \$2, and will operate any one or two-tube receiver not provided with a power tube. It will supply six volts of alternating current for tube heaters and approximately 80 volts of filtered and rectified direct current for plates and screens of tubes similar to the 6J7, 6K7, and 6C5.

All the parts are mounted on a 4" by 7" wooden baseboard. An ordinary bell transformer with a primary of 110-115 volts and a secondary of 6-8 volts furnishes the heater supply for the diode detector rectifying tube (6H6) and the other tubes in the receiver.

The output of the 6H6 as a rectifier is approximately 8 milliamperes—ample for a two-tube set. A 2,000-ohm, 2-watt, wire-wound, fixed resistor; a 1,000-ohm, 2-watt, carbon resistor and a 20-mfd., 150-volt, electrolytic condenser are used to filter the "B" voltage. The 6H6 uses an eight-prong socket.

The plates and cathodes of the 6H6 are connected in parallel, with plates hooked to one side of the transformer primary, and the cathodes connected to the filter circuit. No ground connections should be made to the receiver, as it will be grounded through the power supply, which is connected to the house-wiring circuit.

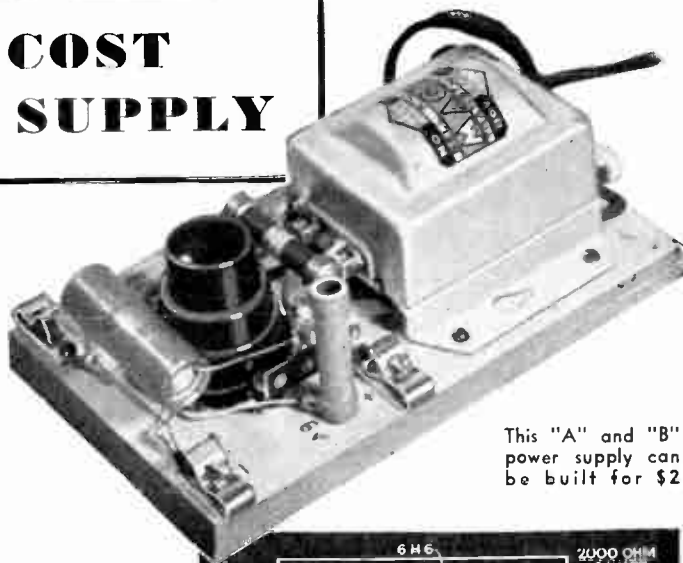

This "A" and "B" power supply can be built for \$2

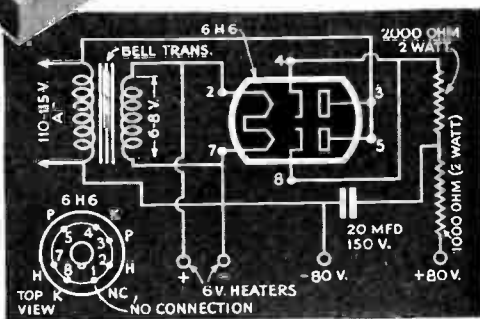

Plates and cathodes of the 6H6 are in parallel



An ordinary bell transformer furnishes the heater supply. At left, hooked up and ready to go, showing its small size

THREE-

IS IDEAL SET FOR
BEGINNERS

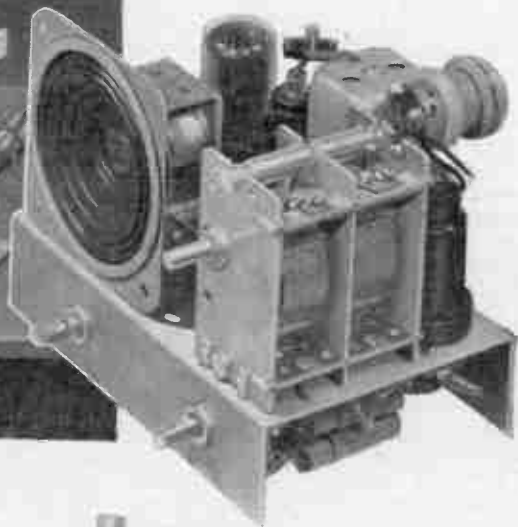

Top view of the chassis, above, will help you arrange the various parts. The chassis measures only $6\frac{1}{2}$ " long by $4\frac{1}{4}$ " in depth

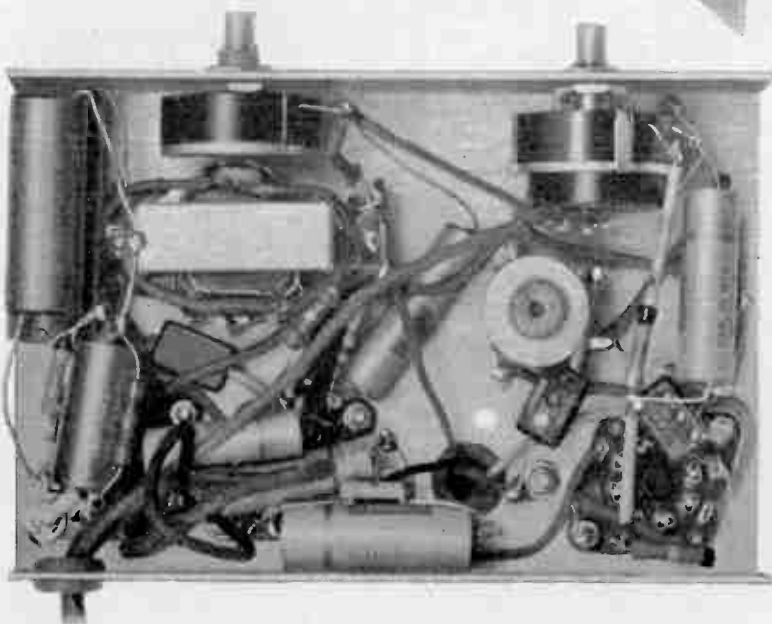

Keep all connections as short as possible. The universal output transformer is mounted directly beneath the speaker, shown above, and secured by the same two bolts

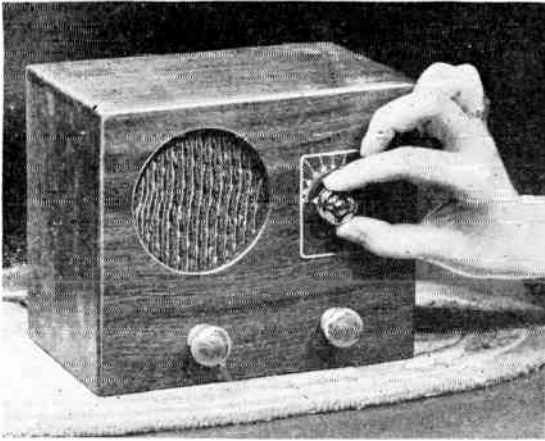

The author built the cabinet of $\frac{3}{8}$ " thick white wood

any winding so that a regenerative detector stage can be used. This stage adds greatly to the receiver's volume.

A cathode feed-back circuit is used to obtain regeneration. It consists of a .005-mfd. mica condenser and a 2,500-ohm variable resistor. If the reader lives near a powerful local station, he should add a volume control consisting of a 10,000-ohm variable resistor in series with the 300-ohm cathode resistor of the first tube.

For tuning, a standard two-gang .000365-mfd. variable condenser is used. This controls the first detector and oscillator stages whose functions are performed by the first tube, 6A8. The .0004-mfd. padding condenser in the oscillator circuit must be within three percent of the rated capacity, to avoid trouble in ganging the two condensers.

The sensitivity of this receiver, especially on distant stations, is greatly increased by the use of the 1-meg. grid leak and the .0002-

Here are overall dimensions of chassis and cabinet

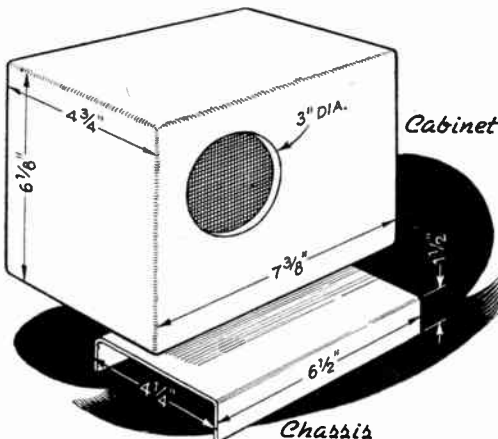

Inserting the grid leak and condenser in the grid lead of the second detector tube to step up sensitivity

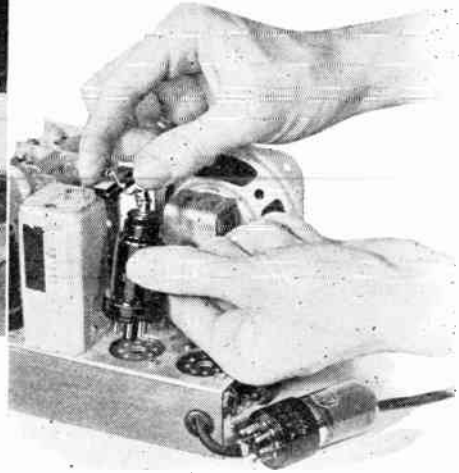

mfd. mica condenser in the grid lead of the second detector tube (6K7).

The small 3" permanent-magnet speaker is connected to the output of the 32L7GT. It is mounted directly to the chassis by means of two long machine screws and metal spacers $\frac{3}{4}$ " long. The universal output transformer is mounted directly beneath it under the chassis, held by the same two screws.

LIST OF PARTS

- 3" Permanent-magnet speaker.
- Universal output transformer.
- Regenerative I.F. transformer with tap, 455 kc.
- Line-cord resistor, 250 ohm.
- Antenna coil.
- Oscillator coil, 455 kc.
- Tubes, 6A8, 6K7, and 32L7GT.
- Regeneration control, 2,500 ohm.
- Electrolytic condenser, 20 mfd., 150 volt.
- Electrolytic condenser, 40 mfd., 150 volt.
- Electrolytic condenser, 10 mfd., 25 volt.
- Two-gang tuning condenser, .000365 mfd.
- Mica condenser, .005 mfd.
- Mica condenser, .0001 mfd.
- Mica condensers (2), .002 mfd.
- Tubular condensers (2), .05 mfd., 400 volt.
- Tubular condensers (2), .02 mfd., 400 volt.
- Tubular condenser, .1 mfd., 400 volt.
- Carbon resistor, 250 ohm, 1 watt.
- Carbon resistors (2), 300 ohm, $\frac{1}{2}$ watt.
- Carbon resistor, 300 ohm, 2 watt.
- Carbon resistors (2), 50,000 ohm, $\frac{1}{2}$ watt.
- Carbon resistor, $\frac{1}{2}$ meg., $\frac{1}{2}$ watt.
- Carbon resistor, $\frac{1}{2}$ to 1 meg., $\frac{1}{2}$ watt.
- Carbon resistor, 150,000 ohm, $\frac{1}{2}$ watt.
- Carbon resistor, 2 meg., $\frac{1}{2}$ watt.

Miscellaneous: Volume control (optional); S.P.S.T. switch plate; three octal wafer sockets; chassis; cabinet, wide, etc.

Compact All-Wave Set IS EASY TO BUILD

YOU should have no trouble getting world-wide reception with the all-wave set illustrated. It uses the new 1E7G tube containing two pentodes, independent of each other except for the connected screens, giving two-tube regenerative results in a one-tube set. A 15-ohm rheostat connected in the positive "A" lead regulates filament voltage, and a 20,000-ohm potentiometer across the tickler coil controls regeneration. The potentiometer is combined with an on-off switch.

Since one pentode is used as a detector, the common screen voltage must be kept down to $22\frac{1}{2}$ volts. Although this means a slight loss of volume in the audio stage, since the screen voltage on the "second" tube should be higher than $22\frac{1}{2}$ volts for maximum amplification, the combined amplification of both stages is greater than that obtainable with two separate triodes.

To obtain regeneration, the author found it necessary to use coils of the type shown in the illustrations.

Note the receiver's small size. Its three control knobs are all on the panel front

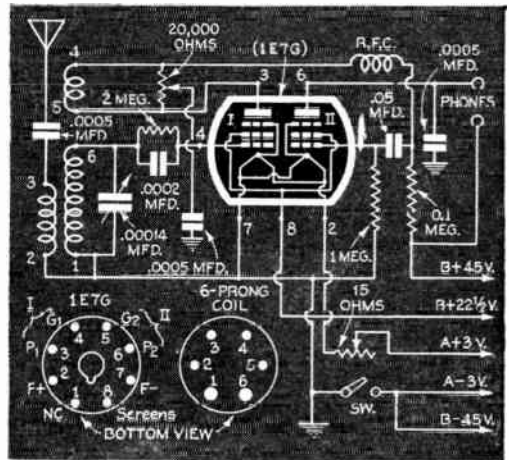
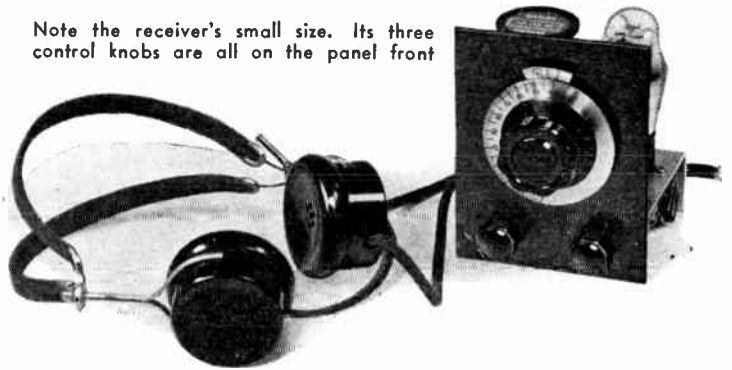

The diagram gives complete wiring details. Mount tube and coil sockets as below

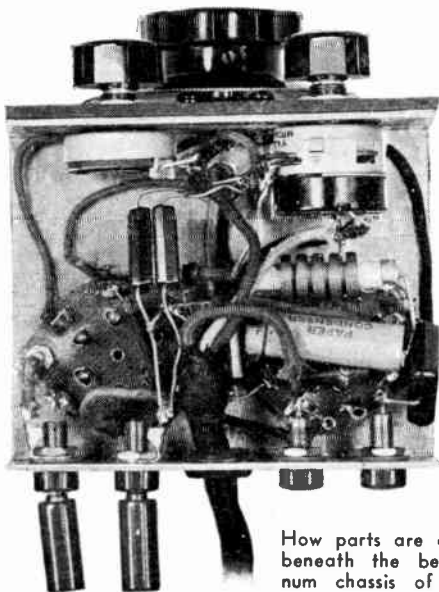

How parts are arranged beneath the bent-aluminum chassis of the set



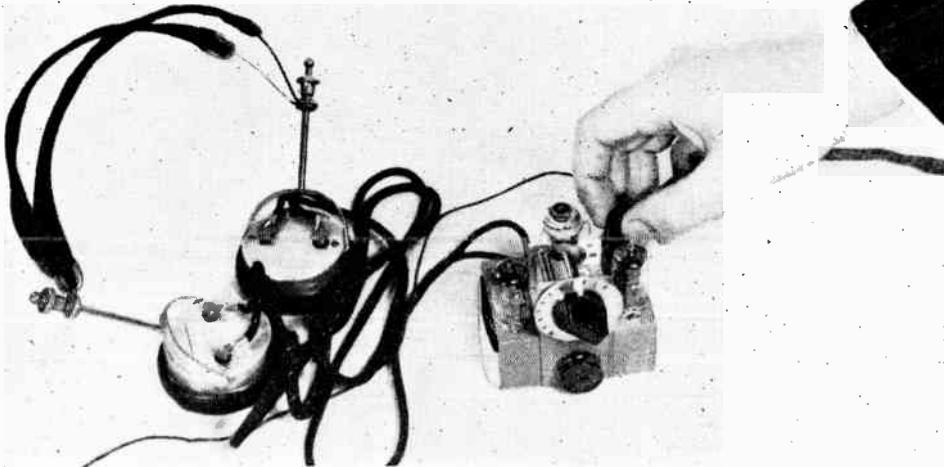

Beside the headphones, the tiny receiver is dwarfed. The plug being inserted is for the antenna

Two-Tube AC-DC Receiver

BUILT on a tiny chassis measuring only $1\frac{1}{4}$ " by $2\frac{1}{4}$ " by 3", this two-tube AC-DC headphone receiver is still powerful enough to pull in many stations besides the local broadcasters. No ground is used with it, and for an antenna a short piece of wire—about 18' long and strung along the floor—will be found sufficient for adequate reception in most cases. The little radio is selective enough to separate local stations and bring them in with great clearness.

Two of the newer midget tubes—the 9001 and the 9002—are used, the 9001 as a pentode detector and the 9002 as a half-wave rectifier. The 9002 is really a triode amplifier tube, but it will also function satisfactorily as a rectifier when its plate and grid are joined together. The 9001 is an RF pentode tube with a high amplification factor. Used in the detector stage, it will enable the listener to bring in stations situated more than 600 miles away if the

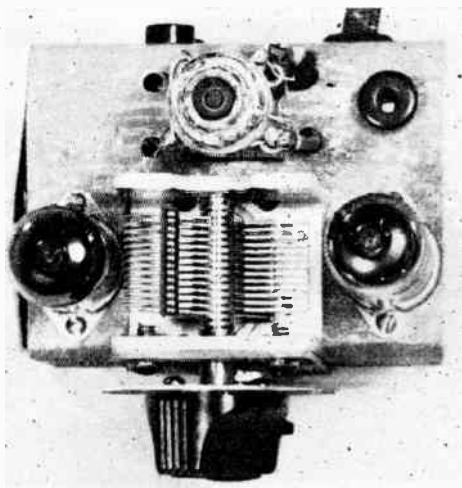

View of the chassis from above. The RF pentode tube is on the right, the rectifier tube at left

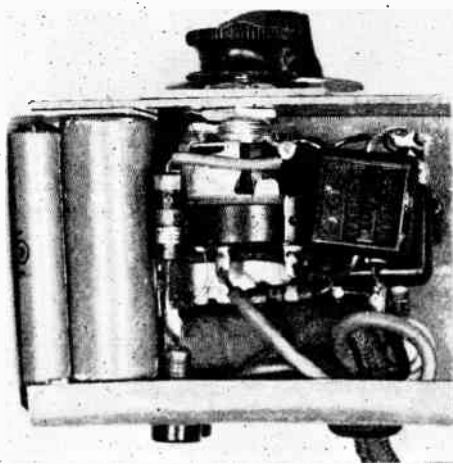

This bottom view shows one resistor at the left. The electrolytic filter condenser is next to it

receiver is used in the country and it is possible to put up a good outside antenna about 75' long.

Because of the low heater-current drain (0.15 ampere for each tube), a line-cord resistor of 600 ohms is required. Since it is impossible to purchase a line cord higher than 350 ohms, two 300-ohm line cords are used in series to bring the resistance up to the amount necessary. The plug is removed from one line cord and the three exposed wires are then soldered to the ends of the

corresponding wires of the second. To do this properly, be sure you disconnect the resistor from the wire to which it is soldered before attempting to join the two line cords. The method is illustrated in detail in the drawing at the lower left-hand corner of this page.

The capacities given in the wiring diagram are not critical, and both capacities and resistances (except that of the line cord) may vary as much as 25 percent. For instance, a .00041-mfd. variable condenser

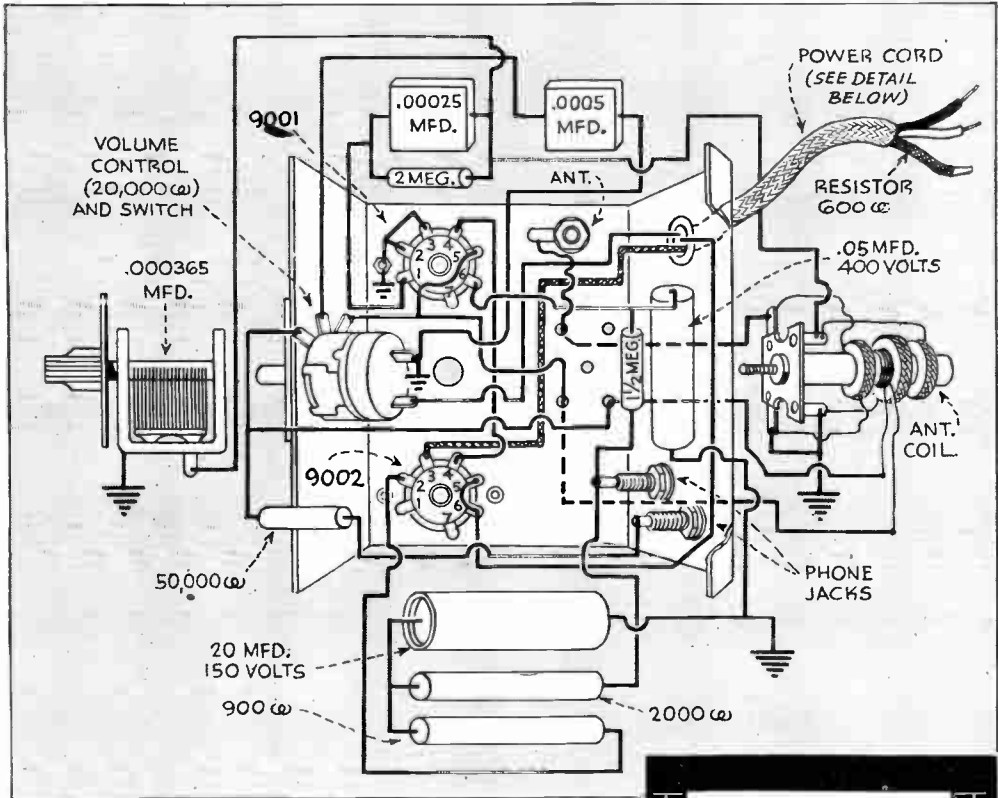

Arrangement of the parts is detailed in the pictorial diagram above. Note that the tickler-coil winding is placed between the antenna-coil and the first of two secondary-coil windings

Two line cords, joined as shown in the sketch below, will be needed to obtain the necessary line-cord resistance. Follow the directions carefully. At the right is the chassis layout

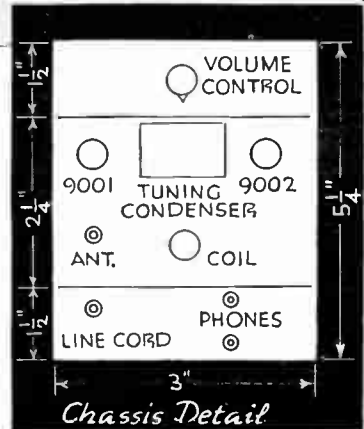
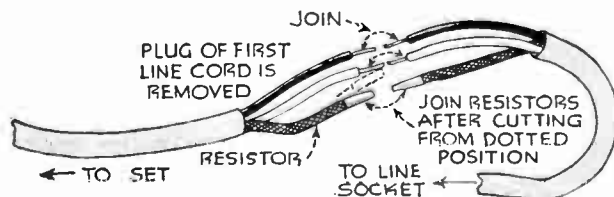

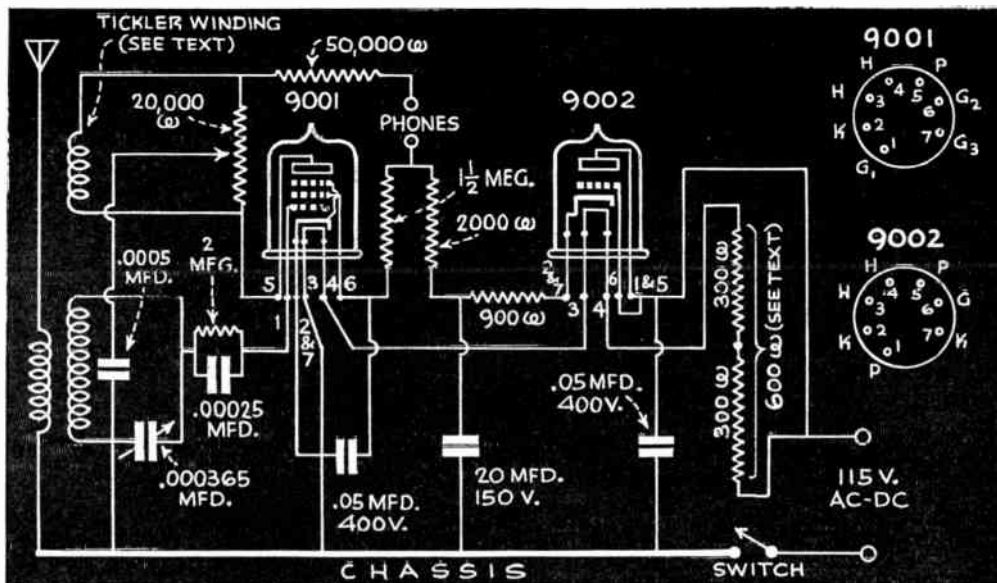

Wiring is made simpler by following this complete diagram. Base layouts for tubes are at right above

LIST OF PARTS

- Midget tuning condenser, .000365 mfd.
- Midget iron-core antenna coil.
- Volume control, 20,000 ohms.
- S. P. S. T. switch.
- Midget pentode tube, 9001.
- Midget triode tube, 9002.
- Seven-prong sockets (2).
- Carbon resistors (5), 2 meg-ohms, 1/2 watt; 1 1/2 meg-ohms, 1/2 watt; 50,000 ohms, 1/2 watt; 2,000 ohms, 2 watts; 900 ohms, 2 watts.
- Line-cord resistors (2), 300 ohms.
- Electrolytic condenser, 20 mfd., 150 volts.
- Paper tubular condensers (2), .05 mfd., 400 volts.
- Mica condensers (2), .0005 mfd.; .00025 mfd.

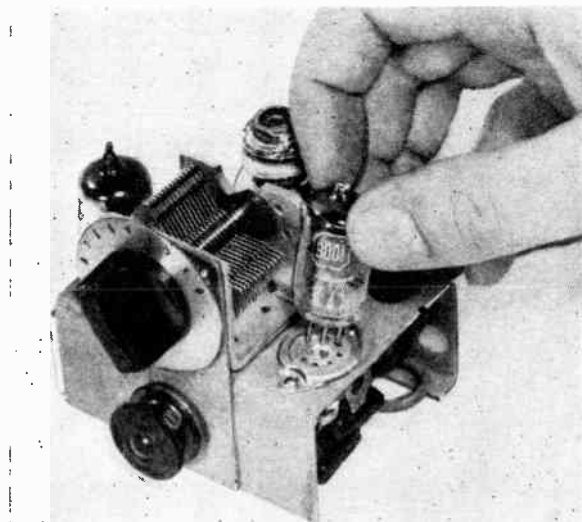

Here the RF pentode detector tube is being inserted. It is all glass with no base. The midget socket is shown clearly

may be used instead of the .000365-mfd. condenser called for in the diagram, and the 2-megohm grid leak may be changed to either a 1-megohm or 5-megohm resistor. This 25-percent margin will enable one to rummage around in old sets or in the junk box for many of the parts.

The simplified filter circuit (using but one electrolytic condenser) is ample to keep any hum from reaching the phones. A tickler winding, consisting of 25 turns of No. 30 double-silk-covered wire, is wound

next to the grid winding on the coil. The coil is a standard antenna coil of the type sold generally for use in small AC-DC receivers. Volume and oscillation are controlled by the 20,000-ohm variable resistor across the tickler winding.

The chassis is made of wood or any odd pieces of metal found around the workshop. A coating of gray wrinkle paint is applied to give it a professional finish. If a case is to be built, simulated leather or scrap may be used.

Servicing Your Radio

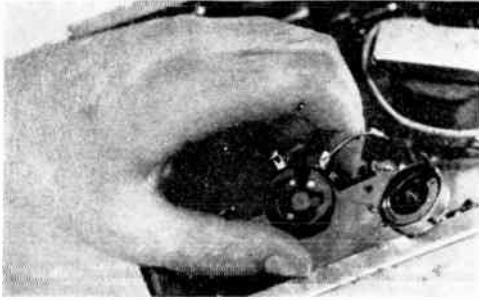

NOISY VOLUME CONTROL caused by the graphite wearing down or becoming coated with a hard film during the constant traction of the moving arm may be easily adjusted. Worn graphite can be restored with a dab of special liquid graphite lubricator. Film may be scraped away with a small screwdriver. Do not use a knife—it is too sharp—and do not scrape too hard.

SHOULD A SPEAKER GIVE NO SOUND even when the tubes light and test O. K. on the meter, the primary and secondary windings on the output transformer also test O. K., and each circuit is receiving the correct "B" voltage, it is a safe bet that the voice-coil winding is burned out. However, before cutting out the cone, make sure that the short pieces of stranded wire connecting the voice coil to the lugs on the speaker frame have not become corroded or disconnected. These are simple things which have happened in more than one receiver, and it saves needless trouble to inspect them.

CONNECTING A PHONOGRAPH PICKUP to the detector stage of a radio receiver—an easy matter with the old receivers where the detector stage usually was a pentode—is a much more difficult operation with the newer models where the detector tube usually is a diode plus a high- μ triode or pentode.

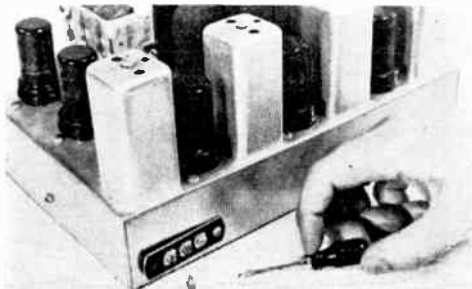

WHEN TUNING-STAGE ALIGNMENT, especially at the upper end of the dial, is not possible with a receiver using a loop antenna, reception may be improved in some cases by connecting a fixed condenser (.002 to .02 mfd.) across the loop antenna and ground, or by shorting the two.

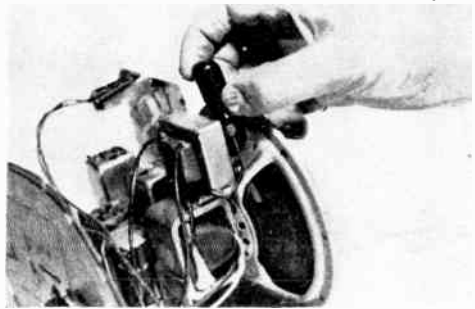
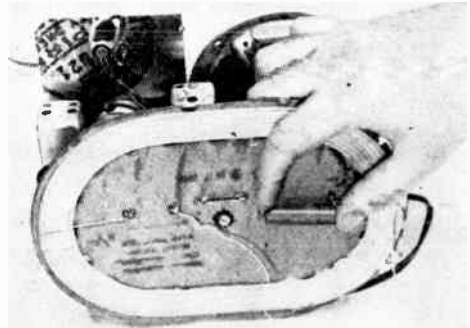

By following carefully the diagram of the simple circuit given below, the amateur serviceman should be able to make the proper connection without too much trouble. This diagram will serve for any of the newer sets, and a connection thus made should give excellent phonograph reception.

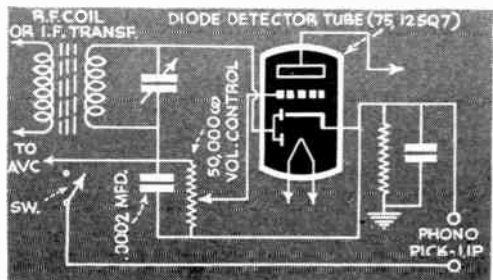

Portable Radio- Phonograph

World's Smallest Model
Has Four Tubes and Is
Compact for Carrying

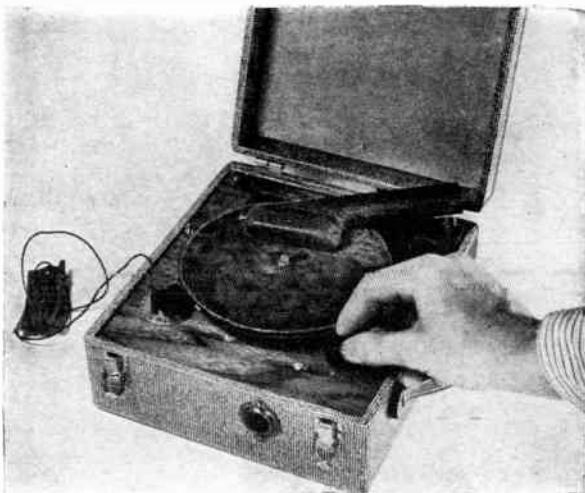

Assembled portable radio phonograph, showing 6" turntable, volume control knobs, and dial

JUST a year ago, there came from radio factories the first midget portable radio, weighing 4 lbs., light enough to carry about like a camera. There have not yet been any really compact portable radio phonographs. The plans given here for building the world's smallest portable radio phonograph are the first to be published.

Built into a case 9 $\frac{3}{4}$ " by 8 $\frac{3}{4}$ " by 4 $\frac{1}{2}$ " is a complete phono-amplifier, crystal pick-up, spring-wound phonograph motor, 6" steel turntable, four-tube radio receiver, 4" per-

manent-magnet speaker, 67 $\frac{1}{2}$ -volt "B" battery, 1 $\frac{1}{2}$ -volt "A" battery, and 3-volt "C" battery.

The four-tube radio circuit uses three 1T4 miniature seven-prong tubes (two as RF amplifiers and the third as a detector) and one 3Q4 miniature seven-prong tube (a beam power pentode, used in the output stage and handling up to 270 milliwatts; it is also the phono-amplifier tube).

Two stages of RF amplification are employed with only two .00036 mfd. tuning condensers because in the untuned antenna circuit the tuning condenser has been replaced by a 75,000-ohm, $\frac{1}{2}$ -watt resistor connected be-

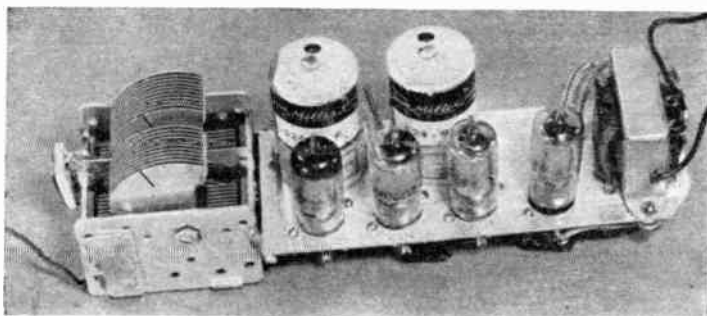

Top view of radio chassis. Left to right, trimmer and tuning condensers, three 1T4 tubes, one 3Q4 tube, and output transformer.

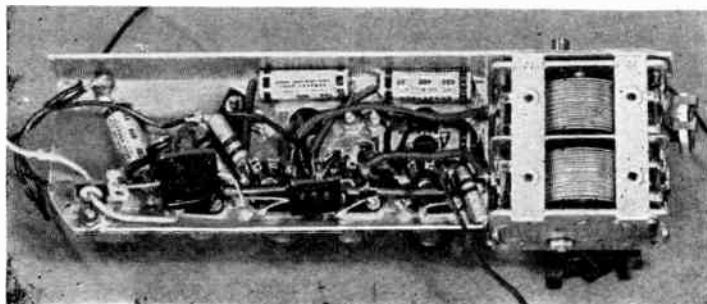

View of radio chassis from the bottom, showing neat arrangement of the paper tubular condensers, tube sockets, and resistors, which permits installation along with equipment for a phonograph in a compact, convenient carrying case

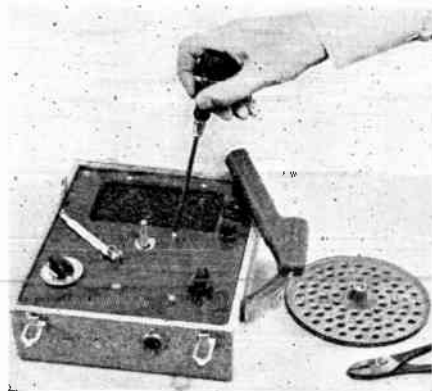
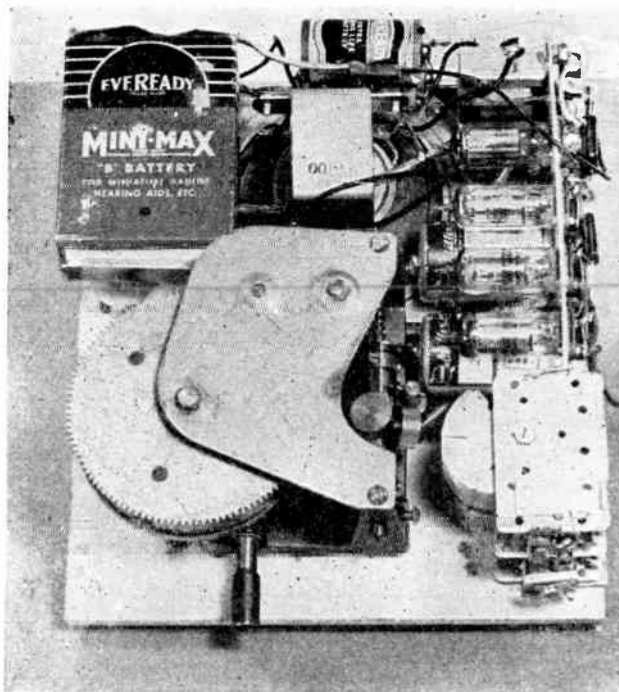

Above, the top of the control panel, with the record turntable removed. This gives a view of the opening for the speaker, in the rear, and the speed regulator under the turntable

Bottom view of the radio phonograph. The radio chassis, turned over on its side, fits snugly into the space left by the phonograph mechanism. The record player is spring-driven; the two batteries ore for the radio

tion. Another variable resistor, in the grid circuit of the 3Q4, controls volume for the phonograph amplifier and pick-up. For radio, this is left at its maximum position.

Because of the size of the unit, a 6" turntable is the largest that can be used. One 8" in diameter would entirely cover the top panel, leaving no room for tuning or volume controls, and would completely hide the speaker.

For the same reason 2½" of the tone arm of the 9" crystal pick-up must be sawed off, reducing the length to 6½", a size that would fit inside the case. This does not impair the performance of the pick-up—the quality of the output being just as good. (When playing recordings, do not use a loud needle as this will overload the 3Q4, caus-

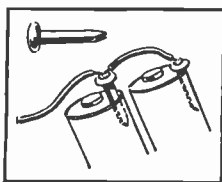

Wire soldered to paper clips makes connection to flashlight batteries

ing distortion in the reproduction of sound.

Inserted in the audio stage is a S. P. D. T. radio-phonograph switch. This is of the rotary type and is mounted in front of the panel to balance up with the small 1¼" tuning dial.

The case is constructed of ¼" thick white pine and is covered with tan airplane cloth fabric, which can be obtained in small rolls. Removable hinges are used, but they are not essential.

The panel is made from a piece of plywood, also ¼" thick, and given a high-gloss finish. The size of the panel is 9" by 8". An oblong hole 5¼" by 2¾" serves as an opening for the 4" speaker.

For outings, or carried from one part of the house to another, this set will give good service.

LIST OF PARTS FOR PORTABLE RADIO-PHONOGRAPH

Metal chassis, 6" by 2¼" by ¾".
 Two-gang tuning condenser, .00036 mfd.
 RF coils (2), iron core, shielded.
 Midget tuning dial.
 Volume controls: (for pick-up) 1 megohm;
 (for radio) 150,000 ohms.
 Switches: attachable, D. P. S. T.; rotary,
 S. P. D. T.
 Miniature seven-prong wafer sockets.
 Tubes: super-control RF amplifier pen-

todes (3), 1T4; beam power output, 3Q4.
 Permanent magnet speaker, 4".
 Midget output transformer.
 Spring-wound phonograph motor.
 Crystal pick-up.
 Condensers: paper tubular (3), .01 mfd.,
 400 volts; paper tubular, .002 mfd., 400
 volts; mica, .00025 mfd.; mica, .005 mfd.
 Carbon resistors, ½ watt (3): 75,000 ohms;
 500,000 ohms; 5 megohms.

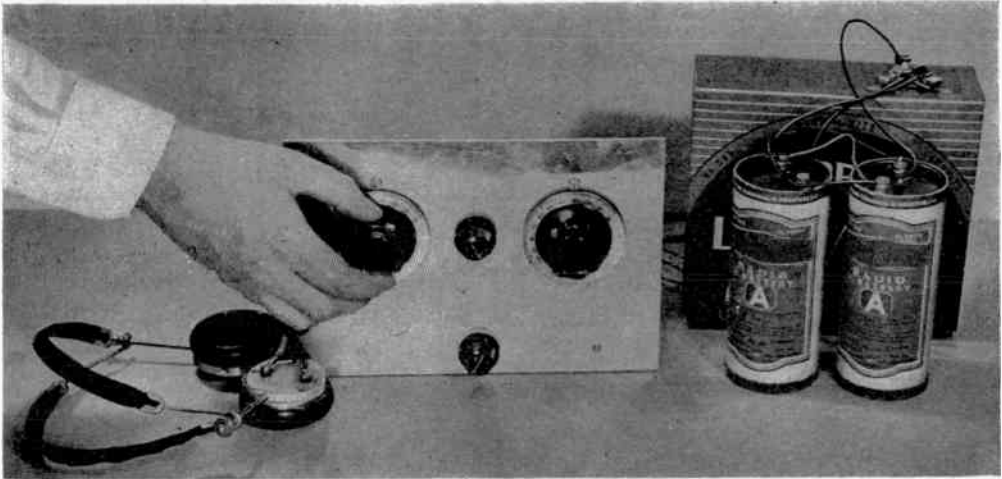

Anything from short waves to the long-wave aircraft beam signals can be tuned in on this one-tube set

One-Tube Short-Wave Set

ALL BANDS up to and including the aircraft beam signals can be worked with this one-tube receiver. The tube is a twin-pentode 1E7G, operating as a push-pull detector. Its output is sufficient to permit operation of a magnetic speaker on the broadcast band when close to the transmitter. Two 1.5-volt dry cells supply the "A" current. The tube operates satisfactorily with 45 volts on plates and screens, but best results are obtained with 90 on plates and 45 on screens. Two plug-in coils are used on each band, tuned by two .00014-mfd. variable condensers. Any type of antenna will do, though with one longer than 20 feet a trimmer condenser may have to be used in the antenna lead for short waves.

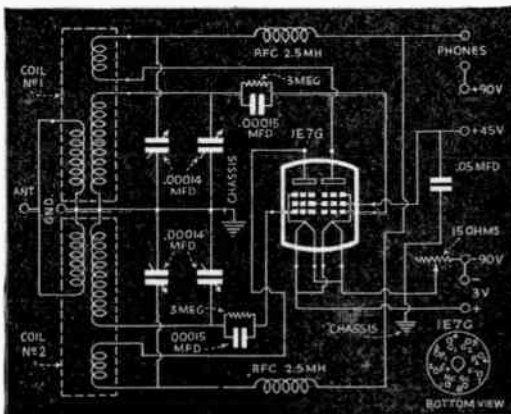
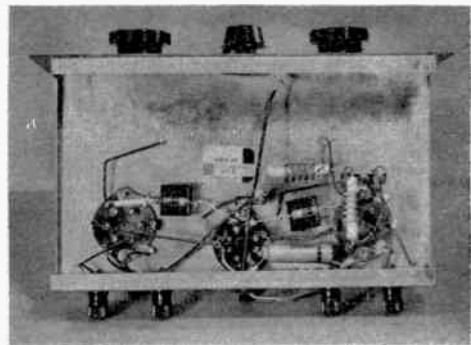
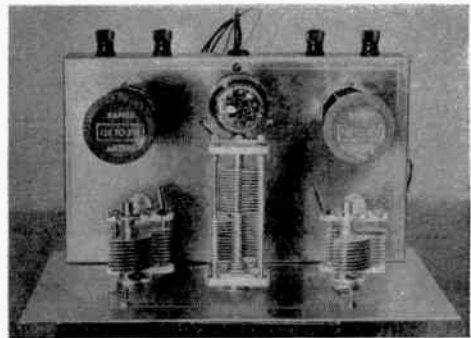

Above, top view; below, bottom view; and left, hook-up of the one-tube push-pull short-wave receiver. Two 1.5-volt dry cells supply the "A" current; "B" current runs 45 to 90 volts. Any type of antenna, ten to 75 feet, will do

Sliding Panel



Two controls — a sliding panel and a volume knob — operate this easily built receiver

Top and bottom views of the L-shaped metal chassis. Note trimmer condensers

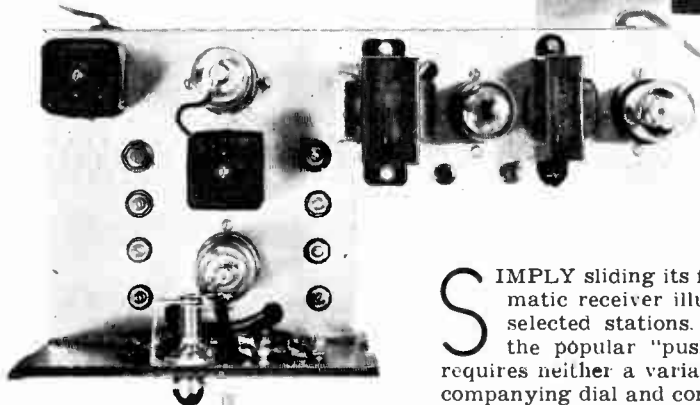
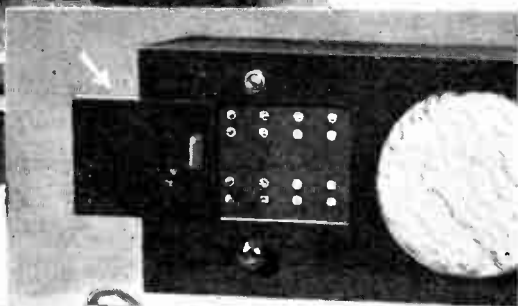

Metal strips backing the panel contact the screw heads to connect the condensers into the circuit

SIMPLY sliding its front panel tunes the novel automatic receiver illustrated to any one of four pre-selected stations. Operating on the principle of the popular "push-button" receivers, the circuit requires neither a variable tuning condenser nor its accompanying dial and control.

The arrangement of the circuit is unusually simple: Instead of a variable tuning condenser, a set of eight ceramic trimmer condensers is used—four across the antenna coil (L_1), and four across the radio-frequency coil (L_2). A common grid lead connects them to the caps of the radio-frequency and detector tubes (12K7GT and 12J7GT respectively). Their ground leads, not grounded directly to the metal chassis, are wired to sets of metal screws mounted on the composition panel, as shown. These screws serve as contacts, and as two phosphor-bronze strips mounted on the rear of the sliding

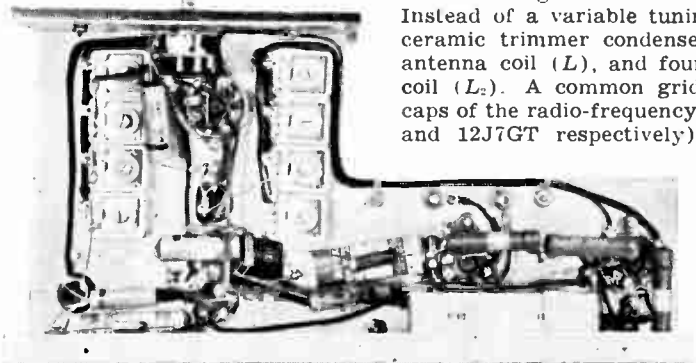

Tunes Novel Receiver

panel contact them, pairs of trimmer condensers become grounded. Since each pair has been pretuned to a station, sliding the panel serves to connect just the right capacities into the circuit to tune it to the desired wave length. The range of the condensers being wide, they can be adjusted with a screw driver to bring in any four stations in the broadcast band.

How the eight trimmers and their contacts are wired is clearly shown in the diagram. There are just two precautions that must be observed—the condensers must be insulated from the metal chassis, and the front panel must be of composition and not of metal.

Four of the latest-type tubes make up the heart of the circuit. The high heater voltage of these tubes makes it possible to eliminate the usual filament resistor built into the line cord and to substitute a simple wire-wound resistor which can be mounted on the chassis.

A 10-henry choke with a resistance of 475 ohms, and a dual 8-25-mfd. electrolytic

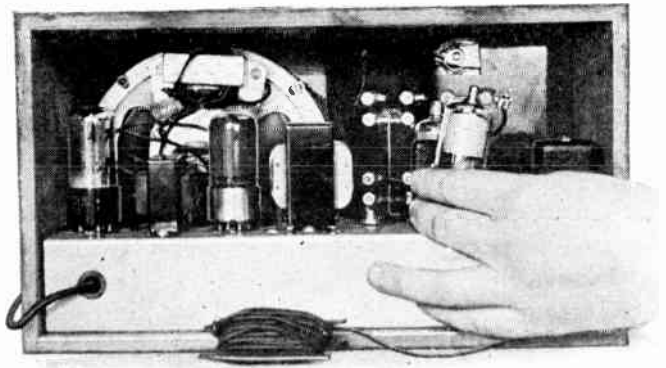

New-type tubes make it unnecessary to use a line-cord resistance

condenser serve to filter the rectified plate voltage and are adequate for providing hum-free reception. Electrolytic condensers are also used to by-pass the 30,000-ohm grid-bias resistor in the cathode lead of the detector tube and the 200-ohm grid-bias resistor of the power tube (35L6GT). These small electrolytic condensers are of the dry cartridge type and are rated at 25 volts and 50 volts respectively.

Impedance coupling was chosen for the audio-frequency stage and consists of a high-impedance choke (510 henry, 6,470 ohm) in the plate lead of the detector, a

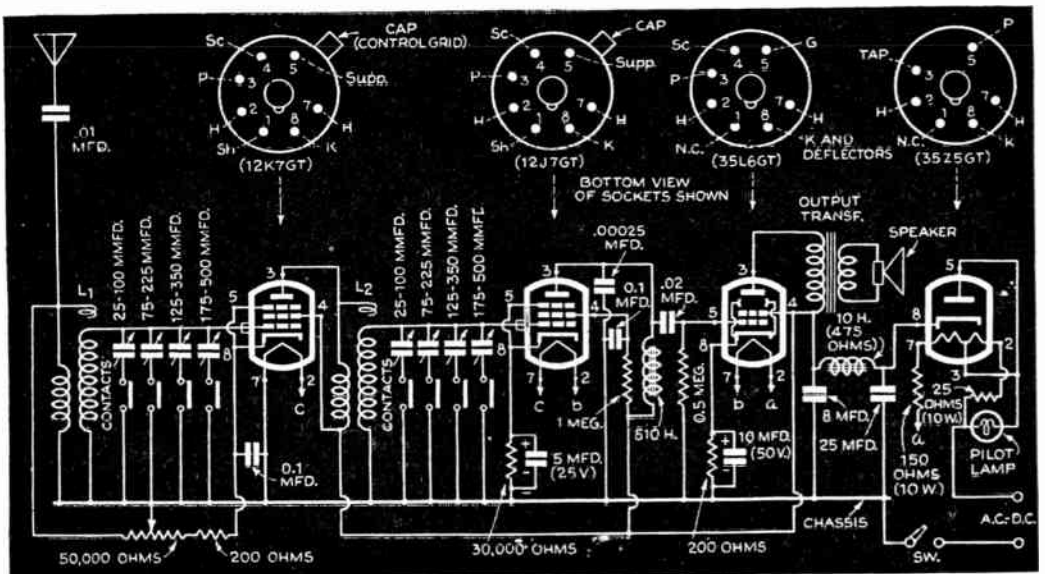

How the various parts are connected. The trimmer condensers must be pretuned to the desired stations

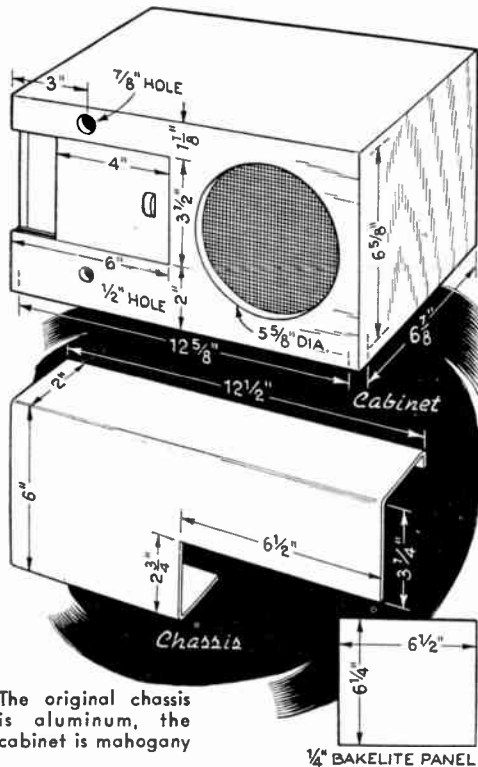

The original chassis is aluminum, the cabinet is mahogany

1/4" BAKELITE PANEL

.02 mfd. coupling condenser, and a 500,000 ohm (1/2 meg.) fixed resistor.

The cost of this receiver is extremely low and the special tuning arrangement costs no more than a good two-gang condenser. No ground is necessary and any antenna can be used.

LIST OF PARTS

Volume control, switch, 50,000 ohm.
 Filter choke, 10 henry.
 High-impedance choke, 510 henry.
 Trimmer condensers, two, 25-100 mmfd.
 Trimmer condensers, two, 75-225 mmfd.
 Trimmer condensers, two, 125-350 mmfd.
 Trimmer condensers, two, 175-500 mmfd.
 Dual electrolytic condenser, 8-25 mfd, 250 v.
 Cardboard electrolytic, 10 mfd. 50 v.
 Cardboard electrolytic, 5 mfd, 25 v.
 Tubular condensers (two), .1 mfd, 200 v.
 Tubular condenser, .01 mfd, 200 v.
 Tubular condenser, .02 mfd, 200 v.
 Mica condenser, .00025 mfd.
 Resistor, carbon, 1 meg., 1/2 watt.
 Resistor, carbon, 1/2 meg., 1/2 watt.
 Resistor, carbon, 30,000 ohm, 1/2 watt.
 Resistor, carbon, 200 ohm, 1/2 watt.
 Resistor, carbon, 200 ohm, 1 watt.
 Resistor, wire-wound, 150 ohm, 10 watt.
 Resistor, wire-wound, 25 ohm, 10 watt.
 Miscellaneous: Antenna and radio-frequency coils, tubes, chassis, cabinet, sockets, speaker, etc.

All Wave



EXTREMELY simple to assemble, this compact loudspeaker receiver will bring in foreign as well as domestic broadcasts. Built around two of the new low-drain 1 1/2-volt battery tubes, the set not only packs a great deal of power, but is extremely economical to operate.

A set of six ready-made plug-in coils provide coverage for the various short-wave and broadcast bands. These coils, which plug into a socket conveniently located on top of the cabinet, should be of the two-winding, four-prong type. A midget, .00014-mfd. variable condenser used for tuning is wired across the secondary or grid winding. The smaller winding, called the tickler, is connected to the outside lugs on a 20,000-ohm variable resistor which serves as the regeneration control. The on-off switch, shown in the "A" minus lead, is mounted directly on the back of this 20,000 ohm variable resistor and is operated by the same control knob.

A 2.1-mh. plate choke wired into the plate circuit of the detector helps to provide smooth regeneration, so that the maximum sensitivity can be obtained when tuning in on the short waves.

Bands on Two Tubes

COMPACT LOUDSPEAKER SET IS INEXPENSIVE TO BUILD

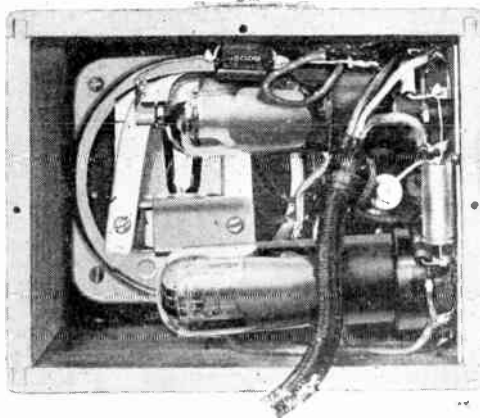

Rear view of the receiver with its back removed to show the tubes and other parts. The coil is mounted on top, as shown in the photo at the left

WHAT YOU NEED

- Tuning condenser, .00014 mfd.
- Variable resistor, wire wound, 20,000 ohm.
- Switch cover plate, . . . P. S. T.
- Midget radio-frequency choke, 2.1-mh.
- Midget trimmer condenser, 3-30 mmfd.
- Magnetic speaker, 3 in.
- Tubular condenser, .01 mfd, 600 v.
- Tubular condenser, .05 mfd, 600 v.
- Mica condenser, .0005 mfd.
- Mica condenser, .00025 mfd.
- Resistor, carbon, 5 meg., ½ watt.
- Resistor, carbon, 1 meg., ½ watt.
- Resistor, carbon, 400,000 ohm, ½ watt.
- Miscellaneous: four-prong wafer socket, two octal sockets, set of four-prong coils, battery cable, batteries, tubes (1N5G and 1A5G), etc.

For the grid leak resistor (5 meg.), a higher than normal value was chosen. This was done to operate the detector tube at its maximum sensitivity. The experimenter can try even higher values (any resistance up to 10 meg. may be used).

The antenna is directly coupled to the grid winding by means of the 35-mmfd. trimmer condenser. A good outside antenna, sixty feet in length, must be used.

If difficulty is experienced in obtaining adequate regeneration, reverse the leads to the tickler coil. If this fails to bring results, increase the capacity of the .00025-mfd. plate by-pass condenser to .0005-mfd., or decrease the capacity of the antenna trimmer condenser by unscrewing the adjusting screw.

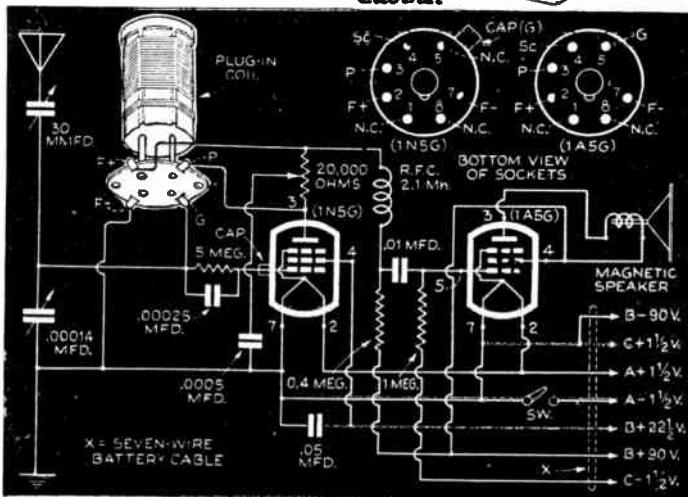
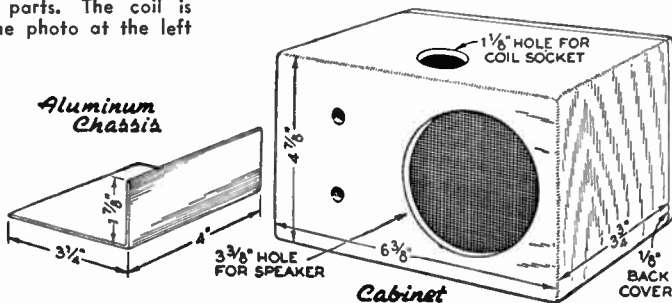

Low-drain 1½-volt tubes make this circuit economical to operate

Compact Radio-Tube Tester

BATTERY-OPERATED UNIT BUILT FOR SIX TYPES OF PRONGS



Leather covering makes a handsome carrying case



One of the eight-prong tubes is being fitted into its socket above. The panel has sockets for tubes with four to eight prongs and for the seven-prong miniature

Slipped into a brief case, as at right, this little unit leaves room for a battery and other accessories

At left, below, top of the panel with the 4.5-volt "C" battery connected. At bottom right is shown wiring, small battery, and flashlight bulbs on the underside

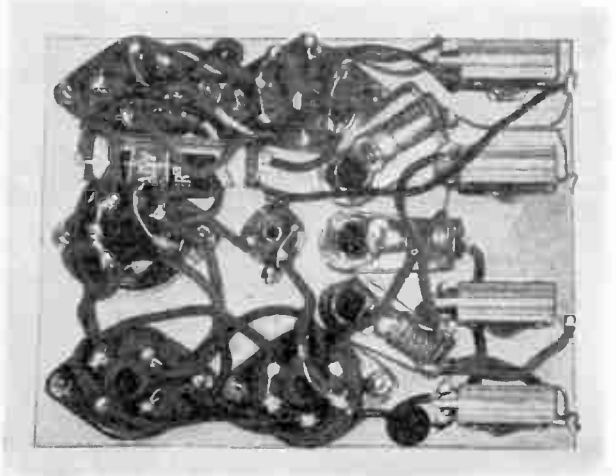

THIS tube tester is compact enough for the serviceman's brief case or tool box and simple enough for the radio owner who does his own servicing. It will handle 80 percent of all tubes made, and, with slight alterations, can be adapted for others. All materials are readily available—it employs, for instance, no meters since they are on the priority lists—and many of the parts may be salvaged from the junk box.

All four-prong to eight-prong tubes for battery, AC, or DC can be handled, and a socket is included for the new miniature seven-prong tube. The device will also test heaters and filaments, and will reveal shorts between elements inside a tube. A loktal-type tube socket can be added by enlarging the case.

No previous adjustment is necessary to test 1.5 and 2-volt DC tubes, 2.5 and 5-volt AC tubes, 6.3, 12.6, 25, 35, and 50-volt AC-DC tubes, or 117-volt heaters and filaments. A tube is placed in the proper socket, and the switch flipped. If it is good, the center jewel reflector lights; if burned out, the reflector remains dark.

Shorts can be detected between the plate of a tube and suppressor and either the screen grid or control grid, between the screen grid and control grid, or between the control grid and cathode or filament. Through operation of three toggle switches, these shorts illuminate the jewel reflector on either the left or right side.

The panel measures 4½" by 5¾", and may be of metal or pressed wood. Five large holes and a smaller one are drilled for tube sockets, three holes for jewel reflectors, and four for toggle switches.

Wiring instructions are given in detail in

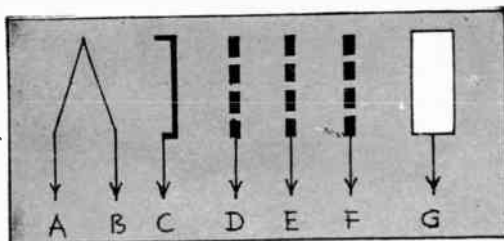

Shorts may be tested between plate and suppressor, G and F above; suppressor and either screen grid, E, or control grid, D; screen and control grid, E and D; control grid and cathode, D and C; and control grid and filament, D and A

the diagram below. The grid-cap and plate connections on each socket are wired together, as are the screens and suppressors, and the cathodes and one side of the heater of each tube. Connections for testing shorts within a tube are shorted in and out of the circuit by toggle switches.

The source of current is a 4.5-volt "C" battery, but a small pen-type 1.5-volt battery is needed for testing shorts between the plate and suppressor or the control grid and screen of a tube. This 1.5-volt battery is installed under the chassis and supported by its own wiring.

The three flashlight bulbs used are the type made for small flashlights, and are rated at 2.2 volts. Do not use any other kind, for no other will work. Some bulbs might even blow out the filaments of a 1.5 or 2-volt battery tube.

A special leather-covered case, 2½" by 5" by 6¼", may be purchased, or a case may be built from small pieces of wood glued together. If desired, cardboard may be used for the top and bottom.

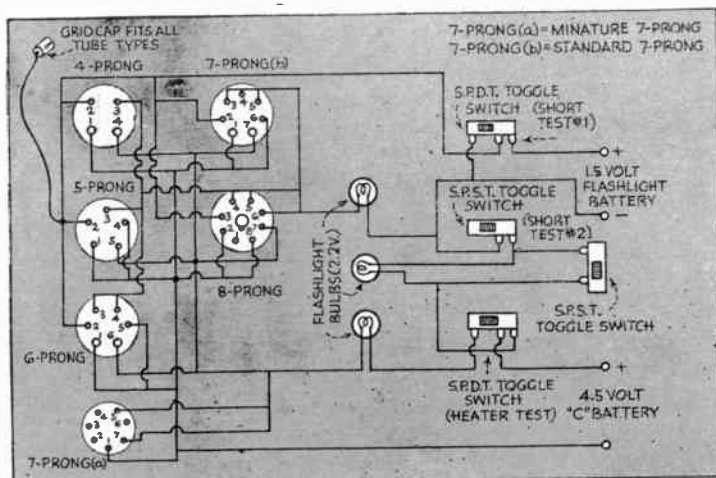
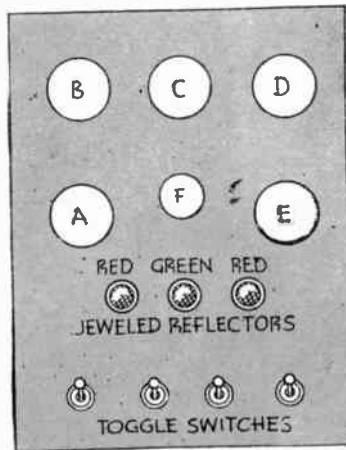

Sockets in the panel layout are: A, 8-prong; B, 5; C, 7; D, 4; E, 6; and F, 7-prong miniature

Wiring may be done in one evening by following this complete diagram

Servicing Your Radio

COST and utility make it well worth your time to build your own loop antenna to modernize your old radio and get rid of unsightly tangled wire strung along the floor or hanging out the window. The cost is but

a few cents, very little time is needed, and you can design the new antenna to fit your individual cabinet. The photographs below show the materials that are needed and also the step-by-step construction.

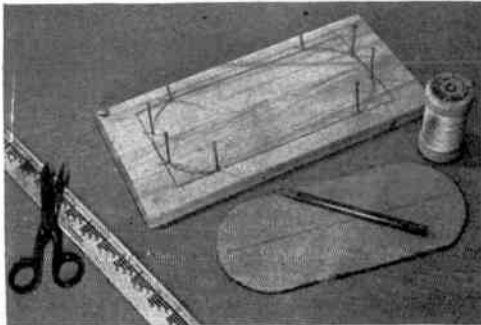

1 Cut a cardboard template about three fourths the size of the back radio cover or opening, lay the template on a board, and around it drive eight 2" nails or pegs. The one here is 4" by 9"

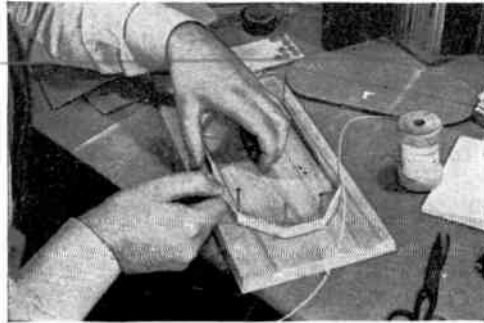

2 Remove the cardboard, and wind either No. 24 or No. 26 double-cotton covered wire around the nails in the form. Approximately 50 turns will be needed. Wind the wire evenly and tight

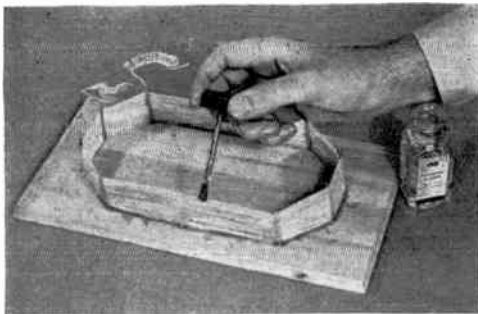

3 At the sides, carefully drive in two more nails to stretch the windings; then apply with a brush a special liquid dope solution carried by radio stores. This sticks the windings together

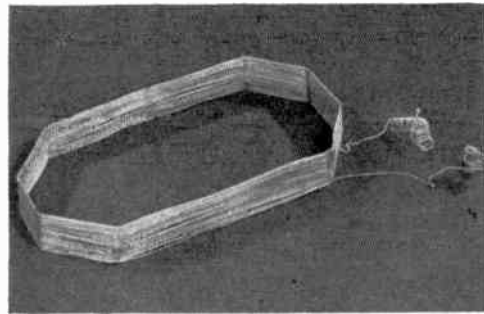

4 When this dope solution has dried so that the wires will not fall apart during handling of the loop, the nails are drawn from the base. The antenna can then be lifted off for installation



5 Adhesive tape or glued paper holds the loop to the back cover of the radio cabinet or suspends it from the top of the back opening. The antenna is light enough to need no other support

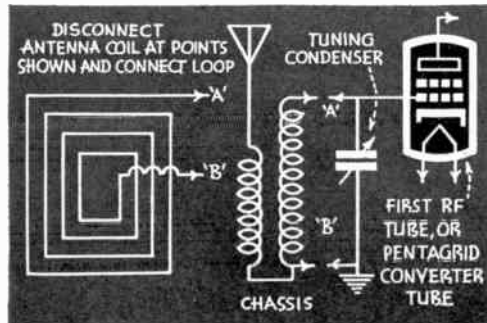

6 To use the loop, disconnect the old antenna coil, as shown. A few turns of the loop may be removed one at a time if needed to balance the trimmer condenser on the ganged tuning condensers

EUROPE ON ONE TUBE



This radio has only two controls. The cabinet scales 4¼ by 5 by 5¼ in.

BEGINNERS who want to try their hand at building a simple, inexpensive radio will find this compact, one-tube A.C.-D.C. set to be just the type of receiver for their needs. It is easy to build, and with a good outdoor antenna it will pull in stations from South America and Europe almost any evening.

Tracing the circuit from the antenna, the signals enter the set through a .01-mfd. paper condenser to the primary winding of a 6-prong plug-in tuning coil. The secondary winding of this coil is tuned by means of a midget, .00014-mfd. variable condenser. A set of plug-in coils gives complete coverage for all wave bands.

The signals then enter the grid of the detector portion of the dual tube (12B8GT) by means of a .00025-mfd. mica condenser and a 3-meg., ½-watt resistor.

Signals from the plate of the detector then go to the headphones through the tickler winding and a 2.5-mh. plate choke. A 20,000-ohm potentiometer across the tickler winding controls the amount of feed-back between the tickler and secondary windings.

The second portion of the tube consists of a triode, which rectifies the alternating house current so that only direct current reaches the plate of the detector. Hum is filtered by a 20-h. choke and two 16-mfd., 150-volt electrolytic condensers.

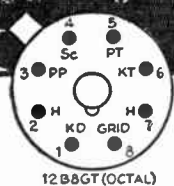
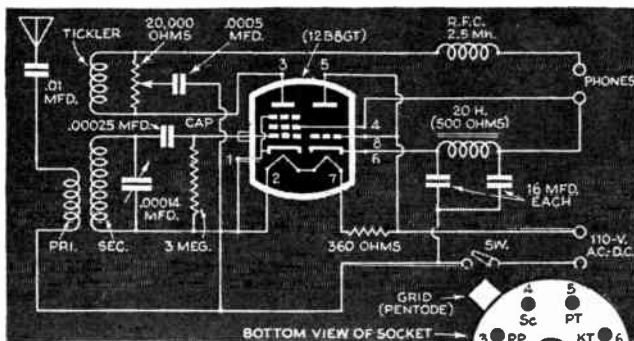

12B8GT (OCTAL)

The diagrams above give specifications for the parts. Note the arrangement of the aluminum chassis

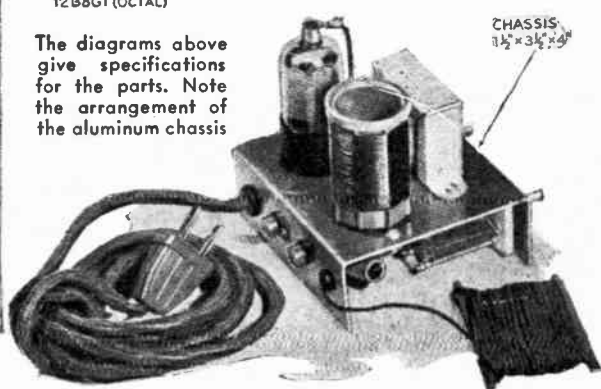
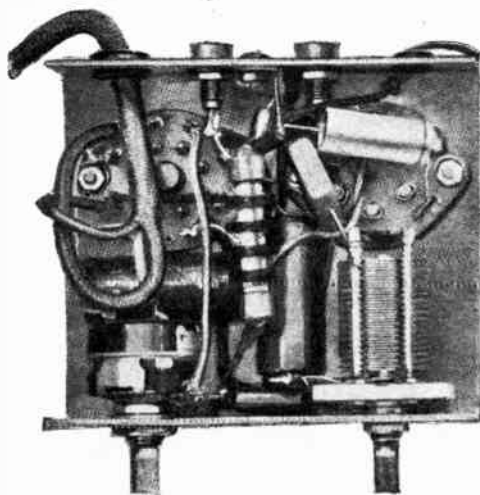

BICYCLE

FANS who would like to install a radio on their bicycles so they can enjoy their favorite programs while riding around town or on short trips will find the inexpensive set described on these pages just what they have been looking for. Fitting in a basket mounted on the handlebars, the battery-operated, four-tube receiver contains its own loudspeaker. It gives excellent results on local broadcast stations, and if iron-core coils instead of the air-space type specified are used this range will be increased.

Owing to the directional properties of a loop antenna, a 4' metal rod was chosen instead. The metal rod is connected directly to the grid cap of the radio-frequency tube. Both of the set's coils are tuned by a midget two-gang tuning condenser, which is mounted on the sloping panel by means of two right-angle brackets.

The antenna rod is insulated from the metal cabinet by a ceramic stand-off insulator. The tops of these insulators are usually threaded, and the best method of attaching the aluminum rod is to thread it to fit, and screw it into the insulator. For greater signal strength, the set will have to be grounded. The bicycle



Keep tuned as you ride with this receiver. Note below how tubes are mounted on aluminum chassis, and the speaker on the sloping panel

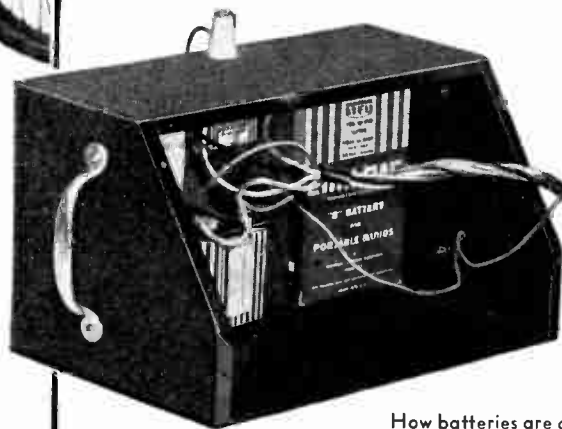

How batteries are arranged in the cabinet

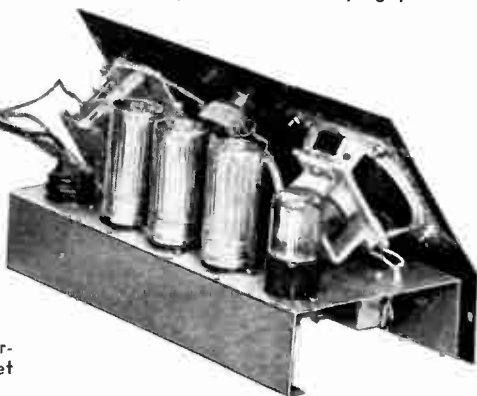

RADIO IS EASY AND CHEAP TO BUILD

frame provides excellent counterpoise capacity for this purpose.

The steel cabinet used for housing the chassis and batteries measures 6½" by 7" by 11" and is small enough to fit inside a standard-size bicycle luggage basket. The panel is attached to the cabinet by means of self-tapping screws. The two "B" batteries that fit inside the cabinet along the back are the new small-size portable type employing the special flat cells with expanding seals. A 1½-volt "A" battery fits in between the two "B" batteries, with the 4½-volt "C" battery directly in front of it. The "A" and "B" batteries are of the plug-in type and use clip-in plugs with Fahnestock terminals. This system makes it an easy matter to change batteries whenever necessary.

In order to obtain ample volume from the speaker, two stages of audio-frequency amplification

are used after the detector. Both stages are resistance-coupled and use the latest-type tubes for maximum sensitivity. Type 1N5GT tubes are used in the radio-frequency, detector, and first audio-frequency stages. A beam power tube, 1T5GT, is used in the output stage, and provides a relatively high output with a very low filament drain.

A 15,000-ohm, ½-watt resistor is used in the grid circuit for the first audio tube. Any increase in value of this resistor will only cause instability and will fail to in-

It's as easy to tune as a car radio. View below shows the parts underneath the chassis

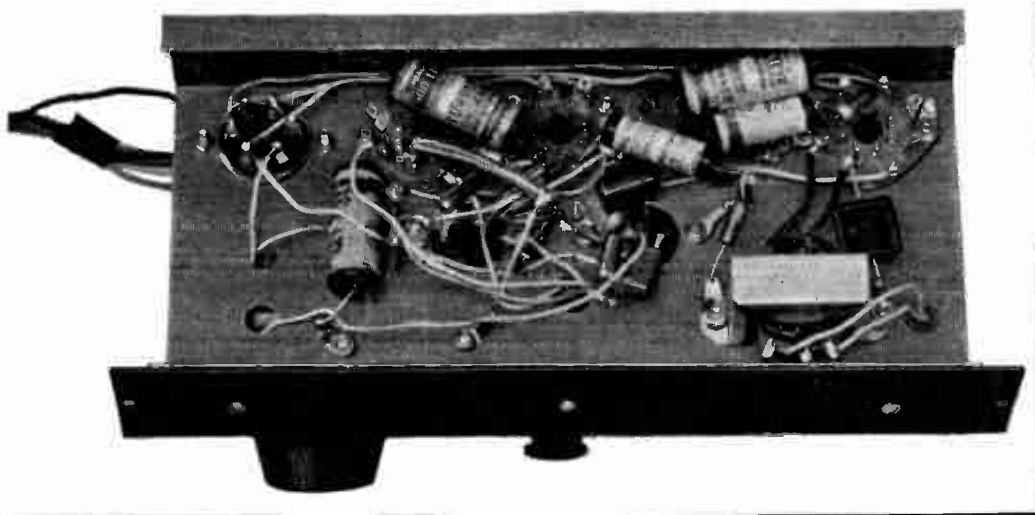
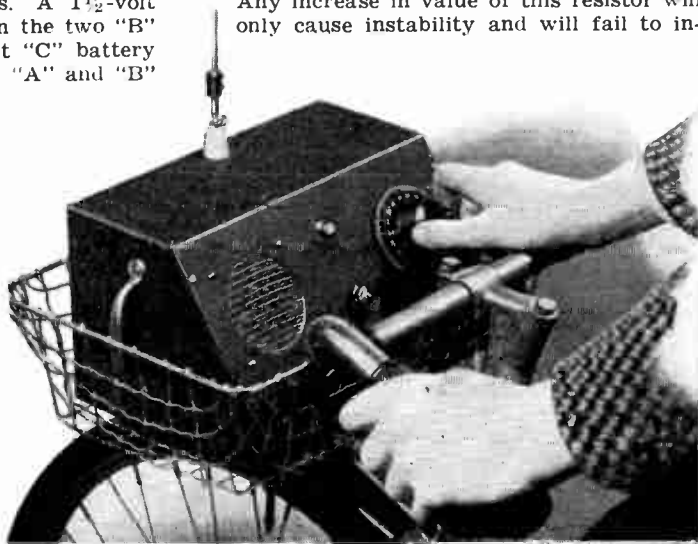

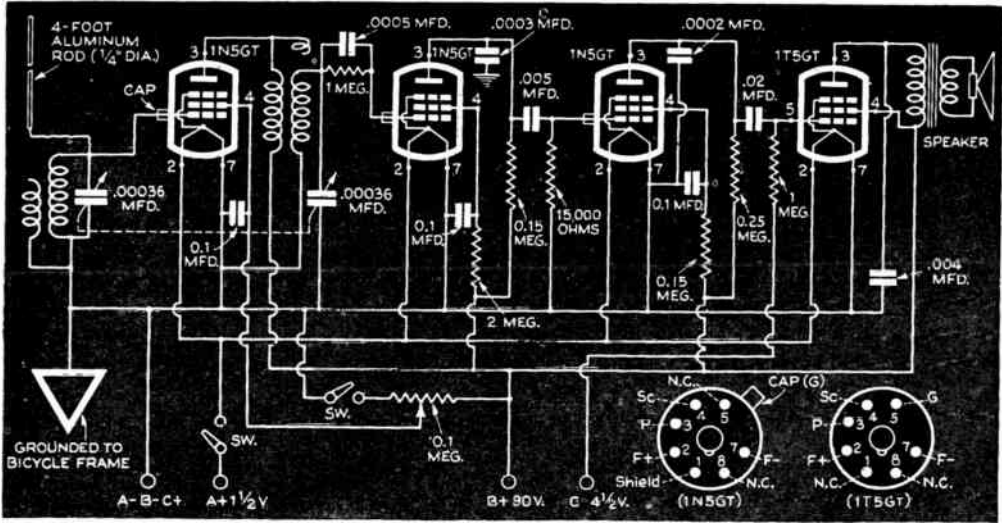

These circuit and tube-socket diagrams should be followed to the letter in constructing the set

crease the amplification. Volume is controlled by a 100,000-ohm potentiometer placed in the screen circuit of the radio-frequency tube.

The key-lock switch is of the double-pole, single-throw type and breaks two circuits at one time, the positive "A" supply and the ground lead of the volume control. This is done to avoid any drain through the "B" supply while the set is turned off.

As a safety measure, it is a good idea to lock the set in the basket or to the bicycle frame. The key switch prevents any one else from turning on the set.

LIST OF PARTS

- Midget 2-gang tuning condenser, .00036 mfd.
- Shielded antenna coil.
- Shielded radio-frequency coil.
- Volume control, 100,000 ohm.
- Output transformer.
- Carbon resistor, ½ watt, 15,000 ohm.
- Two carbon resistors, ½ watt, 150,000 ohm.
- Carbon resistor, ½ watt, 250,000 ohm.
- Two carbon resistors, ½ watt, 1 meg.
- Carbon resistor, ½ watt, 2 meg.
- Mica condenser, .0002 mfd.
- Mica condenser, .0003 mfd.
- Mica condenser, .0005 mfd.
- Mica condenser, .004 mfd.
- Tubular condenser, .005 mfd., 600 volt.
- Tubular condenser, .02 mfd., 600 volt.
- Three tubular condensers, .1 mfd., 600 volt.
- Miscellaneous:** Tubes, four octal wafer sockets, three bantam-tube shields, six-prong speaker plug and wafer socket, key switch, six-way battery cable, batteries, 3" P.M. speaker, cabinet, chassis, antenna, 3" dial, etc.

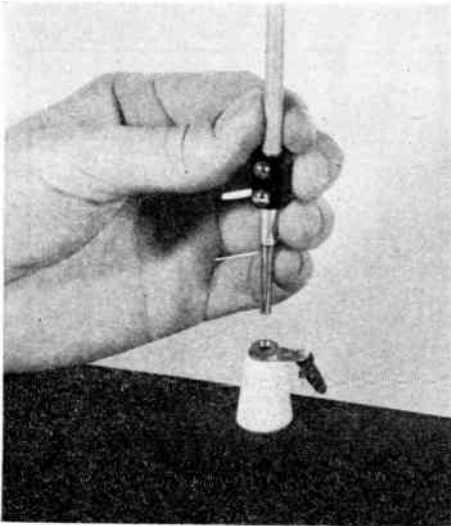

The antenna rod is set in a ceramic insulator atop the cabinet. Right, a key turns on the set



ELECTRIC 'B' SUPPLY FOR PORTABLE SETS

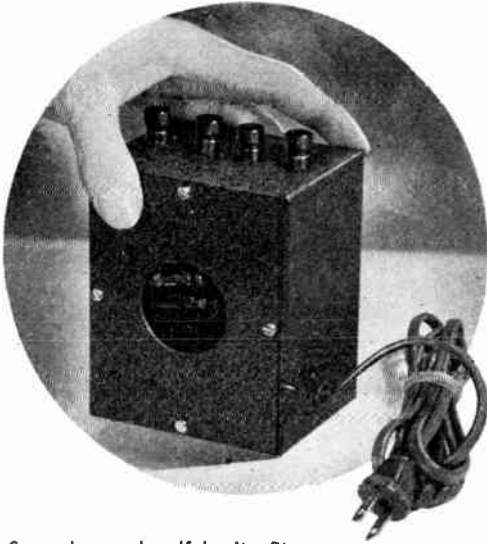

Scarcely a handful, it fits inside most portable radios

Steel Cabinet

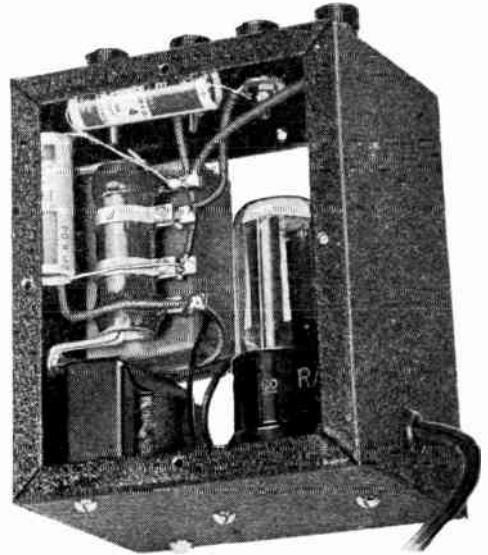
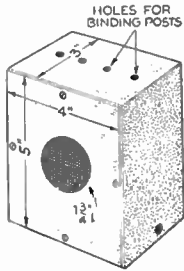

This photograph will help you assemble the outfit in its steel cabinet

THIS compact "B" power pack, no larger than a standard-size portable "B" battery, is a highly useful radio accessory. It is small enough to fit in many of the modern battery portables and may be used to replace "B" batteries in small table receivers of either the tuned radio frequency or regenerative types, for hum-free reception.

An adjustable bleeder circuit is wired across the output of the rectifier, and the connections are brought out to four insulated binding posts on top of the cabinet. The bleeder circuit consists of a 10,000-ohm semi-variable wire-wound resistor with two sliders for adjusting the intermediate voltages.

As shown in the diagram, the circuit is adjusted to give 130, 90, and 30 volts at the different taps when connected to a set drawing about 15 milliamperes plate current.

The 117Z6GT rectifier tube is connected directly across a 117-volt power line without the use of resistors. A 1 3/4" ventilating hole should be drilled in one side of the cabinet.

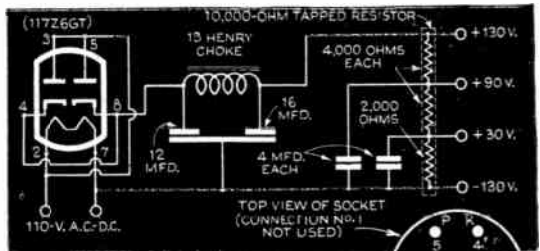
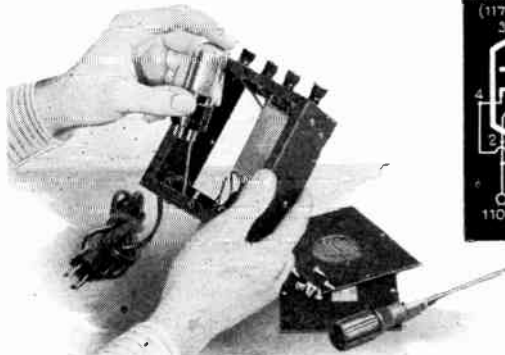

Parts needed for the unit can be itemized from the diagram. Note that the circuit is not grounded



Priority Receiver

USES NEW-TYPE TUNING UNIT

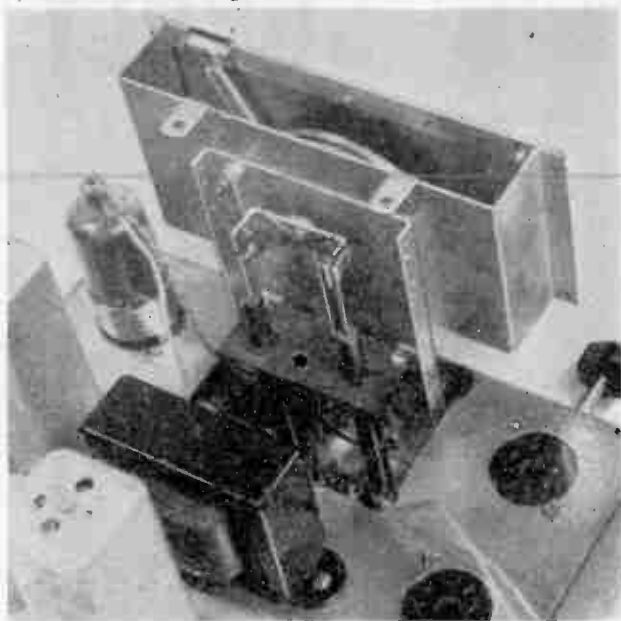

Iron cores moving in antenna and oscillator coils tune this set

WITH tuning condensers becoming increasingly scarce, a timely interest attaches to this five-tube superhet which tunes by varying the induction of the antenna and oscillator coils. A core of compressed powdered iron about 5/16" in diameter and 2 1/8" long moves in and out of each coil. These

iron cores are ganged and regulated by the horizontal tuning dial which, incidentally, is accurately calibrated in kilocycles. The tuning range of this set is similar to that of any standard-type receiver using variable tube condensers—550 to 1,500 kilocycles.

Tubes used are a 12A8-GT as a pentagrid converter; a 6S7 as an I. F. amplifier tube; a 12SQ7 as double-diode detector, AVC, and first audio amplifier tube; a 35L6-GT as power pentode tube capable of an output of 1 1/2 watts without overloading, and a 50Z7-G as a half-wave rectifier tube. The heaters of all these tubes are connected in series with a total voltage of approximately 117 volts, making a series heater resistor unnecessary.

Permeability tuning, as this new method is called, makes it possible to save space as the space taken up

by the new tuning unit behind the tuning dial is approximately half that required by a two-gang variable condenser. And again, since the tuning unit already contains the antenna and oscillator coils, a further saving of space both above and below the chassis is obtained. Notice how well-spread the

Top and bottom views of the chassis show how "permeability tuning" saves space, eliminates crowding, and simplifies wiring of the circuit

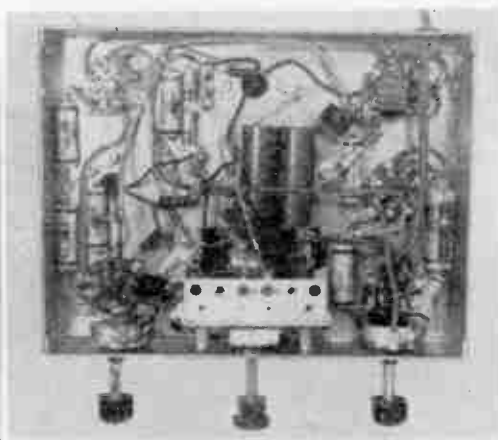
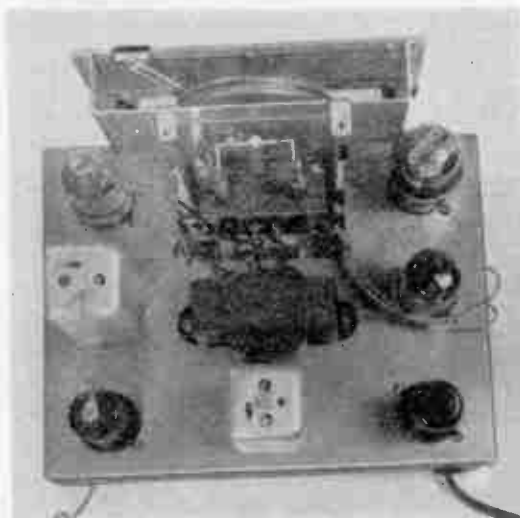

different components are above the chassis—no crowding and bunching. The same holds true for the underside portion of the chassis. It makes the set extremely simple to build and wire.

The war may make it difficult to obtain the exact tube type shown in the parts list. To give the reader as wide a choice as possible, we have given, on the wiring diagram, alternative tube types. The final results will be the same, as the set will operate satisfactorily with any of the tube types listed. The socket connections in most cases will be different. For instance, the 50Y6-GT rectifier tube has its heater brought out to pins Nos. 7 and 2 instead

Alternative tube types given in the wiring diagram below may be substituted if those first listed are unobtainable

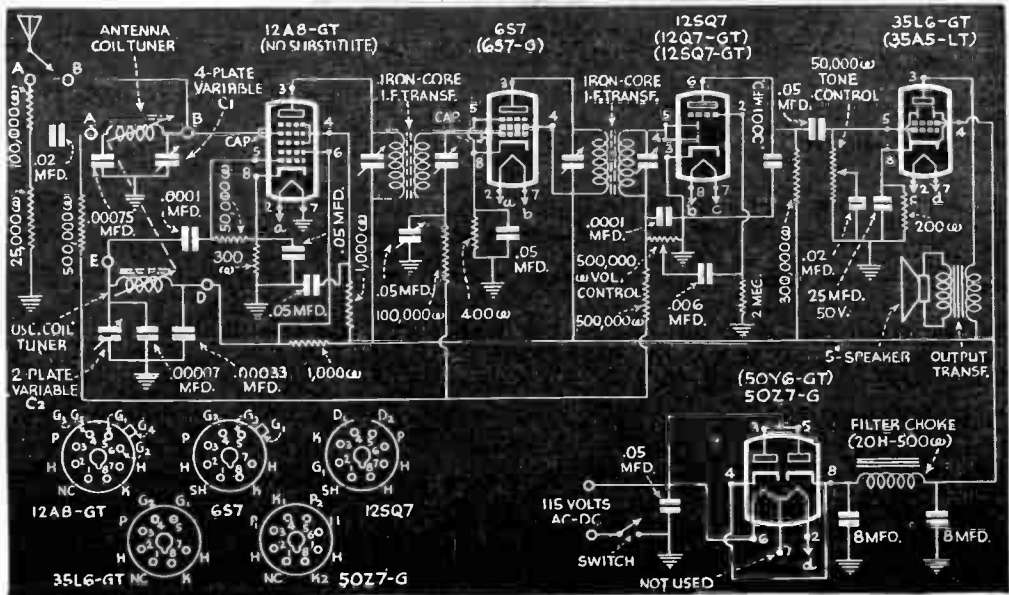
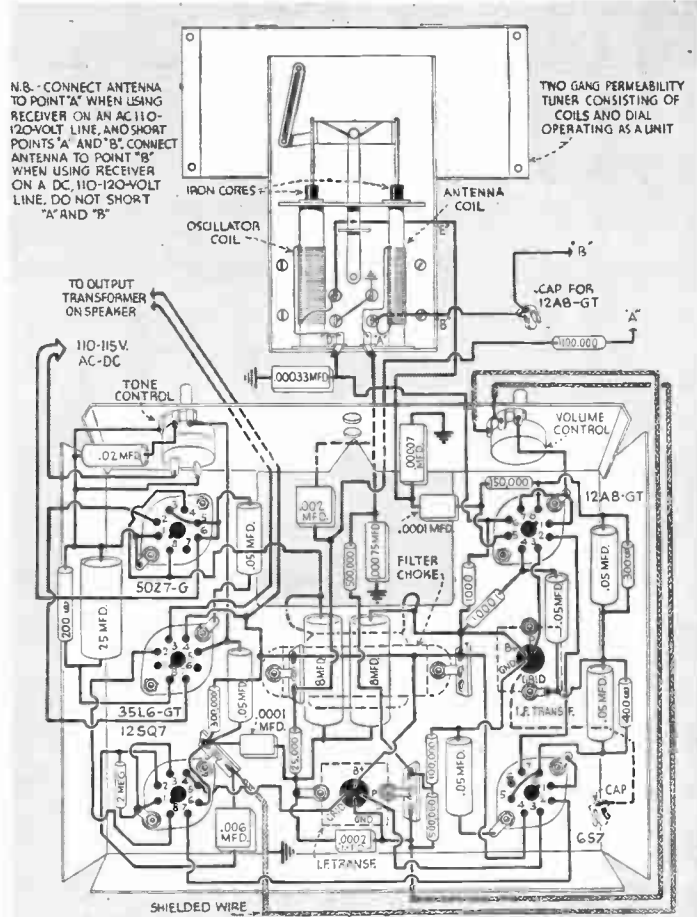

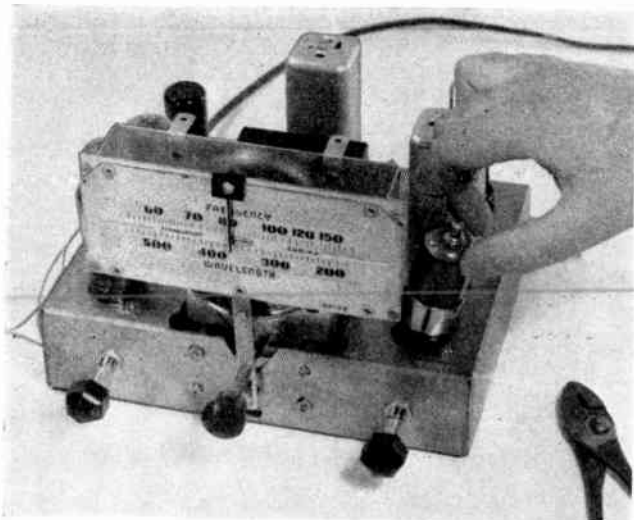

The horizontal slide-rule dial is calibrated in kilocycles. Tube being put into its socket in photo is the 12A8-GT

Tuning is easy. Left-hand knob turns set on and off and controls the tone. Right-hand knob is volume control



of Nos. 6 and 2 as in the case of the 50Z7-GT. If the 35A5-LT is purchased, be sure to buy a "loctal" socket for it instead of an "octal" socket.

Volume is controlled by the 1/2-megohm (500,000-ohm) variable resistor. Tone is controlled by a 50,000-ohm variable resistor and .02 mfd. tubular paper condenser connected in the grid circuit of the 35L6-GT. This arrangement provides an excellent method for artificially boosting the bass notes. It also helps in reducing static by decreasing the value of the high notes.

In order to make the mahogany cabinet as compact as possible, the 5" permanent-magnet speaker is mounted on top of the cabinet directly over the center of the chassis, facing upwards. It is a good idea to have the lid of the cabinet removable; otherwise it will be impossible to slide the chassis in and out of the cabinet unless the speaker is first removed, since the dial will not clear it. Of course the height of the cabinet could be increased, but this was not found as practical a method, as it would tend to unbalance the general appearance of the cabinet.

It will be noted that two holes are drilled in the front of the chassis just below the center of the tuning dial. These are for adjusting the two trimmer condensers of the tuning unit.

In setting the tuning dial, it should be borne in mind that with the cores of the antenna and oscillator windings moved all the way out, the set is tuned to the 1,550-kilocycle end of the dial.

Cabinet cover, below, serves as a baffle for the 5" P.M. speaker. The back is left open for ventilation



LIST OF PARTS

- Permeability tuning unit (with trimmers C₁ and C₂).
- P. M. speaker 5".
- Universal output transformer.
- Iron-core I.F. transformers, 456 kc. (two).
- Filter choke, 20 henrys, 500 ohms.
- Line cord and plug, 9'
- Volume control, 500,000 ohms.
- Tone control and switch, 50,000 ohms.
- Cadmium-plated chassis, 2" by 7" by 9".
- Octal tube sockets (five).
- Paper tubular condensers: .05 mfd., 400 volt (six); .02 mfd., 400 volt.
- Mica condensers: .0001 mfd. (three); .00033 mfd.; .00075 mfd.; .001 mfd.; .002 mfd.; .006 mfd.
- Electrolytic condensers: 8 mfd. 450 v. (two); 25 mfd., 50 v.
- Carbon resistors: 1/2 watt, 500,000 ohms (two); 1/2 watt, 300,000 ohms; 1/2 watt, 2 megohms; 1/2 watt, 100,000 ohms (two); 1/2 watt, 50,000 ohms; 1/2 watt, 1,000 ohms (two); 1/2 watt, 20,000 ohms; 1/2 watt, 400 ohms; 1/2 watt, 300 ohms; 1 watt, 200 ohms.
- Cabinet, 8" by 8" by 10 1/4".
- Tubes: 12A8-GT, 6S7, 12SQ7, 35L6-GT, 50Z7-G.

Compact Rectifier Unit Fits Almost Any Radio Chassis

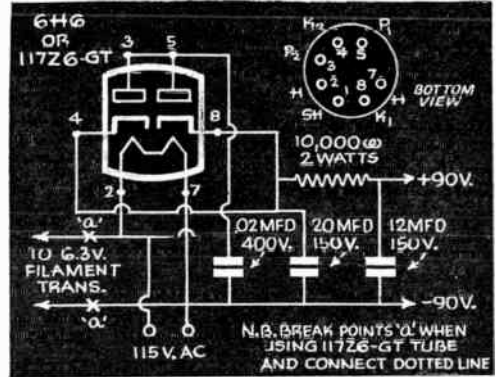
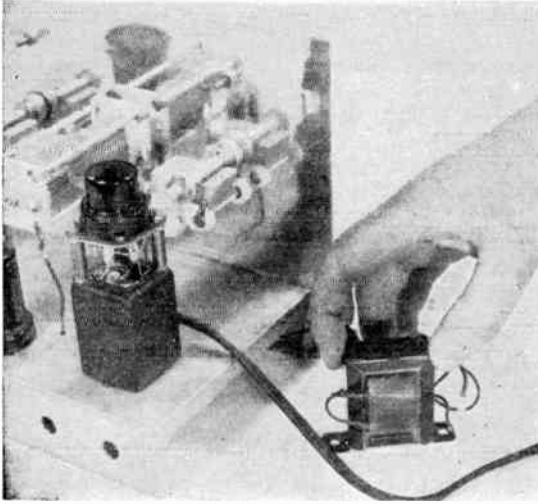

Midget rectifier (at left) mounted on a radio chassis. Filament transformer (on right) is compact and can be easily mounted under chassis. Diagram shows wiring

DRY BATTERIES are going to be increasingly difficult to obtain, and many owners of home-built or commercial one, two, and three-tube headphone receivers will have to convert theirs to operate on the electric house current. This is simple with a new rectifier unit, easily built at home and so compact that it will fit almost any radio chassis. It takes up no more room than a tube or electrolytic condenser, and yet contains a complete filtering circuit and rectifier tube! The metal box ($1\frac{1}{4}$ " by $1\frac{1}{4}$ " by 2") is an old coil shielding can. Besides the rectifier, a compact ($2\frac{1}{4}$ " by $1\frac{1}{2}$ "") filament transformer with a 110-volt primary and a 6.3-volt secondary (1.5 amperes) is used.

The battery tubes will have to be replaced with 6.3 volt AC-DC tubes of equivalent types. Should the plate current drain be too high to use the 6H6 as a rectifier, replace it with a 117Z6-tube.

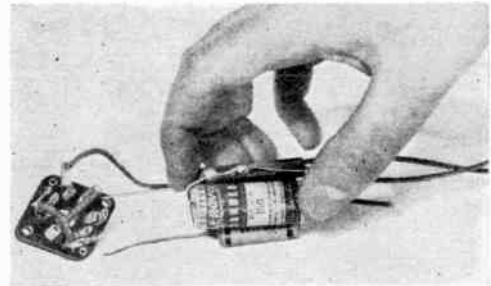

Illustrating how to make a compact "batch" of the condenser and resistor in rectifier, with connections

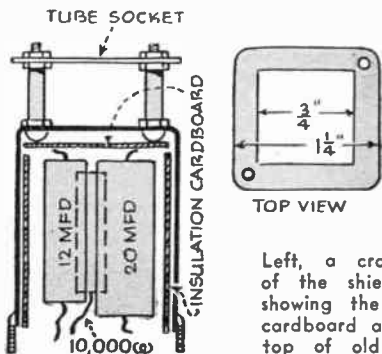
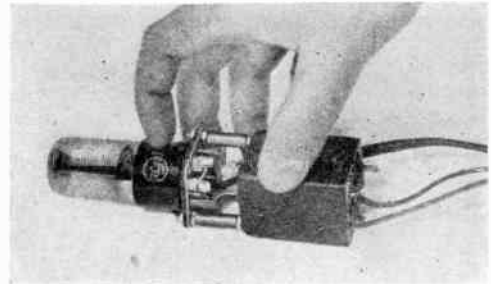

Left, a cross section of the shielding box, showing the insulation cardboard and, above, top of old coil can

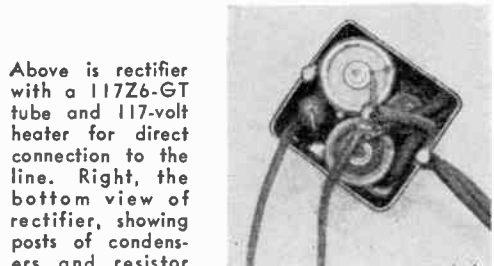

Above is rectifier with a 117Z6-GT tube and 117-volt heater for direct connection to the line. Right, the bottom view of rectifier, showing posts of condensers and resistor

Servicing Your Radio

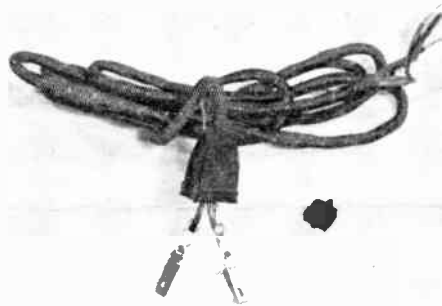

Yanking on a line cord often causes a break in the resistor wire. To avoid this, grasp the plug when removing it

LINE-CORD BREAKS, which occur most frequently in the built-in resistor in a cord of the type shown at the left, may be the reason a receiver goes dead. It is advisable to check this resistor if tests show that all the tubes are good. Sometimes it is possible to solder the thin resistor wire back to the prong, as shown in the sketch; if not, the whole line cord must be replaced.

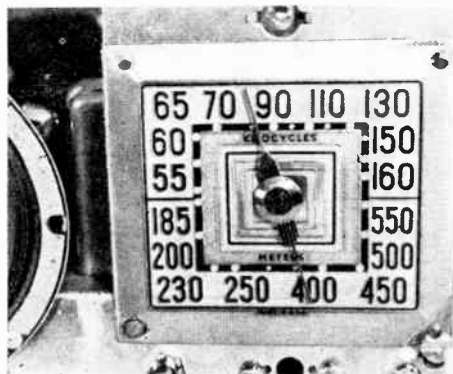
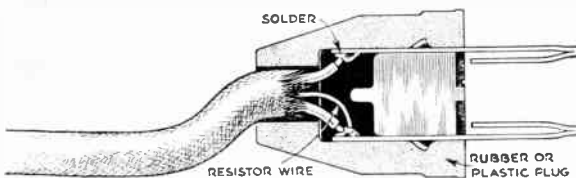

SOME TYPES OF DIAL POINTERS can be repaired easily with common liquid cement. If one cannot be set on the proper station indicator because it has come loose from the center plastic piece to which it was attached, remove the chassis from the cabinet and apply the cement as indicated in the drawing below. Best results can be obtained by removing the pointer assembly from the dial face and laying it flat, as shown. This will keep excess cement from spotting the dial face should any drip off the pointer during the application.



IF BATTERY OPERATION on a three-way portable is fuzzy, but reception is satisfactory on both A.C. and D.C., replacement of the battery pack is usually necessary. "B" batteries showing 75 volts on a meter have been known to have such high internal resistance that the voltage to plates and screens was reduced to as little as 35 volts.

BURNED-OUT BALLAST TUBES need not put a receiver out of service permanently even if the tubes cannot readily be replaced with new ones. Satisfactory results can be obtained by removing the old line cord from the set and substituting a new line cord having a built-in resistor of a resistance value matching the tube heaters.

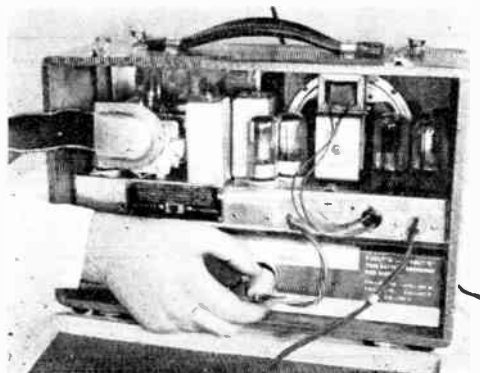

In this Book



**how to modernize
your old radio**



**how to improve
reception**



**how to eliminate
noise and static**



**how to do your
own repairing**



**Complete Plans, Instructions
for building 35 RADIOS
and RADIO PHONOGRAPHS**