

MERIT

GENERAL CATALOG • REPLACEMENT GUIDE

COLOR
BLACK & WHITE
TELEVISION
HI-FIDELITY
RADIO
COMPONENTS
1965-66



COIL AND TRANSFORMER CORPORATION

MERIT PLAZA • HOLLYWOOD, FLORIDA

NUMERICAL INDEX

Merit No.	Page No.	Ref. No.	Merit No.	Page No.	Ref. No.	Merit No.	Page No.	Ref. No.	Merit No.	Page No.	Ref. No.	Merit No.	Page No.	Ref. No.	Merit No.	Page No.	Ref. No.	Merit No.	Page No.	Ref. No.		
A-2700	57	24	P-2847	43	3	A-2934	53	17	A-3015	55	10	A-3101	54	16	A-4002	68	9	T8151EN	69	2	HVO-59	11
A-2701	57	13	P-2848	45	37	A-2935	53	21	A-3016	55	11	A-3102	54	18	A-4003	39	50	T8151MO	69	14	HVO-60	11
A-2702	57	9	P-2849	42	10	A-2936	53	26	A-3018	53	6	A-3105	56	19	A-4040	55	23	T8152EN	69	3	HVO-62	11
A-2704	57	23	A-2850	39	44	A-2937	53	30	A-3019	53	9	A-3109	56	8	A-4041	55	24	T8152MO	69	15	HVO-63	11
A-2705	57	8	A-2851	39	40	A-2938	53	25	A-3020	53	12	A-3110	56	9	P-4051	48	14	T8153EN	69	4	HVO-66	12
A-2706	57	10	A-2852	39	33	P-2939	45	1	A-3021	53	29	A-3111	56	11	P-4062	46	8	T8153MO	69	16	HVO-67	12
A-2720	57	34	A-2853	39	32	P-2940	45	2	A-3022	54	5	A-3113	56	10	P-4071	48	4	T8154EN	69	5	HVO-68	12
A-2740	57	31	A-2854	39	18	P-2941	45	4	A-3023	55	26	P-3116	47	8	P-4076	48	7	T8154MO	69	17	HVO-69	12
A-2742	57	32	A-2855	39	17	P-2942	45	5	A-3024	55	27	P-3117	47	9	P-4077	48	10	T8155EN	69	6	HVO-70	12
A-2743	57	1	A-2856	39	12	P-2943	45	6	A-3025	53	3	A-3120	56	4	P-4078	48	8	T8155MO	69	18	HVO-71	12
A-2744	57	33	P-2858	48	17	P-2944	45	11	A-3026	53	7	A-3121	56	5	P-4079	48	9	T8156EN	69	7	HVO-72	12
A-2745	57	2	P-2859	48	18	P-2945	45	13	A-3027	54	3	A-3127	54	6	A-4080	53	10	T8156MO	69	19	HVO-73	12
A-2747	57	3	P-2860	48	11	P-2946	45	14	A-3028	54	4	A-3128	54	7	A-4081	53	22	T8157EN	69	8	HVO-74	12
A-2751	57	4	P-2861	48	12	P-2947	45	15	A-3029	54	13	A-3129	54	8	P-4082	41	3	T8157MO	69	20	HVO-75	12
A-2753	57	5	P-2862	42	20	P-2948	45	17	A-3030	54	14	A-3130	54	9	P-4083	41	2	T8158EN	69	9	HVO-76	12
A-2755	57	6	P-2863	45	36	P-2949	41	15	A-3031	54	1	A-3131	54	10	C-4084	49	15	T8158MO	69	21	HVO-77	12
A-2757	57	7	P-2864	45	20	P-2950	43	4	A-3032	54	2	A-3132	54	11	P-4085	49	26	T8159EN	69	10	HVO-79	13
A-2759	57	11	P-2865	45	38	P-2951	43	6	A-3033	39	36	A-3133	54	12	P-4086	49	27	T8159MO	69	22	HVO-80	13
A-2760	57	14	P-2867	42	22	P-2952	43	15	A-3034	39	10	P-3134	42	23	P-4087	49	28	T8160EN	69	11	HVO-81	13
A-2761	57	12	P-2870	41	33	P-2953	43	18	A-3035	39	5	P-3135	41	27	A-4088	39	41	T8160MO	69	23	HVO-82	13
A-2763	57	15	P-2871	41	5	P-2954	44	6	A-3036	39	4	P-3136	42	3	A-4089	39	9	T8161EN	69	12	HVO-83	13
A-2765	57	16	P-2872	42	1	P-2955	44	14	A-3037	39	19	P-3138	47	1	A-4090	39	15	T8161MO	69	24	HVO-84	13
A-2767	57	17	P-2873	42	2	P-2956	44	18	A-3038	39	6	P-3139	47	2	A-4091	39	24	HVO-3	7		HVO-85	13
A-2769	57	18	P-2874	42	5	P-2957	43	11	A-3039	39	28	P-3141	45	18	A-4092	57	35	HVO-5	7		HVO-86	13
A-2771	57	19	P-2875	44	5	P-2958	41	19	P-3040	45	3	P-3142	45	35	A-4093	57	36	HVO-6	7		HVO-87	13
A-2773	57	20	P-2876	42	14	P-2959	45	25	P-3043	45	31	P-3143	45	22	A-4094	57	37	HVO-7	7		HVO-88	13
A-2775	57	21	P-2877	43	10	P-2960	45	21	P-3044	41	1	P-3144	41	8	C-4095	49	25	HVO-8	7		HVO-89	13
A-2777	57	22	P-2878	42	13	P-2961	45	32	P-3045	41	7	P-3145	45	23	A-4096	53	1	HVO-9	7		HVO-90	14
A-2779	57	25	P-2879	41	4	P-2962	45	28	P-3046	41	11	P-3146	45	24	A-4097	53	4	HVO-10	7		HVO-91	14
A-2781	57	26	P-2881	42	11	P-2963	45	39	P-3047	41	17	P-3147	41	18	A-4098	39	2	HVO-12	7		HVO-92	14
A-2783	57	27	P-2882	42	16	P-2964	45	7	P-3048	41	23	P-3148	41	24	A-4099	53	19	HVO-13	7		HVO-93	14
A-2785	57	28	P-2883	41	25	P-2966	43	13	P-3049	42	6	P-3149	41	16	A-4100	53	20	HVO-14	7		HVO-94	14
A-2789	57	29	P-2884	43	8	P-2967	43	14	P-3050	45	16	P-3150	43	5	A-4101	53	24	HVO-16	7		HVO-95	14
A-2791	57	30	P-2885	41	30	P-2968	44	11	P-3051	41	22	P-3151	43	7	A-4102	53	18	HVO-17	8		HVO-96	14
A-2800	55	1	P-2886	44	7	P-2969	48	1	P-3052	42	9	P-3152	43	16	A-4103	53	5	HVO-18	8		HVO-97	14
A-2801	55	2	P-2887	43	27	P-2970	48	2	P-3053	44	8	P-3153	43	17	A-4104	55	28	HVO-19	8		HVO-98	14
A-2802	55	3	P-2888	45	10	P-2971	48	3	P-3054	43	20	P-3154	42	4	A-4105	53	13	HVO-20	8		HVO-99	14
A-2803	55	4	P-2889	45	26	P-2972	48	5	P-3055	42	28	P-3155	44	15	A-4106	53	27	HVO-21	8		HVO-100	14
A-2804	55	5	P-2890	45	33	C-2973	49	1	P-3056	42	17	P-3156	44	19	A-4107	53	23	HVO-22	8		HVO-101	14
A-2805	55	12	P-2891	44	12	C-2974	49	12	P-3057	43	24	P-3157	46	3	A-4108	57	38	HVO-23	8		HVO-102	15
A-2806	55	13	P-2892	41	13	C-2975	49	5	P-3058	42	15	P-3158	46	4	P-4109	41	6	HVO-24	8		HVO-103	15
A-2808	55	14	P-2893	41	21	C-2976	49	3	P-3059	43	29	P-3159	46	5	A-4110	54	19	HVO-25	8		HVO-104	15
A-2810	55	15	P-2897	42	12	C-2977	49	4	P-3060	41	26	P-3160	43	12	A-4111	39	39	HVO-26	8		HVO-105	15
A-2813	55	16	A-2900	53	35	P-2978	48	13	P-3061	44	4	P-3161	47	4	A-4113	39	34	HVO-27	8		HVO-106	15
A-2814	55	17	A-2901	53	36	C-2980	68	2	P-3062	41	14	P-3162	47	5	C-4115	49	15A	HVO-28	8		HVO-107	15
A-2815	39	30	A-2902	53	31	C-2981	49	6	P-3063	44	1	P-3163	47	6	A-4117	39	35	HVO-29	9		HVO-108	15
A-2816	39	7	A-2903	53	32	A-2982	39	27	P-3064	42	24	P-3164	47	7	A-4119	39	8	HVO-30	9		HVO-109	15
A-2817	55	6	A-2904	53	37	A-2984	39	21	P-3065	48	19	P-3165	43	21	P-4121	41	12A	HVO-31	9		HVO-110	15
A-2818	55	7	A-2905	53	38	C-2985	49	2	P-3066	44	9	P-3166	46	10	A-4122	39	38	HVO-32	9		HVO-111	15
A-2819	39	25	A-2906	55	18	A-2986	39	20	P-3067	44	16	P-3168	46	7	A-4123	39	26	HVO-33	9		HVO-112	15
A-2820	39	11	A-2907	55	19	C-2987	49	7	P-3068	48	6	P-3169	44	10	C-4124	49	24	HVO-34	9		HVO-113	16
A-2821	39	13	A-2908	55	20	A-2988	39	22	P-3069	43	22	P-3170	44	20	C-4125	49	24A	HVO-35	9		HVO-114	16
A-2822	39	1	A-2909	55	21	C-2990	49	8	P-3070	43	23	P-3171	44	21	P-4126	45	29	HVO-36	9		HVO-115	16
A-2823	39	3	A-2910	56	12	C-2991	49	13	P-3071	43	25	P-3172	47	17	P-4127	45	30	HVO-37	9		HVO-116	16
A-2824	39	37	A-2911	56	13	C-2993	49	10	P-3072	43	26	P-3173	43	19	P-4128	45	27	HVO-38	9		HVO-117	16
A-2825	39	29	A-2913	56	17	C-2994	49	11	P-3073	43	2	P-3174	44	13	P-4129	46	20	HVO-39	9		HVO-118	16
A-2826	39	16	A-2914	56	14	C-2995	49	9	P-3074	45	12	P-3175	46	2	P-4130	46	21	HVO-40	10		HVO-119	16
A-2827	39	31	A-2915	56	15	C-2996	49	14	P-3075	48	15	P-3176	48	16	P-4131	41	8A	HVO-41	10		HVO-120	16
A-2828	39	14	A-2916	56	16	A-2997	54	17	P-3076	41	32	P-3177	47	13	P-4132	47	3	HVO-42	10		HVO-121	16
A-2829	39	23	A-2917	56	18	A-2998	53	33	P-3077	42	27	P-3178	46	1	C-4133	49	15B	HVO-43	10		HVO-122	16
P-2830	41	20	A-2918	55	31	A-2999	53	34	P-3078	44	2	P-3179	44	3	P-4134	47	11	HVO-44	10		HVO-123	16
P-2832	42	19	A-2919	55	32	A-3000	39	49	P-3079	41	9	C-3180	49	16	P-4135	45	8	HVO-45	10		HVO-124	16
P-2833	43	1	A-2920	56	1	A-3001	39	46	A-3080	39	42	C-3181	49	17	A-4136C	38		HVO-46	10		HVO-125	17
P-2834	43	28	A-2921	56	2	A-3002	68	8	A-3081	39	43	C-3182	49	18	A-4137C	38		HVO-47	10		HVO-126	17
P-2835	44	17	A-2922	56	3	A-3003	39	48	P-3082	45	34	C-3183	49	19	A-4138C							

NUMERICAL INDEX Cont.

Merit No.	Page No.	Ref. No.	Merit No.	Page No.	Ref. No.	Merit No.	Page No.	Ref. No.	Merit No.	Page No.	Ref. No.	Merit No.	Page No.	Ref. No.	Merit No.	Page No.	Ref. No.					
HVO-138	18		HVO-214	24		MDF-129	36		TV-140	59	20	TV-240	59	7	BC-372	63	4	BC-553	66	69	Accessories	Description
HVO-139	18		HVO-215	24		MDF-130	36		TV-141	59	18	TV-241	67	7	BC-375	63	18	BC-560	66	24		
HVO-140	18		HVO-216	24		MDF-131	36		TV-142	59	17	TV-242	59	43	BC-377	63	19	BC-561	66	26	BR-5	60,62
HVO-141	18		HVO-217	25		MDF-132	36		TV-144	60	6	TV-243	59	11	BC-381	65	2	BC-562	66	27		
HVO-142	18		HVO-218	25		MDF-133	36		TV-145	60	7	TV-244	61	28	BC-382	65	3	BC-563	66	28	Adapter Plate	
HVO-143	18		HVO-219	25		MDF-134	36		TV-146	60	19	TV-245	59	12	BC-384	65	4	BC-564	66	30		
HVO-144	18		HVO-220	25		MDF-135	36		TV-147	60	20	TV-246	61	29	BC-386	65	5	BC-565	66	32	BR-263	41
HVO-145	18		HVO-221	25		MDF-136	36		TV-149	59	36	TV-247	59	13	BC-387	65	6	BC-566	66	33		
HVO-146	18		HVO-222	25		MDF-137	37		TV-150	67	1	TV-248	60	24	BC-388	65	7	BC-567	62	12	IN-35	29
HVO-147	18		HVO-223	25		MDF-138	37		TV-151	67	2	TV-249	61	33	BC-389	68	3	BC-568	65	22		
HVO-148	19		HVO-224	25		MDF-141	37		TV-152	67	3	TV-250	61	34	BC-390	65	8	BC-569	64	1	M-47-110	37
HVO-149	19		HVO-225	25		MDF-142	37		TV-153	67	4	TV-251	60	25	BC-392	65	10	BC-570	64	2		
HVO-150	19		HVO-227	25		MDF-143	37		TV-154	67	5	TV-252	59	44	BC-393	65	28	BC-571	64	3	Yoke Rear Cover	
HVO-151	19		HVO-228	25		MDF-144C	38		TV-155	59	37	TV-253	59	45	BC-394	65	29	BC-572	64	13		
HVO-152	19		HVO-230C	26					TV-156	59	10	TV-254	61	35	BC-395	65	30	BC-573	64	14	M-51-70-90	37
HVO-153	19		HVO-231C	26		MWC-1	61	1	TV-157	59	38	FM-250	63	20	BC-396	65	31	BC-574	64	5		
HVO-154	19		HVO-232C	26		MWC-2	61	2	TV-158	59	39	FM-251	63	21	BC-397	65	32	BC-575	64	6	Yoke Rear Cover	
HVO-156	19		HVO-233C	26		MWC-3	61	3	TV-159	61	19	FM-252	63	22	BC-398	65	33	BC-576	64	7		
HVO-157	19		HVO-234C	27		MWC-4	61	4	TV-160	61	20	FM-253	63	23	BC-399	65	34	BC-577	64	15	M-238	37
HVO-158	19		HVO-235C	27		MWC-5	61	5	TV-161	61	21	FM-254	63	24	BC-400	65	35	BC-578	64	9		
HVO-159	20		MD-12	29		MWC-6	61	6	TV-162	61	22	FM-255	63	25	BC-401	65	36	BC-579	64	10	Yoke Rear Cover	
HVO-160	20		MD-13	29		MWC-7	61	7	TV-163	61	23	FM-256	63	26	BC-402	65	37	BC-580	64	11		
HVO-161	20		MDF-70	29		MWC-8	61	8	TV-164	61	30	FM-257	63	27	BC-403	65	38	BC-581	64	8	Yoke Rear Cover	
HVO-162	20		MDF-71	29		MWC-9	61	9	TV-165	61	31	FM-258	63	28	BC-410	65	14	BC-582	64	4		
HVO-163	20		MDF-72	29		MWC-10	61	10	TV-166	61	32	FM-260	63	30	BC-411	65	15	BC-584	64	12	Yoke Rear Cover	
HVO-164	20		MDF-73	29		MWC-11	61	11	TV-167	61	24	BC-300	62	45	BC-412	65	16	BC-594	62	27		
HVO-165	20		MDF-74	29		MWC-12	61	12	TV-168	61	25	BC-304	62	46	BC-413	65	17	BC-595	62	28	Yoke Rear Cover	
HVO-166	20		MDF-75	30		MWC-13	61	13	TV-169	61	26	BC-305	62	47	BC-414	65	18	BC-596	62	29		
HVO-167	20		MDF-76	30		MWC-14	61	14	TV-171	61	36	BC-307	62	48	BC-415	65	19	BC-597	62	30	Color Guide Page VIII	
HVO-168	20		MDF-77	30		MWC-15	61	15	TV-172	61	37	BC-308	62	49	BC-416	65	20	BC-598	62	31		
HVO-169	20		MDF-78	30		MWC-16	61	16	TV-173	61	38	BC-311	62	50	BC-417	65	21	BC-599	62	32	DEM-1	
HVO-170	20		MDF-79	30		MWC-17	61	17	TV-180	66	35	BC-312	62	51	BC-418	68	4	BC-635	62	33		
HVO-171	21		MDF-80	30		MWC-18	61	18	TV-181	66	38	BC-315	62	52	BC-419	68	5	BC-636	62	34	Color Guide Page VIII	
HVO-172	21		MDF-81	30		TV-100	59	21	TV-182	66	40	BC-316	62	15	BC-424	62	26	BC-638	62	35		
HVO-173	21		MDF-82	30		TV-101	59	26	TV-183	66	43	BC-317	62	16	BC-500	67	8	BC-639	62	36	Yoke Rear Cover	
HVO-174	21		MDF-83	31		TV-102	59	22	TV-184	66	44	BC-318	62	17	BC-501	67	9	BC-640	62	13		
HVO-175	21		MDF-84	31		TV-103	59	25	TV-185	66	46	BC-320	62	19	BC-502	67	10	BC-641	62	14	Yoke Rear Cover	
HVO-176	21		MDF-85	31		TV-104	59	29	TV-186	66	37	BC-321	63	9	BC-503	67	11	BC-662	66	1		
HVO-177	21		MDF-86	31		TV-105	59	30	TV-187	66	47	BC-322	63	10	BC-504	67	12	BC-663	66	2	Color Guide Page VIII	
HVO-178	21		MDF-87	31		TV-106	60	1	TV-188	66	56	BC-323	63	11	BC-506	67	13	BC-664	66	3		
HVO-179	21		MDF-88	31		TV-107	60	2	TV-189	66	25	BC-324	63	12	BC-507	67	14	BC-665	66	4	Yoke Rear Cover	
HVO-180	21		MDF-89	31		TV-108	59	31	TV-190	66	51	BC-325	63	13	BC-508	67	15	BC-666	66	5		
HVO-181	21		MDF-91	31		TV-109	60	3	TV-191	66	52	BC-326	63	14	BC-509	67	16	BC-667	66	6	Yoke Rear Cover	
HVO-182	22		MDF-92	32		TV-110	60	8	TV-192	66	34	BC-327	63	15	BC-511	67	17	BC-668	66	7		
HVO-183	22		MDF-93	32		TV-111	60	4	TV-193	66	36	BC-328	63	16	BC-512	67	18	BC-669	66	8	Yoke Rear Cover	
HVO-184	22		MDF-94	32		TV-112	59	32	TV-194	66	39	BC-329	63	17	BC-513	66	62	BC-670	66	9		
HVO-185	22		MDF-96	32		TV-113	59	33	TV-195	66	41	BC-330	62	53	BC-514	66	63	BC-671	66	10	Yoke Rear Cover	
HVO-186	22		MDF-97	32		TV-114	60	9	TV-196	66	42	BC-333	62	54	BC-515	67	19	BC-672	66	11		
HVO-187	22		MDF-98	32		TV-115	60	10	TV-198	66	48	BC-336	62	55	BC-516	67	20	BC-673	66	12	Yoke Rear Cover	
HVO-188	22		MDF-99	32		TV-116	59	23	TV-199	66	49	BC-338	62	56	BC-517	67	21	BC-674	66	13		
HVO-189	22		MDF-100	32		TV-117	60	5	TV-200	66	50	BC-341	62	58	BC-519	67	23	BC-675	66	14	Yoke Rear Cover	
HVO-190	22		MDF-104	33		TV-118	59	19	TV-201	66	53	BC-343	62	1	BC-521	67	25	BC-676	66	15		
HVO-191	22		MDF-105	33		TV-119	59	34	TV-202	66	54	BC-344	62	20	BC-524	66	68	BC-677	66	16	Yoke Rear Cover	
HVO-192	22		MDF-106	33		TV-120	59	35	TV-203	66	55	BC-345	62	21	BC-526	67	27	BC-678	66	17		
HVO-193	22		MDF-107	33		TV-121	60	11	TV-204	66	57	BC-346	62	22	BC-527	67	28	BC-679	66	18	Yoke Rear Cover	
HVO-194	23		MDF-108	33		TV-122	60	12	TV-205	66	58	BC-347	62	2	BC-528	67	29	BC-680	66	19		
HVO-195	23		MDF-109	33		TV-122A	60	13	TV-206	66	59	BC-348	62	4	BC-530	67	30	BC-681	66	20	Yoke Rear Cover	
HVO-196	23		MDF-110	33		TV-122B	60	14	TV-207	66	60	BC-349	62	3	BC-532	67	32	BC-682	66	21		
HVO-197	23		MDF-111	33		TV-122C	60	15	TV-208	66	61	BC-350	62	23	BC-533	67	33	BC-683	66	22	Yoke Rear Cover	
HVO-198	23		MDF-112	34		TV-123	60	16	TV-210	68	6	BC-351	62	24	BC-534	67	34	BC-684	62	37		
HVO-199	23		MDF-113	34		TV-124	60	17	TV-211	68	7	BC-352	62	5	BC-535	67	35	BC-685	62	38	Yoke Rear Cover	
HVO-200	23		MDF-115	34		TV-125	59	8	TV-220	68	13	BC-353	62	6	BC-537	68	1	BC-686	62	39		
HVO-201	23		MDF-116	34		TV-126	59	9	TV-221	68	12	BC-354	62	25	BC-538	67	36	BC-687	62	40	Yoke Rear Cover	
HVO-202	23		MDF-117	34		TV-127	59	14	TV-222	68	11	BC-355	62	7	BC-539	67	37	BC-688	62	41		
HVO-203	23		MDF-118	34		TV-128	59	5	TV-224	67	6	BC-356	62	8	BC-540	67	38	BC-689	62	42	Yoke Rear Cover	
HVO-204	23		MDF-119	34		TV-129	59	6	TV-230	65	26	BC-357	62	9	BC-541	67	39					

HORIZONTAL OUTPUT TRANSFORMERS

FLYBACKS

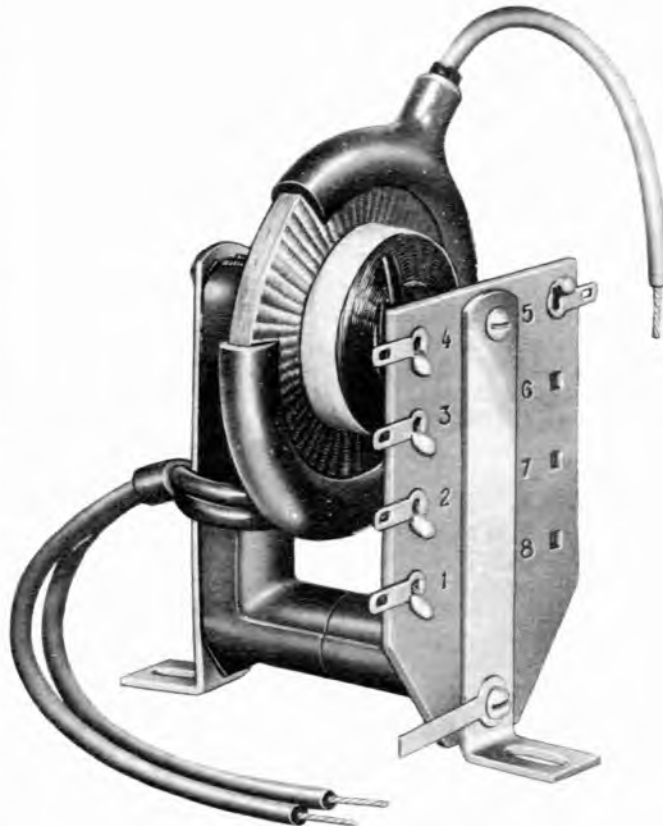

All Horizontal Output Transformers manufactured by Merit are designed as exact replacements for use in a specific TV receiver. However, many of them are also replacements in other TV receivers with slight modifications. When the transformer is specified as a replacement in other than an exact, simple footnotes are added to the Merit replacement part number. This footnote list can be found at the end of the replacement number section.

NOTE: Pages 5 through 27 show listings, photos, schematics, inductance and resistance values of each horizontal output transformer manufactured by Merit.

MERIT #	REPLACEMENT FOR	MERIT #	REPLACEMENT FOR
HVO-3	Admiral, Motorola, RCA, Philco 211T3	HVO-54	Admiral 79C60-2/-3/-4 used in many models
HVO-5	Capehart, Crosley, Philco, Westinghouse 211T5	HVO-55	RCA 78201, 78810, 79145, 79736
HVO-6	G.E. 77J1 and others	HVO-56	Westinghouse V-9904/-1, V-10204-1, V-10213-1, V-10214/-1
HVO-7	Capehart, Emerson, G.E., Truetone, etc. GE77J1 / AGC/AFC	HVO-57	Zenith S-18567, S-18990, S-20993 and many others
HVO-8	Capehart, Emerson, RCA, Silvertone, Air Core	HVO-58	Coronado C-12E23939, C-12E24612/-1
HVO-9	RCA 230T1 and many others	HVO-59	G.E. RTO-125/6/7
HVO-10	Airline, Motorola, Philco, Hallicrafters, etc.	HVO-60	G.E. RTO-101, 104, 109
HVO-12	Motorola 24C701134, 24C710636, 24C792596D	HVO-62	Magnavox 360580-1, 360604-1, 360610-1
HVO-13	Sylvania 241-0003, 0005, 0006/0007	HVO-63	Zenith S-19408
HVO-14	Sylvania 241-0011	HVO-66	Motorola 24K736488
HVO-16	Philco 32-8465-2, 32-8509	HVO-67	Sylvania 241-0019
HVO-17	Philco 32-8484-2, 32-8509-2	HVO-68	Sylvania 241-0025
HVO-18	Philco 32-8428-1/-2	HVO-69	Zenith S-20099
HVO-19	Philco 32-8533/4	HVO-70	Bendix NH-265051-1
HVO-20	Philco 32-8555	HVO-71	Sparton PC-70010, PC-70012
HVO-21	Philco 32-8565, 32-8607	HVO-72	Sparton PC-70015
HVO-22	Admiral 79D41-1/-2 and others	HVO-73	Sparton PC-70019
HVO-23	Admiral 79C30-2/-4	HVO-74	Sparton PC-70025
HVO-24	Admiral 79C30-1/-3	HVO-75	Muntz TO-0050
HVO-25	Emerson 738067/68/69/73/74/75/82 and others	HVO-76	Muntz TO-0039
HVO-26	Silvertone, CBS, etc. 10104/7/8/10/35	HVO-77	Capehart 850220D-1
HVO-27	Silvertone, CBS, etc. 10136/37	HVO-79	CBS 12000751, 12001101
HVO-28	Motorola and others 24K711266, 24K711937	HVO-80	CBS 12001191
HVO-29	Motorola 24K712193	HVO-81	CBS 12000841B
HVO-30	Motorola 24K721301, 24K722126	HVO-82	CBS 12001091
HVO-31	Muntz TO-0031/-1/-2	HVO-83	CBS 12001051
HVO-32	Muntz TO-0036/-1/-2	HVO-84	Crosley 159947/-1/-2
HVO-33	RCA 76501, 76672	HVO-85	Emerson 738091/93/99/100
HVO-34	RCA 75240, 75519, 75585, 76381 and others	HVC-86	Emerson 738106
HVO-35	RCA 76430, 76795	HVO-87	Emerson 738103/109
HVO-36	RCA 235T1 used in many models	HVO-88	Wells-Gardner 53X355
HVO-37	Hallicrafters, Silvertone, Crosley 158481-1, etc.	HVO-89	Raytheon 12E25423/24
HVO-38	Admiral 79C60-1, 79C60-5/6/7 and others	HVO-90	Dumont 20006441-1
HVO-39	Motorola 24K735844 used in many mfg. models	HVO-91	Philharmonic 80-263/265/265-2
HVO-40	Silvertone T80-320	HVO-92	Emerson 738079/84
HVO-41	Truetone, Wells-Gardner 53X326/28/29/30	HVO-93	Sentinel 22E75
HVO-42	CBS PC-10147/61 used in many models	HVO-94	Dumont 20005021
HVO-43	Wells-Gardner 53X301/03/07 used in many models	HVO-95	Dumont 20006731
HVO-44	Wells-Gardner 53X319/20 used in many models	HVO-96	Majestic C-9,253/-1/-2/-E
HVO-45	Westinghouse V-11548-3 used in many models	HVO-97	G.E. RTO-131, 141, 146/-3
HVO-46	Sentinel 22E57/-6, 22E61, 22E67	HVO-98	G.E. RTO-149/-1
HVO-47	RCA 225T1 used in many models	HVO-99	G.E. RTO-151/-3
HVO-48	Magnavox 320055-1, 320061-1	HVO-100	G.E. RTO-161
HVO-49	Raytheon C-201-21025-1, 201-22396-1	HVO-101	G.E. RTO-165/-1, 173
HVO-50	Trav-ler TV-X-105/108	HVO-102	G.E. RTO-166/-5, 174
HVO-51	Hoffman 5146/48/49/55	HVO-103	G.E. RTO-175/-3
HVO-52	Hallicrafters 55C133/143/144	HVO-104	G.E. RTO-179/-4
HVO-53	Zenith S-17435, S-20908 and many others	HVO-105	Zenith 21219
		HVO-106	Zenith 21317
		HVO-107	Zenith 22130
		HVO-108	Zenith 22154
		HVO-109	Zenith 22451
		HVO-110	Zenith 22720
		HVO-111	Zenith 22996
		HVO-112	Zenith 23049
		HVO-113	Motorola 24K743536 Coil only
		HVO-114	G.E. RTO-208
		HVO-115	G.E. RTO-207
		HVO-116	RCA 104876
		HVO-117	Arvin 42721
		HVO-118	Magnavox 360606/-1

MERIT #**REPLACEMENT FOR**

HVO-119 Magnavox 360614/-1, 360623/-1
HVO-120 Zenith S-41198
HVO-121 Hallicrafters 55D285
HVO-122 Motorola 24C730902, 24K730904
HVO-123 RCA 100285
HVO-124 Sylvania 241-0035/36/37/38/41/42
HVO-125 Packard Bell 89479-B
HVO-126 RCA 103839 and Sylvania 241-0046
HVO-127 Sentinel 320811-1
HVO-128 Zenith S-40284, S-41974
HVO-129 Motorola 24C740969
HVO-130 Motorola 24C744042
HVO-131 Trav-ler TR-27
HVO-132 Truetone 53X366
HVO-133 Magnavox 360659-1
HVO-134 Hallicrafters 55-301, 55C301
HVO-135 Admiral 79D41-1/-2
HVO-136 Silvertone 80-375, C80-375,
D-80-375-G
HVO-137 RCA 103092, 104481,106169
HVO-138 Dumont 20010611, 20010612, 20010613
HVO-139 Motorola 24D740660
HVO-140 Motorola 24C742676
HVO-141 Trav-ler TR-24
HVO-142 Motorola 24K748397
HVO-143 Zenith S-40124, S-41196, S-41906
HVO-144 Zenith S-41988
HVO-145 Admiral 79D65-1/-4
HVO-146 Silvertone 80-1-3, C80-1-3B
HVO-147 Zenith S-42878
HVO-148 Motorola 24C739283, 24K741937
HVO-149 Motorola 24K739284
HVO-150 Hallicrafters 56C156/171
HVO-151 Philco 32-8806-1/-2
HVO-152 Admiral 79D77-2/-3/-4/-5 and
Trav-ler TR-51
HVO-153 RCA 104236
HVO-154 Airline, Westinghouse 493V004M04/06
HVO-156 Zenith S-23995
HVO-157 Philco 32-8572
HVO-158 Philco 32-8634
HVO-159 Philco 32-8695/-1
HVO-160 Zenith S-24978
HVO-161 Silvertone C-80-326/336/361/363
HVO-162 G.E. RTO-183
HVO-163 Airline, Truetone, Raytheon 12E-27097,
12E-27149-1
HVO-164 Motorola 24K745702
HVO-165 Motorola 24C745536
HVO-166 G.E. RTO-214/-11
HVO-167 Admiral 79D77-6
HVO-168 Westinghouse 493V003H05/M05
HVO-169 Sparton 70036
HVO-170 Packard Bell 89502
HVO-171 Olympic TR-26205
HVO-172 Magnavox 360779-1
HVO-173 RCA 104309
HVO-174 Airline, Coronado, Truetone, Wells-
Gardner 53X389
HVO-175 Magnavox 360700-1, 360700-2
HVO-176 Zenith S-45510
HVO-177 Westinghouse 493V003H04/M04
HVO-178 Admiral 79D77-1
HVO-179 Zenith S-46592, S-47071
HVO-180 Truetone, Hallicrafters 255-400008
HVO-181 Bendix TSOH03, TSOH05

MERIT #**REPLACEMENT FOR**

HVO-182 Truetone, Wells-Gardner 53X362
HVO-183 Crosley 172387-2
HVO-184 Zenith S-47662
HVO-185 Admiral 79D77-8, 79E77-8
HVO-186 Airline, Coronado, Truetone, Wells-
Gardner 53X382
HVO-187 Zenith S-49918
HVO-188 Zenith S-50095
HVO-189 Sylvania 241-0049 (50-95934-3)
HVO-190 RCA 107698 (907251-2)
HVO-191 Hoffman 782011
HVO-192 Airline, Bradford, Coronado, Wells-
Gardner 53X390
HVO-193 Emerson 738169
HVO-194 Silvertone, Sylvania 241-0050
(50-97572-1)
HVO-195 Motorola 24K754273
HVO-196 Zenith S-46564
HVO-197 Silvertone 80-15-3
HVO-198 Motorola 24D65410A01
HVO-199 Westinghouse 493V006H01
HVO-200 Emerson 738163
HVO-201 Admiral 79D83-4
HVO-202 Admiral 79D77-7, 79E77-7, 79D77-22
HVO-203 Philco 32-8830-1, 32-8830-3
HVO-204 Philco 32-8840-1
HVO-205 Admiral 79B77-11, 79E77-11
HVO-206 Admiral 79E77-15
HVO-207 Motorola 24K752328
HVO-208 Zenith S-51583
HVO-209 Motorola 24D65410A05/-H
HVO-210 RCA 107182 (973892-1)
HVO-211 Muntz TO-0054
HVO-212 G.E. WT77X42/43
HVO-213 Zenith S-45680
HVO-214 Magnavox 360552-1/-2/-2A, 360577-1,
360593-2
HVO-215 Philco 32-8899-1
HVO-216 Philco 32-8903-1
HVO-217 Philco 32-8799-1
HVO-218 Silvertone 80-14-3, D80-14-3C,
D80-14-3E
HVO-219 Olympic TR-5598/-B
HVO-220 Philco 32-8855-1/-5
HVO-221 Philco 38-8951-4
HVO-222 Motorola 24C736487, 24K736487,
24K738699
HVO-223 Motorola 24C65410A02-B-1,
24D65410A02
HVO-224 Motorola 24D66258A03-C
HVO-225 Setchell-Carlson WF-90, WF-110
and others
HVO-227 Curtis-Mathes 1A27
HVO-228 Olympic TR-3599-3/-4/-4A
TR-3599-5/-5A/-5D
HVO-230C RCA 105192, 1106862-1 (color)
and others
HVO-231C RCA 106359, 1106862-2 (color)
and others
HVO-232C RCA 109221, 926636-501 (color)
and others
HVO-233C RCA 112820, 906141-501 (color)
and others
HVO-234C RCA 113382, 906152-501 (color)
and others
HVO-235C Motorola 24D66876A03 (color)



HORIZONTAL OUTPUT
FLYBACK
TRANSFORMERS

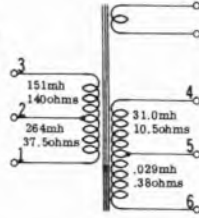

HVO-3

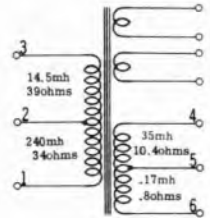

HVO-5

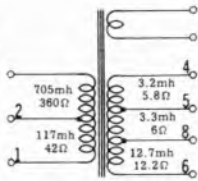

HVO-6

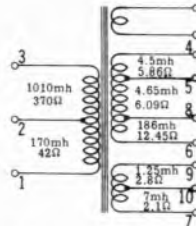

HVO-7

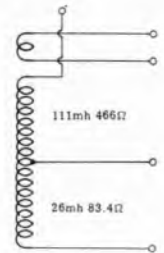

HVO-8

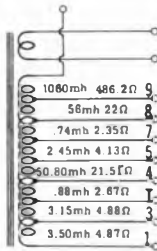

HVO-9

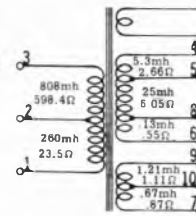

HVO-10

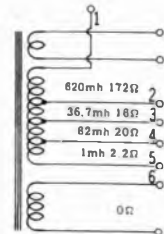

HVO-12

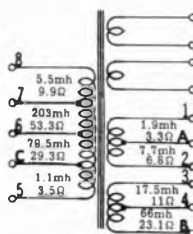

HVO-13

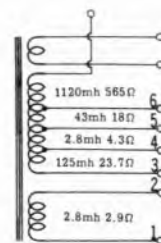

HVO-14

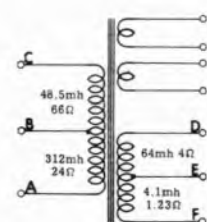

HVO-16

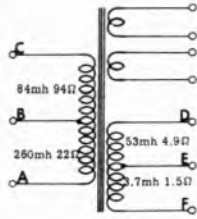

HVO-17

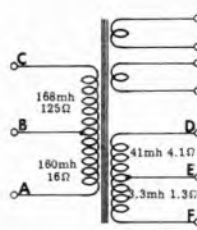

HVO-18

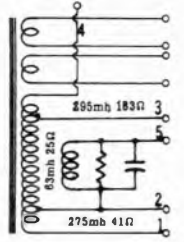

HVO-19

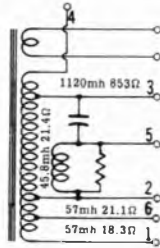

HVO-20

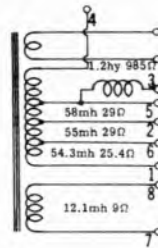

HVO-21

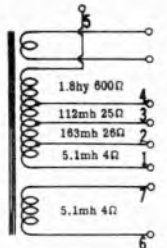

HVO-22

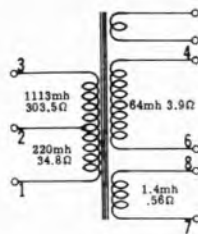

HVO-23

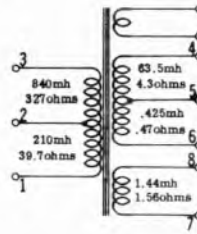

HVO-24

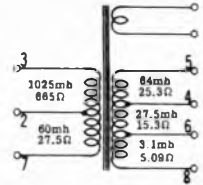
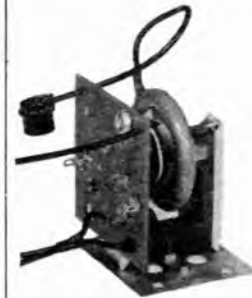

HVO-25

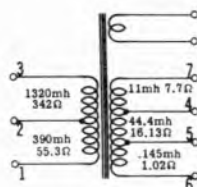

HVO-26

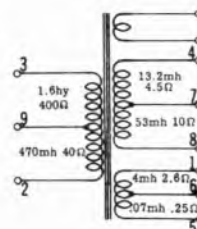

HVO-27

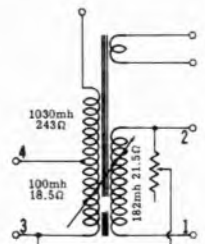

HVO-28



HORIZONTAL OUTPUT
FLYBACK
TRANSFORMERS

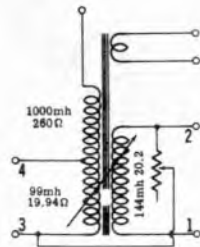

HVO-29

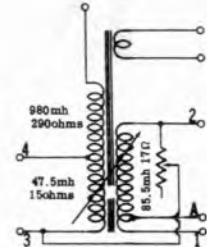

HVO-30

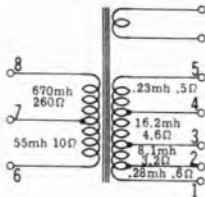

HVO-31

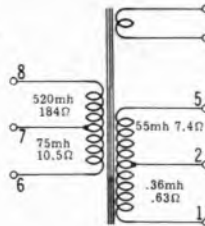

HVO-32

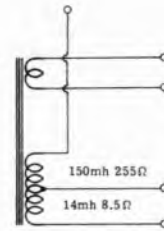

HVO-33

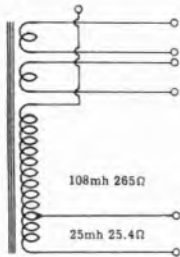

HVO-34

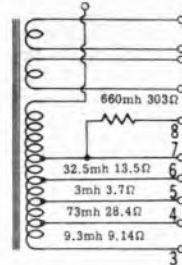

HVO-35

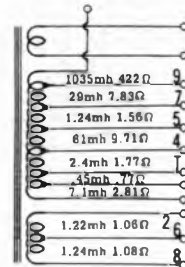

HVO-36

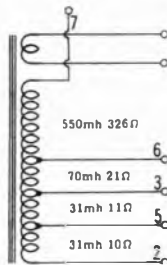

HVO-37

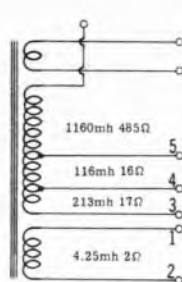

HVO-38

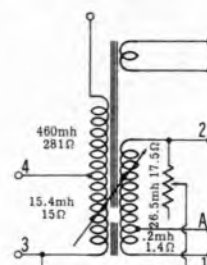

HVO-39

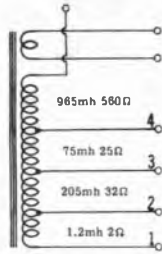

HVO-40

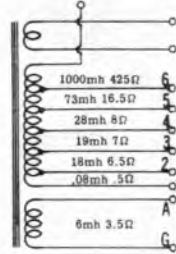

HVO-41

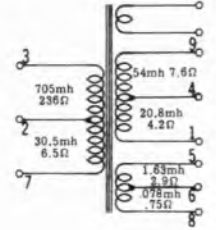

HVO-42

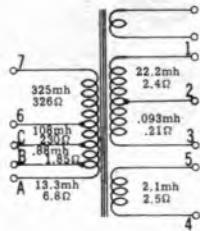

HVO-43

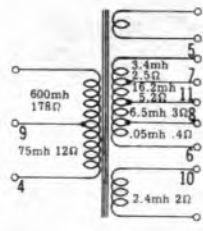

HVO-44

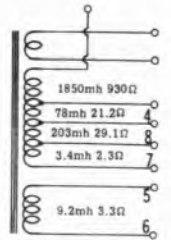

HVO-45

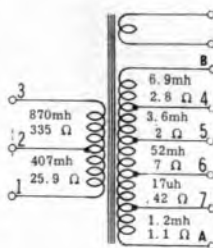

HVO-46

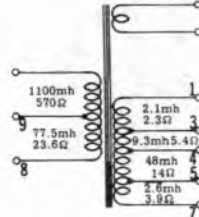

HVO-47

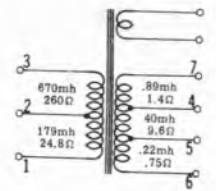

HVO-48

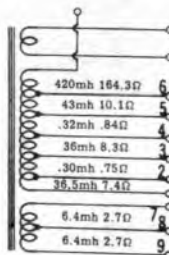

HVO-49

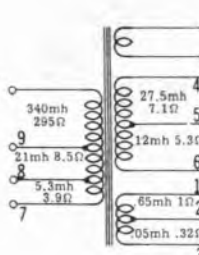

HVO-50

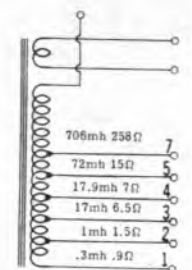

HVO-51



HORIZONTAL OUTPUT
FLYBACK
TRANSFORMERS

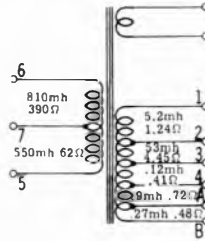

HVO-52

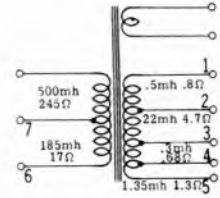

HVO-53

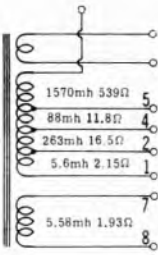

HVO-54

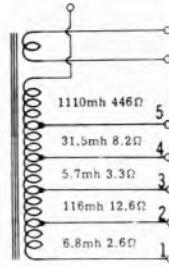
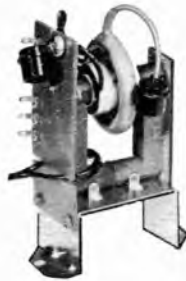

HVO-55

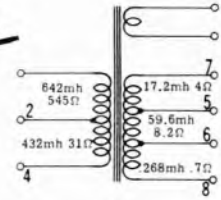
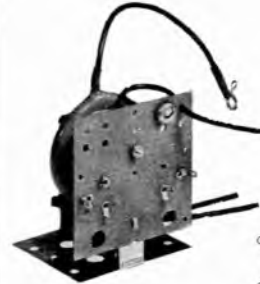

HVO-56

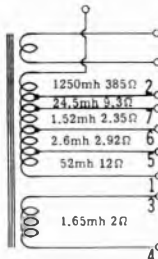

HVO-57

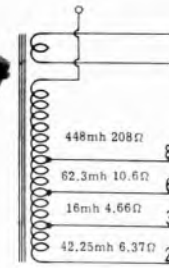

HVO-58

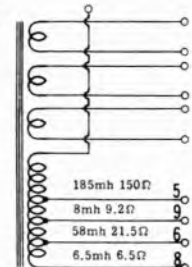

HVO-59

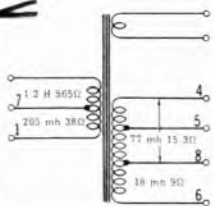
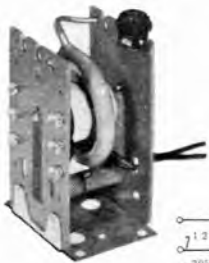

HVO-60

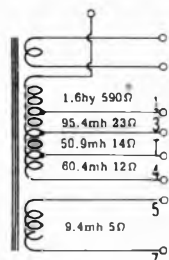

HVO-62

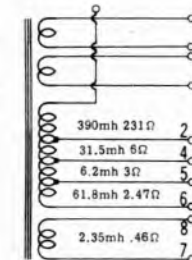

HVO-63

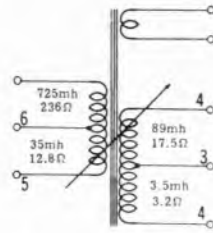

HVO-66

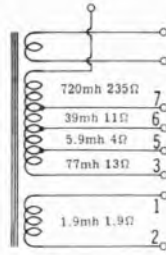

HVO-67

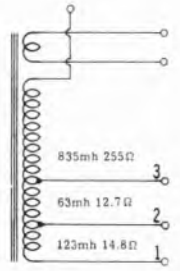

HVO-68

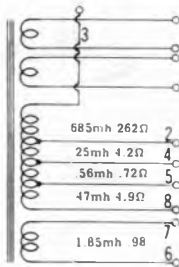

HVO-69

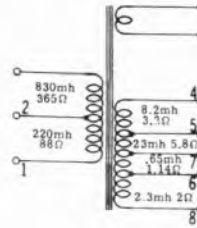

HVO-70

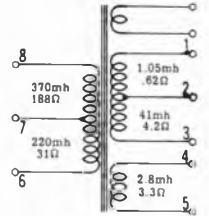

HVO-71

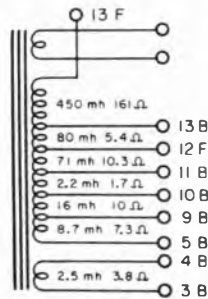

HVO-72

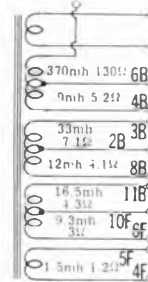

HVO-73

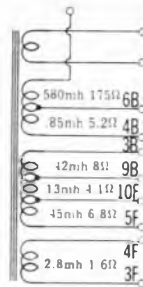

HVO-74

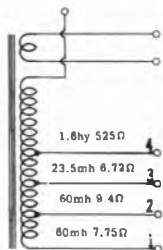

HVO-75

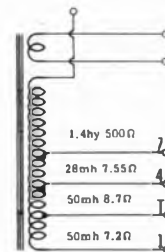

HVO-76

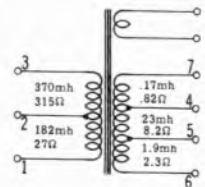

HVO-77



HORIZONTAL OUTPUT
FLYBACK
TRANSFORMERS

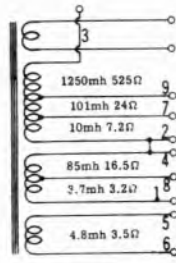

HVO-79

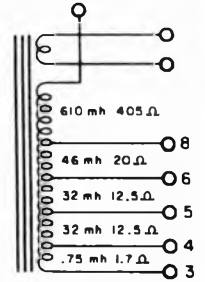

HVO-80

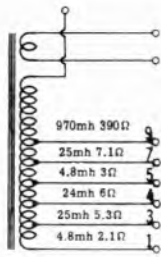

HVO-81

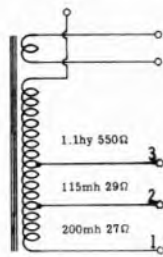

HVO-82

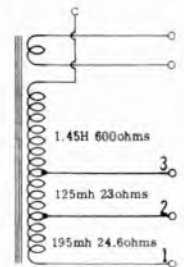
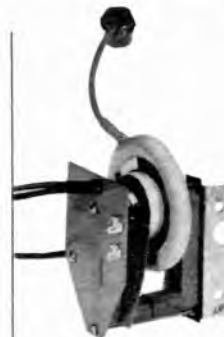

HVO-83

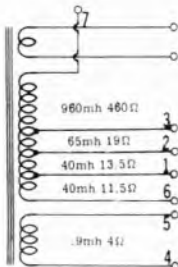

HVO-84

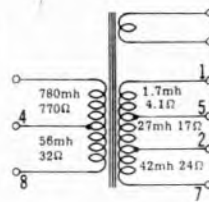

HVO-85

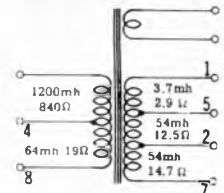

HVO-86

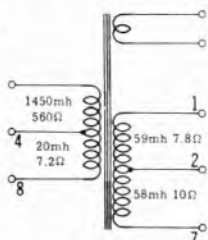

HVO-87

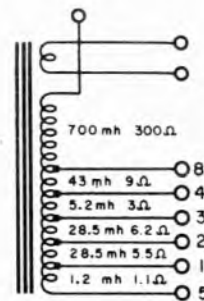

HVO-88

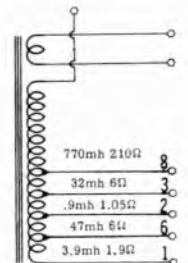

HVO-89

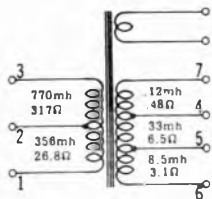

HVO-90

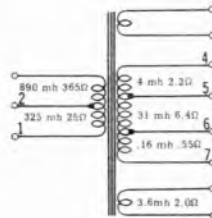

HVO-91

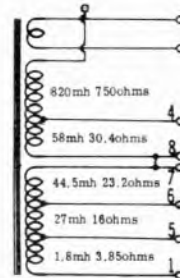

HVO-92

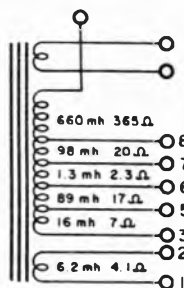

HVO-93

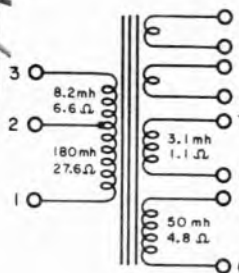

HVO-94

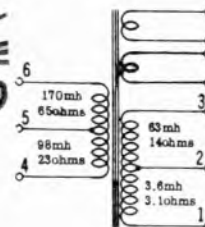

HVO-95

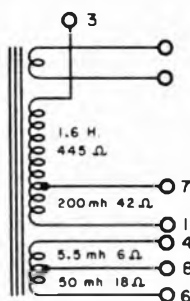

HVO-96

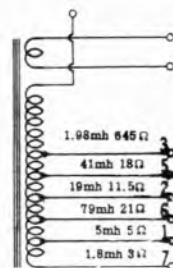

HVO-97

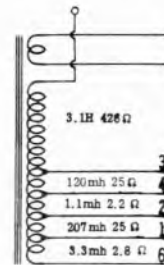

HVO-98

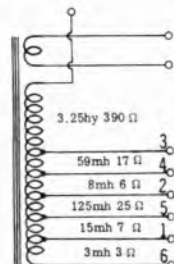

HVO-99

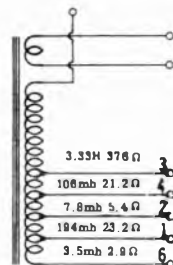

HVO-100

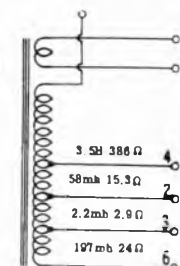

HVO-101



HORIZONTAL OUTPUT
FLYBACK
TRANSFORMERS

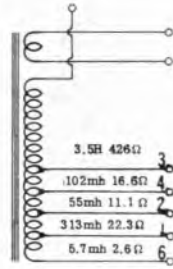

HVO-102

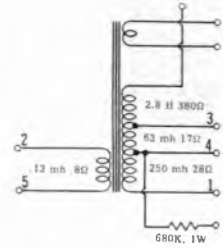

HVO-103

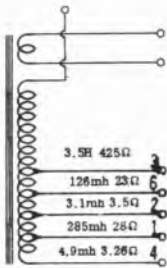

HVO-104

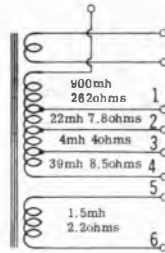

HVO-105

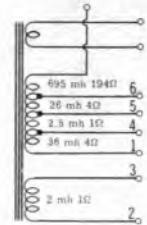

HVO-106

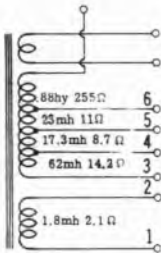

HVO-107

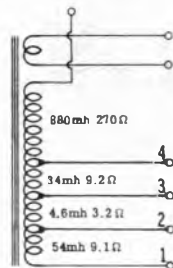

HVO-108

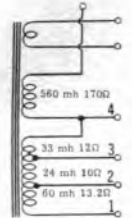

HVO-109

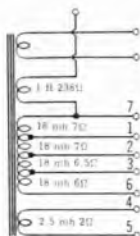

HVO-110

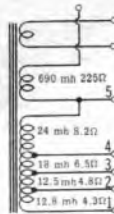

HVO-111

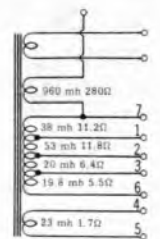

HVO-112

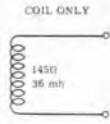

HVO-113

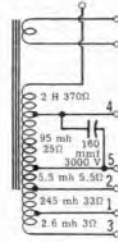

HVO-114

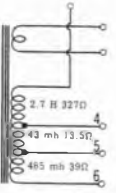

HVO-115

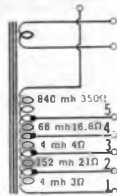

HVO-116

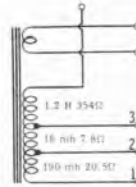

HVO-117

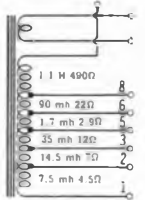

HVO-118

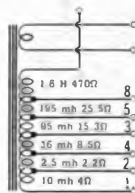

HVO-119

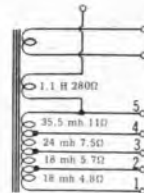

HVO-120

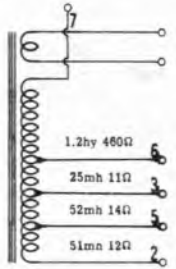

HVO-121

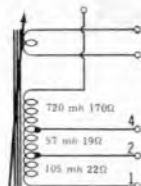

HVO-122

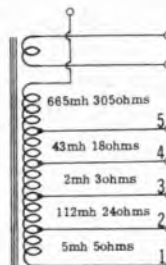

HVO-123

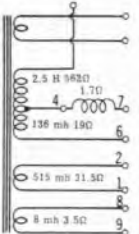

HVO-124



HORIZONTAL OUTPUT
FLYBACK
TRANSFORMERS

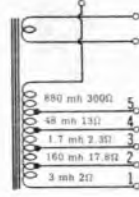

HVO-125

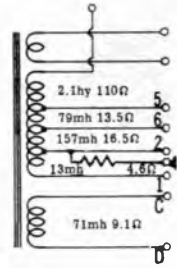

HVO-126

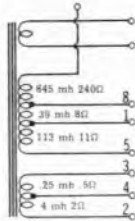

HVO-127

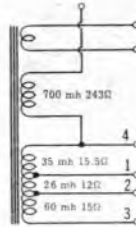

HVO-128

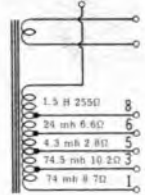

HVO-129

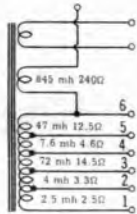

HVO-130

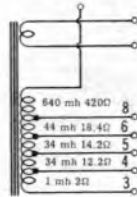

HVO-131

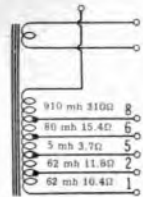

HVO-132

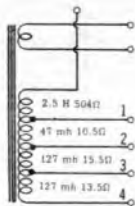

17 HVO-133

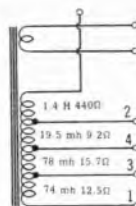

HVO-134

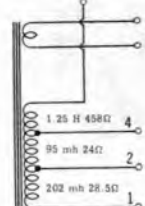

HVO-135

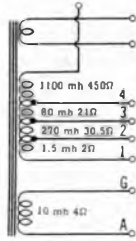

HVO-136

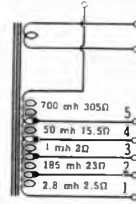

HVO-137

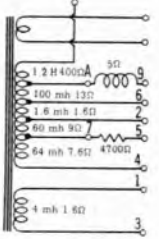

HVO-138

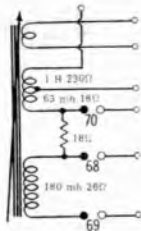

HVO-139

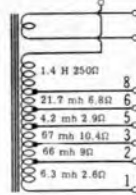

HVO-140

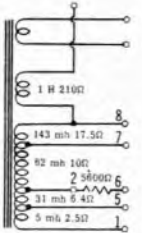

HVO-141

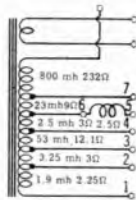

HVO-142

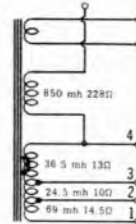

HVO-143

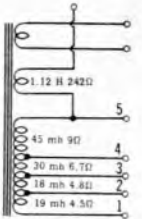

HVO-144

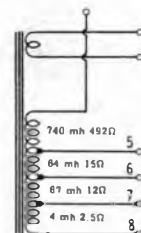

HVO-145

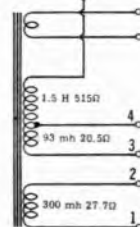

HVO-146

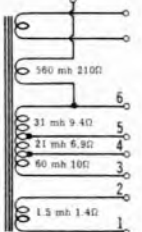

HVO-147



HORIZONTAL OUTPUT
FLYBACK
TRANSFORMERS

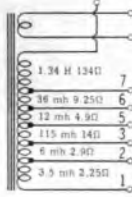

HVO-148

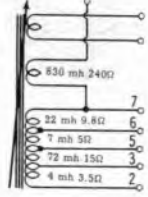

HVO-149

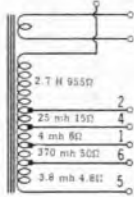

HVO-150

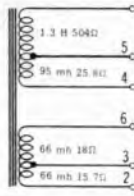

HVO-151

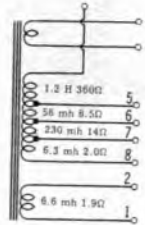

HVO-152

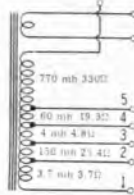

HVO-153

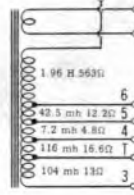

HVO-154

Features of Merit Flybacks

High efficiency powdered Iron Cores for quiet operation. Vacuum impregnated coils insure long life. Tires are properly insulated and moisture proofed to prevent arcing. Filament leads are vinyl insulated to stand high temperatures.

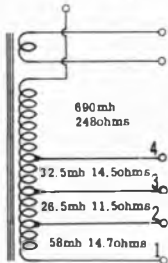

HVO-156

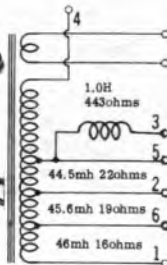

HVO-157

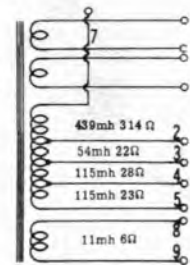

HVO-158

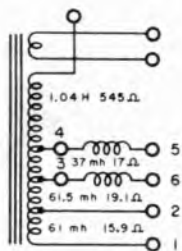

HVO-159

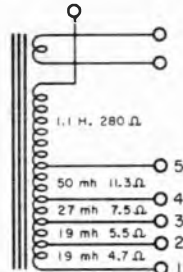

HVO-160

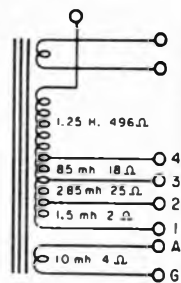

HVO-161

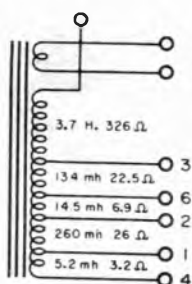

HVO-162

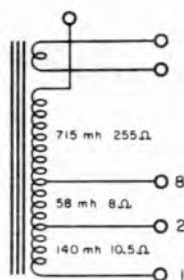

HVO-163

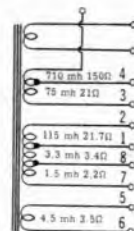

HVO-164

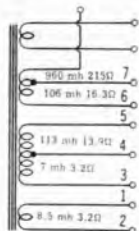

HVO-165

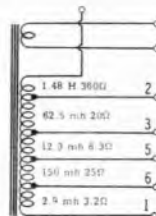

HVO-166

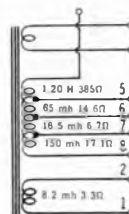

HVO-167

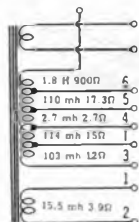

HVO-168

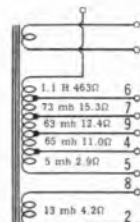

HVO-169

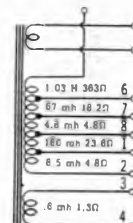

HVO-170



HORIZONTAL OUTPUT
FLYBACK
TRANSFORMERS

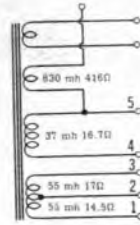

HVO-171

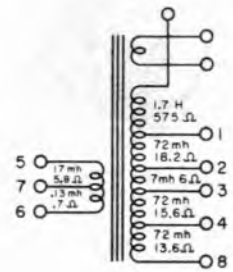

HVO-172

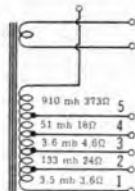

HVO-173

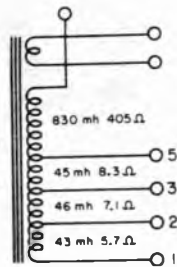

HVO-174

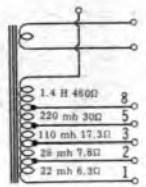

HVO-175

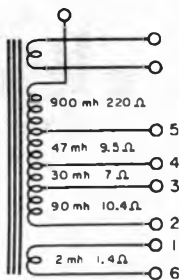

HVO-176

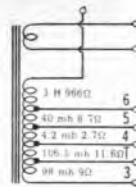

HVO-177

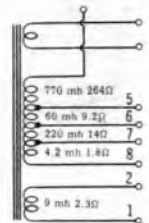

HVO-178

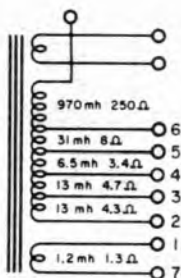

HVO-179

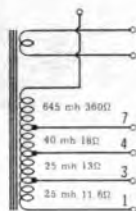

HVO-180

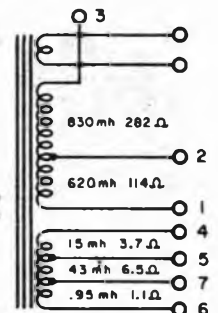

HVO-181

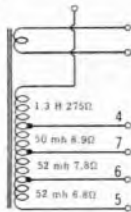

HVO-182

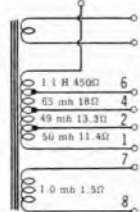

HVO-183

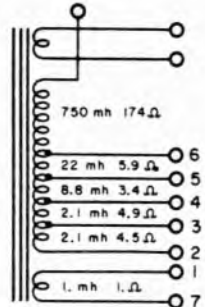

HVO-184

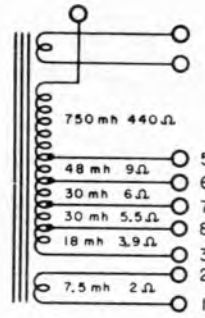

HVO-185

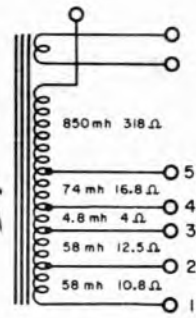

HVO-186

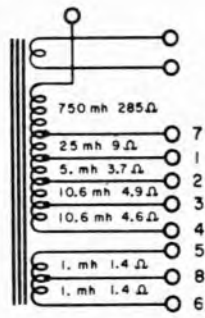

HVO-187

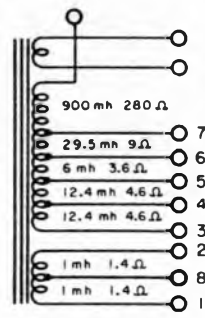

HVO-188

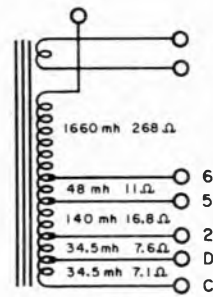

HVO-189

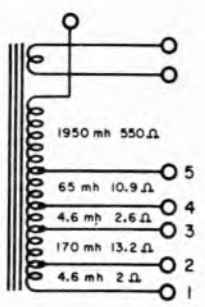

HVO-190

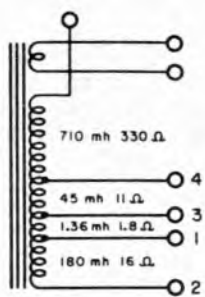

HVO-191

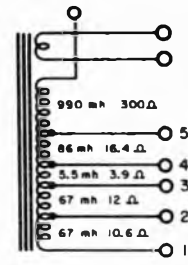

HVO-192

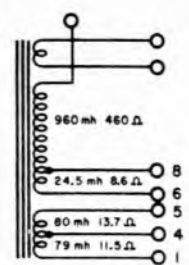

HVO-193



HORIZONTAL OUTPUT
FLYBACK
TRANSFORMERS

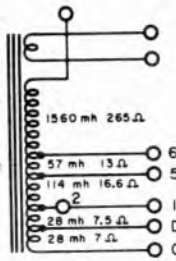

HVO-194

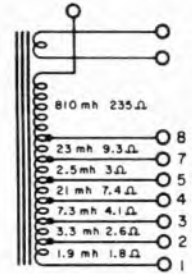

HVO-195

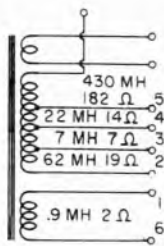

HVO-196

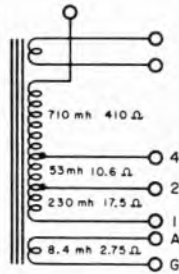

HVO-197

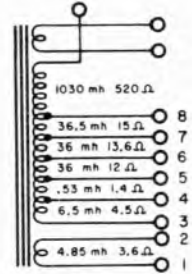

HVO-198

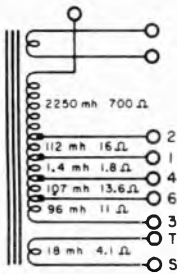

HVO-199

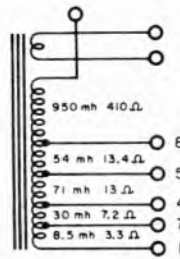

HVO-200

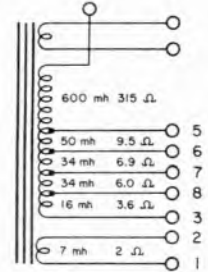

HVO-201

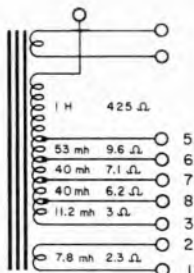

HVO-202

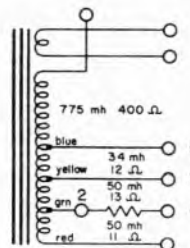

HVO-203

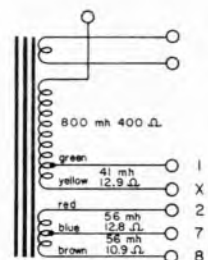

HVO-204

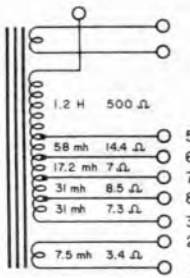

HVO-205

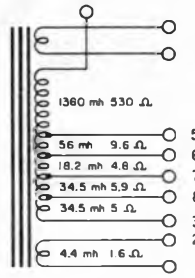

HVO-206

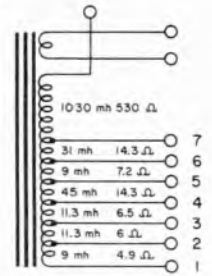

HVO-207

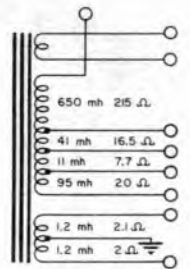

HVO-208

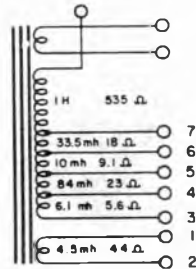

HVO-209

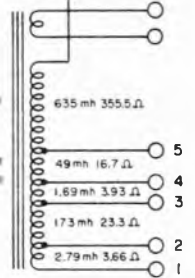

HVO-210

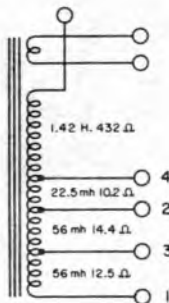

HVO-211

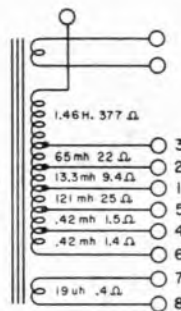

HVO-212

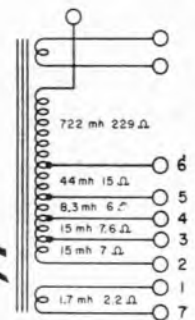

HVO-213

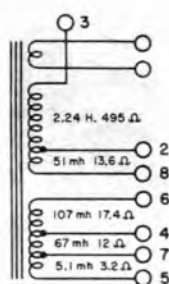

HVO-214

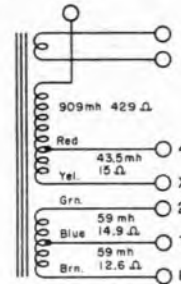

HVO-215

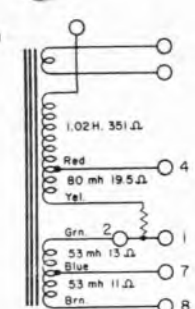

HVO-216



HORIZONTAL OUTPUT
FLYBACK
TRANSFORMERS



HVO-217

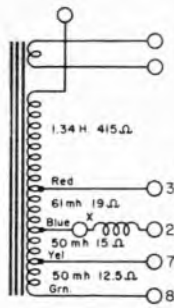

HVO-218

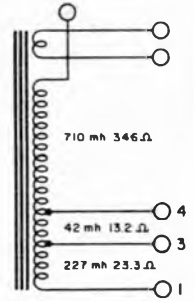

HVO-219

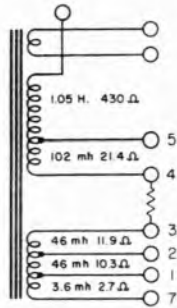

HVO-220

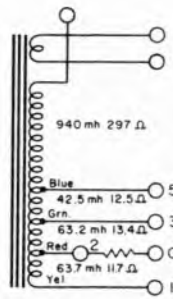

HVO-221

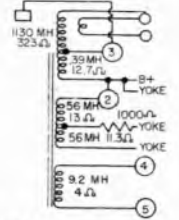

HVO-222

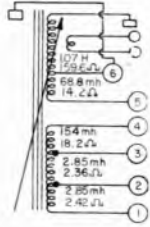

HVO-223

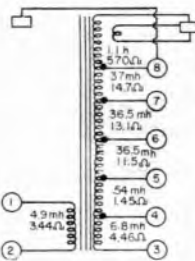

HVO-224

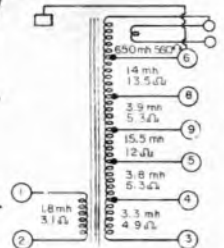

HVO-225

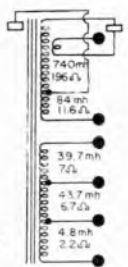

HVO-227

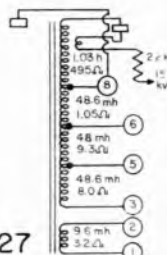

HVO-228

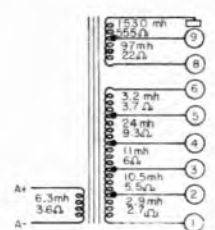

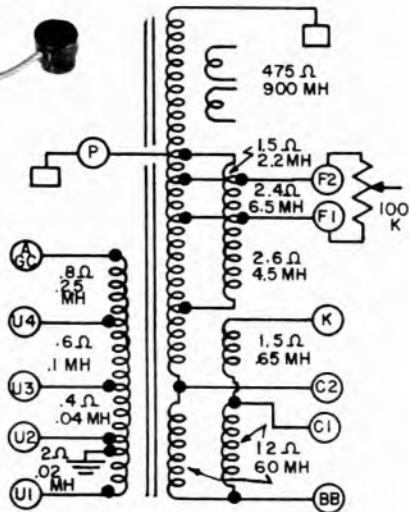
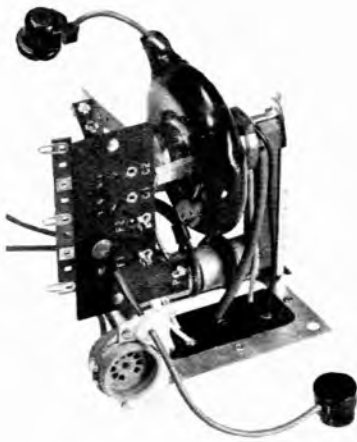

HVO-230 C

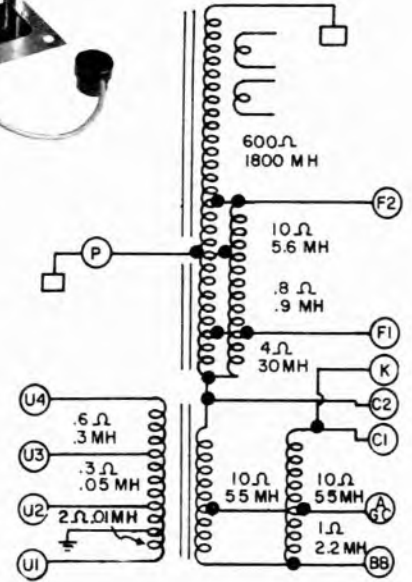
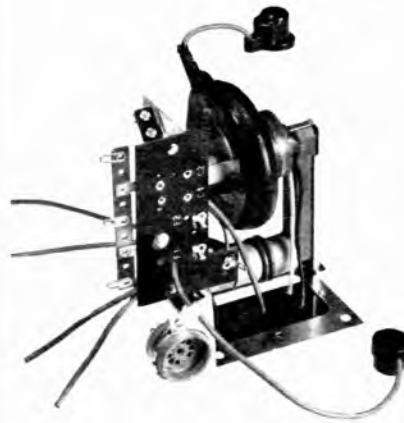

HVO-231 C

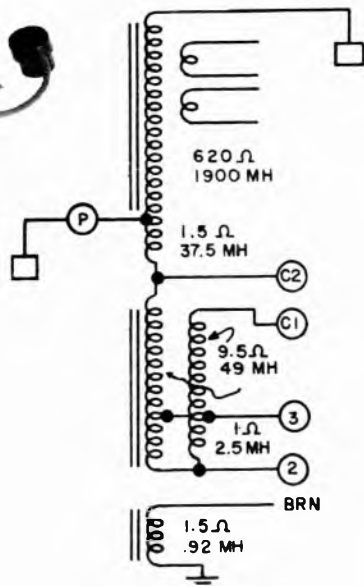

HVO-232 C

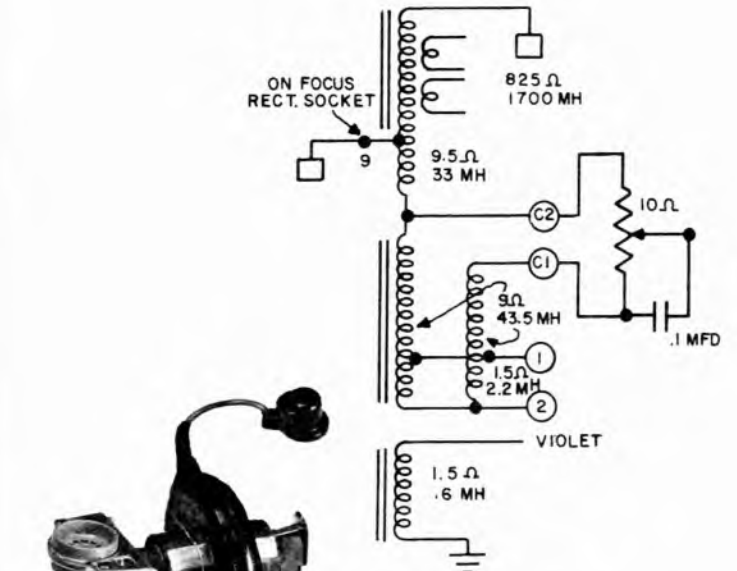

HVO-233 C

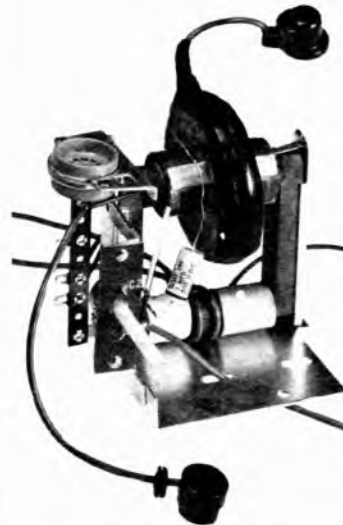

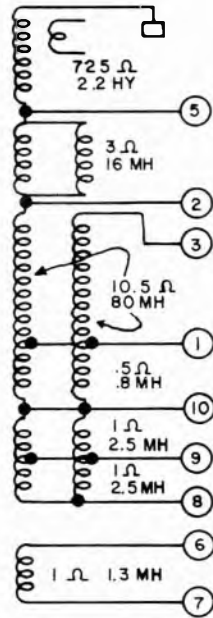

HVO-234 C

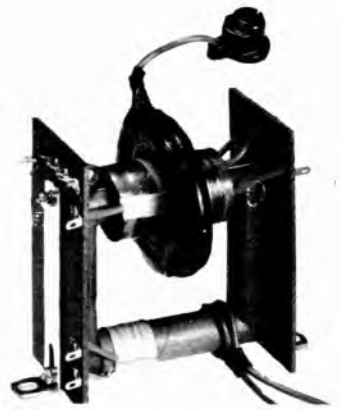
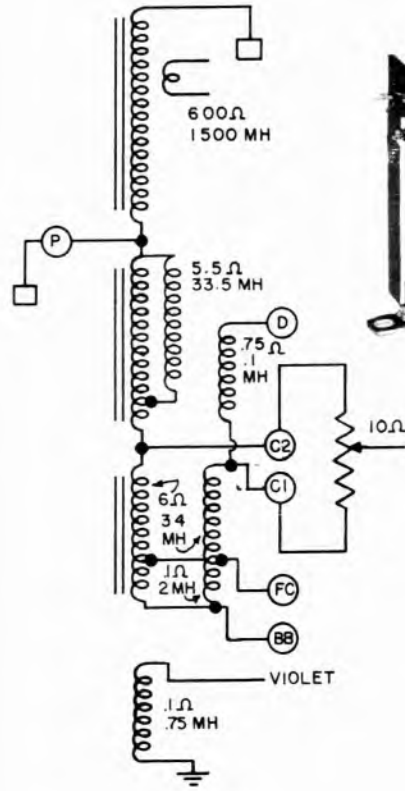

HVO-235 C



DEFLECTION YOKES

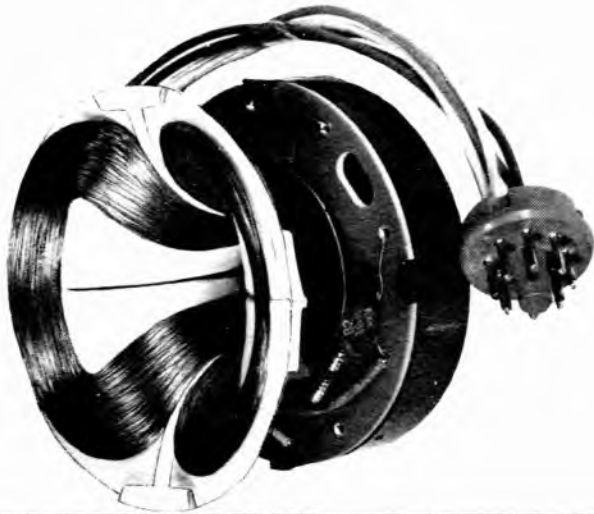

Merit manufactures a complete line of Deflection Yokes ranging in deflection angles of 50° to 114°. All yokes are designed as exact replacements for specific TV receivers. Some units can be used as a universal yoke in many TV receivers with slight changes in the standard networks or circuit change as indicated in footnotes in the replacement number section.

The physical and electrical characteristics of a Merit exact replacement deflection yoke is identical to the original manufacturer's product. Merit continues to use polyethylene insulating material between the Horizontal and Vertical Coils as it has been field tested through the years of use which has proved this type of insulation provides maximum voltage safety and deflection sensitivity.

MERIT #	REPLACEMENT FOR	MERIT #	REPLACEMENT FOR
MD-12	Admiral, Philco, RCA, Sylvania and many others	MDF-105	Crosley 158420-1/-2/-4, 158426-1/-4
MD-13	Sparton, Sylvania, Westinghouse and many others	MDF-106	G.E. RLD-080 (WT76X26)
MDF-70	Airline, CBS, Hallicrafters, Magnavox and many others	MDF-107	Motorola 24D742835
MDF-71	CBS, Philco, Silvertone and many others	MDF-108	Motorola 24K745101
MDF-72	Airline, Philco, Hallicrafters and many others	MDF-109	Westinghouse 490V004M01
MDF-73	Airline, Hoffman, Sylvania, Silvertone and many others	MDF-110	RCA 103830, Sylvania 100-0031 and others
MDF-74	Crosley, RCA, Sentinel and many others	MDF-111	Westinghouse 490V006H01/2
MDF-75	Motorola 24K700694 and many others	MDF-112	Packard Bell 29645C
MDF-76	RCA 74952	MDF-113	RCA 105053 (972958-4)
MDF-77	Admiral 94C30-1/-3 and others	MDF-115	RCA 104482 (972958-3)
MDF-78	Motorola 24C702655, 24K702657 and others	MDF-116	Motorola 24D744084
MDF-79	Motorola 24C730632/3/4 and others	MDF-117	RCA 104078, 104408, 107022A
MDF-80	Motorola 24C711217 and others	MDF-118	Packard Bell 29696
MDF-81	Philco 32-9648/70/80 and others	MDF-119	RCA 104369 (972913-2)
MDF-82	Dumont 21011061, 89012702 and others	MDF-120	Admiral 94D147-1/-3, 94D150-1/3/4/6/7
MDF-83	G.E. RLD-013	MDF-121	Coronado, Wells-Gardner 9A2458-B
MDF-84	G.E. RLD-025	MDF-122	Airline, Westinghouse 490V007H01
MDF-85	G.E. RLD-041/045	MDF-123	Zenith 95-1443
MDF-86	G.E. RLD-042/047	MDF-124	Zenith 95-1768
MDF-87	G.E. RLD-052	MDF-125	Airline, Coronado, Wells-Gardner 9A2452/82
MDF-88	Admiral 94C51-1/-3 and others	MDF-126	Admiral 94D187-2
MDF-89	RCA 77697 and others	MDF-127	Bradford, Wells-Gardner 9A2477
MDF-91	Admiral, CBS, RCA, Zenith and others	MDF-128	Philco 76-10282-5
MDF-92	Airline, Crosley, Silvertone and others	MDF-129	Admiral 94D189-2
MDF-93	G.E. RLD-069 and others	MDF-130	Truetone, Trav-ler L-177
MDF-94	Philco 32-9689/-1 and others	MDF-131	Airline, Wells-Gardner 9A2476
MDF-96	Muntz LC-0085-1	MDF-132	Motorola 24K754300 (24D65616A03B)
MDF-97	Motorola 24D736445, 24D736978 and others	MDF-133	Silvertone 80-12-4
MDF-98	Muntz LC-0061/-1/-2	MDF-134	Admiral 94D189-3
MDF-99	RCA 100586, 101147	MDF-135	Motorola 24D65616A06-H
MDF-100	RCA 76653, 78278	MDF-136	Zenith 95-1666, 95-1721
MDF-104	Sylvania 100-0009	MDF-137	Magnavox 700895-1
		MDF-138	Philco 76-10508-9
		MDF-141	G.E. ET76X36/37
		MDF-142	RCA 112540, 112712, 962675-503/4
		MDF-143	Emerson 708415
		MDF-144C	RCA 109457 (color) and many others



DEFLECTION

YOKES

YOKE SLEEVE INSULATOR - Part Number IN-35.
 Now available from your distributor. To be used in conjunction with 90° Yokes in TV sets equipped with brass width sleeve. Eliminates the need for cutting and forming a piece of 0.010 gauge fishpaper as called for in Sam's Photofacts and Counterfacts.

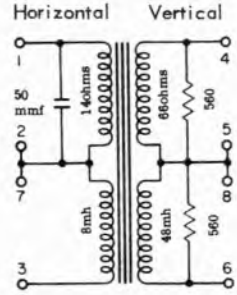

MD-12

53°

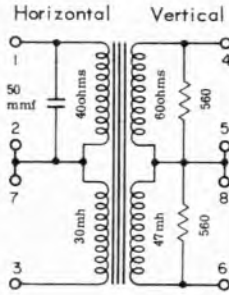

MD-13

53°

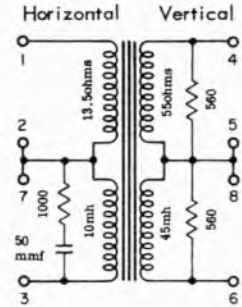

MDF-70

70°

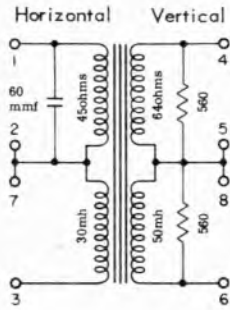

MDF-71

70°

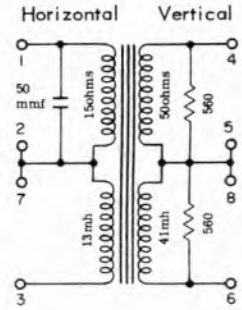

MDF-72

70°

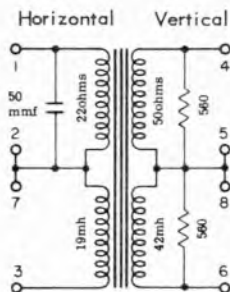

MDF-74

70°

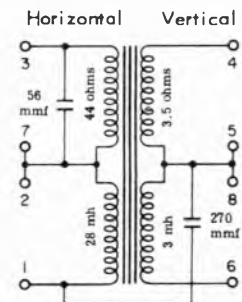

70°

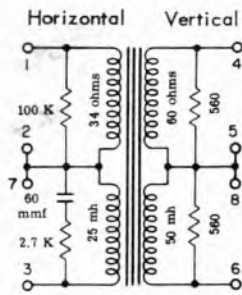
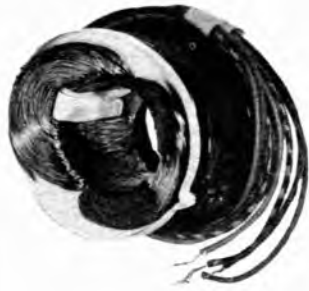

MDF-75

70°

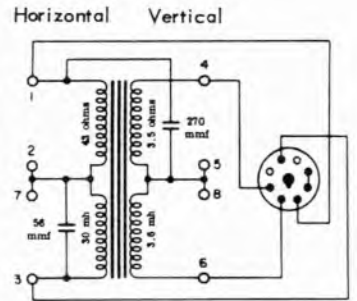

MDF-76

70°

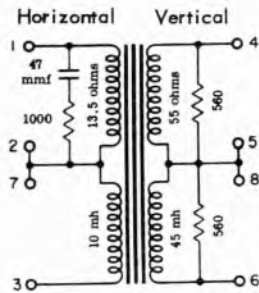

MDF-77

70°

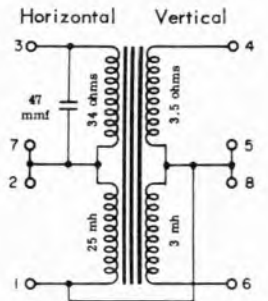

MDF-78

70°

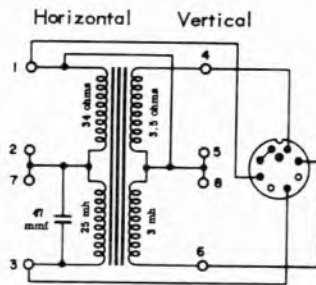

MDF-79

70°

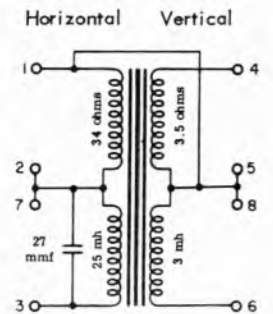

MDF-80

70°

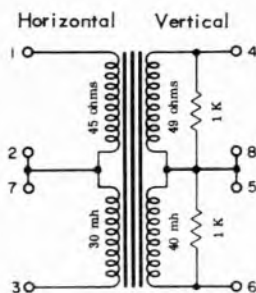

MDF-81

70°

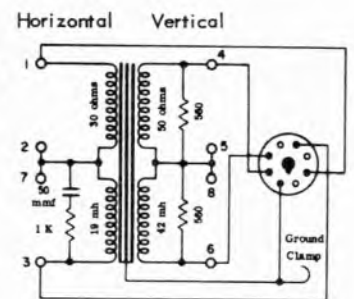

MDF-82

70°

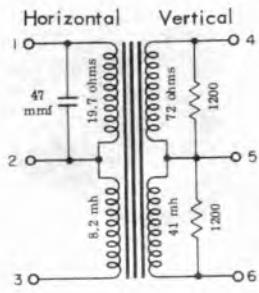

MDF-83

/70°

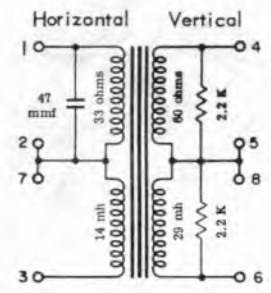

MDF-84

/70°

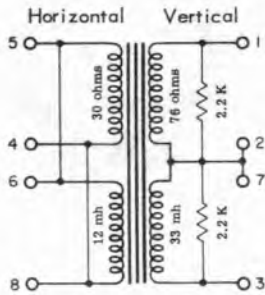

MDF-85

/70°

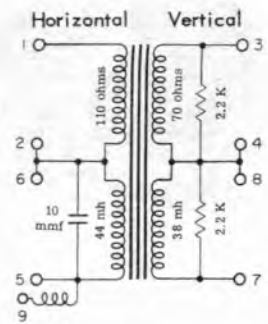

MDF-86

/70°

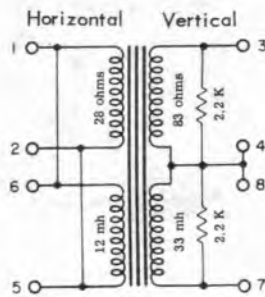

MDF-87

/70°

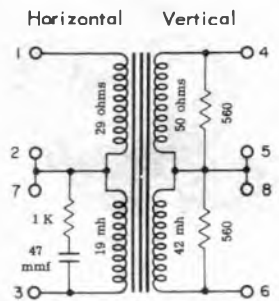

MDF-88

/70°

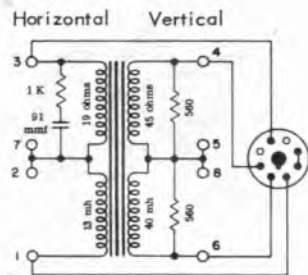

MDF-89

/70°

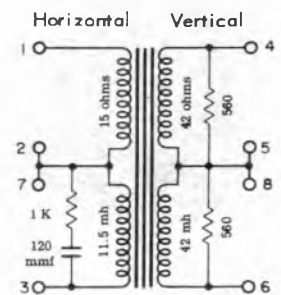

MDF-91

/90°

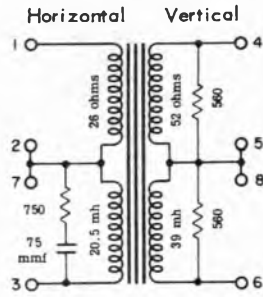

MDF-92

90°

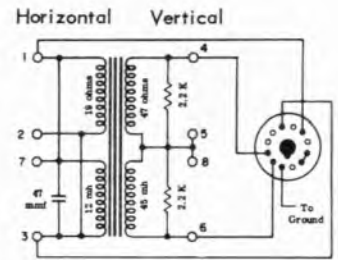

MDF-93

90°

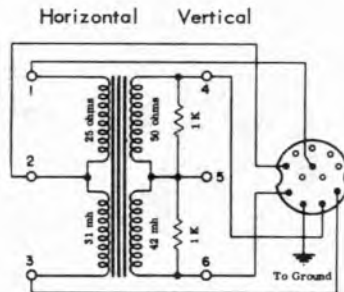

MDF-94

90°

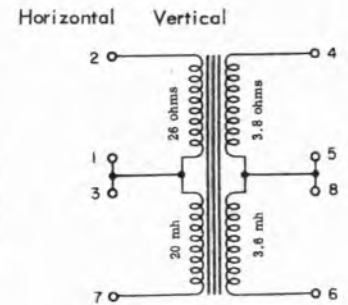

MDF-96

90°

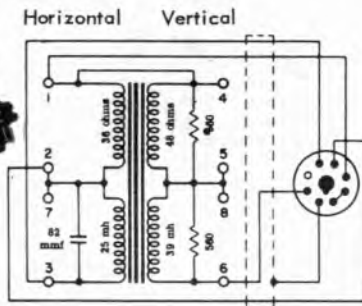

MDF-97

90°

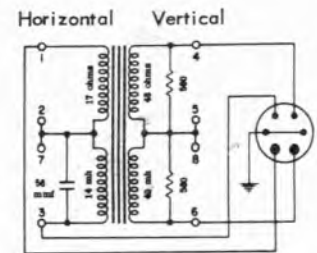

MDF-98

90°

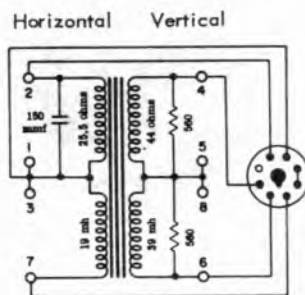

MDF-99

90°

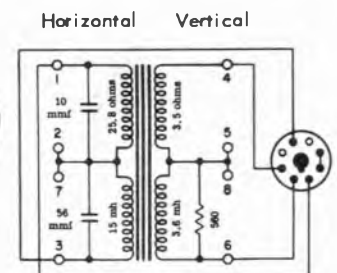

MDF-100

70°



MDF-104

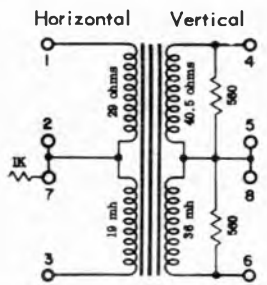

70°



MDF-105

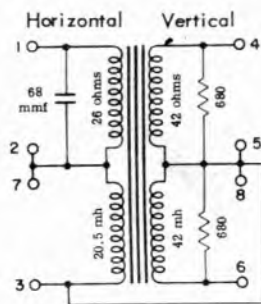

90°



MDF-106

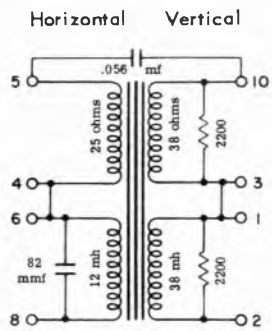

110°



MDF-107

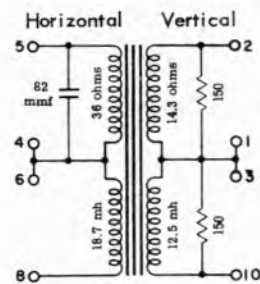

110°



MDF-108

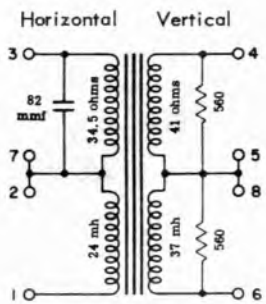

90°



MDF-109

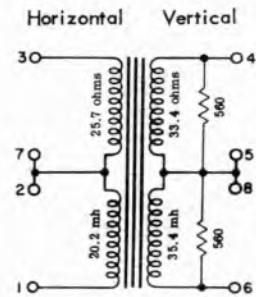

90°



MDF-110

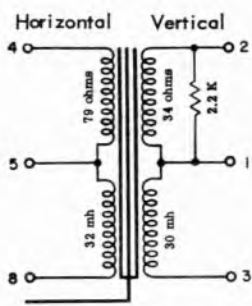

110°



MDF-111

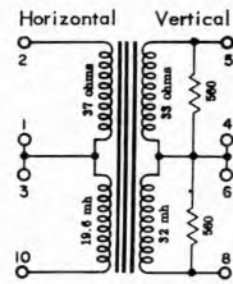

110°

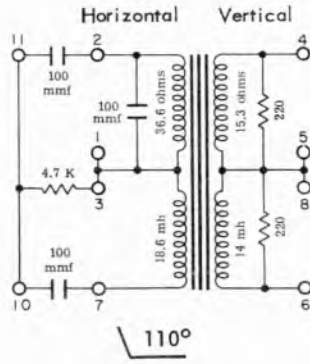

MDF-113

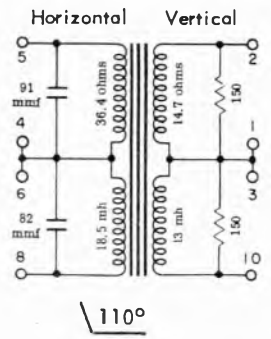

MDF-115

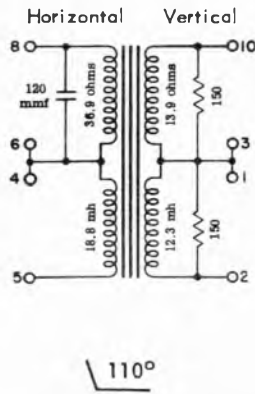

MDF-116

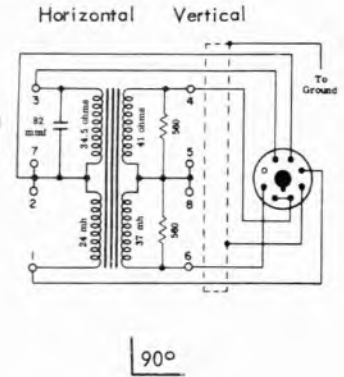

MDF-117

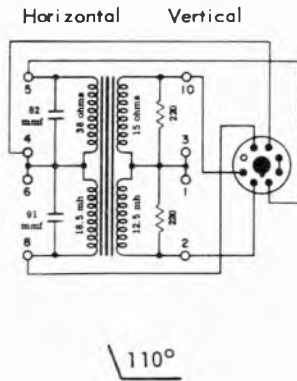

MDF-118

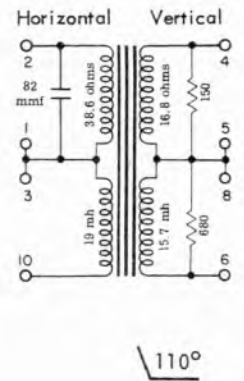

MDF-119

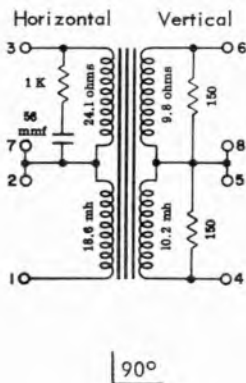

MDF-120

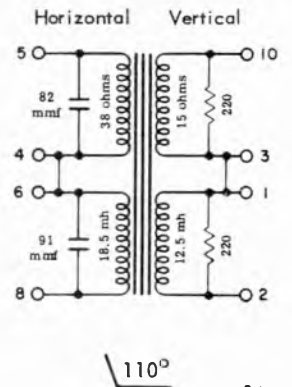

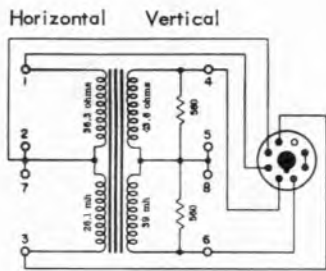

MDF-121

90°

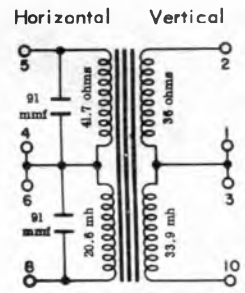

MDF-122

110°

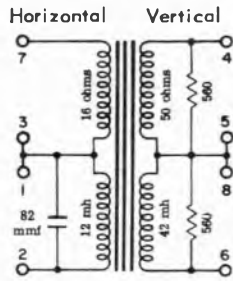

MDF-123

90°

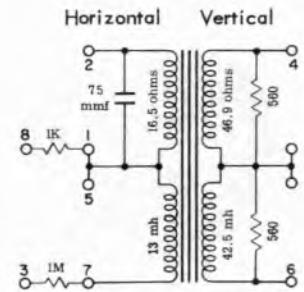

MDF-124

90°

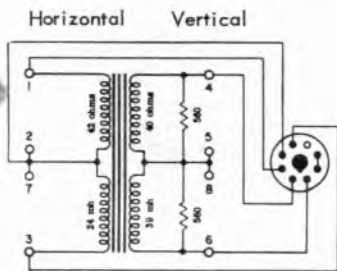

MDF-125

90°

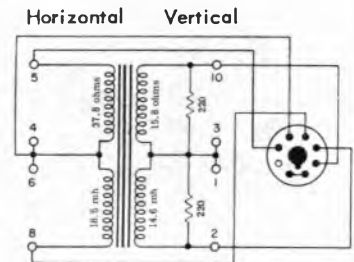

MDF-126

110°

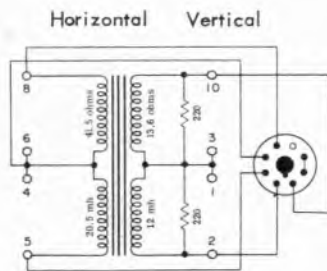

MDF-127

114°

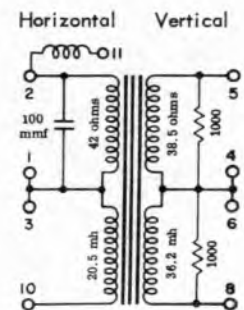

MDF-128

110°

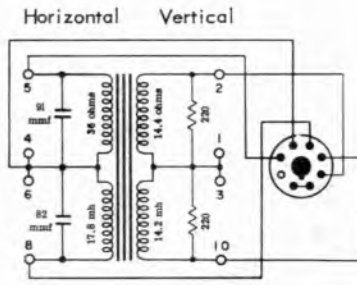

MDF-129

114°

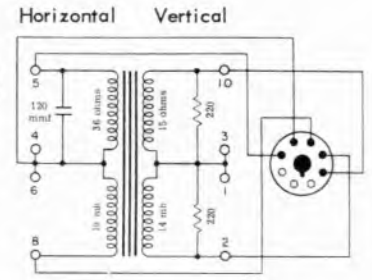

MDF-130

114°

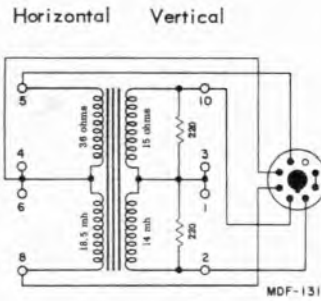

MDF-131

110°

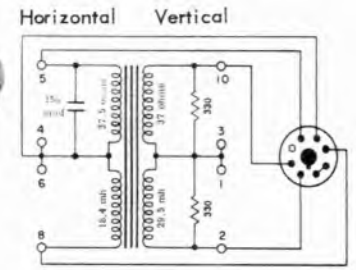

MDF-132

110°

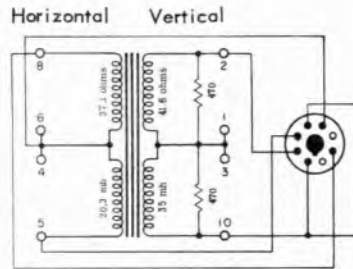

MDF-133

110°

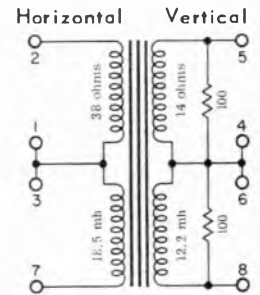

MDF-134

114°

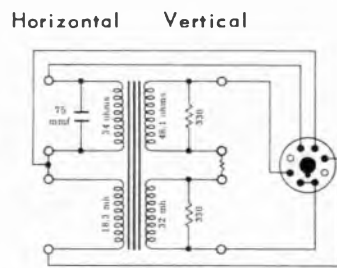

MDF-135

114°

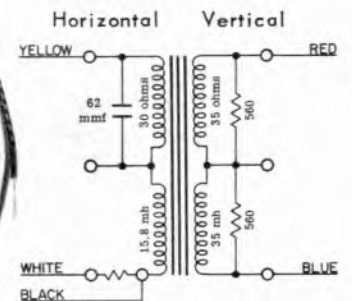

MDF-136

110°

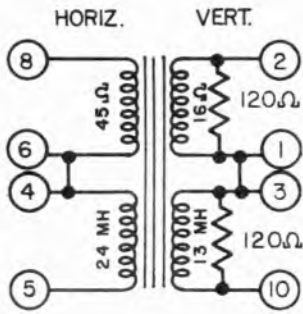

110°

MDF-137

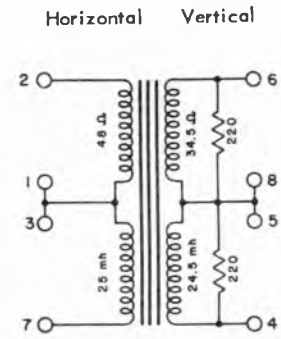

110°

MDF-138

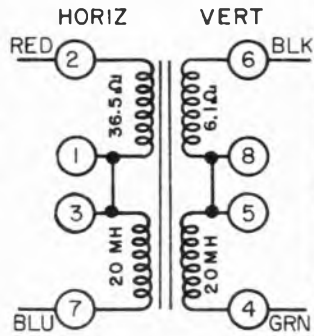

110°
114°

MDF-141

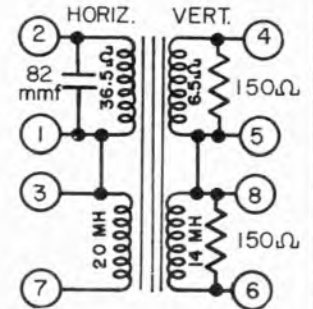

110°
114°

MDF-142

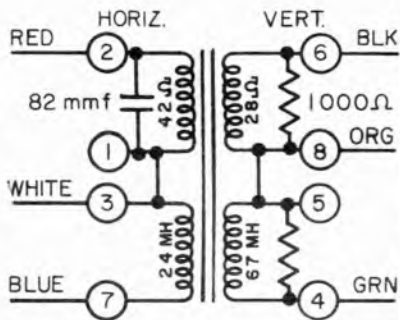

110°
114°

MDF-143

YOKE REAR COVERS

Merit No.	Description
M-47-110	Fits all Merit 110° and 114° yokes. Includes the required centering rings.
M-51-70-90	Fits all Merit 53°, 70° and 90° yokes. Includes the required centering rings.
M-238	Fits all Merit 53°, 70° and 90° yokes. Includes centering rings and extension for yoke clamp.
YC-3-70-90	Fits all Merit 53°, 70° and 90° yokes. No centering rings.



Color Yoke



MDF-144C

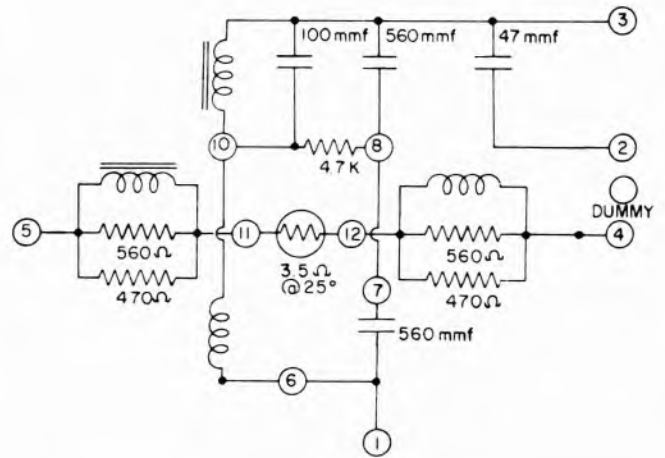

Vertical Output Transformers

FOR COLOR TELEVISION

- A 4136 C
- A 4137 C
- A 4138 C
- A 4139 C
- A 4140 C

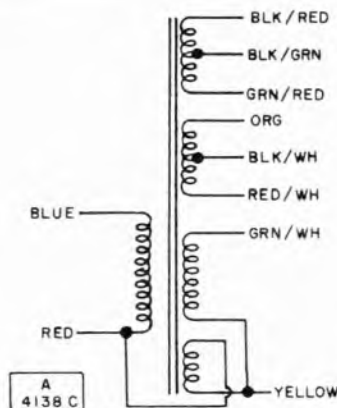
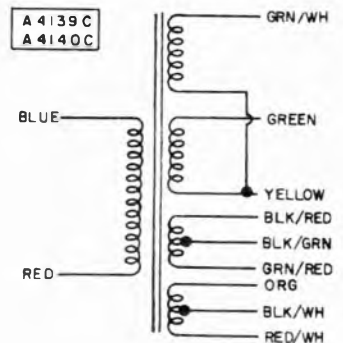
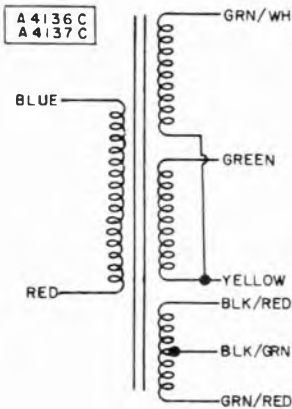
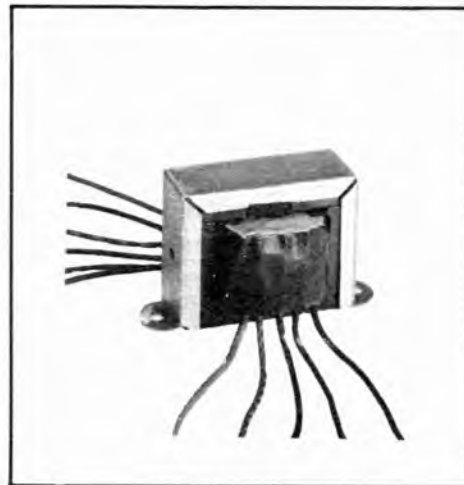



VERTICAL TRANSFORMERS

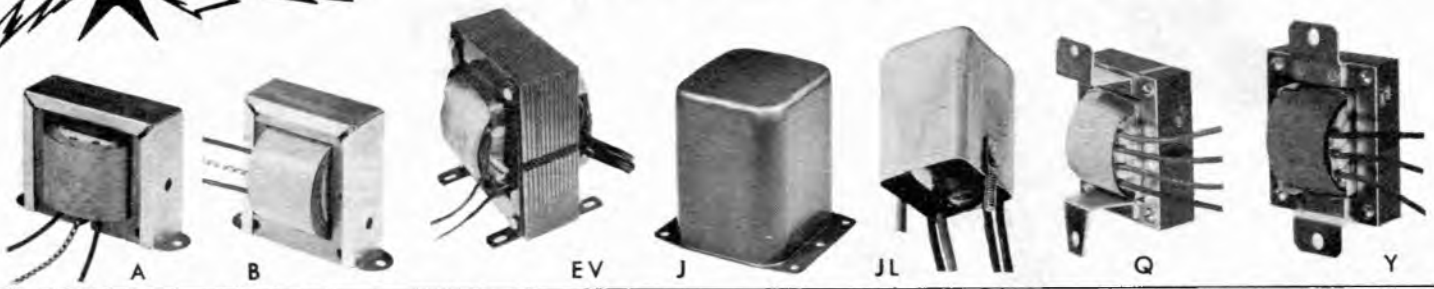

Vertical Output

Used to couple vertical output tube to yoke vertical deflection coils.

Vacuum impregnated windings

Many exact replacements

Easily mounted

Precision wound for exact turns ratio

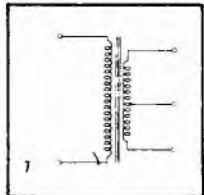
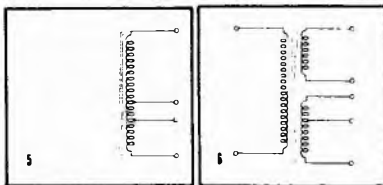
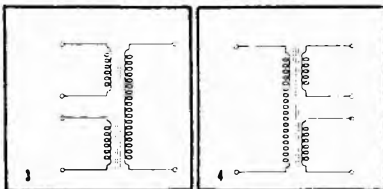
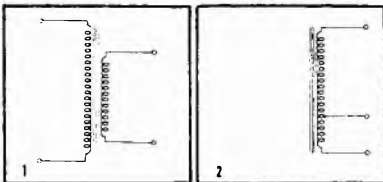

Merit No.	Ref. No.	Turns Ratio Pri./Sec.	Primary Impedance in Ohms @ Rated Current	D.C. Resistance in Ohms		Dimensions in Inches				Mtg. Type	Shipping Weight Lb.-Oz.	
				Pri.	Sec.	Mtg. Centers	H	W	D			
ISOLATION TYPES - PRIMARY & SECONDARY ONLY - See Schematic												
A-2822	1	6:1	4,000@41 madc	310	13	3/8	2 1/4	3 1/16	2	1	A	1-10
A-4098	2	8:1	7,400@40 madc	325	3.6	3/8	2 1/4	3 1/16	2	1	A	1-10
A-2823	3	8:1	8,000@30 madc	385	5.7	3/8	2 1/4	3 1/16	2 1/8	1	A	2-0
A-3036	4	10:1	18,000@13 madc	1210	9.2	2 3/16	2	3 1/4	2	1	A	1-0
A-3035	5	10:1	19,000@13 madc	585	6.8	1 1/8 x 2	3 3/8	2 1/16	2 1/2	1	EV	2-6
A-3038	6	10:1	20,000@13 madc	850	9.1	3/8	2 1/4	3 1/16	2	1	A	1-10
A-2816	7	10:1	25,000@13 madc	1270	6.5	3/8	2 1/4	3 1/16	2 1/8	1	A	2-0
A-4119	8	16.2:1	33,000@14 madc	2023	7.3	2 3/16	2	3 1/4	1 3/4	1	A	1-0
A-4089	9	18:1	45,000@12 madc	1480	5.2	3/8	2 1/4	3 1/16	2	1	A	1-10
A-3034	10	35.8:1	27,000@7 madc	1432	4.0	2 3/8	1 1/8	2 3/16	1 3/8	1	A	0-10

AUTO-TRANSFORMER TYPES - (secondary is tapped portion of primary). See Schematic

A-2820	11	5:1	6,500@15 madc	278	9.0	2 3/16	2	3 1/4	2	2	A	1-4
A-2856	12	5:1	9,000@27 madc	228	11.0	3/8	2 1/4	3 1/16	2	2	A	1-10
A-2821	13	6:1	4,500@38 madc	325	9.5	2 3/16	2	3 1/4	2	2	A	1-4
A-2828	14	6.6:1	7,300@28 madc	324	10.0	3 1/16	2 1/2	4	2 1/4	2	A	2-2
A-4090	15	8:1	10,500@10 madc	390	6.2	2 3/16	2	3 1/4	2	2	A	1-0
A-2826	16	8:1	18,000@15 madc	465	14.0	3/8	1 1/8	3 1/16	2 3/16	2	Y	1-4
A-2855	17	9:1	10,000@25 madc	390	14.8	2 3/16	2	3 1/4	1 3/4	2	A	1-0
A-2854	18	9:1, 10:1	15,000@20 madc	580	15.5	3/8	2 1/4	3 1/16	2	2	A	1-10
A-3037	19	11.4:1	22,000@10 madc	1200	12.0	2 3/16	2	3 1/4	1 3/4	2	A	1-0
A-2986	20	11.5:1	8,600@10 madc	355	2.5	3/8	2 1/4	3 1/16	2	2	A	1-10
A-2984	21	11.7:1	9,200@10 madc	282	2.4	3/8	2 1/4	3 1/16	2	2	A	1-10
A-2988	22	12:1	10,400@10 madc	285	2.5	3/8	2 1/4	3 1/16	2	2	A	1-10
A-2829	23	12.5:1	21,000@19 madc	720	7.4	3/8	2 1/4	3 1/16	2	2	A	1-10
A-4091	24	14.1:1	51,000@10 madc	1390	20	2 3/8	2 1/4	2 3/16	1 1/2	2	B	1-0
A-2819	25	15:1	20,000@25 madc	1200	10.5	3/8	2 1/4	3 1/16	2	2	A	1-10
A-4123	26	15:1	35,000@18 madc	2800	10	2 3/16	2	3 1/4	1 3/4	2	A	1-4
A-2982	27	15.9:1	11,100@30 madc	450	3.4	3/8	2 1/4	3 1/16	2	2	A	1-10
A-3039	28	18:1	29,000@10 madc	1600	4.4	3/8	2 1/4	3 1/16	2 1/8	2	A	2-0
A-2825	29	44:1	16,000@14 madc	730	0.9	2 3/16	2	3 1/4	2	2	A	1-4

SPECIAL ISOLATION AND AUTOFORMER TYPES (with additional windings and/or taps). See Schematic

A-2815	30	5:1 to 50:1	Univ. 35 ma max.	533/585	12.0	3/8	2 1/4	3 1/16	2	3	A	1-10
A-2827	31	8:1	9,000@25 madc	435	14.0	3/4	2	3 3/8	2 3/16	5	Q	1-6
A-2853	32	8:1, 2:1	10,000@20 madc	365	23/6.3	2 3/16	2	3 1/4	2	5	A	1-4
A-2852	33	9:1, 3.5:1	10,000@27 madc	490	175/8.2	3/8	2 1/4	3 1/16	2	5	A	1-10
A-4113	34	11:1, 3.3:1	8,650@38 madc	425	175/4.8	3/8	2 1/4	3 1/16	2	5	A	1-10
A-4117	35	12.3:1, 3.4:1	5,000@32 madc	140	170/2.2	3/8	2 1/4	3 1/16	2	4	A	1-10
A-3033	36	13.3:1, 6.7:1	8,000@25 madc	400	29/10	2 3/16	2	3 1/4	2	5	A	1-4
A-2824	37	15:1, 2.3:1	18,000@11 madc	920	540/10	2 3/16	2	3 1/4	2	5	A	1-4
A-4122	38	16:1, 4.9:1	29,700@15 madc	2450	9/850	2 3/16	2	3 1/4	1 3/4	5	A	1-0
A-4111	39	17:1, 3.4:1	31,500@18 madc	1800	737/4.0	3/8	2 1/4	3 1/16	2	5	A	1-10
A-2851	40	21:1, 2.8:1	6,000@20 madc	137	177/0.8	3/8	2 1/4	3 1/16	2	4	A	1-10
A-4088	41	24:1, 2.8:1	10,000@20 madc	450	180/0.9	3/8	2 1/4	3 1/16	2 1/8	6	A	2-0
A-3080	42	25:1, 50:1	18,000@25 madc	580	2.5/1.5	3/8	3	3 3/8	2 1/8	7	B	2-2
A-3081	43	25:1, 50:1	18,000@25 madc	900	3.6/1.8	3/8	2 1/4	3 1/16	2 1/8	5	A	2-0
A-2850	44	32:1, 2.8:1	9,000@20 madc	435	200/6.3	2 3/16	2	3 1/4	2	4	A	1-4

Vertical Blocking Oscillator

Provides vertical sweep in TV circuits and in typical blocking oscillator circuits to generate pulses for driving grids of the vertical discharge tubes.

Merit No.	Ref. No.	Turns Ratio Pri./Sec.	Dimensions - Inches				Mtg. Type	Shipping Weight Lb.-Oz.
			Mtg. Centers	H	W	D		
A-3004	45	1:1.5	1 3/4	1 3/4	2	1 1/2	B	0-6
A-3001	46	Sec. #1 2.08:1 Sec. #2 1:1	2 3/8	1 1/8	2 3/16	1 1/2	A	1-10
A-3006	47	1:3.5	1 3/4	1 3/8	2 1/8	3/8	A	0-4
A-3003	48	1:1.414	1 3/4	1 3/8	2 1/8	7/8	A	0-4
A-3000	49	1:1.414	2	1 3/8	2 3/8	1 1/4	A	0-6
A-4003	50	1:1.414	1 3/16	1 1/16	1 1/16	1 3/16	JL	0-4
A-4000	51	1:1.414	1 1/16	1 1/16	2 1/16	1 1/2	J	0-5
A-3011	52	1:1.5	2	1 3/8	2 3/8	1 1/4	A	0-4

Merit has long had an excellent record of producing transformers of all types that are completely reliable as exact replacements in radio or television receivers.

The following pages list power transformers in their order of voltage rating. All units have been conservatively designed to meet the requirements of underwriters laboratories.

Merit is continually striving to improve its products through the use of better insulating materials, impregnating compounds and production methods to provide a still better product at lower cost.

It is felt that the following Power Transformers listed in this portion of the catalog will completely cover the requirements of the distributors of transformers for all types of electronic equipment.

POWER TRANSFORMERS

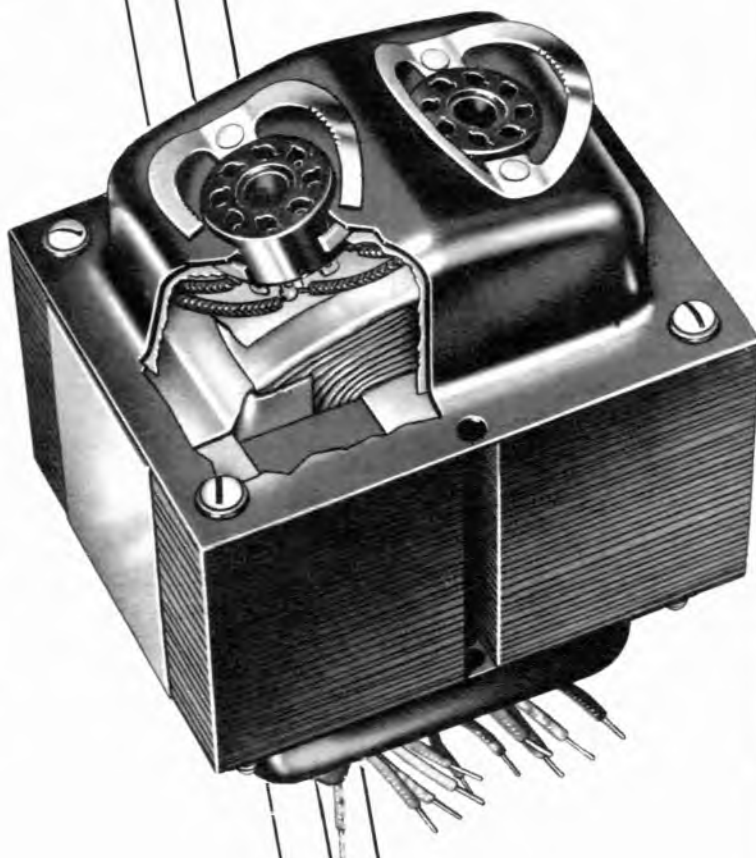



PLATE AND FILAMENT POWER TRANSFORMERS



A



BS



C



CD



CSS

PRIMARY 117VAC 60 CYCLES

Merit No.	Ref. No.	Plate Supply		Rectifier		Filament Wdgs.		Mtg. Type	Dimensions - Inches				Shpg. Wt. Lbs. Oz.	
		Volts	DCMA	Volts	Amps	Volts	Amps		Mtg. Centers	H	W	D		
P-3044	1	96	145			6.3	6.45	C	2 3/8	3	3	2 1/2	3-0	
P-4083	2	110	700			6.3	7.5	C	2 1/4 x 2 1/8	3 1/8	3 3/8	2 1/8	5-6	
P-4082	3	110	900			6.3	11.0	Z	2 1/2 x 2 1/4	3 1/8	3 3/4	3 1/8	5-6	
P-2879	4	117	280			6.3	9.5	C	3 1/8 x 4 1/8	5	4 3/8	3 3/4	9-0	
						6.3	1.2							CD
						6.3	0.6							
P-2871	5	119.5 *	380			6.3	6.5	D	2 1/4 x 2 1/2	3 1/2	2 1/8	3 3/8	4-8	
P-4109	6	120	40			6.3	1.2	BS	2 3/8	2 3/8	2 1/8	2 1/8	1-6	
P-3045	7	120	50			6.3	2.0	A	3 1/8	2 1/8	3 1/8	2 1/8	1-7	
P-3144	8	123 *	200			6.3	10.3	D	2 x 2 1/8	3 1/8	2 1/2	3 1/2	4-0	
P-4131	8A	125	15			6.3	.6	B	2	2	2 3/8	1 1/8	0-10	
P-3079	9	140 *	300			6.3	9.0	C	3 x 3 3/4	3 3/4	4 1/2	3 3/4	8-4	
						6.3	2.0							
						6.3	1.0							
P-3206 §	10	125	300			6.3 c.t.	0.5	A	2 3/8	1 3/8	2 1/8	1 1/8	0-10	
P-3046	11	150	25			6.3 c.t.	2.0	BS	2	2	2 1/2	1 3/8	0-12	
P-4141C	11 A	155	450			6.3	2.0	C	3 1/8 x 3 1/8	4 1/8	3 1/2	4 3/8	12-0	
					6.3	13.5								
P-2843 §	12	185	260			86	0.6	C	1 3/4 x 2 1/8	2 3/4	2 3/4	2 1/4	3-0	
P-4121	12A	125-125	25			6.3	1.0	A	2 3/8	2 3/8	2 7/8	1 3/4	1-0	
P-2892 ¶	13	214-214	240	5	3.0	6.3	8.0	C	3 3/8 x 4 1/8	3 3/8	4 1/2	3 3/4	8-10	
P-3062	14	239-239	240	5	6.0	12.6 c.t.	4.4							CD
P-2949	15	240-240	40	5	2.0	6.3 c.t.	2.0	C	2 3/4 x 3 1/8	4 3/4	4 1/8	3 3/8	8-6	
P-3149	16	240-240	40	5	2.0	6.3 c.t.	2.0	C	2 x 2 1/2	2 1/2	3	2 1/2	2-6	
P-3047	17	240-240	50			6.3	2.5	D	2 x 1 1/8	3 1/8	2 3/8	2 3/8	2-7	
P-3147	18	240-240	50			6.3	2.5	C	2 x 2 1/2	2 1/2	3	2 1/2	2-0	
P-2958	19	240-240	50	5	2.0	6.3	2.6	D	2 x 2 1/2	3	3	2 1/2	2-4	
P-2958	19	240-240	50	5	2.0	6.3	2.6	C	2 x 2 1/2	3	3	2 1/2	2-10	
P-2830	20	253-253	300	5	6.0	6.3	6.0	C	3 x 3 3/4	4 7/8	4 1/2	3 3/4	11-0	
P-2893	21	260-260	70	5	2.0	6.3	6.0							
P-3051	22	260-260	70	5	2.0	6.3 c.t.	1.25							
P-3048	23	260-260	90			6.3	4.7	C	2 x 2 1/2	3	3	2 1/2	3-0	
P-3148	24	260-260	90			6.3	4.7	D	2 x 2 1/2	3 1/8	3	2 1/2	3-0	
P-2883	25	260-260	380	5	6.0	12.6 c.t.	6.4	K	2 x 2 1/2	3 3/8	3	2 1/2	3-2	
P-3060	26	265-265	260	5	3.0			D	2 x 2 3/8	3 1/8	2 5/8	3 1/4	3-6	
P-3135	27	265-265	300	5	6.0	12.6 c.t.	5.5	C	3 x 4 1/4	5 3/4	3 3/4	4 3/8	12-6	
P-3083 †	28	265-265	300	5	6.0	12.6 c.t.	4.7	C	2 1/8 x 3 3/8	4	3 3/4	3 3/8	6-2	
P-2841	29	265-265	320	5	6.0	12.6 c.t.	4.9	K					11-6	
P-2885	30	268-268	260	5	3.0	6.3	8.0	C	3 x 3 3/4	5 1/4	4 1/2	3 3/4	11-14	
								R	3 x 3 3/4	3 3/4	4 1/2	4 3/4	10-0	
								D	2 3/4 x 2 1/8	4 3/8	3 1/8	4	7-6	
P-3076	32	270-270 180-180	300 200 †	5	3.0	6.3	6.5	C	3 x 3 3/4	3 3/4	4 1/2	5	13-8	
						6.3	6.5							
P-2870	33	270-270	200	5	3.0	6.3	8.5	C	2 1/8 x 3 3/8	3 1/2	3 3/4	3 1/8	5-8	
														CD

* Primary Tap * To convert to mtg. type CD, attach 2-BR-263 Mtg. Brackets, available from your Distributor.
 § Autotransformer - † Primary tapped at 117 V and 130 V - ■ Can be used in series for 12.6 volts c.t.
 ‡ Primary tapped at 117 V and 110 V - † Max. MA High Tap Only, 435; Low Tap Only, 500.

PLATE AND FILAMENT POWER TRANSFORMERS



PRIMARY 117VAC 60 CYCLES

Merit No.	Ref. No.	Plate Supply		Rectifier		Filament Wdgs.		Mtg. Type	Dimensions - Inches				Shpg. Wt. Lbs. Oz.
		Volts	DCMA	Volts	Amps	Volts	Amps		Mtg. Centers	H	W	D	
P-2872	1	270-270	260	5	3.0	6.3	10.6	C • CD	2 1/2 x 3 1/8	3 5/8	3 3/4	3 1/8	6.6
P-2873	2	270-270	265	5	3.0	12.6 c.t.	5.1		3 x 3	3 1/8	3 3/4	3 5/8	6.6
P-3136	3	270-270	270	5	3.0	12.6 c.t.	4.4	C • CD	2 1/2 x 3 1/8	4	3 3/4	3 1/8	6.8
									3 x 3	3 1/8	3 3/4	4	8.8
P-3154	4	275-275	50	5	2.0	6.3	2.6	D	2 x 2 3/16	3 1/8	2 5/8	3 1/8	3.5
									P-2874	5	275-275	210	5
P-3049	6	275-275	270	5	3.0	6.3	12.6	CD	3 x 2 3/4	3 1/8	3 3/4	3 3/4	11.0
P-2839	7	276-276	290	5	6.0	6.3	11.5	CSS	3 3/16 x 4	6	4 1/2	3 3/4	13.8
						6.3	3.6						
P-3084	8	278-278	220	5	3.0	6.3	8.0	R	2 3/4 x 3 1/16	3 7/16	4 1/8	4 3/16	9.0
P-3052	9	280-280	90	5	2.0	6.3	5.0	C	2 1/4 x 2 1/16	3 3/4	3 3/8	2 1/16	4.2
P-2849	10	280-280	205	5	3.0	6.3	9.0	C	3 x 3 1/16	3 3/4	4 1/8	3 7/16	8.0
P-2881	11	280-280	250	5	3.0	6.3	9.5	R	1 3/4 x 2 1/2	3 3/4	3 1/8	3 7/16	6.8
P-2897	12	280-280	250	5	3.0	6.3	8.5	R	2 1/2 x 2 1/2	3 1/2	4 1/8	3 1/16	7.8
P-2878	13	280-280	265	5	5.0	6.3	7.1	C •	3 3/16 x 4 1/16	5 1/4	4 5/8	3 3/4	12.0
						6.3	1.2						
P-2876	14	280-280	290	5	5.0	6.3	8.5	C •	3 x 3 3/4	4 1/16	4 1/2	3 3/4	12.0
						6.3	1.2						
P-3058	15	280-280	315	5	6.0	6.3	11.5	C •	3 3/16 x 4 1/16	5 1/2	4 1/2	3 3/4	11.8
P-2882	16	281-281	250	5	3.0	6.3	9.5	Z •	2 1/2 x 2 1/2	3 7/16	4 1/8	4 1/16	8.0
									CD	3 x 3 1/4	4 1/4	3 1/2	4 1/4
P-3056	17	282-282	240	5	3.0	6.3	8.7	C •	3 3/16 x 4 1/16	4 1/2	4 1/2	3 3/4	10.0
P-2837	18	282-282	250	5	3.0	6.3	9.3	CS	3 x 3 3/4	5 1/2	4 1/2	3 3/4	10.8
						6.3	1.25						
P-2832	19	285-285	220	5	3.0	7.0	0.475	Z	3 x 3 5/8	3 3/4	4 1/8	3 1/2	7.0
P-2862	20	285-285	300	5	3.0	12.6 c.t.	5.6	D	2 1/2 x 3 1/8	3 1/8	3 1/8	4 1/4	8.0
P-2842	21	286-286	210	5	3.0	6.3	8.0	C	2 3/4 x 3 1/2	4	4 1/8	3 3/16	8.0
P-2867	22	290-290	230	5	3.0	6.3	12.0	C	3 1/16 x 2 3/4	4 3/4	4 1/8	3 7/16	11.0
P-3134	23	290-290	270	5	3.0	12.6 c.t.	4.8	D	3 x 3 7/8	4 5/8	3 3/4	4 1/8	8.4
P-3064 †	24	290-290	340	5	6.0	12.6 c.t.	6.1	C	3 x 3 3/4	5 1/4	4 1/2	3 3/4	13.0
		275-275	310										
P-2844 †	25	292-292	285	5	3.0	6.3	8.5	C	2 3/4 x 3 1/2	4 3/4	3 1/2	4 1/4	8-14
P-2836	26	300-300	250	5	4.0	6.3	11.7	C	2 3/4 x 3 7/16	5	4 1/8	3 7/16	11.0
						6.3	1.2						
P-3077	27	300-300	250	5	3.0	6.3	9.0	C	3 x 3 3/4	4 1/4	4 1/2	3 3/4	10.2
P-3055	28	300-300	400	5	6.0	6.3	10.0	C	3 x 3 3/4	5 5/8	4 1/2	3 3/4	14.4
						6.3	4.5						

* To convert to mtg. type CD, attach 2-BR-263 Mtg. Brackets, available from your Distributor.

† Primary tapped at 117 V and 110 V



PLATE AND FILAMENT POWER TRANSFORMERS



PRIMARY 117VAC 60 CYCLES

Merit No.	Ref. No.	Plate Supply		Rectifier		Filament Wdgs.		Mtg. Type	Dimensions - Inches				Shpg. Wt. Lbs. Oz.
		Volts	DCMA	Volts	Amps	Volts	Amps		Mtg. Centers	H	W	D	
P-2833	1	305-305	300	5	6.0	{ 6.3 6.3 6.3 ■ 6.3 ■	{ 0.9 1.95 6.4 6.4	C	3 x 3 3/4	3 3/4	4 1/2	5 3/8	13-5
P-3073	2	{ 322-322 205-205	180 † 70	5	3.0	{ 6.3 6.3	{ 10.0 2.7	CS	3 x 3 3/4	5 7/8	4 1/2	3 3/4	12-5
P-2847	3	306-306	460	5	6.0	{ 6.3 46.0	{ 11.4 .15	C	3 1/2 x 4 3/8	4 3/8	5 1/4	4 1/8	14-0
P-2950	4	325-325	40	5	2.0	6.3 c.t.	2.0	C	2 x 2 1/2	2 7/8	3	2 1/2	2-14
P-3150	5	325-325	40	5	2.0	6.3 c.t.	2.0	D	2 x 1 1/8	3 1/8	2 5/8	2 1/8	2-13
P-2951	6	325-325	70	5	3.0	6.3 c.t.	3.5	C	2 x 2 1/2	3 3/8	3	2 1/2	3-6
P-3151	7	325-325	70	5	3.0	6.3 c.t.	3.5	D	2 1/2 x 1 1/8	3 7/8	3 3/8	3 3/8	4-2
P-2884	8	328-328	270	5	3.0	12.6 c.t.	5.2	D	3 x 3 1/2	4 1/8	3 3/4	4	9-0
P-2838	9	333-333	250	5	3.0	{ 6.3 ■ 6.3 ■ 6.3 6.3	{ 5.8 5.8 3.3 0.85	CS	3 x 3 3/4	6 1/8	4 1/2	3 3/4	15-0
P-2877	10	340-340	300	5	6.0	{ 6.3 6.3	{ 10.1 2.4	C CD	3 3/8 x 4 1/8 3 x 4 1/8	5 3/4 4 3/8	4 5/8 3 3/4	3 3/4 5 3/4	13-0
P-2957	11	350-350	50	5	2.0	6.3 c.t.	2.6	C	2 1/4 x 2 1/8	3	3 3/8	2 1/8	3-0
P-3160	12	350-350	50	5	2.0	6.3 c.t.	2.6	D	2 1/4 x 2	3 1/2	2 1/8	3 1/8	3-2
P-2966	13	350-350	70	5	3.0	{ 2.5 c.t. 2.5 c.t.	{ 9.0 3.5	C	2 1/4 x 2 1/8	2 1/8	3 3/8	3 5/8	4-10
P-2967	14	350-350	90	5	3.0	2.5 c.t.	12.5	C	2 1/2 x 3 1/8	3 1/8	3 3/4	4 1/8	6-12
P-2952	15	350-350	90	5	3.0	6.3 c.t.	3.5	C	2 1/4 x 2 1/8	4	3 3/8	2 1/8	5-0
P-3152	16	350-350	90	5	3.0	6.3 c.t.	3.5	D	2 3/4 x 2 3/8	4 1/4	3 3/8	3 3/8	5-0
P-3153	17	350-350	110	5	3.0	6.3 c.t.	4.5	D	3 x 2 1/4	4 5/8	3 1/8	3 3/8	5-12
P-2953	18	350-350	120	5	3.0	6.3 c.t.	4.5	C	2 1/2 x 3 1/8	3 1/8	3 3/4	3 1/8	6-0
P-3173	19	350-350	150	5	3.0	6.3	6.5	D	2 1/2 x 2 7/8	3 7/8	3 1/4	4 1/8	6-12
P-3054	20	{ 350-350 220-220	{ 180 † 70 †	5	6.0	{ 6.3 6.3	{ 10.2 2.7	C	3 x 3 3/4	3 3/4	4 1/2	5 3/8	13-4
P-3165	21	350-350	200	{ 5 5	{ 2.0 3.0	{ 6.3 6.3	{ 0.6 7.0	D	3 x 3 7/8	4 5/8	3 3/4	5	11-10
P-3069	22	350-350	225	5	3.0	{ 6.3 6.3	{ 10.0 2.7	CS	3 x 3 3/4	5 1/8	4 1/2	3 3/4	9-8
P-3070	23	350-350	225	5	3.0	{ 6.3 6.3	{ 10.0 2.7	C	3 x 3 3/4	4	4 1/2	3 3/4	9-0
P-3057	24	350-350	290	5	6.0	{ 6.3 6.3 6.3	{ 9.5 2.4 1.5	C CD	3 3/8 x 4 1/8 3 x 4 3/8	6 1/4 4 1/2	4 1/2 3 3/4	3 3/4 5 3/4	15-0
P-3071	25	360-360	180	5	3.0	6.3	9.0	CS	2 3/4 x 3 3/8	3 1/8	4 1/8	5	9-10
P-3072	26	360-360	180	5	3.0	6.3	9.0	C	2 3/4 x 3 3/8	3 1/8	4 1/8	4 3/8	9-6
P-2887	27	{ 356-356 268-268	{ 180 148	{ 5 5	{ 3.0 3.0	12.6 c.t.	6.0	D	4 x 3	4 3/4	3 7/8	5	13-0
P-2834	28	360-360	225	5	6.0	{ 6.3 6.3 6.3	{ 1.2 3.0 9.0	C	3 x 3 3/4	4 7/8	4 1/2	3 3/4	11-4
P-3059	29	360-360	250	{ 5 5	{ 2.0 3.0	{ 6.3 6.3	{ 2.7 9.0	C	3 x 3 3/4	5 1/8	4 1/2	3 3/4	12-5

† Max. MA High Tap Only, 220; Low Tap Only, 325

■ Can be used in series for 12.6 volts c.t.

* To convert to mtg. type CD, attach 2-BR-263 Mtg. Brackets, available from your Distributor.

PLATE AND FILAMENT POWER TRANSFORMERS



PRIMARY 117VAC 60 CYCLES

Merit No.	Ref. No.	Plate Supply		Rectifier		Filament Wdgs.		Mtg. Type	Dimensions - Inches				Shpg. Wt. Lbs. Oz.	
		Volts	DCMA	Volts	Amps	Volts	Amps		Mtg. Centers	H	W	D		
P-3063	1	360-360	250	5 5	3.0 2.0	6.3 6.3	9.0 1.2	C	3 3/8	4 1/8	5 1/2	4 5/8	3 1/8	11-10
P-3078	2	360-360	275	5	3.0	6.3 6.3 or 5	9.0 1.5 2.7	C	3 x 3 3/4	5 1/4	4 1/2	3 3/4	11-8	
P-3179	3	362-362 210-210	210 120	5 5	3.0 2.0	12.6 c.t.	6.0	D	3 x 4 1/4	4 5/8	3 1/8	5 1/8	12-12	
P-3061	4	362-362	295	5 5	6.0 2.0	12.6 c.t.	5.0	C	3 3/8 x 4 1/8	3 1/8	4 5/8	6 5/8	15-8	
P-2875	5	373-373	190	5	3.0	6.3 6.3	7.8 1.2	C CD	3 x 3 3/4 3 x 3 1/2	4 1/8 4 1/2	4 1/2 3 3/4	3 3/4 4 1/8	10-6	
P-2954	6	375-375	150	5	3.0	6.3 c.t.	5.0	C	2 1/2 x 3 1/8	4 5/8	3 3/4	3 1/8	7-6	
P-2886	7	375-375 220-220	190 100	5 5	3.0 2.0	12.6 c.t.	6.0	D	3 x 3 3/8	4 5/8	3 3/4	4 5/8	11-6	
P-3053	8	375-375 325-325	170 † 130	5 5	3.0 3.0	6.3 6.3 or 5	7.0 7.0 2.7	C	3 x 3 3/4	5 5/8	4 1/2	3 3/4	14-8	
P-3066	9	375-375 325-325	170 † 130	5 5 5	3.0 3.0 2.0	12.6 c.t. 6.3	5.0 2.6	C	3 x 3 3/4	5 3/8	4 1/2	3 3/4	13-2	
P-3169	10	390-390 325-325	160 130	5 5 5	3.0 3.0 2.0	6.3 6.3	8.4 4.0	D	3 x 3 5/8	4 5/8	3 1/8	4 1/8	11-10	
P-2968	11	400-400	110	5	3.0	2.5 c.t. 2.5 c.t.	15.0 3.5	C	3 x 3 3/4	3 3/4	4 1/2	3 1/8	7-12	
P-2891	12	397-397 tap 51	310	5	6.0	5.0 6.3	2.0 9.3	D	3 5/8 x 3 1/4	5 1/8	4 7/8	5 1/8	11-0	
P-3174	13	405-405 325-325	240 † 200	5 5 5	3.0 3.0 3.0	6.3 6.3	6.0 6.0 2.6	D	3 5/8 x 3 7/8	5 1/8	4 7/8	5 5/8	16-8	
P-2955	14	400-400	200	5	3.0	6.3 c.t.	5.0	C	3 x 3 3/4	4 1/8	4 1/2	3 3/4	9-0	
P-3155	15	400-400	200	5	3.0	6.3 c.t.	5.0	D	3 x 3 3/8	4 5/8	3 1/8	4 1/4	9-6	
P-3067	16	400-400 212-212	220 † 90	5 5	3.0 2.0	6.3 6.3	10.0 2.6	C	3 x 3 3/4	5 3/8	4 1/2	3 3/4	13-9	
P-2835	17	420-420	250	5	3.0	6.3 6.3 6.3	8.0 3.0 1.2	C	3 x 3 3/4	5 1/8	4 1/2	3 3/4	12-0	
P-2956	18	435-435 80 volt Bias tap	250	5 2.5	3.0 10.0	6.3 c.t. 6.3 or 5	3.0 3.0	C	3 x 3 3/4	4 3/4	4 1/2	3 3/4	11-8	
P-3156	19	435-435 80 volt Bias tap	250	5 2.5	3.0 10.0	6.3 c.t. 6.3 or 5	3.0 3.0	D	3 x 3 1/8	4 5/8	3 1/8	4 7/8	11-4	
P-3170	20	1750	5	2.5	2.0	6.3 or 2.5	0.9 2.0	D	2 x 2 1/8	3 1/8	2 5/8	2 7/8	2-12	
P-3171	21	2500	5	2.5	2.0	6.3 or 2.5	3.0 3.0	D	2 1/2 x 2 5/8	3 7/8	3 3/8	3 3/8	4-4	

* To convert to mtg. type CD, attach 2-BR-263 Mtg. Brackets, available from your Distributor.

P-3053 & P-3066 P-3067

† Max. MA High Tap Only 320 300
Max. MA Low Tap Only 340 340



FILAMENT POWER TRANSFORMERS

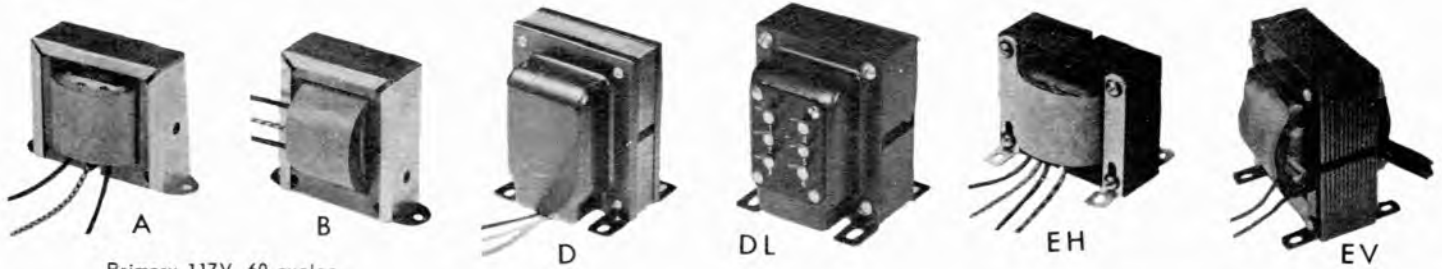

Primary 117V, 60 cycles.

Merit No.	Ref. No.	Sec. Volts	Sec. Amp.	Insulation Volts RMS	Dimensions - Inches				Mtg. Type	Shpg. Wt. Lbs. Oz.
					Mtg. Centers	H	W	D		
P-2939	1	2.5 c.t.	5	2500	2 ¹³ / ₁₆	2	3 ¹ / ₈	1 ⁵ / ₈	A	1-4
P-2940	2	2.5 c.t.	10	7500	3 ¹ / ₈	3	3 ³ / ₈	2 ¹ / ₄	B	2-2
P-3040	3	5.0 c.t.	3	2500	2 ¹³ / ₁₆	2	3 ¹ / ₄	2 ¹ / ₈	A	1-4
P-2941	4	5.0 c.t.	6	2500	3 ¹ / ₈	2 ¹ / ₄	3 ¹¹ / ₁₆	2 ¹ / ₈	A	1-12
P-2942	5	5.0 c.t.	15	10000	3 x 2 ¹ / ₂	4 ¹ / ₂	3 ³ / ₄	3 ¹ / ₂	EV	6-12
P-2943	6	5.0 c.t.	30	2500	2 ¹ / ₂ x 2 ⁷ / ₈	3 ⁷ / ₈	3 ³ / ₁₆	4 ⁷ / ₈	DL	6-4
P-2964	7	6.3	0.6	1500	2	1 ³ / ₈	2 ¹ / ₈	1 ¹ / ₄	A	0-6
P-4135	8	6.3 c.t.	.6	1500	2	1 ³ / ₈	2 ³ / ₈	1 ³ / ₈	A	0-6
P-2846	9	6.3	.7	1500	2	1 ³ / ₈	2 ³ / ₈	1 ³ / ₈	A	0-10
■ P-2888	10	6.3	.85	1500	2 ³ / ₈	1 ⁵ / ₈	2 ¹³ / ₁₆	1 ⁷ / ₈	A	0-10
P-2944	11	6.3 c.t.	1.2	2500	2 ³ / ₈	1 ⁵ / ₈	2 ¹³ / ₁₆	1 ¹ / ₂	A	0-10
P-3074	12	6.3	1.2	5000	2 ¹³ / ₁₆	2	3 ³ / ₄	2	A	1-4
P-2945	13	6.3 c.t.	2	2500	2 ¹³ / ₁₆	2	3 ¹ / ₂	1 ⁵ / ₈	A	1-0
P-2946	14	6.3 c.t.	3	2500	2 ¹³ / ₁₆	2	3 ¹ / ₄	1 ⁷ / ₈	A	1-6
P-2947	15	6.3 c.t.	6	1500	3 ¹ / ₈	3	3 ³ / ₈	2 ¹ / ₄	B	2-4
P-3050	16	6.3	8.8	1500	2 x 2 ¹ / ₁₆	3 ¹ / ₈	2 ¹ / ₂	3	D	3-0
P-2948	17	6.3 c.t.	10	2500	2 ¹ / ₄ x 2 ³ / ₈	3 ¹ / ₁₆	2 ¹³ / ₁₆	2 ⁷ / ₈	EV	3-10
P-3141	18	6.3	10.3	1500	2 x 2 ¹ / ₁₆	3 ³ / ₈	2 ¹ / ₂	3 ¹ / ₈	D	3-5
P-2845	19	6.3	13	1500	2 ¹ / ₄ x 2 ³ / ₈	3 ¹ / ₂	2 ¹³ / ₁₆	3 ¹ / ₂	D	5-0
P-2864	20	6.7	9.6	2500	2 ¹ / ₄ x 2 ¹ / ₈	3 ¹ / ₁₆	2 ¹ / ₂	3 ³ / ₈	D	3-10
P-2960	21	7.5 c.t.	4	2500	2 ¹³ / ₁₆	2 ¹ / ₈	3 ¹ / ₈	1 ⁷ / ₈	B	1-12
P-3143	22	7.5 c.t.	8	2500	2 ¹ / ₄ x 2	3 ¹ / ₂	2 ¹³ / ₁₆	3 ¹ / ₈	D	3-8
P-3145	23	10.0 c.t.	5	2500	2 ¹ / ₄ x 2	3 ¹ / ₂	2 ¹³ / ₁₆	3	D	3-1
P-3146	24	10.0 c.t.	10	3000	2 ¹ / ₂ x 2 ⁷ / ₁₆	3 ³ / ₈	3 ³ / ₁₆	3 ³ / ₈	D	5-6
P-2959	25	12.6 c.t.	2	2500	2 ¹³ / ₁₆	2	3 ¹ / ₄	2	A	1-4
P-2889	26	13.2 c.t.	5.7	1500	2 ¹ / ₄ x 2 ⁵ / ₈	3 ¹ / ₂	2 ¹³ / ₁₆	3 ³ / ₈	D	5-0
P-4128	27	24 c.t.	1	1500	2 ¹³ / ₁₆	1 ¹⁵ / ₁₆	3 ¹ / ₁₆	2	A	1-3
P-2962	28	25.2	1	2500	2 ¹³ / ₁₆	2	3 ¹ / ₄	1 ⁷ / ₈	A	1-6
P-4126	29	25.2 c.t.	2	1500	3 ³ / ₁₆	2 ⁵ / ₈	4	2 ¹ / ₄	A	2-2
P-4127	30	26.8 c.t.	1	1500	2 ¹³ / ₁₆	1 ¹⁵ / ₁₆	3 ⁵ / ₁₆	2	A	1-6

P-3043	31	{ 5.0 6.3 6.3 }	{ 3 3.5 10 }	3000	2 ¹ / ₂ x 3 ¹ / ₈	3 ¹ / ₈	3 ³ / ₄	4 ¹ / ₈	C	5-6
P-2961	32	{ 6.3 c.t. 6.3 c.t. }	{ 3 3 }	2500	3 ¹ / ₈	3	3 ³ / ₈	2 ¹ / ₄	B	2-6
P-2890	33	{ 6.3 † 6.3 6.3 }	{ 7.2 1.2 .6 }	2500	2 x 2 ¹ / ₄	3	2 ¹ / ₂	3 ¹ / ₈	D	4-0
P-3082	34	{ 6.3 6.3 }	{ 8 3 }	{ 5000 2500 }	3 ¹ / ₈	3 ¹ / ₁₆	3 ³ / ₁₆	2 ¹ / ₂	A	2-8
P-3142	35	{ 12.6 6.3 6.3 }	{ .6 7.8 1.2 }	2500	2 x 2 ¹ / ₄	3	2 ¹ / ₂	3 ³ / ₈	D	4-0
P-2863	36	{ 6.7 6.7 }	{ 4.1 6.6 }	1500	2 ¹ / ₄ x 2 ¹ / ₈	3	2 ¹ / ₂	3 ¹ / ₈	D	3-14
P-2848	37	{ 25.8 † 6.7 6.7 }	{ .3 6.5 .9 }	1500	2 x 1 ¹³ / ₁₆	3 ¹ / ₈	2 ¹ / ₂	3	D	2-15
P-2866	38	{ 6.7 6.7 25.2 }	{ 6.4 6 .003 }	2500	2 ¹ / ₂ x 2 ¹ / ₈	3 ¹ / ₈	3 ¹ / ₄	3 ¹ / ₈	D	4-8
P-2963	39	{ 12.6 12.6 }	{ 3.5 3.5 }	2000	2 ¹ / ₄ x 2 ¹ / ₂	3 ¹ / ₂	2 ¹³ / ₁₆	3 ⁵ / ₈	D	4-10

■ Autotransformer

† Primary tap

PLATE AND FILAMENT POWER TRANSFORMERS

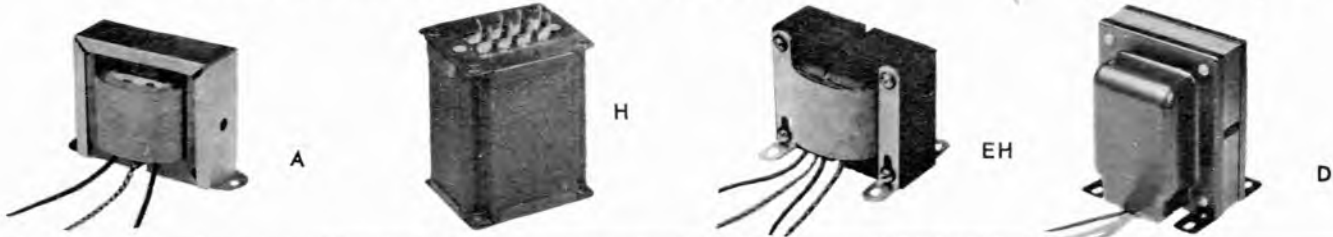

Merit No.	Ref. No.	Sec. Rms. Volts	Sec. DC Volts	Sec. DC MA	Dimensions - Inches				Mtg. Type	Shpg. Wt. Lbs.Oz.
					Mtg. Centers	H	W	D		
P-3178	1	415-415	300	200	2 1/2 x 2 1/4	3 3/8	3 3/8	3 3/8	D	4-15
P-3175	2	550-550	400	150	2 1/4 x 2 3/4	3 3/8	3	3 3/8	D	5-4
P-3157	3	660-660 † 550-550	500 400	250	3 x 3 3/8	4 3/8	3 1/8	4 3/8	D	10-0
P-3158	4	1080-1080 500-500	1000 ‡ 400	125 150	3 x 3 3/8	4 3/8	3 1/8	5	D	11-12
P-3159	5	900-900 800-800	750 600	225	3 x 4 1/8	4 3/8	3 1/8	5 1/8	D	12-6
P-3168	7	2100-2100 1800-1800	1750 1500	300	3 3/8 x 6 1/4	4 3/4	7	6 1/8	EH	29-0
P-4062	8	2900-2900 2385-2385	2500 2000	300	5 1/4 x 5 3/4	8 1/4	6 1/8	6 1/8	H	43-13

Plate

For small or medium powered amateur or commercial and industrial equipment transmitters. Designed to operate continuously at 50° C or less.

DC voltage ratings are approximate values obtained at output of a choke input filter.

‡ For dual operation with simultaneous use of both sec. ratings.

Max. one winding only 275 M.A.

† Has 40V. Bias Tap.

Merit No.	Ref. No.	Plate Volts AC	DC MA	Filament Wdgs. Volts Amps.	Dimensions - Inches				Mtg. Type	Shpg. Wt. Lbs.Oz.
					Mtg. Centers	H	W	D		
P-3095	9	600-600	200	{ 5 3 } { 6.3 3 } { 6.3 3 }	3 x 3 3/8	4 3/8	3 1/8	4 1/4	D	9-6
P-3166	10	400-400	300	{ 5 6 } { 5 3 } { 12.6c.t. 10 }	3 1/2 x 4 1/4	5 3/8	4 1/2	5 3/4	D	18-3

Plate & Filament

To provide plate and filament power for small transmitters and industrial equipment.

Merit No.	Ref. No.	Secondary Volts	Secondary Amps.	Insulation Volts RMS	Dimensions - Inches				Mtg. Type	Shpg. Wt. Lbs.Oz.
					Mtg. Centers	H	W	D		
P-3088	11	13	12	1500	3 1/2 x 2 3/8	3 3/8	4 1/8	3 3/4	EH	6-3
ΔP-3085	12	13* 13*	3 3	1500	2 3/8 x 2 3/8	2 3/8	3 3/8	2 3/4	EH	3-4
P-3093	13	18* 18*	10 10	1500	4 1/2 x 3 1/2	4 3/8	5 1/4	4 3/4	EH	15-8
P-3086	14	104c.t.	3	1500	4 1/4 x 3	4 3/8	5 1/4	4 1/4	EH	15-0
P-4142	15	10 20 c.t. 40 c.t.	.035	1500	2	1 3/8	2 3/8	1 3/8	A	.5
P-4143	16	10 20 c.t. 40 c.t.	.1	1500	2 3/8	1 3/8	2 3/8	1 3/8	A	.7
P-4144	17	10 20 c.t. 40 c.t.	.3	1500	3 3/8	2 3/8	3 1/8	2	A	1.5
P-4145	18	10 20 c.t. 40 c.t.	.75	1500	3 3/8	2 3/8	4	2 1/4	A	2.4
P-4146	19	10 20 c.t. 40 c.t.	1.0	1500	2 x 2 1/4	3 3/8	2 3/8	3	D	3.25

Rectifier

For use with Selenium Rectifiers to suit a variety of low voltage industrial applications.

* Windings may be connected in series or parallel.

Δ Matches Selenium Rectifiers in Federal's "All-Purpose" Assembly Kit.

For 13V @ 3A, 13V @ 3A, 13V @ 6A, or 26 Vc.t. @ 3A.

● Tapped primary to produce lower voltages.

Merit No.	Ref. No.	Rect. CT	Volts Under Load	DC Output Res. Load		DC Output Cap. Load		Dimensions - Inches				Mtg. Type	Shpg. Wt. Lbs.Oz.
				Volts	Amps	Volts	Amps	Mtg. Centers	H	W	D		
				P-4129	20	C. T. Bridge	11.7 to 29.4 11.1 to 28.5	11.2 23.0	2.0 1.25	13.8 30.0	2.0 1.25		
P-4130	21	C. T. Bridge	12.0 to 29.8 12.0 to 29.8	11.1 24.3	4.0 2.0	14.7 33.0	4.0 2.0	2 1/4 x 2 3/8	3 3/8	2 3/8	3 1/2	EV	3-8

† Tapped primaries provide for secondary voltages.

(See instruction sheet packaged with unit.)

Merit No.	Ref. No.	Input Voltage	Output		Dimensions - Inches				Mtg. Type	Shpg. Wt. Lbs.Oz.
			Voltage	Amps.	Mtg. Centers	H	W	D		
P-3097	22	6.3	12.6 or 6.3	1 1.2	2 3/8	1 3/8	3 3/8	2	A	1-4

To isolate the damper tube filament from all other filaments. Operates quietly and efficiently.

TV Isolation (Damper) Filament Transformer



POWER LINE TRANSFORMERS

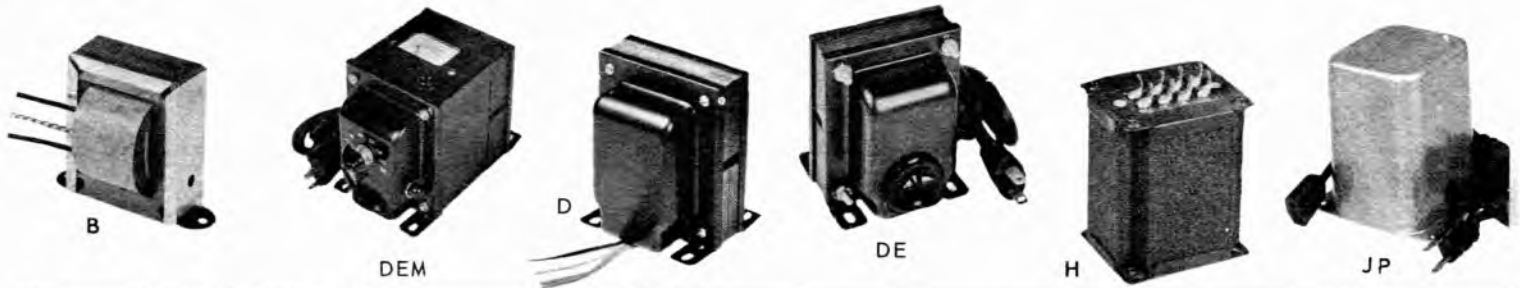

Line Voltage Regulators

Used to adjust line voltages of 65-75-90-100-115-130-145 volts to constant 115V at 50/60 cycles for radio, TV sets, or appliances.

Merit No.	Ref. No.	Input Voltage	Output Voltage [▲]	Watts	Dimensions - Inches				Mtg. Type	Shpg. Wt. Lbs. Oz.
					Mtg. Centers	H	W	D		
P-3138	1	Dependent on line voltage	Dependent on line voltage and position of switch	350	3 x 5 $\frac{1}{8}$	4 $\frac{7}{8}$	3 $\frac{1}{16}$	7 $\frac{1}{2}$	DEM	10-10
P-3139	2	Dependent on line voltage	Dependent on line voltage and position of switch	750	3 $\frac{1}{2}$ x 6 $\frac{1}{8}$	5 $\frac{5}{8}$	4 $\frac{1}{2}$	9 $\frac{1}{2}$	DEM	19- 8

Equipped with voltmeter, line cord and plug, variable primary switch, indicator light and output receptacle. [▲] See detailed instruction sheet packed with unit.

Step-Down Auto-Transformers

For reducing 220 volt line source to 117 volts at 50/60 cycles for export and industrial applications.

Merit No.	Ref. No.	Primary Volts	Secondary Volts	Output Watts	Dimensions - Inches				Mtg. Type	Shpg. Wt. Lbs. Oz.
					Mtg. Centers	H	W	D		
P-4132	3	230	115	50	3 $\frac{1}{8}$	2 $\frac{3}{8}$	3 $\frac{11}{16}$	2	A	1- 5
P-3161	4	220-250	110-125	80	2 $\frac{1}{4}$ x 1 $\frac{7}{8}$	3 $\frac{1}{2}$	2 $\frac{1}{2}$	3	DE	3- 6
P-3162	5	220-250	110-125	150	2 $\frac{1}{2}$ x 2 $\frac{1}{8}$	3 $\frac{3}{8}$	3 $\frac{3}{8}$	3 $\frac{3}{8}$	DE	5- 3
P-3163	6	220-250	110-125	250	3 x 2 $\frac{1}{8}$	4 $\frac{1}{8}$	3 $\frac{1}{8}$	4	DE	8- 7
P-3164	7	220-250	110-125	500	3 x 3 $\frac{1}{8}$	4 $\frac{1}{8}$	3 $\frac{1}{8}$	4 $\frac{1}{8}$	DE	10- 2

Conservatively rated, equipped with cord plug and receptacle.

Step-Down Transformers

Provides isolation as well as step down from primary to secondary. Designed conservatively for export and industrial applications. Primary 230 volts, 50/60 cycles.

Merit No.	Ref. No.	Primary Volts	Secondary Volts	Output Watts	Dimensions - Inches				Mtg. Type	Shpg. Wt. Lbs. Oz.
					Mtg. Centers	H	W	D		
P-3116	8	230	115	100	2 $\frac{1}{4}$ x 2 $\frac{1}{8}$	4 $\frac{1}{4}$	3 $\frac{1}{8}$	3 $\frac{3}{8}$	DE	5- 0
P-3117	9	230	115	250	3 x 3 $\frac{1}{8}$	4 $\frac{1}{8}$	3 $\frac{1}{8}$	4 $\frac{1}{8}$	DE	9-10

Fully static shielded. Equipped with primary cord and plug. Secondary Standard receptacle.

Standard Isolation Transformers

Separate windings. Provides complete isolation between primary and secondary. Primary for 50/60 cycles.

Ideal for testing AC-DC radios and TV sets.

[▲] Equipped with primary cord and plug - secondary standard receptacle. Fully static shielded.

Merit No.	Ref. No.	Primary Volts	Secondary Volts	Output Watts	Dimensions - Inches				Mtg. Type	Shpg. Wt. Lbs. Oz.
					Mtg. Centers	H	W	D		
P-3096	10	117	117	40	3 $\frac{1}{8}$	3 $\frac{1}{8}$	3 $\frac{3}{8}$	2 $\frac{1}{2}$	B	2- 4
P-4134	11	§ 115 230	117	50	3 $\frac{1}{8}$	2 $\frac{3}{8}$	3 $\frac{11}{16}$	2 $\frac{1}{8}$	A	1-7
P-3197	12	117	117	80	2 $\frac{1}{2}$ x 2 $\frac{1}{8}$	3 $\frac{3}{8}$	3 $\frac{3}{8}$	3 $\frac{1}{2}$	D	5- 0
[▲] P-3177	13	117	105-115-125	350	3 $\frac{1}{2}$ x 3 $\frac{1}{8}$	5 $\frac{1}{8}$	4 $\frac{1}{2}$	5 $\frac{1}{2}$	DE	15-10
[▲] P-3198	14	117	117	100	2 $\frac{3}{8}$ x 2 $\frac{1}{8}$	4 $\frac{1}{8}$	3 $\frac{1}{8}$	3 $\frac{3}{8}$	DE	6- 6
[▲] P-3202	15	117	117	175	2 $\frac{3}{8}$ x 3 $\frac{1}{8}$	4 $\frac{1}{8}$	4 $\frac{1}{8}$	3 $\frac{3}{8}$	JP	7- 0
[▲] P-3199	16	117	117	250	3 x 3 $\frac{1}{8}$	4 $\frac{1}{8}$	3 $\frac{1}{8}$	4 $\frac{1}{8}$	DE	12- 2
[▲] P-3172	17	117	117	500	3 $\frac{1}{2}$ x 4 $\frac{1}{8}$	5 $\frac{1}{8}$	4 $\frac{1}{8}$	6 $\frac{1}{2}$	DE	21- 4

§ Split winding.

VIBRATOR POWER TRANSFORMERS

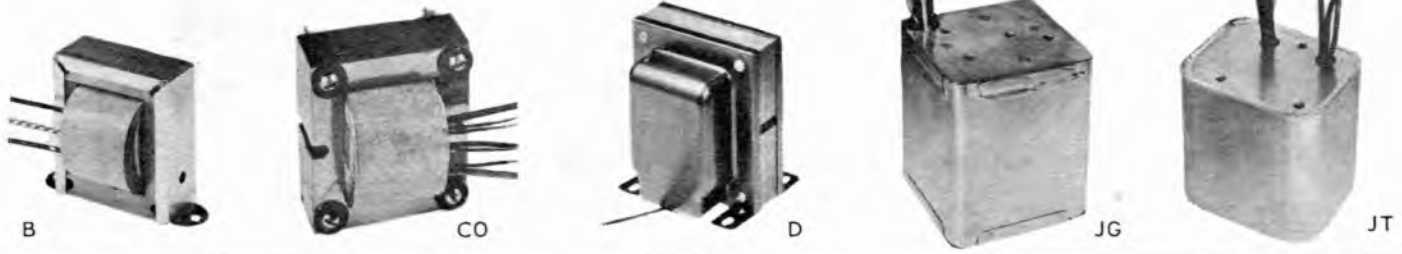

Merit No.	Ref. No.	Sec. Rms. Volts	Sec DC Volts to Filter	Sec. DC MA	Dimensions - Inches				Mtg. Type	Shpg. Wt. Lbs. Oz.
					Mtg. Centers	H	W	D		
P-2969	1	160-160	150	40	2 ³ / ₈	2 ¹ / ₄	2 ⁷ / ₈	1 ³ / ₄	B	1- 1
P-2970	2	235-235	225	40	2 ¹ / ₂	2 ⁵ / ₈	3 ¹ / ₈	2 ¹ / ₈	B	1- 7
P-2971	3	260-260	250	50	2 ¹ / ₂	2 ⁵ / ₈	3 ¹ / ₈	2 ¹ / ₄	B	1-12
P-4071	4	260-260	250	50		3	2 ³ / ₈	2 ³ / ₁₆	JT	2- 0
P-2972	5	265-265	260	60	3 ¹ / ₈	3	3 ⁵ / ₈	2 ¹ / ₈	B	2- 4
P-3068	6	275-275	260	60	1 ³ / ₄ x 2 ³ / ₁₆	2 ³ / ₁₆	2 ⁵ / ₈	1 ⁷ / ₈	CO	1- 6
P-4076 ▲	7	280-280	265	65		3 ¹ / ₄	2 ⁵ / ₈	2 ⁵ / ₈	JG	2- 8
P-4078	8	285-285	270	60		2 ⁵ / ₈	2 ³ / ₁₆	2 ³ / ₄	JT	1-15
P-4079	9	275-275	270	75		3 ¹ / ₃₂	2 ³ / ₈	2 ¹ / ₂	JT	2- 4
P-4077	10	290-290	280	65		3 ¹ / ₈	2 ¹ / ₄	2 ⁵ / ₈	JT	2- 7
P-2860	11	235-235	225	50	2 ¹ / ₂	2 ¹ / ₁₆	3 ¹ / ₈	2 ¹ / ₂	B	2- 0
P-2861	12	260-260	250	60	1 ³ / ₄ x 2 ³ / ₁₆	2 ³ / ₁₆	2 ⁵ / ₈	2 ¹ / ₈	CO	2- 0
P-2978	13	275-275	260	60	1 ³ / ₄ x 2 ³ / ₁₆	2 ³ / ₁₆	2 ⁵ / ₈	1 ⁷ / ₈	CO	1- 8
P-4051 ▲	14	280-280	265	65		3 ¹ / ₄	2 ⁵ / ₈	2 ⁵ / ₈	JG	2- 9

Vibrator Transformers

Used as auto radio replacements or in commercial vibrator power supply equipment.

← For operation from 6 V battery & vibrator.

← For operation from 12 V battery & vibrator.

▲ Built-in Hash Filter

Merit No.	Ref. No.	HV Secondary		Filament		Dimensions - Inches				Mtg. Type	Shpg. Wt. Lbs. Oz.
		DC Volts	DC MA	Volts	Amps.	Mtg. Centers	H	W	D		
P-3075	15	330	100	6.3	4	2 ¹ / ₂ x 2 ³ / ₁₆	3 ⁷ / ₈	3 ³ / ₁₆	3 ³ / ₈	D	4-10
P-3176	16	300	160	6.3 or 5 6.3	3 4.5	3 x 3 ³ / ₁₆	4 ⁵ / ₈	3 ¹ / ₁₆	4 ¹ / ₄	D	9- 6
P-2858	17	330	100	12.6	2	2 ¹ / ₂ x 2 ³ / ₁₆	3 ⁷ / ₈	3 ³ / ₁₆	3 ³ / ₈	D	4-10
P-2859	18	300	160	12.6 12.6	1.5 2.25	3 x 3 ³ / ₁₆	4 ⁵ / ₈	3 ¹ / ₁₆	4 ¹ / ₄	D	9- 6
Merit No.	Ref. No.	Secondary		Dimensions - Inches				Mtg. Type	Shpg. Wt. Lbs. Oz.		
		AC Volts	DCMA	Mtg. Centers	H	W	D				
P-3065	19	1100	1.5	2 ¹ / ₂	2 ⁵ / ₈	3 ¹ / ₈	2	B	1-12		

AC-DC Vibrator Transformers

← For operation from 6V battery & vibrator or 115 V 60 cycle line.

← Designed for use in mobile or portable equipment.

← For operation from 12 V bat. & vib. or 115 V 60 cy. line.

Photo-Flash Power Transformer

← Designed for use with 117V AC, 60 cycle line or a 4V battery vibrator for reduced operation cost in flash photography.

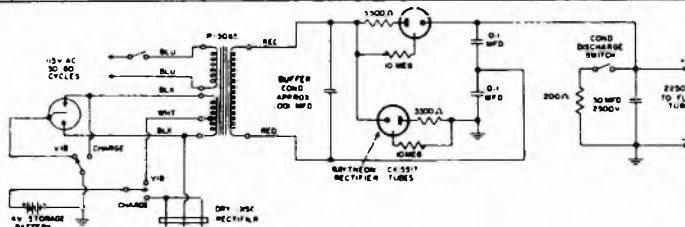



FILTER-CHOKES



Smoothing Filter Chokes

Ideal for replacement or new equipment use, these rugged units are designed to provide maximum inductance for a given rating and physical size. Inductance ratings are values measured at 10V @ 60 cycles with rated current flowing.

Merit No.	Ref. No.	Inductance Henries	Current Rating MA	DC Res. In Ohms	Rms. Volts Insul.	Dimensions - Inches				Mtg. Type	Shpg. Wt. Lbs.Oz.
						Mtg. Centers	H	W	D		
C-2973	1	1.5	10	95	1500	1 ³ / ₄	1 ³ / ₁₆	1 ⁷ / ₁₆	1	A	0- 4
C-2985	2	20.0	15	900	1500	2 ³ / ₈	1 ³ / ₈	2 ¹³ / ₁₆	1 ¹ / ₂	A	0- 10
C-2976	3	8.0	40	500	1500	2	1 ³ / ₈	2 ³ / ₈	1 ¹ / ₄	A	0- 6
C-2977	4	4.5	50	200	1500	2 ³ / ₈	1 ⁵ / ₈	2 ¹³ / ₁₆	1 ¹ / ₂	A	0- 10
C-2975	5	5.5	50	330	1500	2	1 ³ / ₈	2 ³ / ₈	1 ¹ / ₈	A	0- 6
C-2981	6	8.5	50	400	1500	2 ¹ / ₈	1 ⁵ / ₈	2 ¹³ / ₁₆	1 ¹ / ₂	A	0- 10
C-2987	7	16.0	50	550	2000	2 ¹³ / ₁₆	2	3 ¹ / ₄	1 ⁵ / ₈	A	1- 0
C-2990	8	15.0	75	400	2000	3 ¹ / ₈	2 ¹ / ₄	3 ¹¹ / ₁₆	2 ¹ / ₈	A	1- 8
C-2995	9	8.0	100	375	2000	2 ¹³ / ₁₆	2	3 ¹ / ₄	1 ⁵ / ₈	A	1- 0
C-2993	10	10.5	110	220	3000	3 ⁷ / ₁₆	2 ⁷ / ₁₆	4	2 ¹ / ₂	A	2- 2
C-2994	11	1.5	200	90	2000	2 ¹ / ₂	1 ⁵ / ₈	2 ¹³ / ₁₆	1 ⁵ / ₈	A	0- 10
C-2974	12	2.0	200	50	1500	2 ¹³ / ₁₆	2	3 ¹ / ₂	1 ⁵ / ₈	A	1- 0
C-2991	13	2.25	250	53	2000	3 ¹ / ₈	2 ¹ / ₄	3 ¹¹ / ₁₆	2 ¹ / ₈	A	1- 8
C-2996	14	1.0	300	60	2000	3 ¹ / ₈	2 ¹ / ₄	3 ¹¹ / ₁₆	2	A	1- 6
C-4084	15	.85	320	25	2000	2 ¹³ / ₁₆	2	3 ¹ / ₂	1 ¹ / ₈	A	1- 0
C-4115	15A	.85	320	25	2000	2 ³ / ₈	2 ¹ / ₄	2 ⁷ / ₁₆	1 ¹ / ₂	B	1- 1
C-4133	15B	.32	600	10	1500	2 ¹³ / ₁₆	2	3 ¹ / ₄	1 ¹ / ₈	A	1- 4
C-3180	16	10.0	150	210	3000	2 x 1 ¹³ / ₁₆	3 ³ / ₈	2 ⁹ / ₁₆	2 ³ / ₁₆	D	2- 12
C-3181	17	10.0	200	140	3000	2 ¹ / ₂ x 2 ³ / ₂	3 ¹ / ₂	2 ¹⁵ / ₁₆	3 ¹ / ₂	D	4- 7
C-3182	18	10.0	250	125	3000	2 ¹ / ₂ x 2 ¹ / ₂	3 ³ / ₈	3 ¹ / ₄	3 ³ / ₄	D	5- 15
C-3183	19	8.0	300	80	3000	2 ¹ / ₂ x 2 ⁵ / ₈	3 ³ / ₈	3 ¹ / ₄	3 ³ / ₈	D	6- 5
C-3192	20	15.0	85	325	1500	2 x 1 ¹¹ / ₁₆	3 ³ / ₈	2 ⁵ / ₈	2 ⁵ / ₈	D	2- 8
C-3193	21	10.0	110	200	1500	2 x 1 ⁹ / ₁₆	3 ³ / ₈	2 ⁵ / ₈	2 ¹ / ₂	D	2- 6
C-3194	22	12.0	150	230	1500	2 ¹ / ₂ x 2 ¹ / ₈	3 ¹ / ₂	2 ¹⁵ / ₁₆	3 ¹ / ₄	D	3- 12
C-3196	23	5.0	200	90	1500	2 ¹ / ₄ x 2	3 ¹ / ₂	2 ¹⁵ / ₁₆	3 ³ / ₈	D	3- 8
C-4124	24	.3	300	.25	1500	1 ³ / ₄	1 ¹ / ₄	2 ⁷ / ₁₆	1 ¹ / ₈	A	0- 4
C-4125	24A	.6	300	23	1500	2 ³ / ₈	1 ¹ / ₈	2 ¹³ / ₁₆	1 ¹ / ₂	A	0- 10
C-4095	25	11mh	1000	.8	1000	1 ¹ / ₄	1 ¹ / ₄	1 ¹ / ₂	1	PC-1	0- 4

Auto Radio Filter Choke

TRANSISTOR POWER TRANSFORMERS

Transistor power supplies replace Dynamotors and Vibrators wherever a DC voltage change is required. Typical use is in mobile and marine radio receivers and transmitters. They have very high efficiency and long reliable life. The absence of mechanical moving parts contributes to superior performance in every respect.

Merit No.	Ref. No.	DC V Source	DC V Rectified	DC MA	Dimensions - Inches				Mtg. Type	Shpg. Wt. Lbs.Oz.
					Mtg. Centers	H	W	D		
P-4085	26	12.6	250	75	2 ¹³ / ₁₆	2 ¹ / ₁₆	3 ¹ / ₈	2 ¹ / ₈	B	1- 8
P-4086	27	12.6	300	100	2 ¹³ / ₁₆	2 ¹ / ₁₆	3 ¹ / ₈	2 ³ / ₈	B	1- 12
P-4087	28	12.6	325	150	3 ¹ / ₈	3 ¹ / ₁₆	3 ¹ / ₈	2 ⁵ / ₈	B	3- 0

TYPICAL CIRCUIT

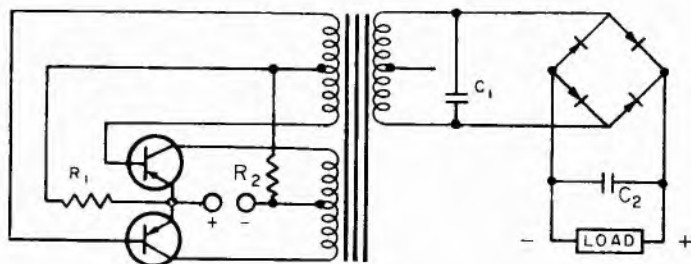

In this circuit:

- A. Use Texas Instruments 2N511 transistors or equivalent.
- B. Use Texas Instruments 1N2070 diodes or equivalent.

C.	R ₁	R ₂	C ₁
P-4085	22 ohms	220 ohms	0.01 mfd, 1000V
P-4086	10 ohms	270 ohms	0.005 mfd, 1000V
P-4087	10 ohms	270 ohms	0.001 mfd, 1000V

AUDIO TRANSFORMERS

Audio Transformers produced by Merit have long been the leaders in this type of transformer. Being constantly on the alert to incorporate new materials and production methods has placed Merit in a position that cannot be other than first place.

All materials used in the construction of transformers at Merit are completely acid free and impervious to corrosion. Merit, using the most modern method of vacuum impregnating their transformers, provides a unit that is completely free of possible failure due to insulation breakdown and a transformer that will continue to function faithfully for the life of the equipment in which it is installed.

The following pages of Audio Transformers list every type of transformer commonly used in all electronic equipment.

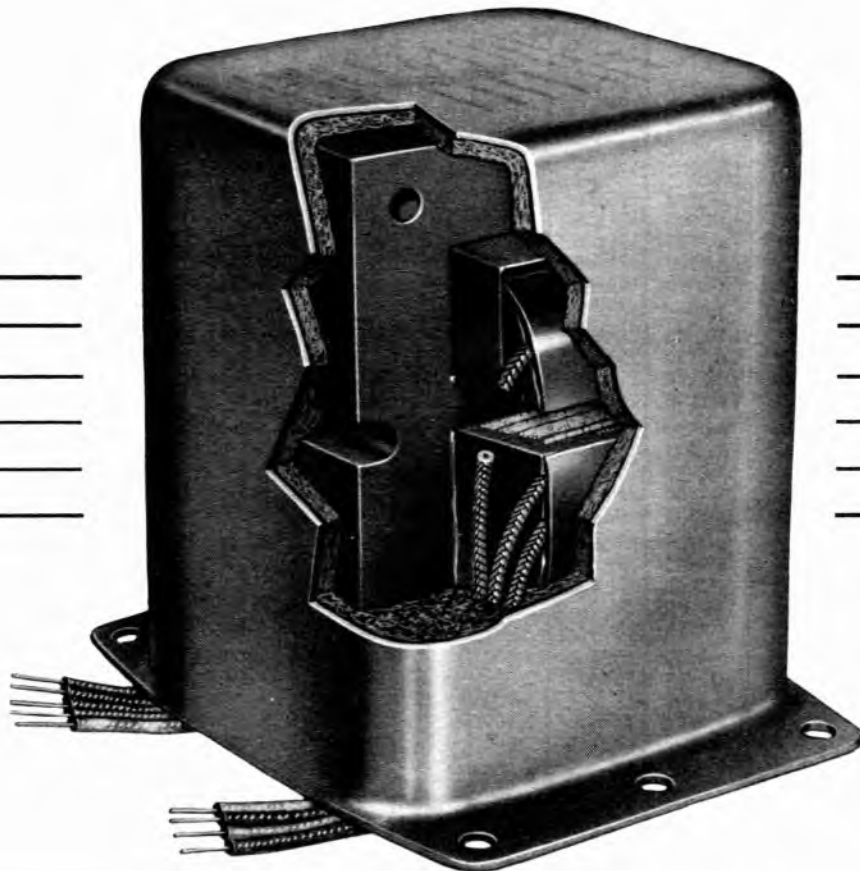



OUTPUT TRANSFORMER CHART

TUBE LIST FOR SINGLE PLATE CLASS A APPLICATIONS

Tube	Plate Load	Watts	Merit No.		Tube	Plate Load	Watts	Merit No.		Tube	Plate Load	Watts	Merit No.	
			Exact	Universal				Exact	Universal				Exact	Universal
1A5-GT	25,000	.115	A-4102	A-2999	7B5	7,000	3.0	A-2931	A-2903	41	9,000	4.5	A-2932	A-2903
1C5-GT	8,000	.240	A-2927	A-2900	7C5	5,000	4.5	A-2930	A-2902	42	7,000	3.0	A-2931	A-2903
1D8-GT	12,000	.200	A-2934	A-2999	8BQ5	4,500	5.7	A-3019	A-2902	43	5,000	2.2	A-3026	A-2998
1F4	16,000	.300	A-2934	A-2999	10	10,200	1.6	A-2932	A-2998	45	4,600	2.0	A-3026	A-2903
1F5-G	16,000	.310	A-2934	A-2999	12A5	3,300	3.4	A-4103	A-2903	46	6,400	1.25	A-2931	A-2998
1G5-G	9,000	.550	A-2932	A-2998	12A7	13,500	.550	A-2934	A-2900	47	7,000	2.7	A-2931	A-2903
1J5-G	13,500	.450	A-2934	A-2900	12AB5	6,000	3.3	A-2931	A-2903	48	1,500	2.5	A-2928	A-2902
1LA4	25,000	.100	A-2791	A-2999	12AB5	5,000	4.5	A-2930	A-2902	49	11,000	.170	A-2932	A-2998
1LB4	12,000	.200	A-2934	A-2999	12AQ5	5,000	4.3	A-2930	A-2902	50	4,350	4.6	A-2930	A-2903
1N6-G	25,000	.100	A-2791	A-2999	12BF6	10,000	.300	A-2932	A-2998	50A5	2,000	2.1	A-2928	A-2903
1Q5-GT	8,000	.330	A-2927	A-2900	12BK5	6,700	3.5	A-2931	A-2903	50B5	2,500	1.9	A-3025	A-2903
IS4	5,000	.180	A-3026	A-2998	12C5	2,500	2.3	A-3025	A-2903	50C5	2,500	2.3	A-3025	A-2903
IS4	8,000	.270	A-2927	A-2900	12CA5	4,500	1.5	A-3026	A-2998	50CA5	3,500	1.1	A-4103	A-2998
1T5-GT	14,000	.170	A-2934	A-2900	12CA5	3,500	1.1	A-4103	A-2998	50C6-G	2,000	3.6	A-2928	A-2903
2A3	2,500	3.5	A-3025	A-2903	12CS5	2,000	2.1	A-2928	A-2903	50EH5	3,000	1.4	A-3025	A-2903
2A5	7,000	4.5	A-2931	A-2903	12CU5	2,500	2.3	A-3025	A-2903	50FE5	1,000	5.6	A-4096	A-2902
3LF4	8,000	.400	A-2927	A-2900	12DB5	2,000	2.1	A-2928	A-2903	50FK5	3,000	1.2	A-3025	A-2903
3Q4	10,000	.270	A-2932	A-2998	12DL8	800	.040	A-2763	-	50L6-GT	2,000	2.1	A-3025	A-2903
3Q5-GT	8,000	.330	A-2927	A-2900	12DS7-A	1,250	.010	A-2763	-	50L6-GT	3,000	4.3	A-4103	A-2903
3S4	5,000	.180	A-3026	A-2998	12DV8	1,250	.005	A-2763	-	50L6-GT	4,000	3.8	A-2930	A-2903
3S4	8,000	.270	A-2927	A-2900	12ED5	4,500	1.5	A-3026	A-2998	55	20,000	.350	A-4102	A-2999
3V4	10,000	.270	A-2932	A-2998	12EH5	3,000	1.4	A-3025	A-2903	59	6,000	3.0	A-2931	A-2903
5AQ5	5,000	4.3	A-2930	A-2902	12EM6	3,500	.010	A-2773	A-2998	60FX5	3,000	1.3	A-3025	A-2903
5CZ5	5,000	5.4	A-2930	A-2902	12J8	2,700	.020	A-2767	A-2903	70A7	2,500	1.5	A-3025	A-2903
5V6-GT	5,000	4.5	A-2930	A-2902	12K5	800	.040	A-2763	-	70L7	2,000	1.8	A-2928	A-2903
6A3	2,500	3.5	A-3025	A-2903	12L6-GT	2,000	2.1	A-3025	A-2903	71A	4,800	.790	A-3026	A-2998
6A4/LA	8,000	1.4	A-2927	A-2900	12L6-GT	3,000	4.3	A-4103	A-2903	85	20,000	.350	A-4102	A-2999
6AC5-GT	7,000	3.7	A-2931	A-2903	12L6-GT	4,000	3.8	A-2930	A-2900	112A	10,650	.285	A-2932	A-2998
6AC6-GT	3,500	3.6	A-4103	A-2998	12V6-GT	5,500	2.0	A-3026	A-2998	117L7	4,000	.850	A-3026	A-2998
6AD7-G	7,000	3.2	A-2931	A-2903	12V6-GT	5,000	4.5	A-2930	A-2902	117M7-GT	4,000	.850	A-3026	A-2998
6AG7	10,000	3.0	A-2932	A-2998	12V6-GT	8,500	5.5	A-2932	A-2901	117N7-GT	3,000	1.2	A-3025	A-2903
6AK7	2,500	6.5	A-3127	A-2902	12W6-GT	2,000	3.3	A-2928	A-2903	117P7-GT	4,000	.850	A-3026	A-2998
6AL6	4,500	6.5	A-3019	A-2902	14A5	7,500	2.8	A-2931	A-2900	183	4,500	1.8	A-3026	A-2998
6AQ5-A	5,000	4.3	A-2930	A-2902	14C5	5,000	4.5	A-2930	A-2902	257	6,000	.800	A-3026	A-2998
6AR5	7,000	3.2	A-2931	A-2903	17CA5	3,500	1.1	A-4103	A-2998	483	4,500	1.8	A-3026	A-2998
6AS5	4,500	2.2	A-3026	A-2998	17CU5	2,500	2.3	A-3025	A-2903	950	13,500	.450	A-2934	A-2999
6B4-G	2,500	3.5	A-3025	A-2903	17L6-GT	2,000	2.1	A-3025	A-2903	955	20,000	.135	A-4102	A-2999
6B5	7,000	4.0	A-2931	A-2903	17L6-GT	3,000	4.3	A-4103	A-2903	1222-A	4,500	6.5	A-3019	A-2902
6BF5	2,500	1.9	A-3025	A-2903	17L6-GT	4,000	3.8	A-2930	A-2900	1621	7,000	4.8	A-2931	A-2901
6BF6	10,000	.300	A-2932	A-2998	19AQ5	5,000	4.3	A-2930	A-2902	1622	4,500	6.5	A-3019	A-2902
6BK5	6,700	3.5	A-2931	A-2903	20	6,500	.110	A-2931	A-2998	1632	2,000	2.1	A-2928	A-2903
6BM8	3,900	1.05	A-4103	A-2903	25A6-GT	5,000	2.2	A-3026	A-2998	5640	3,000	1.25	A-3025	A-2903
6BQ5	4,500	5.7	A-3019	A-2902	25A7-GT	4,500	.770	A-3026	A-2998	5672	20,000	.065	A-2796	A-2998
6CA5	4,500	1.5	A-3026	A-2998	25AC5-GT	2,000	2.0	A-2928	A-2903	5686	9,000	2.7	A-2932	A-2998
6CL6	7,500	2.8	A-2927	A-2900	25B5	2,000	2.0	A-2928	A-2903	5812	1,700	4.3	A-2928	A-2902
6CM6	5,000	4.5	A-2930	A-2902	25BK5	6,700	3.5	A-2931	A-2903	5824	5,000	4.3	A-2930	A-2902
6CU5	2,500	2.3	A-3025	A-2903	25B6	5,000	4.3	A-2930	A-2902	5871	8,500	5.5	A-2932	A-2901
6CZ5	5,000	5.4	A-2930	A-2902	25C5	2,500	2.3	A-3025	A-2903	5881	2,500	6.7	A-3018	A-2903
6DB5	2,000	2.1	A-2928	A-2903	25CA5	3,500	1.1	A-4103	A-2998	5881	4,000	1.8	A-3026	A-2998
6DG6-GT	4,000	3.8	A-3026	A-2903	25CA5	4,500	1.5	A-3026	A-2998	5902	3,000	1.0	A-3025	A-2903
6DS5	8,000	3.6	A-2927	A-2900	25C6-G	2,000	3.6	A-2928	A-2903	5930	2,500	3.5	A-3025	A-2903
6EH5	3,000	1.4	A-3025	A-2903	25EH5	3,000	1.4	A-3025	A-2903	5932	2,500	6.5	A-3018	A-2902
6F6-GT	7,000	4.5	A-2931	A-2903	25L6-GT	2,000	2.1	A-3025	A-2903	5992	5,000	4.5	A-2930	A-2902
6FE5	1,000	5.6	A-4096	A-2902	25L6-GT	3,000	4.3	A-4103	A-2903	6005	5,000	4.5	A-2930	A-2902
6G6-G	10,000	1.1	A-2932	A-2998	25L6-GT	4,000	3.8	A-2930	A-2900	6005	10,000	10.0	A-3022	-
6K6-GT	7,600	3.4	A-2927	A-2900	25N6-G	4,000	3.8	A-2930	A-2900	6046	2,000	2.1	A-2928	A-2903
6K6-GT	9,000	4.5	A-2932	A-2901	25W6	2,000	2.1	A-2928	A-2903	6216	4,500	3.8	A-2930	A-2903
6L6-GC	2,500	6.5	A-3018	A-2902	31	5,700	.375	A-3026	A-2998	6287	6,000	4.5	A-2931	A-2903
6L6-GC	4,200	10.8	A-3019	A-2902	32ET5	2,800	1.2	A-3025	A-2903	6516	16,000	1.4	A-2934	A-2999
6L6-GC	5,000	1.4	A-3026	A-2998	32L7	2,600	1.0	A-3025	A-2903	6526	10,000	.375	A-2932	A-2998
6N6-G	7,000	6.5	A-2931	A-2901	33	6,000	1.4	A-3026	A-2998	6550	3,000	12.5	-	A-2905
6V6-GT	5,500	2.0	A-3026	A-2998	35A5	2,500	1.5	A-3025	A-2903	6669	5,000	4.5	A-2930	A-2902
6V6-GT	5,000	4.5	A-2930	A-2902	35A5	4,500	3.3	A-3026	A-2903	7061	5,000	3.0	A-3026	A-2998
6V6-GT	8,500	5.5	A-2932	A-2901	35B5	2,500	1.5	A-3025	A-2903	7868	3,000	11.0	-	A-2902
6V7-G	20,000	.350	A-4102	A-2998	35C5	2,500	1.5	A-3025	A-2903	EL34	2,000	11.0	-	A-2902
6W6-GT	2,000	2.1	A-2928	A-2903	35EH5	3,000	1.2	A-3025	A-2903	ECL82	3,900	1.05	A-3026	A-2903
6W6-GT	4,000	3.8	A-2930	A-2903	35L6-GT	2,500	1.5	A-3025	A-2903	EL84	5,000	5.3	A-2930	A-2902
6Y6-GA	2,000	3.6	A-2928	A-2903	35L6-GT	4,500	3.3	A-3026	A-2903	EL84	10,000	15.0	-	A-2904
6Y6-GA	2,600	6.0	A-3018	A-2902	38	10,000	2.5	A-2932	A-2998	KT66	2,200	7.25	A-3127	A-2902
7A5	2,500	1.5	A-3025	A-2903	41	7,600	3.4	A-2927	A-2900	HL92	2,500	2.3	A-3025	A-2903

OUTPUT TRANSFORMER CHART



TUBE LIST FOR PUSH-PULL APPLICATIONS

Tube	Class	Plate Load	Watts	Merit No.		Tube	Class	Plate Load	Watts	Merit No.	
				Exact	Universal					Exact	Universal
1A5-GT	A	50,000	.230	A-3017	-	12AB5	AB ₁	10,000	10.0	A-2936	A-2904
1AC5	A	50,000	.100	A-3017	-	12AQ5	AB ₁	8,000	13.0	A-4101	A-2904
1E7-GT	A	24,000	.600	A-2937	-	12CM6	AB ₁	10,000	10.0	A-2936	A-2904
1G6-GT	B	12,000	.670	A-2938	A-2900	12EH5	AB ₁	6,000	3.8	A-4107	A-2900
1H4-G	B	10,000	2.1	A-2938	A-2900	12V6-GT	A	8,000	14.0	A-4101	A-2904
1J6-GT	B	10,000	2.1	A-2938	A-2900	12V6-GT	A	10,000	10.0	A-2936	A-2904
1LA4	A	50,000	.200	A-3017	-	14C5	AB ₁	10,000	10.0	A-2936	A-2904
1N6-G	A	50,000	.200	A-3017	-	19	B	10,000	2.1	A-2938	A-2900
2A3	AB ₁	3,000	15.0	A-4100	A-2905	19AQ5	AB ₁	8,000	13.0	A-4101	A-2904
2A5	A	10,000	10.5	A-2936	A-2904	25EH5	AB ₁	6,000	3.8	A-4107	A-2900
2A5	AB ₂	10,000	19.0	A-3132	A-2904	25F5	AB ₁	4,500	2.9	-	A-2900
3B7	AB ₂	16,000	1.5	-	A-2900	35EH5	AB ₁	6,000	3.8	A-4107	A-2900
4A6	A	8,000	1.0	A-4101	A-2900	35GL6	AB ₁	2,500	1.8	A-4100	-
5AQ5	AB ₁	8,000	13.0	A-4101	A-2904	41	A	12,000	9.8	A-3021	A-2904
5V6-GT	AB ₁	10,000	10.0	A-3012	A-2904	42	A	10,000	10.5	A-2936	A-2904
6A3	AB ₁	5,000	10.0	A-2935	A-2904	42	AB ₂	10,000	19.0	A-3132	A-2905
6A5	A	3,500	15.0	A-4100	A-2905	45	AB ₂	5,000	12.0	A-2935	A-2904
6A6	B	8,000	4.6	A-4101	A-2900	46	B	5,800	20.0	A-2935	A-2905
6AC5-GT	B	10,000	9.5	A-2936	A-2904	47	A	14,000	6.0	A-3021	A-2901
6AD7-G	AB ₁	14,000	6.0	A-3021	A-2901	50EH5	AB ₁	6,000	3.8	A-4107	A-2900
6AE7-GT	AB ₁	10,000	9.5	A-2936	A-2904	50FE5	A	1,600	8.5	A-4099	-
6AJ5	AB ₁	28,000	1.0	A-2937	-	53	B	8,000	10.0	A-4101	A-2904
6AL6	A	5,000	18.0	A-2935	A-2904	59	B	6,000	20.0	A-2935	A-2905
6AL6	AB ₁	6,600	25.0	A-3130	A-2905	79	B	14,000	8.0	A-3021	A-2901
6AM5	AB ₁	20,000	4.8	A-2937	-	89	B	9,400	3.5	A-2938	A-2900
6AQ5-A	AB ₁	8,000	13.0	A-4101	A-2904	807/W	AB ₁	3,300	55.0	A-3133	-
6B4-G	AB ₁	5,000	10.0	A-2935	A-2904	1291	AB ₂	16,000	1.5	-	A-2900
6BQ5	AB ₁	8,000	11.0	A-4101	A-2904	1614	AB ₁	6,600	26.5	A-3130	A-2905
6CM6	AB ₁	10,000	10.0	A-2936	A-2904	1625	AB ₁	3,300	55.0	A-3133	-
6DZ7	AB ₁	9,000	12	A-3027	A-2904	1631	AB ₁	6,600	26.5	A-3130	A-2905
6DZ7	AB ₁	9,000	18	A-3132	A-2904	1635	B	12,000	10.4	A-3021	A-2904
6E6	A	14,000	1.6	A-3021	A-2900	1644	A	10,000	1.0	A-2938	A-2900
6EH5	AB ₁	6,000	3.8	A-4107	A-2900	5670	AB ₁	27,000	1.0	A-2937	-
6F6-GT	A	10,000	11.0	A-2936	A-2904	5881	A	5,000	18.0	A-2935	A-2904
6F6-GT	AB ₂	10,000	19.0	A-3132	A-2904	5930	AB ₁	5,000	10.0	A-2935	A-2904
6FE5	A	1,600	8.5	A-4099	-	6095	AB ₁	10,000	10.0	A-2936	A-2904
6GK6	AB ₁	8,000	11.0	A-4101	A-2904	6146	A	10,000	18.0	A-3132	A-2904
6GK6	B	8,000	17.0	A-4101	A-2904	6360	AB ₁	8,000	9.3	A-4101	A-2904
6K6-GT	A	12,000	9.8	A-3021	A-2904	6550	AB ₁	3,300	55.0	A-3133	-
6L6-GC	A	5,000	14.5	A-2935	A-2904	6973	AB ₁	6,000	17.0	A-2935	A-2904
6L6-GC	A	5,000	17.5	A-2935	A-2904	6973	AB ₁	8,000	12.5	A-4101	A-2904
6L6-GC	AB ₁	6,600	26.5	A-3130	A-2905	6973	AB ₁	13,000	15.0	A-4106	A-2904
6L6-GC	AB ₁	3,800	18.0	A-2935	A-2905	7027A	AB ₁	3,800	44.0	A-3133	-
6L6-GC	AB ₂	6,000	31.0	A-3130	-	7027A	AB ₁	6,600	32.0	A-3130	-
6M5	AB ₁	7,000	9.4	A-4101	A-2904	7027A	AB ₁	8,000	24.0	-	A-2905
6N7-GT	B	8,000	10.0	A-4101	A-2904	7189	AB ₁	11,000	16.5	A-3132	A-2904
6V5	AB ₁	10,000	10.0	A-2936	A-2904	7868	AB ₁	6,600	38.0	A-3130	-
6V6-GT	A	8,000	14.0	A-4101	A-2904	7868	AB ₁	10,000	28.0	A-3132	A-2905
6V6-GT	A	10,000	10.0	A-2936	A-2904	EL34	A	7,000	20.0	A-3130	A-2905
6Y7-G	B	7,000	5.5	A-4107	A-2901	EL34	AB ₂	3,300	50.0	A-3133	-
6Y7-G	B	14,000	8.0	A-3021	A-2901	EL84	AB ₁	8,000	11.0	A-4101	A-2904
6Z7-G	B	12,000	4.2	A-2938	A-2901	EL84	A	10,000	15.0	A-3027	A-2904
7C5	AB ₁	10,000	10.0	A-2936	A-2904	EL90	AB ₁	8,000	13.0	A-4101	A-2904
8BQ5	AB ₁	8,000	11.0	A-4101	A-2904	KT66	A	10,000	10.0	A-2936	A-2904
8BQ5	AB ₁	8,000	17.0	A-4101	A-2904	KT66	AB ₁	5,000	19.0	A-2935	A-2905

HIGH FIDELITY APPLICATIONS

5V6	A	10,000	12.0	A-3101	PENTODE CONNECTION	6AL6	A	6,600	22.2	A-3102	WILLIAMSON SCREEN TAPPED CONNECTION
6AL6	A	10,000	16.0	A-3101		6L6	A	6,600	22.3	A-3102	
6AL6	A	5,000	18.0	A-3100		807	A	6,600	28.0	A-3102	
6F6	A	10,000	14.5	A-3101		1614	A	6,600	28.3	A-3102	
6L6	A	5,000	18.0	A-3100		5881	A	6,600	22.6	A-3102	
6V6	A	10,000	12.0	A-3101		6550	A	6,600	31.7	A-3102	
807	A	10,000	22.0	A-3101		EL-34	A	6,600	36.7	A-3102	
1614	A	10,000	19.0	A-3101		EL-84	A	6,600	16.9	A-3102	
5881	A	5,000	21.0	A-3100		KT-66	A	6,600	30.4	A-3102	
6146	A	10,000	18.0	A-3101							
6550	A	5,000	22.0	A-3100							
EL-34	A	10,000	22.0	A-3101							
EL-84	A	10,000	15.0	A-3101							
KT-66	A	5,000	19.0	A-3100							



AUDIO OUTPUT TRANSFORMERS

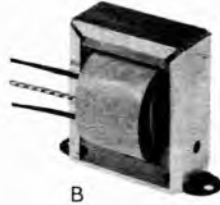
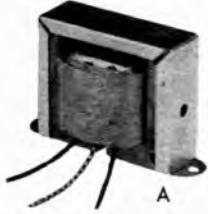

Single Plate To Voice Coil

Merit No.	Ref. No.	OHMS Impedance		Pri. Ma.	Max Watts	Mtg. Type	Dimensions - Inches				Shpg. Weight Lb.-Oz
		Primary	Sec.				Mtg. Ctrs.	H	W	D	
A-4096	1	1000	3-4/6-8	90	6	A	2 3/8	1 5/8	2 13/16	1 1/2	0-10
A-2928	2	2000	3-4	60	5	A	2	1 3/8	2 3/8	1 1/4	0-6
A-3025	3	2500	3-4	50	3	A	1 3/4	1 3/16	2 1/16	1	0-4
A-4097	4	2600	6-8	30	5	A	1 3/4	1 3/16	2 1/16	1 1/16	0-4
A-4103	5	3500	3-4/6-8	40	5	A	2	1 3/8	2 3/8	1 1/16	0-6
A-3018	6	3500	3-4	60	8	A	2 3/8	1 5/8	2 13/16	1 1/2	0-10
A-3026	7	5000	3-4	40	3	A	1 3/4	1 3/16	2 1/16	1	0-4
A-2930	8	5000	3-4	40	5	A	2	1 3/8	2 3/8	1 1/4	0-6
A-3019	9	5000	3-4	50	8	A	2 3/8	1 5/8	2 13/16	1 1/2	0-10
A-4080	10	6000	6-8	45	5	G	1 1/2	1 7/16	1 3/4	1 1/8	0-4
A-2931	11	7000	3-4	40	5	A	2	1 3/8	2 3/8	1 1/4	0-6
A-3020	12	7000	3-4	40	8	A	2 3/8	1 5/8	2 13/16	1 1/2	0-10
A-4105	13	7600	3-4/6-8	40	8	A	2 13/16	1 5/16	3 1/4	1 13/16	0-10
A-2927	14	8000	3-4	20	3	B	1 1/2	1 7/16	1 7/8	1	0-4
A-2932	15	10000	3-4	30	5	A	2	1 3/8	2 3/8	1 1/4	0-6
A-2933	16	12000	3-4	10	5	A	2	1 3/8	2 3/8	1 1/4	0-6
A-2934	17	15000	3-4	10	5	A	2	1 3/8	2 3/8	1 1/4	0-6
A-4102	18	25000	3-4	5	3	A	2	1 3/8	2 3/8	1 1/4	0-4

Push-Pull Plates To Voice Coil

A-4099	19	1600c.t.	3-4/6-8	75	10	A	2 3/8	1 5/8	2 13/16	1 3/4	0-10
A-4100	20	3500c.t.	3-4/6-8	70	15	A	3 1/8	2 1/4	3 11/16	2 1/16	1-6
A-2935	21	5000c.t.	3-4	75	18	A	2 13/16	2	3 1/4	1 5/8	1-0
A-4081	22	5500c.t.	6-8	90	10	A	2 13/16	2	3 1/4	1 3/4	0-6
A-4107	23	6600c.t.	3-4/6-8	40	8	A	2 3/8	1 5/8	2 13/16	1 11/16	0-10
A-4101	24	8000c.t.	3-4/6-8	70	15	A	3 1/8	2 1/4	3 11/16	2 1/16	1-2
A-2938	25	10000c.t.	3-4	40	5	A	2	1 3/8	2 3/8	1 1/4	0-6
A-2936	26	10000c.t.	3-4	40	10	A	2 3/8	1 5/8	2 13/16	1 1/2	0-10
A-4106	27	10000c.t.	3-4/6-8	60	15	A	3 1/8	2 1/4	3 11/16	2 1/16	1-2
A-3012	28	10000c.t.	3-4	25	10	B	1 23/32	1 11/16	2	1 1/2	0-10
A-3021	29	14000c.t.	3-4	35	12	A	2 13/16	2	3 1/4	1 5/8	1-0
A-2937	30	25000c.t.	3-4	10	5	A	2	1 3/8	2 3/8	1 1/4	0-6

Universal Type Single Plate

A-2902	31	1500,2000,4000 5000,7000,10000	.1 to 40	55	10	F	2 3/8	1 5/8	2 13/16	1 1/2	0-10
A-2903	32	2000,4500,7000 10000	3.2	30	4	F	2	1 3/8	2 3/8	1 1/4	0-6
A-2998	33	3500,5000,7000 10000	3.2	35	3	F	1 3/4	1 1/8	2 1/8	1 1/8	0-4
A-2999	34	12000,15000 18000,25000	3.2	10	3	F	1 3/4	1 1/8	2 1/8	1 1/8	0-4

Universal Type Single or Push-Pull

A-2900	35	4000,7000,8000, 10000,14000 c.t.	.17 to 32	35	4	F	2	1 3/8	2 3/8	1 1/2	0-6
A-2901	36	4000,7000,8000, 10000,14000 c.t.	.17 to 32	40	8	F	2 3/8	1 5/8	2 13/16	1 1/2	0-10
A-2904	37	4000,7000,8000, 10000,14000 c.t.	.17 to 32	40	18	G	2 3/8	2 1/4	2 3/8	1 7/8	1-1
A-2905	38	3000,5000,7000, 8000,10000 c.t.	.17 to 32	70	24	F	3 1/8	2 1/4	3 11/16	2 1/8	1-10

AUDIO OUTPUT TRANSFORMERS



A



D



J



JS

Merit No.	Ref. No.	Tube	Ohms Impedance		Pri. Ma.	Max. Watts	Mtg. Type	Dimensions - Inches				Shpg. Wt. Lbs. Oz.
			Primary	Sec.				Mtg. Centers	H	W	D	
A-3031	1	Single	3000	3-4	50	5	A	2	1 $\frac{3}{8}$	2 $\frac{3}{8}$	1 $\frac{1}{4}$	0- 6
A-3032	2	Single	6000	3-4	40	5	A	2	1 $\frac{3}{8}$	2 $\frac{3}{8}$	1 $\frac{1}{4}$	0- 6
A-3027	3	PP6F6, 6V6, etc.	10000c.t.	#	45A	15	F	2 $\frac{1}{8}$	2	3 $\frac{1}{4}$	1 $\frac{1}{8}$	1- 0
A-3028	4	PP6L6, etc.	5000c.t.	#	70A	20	F	3 $\frac{1}{8}$	2 $\frac{3}{8}$	3 $\frac{1}{8}$	2	1- 8
A-3022	5	P-P6V6	10000	3.2	50A	10	JS	1 $\frac{1}{4}$	1 $\frac{3}{16}$	1 $\frac{5}{8}$	1 $\frac{1}{2}$	0-10
A-3127	6	Single 6L6, 6Y6, etc.	2500	#	80A	8	D	2 x 1 $\frac{1}{8}$	3 $\frac{1}{8}$	2 $\frac{3}{8}$	2 $\frac{1}{2}$	2- 6
A-3128	7	P.P.6F6, 6V6, etc.	8000c.t.†	#	50A	14	D	2 $\frac{1}{4}$ x 2	3 $\frac{1}{2}$	2 $\frac{3}{8}$	3 $\frac{1}{8}$	3- 8
A-3129	8	PP6L6	4300c.t.†	#	95A	25	D	2 $\frac{1}{4}$ x 2	3 $\frac{1}{2}$	2 $\frac{1}{2}$	3 $\frac{1}{8}$	3- 8
A-3130	9	PP6L6	6600c.t.†	#	80A	34	D	2 $\frac{1}{2}$ x 2 $\frac{1}{8}$	3 $\frac{1}{8}$	3 $\frac{3}{8}$	3 $\frac{1}{2}$	4-14
A-3131	10	P.P.6L6, 6Y6, etc.	5000c.t.†	#	80A	30	D	2 $\frac{1}{4}$ x 2	3 $\frac{1}{2}$	2 $\frac{1}{8}$	3 $\frac{1}{8}$	3- 8
A-3132	11	P.P.6F6, 7C5, etc.	10000c.t.†	#	40A	25	D	2 $\frac{1}{4}$ x 2	3 $\frac{1}{2}$	2 $\frac{1}{8}$	3 $\frac{1}{8}$	3- 8
A-3133	12	PP Par, 6L6, PP807	3300c.t.	#	240A	55	D	3 x 2 $\frac{1}{8}$	4 $\frac{1}{8}$	3 $\frac{3}{8}$	4	7-11
A-3029	13	25L6, 35A5	2000	3-4	60	5	A	2	1 $\frac{3}{8}$	2 $\frac{3}{8}$	1 $\frac{1}{4}$	0- 6
		1S4, 3Q5	6000	3-4	10							
A-3030	14	25L6, 35A5	2000	3-4	60	5	A	2	1 $\frac{3}{8}$	2 $\frac{3}{8}$	1 $\frac{3}{8}$	0- 6
		1S4, 3Q5	10000	3-4	10							
A-3100	15	PP6L6, etc.	5000-3000 c.t.	4-8-16	100A	20	D	2 $\frac{1}{2}$ x 2 $\frac{1}{8}$	3 $\frac{3}{8}$	3 $\frac{3}{8}$	3 $\frac{3}{8}$	4-15
A-3101	16	PP6F6, 6L6, 6V6, etc.	10000-6600 c.t.	4-8-16	100A	25	D	2 $\frac{3}{4}$ x 2 $\frac{1}{8}$	4 $\frac{1}{4}$	3 $\frac{1}{2}$	3 $\frac{3}{8}$	6- 6
†A-2997	17	6BQ5	2 Required (For Crowhurst Amp.)				A	3 $\frac{1}{8}$	2 $\frac{1}{4}$	3 $\frac{1}{8}$	2 $\frac{1}{8}$	3- 2
A-3102	18	PP6L6, 807, etc.	6600c.t.	4-8-16	100A	25	J	2 $\frac{3}{4}$ x 3 $\frac{1}{8}$	4 $\frac{1}{4}$	4 $\frac{1}{8}$	3 $\frac{3}{8}$	7- 0

Frequency response \pm 1 DB—10 CPS to 100KC.

Merit No.	Ref. No.	Impedance Range	Power	Mtg. Type	Dimensions - Inches				Shpg. Wt. Lbs. Oz.
					Mtg. Centers	H	W	D	
A-4110	19	+16, +8, +4, 0, -4, -8, -16 ohms (Minus sign refers to reversed polarity.)	30 watts.	A	3 $\frac{1}{8}$	2 $\frac{1}{4}$	3 $\frac{1}{8}$	2 $\frac{1}{8}$	1- 8

Frequency Response : 40 to 20,000 cycles. Peak Power 100 watts.

- † Packed 2 to a carton.
- ‡ 10% Feedback Winding
- ‡ Suitable for Williamson Screen Tapped Circuits
- # Sec. Impedance 2-4-8-15-250-500 ohms.
- ▲ Pri. Ma. Per Side.

Filter Tapped

Primary has 3 % and 6% humbucking taps.

Special Type

Medium power types to couple output tubes to soaker on line.

Heavy Duty Type

High level type to couple output tubes to line or speaker. Frequency response \pm 2 DB—50 to 10,000 CPS.

Dual Primary Type

For use with AC-DC battery portable receivers.

High Fidelity Type

For high quality wide frequency range applications. Frequency response \pm 1 DB—20 to 20,000 CPS low distortion.

Ultra High Fidelity Type

For Highest quality hi-fidelity application.

Stereo Output Matching Transformer

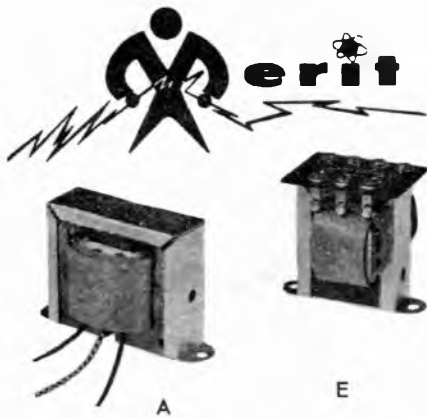

LINE AUDIO TRANSFORMERS

70.7 Volt Line Transformers

Merit No.	Ref. No.	Ohms Impedance		Watts	Dimensions — Inches				Mtg. Type	Shpg. Wt. lbs Oz.
		Pri.	Sec.		Mtg. Centers	H	W	D		
A-2800	1	{1000-1250-1667-2500-5000}	3.2, 8	1-5	2	1 3/8	2 3/8	1 1/2	F	0- 7
A-2801	2	500-555-625-715-833	3.2, 8	6-10	2 3/8	1 3/8	2 13/16	1 1/2	F	0-10
A-2802	3	333-357-384-417-455	8, 16	11-15	2 13/16	2	3 1/4	1 5/8	F	1- 0
A-2803	4	250-263-278-294-312	8, 16	16-20	2 3/8	2 1/4	2 13/16	2	G	1- 4
A-2804	5	200-208-217-227-238	8, 16	21-25	2 13/16	2 5/8	3 1/8	1 7/8	G	1- 8
A-2817	6	{40000-20000-10000-5000-2500-1250}	3-4	1/8 to 4	2 3/8	2 1/2	2 3/8	1 3/4	E	0-15
A-2818	7	{40000-20000-10000-5000-2500-1250}	8	1/8 to 4	2 3/8	2 1/2	2 7/8	1 3/4	E	0-15
A-3013	8	{1000-2000-4000-8000-16000}	3.5, 7	.31-5	2	1 3/16	2 3/8	1 1/2	P	0- 7
A-3014	9	{500-1000-2000-4000-8000}	4-8-16	.62-10	2 3/8	1 5/8	2 13/16	1 1/2	F	0- 7
A-3015	10	{275-550-1100-2200-4400-8800}	4-8-16	.56-18	2 3/8	2 1/4	2 3/8	1 5/8	G	1- 0
A-3016	11	{210-420-840-1680-3360-6720}	4-8-16	.75-24	3 1/8	2 1/4	3 11/16	2 3/8	F	1-10

25 Volt Line Transformers

A-2805	12	125-250-500-1000-2000	3.5, 7	.31-5	2	1 3/16	2 3/8	1 1/2	F	0- 7
A-2806	13	62.5-125-250-500-1000	4-8-16	.62-10	2 3/8	1 5/8	2 13/16	1 1/2	F	0- 7
A-2808	14	26-52-104-208-416-832	4-8-16	.75-24	2 3/8	2 1/4	2 3/8	1 7/8	F	1-10

Universal Line Impedance Matching Transformers

A-2810	15	500-1000-1500-2000	3.2, 4.8, 6, 8	10	2 3/8	1 5/8	2 13/16	1 1/2	F	0-10
A-2813	16	2500-5000-7000-10000	4.8, 6, 8	5	2	1 3/8	2 3/8	1 3/8	F	0- 8
A-2814	17	31-62-125-250	4.8, 6, 8	20	2 3/8	2 1/4	2 13/16	1 5/8	G	1- 4
A-2906	18	500-1000-1500-2000	3.2, 6-8	10	2 3/8	1 5/8	2 13/16	1 1/2	F	0-10
A-2907	19	500-1000-1500-2000	3.2, 6-8	18	2 3/8	2 1/4	2 3/8	1 1/2	G	1- 0
A-2908	20	500-1000-1500-2000	6-8, 16	24	3 1/8	2 1/4	3 11/16	2 1/8	F	1- 8
A-2909	21	45-50	3.2, 6-8	8	2	1 13/16	2 3/8	1 1/2	G	0-10
A-3005	22	500	3.2, 6-8	5	2	1 5/8	2 3/8	1 1/4	A	0- 6
A-4040	23	{250-500-1000-1500-2000}	4-8-16	8	2 1/4 x 3 3/8	4 1/4	4 3/8	3 3/8	JO	4- 0
A-4041	24	{250-500-1000-1500-2000}	4-8-16	12	2 1/4 x 3 3/8	4 1/4	4 3/8	3 3/8	JO	4- 4

Tube to Line Transformers

For matching single or push-pull plates to line or mixer.

Merit No.	Ref. No.	Ohms Impedance		Pri. MA	Dimensions — Inches				Mtg. Type	Shpg. Wt.
		Pri.	Sec.		Mtg. Centers	H	W	D		
A-2925	25	20000 c.t.	500-125	10	2 13/16	2	3 1/4	1 3/8	A	1- 0
A-3023	26	5000-10000-20000 c.t.	{500-333-200-125-50}	15	2 13/16	2	3 1/4	1 3/4	F	1- 0
A-3024	27	5000-10000-20000 c.t.	{500-333-200-125-50}	50	2 x 1 11/16	3 3/8	2 5/8	2 3/8	DL	2- 8
A-4104	28	{2500, 4000, 5000, 6000, 7000}	500	60	2 13/16	2 5/8	3 3/8	1 7/8	G	1- 8

Input Transformers

Used to couple a microphone or a line to single or push-pull grids.

Merit No.	Ref. No.	Ohms Impedance		Turns Radio	Dimensions — Inches				Mtg. Type	Shpg. Wt.
		Pri.	Sec.		Mtg. Centers	H	W	D		
A-2923	29	3.2	50000	1:125	2	1 3/8	2 3/8	1 1/4	A	0- 6
A-2929	30	100	60000	1:24	1 3/8	1 3/8	2 1/8	1 1/8	A	0- 4
A-2918	31	100	400000 c.t.	1:64	2 13/16	2	3 1/4	1 5/8	A	0-15
A-2919	32	200-50	100000	1:22	2 13/16	2	3 1/4	1 5/8	A	0-14
A-2924	33	500-125	100000 c.t.	1:14	2 13/16	2	3 1/4	1 5/8	A	0-15
A-3010	34	Exact for Delco 6061				1 3/8	1 3/8	1 1/4	A	0- 6

DRIVER AND MODULATION AUDIO TRANSFORMERS



Merit No.	Ref. No.	Driver	Typical Outputs	Turn Ratio Pri. to 1/2 Sec.	Pri. MA	Dimensions - Inches				Mtg. Type	Shpg. Wt. Lbs.Oz.
						Mtg. Centers	H	W	D		
A-2920	1	6C5, 1H4, 30, 49, etc.	1J6, 19, PP30, 49, etc.	2.5:1	10	2 3/8	1 5/8	2 1/16	1 1/2	A	0-10
A-2921	2	6F6, 2A5, 42, etc.	PP6F6, 2A5, 6L6, etc.	1.7:1, 1.5:1, 1.3:1	35	2 13/16	2	3 1/4	1 5/8	A	1-0
A-2922	3	6A6, 6C5, 6N7, 46, etc.	6A6, 6N7, PP46, etc.	5:1, 4:1, 3:1, 2.5:1	20	2 13/16	2	3 1/4	1 5/8	A	1-0

Driver Transformers

Used to couple driver plates to amplifier grids. Conservative design and rating assure good regulation for communication and commercial sound system applications.

A-3120	4	500 ohm line	Class B Grids 15 Watt Capacity	1:1.75, 1:1.85, 1:1, 1:1.25, 1:1.45		2 3/16 x 2	3 3/16	2 5/8	3 3/8	DL	3-
A-3121	5	500 ohm line	Class B Grids 30 Watt Capacity	1:1.75, 1:2, 1:2.25, 1:2.5, 1:2.75, 1:3		2 1/4 x 2 1/4	3 3/16	3	3 3/4	DL	3-14

Universal Driver Transformers

Merit No.	Ref. No.	Class B Outputs	Ohms Impedance		Max. MA		Watts	Dimensions - Inches				Mtg. Type	Shpg. Wt. Lbs.Oz.
			Pri.	Sec.	Pri.	Sec.		Mtg. Centers	H	W	D		
A-3007	6	{19, 1J6, 6A6, 6N7, PP1H4}	10000c.t.	{5000, 8000, 10000}	60	50	5	1 3/4	1 1/8	2 1/16	1 1/8	A	0-4
A-3008	7	{PP6AV5, 6V6, 6F6, Sgl. 6A6, 6N7, 53}	10000c.t.	{4000, 5000, 7500, 10000, 12000}	50	60	10	2 3/8	2 1/4	2 3/8	2 3/8	B	1-5
A-3109	8	{PP2A3, 6A3, 6B4, 6L6, 45, 46, 59}	{6000c.t., 3800c.t., 3000c.t.}	{5000, 8000, 10000}	80	100	25	2 x 1 13/16	3 3/8	2 5/8	2 3/4	D	2-8
A-3110	9	{PP6L6, 807, PPRK41, HY56, PPHY61, HK24}	{6600c.t., 3800c.t.}	{4000, 5000, 7500, 10000, 12000}	175	150	60	2 1/4 x 2 13/16	4 1/4	3 1/2	3 3/4	D	6-3
A-3113	10	{PP800, 809, IZ40, T55, HK54, RK31, HY40, 811A, 807, 812A}	{15,000, 6900c.t.}	{3000, 4000, 5000, 6000}	250	300	175	3 x 4 1/16	4 5/8	3 13/16	5 5/8	D	14-10
A-3111	11	6AQ5	5000-6750	3.2	80		5	2 13/16	1 3/16	3 1/4	1 1/2	A	1-0

Modulation Transformers

Designed for matching specific Class C modulating impedances to Class B plates. Frequency response range from 150 to 5,000 CPS. Rugged construction includes vacuum impregnation, precise windings and ample insulation to insure stable operation.

Merit No.	Ref. No.	Ohms Impedance		Turns Ratio	Pri. MA	Dimensions - Inches				Mtg. Type	Shpg. Wt. Lbs.Oz.
		Pri.	Sec.			Mtg. Centers	H	W	D		
A-2910	12	10000	90000	1:3	10	2	1 3/8	2 3/8	1 1/4	A	0-6
A-2911	13	10000	90000	1:3	10	2 3/8	1 3/8	2 13/16	1 1/2	A	0-9
A-2914	14	10000	90000c.t.	1:3	10	2	1 3/8	2 3/8	1 1/4	A	0-6
A-2915	15	10000	90000c.t.	1:3	10	2 3/8	1 3/8	2 13/16	1 1/2	A	0-10
A-2916	16	10000	90000c.t.	1:3	10	2 13/16	2	3 1/4	1 5/8	A	0-15
A-2913	17	20000c.t.	20000c.t.	1:1	10 Δ	2 3/8	1 3/8	2 13/16	1 1/2	A	0-10
A-2917	18	20000c.t.	45000c.t.	1:1.5	10 Δ	2 13/16	2	3 1/4	1 5/8	A	0-14

Interstage Transformers

To couple a single plate to a single grid.
To couple a single plate to push-pull grids.
To couple push-pull plates to push-pull grids.

Merit No.	Ref. No.	Pri. Impedance	Pri. MA Per Side	Sec. Impedance	Max. Sec. MA †	Watts	Dimensions - Inches				Mtg. Type	Shpg. Wt. Lbs.Oz.
							Mtg. Centers	H	W	D		
A-3105	19	2000-20000	150	2000-20000	150/300	60	2 1/2 x 2 13/16	3 3/8	3 3/8	4 1/8	DL	6-12

Universal Modulation Transformer



TRANSISTOR AUDIO TRANSFORMERS



AA



A



PC



PC-1

Merit No.	Ref. No.	Function	Turns Ratio	Ohms Impedance		D.C. Res.		Pri. MADC	Watts	Mtg. Type	Dimensions - Inches				
				Pri.	Sec.	Pri.	Sec.				H	W	Case Width	D	Mtg. Ctrs.
A-2743	1	Output	1.81:1	24 c.t.	8/4	2.47	4.1	600	10	A	1 ¹⁵ / ₁₆	3 ¹ / ₄	2 ³ / ₁₆	1 ¹³ / ₁₆	2 ¹ / ₁₆
A-2745	2	Output	1.43:1	32 c.t.	16/8/4	2.14	1.37	600	10	A	1 ¹⁵ / ₁₆	3 ¹ / ₄	2 ³ / ₁₆	1 ¹³ / ₁₆	2 ¹ / ₁₆
A-2747	3	Output	1.73:1	50 c.t.	16/8	4.5	3.08	275	5	A	1 ¹⁵ / ₁₆	3 ¹ / ₄	2 ³ / ₁₆	1 ¹ / ₂	2 ¹ / ₁₆
A-2751	4	Gen. Pur.	1:1	100	100 c.t.	10.4	10.8	100	.500	A	1 ⁵ / ₈	2 ³ / ₁₆	1 ¹⁵ / ₁₆	1 ⁷ / ₁₆	2 ³ / ₈
A-2753	5	Output	4:1	125 c.t.	8/4	17.0	1.61	15	.200	A	1 ¹³ / ₁₆	1 ⁵ / ₈	1 ¹ / ₁₆	7 ⁷ / ₁₆	1 ³ / ₈
A-2755	6	Output	4.96:1	200 c.t.	8/4	27.7	1.6	60	2	A	1 ¹³ / ₁₆	2 ¹ / ₁₆	1 ¹ / ₁₆	7 ⁷ / ₁₆	1 ³ / ₈
A-2757	7	Output	3.92:1	250 c.t.	16/8/4	37.4	4.14	10	.200	A	1 ¹³ / ₁₆	1 ⁵ / ₈	1 ¹ / ₁₆	7 ⁷ / ₁₆	1 ³ / ₈
A-2705A	8	Output	4.62:1	250 c.t.	11	21.8	.657	2	.175	PC	2 ¹ / ₃₂	2 ²⁵ / ₃₂	2 ²⁵ / ₃₂	2 ²¹ / ₃₂	3 ³ / ₄
A-2702A	9	Output	11:1	450 c.t.	3.2	32.1	.60	2	.100	PC	1 ¹ / ₁₆	1 ¹ / ₁₆	1 ¹ / ₁₆	3 ³ / ₄	1 ¹ / ₁₆
A-2706A	10	Output	6.1:1	500	12	39.8	2.6	15	.175	PC	2 ¹ / ₃₂	2 ²⁵ / ₃₂	2 ²⁵ / ₃₂	5 ⁵ / ₈	2 ²⁵ / ₃₂
A-2759	11	Dr. or Int.	1.8:1	500 c.t.	150c.t.	80.8	28.3	2	.100	A	1 ¹¹ / ₁₆	1 ¹ / ₃₂	1 ¹³ / ₁₆	1 ¹¹ / ₁₆	1 ¹ / ₁₆
A-2761	12	Output	5.2:1	500 c.t.	16/8/4	65.5	4.16	5	.200	A	1 ¹³ / ₁₆	1 ⁵ / ₈	1 ¹ / ₁₆	7 ⁷ / ₁₆	1 ³ / ₈
A-2701A	13	Output	14.3:1	725 c.t.	3.2	53.9	.34	1	.175	PC	3 ³ / ₄	1 ¹ / ₁₆	1 ¹ / ₁₆	3 ³ / ₄	1 ¹ / ₁₆
A-2760	14	Output	4.2:1	1,000	50/60	108	6.16	3	.001	AA	3 ³ / ₈	3 ³ / ₈	3 ³ / ₈	3 ³ / ₈	—
A-2763	15	Output	7.9:1	1,000	16/8/4	200	4.06	10	.200	A	3 ³ / ₄	1 ⁵ / ₈	1 ¹ / ₁₆	1 ¹³ / ₁₆	1 ³ / ₈
A-2765	16	Dr. or Int.	2:1	2,000 c.t.	500 c.t.	113.1	62	2	.200	A	3 ³ / ₄	1 ⁵ / ₈	1 ¹ / ₁₆	1 ¹³ / ₁₆	1 ³ / ₈
A-2767	17	Output	11.2:1	2,000 c.t.	16/8/4	272	4.2	10	.200	A	3 ³ / ₄	1 ⁵ / ₈	1 ¹ / ₁₆	7 ⁷ / ₁₆	1 ³ / ₈
A-2769	18	Gen. pur.	1:2	2,000 c.t.	8,000 c.t.	250	800	4	.200	A	3 ³ / ₄	1 ⁵ / ₈	1 ¹ / ₁₆	1 ¹³ / ₁₆	1 ³ / ₈
A-2771	19	Dr. or Int.	1.72:1	3,000 c.t.	1,000 c.t.	145	112	4	.200	A	3 ³ / ₄	1 ⁵ / ₈	1 ¹ / ₁₆	1 ¹³ / ₁₆	1 ³ / ₈
A-2773	20	Output	15.5:1	4,000 c.t.	16/8/4	350	1.88	4	.200	A	3 ³ / ₄	1 ⁵ / ₈	1 ¹ / ₁₆	1 ¹³ / ₁₆	1 ³ / ₈
A-2775	21	Gen. Pur.	13:2	5,000 c.t.	50,000 c.t.	416	6750	1	.200	A	3 ³ / ₄	1 ⁵ / ₈	1 ¹ / ₁₆	1 ¹³ / ₁₆	1 ³ / ₈
A-2777	22	Dr. or Int.	5:1	5,000	200 c.t.	390.9	21.4	1	.100	A	2 ¹ / ₃₂	1 ¹ / ₃₂	1 ¹³ / ₁₆	5 ⁵ / ₈	1 ¹ / ₁₆
A-2704A	23	Dr. or Int.	1.14:1	5,000	2,500 c.t.	274	41.2	1.5	.350	PC	2 ¹ / ₃₂	2 ²⁵ / ₃₂	2 ²⁵ / ₃₂	1 ¹¹ / ₁₆	3 ³ / ₄
A-2700A	24	Dr. or Out.	25:1	10,000	16	740	2.83	2	.020	PC	5 ⁵ / ₈	2 ²⁵ / ₃₂	2 ²⁵ / ₃₂	5 ⁵ / ₈	3 ³ / ₄
A-2779	25	Output	50:1	10,000	4	760	1.57	2	.100	A	2 ¹ / ₃₂	1 ¹ / ₃₂	1 ¹³ / ₁₆	5 ⁵ / ₈	1 ¹ / ₁₆
A-2781	26	Dr. or Int.	2.24:1	10,000	2,000 c.t.	1245	290	1	.050	A	3 ³ / ₄	1 ⁵ / ₈	1 ¹ / ₁₆	1 ¹³ / ₁₆	1 ³ / ₈
A-2783	27	Gen. Pur.	8.65:1	15,000	200 c.t.	2420	56.8	1.5	.100	A	3 ³ / ₄	1 ⁵ / ₈	1 ¹ / ₁₆	1 ¹³ / ₁₆	1 ³ / ₈
A-2785	28	Interstage	2:1	16,000	4,000	1535	332	1	.100	A	2 ¹ / ₃₂	1 ¹ / ₃₂	1 ¹³ / ₁₆	3 ³ / ₈	1 ¹ / ₁₆
A-2789	29	Dr. or Int.	5:1	20,000	800 c.t.	1543	89	.5	.100	A	2 ¹ / ₃₂	1 ¹ / ₃₂	1 ¹³ / ₁₆	2 ¹ / ₃₂	1 ¹ / ₁₆
A-2791	30	Output	50:1	20,000	8/4	1545	1.19	.5	.100	A	2 ¹ / ₃₂	1 ¹ / ₃₂	1 ¹³ / ₁₆	1 ¹¹ / ₁₆	1 ¹ / ₁₆
A-2740	31	Interstage	4.5:1	20,000	1,000	—	—	.5	.001	AA	3 ³ / ₈	3 ³ / ₈	3 ³ / ₈	3 ³ / ₈	—
A-2742	32	Dr. or Int.	4.1:1	50,000	3,000 c.t.	4320	253	.5	.200	A	3 ³ / ₄	1 ⁵ / ₈	1 ¹ / ₁₆	2 ²⁵ / ₃₂	1 ³ / ₈
A-2744	33	Dr. or Int.	10:1	50,000	500 c.t.	4611	51.4	.5	.100	A	2 ¹ / ₃₂	1 ¹ / ₃₂	1 ¹³ / ₁₆	5 ⁵ / ₈	1 ¹ / ₁₆
A-2720	34	Input.	14.7:1	200,000	1,000	5200	222	0	.001	AA	3 ³ / ₈	3 ³ / ₈	3 ³ / ₈	3 ³ / ₈	—

AUTO RADIO TRANSFORMERS

Merit No.	Ref. No.	Function	Turns Ratio	Ohms Impedance		D.C. Res.		Pri. MADC	Watts	Mtg. Type	Dimensions - Inches				
				Pri.	Sec.	Pri.	Sec.				H	W	Case Width	D	Mtg. Ctrs.
A-4092A	35	Driver	5:1	1100	40	131	2.7	10	2	PC-1	1 ²¹ / ₃₂	1 ³ / ₈	1 ³ / ₈	1 ¹ / ₄	1 ¹ / ₁₆
A-4093A	36	Output	1.8:1	9	4	1.0	.38	920	10	PC-1	1 ¹³ / ₁₆	2 ³ / ₁₆	2 ³ / ₁₆	1 ¹ / ₁₆	1 ¹³ / ₁₆
A-4094A	37	Driver	10:1	1250	10	184	1.0	10	2	PC-1	1 ²¹ / ₃₂	1 ³ / ₈	1 ³ / ₈	1 ¹ / ₄	1 ¹ / ₁₆
A-4108A	38	Output	{3.4:1 3.4:1}	{35 c.t. 35 c.t.}	3-4	{120 c.t. 120 c.t.}	.4	1000	10	PC	1 ⁵ / ₈	1 ¹⁵ / ₁₆	1 ¹⁵ / ₁₆	1 ¹ / ₈	1 ¹⁵ / ₁₆

▲ For printed circuit application.

RF-IF TRANSFORMERS AND COILS

The following pages listing RF-IF Transformers and coils manufactured by Merit are units that cover a wide variety of coils for use in replacement in radio and television receivers. All coils are precision built to the most exacting specifications. All coils that are tunable are set at the frequency it is intended to operate. All coils that are 'fixed' or manufactured to a specific value, are held within very close tolerance. Schematic drawings are provided for ease of identification of part function.

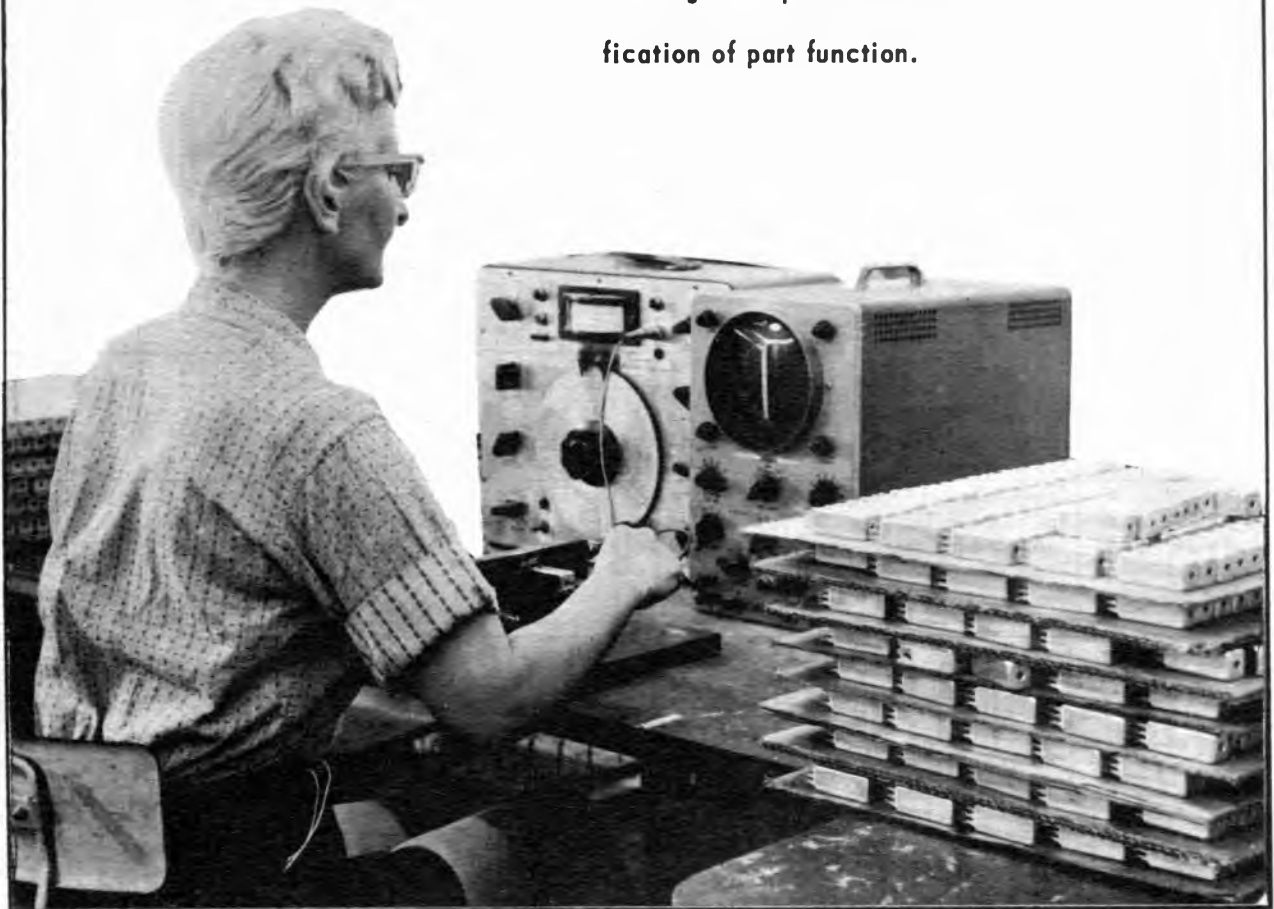



VIDEO AND SOUND IF



Q



K



WC3



K1



W

Merit No.	Ref. No.	Function	Freq. MC	Dimensions—Inches			Mtg. Type	Schematic No.	Shpg. Wt. Oz.
				Mtg. Centers	D	W			
TV-130	1	Tunable Video IF Trans.	41-46	$\frac{5}{16}$ Hole	$\frac{3}{4}$ Max. OD	$1\frac{1}{4}$	Q	9	1
TV-131	2	Tunable Video IF Choke	41-46	$\frac{5}{16}$ Hole	$\frac{3}{4}$ Max. OD	$1\frac{1}{4}$	Q	2	1
TV-134	3	Video IF Choke W/T @ 47.25 MC	45.75	$\frac{5}{16}$ Hole	$\frac{3}{4}$ Max. OD	2	Q	15	1
TV-136	4	Video IF Coil W/T @ 27.25 MC	25.5	$\frac{5}{16}$ Hole	$\frac{3}{4}$ Max. OD	$2\frac{1}{2}$	Q	1A	1
TV-128	5	Video IF Trans. W/T @ 47.25 MC	45.5	Clip	$\frac{3}{4}$ $\frac{3}{4}$	$1\frac{3}{8}$	K	13	2
TV-129	6	Video IF Choke W/T @ 47.25 MC	45.75	Clip	$\frac{3}{4}$ $\frac{3}{4}$	2	K	14	2
TV-240	7	4th Video IF Trans.	44.15	Lug	$\frac{1}{2}$ Max. OD	$2\frac{1}{2}$	WC-3	9	1
TV-125	8	Video IF Trans. (Link Input)	44	Clip	$\frac{3}{4}$ $\frac{3}{4}$	$1\frac{3}{8}$	K	44	2
TV-126	9	Video IF Trans.	44	Clip	$\frac{3}{4}$ $\frac{3}{4}$	$1\frac{3}{8}$	K	44	2
TV-156	10	1st Video IF Coil W/T @ 41.25 MC	44	$\frac{5}{16}$ Hole	$\frac{3}{4}$ Max. OD	$1\frac{3}{4}$	Q	61A	1
TV-243	11	2nd Video IF Trans. W/T @ 47.25 MC	44	$\frac{5}{16}$ Hole	$\frac{3}{4}$ Max. OD	$1\frac{5}{8}$	Q	13B	1
TV-245	12	3rd Video IF Trans. W/T @ 41.25 MC	44	$\frac{5}{16}$ Hole	$\frac{3}{4}$ Max. OD	$1\frac{5}{8}$	Q	13B	1
TV-247	13	4th Video IF Trans.	44	$1\frac{1}{8}$	$1\frac{1}{8}$ $1\frac{1}{8}$	2	K1	83	1
TV-127	14	Video IF Trans. W/T @ 41.25 MC	42.5	Clip	$\frac{3}{4}$ $\frac{3}{4}$	$1\frac{3}{8}$	K	13	2
TV-132	15	Video IF Choke W/T @ 41.25 MC	42.5	$\frac{5}{16}$ Hole	$\frac{3}{4}$ Max. OD	2	Q	15	1
TV-133	16	Video IF Choke W/T @ 39.75 MC	42.25	$\frac{5}{16}$ Hole	$\frac{3}{4}$ Max. OD	2	Q	15	1
TV-142	17	Video IF Coil W/T @ 24-29 MC	22-32	$\frac{5}{16}$ Hole	$\frac{3}{4}$ Max. OD	$2\frac{1}{2}$	Q	13A	1
TV-141	18	Video IF Coil W/T @ 20-23 MC	21-30	$\frac{5}{16}$ Hole	$\frac{3}{4}$ Max. OD	$2\frac{1}{2}$	Q	13A	1
TV-118	19	Tunable Video IF Coil	25-29	$\frac{7}{16}$ Hole	$\frac{3}{4}$ Max. OD	$1\frac{1}{2}$	Q	2	2
TV-140	20	Video IF Trans.	25-29	$\frac{27}{32}$	$\frac{3}{4}$ $\frac{3}{4}$	$1\frac{5}{16}$	W	44	1
TV-100	21	1st Pix IF Amp. W/T @ 27.25 MC	25.3	$\frac{13}{16}$	$\frac{7}{8}$ $\frac{7}{8}$	$2\frac{1}{4}$	W	1	2
TV-102	22	3rd Pix IF Amp.	25.2	$\frac{7}{16}$ Hole	$1\frac{1}{16}$ Max. OD	$1\frac{1}{2}$	Q	2	1
TV-116	23	Tunable Video IF Trans.	21-25	$\frac{5}{16}$ Hole	$\frac{3}{4}$ Max. OD	$1\frac{1}{2}$	Q	9	1
TV-103	25	4th Pix Amp.	23.4	$\frac{7}{16}$ Hole	$\frac{3}{4}$ Max. OD	$1\frac{1}{2}$	Q	2	1
TV-101	26	2nd Pix IF Amp. W/T @ 19.75 MC	22.3	$\frac{31}{32}$	$\frac{7}{8}$ $\frac{7}{8}$	$2\frac{1}{4}$	W	1	2
TV-137	27	Video IF Coil W/T @ 21.2 MC	22	$\frac{5}{16}$ Hole	$\frac{3}{4}$ Max. OD	$2\frac{1}{2}$	Q	1A	1
TV-138	28	Video Detector	24.5	$\frac{5}{16}$ Hole	$\frac{1}{2}$ Max. OD	$1\frac{1}{2}$	Q	2	1
TV-104	29	1st Sound IF Trans.	21.25	$\frac{7}{8}$	$\frac{7}{8}$ $\frac{7}{8}$	$2\frac{1}{4}$	W	3	2
TV-105	30	2nd Sound IF Trans.	21.25	$\frac{7}{8}$	$\frac{7}{8}$ $\frac{7}{8}$	$2\frac{1}{4}$	W	3	2
TV-108	31	Sound IF Trans.	4.5	$1\frac{1}{8}$	$1\frac{1}{8}$ $1\frac{1}{8}$	$2\frac{1}{4}$	W	3	2
TV-112	32	Tunable Video IF Choke	21-26	$\frac{7}{16}$	$\frac{1}{2}$ Max. OD	$1\frac{1}{2}$	Q	2	1
TV-113	33	Interstage IF Trans.	4.5	Clip	$\frac{3}{4}$ $\frac{3}{4}$	2	K	3	2
TV-119	34	Sound Take-Off Coil	4.5	$\frac{5}{16}$ Hole	$\frac{3}{4}$ Max. OD	$1\frac{1}{2}$	Q	18A	2
TV-120	35	Sound IF and Trap	4.5	$\frac{7}{16}$ Hole	$\frac{3}{4}$ Max. OD	$2\frac{1}{4}$	Q	9A	2
TV-149	36	2nd Sound IF Trans.	4.5	$\frac{7}{16}$ Hole	$\frac{3}{4}$ Max. OD	$1\frac{5}{8}$	Q	9B	1
TV-155	37	1st Sound IF Trans.	4.5	Clip	$\frac{3}{4}$ $\frac{3}{4}$	2	K	60	2
TV-157	38	2nd Sound IF Trans.	4.5	$\frac{3}{4}$	$\frac{3}{4}$ $\frac{3}{4}$	2	WC	3	2
TV-158	39	Sound IF and Trap	4.5	$\frac{3}{4}$	$\frac{3}{4}$ $\frac{3}{4}$	2	WC	62	2
TV-236	40	Sound Take-Off Trans.	4.5	Lug	$\frac{5}{8}$ Max. OD	$1\frac{3}{4}$	WC-3	62A	2
TV-237	41	Sound Take-Off Trans.	4.5	Lug	$\frac{1}{2}$ Max. OD	$1\frac{1}{4}$	WC-3	9	1
TV-238	42	2nd Sound IF Trans.	4.5	$\frac{5}{16}$ Hole	$\frac{3}{4}$ Max. OD	$1\frac{3}{4}$	Q	63	1
TV-242	43	2nd Sound IF Trans.	4.5	Lug	$\frac{1}{2}$ Max. OD	$2\frac{3}{4}$	WC-3	47A	1
TV-252	44	Video IF and Detector	44	Clip	$\frac{3}{4}$ $\frac{3}{4}$	2	K	83	2
TV-253	45	Sound IF Trans	4.5	$\frac{31}{32}$	$\frac{7}{8}$ $\frac{7}{8}$	$2\frac{1}{4}$	W		2

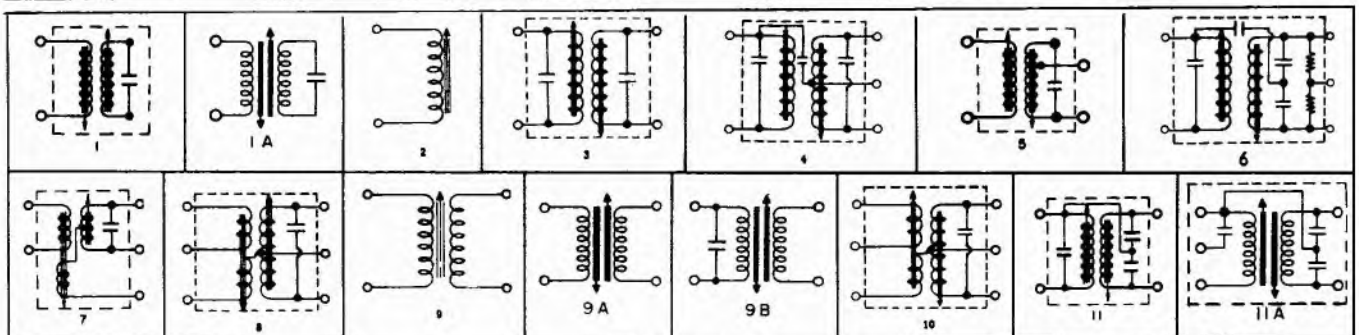

▲ For Printed Circuit Application

TRANSFORMERS AND COILS



WC



WP



WX

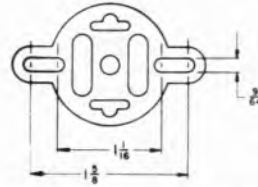

ADAPTER PLATE
BR-5
If needed for 'K' mounted
coils, order from your dis-
tributor by description.

Merit No.	Ref. No.	Function	Freq. MC	Dimensions—Inches				Mtg. Type	Schematic No.	Shpg. Wt. Oz.
				Mtg. Centers	D	W	H			
TV-106	1	Sound Discriminator	21.25	1 1/8	1 1/8	1 1/8	2 1/2	W	4	3
TV-107	2	Converter	21.8	7/8	7/8	7/8	2 1/4	W	5	2
TV-109	3	Sound Discriminator	4.5	1 1/16	1 1/8	1 1/8	2 1/4	W	6	3
TV-111	4	Ratio Detector	21.25	1 1/8	1 1/8	1 1/8	2 1/4	W	10	3
TV-117	5	Sound Discriminator	21.25	7/8	7/8	7/8	2 1/4	W	11	2
TV-144	6	Sound Discriminator	21.25	Clip	3/4	3/4	2	K	4	3
TV-145	7	Ratio Detector	21.25	Clip	3/4	3/4	2	K	58A	3
TV-110	8	Ratio Detector	4.5	1 1/16	1 1/8	1 1/8	2 1/4	W	7	3
TV-114	9	Sound Discriminator	4.5	Clip	3/4	3/4	2	K	4	2
TV-115	10	Ratio Detector	4.5	Clip	3/4	3/4	2	K	8	2
TV-121	11	Quadrature Coil	4.5	5/16 or 7/16	3/4 Max. OD		2 1/4	Q	17	2
▲TV-122	12	Ratio Detector	4.5	Lugs	7/8	7/8	2 1/2	WX	58	3
▲TV-122A	13	Ratio Detector	4.5	Lugs	7/8	7/8	2 1/2	WX	58	3
▲TV-122B	14	Ratio Detector	4.5	Lugs	7/8	7/8	2 1/2	WX	58	3
▲TV-122C	15	Ratio Detector	4.5	Lugs	7/8	7/8	2 1/2	WX	58	3
TV-123	16	Sound Discriminator	4.5	Clip	3/4	3/4	2	K	11A	2
TV-124	17	Quadrature Coil	4.5	15/16	7/8	7/8	1 5/8	W	17A	2
TV-135	18	Sound Discriminator	21.75	Clip	3/4	3/4	1 7/8	W	11	2
▲TV-146	19	Ratio Detector	4.5	Lugs	3/4	3/4	2	WP	58A	2
▲TV-147	20	Ratio Detector	4.5	Lugs	3/4	3/4	2	WP	59	2
▲TV-232	21	Sound Discriminator	4.5	3/4	3/4	3/4	2	WC	58A	2
▲TV-234	22	Quadrature Coil	4.5	3/4	3/4	3/4	2	WP	17A	2
▲TV-235	23	Ratio Detector	4.5	3/4	3/4	3/4	2	WC	59	2
▲TV-248	24	Quadrature Coil	4.5	Lugs	7/16 Max. OD		1 1/2	WC-3	2	1
▲TV-251	25	Sound Discriminator	4.5	3/4	3/4	3/4	2	WC	11	2

▲ For Printed Circuit Application

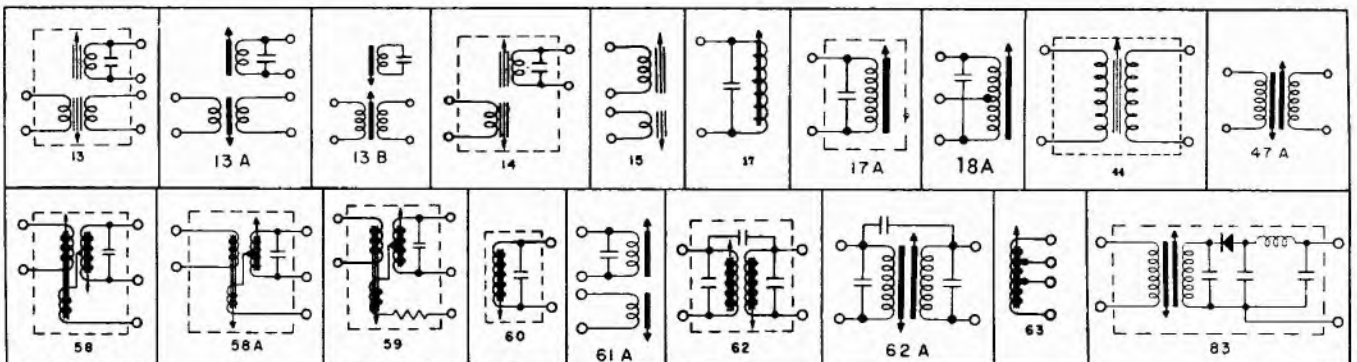

HORIZONTAL SCAN COILS

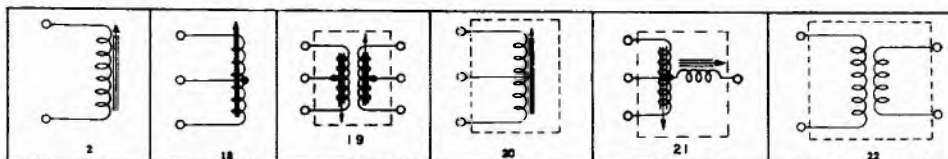

WC-1

Width or
Linearity Coils

Merit No.	Ref. No.	Inductance Millihenries	DC. RESISTANCE OHMS		Mtg. Hole Inches	Shpg. Wt. Oz.	Schematic No.		
			Start to Finish	Start to Tap					
MWC-1	1	3.9-28.2	2.7-8.2 ●	30	29 ●	15.0 ●	7/16 or 5/16	2	74
MWC-2	2	0.3 - 3.1		7.5			7/16 or 5/16	2	2
MWC-3	3	11.0 - 60.0		50.0			7/16	2	2
MWC-4	4	0.3 - 2.65		7.9		2.1	7/16 or 5/16	2	18
MWC-5	5	.5 - 4.5		9.5		3.75	7/16 or 5/16	2	18
MWC-6	6	1.35 - 9.0		8.7			7/16 or 5/16	2	2
MWC-7	7	0.054 - 0.5		0.57			7/16 or 5/16	2	2
MWC-8	8	0.150 - 1.300		1.0			7/16 or 5/16	2	2
MWC-9	9	.135 - 10.0		9.0		6.0	7/16 or 5/16	2	18
MWC-10	10	.35-2.1	4.8-28 ●	2.4	23.5 ●		7/16 or 5/16	2	33
MWC-11	11	2.6 - 16.0		12.0			7/16 or 5/16	2	2
MWC-12	12	7.8 - 27.0		33.0			7/16 or 5/16	2	2
MWC-13	13	49 - 136		190.0		50.0	7/16 or 5/16	2	18
MWC-14	14	.15 - 1.5		4.5			5/16 or 7/16	2	2
MWC-15	15	.04 - .6		0.72		0.3	5/16 or 7/16	2	18
MWC-16	16	.32 - 2.9		6.7		3.6	5/16 or 7/16	2	18
MWC-17	17	1.1 - 5.0		3.4		1.8	5/16 or 7/16	2	18
MWC-18	18	.35 - 2.0		1.8			5/16 or 7/16	2	2



W



WC-3

Horizontal "Sync"
Transformers

For horizontal sweep oscillators and automatic frequency control circuits.

Merit No.	Ref. No.	Function	Freq.	Dimensions—Inches			Mtg. Type	Schematic No.	Shpg. Wt. Oz.
				Mtg. Centers	D	W			
TV-159	19	Hor. Osc.	15.75 KC	5/16 hole	5/8	1 7/8	WC-1	18	3
TV-160	20	"Sync" lock	15.75 KC	1 3/8	1 3/8	2 5/16	W	19	3
TV-161	21	"Sync" guide	15.75 KC	1 3/8	1 3/8	2 5/16	W	20	3
TV-162	22	"Sync" freq. and phase	15.75 KC	1 3/8	1 3/8	2 5/16	W	21	3
TV-163	23	Ring coil	15.75 KC	7/16 hole	1 1/16	2	WC-1	2	2
TV-167	24	Hor. Osc.-sync stabilizer	15.75 KC	1 5/16	1 7/16	2 5/16	W	75	3
TV-168	25	Sync-stabilizer coil — tapped	15.75 KC	5/16 or 7/16 hole	5/8	2	WC-1	20A	2
TV-169	26	Sync-stabilizer coil — tapped	15.75 KC	7/16 hole	1 3/16	2	WC-1	20A	2
▲TV-233	27	Hor. Osc.-sync stabilizer	15.75 KC	Lugs	5/8	2 3/4	WC-3	21A	2
▲TV-244	28	Horiz. Waveform	15.75 KC	Lugs	1/2	1 1/4	WC-3	2	1
▲TV-246	29	Horiz. Waveform	15.75 KC	Lugs	5/8	1 3/4	WC-3	2	1
▲TV-164	30	Horiz. Osc.	15.75 KC	Lugs	3/4	2 1/4	WC-3	2	2
▲TV-165	31	Horiz. Osc.	15.75 KC	Lugs	5/8	2 1/4	WC-3	18	1
▲TV-166	32	Horiz. Sync	15.75 KC	Lugs	1/2	2	WC-1	2	1
▲TV-249	33	Horiz. Osc.	15.75 KC	Lugs	5/8	1 3/8	WC-3	18	1
▲TV-250	34	Horiz. Stabilizer	15.75 KC	Lugs	1/2	1 1/2	WC-3	2	1
▲TV-254	35	Hor. Osc.-Sync Stab.	15.75 KC	Lugs	5/8	2 1/2	WC-3	21A	2

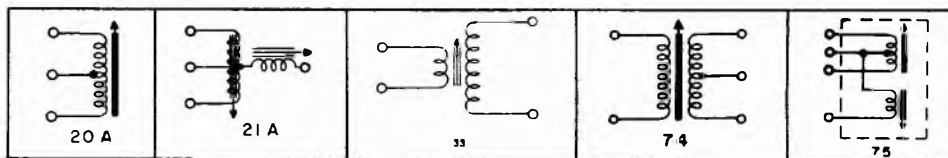

Antenna Matching Transformers



X



YA



YB

Correct matching of impedance between antenna and receiver will provide the best picture quality over the entire frequency range.

Merit No.	Ref. No.	Impedance Ratio	Mtg.	Dimensions—Inches			Mtg. Type	Schematic No.	Shpg. Wt. Oz.
				D	W	H			
TV-171	36	72/300 or 300/72	"L" Bracket	3/4	3/4	1 1/8	X	22	1
Merit No.	Ref. No.	Impedance Ratio	Mtg.	Dimensions—Inches			Mtg. Type	Equivalent Type	
TV-172	37	52/300 or 300/52 72/300 or 300/72 300/300	Leads	5/16 Dia. x 1 1/8			YB	RCA-73591, etc.	
TV-173	38	Exact Replacement	Leads	1/4 x 3/4			YA	GE. RLA-036 RLA-037 RLA-040 RLA-041 Magnavox 360490	

■ Two Required. See instruction sheet packaged with unit.

▲ For Printed Circuit Applications. ● Tapped.

FLORITRAN I F TRANSFORMERS

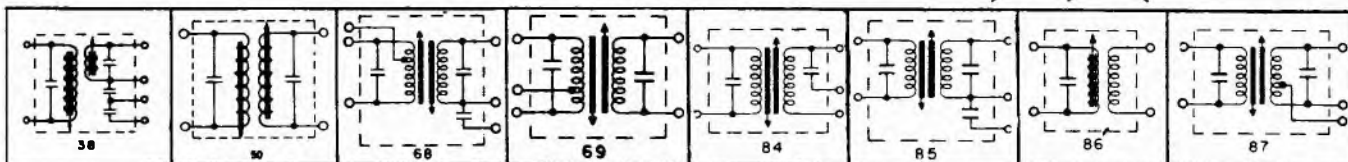

Merit No.	Ref. No.	Function	Freq.	Dimensions—Inches			Mtg. Type	Schematic No.	Shpg. Wt. Oz.	
				Mtg. Centers	D	W				H
BC-343	1	Input-Output	455 KC	Mtg. Tab	3/4	3/4	1 1/8	RA	50	2
BC-347	2	iF Trans. ■	455 KC	Clip	3/4	3/4	2	K	69	2
▲BC-349	3	Output	455 KC	1/2	1/2	1/2	1 1/2	WC	50	2
▲BC-348	4	Input	455 KC	1/2	1/2	1/2	1 1/2	WC	50	2
BC-352	5	Input	455 KC	Clip	3/4	3/4	2	K	50	2
BC-353	6	Output	455 KC	Clip	3/4	3/4	2	K	50	2
BC-355	7	Output †	455 KC	Clip	3/4	3/4	2	K	38	2
▲BC-356	8	Input	455 KC	3/4	3/4	3/4	2	WC	50	2
▲BC-357	9	Output	455 KC	3/4	3/4	3/4	2	WC	50	2
▲BC-358	10	Input	455 KC	1/2	1/2	1/2	1 1/2	WC	50	2
▲BC-359	11	Output	455 KC	1/2	1/2	1/2	1 1/2	WC	50	2
BC-567	12	Input	455 KC	Clip	3/4	3/4	2	K	69	2
▲BC-640	13	iF Trans.	455 KC	3/4	3/4	3/4	2	WC	69	2
▲BC-641	14	Output †	455 KC	3/4	3/4	3/4	2	WC	38	2
BC-316	15	Output †	262 KC	Clip	3/4	3/4	1 1/8	K	38	2
▲BC-317	16	Input	262 KC	3/4	3/4	3/4	1 1/8	WC	50	2
▲BC-318	17	Output	262 KC	3/4	3/4	3/4	1 1/8	WC	68	2
▲BC-320	19	Output †	262 KC	3/4	3/4	3/4	1 1/8	WC	38	2
▲BC-344	20	Input	262 KC	3/4	3/4	3/4	2	WC	50	2
▲BC-345	21	Output	262 KC	3/4	3/4	3/4	2	WC	50	2
▲BC-346	22	Output †	262 KC	3/4	3/4	3/4	2	WC	38	2
BC-350	23	Input	262 KC	Clip	3/4	3/4	2	K	50	2
BC-351	24	Output	262 KC	Clip	3/4	3/4	1 1/8	K	50	2
BC-354	25	Output †	262 KC	Clip	3/4	3/4	2	K	38	2
▲BC-424	26	Output	262 KC	3/4	3/4	3/4	2	WC	68	2
▲BC-594	27	Output †	262 KC	3/4	3/4	3/4	2	WC	68	2
▲BC-595	28	Input	262 KC	3/4	3/4	3/4	2	WC	84	2
▲BC-596	29	Input	262 KC	3/4	3/4	3/4	2	WC	85	2
▲BC-597	30	Output †	262 KC	3/4	3/4	3/4	2	WC	68	2
▲BC-598	31	Input	262 KC	3/4	3/4	3/4	2	WC	84	2
▲BC-599	32	Output †	262 KC	3/4	3/4	3/4	2	WC	68	2
▲BC-635	33	Output	262 KC	3/4	3/4	3/4	2	WC	86	2
▲BC-636	34	Input	262 KC	3/4	3/4	3/4	2	WC	87	2
▲BC-638	35	Input	262 KC	3/4	3/4	3/4	2	WC	87	2
▲BC-639	36	Output	262 KC	3/4	3/4	3/4	2	WC	88	2
▲BC-684	37	Output	262 KC	3/4	3/4	3/4	2	WC	68	2
▲BC-685	38	Output †	262 KC	3/4	3/4	3/4	2	WC	98	2
▲BC-686	39	Output †	262 KC	3/4	3/4	3/4	2	WC	68	2
▲BC-687	40	Input	262 KC	3/4	3/4	3/4	2	WC	84	2
▲BC-688	41	Input	262 KC	3/4	3/4	3/4	2	WC	84	2
▲BC-689	42	Input	262 KC	3/4	3/4	3/4	2	WC	84	2
BC-690	43	Input	262 KC	Clip	3/4	3/4	2	K	87	2
BC-691	44	Output	262 KC	Clip	3/4	3/4	2	K	88	2

Permeability tuned.

FLORITRANS

Silver Ceramic Capacitors

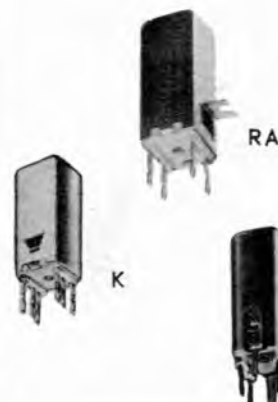

ADAPTER PLATE
BR-5

If needed for 'K' mounted coils, order from your distributor by description.

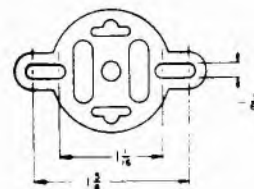

BC-300	45	Input-Output	175 KC	1 3/8	1 3/8	1 3/8	2 3/8	IF	34	4
BC-304	46	Input	262 KC	1 3/8	1 3/8	1 3/8	2 3/8	IF	34	4
BC-305	47	Interstage	262 KC	1 3/8	1 3/8	1 3/8	2 3/8	IF	34	4
BC-307	48	Half Wave Output	262 KC	1 3/8	1 3/8	1 3/8	2 3/8	IF	34	4
BC-308	49	Input	455 KC	1 3/8	1 3/8	1 3/8	2 3/8	IF	35	4
BC-311	50	Half Wave Output	455 KC	1 3/8	1 3/8	1 3/8	2 3/8	IF	35	4
BC-312	51	Input	1500 KC	1 3/8	1 3/8	1 3/8	2 3/8	IF	34	4
BC-315	52	Half Wave Output	1500 KC	1 3/8	1 3/8	1 3/8	2 3/8	IF	34	4
BC-330	53	Input	175 KC	1 3/8	1 3/8	1 3/8	3 1/4	IF	36	5
BC-333	54	Half Wave Output	175 KC	1 3/8	1 3/8	1 3/8	3 1/4	IF	36	5
BC-336	55	Full Wave Output	262 KC	1 3/8	1 3/8	1 3/8	3 1/4	IF	37	5
BC-338	56	Input-Output	455 KC	1 3/8	1 3/8	1 3/8	3 1/4	IF	36	4
BC-341	58	Full Wave Output	455 KC	1 3/8	1 3/8	1 3/8	3 1/4	IF	37	4

Broadcast type capacity tuned for broadcast, communication, and auto receivers.



Broadcast type iron core capacity tuned for broadcast, communication, and auto receivers.

▲ Primarily for Printed Circuit Application.

† Includes Output Filter

■ Designed to Operate into a 12AU6 or Equivalent Tube Used as an Autodyne Converter.

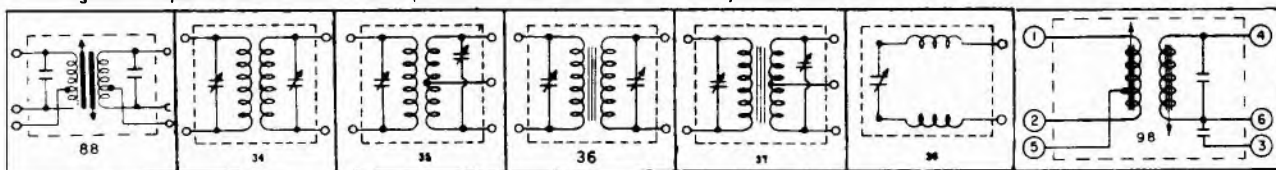



IF TRANSFORMERS

ADAPTER PLATE

If needed for 'K' mounted coils, order from distributor by description.

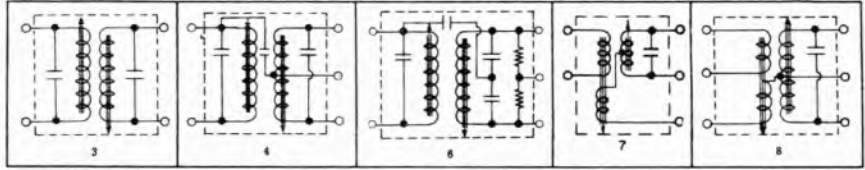
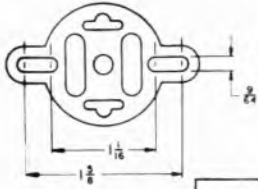

Used to couple the signal from one amplification stage to the next stage.



Capacity tuned for broadcast, communication, and auto receiver.

TRANSISTOR TYPE



KT

SPECIAL TYPE



WC

For combination AM-FM receiver.

Merit No.	Ref. No.	Description	Frequency	Dimensions - Inches				Mtg. Type	Schematic No.	Shpg. Wt. Oz.
				Mtg. Centers	D	W	H			
BC-360	1	Input-Output	175 KC	1/8	1/8	1/8	2/4	IF	34	3
BC-366	2	Full Wave Output	262 KC	1/8	1/8	1/8	2/4	IF	35	3
BC-367	3	Half Wave Output	262 KC	1/8	1/8	1/8	2/4	IF	34	3
BC-372	4	Half Wave Output †	262 KC	1/8	1/8	1/8	2/4	IF	39	3
BC-368	5	Input	455 KC	1/8	1/8	1/8	2/4	IF	34	3
BC-369	6	Interstage	455 KC	1/8	1/8	1/8	2/4	IF	34	3
BC-370	7	Full Wave Output	455 KC	1/8	1/8	1/8	2/4	IF	35	3
BC-371	8	Half Wave Output	455 KC	1/8	1/8	1/8	2/4	IF	34	3

Merit No.	Ref. No.	Function	Frequency	Dimensions - Inches			Mtg. Type	Schematic No.	Shpg. Wt. Oz.
				H	W	D			
▲ BC-321	9	Input	455 KC	9/16	1/2	1/2	KT	95	2
▲ BC-322	10	Interstage	455 KC	9/16	1/2	1/2	KT	95	2
▲ BC-323	11	Output	455 KC	9/16	1/2	1/2	KT	95	2
▲ BC-324	12	Input	455 KC	1 1/16	1/2	1/2	KT	95	2
▲ BC-325	13	Interstage	455 KC	1 1/16	1/2	1/2	KT	95	2
▲ BC-326	14	Output	455 KC	1 1/16	1/2	1/2	KT	95	2
▲ BC-327	15	Input	455 KC	1 1/8	3/4	3/4	WC	96	2
▲ BC-328	16	Interstage	455 KC	1 3/8	3/4	3/4	WC	97	2
▲ BC-329	17	Output	455 KC	1 1/8	3/4	3/4	WC	95	2

Merit No.	Ref. No.	Description	Frequency	Dimensions - Inches			Mtg. Type	Schematic No.	Shpg. Wt. Oz.	
				Mtg. Centers	D	W				H
BC-375	18	Cartwheel	455 KC	6-32 Screw	1 3/8 x 1 1/2			40	2	
BC-377	19	AM-FM	455 KC-10.7 MC	1 1/8	1 3/8	1 3/8	2 1/2	W	42	3

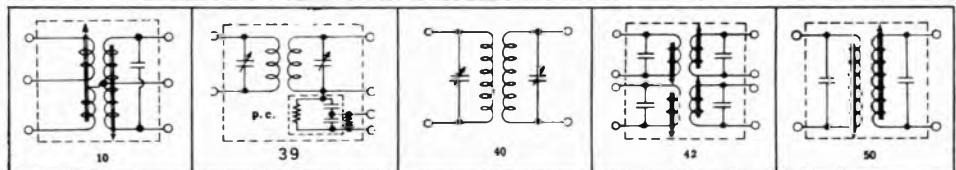

Merit No.	Ref. No.	Description	Frequency	Dimensions - Inches				Mtg. Type	Schematic No.	Shpg. Wt. Oz.
				Mtg. Centers	D	W	H			
FM-250	20	Discriminator	10.7 MC	1/8	1/8	1/8	2/4	W	6	3
FM-251	21	Amp. Interstage	10.7 MC	1/8	1/8	1/8	2/4	W	50	2
FM-252	22	Ratio Detector	10.7 MC	1/8	1/8	1/8	2/4	W	10	2
FM-253	23	Discriminator	10.7 MC	Clip	3/4	3/4	2	K	4	2
FM-254	24	Amp. Interstage	10.7 MC	Clip	3/4	3/4	2	K	50	2
FM-255	25	Ratio Detector	10.7 MC	Clip	3/4	3/4	2	K	8	2
▲ FM-256	26	IF Transformer	10.7 MC	3/4	3/4	3/4	2	KT	50	2
▲ FM-257	27	Ratio Detector	10.7 MC	3/4	3/4	3/4	2	KT	71	2
▲ FM-258	28	Ratio Detector	10.7 MC	3/4	3/4	3/4	2	KT	7	2
▲ FM-260	30	Discriminator	10.7 MC	3/4	3/4	3/4	2	KT	4	2

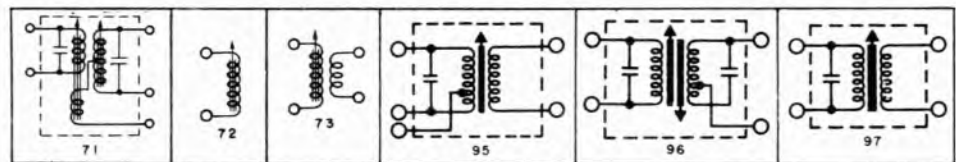

FM Units

FM type permeability tuned for FM receiver.



K



W

Short Wave Types

For communications receivers covering the short wave bands.



Q



IF

Merit No.	Ref. No.	Function	Frequency In KC	Dimensions - Inches			Mtg. Type	Schematic No.	Shpg. Wt. Oz.	
				Mtg. Centers	D	W				H
SW-605	34	Interstage	1400-1600	1/8	1/8	1/8	2	IF	34	2
SW-606	35	Full Wave Output	1400-1600	1/8	1/8	1/8	2	IF	35	2
SW-607	36	Half Wave Output	1400-1600	1/8	1/8	1/8	2	IF	34	2
SW-608	37	RF Coil	27 MC	5/16 Hole	3/4	1/8		Q	72	1

‡ Includes output filter. ■ Capacity tuned.
 ▲ For printed circuit application. † Permeability tuned.
 See page 62 for Schematic Nos. 34 and 35.

SUBMINIATURE TRANSFORMERS AND OSCILLATOR COILS

For Printed Circuit Applications

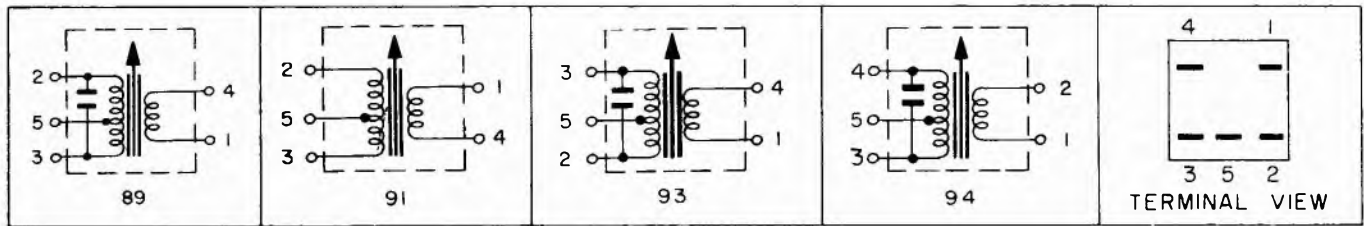

SUBMINIATURE 455 KC IF TRANSFORMERS PERMEABILITY TUNED KT MOUNTING

$1/4 \times 1/4 \times 7/16$

Merit No.	Ref. No.	Function	Primary		DC Res. — Ohms			Resistance Ratio		Schematic No.	
			Q	C-uufd	2-3	2-5	3-5	Sec.	Pri.:2-5		Pri.:3-5
BC-569	1	1st IF	124	85	14.0	9.0	5.0	0.5	1.6:1	2.8:1	89
BC-570	2	2nd IF	120	75	15.0	12.0	3.0	0.5	1.3:1	5.0:1	89
BC-571	3	3rd IF	118	66	17.0	14.0	3.0	1.0	1.2:1	5.7:1	89
BC-582	4	1st, 2nd or 3rd IF			15.0	12.0	3.0	1.0	1.3:1	5.0:1	91

$3/8 \times 3/8 \times 1/2$

BC-574	5	1st IF	120	105	8.0	5.0	3.0	1.0	1.6:1	2.7:1	89
BC-575	6	2nd IF	116	115	7.0	5.0	2.0	1.0	1.4:1	3.5:1	89
BC-576	7	3rd IF	117	125	7.0	5.5	1.5	3.5	1.3:1	4.7:1	89
BC-581	8	1st, 2nd or 3rd IF	625	137	16.0	9.0	7.0	1.0	1.8:1	2.3:1	91
BC-578	9	2nd IF	96.4	125	9.5	6.0	3.5	1.0	1.6:1	2.7:1	89
BC-579	10	2nd IF	133.5	125	8.0	5.5	3.0	2.0	1.5:1	2.7:1	93
BC-580	11	2nd IF			7.0	4.5	2.5	1.3	1.6:1	2.8:1	89
BC-584	12	2nd IF	130	137	7.5	4.5	3.0	1.5	1.7:1	2.5:1	94

SUBMINIATURE OSCILLATOR COILS

FREQUENCY RANGE 530—1700 KC PERMEABILITY TUNED KT MOUNTING

$1/4 \times 1/4 \times 7/16$

Merit No.	Ref. No.	Pri. Q	L uh	Pri. DC Res. 1-4	Sec. DC Res.			Resistance Ratio		Schematic No.
					2-3	2-5	3-5	Sec.:2-5	Sec.:3-5	
BC-572	13	124	350	0.5	3.5	3.4	0.1	1.0:1	35.0:1	91
BC-573	14	124	350	0.5	3.5	0.1	3.4	35.0:1	1.0:1	91

$3/8 \times 3/8 \times 1/2$

BC-577	15	125	350	1.0	3.8	3.7	0.1	1.0:1	38.0:1	89
--------	----	-----	-----	-----	-----	-----	-----	-------	--------	----



RF, ANTENNA AND OSCILLATOR COILS

Used extensively for universal replacement frequency range from 530 KC and 1700 KC. Permeability tuned.

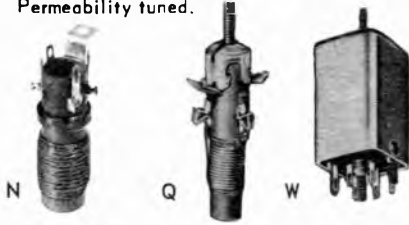

Merit No.	Ref. No.	Description	Condenser Size Max. Cap.	Dimensions — inches			Mtg. Type	Schematic No.	Shpg. Wt. Oz.	
				Mtg. Centers	D	W				H
BC-381	2	Oscillator	250-450 MMFD	"L" Bracket	3/4 Dia. x 2		N	43	2	
BC-382	3	R.F.	250-450 MMFD	"L" Bracket	3/4 Dia. x 2		N	9	2	
BC-384	4	Oscillator (Shielded)	250-450 MMFD	1 3/8 centers	1 1/8	2 1/2	W	45	3	
BC-386	5	Antenna	365 MMFD	5/16 hole	1/2 Dia. x 1 1/2		Q	9	2	
BC-387	6	Oscillator	365 MMFD	5/16 hole	1/2 Dia. x 1 1/2		Q	43	2	
BC-388	7	R.F.	365 MMFD	5/16 hole	1/2 Dia. x 1 1/2		Q	9	2	
BC-390	8	Antenna	365 MMFD	Clip	3/4	3/4	2	K	20	2
BC-392	10	Oscillator	365 MMFD	Clip	3/4	3/4	2	K	20	2

Miniature Type

Capacity tuned.



Merit No.	Ref. No.	Description	Frequency Range KC	Dimensions — inches			Mtg. Type	Schematic No.	Shpg. Wt. Oz.	
				Mtg. Centers	D	W				H
SW-620	11	Antenna	2100-6300	Clip	3/4	3/4	2	K	12	2
SW-621	12	R.F.	2100-6300	Clip	3/4	3/4	2	K	31	2

† 1600 MMFD, series paa.

Tuned RF Coils

Used for broadcast receiver replacement—Air Core shielded or unshielded types.



Merit No.	Ref. No.	Description	Frequency Range	Dimensions — inches			Mtg. Type	Schematic No.	Shpg. Wt. Oz.	
				Mtg. Centers	D	W				H
BC-410	14	Antenna	540-1700 KC	—	1 3/8 Dia. x 2		N	47	2	
BC-411	15	R.F.	540-1700 KC	—	1 3/8 Dia. x 2		N	47	2	
BC-412	16	Antenna	540-1700 KC	—	5/8 Dia. x 2 1/8		N	47	1	
BC-413	17	R.F.	540-1700 KC	—	5/8 Dia. x 2 1/8		N	47	1	
BC-414	18	Band-Pass	540-1700 KC	—	5/8 Dia. x 2 1/8		N	24	1	
BC-415	19	Antenna (Shielded)	540-1700 KC	1 5/16	1 3/8	2 5/8	W	23	2	
BC-416	20	R.F. (Shielded)	540-1700 KC	1 5/16	1 3/8	2 5/8	W	23	2	
BC-417	21	Band-Pass (Shielded)	540-1700 KC	1 5/16	1 3/8	2 5/8	W	32	2	
BC-568	22	R.F. Transformer	535-1650 KC	Clip	3/4	3/4	2	K	44	2

High Voltage Oscillator



Merit No.	Ref. No.	Output — Volts	Dimensions — inches		Mtg. Type	Schematic No.	Ship. Wt. Oz.
			Mtg. Centers				
TV-230	26	To 4000	1 1/16	1 1/4 x 3 3/4	U	28	4
TV-231	27	To 30000	2 1/4	2 1/4 x 6	U	28	6

Oscillator Coils



For use in all types of broadcast receivers having 455 KC int. frequency.

Merit No.	Ref. No.	Description	Frequency Range — KC	Dimensions — inches	Mtg. Type	Schematic No.	Shpg. Wt. Oz.
BC-394	29	Oscillator Adj. Ind.	535-1620	3/8 Dia. x 1 High	V	65	1
BC-395	30	Oscillator Fixed Ind.	175	1 Dia. x 1 High	L	47	1
BC-396	31	Oscillator Fixed Ind.	262	1 Dia. x 1 High	L	47	1
BC-397	32	Oscillator Fixed Ind.	455	1 Dia. x 1 High	L	47	1
BC-398	33	Oscillator (autoformer)	175	1 Dia. x 1 High	L	67	1
BC-399	34	Oscillator (autoformer)	262	1 Dia. x 1 High	L	67	1
BC-400	35	Oscillator (autoformer)	455	1 Dia. x 1 High	L	67	1
† BC-401	36	Oscillator Adj. Ind.	535-1620	3/8 Dia. x 1 1/4 High	V	64	1
BC-402	37	Oscillator Adj. Ind.	262	3/8 Dia. x 1 1/4 High	V	65	1
§ BC-403	38	Oscillator transistor	535-1620	3/8 Dia. x 1 1/4 High	V	65	1

† For use in portable receivers using a 1.4 volt converter tube.

§ For use with transistor converters.

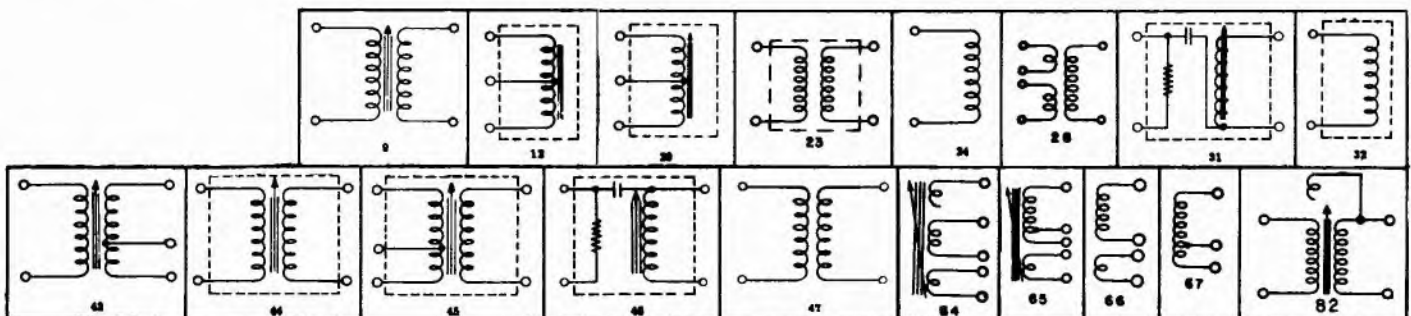



Merit No.	Ref. No.	Ind. in uh	Max. Current in ma.	DC Resistance
BC-662	1	27	60	2.5
BC-663	2	33	60	2.5
BC-664	3	39	60	2.5
BC-665	4	47	60	3.0
BC-666	5	56	60	3.0
BC-667	6	68	50	3.5
BC-668	7	82	50	5.0
BC-669	8	100	50	6.0
BC-670	9	120	50	7.0
BC-671	10	150	50	7.5
BC-672	11	180	50	8.0
BC-673	12	220	50	9.0
BC-674	13	270	50	10.0
BC-675	14	330	50	11.0
BC-676	15	390	40	12.0
BC-677	16	470	40	14.0
BC-678	17	560	40	15.0
BC-679	18	680	40	27.0
BC-680	19	820	40	30.0
BC-681	20	1.0 mh	25	35.0
BC-682	21	1.2 mh	25	37.0
BC-683	22	1.5 mh	25	40.0

FLORIMOLD MINIATURE RF CHOKES AIR CORE

For printed circuit application as Peaking Coils or as RF Chokes.

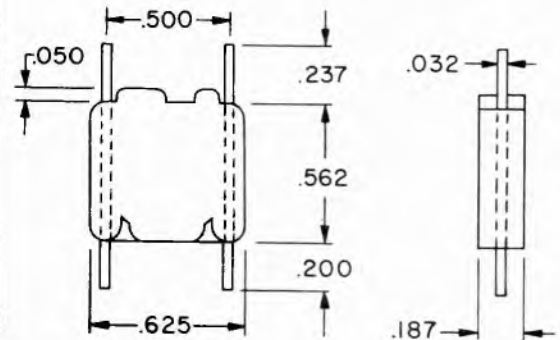
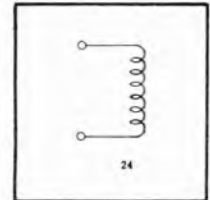

Merit No.	Ref. No.	Ind. in uh	Max. Current in ma.	DC Resistance	Core	Merit No.	Ref. No.	Ind. in uh	Max. Current in ma.	DC Resistance	Core
TV-239†	23	.47	600	.1	Air	TV-185▲	46	250	20	11.5	Air
BC-560†	24	.7	600	.04	Air	TV-187▲	47	250	20	11.5	22K Ω R
TV-189†	25	.8	4.0A	.02	Air	TV-198▲	48	275	20	10.3	Air
BC-561†	26	1.0	600	.05	Air	TV-199▲	49	300	20	11.0	Air
BC-562†	27	1.5	600	.08	Air	TV-200▲	50	330	20	11.5	Air
BC-563†	28	2.4	600	.16	Air	TV-190▲	51	350	20	14.0	Air
BC-564†	30	3.9	600	.40	Air	TV-191▲	52	350	20	14.0	100 K Ω R
BC-565†	32	6.2	600	.75	Air	TV-201▲	53	375	20	12.5	Air
BC-566†	33	10.0	200	1.85	Air	TV-202▲	54	420	20	13.2	Air
TV-192▲	34	20.0	20	2.4	Air	TV-203▲	55	470	20	14.0	Air
TV-180▲	35	36.0	20	4.0	Air	TV-188▲	56	500	20	18.0	10 Meg. R
TV-193▲	36	60.0	20	4.4	Air	TV-204▲	57	550	20	17.0	Air
TV-186▲	37	73.0	20	6.0	10 Meg. R	TV-205▲	58	600	20	17.7	Air
TV-181▲	38	93.0	20	6.5	Air	TV-206▲	59	700	20	19.2	Air
TV-194▲	39	100	20	5.8	Air	TV-207▲	60	800	20	20.5	Air
TV-182▲	40	120	20	8.0	22K Ω R	TV-208▲	61	950	20	22.0	Air
TV-195▲	41	120	20	6.5	Air	BC-513Ⓢ	62	1.0 K	200	4.5	Iron
TV-196▲	42	155	20	7.5	Air	BC-514Ⓢ	63	1.5 K	200	5.5	Iron
TV-183▲	43	180	20	10.0	39K Ω R	BC-551Ⓢ	64	2.5 K	200	7.4	Iron
TV-184▲	44	180	20	10.0	Air	BC-549Ⓢ	65	2.5 K	200	23.0	Air
						BC-524Ⓢ	68	6.2 K	125	17.5	Iron
						BC-553Ⓢ	69	10.0 K	125	26.0	Iron

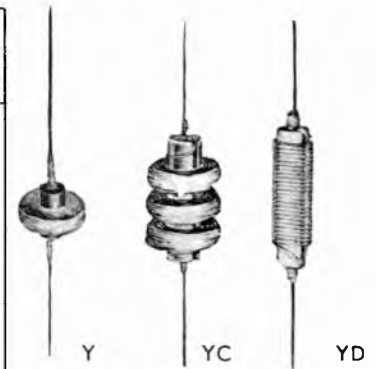

Inductors

Used as RF Chokes, Peaking Coils, Filters and other circuit applications.

▲ Peaking coils - Type Y Ⓢ General Use - Type YC A - Amperes
 † Filament chokes - Type YD † UHF choke - Type YD

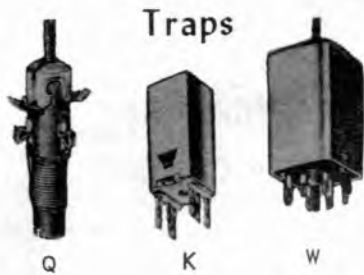

Traps

To attenuate unwanted and adjacent channel signals from Video Section. Permeability tuned.

Merit No.	Ref. No.	Function	Freq. MC	Dimensions - Inches			Mtg. Type	Schematic No.	Shpg. Wt. Oz.	
				Mtg. Centers	D	W				H
TV-150	1	Cathode Trap	21.25	$\frac{7}{16}$ hole	$\frac{1}{2}$		$1\frac{1}{2}$	Q	16	1
TV-151	2	Sound Trap	4.5	$\frac{5}{16}$ hole	$\frac{1}{2}$		$1\frac{1}{2}$	Q	17	1
TV-152	3	Adj. Channel Trap	39.75	$\frac{5}{16}$ hole	$\frac{1}{2}$		$1\frac{3}{8}$	Q	2	1
TV-153	4	Adj. Channel Trap (Tapped)	47.25	$\frac{5}{16}$ hole	$\frac{1}{2}$		$1\frac{1}{4}$	Q	18	1
TV-154	5	Sound Trap	4.5	Clip	$\frac{3}{4}$	$\frac{3}{4}$	2	K	17	2
TV-224	6	Cathode Trap	21.25	$\frac{5}{16}$ hole	$\frac{3}{4}$		$2\frac{7}{8}$	Q	59	1
TV-241	7	Sound Trap	4.5	1	$\frac{7}{8}$	$\frac{7}{8}$	2	W	62	2

AIR AND IRON CORE CHOKES

Air Core
UNSHIELDED

Air Core
SHIELDED



S

Iron Core
UNSHIELDED



R

Iron Core
SHIELDED

Merit No.	Ref. No.	Inductance Millihenries	Current DCMA	DC Res. in Ohms	Mtg. Centers	Dimensions Inches	Mtg. Type	Schematic No.	Shpg. Wt. Oz.
BC-500	8	0.25	125	8	Single Bolt	$1\frac{1}{8}$ Dia. x $\frac{7}{16}$	R	24	1
BC-501	9	0.75	125	17	Single Bolt	$1\frac{1}{8}$ Dia. x $\frac{7}{16}$	R	24	1
BC-502	10	1.50	125	21	Single Bolt	$1\frac{1}{8}$ Dia. x $\frac{7}{16}$	R	24	1
BC-503	11	2.50	125	28	Single Bolt	$1\frac{1}{8}$ Dia. x $\frac{7}{16}$	R	24	1
BC-504	12	5.0	125	41	Single Bolt	$1\frac{1}{8}$ Dia. x $\frac{7}{16}$	R	24	1
BC-506	13	10.0	125	64	Single Bolt	$1\frac{1}{8}$ Dia. x $\frac{3}{8}$	R	24	1
BC-507	14	12.5	125	74	Single Bolt	$1\frac{1}{8}$ Dia. x $\frac{3}{8}$	R	24	1
BC-508	15	15.0	125	83	Single Bolt	$1\frac{1}{8}$ Dia. x $\frac{3}{8}$	R	24	1
BC-509	16	20.0	125	97	Single Bolt	$1\frac{1}{8}$ Dia. x $\frac{3}{8}$	R	24	1
BC-511	17	60.0	100	175	Single Bolt	$1\frac{1}{8}$ Dia. x $\frac{3}{8}$	R	24	2
BC-512	18	80.0	100	270	Single Bolt	$1\frac{1}{8}$ Dia. x $\frac{3}{8}$	R	24	2
BC-515	19	0.5	125	10	$1\frac{1}{4}$	$1\frac{1}{4}$ Dia. x $1\frac{1}{8}$	S	32	1
BC-516	20	1.0	125	17	$1\frac{1}{4}$	$1\frac{1}{4}$ Dia. x $1\frac{1}{8}$	S	32	1
BC-517	21	2.5	125	30	$1\frac{1}{4}$	$1\frac{1}{4}$ Dia. x $1\frac{1}{8}$	S	32	1
BC-519	23	7.5	125	61	$1\frac{1}{4}$	$1\frac{1}{4}$ Dia. x $1\frac{1}{8}$	S	32	2
BC-521	25	25.0	125	125	$1\frac{1}{4}$	$1\frac{1}{4}$ Dia. x $1\frac{1}{8}$	S	32	2

BC-526	27	1.0	125	10.9	Single Bolt	$1\frac{1}{8}$ Dia. x $\frac{5}{8}$	R	29	1
BC-527	28	2.5	125	19.5	Single Bolt	$1\frac{1}{8}$ Dia. x $\frac{5}{8}$	R	29	1
BC-528	29	5.0	125	23.0	Single Bolt	$1\frac{1}{8}$ Dia. x $\frac{5}{8}$	R	29	1
BC-530	30	10.0	125	45.0	Single Bolt	$1\frac{1}{8}$ Dia. x $\frac{5}{8}$	R	29	1
BC-532	32	50.0	100	130.0	Single Bolt	$1\frac{1}{8}$ Dia. x $\frac{3}{8}$	R	29	1
BC-533	33	75.0	100	172.0	Single Bolt	$1\frac{1}{8}$ Dia. x $\frac{5}{8}$	R	29	2
BC-534	34	100.0	100	210.0	Single Bolt	$1\frac{1}{8}$ Dia. x $\frac{5}{8}$	R	29	2
BC-535	35	150.0	100	268.0	Single Bolt	$1\frac{1}{8}$ Dia. x $\frac{5}{8}$	R	29	2
BC-538	36	0.5	125	8.6	$1\frac{1}{4}$	$1\frac{1}{4}$ Dia. x $1\frac{1}{8}$	S	51	1
BC-539	37	1.0	125	11.5	$1\frac{1}{4}$	$1\frac{1}{4}$ Dia. x $1\frac{1}{8}$	S	51	1
BC-540	38	2.5	125	22.0	$1\frac{1}{4}$	$1\frac{1}{4}$ Dia. x $1\frac{1}{8}$	S	51	1
BC-541	39	5.0	125	31.0	$1\frac{1}{4}$	$1\frac{1}{4}$ Dia. x $1\frac{1}{8}$	S	51	1
BC-542	40	7.5	125	42.0	$1\frac{1}{4}$	$1\frac{1}{4}$ Dia. x $1\frac{1}{8}$	S	51	2
BC-543	41	10.0	125	47.0	$1\frac{1}{4}$	$1\frac{1}{4}$ Dia. x $1\frac{1}{8}$	S	51	2
BC-544	42	25.0	125	100.0	$1\frac{1}{4}$	$1\frac{1}{4}$ Dia. x $1\frac{1}{8}$	S	51	2
BC-545	43	50.0	100	160.0	$1\frac{1}{2}$	$1\frac{1}{2}$ Dia. x $1\frac{1}{8}$	S	51	2
BC-546	44	75.0	100	222.0	$1\frac{1}{2}$	$1\frac{1}{2}$ Dia. x $1\frac{1}{8}$	S	51	2
BC-547	45	100.0	100	348.0	$1\frac{1}{2}$	$1\frac{1}{2}$ Dia. x $1\frac{1}{8}$	S	51	2
BC-548	46	150.0	100	520.0	$1\frac{1}{2}$	$1\frac{1}{2}$ Dia. x $1\frac{1}{8}$	S	51	2

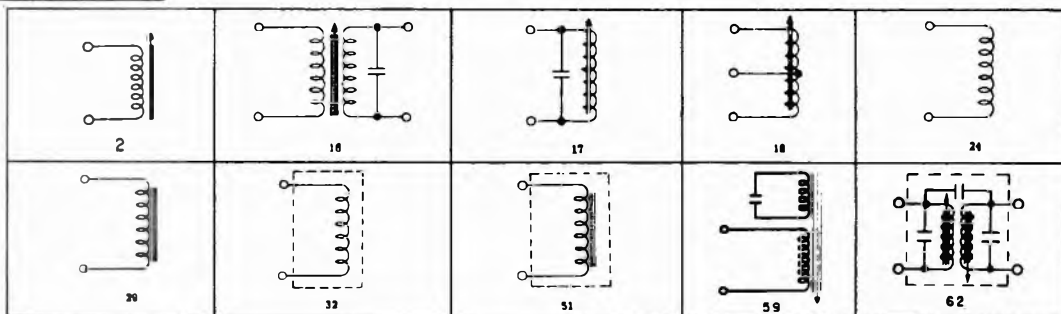

MISCELLANEOUS UNITS

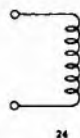

Merit No.	Ref. No.	Inductance Microhenries	Current Amps.	DC Res. in Ohms	Mtg. Centers	Dimensions - Inches	Schematic No.	Shpg. Wt. Oz.
BC-537	1	10.0	8	0.02	Leads	3/4 Dia. x 1 1/8	24	1



Hash Filter Choke

Merit No.	Ref. No.	Description	Dimensions - Inches				Mtg. Type	Shpg. Wt. Oz.
			Mtg. Centers	H	W	D		
C-2980	2	Exact Sylvania 241-0002	1 23/32	1 11/16	2	1 1/4	B	6



Horizontal Scan Choke

A plate load choke to match the horizontal output tube to the deflection yoke.

Merit No.	Ref. No.	Frequency Range	Dimensions - Inches			Shpg. Wt. Oz.
			Mtg. Centers	Length	Dia.	
▲ BC-389	3	535-1620 KC	3/8 hole	2 1/4	3/8	3/4
‡ BC-418	4	535-1620 KC	5 3/4	8 1/8 Rod	1 1/32	2
‡ BC-419	5	535-1620 KC	4	6 3/8 Rod	1 1/64	1

▲ Subminiature type.

‡ Antenna rod may easily be removed from terminal board when mounting is provided in receiver. Replaces all Air Type antennas.

Ferrite Rod Antennas

Inductance is adjustable for efficient operation in all standard receivers.

Q is very high for maximum signal pick up.

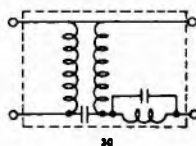
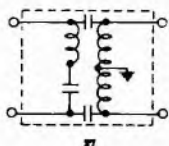

Merit No.	Ref. No.	Line Impedance	Dimensions - Inches				Mtg. Type	Schematic No.	Shpg. Wt. Oz.
			Mtg. Centers	D	W	H			
TV-210	6	72 Ohms	2 1/8	1 1/8	1 1/8	3 1/2	WT	30	4
TV-211	7	300 Ohms	2 1/8	1 1/8	1 1/8	3 1/2	WT	27	4

Designed to pass all TV channels with minimum loss, and eliminate or reduce interference which may be picked up by the IF amplifier section of the TV receiver.



Filters

WT

TV-HIGH PASS Connected between antenna and receiver to eliminate interference below 50 megacycles.

Horizontal Blocking Oscillator Transformers

Merit No.	Ref. No.	Turns Ratio Pri./Sec.	Dimensions - Inches				Mtg. Type	Shpg. Wt. Lbs. Oz.
			Mtg. Centers	H	W	D		
A-3002	8	2:1	2	1 3/8	2 3/8	1 1/4	A	0- 6
A-4002	9	2:1	1 3/16	1 3/4	2 3/8	1 1/2	J	0- 5



A

J

Merit No.	Ref. No.	Freq. Range	Dimensions - Inches				Mtg. Type	Schematic No.	Shpg. Wt. Oz.
			Mtg. Centers	D	W	H			
TV-222	11	40- 80 MC	2 1/8	1 3/8	1 1/8	3 1/2	WT	26	4
TV-221	12	75-150 MC	2 1/8	1 3/8	1 1/8	3 1/2	WT	26	4
TV-220	13	150-250 MC	2 1/8	1 3/8	1 1/8	3 1/2	WT	26	4

Wave Traps

These capacity tuned units are designed to reject interference caused by amateur radio, diathermy, X-ray, and mobile radio or FM transmission equipment.



TOROIDS

Merit Toroid Coils incorporate the use of powdered nickel alloy which provides a High Q Coil for minimum size. The coils have high stability with temperature and extremely resistant to shock.

The stock Toroid Inductors listed here are held to $\pm 2\%$ of inductance specified.

Merit Type 'EN' series are supplied with rugged solder terminals and are encapsulated with an epoxy material to meet most mechanical and thermal shock requirements.

Merit Type 'MO' series are supplied in a molded epoxy case which will meet all test requirements for shock and extreme temperatures. Wrap-around stud terminals are provided for lead attachment. Will meet MIL-T-27A tests.

NOTE: We invite your inquiries for price and delivery quotations for Toroid Coils (Inductors or Transformers) that can be manufactured to your exact specifications.



EN

$1\frac{1}{32}$ MAX. DIA.

$\frac{1}{8}$ MAX. HT.

$\frac{1}{32}$ HOLE



MO

$1\frac{1}{8}$ MAX. DIA.

$\frac{1}{4}$ MAX. HT.

$\frac{1}{32}$ MAX. HOLE

Encapsulated

Suffix letters indicate mounting type.

Merit No.	Ref. No.	Inductance MH	Resistance Ohms	DC-MA For 5% Ind. Drop
T-8150-EN	1	1	.40	520
T-8151-EN	2	3	.70	300
T-8152-EN	3	5	.92	233
T-8153-EN	4	10	1.30	165
T-8154-EN	5	20	1.85	116
T-8155-EN	6	30	2.85	95
T-8156-EN	7	50	4.60	74
T-8157-EN	8	100	8.00	52
T-8158-EN	9	300	38.2	30
T-8159-EN	10	400	44.0	26
T-8160-EN	11	500	63.5	23
T-8161-EN	12	1000	113.0	16.5

Molded Case

Merit No.	Ref. No.	Inductance MH	Resistance Ohms	DC-MA For 5% Ind. Drop
T-8150-MO	13	1	.40	520
T-8151-MO	14	3	.70	300
T-8152-MO	15	5	.92	233
T-8153-MO	16	10	1.30	165
T-8154-MO	17	20	1.85	116
T-8155-MO	18	30	2.85	95
T-8156-MO	19	50	4.60	74
T-8157-MO	20	100	8.00	52
T-8158-MO	21	300	38.2	30
T-8159-MO	22	400	44.0	26
T-8160-MO	23	500	63.5	23
T-8161-MO	24	1000	113.0	16.5

COLOR TV
REPLACEMENT
GUIDE



merit

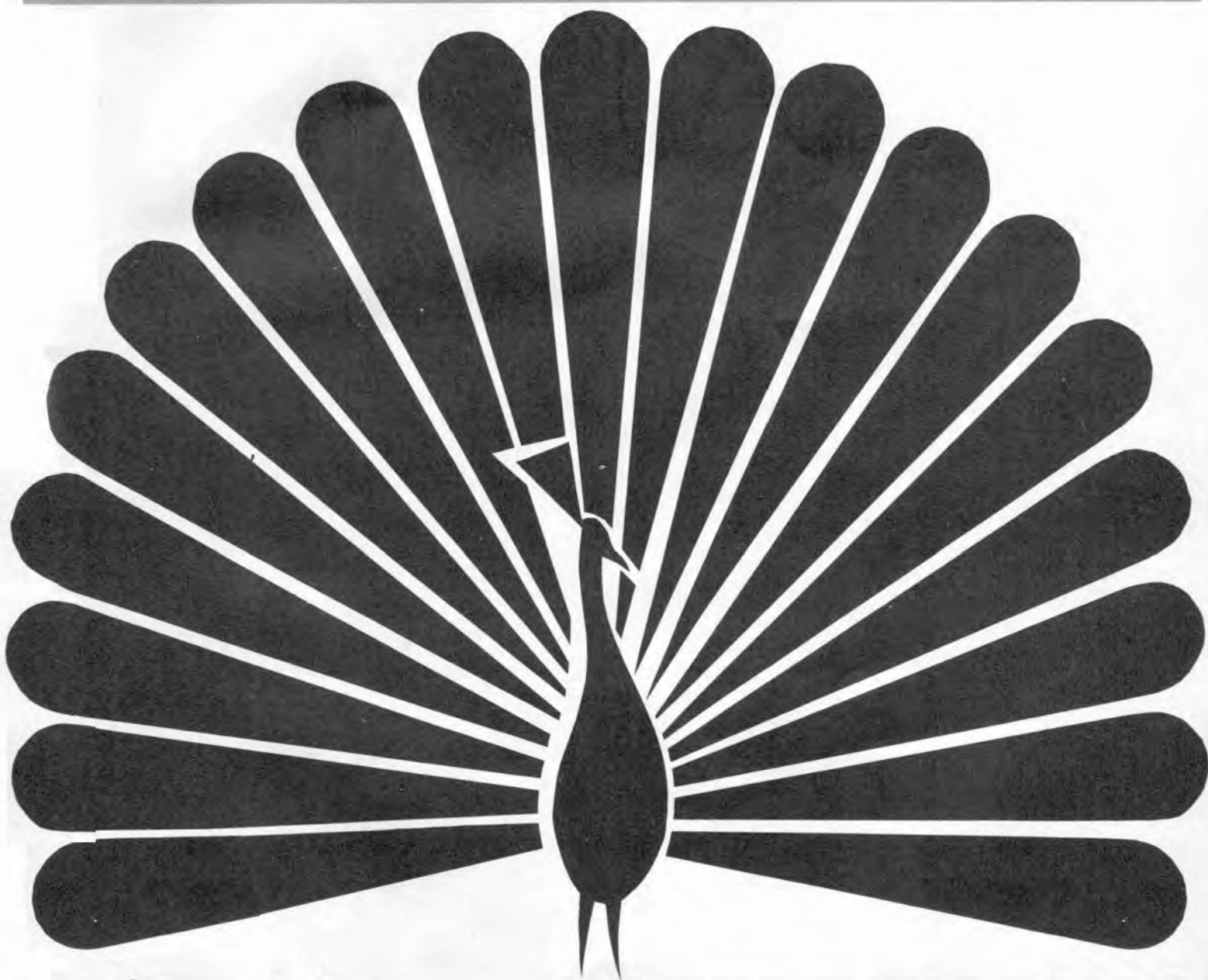

**erit**

COIL & TRANSFORMER CORPORATION • MERIT PLAZA, HOLLYWOOD, FLORIDA

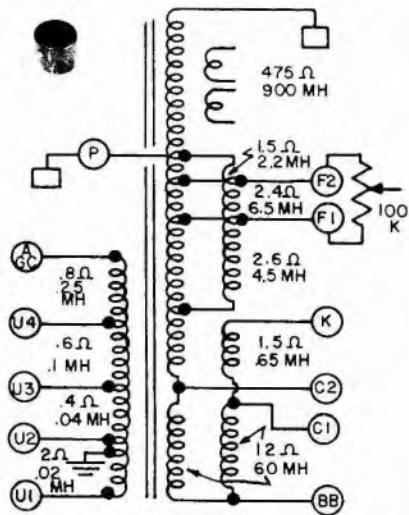
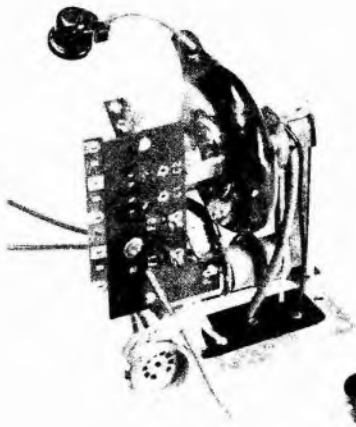

HVO - 230 C

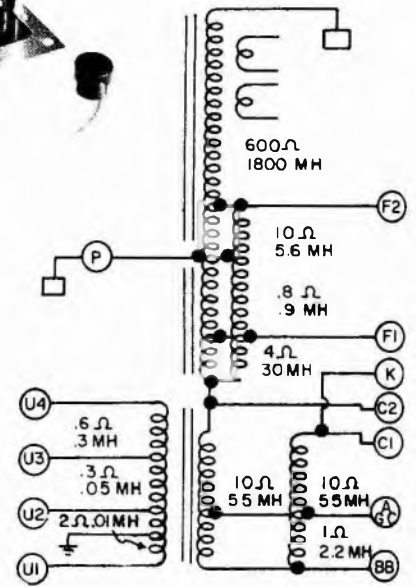
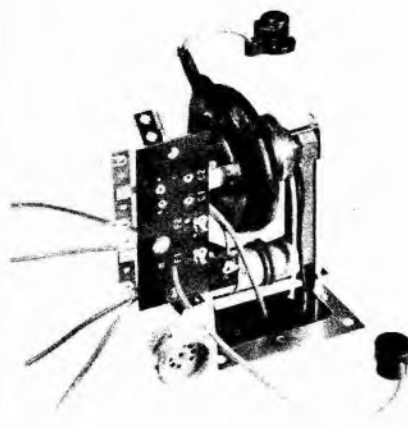

HVO-231C

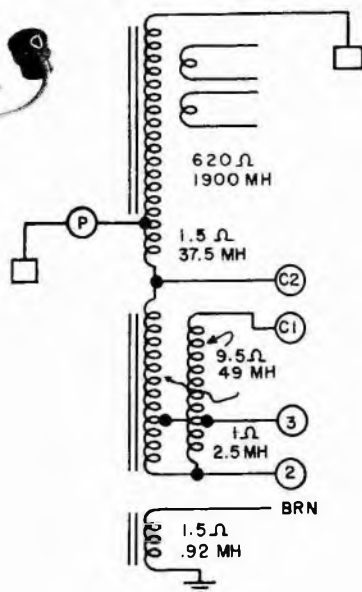
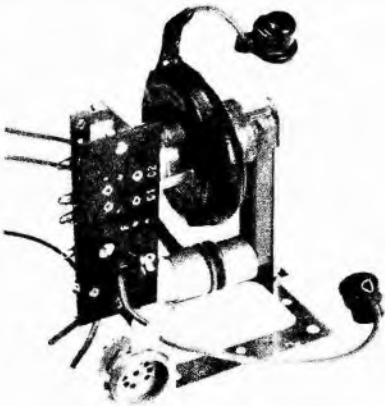

HVO-232 C

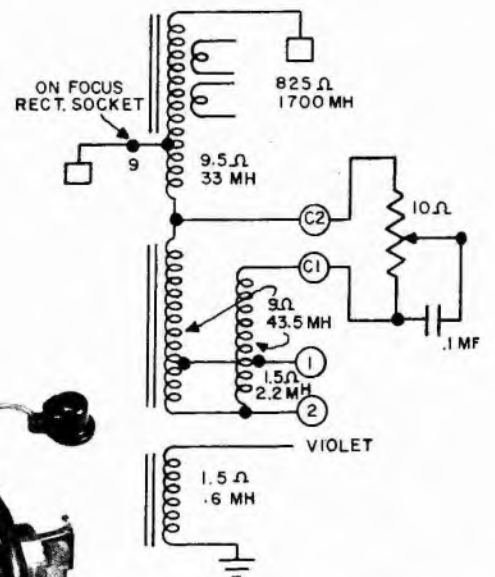

HVO-233C

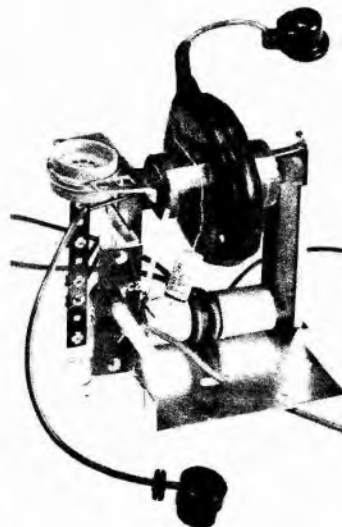

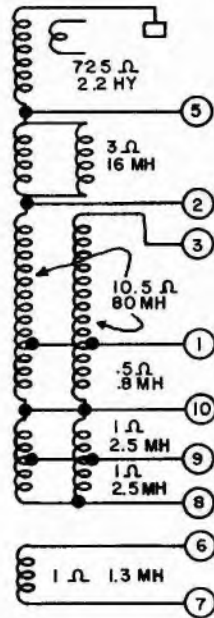
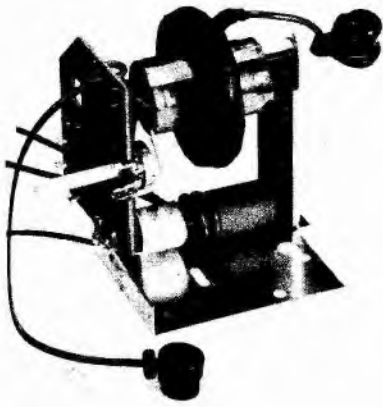

HVO-234 C

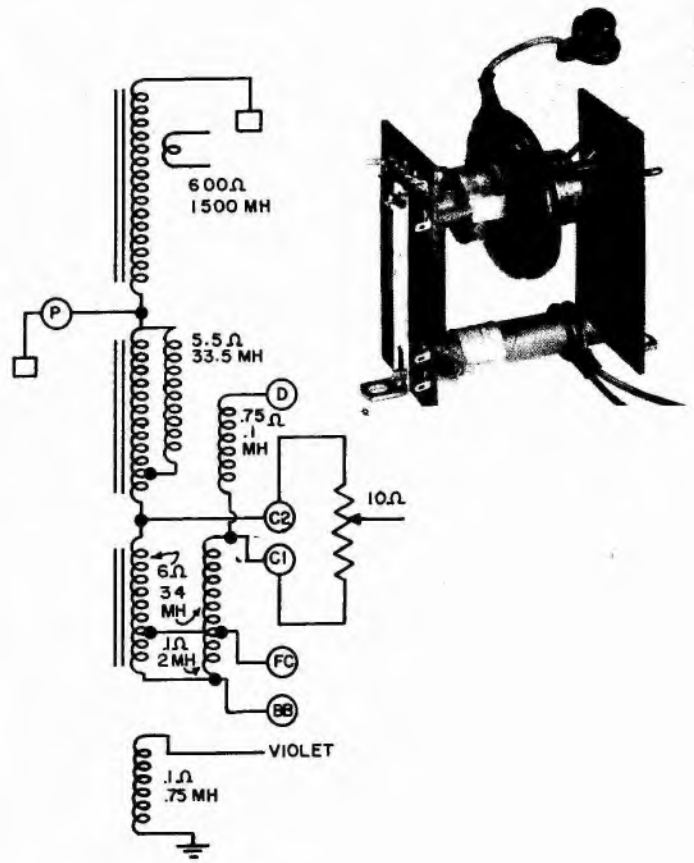

HVO-235 C

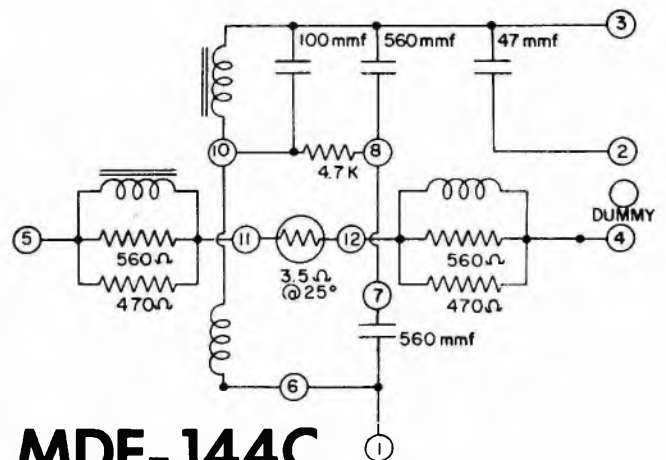
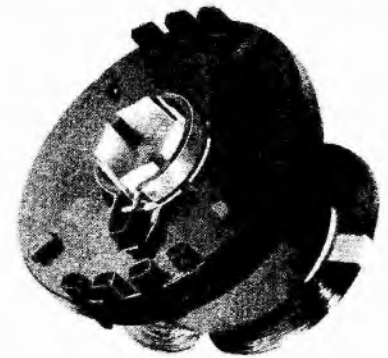
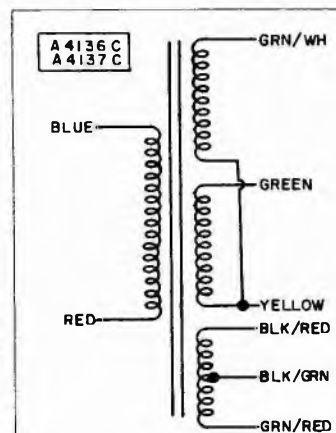
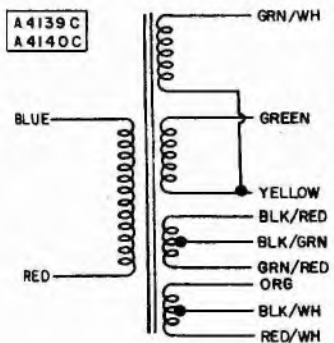
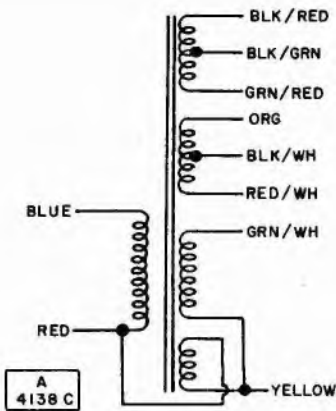
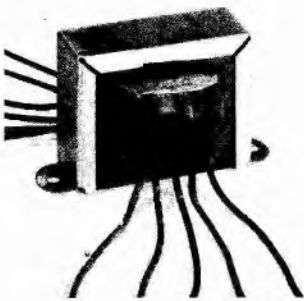

MDF-144C



COLOR COMPONENTS

VERT. OUTPUT TRANSFORMERS

MERIT PART NO.	REPLACEMENT PART NUMBER
A-4136 C	RCA 105193 (1107893-1)
A-4137 C	RCA 106360
A-4138 C	RCA 109263 (961415-1)
A-4139 C	RCA 109850 (961415-1, 961415-7)
A-4140 C	RCA 113390 (961415-3)

FLYBACKS

HVO-230C	RCA 105192 (1106862-1)
HVO-231C	RCA 106359 (1106862-2)
HVO-232C	RCA 109221 (926636-501)
HVO-233C	RCA 112820 (906141-501)
HVO-234C	RCA 113382 (906152-501)
HVO-235C	MOTOROLA 24D66876A03

DEFLECTION YOKE

MDF-144C	RCA 109457, 903562-502, 903562-507
----------	------------------------------------

POWER TRANSFORMER

PART NO.	PLATE SUPPLY		FILAMENTS		HEIGHT OVERALL	BASE AREA	MTG. CTRS.	MTG. TYPE.
	AC. VOLTS	DC MA	VOLTS	AMPS				
P-4141C	155*	450	6.3 6.3	2.0 13.5	4 1/8	3 1/2 x 4 7/8	3 1/16 x 3 1/16	C
*FOR USE IN VOLTAGE DOUBLER CIRCUITS =PRIMARY 117 VOLTS, 60 CYCLES=								

**SCHEMATIC FOR P-4141C
REPLACEMENT FOR
RCA 112845**

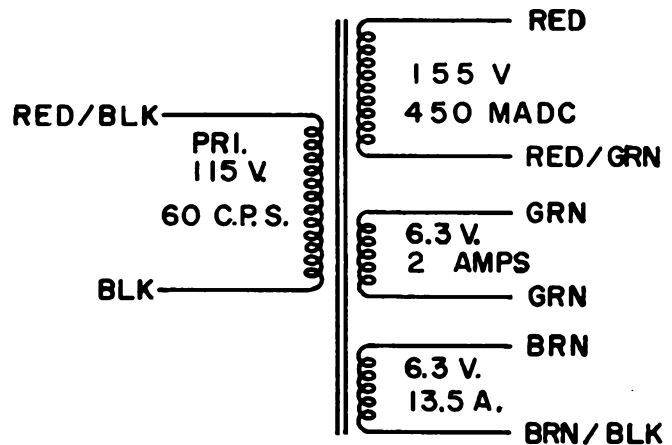

COLOR COMPONENTS

PART NUMBERS		PART NUMBERS		PART NUMBERS		PART NUMBERS	
MFGR.	MERIT	MFGR.	MERIT	MFGR.	MERIT	MFGR.	MERIT
ADMIRAL (Also see RCA)		AIRLINE		CBS-COLUMBIA		EMERSON	
74B18-20	C-4133	903562-502	MDF-144C	10000231	A-3019	R113383	P-4141C
74B24-2	C-4133	903562-507	MDF-144C	10000631	P-2945(2,15)	R113390	A-4140C
74B25-2	C-4133	906152-501	HVO-234C	12000971	A-4003	708226	MWC-18
74B25-3	C-4133	906153-501	P-4141C	12000981	A-2823	708228	MWC-11
79B66-7	A-2902(2)	961415-3	A-4140C	16000111	TV-163	708249	MWC-18
79B87-8	A-3020	961429-3	A-2901	16000271	MWC-6	708255	TV-163
79B89-2	A-4137C	961429-7	A-3019	16001251	MWC-2	708448	MDF-144C
79B89-8	A-3020	1104665-3	C-4133	16001301	C-2995	734126	A-3019
79C96-2	A-4138C			16001321	MWC-11	737027	C-4125
79C103-3	A-2901					737028	C-4125
79C106-1	A-4139C	ANDREA (Also see RCA)		CORONADO (Also see RCA)		738090	A-4003
79D33-65	A-3019	A52-3104	A-3020	109457	MDF-144C	738124	A-4098
79D90-2	HVO-231C	A52-3160	C-4133	112820	HVO-233C	738195	HVO-234C
79D96-1/-2	A-4138C	A52-3161	P-4141C	112821	A-4139C	738196	A-4140C
79D97-501	HVO-232C	A52-3162	HVO-232C	112822	A-3019	903562-502	MDF-144C
79D102-501	HVO-233C	A52-3163	A-4139C	112829	A-4133	903562-504	MDF-144C
79D107-1	HVO-233C	A52-3170	MDF-144C	112845	P-4141C	903562-507	MDF-144C
80D79-1	P-4141C			113382	HVO-234C	906152-501	HVO-234C
80D85-1	P-4141C			113383	P-4141C	906153-501	P-4141C
94A193-502	MDF-144C			113390	A-4140C	926636-501	HVO-232C
94A193-505	MDF-144C	ARVIN		903562-507	MDF-144C	961415-1	A-4139C
94A193-507	MDF-144C	A-42242	A-3038(2)	906152-501	HVO-234C	961415-3	A-4140C
94B177-3	TV-165	C-22561-5	C-2996	906153-501	P-4141C	961416-1	P-4141C
94D180-2	MDF-144C	C-24776-5	A-3019	961415-3	A-4140C	961429-3	A-3019
903562-504X	MDF-144C	C-41745-1	A-3003	961429-3	A-3019	962636-501	HVO-232C
903562-507	MDF-144C	XT-7898-A	A-3038(2)	961429-7	A-3019	962712-502	P-4141C
906141-501	HVO-233C			1104665-3	C-4133	972128-8	A-3020
961415-1	A-4138C	BRADFORD (Also see RCA)				1104665-2	C-4133
962636-501	HVO-232C	109457	MDF-144C			1104665-3	C-4133
972128-8	A-3020	112820	HVO-233C				
1104665-2/-3	C-4133	112821	A-4139C				
		112822	A-3019				
		112829	C-4133				
		112845	P-4141C				
AIRLINE (Also see RCA)		CAPEHART		CURTIS MATHES (Also see RCA)		GENERAL ELECTRIC (Also see RCA)	
AT-77	A-4107(2)	650215A-5	C-4115	1A168	MDF-144C	ET61X132	A-3020
AT-79	A-2901	650216A-2	A-3019	1A169	MVO-233C	ET63X59	C-4133
FC-24	C-4133	650216A-7	A-3019	10A37	C-4133	ET63X62	C-4133
L-246	MDF-144C	650587C-5	C-4084	10A38	A-4139C	ET64X87	A-4139C
TR-84	HVO-234C	650637B-1	TV-163	12A46	P-4141C	ET64X97	A-3020
TR-85	P-4141C	651145B-1	MWC-6			ET64X102	A-4140C
TR-86	A-4140C	750730B-2	A-4003	DUMONT (See Emerson)		ET76X32	MDF-144C
XD-2607	A-2823	750731A-1	A-2823	EMERSON (Also see RCA)		ET77X66	HVO-232C
20E831	TV-163			R100037	A-3020	ET77X73	HVO-233C
20E1116	MWC-11			R102134	C-4133	ET77X78	HVO-234C
20E1118	MWC-18	CATALINA (Also see RCA)		R105195	C-4133	ET77X79	HVO-234C
20E1222	MWC-18	9A2576-001	MDF-144C	R109221	HVO-232C	ET88X61	P-4141C
22E102	A-2902(2)	51X0220-005	A-2901(2)	R109263	A-4139C	ET88X76	P-4141C
22E106	A-3003	51X0236-000	A-2901			ET88X77	P-4141C
22E108	A-2823	51X0236-001	A-2901	R109286	P-4141C	ET88X85	P-4141C
22E109 (Low B+)	C-4084	51X0237-000	A-4140C	R109457	MDF-144C	M124J866-2	C-4133
109457	MDF-144C	51X0237-001	A-4140C	R109845	MDF-144C	M124J999-1	A-3020
112820	HVO-233C	52X0114-000	C-4133	R109850	A-4139C	P126J717-1	MDF-144C
112821	A-4139C	52X0114-001	C-4133	R112820	HVO-233C	126J377-3	A-4140C
112822	A-3019	53X0414-001/-A	P-4141C			906152-501	HVO-234C
112829	C-4133	53X0416-001	HVO-234C			906153-501	P-4141C
112845	P-4141C			R112821	A-4139C	961415-3	A-4140C
113382	HVO-234C			R112822	A-3019		
113383	P-4141C			R112829	C-4133		
113390	A-4140C			R112845	P-4141C		
				R113382	HVO-234C		

2. Mounting difference.
15. Ignore low current 6.3 volt winding.

COLOR COMPONENTS

PART NUMBERS		PART NUMBERS		PART NUMBERS		PART NUMBERS	
MFGR.	MERIT	MFGR.	MERIT	MFGR.	MERIT	MFGR.	MERIT
RCA		SENTINEL		SPARTON		WESTINGHOUSE (Also see RCA)	
105197	TV-165	20E831	TV-163	AB-44066-3	A-3020	V-6471H-2	C-4084
105771	P-3151(2)	20E1116	MWC-11	AB-470009-1	C-2994	V-6764-1	TV-163
106305	MDF-144C	20E1118	MWC-4	XT-7898-A	A-3035(2)	V-6981-6/-7	A-3038
106359	HVO-231C	20E1210	MWC-3	208T9	A-4003	V-9238-1	A-2931
106360	A-4137C	20E1222	MWC-2			V-9238D-1	A-2931
109221	HVO-232C	20E1241	MWC-2	STROMBERG-CARLSON		V-12974-1	MWC-3
109263	A-4139C	22E102	A-2935	114138	MWC-3	V-12988-1	C-2996
109286	P-4141C	22E106	A-3003	114139	MWC-3	430V027H01	A-2930
109457	MDF-144C	22E108	A-2823	161254	A-3003	430V027M01	A-2930
109845	MDF-144C	22E109 (Low B+)	C-2974	161265	A-3019	690V037H23	HVO-233C
109850	A-4139C			161274	TV-162	690V037H24	A-3019
110027	A-3027	SETCHELL-CARLSON		161278	A-3038	690V037H25	A-4139C
110482	P-2834(10)	(Also see RCA)		161425	P-2946(20)	690V037H26	P-4141C
111401	P-4082(2)	LM-1026	C-4133	161444	P-3055(11)	690V037H41	C-4133
111517	A-4106(2)	SC-1085-6	A-2901(2)	161448	P-3067(14)	690V038H46	MDF-144C
112820	HVO-233C	TF-1025	HVO-234C			690V039H32	HVO-234C
112821	A-4139C	TM-1016	A-4140C	SYLVANIA		690V039H33	A-4140C
112822	A-3019	Y-1023	MDF-144C	(Also see RCA)		690V039H34	P-4141C
112829	C-4133			A109457	MDF-144C	690V045H50	P-4141C
112845	P-4141C			A112820	HVO-233C	690V045H51	A-4140C
113382	HVO-234C	906415-3	A-4140C	A112821	A-4139C	300226-1	P-4141C
113383	P-4141C	1104665-3	C-4133	A112822	A-3019	320111-4	A-4140C
113390	A-4140C			A112822	C-4133	360947-1	MDF-144C
791391-3	A-2823(2)			A112829	C-4133	903562-507	MDF-144C
902473-1	A-3019					906152-501	HVO-234C
903562-502	MDF-144C	SILVERTONE		A112845	P-4141C	906153-501	P-4141C
903562-504X	MDF-144C	(Also see RCA)		50-16016-1	HVO-234C	961415-3	A-4140C
903562-507	MDF-144C	B80-371	A-4003	51-16083-1	MDF-144C	961429-3	A-3019
906141-501	HVO-233C	10-19-4	TV-165	56-16013-3	A-3019	1104665-3	C-4133
906152-501	HVO-234C	10-32-1	MWC-18	56-16015-1	P-4141C		
906153-501	P-4141C	33-244 (Low B+)	C-4115	56-16017-3	A-4140C		
926636-501	HVO-232C	80-14-2	A-4139C	56-16024-3	C-4133		
941129-1	A-4003	80-16-2	A-4140C	132-0001	TV-165(12)		
942476-4	A-3003	80-23-6	C-4133	143-0054	A-3019		
961415-1	A-4138C	80-25-3	HVO-233C	145-0023	C-4084		
961415-2	A-4139C	80-31-4	MDF-144C	29737	MDF-144C	ZENITH	
961415-3	A-4140C	80-33-3	HVO-234C	89466	A-3020	95-1793	MDF-144C(75,96)
961415-7	A-4139	80-72-0	P-4141C	89506	P-4141C	95-1904/-A	A-2900
961416-1	P-4141C	80-81-0	P-4141C	89507	HVO-231C	95-1913	A-2905
961429-3	A-3019	80-169-1	A-3020	89508	A-4137C	95-1971	C-4084
961429	A-3019	80-179-1	A-2904			95-1973	A-3019(2)
961429-7	A-3019	80-352	A-2823	89510	C-4133	95-1974	MDF-144C(96,97,98)
962636-501	HVO-232C	80-353	A-3019	89554	P-4141C	95-2052/-AR	A-2935
962712-502	P-4141C	80-371	A-4003	TRUETONE		95-2067	MDF-144C(96,97)
970727-8	A-2901	100037	A-3020	(Also see RCA)		95-2118	C-2991
970727-23	A-3020	102134	C-4133	12D-26582	P-3097(2)	95-2190/-X	A-3020
971391-3	A-2823(2)	109286	P-4141C	12M-18241	A-3003		
971391-5	A-2823(2)	109845	MDF-144C	13M-26268	MWC-18		
972128-6/-8	A-3020	109850	A-4139C	13M-26310	TV-163		
1104310-1/-2	C-4133	903562-504	MDF-144C	16B-26052	C-2996		
1104665-1/-2/-3	C-4133	903562-507	MDF-144C	109457	MDF-144C		
1		906152-501	HVO-234C	112822	A-2901		
1106861-2	MDF-144C	906153-501	P-4141C	112829	C-4133C		
1106862-1	HVO-230C	961415-1	A-4139C	113382	HVO-234C		
1106862-2	HVO-231C	961416-1	P-4141C	113383	P-4141C		
1107893-1	A-4136C	962636-501	HVO-232C				
		972128-8	A-3020	113390	A-4140C		
		1104665-1	C-4133	906153-501	P-4141C		
				961429-7	A-2901		
				1104665-3	C-4133		

2. Mounting difference.

10. Parallel and phase 6.3 volt windings.

11. Use high current 6.3 volt winding.

12. Ignore center tap.

14. Use high secondary tap. Use high current filament winding.

20. May require shielding.

75. Connect as in original circuit.

96. Requires use of original centering assembly.

97. Delete 560 ohm resistors from terminals 4-12, 5-11.

Delete 560 mmf capacitors from terminals 1-7, 3-8.

Delete 47 mmf capacitor from terminals 2-3, jumper terminals 8-2.

98. Use original 1 meg. thermistor and connect as original.

**INDISPENSABLE
TO THE
COLOR
TECHNICIAN!**

COLOR TV DEGAUSSING COIL

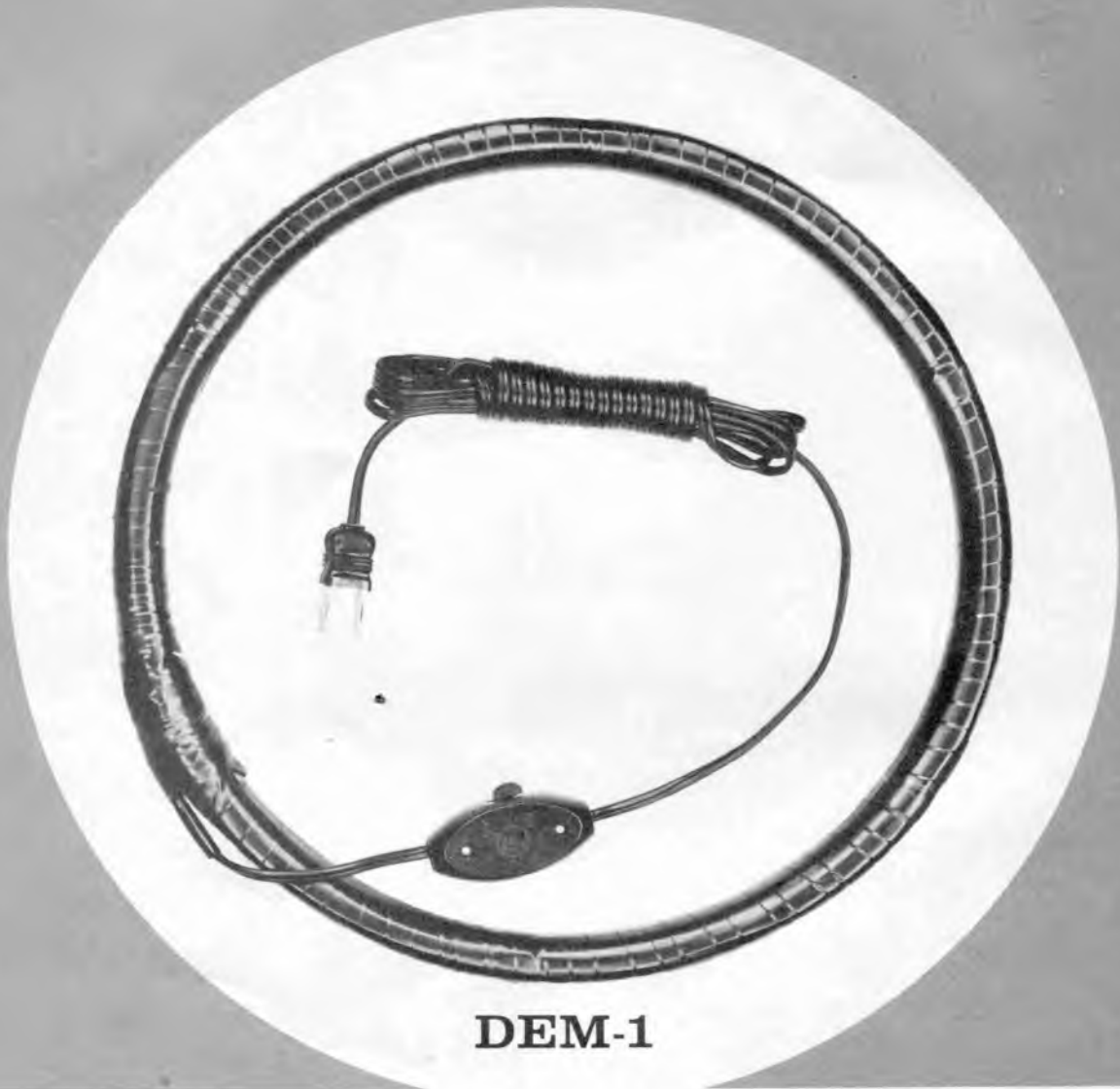

DEM-1

Merit Coil & Transformer Corp.
Merit Plaza Hollywood, Florida

Replacement Guide Section



Immediately following is the famous MERIT Replacement Guide Section listing over 30,000 Manufacturers Part Numbers to MERIT Part Numbers.

Carefully edited from all available sources of information, and brought up-to-date constantly, this listing covers the following categories:

TELEVISION RECEIVERS
HOME RADIOS
AUTO RADIOS
HIGH FIDELITY EQUIPMENT
TAPE RECORDERS
COMMERCIAL SOUND EQUIPMENT

Note carefully – All MERIT Numbers listed are Exact Replacements, unless a footnote follows the MERIT Number. This indicates a minor change, listed on page 150 of this catalog.

You name it.....
Merit makes it!



A MERIT Innovation:

Following is a list of manufacturers and the various trade names under which they make receivers.

MFR.	TRADE NAME	MFR.	TRADE NAME	MFR.	TRADE NAME	MFR.	TRADE NAME
Admiral	Admiral		Kaiser-Frazer		Studebaker		
Airking	Firestone	Hallicrafters	Ambassador		Mopar	Teletone	Coronado
	CBS		Hyde Park	Philmore	Philmore		Firestone
	Silvertone		Airline	Pilot	Pilot		Pathe
Altec-Lansing	Altec-Lansing		Artone	Radio Craftsmen	RadioCraftsmen	Temple	Silvertone
Andrea	Andrea		Coronado	RCA	Admiral(Color)	Trad	Temple
Arvin	Silvertone		Delco		Airking	Transvision	Ambassador
ATR	ATR		Herald		Ansley	Trav-ler	Transvision
Automatic	Automatic		Meteor		Magnavox(Color)		Airline
	Aircastle		Silvertone		Dumont(Color)		AMC
	Airline		Trans-American		Dewald		Coronado
	Firestone		Truetone		Emerson(Color)		Musicaire
	Riverside		Firestone		Olympic(Color)		Sonora
	Truetone	Harold Sheevers	Gotham	Raytheon(Belmont)		U.S. Television	Truetone
Bendix	AMC	Hoffman	Hoffman		Airline	Videodyne	U.S. Television
	Continental	Jackson	Aircastle		Coronado	Videola	Videodyne
	Ford		Aldens		Firestone	(Video Corp.)	
	KarmannGhia	Jewel	Transvue		Truetone	Video Products	Videola
	Lincoln	Kaye Halbert	Truetone	Regal	Regal		Sheraton
	Mercury	Magnavox	Kaye Halbert	Rembrandt	Rembrandt	Warwick	Mattison
	Edsel		Sentinel(Late)	Sentinel	Airline		Aircastle
	Mopar		AMC		Firestone		Allstate
Cal Tech	Walsco	Majestic	Airline	Setchell Carlson	Setchell Carlson		Ambassador
Capehart	Capehart		Meteor	Shaw	Shaw		AMC
Conrac	Fleetwood		Muntz	Sheraton	VideoProducts		Apex
Crosley	Airline		Truetone		Mattison		Brunswick
	Sentinel		Wilcox Gay	Sonora	Airline		Clarion
Croydon	Croydon	Mattison	Sheraton		Mitchell		Coronado
Curtis Mathes	Curtis Mathes		(VideoProd.)		Olympic		Meteor
De Forest	Douglas	Meck	Aircastle	Sparton	Sparton		Philharmonic
Delco	Buick		Ambassador	Starrett	Ambassador		Silvertone
	Cadillac		Brunswick		AMC		Truetone
	Chevrolet		Mirrortone		Bell Air	Wells Gardner	Regal
	Corvaire		Scott		Drexel		Firestone
	Corvette		Silvertone		General		Airline
	Opel		Vision Master		Lafayette		AMC
	Pontiac		Philharmonic		Royal		Arlington
	Vauxhall	Meissner	Meissner	Stewart Warner	Coronado		Bradford
	Willys	Motorola	Motorola		Firestone		Coronado
	Delco		American Motor		Silvertone		Dumont
	Frazer		Ford		Truetone		Fairmont
	Kaiser-Frazer		International	StrombergCarlson	Edsel		Firestone
	GMC Truck		Mopar		StrombergCarl.		Hudson
	Oldsmobile		Nash	Sylvania		Westinghouse	Truetone
	Packard		Studebaker	(Colonial)	Ford		Telecraft
	Studebaker		Willys		Hudson		Airline
	Volkswagen		Hudson		Lincoln		AMC
Detrola	Firestone	Muntz	Muntz		Mercury	Wilcox Gay	Wilcox Gay
	Ford	National	National		Mopar	Zenith	Ford
	Willys	Nordic	Nordic		RCA		Hudson
Dewald	Dewald	Norelco	Norelco		Silvertone		Lincoln
Douglas	Douglas	Olympic	AMC		Tech Master		Mercury
		Pacific Mercury	Meteor	Tech Master	Teleking		Nash
Dumont	Dumont		Silvertone				Zenith
Echstein	Karadio		Packard Bell		Artone		
Emerson	Emerson	Packard Bell	Packard Bell		Astoria		
Fada	Fada	Parkview	Parkview		Coronado		
Freed-Eisemann	Freed-Eisemann	Philco	Philco	Telequip	Hyde Park		
Garod	Garod		Mercury		Silvertone		
G.E.	Hotpoint		Packard		Stratford		

* * * * *

PART NUMBERS		PART NUMBERS		PART NUMBERS		PART NUMBERS	
MFGR.	MERIT	MFGR.	MERIT	MFGR.	MERIT	MFGR.	MERIT
ADMIRAL		ADMIRAL		ADMIRAL		ADMIRAL	
A-3044	MD-12	72B93	FM-254(2)	72C196-1	TV-115	73B5-26	TV-184(5)
A-3178	MDF-77	72B94	BC-353(2)	72C196-2	FM-255	73B5-27	TV-195
A-3197	MDF-77	72B97/-1	BC-352	72C196-5	FM-257	73B5-31	TV-195
A-3222	MDF-77	72B98/-1	FM-254(2)	72C225-4	FM-256	73B5-32	TV-184(5)
A-3412	MDF-77	72B99-1/-2/-3	TV-119(12)	72C227-4/-9	BC-357	73B5-34	TV-207
SP-TR-31	A-3025	72B99-4/-6/-7	TV-119(12)	72C227-10/-13	BC-357	73B5-39	TV-184(5)
18-3947	A-3025	72B99-13/-14	TV-119(12)	72C236-1	TV-190	73B8-12	BC-553
59B228-6	BC-419	72B106	TV-100(55)	72C236-1	TV-195	73B11-1	TV-206
69A32	TV-102	72B107-1	TV-140(2)	72C246-1	FM-256	73B24-3	TV-192
69A39-8	BC-394	72B109-1	TV-100(55)	72D28-5	BC-327	73B24-4	TV-180
69A52	BC-400	72B110-1	TV-139(2)	72D28-68	FM-254	73B24-6	TV-205
69A52-2/-4	BC-387	72B113-1	TV-139(2)	72D28-69	FM-255	73B25-5	TV-190
69A52-5/-6	BC-381	72B132-1	TV-151	72D28-70/ 71	BC-352	73B25-7	TV-207
69A165-1	BC-393	72B132-18/-37	TV-248	72D28-73	FM-253	73B27-2	BC-562
69A184-5	BC-394	72B142/-1	TV-104	72D111-1/-2	TV-116	73B31-3	TV-180
69A243-2	BC-393	72B143/-1/-2/-3	TV-126(1)	72D111-6/-7	TV-130	73B31-4	BC-566
69A295-1	BC-419	72B166-1/-2	TV-152	72D111-8/-10	TV-153(12)	73B31-5	BC-561(5)
69B110	TV-162	72B185-2	TV-236	72D111-18/-19	TV-130	73B31-8	BC-563
69B228-3/-4	BC-419	72B196-6	FM-257	72D111-20	TV-131	73B31-9	BC-564
69B229-1/-2/-3	BC-418	72B238-1	BC-356	72D111-28	TV-116	73B33-1	BC-566
69B229-4	BC-419	72B249-1	BC-569(96)	72D111-29	TV-118	73B37-2	BC-562
69B243-1	BC-393	72B249-2	BC-571	72D111-31/-32	TV-130	73B37-3/-4	BC-562
69B244-1	BC-418	72B254-1	BC-574	72D111-33	TV-153(12)	73B37-6	TV-239
69B258-1	BC-418	72B254-2	BC-575	72D111-34/-35/-36	TV-130	73B37-8	BC-562
69B295-2/-4	BC-419	72B254-3	BC-576	72D111-37	TV-131	73B37-9/-10	BC-564
69B297-1	BC-573	72B254-5	BC-574	72D111-38/-39/-40	TV-130	73B42-21	TV-193(5)
69B307-1	BC-577	72B254-6	BC-575	72D162-2	TV-151	73B43-11	TV-205
69B309-2	BC-577	72B254-7	BC-576	72D165-2	TV-119	73B44-6	TV-184
69B314-1	BC-394(2)	72B254-18/-19	FM-256	72D196-2	FM-255	73B44-8	BC-566
69B314-2/-6	BC-419	72B254-20	FM-257	72D196-4/-5/-6	FM-257	73B45-231	BC-562
69C228-5	BC-419	72B254-21/-22	BC-356	72D224-1	FM-257	73B45-251	BC-566
69C243-3/-5/-3F	BC-393	72B254-24	BC-356	72D224-2/-3	FM-256	73B46-6	TV-185
69C243-6	BC-394	72B254-25	BC-569	72D224-4/-5	BC-356	73B46-13	TV-180
69C256-1	BC-419	72B254-26	BC-570	72D225-1/-2	FM-254	73B46-14	TV-184
69C263-5	BC-387(83)	72B254-27	BC-571	72D225-3	FM-256	73B46-19	TV-193
69C295-5	BC-419	72B254-34	FM-257	72D225-4/-5	FM-259	73B46-21	TV-193(5)
69D258-1	BC-418	72B254-35	BC-357	72D225-6/-7/-8	FM-256	73B46-22	TV-184
69D295	BC-419	72B254-48	BC-570	72D227-1/-2	BC-352	73B46-31	TV-185(5)
72A4-1	TV 151	72C28-7/-111	BC-352	72D227-2/-4/-5	BC-356	73B46-32	TV-185(5)
72A59-1	TV-102	72C28-65	BC-356	72D227-6/-7	BC-352	73B46-40	TV-193
72A59-1	TV-103	72C28-68	FM-254	72D227-8/-11	BC-357	73B46-41	TV-195
72A60-1	TV-151	72C28-70	BC-352	72D254-17	BC-569	73B49-1	TV-183
72A83-1/-2/-3	TV-116	72C28-71	BC-353	72D277-1	BC-352	73B53-231	BC-562
72A84	TV-116	72C68-2/-4	TV-110(39)	73A2-5	TV-189	73B56-1	TV 186
72A88-1	TV-103	72C96-2	TV-112	73A2-14	BC-562	73B57-19	TV-195
72A120-1	FM-254	72C96-2	TV-150	73A4-1	TV-151	73B72-5	BC-561
72A120-2	FM-253	72C96-3/-4/-6	TV-116	73A5-7	TV-184	73C2-10/-15	BC-562
72A120-3/-4	BC 352	72C96-7/-8/-9	TV-116	73A5-9	TV-126	73C5-20	TV-203
72A132	TV-131	72C96-10/-11/-14	TV-116	73A5-15	TV-188	73C5-34/-36	TV-208
72A132-39	TV-240	72C96-16/-21/-22	TV-116	73A5-23	TV-184(5)	73C5-40	TV-197(5)
72B28-7/-11	BC 352	72C96-23/-25	TV-118	73A6-9	BC-562	73C5-41	TV-202
72B28-17/-63	BC-353	72C96-29	TV-116	73A11-1	TV-207(5)	73C5-42	TV-203(5)
72B37	FM-251	72C96-30	TV-112	73A17-1	BC-564	73C5-43	TV-206(5)
72B38	FM-251	72C99-25	TV-116	73A17-2	BC-562	73C5-44	TV-207
72B39	FM-252(2)	72C132-19	TV-237	73A24-1	BC-565	73C5-45	TV-201(5)
72B44	TV-104	72C132-37/-52	TV-248	73A24-2	TV 180	73C5-46	TV-207(5)
72B45	TV-111	72C132-39	TV-240(89)	73A47-3	BC-562	73C5-47	TV-203
72B49	BC-352	72C170-1/-2/-3	BC-356	73A50-1	BC-562	73C5-50	TV-184(5)
72B50	BC-368	72C170-4/-5	BC-356	73B5-7	TV-204	73C5-53	TV-190(5)
72B51	BC-372	72C170-10/-11	BC-356	73B5-8	TV-199(5)	73C55-2	TV-193
72B54	BC-353	72C170-14	BC-357	73B5-14	TV 185(5)	73C55-8	BC-566
72B58	TV-104(2)	72C170-15	BC-356	73B5-15	TV-184(5)	73D2-15	BC-562
72B68/-1/-2/-4	TV-110	72C170-16/-17	BC-356	73B5-20	TV-203	73D31-3	TV-180
72B73	BC-567	72C170-18	BC-357	73B5-20	TV-204	73D37-2	BC-562
72B74	BC-353	72C175-1	BC-640	73B5-21	TV-185	74A10	C-2994
72B75	FM-254	72C182-1	BC-321	73B5-21	TV-201(5)	74A12	C-2991(2)
72B76	FM-254	72C182-2	BC-322	73B5-22	TV-190(5)	74A13	C-2994
72B86-1/-2	TV-104(2)	72C182-3	BC-323	73B5-22	TV-198(5)	74A15-2	C-2977
72B87-1	TV-111	72C182-37	TV-248	73B5-23	TV-184(5)	74A17	C-2994(2)
72B92	BC-352(1)	72C185-2	TV-236	73B5-25	TV-204	74B18/-1	C-4115

PART NUMBERS		PART NUMBERS		PART NUMBERS		PART NUMBERS	
MFGR.	MERIT	MFGR.	MERIT	MFGR.	MERIT	MFGR.	MERIT
ADMIRAL		ADMIRAL		ADMIRAL		ADMIRAL	
74B18-2	C-2974	79B6	A-3035	79C43-20	A-2988	79D81-19/-20/-21	A-3026
74B18-3	C-4115(2)	79B7	HVO-3	79C43-22/-23	A-2854	79D83-1	HVO-152(2)
74B18-4	C-2991(2)	79B18-4/-7	A-3003(22)	79C45-4	A-3031	79D83-4/-6/-7	HVO-201
74B18-6	C-2974	79B20	A-3035	79C46-1	A-3031(2)	79D90-2	HVO-231C
74B18-7/-10	C-2994	79B24/-1	A-3036	79C56-3	A-2935	79D96-1/-2	A-4138C
74B18-13/-14	C-4115	79B29/-1/-2	A-3037	79C56-4	A-2905(2)	79D97-501	HVO-232C
74B18-15/-19	C-4115	79B31-1	A-2935	79C56-6	A-2901	79D100-3/-6	A-2988
74B18-20	C-4133	79B31-2	A-4103	79C56-7/-8	A-2935	79D102-501	HVO-233C
74B18-23	C-2996	79B31-3	A-3019(2)	79C57-2	A-2905	79D107-1	HVO-233C
74B18-24	C-4084	79B33-15	A-3025	79C60-1	HVO-38	79D142-9	A-3025
74B18-25/-27	C-4115	79B33-58	A-2927	79C60-2/-3/-4	HVO-54(3)	79E77-7	HVO-202
74B18-28/-29	C-4084	79B34-1	A-3037	79C60-5/-6/-7	HVO 38(3)	79E77-8/-9	HVO-185
74B18-31	C-4115	79B39-1	A-3036	79C60-10/ 11	HVO-135(2)	79E77-11	HVO-205
74B18-33/-34	C 4084	79B40-1/-2/-3	A-2819	79C63-3	A-3003(22)	79E77-15/-16	HVO-206
74B18-35/-36	C-4115	79B43-1/-8	A-2854	79C65-3	HVO-54(7,17)	79E77-22	HVO-202
74B18-39/-42	C-4115	79B43-4/-10	A-2819	79C88-4	A-3025	80B1	P-3051(2)
74B18-43	C-4084	79B43-5	A-2825	79C96-2	A-4138C	80B5	P-3052(2)
74B24-2	C-4133	79B43-12/-13	A-2988	79C103-3	A-2901	80B7	P-3165(2)
74B25-2/-3	C-4133	79B43-14	A-2984	79C106-1	A-4139C	80B11	P-3059(11)
74C18-31	C-4115	79B43-16/-17/-18	A-2986	79D28-5	BC-356	80B15	P-3059(11)
74C18-33/-34	C-4084	79B43-19/-20	A-2988	79D33-11/ 13/-14	A-3025	80B19	P-3069(11)
74C18-35	C-2994	79B43-22/-23	A-2854	79D33-15/-16/-17	A-3025	80B21	P-3069(11)
74C18-36/-39	C-4115	79B43-24	A-2828(2)	79D33-20	A-3019	80B22	P-3052(2)
74C18-42/-45	C-4115	79B49-2	A-3026	79D33-21	A-3018	80B23-1	P-3052(2)
74C18-47	C-4125	79B49-18	A-2986	79D33-23	A-3019	80B24-1	P-3054
74C18-49	C-4115	79B63-1/-3	A-3003(22)	79D33-27	A-2935	80B32	P-3097(2)
74C18-51	C-2994(2)	79B65-1	HVO-145	79D33-28	A-3025	80B48-3	P-3151
74C18-53	C-4115	79B66-1/-2	A-2928(2)	79D33-29	A-3026	80B52-4	P-2964(2)
74D18-51	C-2994(2)	79B66-7	A-2902(2)	79D33-31/-32/-33	A-2905(2)	80B60-1	P-2893(2)
74D18-53	C-4115	79B68-3	A-2706	79D33-34	A-2900	80C26-1/-2	P-2867
74D142-8	A-3025	79B71-1	A-4091	79D33-35	A-3018	80C35-1/-2	P-2849
75B5-21	TV-202	79B77-1	A-2928(2)	79D33-36	A-3019	80C35-3	P-3055(10)
75B18-15	C-2996(2)	79B77-6	HVO-167	79D33-37	A-2928	80C35-4/-6	P-2867
75B18-19	C-2994	79B77-9	HVO-185	79D33-40	A-3018	80C35-7	P-2849
75B99-3	TV-119(12)	79B77-11	HVO-205	79D33-41	A-3025	80C35-8	P-3055(10)
75B254-1	BC-574	79B78-1	A-2902(2)	79D33-43	A-3020	80C35-12	P-2876(10)
75D227-1	BC-352	79B81-2	A-2935	79D33-44	A-3025	80D65-18	P-2885
75D227-11	BC-356	79B81-3/-4	A-2930	79D33-45/-46/-47	A-3018	80D65-22	P-2882
78B76-2	A-3018	79B81-6	A-2931	79D33-48	A-3019	80D65-26	P-2885
78B77-1	A-2928(2)	79B81-8/-9	A-2930	79D33-56/-57	A-3025	80D69-4/-G	P-2947(2,12)
78B84-7	A-3025	79B81-11/-14	A-4103	79D33-58	A-2928	80D73-1/-3	P-2882
78B94-2/-4	A-3025	79B81-12	A-2902	79D33-59	A-3019	80D78-1/-2	P-2885
78B98-1	A-2930	79B81-16	A-2930	79D33-60	A-3031	80D78-3	P-2872(93)
78B101-1	A-3026	79B87-8	A-3020	79D33-64	A-2928	80D79-1	P-4141C
78B105-1	A-2928	79B88-1/-2	A-3025	79D33-65	A-3019	80D85-1	P-4141C
78B106-1	A-2928(2)	79B89-2	A-4137C	79D33-66/-67	A-2900	94A3	MWC-12
78B123-1	A-3025	79B89-8	A-3020	79D33-68/-69	A-3026	94A4/-1	MWC-7
78B124-3	A-2928	79B98-1	A-3025	79D33-72	A-2928	94A11	MWC-4
78B142-3/-5	A-3025	79C17-1/-2/-3	HVO-5	79D33-78	A-2932	94A12	MWC 8
78B142-8/-9	A-3025	79C18-33	C-4084	79D38-1	HVO-23	94A17	TV-163
78B171-4	A-2928	79C19/-1/-2	HVO-3	79D40-2	A-2819	94A26	MWC-9
78C18-35	C-4115	79C23/-2/-3	HVO-3	79D41-1/ 2	HVO-22	94A28	MWC-9
78C107-1	A-2902	79C28-1/-3	HVO-3	79D43-4	A-2819	94A29	MWC-2
78C109-1	A-2928	79C30-1/-3	HVO-24	79D43-8	A-2854	94A29-1	MWC-6
78C111-4	A-2928(2)	79C30-2/-4	HVO-23	79D43-20	A-2988	94A29-2	MWC-8
78C124-2	A-2928	79C32-1	HVO-24(7)	79D43-23	A-2822(18)	94A39-1	MWC-9
78D142-6-T/-8	A-3025	79C33-1	A-2930	79D56-11/-13	A-2904(2)	94A49-1/-2/-3/-4	MWC-10(6)
78D146-6	A-3025	79C33-2	A-3019	79D56-16	A-3019	94A50-1/-2	MWC-6(6)
79A8	A-4103(2)	79C33-3/-4	A-2935	79D65-1/-2	HVO-145	94A55-1	MWC-6
79A9	A-3019(2)	79C33-5	A-2901	79D65-3	HVO-54(7,17)	94A56-1/-2	MWC-10
79A10	A-2901	79C33-6/-7	A-3019(2)	79D65-4	HVO-145	94A98/-1	MWC-6
79A11-2/-3/-4	A-2928	79C33-8	A-2932(2)	79D74-1/-2	HVO-135	94A193-502/-505	MDF-144C
79A13	A-4105	79C33-9	A-2902(2)	79D77-1	HVO-178	94A193-507	MDF-144C
79A14-2	A-2928	79C33-10	A-2928(2)	79D77-2/-3/-4	HVO-152	94B2-1/-2	MD-12
79A16	A-2936	79C33-11	A-3025	79D77-5	HVO-152	94B17/-1	TV-163
79A18-1/-2/-3	A-3003	79C33-71	A-2928	79D77-6	HVO-167	94B24-1/-2	MD-12
79A18-4/ 5	A-3003	79C33-75	A-2928	79D77-7	HVO-202	94B48-1	TV-163(37)
79A22	A-3019	79C36-1/-3	HVO-24(7)	79D77-8	HVO-185	94B87-13	MDF-92(4,8)
79A27	A-4103	79C38-1	HVO-23	79D77-22	HVO-202	94B133-1	MWC-8
79A31-1/-4	A-3019(2)	79C43-19	A-2984	79D81-11	A-3025(2)	94B133-2	MWC-18

MERIT COIL AND TRANSFORMER CORPORATION

PART NUMBERS		PART NUMBERS		PART NUMBERS		PART NUMBERS	
MFGR.	MERIT	MFGR.	MERIT	MFGR.	MERIT	MFGR.	MERIT
ADMIRAL		AIR KING (See CBS - Columbia)		AIRLINE		AIRLINE	
94B177-3	TV-165			C-9.242	MDF-70	J-6227	BC-575
94C17-1/-3	TV-163			C-9A-2403	MDF-125	J-6228	BC-576
94C17-4	TV-164			C-9A-2452	MDF-125	J-6231	BC-569
94C17-12	TV-163			C-12A-1782	P-3078(11)	J-6232	BC-569
94C17-14/-15	TV-250(2)			C-12A-18839/-1	P-3070	J-6233	BC-571
94C17-16/-17	TV-163(2)	A-13D-16943	TV-163	C-12M-18285	HVO-10(2,3)	J-6234	BC-574
94C30-1/-3	MDF-77	A-13D-19355	TV-163	C-12M-18689/1/-2	HVO-10(2,3)	J-6235	BC-575
94C51-1/-3	MDF-88	A-13D-19540	TV-163	C-12M-19407-1	HVO-10(3,2)	J-6236	BC-576
94C74-3/-4	MDF-92(4)	A-13M-18026	TV-102	C-12M-19408	HVO-10(3,2)	J-6237	BC-569
94C74-5/-6/-7	MDF-92(4,8)	A-13M-18233	MWC-7(6)	C-16A-15624	C-2991	J-6238	BC-570
94C194-1	TV-166	A-13M-18961	MWC-4(6)	C-18A-16474	A-3019(2)	J-6239	BC-571
94D17-7	TV-163	A-16A-18025	TV-102	C-18A-18022	A-2931	L-50	TV-247
94D17-15	TV-250(2)	A-16A-19486	TV-126	C-18A-18157	A-2931(2)	L-103	TV-127
94D17-16	TV-163	A-51A-16945	TV-163	C-30.309-2	A-3019	L-110A/B/C	TV-154
94D74-5/-6	MDF-92(4,8)	A 201-16329	TV 137	C-201-15717	TV-110	L-126	TV-196(5)
94D87-1/-2/-3	MDF-92(4,8)	A 201-17962	TV-151	C-201-16155	TV-108	L-127	TV-201(5)
94D87-8/-9/-10	MDF-92(4)	A-201-18695	TV-151	C-201-16269	HVO-10(3,2)	L-128	TV 207
94D87-12/-13/ 15	MDF-92(4)	A-201-19363	TV-119(12)	C-201-16411	TV-108	L-132A	TV-168(12)
94D87-16/-17/-18	MDF-92(4,8)	AA-157787-1-5	TV-102	C-201-18530	HVO-10(2,3)	L-133	TV-192
94D87-20	MDF-92(4,7,8)	AD-158426-1-2	MDF-105	C-201-18562/-1	HVO-10(2,3)	L-149/B	MDF-130
94D147-1/-3	MDF-120	AR-262	BC-350	C-201-18843	HVO-10(2,3)	L-150	TV-126(83)
94D150-1/-3	MDF-120	AT-52/A	A-3025	C-201-19269	HVO-10(2,3)	L-152	TV-252
94D150-4/-6/-7	MDF-120	AT-62	A-2902(2)	C-201-19533	HVO-10(2,3)	L-154	TV-241
94D169-1/-2	MDF-92(4,8)	AT-63	A-4080(2)	C-10476	TV-116	L-156	TV-163
94D172-1	MDF-126	AT-67	A-2902	C-10503-2	TV-126	L-158	TV-192
94D180-2	MDF-144C	AT-72	A-2902(2)	C-10509-1	TV-113	L-160	BC-566
94D187-2/-2C	MDF-126	AT-77	A-4107(2)	C-10521	TV-115	L-162	TV-184(5)
94D189-1	MDF-134	AT-79	A-2901	C-1052-2	TV-126	L-163	TV-208(5)
94D189-2	MDF-129	B-1.507	TV-163	C-158225-1-2	TV-167	L 164	BC-562
94D189-3/-3F	MDF-134	B-1.519	TV-163	D-9.235	P-2835(2)	L-165	TV-128
94D189-4/-9/-F	MDF-129(7)	B-12C-10074-4	A-2928	D-9A2477-1C	MDF-127	L-167	TV-253
94D189-4C/-4E	MDF-129(7)	B-12C-16050	A-3038	E-622	BC-352	L-178/A	MDF-92(3,4,54)
94D192-1	MDF-92(4,7,8)	B-12C-17303	A-3036	E-1111	A-2998	L-179	TV-127
94D205-1C/-2D	MDF-92(4)	B-12C-18743/-1	A-2931	E-1113	A-3025	L-185	MDF-92(90,92)
94D205-3/-4	MDF-92(4,90)	B-12C-19009	A-3019	E-1137/-B	A-3031	L-186	MDF-108(90,94)
94D238-1/-1A	MDF-134(4)	B-12C 19048	A-3038(18)	E-1146/-B	A-2928	L-188	TV-113(19)
94D240-1A	MDF-134(4)	B-12M-18241	A-3003	E-1708	A-3025	L-189	TV-202
97D54-1	MDF-91(4)	B-13A-18783	TV-154(2)	E-6055	BC-419	L-190	TV-195
97D87-18/-20	MDF-92(4,8)	B-13M-13590	MD-12	E-6056	BC-419	L-191	TV-199
98A4	A-2928	B-13M-16335	TV-110(1)	E-6127/-A	BC-393(2)	L-192	MDF-129(4)
98A18	A-2928	B-13M-17273	TV-110(1)	E-6146/-A	BC-393	L-197	MDF-143(4,92)
98A33-10	A-2928(29)	B-13M-17962	TV-110(1)	E-6166-A	BC-393	L-199	BC-566
98A34-10	A-2901	B-13M-18888	MDF-70(4)	E-6211	BC-357	L-201	BC-381
750C305-6	MDF-134	B-13M-19254	MDF-70(4)	E-6217	FM-254	L-246	MDF-144C
750C305-7	MDF-129(4)	B-13M-19488	MD-12	E-6218	BC-353	LI-10	BC-327
750C305-10	MDF-92(4,90)	B-16A-1605-1	C-4084	E-6256/-1/-3	BC-352	LI-11	BC-328
750C305-11	MDF-134	B-16A-17959	C-4084	E-6264/-1/-2	BC-356	LI-19	BC-352
750C305-13	MDF-92(4,90)	B-18A-16440	A-3019(2)	E-6265-A	BC-574	LI-34	FM-255
750C305-14	MDF-126(4,7)	B-201-15612	TV-103	E-6266-A	BC-575	LL-61	BC-419
750C305-19/-20	MDF-134(4)	B-201-15945	TV-116(19)	E-6270	FM-255	LO-18	BC-381
750C305-23	MDF-126(4,7)	B-201-16410	TV-102(4)	E-6283	FM-255	LO-26	BC-393
105195	C-4133	B-155255-3-1	A-3006	E-6290	BC-574	MW20E360	TV-102
280076	A-3025	B-155529-1-1	C-2994	E-6291	BC-575	MW20E360	TV-103
706412	A-2928	B-157919-1-1	A-3025	E-6292	BC-576	MW20E361	TV-119(19)
903562-504X/-507	MDF-144C	B-158222-1-1	TV-206(5)	E-627189	FM-254	MW20E362	TV-115(1)
906141-501	HVO-233C	B-158224-1-3	TV-141	F-6264	BC-356	MW20E409	TV-163
961415-1	A-4138C	B-158351-1-2	TV-121	FC-5/-B	C-4125	MW20E415	MWC-7
962636-501	HVO-232C	B 158352-1-1	TV-192	FC-9	C-4125	MW20E524	MWC-6
972128-8	A-3020	B-158353-1-2	TV-120	FC-18	C-4115	MW20E537	TV-110
1104665-1/-2/-3	C-4133	B-158354-1-2	TV-120	FC-23	C-4133	MW20E639	MWC-7
		B-158355-1-4	TV-139	FC-24	C-4133	MW20E685	MWC-2(6)
		C-1.458	MWC-7	J-612	BC-577	MW20E688	MWC-11(6)
		C-1.459	MWC-12	J-6129	BC-566	MW20E721	TV-151
		C-9.209	MD-12	J-6212	BC-576	MW20E725	TV-118
		C-9.228-3	A-3036	J-6213	BC-574	MW20E732	BC-352
		C-9.230-2	A-3003	J-6214	BC-574	MW20E786	TV-163
		C-9.236	HVO-3	J-6215	BC-575	MW20E788-2	MDF-78(8)
		C-9.237	C-2991	J-6219	BC-569	MW20E825	BC-352
		C-9.240-1	HVO-3	J-620	BC-569	MW20E827	BC-387
		C-9.241	A-3019	J-621	BC-569	MW20E831	TV-163
AIR CASTLE (See Jackson)							
AIR CHIEF (See Firestone)							

PART NUMBERS		PART NUMBERS		PART NUMBERS		PART NUMBERS	
MFGR.	MERIT	MFGR.	MERIT	MFGR.	MERIT	MFGR.	MERIT
AIRLINE		AIRLINE		AIRLINE		AIRLINE	
MW20E938	BC-394	R-1432	TV-132	12E-27156	A-2829	20E859	TV-245
MW22E35-2/-3	A-2931	R-1470	TV-181	12M-18241/-1/-3	A-3003	20E860	TV-247
MW22E43	P-3078	R-1471	TV-201(5)	12M-21644	TV-110	20E947	HVO-9(7,91)
MW22E51	A-3037	R 1635	TV-151	13A-19514	TV-154	20E952	MWC-6
MW22E52	C-2994(2)	R-1950	TV-190(5)	13A-26994	TV-130(37)	20E990	BC-387
MW22E55/-2	A-3003	R-2056	C-4115	13A-26995	TV-243(37)	20E994	TV-116
MW22E56	P-2835	R-2057/-1	HVO-141	13A-26998	TV-132(19,37)	20E995/ 2	HVO-37
MW22E57/-2/-3	HVO-46	R-2058	A-3039(2)	13B-17731	BC-353	20E1032	TV-131
MW22E57-5/-6	HVO-46	R-2059	A-2934	13B-17731	BC-352	20E1033	TV-243
MW22E61-2/ 3	HVO-46	R-2060	MDF-108(7)	13B-19540	TV-163	20E1034	TV-245
MW22E63	A-2829	R-2061	A-3003(2)	13B-22068	BC-352	20E1035	TV-120
MW22E64	C-2991	R-2062	TV-131	13B-22428	TV-125	20E1036	TV-120
MW22E67	HVO-46(3)	R-2159	TV-121	13B-23887	TV-130	20E1037	TV-121
MW22E68	P-3078	R-2701	TV-130	13D-19540	TV-163	20E1038	TV-163
MW22E69	P-2830(10)	R-2711	A 2999	13M-18233	MWC-7(6)	20E1039	BC-566
MW22E70	A-3006	R-2712	A-3003(2)	13M-19251	TV-118	20E1080	TV-130
MW22E71	A-2928	S-38A1003	TV-165	13M-19257	TV-110	20E1081	TV-130
MW22E72	A-2825	SPK-144	A-3025	13M-19512	TV-118	20E1083	TV-153
MW22E73	C-2974	TO-4502/P	A-2930	13M-19521	TV-118	20E1084	TV-152
MW22E74	P 2837	TR-26B	A-2823	13M-19643	TV-110	20E1088	TV-121
MW22E75/-L	HVO-93	TR-36A	A-2822	13M-21644	TV-110	20E1089	TV-152
MW22E88	A-3025	TR-50A/B	A-2984	13M-22303	TV-115	20E1090	TV-119
MW30E164/-2/-5	MDF-70	TR-51A	HVO-152	13M-22482	TV-172	20E1116	MWC-11
MW30E164-6/-7	MDF-70	TR-52A	P-2881	13M-23755	MDF-70(4,8)	20E1118	MWC-18
MW30E168	MDF-70	TR-53	HVO-185(7)	13M-24085	TV-166	20E1159/-2	MDF-96(4,8)
MW30E176	MDF-70	TR-72	HVO-133(29)	13M-24086	TV-165(2)	20E1168	TV-130
N-7746	TV-151	TR-77	A-2988	13M-26988	TV-121(37)	20E122	MWC-18
N-7981	BC-352	TR-78/A	A-2822	13M-26992	TV-166(2)	22E28	A-2930
N-8552	BC-387	TR-84	HVO-234C	14-265/X	BC-350	22E35	A-2931
N-8928	TV-110	TR-85	P-4141C	14-267/X	BC-354	22E36	C-2994
N-8929	TV-116	TR-86	A-4140C	14-455	BC-352	22E38	A-4000
N-8930	MDF-74(4)	TV-86/A	P-2971(2)	14-1655	BC-350	22E39	A-3036
N-8931	TV-163	TV-100/A/B	P-2970	14-1655-6/X	BC-352	22E42	HVO-3
N-8932	TV-180	TV-100C	P-2971(20)	16A-17959	C-4084	22E72-2	A-2825
N-8933	TV-199(5)	TV-555-D	P-2860(20)	16A-21214	C-2996(2)	22E73-2	C-2974
N-8934	TV-188(5)	TVL-178/A	MDF-92(4,3,54)	16A-23889	C-4084(2)	22E89	A-3003
N-8936	HVO-49(7)	TVL-185	MDF-92(7,8)	16A-26991	TV-151	22E89-2	A-3006
N-8937	A-2825	TVL-186	MDF-108(90,94)	16B-25146-3	C-4084	22E91	A-3025
N-8938	A-2928	TVL-192	MDF-129(4)	20E64	BC-381	22E94	P-2837
N-9002	A-3003(2)	V-15480-6	TV-190	20E360	TV-102	22E97	A-2824
N-9011	TV-151	V-15796-1	TV-181	20E360	TV-103	22E99	A-3025
N 9250	TV-188	V-15796-3	TV-196	20E361	TV-119	22E100	C-2996(2)
N-9250	TV-192	V-15796-6	TV-190	20E363-19	TV-210(5)	22E101	A-2825
N-9408	TV-118	V-15996-2	MDF-92(8)	20E363-25	TV-185	22E102	A-2902(2)
N-9657	BC-352	XD-2607	A-2823	20E363-26	TV-207	22E106	A-3003
N-9664	A-3031	3X109	A-2932	20E370	TV-230(2)	22E108	A-283
N-9805	TV-130	9X101	BC-381	20E409	TV-163	22E109	C-4084
PM-TR12	A-2901	9X102	BC-381	20E410	MWC-12	30E144-2	MD-12
PM-200	A-2930	9X104	BC-388	20E415	MWC-7	31A078	TV-118
PM-250	A-2930	9X105	BC-352	20E524	MWC-11	31A095	TV-118
PM-252	A-2930	9X105	BC-353	20E537	TV-110	31B257-8	TV-118
PM-705/B	A-2930	9X106	BC-352	20E549/-2	BC-352	31X100	A-3025
PM-900	A-2930	9X106	BC-353	20E639	MWC-15	61MW55	BC-577
R-1080	A-2932	9X120	BC-387	20E684	TV-115(1)	62MW50	BC-575
R-1102	BC-387	12A-19942/-1	P-3059(2)	20E685	MWC-11	62MW56	BC-574
R-1140	TV-199(5)	12C-18743-1	A-2931	20E688	MWC-6	62MW56	BC-575
R-1144	TV-130	12C-19849	A-3036	20E721	TV-151	62MW56	BC-576
R-1234	BC-352	12C-20761-1	A-3039	20E725	TV-102	62MW60	BC-569
R-1336	A-3025	12C-20761-2	A-2819	20E725	TV-103	62MW61	BC-570
R-1405	TV 166	12C-21215	A-2928	20E732	BC-352	62MW62	BC-571
R-1406	TV-165	12C-21731	A-2930(22)	20E779	TV-139	62MW67	BC-574
R-1407	TV-121	12C-22508	A-2928	20E780	TV-118	62MW68	BC-575
R-1408	C-4084(2)	12C-23704/-2	A-2998	20E781	TV-116	62MW69	BC-576
R-1418	A-2822	12D-19250	P-3097(2,45)	20E783	TV-110	62MW71	BC-574
R-1419	A-2928(2)	12D-21160-1	P-2947(2,20)	20E785	TV-151	62MW71	BC-575
R-1420	TV-238	12D-23699	P-2959(20)	20E786	TV-163	62MW71	BC-576
R-1421	MDF-73(4,8)	12E-23726	A-3037	20E788-5	MDF-78(8)	62MW74	BC-575
R-1425	A-3003(2)	12E-23939	HVO-58	20E831	TV-163	62MW75	BC-576
R-1427	TV-130	12E-26993	TV-165(2)	20E857	TV-131	62MW81	BC-574
R-1429	BC-566	12E-27097	HVO-163	20E858	TV-243	62MW82	BC-575

MERIT COIL AND TRANSFORMER CORPORATION

PART NUMBERS		PART NUMBERS		PART NUMBERS		PART NUMBERS	
MFGR.	MERIT	MFGR.	MERIT	MFGR.	MERIT	MFGR.	MERIT
ANDREA		ANDREA		ANDREA		APELCO	
A2-275	BC-353	SA-329	TV-104	SL-4014	A-2931	302217K	BC-352
A51-0364	TV-198	SA-331	TV-100	ST-2025-1	A-3038	302225K	BC-353
A51-0378	TV-130	SA-334	TV-100(2)	ST-3010	A-3038		
A51-0380	TV-126	SA-335/-1	TV-167	ST-3013	MD-12(4)		
A51-0381	TV-153	SA-336	MWC-7	ST-3018/-1	HVO-3		
A51-0405	BC-353	SA-388-1	338-TV-130	ST-3020	A-4003	ARKAY INTL.	
A51-0406	BC-352	SA-339	MWC-18	ST-3021	C-2976(2)	A-12 F & V	P-2952
A51-0408	FM-254	SA-340	MWC-4	ST-3022/-1	P-2884(2,21)	ED-531K	FM-253
A51-0409	FM-254	SA-343A	BC-352(2)	ST-3023/-1	P-3169(14)	FL-30 F & V	P-2955
A51-0411	FM-255	SA-344D	BC-355(2)	ST-3025/-1	A-3038	L-100	BC-352
A51-0415	BC-564	SA-346	MWC-6	ST-3027	HVO-5	1607-1/-6	FM-254
A51-0416	BC-563	SA-348	MWC-6	ST-3028	MDF-70	2607-1	FM-253
A51-0418	MWC-6	SA-349	TV-193	ST-3029	A-4003		
A51-0420	BC-566	SA-350	TV-200	ST-3030	A-3036		
A51-0423	TV-202	SA-351	TV-115(2)	ST-3031	C-2991		
A51-0424	TV-120	SA-352	TV-154(2)	ST-3033	P-2835(93)	ARLINGTON	
A51-0426	TV-115	SA-353	TV-113(2)	ST-3034	MD-12	(See Wells-Gardner)	
A51-0428	TV-167	SA-355	TV-127(2,83)	ST-3037	MDF-70		
A51-0430	TV-156	SA-359	TV-126	ST-3038	C-2997(2)		
A51-0434	TV-154	SA-360	TV-126	ST-3040/-1	A-3039		
A51-0435	TV-113	SA-361	MWC-11	ST-3041	P-3169(14,16)	ARTONE	
A51-0442	MWC-6	SA-364	TV-198	ST-3042	HVO-7(2,3,91)	(See Teleking)	
A51-0443	TV-163	SA-366	MWC-11	ST-3043	MDF-72		
A51-0445	BC-565	SA-367	TV-127(61)	ST-3049	MDF-72(4)		
A51-0446	TV-193(5)	SA-368	TV-127	ST-3050	HVO-47		
A51-0450	BC-419	SA-369	TV-128	ST-3051	HVO-9	A-42242	A-3038(2)
A51-0451	BC-394(83)	SA-370	TV-126	ST-3055	P-2876(93)	A-42245	MWC-3
A51-0482	BC-565	SA-371	TV-126	ST-3056	HVO-9	A-42247	MWC-12
A51-0485	TV-234	SA-373	TV-113(19)	ST-3057	A-4003	AC-22255-1	BC-387
A51-0491	TV-157	SA-374	TV-115	ST-3058	A-3039	AC-22587	BC-387
A51-0492	TV-198	SA-377/A/C	TV-245	ST-3059	A-3020	AC-22995-1	A-3026
A51-0493	TV-203	SA-378/-1	TV-130	ST-3061	A-3019	AC-23084-1	MDF-73(4)
A52-0447	BC-562	SA-379	TV-130	ST-3062	P-3055(2)	AC-23090-1	A-4103
A52-0448	TV-205	SA-380	TV-126	ST-3063	HVO-36(2,7)	AC-23139	BC-387
A52-3096	MDF-112(4)	SA-381	TV-153(12)	ST-3064	A-2822	AC-23162-1	BC-371
A52-3104	A-3020	SA-382	TV-204	ST-3065	C-4084	AC-23163	BC-388
A52-3107	C-4084	SA-385	TV-180	ST-3066/A	MDF-92(4,8)	AC-23751-1	BC-387
A52-3114	P-2836	SA-386	BC-352	ST-3068	A-4003	AC-23816-1	MDF-72(4)
A52-3119	A-2936	SA-387	BC-353	ST-3070	A-3019(2)	AC-23816-2	MDF-73(4)
A52-3128	P-2862(2)	SA-390	TV-126	ST-3071	A-2933(2)	AC-24308-1	BC-566
A52-3129	C-4115	SA-393	MWC-11	ST-3073	P-2951	AC-25383-1	BC-381
A52-3151	MDF-120(5)	SA-394	MWC-6	ST-3075	A-2901	AC-25706-1	BC-388
A52-3155	A-2930	SA-395	TV-163	ST-3076/-1/-2	A-2901	AC-25728-1	BC-368
A52-3158	A-3018(2)	SA-397	TV-151	ST-3077	C-2991	AC-25728-1	BC-369
A52-3160	C-4133	SA-398	TV-184	ST-3078-1	C-2991	AC-25729-1	BC-371
A52-3161	P-4141C	SA-399	TV-113	ST-3082-1	P-2836	AD-22592-1	FM-255
A52-3162	HVO-232C	SA-400	TV-115	ST-3083	MDF-92(4)	AD-24683-2	MDF-72(4)
A52-3163	A-4139C	SA-402	BC-419	ST-3084	A-4003	AD-24694-1	MDF-73(4)
A52-3170	MDF-144C	SA-403	BC-388	ST-3085	HVO-36(2,7)	AD-42259-1	TV-124
A52-3194	A-2930	SA-404	BC-393	ST-3086	A-3038(18)	AD-42317-1	TV-151
MLB-VQ21-110	TV-184	SA-405	BC-352	ST-3087	C-2991	C-21797-8/-16	BC-352
N2-414	BC-352	SA-406	BC-353	ST-3089-1	A-3129(2)	C-21797-81	BC-355
N2-415	FM-254	SA-408	FM-254	ST-3091	P-2836	C-22352	BC-352
S-154	MDF-120(7)	SA-409	FM-254	ST-3095/-1/-2	HVO-81(7)	C-22446/-1/-2	A-4003
SA-287	TV-150	SA-411	FM-255	ST-3096	MDF-112(4)	C-22497/-1	A-3020
SA-289-1	TV-104	SA-415	BC-564	ST-3097/-1	A-2988	C-22498	TV-101
SA-290-1	TV-101(19)	SA-416	BC-563	ST-3104	A-3019	C-22501	TV-151
SA-291-1	TV-100(19)	SA-418	MWC-6	ST-3105	P-3064(14)	C-22502	TV-100
SA-292-1/-2	TV-100(19)	SA-420	BC-566	ST-3107	C-4084	C-22556	TV-100
SA-307	TV-160	SA-421	TV-113	ST-3112	A-3019	C-22558	TV-105
SA-309-A	BC-352(1)	SA-422	TV-115	1-110	BC-353	C-22559	MWC-7
SA-310-D	BC-353(1)	SA-423	TV-202	1C42-G1	C-2977(2)	C-22561-1/-2	C-2996
SA-311	TV-111	SA-424	TV-120	2-47-4	FM-255	C-22561-3/-4/-5	C-2996
SA-312	TV-104	SL-4005	A-3019	3T-3095-2	HVO-81	C-22562	MWC-12
SA-313	TV-105	SL-4006	A-3019	1091C-2	BC-347	C-22563	TV-162
SA-314	MWC-7	SL-4009	A-2931	1106B-1	FM-254	C-22564	HVO-3
SA-315/-1	MWC-12	SL-4010	A-3020(2)	1106B-2	FM-255	C-22565	TV-104
SA-323	MWC-4	SL-4011	A-4105			C-22566	TV-106
SA-327	TV-145(2)	SL-4012	A-3020(2)			C-22567	A-3035(2)
SA-328	TV-151	SL-4013	A-3020(2)			C-22575	MD-12

MERIT COIL AND TRANSFORMER CORPORATION

PART NUMBERS		PART NUMBERS		PART NUMBERS		PART NUMBERS	
MFGR.	MERIT	MFGR.	MERIT	MFGR.	MERIT	MFGR.	MERIT
ARVIN		ARVIN		ARVIN		ARVIN	
C-22590	FM-254	D-23449	TV-163	40537	MDF-91(4,92)	46200-9/-14	A-2900
C-22864	BC-386	D-24807	MDF-73(4,54)	40845-1	BC-352	46200-18/-21	A-4097
C-22905/-1	A-3037	D-25005	MDF-72(4)	40925-1	C-4115	46262-2	BC-419
C-23085	MDF-73(4)	D-25322	TV-110	40937	TV-124(2)	46468-1	A-2901(22)
C-23087/-1	C-2994	D-40072	TV-130	41020	MWC-11	46568-2/-3/-4	BC-419
C-23091-2	TV-131	D-40073	TV-130	41023-1/-2	A-2823	46568-5/-7/-8	BC-419
C-23092	TV-134	D-40074	TV-132	41092-2	A-2815(46)	46568-9/-10/-11	BC-419
C-23093	TV-151	D-40077	TV-113(1)	41173	TV-130	46568-13/-14/-16	BC-419
C-23094	TV-115	D-40537	MDF-91(4,54)	41177	TV-113(2)	46568-17/-19/-20	BC-419
C-23443	TV-133	D-40937	TV-124(2)	41213-1	A-3025	46568-22/-23	BC-419
C-23444	TV-134	D-41173	TV-130	41706-1	A-3025	46588-8	BC-419
C-23445	TV-127(1)	D-41177	TV-113(1)	41745-1	A-3003	46700-1/-2/-3	A-3025
C-23446	TV-129(2)	E-22571	P-3053(10,14)	41802	HVO-9(7,91)	46700-4/-5/-6	A-3025
C-23447	TV-113	E-22807	P-3053(10,13,14)	41803	HVO-36	46700-8	A-3025(2)
C-23448	TV-154	E-23397	P-2836(11)	41848	TV-152	46861-1	BC-418
C-23449	TV-163	E-23799	P-3057	41849	TV-153(12)	46971-2/-3/-4	FM-256
C-23490/-1	A-2928(2)	E-23802-1	HVO-7(2)	41852	HVO-55(7)	46975-1	BC-418
C-23614	TV-132	E-23840	P-2948(2)	41879	TV-113(1)	46975-3	BC-419
C-23657	A-3037	E-24127	HVO-7(3)	41884	MWC-11	47828-3	C-2976(2)
C-23670	TV-151	E-24654	P-3057	41887	MWC-6	47828-4	C-2975
C-23672	TV-134	E-24681	HVO-7(3)	41984-1	A-2823	48921-2	A-2901(2)
C-23800	MWC-12	E-24989	HVO-47	42026-4	A-2927(2)	48989-2	P-3148
C-23801	MWC-1	E-25433	P-2877	42028-1	A-3025	49382-2	BC-572
C-23817	MDF-73(4)	E-25919	P-3055(10)	42135	TV-130	49388-10/-16	BC-574
C-23821	TV-130	E-40117	HVO-7(3,91)	42144-1	A-2931	49388-20/-21	BC-575
C-23893	TV-114	E-40513	HVO-36	42144-2	A-3025	49388-27	BC-574
C-23894	MWC-6	E-40926	P-3055(10)	42157	MWC-6(6)	49388-30	BC-571
C-24283	MDF-73(4)	E-41024	HVO-9(7,91)	42301-600	C-4115(2)	49388-34	BC-576
C-2465	MWC-1	LV-226	A-3033(2,86)	42504	MDF-91(4)	49388-36/-37	BC-576
C-24734	MWC-9	N-21797-16	BC-352	42700-1/-5/-7	A-3025	49455-1/-2	BC-356
C-24754	MWC-9	N-22334-1	TV-189	42700-9/-11/-13	A-3025	49455-7/-8	BC-356
C-24776-1/-2	A-3019	N-22352-1	BC-352	42700-15/-16/-17	A-3025	49515-1/-2/-3	BC-561
C-24776-4/-5	A-3019	N-22590	FM-254	42700-18/-19/-20	A-3025	49555-1/-2	BC-356
C-24988	TV-132	N-25706-1	BC-382	42700-21	A-3025	66682-21	A-2903
C-24990/-1/-2	A-3039	N-25828-1	BC-382(2)	42720	MDF-73(8)	66682-40	A-3025(2)
C-24991	MWC-6	N-43412-1	BC-352	42721	HVO-117	68392-11	BC-569
C-25322	TV-110	XL-582-C	MWC-12	42750-1	TV-238	68392-12	BC-570
C-25410	TV-132	XL-696-A	MWC-3	42751-2	TV-130	68392-13	BC-571
C-25411	TV-133	XT-7898-A	A-3038(2)	42754-1	TV-151	68504-40	BC-566
C-25412	TV-134	17-4523	TV-130	42755-1	TV-151	68504-42	TV-190
C-25414	TV-129(2)	40E56W	A-2930	42756-1	A-2822	68504-44	TV-197
C-25416	TV-151	21797-2/-3/-6	BC-352	42757-1	TV-131	68504-45	TV-194
C-25474	TV-129(2)	22561-6	C-2996	42758-1	TV-121	68504-121	A-2930
C-25543	TV-154(2)	23449	TV-163	42759-1	TV-167	68504-122	A-3033(2,86)
C-25609	TV-151	23464-1	A-3025	42760-1	C-4084(2)	68504-125/-126	BC-565
C-40028	MWC-5	23669-3	A-2930	42761-1	BC-562	95073-1	BC-566
C-40098	MWC-2	24308-1/-2/-3	BC-564	42766-1	A-3003(2)	97100-2	FM-259
C-40470-1	A-3037(2)	24771	BC-352(1)	43150-1	BC-394	97712-1/-2/-3/-5	BC-356
C-40532	MWC-1	24776-5	A-3019	43393-1/-4/-6	A-3031	98494-1	P-2944(2,12)
C-40533	MWC-6	24807	MDF-73(4,92)	43393-7	A-4081(2)	358054	MWC-6
C-40690	FM-251	25468-10/-22	TV-181	43393-8	A-2900	358068	TV-165
C-40845-1	BC-352	25468-23	TV-195	43412-1	BC-352	358069	TV-246
C-40845-2	BC-355	25468-24/-29	TV-184	43622	BC-356	423016	C-4115(2)
C-41020	MWC-6	25468-30	TV-188(5)	43669-1	BC-356	453074	A-4103
C-41092-1	A-2815(46)	25468-31	TV-195(5)	44282-1	BC-356	700070	A-2902
C-41168-1	BC-355	25609	TV-151	44471-67	BC-419	ASTORIA (See Teleking)	
C-41175	TV-132	32140-300	TV-151	44671	A-2757(2)		
C-41212	BC-387	32190-900	TV-130	45240	FM-257		
C-41745	A-3003	32191-100	TV-130	45240-2	FM-255		
C-41884	MWC-6	32192-200	TV-131	45240-3/-4	FM-258		
C-41887	MWC-6	32201-400	BC-574	45307-400	A-4103		
C-43042	BC-352	32201-400	BC-575	45430-1	BC-357		
C-44028	MWC-5	32222-500	BC-576	45500-1	P-2964		
D-5322	TV-110	32390-600	TV-153(12)	45534-1/-8/-9/-12	BC-419		
D-21797-3	BC-353	32501-100	TV-122(2)	45568-7	BC-419		
D-22446-1	A-4003	35202-800	MDF-141(4)	45838-1	A-2757(2)	ATR	
D-22466-1	A-4003	35805-300	TV-165	46131-1	A-2901		
D-22561	C-2991	35805-400	MWC-6	46131-2	A-2902		
D-22563	TV-162	40532	MWC-1	46200-7	A-3031(2)		
D-23094	TV-115	40533	MWC-6	46200-8	A-2903(2)		
						E014922	BC-691
						IF1276	BC-350
						L-301	TV-181
						L-302	TV-190

MERIT COIL AND TRANSFORMER CORPORATION

PART NUMBERS		PART NUMBERS		PART NUMBERS		PART NUMBERS	
MFGR.	MERIT	MFGR.	MERIT	MFGR.	MERIT	MFGR.	MERIT
ATR		AUTOMATIC		AUTOMATIC		BELL SOUND	
L-303	TV-181	AR-262	BC-350	14-1607-4A	FM-254	B-20377	P-2952
L-601	MWC-6	DY-12	MD-12	14-1655	BC-350	GT-24605	FM-254
L 602	MWC-12	FAR-3018	C-4095(22)	14-1655/6/X/16	BC-352	GT-24606	FM-254
LIFT-67	BC-352	GE-77J1	HVO-7	14-2607-1	FM-253	GT-24608	FM-253
LOT-85	BC-393	GE-77J2	MDF-70(4)	14-2654	BC-690	GT-24609	BC-352
LT-87/90	BC-419	H-294	FM-254	14-2655	BC-691	GT-24610	BC-353
OT-1276	A-2930	H-295	FM-253	45	BC-537	31A1	BC-393
PT-1276	P-3068	H-355	FM-254	73-TR12	A-2935	31A21	BC-564
SPK-87B/90	A-3025	H-371	FM-254	75-460	A-4093(2)	31A22	BC-562
ST-7	TV-154(1)	HL-10	MWC-12	75-4252	A-2928	31A24	BC-560
T-102	TV-113(1)	IF-22	TV-102	75-4502/B	A-2930	31A26	BC-393
T-103	TV-110	IF-23	TV-116	75A601	C-4095(22)	31A36	BC-562
T-104	A-2901(2)	IF-24	TV-116	75A602A	A-4094(2)	31A43	BC-561
T-201	TV-127(1)	J-70-14	MDF-72	75A604	A-4094(2)	31A44	BC-561
T-204	TV-130	L-1	BC-537	75A787C	A-2781	31A50	BC-393
T-205	TV-130	L-8	BC-537	75A1025	A-2903	31A53	BC-562
T-301	TV-151	L-201	BC-381(2)	75A1202	A-2930	31A55	BC-561
T-501	A-3003(18)	L-202/A	BC-537	75A1203	A-2930	31A59	BC-563
T-502	A-3035	L 203	BC-537	75A1264	A-4092	31A61	BC-561
T-601	TV-162	L-204	BC-394(12)	75A1269	C-4095	31A83	BC-563
T-602	HVO-36(7,8)	L-305	BC-401	75A1539	A-4093(2)	32A27	BC-388
YMP-288	HVO-36(7,50)	LA-51	BC-419	75A1636	BC-565	32A39	BC-386
ZMP-376	TV-130	LA-100	BC-419	75A1673	A-4093(2)	32B17	P-3048
ZMP-377	TV-119(12)	LA-449	A-3003	75A1860	A-4093(2)	32B20	A-3027(2)
ZMP-380	TV-162	NE-618A	A-4000	75A2057	C-4095(22)	32B74	A-2901
ZMP-381	TV-127(1)	NE-647P	A-3035(2)	75A2500	A-2777	32C24	FM-254
ZMP-384	A-2901(2)	NE-664S/-6	A-3036	75A3082	C-4095	32C25	BC-352
ZMP-385	A-3035	NE-685	C-2991	75A6001	C-4095(2)	32C44	FM-254
ZMP-387	A-3003(18)	NE-699P	P-3067(14)	75B601B	C-4095	32C60	FM-253
ZMP-388	TV-113(1)	NE-708P	P-2835(15)	318V-2	P-2970	32C66	FM-255
ZMP-389	TV-110	NE-734F	P-2944	385PC	BC-359	32C67	BC-352
ZMP-390	MWC-6	O-10	TV-163	385PC	BC-348	32C79	BC-353
ZMP-394	MWC-12	PM-45	A-3026	392PC	BC-358	32C81	FM-254
ZMP-398	MDF-92(4)	PM-200X	A-3028(2)	1455-16	BC-371	32C86	FM-255
21AC53A	A-2930	PM-250	A-2930	1655-6/-16/PC	BC-352	32C88	BC-382(2)
454AT1	A-4094(2)	PM-252	A-2930	6455A6	BC-352	32C99	BC-352
454C1	C-4095	PM-255-2	A-2930	7591-1	A-2901	32C100	FM-254
454CB3	C-4095(2)	PM-705	A-2930	14267/A	BC-354	32C117	FM-253
		PM-705B	A-3019	14977	BC-352	32C126	BC-568
		PM-720	A-2930			56-361	FM-254
AUDIO INDUSTRIES		PM-900	A-2930			56-362	FM-254
1110	P-3048	RD-7/B	TV-110			56-363	FM-253
1209E	A-3026	ST-10	TV-113(1)	AUTOVOX		56-364	BC-353
1211	A-2901	T-12	P-2948(2)	H9652.06	BC-350	56-365	BC-352
1215	A-3027	TO-86	A-2930	H9652.07	BC-351	56-466	FM-254
1216/A	A-3025			K9608.04	C-4095(2)		
1217	A-2935	TO-908	A-2930	2615.0041	BC-561		
1219/A	A-3019	TO-3252	A-3025	2615.0048	TV-192(5)		
1220	A-3026	TO-4502/P	A-2930				
1221	A-2905	TV-86/A	P-2971(2)	2615.0049	TV-180(5)	BELMONT	
1303	BC-561	TV-100/A/B/D	P-2970	2615.0050	BC-673(5)	(See Raytheon)	
1304	BC-561	TV-555D	P-2860(20)	2615.0051	BC-683(5)		
1401A/B/C	BC-393	14-6.2	BC-565	2615.2011	C-4095		
1405	BC-352	14-18	BC-567	2621.1177	A-4093(2)		
1406/A	BC-353	14-19	BC-567			BENDIX	
1408A	BC-393	14-20	BC-567	2621.1178	A-4093	C-4406	A-3025(22)
1409	FM-254	14-22	BC-567			C-71012-C	A-2930
1410	FM-253	14-82	TV-182	BELL & HOWELL		C-215521-2	BC-537
1412	BC-388	14-205	BC-566	13-3	P-2953	C-217018	A-2900(2)
1413	BC-354	14-265/A/S/X	BC-566	777327	A-2900(22)	C-217019	A-2900(2)
1413B	FM-254	14-267/A/S/X	BC-354	800898	A-2900	C-217020	P-4078(2)
1414/A	FM-255	14-268/X	BC-350			C-217121-1	P-4078(2)
1416	BC-393	14-269/X	BC-354	BELL SOUND		C-217453-1	P-2971(2)
1418	FM-255	14-270/A/B/X	BC-690			C-217465	A-2900(2)
1419	FM-254	14-271/A/B/X	BC-691			C-282975-1	P-3068
1512E	BC-418	14-272/X	BC-350				
1514	BC-418	14-273/X	BC-424	B-20295	A-3028(5)	C-282975-2	P-2978
2623A	A-3026	14-274	BC-690	B-20297	P-2952	C-291701	BC-350
2634	A-3025	14-275	BC-691	B-20305	P-2954(12)	C-291702/-1	BC-354
		14-296X	BC-354	B-20344	A-2904	C-291706-2/-3/-6	BC-354
		14-455	BC-352	B-20373	P-3173	C-291714-1/-2	BC-350

PART NUMBERS		PART NUMBERS		PART NUMBERS		PART NUMBERS	
MFGR.	MERIT	MFGR.	MERIT	MFGR.	MERIT	MFGR.	MERIT
BENDIX		BENDIX		BENDIX		BENDIX	
C-291714-5	BC-350	TA-0023	A-2931	265108-1	A-2928	2092050-8/-11	C-4095(2)
C-291787-1	P-3068(2)	TA-0024	A-2930	265109-3	P-2881(2)	2092050-15/-16	C-4095(2)
C-291788-1	A-2930	TA-0025	A-2931(2)	265110-1	A-3037	2092050-0008	C-4095(2)
C-291798-2/-3	A-2938	TA-0026	A-4103	265111-1	HVO-38(2,7)	2092050-0011	C-4095(2)
CH-259038-1	BC-355	TA-0027	A-3020	265112-1	HVO-38(2)	2092050-0016	C-4124(2)
CH-259136-2	TV-119(12)	TA-0500	TV-165	282975-3	P-2978	2092050-0719	C-4095(2)
CH-259148-1	TV-131	TOOV00	A-4000	291791-2/-3	BC-344	2092138-07111	C-4095
D-71012	A-2930	TPOH03	P-2951	291798-5	A-2938	2092202-1	BC-638
D-71014	P-4078(2)	TPOR00	P-3070	291806-3	BC-350	2092202-2/-3	BC-636
D-71192-1	BC-354	TPOY02	P-3070(2)	291807-6	BC-316	2092202-4/-5	BC-636
D-71193-1	BC-367	TPOY03	P-3059(16)	291818-1	P-2978	2092203-1/-2	BC-639
DB-70265	BC-367	TROR00	FM-252	291820-2	BC-346	2092203-3/-4/-5	BC-639
DB-70266	BC-354	TSOH02	HVO-3	2090038-3	A-4093(2)	2092210-4	BC-566
DC-70264-C	A-2930(2)	TSOH03	HVO-181	2090039-1	A-2938	2092210-5	BC-561
DC-70267-C	P-4071	TSOH04/05	HVO-70	2090075-1	A-3010(22)	2092210-7	BC-563
EC-71014	P-4078(2)	TSOV00	A-3035	2090088-1/-8/-11	TV-193(5)	2092210-8	BC-566
HN-265051-1	HVO-70	TSOV01/02/03	A-3036	2090088-14	BC-667(5)	2093163-0705	BC-636
L-10T14	TV-119	209108-1	BC-346	2090088-15	BC-549(5)	2093163-1	BC-336
L-10T17	TV-119(12)	251405-1	TV-163	2090088-16	BC-667	2093163-2	BC-636
L-291701	BC-350	259082-5	MWC-12	2090088-17	BC-552(5)	2093164-1/-2	BC-639
L-291702/-1	BC-354	259082-6	MWC-6	2090088-0720	BC-682	2093164-0704	BC-639
L-291706-2/-3	BC-354	259108-1/-2	TV-151	2090237-1	BC-594	7268860	A-2901(2)
L-291706-4/-6	BC-354	259114-1/3	MWC-6	2090237-2	BC-684	7281946	BC-565
L-291714-1/-2	BC-350	259115-1	MWC-6	2090237-3	BC-685	7283586	A-4094
L-291714-3/-5	BC-350	259115-2	TV-110	2090237-4	BC-686	7284029	C-4095
L-291791-1	BC-344	259120-7	TV-202(5)	2090237-5/-6	BC-594	7285451	A-4093
L-291806-1/-2	BC-350	259120-8	TV-190(5)	2090239-1	BC-687		
L-291807-1/-1B	BC-354	259120-9	TV-184	2090239-2	BC-688		
L-291807-2/-4	BC-354	259120-10	TV-185(5)	2090239-3	BC-689		
L-291807-6	BC-351	259120-11	TV-190	2090340-3	BC-563		
L-291817-1	A-3020	259120-12	TV-196	2090341-1	BC-562		
L-291818-1	P-2861	259120-13	TV-200	2090351-1	FM-254		
L-291820-1	BC-346	259120-14	TV-201(5)	2090354-1	FM-253		
L-291824-1	A-2931	259121-1	TV-163	2090433-1	A-4092		
LC-OD00/01	MD-12	259136-2	TV-119(12)	2090492-1	BC-687		
LC-OD02/03	MD-12	259138-1	TV-131	2090493-1	BC-684	3210006	A-3025
LC-OD04/05/06	MDF-70	259144-1	TV-130	2090513-1	BC-596	3220018	FM-254
LC-OL00/01	MWC-12	259145-1/-2	TV-130	2090520-8	C-4095	3220020	FM-255
LC-OW00	MWC-7	259145-5	TV-116	2090520-9	C-4124(2)	3330037	TV-203
LH-259082-5	MWC-12	259148-1	TV-131	2090532-1	TV-202	3330038	BC-564
LH-259103-1	TV-151	259150-1	TV-192	2090549-1	BC-597	3340007	BC-561
LH-259108-1	TV-151	259154-1	TV-113	2090671-1	BC-564	3340008	BC-561
LH-259114-1	MWC-6	259156-1/-2	TV-115	2090671-2	BC-565	3340012	BC-561
LH-259121-1	TV-163	259157-1/-2	TV-127(41)	2090815-5	A-4092(2)	3340018	BC-561
LH-259144-1	TV-130	259157-3	TV-129	2090849-5	A-4093(2)	3340068	BC-562
LH-259145-1	TV-130	259161-1	TV-116(2)	2090876-1/-2	BC-598		
LH-265047-3	C-2994(2)	259162-1	TV-120	2090876-3/-4	BC-598		
LH-265071-9/-10	A-3019(2)	259163-1	TV-120	2090876-5	BC-595		
LH-265072-5	A-3036	259164-1	TV-121	2090876-6/-7/-8	BC-598		
LO-1T24	TV-163	259165-1	TV-113	2090877-1	BC-686		
NH-259115-2	TV-110	265047-3	C-2994(2)	2090877-4/-6/-7	BC-594		
NH-259138-1	TV-131	265048-1	P-3169(2,14,16)	2090877-8	BC-684		
NH-265048-1	P-3169(2,14,16)	265051-1	HVO-70	2090877-9	BC-594		
NH-265051-1	HVO-70	265054-2	A-4000	2090907-1	BC-638		
NH-265060-1	MDF-73(4)	265060-1	MDF-73(4)	2090907-2/-3	BC-596		
T10C14	BC-352	265071-12	A-3019	2090907-4	BC-344	E-1146D	A-2928
T10C15	FM-254	265071-17	A-3018	2090907-5/-7	BC-596	E-6166A	BC-393(2)
T10D14	BC-352	265072-5/-8/-9	A-3036	2090907-6	BC-344	E-6256-1	BC-352
T10D24	TV-116	265074-1	MDF-91(4)	2090907-8	BC-596	E-6283	FM-255
T10D25	TV-110	265077-1/-2	MDF-73(4)	2090907-9	BC-344	FMC-1877	BC-574
T10D26	TV-116	265086-1/-4	HVO-9(7,91)	2090907-10	BC-596	FMN-1519	BC-575
T10D27	BC-353	265089-1	A-2823	2090907-12	BC-344	R-29314	BC-576
T10I04	TV-116	265092-5/-6/-7	A-3025	2090907-14/-16	BC-596	22306	BC-574
T10I05	TV-116	265093-2/-3/-4/-5	C-2994	2090907-17/-18	BC-596	22307	BC-575
T10I06	TV-116	265094-2	A-3003	2090908-2	BC-594	22308	BC-576
T10I07	TV-116	265095-2	HVO-9(3,7,91)	2090908-3/-4/-5	BC-597	42700-2/-10	A-3025
T10I08	TV-116	265096-2/-5	MDF-73(4,8)	2090908-6/-7/-8	BC-597	45240-3	FM-257
T10T14	TV-119	265105-2	MDF-70(8)	2090908-12/15/16	BC-597	46568-7	BC 419
TA-0018	A-2928	265106-1	HVO-58(2,7)	2091874-1/-2	A-4093(2)	46971-4	FM-256
TA-0022	A-2931	265107-1/-2	A-3037	2091874-5	C-4095	49455-7/-8	BC-356

BENRUS
(See Sentinel)

BLONDER-TONGUE

BOULEVARD

BRADFORD
(Also See Wells-Gardner)

PART NUMBERS		PART NUMBERS		PART NUMBERS		PART NUMBERS	
MFGR.	MERIT	MFGR.	MERIT	MFGR.	MERIT	MFGR.	MERIT
CATALINA (Also See Wells-Gardner)		CBS - COLUMBIA		CBS - COLUMBIA		CBS - COLUMBIA	
A30105-A-26	MDF-117(88)	L-150	TV-126	TVL-186	MDF-108(9,90)	21F211	C-2994
A40183-A	TV-167(2)	L-152	TV-252	1L170	A-3031	21F212	BC-562
A40558-A	TV-151	L-154	TV-241	2B119	P-3148(2)	38G53	A-3026
A40559-A	TV-151	L-167	TV-253	2F116	P-3055	201D1	MD-12
109457	MDF-144C	L-186	MDF-108(9,90)	3A210	A-2901	201K1	TV-104
113382	HVO-234C	LF-52	FM-254	3A218	A-2936(2)	201R1	MWC-11
113390	A-4140C	LF-53	FM-255	3B205	A-3025	201R3	MWC-12
440242	C-4084(2)	LF-54	BC-352	3B221	A-2900	201T6	P-3061
44239-D	TV-116	LF-58	FM-254	3B241	A-3025(2)	202K2	TV-100
44562-8	A-3018	LF-59	BC-353	3B242	A-3025	202K3/K4	TV-101
		PA-28218	MWC-18	3B259	A-3025(2)	202L1	TV-102
		PA-28254	TV-120	3B262	A-3019	202L1	TV-103
		PA-28263	TV-163	3B263	A-2900	203K1	TV-106
		PA-28279	MWC-8	3B266	A-2928	204T2	A-3035
		PA-28286	TV-151	3B267	A-2905(2)	208T2	A-4000
		PA-28292	MWC-12	3F247	A-2901(2)	208T8	TV-160
		PA-28318	MWC-18	3F249	A-3019	211T1	HVO-3
		PB-1097	A-3003	3G252	A-3025	515-3	BC-562
		PB-1201	TV-115	3G254	A-2928(2)	515-25	FM-254
		PB-1202	TV-115	3G264	A-3025	515-27	FM-253
		PB-1350	A-3036	3G271	A-3020	515-31	BC-353
		PB-1353	A-3026	3K273	A-2933(2)	10152-1	A-2815(44)
		PB-1406	C-2974	20A309	BC-403	700054	P-3048
		PB-1414	C-2974	20B310	BC-393(7)	10000663	A-3003
		PB-3392	TV-102	20B311	BC-352	10000221	A-2819
		PB-3392	TV-103	20B311	BC-353	10000231	A-3019
		PB-3393	TV-110(1)	20B406	BC-419	10000411	P-2836
		PB-10106-2	A-3003	20B407	BC-561	10000551	A-2854
		PB-10115-2	A-3038	20B408	BC-393	10000561	P-2836
		PB-10115-4	A-3036	20B411	BC-352	10000571	P-2836
		PB-10125	A-3003	20B411	BC-353	10000611	A-2819
		PB-28278-3	MDF-70	20B412	FM-255	10000631	P-2945(2,15)
		PB-28286	TV-151	20B413	FM-254	10000661	A-2823
		PB-28318	MWC-18	20B414	BC-419	10000671	A-2928(2)
		PB-28320	TV-137	20B415	BC-393	10000691	A-2823(18)
		PB-28327	MWC-6	20B417	FM-254	10000701	A-2902
		PB-33102A	BC-352	20B418	FM-254	10000731	P-2867(2)
		PB-33102A	BC-353	20B419	FM-254	10000741	A-2928
		PC-1099	A-3003	20B420	FM-253	10000761	A-3031
		PC-5866	A-3026	20C304	BC-356	12000091	HVO-27
		PC-10100	HVO-3	20C317	BC-356	12000092	HVO-27
		PC-10107	HVO-26	20C318	BC-357	12000151	HVO-79
		PC-10108	HVO-26	20C361	BC-393	12000201	TV-115
		PC-10109	P-3069	20C362	BC-418	12000281	BC-352
		PC-10115-6	A-3038	20E326	FM-254	12000341	TV-126(41)
		PC-10137C	HVO-27	20E328	BC-352	12000751	HVO-79
		PC-10147	HVO-42	20E340	FM-253	12000771	TV-127
		PC-10148	P-2831	20E341	BC-418	12000781	TV-128
		PC-10151	P-2831	20F329	BC-352	12000801	TV-127
		PC-10154-1/-2	A 3038	20F330	BC-353	12000841	HVO-81
		PC-10155	HVO-36	20F331	FM-253	12000891	TV-128(1,41)
		PC-10161	HVO-42	20F333	BC-418	12000901	TV-126
		PC-28278	MDF-70	20F343	FM-254	12000911	TV-126
		PC-28302-1	MDF-70	20F344	BC-419	12000931	TV-113
		PC-28317-1/-1E	MDF-70	20F345	BC-388	12000971	A-4003
		PC-28326	MDF-91(4)	20F346	BC-394	12000981	A-2823
		PC-28393	MDF-71	20F347	BC-352	12001011	TV-126
		PC-58121/-3	A-2935	20F348	FM-256	12001031	TV-126(19)
		PC-58124	A-3026(2)	20F349	BC-329	12001051	HVO-83
		PC-58134	A-3026(2)	20F350	FM-257	12001091	HVO-82
		PD-58121	A-3019	20F357	BC-419	12001101	HVO-79
		PP-3392	TV-102	20F359	BC-352	12001121	TV-126
		PP-3392	TV-103	20G360	FM-254	12001131	HVO-82
		PP-28258	MWC-7	20G361	BC-394	12001151	TV-113
		PP-28261	MD-12	20G362	BC-418	12001171	TV-126
		TR-36A	A-2822	20L393	BC-402	12001181	HVO-54(2,4)
		TR-72	HVO-133(29)	20L400	BC-419	12001191	HVO-80
		TR-109	A-3025	21B215	BC-564	12001211	TV-127
		TR-125	A-3130(2)	21B216	BC-561	12001221	TV-128
		TR-131	P-3151	21C201	BC-561	12001241	TV-115

MERIT COIL AND TRANSFORMER CORPORATION

PART NUMBERS		PART NUMBERS		PART NUMBERS		PART NUMBERS	
MFGR.	MERIT	MFGR.	MERIT	MFGR.	MERIT	MFGR.	MERIT
CBS - COLUMBIA		CHANNEL MASTER		CHRYSLER (See Mopar)		CONCORD	
12001251	HVO-54(2,4,7)	C-014	BC-580			OT-844	A-4080(2)
12001261	TV-126(41)	C-015	BC-576			OT-1079B	A-2900
12001271	HVO-131(7)	C-016	BC-578			TC-81H	A-4080(2)
14000021	C-2991(2)	C-021	BC-574			446143	A-2900(2)
14000101	C-2991(2)	C-022	BC-575			6001131	BC-352
14000111	C-2994	C-023	BC-576	CLAIRTONE		6001132	BC-353
14000122	C-2991(2)	C-028	BC-569	K1800	FM-255	6002011	FM-254
14000141	C-2974	C-033	BC-574	K1009	FM-254	6002012	FM-254
15000531	BC-514	C-034	BC-576	RC82-817	A-2902(2)	6002013	FM-254
15000541	BC-513	C-037	BC-581	RC82C-011	BC-561	6002014	FM-253
15000611	BC-524	C-038	BC-575	RC82C-012	BC-560		
15000631	TV-119	C-039	BC-576	070-369	TV-249	601505	BC-419
15000681	TV-167	C-042	BC-574	070-394	BC-566	602201	BC-562
15000701	BC-566	C-043	BC-578	05044600	A-2823(18)	609235	BC-393
15000721	TV-124	C-044	BC-579	05045000	C-2996		
				05045700	A-2855		
15000741	TV-167	C-053	BC-578	06040301	TV-130		
16000041	TV-195	C-054	BC-578	06040702	MDF-122(4,88,92)		
16000042	TV-184	C-056	BC-575	06040703	MDF-122(88)		
16000042	TV-203	C-057	BC-576	06043700	TV-238		
16000044	TV-190	C-070	BC-576	06043800	TV-120		
16000045	TV-204	C-074	BC-575	07041600	TV-121	CONRAC	
16000051	TV-185	C-075	BC-576	07041700	TV-195(5)	C-2302	A-2823
16000052	TV-184	C-076	BC-574	07041800	TV-185(5)	XL-537A	MWC-6
16000055	TV-190	C-083	BC-575	07042700	TV-204(5)	XL-665A	MWC-12
16000056	TV-185	C-084	BC-576	07045501	TV-185	XM-726	TV-113(1)
						202K11	TV-150
16000111	TV-163	C-501	A-3028	07047901	TV-196	202L1	TV-103
16000201	MWC-12	C-505	FM-254	07048001	TV-201	203L5	TV-151
16000271	MWC-6	C-506	FM-253	07048201	TV-187	212R1	MWC-12
16000351	MWC-6(2)	C-507	BC-352	07048202	TV-187	213R1	MWC-6
16000361	TV-184(5)	C-508	BC-419	07048301	BC-566	215R1	MWC-11
16000521	TV-192	C-509	BC-393	39-12591-1	TV-239	219D1	MDF-91(4)
16000522	TV-195	C-512	BC-561	39-12595-1	TV-189	460T105	TV-136
16000524	TV-180	C-513	BC-563	75-254564-2	A-2901	520L301	C-2991
16000542	MDF-75(4,7)	C-514	BC-564	75-254564-4	P-2897(2)	549T101	TV-137
16001111	MWC-2	C-515	BC-562	75-254565-1/-2	A-4081	600T106	P-3148
16001201	MDF-91	E-636	BC-419	75-254634-2	A-2902		
16001251	MWC-2	E-1137B	A-3031	75-254634-7	A-4107	660T301	P-3070
16001301	C-2995	E-6256-3	BC-352	75-270490-1	A-2901	740T601	HVO-36
16001321	MWC-11	E-6264/-1/-2	BC-356	83-270886-14	BC-387	741/C	HVO-36
16001351	MDF-75(4,87)	E-6283	FM-255	83-270888-1	BC-327	838	P-3053(10,28)
						857	A-3020
16001362	TV-185(5)	GT-V04	A-2903	83-270888-2	BC-328	956/B	TV-110
16001364	TV-185	R-W5T009	BC-575	83-270888-3	BC-329	994	TV-163
16001381	MDF-75(4)	R-W5T043	BC-576	83A254591-1/-8	BC-386	1037	MWC-10
16001391	MDF-75(4,87)	R-W5T056	BC-574	83A254592-2/-6	BC-393	1039	TV-199
16001401	TV-151	R-W5T059	BC-574	83A254592-7	BC-393	1042	TV-151
16001481	MDF-75(4,87)	R-W5T062	BC-576	83A270261-4/-5	BC-419	1044/B	C-2994
16001491	MDF-92(4,87)	R-W5T073	BC-576	83A270620-1	TV-205	1056/A	C-2996
16001501	MDF-92(4)	R-W5T084	BC-575	83A270881 1	BC-419	1058	MWC-11
16001521	TV-163	R-W5T124	BC-574	122-2-44	BC-393	1078	TV-113(1,41)
16001531	MDF-92(4)	R-W6164	C-4095	122-2-45	BC-566	1079	TV-151
16001541	MDF-92(4,8)	R-W7022	P-2870	122-2-46	TV-189	1082	HVO-36
73000102	A-3025	R-W8075	BC-577	148-9-45	A-2901(2)	1134	MWC-6
73000411	A-2930	R-W8086	BC-577	148-9-47	FM-254	1135	MWC-11
73000422	A-2900(2)	T-A05	TV-166	148-9-48	FM-255	1160	TV-139(1)
73000521	A-2928	T-A18	TV-159	148-9-49/-50	BC-352	1161	TV-150
73000801	C-2994	T-B19	C-4084	1607-4/-5	FM-254	1163	TV-141
73000801	A-2928	T-D37A	MDF-143(4)	1655-6	BC-352	1164	TV-116
73000871	C-2974	T-L64	BC-563	2607-4/-5	FM-255	1200	TV-112
73000871	A-2928	T-L151	BC-673			1202	TV-150
73001161	A-3025	T-L152	BC-679			1203	TV-150(79)
		T-L209	TV-180	CLARION		1204	TV-196(5)
		T-W19	A-2819	(See Warwick)		1216	TV-202
		T-W5007A	BC-574			1217	TV-185(5)
		T-W5008A	BC-575	CLARK		1508	A-2823(18)
		T-W5009A	BC-576	(See Wells-Gardner)		1509	HVO-36(7)
CHANNEL MASTER						1574	TV-152
C-005	BC-579			COMET		1575	TV-153(12)
C-006	BC-578			(See Ford)		1703	TV-198(5)
C-007	BC-576	CHEVROLET				1704	TV-200
C-010	BC-574	(See Delco)				1705	TV-195(5)
C-011	BC-575						

PART NUMBERS		PART NUMBERS		PART NUMBERS		PART NUMBERS	
MFGR.	MERIT	MFGR.	MERIT	MFGR.	MERIT	MFGR.	MERIT
CONRAC		CONTINENTAL AUTO (See Ford)		CORONADO (Also See Wells-Gardner)		CORONADO (Also See Wells-Gardner)	
1717	TV-151			HA8-3F	BC-576	TLF-580-D	TV-165
1737	P-3055(10)			HA8-0C	BC-573	TLF-581-D	TV-166
1754	TV-192			IF-71	BC-569	TLF-593-D	TV-116
1755	TV-192			IF-72	BC-570	TLF-594-D	TV-115
1867	MWC-6			IF-73	BC-571	TO-6133	A-3025
1904	TV-194(5)	A-10-508	BC-352	IF-5161	FM-254	TPW-951	C-4115
1905	TV-195(5)	A-10-509	BC-353	IF-5163	BC-355	TR-50A/B	A-2986
1908	TV-124	A-13D-16943	TV-163	IF-5164	BC-352	TR-51/A	HVO-152
2073	A-3020	A-13D-19355	TV-163	IF-5290	BC-352	TR-52A	P-2882
2227/A	A-2988	A-13M-18026	TV-102	IF-5292	FM-254	TR-77A	A-2988
2433	HVO-116	A-13M-18961	MWC-4(6)	IF-5293	FM-255	TR-78/A	A-2822
2434	MDF-117(8)	A-13M-19521	TV-118	J12-1F	BC-574	TSB-205	A-4080(2)
2624	A-2935	A-201-17962	TV-151	J12-2F	BC-575	TTO-3N1F5	BC-577
2645-3	TV-115	A-201-18695	TV-151	J12-3F	BC-576	TTR-185-1-D	A-3036
13865	C-2991(2)	A-201-18742	TV-151	L-103	TV-127	TTR-195-20	A-2928
29542	MDF-88	A-201-18746	TV-151	L-110A/B	TV-154(62)	TTR-209-D	HVO-7(2)
650350	P-3070	A-201-19363	TV-119(12)	L-126	TV-196	TTR-224-D	MDF-71(4)
758001	TV-126(1)	AT-50	A-3026	L-127	TV-201	TTR-226-D	C-4084
760001	TV-131	AT-52	A-3025	L-128	TV-207	TVL-177	MDF-130
760003	TV-130	B-12C-10074-4	A-2928	L-132A	TV-168(12)	051-102101	TV-201(5)
764001	MWC-6	B-12C-10235	A-2931	L-133	TV-192	051-102102	TV-207
770001	TV-181	B-12C-16050	A-3038	L-149/B	MDF-130(88)	051-102184	TV-196(5)
770003	TV-198	B-12C-17303	A-3036	L-150	TV-126(41)	051-201857	TV-121
770003	TV-200	B-12C-21731	A-2930(2)	L-151	TV-126	051-201996	TV-120
771001	TV-119	B-13A-16662	BC-352	L-152	TV-252	051-202167	TV-131
772001	TV-154(1)	B-13A-18567	FM-254	L-154	TV-241	051-202169	TV-163
774001	TV-110	B-13A-18783	TV-154	L-158	TV-192	053-300396	MDF-108(4,75)
780001	TV-152	B-13B-17731	BC-347	L-160	BC-566	055-100303	A-2822(2)
780003	TV-153(12)	B-13B-17956	TV-140	L-162	TV-184(5)	055-300301	HVO-134
780004	TV-153(12)	B-13B-18568	FM-254	L-163	TV-208(5)	055-300303	A-2822(2)
780005	TV-151	B-13B-18784	TV-140(2)	L-165	TV-128	10-541	TV-116
781001	TV-163	B-13M-13590	MD-12(4)	L-167	TV-253	10-542	TV-116
784001	C-4084(2)	B-13M-17273	TV-110(1)	L-177	MDF-130	10-543	TV-116
790001	BC-565	B-13M-18888	MDF-70(4)	L-179	TV-129	10-544	TV-119
965001	A-2902(2)	B-13M-19257	TV-110	L-188	TV-113(19)	10-551	MWC-7
994001	MDF-120(4)	B-16A-16051	C-4133	L-195	TV-127	10-552	TV-110
		B-80-242	A-2930(2)	L-199	BC-566	10-553	BC-387
		B-80-243	P-2970	LC-9	C-2991	10-554	TV-119(12)
		B-201-15612	TV-102	LHO-2-E	TV-163	10-555	TV-163
		B-201-15612	TV-103	LIF-8-C	TV-124	12A-18839/-1	P-3070
		B-201-15945	TV-116(37)	LIF-11	TV-154	12C-18743	A-2931
		C-9-228-5	A-3036	LIF-13	BC-352	12C-19048	A-3038(18)
		C-12A-17822	P-3078(11)	LIFT-10T	BC-353	12C-23704/-1/-2	A-2998
		C-12M 18285	HVO-10(2,3)	LIFT-102	BC-352	12C-25148-1	A-2928
		C-12M-18689/-1/-2	HVO-10(2,3)	L-M77J4	MWC-12	12D-23699/-3	P-2959(20)
		C-12M-19407-1/-2	HVO-10(2,3)	L-M77J4-3	MWC-1	12D-25563	P-2889(2)
		C-12M-19408	HVO-10(2,3)	LS-808	BC-418	12E-19048-2	A-2829
		C-16A-15624	C-2991	LS-5283	BC-419	12E-23726/-1	A-3037
		C-18A-18022	A-2931	LTO-3/-13	TV-113	12E-23939	HVO-58
		C-18A-18157	A-2931(2)	LV-6	TV-102	12E-24440	TV-165
		C-201-15717	TV-110(1)	LV-7/-8	TV-116	12E-25101-1	A-2815(46)
		C-201-16155	TV-108(1)	LV-9	TV-102	12E-25423	HVO-89
		C-201-18530	HVO-10(2,3)	O-5163	BC-393	12E-26993	TV-165(2)
		C-201-18562/-1	HVO-10(2,3)	O-5282	BC-393	12E-27097	HVO-163
		C-201-18567-1	HVO-10(2,3)	O-6241	BC-393	12E-27149	HVO-163
		C-201-19490	MDF-70(4)	R-1630	BC-419	12E-27156	A-2829
		DY-12-M	MDF-72	RD-5160	FM-255	12E-27189	A-3037
		E-624	BC-353	S-38A1003	TV-165	12M-18241/-1	A-3003
		E-1137	A-3031	T-64L0	TV-163	13A-19514	TV-154
		E-6147	BC-393	T-116	A-2823	13A-24203	TV-132(19,37)
		E-6256	BC-352	T-116A/B	A-3038	13A-24224	TV-130
		FC-5/B	C-4115	T-122A/B	P-2947(2)	13A-24937	TV-128
		FC-18	C-4084	T-123	A-2930	13A-25139	TV-116
		FC-23	C-4084	T-124A/B/D	HVO-7	13A-25140	TV-116
		H6-0C	BC-573	T-129	P-2947(2)	13A-26994	TV-130(37)
		H6-1F	BC-574	T-4051	A-3025	13A-26995	TV-243(37)
		H6-2F	BC-575	TLF-553-D	MWC-11	13A-26998	TV-132(37,19)
		H6-3F	BC-576	TLF-574-D	TV-116	13B-17397	BC-352
		HA8-1F	BC-574	TLF-576-D	TV-116	13B-17399	BC-347
		HA8-2F	BC-575	TLF-579-D	TV-151	13B-17399	BC-353

MERIT COIL AND TRANSFORMER CORPORATION

PART NUMBERS		PART NUMBERS		PART NUMBERS		PART NUMBERS	
MFGR.	MERIT	MFGR.	MERIT	MFGR.	MERIT	MFGR.	MERIT
CROSLEY		CROSLEY		CROSLEY		CROYDON	
C-147504	P-2834	154287	TV-102	159210-1	TV-204	22-A-11-C	TV-163
C-147682	P-3053(2,30)	154290	P-2890	159215-1	TV-208(5)	22-A-13-C	TV-151
C-148282	P-3070	154307	TV-140(2)	159310-1	TV-141	22-A-15-H	A-2930
C-148562	P-2834(2)	154319	TV-141	159384-1	TV-243	22-A-88-C	MWC-7
C-148975	P-3070	154321	TV-140(1,63)	159385-1	TV-128(1,6,41)	22-A-152	TV-116
C-150394	TV-110	154376-1	TV-192	159395-1	TV-181(5)	22-B-146	A-3003
C-151612	P-3070	154442	C-2994	159396-1	TV-207(5)	22-B-147	A-3036
C-152433	P-3070	154587	A-2935(2)	159397-1	TV-185(5)	22-B-148	MDF-70
C-155572/-1/-2	A-2825	154726-1	A-2824	159398-1	TV-190	22-C-35-H	P-3070
D-145025-1/-3	FM-254	154990	HVO-39(3)	159399-1	TV-185	22-73-C	TV-110
D-158481-3-12	HVO-37	155007-1	BC-347	159400-1	TV-181(5)	22-180	HVO-91(2)
D-160015-2	A-3001	155109-3	A-2928	159412-1/-2	HVO-37		
D-160318	P-2952(12)	155255-1/-2/-3	A-3006	159412-3/-13	HVO-37		
TR-1001	BC-568	155304	TV-136	159418-2	TV-245		
W-139185	MWC-7	155319/-1	TV-116	159419-1	TV-120		
W-139186	MWC-12	155329	BC-387	159420-2	TV-120	CURTIS MATHES	
W-139188	TV-100	155348/-1	TV-141	159421-1	TV-121	1A1	BC-381
W-139189	TV-101	155390	P-3050	159462-1	BC-527	1A2	BC-394
W-139190	TV-106	155442	TV-151	159463-1	TV-181(5)	1A4	BC-352
W-139191	A-4000(2)	155446	TV-151	159463-1	TV-126(1)	1A5	BC-353
W-139192	A-3035	155514-1	HVO-39(3)	159527-1		1A6	BC-419
W-139193	TV-160	155529/-1/-2/-3	C-4115	159580-1	BC-565	1A7	BC-352
W-139194	HVO-3	155529-4/-5	C-4115	159873-1	TV-120	1A8	BC-355
W-139195	P-3061	155532/-A	P-2889	159925-1	TV-128	1A9	FM-252
W-139196	TV-104	155572/-2	A-2825	159928-1	TV-128	1A10	FM-254
W-139198	A-2931(2)	155587-1	A-2935(2)	159931-1	TV-127	1A11	BC-419
W-139200	MD-12	155594/-1	A-2935(2)	159947-1/-2	HVO-84	1A12	TV-153
W-144605	C-2996	155966/-1/-2	TV-139	170096-1	TV-128	1A13	TV-131
W-144699	TV-103	156005-1	A-2819	170097-1	TV-127	1A14	TV-243
W-160200	A-3035	156330-1	C-4084	170138-1	TV-120	1A15	TV-245
W-160201	HVO-3	156469-1	HVO-39(3)	170253-1	A-3006(7)	1A16	TV-247
1219260	MD-12	156839-1	MDF-91	170339-1	TV-128(1)	1A17	TV-151
138131-2	A-3019	157044-1/-2	MDF-91	170349-1	A-3006(7)	1A18	TV-154
138132-2	A-2935	157045-1	MDF-78(8)	170357-1	TV-127(1)	1A19	TV-113
139919-3	BC-352	157787-1	HVO-39(3)	170465-1	TV-184	1A20	TV-121
139919-3	BC-353	157789-1	TV-102	170467-1	TV-203	1A21	TV-165
145025-1/-3	FM-254	157791/-1	TV-116	170468-1	TV-181(5)	1A22	TV-166
145193-1	FM-255	157820-5-1/-6	TV-167	170651-1	TV-194(5)	1A23	BC-562
145629	HVO-3	157833	HVO-37(3)	170652-1	TV-181	1A24	TV-180
146698	TV-167	157841-1	TV-206(5)	170933-1-3	A-3025(22)	1A25	HVO-116(2,7)
146763	TV-102	157842/-1	TV-120	172022-1	TV-102	1A26-2	MDF-131(88)
147672	C-4115	157844-1	TV-121	172249-1	A-3006(2,7)	1A27	HVO-227
147974	TV-116	157856-1	TV-139	172387-1	HVO-183	1A28	MDF-92(4,7,8)
148983	TV-116	157908-1/-2-1	TV-149	172388-1/-1-4F	MDF-105	1A30-1	MDF-131(88)
149460	A-2931	157915-1	MDF-78(8)	172454-1	TV-157	1A31	FM-254
150394	TV-110	157919-1/-2/-6	P-2964	172596-1	A-2931	1A32	FM-253
151757	MWC-2	157936-1	A-3025	172678-1	TV-180	1A33	BC-419
151999	TV-188	158007-1	TV-141	172679-1	TV-182	1A35	BC-393
152000	TV-116	158106-11	TV-185(5)	172680-1	TV-188	1A36	TV-169
152056	MWC-2	158420-1/-1-2	TV-118	172681-1	TV-196	1A37	TV-121
153162	A-3019(2)	158420-1-17/-4	MDF-105	172682-1	TV-185(5)	1A39	TV-243
153360	A-3019(2)	158426-1/-4	MDF-105	172683-1	TV-181(5)	1A40	TV-245
153405	BC-381	158477-1	A-2824	172973-1	TV-185	1A41	MWC-13
153526	P-3070	158481-1/-2	HVO-37	172974-1	TV-184(5)	1A45	BC-381
153612	P-3070	158481-3/-5/-12	HVO-37	172978-1	A-2900	1A67	BC-352
153614	MDF-70(4)	158586-1	TV-130			1A68	FM-254
153619	HVO-7(2,3,91)	158615-1	TV-245			1A69	BC-393
153665	TV-108	158621-1	TV-126(1)			1A74	HVO-169(2,34)
153746	MWC-2	158627-1	TV-185(5)			1A75/-1/-2	MDF-92(7,90)
153782	C-2994	158628-1	TV-188(5)			1A76	TV-128(1)
154069-1	HVO-39(3)	158628-1	TV-204(5)			1A77	TV-127(1)
154105-1	A-3006	158630-1	TV-185(5)			1A78	TV-130(2)
154106	A-2825	158699-1	BC-566			1A79	TV-133
154108/-1	TV-110	158718-1	TV-129(1)			1A80	TV-153
154109-1/-2/-2A	A-2928	158721-1	TV-126(1)			1A81	TV-124(2,5)
154109-3	A-2928	158726-1/-2/-4/-5	A-2824			1A82	FM-255
154158	TV-151	158726-1-6	A-2824			1A83	BC-419
154183	TV-151	158785-1	A-3025(2)			1A84	BC-393
154220	TV-163	158815-1	TV-245			1A86	TV-247
154221-6/-9	MDF-78(7,8)	159029-1	TV-131			1A87	FM-255
						1A93/-1	HVO-169(34)
				CROWN (See Shriro)			

MERIT COIL AND TRANSFORMER CORPORATION

PART NUMBERS		PART NUMBERS		PART NUMBERS		PART NUMBERS	
MFGR.	MERIT	MFGR.	MERIT	MFGR.	MERIT	MFGR.	MERIT
CURTIS MATHES		DAVID BOGEN		DECCA		DELCO	
1A94	TV-120(19)	H-294	FM-254	LI-41	BC-352	6063	A-2936(22)
1A96	TV-113	H-295	FM-253	LI-42	FM-257	6064	P-4051(2)
1A97	BC-387	H-297	BC-352	LL-61	BC-419	6065	P-2978
1A151	HVO-169(7,34)	H-355	FM-254	LO-26	BC-393	6066	P-4051
1A153	MDF-127(7)	H-356	BC-353	SPK-23A	A-3025	6067	P-2861
1A168	MDF-144C	H-386	BC-352	TR-4	A-4103	6160	BC-350
1A169	HVO-233C	H-387	FM-255	TR-109	A-3025	6163	BC-354
1A185	BC-353	H-458	FM-254	TR-137	A-3025(2)	121255	BC-424
1A193D	MDF-141(4)	H-501	BC-561	TR-170	A-3025	727610	P-2970(2)
1A210	MDF-141	H-615	FM-254	TR-180/-1	P-3148(2)	1210012	BC-350
10A3/A/-1	A-2935	H-665	FM-253	TR-184	A-3019	1213670	P-3068(2)
10A3-5D/-6D	A-2905	H-668	BC-419	TR-199	A-3025	1214391	P-3068(2)
10A3-5/-6/-7/-8	A-2905	H-694	BC-419	TR-201	A-2900	1214411	P-3068(29)
10A3-10	A-2905	T-139-4	A-2937	TR-207	A-3025	1214488	A-2901(2)
10A4B	A-2900	T-292-1A	A-3027	TR-213	A-3025	1214491	BC-367
10A5	A-2901(22)	T-292-30	A-2901(2)	TR-218	A-2900	1214492	BC-372
10A9	A-2988	T-322F	P-3176	TR-219	A-2903	1215807	P-4076(2)
10A10	A-2902(2)	T-2123	A-3130	TR-220	A-2928	1215916	BC-367
10A11-1	A-3003	T-2129	A-2902	TR-222	A-3025	1215917	BC-354
10A11/-3	A-3006	T-2145B	A-2905	TR-229	A-2928	1215918	A-2930(2)
10A12	C-4084	T-3142	P-2952(53)	TR-235	A-3025	1216010	A-2931
10A12-1	A-2902	U-201	TV-163	TR-244	A-3025	1216011	P-2971(2)
10A14/-1/-2/-3/-4	A-2854	U-303	BC-381	TR-248-1	A-3025(22)	1216014	BC-371
10A15-1/-2	A-2902(2)	U-420	BC-562	38B22	A-3025	1216015	BC-354
10A15-3A/-4A	A-4101	U-432	BC-561	3823-26A	A-3025	1216666	BC-367
10A15-6C/-7C	A-3020(2)	U-439	BC-562(5)	430250	A-2900	1216667	BC-354
10A15-8/-9	A-3020(2)	U-451	BC-561	430574	A-2900	1216675	A-2900(2)
10A15-10	A-2902(2)	U-457	BC-561			1217846	BC-562
10A18	C-4115(20)	U-501	BC-561			1218008	P-4079(2)
10A24	A-3018	U-507	BC-564			1218021	A-2930(2)
10A25	HVO-116(2,7)	U-508	BC-549			1218022	P-4076(2)
10A26/-1	A-2935	U-509	BC-566			1218032	BC-354
10A27/-1/-2	A-4101	U-511	BC-562			1218033	BC-367
10A28/-2	C-2994	U-512	BC-363			1218035	BC-354
10A30	C-4084	83-288	A-2901(2)			1218059	A-2900(2)
10A31	A-2900	83-504	P-3148			1218660	BC-350
10A32	C-4115(20)	83-508	P-2952			1218661	BC-354
10A37	C-4133	85-270-020	A-2905			1218662	A-2931
10A38	A-4139C	95-5005-01/-02	BC-562			1218663	P-3078
10A39	A-2988	95-5008-01	BC-419			1218725	BC-350
10A42-1	A-3019	95-5009-01	BC-392			1218726	BC-354
10A47	A-3025(29)	95-5010-01	FM-254			1218952	TV-119(12)
10A48	A-2900(1)	95-5011-01	FM-254			1218953	TV-230(2)
11A1	BC-393	95-5012-01	FM-255			1218954	A-2928
12A10-1	P-3148(2)	95-5013-01	BC-352			1218961	C-2991(2)
12A45	P-4082(2)	95-5015-01	BC-562			1219064	TV-110
12A46	P-4141C	95-5016-01	BC-561			1219233	TV-102
12A47	P-4082(2)	95-5018-01	BC-561			1219233	TV-103
12A49-1	P-2872(2)	95-5019-01	BC-561			1219240	MWC-12
12A53	P-2959(2)	95-5019-02	BC-564			1219241	MWC-7
14A1	TV-184	95-5020-01	FM-253			1219260	MD-12
14A2	TV-194(5)	95-5021-01	FM-254			1219263	TV-163
14A3	TV-180(5)	95-5022-01	BC-419			1219264	A-3000
14A4	TV-184(5)	95-5032-01	BC-568			1219265	P-3169(2,10,14)
14A6	TV-185					1219266	HVO-3
14A13	TV-184(5)					1219267	A-3035
14A23	BC-566					1219300	A-2931(2)
14A27	BC-563					1219314	A-2900(2)
14A28	BC-565					1219316	P-4079(2)
14A29	TV-200					1219343	HVO-3
14A30	TV-180					1219345	A-2931(2)
17A1	BC-562					1219409	HVO-3
17A2	BC-564					1219421	P-3169(2,10,14)
						1219423	HVO-3
						1219424	TV-119(12)
						1219508	BC-350
						1219509	BC-354
						1219583	BC-350
						1219584	BC-351
						1219702	BC-350

MERIT COIL AND TRANSFORMER CORPORATION

PART NUMBERS		PART NUMBERS		PART NUMBERS		PART NUMBERS	
MFGR.	MERIT	MFGR.	MERIT	MFGR.	MERIT	MFGR.	MERIT
DELCO		DELCO		DELCO		DELMONICO	
1219703	BC-354	7259336	A-2901(2)	7283586	A-4094	03020-1/-10	A-2928
1219711	P-4078(2)	7259375	P-4076	7283682	A-4094(2)	03023-4	A-2902(2)
1220163	P-4076(2)	7259377	P-4076	7284029	C-4095	04322-1	BC-561
1220204	BC-354	7259419	A-2901(2)	7284069	C-4095	33210-A	TV-154(1)
1220867	P-4051	7259770	BC-350	7284790	C-4095	44239-D	TV-116
1220888	BC-344	7259790	BC-319	7285451	A-4093	44262-A	MWC-17(1)
1220889	BC-346	7260060	A-3019(2)	7286353	C-4095	44356-20	TV-192
1220902	A-3010(20)	7260100	P-4076(2)			44356-27	BC-662
1220990	BC-317	7260712	A-2901(2)			44356-57	TV-193
1220992	BC-346	7260855	A-2936(22)			44356-80	BC-668
1221015	BC-317	7260856	A-2936(22)			44356-100	TV-194
1221021	BC-318	7261410	P-4076(2)			44356-160	TV-196
1221159	A-4094	7262498	A-2936(22)			44356-180	TV-184
1221253	BC-424	7262511	P-3068			44356-620	TV-204
1221255	BC-424	7262812	A-2901(2)	DELMONICO		45333-C	BC-393(2)
1221257	BC-344	7262956	P-4076(2)	A-04095-1	TV-192		
1221290	A-4093	7263031	A-2936(22)	A-04096-180	TV-184		
1221425	A-4092	7263094	P-2978	A-04096-330	TV-200		
1221428	A-4093(2)	7263100	P-4051(2)	A-04096-390	TV-201		
1221431	A-4093(3)	7263118	P-4051(2)	A-20098-F-22	MDF-143(4,7)		
1221499	A-4093	7263605	A-2936(22)	A-20262/-A	MDF-143	DE SOTO	(See Mopar)
1221522	A-4093	7264125	A-2936(22)	A-30105-A-26	MDF-117(4,88)		
1221535	A-4093(2)	7264252	P-4051(2)	A-40183-A	TV-162		
1221590	A-4092(2)	7264880	P-4051(2)	A-40184-A	TV-110		
1221621	BC-317	7264884	P-2861	A-40213	TV-151	DEWALD	
1221623	C-4095	7265604	P-2860(33)	A-40267-4.25	BC-564	ATC-1501	A-3025
1221859	BC-639	7266997	A-2901(22)	A-40337	A-3020(2)	DD-155	A-2905
7238546	BC-304	7268193	A-2745	A-40358	A-2892(2)	EF-215	P-3051
7240453	A-2901(2)	7268860	A-2901(2)	A-40408-12	BC-566	EH-245	P-2885(2,53)
7240467	BC-354	7269046	BC-562	A-40554/ C	A-2930	EH-248	P-2872
7240519	P-4077	7269116	A-2901(2)	A-40558-A	TV-151	I-110	BC-352
7241056	A-3019(2)	7269118	P-2978(22)	A-40559-A	TV-151	L-155C-4	BC-419
7241172	P-4076(2)	7269231	A-3027(33)	A-40822	A-2854(2)	O-101	BC-394
7241708	BC-537	7269294	A-2901(2)	A-41835/-A	A-2823(18)	O-149	BC-403
7242079	BC-367(2)	7269647	C-4124	A-41963-A	TV 168	O-159-1	BC-403
7242258	A-3019(2)	7269650	A-4093(2)	BT-10A	BC-574	OT-145	A-2902(22)
7242417	BC-354	7269684	BC-514	BT-10B	BC-575	PT-67	P-3052
7242533	BC-354	7269870	A-4093	BT-10C	BC-576	PT-157	P-3045
7253855	BC-354	7269877	A-4092	BV-884	BC-419	T-153	P-3052
7255738	BC-566	7269881	C-4124	BV-1046	A-3032(2)	T-154	A-3028(2)
7255770	BC-636	7270689	C 4095	BV-1063	P-3051(12)	1-131-1	BC-358
7255881	P-4076(2)	7270804	A-2761	E-0320-8	BC-419	1-131 2	BC-359
7256009	A-3019(2)	7271233	P-2860(22)	E-0343	P-3197(2)	103B-2	FM-253
7256011	BC-371	7271321	C-4095(2)	E-0460-1	A-2888	1002B 3	BC-339
7256012	BC-354	7271448	A-4093(2)	L-303	BC-565	1003	BC-338
7256218	BC-364	7271585	A-4094	L-310	BC-562	1038-2/B-2	FM-253
7256293	P-4079(2)	7271816	A-3020(2)	L-1031	MWC-5	1038-5/B-5	FM-254
7256371	BC-372	7271827	A-4093(2)	L-1352	C-4084	1050	P-3061
7256628	A-2901(2)	7271865	A 4093(2)	L-1355	MWC-8	1051	HVO-3
7256662	BC-354	7272610	P-2970(2)	L-1385	MDF-70(10)	1052	A-3035
7256664	A-3020(2)	7272822	A-4094	PTV-19/25	MDF-117(4,88)	1053	A-4000
7256907	A-2936(2)	7272827	C-4095	PTV-19/34	TV-154(1)	1055	MD-12
7256932	BC-316	7273024	C-4095	PTV-19/38	TV-167(2)	1064	TV-160
7256939	P-4077	7273026	A-4093	PTV-19/39	TV-110	1065	MWC-12
7257220	A-2901(2)	7273626	A-4093(2)	PTV-19/43	C-4084	1066	MWC-7
7257594	BC-354	7273764	A-2781(22)	PTV-19/66	A-3020	1078	MWC-7
7257832	BC-367(2)	7273850	C-4095	PTV-19/106	TV-116	1079/A	MWC-12
7257988	BC-367(2)	7274011	C-4095	PTV-19/110	TV-192	1080	A-4000
7258182	A-2901(2)	7274068	A-4094	PTV-19/111	TV-186	1081	A-3035(2)
7258188	BC-350	7274342	C-4095	T-343	A-2902	1082/B-2	P-3078
7258198	BC-354	7274409	A 4092	T-1036/-1	A-4000	1084	TV-102
7258199	BC-354	7274608	A-4093	T-1037	A-2931(2)	1089/-1	MD-12
7258390	A-2901(2)	7275145	A-4092	T-1359	P-3059(16)	1091A/C-7	BC-352
7258747	P-3068(2)	7275770	BC-636	T-1360	HVO-26	1093A	BC-387
7258849	BC-367(2)	7277396	A-4093	T-1361	A-3037	1097	HVO-3
7258850	BC-316	7278020	A-4093	T-1362	TV 162	1098/B	TV-163
7258941	A-3010	7280915	A-4094(22)	T-1415	A-3020	1101-3	BC-393
7258945	A-2936	7281131	A-4093(2)	920-26	C-2993(2)	1106B-2	FM-255
7259249	A-2901(2)	7281946	BC-565	920-27	BC-419	1106B-3	FM-254
7259324	A-2901(2)	7282586	BC-566	1211-31	BC-419	1109A/-2/-4	A-3003

MERIT COIL AND TRANSFORMER CORPORATION

PART NUMBERS		PART NUMBERS		PART NUMBERS		PART NUMBERS	
MFGR.	MERIT	MFGR.	MERIT	MFGR.	MERIT	MFGR.	MERIT
DEWALD		DUMONT (Also See Emerson)		DUMONT (Also See Emerson)		DUMONT (Also See Emerson)	
1110/-3/-4	A-3037	L3A1	MWC-12	902492-2	A-4103	20005211	TV-100(19)
1114	TV-110	L4A1	MWC-12	10110032	TV-102	20005241	TV-139
1120A/-2/C-1	HVO-10(2,3)	L5A1	MWC-5	18002761	A-3019	20005251	TV-139
1121/D/-3	MDF-70	L6A1	MWC-5	18002771	A-3019(2)	20005271	TV-117(2)
1122-2	A-2931	L7A1	MWC-9	18002791	A-4105	20005351	TV-100
1130A/B/-1	P-2834(15)	L8A1	MWC-5	18002792	A-3019(2)	20005491	A-3038
1132-1	A-2931	P4A1	P-3174	18002793	A-4105	20005492	A-3038(2)
1134	TV-116	P5A1	P-2835-10	18002801	A-2936(2)	20005497	A-3038(2)
1156F-7	BC-419	P11A1	P-2844	18003041	A-3019(2)	20005571	TV-162
3823-24	A-3025	P12A1	P-2836(15)	18003061	A-3019	20005581	TV-104(2)
7003C-9	A-3025	P13A1	P-2836	18003131	A-3019(2)	20005662	A-3038(2)
7010	A-2931	SD5A1	TV-115	18003141	A-3019(2)	20005781	TV-104(19)
7017-2	A-2928(2)	V1A1	A-3035	18003212	A-3019(2)	20005791	TV-139
		V1B1	A-3001	18003321	A-3019(2)	20005801	TV-139
		V2A1	A-3038(2)	18003322	A-3019(2)	20005821	TV-139
		V2B1	A-3001	18003331	A-3019(2)	20005851	TV-162
DODGE (See Mopar)		V3A1	A-3038(2)	18003361	A-3019(2)	20005852	TV-162
		V3B1	A-4003	18003471	A-3019	20005882	TV-162
		V4A1	A-3039	18003481	A-3019	20005891	P-2953(2)
		W1B2	MWC-7	18003501	A-3018(2)	20006141	TV-115
		W3A1	MWC-7	18003511	A-3018(2)	20006731	HVO-95
DOUGLAS (See Hoffman)		W4A1	MWC-7	18003521	A-3018(2)	20006861	TV-126
		W4H1	MWC-15	18003611	A-2930	20006871	TV-126
		W6A1	MWC-5	18004021	A-3025	20006883	P-2833(15)
		W7A1	MWC-11	20003901	TV-111	20006884	P-2833(15)
		W9A1	MWC-7	20003921	TV-160	20007611	TV-162
DUFFENHORST		W11A1	MWC-5	20003923	TV-160	20007770	TV-130
38820031111	BC-419	Y1C1	MD-12	20003931	A-3001	20008021	A-3039
		Y3C1	MDF-70	20003941	A-3035	20008031	P-2844
		Y4C1	MD-12	20003942	A-3035	20008041	TV-116
		Y9C1	MDF-70	20003944	A-3035	20008061	HVO-47
DUAL		Y10C1	MDF-72(4,8)	20003951	HVO-5	20008182	P-2836(11)
4025U24	A-2901	Y11C1	MDF-82	20004044	BC-355	20008241	TV-126(19,83)
		Y12C1	MDF-70	20004061	HVO-5	20008251	TV-129(19)
		Y14C1	MDF-82	20004071	P-2946(2,20)	20008261	TV-126
		9A2363	TV-153	20004081	TV-160	20008303	TV-126
		9A2365	TV-131	20004101	TV-104(2)	20008402	HVO-47(7)
		9A2366	TV-151	20004142	A-3001	20008481	A-3039
DUMONT (Also See Emerson)		9A2367	TV-121	20004261	HVO-3	20008482	A-3039
		9A2372	TV-166	20004331	P-3074(2,20)	20008570	TV-130
C2B2	C-2994	9A2415B	MDF-131	20004441	TV-144	20008711	A-3038(2)
C4B1	C-2991(2)	9A2416	TV-165	20004511	TV-104(2)	20008712	A-2829(2)
C4B2	C-2996(2)	9A2434	TV-154	20004521	HVO-90(3)	20008731	TV-130
C4B8	C-2996(2)	20-375	HVO-3	20004581	HVO-90(3)	20008745	TV-134
C5B1	C-2991	20-380	A-3035	20004611	TV-162	20008761	TV-115
C5B2	C-2996	20C-12477	TV-111	20004671	TV-139	20008771	P-2836
C5D1	TV-238(12)	20C-12478	TV-105(2)	20004711	TV-139	20008801	HVO-36
C6B1	C-4115	20C-12572-1	TV-160	20004721	A-4003	20008901	P-3064(14)
C16G1	TV-126	20C-12922-1/ 2	BC-353(1)	20004722	A-4003	20008991	TV-130
C17G1	TV-128	20D-4901 2	A-3001	20004723	A-4003	20008993	TV-130
C532	MDF-70	20D-12926	P-2952	20004726	A-4003(2)	20008995	TV-130
F2A1	P-3074(20)	21-388	MD-12	20004728	A-4003	20008997	TV-130
F3A1	P-3074(2,20)	21A-13087-101	TV-103	20004731	A-3038(2)	20008998	TV-130
F8A1	P-2946(2,20)	21A-13088-101	TV-103	20004732	A-3038(2)	20009016	P-2830(10)
H1B1	TV-160	21A-13089-101	TV-103	20004741	TV-139	20009018	P-2830(10)
H1D1	TV-163	21A-13089-103	TV-103	20004751	TV-139	20009019	P-2830(10)
H2A1	HVO-3	21A-13090-101	TV-103	20004761	TV-139	20009041	TV-115(1)
H2B1	TV-160	21A-13090-102	TV-103	20004771	P-2835(10)	20009043	TV-115(1)
H3A1	TV-160	21A-13090-103	TV-103	20004801	TV-103	20009091	HVO-36(7)
H3B1	TV-162	21A-13090-104	TV-103	20004802	TV-103	20009261	TV-172
H4A1	HVO-5	21A-13098-101	TV-151	20004961	P-3174	20009262	TV-172
H4B1	TV 162	21A 13230-101	MWC-7	20005011	P-3074(20)	20009321	A-3039
H4C1	MD-12	21A-13307	MWC-12	20005012	P-3074(20)	20009322	A-3039
H5B1	TV-162	51X-185	A-3026	20005013	P-3074(20)	20009391	HVO-36(7)
H8A1	HVO-90(3)	51X-191B	A-2988	20005014	P-3074(20)	20009701	A-2900(30)
H10A1	HVO-94	52X-95-7	C-4115	20005015	P-3074(20)	20009729	A-2900
H13A1	HVO-95	53D-12540-101	A-3019(2)	20005021	HVO-94	20009761	A-3003
H14A1	HVO-47	53D-12982-101	A-3019(2)	20005031	A-3038(2)	20009781	HVO-36(7)
H15A1	HVO-5	53X-366-A	HVO-132	20005032	A-3038(2)	20009791	A-2902(2)
L2A1	MWC-12	54X-19	A-3003	20005037	A-3038(2)	20009792	A-2900(30)

MERIT COIL AND TRANSFORMER CORPORATION

PART NUMBERS		PART NUMBERS		PART NUMBERS		PART NUMBERS	
MFGR.	MERIT	MFGR.	MERIT	MFGR.	MERIT	MFGR.	MERIT
DUMONT (Also See Emerson)		DUMONT (Also See Emerson)		DUMONT (Also See Emerson)		DUMONT (Also See Emerson)	
20009795	A-2931	20114721	C-2994(2)	21012431	C-4115	21018561	TV-151
20009797	A-2930	21004722	C-2994	21012451	TV-192	21018571	TV-196
20009798	A-2930	21004741	MWC-7	21012453	TV-192	21018581	TV-184
20010091	A-2905(2)	21004751	MWC-12	21012455	BC-561	21018591	C-4084(2)
20010121	TV-119(12)	21004762	MWC-7	21012851	TV-121	21018601	TV-165
20010141	P-2876(10)	21004763	MWC-7	21013231	BC-352	21018611	TV-166
20010142	P-2876(11)	21004771	MWC-12	21013231	BC-353	21816182	TV-153(12)
20010161	A-3026	21004801	TV-103	21013261	MDF-75(4,8)	29000771	M51-70-90
20010185	P-3077	21004802	TV-103	21013781	TV-151	29000952	M51-70-90
20010221	A-3031(2)	21004831	TV-151	21013782	TV-151	29013574	MDF-75(4,8,87)
20010231	BC-327	21004971	MDF-70	21013783	TV-151	87000021	MDF-70
20010231	BC-328	21005211	C-2991(2)	21013791	TV-151	87000031	MDF-70
20010331/-1	A-3037	21005212	C-2996(2)	21013792	TV-151	87000041	MDF-70
20010332	A-2855	21005213	C-2991(2)	21013793	TV-151	87000051	MDF-70
20010402	P-3051	21005218	C-2996(2)	21013861	TV-196	87000061	MD-12
20010451	A-2819	21005221	MWC-5	21013864	TV-185	87000201	MDF-70
20010452	A-2829	21005322	MWC-5	21013871	TV-120	89013321	MDF-82
20010453	A-3028(18)	21005431	C-4115	21013881	MDF-92(4,8)	89013333	MDF-91(4,7)
20010454	A-3038(2)	21005432	C-4115	21013912	TV-119(12)	89013572	MDF-75(4,87)
20010461	BC-352	21005433	C-4115	21013913	TV-119(12)	89013574	MDF-75(4,8)
20010481	A-2998	21005491	MWC-5	21014251	TV-194	89013801	MDF-92(4,8)
20010521	TV-126(1)	21005501	MD-12	21014252	TV-184	89014092	MDF-92(8)
20010531	TV-126(1)	21005541	MDF-70	21014254	TV-196	89014132	MDF-123(87,92)
20010531	TV-130(37)	21005711/B	MDF-70	21014255	TV-185	89014491	MDF-92(4,8)
20010532	TV-130(37)	21005821	MWC-11	21014257	TV-184	89014641	MDF-110(4,92)
20010561	TV-113(5)	21006091	MDF-70	21014258	TV-195	89015781	MDF-131(88)
20010562	TV-149	21006191	MDF-70	21014259	TV-188		
20010571	A-2902(2)	21006550	BC-566	21014481	TV-120		
20010572	A-2998	21006622	TV-181	21014851	TV-121		
20010573	A-2998	21006628	TV-184	21014852	TV-121(39)		
20010601	P-2867	21006629	TV-188	21014871	C-2991(2)		
20010611	HVO-138	21006641	MDF-70	21014872	C-4084		
20010612	HVO-138	21006926	MDF-70	21014874	C-2996		
20010613	HVO-138	21007791	MWC-9	21014876	C-4084		
20010871	HVO-36(2)	21008871	MDF-70	21014877	C-4084		
20010873	HVO-36(2,7)	21009091	TV-131	21014891	TV-120		
20011101	BC-356	21009101	TV-153(12)	21014892	TV-120(19)		
20011101	BC-357	21009961	MDF-72(4)	21014911	TV-163		
20011112	A-2761(2)	21009962	MDF-72(4)	21014914	TV-165(12)		
20011152	BC-325	21010121	TV-238(12)	21014931	TV-153		
20011171	A-3102(2)	21010131	TV-151	21014932	TV-153		
20012681	P-2844	21010951	C-2991	21014933	TV-153(12)		
20012691	HVO-26	21010952	C-2996	21014942	TV-152		
20012692	HVO-126	21010953	C-2996	21014951	TV-152		
10013881	A-3026	21010954	C-2996	21014952	TV-152		
20013891	TV-243	21010955	C-2996	21014954	TV-152		
20013901	TV-245	21010956	C-2996	21014961	TV-153		
20013911	TV-247	21010958	C-2996	21014962	TV-153		
20013931	A-2988	21010961	TV-151	21014971	TV-131		
20013941	A-3003	21010962	TV-151	21014972	TV-131		
20013951	HVO 132	21010964	TV-151	21015531	MDF-123(92)		
20014071	A-2901	21010991	TV 163	21015532-1	MDF-123(92)		
20018712	A-2829(2)	21010992	TV-163	21015541	BC-393		
20019761	A-3003	21011001	MWC-5	21015561	TV-201		
21003971	TV-103	21011011	MWC-6	21015562	TV-198		
21004121	TV-119(12)	21011013	MWC-6	21015563	TV-184		
21004135	TV-103	21011021	TV-238(12)	21016051	MDF-110(4)		
21004135	TV-102	21011032	TV-102	21016171	TV-163		
21004136	TV-103	21011032	TV-118	21016181	TV-153(12)		
21004136	TV-102	21011061	MDF-82	21016182	TV-153		
21004137	TV-102	21011062	MDF-82	21016691	MDF-92(4,8)		
21004137	TV-103	21011245	TV-192	21017691	MWC-3		
21004138	TV-102	21011383	TV-119(12)	21017692	MWC-3		
21004138	TV-103	21011601	MWC-11	21017791	MWC-5		
21004171	MWC-7	21011742	MDF-82	21018491	TV-154		
21004241	MDF-70	21011762	BC-562	21018501	TV-121		
21004242	MD-12	21012191	BC-503	21018511	TV-152		
21004350	MWC-12	21012211	TV-151	21018521	TV-131		
21004351	MWC-12	21012212	TV-151	21018541	TV-196		
21004711	MWC-7	21012251	MDF-91(4,92)	21018551	TV-194		
						DYNAMIC (See Dewald)	
						EDSEL (See Ford)	
						EICO	
						30041	A-2959(2)
						34600	FM-254
						34601	FM-254
						34602	FM-255
						34603	BC-352
						34605	BC-353
						34613	FM-254
						34614	FM-254
						34629	BC-575
						34630	BC-576
						35024	BC-561
						35025	BC-563
						35049	BC 419
						35052	TV-194
						36016	BC-393
						ELCO (See Truetone)	

MERIT COIL AND TRANSFORMER CORPORATION

PART NUMBERS		PART NUMBERS		PART NUMBERS		PART NUMBERS	
MFGR.	MERIT	MFGR.	MERIT	MFGR.	MERIT	MFGR.	MERIT
ELECTRO-HOME		ELGIN		EMERSON		EMERSON	
21-102-14	MDF-130(4,76)	CO-3R10	BC-574	700189	BC-419	708228	MWC-11
21-105-01/-08	MDF-130(4,76)	CO-4R10	BC-575	702104-1	TV-116	708232	MDF-92(4,7)
21-210-02	HVO-201(2,94)	CO-5R10	BC-576	705014	TV-180	708243	TV-203
21-234-03	TV-168(12)	CO-12R15	BC-575	705021	BC-566	708247	TV-208
21-300-01	TV-239	CO-13R15	BC-576	705023	BC-562	708248	TV-180
21-302-01	BC-566	2866-01/-06	BC-574	705024	BC-565	708249	MWC-18
21-309-01	TV-126	2867-01/-06	BC-575	705029	BC-563	708255	TV-163
21-310-01	TV-126	2868-01/-06	BC-576	705031	BC-561	708269	MDF-92(4,9)
21-311-03	TV-113(83)			705033	BC-561	708270	MDF-73(4,9)
21-314-02	TV-193			705034	BC-564	708271/A	BC-564
21-314-03	TV-185			705039	TV-192	708272	TV-180
21-314-12	TV-191			705040	BC-564	708272A	TV-200
21-314-13	TV-190(5)			705041	BC-562	708273	TV-202
21-314-14	TV-185(5)			705042	BC-564	708274	TV-206
21-314-15	TV-204	EMERSON		705120	TV-151	708275	TV-246
21-314-16	TV-184	CL-473	FM-255	708001	TV-114	708276	TV-251
21-314-20	TV-206(5)	R-77842	TV-186	708003	MWC-12	708279/A	TV-203
21-314-25	TV-190(5)	R-78466	BC-562	708004	MWC-12	708312	BC-566
21-314-26	TV-190(5)	R-100037	A-3020	708005	FM-253	708313	MDF-92(4,9,90)
21-314-30	TV-196(5)	R-100131	TV-195	708008	TV-144	708321	MDF-73(4,9)
21-314-31	TV-205(5)	R-100441	BC-566	708017	TV-114	708322	MDF-92(4,7,9,90)
21-314-32	TV-185(5)	R-101819	TV-180	708018	TV-114	708326	BC-564
21-314-33	TV-199	R-102134	C-4133	708019	MWC-8	708330	MDF-111(2,88)
21-334-02/-03	TV-168(12)	R-102201	TV-193	708021	MWC-16	708332	MDF-92(4,8,9)
21-339-01	TV-121	R-105195	C-4133	708030	MD-12	708335	TV-199
21-344-01	TV-113	R-105308	BC-566	708031/B	TV-114	708336	TV-208
21-347-0/-01	TV-151	R-109221	HVO-232C	708032/-1	TV-119(12)	708341	FM-255
21-350-01	TV-126	R-109248	BC-562	708033	BC-352	708342	MWC-12
21-360-01	TV-121	R-109257	TV-205	708036	MD-12	708344	MDF-111(88)
21-383-01	TV-124	R-109263	A-4139C	708037	TV-166	708346	TV-194
21-386-01	BC-566	R-109286	P-4141C	708043	MDF-74	708346	TV-185
21-387-01	BC-562	R-109457	MDF-144C	708051	MWC-7	708347	FM-253
21-389-01	TV-113	R-109825	BC-562	708052	MWC-12	708349	TV-185(5)
21-391-01	TV-245	R-109826	TV-193(5)	708054	MWC-5	708351	BC-677
21-392-01	TV-130	R-109838	TV-183	708055	MWC-12	708352	MDF-92(7)
21-394-01	TV-131	R-109840	TV-193	708056	MWC-12	708353	MDF-92(7,8)
21-421-01	BC-387(2,12)	R-109845	MDF-144C	708058	MWC-6	708357	TV-206
21-432-02	BC-352	R-109850	A-4139C	708062	FM-253	708358	FM-257
21-432-04	BC-355	R-112820	HVO-233C	708064	MDF-74	708359A	MDF-111(88)
21-433-02/-03/-04	FM-254	R-112821	A-4139C	708068	MWC-6(2)	708361A	TV-194
21-439-02	BC-563	R-112822	A-3019	708071	TV-114	708367	MDF-111(4,8)
21-455-01	FM-253	R-112829	C-4133	708073	MDF-74	708368	FM-255
21-485-01	FM-255	R-112845	P-4141C	708082/-1	MWC-7	708370	BC-673
24-10080-01	P-2871(2)	R-113382	HVO-234C	708090	TV-186	708373	MDF-92(7,8)
24-10082-01	P-2871(2)	R-113383	P-4141C	708099	TV-200	708374	FM-253
24-80008-08	A-2931	R-113390	A-4140C	708109	TV-185	708379/A/B	MDF-111(4,88)
24-80008-10	A-2900	TR-2000	A-3025	708117	MDF-74	708381	MDF-92(7)
24-80014-07	A-3019	18-26/-32/-46	BC-419	708122	MDF-70	708382	MDF 92(4,8)
24-80042-02	A-2902(2)	18-47/-56/-61	BC-393(83)	708130/R	MD-12	708392	MDF-111(4,88)
24-80054-01	A-2902(2)	33-31/A/-32/A	A-4097(2)	708131	MDF-74	708393	MDF-111(4,88)
24-80063-01	A-2901(2)	33-36	A-4103	708135	MDF-74	708394	MWC-11
24-100005-04/-05	A-2986	33-40/-41	A-4097(2)	708137	MDF-73(4)	708401	BC-672
24-100008-03	A-2984	34-25	A-3025	708150	MDF-74	708402	MDF-111(4)
24-110002-01/-03	C-4115	150A17	A-3025	708151	TV-114	708403	MDF-111(4)
		102134	C-4133	708156	MWC-6	708404	BC-678
		105195	C-4133	708158	TV-166	708405	BC-674
		180076	C-2974	708162	MDF-73(4)	708406	BC-668
		180217	A-3025	708163	MDF-73(4)	708407	MDF-92(4,90)
		180239	A-3025	708164	TV-151	708410	FM-255
		180240	A-3025	708165	MDF 73(4)	708415	MDF-143
		180257	A-3025	708174	MDF-92(4)	708416	MWC-11
		180261	A-3025	708175	TV-114	708417	TV-169
		180263	A-3025	708176	MDF-75(4)	708419	FM-257
		180281	A-3025	708180	TV-166	708448	MDF-144C
		630002	A-3032	708210	TV-123	708451	MDF-143
ELECTRO-VOICE		700103	BC-419	708211	MDF-75(4)	709099	TV-200
1599	C-2974	700155	BC-418	708212	MDF-75(4)	710034	BC-561
15004	FM-254(1,2)	700177	BC-419	708213	TV-131	713046	TV-131
15008	FM-254(1,2)	700179	BC-419	708214	MDF-73(4)	713047	TV-131
15009	BC-393	700182	BC-419	708226	MWC-18	713049	TV-153

PART NUMBERS		PART NUMBERS		PART NUMBERS		PART NUMBERS	
MFGR.	MERIT	MFGR.	MERIT	MFGR.	MERIT	MFGR.	MERIT
EMERSON		EMERSON		EMERSON		EMERSON	
713050	TV-119	720157	TV-113	730046	P-3064(14)	737011	C-2991(2)
716048	TV-166	720166	TV-153(12)	730051	P-2888	737012	C-2991
716052/A	TV-165	720175	TV-130	730052	P-3062	737015	C-2991(2)
716055	BC-347	720178	TV-113	730054	P-2888	737016	C-4084
716056	BC-387	720181	TV-130(64)	730060	P-3060	737017	C-2994
716073	TV-165	720182	TV-113	730062	P-3060	737018	C-2996
716074	TV-163	720185	TV-113	730064	P-2872(2)	737019	C-4115
716075	BC-394	720187	BC-352	730065	P-2872(2)	737023	C-4084
716083	TV-165	720197	TV-126(83)	730074	P-2872(2)	737027	C-4125
716084	TV-163	720198	TV-130	730079	P-2870	737028	C-4125
716102	TV-249	720199	TV-130(64)	730094	P-2872(2)	737031	C-4115(2)
716111	BC-393	720201	TV-126(83)	730108	P-2872	737033	C-4115
716117	TV-168	720203	BC-352	730111	P-2872	737036	C-4084(2)
716122	BC-393	720204	TV-130(64)	730113	P-2870	737037	C-4084
716142	BC-393	720213	TV-130(64)	734004	A-3027	737038	C-4115
716145	BC-393(2,12)	720216	TV-130	734018	A-3019	737039	C-4084(2)
716177	TV-165	720226	TV-130(66)	734028	A-2900	737043	C-4084(2)
720024	FM-254	720231	TV-130(2)	734044	A-3025	737044	C-4084(2)
720025	FM-254	720233	TV-130(65)	734051	A-3019	737046	C-2996
720026	FM-254	720238	TV-130(2)	734052	A-3025	737047	C-4115
720031	BC-352	720241	TV-130(65)	734058/-1	A-2928	737048	C-4125
720032	BC-355(5)	720246	TV-113	734063	A-3031(2)	738000	HVO-3
720033	BC-352	720247	TV-130(2)	734064	A-3031	738004	A-40 0
720041	TV-113	720259	BC-356	734074	A-3019	738005	A-4002
720042	TV-137	720259-2	BC-328	734082	A-3025	738008	A-3002
720043	TV-141(83)	720259-3/-4	BC-356	734084	A-3020	738009	HVO-3
720044	TV-136	720262	TV-130(64)	734088	A-3026	738010/-1	A-3035
720055	BC-352	720289	TV-128	734099	A-3026	738011	A-3036
720066A	BC-353	720292	TV-130(65)	734103	A-3026	738012	HVO-3
720067	FM-254	720294	BC-356	734104	A-3025(2)	738013	HVO-3
720073	TV-102	720295	BC-356	734107	A-3025	738014	HVO-5
720075	BC-352	720297/A	TV-236	734122	A-3025(22)	738015	HVO-3
720076	BC-355	720307	FM-254	734123	A-3026(2)	738016	A-3035
720081/A	TV-113	720326	FM-254	734126	A-3019	738017	A-3035
720084	BC-352	720327	FM-254	734129	A-2702	738019	TV-230
720085	BC-355	720336	TV-234	734133	A-2928(2)	738020	A-3002
720088	TV-118(37)	720337	TV-157	734134	A-2902(2)	738022	A-3002
720089	TV-118	720346-A	TV-158	734138	A-3025	738023	A-3002
720091	TV-136	720351	FM-256	734139	A-3026	738024	HVO-5
720092	TV-113	720364/A	TV-157(3)	734144	A-3025(22)	738026/A	A-3036(2)
720093	TV-104	720366	FM-254	734146	A-3026(22)	738027	A-3036(2)
720 96	TV-116	720393	BC-356	734156	A-2905	738028	HVO-3
720097	TV-116	720394	BC-357	734158	A-2757(2)	738029/-2	A-3037
720098	TV-116	720404	TV-234	734161	A-3025(2)	738030	A-4000
720103	TV-154	720418	BC-571	734162	A-3026(2)	738031	A-3002
720104/-1	TV-116	720421	TV-130	734164	A-2902(2)	738032/A	A-3038
720105	TV-137	720433	TV-113	734168	A-3026(22)	738033	A-3038
720106	TV-141	720434	TV-121	734172	A-3026(22)	738034	HVO-26(2)
720107	TV-116	720462	TV-130	734176	A-3026	738035	TV-162
720109	TV-102	720465	BC-356	734178	A-3025	738037	TV-166
720125	BC-355	720466	BC-357	734181	A-2902(22)	738039	HVO-6(31)
720126	FM-254	720467	FM-256	734184	A-2905	738042	A-3002
720127	TV-139	720484	FM-256	734185	A-2930	738044	A-3080(2,23)
720128	TV-139	720525	BC-352	734186	A-2900	738047	HVO-8
720129	TV-141	730005	P-3053(2,14,13,10)	734188	A-3025(22)	738048/A	HVO-8
720131	TV-116	730015	P-3043	734193	A-3025(22)	738050	A-4090
720133	TV-141	730016	P-3043	734195	A-3025	738052	A-3080(2,23)
720135	TV-113	730018	P-3053(14)	734196	A-2902(22)	738053	HVO-8
720137	TV-142	730022	P-3070	734202	A-3019	738054	A-4090
720139	TV-142	730 23	P-3053(10,14)	734205	A-2998	738059	A-2825(2)
720141	TV-113	730024	P-3097	734208	A-3025(2)	738065	TV-166
720142	TV-113	730026	P-2835	734212	A-2902(22)	738066	A-2823(18)
720146	TV-113	730029	P-2834	734215	A-3025	738067	HVO-25
720147	TV-126(83)	730031	P-2834	734219	A-4097	738068	HVO-25
720148	TV-130	730032	P-2830(27)	734221	A-3025	738069	HVO-25(7)
720149	TV-131	730037	P-2830(27)	734222	A-2900	738070	A-2854
720152	BC-347	730039	P-2830(27)	734226	A-3025	738071	TV-166
720154	TV-153(12)	730041	P-3064(14)	736068	MWC-6	738073	HVO-25
720155	TV-126	730043	P-2830(27)	737002	C-2981	738075	HVO-25
720156	TV-126(83)	730044	P-2830(27)	737003	C-2991	738076	A-2823(18)

MERIT COIL AND TRANSFORMER CORPORATION

PART NUMBERS		PART NUMBERS		PART NUMBERS		PART NUMBERS	
MFGR.	MERIT	MFGR.	MERIT	MFGR.	MERIT	MFGR.	MERIT
EMERSON		EMERSON		FADA		FIRESTONE	
738078	HVO-36(2,7,99)	961429-3	A-3019	37.277	TV-127	A-5866	A-3026
738079	HVO-92	962191	BC-393	37.278	TV-128	A-10104	HVO-26
738080	A-3036	962197	BC-352	37.279	TV-126	A-10106	A-300
738081	A-3036	962198	FM-254	37.280	HVO-44(3)	A-10108	HVO-26
738082	HVO-25	962636-501	HVO-232C	37.281	MDF-91	A-10109	P-3069
738083	HVO-25	962712-502	P-4141C	37.285	TV-113(41)	A-10115	A-4089
738084	HVO-92	963372	FM-254	37.286	MDF-75(4)	A-10125	A-3000
738085	HVO-25	972128-8	A-3020	37.289	TV-195(5)	A-10134	A-40 3
738086	HVO-25	1104665-1/-2/-3	C-4133	37.290	TV-185(5)	A-10135	HVO-26
738090	A-40^3			37.299	TV-128	A-10136	HVO-27
738091	HVO-85			37.300	BC-566	A-10137	HVO-27
738094	HVO-92			42.12	P-3061	A-10152/-1	A-4089
738095	HVO-92	ESPEY		42.13	HVO-3	A-15832	A-2902(2)
738096	HVO-85	2.414	BC-352	42.14/-1/-3	A-3035	A-19137	HVO-27
738097	A-3036	2.415	FM-254	42.15/ 1/-3	A-4000	A-28263	TV-163
738098	A-3036	2.474	FM-255	42.16	A-2931	A-28278-3	MDF-70
738099	HVO-85	2.754	FM-254	42.28	C-2996(2)	A-28279-1	MWC-8
738100	HVO-85	2.755	FM-254(41)	42.34	P-2954(2)	A-28286	TV-151
738102	A-283			42.43	HVO-5	A-28292	MWC-12
738103	HVO-87	2.756	FM-253	42.44	A-2902	A-28302-1E	MDF-70
738105	A-2823			42.45	HVO-3	A-28318-1	MWC-18
738106	HVO-86			42.53	A-3000	A-2832-1	MDF-70
738107	HVO-86			42.54	P-3055	A-28330	MDF-70(8)
738108	A-2823	ESQUIRE		42.56	C-2996(2)	A-28331	M-51-70-90
738109	HVO-87	(See Truetone)		42.57	A-2930	A-58124	A-3026(2)
738110	A-2823			42.58	P-3057(10)	AT-51	A-3025
738111	HVO-86			42.60	C-2996(2)	AT-52	A-3025
738119	HVO-36(2,7)			42.61	P-3057(2)	AT-70/71	A-3031
738120	HVO-36(2,7)	FADA		42.62	A-3037	B80-242	A-2930(2)
738121	A-2823			42.65	A-3039	B80-243	P-2970
738122	HVO-36(2,7)	37.25B	HVO-10(2,3)	42.82	A-3039	B-10106	A-3000
738124	A 4098	37.94	TV-104	42.90	P-3056(2)	E1113	A-3025
738127	A-2822(2)	37.94	TV-105	42.91	C-2974	E6127	BC-393
728129	HVO-92	37.95	TV-106	42.92	HVO-92	E6256	BC-352
738134	A-3034	37.96	TV-100(2)	42.93	A-3037	FC-5	C-4115
738138/A	HVO-87(7)	37.97	TV-101	42.96	HVO-38(7)	L-103	TV-127(7)
738139	A-2823(2)	37.98	TV-101(2)			L-110-A/B	TV-154(62)
738140	HVO-92	37.99	TV-102			L-152	TV-252
738142	HVO-92(34,7)	37.99	TV-103			L-154	TV-241
738150	A-2823	37.100	TV-102			L-156	TV-163
738152	A-2822(2)	37.101	MD-12	FAIRMONT		L-158	TV-192
738153	A-283	37.104	TV-160	(See Coronado)		L-160	BC-566
738156	A-2815(38)	37.105	MWC-12	FALCON		L 162	TV-184(5)
738160	HVO-87(7)	37.106	MWC-7	(See Ford)		L-163	TV-208(5)
738161	A-2822(2)	37.214	MWC-4			L-167	TV-253
738163	HVO-200	37.215	MWC-8	FANNON		L-177	MDF-130
738168	HVO-138	37.219	TV-162(26)			L-179	TV-128(83)
738169	HVO-193	37.26	TV-151	FX313	A-3025	LF-50	BC-352
738170	A-282(2)	37.230	TV-115	OPC-3	A-3025(2)	LF-52	FM-254
738171	A-4098	37.231	MWC-2	OT-59	A-3025	LF-54	BC-352
738176	A-2823	37.233	TV-163	OT-148	A-3025	LF-58	FM-254
738177	HVO-200	37.242	MDF-70	32-83.16-9	A-2900(2)	LF-59	BC-353
738180	A-2815(38)	37.244	MWC-5			LF-62	BC-352
738189	A-4098	37.247	HVO-10(2,3)	52A47	A-2900(2)	LI-35	BC-347
738194	A-2823	37.248	MWC-18	1022	BC-419	LI-40	FM-256
738195	HVO-234C	37.249	MDF-70	4855-6/-12	BC-356	LI-41	BC-356
738196	A-4140C	37.250	MWC-9			LI-42	FM-257
739000	HVO-3	37.252	TV-113	FIRESTONE		LL-61	BC-419
790394	BC-357	37.253	TV-115	(Also See Wells-Gardner)		LL-62	BC-419
800204	HVO-138	37.254	MDF-70			N-7694	BC-567
902492-2	A-4103	37.255/B	HVO-10(2,3)	A10-508/509	BC-352	PA-28263	TV-163
903562-502	MDF-144C	37.256	MDF-70	A-1201	TV-115	PA-28279	MWC-8
903562-504	MDF-144C	37.258	HVO-10(2,3)	A-1202	TV-115	PA-28286	TV-151
903562-507	MDF-144C	37.261	MDF-70	A-1406	C-2974	PA-28292	MWC-12
906152-501	HVO-234C	37.264	HVO-44(3)	A-3392	TV-102	PA-28310	MWC-2
906153-501	P-4141C	37.265	MDF 72(4)	A-3392	TV-103	PA-28318	MWC-18
926636-501	HVO-232C	37.272	HVO-44(3)	A-3395	FM-254	PB-1201	TV-115
961415-1	A-4139C	37.273	MDF-72(4)	A-3396	BC-352	PB-1202	TV-115
961415-3	A-4140C	37.275	MDF-72(4)	A-3397	FM-255	PB-1406	C-2974
961416-1	P-4141C	37.276	TV-126	A-3399	BC-353	PB-1414	C-2974

MERIT COIL AND TRANSFORMER CORPORATION

PART NUMBERS		PART NUMBERS		PART NUMBERS		PART NUMBERS	
MFGR.	MERIT	MFGR.	MERIT	MFGR.	MERIT	MFGR.	MERIT
FIRESTONE		FIRESTONE		FIRESTONE		FISHER	
PB-3392	TV-102	12E-26993	TV-165(2)	38890	BC-355(1)	L-509-135	TV-180
PB-3392	TV-103	12E-27097	HVO-163	40845-1	BC-352	L-509-139	TV-172
PB-10106-2	A-3003	12E-27149	HVO-163	42700-7/-20/-21	A-3025	L-509-140	BC-563
PB-10115-4	A-3036	12E-27156	A-2829	43412-1	BC-352	L-509-147	BC-564
PB-10125	A-3000	12E-27189	A-3037	44282-1	BC-356	L-520-156	BC-561
PB-28278-3	MDF-70	13A-24023	TV-132(19,37)	45240-3	FM-258	L-520-178	BC-563
PB-28320	TV-137	13A-24203	TV-132(19,37)	46200-13	A-3025	L-550-122	BC-393
PB-28327	MWC-6	13A-24224	TV-130(37)	46568-1/ 3/-8	BC-419	L-670-151	BC-382(2,33)
PC-5866/-P	A-3026	13A-24937	TV-243(37)	46568-11/ 14	BC-419	L-721-136	BC-419
PC-10104	HVO-26	13A-26994	TV-130(37)	46700-2/-6	A-3025	L-3352	BC-563
PC-10108	HVO-26	13A-26995	TV-243	46971-4	FM-256	L-50066-1	BC-560
PC-10109	P-3068	13A-26998	TV-132(19,37)	49455-1/-2	BC-356	L-50066-2/-3	BC-561
PC-10115-6	A-3038	13B-23887	TV-104(2)	49515-1	BC-561	L-50066-4	BC-562
PC-10147	HVO-42	13M-23755	MDF-70(4,8)	94078	P-4071(2)	L-50066-6	BC-563
PC-10154-1	A-3038	13M-24085	TV-166	94080	A-2930	L-50066-8	BC-564
PC-10155	HVO-36	13M-24086	TV-165	94111	A-2900	L-50210-2	BC-393
PC-28278-3	MDF-70	13M-24441	TV-166	9420	A-2903	L-50210-23	BC-568
PC-28302-1	MDF-70	13M-26992	TV-166(2)	95073-1	BC-564	L-50210-24/-25/-26	BC-419
PC-28317-1	MDF-70	14-6.2	BC-565	162190	MWC-2	T-552-113	A-3132(2)
PC-28326	MDF-91	16A-19365	TV-202	430410	A-2761(24)	T-725-115	P-3152(2)
PC-58124	A-3026(2)	16A-20970	TV-185	505867	BC-352	T-725-116	A-3128(2)
PD-58121	A-3019	16A-21391	TV-199	505905	FM-254	ZZ-2984	BC-353
PM-TR12	A-2901	16A-2427	BC-565	505912	A-3019	ZZ-2985	BC-352
PM-250	A-2930	16A-22923	TV-192	506080	FM-254	ZZ-2986	FM-255
PM-251	A-2928	16A-23889/-1	C-4084(2)	507321	TV-110(12)	ZZ-2987	FM-254
PM-252	A-2930	16A-24019	TV-203	507343	TV-102	ZZ-509-130	FM-254
PM-611	A-2930	16A-24020	TV-184	507343	TV-103	ZZ-509-131	FM-253
PM-705	A-2930	16A-24090	BC-566	508061	TV-113	ZZ-550-145	FM-253
PM-720	A-2930(2)	16A-24375	TV-207	508076	A-3003	ZZ-592-170	FM-255
PM-900	A-2930	16A-24505	TV-151	508157	FM-255	ZZ-629-142	FM-254
PP-28292	MWC-12	16A-24998	TV-195	508341	C-2996	ZZ-630-114	FM-254
TLF-114-D	TV-154	16A-25441	TV-151	508667	MWC-1(7)	ZZ-662-117	FM-256
TLF-115-D	TV-110	16A-26991	TV-151(37)	508675	MDF-70(7)	ZZ-50210-2/-4	FM-254
TLF-137-D	TV-230	16B-25146/-3	C-4084	508679	HVO-7(2)		
TLF-142-D	TV-115	20E-360	TV-102	508883	HVO-7		
TLF-147-D	TV-115(1)	20E-360	TV-103	508956	A-3037		
TLF-505	MWC-7	20E-361	TV-119	508967	TV-163		
TLF-506	MWC-12	20E-362	TV-110	508971	HVO-7(2,3)	FLEETWOOD	
TO-4502/P	A-2930	20E-409	TV-163	509361	MWC-18	(See Conrac)	
TR-50B	A-2986	20E-410	MWC-12	509375	A-3038(18)		
TR-51A	HVO-152	20E-415	MWC-7	509376	A-2930		
TSP-41-8	A-3025	22E-30	P-2955(15)	509378	TV-154	FORD	
TSP-46-B	A-2928	22E-31	A-4000	509380	P-3070	(Also See Bendix & Motorola)	
TT-106-D	C-2991(2)	22E-32	C-3181(2)	509384	HVO-10(2,3)		
TTR-105	P-3059	22E-33	A-3035	509603	TV-151		
TTR-106-D	C-4115	22E-34	HVO-3	509704	MDF-70(72,75,92)	H-121-0004	BC-354
TTR-152	A-4000	22E-35	A-2931	509706	TV-110(12)	H-122-0004	BC-372
TTR-153	A-3035	75A1561	A-2749	720393	BC-356	H-141-0004	P-4078(2)
TTR-154	HVO-3	75A1636	BC-565	720394	BC-357	H-143-0003	A-2900(2)
TTR-156	A-2931	75A2057	C-4095(2)	10000061	A-3003	L-222811-1	BC-372
TTR-157	TV-161	201-23727	TV-121	10000071	P-3069	L-222812-1	BC-364
TTR-159-D	MD-12	201-23729	TV-120	10000133	A-2815(44)	32-4676-4/-5	BC-317
TTR-168-D	A-3002	201-23744	MDF-70(4,8)	12000082	HVO-27	32-4677-4	BC-318
TTR-178-1D	C-2994	201-23829	TV-103	12000092	HVO-27	32-4677-5	BC-345
TV-86/A	P-2970(2)	201-23873	TV-113(1)	12000201	TV-115	32-4770-1/-2	BC-344
TV-100/A/B	P-2970	201-24056	MDF-70(4,8)	12000231	TV-102	55-75787-2	P-4071
TV-100C	P-2971	201-24472	TV-165	12000231	TV-103	56-75931-2	A-2901
TV-555D	P-2860	201-24473-3	TV-166	14000021	C-4084	57-71702-2	BC-350(1)
TVL-177	MDF-130	201-24749	TV-151	16000191	TV-151	57-76096-1	BC-354(1,5)
2E80	MD-12	201-25360/-1	MDF-92(4,8,9)	16000361	MDF-70	95-914	P-4071(2)
12C-23704/-2	A-2998	201-25566	MDF-70(4,8)	16000381	MDF-70	95-915	A-2930(2)
12C-24170	A-2931	201-27120	MDF-92(4,8)	73000011	A-3026	95-916	BC-367
12D-23699/-3	P-2959(20)	318V-2	P-2970	73000071	A-3026	95-942	BC-372
12D-25563	P-2889(2)	1405	BC-352	73000211	A-2900(2)	95-944	BC-350(1)
12E-19048-2	A-3038(18)	1655-6/16	BC-352	73000221	A-2900(2)	95-945	BC-372
12E-23726/-1	A-3037	3823-26C	A-3025			95-947	A-2936
12E-23939	HVO-58	14977	BC-352			95-948	P-4078(2)
12E-24440	TV-165	38274	BC-368			95-1023	P-2970(2)
12E-25423	HVO-89	38275	BC-355(1)			95-1024	P-2970(2)
12E-25424	HVO-89	38889	BC-368			95-1026	A-2930(2)

MERIT COIL AND TRANSFORMER CORPORATION

PART NUMBERS		PART NUMBERS		PART NUMBERS		PART NUMBERS	
MFGR.	MERIT	MFGR.	MERIT	MFGR.	MERIT	MFGR.	MERIT
FORD		G. E.		G. E.		G. E.	
95-1027	A-2930(2)	EA64X1	A-2902(2)	ET64X92	A-3025	K83J374-1	A-3037(2,20)
95-1071	P-4079	EA64X2	A-2902	ET64X93	A-3081(2)	K83J542-1	C-4084
95-1073	P-4071	EA64X4	A-4097(2)	ET64X95	A-4100	K83J544-2	C-2991
95-1077	BC-367	EA64X7	A-4101	ET64X97	A-3020	K83J750-1	A-2930
95-1078	BC-372	EA64X8	A-2904	ET64X98	A-2988(2)	K83J998-4	A-3019
95-1079	A-2901	EA64X9	A-4097	ET64X102	A-4140C	K109J2/-4/-6/-7	A-2930
95-1134	BC-367	EA64X10	A-4100	ET76X31	MDF-106(7)	K115J217-1	A-3039(2)
95-1135	BC-372	EA64X11	A-2902	ET76X32	MDF-144C	K115J217-2	A-2824(35)
95-1143	P-4071	EA64X12	A-2900	ET76X33	MDF-106(4)	K115J630-11	C-4115
95-1144	P-4071(2)	EA64X13	A-4103	ET76X36	MDF-141(4)	K115J818-1	A-2824(35)
95-1195	BC-350(1)	EA83X2	BC-419	ET76X37	MDF-141	K115J857-1/-2	A-30 4(2)
121-0015	BC-350(1)	EA83X3	BC-418	ET76X39/-2	MDF-141	K119J14	P-3064
121-0019	BC-350(1)	EA83X5	BC-419	ET77X48	HVO-212	K119J15	P-3083
121-0020	BC-350	ER36X1	BC-562	ET77X64	HVO-212	K119J17	C-2996(2)
122-0015	BC-354(1,5)	ER36X2	TV-208(5)	ET77X66	HVO-232C	K119J18-1	C-4084
122-0021	BC-354(1,5)	ER61X3	BC-576	ET77X68	HVO-212	K128J68-3/-4	C-2994
122-0022	BC-354	ER61X4	BC-575	ET77X71	HVO-212	K129J26	P-2841
141-0010	P-4071(2)	ER61X5	BC-575	ET77X73	HVO-233C	K129J27	P-3064(33)
141-0025	P-3068	ET36X105	BC-566	ET77X74	HVO-212	K129J91	A-2819
143-0012	A-2901	ET36X106	BC-564	ET77X78	HVO-234C	K132J30-1	A-3003
143-0024	A-2900(2)	ET36X134	BC-675	ET77X79	HVO-234C	K138J72-1	A-2855
147-0007	BC-537	ET36X157	TV-184	ET83X32	BC-419	K138J73-1	A-2900(2)
71702	BC-350(1)	ET36X261	BC-679	ET88X61	P-4141C	K141J50	C-4084
71703	BC-354(1,5)	ET36X264	TV-201	ET88X76	P-4141C	K142J96-1	A-3026
71704	P-4071(2)	ET36X271	TV-203	ET88X77	P-4141C	K142J98	P-2844
71705	A-2901	ET36X275	TV-199	ET88X79	P-4083(2)	K144J25	P-2843
161000-020	A-4108	ET36X283	TV-200	ET88X85	P-4141C	K144J48-1	A-3037
		ET36X345	TV-204	ETL-001	FM-254	K148J27-1/-2	A-2998
		ET36X375	TV-199	ETL-002	BC-352	K148J53-2/-4	C-4115
		ET36X410	BC-670	ETL-004	BC-562	K149J79-1	A-3004
FREED EISEMAN (See Silvertone)		ET36X420	BC-566	ETO-185	A-3128	K149J89-1	P-2832
		ET36X424	TV-185	K63J132-1	P-3055	K151J32-1	A-2930
		ET36X425	BC-673	K63J134-1	A-3132	K188J46-1	P-2842
		ET36X433	BC-669	K63J135-1	C-3196(2)	M72J425-1	TV-133
		ET36X438	BC-562	K65J435	A-3035(2)	M72J425-3	TV-132
FUTURA		ET36X439	BC-393	K65J436	C-2995(2)	M76J102	TV-163
FP-50-27	BC-577	ET36X448	TV-248	K65J438	A-3019	M76J433-1	BC-352
FP-50-28	BC-581	ET36X449	BC-565	K66J301	C-3181(2)	M76J461-1	FM-253
FP-50-29	BC-581	ET36X541	BC-562	K67J460-1	A-2930	M76J509-2	FM-254
FP-50-34	BC-581	ET36X542	BC-566	K68J13	A-3020	M76J581-1	TV-161(2)
GAMBLE-SKOGMO (See Coronado)		ET36X544	TV-193	K68J41-1	A-3019	M76J582-2	MWC-11
		ET36X545	BC-562	K68J297	A-3035(2)	M76J582-3	MWC-12
		ET36X546	BC-566	K68J420-2	P-3066	M76J725-1	TV-110
		ET36X547	TV-193	K68J436	A-3035(2)	M77J1-1	HVO-6
		ET36X548	TV-195	K68J489/-1	A-2816	M77J1-2/ 4	HVO-6(31)
GAROD (See Majestic)		ET36X551	BC562	K68J490-1	A-3025(2)	M77J1-7	HVO-6(31)
		ET36X552	TV-205	K68J640	P-3084	M77J1-13/-16	HVO-6
		ET36X583	TV-180	K69J88/-1	C-4115	M77J2-1	MDF-83
		ET36X589	TV-248	K69J91-1/-2/ 3	A-3018	M77J4/-1/-2/-6	MWC-12
		ET36X612	TV-193	K69J91-4/-6	A-3018	M77J4-3	MWC-1
G. E.		ET36X664	TV-250	K69J367-1	C-4084	M77J4-4	MWC-11
EA35X3	BC-393	ET36X717	TV-190	K69J449	P-3066	M77J4-5	MWC-6
EA35X10	BC-419	ET36X722	BC-562	K69J489	A-2816	M77J5-1	TV-165
EA36X1	BC-564	ET56X54	FM-253	K69J620	A-3025	M77J11-8	MDF-84
EA36X2	BC-562	ET61X109	FM-254	K69J673	A-4003(2)	M77J11-25	MDF-85
EA36X7	BC-560						
EA36X9	BC-564	ET61X110	BC-352	K69J681	C-4084(2)	M77J13-2/-3/-4	HVO-60
EA36X21	BC-564	ET61X111	BC-353	K69J682	C-2974	M77J13-8/-9/-10	HVO-59
EA36X22	BC-563	ET61X132	A-3020	K69J842	A-2816	M77J13-11/-12	HVO-61
EA56X1	FM-253	ET63X58	C-4115	K71J87-1	A-3019	M77J15-1/-2	MDF-86
EA56X3	FM-260	ET63X59	C-4133	K71J129/-1	A-3020	M77J15-5	MDF-87
EA61X1	FM-254	ET63X60	C-2994	K71J363	HVO-6	M77J15/-11/-13	MDF-87
EA61X3	BC-352	ET63X61	C-4115	K71J417	A-2930	M77J15-14/-16	MDF-87
EA61X4	BC-353	ET63X62	C-4133	K71J631-1	C-2995	M77J20-1/-2	HVO-98
EA61X5	FM-256	ET63X63	C-4115	K71J811-1	A-2935	M77J21-2	HVO-101
EA61X7	BC-356	ET63X65	C-4084	K71J844-1/-2	A-4003	M77J21-6	HVO-103
EA61X9	FM-256	ET64X80	A-3025	K71J845-1	A-3038(2)	M77J21-9	HVO-115
EA61X10	FM-256	ET64X84	A-2824(35)	K82J154-1/-2	HVO-6(31)	M77J21-10	HVO-114
EA61X11	BC-356	ET64X85	A-3025	K82J182-1	C-2991(2)	M77J21-11/-12	HVO-166
EA61X11	BC-357	ET64X87	A-4139C	K82J363	P-2944	M77J21-13/-14/-15	HVO-212
EA61X12	FM-256	ET64X90	A-2998	K83J284-1	A-2856	M77J22-1/-4	MDF-91(90)

MERIT COIL AND TRANSFORMER CORPORATION

PART NUMBERS		PART NUMBERS		PART NUMBERS		PART NUMBERS	
MFGR.	MERIT	MFGR.	MERIT	MFGR.	MERIT	MFGR.	MERIT
G. E.		G. E.		G. E.		G. E.	
M77J46-11	MWC-11(6)	RLC-107	TV-161(26)	RLI-131	TV-131	RLI-345	TV-201
M77J165-2	TV-113(1)	RLC-108	A-4003	RLI-132	TV-127(1,12)	RLI-352	TV-203
M77J430-1	TV-133	RLC-115	BC-387	RLI-133	TV-128(1,12)	RLI-353	BC-562
M77J432-1	TV-161(37)	RLC-117	BC-381	RLI-135	TV-152	RLI-354	TV-131(2)
M77J507-1	TV-113	RLC-118	BC-387	RLI-139	TV-119(12)	RLI-355	TV-131(12)
M77J510-1	TV-128	RLC-119/121	BC-381	RLI-140	TV-151	RLI-357	TV-166
M77J1123	MDF-85	RLC-122	BC-394	RLI-142	BC-561	RLI-364	TV-153
M123J423-1	A-3019	RLC-125	BC-165	RLI-144	TV-130	RLI-367	TV-202
M123J455-2/3	MDF-106	RLC-126	BC-387	RLI-148	TV-196	RLI-368	TV-207
M123J462-1	A-2998	RLC-129	BC-387	RLI-150	TV-190	RLI-382	TV-194
M123J472-1	A-3037(2)	RLC-134	BC-387(2)	RLI-151	TV-151	RLI-383	TV-184
M123J655-1/2	MDF-106	RLC-137	A-3004(7)	RLI-153	BC-566	RLI-386	BC-514
M123J655-3/5	MDF-106(4)	RLD-015	MWC-11	RLI-154	TV-202	RLI-423	BC-561
M123J720-1/-2	A-2998	RLD-012	MWC-12	RLI-173	TV-134	RLI-430	TV-205
M123J721-1	A-2821	RLD-013	MDF-83	RLI-177	TV-180	RLI-439	TV-164
M123J722-1/-2	C-4084	RLD-014	MWC-12	RLI-180	TV-113(2)	RLI-445	TV-185
M123J827-1/-2/-3	C-4115	RLD-016	MWC-11	RLI-181/2	TV-151	RLI-449	BC-560
M123J827-6	C-4115	RLD-017	MWC-11	RLI-192	TV-131	RLO-014	TV-102
M123J828-1	A-4123	RLD-018/019	MWC-12	RLI-194	TV-190	RLO-014	TV-103
M123J829-1	A-3025	RLD-020	MWC-6	RLI-20	TV-152	RLP-011/2/3	TV-112
M123J845-1	A-3019	RLD-025	MDF-84	RLI-201	TV-153	RLP-014	TV-102
M123J846-1	A-4123	RLD-027	MWC-11(6)	RLI-202/3	TV-151	RLP-014	TV-103
M123J942-1	A-2902	RLD-041	MDF-85	RLI-204	TV-153(12)	RLP-016	TV-243
M123J965-1	A-2901	RLD-042	MDF-86	RLI-205	TV-195	RLP-018	TV-134
M123J979-1	A-4119(18)	RLD-044	MWC-12	RLI-206	TV-131	RLP-019	TV-132
M124J165-1	P-2962(20)	RLD-045	MDF-85	RLI-207	TV-181	RLP-020	TV-134
M124J248-1	A-3019	RLD-046	MWC-12	RLI-209	TV-185	RLP-021/2	TV-132
M124J289-1	A-3020(2)	RLD-047	MDF-86	RLI-210	TV-163	RLT-003	HVO-7(2,3,31)
M124J329-1	C-4115	RLD-048/049	MWC-12	RLI-213	TV-152	RLT-004	HVO-7(2,3,31)
M124J424-1	A-3025	RLD-052	MDF-87	RLI-215	TV-151	RLT-247	TV-163
M124J440-2/-3	C-4115	RLD-053	MWC-10	RLI-217	TV-153(12)	RLX-032	TV-243
M124J4 6-1	A-3018	RLD-054/6/7	MWC-12(6)	RLI-220	TV-184	RLX-033/6	TV-133
M124J798-1	A-2998	RLD-058	MWC-10(37)	RLI-226	TV-151	RLX-038	TV-243
M124J799-1	A-3081(2)	RLD-060	MWC-11	RLI-228	TV-113(2)	RLX-042	TV-130
M124J866-2	C-4133	RLD-066	MWC-6(2)	RLI-241	TV-193	RS-1082	BC-327
M124J942 1	A-2902	RLD-067/68	MDF-87	RLI-243/4	TV-151	RS-1083	BC-328
M124J943-1	A-4100	RLD-069	MDF-92	RLI-245	TV-184(5)	RS-1084	BC-329
M124J999-1	A-3020	RLD-071	MDF-91(7,90)	RLI-246	TV-153(12)	RS-1143	BC-356
M128J280	A-3025	RLD-073	MDF-87	RLI-247	TV-163	RS-1289	FM-254
N-RLC-134	BC-387(2)	RLD-075	MDF-87(7)	RLI-260	TV-193	RS-1292	BC-562
N-RLI-319	TV-134(2)	RLD-076	MDF-91(7)	RLI-263	TV-196	RS-1311	FM-256
N-RLI-320	TV-163(2)	RLD-080	MDF-106	RLI-269	TV-130	RS-1313	BC-357
N-RLI-322	TV-193	RLD-091	TV-165	RLI-270	TV-200	RS-1321	BC-356
N-RLI-323	TV-130(2,41)	RLF-005	C-2995(2)	RLI-277	TV-151	RS-1322	BC 419
N-RLI-324	TV-151(2)	RLF-010	C-3196(2)	RLI-278	TV-131	RS-1409	BC-389
N-RLI-325	TV-132(2,84)	RLF-011	C-3181(2)	RLI-279	TV-153	RS-1415	BC-356
N-RLI-326	TV-134(2,84)	RLF-024	TV-180	RLI-280	TV-113(2)	RS-1416	A-3025(22)
N-RLI-327	TV-205	RLF-031	C-2974(2)	RLI-291	TV-151	RS-1481	BC-419
N-RLI-331	TV-185	RLF-032	C-4084(2)	RLI-292	TV-152	RS-1502	FM 256
N-RTD-019	TV-115	RLF-040	C-2995	RLI-295	TV-193	RS-1503	BC 357
N-RTD-171	A-2927	RLF-045	C-2991(2)	RLI-296	BC-566	RS-1504	BC-356
N-RTL-175	TV-130(2)	RLF-051/056	C-4084	RLI-30	TV-184(5)	RS-1505	FM-256
N-RTL-176	TV-130(2)	RLF-061	C-2996(2)	RLI-310/11	TV-184(5)	RS-1507	A-3025
N-RTL-178	TV-130(2)	RLF-062	C-4084	RLI-312	TV-120	RS-1567	A-3025
N-RTL-179	TV-130(2)	RLF-068	C-4115	RLI-315	TV-199	RS-1646	A-3021
N-RTO-168	A-3026	RLF-069	C-2991	RLI-317	TV-181	RS-1655	BC-561
N-RTO-172	A-2927(2)	RLF-070	C-4084	RLI-319	TV-134(2)	RS-1793	A-2901
P74J18-2	C-2994	RLF-072/3/4/5/6	C-4115	RLI-320	TV-120	RS-1963	BC-418
P74J615/-2/-6	HVO-7(2,3,31,91)	RLF-078	C-4084	RLI-321	TV-163	RS-2121	BC-418
P79J964-1	MDF-92	RLF-079/080	C-4115	RLI-323	TV-131	RS-2124	P-3048
P126J717-1	MDF-144C	RLI-003/004	HVO-7(2,3,91)	RLI-324	TV-151	RS-2149	BC-356
P174J90-1	MDF-92	RLI-045/055	TV-163	RLI-325	TV-152	RS-2230	BC-418
RLA-036/037	TV-173	RLI-096	TV-131	RLI-326	TV-153	RS-2255	A 3025(2)
RLA-040/041	TV-173	RLI-097	TV-113(1)	RLI-328	TV-190(5)	RS-2310	A-3019
RLB-030	BC-388	RLI-10	TV-151	RLI-330	BC-514	RS-2424	A-2902(2)
RLC-055	BC-394	RLI-110	TV-134	RLI-336	TV-130(41)	RS-2522	BC-394
RLC-066	BC-381	RLI-111	TV-151	RLI-338	TV-151	RS-2524	FM-254
RLC-068	BC-387	RLI-122	BC-563	RLI-342	TV-206	RS-2526	BC-564
RLC-091	TV-165	RLI-123	TV-132	RLI-343	TV-120	RS-2527	BC-562
RLC-101	BC-381(2)	RLI-124	BC-563	RLI-344	TV-166	RS-2532	FM-253

MERIT COIL AND TRANSFORMER CORPORATION

PART NUMBERS		PART NUMBERS		PART NUMBERS		PART NUMBERS	
MFGR.	MERIT	MFGR.	MERIT	MFGR.	MERIT	MFGR.	MERIT
G. E.		G. E.		G. E.		G. E.	
RS-2533	BC-352	RTL-269	TV 130	RTO-062	A-3025	RTO-179/-4	HVO-104
RS-2540	BC-419	RTL-041	BC-371	RTO-064	A-2816	RTO-180	A-3037
RS-2548	A-3025(22)	RTL-042	BC-354	RTO-066	A-3018	RTO-181	A-2930(2)
RS-2632	BC-389	RTL-043	BC-377(2)	RTO-067	HVO-7(2,31,91)	RTO-183	HVO-162
RS-2652	BC-419	RTL-052	BC-352	RTO-068	HVO-6	RTO-184	A-4119
RS-2716	A-3019	RTL-054	BC-352	RTO-070	A-2932(2)	RTO-186	A-2927(2)
RS-2805	FM-256	RTL-066	C-2994	RTO-071	HVO-6(31)	RTO-187/-6	HVO-103
RS-2807	BC-356	RTL-078/79	BC-353	RTO-072	A-3018	RTO-189	A-4123
RS-2814	BC-418	RTL-080	FM-254	RTO-073	A-3019	RTO-190	HVO-104
RS-2840	A-3025	RTL-086	C-2994	RTO-074	A-3035(2)	RTO-191	BC-357
RS-2841	BC-419	RTL-087	BC-354	RTO-076	HVO-6(2,31,91)	RTO-192	A-3004(7)
RS-2842	BC-564	RTL-090	TV-104	RTO-077/081	A-3025	RTO-193	A-4123
RS-2846	BC-563	RTL-096	C-4115	RTO-082	A-3018	RTO-194	A-3019
RS-2930	A-3025	RTL-097	BC-356	RTO-084	A-3019	RTO-197	A-2998(48)
RS-2978	BC-575	RTL-098	BC-352	RTO-085	HVO-6(31)	RTO-198	A-3037(2)
RS-2979	BC-576	RTL-099	FM-254	RTO-086	A-3018	RTO-207-9	HVO-115
RS-3008	BC-571	RTL-111	BC-355	RTO-088	HVO-6	RTO-208	HVO-114
RS-3111	A-4103	RTL-112/3	FM-254	RTO-089	A 2930	RTO-209	A-2821
RS-3112	A-2903	RTL-115	BC-368	RTO-090	HVO-6	RTO-210	A-2998
RS-3124	BC-576	RTL-118	TV-133	RTO-096	A-2935	RTO-212	A-4123
RS-3202	BC-570	RTL-119	TV-132	RTO-097	A-3038(2)	RTO-213	A-3025
RS-3219	FM-256	RTL-120	TV-113(2)	RTO-101	HVO-60	RTO-214/-11	HVO-166
RS-3455	A-3025	RTL-122	TV-133	RTO-103	A-4003	RTO-215	A-3004(2,7)
RS-3567	BC-575	RTL-125	TV-128(2)	RTO-104	HVO-60	RTO-216	A-4119(18)
RS-3580/98	A-2903	RTL-127	TV-245	RTO-105	A-3018	RTO-217	A-3019
RS-3599	A-4103	RTL-128	BC-352	RTO-108	A-2998	RTO-290	A-2821
RS-3694	FM-256	RTL-129	FM-254	RTO-109	HVO-60	RTP-016	A-3035(2)
RS-3724/25	A-2901	RTL-130	FM-254(41)	RTO-114	HVO-7	RTP-035	P-3055
RS-3757/8	FM-256	RTL-135	BC-352	RTO-116	HVO-6	RTP-062	P-3066
RS-3759	BC-357	RTL-136	BC-355	RTO-117	A-3037(2,32)	RTP-066	P-3066
RS-3761	BC-356	RTL-137/38	TV-243	RTO-118	A-2900	RTP-300	P-3066
RS-3982	BC-419	RTL-143	BC-343	RTO-121	A-2856	RTP-301	P-3066
RS-4062	A-2749	RTL-144/45	TV-130	RTO-123/4	A 2930	RTP-314	P-3064
RS-4097	A-2928	RTL-147	TV-243	RTO-125/6/7	HVO-59	RTP-315	P-3083
RS-4216	A-2902	RTL-152	BC-352	RTO-128	A-3025	RTP-318	P-3084
RS-4271	A-2900	RTL-153/4/5	TV-130	RTO-129/30	HVO-61	RTP-321	P-2841
RS-4307	BC-419	RTL-156	BC-352	RTO-131	HVO-97	RTP-322	P-3064(2,28)
RS-4343	BC-419	RTL-163	BC-343	RTO-133	A-2998	RTP-325	P-2842
RS-4368/69/70	FM-256	RTL-165	A-3003	RTO-134	A-2930	RTP-326	P-2843
RS-4371	FM-260	RTL-174	BC-352	RTO-135	A-3019	RTP-327	P-2844
RS-4534	BC-575	RTL-175	TV-130(2)	RTO-136	A-2857	RTP 331	P-2832
RS-4597	BC-357	RTL-176/8/9	TV-130	RTO-138	A-3031(2)	RTX-042	TV-130
RS-4632	BC-419	RTL-180	TV-108	RTO-139/40	A-2930	STL-009	BC-352
RS-4652	A-4103	RTL-182/3	BC-352	RTO-141	HVO-97	TRD-012	TV-110(62)
RS-4793	BC-419	RTL-185	TV-130	RTO-142	A-2856	WT25X24	BC-566
RS-4943	A-2902	RTL-186/7	TV-130(2)	RTO-144	A-3031(2)	WT35X18	TV-165
RS-4944	BC-419	RTL-191	TV-130	RTO-146/-3	HVO-97	WT35X24	TV-161(26)
RS-4964/65	FM-256	RTL-192	TV-243	RTO-149/-1	HVO-98	WT35X25	A-4003
RS-4982	BC-357	RTL-193	BC-356	RTO-150	HVO-98	WT35X29	A-3004(7)
RS-5977	FM-256	RTL-195	TV-126	RTO-151/-3	HVO-99	WT35X34	TV-163
RS-6197	BC-570(7)	RTL-197	BC-356	RTO-153	A-2900(2)	WT35X37	TV-163
RTD-006	FM-253	RTM-003	TV-161(2)	RTO-154	A-2819	WT35X241	TV-120
RTD-008	TV-110(1)	RTM-007	A-4003(2)	RTO-155	A-2823(18)	WT36X2	MWC-11
RTD-011/2/3/4	TV-110(5)	RTM-008	TV-113	RTO-156	A-3019	WT36X3	MWC-12
RTD-015	TV-110(2,5)	RTM-088	TV-113(1)	RTO-159	A-2856	WT36X4	MWC-11
RTD-018	TV-110(62)	RTO-015	A-2930	RTO-161	HVO-100	WT36X5	MWC-1
RTD-019	TV-115	RTO-016	A-3035(2)	RTO-162	A-2855	WT36X6/7	MWC-12
RTD-020	TV-146	RTO-017	A-3019	RTO-163	A-2900(2)	WT36X8	MWC-6
RTD-021	TV-115	RTO-020	TV-146	RTO-165/-1	HVO-101	WT36X10	MWC-12(6)
RTD-022	TV-115(1,5)	RTO-021	TV-115	RTO-166/-5	HVO-102	WT36X15/16	MWC-12
RTD-023	TV-115(62)	RTO-026	A-3132	RTO-167	A-3037	WT36X17	MWC-10(6)
RTD-025	TV-146	RTO-027	A-3019	RTO-168	A-3026	WT36X18/19/20	MWC-12(6)
RTD-026	TV-147	RTO-035	A-3019	RTO-169	A-2901(2)	WT36X22	MWC-11
RTD-030	TV-235	RTO-050	A-2932	RTO-170	A-2901	WT36X26	MWC-6(2)
RTD-032	TV-147	RTO-051	A-2930	RTO-171	A-2927	WT36X30	TV-180
RTD-203	TV-115	RTO-052	A-3020	RTO-173	HVO-101	WT36X32	TV-146
RTD-212	A-3037	RTO-053	A-3035(2)	RTO-174	HVO-102	WT36X38	TV-102
RTF-002	P-2944	RTO-054	HVO-7(2,31,91)	RTO-175/-3	HVO-103	WT36X38	TV-103
RTF-003	P-2947(20)	RTO-058	HVO-7(2,31,91)	RTO-176	A-3025(22)	WT36X66	BC-563
RTF-004	P-2964(2)	RTO-061	A-2816	RTO-178	A-2998	WT36X70	TV-131

PART NUMBERS		PART NUMBERS		PART NUMBERS		PART NUMBERS	
MFGR.	MERIT	MFGR.	MERIT	MFGR.	MERIT	MFGR.	MERIT
G. E.		G. E.		G. E.		G. E.	
WT36X72	TV-151	WT36X284	TV-207	WT61X70	TV-130	WT64X58	A-3037(2)
WT36X78	TV-134	WT36X294	TV-194	WT61X71	TV-243	WT64X61	A-2821
WT36X79	TV-151	WT36X295	TV-184	WT61X72	TV-126	WT64X62	A-2998
WT36X87	TV-132	WT36X297	BC-514	WT61X91	A-2998	WT64X63	A-4123
WT36X88	TV-131	WT36X323	BC-561	WT61X109	FM-254	WT64X64	A-3025
WT36X90	TV-129	WT36X324	TV-164	WT61X110	BC-352	WT64X65	A-3004(7,22)
WT36X92	TV-152	WT36X329	TV-205	WT61X111	BC-353	WT64X66	A-4123
WT36X94	TV-119(12)	WT36X334	TV-164	WT63X1	C-2995(2)	WT64X67	A-3019
WT36X95	TV-151	WT36X339	TV-185	WT63X13	C-2974(2)	WT64X69	A-4123
WT36X103	TV-151	WT36X343	BC-560	WT63X14	C-4084(2)	WT64X70	A-2902
WT36X105	BC-566	WT36X344	BC-565	WT63X17	C-2995	WT64X72	A-2901
WT36X116	TV-134	WT36X352	TV-112	WT63X34	C-2996(2)	WT64X73	P-2962(20)
WT36X122/123	TV-151	WT36X356	TV-132	WT63X35	C-4084	WT64X75	A-3019
WT36X132	TV-131	WT36X357	TV-134	WT63X40	C-4115	WT64X76	A-3020(2)
WT36X134	TV-190	WT36X358/9	TV-132	WT63X41	C-2991	WT64X80	A-3018
WT36X139	TV-152	WT36X367	TV-198	WT63X42	C-4084	WT64X81	A-4105
WT36X140	TV-153	WT36X370	TV-188	WT63X44	C-4115	WT64X84	A-4123
WT36X141/2	TV-151	WT36X374/5	TV-199	WT63X46	C-4115	WT64X85	A-3025
WT36X143	TV-153(12)	WT36X376	TV-206	WT63X47	C-2994	WT66X35	TV-115(62)
WT36X144	TV-195	WT36X381	BC-561	WT63X48	C-4084(2)	WT75X3	MDF-83
WT36X145	TV-131	WT36X387	TV-181	WT63X50	C-4084	WT76X6	MDF-84
WT36X146	TV-181	WT36X401	BC-566	WT63X51	C-4115	WT76X12/13	MDF-85
WT36X148	TV-185	WT36X402	TV-250	WT63X52	C-4115	WT76X14	MDF-86
WT36X150	TV-152	WT36X410	TV-195	WT63X55	C-2994	WT76X16	MDF-87
WT36X152	TV-151	WT36X416	BC-535	WT63X56/57	C-4115	WT76X19/20	MDF-87
WT36X154	TV-153	WT36X419	BC-561	WT63X58	C-4115	WT76X21	MDF-93
WT36X157	TV-184	WT36X420	BC-566	WT64X1	P-2944	WT76X22	MDF-87
WT36X163	TV-151	WT36X425	TV-185	WT64X2	P-2947(20)	WT76X23	MDF-87(7)
WT36X176/7	TV-151	WT36X427	BC-565	WT64X3	P-2964(2)	WT75X24	MDF-91(2,7)
WT36X178	TV-184(5)	WT36X433	TV-194	WT64X5	A-3003	WT76X26	MDF-106
WT36X179	TV-153(12)	WT36X434	TV-196	WT64X7	A-3035(2)	WT76X27	MDF-106
WT36X180	TV-163	WT36X449	BC-565	WT64X8/9	A-3019	WT76X28	MDF-106(4)
WT36X191	TV-193	WT36X875	TV-199	WT64X12	A-3020	WT76X31	MDF-106(7)
WT36X194	TV-196	WT51X5	TV-161(2)	WT64X13	A-3035(2)	WT77X2	HVO-6
WT36X200	TV-130	WT51X7	A-4003(2)	WT64X14	A-2816	WT77X3/4	HVO-6(31)
WT36X206	TV-151	WT51X8	TV-113	WT64X15	A-3025	WT77X5/6	HVO-6
WT36X207	TV-131	WT56X14	TV-130	WT64X16	A-2816	WT77X7	HVO-7(2,3,91)
WT36X215	TV-151	WT56X22	TV-110	WT64X17	A-3019	WT77X9/10/11	HVO-60
WT36X219	TV-193	WT56X24	TV-110	WT64X18	A-3035(2)	WT77X12	HVO-7
WT36X220	BC-566	WT56X25	TV-110(5)	WT64X19/20	A-3025	WT77X13	HVO-6
WT36X224	TV-184(5)	WT56X26	TV-110(62)	WT64X21	A-3018	WT77X15/16	HVO-59
WT36X233	TV-184(5)	WT56X27	TV-110	WT64X22	A-3019	WT77X19/20/21	HVO-97
WT36X234	TV-184(5)	WT56X28	TV-110(2,5)	WT64X23	A-3018	WT77X22	HVO-98
WT36X235	TV-120	WT56X30	TV-110(19)	WT64X24	C-2994	WT77X23	HVO-162
WT36X237	TV-199	WT56X31	TV-115	WT64X25	A-3038(2)	WT77X24	HVO-99
WT36X239	TV-181	WT56X33	TV-115	WT64X27	A-4003	WT77X26	HVO-100
WT36X240	TV-134(2)	WT56X34	TV-115(1,5)	WT64X28	A-3018	WT77X27	HVO-101
WT36X241	TV-120	WT56X35	TV-115(19)	WT64X30	A-3037(2,32)	WT77X28	HVO-102
WT36X242	TV-163	WT56X36/37	TV-146	WT64X31	A-2856	WT77X29	HVO-101
WT36X244	TV-131	WT56X38	TV-147	WT64X32/3/4	A-2930	WT77X30	HVO-103
WT36X245	TV-151	WT56X41	TV-235	WT64X35	A-3019	WT77X31	HVO-104
WT36X246	TV-152	WT56X42	TV-147	WT64X37/38	A-2930	WT77X33	HVO-103
WT36X247	TV-153	WT56X43/44	TV-130	WT64X39	A-2820(2)	WT77X34	HVO-114
WT36X248	TV-190(5)	WT56X47	TV-147	WT64X40	A-2819	WT77X35	HVO-104
WT36X250	BC-514	WT56X54	FM-253	WT64X41	A-2823(18)	WT77X38	HVO-115
WT36X256	TV-130(41)	WT61X2	TV-113(1)	WT64X42	A-3019	WT77X39	HVO-114
WT36X258	TV-151	WT61X3/4/5	TV-113(2)	WT64X43	A-2856	WT77X40/41	HVO-166
WT36X259	TV-164	WT61X17	C-2994	WT64X45	A-2855	WT77X42	HVO-212(80)
WT36X260	BC-565	WT61X27	TV-104	WT64X46	A-2900(2)	WT77X43/44	HVO-212
WT36X261	TV-206	WT61X32	TV-132	WT64X47	A-3026	WT77X48	HVO-212
WT36X262	TV-120	WT61X33	TV-113(2)	WT64X48	A-2901(2)	WT88X5	P-3066(13)
WT36X263	TV-166	WT61X35	TV-128(2)	WT64X49	A-2901	WT88X6/7/8	P-3066
WT36X264	TV-201	WT61X43/44	TV-130	WT64X50	A-3026	WT88X15	P-3064
WT36X271	TV-203	WT61X46	TV-234	WT64X51	A-3037	WT88X16	P-3083
WT36X272	BC-562	WT61X48	TV-130	WT64X52	A-2930(2)	WT88X17	P-3084
WT36X273	TV-131(2)	WT61X62	TV-130(2)	WT64X53	A-4123	WT88X20	P-2841
WT36X274	TV-131(12)	WT61X63	TV-130	WT64X54	A-3004(2,7)	WT88X21	P-3064(2,28)
WT36X276	TV-166	WT61X65	TV-130	WT64X55	A-4123	WT88X23	P-2842
WT36X281	TV-153	WT61X67	TV-130	WT64X56	A-3019	WT88X24	P-2843
WT36X283	TV-202	WT61X68/69	TV-130(2)	WT64X57	A-2998(48)	WT88X25	P-2844

MERIT COIL AND TRANSFORMER CORPORATION

PART NUMBERS		PART NUMBERS		PART NUMBERS		PART NUMBERS	
MFGR.	MERIT	MFGR.	MERIT	MFGR.	MERIT	MFGR.	MERIT
G.E.		GMC (See Delco)		GROMMES		HALLICRAFTERS	
WT88X27	P-2832			EI-957J	FM-254	50C517	FM-254
WT88X36	P-2872(29)			ER-640J	FM-255	50C518	FM-255
WT88X46	P-2872(93)			GT-24605	FM-254	50C519	FM-254
WT105X41	FM-253	GONSET		GT-24608	FM-253	50C604	TV-126(1,41)
WT105X44	BC-353			GT-24610	BC-352	50C606	TV-126(1,41)
WT105X45	FM-254	JA-001	P-3048	TO-10B/C	A-2904(2)	50C607	TV-126(1,41)
79J964	MDF-93	JB-001	A-3026	TO-22	A-3102	50C609	TV-126(1,41)
83J270	P-2947(20)	012-068	TV-118	TO-25	A 3131	50C610	TV-126(1,41)
83J284/-2/-4	A-2856	012-169	TV-118	TO-60A	A-3100(2)	50C648	TV-163
83J750	A-2930	012-414	TV-118	TP-1T	P-3048	50C657	BC-353
109J2-3	A-2930	012-415	TV-118	TP-2L	A-2952	51-1489	MWC-11(6)
112B3916-1	A-4100	014-022	FM-254(1)	TP-2U	P-3151(2)	51-1947	TV-204(5)
113A6482-1	A-3025(22)	014-086	BC-352	TP-14	P-2954(29)	51-1952	TV-184(5)
113A6523-3	A-3025	027-004	BC-565	56-361/-362	FM-254	51-2029	TV-184(5)
113A7326-1	A-2902	027-010	BC-537	56-363	FM-253	51-2030	TV-202
123J827-1	C-2994	027-028	BC-565	56-364/-365	BC-352	51-2031	TV-201
124J525P3	A-2824(35)	027-045	BC-562	56-370	BC-353	51-2065-C	TV-108
124J621-2	A-3025	027-073	TV 239	136A9	A-3027	51-2100	TV-184(5)
124J627-3	A-3025	027-077	TV-239	136P2	P-2952	51-2101	TV-201(5)
126J377-3	A-4140C			216BA	C-2991	51-2102	TV-206
128J68-1/-2/-3	C-4115	GOTHAM		1655-19	BC-352	51-2103	TV-120
128J127-2	A-2988(2)	DY-6	MDF-72			51-2104	TV-131
132J21-1	A-3019	LK-1	TV-115	GRUNDIG		51-2105	TV-130
134J74-1/-2	A-2823(18)	LK-3	TV-154	(See Majestic)		51-2167	TV-131
143J53-1	A-3037	LK-4	TV-113			51-2169	TV-163
144J45-1	A-2901	LM77J4	MWC-12				
145A9015-4/-6	A-4103			GUILD		51-2184	TV-196(5)
145A9200-A	A-4103	M77J4-3	MWC-1			51A857	TV-121
145A9200-3	A-4103	TA-2	A-3025	TAO-8K1-PR	A-2904(2)	51A1153	TV-167
145A9266-1	A-4101	TA-4	A-2930	TP-3323-GB	P-3055	51A1243/-C	MWC-5
145A9827-1	A-2904	TF-4	C-2974	TRI-455-1/-2	BC-352	51A1261/-C	MWC-12
145A9837-1	A-2900	TH-2	HVO-7(2)			51A1288/-B	TV-116
145A9847-1	A-2902	TP-4	P-3078			51A1289/-B	TV-116
145A9860-1	A-4097	TV-3	A-3028(2)			51A1470	MWC-6(6)
145A9874-1	A-3019	TV-4	C-2974	HALLICRAFTERS		51A1854	TV-116
145A9875-1	A-2902	26-1007	A-2998			51A1857	TV-121
154A5183	A-2902	403	TV-163	50-472	BC-353	51A1858	TV-120
906152-501	HVO-234C	2153	C-4133(2)	50-686	BC-352	51A1859	TV-149
906153-501	P-4141C	3593	A-3025	50A372/-1	TV-102	51A1861	TV-102(55)
961415-3	A-4140C			50A372/-1	TV-103	51A1862	TV-141
				50A431	TV-116	51A1875	BC-513(5)
		GRANCO		50A432	TV-120	51A1925	TV-131
		AL-477	BC-561	50A450	TV-151	51A1926	TV-126(1)
GIBBS		BL-567	BC-353	50A472	BC-352	51A1927	TV-132
70284	C-4095	BL-576	BC-352	50A474/G	TV-151	51A1946	BC-513
70359	C-4095	CL-472	FM-254	50A475	TV-116	51A1947	TV-204(5)
		CL-473	FM-255	50A476/-E	TV-141	51A1948	TV-132
		L-472	FM-254	50A477	TV-116	51A1952	TV-184(5)
		L-473	FM-255	50A623	TV-139	51A1996	TV-120
		L-477	BC-561	50A654	TV-126(1)	51A1997	BC-513(5)
		L-576	BC-352	50B406	TV-110	51A2040	TV-185
		T-629	A-3025	50B411	TV-163(37)	51A2041	TV-184(5)
GLOBE ELECTRONICS				50B445	TV-107	51A2184	TV-196(5)
1205-006/A	BC-350	18-3	BC-563	50B446	TV-104	51B1037	TV-119(12)
1205-007/A	BC-351	18-12-5	BC-393	50B447	TV-106	51B1038	TV-230
1300-007	C-2975(2)	28-1/-2	FM 254	50B451	TV-116	51B1071	MWC-12
1300-018	BC-537	28-3	BC-352	50B458	TV-116	51B1072/-1	MWC-7
1301-006	TV-206	28-4	FM-254	50B472	BC-352	51B1132	TV-119(12)
1301-025	TV-195	33-2/-3	A-3025	50B473/-D	TV-110	51B1153	TV-167
1400-103	TV-112	33-3-1	A-3025(2)	50B474/-G	TV-151	51B1205	MWC-12
1400-104	TV-116	33-5A	A-3027	50B562	TV-139(1)	51B1230	MWC-7
1400-105	TV-112	33-18	A-2938	50B573	TV-126(1,41)	51B1232	MWC-12
1400-106	TV-118	33-21A/-22A/-23A	A-3025	50B574	TV-127(1,41)	51B1242	TV-162
1400-116/-117	TV-112	33-24	A-4097	50B575	TV-126(1)	51B1243/-C	MWC-5
1400-128	TV-116	33-28/-29/-31	A-3025	50B622	TV-167	51B1277/-B	MWC-5
12005-009	BC-352	545-7	P-3045(2)	50B654	TV-125(1)	51B1301	TV-102
		57462	FM-254	50B1536	TV-163	51B1330	MWC-12(6)
		700177	BC-419	50C233	BC-352	51B1331	MWC-5(6)
		716142	BC-393	50C242	BC-352	51B1332	TV-141
				50C248	BC-352	51B1333	TV-151
				50C473	TV-110	51B1334	TV-116

PART NUMBERS		PART NUMBERS		PART NUMBERS		PART NUMBERS	
MFGR.	MERIT	MFGR.	MERIT	MFGR.	MERIT	MFGR.	MERIT
HARPERS		HINNERS GALANEK		HOFFMAN		HOFFMAN	
FHC-9237	BC-575	130-102	BC-352	5021	P-3097(2,45)	5168	HVO-39(50)
9237	BC-575	130-106	BC-567	5023	P-2835	5169	A-2901
9238	BC-576	130-107	BC-353	5026	P-3072	5171	BC-352
		130-108	FM-254	5027	P-2835	5172	BC-353
		130-109	FM-254	5029	P-3078	5173	A-3018
HEATH							
40-31	BC-419	130-110	FM-255	5030	P-2838(10)	5174	P-3142(2)
40-65	BC-563	130-111	BC-352	5031	P-3067(11,13,14)	5175	C-2994
40-73	BC-393	130-114	BC-352	5032	P-2834	5176/-2	A-3006
40-89	BC-393	130-117	BC-348	5034	P-3142	5177	A-2825
40-108	BC-563	130-148	FM-254	5035	HVO-9(7)	5177A/-4	HVO-36(2,7)
40-309	BC-418	132-118A	BC-419	5036	P-2953(2)	5178	A-2928
40-447	BC-419	132-134	BC-419	5049/-1	P-3079(11,77)	5179	A-3039
45-3	TV-208	132-135	BC-419	5050	P-3079(11,77)	5184	HVO-9
45-12	TV-180(5)	132-140A	BC-419	5053	P-3079(10,11)	5184A	A-3025
45-16	BC-553	132-145	BC-419	5055-1	P-3079(10,11)	5186	A-3020
45-17	BC-563	132-147B	BC-419	5061-1	P-3055(10)	5187	HVO-36(7)
45-20	BC-537	132-150A	BC-419	5064	P-3055(10)	5188/-6	A-2823
45-23	TV-193	132-155A	BC-419	5067-1	P-2892	5189	MDF-91
45-24	TV-181	136-131	BC-393(2)	5079	P-3055	5189A/-2	A-2822(2)
45-27	TV-180	136-134	BC-401	5081	P-3055(11)	5190A/-2	C-4084(2)
45-30	TV-204	136-141A/E/F	BC-393	5100B	A-3019	5191A	HVO-12(3)
45-31	BC-566	136-141-1/ 2	BC-393	5102	A-3019	5192	A-2900(2)
45-32	TV-196	138-116	A-3031	5104A	A-2900(2)	5192A-1	MDF-73(4,8)
45-33	TV-200	138-118/B	A-3025	5105	HVO-36	5193	A-2904(2)
45-35	BC-562	138-125	A-2927	5106/A/-2/-3	A-2825	5194	A-2825
45-38	BC-561	138-130	A-3025(2)	5107	A-2823	5195	C-4115
46-3	C-2994(2)	138-132	A-3031	5109A	A-3039(2)	5196	HVO-36
46-10	C-3183(2)	138-148	A-3025	5111-2	A-2936	5196A	A-3020
46-11	C-3193	138-150	A-3025	5116A	A-2900(2)	5197	HVO-157(7)
46-12	C-3196(2)	138-152A	A-3025	5118A	HVO-36(7)	5198-1	MDF-74(4)
46-17	C-3180(2)			5121A/ 1	MDF-91(4)	5201	TV-103
51-3	A-2931			5123	HVO-3	5202	TV-136
51-11	A-3102			5124	A-2931(2)	5203	TV-101
51-17	A-3102			5124A/-1	MDF-74(4,8)	5208	TV-163
51-38	A-2913(2)			5125A/-3	HVO-36(2,7)	5211A	TV-151
51-70	A-4081			5127/A	A-4003	5214	TV-112
52-4	BC-352			5128/A	A-2998	5215	TV-151
52-5	BC-354			5129	A-3035(2)	5218	TV-116
52-6	FM-254			5131	A-3020	5219	TV-130
52-7	BC-352			5132A/ 1	HVO-9(7)	5219A	TV-131
52-8	BC-352			5133-1	BC-562	5220	TV-238(12)
52-9	BC-353			5134	HVO-3	5220A	TV-245
52-19	BC-356			5134A/ 1	HVO-54(7)	5221A	TV 243
52-23	FM-256			5135	HVO-5	5227	TV-142(19,62,83)
52-26	FM-254			5135A	C-2996(2)	5228	TV-115
52-27	FM-254			5140	A-3037	5229	MWC-6
52-38	BC-352			5140A	A-2823	5231	MDF-91
52-39	BC-353			5142	A-3019	5233	TV-120(83)
52-62	BC-356			5144	HVO-51	5235A	TV-110
52-64	BC-357			5145	HVO-51	5236A/-1	TV-163
53-2	FM-255			5146	HVO-51	5240A	TV-152
53-4	FM-255			5147	A-3020	5241A	TV-153
54-23	P-3046			5148	HVO-51	5241A-5	TV-152
				5149	HVO-51	5242A/-3/ 6	TV-126
				5152	A-3027	5243A	TV-130
				5155	HVO-51	5243A-6	TV-126
				5155A/-1/-2	A-2823	5248A	TV-181(5)
				5156	HVO-47	5250A	TV-200
				5157	A-3039	5251A	TV-207(5)
				5158	A-3020	5252A/-1	TV-115
				5158A/-2	HVO-36(2)	5254A	TV-126
				5160	HVO-47(7)	5255A	TV-151
				5160A	A-2931(2)	5256A	TV-151
				5161A-1	MDF-92(4)	5263A	TV-181
				5162	A-3006	5264A	TV-180
				5162A	A-2904(2)	5265A	TV-203
				5163	A-2928	5265A	TV-188
				5164	A-2825	5266	BC-563
				5164A	C-4084(2)	5269A	BC-566
				5165	HVO-39(50)	5276A	TV-185

PART NUMBERS		PART NUMBERS		PART NUMBERS		PART NUMBERS	
MFGR.	MERIT	MFGR.	MERIT	MFGR.	MERIT	MFGR.	MERIT
HOFFMAN		HOFFMAN		HOFFMAN		HOFFMAN	
5284A	TV-153	5443	TV-110	728002	A-2823(2)	768012	TV-163
5286	BC-352	5446	TV-103	728003	A-2823	768014	TV-165
5287	BC-353	5447	TV-163	728008	A-2988	768015	TV-166
5290	MWC-7	5453	TV-151	728011	A-2822(2)	768016	TV-163
5291	MWC-4	5454	TV-151	728013	HVO-134(34)	768017	TV-163
5293	MD-12(54)	5456	TV-141(37)	730001	A-3003	768019	BC-393
5294	MWC-12	5457	MWC-6	734001	C-4133(2)	768020	TV-163
5295	MWC-7	5460	TV-185	734003	C-4084(2)	768021	TV-163
5295A	MWC-2	5462	TV-151	734004	C-4084(2)	768027	BC-577
5297A	TV-127(1,55)	5464	MWC-11	734006	C-4115	768039	BC-394(79)
5298	TV-102	5537	TV-126	734007	C-4084(2)	771008	TV-181
5298	TV-103	5538/-6	TV-126	734008	C-4084(2)	771009	TV-207
5299	TV-150	5538-8	TV-128(55)	750001	BC-566	771011	TV-184(5)
5300	TV-163	5538-8	TV-127(55)	750002	BC-561	771014	TV-190
5301	TV-199	5538-8	TV-125(55)	750004	TV-192	771019	TV-207
5304	TV-104	5539	TV-126(41)	750005	BC-566	771023	TV-205
5305	TV-111	5542	TV-127	750006	BC-562	771024	BC-513
5306A	TV-193(5)	5543	TV-126(1)	750007	BC-561	771025	TV-193
5307A	TV-207(5)	5545	TV-181(5)	750008	BC-561	771026	TV-184
5308	TV-151	5561	MWC-6	750014	BC-565	771027	TV-184(5)
5312A	TV-115	5562	TV-131	750015	BC-562	771028	TV-184(5)
5313A	TV-185(5)	5571	MWC-12	750016	BC-563	771029	TV-199
5314A	TV-185	5591	TV-127(1)	756001	MWC-14	771030	TV-185
5316	MWC-7	5591	TV-128(1)	756002	MWC-15	771031	TV-184
5316A	TV-153	5593-1	TV-113(1)	760003	TV-113	771330	TV-200
5317	MWC-8	9712	MDF-75	760004/-0	TV-126	774001	TV-121
5321A	TV-151	9714	MDF-72	760011	BC-352	774002/-0	TV-115
5322A	TV-151	9729	MDF-88	760012	FM-254	774004	FM-255
5324	MDF-70(54)	9747	MDF-78	760013	FM-254	774006	TV-115(39)
5325	MWC-2	9748	MDF-92(4,54)	760019	TV-126	774007	TV-121
5326	MWC-5	9753	MDF-78	760022	TV-247	774009	TV-121
5326A	TV-245	9761	MDF-78	760024	TV-113	778002	MWC-11
5327A	TV-243	9828-2	MDF-73(4,7,8)	760027	BC-569	778003	MWC-6
5328A	BC-513	99698	MDF-74(4,54)	760028	BC-570	780001	TV-152(12)
5331A	TV-181	99723	MDF-74(4,8)	760029	BC-571	782002	HVO-36(7)
5334A	TV-245	99740	MDF-74(4,8)	760030	BC-571	782005/-1	HVO-137
5335	TV-116	99785/-1	MDF-91(4)	760057	FM-256	782006/-1	HVO-153(7)
5336A	TV-154	99787/-3	MDF-92(4)	760058	FM-256	782007	HVO-132
5344	TV-118	99794	MDF-74(4)	760060	FM-257	782009	HVO-153(7)
5352A	TV-115	99810	MDF-92(4,8)	760061	BC-356	782010	HVO-153(7)
5363A	TV-131	99811/-1	MDF-91(4)	760062	BC-357	782011	HVO-191
5365A	TV-165(79)	99828/-2	MDF-73(4,7)	760063	BC-357	788005	MDF-120(4)
5369A	TV-121	582002	HVO-36(7)	762004	TV-119(12)	790002	MDF-92(4,8)
5370A	TV-113	716004	P-3055	762005	TV-151	790005	MDF-120(4)
5376/A	TV-151	716005	P-3055(11)	762006	TV-131	790007	MDF-120(88,92)
5389/-1	MDF-75	716006	P-3051	762007	TV-243	790008	MDF-131(88)
5391	TV-137	716007	P-3052(32)	762008	TV-245	790009	MDF-115(4,92)
5395	TV-150(79)	720002	MDF-92(4,8)	762009/-1	TV-130	790010	MDF-115(4,92)
5396	TV-118	724001	A-2998	762010	TV-131	790011	MDF-115(4,92)
5402	TV-151	724003	A-2931	762013	TV-132	790013	MDF-108(4,7,90)
5403	FM-254(2)	724004	A-3020	762017	TV-130	790014	MDF-120(54)
5404	FM-254(2)	724005	A-2902	762018	TV-154	924002	BC-418
5405	BC-352(2)	724006	A-2904(2)	762019	TV-126	924017	BC-419
5406	BC-353(2)	724009-2	A-2905(2)	762020	TV-131	924018	BC-419
5413	FM-255(1)	724014	A-2905	762021	TV-151		
5420	TV-116	724015/-1	A-2931	762022	TV-243		
5422	MWC-5	724019	A-3026	762023	TV-245		
5423	MWC-11	724021	A-3020	762024	TV-130		
5428	TV-151	724025	A-3026	762025	TV-243		
5429	TV-110	724028	A-3027	762027	TV-120		
5430	TV-119(12)	724030	A-3130(2)	762028	TV-131		
5433	TV-181(5)	724033	A-2902	762031	TV-134		
5434A	TV-245	724034-1	A-2902	762032	TV-243		
5437	TV-151	724038	A-2998	767010	TV-131		
5438	TV-152	724039	A-3019	768001	TV-165		
5439	TV-130	724041	A-3026	768002	MWC-11		
5440	TV-152	724043	A-2901	768004	TV-163		
5440	TV-153	724058	A-2928	768006	TV-163		
5441	TV-130	724059	A-4103	768007	TV-164		
5442	TV-130	724060	A-4103	768010	BC-393		
						HOTPOINT	
						(See G.E.)	

MERIT COIL AND TRANSFORMER CORPORATION

PART NUMBERS		PART NUMBERS		PART NUMBERS		PART NUMBERS	
MFGR.	MERIT	MFGR.	MERIT	MFGR.	MERIT	MFGR.	MERIT
HUDSON AUTO		I.T.&T.		JACKSON		JEWEL (See Truetone)	
24C485553	BC-352	31-3131	BC-574	LF-52	FM-254		
24K485555	BC-355	31-3132	BC-575	LG-10007	C-2974		
25B533038/-C	A-2900(2)	31-3133	BC-576	LF-10017	TV-163		
95-914	P-4071	31-3572	BC-570	LO-8/-13	BC-381		
95-915	A-2930(2)	31-3573	BC-571	N-201-18746	TV-151		
95-916	BC-367	31-35150	BC-574	N-7981	BC-352	22.1549	TV-192
95-917	BC-372	31-35151	BC-575	PM-200X	A-3026(2)	22.1556	BC-352
95-942	BC-372	31-231051	BC-569	PM-250	A-2930	22.1557	BC-353
95-1023	P-2971(2)	31-231052	BC-570	PM-255-2	A-2930	22.1964-1/-3	BC-352
95-1024	P-2971(2)	31-231053	BC-571	PM-702	A-2930	23.1175-15	TV-118
95-1030	A-2930			PM-705/B	A-2930	23.1175-17/-24	TV-118
95-1060	BC-372			PM-706	A-2930		
95-1066	P-4071(2)			PM-710	A-3025(2)		
95-1077	BC-367			PM-720	A-2930		
95-1087	BC-367			SR-10019	A-2930(2)		
95-1088	BC-372	JACKSON		TO-10004A	A-2928(2)	KAISER FRAZER	
121-0015	BC-367	A10-485	BC-386	TO-10020	HVO-3	P74J110	P-2971(2)
121-0020	BC-350	A10-505	BC-387	TO-10021/-D	A-3036	P74J301-1	A-2930(2)
122-0015	BC-372	A10-508	BC-352	TO-10022	A-4000	RTL-041	BC-367
122-0022	BC-354	A10-509	BC-353	TO-10023	MWC-7	RTL-042	BC-372
141-0012	P-4071(2)	A13D-16943	TV-163	TO-10024	MWC-12	RTL-086	BC-367
141-0025	P-3068	A-13M-18026	TV-102	TO-10026	MDF-70	RTL-087	BC-372
143-0004	A-2930	A-13M-18233	MWC-7	TO-10028	HVO-3	RTO-033	A-2930(2)
143-0025	A-2936(2)	A-201-17962	TV-151	TOA-10030	A-3003	RTO-056	A-2936
206662	P-2971(2)	A-201-18695	TV-151	TP-10002	P-2846(20)	RTP-043	P-2971(2)
207301	BC-372	A-1475-10	TV-102	TP-10003	P-2834(11)	RTP-065	P-2971(2)
209569	BC-367	A-1476-10	TV-116	TRF-10023	TV-230(2)	6060	P-4076(2)
209684	P-4071	A-1477-10	TV-151	TS-10030	TV-102	1218725	BC-350
209865	A-2930(2)	A-1478-10	TV-110	TS-10030	TV-103	1218726	BC-354
215456	BC-367	A-1479-10	TV-163	TS-10032	TV-116	7255881	P-4076(2)
215457	BC-372	A-1480-10	TV-150(79)	TS-10034B	TV-110	7259375	P-4076
215497	A-2930	A-1486-10	MWC-7	TS-10042	TV-108(2)	7259614	P-4076(2)
215498	P-4071(2)	A-1490-10	BC-352	TV-86/A	P-2971(2)	7260531	A-2901(2)
		A-1491-10	BC-353	TV-100/A	P-2970	7260712	A-3019(2)
		A-1651/-13	C-2991	TV-200	P-2971(2)		
		A-1652-13	A-3036	12A-306	A-3078		
		A-1654-13	A-3019	12A-449	P-3078		
		A-1661-13	A-3003	12B-401	A-2900		
		B-12C-17303	A-3036	12C-314	A-2930		
		B-12M-18241-1	A-3003	12C-351	A-3036		
		B-13A-17978	TV-154(2)	12C-598	HVO-91(2)	KARADIO (See ATR)	
		B-13B-17956	TV-140(2)	12F-345	HVO-3		
		B-13M-13590	MD-12(54)	12F-450	HVO-91(2)		
		B-13M-17273	TV-110	12F-598	HVO-91(2)		
		B-13M-18693	MDF-70	13A-188	TV-102		
		B-16A-17959-1	C-4084	13A-189	TV-116	KARR	
		B80-242	A-2900(2)	13A-398	BC-352	201-115	TV-239
		B80-243/E	P-2970	13A-399	BC-355	219-111	BC-566
		B-201-15612	TV-102	13F-190	TV-150(79)	1655-2	BC-352
		B-201-15612	TV-103	13F-192	TV-163		
		B-1450-9	MDF-70	13F-389	TV-151		
		B-1452-9/-9C	MDF-70	13K-191	TV-110		
		B-1467-10	MWC-15	13M-347	MD-12	KAYE-HALBERT	
		B-1471-10	TV-116	13M-459	MD-12	C-101	P-3169(16,28)
		B-1472-10	TV-110	13N-348	MWC-7	C-102	P-3169(14,13)
		B-1650-13	P-3070	14A-1477-10	TV-151	C-103	P-2964
		B-1651-10	C-2991	17B-440	C-2991	C-1002	C-2996
		B-1652-13	A-3036	60-8	C-2991	C-2002	A-2930
		B-1653-13	A-3019	62-2	BC-388	C-2004	A-2930
		B-1662-13	A-3037	62-14	BC-353	C-2005	A-2930
		B-1675-13A	HVO-46(2,7)	130-102	BC-386	C-2020	A-2931
		B-1676-13A	HVO-46(2,7)	130-107	BC-352	C-2120	HVO-47
		C-12A-18399	P-3070	130-108	BC-353	C-2121	HVO-47
		C-12A-18839	P-3070	130-109	FM-254	C-2123	HVO-36
		C-18A-18468	A-3020	130-110	FM-255	C-2302	A-2823
		C-1803/-1	BC-352	132-109	BC-563	C-2304	A-2821
		C-5013P	BC-287	132-112	BC-564	C-2306	A-3039
		IF-51	FM-254	318V-2	P-2970(2)	C-3102	A-3003
		IF-53	FM-255	1405	BC-352	H110	TV-110
		LF-24	BC-352	1406-A	BC-355	H112	TV-116
		LF-50	BC-352	1655-16	BC-352	H116	TV-151
				14977	BC-352	H118	TV-104
						H120	TV-111
INTERNATIONAL (See Motorola)							

PART NUMBERS		PART NUMBERS		PART NUMBERS		PART NUMBERS	
MFGR.	MERIT	MFGR.	MERIT	MFGR.	MERIT	MFGR.	MERIT
MAGNAVOX		MAGNAVOX		MAGNAVOX		MAGNAVOX	
320279-1/-3/-4	A-3018	360496-1	MDF-70	360625-1/-2	BC-355	360870-1	BC-571
320279-5	A-3019	360499-1	TV-167	360626-1	FM-254	360873-4	BC-419
320280-1	A-3018	360499-3/-4	TV-162	360627-1	FM-255	360874-1	BC-573
320287-1	A-2902	360511-1	TV-116	360631-1	MWC-2(6)	360881/-1	360881-175
320295-1	A-2935	360512-1/-2	TV-114	360632-1	HVO-62(3)	360887-1	BC-397
320297-1	A-3018(1)	360515-1/-2	MDF-70(4)	360636-1	TV-130	360888-1	BC-352
320303-1	A-3025(22)	360516-1	MDF-70(4)	360640-1	TV-131	360889-1	FM-256
320304-1	A-3031(2)	360517-1	MWC-2	360642-1	TV-114	360890-1	BC-641
320304-2	A-3025	360519-1	TV-113	360643-1	TV-247(5)	360891-1	FM-257
320306-1	A-2930	360522-9	BC-561	360644-1	TV-128(2)	360895-1	BC-419
320309-1	A-2928	360526-1	MDF-70(4)	360645-1	TV-132	360898-1/-2	HVO-119(7)
320312-1	A-3019	360529-1	TV-142	360650-1	TV-120(2)	360899-1	BC-553
320663-1	A-3019	360533-1	MWC-6	360651-1/-2	TV-124(2)	360900-1	MDF-137
320802-2	A-2928	360534-1	MWC-1	360652-1	MWC-12(6)	360912-1	HVO-172(7)
320803-2	C-4115	360535-1	TV-119	360653-1	BC-562	360927-1	BC-356
320807-2	A-3025	360540-1	TV-131	360657-1	TV-151(2)	360927-2	BC-356
320810-1	A-3037	360545-1	TV-128(83)	360659-1	HVO-133	360927-3	BC-569
320811-1	HVO-127	360549-1	TV-247	360660-1	MDF-92(4,8)	360927-4	BC-570
320819-1	A-2935	360552-1/-2/-2A	HVO-214	360665-1	TV-157	360928-1	BC-357
320984	A-2930	360553-1	MWC-6	360667-2	TV-185	360930-5	BC-577
326078-2	C-2994	360554-1	TV-153	360667-3	TV-202	360934-1/-2	BC-574
330037-3	A-2900	360556-1/-2/-3	MDF-92(4,54,75)	360667-4	TV-185	360934-3	BC-575
330038-1	A-4107(2)	360556-4/-5	MDF-92(4,54,75)	360669	MWC-12(2)	360934-4	BC-576
330039-1	A-4107	360570-1	MWC-1	360673-11	TV-186	360934-8	BC-574
330041-1	A-2901	360572-1/-9	TV-163	360673-13	TV-195(5)	360934-9	BC-575
330043-1	A-3027	360575-1	BC-561	360673-14	TV-180	360934-10	BC-576
350046-1	C-2996(2)	360577-1	HVO-214	360673-15	TV-205(5)	360934-19	BC-574
350579-1	TV-163	360579-1/2	TV-163	360674-6	TV-205	360934-20	BC-575
350700-2	HVO-175	360580-1	HVO-62	360676-1	BC-566	360934-21	BC-576
360067-1	A-3039	360581-1	TV-130	360676-5	BC-565	360934-22	BC-569
360329-1	BC-386	360583-1	TV-130	360676-8	BC-562	360934-23	BC-570
360330-1/-5	MD-12	360584/-1	TV-151	360699/-1	MWC-12(6)	360934-24	BC-571
360330-7	MDF-70	360585-1/2	MWC-10(6)	360700-1/-2	HVO-175	360946-1	HVO-233C
360330-9	MD-12	360586-1	MWC-6(2)	360702-1	BC-397	360947-1	MDF-144C
360331-1/-2	MWC-7	360587/-1/-3	MDF-73(4)	360714-1	TV-151	360950-1	TV-190
360332-3/-G3	TV-100	360588-1	TV-115	360715-1	TV-120	360950-1	TV-195
360332-4/-G4	TV-101	360591-1	TV-163	360716-1/-2	TV-124(2)	360968-1	TV-192
360332-5/-G5	TV-101	360593-1/-2	HVO-214	360720-1	TV-130	360971-1	BC-387
360332-6/-G6	TV-102	360599-5/-7	MDF-92(4,54,75)	360722-1	TV-119(12)	361001-2	BC-419
360332-12/-G12	TV-105	360601-6	BC-564	360746-1/-4	BC-419	361013-1	BC-419
360332-13/-G12	TV-106	360601-9	BC-561	360747-1/-2	FM-256	361016-1	FM-257
360334-1	MWC-12	360601-10	BC-560	360748-1	FM-257	361017-1	BC-419
360340-1	C-2991(2)	360604-1	HVO-62	360752-1	BC-393	361018-2	BC-666
360357-1	MWC-8	360606/-1	HVO-118	360753-1	BC-388	361043-1	BC-566
360358-1	MWC-4	360609-1	MWC-11(6)	360754-1/-2	MDF-120(75,88)	361043-3	BC-679
360373-2	BC-353	360610-1	HVO-62(3)	360755-1	M47-110	361043-4	BC-566
360374-1	FM-254	360611-1	BC-352	360772-1	TV-119(12)	361044-4	TV-157
360375-1	FM-253	360613-1	TV-114	360777-1	HVO-175(7,29)	361046-1	HVO-234C
360379-1	TV-141(41)	360614/-1	HVO-119	360779-1	HVO-172	361047-1	MDF-143(4)
360381-1	TV-104(2,19)	360617-1/-2	MDF-92(4)	360780-1	MDF-92(4,75,90,92)	361050-1	TV-194
360382-1	TV-104	360620-1	BC-562	360781-1/-2	BC-641	361050-2	TV-202
360384-1	MD-12	360622-2	TV-196(5)	360782-1/-2/-3	BC-419	361050-3	TV-199
360402-1	TV-162	360622-4	TV-203	360783-1	BC-564	361050-4	TV-184
360403-1/-5	TV-119(12)	360622-5	TV-184	360798-1	TV-130	361050-5	TV-192
360407/-1	BC-381(28)	360622-6	TV-195(5)	360799-1/-2	TV-130	361053-1	TV-250
360407-2	BC-393	360622-7	TV-202	360800-1	TV-247	361054-1	MWC-5(2)
360434-1	TV-110	360622-8	TV-196	360801-1	TV-152	361062-1-2-3	BC-419
360440-1	TV-113(2)	360622-9	TV-185	360801-1	TV-153	361063-1-2-3	BC-356
360443-23	BC-565	360622-10	TV-205	360804-1	M47-110	361063-4/-5	BC-356
360443-37	TV-206	360622-11	TV-195	360805-1	TV-151	361064-1-2	FM-259
360443-39	TV-190(5)	360622-12	TV-203	360852-1	BC-566	361065-1	FM-258
360461-1/-2/G1	TV-116	360622-13	TV-181(5)	360852-2	BC-565	361066-1	TV-198
360462-1/-4/-5/-6	MDF-70	360622-13	TV-194(5)	360852-3	BC-563	361067-1	BC-394(79)
360464	MDF-70	360622-14	TV-186(5)	360853-1	BC-674	361079-3	FM-257
360479-1	TV-162	360622-15	TV-185(5)	360853-2	BC-676	361202-1	TV-243
360481-1/-2/G1	TV-151	360622-16	TV-198	360853-3	BC-670	361207-1	TV-121
360482-1/G1	TV-110	360622-17	TV-198(5)	360862-1	MWC-12	361209-1	TV-163
360483-1	TV-151	360622-18	TV-195	360865-1	FM-255	361215-1	BC-352
360484-1	TV-118	360623/-1	HVO-119	360868-1	BC-569	361216-1	BC-353
360490	TV-173	360624-1	TV-131	360869-1	BC-570	361218-1	TV-120

PART NUMBERS		PART NUMBERS		PART NUMBERS		PART NUMBERS	
MFGR.	MERIT	MFGR.	MERIT	MFGR.	MERIT	MFGR.	MERIT
MAGNAVOX		MAJESTIC		MAJESTIC		MATSUSHITA	
361219-1	TV-113(1)	C-1.554	TV-119	9238-051/-060	BC-561	IF-M1-LB	BC-357
361221-1	TV-245	C-1.555	TV-151(5)	9238-080	BC-562	LA-0T-956	A-2930
361222-1	MDF-92(4,7,87)	C-1.601	BC-394	9238-106/-176	BC-560	LD-02501-5	BC-662
361223-1	M51-70-90	C-1.704	TV-127	9264	A-2936	LD-12501-5	BC-670
460894-4	BC-419	C-1.705	TV-128	9282-4	A-2900	LD-25501-1	TV-198
620032	A-2901(2)	C-1.706	TV-126	9303	A-3020	LD-40001-5	BC-676
623278-1	A-2902(2)	C-1.707	TV-113	9303-2	A-2901	LD-55001-5	BC-678
700703-1/-5	MDF-92(7,8,75)	C-1.709	TV-113			LH-203-1	MWC-12
700747-1/-2/-4	MDF-120(54,72)	C-1.710	TV-124(2)			LH-302	TV-165
700747-5/-6/-7	MDF-120(54,72)	C-9.201	P-2952			LH-601	MWC-2
703046-2/-2B/-3	MDF-143	C-9.209	MD-12(4)	MASCO		LH-603-2	MWC-2
903562-502	MDF-144C	C-9.212	A-4002	A-10	P-2952	LI-6653	BC-566
903562-507	MDF-144C	C-9.213	A-4000	E-622	BC-352	LP-407	TV-189
906141-501	HVO-233C	C-9.220	HVO-3	P-236	P-3155(2)	LQ-121-199	TV-195
926636-501	HVO-232C	C-9.221	A-3036	1607-1/-5	FM-254	LQ-131-999	TV-195
				1655-6/-7/-12	BC-352		
942476-4	A-3003	C-9.223	C-2974	2607-1	FM-253	LQ-250-107	BC-566
961415-1	A-4138C	C-9.224	C-2991			LQ-301-153	TV-199(5)
961415-2/-7	A-4139C	C-9.225/-3/-3C	A-3020			LQ-301-822	TV-199(5)
961416-1	P-4141C	C-9.225-4E	A-3020			LQ-750-272	TV-193(5)
961429-3	A-3019	C-9.226	A-3027			LQ-951-272	TV-208(5)
962636-501	HVO-232C	C-9.228/-3/-4/-5	A-3036	MASTERWORK		LS-1001	TV-119(12)
962712-502	P-4141C	C-9.230-2/-3	A-3003	C-3115	A-2932	LS-1001-2	TV-151
970727-23	A-3020	C-9.230-4/-5	A-3003	E20120	BC-574	MI-B/2/3	BC-574
972128-6/-8	A-3020	C-9.237/-2/-3/B	C-2991	E20120	BC-575	OT-329/W	A-2902
1104310-2	C-4133	C-9.240-1	HVO-3	E20120	BC-576	OT-482	A-2755
				F3135	A-3025		
1104665-1/-2/-3	C-4133	C-9.241	A-3019	G20108	BC-356	OT-956	A-2928
1106861-2	MDF-144C	C-9.241-2	A-3018	G20109	FM-257	OT-964W	A-2900
1106862-2	HVO-231C	C-9.242	MDF-70	G21107	BC-419	QL-501-999	TV-203
		C-9.244	HVO-7(2)	P-3126	A-2902	RFCB-25215	BC-561
		C-9.253-1/-2	HVO-96	P-20159	BC-419	TAI-10S-CXF-1A	BC-574
		C-9.254/-3/-J/-L	MDF-72(4,8)	P-21147	BC-566	TC-91M	A-3031
		C-9.259/-1	HVO-96	56-69	A-2902	TC-91Q	A-2930
		C-9.287	A-2901	56-71	A-2902(2)	TC-131C	A-2902
		C-9.310	P-3045(2)	57-21	C-4095(2)	TC-941	A-3031
		C-9.381-1	C-2974	72-86	BC-394	TI-S1B	BC-569
MAJESTIC				75-19	BC-562	TI-S1C	BC-569
A2016	TV-104	C-9.384	P-3050(2)	75-54	BC-566	TI-S2B/C/D	BC-570
B-1.458	MWC-7	C-9.385-1	A-2928	270-58	BC-419	TI-S3C	BC-571
B-1.459	MWC-12	D-9.225	P-2835(11)	273-129	BC-352	TI-W1C	BC-574
B-1.519	TV-163	D-9.228-6	A-3036	273-151	FM-254	TI-W2/W4	BC-584
B-1.530	TV-169	D-9.235	P-2835(11)				
				279-80	FM-255(63)	TI-W4E	BC-576
B-1.531	MWC-11	D-9.246	MDF-70			TI-Z1D	BC-584
B-1.533/-1	MWC-12	D-9.252/A	P-3055			TI-Z1G	BC-574
B-1.549	TV-162	D-9.260	P-3055			TI-Z2B	BC-584
B-1.553/-1	MWC-12	D-9.263-2	P-3147			TI-Z2D	BC-575
B-9.282-3/-4	A-2930	D-9.270	MDF-91(4)				
BV1975/I	BC-562	D-9.272	P-3055	MATTISON		TI-Z3B	BC-584
BV1976/I	BC-563	D-9.382-1	MDF-75(4)	(See Sheraton)		TI-Z3E	BC-576
BV9060-506.01	A-2901(2)	D-9.383-1	HVO-92			TRI-2-11/2/3	BC-584
BV9066-501	A-3019(2)	HFBV1833	BC-562			TRI-7-15D	BC-571
BV9218-012	BC-565	HFBV1950/I	BC-561	MATSUSHITA		TRI-10-1D	BC-576
				A007-EJ-2	BC-394	TRI-10-11B	BC-575
C-1.445-2/-3/-5/-6	BC-352	HFBV1975/I	BC-562	A007-PW	BC-394	TRI-10-11D	BC-584
C-1.446-2/-3	FM-254	SM118	BC-368(2)	A007-X	BC-387	TRI-10-32B	BC-575
C-1.458	MWC-7	ZF340	TV-106	AM-1080-A/-B	BC-419	TRI-10D-7A	BC-574
C-1.459	MWC-12	ZS337-L	TV-104	AR-1080-FJ-1/-2	BC-389	TRI-1055A	BC-574
C-1.461	TV-114(1)	ZV320T	TV-100(2)				
				E6055	BC-419	TRI-1055B	BC-575
C-1.475-1	TV-103	9.260	P-3055	E6271	BC-356	TRI-1055D	BC-576
C-1.476	TV-116	80-2109-2	A-2930	E6273	FM-257	956MA	A-2928
C-1.477/-2	TV-113	9054-017	A-3032(2)	EFI-20A-LAG-3A	FM-256	101104101	BC-569
C-1.509-1	TV-113	9060-098-03	A-4101(1)	EFI-20R-LBG-1C	FM-256	101104102	BC-570
C-1.520	MWC-12	9060-501	A-2901(2)				
				EFI-20S-LAG-3A	FM-256	101104103	BC-571
C-1.521	TV-110(1)	9218-015	BC-561	EFI-20S-LAG-4A	FM-256		
C-1.522-2	TV-202	9218-016	BC-560	EFI-20S-LBG-2B	FM-256		
C-1.522-3	TV-194	9218-017	BC-562	EFI-20S-LBG-1C	FM-256		
C-1.522-4	TV-195	9218-103	TV-192	EIA-75-111A	BC-569		
C-1.528-1	TV-115	9233-013	BC-389				
				EIA-10S101D	BC-576		
C-1.529/-1/-2	TV-119(12)	9233-020/021	BC-419	ELL-7S7	BC-572	MAXWELL	
C-1.542-1	FM-255	9233-052/053	BC-419	FMI-20P-BR	FM-257	200-0005-001	BC-356
C-1.549	TV-162	9233-054/-071	BC-419	FMI-22Q-A1	FM-256		
C-1.552/-1	TV-115	9238-012/022	BC-562	IF-M1-LA	BC-356		
C-1.553	TV-116						

MERIT COIL AND TRANSFORMER CORPORATION

PART NUMBERS		PART NUMBERS		PART NUMBERS		PART NUMBERS	
MFGR.	MERIT	MFGR.	MERIT	MFGR.	MERIT	MFGR.	MERIT
MOTOROLA		MOTOROLA		MOTOROLA		MOTOROLA	
1X712105	TV-116	24B543286	BC-350	24B780356	TV-161(2)	24C66772A02	BC-564
1X712106	TV-116	24B562109	BC-355	24B780390	TV-116	24C66772A03/A05	BC-565
1X790341	TV-151	24B580193	BC-350	24B780394	TV-103	24C66772A06	BC-565
1X792591	TV-116	24B590193	BC-350	24B790055	TV-163	24C66772A07	BC-562
1X792736	TV-151	24B621561	BC-387	24B790125	TV-115(1,2)	24C66940A01	TV-208
15C742818	MDF-116(8,9)	24B631278	BC-353(2)	24B790849	TV-103	24C90118	MD-12
24A64389A01	BC-561	24B632943	BC-394	24B790851	TV-151	24C472533	P-4071
24A64389A02	BC-562	24B638340	BC-393	24B790852	TV-116	24C484877	MD-12
24A90197	TV-102	24B690540	FM-254(1,2)	24B791592	TV-118	24C485553	BC-352
24A470159	TV-151	24B690541	FM-254(1,2)	24B791793	P-2848	24C485554	BC-355
24A472535	BC-537	24B690542	FM-252(2)	24B792585	TV-116	24C485555	BC-355
24A531057	BC-537	24B700088	MWC-6(6)	24B792586	TV-136	24C504263	BC-346
24A532148	TV-180	24B701343	TV-142(83)	24B792735	TV-151	24C536543	BC-346
24A538914	BC-537	24B702543	TV-110	24C40788A04	BC-562	24C539614	TV-184
24A721274	BC-562	24B702984	TV-141(37)	24C40788A05	BC-562	24C540911	BC-344
24A733225	BC-566	24B720977	TV-142(37)	24C40788A08	BC-561	24C541028	BC-320
24A737733	BC-566	24B721273	TV-141	24C40788A11	BC-562	24C544393	FM-254
24A737829	BC-566	24B721869	TV-131	24C60418A01	BC-568	24C561406	BC-354
24A790033	TV-172	24B721949	TV-247	24C60420A01/A04	FM-254	24C561809	BC-681(5)
24A790176	TV-102	24B721951	TV-127(1)	24C60420A05/A06	FM-254	24C564263	BC-346
24A790184	HVO-12(3)	24B721953	TV-128(1)	24C60420A07	FM-256	24C580066	P-4078
24B60948A01	TV-239	24B730392	TV-131	24C60421A01	FM-255	24C622774	BC-352
24B61184A03	BC-393(7)	24B730614	TV-128(1)	24C60513A01	BC-569	24C630284	BC-352
24B61364A01/A02	BC-419	24B730615	TV-127(1)	24C60513A02	BC-570	24C631118	BC-353
24B61719A01	BC-393(83)	24B731090	MWC-10	24C60513A03	BC-571	24C631955	BC-352
24B62393A01	BC-388	24B731883	TV-151	24C60527A01	BC-572	24C632774	BC-352
24B62428A01	BC-386	24B732201	TV-127(1,2)	24C61565A01	BC-573	24C632775	BC-355
24B62676A01	BC-419	24B732672	TV-208	24C61572A01	BC-574(39)	24C634507	BC-352
24B64613A01	BC-596	24B733484	TV-127(1,2)	24C61572A02	BC-575(39)	24C638488	FM-255
24B64613A02	BC-639	24B733485	TV-128(1,2)	24C61572A03	BC-576(39)	24C643901	BC-356
24B64614A02/A03	BC-639	24B733751	MWC-10	24C61707A01	BC-393	24C646136	BC-574
24B64785A01	BC-681(5)	24B733873	TV-119(12)	24C61717A01	FM-255(63)	24C647050	FM-257
24B64785A02	BC-673(5)	24B735179	TV-245	24C61935A01	FM-257	24C700050	MDF-75
24B64785A03	BC-562	24B735180	TV-243	24C62093A01	BC-356	24C700069	MDF-75
24B64861A02	BC-691	24B735532	TV-190	24C62093A02	BC-641(5)	24C700714	MDF-75
24B64861A03	BC-690	24B736226	TV-151	24C62093A03	BC-355(5)	24C700774	MDF-75
24B65362A01	TV-119(12)	24B736258	TV-130	24C62093A04	BC-356	24C700776	MDF-75
24B70827	BC-352(1)	24B736267	TV-130	24C62361A01	FM-256	24C700778	MDF-75
24B76553	BC-352(1)	24B736268	TV-130	24C62450A02	BC-419	24C701134	HVO-12
24B90060	TV-103	24B736673	TV-115	24C62505A01	BC-356	24C701600	MDF-70
24B90119	MWC-7	24B736966	TV-152	24C62691A01	FM-258	24C701601	MDF-70
24B470316	TV-115(1,2)	24B737734	TV-151	24C62702A01	FM-259	24C701609	MDF-70
24B470794	TV-160(2)	24B737848	TV-153(12)	24C65410A02-B-1	HVO-223	24C701611	MDF-70
24B470796	MWC-12	24B737850	TV-130	24C65410A05-H	HVO-209	24C701612	MDF-70
24B471340	TV-106(2)	24B738122	TV-119	24C65775A01	BC-537	24C702655	MDF-78
24B471520	BC-353(2)	24B738942	TV-151	24C65828A01/A02	BC-566	24C702958	MDF-78
24B471670	TV-113(2)	24B738943	TV-113(39)	24C65828A06	BC-514(5)	24C703240	MDF-70
24B471672	TV-113(2)	24B739281	HVO-113	24C65828A07	BC-678	24C703260/B	MDF-80
24B471718	BC-352(2)	24B739290	TV-151	24C65828A08	BC-565	24C710636	HVO-12
24B471720	TV-113(2)	24B739304	TV-119	24C65828A09	BC-566	24C711217	MDF-78
24B471722	TV-115(2)	24B740553	TV-151(12)	24C65828A11	BC-681	24C711236	MDF-78
24B481874	BC-352(2)	24B740980	TV-128	24C65828A12	BC-673	24C711265/A	HVO-28
24B482863	BC-352(1,2)	24B740982	TV-127	24C65828A13	BC-674	24C711268	MDF-78
24B482865	BC-353(1,2)	24B740984	TV-126	24C65828A14/A15	BC-673	24C711581	MDF-78
24B484077	TV-151	24B741341	TV-126	24C65828A16/A17	BC-565	24C711583	MDF-78
24B484078	TV-163	24B741645	TV-154	24C65828A19	BC-671	24C711584	MDF-78
24B484084	TV-111(2)	24B741646	TV-113	24C65828A21	BC-674	24C711585	MDF-78
24B485553	BC-352	24B742247	TV-115	24C65828A23/A24	BC-670	24C711587	MDF-78
24B485554	BC-355	24B742767	TV-119(12)	24C65828A25	SW-630	24C720154	MDF-78
24B485555	BC-355	24B742768	TV-119	24C65828A28	BC-671	24C720155	MDF-78
24B485670	BC-352(1)	24B742789	TV-130	24C65828A33	SW-631	24C720622	MDF-78
24B489033	BC-353(2)	24B742790	TV-130	24C65828A34	TV-208	24C720623	MDF-78
24B489056	TV-104(2)	24B743328	TV-130	24C65828A36	BC-668	24C720624	MDF-78
24B489071	TV-116	24B743330	TV-130(19)	24C65828A38	BC-669	24C720747	MDF-78
24B532152	BC-350	24B743426	TV-163(2)	24C65828A40	BC-565	24C721290	HVO-28
24B533073	BC-354	24B743552	BC-562	24C65828A41	BC-673(5)	24C721829	MDF-78
24B533460	BC-355	24B743675	BC-562	24C65828A43	TV-192	24C721830	MDF-78
24B536693	BC-350	24B747171	BC-565	24C65853A01/A02	TV-165	24C721831	MDF-78
24B542371	BC-354	24B747199	TV-113	24C66491A01	TV-152	24C730632	MDF-79
24B542748	BC-350	24B780319	TV-105(2)	24C66772A01	BC-565	24C730633	MDF-79

MERIT COIL AND TRANSFORMER CORPORATION

PART NUMBERS		PART NUMBERS		PART NUMBERS		PART NUMBERS	
MFGR.	MERIT	MFGR.	MERIT	MFGR.	MERIT	MFGR.	MERIT
MOTOROLA		MOTOROLA		MOTOROLA		MOTOROLA	
24C730634	MDF-79	24D65410A01	HVO-198	24D754518	MDF-116	24K565244	BC-552
24C730902	HVO-122	24D65410A02/-B-1	HVO-223	24K40276A03	BC-635	24K580194	BC-354
24C733411	MDF-80(75,87,92)	24D65410A05/-H	HVO-209	24K54209	TV-153(12)	24K591267	BC-354
24C733436	MDF-80(75,87,92)	24D65616A02-B	MDF-132(7)	24K63017	BC-357	24K591555	BC-355
24C734459	TV-115	24D65616A03B	MDF-135	24K64313	BC-356	24K591556	BC-352
24C735763	MDF-79	24D65616A05/-F	MDF-135	24K92173	MDF-75	24K592197	BC-563
24C736006	TV-184	24D65616A06/-H	MDF-135	24K470159	TV-151	26K600824	BC-352
24C736095	HVO-113(112)	24D65616A17	MDF-143(7)	24K472535	BC-537	24K600825	BC-353
24C736487	HVO-222	24D65666A01	TV-152	24K482172	MD-12	24K600893	FM-255(1,2)
24C736623	HVO-113	24D65666A06	TV-153(71)	24K484082	TV-103	24K610639	BC-352
24C736966	TV-131	24D65666A07	TV-134	24K485474	MD-12	24K611438	BC-352
24C739283	HVO-148	24D65666A12/A13	TV-153(2)	24K485475	MD-12	24K611439	BC-353
24C740969	HVO-129	24D65666A15	TV-132	24K485476	MD-12	24K620020	BC-353
24C742676	HVO-140	24D65698A07	MWC-12	24K485554	BC-355	24K630867	BC-355
24C743536	HVO-113	24D65707A01	MDF-132	24K485555	BC-355	24K630898	BC-353
24C743768	TV-126(19)	24D65832A02	TV-165	24K489071	TV-116	24K631969	BC-353
24C744042	HVO-130	24D65853A02/A04	TV-165	24K502819	BC-352	24K632039	BC-352
24C744200	TV-172	24D65950A04/A08	MWC-6	24K512407	BC-350	24K632775	BC-355
24C744406	HVO-164	24D65950A10	MWC-2	24K512408	BC-354	24K632782	BC-355
24C745536	HVO-165	24D66258A03-C	HVO-224	24K532153	BC-354	24K633165	BC-356
24C746779	TV-159(2)	24D66621A01	MDF-99(4,87)	24K532582/B	A-2900(2)	24K633497	BC-353
24C747584	TV-153	24D66866A01	TV-130	24K533461	BC-352	24K634508	BC-355
24C749508	BC-677	24D66872A01/B	MDF-144C	24K534323	BC-537	24K635586	BC-356
24C751034	TV-121	24D66876A03	HVO-235C	24K534901	TV-180	24K635587	BC-357
24C753509	BC-566	24D66876A05-G	HVO-235C	24K536450	BC-355	24K635929	BC-357
24C780417	MD-12	24D66926A08	MDF-143	24K537218	BC-344	24K636016	BC-356
24C780441	MD-12	24D67324A01	BC-675	24K537545	BC-562	24K636017	BC-357
24C780542	MDF-75	24D67324A02	BC-562	24K537792	BC-350	24K638563	BC-357
24C790184	HVO-12(3)	24D67324A03	BC-668	24K539616	TV-195	24K641313	BC-356
24C791181	MDF-75	24D67324A07	BC-677	24K540633	BC-356	24K641654	BC-352
24C791723	MDF-75	24D67324A13	BC-673	24K540912	BC-346	24K641655	BC-355
24C792171	MDF-75	24D67324A14	BC-566	24K541029	BC-356	24K642112	FM-254
24C792173	MDF-75	24D67324A20	BC-671	24K542374	BC-350	24K642707	BC-355
24C792489	MDF-75	24D67324A21	BC-669	24K542491	BC-350	24K643902	BC-357
24C792506	MDF-75	24D67324A24	BC-566	24K542675	BC-354	24K643903	BC-356
24C792508	MDF-75	24D67324A31	BC-563	24K542749	BC-354	24K643904	BC-357
24C792596D	HVO-12	24D67324A32	BC-671	24K543286	BC-350	24K644697	BC-578
24C792691	HVO-10(2,3)	24D67324A33	BC-677	24K543287	BC-354	24K646137	BC-575
24C792699	MDF-70	24D67461A01/A03	MDF-143	24K544395	FM-254	24K646138	BC-576
24C792714	MDF-70	24D544057	TV-180	24K560418	BC-350	24K646154	BC-357(5)
24C792715	MDF-70	24D563300	BC-424	24K560419	BC-350	24K646245	BC-576
24D6661A01-D	MDF-116(3,87)	24D637271	BC-356	24K560753	TV-186	24K646566/-P	BC-574
24D40074A01	BC-636	24D732710	MDF-78	24K560753	TV-193	24K646859	BC-356
24D40074A03	BC-344	24D733411	MDF-78	24K560801	BC-355	24K647022	BC-356
24D40074A05/A07	BC-638	24D735869	MDF-108(7,54)	24K560863	BC-352	24K647049	FM-256
24D40074A09/A13	BC-638	24D735962	MDF-79	24K560873	BC-352	24K647238	BC-574
24D40074A14/A15	BC-638	24D736006	TV-184	24K561390	BC-350	24K647319	BC-574
24D40074A16/A17	BC-638	24D736053	MDF-108	24K561403	BC-346	24K647320	BC-575
24D40074A19	BC-638	24D736445	MDF-97(90)	24K561404	BC-344	24K647321	BC-576
24D40075A01/H	BC-639	24D736449	MDF-108	24K561842	BC-344	24K647701	BC-575
24D40075A03	BC-597	24D736977	MDF-108	24K561843	BC-346	24K647912	BC-356
24D40075A05/A07	BC-639	24D736978	MDF-97	24K562110	BC-352	24K700089	MWC-6(6)
24D40075A11/A12	BC-639	24D739257	MDF-92(4,7,8)	24K562113	TV-192	24K700588	HVO-12
24D40075A15	BC-639	24D739275	MDF-116(4,7,8)	24K562151	BC-354	24K700694	MDF-75
24D40075A16/A17	BC-639	24D739276	MDF-92(4,7,8)	24K562152	BC-350	24K700714	MDF-75
24D40075A19	BC-639	24D740587	MDF-108(7,8)	24K562153	BC-350	24K700774	MDF-75
24D40276A03	BC-635	24D740660	HVO-139	24K562320	BC-354	24K700776	MDF-75
24D42032A05	C-4095	24D740942	MDF-116(90)	24K563457	BC-346	24K700778	MDF-75
24D60418A01	BC-352	24D742835-D	MDF-107	24K563462	BC-344	24K701016	TV-116
24D60419A01/A02	BC-352	24D743675	MDF-116	24K563464	BC-344	24K701069	A-3006
24D60419A03	BC-352	24D743765/-AD	MDF-116	24K563490	TV-180	24K701099	HVO-12
24D60419A05/A06	BC-355	24D744084	MDF-116	24K563788	BC-665	24K701136	MDF-75
24D60419A07	BC-352	24D744322	MDF-116	24K564120	BC-344	24K701138	MDF-75
24D60419A09	BC-356	24D746645	MDF-111(7,8)	24K564146	BC-665	24K701139	MDF-75
24D60420A04	FM-254	24D747199	TV-113	24K564264	BC-344	24K701141	MDF-75
24D60421A01	FM-255	24D747492	MDF-116	24K564671	BC-318	24K701142	MDF-75
24D61719A02	BC-393	24D747493	MDF-116	24K564673	BC-344	24K701344	TV-137
24D62409A01	BC-356	24D749113	MDF-116	24K564869	BC-344	24K701349	MWC-6(6)
24D62409A02	BC-355	24D751031	TV-113	24K565153	BC-561	24K701558	TV-163
24D64616A03B	MDF-132	24D752839	TV-124(2)	24K565199	BC-677	24K701559	TV-163

MERIT COIL AND TRANSFORMER CORPORATION

PART NUMBERS		PART NUMBERS		PART NUMBERS		PART NUMBERS	
MFGR.	MERIT	MFGR.	MERIT	MFGR.	MERIT	MFGR.	MERIT
MOTOROLA		MOTOROLA		MOTOROLA		MOTOROLA	
24K701566	MWC-6	24K733225	BC-566	24K745111	TV-202	24K754206	TV-130
24K701600	MDF-70	24K733407	HVO-39	24K745114	TV-181(5)	24K754208	TV-131
24K701601	MDF-70	24K733731	MWC-11	24K745605	TV-126	24K754209	TV-152
24K701609	MDF-70	24K733734	MWC-11	24K745702	HVO-164	24K754209	TV-153
24K701610	MDF-70	24K733875	TV-131	24K746091	TV-130	24K754214	TV-151
24K701611	MDF-70	24K734187	TV-208(5)	24K746440	TV-131	24K754220	BC-679(5)
24K701612	MDF-70	24K734638-B	P-2845	24K746446	MDF-116	24K754273/-Z	HVO-195
24K702039	MDF-75	24K734820	TV-131	24K746552	TV-119	24K754297	BC-676
24K702040	MDF-70	24K735697	TV-115	24K746645	MDF-111(2,5)	24K754300	MDF-132
24K702655	MDF-78	24K735844	HVO-39(7)	24K746772	BC-562	24K754360	BC-669(5)
24K702657	MDF-78	24K735868	HVO-39(7)	24K746871	TV-200(5)	24K754488	HVO-207
24K702661	MDF-80	24K736008	TV-185	24K746872	TV-204	24K754490/-AG	MDF-116
24K702663	MDF-80	24K736012	TV-185(5)	24K746911	MDF-111(4,8)	24K754518	MDF-116(90)
24K702772	MDF-70	24K736229	TV-151	24K747492/-W	MDF-116	24K780128	BC-563
24K702773	MDF-70	24K736270	TV-130	24K747493	MDF-116	24K780152	TV-103
24K702958	MDF-80	24K736487	HVO-222	24K747583	TV-152	24K780390	TV-116
24K702959	MDF-80	24K736488	HVO-66	24K747585	TV-153	24K780398	TV-116
24K703239	MDF-70	24K736496	TV-208(5)	24K747587	TV-130	24K780402	TV-151
24K703240	MDF-70	24K736496	BC-513(5)	24K748031	TV-124(2,19)	24K780418	MD-12
24K703262	MDF-80	24K736961	TV-195(5)	24K748138	BC-671(5)	24K780543	MDF-75
24K703263	MDF-80	24K736963	TV-202	24K748397/-W	HVO-142	24K780549	MD-12
24K703265	MDF-80	24K736963	TV-189	24K748398	HVO-142	24K780595	MD-12
24K703312	TV-151	24K737213	TV-206(5)	24K748906	TV-119(12)	24K790689	MWC-7
24K711266	HVO-28	24K737218	HVO-113	24K749113	MDF-116(8,9)	24K791182	MDF-75
24K711268	MDF-80	24K737342	TV-151	24K749668	BC-514	24K791433	TV-102
24K711581	MDF-78	24K737447	TV-186	24K749669	BC-675	24K791446	BC-566
24K711583	MDF-78	24K737615	TV-151	24K749670	BC-674	24K791725	MDF-75
24K711584	MDF-80	24K737733	BC-566	24K749673	BC-676	24K791974	HVO-12(3)
24K711585	MDF-78	24K737829	BC-562	24K749674	BC-672	24K792173	MDF-75
24K711587	MDF-78	24K738699	HVO-222	24K750578	TV-153(12)	24K792489	MDF-75
24K711937	HVO-28	24K738803	TV-184(5)	24K750825	BC-669	24K792508	MDF-75
24K712193	HVO-29	24K739284	HVO-149	24K750834	BC-671	24K792587	TV-137
24K720155	MDF-78	24K739290	TV-151(12)	24K750835	BC-669	24K792714	MDF-70
24K720622	MDF-78	24K739630	TV-119	24K750836	BC-669	24K792722	MWC-3
24K720623	MDF-80	24K739631	TV-119(12)	24K751018	MDF-116	24K792753/-D	HVO 12
24K720624	MDF-80	24K740117	TV-200	24K751034	TV-121	24K792756	MDF-75
24K720747	MDF-80	24K740117	BC-675	24K751190	HVO-140(7,34)	24K792758	MDF-75
24K721064	TV-163	24K740416	BC-566	24K751248	TV-130	24K792759	MDF-75
24K721065	TV-163	24K740512	TV-208(5)	24K751251	TV-113	24K792820	MWC-12
24K721074	TV-163	24K740512	TV-207	24K751253	BC-672(5)	24L844409	TV-202(5)
24K721274	BC-562	24K740513	BC-674(5)	24K751487	BC-678	24P65127A97	TV-153(12)
24K721290C	HVO-28	24K740545	TV-192(5)	24K751492	TV-124(2)	24P65127A99	TV-119
24K721301/-C	HVO-30	24K740546	TV-193(5)	24K751498	TV-113	24P65131A02	MWC-2
24K721830	MDF-80	24K740596	TV-151	24K751876	BC-566	24P65131A05	TV-165(12)
24K721831	MDF-78	24K740642	TV-184(5)	24K751880	TV-154(19)	24P65131A05	TV-159(12)
24K722126	HVO-30	24K740643	TV-188	24K751948	MDF-111(4,88)	24P65131A06	MWC-6
24K730103	TV-110	24K741492	TV-185(5)	24K751989AB	A-2900(2)	24P65131A10	TV-130
24K730391	TV-189	24K741937	HVO-148	24K752132-W	MDF-135	24P65131A11	TV-130
24K730391	BC-562	24K741938	HVO-149	24K752324	BC-672(5)	24R119847	TV-195
24K730633	MDF-79	24K741941	HVO-113	24K752328/-G	HVO-207	24R119850	TV-184(5)
24K730677	TV-172	24K742634	TV-184(5)	24K752351	BC-674(5)	24R119855	TV-190
24K730692	HVO-28	24K742781	BC-562	24K752352	BC-549(5)	24R119856	TV-190
24K730695	HVO-28(51)	24K743210	A-2930	24K752840	TV-113(7)	24R119889	BC-566
24K730903	HVO-122	24K743212	C-4084	24K752963	BC-674	24R120588	TV-184
24K730904	HVO-122	24K743272	TV-119(12)	24K753093	TV-121	24R121805	TV-185(5)
24K731893	TV-132	24K743287	BC-562	24K753234	TV-113	24R132921	BC-566
24K731937	HVO-148	24K743340	BC-514(5)	24K753305	BC-681(5)	24S132059	BC-565
24K732584	HVO-39	24K743426	TV-163	24K753397	TV-113(39)	25A72258	A-2900(4)
24K732710	MDF-80	24K743453	TV-130	24K753479	BC-674(5)	25B21175	A-2930
24K732711	MDF-80	24K743456	MDF-116(8,9)	24K753543	BC-566	25B60254A01/-F	A-2900
24K732746	HVO-122	24K743675	BC-562	24K753544	BC-562	25B60255A01/B/E	A-4097
24K732747	HVO-122	24K743727	BC-565	24K753803	BC-671	25B60328A01-4	A-2901(2)
24K732806	TV-184	24K743769	TV-131	24K753804	BC-671	25B60373A01-G	A-4103
24K732807	TV-184(5)	24K744322	MDF-116	24K754003	BC-681(5)	25B60373A02	A-2900
24K732808	TV-185(5)	24K744409	TV-202(5)	24K754004	BC-669	25B60373A03/-H	A-4103(2)
24K732809	TV-185	24K744410	TV-202	24K754010	TV-159	25B60373A04/-J	A-4103(2)
24K732820	TV-131	24K744411	TV-181(5)	24K754048	TV-152	25B60373A010	A-2900
24K733106	HVO-28(7)	24K744974	A-2853(35)	24K754051	TV-113	25B60391A02C	A-2901
24K733107	HVO-28(51)	24K745101	MDF-108	24K754052	TV-154	25B60391A03/-K	A-2901
24K733200	BC-502	24K745110	BC-549(5)	24K754084	TV-131	25B60391A04	A-2901

MERIT COIL AND TRANSFORMER CORPORATION

PART NUMBERS		PART NUMBERS		PART NUMBERS		PART NUMBERS	
MFGR.	MERIT	MFGR.	MERIT	MFGR.	MERIT	MFGR.	MERIT
MOTOROLA		MOTOROLA		MOTOROLA		MOTOROLA	
25B60391A05	A-2901	25C61032A01-D	A-2745	25B692076	A-2927(2)	25C701025	P-3073(2,11,14)
25B60391A07-T	A-2901	25C61055A02-E	A-2928(22)	25B700137	P-2848	25C701127	P-3069
25B60666A01	A-2757(22)	25C61055A04-G	A-2928(22)	25B701075	C-2994	25C701659	P-3069
25B60941A01	A-4103	25C61056A01	A-2905(2)	25B702445	A-2825	25C710656	P-3073(2,11,14)
25B60941A02/-B	A-4103	25C61527A01/-D	A-4097	25B702455	A-2825	25C710657	P-3073(2,11,14)
25B60941A02/-C	A-4080	25C61527A01/-E	A-4103	25B710921	P-3142	25C710658	P-3073(2,11,14)
25B60941A03-B	A-4103	25C61527A02	A-4103(1)	25B710925/-C/-D	A-2928	25C737472	P-3049
25B61288A01-C	A-4097(22)	25C61623A01/A02	A-2901	25B711592	P-2888(2)	25C738847	A-3019
25B61501A01/-A	A-4097(22)	25C61672A01/-B	A-2901	25B711847	P-3142	25G738848	A-2930
25B61632A01/-A	A-2902(2)	25C62132A01/-0	A-4099(2)	25B720749	P-3141(2)	25C743545	A-2930(33)
25B61635A01/-0	A-4101	25C62842A01	A-2745	25B721027	A-2825	25C743634/B	A-4090
25B61636A01-0	A-4101	25C65806A01/-A	C-4084	25B721871	A-3006(2)	25C746165	A-3026
25B61672A01/-B	A-4101	25C65806A02/-B	C-4084	25B721872	A-3019	25C790151	A-3036
25B61689A01/-D	A-2902(2)	25C65806A03/-H	C-4084	25B730138	A-2825(2)	25C790863	P-2837
25B61690A01/-A	A-3025	25C65806A05/-H	C-4084	25B730139	P-3144	25C790864	P-2847
25B61690A01-0	A-2902	25C65806A06/-M	C-4133	25B730179/-C	A-3006	25C65806410-J	C-4133
25B64610A02	A-4092	25C65806A07/-M	C-4133	25B730204	C-2994(2)	25D6001A04-J	P-2846(2)
25B64747A01	C-4124	25C65806A08/-N	C-4133	25B730923	A-2825(2)	25D6563A01-D	P-2872(93)
25B64747A02	C-4124(2)	25C65806A09/-P	C-4084	25B731015	A-2825	25D40933A03	A-4094(2)
25B64747A03	C-4124	25C65806A10	C-4133	25B733199	P-3141	25D42032A01/A02	C-4095
25B64839A01	C-4095	25C65806A11	C-4084	25B733443	A-3018	25D42032A07/A10	C-4095
25B70171/E/N/P	A-2931	25C65806A11-AA	C-4084	25B734495A	C-4133(2)	25D42045A06	A-2773(2)
25B70619	A-2900	25C90009	A-2823(2)	25B734908	C-4084(2)	25D42101A05	A-2743
25B70950/B/D/E	P-4071	25C90025	P-2955	25B734976	A-2815(59)	25D42143A02	C-4095
25B72258	A-2900(2)	25C90026	P-3059	25B735740	A-3037	25D65663A02/-AH	P-2885(2)
25B76952	A-2932(2)	25C90052	HVO-3	25B736967	P-2845(2)	25D65663A02/-L	P-2885(2)
25B79050	P-4071	25C472533/-J	P-4071	25B737467-B	C-4084	25D65663A02-T/-V	P-2885(2)
25B90010	A-4000	25C472586	P-4076	25B738716	A-4090	25D65663A03/-J	P-2897(2)
25B90014	C-2991(2)	25C484095	P-3067	25B738847	A-3019	25D65840A01/-D	A-2854
25B470622	A-2927(2)	25C484843	P-3067	25B738848	A-2930	25D65840A02/-1/-A	A-4090
25B472214	P-4071	25C485630	P-3068	25B739866	A-3006(2)	25D65840A02-H	A-2855
25B472533/-J	P-4071	25C500189	P-2969(2)	25B739898	A-3037	25D65840A02-K	A-2854
25B472558	A-2900	25C500727	A-2930	25B740238	A-3031	25D65840A04	A-4090
25B489030	A-2930	25C501303/-D/-G/-J	P-2971(2)	25B740426	C-2994	25D65840A04-D	A-4090
25B500727/-F	A-2930	25C501644/-J	P-2971(2)	25B741322/-A	A-2821	25D65840A05/A06	A-2854
25B501684/-G	A-2930(2)	25C511653/-B	P-2971(2,20)	25B742214	P-4071	25D65840A08/-L	A-2815(18,46)
25B501722	A-2900(2)	25C521454	P-2971(2,20)	25B742558	A-2900	25D65840A09	A-2821
25B501909	A-2930(2)	25C521841	P-2861	25B742649	A-3025	25D65840A10/-R	A-4090
25B502142	A-3019	25C532402/-F	P-2971(2)	25B743545	A-2930(33)	25D65840A13/-AB	A-2823(86)
25B502330/-F	A-3020	25C532631/-A	P-3068(29)	25B790015	A-3036	25D65840A13/-U	A-4090
25B502331	A-2900	25C532884/-A	P-3068(29)	25B790140	P-3074(2)	25D65840A14	A-2853(3,86)
25B511641/-A	A-2930(2)	25C534414	P-2861	25B790141	P-2890(11)	25D65840A16/-AB	A-2988(2)
25B530178/-C/-0	A-2900	25C535035/-B	P-2861	25B790686	A-2930	25D65984A03/-J	A-2901
25B530217/-A	A-2930	25C535794	P-2978(29)	25B790698	A-2902(2)	25D65984A04	A-2900(2)
25B530761	A-3019	25C542489	A-4093(2)	25B790914	A-3006	25D65984A05/-H	A-4080
25B530924-0	A-2900(2)	25C563445/-E	C-4095(2)	25B791793	P-2848	25D65984A06/-G/-W	A-2901
25B532086-A	A-2900(2)	25C563446/-B	C-4095(2)	25B792168/-D	A-2823	25C65984A10	A-2900(2)
25B532839/-E	A-2930(2)	25C580066	P-4071	25B798545-A	A-2823(2)	25D65984A11/-N	A-2902(2)
25B533038/-A	A-2900(2)	25C591264	P-2971(2,20)	25B6458350	A-2900	25D65984A12/-R	A-2902
25B537543	C-4095	25C591533	P-2969(2)	25C6229A01/-B	A-4096	25D65984A13-Z	A-2902
25B543338	C-4095	25C591740	P-2969(2,32)	25C6229A02/-B	A-4096	25D65984A14-Z	A-2902
25B543396	C-4124(2)	25C634160	A-2902(2)	25C40474A02/-B/-D	C-4095(2)	25D65984A15/-Y	A-2901
25B590648	A-2930	25C634503	A-2901	25C40474A03	C-4095(22)	25D65984A18/-AB	A-2902
25B591263	A-2930	25C638416-A	A-3019(2)	25C40759A02	C-4095	25D65984A21/-AG	A-2900(2)
25B591533	P-2969(2)	25C638852	P-3154(2)	25C40931A01	A-4094(2)	25D66761A02/-D	A-4139C
25B600648	P-3154	25C638890	A-2930	25C41272A01	A-2767	25D67448A01	P-4082(2)
25B600684	P-3154	25C639252	A-2905(2)	25C41619A01	C-4095	25D642131	P-2836(29)
25B600969	A-3020	25C640766	A-2928(22)	25C41871A02/A03	C-4095	25D743311	P-2881(2)
25B621637-A	A-2927	25C641522	A-3025	25C41871A04/A05	C-4095(2)	25D748820	P-2947(2)
25B631208	A-2927(2)	25C641731	A-2905	25C41871A06	C-4095	25D6598419-AD	A-2900(2)
25B632025	A-3025(22)	25C642122	A-3038(2)	25C42385A06	C-4095	25K7133	A-2902(2)
25B633669-A	A-3025(22)	25C644068-F	A-2902	25C60238A01-A	A-2901	25K72044	A-2900
25B635932	A-3025(22)	25C644179-L	A-2904(2)	25C60238A02	A-2901	25K470392	A-2928
25B636165-0	A-3025(22)	25C645355-E	A-2905	25C60329A01-B/-C/-D	A-2901	25K472558	A-2900
25B637155	A-2998(2)	25C645446/-A	A-2902(2)	25C60329A02/-E	A-4106(2)	25K489134	A-2823(2)
25B638839	A-2931	25C645449/-F	A-4080	25C60329A03/-C	A-2901	25K500194	A-2930
25B639195	A-2900(2)	25C645452-H	A-2902	25C6037A01	A-4101	25K512083	P-3068
25B640767	A-3025(22)	25C645453-D	A-2905	25C60394A01-E	A-4106	25K532582	A-3022
25B641660	A-2902(2)	25C700161	P-3073(2,11,14)	25C60394A03	A-2901(2)	25K535795-0	P-2978(22)
25B642137	A-2930	25C700169	P-3073(2,11,14)	25C60510A01	A-2928(22)	25K538445	P-2970

MERIT COIL AND TRANSFORMER CORPORATION

PART NUMBERS		PART NUMBERS		PART NUMBERS		PART NUMBERS	
MFGR.	MERIT	MFGR.	MERIT	MFGR.	MERIT	MFGR.	MERIT
MOTOROLA		MOTOROLA		MUNTZ		MUNTZ	
25K540681	C-4095(22)	25K744697	A-4090	LC-0056	MDF-70	LO-0059	TV-119(12,64)
25K542487	C-4095	25K744974/-AN/-AT	A-4090	LC-0057-8	TV-306	LO-0076	TV-123
25K543844	C-4124(2)	25K744974-W	A-4090	LC-0057-9	TV-200(5)	LO-0077	TV-163
25K544637	A-4093(22)	25K745051	A-2820	LC-0057-10	TV-194	LO-33	TV-119
25K544761	A-2773	25K745052	C-4084	LC-0057-11	TV-201(5)	LO-34	TV-150
25K544798	C-4095	25K745059/-J	A-2821	LC-0057-12	TV-203	LO-8001	BC-393
25K560799	A-4091(1)	25K745919	C-4084	LC-0058/-1/-2	MDF-72(4,8)	LO 8002	FM-255
25K561571	C-4095(2)	25K746756/-AKA	A-2854	LC-0060	MDF-72(4)	LO-8005	FM-253
25K561731	C-4095(1)	25K746803	C-4084	LC-0061/-1/-2	MDF-98	LO-8005-1	FH-255
25K563567	C-4095(2)	25K747597	A-4090	LC-0062	TV-151	LO-8006	BC-393
25K564230-J	C-4095	25K747849	C-4084	LC-0073	TV-195	LO-8008	BC-393
25K565189	C-4095(2)	25K748245	A-3026	LC-0074	TV-185(5)	LR-0019	MWC-12
25K580539	P-4071(2)	25K749146/-D	A-2902	LC-0075	TV-188	LR-0034	MWC-5(6)
25K580593	P-4071	25K749230/-1/-Y	A-2902	LC-0076	BC-562	LR-18	MWC-7
25K590650	P-3068(1)	25K749593	C-4084	LC-0079	BC-560	LR-19	MWC-12
25K635954	A-3025	25K749665	A-2900	LC-0080	BC-561	LR-8001	BC-388
25K636482	A-2901	25K749732	P-2846	LC-0081/-3	C-4115	LR-8002	BC-388
25K637227	A-2932(2)	25K751215	C-2996	LC-0082	MDF-74(4,87)	SK-0022	A-3031(2)
25K638007	A-3025(22)	25K751216	A-2928(2)	LC-0085-1/-2	MDF-96(87)	TA-8004	A-3018
25K640646	A-2998(22)	25K751752/-AY/-BA	C-4115	LC-0087	TV-131	TA-8005	A-2901(2)
25K640899	A-3031(22)	25K751796/-AV	C-4084	LC-0095/-1	TV-151	TA-8006	A-2902
25K641497	A-2900(2)	25K751797/-AZ/-BA	C-4084	LC-0097	BC-551	TA-8007/-1	A-2998
25K647125-H	A-2902(2)	25K751989/-AB	A-2900(2)	LC-0098	BC-566	TA-8008	A-4081
25K647133/-J/-R	A-2902(2)	25K752106	P-2881(2)	LC-0099	MDF-74(75)	TA-8009	A-2928
25K647578	A-4080(2)	25K752869-W	P-2872(93)	LC-0100-1/-2	C-4084	TO-0015	A-3019
25K647851/-N/-R	A-2902(2)	25K753338	A-4090	LC-0100-3	C-4133	TO-0016A	A-3035(2)
25K692006	A-2927(2)	25K753388/-AC	A-4090	LC-0101-1	TV-195	TO-0017A	HVO-3
25K700882	P-3073(2,11,14)	25K754067/-AS	A-2854	LC-0101-2	TV-198	TO-0018B	A-3037
25K701068	A-2923(2)	25K754288/-AE	A-4080	LC-0101-4	TV-185	TO-0019	A-3019
25K701069	A-3006	25K754329/-AB	A-2857	LC-0102	TV-131	TO-0020	HVO-10(2,3)
25K701143	A-2823	25K754420/-AK	A-2900(2)	LC-0105	TV-119(12)	TO-0021	HVO-10(2,3)
25K701619	A-2823	25K791804	A-3036(2)	LC-0106-1	MDF-115(72,88)	TO-0022A	A-3003
25K701632	A-2930	25K792564	P-3055(2)	LC-0107	TV-151	TO-0023C	A-3037
25K702429/-A/-J/-K	A-3006	25K792710	A-2823	LC-0108	MDF-115(72,88)	TO-0024	HVO-10(2,3)
25K702800	A-3003	25K792753-D	HVO-12	LC-0123	TV-131	TO-0027	A-3037(2)
25K703068	A-2930(2)	25P60015A08	A-3025	LC-42	MD-12	TO-0031/-2	HVO-31
25K710060	A-2928	50C64377	A-3025	LC-46	MD-12	TO-0032	A-3037(2)
25K710730	A-3006	50D643924	A-3025	LC-47	C-2994(2)	TO-0033	A-3018
25K710731	A-3006	903562-507	MDF-144C	LC-48	MDF-70	TO-0034/-2	A-3037
25K712297	P-3142			LC-51	MDF-70	TO-0035/-3	A-3003
25K720048	P-2846	MULTI-PRODUCTS		LC-8003	BC-564	TO-0036/-2	HVO-32
25K720050	P-2846	G-15	TV-118	LC-8009	BC-564	TO-0037	A-3035(2,18)
25K720128	A-2928	121-A6	A-3026	LC-9121-2	C-4133	TO-0038	A-3003
25K720168	A-2928	525	BC-356	LC-9125	BC-561	TO-0039	HVO-76
25K721027	A-2825	604	TV-118	LC-9127	MDF-144C	TO-0040	A-4088
25K721878	A-3019			LI-0040/A	TV-116	TO-0045	A-2850
25K730140	A-2928			LI-0041/A	TV-116	TO-0049-1/-2	A-3019
25K731058	A-2825(2)			LI-0042/A	TV-116	TO-0049-3	A-3020
25K731268	P-3141(2)			LI-0044	TV-110	TO-0050	HVO-75
25K731565	A-3006			LI-0046/B	TV-110	TO-0051/-1	A-2851
25K732800	A-3006			LI-0057	TV-113(2)	TO-0053	A-2902
25K733106	HVO-28(51)	B-1.531	MWC-11	LI-0058	TV-121	TO-0054	HVO-211
25K733190-F	P-2846	B-1.549	TV-162	LI-0060	TV-113	TO-0055	HVO-211
25K733208-C	A-2931	B-1.553-1	MWC-12	LI-40	TV-118	TO-0056	A-4117
25K734638-B	P-2845	C-1.476	TV-116	LI-41	TV-116	TO-0062	A-3018
25K734746/7	A-3006	C-1.528-1	TV-115				
25K736254	A-3006	C-1.529-2	TV-119	LI-42	TV-116	TO-14	HVO-3
25K736255	A-3037	C-9.225-3C	A-3020	LI-44	TV 110	TO-15	A-3019
25K736256-C-D	A-3018	C-9.228-5	A-3036	LI-8001	BC-352	TO-16	A-3035(2)
25K738763	C-4084	C-9.230-4	A-3003	LI-8002	FM-254	TO-17/A	HVO-3
		C-9.237-3	C-2991(2)	LI-8004	FM-254	TO-18	A-3036
25K739239	C-4133(2)	C-9.253-1/-2	HVO-96	LI-8005	FM-254	TO-19	A-3019
25K739569	P-3049	C-9.254-3	MDF-72	LI-8006	BC-352	TO-20	HVO-3
25K740392	A-2928	D-9.252	P-3055	LI-9001	BC-352	TO-21	HVO-3
25K740455-H	A-3006	L-12	TV-151	LI-9002	FM-254	TO-9001	A-2930(2)
25K740674	C-4084	LA-8001	BC-386	LI-9003	FM-254	TO-9103	A-4140C
25K740915	A-3026	LC-0015	MDF-142	LI-9004	FM-252	TO-9104	HVO-234C
25K742869	P-2885(2)	LC-0046	MD-12	LO-0035B	TV-167	TO-9105	A-2902
25K743210	A-2930	LC-0048	MDF-70	LO-0036A	TV-120	TP-0015C	P-2875
25K743211	A-3019	LC-0051	MDF-70	LO-0038/-1	TV-119(12)	TP-0031	P-3206
25K743212-Y	C-4084	LC-0053	MDF-70	LO-0039	TV-167	TP-15C	P-2875

MERIT COIL AND TRANSFORMER CORPORATION

PART NUMBERS		PART NUMBERS		PART NUMBERS		PART NUMBERS	
MFGR.	MERIT	MFGR.	MERIT	MFGR.	MERIT	MFGR.	MERIT
MUNTZ		NORELCO (North American Phillips Co.)		OLDSMOBILE (See Delco)		OLYMPIC	
TP-16	P-3070	A-3 803 31	BC-419			CL-3668	TV-116
TP-17	P-3070	WE-35825	BC-419			CL-3715	TV-116
TP-8002	P-3052(53)	20-1	TV-106			CL-3831	TV-130
TP-9191	P-4141C	20-9	TV-104	OLSON		CL-3833-1	TV-127
		20-21	A-3018(2)	GL4185308	BC-393	CL-3847	MDF-73(7)
				GL4425549	BC-418		
		20-27	TV-110	GL4425550	FM-255	CL-3921	TV-116(79)
		20-38	HVO-3	GLCOM5594	BC-551	CL-4021	TV-238
MUSICAIRE		20B-515	P-2835(10)	GT2503045	FM-254	CL-4413	TV-116
(See Travler)		20B-563	A-3036			CL-4511	TV-130
		20B-564	A-3003	GTCOM4152	BC-352	CL-4753/-1	TV-131
				GTCOM4153	BC-353		
		21-6	MWC-12			CL-4791	TV-130
		21-28	TV-163	OLYMPIC		CL-4806	TV-127(83)
NASH		21A-517-1	TV-150	AT-2905	A-3025	CL-4806-1	TV-128(41)
(See Zenith and Motorola)		21A-517-2/-3	TV-112	CK-1346	C-2991(2)	CL-5402	MWC-6
		21A-517-4	TV-102	CK-2445	C-4115(2)	CL-5464/-1	TV-163(2)
				CK-4047	BC-562		
		21A-517-5	TV-151	CK-4225		CL-5664-1	TV-163(2)
		21B-539	C-2991(2)			CL-5706	TV-120
		922/01	BC-419			CL-5827	TV-199(5)
NATIONAL						CL-5837	TV-153(12)
E-450-1	A-2902(2)					CL-21686	TV-196
F-450/-1	A-2902(2)	NORWOOD		CK-4415	BC-565	CL-25412-1	TV-192
K-890-1	TV-230(2)	IA-010	BC-574	CK-5742	BC-564	CL-25491	TV-206(5)
K-927/-1/-2	C-2991	IB-010	BC-575	CK-25465	C-2974(2)	CL-25518	TV-154
L-250	A-4000(2)	IC-010	BC-576	CK-26651/-2	C-4125	CL-25786	TV-185
		64A	BC-574	CK-32072-R	C-4133	CL-25787	TV-195
L 251-1	MD-12	64B	BC-575				
L-253/-1	A-3036			CKJ-33014	C-4125	CL-25919	BC-514
L-254-1	A-4003			CL-1356	MD-12	CL-26189	TV-128(2,41)
L-255-1/-3	HVO-3	64C	BC-576	CL-1358	TV-184(5)	CL-26215	MDF-128(7,8,54)
L-256-1	MWC-7			CL-1466	BC-397(2)	CL-26425	TV-194
				CL-1471	TV-102	CL-26426	TV-196
L-257-1	MWC-12						
L-275-1	P-3067			CL-1471	TV-103	CL-26430	TV-193
L-275-2	P-3053(14)	NUTONE		CL-1472	TV-150	CL-26946	TV-131
P-272/-1	HVO-7(2,3,31)	A-30019	BC-562	CL-1502	MWC-7	CL-27155	BC-393
P-273/-1	MWC-12	A-30020	BC-562	CL-1503	MWC-12	CL-27854	MDF-8(2,4,88)
		A-30031	BC-564	CL-1535	TV-180	CL-28083	TV-130
P-274/-1	MWC-1	A-30032	TV-189				
P-283	MDF-73	A-30033	TV-239	CL-1537	TV-183	CL-28212	TV-128(41)
P-283-1	MDF-70			CL-1537	TV-184(5)	CL-28234	TV-126(19,63)
SA-4997	TV-110(2)	A-30509	BC-386	CL-2073	TV-185(5)	CL-28518	TV-163
SA-5487	TV-163	B-30010	BC-564	CL-2087/-2	MDF-70	CL-28650	TV-153
		B-30011	BC-562	CL-2309	TV-116	CL-28785	TV-163(2)
SA-5498	TV-120	B-30012	BC-393				
SA-5515	TV-151	B-30055	C-4095(2)	CL-2331	TV-151	CL-31052/-1	TV-124(2)
SA-5516	TV-151			CL-2364	TV-141	CL-32138-R	MDF-144C
SA-6392	TV-120	B-30512	A-3025	CL-2365	TV-142	CL-32624-P	TV-194
SA-6393	TV-120	B-30516	A-3018(2)	CL-2427	BC-562	CL-32627	BC-383
		B-30528	A-2930(22)	CL-2578-G	TV-185	CLH-30236	BC-393
SA-6395-1/-3	TV-102	C-30505	BC-352				
SA-6395-1/-3	TV-103	C-30506	FM-254	CL-2614	TV-203(5)	CLH-30281	BC-393
				CL-2619	TV-141	CLJ-30512	BC-577
		C-30507	FM-254	CL-2620	TV-142	CLJ-30696	BC-393(2)
		C-30508	FM-255	CL-2627	TV-141	CLJ-30907	BC-560
		C-30510	BC-356		MWC-12	CLJ-31168	BC-393
		C-30511	BC-357	CL-2709	BC-393	CLJ-31170	FM-256
		C-30519	BC-357	CL-2752	MWC-12	CLJ-31171	FM-256
NEWCOMB				CL-2753	MDF-72(4)	CLJ-31252	BC-577
RC-10	FM-254	C-30521	FM-256	CL-2754	TV-137	CLJ-31367	MDF-143(4)
RC-23	FM-255	C-30522	FM-256	CL-2760	TV-166	CLJ-31368	TV-131
RC-24	BC-352	31A1	BC-393				
RC-25	BC-353	31A21	BC-564	CL-2767	TV-165	CLJ-31369	TV-130
TR-118	P-3173(2)	31A22	BC-562	CL-2990	TV-162	CLJ-31370	TV-130
				CL-3398	TV-184(5)	CLJ-31371	TV-153
TR-134	A-3027	31B8	BC-562	CL-3401	TV-181(5)	CLJ-31373	TV-151
TR-161	A-3130(2)	32B23	A-2927	CL-3403	TV-199	CLJ-31375	TV-165
TR-184	P-3045(2)	32B24	FM-254				
TR-201	P-3173	32B25	BC-352	CL-3497	TV-126	CLJ-31407	BC-577
TR-202	A-3132(2)	32B28	FM-255	CL-3498	TV-127	CLJ-33010	MDF-143
				CL-3499	TV-128	CLJ-33206	MDF-143(7)
		32B41	A-2930	CL-3500	TV-126	CLP-31683	TV-180
NORDIC		32B161	A-3018(2)	CL-3598	MDF-73(4)	CLP-31686	TV-196
		30035	BC-564				
95-1	A-2930	30055	C-4095(2)	CL-3600/-1/-3/-4	MDF-92(4,90)	LP-25351	BC-419
95-3	BC-352	30511	BC-356	CL-3600-6/-7	MDF-92(4,90)	LP-25937	BC-419
				CL-3603/-1/-1C	TV-154	LP-26011	BC-419
		30525	FM-257	CL-3606-1	TV-124(2)	LP-26604	BC-419
		30528	A-2930(22)	CL-3659	TV-116	LP-26983	BC-419

PART NUMBERS		PART NUMBERS		PART NUMBERS		PART NUMBERS	
MFGR.	MERIT	MFGR.	MERIT	MFGR.	MERIT	MFGR.	MERIT
OLYMPIC		OLYMPIC		OLYMPIC		OLYMPIC	
LP-27872	BC-419	TR-1688	P-3059(16)	TR-28017	BC-352	38CE53	A-3025
LP-29073	BC-419	TR-1764	A-3036	TR-28019-2/-B	A-2931	38CX23	A-2998
LP-29257	BC-419	TR-1914	HVO-3	TR-28019-3	A-2930	67/380	A-3019(2)
LP-29258	BC-419	TR-1966/-1	P-3059(16)	TR-28051/-D	A-4103	130-104	BC-352
LP-31700	BC-419	TR-2092/-1	HVO-10(2,3)	TR-28152	P-2844	130-114	BC-352
LPE-30418	BC-419	TR-2117	TV-101	TR-28314	P-2888	136-114	BC-393
LPE-30456	BC-419	TR-2180	FM-254	TR-28475	A-3130	136-125	BC-393
LPG-30107	BC-419	TR-2189/-A	A-3038	TR-28495/-1	A-3026	136-145	BC-393
LPH-30235	BC-419	TR-2293/-1	HVO-26	TR-29105	A-2999	138-118B	A-3025
LPH-30261	BC-419	TR-2294	TV-162(26)	TR-29530	A-3026	138-139	A-3025
LPH-30273	BC-419	TR-2605	HVO-171	TR-31659-1	A-2823(1)	138-140	A-3025
LPH-30280	BC-419	TR-2615	HVO-26	TR-31752	P-2872	159-26	A-3025(2)
LPJ-30695	BC-419	TR-2630	TV-115	TR-31898P	BC-357	220-001A	A-3025
LPJ-30711	BC-419	TR-2686	A-3020	TR-31906	A-4096	550-001A	BC-356
LPJ-31169	BC-419	TR-2690-1	A-3031(2)	TR-32060R	P-4141C	550-002A	BC-357
LPP-33102	BC-419	TR-2706-1	A-3025	TR-32061R	HVO-234C	1563-1	A-3025
N-9011	TV-151	TR-2765	A-2815(59)	TR-32062R	A-4140C	3823-21	A-2928(2)
R-1405	TV-166(2)	TR-2766	A-2928	TR-32063R	A-3019	3823-24	A-3025
R-1406	TV-165	TR-2766-1/-2/-B	A-3025	TRE-25239	BC-562	3823-41	A-3625
R-1470	TV-181	TR-2766-1C	A-2902(2)	TRE-30420	A-3019(2)	5023-6	A-2928
R-1635	TV-151	TR-2770	P-2936	TRE-30455	A-2901(2)	100037	A-3020
R-1949	BC-513(5)	TR-2771/-1/-2	HVO-47(2)	TRH-30223	A-3018(2)	102134	C-4133
R-1950	TV-190(5)	TR-2781-1	TV-114	TRH-30237	BC-352	105195	C-4133
R-2055	TV-130	TR-2977	TV-113	TRH-30263	A-3025	109221	HVO-232C
R-2056	C-4115	TR-2978	P-3070(2)	TRH-30301	A-3025	109263	A-4138C
R-2057-1	HVO-141(7)	TR-2990/-1	TV-167	TRJ-30511	BC-578	109286	P-4141C
R-2058	A-3039(2)	TR-3159	A-2901(2)	TRJ-30552	BC-574	109457	MDF-144C
R-2059	A-2934	TR-3373	BC-352	TRJ-30553	BC-575	109850	A-4139C
R-2060	MDF-108(4,7)	TR-3385	A-3036	TRJ-30554	BC-576	112820	HVO-233C
R-2061	A-3003(2)	TR-3386/-1	TV-113(19)	TRJ-30698	FM-256	112821	A-4139C
R-2062	TV-131	TR-3399-2	HVO-47(2,7)	TRJ-30699	FM-257	112822	A-3020
R-2065	BC-562	TR-3597/-1/-2	HVO-38	TRJ-30700	BC-356	112829	C-4133
R-2159	TV-121	TR-3599/-1/-2/-3	HVO-228	TRJ-30701	BC-357	112845	P-4141C
SA-29096	MDF-92(4,90)	TR-3599-4/-4A/-5	HVO-228	TRJ-30935	BC-570	113382	HVO-234C
SA-29097	MDF-128(88,92)	TR-3599-5A/-5D/-6	HVO-228	TRJ-30936	BC-570	113390	A-4140C
SA-29939	MDF-92	TR-3642	P-2948(2)	TRJ-30937	BC-582	903562-502	MDF-144C
SK-3235	A-3031	TR-3659	A-4089(2)	TRJ-30976	BC-574	906153-501	P-4141C
SKL-30593	A-3025	TR-3661	A-2932	TRJ-30977	BC-575	926636-501	HVO-232C
SKL-30610	A-3025	TR-3667	P-3077	TRJ-30978	BC-576	961415-1	A-4138C
SKL-30621	A-3025	TR-3689/-1/-C/-D	A-4089(2)	TRJ-31170	FM-256	961415-7	A-4139C
SKL-30644	A-3025	TR-3821/-1/-2	P-2844	TRJ-31171	FM-256	961416-1	P-4141C
SKL-31157	A-3025	TR-3855	HVO-9(2,7)	TRJ-31172	FM-257	972128-8	A-3020
SKP-30810	A-3025	TR-4007/-2	P-2844	TRJ-31173	BC-356	1104665-1/-2/-3	C-4133
SKP-30900	A-3025	TR-4007-2B/-2R2	P-2870	TRJ-31174	BC-357		
SKP-30979	A-3025	TR-4697	A-2934(2)	TRJ-31175	A-2928		
SLL-30610	A-3025	TR-4775	BC-352	TRJ-31253	BC-574		
TDT-276	TV-165	TR-5598/-B	HVO-219	TRJ-31254	BC-575		
TDT-330	A-2822(2)	TR-5620/-1/-1A/-2	A-3025	TRJ-31255	BC-576		
TDT-332E-1	MDF-143(4)	TR-5620-3	A-3026	TRJ-31364	A-2822(2)		
TDT-335JE-1	MDF-143	TR-5657	A-4089(2)	TRJ-31365	A-2930		
TLT-122-07	C-4115	TR-21626	A-2815(38)	TRJ-31408	BC-574		
TLT-122/-21	C-4125	TR-25367	A-2900(2)	TRJ-31409	BC-575		
TLT-123/H41	A-4103	TR-25743	A-2901	TRJ-31410	BC-576		
TLT-128/H41	A-2931	TR-25791/-1/-1A	A-4119	TRJ-31489	BC-569		
TLT-1224	C-4115	TR-25791-2/-C	A-4119	TRJ-31490	BC-570		
TR-3	A-3025	TR-25922/-1	A-3018	TRJ-31491	BC-571		
TR-4	A-2998	TR-25985	P-3096	TRJ-33025	A-2931		
TR-1342	HVO-3	TR-26020	A-2900	TRL-30632	A-3018(2)		
TR-1343	A-3025	TR-26192	P-3070(11)	TRL-30653	BC-356		
TR-1469	TV-106	TR-26192-1	P-2844	TRL-30654	BC-357		
TR-1470	TV-104	TR-26205/-1	HVO-171	TRL-31311	A-2928		
TR-1473	A-3003	TR-26214	P-4083(2)	TRP-30786	BC-356		
TR-1474	P-3063	TR-26216	A-4098	TRP-30787	BC-357		
TR-1475/-1	TV-161	TR-26714	FM-254	TRP-30904	BC-356		
TR-1492	HVO-3	TR-26982	FM-255	TRP-30905	BC-357		
TR-1506	A-2930	TR-27104	A-3025	TRP-31707	BC-356		
TR-1643	FM-254	TR-27125	P-2872	TRP-31715	A-3019		
TR-1644	BC-352	TR-27126	FM-254	TRP-31724	FM-256		
TR-1645	BC-353	TR-27837-2	HVO-131(2)	21CX23	A-2900		
TR-1646	FM-255	TR-27876	P-2872	20DA23	A-2928		
						OPEL (See Delco)	
						PACIFIC MERCURY	
						C-56015	MDF-91(4)
						PMA-52021	TV-103
						PMA-52027	TV-115
						PMA-52028/-1/-2	TV-151
						PMA-52029/-2	TV-116
						PMA-56000	MDF-72(4)
						PMA-56001	MWC-5
						PMA-56003	MWC-6
						PMA-56004	A-3039
						PMA-56005	A-3003
						PMA-56005-2	A-3000
						PMA-56019	MWC-1(7)
						PMA-62028-2	TV-151
						PMB-50003	P-2838(10)
						PMB-51005	A-2931

MERIT COIL AND TRANSFORMER CORPORATION

PART NUMBERS		PART NUMBERS		PART NUMBERS		PART NUMBERS	
MFGR.	MERIT	MFGR.	MERIT	MFGR.	MERIT	MFGR.	MERIT
PACIFIC MERCURY		PACKARD-BELL		PACKARD-BELL		PACKARD-BELL	
PMB-51013	A-2901(2)	29029	TV-111	29531/B/C	MWC-5	29697	TV-130
PMB-52019	TV-162	29030	TV-160	29532	MWC-2	29699A	TV-163
PMB-52049	TV-128(7)	29031	TV-111	29533	MDF-74(4)	29703/A/B	TV-163
PMB-52050	TV-127(7)	29038	FM-254	29536	MDF-74(4)	29713	TV-205
PMB-52052/-2	TV-126	29048	TV 167	29537	MDF-74(4)	29714/C	TV-151
PMB-56016	A-3038	29053/B/C	TV-151	29538	TV-141	29715A	TV-163
PMB-56018	C-2996(2)	29054	TV-110	29539	MDF-72(4)	29716	MDF-119
PMC-56002	HVO-47	29055	TV-116	29540/B	MWC-6	29717	MDF-118(76)
PMC-56017	HVO-36	29056	TV-116	29541	TV-113(1)	29718/A/B/C	MWC-11
PMD-52033-1/-2	BC-352	29058	FM-252	29542/A	MDF-73(4)	29725	BC-566
PMD-52037	BC-352	29063	BC-352(2)	29545/A	TV-151	29726	BC-562
		29064	BC-353(2)	29546	TV-141	29731	BC-672
		29066	BC-352	29547	TV-142	29732	TV-184(5)
		29067	BC-353	29548/A/C	TV-151	29737	MDF-144C
		29068	TV-110	29549	TV-142	29742	BC-566
		29071/A	FM-254	29552	TV-181(5)	29743	TV-205
		29072	FM-254	29553	TV-141	29752	TV-184(5)
		29073	FM-255	29554	TV-142	29753	TV-163
		29077	BC-352	29555/B	MWC-11(6)	29755	TV-131
		29078	BC-353	29557	TV-185	29757	TV-153
		29080/C/D	TV-113(1)	29558	TV-188	29758/A	MDF-118(88)
		29081	TV-121	29558	TV-202(5)	29759	TV-153(12)
		29082	BC-348	29559/A	TV-131	29760	TV-131
		29083	BC-349	29561/A	TV-130	29766A	TV-153
		29084/-1	FM-255	29563	TV-113	29767	TV-130
		29091/A/B	TV-124	29564/A	TV-153	29768/A	TV-130
		29119	BC-382	29566	BC-566	29769B	TV-130
		29124	BC-561	29567	MDF-91	29771	TV-196
		29148	FM-254	29568	MWC-12	29773	TV-185(5)
		29152	FM-254	29569	MWC-6	29778	TV-151
		29155	BC-352	29572/A	TV-130	29779	TV-247
		29156	BC-353	29575	MDF-91(7)	29781	TV-185(5)
		29157C	BC-393	29576/A	TV-151	29782A/B	TV-192
		29164/-1	FM-254	29577	TV-190(5)	29787B	BC-565
		29167	FM-254	29577	TV-202(5)	29789	BC-564
		29169	BC-561	29578	TV-130	29797	MDF-118(88)
		29229B	BC-393(39)	29579	TV-130	29802A	TV-119
		29244	BC-393	29581/A	MWC-12	29818A	TV-130
		29247/A/B	BC-393	29582/A	TV-163	29825D/F	TV-121(37)
		29257	TV-163	29584/A	TV-131	29826/B	MDF-119(90)
		29267	BC-352	29585	TV-130	29828	TV-130
		29268	FM-257	29586A	TV-130	29829	TV-153(12)
		29269	FM-256	29587/A/B	TV-130	29830	TV-152
		29271	FM-256	29589/A	TV-163	29836	TV-180
		29274B	BC-393	29590A/B/C	MDF-108(4)	29838	TV-121
		29277	BC-356	29599/A	TV-131	29839	TV-131
		29277	BC-357	29629	TV-163	29840	MDF-144C
		29358A	BC-419	29644/A	TV-130	29841A	BC-562
		29360A	BC-419	29645C	MDF-112	29842	MDF-119(4)
		29363	BC-419	29646/A/B	BC-566	89027A	P-3166(2)
		29364	BC-419	29650	TV-193	89031	A-3003
		29371	BC-419	29651	TV-184	89032	P-3169(2,14,16)
		29427	A-2931	29656	TV-184(5)	89033	P-3174(2,14,16,27)
		29446	TV-141	29657	TV-184(5)	89035	P-3070(2)
		29501	MD-12	29658	TV-184	89036/B/C	P-3078(2)
		29502	TV-101	29659/D	TV-163	89041	P-3078(2)
		29503	MWC-7	29660	TV-199	89042	P-3070(2)
		29504	MWC-12	29661	TV-244	89043/B	P-3070(2)
		29506	TV-182	29669	TV-205	89045/B	P-3055(2,11)
		29507	TV-163	29670	TV-184	89046/B	A-3003
		29508	TV-183(5)	29671	BC-513	89047	P-3053(2,10,28,13)
		29509	TV-185	29673	TV-131	89050	P-2830(10)
		29510	A-4000	29674	TV-153(12)	89051	P-2830(2,10)
		29511	HVO-3	29675	TV-165	89056A	P-3077(2)
		29515	A-3003	29676	MWC-16	89058	P-2873(2)
		29516	TV-150	29677	MWC-8	89067	HVO-153(7)
		29517	MWC-4	29681	BC-561	89076/A/B	P-3055
		29527	TV-163	29694	TV-115(1)	89098/A	P-2881(2)
		29529	TV-151	29695/A/B/D	TV-163	89405	A-3019(2)
		29530	MDF-70(4)	29696	MDF-118(76)	89417A	A-3025
PACKARD		PACKARD-BELL		PACKARD-BELL		PACKARD-BELL	
32-4160-2	BC-350	29071/A	FM-254	29552	TV-181(5)	29743	TV-205
32-4161-2	BC-351	29072	FM-254	29553	TV-141	29752	TV-184(5)
32-8314-1	P-4078(2)	29073	FM-255	29554	TV-142	29753	TV-163
32-8325	A-2900	29077	BC-352	29555/B	MWC-11(6)	29755	TV-131
65-0352	BC-350(1)	29078	BC-353	29557	TV-185	29757	TV-153
65-0358	P-4078(2)	29080/C/D	TV-113(1)	29558	TV-188	29758/A	MDF-118(88)
65-0409	A-2901(22)	29081	TV-121	29558	TV-202(5)	29759	TV-153(12)
65-0410	BC-372	29082	BC-348	29559/A	TV-131	29760	TV-131
6060	P-4076(2)	29083	BC-349	29561/A	TV-130	29766A	TV-153
6061	A-3010	29084/-1	FM-255	29563	TV-113	29767	TV-130
6063	A-2936(22)	29091/A/B	TV-124	29564/A	TV-153	29768/A	TV-130
6064	P-2861	29119	BC-382	29566	BC-566	29769B	TV-130
6065	P-2861	29124	BC-561	29567	MDF-91	29771	TV-196
6067	P-2861	29148	FM-254	29568	MWC-12	29773	TV-185(5)
1218725	BC-350	29152	FM-254	29569	MWC-6	29778	TV-151
1218726	BC-354	29155	BC-352	29572/A	TV-130	29779	TV-247
1219508	BC-319	29156	BC-353	29575	MDF-91(7)	29781	TV-185(5)
1219509	BC-354	29157C	BC-393	29576/A	TV-151	29782A/B	TV-192
1220888	BC-344	29164/-1	FM-254	29577	TV-190(5)	29787B	BC-565
1220889	BC-346	29167	FM-254	29577	TV-202(5)	29789	BC-564
7255881	P-4076	29169	BC-561	29578	TV-130	29797	MDF-118(88)
7258850	BC-354	29229B	BC-393(39)	29579	TV-130	29802A	TV-119
7259790	BC-319	29244	BC-393	29581/A	MWC-12	29818A	TV-130
7260006	A-2936(22)	29247/A/B	BC-393	29582/A	TV-163	29825D/F	TV-121(37)
7260167	A-2936(22)	29257	TV-163	29584/A	TV-131	29826/B	MDF-119(90)
7261402	P-4076(2)	29267	BC-352	29585	TV-130	29828	TV-130
		29268	FM-257	29586A	TV-130	29829	TV-153(12)
		29269	FM-256	29587/A/B	TV-130	29830	TV-152
		29271	FM-256	29589/A	TV-163	29836	TV-180
		29274B	BC-393	29590A/B/C	MDF-108(4)	29838	TV-121
		29277	BC-356	29599/A	TV-131	29839	TV-131
		29277	BC-357	29629	TV-163	29840	MDF-144C
		29358A	BC-419	29644/A	TV-130	29841A	BC-562
		29360A	BC-419	29645C	MDF-112	29842	MDF-119(4)
		29363	BC-419	29646/A/B	BC-566	89027A	P-3166(2)
		29364	BC-419	29650	TV-193	89031	A-3003
		29371	BC-419	29651	TV-184	89032	P-3169(2,14,16)
		29427	A-2931	29656	TV-184(5)	89033	P-3174(2,14,16,27)
		29446	TV-141	29657	TV-184(5)	89035	P-3070(2)
		29501	MD-12	29658	TV-184	89036/B/C	P-3078(2)
		29502	TV-101	29659/D	TV-163	89041	P-3078(2)
		29503	MWC-7	29660	TV-199	89042	P-3070(2)
		29504	MWC-12	29661	TV-244	89043/B	P-3070(2)
		29506	TV-182	29669	TV-205	89045/B	P-3055(2,11)
		29507	TV-163	29670	TV-184	89046/B	A-3003
		29508	TV-183(5)	29671	BC-513	89047	P-3053(2,10,28,13)
		29509	TV-185	29673	TV-131	89050	P-2830(10)
		29510	A-4000	29674	TV-153(12)	89051	P-2830(2,10)
		29511	HVO-3	29675	TV-165	89056A	P-3077(2)
		29515	A-3003	29676	MWC-16	89058	P-2873(2)
		29516	TV-150	29677	MWC-8	89067	HVO-153(7)
		29517	MWC-4	29681	BC-561	89076/A/B	P-3055
		29527	TV-163	29694	TV-115(1)	89098/A	P-2881(2)
		29529	TV-151	29695/A/B/D	TV-163	89405	A-3019(2)
		29530	MDF-70(4)	29696	MDF-118(76)	89417A	A-3025

MERIT COIL AND TRANSFORMER CORPORATION

PART NUMBERS		PART NUMBERS		PART NUMBERS		PART NUMBERS	
MFGR.	MERIT	MFGR.	MERIT	MFGR.	MERIT	MFGR.	MERIT
PHILCO		PHILCO		PHILCO		PHILCO	
32-4480-18/-24	TV-196	32-4632-2	BC-563	32-4769-11	BC-674(5)	32-8483	A-3018(2)
32-4480-35	TV-196	32-4632-5	BC-566	32-4770-1	BC-344	32-8484-2	HVO-17
32-4480-36	TV-184	32-4633	TV-115	32-4770-2	BC-394	32-8488	P-3053(13,28)
32-4480-37	BC-513(5)	32-4645	BC-564	32-4770-3	TV-162(2)	32-8492	A-2823(18)
32-4483-1	BC-352	32-4645-1	BC-563	32-4773-1/-2	BC-344	32-8500	C-2991
32-4486	TV-102	32-4645-2/-3	BC-562	32-4827-1	FM-257	32-8509	HVO-16
32-4486-6	TV-116	32-4645-4	BC-561	32-4834-1/-2/-3	BC-356	32-8509-2	HVO-17
32-4486-9	TV-102	32-4645-10	BC-562	32-4834-4/-5	BC-356	32-8514	C-2996(2)
32-4486-12/-13/-17	TV-116	32-4645-19	BC-563	32-4837-1	TV-192	32-8515	A-2822
32-4486-23	TV-116	32-4645-20	BC-561	32-4838-1	TV-186	32-8519	P-2866
32-4486-27	TV-118	32-4645-32	BC-562	32-4842-2	C-4124(2)	32-8525-1	A-2930
32-4486-29	TV-116	32-4645-33	TV-189	32-4851-4	TV-205(5)	32-8528	A-2927(2)
32-4486-30	TV-103	32-4645-36	TV-189	32-4853-4	BC-679	32-8533	HVO-19
32-4486-32	TV-102	32-4645-42	TV-239	32-4854-1	TV-201	32-8534	HVO-19
32-4486-33	TV-116	32-4645-44	BC-564	32-8206-1	A-3035(2)	32-8537-1	C-2996(2)
32-4486-41/-42/-43	TV-130	32-4645-48/-49	BC-560	32-8242/-7/-9	A-3019	32-8538	P-2845
32-4486-45/-46/-47	TV-130	32-4647-1	TV-192	32-8242-11/-12	A-3019	32-8539/-1	A-2821
32-4486-48/-49	TV-130	32-4653-1	TV-184	32-8244/-1/-2	A-3020(2)	32-8555	HVO 20
32-4497A	TV-113	32-4653-4	TV-181	32-8304/-3/-4	A-3004	32-8565	HVO-21
32-4505	MWC-2	32-4653-5	TV-196	32-8306/-1	A-3035(2)	32-8572	HVO-157
32-4506-1	TV-162(2)	32-4662-1	TV-131	32-8307/-2/ 3	A-3002(2)	32-8573/-1/-2	P-2864(2)
32-4517-1A	BC-353	32-4672-3	MWC-3	32-8308	C-3183(2)	32-8574/-1	P-2864
32-4518A/-1A	FM-254	32-4674	BC-566	32-8310-3	A-3025	32-8575	P-2863
32-4527	TV-172	32-4674/-1/-3	TV-192	32-8312	C-2977	32-8577/-1	A-2855
32-4537A	BC-352	32-4676-1/-2	BC-344	32-8313	P-3068	32-8578	A-2930
32-4548-9/-11	TV-130	32-4676-4	BC-317	32-8314/-1	P-4078(2)	32-8590	P-2864(2)
32-4548-12	BC-561	32-4676-6	BC-319	32-8314-2	P-4071(2)	32-8592-1	P-2978
32-4548-23/-24/-25	TV-130	32-4676-7	BC-344	32-8315/-1/-2	A-2930(29)	32-8599/-2	A-2815(2,25)
32-4548-26/-27	TV-130	32-4677-2/-4/-8	BC-318	32-8316	A-2938(2)	32-8605	C-4084
32-4548-29	TV-116	32-4684/-1/-2	TV-130	32-8356/-1	A-2930	32-8607	HVO-21
32-4557/-3/-4	TV-163	32-4685-1	TV-202	32-8358	HVO-5(2)	32 8617	C-4084
32-4557-5	MWC-2	32-4688-1/-2	TV-158	32-8366	C-3196(2)	32-8624/-1	HVO-21(7)
32-4561	TV-180	32-4688-6/-7/-8	TV-158	32-8367/-1/-3/-5	A-3018	32-8625/-1/-2	A-2821
32-4569-2	BC-381	32-4688-9/-10	TV-158	32-8384-2/-3/-12	A-3025	32-8629	A-3019
32-4572	BC-388	32-4688-11	TV-157(19)	32-8391	P-3054(10)	32-8634	HVO-158
32-4574/-2/-3/-4	BC-381	32-4689/-1	TV-232	32-8398/-1	HVO-5(2)	32-8635	P-2871
32-4582	BC-387	32-4690-3	TV-181	32-8399	C-3196(2)	32-8637	A-2828
32-4583	BC-327	32-4690-5	TV-196	32-8405/-1	A-3038	32-8640	A-2901(2)
32-4583-1	BC-352(2)	32-4690-7	TV-185	32-8409	HVO-3(2)	32-8653/-1	HVO-21(7,33)
32-4583-3	BC-356	32-4690-11	TV-190	32-8411-1	P-3070(2)	32-8657	P-3049
32-4583-5	BC-327	32-4690-12	TV-203	32-8417	P-3067(2)	32-8658/-1/-2/-4	A-3037
32-4583-8/-9	BC-356	32-4690-14	TV-206	32-8419-2	C-2994	32-8661	P-2839(11)
32-4583-10/-11	BC-356	32-4692-10/-11	BC-419	32-8421	HVO-3(2)	32-8666/-1/-2/-3	HVO-36(2,7)
32-4583-13	BC-328	32-4692-14/-17	BC-419	32-8422-1	A-2822(2)	32-8667	A-2857
32-4583-14/-15	BC-356	32-4692-18/-19	BC-419	32-8423-2	P-3067(14,16)	32-8673	P-2869
32-4583-16/-17	BC-356	32-4712-1/-2/-3/-4	FM-256	32-8425/-1	A-2823	32-8674/-1	A-3025
32-4583-20/-21	BC-356	32-4714-2/-3	FM-260	32-8428/-1/ 2	HVO-18	32-8675	C-2994
32-4583-22	BC-356	32-4715-1	FM-254	32-8431/-2/-3/-4	A-3011	32-8676/-1	A-3004(2,7)
32-4583-23	BC-357	32-4735/-1/-2	TV-232	32-8431-7/-8/-9/-14	A-3011	32-8677	HVO-21(7,33)
32-4583-27/-28	BC-356	32-4745-2/ 4	TV-157	32-8432	A-2815(2,46)	32-8685	A-3019
32-4583-29/-30	BC-356	32-4745-5/-6/-8	TV-157	32-8434-1	A-2998	32-8686	A-2857
32-4583-31	BC-356	32-4752-1	FM-255	32-8435	C-2974	32-8686-2	A-2828
32-4584/-1	BC-641	32-4754-3	TV-250	32-8437	HVO-3(2)	32-8690	P-2870
32-4585-28	BC-357	32-4762-6	BC-671	32-8438/-1	C-2991	32-8691	HVO-36(2,7)
32-4597-2	BC-562	32-4762-7	BC-672	32-8442	A-3004	32-8693	C-2996(2)
32-4597-3	TV-189	32-4762-8	BC-673	32-8450	A-3025	32-8695/-1	HVO-159(2)
32-4597-11	BC-564	32-4762-9	BC-674	32-8451	P-2969(2)	32-8701/-1	HVO-21(2,7)
32-4597-12/-15	BC-562	32-4762-10	BC-675	32-8452	P-2833	32-8704	A-2829
32-4597-16	BC-566	32-4762-11	BC-676	32-8454/-1/-5	A-3036	32-8705-1	HVO-36(2,7)
32-4598/-2/-3	TV-130	32-4762-12	BC-677	32-8455	C-2974(2)	32-8708	P-2862
32-4598-4/-5	TV-130	32-4762-13	TV-204	32-8456	C-4115	32-8709-1	HVO-36(2)
32-4599-12/-2	TB-130	32-4762-14	BC-679	32-8457	P-4071(2)	32-8710/-2/-3/-4	C-4084
32-4601-1A	BC-352	32-4762-17	BC-666	32-8465-2	HVO-16	32-8710-5/-6/-7	C-4084
32-4607-1A	BC-355	32-4762-20	BC-675	32-8466	HVO-7(2,3,91)	32-8710-8/-9	C-4084
32-4614	BC-381	32-4762-21	BC-668	32-8468	P-2961(2)	32 8710-10	C-4084
32-4619	BC-355	32-4766-1	TV-157	32-8469	P-2877	32-8711	P-2872
32-4623-6	BC-394	32-4769-3	BC-678	32-8478/-2	C-2996	32-8712	A-2852
32-4628	BC-534	32-4769-4	BC-675	32-8479/-2	C-2994	32-8719	P-2873
32-4630	TV-192	32-4769-6	BC-672	32-8480	A-3025	32-8731	A-2822(18)
32-4631/-1/-A/-1A	TV-115	32-4769-7	BC-676	32-8481	P-3053(13,28)	32-8732	P-2862

MERIT COIL AND TRANSFORMER CORPORATION

PART NUMBERS		PART NUMBERS		PART NUMBERS		PART NUMBERS	
MFGR.	MERIT	MFGR.	MERIT	MFGR.	MERIT	MFGR.	MERIT
PHILCO		PHILCO		PHILCO		PHILCO	
32-8745	C-4084	32-9604	MD-12(4)	76-12530-6/-8	MDF-138(7,54,88)	412-5033-29	BC-393
32-8747-1/-2/-3	A-3026	32-9620	MD-12(4)	76-12554-1	MDF-92(4,7,8)	412-5033-30	FM-254
32-8747-4/-5/-6	A-3026	32-9622	MD-12(4)	76-12554-3	MDF-108(90)	412-5033-31	FM-252
32-8747-7	A-3026	32-9628	MD-12(4)	76-12744-1	MDF-138(88,95)	412-5033-32	A-3025
32-8748	A-2928	32-9633	MDF-70(4)	76-12784-2/-4	BC-419	412-5033-33	BC-419
32-8750	A-3001(2,7)	32-9641	MDF-70(4)	76-12942-3/-4	MDF-143	412-5033-34	BC-352
32-8753-1	HVO-155(7)	32-9642	MDF-70(4)	76-13222-1/-2	MDF-108(7,90)	412-5033-35	BC-354
32-8755	C-4084	32-9644	MDF-70(4)	322-0010	TV-205	7937-2	A-3025
32-8756	P-2862(2)	32-9648	MDF-81(75,92)	322-0054	A-3025(2)	13706	A-3025
32-8757	HVO-155(7)	32-9663/-1	MDF-94(92)	322-0083	MWC-11	13808E	A-2902(2)
32-8758	A-2823(18)	32-9670	MDF-81(75,92)	322-0092	HVO-232C	14522	A-2928(2)
32-8759	C-4115	32-9680	MDF-81	322-0094	BC-562	15463-A	A-2928(2)
32-8775-2	P-3173(2)	32-9688-1	MDF-81(75,92)	322-0100	TV-205	15732	A-2902(2)
32-8784	A-3031	32-9689/-1	MDF-94	322-0103	A-4139C	16722	A-3025
32-8790	P-3152(33)	32-9731-1/-3	MDF-138(4,92)	322-0105	P-4141C	16763	A-2928
32-8792	A-3025	32-9731-4/-7	MDF-138(4,92)	322-0106	MDF-144C	105195	C-4133
32-8795/-1	HVO-155(7)	32-10005-1	A-4098	322-0107	A-3020	903562-504	MDF-144C
32-8799-1	HVO-217	32-10007-1/-2	A-4097	322-0110	BC-562	903562-507	MDF-144C
32-8802-1	A-2821	32-10010-2/-4	C-4125	322-0111	TV-195	906152-501	HVO-234C
32-8806-1/-2	HVO-151	32-10010-5/-6	C-4125	322-0112	BC-566	961415-1	A-4139C
32-8807-3	P-2872	32-10013-1	A-2900(2)	322-0113	C-4133	961416-1	P-4141C
32-8812	A-2755(2)	32-10013-2	A-3025	322-0114	TV-193(5)	962636-501	HVO-232C
32-8814-1	A-3037	32-10013-3	A-2998	322-0120	BC-566	962712-502	P-4141C
32-8825-2	A-2932	32-10016-1	A-3020	322-0123	BC-562	972128-8	A-3020
32-8829-1/-2/-4/-5	A-4098	32-10017-2	A-4140C	322-0124	TV-193	1104665-1/-2/-3	C-4133
32-8830-1/-2/-3	HVO-203	32-10018-1	C-4133	322-0125	TV-193		
32-8840-1	HVO-204	32-10019-2	P-4141C	322-0130	TV-195		
32-8847-1	A-2901(2)	32-10023-1	HVO-234C	322-0130	TV-190		
32-8852-1/-2	A-4098	33-1689-13	A-3025	322-0130	C-4133		
32-8855-1/-2/-5	HVO-220	36-1646-5	C-2996	322-0159	HVO-233C		
32-8855-8	HVO-203	36-1654-17	A-3025	322-0162	A-3020	LG-10021	C-4084
32-8855-9	HVO-220	36-1673-16	A-3025	322-0163	A-4139C	SR-10019	A-2930(2)
32-8862-1/-2	A-2930	36-1675-18	A-3025	322-0164	P-4141C	SR-10020	A-2930(2)
32-8875-2	A-4092(2)	38EB23	A-3025(12)	322-0179	TV-157	SR-10021	A-2930(2)
32-8876-1	A-2932	38EF23	A-3025	322-0180	TV-180	TO-10020	HVO-3
32-8886-1	A-2901	65-0191	BC-365	322-0185	BC-566	TO-10021	A-3035(2)
32-8899-1	HVO-215	65-0234	P-4071(2)	322-0192	BC-569	TO-10022	A-4000
32-8903-1	HVO-216	65-0317	A-3026(2)	322-0192	BC-571	TO-10023	MWC-7
32-8904-1	A-2815(52)	65-0319	BC-368	322-0193	BC-570	TO-10024	MWC-12
32-8906-1	A-2932	65-0320	BC-371(63)	322-0194	BC-571	TO-10026/A	MDF-70
32-8925-1	A-2902(2)	65-0352	BC-371	322-0217	BC-570	TO-10028	HVO-3
32-8928-2/-3	A-3025	65-0399	BC-368	322-0218	BC-571	TO-10031	A-2930
32-8929-1	A-3025(2)	65-0404	P-2969	322-0223	BC-356	TO-10032	A-2928
32-8930-1/-2	A-2905	65-0408	A-3019	322-0224	BC-357	TO-10045	A-3036
32-8940-1/-2/-4	A-2823	65-0415	A-2930(2)	322-0228	BC-569	TO-20024	MWC-12
32-8940-5	A-2823	65-0419	A-2930(2)	322-0229	BC-570	TOA-10030A	A-3003
32-8951-4	HVO-221	73-0027/-1	A-2928(2)	322-0230	BC-571	TP-10003/B	P-2834
32-8953-1	A-2931	76-5767	TV-172	322-0290	BC-569	TS-10030	TV-102
32-8953-3	A-2930	76-6459	TV-172	322-0291	BC-570	TS-10030	TV-103
32-8958-2	A-4103	76-6780	TV-172	322-0292	BC-571	TS-10034B	TV-115
32-8961-1	A-3025	76-7071	TV-172	322-0299	BC-574	TS-10042	TV-120
32-8961-2/-3	A-4097	76-7188	MDF-72(4)	322-0300	BC-575	10-541	TV-118
32-8963-1	A-2900	76-9173-2	MDF-94(92)	322-0301	BC-576	10-542	TV-116
32-8980-2/-3	C-4084	76-9173-3	MDF-81	322-0319	BC-573	10-543	TV-116
32-8980-4/-5	C-4133	76-9173-6/-8	MDF-94	322-0320	BC-574	10-551	MWC-15
32-8980-6	C-4084	76-9173-9	MDF-81(4,8)	322-0324	BC-575	10-552	TV-115
32-8982-1/-2/-3/-4	A-4098	76-9173-10/-12	MDF-94	322-0326	BC-576	10-553	TV-115
32-8985-1	A-2998	76-9173-13/-14	MDF-92(4,7,8)	322-8002	MDF-138(4,92)	10-554	TV-113(19)
32-8985-2	A-3026	76-10119-2/-5	MDF-92(4)	325-0122-5	A-2902(2)	10-555	TV-163
32-8985-3	A-2932(2)	76-10282-1/-2/-3	MDF-128(8)	325-0122-6	A-3025	10-556	TV-151
32-8995-4	A-2900	76-10282-4/-5	MDF-128(8)	325-0123-5	A-2928(2)	10-561	MWC-12
32-8985-5	A-2998	76-10508-3/-4	MDF-138	325-0123-6	A-2935(2)	10-562	TV-151
32-8989-2	A-2901	76-10508-6/-9/-14	MDF-138	325-0123-45	A-2928	10-573	TV-116
32-8989-4	A-2900	76-11070	MDF-71(4,7,8)	325-0124-6	A-2928(2)	10-575	MWC-15
32-8990-3/-4	A-4080(2)	76-11070-1	MDF-92(4,7,8)	325-0127-2	A-2902(2)	10-601	MDF-70
32-8990-5/-6	A-4103(2)	76-11115	TV-172	325-0721-5	A-3025	10-604	MWC-6
32-8991-2	A-2901(2)	76-11489-1	TV-172	327-0006-2	TV-239	10-605	TV-131
32-8993-1/-3	HVO-221	76-12097-1/-4	MDF-138(4,92)	327-0006-4	FM-256	10-606	TV-243
32-8996-1/-3/-4	A-2901	76-12279-4/-8	MDF-138(4,92)	327-0006-5	FM-257	10-607	TV-245
32-8999-1/-2	C-4115	76-12530-2/-3/-5	MDF-138(7,54,88)	327-0006-6	A-2928(2)	10-608	TV-130

MERIT COIL AND TRANSFORMER CORPORATION

PART NUMBERS		PART NUMBERS		PART NUMBERS		PART NUMBERS	
MFGR.	MERIT	MFGR.	MERIT	MFGR.	MERIT	MFGR.	MERIT
RAYTHEON		RAYTHEON		RAYTHEON		RAYTHEON	
B-13A-18567	FM-254	DP-103	BC-562	16A-22923	TV-192	201-25088	TV-120(19)
B-13A-18568	FM-254	DP-111	A-2931	16A-23889/-1	C-4084(2)	201-25360	MDF-92(4,8,9)
B-13A-18783	TV-154	DP-171	BC-350	16A-24019	TV-188	201-25566	MDF-70(4,8)
B-13A-19514	TV-154	DP-176	A-2929(2)	16A-24019	TV-203	201-26019	MDF-75(8)
B-13B-16000	FM-254(2)	T105-116T	BC-537	16A-24020	TV-184	201-27120	MDF-92(4,8)
B-13B-16302	BC-352(2)	TL-91	TV-118	16A-24090	BC-566	302217K	BC-352
B-13B-19958	TV-139(2)	0074	BC-352	16A-24210	BC-566	302225K	BC-352
B-13D-12574	TV-230	12A-18839/-1	P-3059(16)	16A-24375	TV-207		
B-13D-13544	TV-230	12A-21447	P-3078(10)	16A-24505	TV-151(2)		
B-13M-13590	MD-12(92)	12C-17595	A-3025	16A-24655	C-4084(2)		
B-13M-16001	FM-252(1)	12C-20761-2	A-2819	16A-24998	TV-195		
B-13M-16335	TV-110	12C-21215	A-2928	16A-24998	TV-196		
B-13M-17273	TV-110	12C-21518	A-2931	16A-25441	TV-151		
B-13M-18693	MDF-70	12C-22508	A-2928	16A-25688	BC-562		
B-13M-18888	MDF-70(4)	12C-23704/-1	A-2998	16A-26151	BC-513		
B-13M-19257	TV-110	12C-24015	BC-352	16A-26156	BC-566	B-941688-3	C-2991
B-13M-19356	FM-252	12C-24170	A-2931	16A-26161	TV-180	C-974302-21	A-2998
B-13M-19488	MD-12(54)	12C-24591	A-3020(2)	16A-26416	TV-188	C-974302-22	A-3026
B-13M-19521	TV-102	12D-21160-1	P-2947(20)	16A-26417	TV-194	C-8702754	A-2900
B-13M-19643	TV-110	12D-23699/-3	P-2959(20)	16A-26986	BC-565	D-961429-1	A-4105
B-13M-20002	MWC-5(6)	12D-25563	P-2963(2)	16A-26991	TV-151	D-961429-3	A-2901
B-16A-17959/-1	C-4084	12D-26582	P-3097(2,11,20)	16A-27202	TV-185	10B286	C-4084(2)
B-18A-16440	A-2935	12E-19048-2	A-2829	16A-27204	TV-202	50-94292-1	HVO-126
B-18A-16702	A-3019(2)	12E-23726/-1	A-3037	16A-27466	TV-186	51-94416-1	MDF-110
B-201-15612	TV-102	12E-23939	HVO-58	16A-27467	TV-202	56-94273-1	A-4098(18)
B-201-15612	TV-103	12E-24440	TV-165	16B-25146	C-4084	201D12	MD-12
B-201-15945	TV-116(19,37)	12E-24612/-1	HVO-58	16B-26052	C-2991	201R1	MWC-7
B-201-19363	TV-151	12E-25040	HVO-89	201-15608	TV-192	201R3	MWC-12
B-201-19458	TV-151	12E-25423	HVO-89	201-15652	TV-102	201R4	MWC-8
B-201-20696	TV-151	12E-25424	HVO-89	201-15652	TV-103	201R5	MWC-4
BI-302217-K	BC-352	12M-18241/-3	A-3003	201-19489	MDF-70(4)	201T6	P-3061
BI-302225-K	BC-353	12M-18689-2	HVO-10(2,3)	201-19817/-1	HVO-10(2,3)	201T7	P-3067(2,11,14)
C-12A-11640	P-3165(10,16)	13-17731	BC-353	201-19947-1	MDF-70(4)	201T8	P-3063
C-12A-15290	P-3165(10,16)	13A-19514	TV-154	201-20062	TV-151	203R1	TV-161
C-12A-17822	P-3078(11)	13A-24203	TV-132(19,37)	201-20186	MWC-5(6)	204T2	A-3035
C-12A-18399/-1	P-3070	13A-24224	TV-130	201-20186-1	MWC-4(6)	204T9	A-3035(2)
C-12A-18839	P-3070	13A-24937	TV-243(37)	201-20265	TV-180	205R1	TV-162
C-12A-19942/-1	P-3059(16)	13A-25139	TV-116	201-20291	TV-163	207R1	MWC-5
C-12E-23939	HVO-58	13A-25140	TV-116	201-20782	TV-102	208T2	A-4000
C-12E-27097	HVO-163	13B-17731/-1	BC-352	201-20936	MDF-70(4)	208T8	TV-160
C-12E-27194-49	HVO-163	13B-19958	TV-140	201-21111	TV-103	208T9	A-4003
C-12M-17967	HVO-10(2,3)	13B-22939	TV-139(2)	201-21398	TV-151	209R1	MWC-5
C-12M-18285	HVO-10(2,3)	13C-24963	TV-120	201-21550	TV-103	211D1	MDF-74
C-12M-18286	HVO-10(2,3)	13D-19540	TV-163	201-21670	TV-151	211R1	MWC-6
C-12M-18530	HVO-10(2,3)	13M-18233	MWC-7(6)	201-22302	TV-163	211T3	HVO-3
C-12M-18689/-1/-2	HVO-10(2,3)	13M-19643	TV-110(1)	201-22396/-1	HVO-49	211T5	HVO-5
C-12M-19407-1/-2	HVO-10(2,3)	13M-21644	TV-110(1)	201-22571	TV-151	213R1	MWC-6
C-16A-15624	C-2991	13M-22303	TV-115	201-22581	TV-119(12)	230T1	HVO-9
C-16B-11641	C-2993(2)	13M-22810	MDF-91(4,54)	201-22582	TV-119(12)	232T1	HVO-36
C-18A-16474	A-2935	13M-23755	MDF-70(4,87)	201-22585	TV-131	235D1	MDF-92
C-18A-18022	A-2931	13M-24085	TV-166	201-22588	TV-153(12)	235T1	HVO-36
C-18A-18157	A-2931(2)	13M-24086	TV-165	201-22697	MDF-70(4)	10411	BC-418
C-18A-18176	A-2931(2)	13M-24441	TV-166	201-22857	MDF-91(4,54)	12442	A-3026
C-18A-18468	A-3020	13M-25678	TV-16	201-22924	TV-102	31301	A-2936
C-18A-18588	A-2931(2)	13M-26083	TV-126(2)	201-22949	TV-163	35636	BC-352
C-201-15717	TV-110(1)	13M-26242	TV-113	201-23180	TV-163	35790	BC-355
C-201-16155	TV-108(1)	13M-26243	TV-115	201-23477	TV-151	37048	P-2954(2)
C-201-16411	TV-108	13M-26268	MWC-2	201-23727	TV-121	37899	A-2901
C-201-18562/-1	HVO-10(2,3)	13M-26310	TV-163	201-23729	TV-120(19)	38344	BC-386
C-201-19490/-1	MDF-70(4)	13M-26988	TV-124	201-23744	MDF-70(87)	38345	BC-381
C-201-19533/-1	HVO-10(2,3)	16A-17959	C-4084	201-23829	TV-103	70127	P-3047
C-201-19817-3	HVO-10(2,3)	16A-19365	TV-190	201-23873	TV-120(37)	70128	BC-368
C-201-19947	MDF-70(4)	16A-19365	TV-202	201-24056	MDF-70(4,87)	70129	BC-371
C-201-21025/-1	HVO-49(3)	16A-20970	TV-185	201-24183	MDF-70(4,87)	70133	BC-381
C-201-21130	MDF-70(4)	16A-21214	C-2996(2)	201-24472	TV-165	70380	BC-355
C-201-21514	MDF-70(4)	16A-21391	TV-199	201-24473/-1/-2	TV-166	70386	BC-368
C-201-21524	MDF-70(4)	16A-22427	BC-566	201-24563-1	MDF-70(4,8,9)	70387	BC-371
C-201-22396/B	HVO-49(7)	16A-22427	BC-565	201-24632/-1	MDF-75	70403	BC-381
D13M-21120	MDF-70(4)	16A-22448	C-4084	201-24748	MDF-70(4,87)	70411	BC-352
DP-101	BC-352	16A-22584	C-2994(2)	201-24749	TV-151	70466	BC-355

MERIT COIL AND TRANSFORMER CORPORATION

PART NUMBERS		PART NUMBERS		PART NUMBERS		PART NUMBERS	
MFGR.	MERIT	MFGR.	MERIT	MFGR.	MERIT	MFGR.	MERIT
RCA		RCA		RCA		RCA	
70477	BC-381	73570	HVO-3	76136	MDF-74	77514	FM-251(2)
71047	A-2900	73571	TV-100	76139	A-3080(2,23)	77517	A-3031(2)
71299	BC-352	73572	TV-100	76140	C-4115	77525	BC-388
71415	P-3061	73573	TV-107(1)	76154	HVO-34	77526	BC-381
71416	HVO-3	73574	TV-100	76156	A-2931	77535	BC-566
71417	A-3035	73575	TV-101	76264	TV-101	77625	MDF-89
71418	A-4000	73576	TV-162	76264	TV-107	77626	TV-172
71419	A-2930	73577	TV-151	76271	A-2901	77635	P-2876
71420	MD-12	73578	TV-172	76284	C-2996	77636	A-2823(2)
71422	TV-101	73591	TV-172	76328	BC-353	77638	TV-130
71423	TV-100	73636	A-2936	76329	FM-251	77649	P-2877
71424	TV-104	73708	TV-136	76335	BC-352	77650	A-3003(7,18)
71425	TV-101	73743	FM-252	76337	BC-393	77676	C-4084
71426	TV-102	74019	BC-377	76338	BC-388	77697	MDF-89
71426	TV-103	74046	P-3067(14)	76351	BC-566	77821	A-2901
71427	TV-106	74141	MD-12	76381	HVO-34	77823	A-2823(2)
71428	TV-160	74143	P-3067(2,11,13,14)	76429	P-2879	77842	TV-186
71429	MWC-7	74144	A-4003	76430	HVO-35	77868	MDF-91(4,29)
71442	TV-101	74145	HVO-5	76431	A-2823(2)	77938	FM-252
71449	MWC-12	74194	P-2834(2,11)	76432	TV-127(2,5)	77994	BC-353
71526	TV-185	74214	TV-184	76433	TV-130	77997	MWC-6
71558	BC-352	74262	MD-12	76436	TV-247	78197	MWC-6
71625	BC-352(1)	74264	P-3067(2,13,14)	76438	TV-113(2)	78200	P-3058
71631	BC-353(1)	74358	A-2930	76439	TV-110	78201	HVO-55
71633	BC-381	74586	P-3070(2)	76440	TV-162	78202	A-2854
71661	A-2904	74587	A-3037(2)	76441	MWC-11	78203	TV-130
71772	P-3063	74589	TV-101(1)	76442	MWC-6	78204	TV-153
71773	A-3002	74590	TV-100	76481	TV-186	78205	MWC-6
71774	A-3035(2)	74591	TV-107	76482	TV-151	78268	TV-172
71775	A-4000	74592	TV-100	76483	MWC-2	78278	MDF-100
71776	A-2901(2)	74600	A-3020	76484	MWC-13(12)	78396	TV-172
71777	MD-12	74775	BC-355	76488	TV-130	78466	BC-562
71778	TV-150	74779	A-2998	76494	A-2815(2,60)	78805	P-3058
71845	FM-251	74780	BC-387	76495	P-3057	78809	A-2854
71846	BC-352(1)	74874	P-3057(2,11)	76498	C-4084	78810	HVO-55
71847	FM-251	74892	P-3057	76501	HVO-33	78869	MDF-91(54)
71848	BC-353(1)	74902	A-2905	76536	TV-172	78961	C-4133
71849	FM-251	74918	BC-352	76616	MDF-89(4,54)	78990	TV-130
71942	BC-561	74930	BC-566(5)	76640	BC-562	78991	TV-130
71970	C-2991	74949	P-3063(16)	76653	MDF-100	78992	TV-130
71975	P-2952(2)	74950	A-3080(2,23)	76675	TV-130	78993	TV-128
72167	C-2974	74951	HVO-8	76702	TV-115(2)	78996	TV-113(1)
72177	P-3072(2)	74952	MDF-76	76703	TV-119(4)	78997	TV-110
72179	C-2991(2)	74981	P-3078	76704	TV-151	78998	MWC-3(2)
72332	A-3020	75034	A-2931	76779	TV-118	79010	MWC-3
72333	BC-381	75036	A-2901	76794	HVO-35	79055	A-3031
72593	FM-251	75084	P-2834	76795	HVO-35	79057	BC-393
72594	FM-251	75181	TV-116	76796	HVO-35	79141	TV-122B
72619	FM-254	75204	MDF-74	76938	A-2852(2)	79143	A-2826
72723	FM-251	75207	P-2880	76977	TV-172	79144	MWC-11
72743	FM-252	75208	A-3080(2,24)	76978	A-2854(2)	79145	HVO-55
72770	TV-161	75209	TV-107	76980	TV-116	79157	TV-119(12)
72887	FM-251	75210	TV-118	76981	TV-113	79159	A-3019
72888	FM-251	75212	TV-117	76982	A-2931	79160	TV-165
72889	FM-252	75213	TV-167	76983	TV-151	79161	TV-166
72952	A-3035	75240	HVO-34	76984	P-2878	79162	P-3056
73017	BC-355	75251	TV-151	76997	A-3020	79164	TV-166
73036	BC-352	75252	TV-188	77112	TV-110	79185	BC-513
73037	BC-355	75253	TV-195	77122	A-2900	79278	BC-565
73048	BC-393	75486	BC-352	77129	A-3019	79283	A-3031
73114	BC-397	74587	BC-353	77194	BC-513	79379	A-3003
73129	BC-352	75508	P-2875	77198	TV-127(1,19)	79382	A-2854
73130	BC-355	75519	HVO-34	77225	TV-151	79383	TV-152
73154	C-2991	75520	A-3020	77323	A-2936(2)	79386	TV-119(12)
73376	BC-377	75559	FM-251	77416	BC-352	79387	P-3058
73448	TV-118	75560	FM-254(1)	77417	BC-355	79388	TV-127(1,19)
73477	TV-239	75566	P-2951	77433	TV-130	79390	TV-153(12)
73567	P-3067(2,11,14)	75585	HVO-34	77511	FM-253	79394	A-2854
73568	A-3035(2)	75645	P-2835(10)	77512	FM-254	79476	A-3019
73569	A-4003	75774	BC-387	77513	FM-254	79490	MDF-91(54)

MERIT COIL AND TRANSFORMER CORPORATION

PART NUMBERS		PART NUMBERS		PART NUMBERS		PART NUMBERS	
MFGR.	MERIT	MFGR.	MERIT	MFGR.	MERIT	MFGR.	MERIT
RCA		RCA		RCA		RCA	
79510	MDF-89(4)	101288	TV-184(5)	103103	TV-159	106142	MDF-117
79527	BC-353	101299	TV-199(5)	103104	MWC-11	106144	HVO-137
79534	TV-165	101290	TV-182	103114	MDF-119(8)	106145	P-2881
79629	TV-110	101605	BC-381	103207	BC-327	106169	HVO-137
79630	A-2823(2)	101718	A-3019	103312	A-2900	106211	A-3019(2)
79706	P-3056	101720	P-3147	103336	A-2901(2)	106219	HVO-123
79733	TV-172	101819	TV-180	103525	TV-172	106305	MDF-144C
79736	HVO-55	101849	P-3147	103570	TV-165	106359	HVO-231C
79763	BC-352	101880	A-2998	103809	C-4084	106360	A-4137C
79764	BC-353	102018	BC-326	103810	BC-566	106377	TV-163
79766	BC-387(7)	102019	BC-325	103829	A-4098(18)	106378	TV-180
79868	MDF-89(4,29)	102020	BC-326	103830	MDF-110	106434	TV-119(12)
79869	P-3056	102046	A-3034	103839	HVO-126	106504	A-2902
79870	HVO-55	102047	P-3044	103859	TV-190	106533	HVO-173
79947	BC-394	102048	A-2927(2)	103860	TV-184	106716	BC-388
79966/A	TV-165	102049	TV-154(2)	103903	BC-566	106757	TV-195
79986	A-2902	102050	TV-115(2)	103904	A-3026	106757	TV-185(5)
87311	A-3020	102054	MWC-11	104078	MDF-117(8)	106758	TV-199(5)
93486	TV-163	102087	TV-199	104085	A-2982	106965	P-3052
94161-501	P-2954(2)	102134	C-4133	104086	MWC-6	107022/-A	MDF-117
97604	A-2901	102136	TV-153(12)	104087	TV-169	107050	BC-419
97682-1	A-3080(2,24)	102138	MWC-14	104101	A-2982	107165	BC-667
98684	A-3101(2)	102195	TV-244	104130	P-2882	107166	BC-674(5)
98685	A-3100	102196	TV-184(5)	104192	A-2982(2)	107167	BC-675(5)
100037	A-3020	102197	TV-184(5)	104193	A-2931	107182	HVO-210
100075	BC-352	102198	TV-184	104228	BC-676	107192	M-47-110
100076	BC-355	102199	TV-195	194229	BC-672	107199	BC-680(5)
100112	FM-254	102200	TV-199	104230	BC-675	107222	A-2982
100131	TV-195(5)	102201	TV-193(5)	104236	HVO-152	107233	P-2897
100245	BC-352	102202	TV-206	104309	HVO-173	107284	TV-254
100246	BC-353	102243	BC-564	104337	A-2905	107296	BC-561
100285	HVO-123	102245	BC-566	104368	M-238	107327	A-2982
100286	C-4115	102246	BC-513	104369	MDF-119(8)	107338	A-2854
100300	TV-244	102247	TV-184	104408	MDF-117	107377	P-2882(2)
100358	TV-151	102248	TV-205	104481	HVO-137	107385	BC-566
100359	TV-180	102253	TV-122-B	104482	MDF-115(8)	107408	MDF-99(4,8)
100360	TV-199	102351	TV-184	104876	HVO-116	107421	HVO-116(2)
100361	TV-199(5)	102406	P-2881(2)	104877	A-2982	107422	HVO-116(2)
100362	TV-188	102407	A-2854	104904	BC-672	107668	MDF-117(8)
100363	TV-188	102431	TV-163	104921	P-2882	107698	HVO-190
100364	TV-122C	102432	TV-192	105020	MDF-144C	107933	MDF-117(8)
100365	TV-119(12)	102518	TV-119(12)	105053	MDF-113	108003	A-2935
100397	C-4133	102567	TV-130	105173	A-4136C	108007	BC-356
100418	TV-127	102576	TV-172	105174	A-3025	108008	BC-357
100420	TV-115	102637	A-2931	105192	HVO-230C	108411	BC-418
100421	TV-152	102638	C-4115	105195	C-4138	108421	A-2905
100422	TV-153(12)	102639	TV-192	105197	TV-165	108440	BC-418
100441	BC-566	102644	TV-122A	105250	BC-566	108472	A-4105(2)
100442	TV-199	102692	TV-122	105255	TV-185(5)	108489	P-2951
100448	BC-514	102696	TV-184(5)	105308	BC-566	108582	FM-255
100454	TV-172	102698	TV-195	105311	TV-185(5)	108583	FM-255
100586	MDF-99	102699	TV-195(5)	105456	BC-670	108679	A-3025
100597	TV-206	103016	BC-419	105513	BC-561	108687	A-3025
100827	A-3020	103018	BC-324	105516	BC-678	108792	A-2905
100828	HVO-123	103019	BC-325	105522	MWC-6	108973	BC-514
100834	A-2854	103020	BC-326	105597	A-2935	108974	A-3025
100853	MWC-10	103037	TV-201	105632	MDF-113	108995	BC-352
100855	P-2881	103038	TV-199(5)	105648	HVO-173(2)	108996	BC-355
100856	A-3020	103039	TV-199(5)	105649	A-2982	108997	BC-387
100857	A-2901	103092	HVO-137	105668	BC-674	108999	BC-419
100860	HVO-55	103093	A-2982	105771	P-3151(2)	109066	A-2988
100867	A-2827	103094	A-3026	105904	BC-326	109067	A-2931
100892	BC-394	103095	TV-113(1)	105905	BC-323	109068	HVO-116(2)
101067	BC-327	103096	TV-124	105906	BC-325	109069	P-4082
101098	BC-352	103097	TV-130	105924	TV-172	109070	MDF-115(8)
101099	BC-355	103098	TV-130	105926	A-2998(22)	109171	BC-565
101147	MDF-99	103099	TV-131	105934	BC-353(19)	109221	HVO-232C
101220	TV-119(12)	103100	TV-153	105935	BC-401(7)	109237	TV-166
101252	P-2882	103101	TV-121	106062	P-2872	109248	BC-562
101287	TV-185	103102	TV-166	106063	HVO-116	109257	TV-205

MERIT COIL AND TRANSFORMER CORPORATION

PART NUMBERS		PART NUMBERS		PART NUMBERS		PART NUMBERS	
MFGR.	MERIT	MFGR.	MERIT	MFGR.	MERIT	MFGR.	MERIT
RCA		RCA		RCA		RCA	
109263	A-4139C	111401	P-4082(2)	902475-1	A-2931	961419-502	MDF-115(4,8)
109286	P-4141C	111470	BC-357	903562-502	MDF-144C	961419-503	MDF-117(8)
109297	P-2882	111471	BC-356	903562-504X	MDF-144C	961422-1/-3/-4	A-2984
109298	TV-185	111517	A-4106(2)	903562-507	MDF-144C	961423-501	HVO-116
109299	A-4105	111540	BC-419	906102-504	MDF-99(90)	961429-3	A-3019
109318	TV-254	111621	BC-419	906121-501	HVO-116(2)	961429-7	A-3019
109385	A-2988	111643	A-3019	906122-501	MDF-115	961795-7	P-4082(2)
109457	MDF-144C	111660	A-3031(2)	906122-504	MDF-117(8)	961809-1/-2/-3/-5	P-2882
109532/A	MDF-117(8)	112135	P-2945(2)	906122-506	MDF-113(7,88)	962628-7	A-3019(2)
109685	A-2984	112250	P-4083	906128-501	P-2881(2)	962628-10	A-2902(2)
109695	MDF-115	112252	BC-352	906130-501	P-4082(2)	962636-501	HVO-232C
109696	HVO-116	112253	BC-353	906133-501	P-4082(2)	962675-503/-504	MDF-142
109735	BC-393	112256	C-2994(2)	906141-501	HVO-233C	962712-502	P-4141C
109758	TV-180	112299	BC-679	906148-501	P-4082(2)	970122-8	MD-12
109771	MDF-92(90)	112540	MDF-142	906152-501	HVO-234C	970144-1	TV-101
109782	TV-199	112541	P-4082(2)	906153-501	P-4141C	970144-3	TV-100
109783	A-2857(1)	112554	M-47-110	907251-1	HVO-116(2)	970145-1	TV-106
109834	TV-190	112577	P-4082(2)	907251-2	HVO-190	970148-1	TV-104
109834	TV-195	112646	P-2945(2)	912134-1	A-2902	970148-2	TV-101
109840	BC-666	112655	A-2900(2)	920005-4	BC-355	970160-1	TV-150
109845	MDF-144C	112712	MDF-142	926636-501	HVO-232C	970166-1	A-3035(2)
109850	A-4139C	112820	HVO-233C	940120-1	TV-160	970294-1/-2/-3	FM-251
109942	MWC-6	112821	A-4139C	940139-1/-2	A-2930	970294-4/-5	BC-352(1)
109943	BC-667	112822	A-3019	940144-9	TV-184	970294-11	FM-251
109944	BC-674	112829	C-4133	940144-10	TV-195	970441-2	BC-355
109945	BC-676	112845	P-4141C	940144-12	TV-163	970441-9/-11/-12	BC-352
109946	BC-672	112867	BC-566	940185-3	MWC-12	970445-1	P-3047
109949	TV-236	112870	TV-157	940185-4/-6	MWC-6	970445-5	P-2951
109950	A-2900(2)	112974	MWC-6	940187-1	A-3035	970507-4/-5	FM-252
109962	MDF-113(2,6) M47-110	113045	MDF-92(90)	940188-1	MWC-15	970608-7	A-2931
109991	A-4105	113100	A-2998	940351-2	BC-353(1)	970667-1	P-3078
109993	P-2872(93)	113216	P-4082(2)	940394-1	A-2904	970669-1	MDF-76
109999-1	A-3020	113256	C-4125	940762-1	P-3063	970679-1	P-2834
110005	FM-254	113280	BC-675	940777-1	P-3072(2)	970680-1	TV-167
110006	FM-255	113281	BC-665	940873-3	C-2991	970682-3	A-3080(2,23)
110027	A-3027	113382	HVO-234C	940877-1/-2	C-2991(2)	970683-1-6	P-2880
110057	BC-356	113383	P-4141C	940897-1	TV-161	970690/-1	MDF-74
110063	BC-419	113388	TV-205(5)	940934-1	A-2904	970694-1	HVO-34
110104	P-3045	113390	A-4140C	941110-1	A-3035	970712-1-2	P-2835(10)
110111	A-3019	113404	BC-679	941129-1	A-4003	970721-1-2	P-2835(10)
110127	BC-419	113424	BC-665	941129-4-5	A-4003	970722-25	A-2901
110132	BC-419	113428	A-3025	941150-1	TV-100	970727-6/-7/-8	A-3020
110133	A-3031(2)	113468	MDF-117(2)	941151-1/-2	TV-100	970727-10/-14	A-3020
110246	BC-357	113570	MWC-6	941152-1	TV-107	970727-15/-24	A-3019
110247	BC-356	113997	A-2901	941153-1	TV-100	970727-23	A-3020
110330	P-2872(1)	114000	BC-665	941154-1	TV-101	970727-25	A-2901
110366	BC-419	114165	MWC-6	941521-251	BC-566	970727-26/-27	A-3020
110462	BC-393	114268	C-4125	941622-18	TV-199	970918-1	P-3067(2,11,14)
110463	BC-353	114343	P-4082	942126-1	C-4115	970920-1	TV-162
110464	BC-352	203667	FM-253	942143-3	MWC-12	970921-1	HVO-3
110482	P-2834(10)	203669	FM-254	942176-1/-5	C-4084	970923-1	HVO-5
110494	BC-418	204126	BC-352	942176-12	C-4084	970924-1	P-2834(2,11)
110498	A-3020(2)	204127	BC-352	942476-1/-4	A-3003(7,18)	970925-1	P-3067
110850	FM-259	204130	BC-387	942541-2/-3	MWC-11	970950-1	P-3067(14)
110851	BC-357	219983	BC-565	942889-2	A-2900	970960-1	P-3067(2,13,14)
110871	FM-258	219988	TV-204	942971-1	TV-119(12)	970972-1-3	P-3070(2)
110879	BC-356	219990	A-2938	943431-2/-3	C-4115	970979-1	HVO-8
110889	FM-255	226185	TV-194	943431-12/-13	C-4115	970984-1	P-3057(2,11)
111014	FM-258	226186	TV-195	943431-15/-16	C-4115	970987-1	P-2834(2)
111015	FM-259	337548-18	C-2994(2)	943431-18/-20	C-4115	971165-2	A-4106
111179	A-2902(2)	345259-12	P-4083	943447-1	TV-151	971165-15	A-2905
111295	BC-353	345362-9/-10	A-3019(2)	961199-2-5	P-2882	971169-1	FM-251
111296	BC-352	734046	P-3067(14)	961411-1/-2	P-2882(2)	971169-2	FM-254(1)
111315	BC-419	778686	MDF-91(4)	961413-2Y	P-4082	971237-1/-3/-4/-6	P-3056
111382	BC-561	791391-3	A-2823(2)	961415-1	A-4138C	971239-1/-2	HVO-55
111383	BC-356	902462-1	A-3020	961415-2	A-4139C	971316-1-4	P-2875
111384	FM-259	902469-1	A-3020(2)	961415-3	A-4140C	971317-1/-2	HVO-34
111385	BC-357	902470-1	A-2931	961415-7	A-4139C	971321-1	HVO-34
111386	FM-259	902472-1	A-2901	961416-1	P-4141C	971324-1	MDF-74
111390	BC-419	902473-1	A-3019	961417-8	A-3031(2)	971334-1	HVO-35

MERIT COIL AND TRANSFORMER CORPORATION

PART NUMBERS		PART NUMBERS		PART NUMBERS		PART NUMBERS	
MFGR.	MERIT	MFGR.	MERIT	MFGR.	MERIT	MFGR.	MERIT
SENTINEL		SENTINEL		SETCHELL-CARLSON		SETCHELL-CARLSON	
22E32	C-3181(2)	320801-2	A-3006	LM-1084	C-4115	TM-1761	A-2902(2)
22E33	A-3035	320802-1/-2	A-2928	LM-1222	C-4084(2)	TM-1895	P-4082
22E34/-2	HVO-3	320803-1/-2/-3	C-2996(2)	M-571-D	C-4084	TT-107	C-4084
22E35/-2/-3	A-2931	320804-1	A-3037	M-572	A-3037	TWF-90	HVO-225
22E36	C-2994	320805-1/-2	HVO-137	M-573	A-3006	TWF-110/X	HVO-225
22E38	A-4000	320810-1	A-3037	M-580	A-2930	V-1785	MDF-92(4,7,8,9)
22E39	A-3036	320811-1	HVO-127	M-581	A-3006	WF-9	HVO-225
22E42	HVO-3	360659-1	HVO-133	M-681	A-2931	WF-14	HVO-54(2,7)
22E43	P-3078	360660-1	MDF-92(4,8,75,92)	M-682	A-3000	WF-70	HVO-54(2,7)
22E47	P-2837	361201-1	TV-131	M-685	A-3037	WF-90	HVO-225
22E51	A-3037	361202-1	TV-243	M-751-D	C-4084	WF-110	HVO-225
22E52	C-2994(2)	361203-1	TV-245	M-789	A-2936	Y-100	MDF-92(4,7,8,9)
22E53	P-2835	361205-1	TV-120	M-814	P-2849	Y-102	M-51-70-90
22E54	HVO-10(2,3)	361206-1	TV-120	M-815/D-1	A-2852(2)	Y-104	MDF-92(4,8)
22E55/-2	A-3003	361207-1	TV-121	M-815D-2	A-2821	Y-105	M-238
22E56	P-2835	361208-1	TV-202	M-816	C-2974	Y-109	MDF-109(4,90)
22E57/-2/-3/-4	HVO-46	361208-2	TV-185	M-817	A-2930	Y-110/-A	MDF-133(54)
22E57-5/-6	HVO-46	361208-3	TV-205	M-847	A-2930	Y-114	MDF-128(4,88)
22E58	A-3037	361208-4	TV-195	M-1028/SC	A-3026	Y-1023	MDF-144C
22E59	P-2830(10)	361209-1	TV-163	M-1162	A-2904(2)	Y-1068A	MDF-128(4,88)
22E61/-2/-3	HVO-46	361212-2	MDF-92(4,87)	M-1192C/-R1	P-4082(2)	13M17273	TV-115(1)
22E63	A-2829	361218-1	TV-120	M-1372	A-2902	20-100Y	MDF-128(4,7,8)
22E64	C-2991	361219-1	TV-113(1)	M-1547	A-3021	52B13-1/-B	MDF-70(4,8,9,54)
22E67	HVO-46(3)	361221-1	TV-245	M-1751	A-2932	72A60-1	TV-119(12)
22E68	P-3078	361222-1	MDF-92(4,8)	M-1761	A-2902(2)	94A17	TV-163
22E69	P-2830(10)	361224-1	TV-206(5)	M-1895	P-4082	362-114	MDF-133(4,88)
22E70	A-3006	361224-2	TV-188	P-68-114	MDF-133(4,7,88)	449-IF	BC-352
22E71/-2	A-2928	361224-3/-4	TV-185(5)	PF-155	HVO-54(7,29)	484	MDF-92(4,8,9)
22E72/-2	A-2825	361224-5	TV-195(5)	S-1028SC/-A0	A-2931	570-455	BC-352(1)
22E73/-2	C-2974			S-3700	MDF-92(4,90)	571D	C-4084
22D74	P-2837			SC-1085-6	A-2901(2)	789	A-2901
22E75/-1	HVO-93			SC-63420	A-3019	815/A/B/C/D	A-2852(2)
22E77	C-2994			T-100	P-2849	815E	A-2815(2,18,47)
22E78	C-2994(2)			T-101	A-2852(2)	1018ED	P-4082(2)
22E80/-C	HVO-92(7,91)			T-102	A-2930	17189-2	MDF-92(4,7,8,9)
22E81	A-2823	A-449B	BC-388	T-103	HVO-38(7)	17671-1/-2	MDF-92(4,8)
22E82	P-2839	B-13M19643	TV-110	T-104	TV-115	17731-20/-21	MDF 133(92)
22E83	C-2996(2)	B-72A83-3	TV-116	T-109	TV-113(1)	906415-3	A-4140C
22E86/-B	P-2839	B-202	BC-566	T-110	A-2936	1104665-3	C-4133
22E89	A-3003	B-203	TV-128(1,2,41)	T-111	HVO-54(7,29)		
22E89-2/-3	A-3006	B-7283-3	TV-116	T-113	BC-388		
22E90	A-2823(18)	C-4501-A/-C	TV-154	T-115	BC-352		
22E91	A-3025	C-4502/-A	TV-113(1)	T-117	TV-119(12)		
22E94	P-2837	C-4503	TV-115	T-120	A-2930		
22E97	A-2824	D-200	TV-187	T-123	HVO-54(2,7)	SHARP	
22E99	A-3025	D-201	TV-190(5)	T-124	HVO-54(2,7)	DC-134	MDF-127(4,95)
22E100/-B	C-2996(2)	D-201	TV-199(5)	T-125	P-4082(2)	J-624	BC-574
22E101	A-2825	D-203	TV-195	T-126	A-2900	J-625	BC-575
22E102	A-2935	FA-53-102	MDF-70(4,8,9,54)	T-301	P-4082(2)	J-6212	BC-576
22E103	A-3019	HF-155	HVO-38(7)	TF-10	HVO-54(7,29)	TL-21	BC-562
22E104	P-2839(11)	L-100	C-2974	TF-90	HVO-225	TL-212	TV-190
22E105	C-2996	L-102	TV-199(5)	TF-1025	HVO-234C	TL-223	TV-185
22E106	A-3003	L-103	TV-119(12)	TL-104	TV-115	TL-230	TV-192
22E108	A-2823	L-104	TV-195	TL-107-4	FM-255	TL-248	TV-193
22E109	C-2974	L-105	TV-154	TL-107-5	FM-254	TL-249	TV-184
22E118-B	A-3037	L-106	BC-566	TL-115	BC-352	TL-264	TV-192
22E119-A	A-2928	L-108	C-4084	TL-115	BC-353	TL-265	TV-193
30E141-2/-3	MD-12	L-110	TV-190(5)	TL-117	TV-119	TL-266	TV-184
30E162	MDF-70	L-110	TV-202(5)	TL-117	TV-238	TL-267	TV-185
30E164/-2/-3	MDF-70	L-111	TV-185(5)	TL-120	TV-131	TL-267	TV-200
30E164-4/-5/-7	MDF-70	L-112	C-4084	TL-1004	TV-119	TL-601	BC-566
30E168	MDF-70	L-152	TV-252	TM-815D-2	A-2853(35)	TL-603	BC-560
30E176	MDF-70	L-167	TV-253	TM-815E	A-2815(2,18,47)	TL-616	TV-180
158385-1	MDF-105	L-1005	TV-193	TM-1016	A-4140C	TL-983	MWC-5(12)
158426-1-2	MDF-105	L-1013	TV-205	TM-1028/SC	A-2931	TL-996	BC-562
300094-1	P-2882(2)	L-1036	TV-195	TM-1085	A-2900(2)	2TIF-430	TV-119
320266-1	A-2998	LC-102	TV-199	TM-1086	A-2852(2)	2TIF-431	TV-153
320268-1	C-4084	LC-106	BC-566	TM-1192C/CDS	P-4082(2)	2TIF-443	TV-153
320269-1	A-2857(2)	LM-1026	C-4133	TM-1372	A-2902	4L-130A	BC-419
320272-1	A-2901	LM-1083	C-4084(2)	TM-1547	A-3021	4L-316B	BC-394

MERIT COIL AND TRANSFORMER CORPORATION

PART NUMBERS		PART NUMBERS		PART NUMBERS		PART NUMBERS	
MFGR.	MERIT	MFGR.	MERIT	MFGR.	MERIT	MFGR.	MERIT
SHARP		SHERATON		SILVERTONE		SILVERTONE	
71F-719	BC-575	EL-113	C-2996(2)	A10-13-5	TV-233	B12C-1122	A-2931
71F-728	BC-576	EL-120	TV-107	A10-508/509	BC-352	B13H-1369	TV-101(2)
71F-748	BC-574	EL-121	TV-142(83)	A10-512	BC-381	B13K-1047	TV-111
7L-232A	BC-419	EL-122	TV-137	A10-521/529	BC-352	B80-1	A-3003
7T-145	A-4103(2)	EL-126	MWC-4	A10-537	BC-350	B80-1-2C/F/G	A-4123
7T-153	A-2900	EL-127	MWC-5	A10-540	BC-316	B80-3-2C	A-2815(18,38)
7T-154	A-3020	EL-128	TV-166	A10-667	BC-387	B80-21-1C	A-3026
7T-161	A-2900	EL-130-C	TV-165	A12D-1028	P-3142(2)	B80-78-1D	A-2903
8T-157	A-4113(2,35)	EL-138/-A	MDF-70	A13A-1139-1	TV-102	B80-81-1E	A-2930
9L-201	TV-192	EL-141	MWC-2	A13A-1139-1	TV-103	B80-107-1A	A-3031
9L-202	TV-195	EL-151-B	MDF-70	A13D-1456	TV-163	B80-122-1B	A-4097
9L-203	TV-199	EL-152	TV-113(1)	A13D-1479	TV-163	B80-126-1C	A-2902
9L-204	TV-203	EL-153	TV-115	A17B-1031	C-2991(2)	B80-143-1	A-2902
9L-205	BC-662	EL-154/-B	C-2974	A80-15-6	C-4115	B80-162-1B	A-2902
9L-206	BC-670	EL-160	MWC-6	A80-63-1D	A-3026	B80-242	A-2930(2)
9L-207	BC-675	EL-161	TV-116	A80-135-1E	A-2930	B80-243	P-2970(2)
9L-208	BC-678	EL-162	TV-102	A80-136-1B	A-3026	B80-249	A-2900
8503	BC-575	EL-162	TV-103	A80-170-1C	A-3019(2)	B80-271	P-2970(2)
8511	BC-574	EL-163	TV-116	A80-419	C-4095(2)	B80-286	A-3019
8518	BC-576	EL-171	TV-104	A-1095	HVO-3	B80-296	P-2860
216311	MDF-107(88,92)	EL-173/-B	MDF-73(4)	A-1099	A-3003	B80-304	A-2930
301010	MDF-127	EL-175	TV-124	A-1201	TV-115	B80-314	P-2970(2)
301012	MDF-107(88,92)	EL-184	TV-151	A-1202	TV-115	B80-315	A-3026(2)
301040	BC-419	EL-195	MWC-6	A-1350-2	A-3038	B80-325	A-3039(2)
301100	MDF-107	EL-196	TV-151	A-1352	A-3036	B80-371	A-4003
302010	A-4103	EL-197	TV-116	A-1354	A-3036	B80-377	A-3039(2)
302012	A-2900	EL-203	C-2996(2)	A-1406	C-2974	B80-380-A	A-3003
302053	BC-577	EL-1062	TV-151	A-3392	TV-102	B-10106	A-3000
303010	A-4113	ET-100	TV-160	A-3392	TV-103	C-1.549	TV-162
303050	BC-574	ET-100-B	TV-162	A-3393	TV-115(1)	C-1.552-1	TV-115
303053	BC-574	ET-101-B	P-3067(2,13,14)	A-3395	FM-254	C-1.553	TV-116
304041	BC-574	ET-102	A-4000	A-3396	BC-352	C-1.554	TV-119
304053	BC-575	ET-103	A-3038(2)	A-3397	FM-255	C-9.228-5	A-3036
304062	BC-569	ET-105	A-2931	A-3399	FM-255	C-9.230-4	A-3003
305041	BC-575	ET-106	HVO-91(7,29)	A-10100	HVO-3	C-9.237-3	C-2991(2)
305050	BC-576	ET-109-1	A-2928	A-10104	HVO-26	C-9.254-3	MDF-72
305053	BC-576	ET-109-2	A-2930	A-10105	P-3069(10)	C-9.259-1	HVO-96
306062	BC-571	ET-110	A-3036	A-10106	A-3003	C10-34-0	FM-258
307012	BC-562	ET-112-A	HVO-25	A-10108	HVO-26	C10-815-B	MDF-92(4,7,8)
307062	BC-569	ET-112-D	MDF-70	A-10109	P-3069	C80-1-3B/H/R/S	HVO-146
309063	BC-570	ET-115	A-3000	A-10115-4	A-3036	C80-3-7B	A-3006
310010	TV-184	ET-119/-B	HVO-25	A-10115/-5	A-3038	C80-4-2C	A-2823(18)
310040	BC-575	ET-120-A	P-2945	A-10134	A-4003	C80-87-1A	A-3020(2)
310063	BC-571	L-1033	C-2996(2)	A-10135	HVO-26	C80-112-1B	A-2902(2)
311010	TV-185	T-1036-1	A-4000	A-10136	HVO-27	C80-116-1A	A-2905
311040	BC-576	1645-2	TV-113	A-10137	HVO-27	C80-132-1B	A-2902(2)
313010	BC-566			A-10152/-1	A-4089	C80-250	P-2970(2)
314040	TV-203			A-28254	TV-120	C80-253	A-3019
316100	MWC-6			A-28258/-1/-2	MWC-7	C80-258/E	P-2970(2)
317100	MWC-6			A-28259	MWC-12	C80-292	P-2835
318100	TV-166	SHERWOOD		A-28261	MD-12	C80-296	P-2860
319010	TV-192	55-364	FM-254	A-28263	TV-163	C80-326	HVO-161
319100	A-3020	59-154	FM-254	A-28278-2/-3	MDF-70	C80-336	HVO-161
320010	TV-193	59-199	FM-253	A-28279/-1/-2	MWC-8	C80-361	HVO-161
321010	MWC-5(12)			A-28286	TV-151	C80-363	HVO-161
				A-28292/G	MWC-12	C80-375	HVO-136(7)
		SHRIRO		A-28301-3	MDF-7	C-23087-1	C-2994
		FMC-5485	BC-578	A-28302-1E	MDF-70	C-24776-1	A-3019
		FMC-6019	BC-579	A-28303	TV-165	C-9.259-1	HVO-96
		FMC-6088	BC-578	A-28304	TV-166	D-9.260	P-3055
		6046	BC-575				
		6047	BC-575	A-28305	TV-116	D80-1-4L	MDF-92(4,7,8)
				A-28317-3	MDF-70	D80-2-3A	HVO-136
				A-28318-1	MWC-18	D80-2-4J	MDF-92(4,8)
		6612	BC-574	A-28322-1	MDF-70	D80-5-4A/F	MDF-92(4,7,8)
		6641	BC-578	A-28330	MDF-70(8)	D80-7-4H	MDF-133(2,7)
		8503	BC-575				
		8508	BC-574	B-1.531	MWC-11	D80-9-4A	MDF-133(7)
		8518	BC-579	B-1.533-1	MWC-12	D80-10-2A	A-2823(18)
				B-1.549	TV-162	D80-10-3B	HVO-197
		8549	BC-575	B10-116-2A	BC-356	D80-10-4	MDF-133
		8603	BC-575	B10-135-2	FM-256	D80-14-3C/E/H	HVO-218
SHAW (See Delmonico)							
SHERATON							
EL-101	TV-101						
EL-102	TV-151						
EL-104	TV-124						
EL-105	TV-106						
EL-112-D	MDF-70						

PART NUMBERS		PART NUMBERS		PART NUMBERS		PART NUMBERS	
MFGR.	MERIT	MFGR.	MERIT	MFGR.	MERIT	MFGR.	MERIT
SILVERTONE		SILVERTONE		SILVERTONE		SILVERTONE	
D80-16-4B	MDF-133	M55C134	A-2931	N-41092-1	A-2815(46)	PMC-50034	P-3082
D80-20-4B/E	MDF-133(88)	M55C144	HVO-52(3)	N-41119-1	A-3025(2)	PMC-56002	HVO-47
D80-21-4E	MDF-133	M55C149	HVO-47(7)	N-41173	TV-130	PMC-56017	HVO-36
D80-27-4A	MDF-133(76)	M55C152-B	HVO-47(7)	N-41177	TV-113(1)	PMC-56038	HVO-40
D80-29-4B/F	MDF-133(88)	M55C154	HVO-52(3)	N-41366-1	A-3025	PMC-56039/-2	MDF-75(4,7,8)
D80-35-4F	MDF-143(4)	M55C155	HVO-52(3)	N-41745-1	A-3003	PMC-56044	MDF-75(4,7,8)
D80-36-4P	MDF-133	M55C156	HVO-150	N-41848	TV-152	PMC-56049	HVO-161
D80-38-4A	MDF-133	M55C171	HVO-150	N-41849	TV-153(12)	PMC-56050	MDF-92(4,7,8)
D80-42-4A	MDF-133(7)	M56B117	C-2994(2)	N-41852	HVO-55(7)	PMC-97281	MDF-91(4,5,4)
D80-376	HVO-161	M56C116	C-2994(2)	N-41879	TV-113(1,19)	PMD-52033-1/-2	BC-352
E-622	BC-352	N-21797-16	BC-352	N-41884	MWC-11(6)	R50-74589-1	TV-189
E-6119	TV-151	N-22334-1	TV-189	N-41887	MWC-6(6)	R50-83834-1	BC-400(2)
E-6256	BC-352	N-22446-1/-2/-3	A-4003	N-41984-1	A-2823	R57-74581-1	FM-254
E-6283	FM-255	N-22561-1/-2	C-2996	N-42135	TV-130	R57-74582-1	BC-355
E-6296	FM-254	N-22561-5/-6	C-2996	N-42144/-1	A-2931	R57-74583-1	FM-255
E-62419	BC-353	N-22562	MWC-12	N-42504	MDF-91(4,54)	R57-83693-1	BC-352
E-627189	FM-254	N-22563	TV-162	N-43412-1	BC-352	R57-83694-1	FM-254
FC-21/22	C-4095(2)	N-22587-1	BC-381(2)	O-13093	BC-418	R-45018	BC-308
LC-A9	TV-102	N-22592-1	FM-255(1)	PB-10125	A-3003	R-45079	A-2900
LC-A23	MWC-12	N-22905-1	A-3037	PB-28302-1	MDF-70	R-45100	P-3068(29)
LC-A29	MWC-1	N-23085	MDF-73(4)	PC-5866	A-3026	R-45162	P-3068(29)
LF-30	FM-254	N-23087/-1	C-2994	PC-10107	HVO-26	R-45166	A-2900
LF-32	BC-352	N-23088-1	C-2994	PC-28263	MDF-70	R-45168S	BC-367
LF-33	FM-255	N-23090-1	A-4103	PC-28278	MDF-70	R-45169S	BC-372
LF-34	FM-254	N-23093	TV-151	PC-28330	MDF-70(8)	R-60418	BC-353(1)
LF-35	BC-353	N-23094	TV-115	PCM-5866	A-3026	R-62149	P-3077(93)
LG-10017	TV-163	N-23397	P-2836	P.I.A.-80-22-4	MDF-133	R-62174	A-3027
LGA-10017A/B	TV-163	N-23449	TV-163	PMA-51022	A-3026	R-62175	C-2995
LGA-10021A	C-4084	N-23490/-1	A-2928(2)	PMA-52020	TV-112	R-62510	A-2930
M50A432	TV-120	N-23542	P-3040(2)	PMA-52021	TV-103	R-62516	BC-338
M50A474-G	TV-151	N-23614	TV-132	PMA-52021	TV-138	R-63929	A-3032(2)
M50A475	TV-116	N-23657	A-3037	PMA-52027	TV-115	R-65426	TV-141(83)
M50A476-E	TV-141	N-23669-1/-2	A-2930	PMA-52028/-1/-2	TV-151	R-65427	TV-142
M50A477	TV-116	N-23672	TV-134	PMA-52029	TV-116	R-65428	A-3000
M50B473/-D	TV-110	N-23802-1	HVO-7(2,3,91)	PMA-52102	TV-137	R-65432	P-3048
M50B474	TV-151	N-23817	MDF-73(4)	PMA-52104	TV-116	R-65441	HVO-3
M51A1243-C	MWC-5	N-23840	P-2948(2)	PMA-52105	TV-120	R-65451	A-3035(29)
M51A1261-C	MWC-12	N-23894	MWC-6	PMA-56000	MDF-72(4)	R-65452	MWC-7
M51A1288	TV-116	N-23931-1	A-2928	PMA-56001	MWC-5	R-65453	MWC-12
M51A1289	TV-116	N-24283	MDF-73(4)	PMA-56003	MWC-6	R-65461	MD-12
M51B1071	MWC-12	N-24440	P-3151	PMA-56004	A-3039	R-65463	P-3067(11,13,14)
M51B1072/-1	MWC-7	N-24771	BC-352(1)	PMA-56005	A-3003	R-65479	TV-104(19)
M51B1153	TV-167	N-24776-1/-3/-5	A-3019	PMA-56005-2	A-3000	R-65480	TV-105
M51B1230	MWC-7	N-24807	MDF-73(4)	PMA-56019	MWC-1(7)	R-65513	BC-352(1)
M51B1232	MWC-12	N-24989	HVO-47	PMB-50003	P-2838(10)	R-66191	P-3048
M51B1242	TV-162	N-24990-1	A-3039	PMB-51005	A-2931	R-66192	A-3032(2)
M51B1277	MWC-5	N-25322	TV-110	PMB-51018	A-3026	R-67133	C-4115
M51B1290	TV-116	N-25410	TV-132	PMB-51020	A-3019(2)	R-67304	P-3067(11,13,14)
M51B1335	MWC-11	N-25411	TV-133	PMB-52019	TV-162	R-67316	A-2931(2)
M52C196	P-2836	N-25412	TV-134	PMB-52033	BC-352	R-67800	BC-352
M52C199	P-3169(2,14,16)	N-25433	P-3078(11)	PMB-52049	TV-128	R-67801	BC-353
M52C204	P-3073	N-25474	TV-129(1)	PMB-52050	TV-127	R-67802	FM-254
M52C223	P-3071	N-25543	TV-154	PMB-52052	TV-126	R-67803	FM-254
M53A180	MD-12	N-25609	TV-151	PMB-52102	TV-137	R-67885	A-2931(2)
M53C194	MD-12	N-25706-1	BC-382(2)	PMB-52105	TV-120	R-70077	TV-119(12)
M53C195	MDF-72	N-25728-1	BC-368	PMB-52106	TV-110	R-70155	HVO-3
M53C197-B	MDF-72(4)	N-25729-1	BC-371	PMB-52108	TV-127(83)	R-70158	A-2931(2)
M53C201-D	MDF-72(4)	N-25828-1	BC-382	PMB-52109	TV-128	R-70181	TV-154
M53C202	MDF-70	N-40028	MWC-5	PMB-52110	TV-126	R-70189	P-3067(11,13,14)
M53C203	MDF-71	N-40513	HVO-36	PMB-52111	TV-126	R-70190	P-3067(11,13,14)
M53C217	MDF-71	N-40532	MWC-1	PMB-52121	TV-126	R-70656	TV-103
M55A128	A-3037	N-40533	MWC-6	PMB-52122	TV-162	R-70834	TV-113
M55A157	A-3018	N-40537	MDF-91(4)	PMB-56016	A-3038	R-70930	HVO-3
M55A166	A-3037	N-40690	FM-251	PMB-5608	C-2996(2)	S84-383	A-3019(4)
M55B115	A-3000	N-40925-1	C-2994	PMB-56037	A-3003(2)	SA192-31	TV-126
M55B128	A-3037	N-40926	P-3055(10)	PMB-56040	A-3039(2)	SA192-32	TV-126
M55B150	A-2930(2)	N-40937	TV-124(2)	PMB-56048	A-3039(2)	T10-42-2	BC-352
M55B151-B	A-3039	N-41020	MWC-11	PMB-97213	MDF-72(4)	T10-43-2/-4	BC-353
M55C115	A-3000	N-41023-2	A-2823	PMC-50003	P-2838	T10-45-2	BC-352
M55C133	HVO-52(3)	N-41024	HVO-9	PMC-50006	P-2833	T10-46-2	BC-353

MERIT COIL AND TRANSFORMER CORPORATION

PART NUMBERS		PART NUMBERS		PART NUMBERS		PART NUMBERS	
MFGR.	MERIT	MFGR.	MERIT	MFGR.	MERIT	MFGR.	MERIT
SILVERTONE		SILVERTONE		SILVERTONE		SILVERTONE	
T10-47-2	BC-350	T80-280	A-2900(2)	TOA-10024	MWC-12	W-507343	TV-102
T10-48-2	BC-354	T80-284	A-3003(2)	TOA-10051A	A-3003	W-507343	TV-103
T10-479	BC-353	T80-286	A-3019	TOA-10053	MWC-12	W-507791	MD-12
T10-508	BC-352	T80-287	A-3037	TOB-10045D	A-3036	W-507986	TV-189
T10-509	BC-353	T80-288	A-3003(2)	TOB-10045E	A-3037	W-508058	HVO-3
T10-521	BC-352	T80-289	HVO-41	TOC-10034/C	A-3026	W-508059	A-3036
T10-529	BC-353	T80-290	A-2855	TPC-10005A	P-2834(15)	W-508076	A-3003
T10-537	BC-354	T80-291	A-2902	TPC-10011	P-2834(15)	W-508077	TV-163
T10-540	BC-350	T80-292	P-2835	TPC-10018	P-2834(15)	W-508179	FM-255
T10-541	TV-116	T80-293	HVO-41	TR-A27	TV-106	W-508341	C-2996
T10-542	TV-116	T80-294	P-2876	TR-A28	TV-105	W-508667	MWC-1
T10-543	TV-116	T80-295	A-2901	TR-A29	TV-100	W-508674	A-3037
T10-551	MWC-7	T80-296	P-2860	TR-A30	TV-101	W-508675	MDF-70
T10-552	TV-110	T80-313	A-2927(2)	TR-A32	TV-160	W-508679	HVO-7(2)
T10-555	TV-163	T80-314	P-2970(2)	TR-A40	MDF-70	W-508883	HVO-7(2)
T10-556	TV-151	T80-315	A-3026(2)	TR-B41	HVO-7	W-508956	A-3037
T10-561	MWC-12	T80-316	A-3039(2)	TSA-10030B	TV-102	W-508967	TV-163
T10-571	TV-151	T80-317	A-3003(2)	TSA-10050A/B/C	TV-151	W-508971	HVO-7(2)
T10-574	TV-150	T80-318	P-3082	TSA-10054	TV-116	W-509361	MWC-18
T10-581	TV-151	T80-319	A-3026	TSB-10051/A	TV-110	W-509375	A-3038(18)
T10-582	MWC-6	T80-320	HVO-40	TSP-41-8	A-3025	W-509376	A-2930
T10-583	TV-163	T80-324	A-2927(2)	TTH-253-D-1	HVO-7(2)	W-509380	P-3070
T10-587	TV-151	T80-325	A-3039(2)	TTR-105	P-3059	W-509384	HVO-10(7)
T10-594	TV-127(2)	T80-326	HVO-161	TTR-106-D/-1-D/-2-D	C-4115	W-509603	TV-151
T10-595	TV-128(2)	T80-328	A-3003	TTR-152	A-4000	W-509704	MDF-70(72,75,92)
T10-596	TV-126(2)	T80-329	A-3019	TTR-152-2	A-3000	W-509706	TV-110
T10-597	TV-247	T80-336	HVO-161	TTR-153/-2-D	A-3035	W-520942	MDF-72
T10-602	MWC-7(6)	T80-340	A-2930	TTR-153-4-D	A-3036	W-520943	TV-167
T10-604	MWC-6(6)	T80-342	A-3019	TTR-154	HVO-3	W-520975	A-3038(4,18)
T10-645	BC-381(2)	T80-347	A-3039	TTR-156	A-2931	W-520977	TV-116
T10-658	TV-125	T83-669	MDF-70(4)	TTR-157/-D	TV-161	W-520979	TV-116
T10-659	TV-127(1,2)	T83-694	MDF-70(4)	TTR-159-D	MD-12	W-520980	A-3003
T10-660	TV-128	T83-743	MDF-72(4)	TTR-161-D/-1-D	A-3000(20)	W-521066	HVO-9(2,7)
T10-661	TV-126(2,12)	T83-776	MDF-72(4)	TTR-161-2-D/-3	A-3000(20)	W-521157	BC-382(2)
T10-667	BC-387	TA-B5	A-3035(2)	TTR-165-D	A-2930	W-522519	TV-162
T10-669	TV-162	TA-B7	A-2935	TTR-165-1-D	A-3026	YD-1001	MDF-70
T10-670	TV-137	TA-B9	A-3003	TTR-170-D	P-2835(7)	YDB-10000A	MDF-70
T10-672	TV-116	TC-A5	C-2991	TTR-178-1-D	C-2994	030-001	TV-203
T10-673	MDF-73(4,7,8)	TC-A7	C-2974	TTR-179-D	A-2930	030-005	TV-239
T10-674	TV-120	TH-10000	HVO-91(2,3)	TTR-181-D	HVO-3	10-2-4	BC-393
T10-675	TV-139(2)	THC-10000A	HVO-91(2,3)	TTR-182-D	P-3078	10-3-0	TV-115
T10-677	TV-128	THC-10002	HVO-10(2,3)	TTR-185-D/-1-D	A-3036	10-7-2	TV-126
T10-678	TV-126	THC-10003/E	HVO-91(2,3)	TTR-186-D/-1-D	HVO-3	10-7-3	TV-131
T10-679	TV-126	TLF-114-D	TV-154	TTR-188-D	P-3078	10-8-2	TV-126
T10-680	TV-127(41)	TLF-137-D	TV-230	TTR-195-2-D	A-2928	10-9-2	TV-127
T10-682	MDF-73(4,7,8)	TLF-142-D	TV-115(1)	TTR-201-D	MDF-70	10-11-0	TV-113
T10-689	TV-115	TLF-505/-D	MWC-7	TTR-208-D	HVO-8	10-12-1	TV-195
T10-690	TV-167	TLF-506/-DA	MWC-12	TTR-209-D	HVO-7(2)	10-13-5	TV-233
T10-692	MDF-73(4,7,8)	TLF-524-D	TV-151	TTR-210-D	HVO-7(2)	10-15-0	FM-255
T10-693	MDF-73(4,7,8)	TLF-525-D	TV-151	TTR-212	HVO-26(2)	10-15-1	BC-674(5)
T10-695	TV-126	TLF-531-D	TV-115	TTR-217-D	MDF-71	10-17-2	TV-126
T10-696	MDF-73(4,7,8)	TLF-552-D	TV-115	TTR-219-D	HVO-26(2)	10-18-0	FM-253
T10-698/D	MDF-92(4,7)	TLF-553-D	MWC-12	TTR-220-D	MDF-70	10-18-1	TV-162(2)
T10-715	TV-110	TLF-557-D	TV-124(2)	TTR-223-D	MDF-70	10-18-2	TV-126
T10-716	TV-110	TLF-566-D	TV-162	TTR-224-D	MDF-71(4)	10-19-4	TV-165
T33-238	C-2994	TLF-570-D	TV-151	TTR-226-D	C-4084	10-20-5	TV-233
T80-21-0	P-2969	TLF-574-D	TV-116	TTR-227-D	MDF-71	10-21-2	TV-113
T80-57-1	A-2998	TLF-576-D	TV-116	TTR-242-D	MDF-70	10-21-5	TV-233
T80-251	A-3019	TLF-579-D	TV-151	TTV-254-D	A-3036	10-23-3	TV-242
T80-253/E	A-3019	TLF-580-D	TV-165	W-115228	MDF-70(72,75,92)	10-24-3	TV-240
T80-257	A-3003(2)	TLF-581-D	TV-166	W-162056	MWC-9	10-26-1	TV-110
T80-258	P-2970(2)	TLF-593-D	TV-116	W-162190	MWC-2	10-26-3	TV-131
T80-261	A-3037	TLF-594-D	TV-115	W-505797	BC-353	10-28-0	BC-560
T80-263	HVO-9	TLF-619-D	MWC-12	W-505867	BC-352	10-29-0	FM-257
T80-264	P-2835	TO-10023	MWC-7	W-505905	FM-254	10-29-3	TV-236
T80-265/G	HVO-91	TO-10024	MWC-12	W-505912	A-3019	10-30-1	TV-185
T80-271	P-2970(2)	TO-10034	A-3026	W-506080	FM-254	10-30-5	TV-166
T80-277	A-3037	TO-10045	A-3036	W-506333	BC-352	10-31-2	TV-126
T80-278	HVO-41	TO-10051	A-3003	W-506709	P-2952	10-32-1	MWC-18
T80-279	HVO-91	TOA-10023/C	MWC-7	W-507321	TV-110	10-32-2	BC-352

PART NUMBERS		PART NUMBERS		PART NUMBERS		PART NUMBERS	
MFGR.	MERIT	MFGR.	MERIT	MFGR.	MERIT	MFGR.	MERIT
SILVERTONE		SILVERTONE		SILVERTONE		SILVERTONE	
10-33-0	FM-258	10-146-2	BC-576	33-244	C-4115	56-74936-1	A-3032
10-34-0	FM-258	10-147-1	BC-674	33-246	BC-562	56A250	C-4115
10-34-5	TV-164	10-148-1	BC-666	38G53	A-3026	56B187	C-2994
10-36-1	BC-566	10-149-2/C	BC-356	50-688	TV-126(1)	56B224	C-4115
10-38-0	FM-257	10-150-1	BC-674(5)	50A432	TV-120	73TR12	A-3019
10-38-1	TV-180	10-150-2/A	BC-357	50A623	TV-139(2)	80-1-2	A-4123
10-41-2	BC-353	10-152-1	TV-236(7)	50A654	TV-126(2)	80-1-3/Q	HVO-146
10-42-2/-7	BC-352	10-155-1	BC-563	50B58	TV-116	80-1-4	MDF-92(4,7,8)
10-43-1	BC-563	10-156-1	BC-561	50B406	TV-110	80-1-6	C-2993
10-43-2	BC-353	10-166-1	TV-198(5)	50B622	TV-167	80-1-7	A-3003
10-44-2	FM-254	10-169-1	BC-563	50C648	TV-167	80-2-0	P-3047
10-45-2	BC-352	10-170-1	TV-198(5)	51-2100	TV-184(5)	80-2-2	A-3039(2)
10-45-3	TV-156	10-172-1	BC-566	51-2101	TV-201(5)	20-2-3	HVO-136
10-46-2	BC-353	10-177-2	TV-130	51-2102	TV-207	80-2-4/H/J	MDF-92(7,90)
10-50-4	BC-393	10-178-1	A-3025	51-2103	TV-120	80-3-0	P-3048
10-54-0	TV-120	10-183-1	BC-672(5)	51-2104	TV-131	80-3-1	A-2900
10-54-7	BC-353	10-184-1	TV-198(5)	51-2167	TV-131	80-3-2	A-2815(18,38)
10-55-2	FM-254	10-206-1	BC-677	51-2169	TV-163	80-3-7	A-3006
10-56-2	FM-254	10-207-1	BC-674(5)	51A1854	TV-116	80-4-1	A-2927(22)
10-60-0	FM-258	10-221-1	BC-566	51A1857	TV-121	80-4-2	A-2815(18,38)
10-61-1	TV-113	10-223-1	TV-193	51A1858	TV-120	80-5-4/A/G	MDF-92(4,7)
10-63-2	BC-356	10-225-1	TV-204	51A1859	TV-149	80-6-1	A-3026
10-64-1	TV-193	10-479	BC-353	51A1861	TV-102	80-7-2/A	A-2815(18,38)
10-65-1	BC-566	10-508	BC-352	51A1862	TV-141	80-7-4	MDF-133(4,7)
10-66-1	TV-198(5)	10-519	FM-254	51A1925	TV-131	80-8-2/A	A-2857
10-66-5	TV-121	10-521	BC-352	51A1926	TV-131	80-8-3	HVO-152(7)
10-67-1	TV-203(5)	10-529	BC-353	51A1927	TV-132	80-9-4	MDF-133(7)
10-70-1	TV-192	10-534	FM-255	51A1947	TV-204(5)	80-10-2/E/A	A-2823(18)
10-70-2	BC-356	10-552	TV-110	51A1948	TV-132	80-10-2/F	A-4098
10-71-1	TV-180	10-553	TV-115	51A1952	TV-193(5)	80-10-3	HVO-199
10-71-2	BC-357	10-555	TV-163	51A1996	TV-120	80-10-4	MDF-133
10-72-1	TV-184	10-556	TV-151	51A1997	BC-513(5)	80-11-2/A/B	A-2821
10-72-2	BC-357	10-561	MWC-12	51A2184	TV-196(5)	80-11-4	MDF-133
10-73-1	TV-200	10-562	TV-151	51B1948	TV-132	80-11-6	C-2994(22)
10-73-2	BC-356	10-573	TV-116	51B1996	TV-120	80-12-0	P-2882
10-74-2	BC-357	10-575	MWC-7	51B2109	TV-163	80-12-3	HVO-197
10-75-1	TV-197	10-590	TV-198	51C1875	TV-208(5)	80-12-4	MDF-133
10-76-2	TV-128	10-648	BC-393	51C1876	TV-203(5)	80-13-2/E	A-2823(3,18)
10-81-2	BC-356	10-670	TV-137	52C314	P-2848	80-13-4	MDF-133(88)
10-84-2	BC-356	10-672	TV-116	52C322	P-2848	80-13-6	C-4115(2)
10-86-1	TV-208	10-674	TV-120	52C341	P-3142(2)	80-14-1	A-2928
10-86-1	TV-198	10-675	TV-139(2)	53-377	MDF-73(4,7,8)	80-14-2	A-4139C
10-86-1	TV-185	10-677	TV-128	53-396	MDF-108(4,7)	80-14-3/J	HVO-218
10-90-2	BC-356	10-678	TV-126	53A307	TV-192	80-15-2/A	A-3033(35)
10-91-1	TV-113	10-679	TV-126	53B324	MDF-78(8)	80-15-3	HVO-197
10-91-2	BC-357	10-680	TV-127	53C322	P-2848	80-15-6	C-4115(2)
10-94-2	BC-356	10-689	TV-115	53C324	MDF-78(8,100)	80-16-2	A-4140C
10-95-2	BC-357	10-690	TV-167	53D325	MDF-92(4,7,8)	80-16-4	MDF-133(88)
10-96-2	BC-356	10-692	MDF-73(7,8)	55-248	A-3025	80-16-6	C-4115
10-97-2	BC-357	10-695	TV-126	55-251	HVO-37(3)	80-17-1	A-2904(2)
10-101-2	BC-352	10-698/A/D	MDF-92(4,7)	55-274	HVO-37(7)	80-17-3	HVO-218
10-102-2	BC-356	10-699	MDF-73(4,7,8)	55-301	HVO-134	80-17-4	MDF-92(7)
10-108-2	BC-352	10-715	TV-110	55-302	A-3026	80-19-6/C	C-4115
10-110-2	BC-353	10-716	TV-110	55-303	A-2822(2)	80-20-2/B	A-2853(35)
10-112-2	BC-356	10-719	TV-243	55B248	A-3025	80-20-4/B/L	MDF-133(88)
10-116-2/-2A/-7	BC-356	10-720	TV-142	55B249	A-2825	80-20-6/B	C-4125
10-11712/-2A	FM-256	10-729	MDF-75(4,8,9)	55B250	A-3006	80-21-1	A-3026
10-118-2/-A	FM-256	10-764	TV-130	55B251	HVO-37(7)	80-21-4	MDF-133(88)
10-120-1	TV-236(96)	10-781	TV-113	55B253	HVO-37(7)	80-22-4	MDF-133
10-122-1	BC-563	10-782	TV-113	55B260	A-2824	80-23-0	P-2844
10-126-1	TV-198	10-785	TV-131	55B266	HVO-37(7)	80-23-6	C-4133
10-127-1	TV-200	10-788	TV-193	55B270	HVO-37(7)	80-24-1	A-2905(2)
10-129-1	BC-563	10-789	BC-566	55B274	HVO-37(7)	80-24-4/A	MDF-92(7,8)
10-132-1	TV-184(5)	10-792	MDF-75(4,8)	55C249	A-2825	80-24-6/B	C-4084
10-135-2	FM-256	10-796	TV-130	55C260	A-2824	80-25-1	A-2902(2)
10-140-1	BC-563	10-815/J	MDF-92(4,7,8)	55C284	A-2823(2)	80-25-3	HVO-233C
10-142-2	BC-356	14-1655-6/X	BC-352	55C292	A-3025	80-25-4/A/B	MDF-92(7,8)
10-144-2	BC-574	14-1655-6/X	BC-353	55D270	HVO-37(7)	80-27-4	MDF-133(88)
10-145-2	BC-575	16-116-2A	BC-356	55D274	HVO-37(7)	80-29-4/A/B	MDF-133(88)
10-146-1	TV-236	33-243	C-2977	55D285	HVO-121	80-31-4	MDF-144C

MERIT COIL AND TRANSFORMER CORPORATION

PART NUMBERS		PART NUMBERS		PART NUMBERS		PART NUMBERS	
MFGR.	MERIT	MFGR.	MERIT	MFGR.	MERIT	MFGR.	MERIT
SILVERTONE		SILVERTONE		SILVERTONE		SILVERTONE	
80-33-1	A-2928	80-243/E	P-2970(2)	82-5000-0	BC-419	506080	FM-254
80-33-3	HVO-234C	80-251E	A-3019	83-154-1	A-3025	506332	FM-252
80-34-1	A-2902	80-252	HVO-3	83-231-0	BC-419	506333	BC-352
80-35-4	MDF-143(4)	80-253	A-3019	83-319	A-3026(2)	506709	P-2952
80-36-4	MDF-133	80-254	P-2875	83-650	MD-12	507343	TV-102
80-38-4	MDF-133	80-255	A-3035(2)	83-669-1	MDF-70	507343	TV-103
80-42-4	MDF-133(7)	80-257	A-3003	84-2530	BC-418	508341	C-2996
80-45-0	P-2881(2)	80-261	A-3037	85C-186	A-3025(2)	508486	A-3032(2)
80-47-0	P-4109(2)	80-264	P-2835	100-0040	MDF-110	509376	A-2930
80-56-0	P-3047	80-265-2	HVO-91	143-0095	A-2998	509603	TV-151
80-58-0	P-4109(2)	80-266	P-2970(2)	145-0020	C-4084	509706	TV-115(1)
80-58-1	A-2902	80-266-1	P-3067(14,16)	241-0047	A-2815(18,40)	520487	P-3078
80-59-1	A-2901(2)	80-267	A-2930	241-0050	HVO-194	520489	HVO-10(7)
80-62-0	P-4082(2)	80-268	A-3031	5241-501	TV-172	520942	MDF-72(4,8)
80-62-1	A-2998(22)	80-271	P-2970(2)	7591-1	A-2901	520943	TV-167
80-63-1	A-3026	80-272	A-2930	23669-3	A-2930	520951	P-2838(27)
80-65-1	A-2904(2)	80-281	A-2998(2)	25322	TV-110	520975	A-3038(4,18)
80-66-1	A-2905	80-283	A-3031	40845-1	BC-352	520977	TV-116
80-67-1	A-3025	80-311	A-2902(2)	42700-1	A-2998	520979	TV-116
80-69-1	A-2900	80-315	A-3026(2)	42700-5/-7/-13	A-3025	520980	A-3003
80-72-0	P-4141C	80-318	P-3082	42700-19/-20/-21	A-3025	521066	HVO-9(2,7)
80-72-1	A-3026	80-319	A-3026	43669-1	BC-356	522303	A-2936(2)
80-74-1	A-2904	80-323	A-3031	43700-3	A-3025	522519	TV-162
80-78-1	A-4103	80-324	A-2932	44282-1	BC-356	700055	A-2930
80-80-1/B	A-3026	80-325	A-3039(2)	44671	A-2757(29)	700089	P-3047(33)
80-81-0	P-4141C	80-326/B	HVO-161	44671-3	A-2753(2)	706063	A-3025
80-81-1	A-2930	80-328	A-3003	45240	FM-257	903562-504	MDF-144C
80-87-1A	A-2935	80-336	HVO-161	45240-3	FM-258	903562-507	MDF-144C
80-91-1	A-2928	80-339	A-2905	45500-1	P-2964	906152-501	HVO-234C
80-97-1	A-2902(2)	80-342	A-3019	45534-3	BC-419	906153-501	P-4141C
80-98-1	A-2904	80-347	A-3039	46568-7/-8/-12	BC-419	961415-1	A-4139C
80-103-1	A-3026	80-352	A-2823	46568-15/-19/-21	BC-419	961416-1	P-4141C
80-106-1	A-2905	80-353	A-3019	46568-23	BC-419	962636-501	HVO-232C
80-110-1	A-4103	80-361	HVO-161	46700-8	A-3025	972128-8	A-3020
80-112-1	A-2902(2)	80-363	HVO-161	46700-10	A-4097	1104665-1/-2/-3	C-4133
80-117-1	A-2930	80-368	HVO-146	46971-3/-4	FM-259		
80-117-1A	A-3019(22)	80-370	A-3025	46972-1	FM-260		
80-121-1	A-2902(2)	80-371	A-4003	48197-9/-10	BC-576		
80-122-1	A-4097	80-374	A-3031(2)	49383-11/-12	BC-569		
80-124-1	A-2902	80-375	HVO-136	49383-20/-21	BC-570		
80-126-1/C	A-2902(2)	80-376	HVO-161	49383-30/-31	BC-571		
80-132-1A	A-2902	80-377	A-3039(2)	49388-10	BC-574(89)		
80-135-1/-1D	A-2931	80-378	A-3026	49388-20/-25D	BC-575		
80-136-1	A-3026	80-380	A-3003	49388-30	BC-576(89)		
80-137-1	A-3026(2)	80-384	A-2905	49455-1/-2	BC-356		
80-138-1A	A-3025	80-386	P-3082	49455-7/-8	BC-356	22-010-002	BC-352
80-140-1/B	A-4096	80-387	A-2930(2)	49515-1/-3	BC-561	22-010-018	BC-319
80-143-1	A-2902	80-388	A-2901	78466	BC-562	22-010-020	BC-352
80-144-1/-1C	A-2902	80-389	A-2902	95073-1	BC-564	22-040-001	SW-608
80-145-1	A-2900	80-390	HVO-146	97712-1/-2	BC-356	22-040-002	SW-608
80-146-1	A-3031	80-408	A-3101(2)	98494-1	P-2944(2)	22-050-001	SW-608
80-147-1	A-3025	80-411	HVO-146	100037	A-3020	22-060-001	TV-185
80-149-1/B/F	A-2932	80-415	HVO-161	100131	TV-195(5)	22-060-005	TV-192
80-151-1	A-2905(2)	80-432-1	A-2927	100441	BC-566	22-100-002	BC-537
80-152-1	A-2905(2)	80-5032-1	A-2905	102134	C-4133	22-100-003	BC-537
80-156-1/-2	A-2902(2)	82-21-1	A-2998	102201	TV-193(5)		
80-161-1	A-2904	82-126-0	BC-418	105308	BC-566		
80-162-1	A-2902	82-151-0	BC-418	109221	HVO-232C		
80-167-1	A-3025	82-172-0	BC-419	109237	MWC-12(4)		
80-168-1	A-2902	82-174-0	BC-419	109248	BC-562		
80-169-1	A-3020	82-194-0	BC-419	109257	TV-205	N-6920	A-3035
80-170-1	A-3019(2)	82-197-0	BC-419	109286	P-4141C	N-6922	MD-12
80-172-1A/-1D	A-3019	82-200-0	BC-419	109825	BC-562	N-6923	HVO-3
80-175-1	A-2902	82-206-0/F	BC-419	109826	TV-193(5)	N-6925	P-3067(11)
80-179-1/C	A-2904	82-208	BC-419	109838	TV-183	N-6928	MWC-7
80-180-1	A-4097(22)	82-211-0	BC-419	109840	TV-193	N-6930	TV-160
80-183-1	A-2755(2)	82-215-0	BC-419	109845	MDF-144C	N-6932	A-2930(2)
80-192-1/G	A-3025	82-223-0	BC-419	109850	A-4139C	N-6962	MWC-12
80-198-1/A	A-2902	82-224-0	BC-419	505795	BC-353	N-7123	MWC-12
80-242	A-2930(2)	82-225-0	BC-419	505905	FM-254	N-7236	A-3035(2)
						SIMCA (See Mopar)	
						SONAR	
						SONORA (Also see Travler)	

MERIT COIL AND TRANSFORMER CORPORATION

PART NUMBERS		PART NUMBERS		PART NUMBERS		PART NUMBERS	
MFGR.	MERIT	MFGR.	MERIT	MFGR.	MERIT	MFGR.	MERIT
SONORA		SONORA		SOUNDEX		SPARTON	
N-7717	A-3037	R-2062	TV-131	TF-4C	C-4095	AB43523-11	TV-102
N-7718	MDF-72(4)	R-2159	TV-121	TF-6C	C-4095	AB43524-7/-8	TV-150
N-7719	MWC-18	R-2226	A-2901	TF-14	BC-565	AB43525-1/-2/-3	MD-13
N-7720	MWC-5	R-2314	A-2998(2)			AB43547-1	TV-231(2)
N-7744	TV-110	R-2597	A-3025(2)			AB44010-1	P-3051(2)
N-7745	TV-102	R-2701	TV-130	SOUND PROJECT		AB44013-1	P-3052
N-7745	TV-103	R-2711	A-2999	28P1001	A-2902	AB44014-1	P-3053(11,14)
N-7746	TV-151	R-2712	A-3003(2)	34-27	A-2936	AB44015-1	P-2834(11)
N-7748	TV-163	W-9657	BC-352	46-59	P-3051	AB44017-1	P-3169(2,14,16)
N-7764	A-3003(2)	31T-413	TV-172	46-70	A-3051	AB44018-1	P-3067(15,16)
N-7766	A-2930(2)	100-629	A-2700	330-1	A-2936	AB44019-1/-2	P-3067
N-7906	A-2930(2)					AB44020-1	P-3043(2)
N-7981	BC-352					AB44022-1	P-3043(2)
N-8055	A-2930					AB44025-1	P-3067
N-8057/-47	MDF-70					AB44027-1	P-3059(16)
N-8063	MWC-12	SONY		SPARTON		AB44056-2	A-2931
N-8064	C-2991(2)	LI-001-AP	BC-574	(See Magnavox)		AB44061-2/-5	A-3020
N-8069	P-3070	LI-001-BP	BC-575			AB44062-1/-2/-3	A-3035
N-8070	HVO-7(2,3)	LI-001-CP	BC-576			AB44062-4/-5/-7	A-3035
N-8104	HVO-7(2,3)	LI-008-CP	BC-576			AB44063-1/-2	A-3020
		LI-0083-P	BC-579	SPARTON		AB44066-1/-2/-3	A-3020
N-8134	MWC-12	LI-020-AP	BC-579	AA6364-2	TV-155(1)	AB44066-4	A-3019
N-8170	A-2930	LI-023-AP	BC-576	AA6400-1	MWC-12	AB44070-1	A-3036(2)
N-8887	A-3025	TX-006	A-2757(2)	AA6400-3/-4	MWC-2	AB44071-1/-2	A-3035
N-8928	TV-110	TX-022	A-2753(2)	AA6400-5/-6	MWC-6	AB44072-1	A-3036(47)
N-8929	TV-116	1-402-074	BC-576	AA6400-7	MWC-2(6)		
N-8930	MDF-74(4)			AA6400-8	MWC-6(6)	AB44073-1	A-2815(2,59)
N-8931	TV-163	1-403-024-02	BC-569	AA6400-9	MWC-2(6)	AB44074-1	A-3018(2)
N-8936	HVO-49(3)	1-403-025-00	BC-569	AA6400-10	MWC-11(6)	AB47003-1	A-4000
N-8937	A-2825	1-403-025-02/-03	BC-569	AA6401-1	TV-163	AB47004-1	C-2975
N-8938	A-2928	1-403-026-00	BC-570	AA6402-9	TV-204(5)	AB47006-1/-2/-3	A-3000
		1-403-026-02/-03	BC-570				
N-8969	P-3070	1-403-027-00	BC-571	AA6402-10	TV-181(5)	AB47006-4/-5	A-3000
N-9002	A-3003(2)	1-403-027-02	BC-571	AA6402-11	TV-205(5)	AB47009-1/-2/-3	C-2994
N-9011	TV-151	1-403-034	BC-578	AA6402-12	TV-203(5)	AB47010-2	C-4084(2)
N-9430	A-3031	1-403-034-00	BC-574	AA6403-1/-2/-8	TV-163	AB47014-1	A-3000
N-9600	FM-254	1-403-035-00	BC-575	AA6404-1	TV-151	AC6088-1	MDF-91
N-9605	FM-252(2)						
R-1101	TV-184	1-403-036-00	BC-576	AA6407-1	TV-151	PB40216	HVO-3
R-1102	BC-381	1-403-050	BC-574	AA6408-1	TV-102	PC7001RA	MDF-77
R-1140	TV-199(5)	1-403-051	BC-575	AA6408-1	TV-103	PC63087-1	HVO-10(2,3)
R-1144	TV-130	1-403-052-12	BC-576	AA6409-1	TV-116	PC70002	MD-13
		1-403-057-00	BC-569	AA6410-1	TV-163	PC70003	MD-13
R-1160	TV-189						
R-1404	M50-70-90	1-403-058	BC-569	AA6422-1	TV-131	PC70004	MD-12
R-1405	TV-166	1-403-058-00	BC-570	AA6424-1	TV-119	PC70007	HVO-10(2,3)
R-1406	TV-165	1-403-059	BC-569	AA6425-1	TV-151	PC70009/-C	MDF-77
R-1407	TV-121	1-403-059-00	BC-571	AA6613-11/-12	TV-185	PC70010/-6	HVO-71
		1-403-066-00	BC-569	AA6613-13	TV-181	PC70011	MDF-77
R-1408	C-4084(2)						
R-1418	A-2822	1-403-068-00	BC-570	AA6613-14	TV-206	PC70012/F	HVO-71
R-1419	A-2928(2)	1-403-070-00	BC-571	AA6659-1	MWC-4	PC70013	MDF-77
R-1420	TV-238	1-403-073-00	BC-577	AA6667-1/-3	FM-251	PC70015/B	HVO-72
R-1421	MDF-73(4,8)	1-403-092-11	BC-576	AA6667-5	TV-108	PC70016/-1/F	MDF-70
		1-403-093-11	BC-575	AA6668-1/-5	BC-353(1)	PC70017	MDF-70
R-1425	A-3003(2)						
R-1427	TV-130	1-407-027-11	TV-193	AA6684-1	FM-252	PC70018/A	MDF-77(8)
R-1432	TV-132	1-407-030-11	TV-196	AA6684-2/-3	TV-111	PC70019	HVO-73
R-1470	TV-181	1-407-049-11	TV-198	AA6684-4	TV-110	PC70020	MDF-91
R-1471	TV-201(5)	1-411-002	TV-203	AA6768-3/-4	BC-377	PC70022	HVO-74
		1-411-003	TV-185	AA6830-1	BC-566	PC70025	HVO-74
R-1480	A-3025(2)						
R-1635	TV-151	403-025-02	BC-569	AB43070-2/-3	MDF-70	PC70028	MDF-91(7)
R-1841	A-3025	403-026-00	BC-569	AB43071-1	MDF-77(8)	PC70030/-1	HVO-21(2,7)
R-1947	HVO-37(7)	403-026-00	BC-570	AB43080-4	TV-154	PC70031	MDF-73(4)
R-1948	MDF-91(4,7,8)	403-026-02	BC-570	AB43080-5	TV-113	PC70033	HVO-54(2,7)
		403-027-00	BC-571	AB43080-6	TV-115	PC70034	MDF-92(4)
R-1949	BC-513(5)						
R-1950	TV-190	403-027-02	BC-571	AB43080-8	TV-126	PC70036	HVO-169
R-2054	TV-130	403-050-02	BC-574	AB43095-1/-2	TV-127(41)	XT-7898-A	A-3035(2)
R-2055	TV-130	403-051-02	BC-575	AB43095-3	TV-128	208T9	A-4003
R-2056	C-4115	403-052-02	BC-576	AB43521-1	TV-231(2)	6667-5	TV-108
		403-074-02	BC-576	AB43523-1/-2	TV-102	6684-4	TV-110
R-2057/-1	HVO-141(7)						
R-2058	A-3039(2)	403-081-11	BC-571	AB43523-1/-2	TV-103	44034-1	P-3066
R-2059	A-2934	411-002	TV-203	AB43523-3/-4	TV-102	70036	HVO-169
R-2060	MDF-108(4)	411-003	TV-185	AB43523-5/-6	TV-102		
R-2061	A-3003(2)	423-082-11	BC-570	AB43523-8/-10	TV-103		

MERIT COIL AND TRANSFORMER CORPORATION

PART NUMBERS		PART NUMBERS		PART NUMBERS		PART NUMBERS	
MFGR.	MERIT	MFGR.	MERIT	MFGR.	MERIT	MFGR.	MERIT
SPICA		STERLING NORMENDE		STEWART WARNER		STROMBERG CARLSON	
6268A	BC-574	423.030	BC-561	509378	TV-154	114074	MWC-2
8524A	BC-575	423.219	BC-380	509380	P-3070	114075	MWC-12
8549A	BC-576	423.505	TV-192	509384	HVO-10(2,3)	114083	MWC-2
				509433	BC-352	114084	MWC-5
				509491	FM-253	114087	MWC-2
				509506	A-3027(2)	114093	TV-116
STANDARD				509603	TV-151	114104	TV-139(2)
LT-324	BC-574			509704	MDF-70(7)	114105	MWC-2
LT-352	BC-575			509706	TV-110(1)	114106	MWC-5
LT-355	BC-570			520487	P-3070	114109	MWC-5
LT-359	BC-571(2)	STEWART WARNER					
LT-1375	BC-569	W-505797	BC-353	520489	HVO-10(2,3)	114125	MWC-6
		W-505905	FM-254	520911	MWC-6	114129	MWC-10
		W-506080	FM-254	520942	MDF-72(4,8)	114132	TV-163
		W-506332	FM-252(2)	520943	TV-167	114133	MWC-6
		W-506333	BC-352	520951	P-2838(15,27)	114138	MWC-3
STARLITE							
CH-2015	C-2994	W-521157	BC-382(2)	520975	A-3038(4,18)	114139	MWC-3
FMC-187	BC-574	115154	MDF-70(7)	520980	A-3003	114146	MWC-6
FMC-483	BC-575	115185	MDF-70(72,75,92)	520984	TV-195	114161	MWC-6
FMC-6089	BC-576	115228	MDF-70(72,75,92)	521066	HVO-9(2,7)	114165-000	BC-549
FTO-2286-R5	BC-577	115311	MDF-91(4)	521156	P-2877(2)	114168	BC-353
521070	BC-356	115423	MDF-91(4)	521319	BC-353	114188/-000	BC-393
		162056	MWC-9	521343	HVO-36	114189	TV-172
		162190	MWC-2	521550	BC-387	114193-000	BC-563
		409376	A-2930	521659	TV-180	114337	BC-352
		503951	TV-163(37)	521735	HVO-36(2)	114341	TV-102
STEELMAN							
A30221	A-3025	505579	A-2930(2)	521756	BC-381	114342	TV-103
GTCOM2752	BC-356	505580	A-3035(2)	522339	P-3069	114343	TV-102
GTCOM2753	BC-357	505590	C-2995(2)	522342	HVO-9(2,7)	114344	TV-103
IFT-50	BC-352	505797	BC-353	522343	C-2994(2)	114345	TV-151
LC-10-1	BC-393	505867	BC-352	522344	A-3037	114346	TV-103
LF-24	BC-352	505905	FM-254	522350	MDF-72(8)	114347	TV-102
LF-50	BC-352	505912	A-3019	522469	HVO-31(7,29)	114348	TV-103
LF-52	FM-254	506080	FM-254	522519	TV-162	114349	TV-136(83)
LF-53	FM-255	506333	BC-352	522578	TV-127(1,55)	114363/-000	FM-254
LF-54	BC-352	506709	P-2952	522579	TV-128(1)	114364/-000	BC-352
LF-57	BC-352	506805	MD-12	522600	TV-167	114367	TV-104(2)
LF-58	FM-254	507209	A-2928(2)	522608	C-2994(2)	114370	TV-111
LF-59	BC-353	507212	A-2928	522674	A-3003	114371	TV-160
TR-122-1	A-3025	507219	A-2928(2)	522791	TV-116	114374	TV-119
TR-125	A-2928	507312	A-3038	522924	MDF-72(4)	114375	TV-115
3823-21	A-3025(2)	507313	C-4133(2)	522973	P-3073(14)	114376	TV-116
43022	A-2901(22)	507321	TV-110(1)	522975	HVO-36(2,7,18)	114377	TV-116
414001	A-3025(2)	507343	TV-102	522987	MDF-92(4,8)	114379	TV-102
420250	A-2901	507343	TV-103	523087	HVO-36(2,7)	114382	TV-116
430202	A-3025	507384	TV-108			114383	TV-151
430211	A-2930	507440	TV-163(37)			114384	TV-116(83)
430250	A-2900	507565	TV-163(37)			114388	TV-151
430260	A-2902(2)	507712	A-4000			114391	TV-116
430330	A-3025	507791	MD-12			114392	TV-151
430360	A-2904(2)	507991	A-3018			114396	TV-139(2)
				STROMBERG CARLSON			
430470	A-2901(2)	508058	HVO-3	33853	A-2900	114399	TV-139(2)
430566	A-2928	508059	A-3036	33900	P-2954(2)	114400	TV-154
430574	A-3026	508061	TV-113	114000-002	TV-180	114401	TV-113
430595	A-2928	508076	A-3003	114000-004	TV-196	114403	FM-254
450005	FM-254	508077	TV-163	114000-020	BC-344	114404	FM-255
450006	FM-255	508179	FM-255	114000-030	BC-346(2)	114414	BC-353
450013	BC-353	508341	C-2996	114000-040	BC-346(2)	114415	TV-151
450023	BC-352	508413	P-3173(2)	114000-079	BC-393	114417	TV-151
450026	BC-356	508420	HVO-3(2)	114000-104	BC-393	114418	TV-115
450027	FM-260	508667	MWC-1	114000-106	BC-386	114419	TV-151
450028	BC-357	508674	A-3037	114000-202	FM-255	114420	TV-127
455056	BC-393(2)	508575	MDF-70	114000-203	BC-350	114421	TV-127
455057	BC-564	508679	HVO-7(2)	114000-204	BC-354	114422	TV-128
455059	BC-561	508883	HVO-7	114000-209	BC-350	114423	TV-126
455064	BC-393	508956	A-3037	114000-215	BC-352	114425	TV-132
455077	BC-562	508967	TV-163	114000-216	BC-353	114426	TV-132
455080	BC-393	508971	HVO-7(2,3)	114000-252	FM-255	114431	TV-243
455081	BC-562	509361	MWC-18	114000-254	FM-255(63)	114432	TV-130
		509375	A-3038(18)	114069	TV-163	114433	TV-130
		509376	A-2930	114071	MWC-12	114437	TV-119

MERIT COIL AND TRANSFORMER CORPORATION

PART NUMBERS		PART NUMBERS		PART NUMBERS		PART NUMBERS	
MFGR.	MERIT	MFGR.	MERIT	MFGR.	MERIT	MFGR.	MERIT
SYLVANIA		SYLVANIA		SYLVANIA		SYLVANIA	
56-97301-3	A-2998	118-0025	TV-152	121-0120	BC-352	131-2036	BC-667
56-98103-2	A-3020	118-0026	TV-153(12)	122-0004	BC-354	131-2037	BC-676
56-98308-1	A-3025(2)	118-0027	BC-514	122-0010	BC-353	131-2043	TV-182
56-98356-3	A-3025(2)	118-0028	TV-185	122-0011	FM-254	132-0001	TV-165(12)
56-98891-1	A-2935	118-0029	BC-561	122-0013	BC-353	132-0002	MWC-2
56-99229-1/-2	C-4084(2)	118-0030	TV-153(12)	122-0015	BC-354	132-0003	MWC-2(2)
57-10243-1	BC-352	118-0032	BC-561	122-0017	FM-254	132-0005	MWC-6
57-10249-1	FM-254	118-0079	BC-561	122-0018	BC-353	132-0007	MWC-2(2)
57-10250-1	FM-254	119-0002	TV-127(61)	122-0019	BC-355	132-0009	TV-168
57-10251-1	FM-254	119-0003	TV-127	122-0021	BC-354	132-0011	MWC-2(2)
57-10252-1	FM-255	119-0004	TV-128	122-0022	BC-354	132-0012	MWC-2(2)
73B8-12	BC-553	119-0005	TV-126	122-0023	BC-353	132-0016	TV-163
100-0001	MDF-71(4,12)	119-0006	TV-126	122-0024	BC-353	132-0019	TV-163
100-0002	MDF-71(4,12)	119-0007	TV-129	122-0028	BC-358	132-0021	MWC-3
100-0009	MDF-104	119-0008	TV-127(41)	122-0032	BC-357	132-0027	MWC-12
100-0010	MDF-91	119-0009	TV-126	122-0037	BC-355	133-0001	MWC-5
100-0011	MDF-91(4)	119-0010	TV-129	122-0039	FM-254	133-0002	MWC-5
100-0013	MDF-91(7)	119-0011	TV-127(41)	122-0044	FM-254	133-0003	MWC-5
100-0015	MDF-73(33)	119-0012	TV-127	122-0050	BC-575	134-0070	A-2930(2)
100-0019	MDF-74(7,8)	119-0013	TV-126	122-0056	BC-574	141-0008	P-3076(10)
100-0022	MDF-74(7,8)	119-0014	TV-126	122-0057	FM-254	141-0009	P-3076(10)
100-0023	MDF-92(4,7)	119-0019	TV-126	122-0112	BC-352	141-0013	P-3055
100-0025	MDF-92(4,7)	119-0020	TV-130	122-0124	BC-574	141-0015	P-3055
100-0030	MDF-88(4,7)	119-0026	TV-153(33)	122-0125	BC-352	141-0016	P-3055
100-0031	MDF-110	120-0001	TV-113	122-0126	FM-254	141-0024	P-3069
100-0032	MDF-110	120-0002	TV-113	123-0038	FM-254	141-0030	P-3065
100-0033	MDF-110	120-0003	TV-113	124-0002	TV-234	141-0039	P-3069
100-0034	MDF-110(7,8)	120-0008	TV-113	124-0003	TV-121	141-0041	P-3065(2)
100-0035	MDF-110(7,8)	120-0009	TV-113	125-0001	TV-116	141-0053	P-3097(2,45)
100-0036	MDF-110(7,8)	120-0010	TV-125	125-0002	TV-116	141-0063	P-2944(2)
110-0038	MDF-110(7,8)	120-0011	TV-126	126-0001	TV-247	141-0064	P-3043(2)
100-0040	MDF-110	120-0017	TV-127	126-0002	TV-126(1)	141-0073	P-2952(32)
100-0041	MDF-110	120-0018	TV-131	126-0004	TV-126	141-0075	P-2882
100-0042	MDF-110	120-0019	TV-113	126-0006	TV-126	141-0078	P-3084
100-0043	MDF-110	120-0021	TV-157	127-0001	FM-255	141-0087	P-3148(2)
112-0012	BC-388	120-0023	TV-157(1)	127-0003	FM-255	141-0089	P-3165(2,53)
113-0010	TV-230	121-0004	BC-371	127-0005	FM-255	141-0090	P-2952
113-0023	BC-381	121-0010	BC-352	128-0007	FM-255	141-0092	P-2897(2)
113-0026	BC-381	121-0011	FM-254	128-0008	TV-115	141-0095	P-2871(2)
113-0027	BC-387	121-0013	BC-352	128-0014	TV-115	141-0097	P-3084
113-0028	BC-381	121-0016	BC-352	128-0016	FM-253	143-0009	A-3018
113-0029	BC-394	121-0017	FM-254	128-0017	FM-253	143-0010	A-3018(2)
113-0030	BC-387	121-0018	BC-352	128-0018	FM-253	143-0013	A-3019(2)
113-0041	BC-393(7)	121-0019	BC-316	128-0019	FM-254	143-0014	A-3019
113-0049	BC-393	121-0020	BC-319	128-0020	FM-254	143-0015	A-2998(2)
113-0050	BC-393	121-0021	BC-352	128-0021	FM-253	143-0017	A-3018(2)
113-0053	BC-400	121-0022	BC-352	128-0022	FM-255	143-0020	A-2930
113-0079	BC-387	121-0025	BC-352	128-0023	FM-255	143-0021	A-2930
113-0080	BC-400	121-0026	BC-352	129-0001	TV-151	143-0022	A-3019
113-0081	BC-394	121-0027	BC-356	129-0004	MWC-6	143-0023	A-3019
113-0085	BC-393	121-0028	BC-352	129-0006	TV-166	143-0033	A-2930
113-0088	BC-387	121-0032	BC-353	130-0001	TV-238(12)	143-0034	A-3018
113-0089	BC-393	121-0033	BC-352	130-0002	TV-151(5)	143-0040	A-3031(2)
113-0096	BC-393	121-0034	FM-254	130-0003	TV-119(12)	143-0041	A-3025
113-0098	BC-393	121-0036	BC-352	130-0004	TV-151	143-0045	A-3025
113-0099	BC-393	121-0043	BC-574	131-2013	TV-195	143-0046	A-3020
113-0104	BC-393	121-0044	BC-356	131-2014	TV-184	143-0047	A-2930
115-0001	TV-126(83)	121-0045	FM-254	131-2015	TV-185	143-0048	A-3027
115-0003	TV-151	121-0101	BC-352	131-2018	TV-206	143-0049	A-3025
115-0004	TV-119(12)	121-0102	BC-352	131-2022	TV-202	143-0052	A-3025
115-0005	TV-116	121-0104	BC-356	131-2024	TV-181	143-0054	A-3019
118-0003	TV-151	121-0105	BC-352	131-2025	MWC-12	143-0055	A-3025
118-0004	TV-238(12)	121-0106	FM-254	131-2026	TV-196	143-0058	A-2900
118-0005	TV-116	121-0108	BC-356	131-2030	TV-199	143-0059	A-3026
118-0010	BC-566	121-0110	BC-356	131-2031	TV-207	143-0060	A-2998
118-0011	TV-132	121-0111	BC-352	131-2032	TV-185	143-0061	A-3026
118-0019	TV-151	121-0114	BC-352	131-2033	TV-200	143-0064	A-2905(2)
118-0020	BC-562	121-0115	FM-254	131-2033	TV-190	143-0065	A-2935
118-0020	BC-566	121-0118	BC-352	131-2034	TV-196	143-0066	A-2905
118-0022	TV-151	121-0119	BC-353	131-2035	TV-194	143-0069	A-2901

MERIT COIL AND TRANSFORMER CORPORATION

PART NUMBERS		PART NUMBERS		PART NUMBERS		PART NUMBERS	
MFGR.	MERIT	MFGR.	MERIT	MFGR.	MERIT	MFGR.	MERIT
TRAV-LER		TRAV-LER		TRAV-LER		TRAV-LER	
L-65	TV-206	L-192	MDF-129	TR-57	HVO-133(7,29)	TV-L-67	TV-116
L-66	TV-190	L-199	BC-566	TR-72	HVO-133(29)	TV-L-68	TV-119
L-66A	TV-188(5)	L-206	TV-234	TR-77A	A-2988	TV-L-69	TV-151
L-68	TV-119(12)	L-248	MDF-108(7)	TR-78B	A-2822	TV-L-71	MDF-73(4,8)
L-69	TV-151	LB-101	BC-564	TR-109	A-3025	TV-L-73	TV-141(83)
L-71/A/-1	MDF-73(4,8)	LB-102	BC-561	TR-146	A-3025	TV-L-74	TV-116
L-76	TV-131	LF-100	BC-352	TR-170	A-3025(2)	TV-L-75	TV-102
L-77	TV-119(2,12)	LF-101	BC-353	TR-174	A-3025(2)	TV-L-118C	MDF-92(4,8)
L-79	TV-121	LF-104	BC-352	TR-178	A-3019	TV-L-135A	MDF-108(7,90)
L-80/A	TV-149	LF-105	FM-254	TR-180	P-3148(2)	TV-L-174/B	MDF-129
L-81/A	MDF-92(4,8)	LF-106	FM-253	TR-181	P-3148(2)	TV-L-177	MDF-130
L-82	TV-131	LF-107	FM-254	TR-182	A-2905(2)	TV-L-178	MDF-92(4,75)
L-84	TV-130	LF-108	FM-254	TR-184	A-3019	TV-L-186	MDF-108(90)
L-85	BC-566	LF-109	FM-255	TR-196	A-3019(2)	TV-L-248	MDF-108(7)
L-86	TV-192(5)	LF-110	FM-254	TR-197	A-2928	TV-SPK-15	A-2902(2)
L-87	TV-186	LF-111	BC-353	TR-198	A-3025	TV-SPK-18	A-3020
L-88	BC-513(5)	LF-113	FM-255(63)	TR-199	A-3025	TV-TR-1	P-3169(2,14,16)
L-89	TV-151	LF-114-1	BC-356	TR-201	A-2900	TV-TR-2	A-3036
L-90	TV-151	LF-117-1	BC-356	TR-202	A-2928	TV-TR-3	A-4003
L-92/A	TV-166	LF-118-1	FM-256	TR-216	A-2928	TV-TR-4	HVO-3
L-93/A	TV-165	LI-3	BC-352	TR-218	A-2932	TV-TR-5	A-3035(2)
L-94	TV-130	LI-10	BC-352	TR-219	A-2928	TV-TR-6	HVO-3
L-102	TV-126	LI-10	BC-353	TR-220	A-2928	TV-TR-8	A-3037
L-103	TV-127	LI-11	BC-357	TR-225	P-3148	TV-TR-10	A-3003(20)
L-103	TV-131	LI-13	BC-352	TR-226	A-2932	TV-TR-15/A	HVO-25(2,7)
L-104	TV-126	LI-13	BC-353	TR-232	A-2928	TV-TR-18	A-2850
L-106	TV-113	LI-15	BC-352	TR-233	A-2928	TV-TR-19	HVO-36(2,7)
L-107	TV-195	LI-19	BC-352	TR-234	A-3025(2)	TV-TR-20	HVO-87(7,29)
L-108	TV-204	LI-32	FM-254	TR-234-1	A-3026	TV-TR-21	A-2822(2)
L-109	TV-185	LI-33	FM-254	TR-235	A-3025	TV-TR-22	A-3003
L-110/A/B	TV-154(5)	LI-34	FM-255	TR-247-1/-3	A-2938	TV-TR-26	HVO-3
L-114	TV-151	LL-60	BC-419	TR-248-1	A-2998(22)	TV-TR-51A	HVO-152
L-115	BC-562	LL-61	BC-419	TTR-001	A-2928	TV-TR-72	HVO-133(29)
L-116	BC-562	LO-21	BC-387	TTR-002	A-2815(3,7)	TV-X-104	HVO-50(3)
L-117	BC-565	LO-21	BC-394	TTR-004	C-4084	TV-X-105	HVO-50(3)
L-118/B/C/D	MDF-92(4,8,54)	LO-24	BC-393	TV-AT-11	A-2930	TV-X-106	HVO-50(3)
L-119/A	TV-167	LO-26	BC-393	TV-AT-16	A-2930	TV-X-107	HVO-50(3)
L-124	TV-121(5)	LO-27	BC-393(2)	TV-AT-17	A-3019	TV-X-108	HVO-50(3)
L-125	TV-120	LO-107	BC-393	TV-FC-1	C-2974	TV-X-109	HVO-50(3)
L-126A	TV-196	LO-110	BC-393	TV-FC-3	C-4115	TV-X-110	HVO-50
L-127A	TV-201	LO-111	BC-387	TV-FC-9	C-4115	TV-X-111	HVO-50
L-128A	TV-207	SPK-19	A-3031(2,29)	TV-L-13/A	TV-102	TV-X-112	HVO-50
L-130	TV-131	SPK-22	A-3025	TV-L-13/A	TV-103	TV-X-113	HVO-50
L-132/A	TV-163	SPK-29	A-2998	TV-L-16/A/B/C	TV-119	TV-X-114	HVO-50(3)
L-133A	TV-192	SPK-37	A-3025(2,29)	TV-L-16/A/B/C	TV-151	TV-X-130/A	HVO-25(2,7)
L-135/A	MDF-108(7,90)	SPK-83	A-3026	TV-L-17	TV-115	TV-X-131	HVO-25(2,7)
L-147	MDF-120	SPK-89B	A-3025	TV-L-18	TV-163(2)	TV-X-141A	HVO-25(2,7)
L-149/B/C/M	MDF-130	TDR-003	HVO-154(7)	TV-L-19	MWC-7	YSG-35461	A-2930(22)
L-150	TV-126(41)	TDY-001	MDF-127(7,75)	TV-L-25	MD-12	YSG-35552	TV-184
L-151	TV-126	TLF-001	TV-234	TV-L-27/A	MDF-70(4)	YSG-35552	TV-199
L-152	TV-252	TLF-003	TV-155	TV-L-29	MWC-5	YSG-35552	TV-202
L-154	TV-241	TR-18	A-2850	TV-L-30	MWC-2	YSG-35552	TV-192
L-156	TV-163(2)	TR-19	HVO-36(2,7)	TV-L-31	TV-184(5)	YSG-35552	TV-194
L-158	TV-192	TR-20	HVO-87(7,29)	TV-L-32A	TV-206	YSG-35631	A-2822
L-160	BC-566	TR-21	A-2822(2)	TV-L-32B	TV-207	YSG-35784	MWC-5(2,12)
L-162	TV-184(4)	TR-22	A-3003	TV-L-33	MWC-2	1224	A-2930
L-163	TV-208(5)	TR-23	A-3003(2)	TV-L-34	MWC-2	1429	BC-352
L-164	BC-562	TR-24	HVO-141	TV-L-35	MDF-70(4)	1434	FM-254
L-165	TV-128	TR-25/A	A-4089(2)	TV-L-38	TV-116	1435	FM-255
L-167	TV-253	TR-26/B/C	A-2823	TV-L-40	MDF-70(4)	1436	BC-394
L-168	TV-151	TR-27	HVO-131	TV-L-41	MWC-2	1518	BC-419
L-174/B/C	MDF-129	TR-34	HVO-134	TV-L-42	TV-137	3823-7	A-3025(22)
L-175	TV-241	TR-35	P-3060	TV-L-48	TV-128(1)	220051	BC-569
L-177	MDF-130	TR-36/A	A-2822(2)	TV-L-49	TV-127(1)	220052	BC-570
L-178/A	MDF-92(4,8,54)	TR-37	HVO-134	TV-L-52	MDF-70(4,8)	220053	BC-571
L-179	TV-129	TR-49	HVO-152(2,7)	TV-L-60	MDF-74(4,8)	220103	BC-569
L-186	MDF-108(90)	TR-50/A/B	A-2984	TV-L-63	TV-116	220104	BC-570
L-189	TV-202	TR-51/A	HVO-152	TV-L-64	TV-163	220105	BC-571
L-190	TV-195	TR-52A/B	P-2882(93)	TV-L-65	TV-206	240012	BC-572
L-191	TV-199	TR-53/A	HVO-185	TV-L-66	TV-190(5)	724038	A-2998

MERIT COIL AND TRANSFORMER CORPORATION

PART NUMBERS		PART NUMBERS		PART NUMBERS		PART NUMBERS	
MFGR.	MERIT	MFGR.	MERIT	MFGR.	MERIT	MFGR.	MERIT
TRAV-LER		TRUETONE		TRUETONE		TRUETONE	
730060	P-3060	B-12C-19990	A-3019(2)	D-9.235	P-2835(11)	L-81A	MDF-92(4,7,75,92,100)
760019	TV-126	B-12C-20761-1	A-3039	D-9-252A	P-3055	L-82	TV-131
760024	TV-113	B-12M-18241/-1/-3	A-3003	DB-11F	BC-574	L-89	TV-151
762005	TV-151	B-13A-16612	FM-254(2)	DB-21F	BC-575	L-90	TV-151
762017	TV-130	B-13A-16662	BC-352(2)	DB-31F	BC-576	L-103	TV-127
762031	TV-134	B-13A-18783	TV-154(2)	E7-1F	BC-569	L-110/A/B	TV-154(62)
762032	TV-243	B-13B-16000	FM-254(2)	E7-2F	BC-570	L-118D	MDF-92
768020	TV-163	B-13B-16302	BC-353	E-103X	A-3025	L-119A	TV-162
774001	TV-121	B-13M-13590	MD-12	E-615	BC-380	L-123	TV-126(1)
782011	HVO-191	B-13M-16001	FM-252	E-622	BC-352	L-126/A	TV-196(5)
790014	MDF-120(88,92)	B-13M-16335	TV-110	E-624	BC-353	L-127/A	TV-201(5)
		B-13M-17273	TV-110	E-1111	A-2998	L-128	TV-207
		B-13M-18888	MDF-70(4)	E-1112	A-3025	L-132A	TV-163
		B-16A-1605-1	C-4084(2)	E-1113	A-3025	L-133	TV-192
		B-16A-17959	C-2991(2)	E-1121	A-3025(22)	L-135A	MDF-108(4,54)
		B-18A-16440	A-3019(2)	E-1126B	A-3025(2)	L-149/B	MDF-130(88)
TRIUMPH		B-51X-208	A-2931	E-1127B/-1	A-3025(2)	L-150	TV-126
(See Bendix)		B-52X-104-1A	C-4084	E-1137	A-3031	L-151	TV-126
		B-80-242	A-2930	E-1146	A-2928	L-152	TV-252
		B-80-243	P-2970	E-6055	BC-419	L-154	TV-241
TRIX		B-201-15612	TV-102	E-6127/X	BC-393(2)	L-155	TV-253
E-839	A-2901(2)	B-201-15945	TV-116(19)	E-6128	BC-403	L-156	TV-163
G-7352	A-2930	B-201-16412	TV-102	E-6134	BC-393	L-158	TV-192
H-4150	A-2901(2)	B-201-23744	MDF-70(4,8)	E-6135	BC-393	L-160	BC-566
		BIFT-1	BC-575	E-6139	BC-393	L-162	TV-184
		BIFT-2	BC-575	E-6142A	BC-393	L-163	TV-208
		BIFT-3	BC-575	E-6146	BC-393	L-164	BC-562
		B5-1F1	BC-574	E-6147	BC-393	L-165	TV-128
		B5-1F2	BC-575	E-6166A	BC-393(2)	L-167	TV-253
		B5-1F3	BC-576	E-6211	BC-357	L-174/B/C	MDF-130
		B7-07	BC-573	E-6217	FM-254	L-175	TV-241
		B7-1F	BC-574	E-6218	BC-353	L-176	TV-253
		B7-2F	BC-575	E-6256/-1	BC-352	L-177	MDF-130(88)
		B7-3F	BC-576	E-6256/-2/-3	BC-353	L-178A	MDF-92(4,8,54)
		C-1.458	MWC-7	E-6264	BC-356	L-179	TV-128(83)
TRUETONE		C-1.459	MWC-12	E-6265A	BC-574	L-186	MDF-108(7)
(Also see Wells-Gardner)		C-9.209	MD-12	E-6266A	BC-575	L-188	TV-113(19)
A-10-508	BC-352	C-9.228-3	A-3036	E-6267	FM-254	L-189	TV-202(5)
A-10-509	BC-353	C-9.230-2	A-3003	E-6271	BC-356	L-190	TV-195(5)
A-13D-16943	TV-163	C-9.236	HVO-3	E-6273	FM-257	L-191	TV-199
A-13D-19355	TV-163	C-9.237	C-2991	E-6283	FM-255	L-192	MDF-129(4)
A-13M-18026	TV-102	C-9.241	A-3019	E-09987	BC-352	L-195	TV-127(83)
A-13M-18233	MWC-7(6)	C-12A-17822	P-3078(11)	E-62419	BC-353	L-199	TV-199
A-13M-18461	MWC-4(6)	C-12A-18839	P-3059(16)	E-627189	FM-254	L-200	MDF-130(4,7)
A-201-16329	TV-137	C-12M-18285	HVO-10(2,3)	F-1126-B-2	A-3025	L-202	TV-250
A-201-18695	TV-151	C-12M-18286	HVO-10(2,3)	FC-5/A/B	C-4115	L-203	TV-158
A-201-18746	TV-151	C-12M-18689-2	HVO-10(2,3)	FC-18/A	C-4115	L-206	TV-234
A-201-19363	TV-151	C-12M-19407/-2	HVO-10(2,3)	FC-23	C-4133	L-209	MDF-143(4,7)
AMA-6459	BC-419	C-16A-15624	C-2991	FC-23A	C-4084	L-262	MDF-143(3)
AT-18	A-2934	C-18A-18022	A-2931	FMAC-6456	BC-561	L-263	MDF-143(3)
AT-28	A-3026(1)	C-18A-18588	A-2931(2)	HI-1F	BC-574	L-265	TV-127
AT-32	A-3026	C-201-15717	TV-110	HI-2F	BC-575	L-267	BC-566
AT-50/A	A-3026	C-201-16155	TV-108	HI-3F	BC-576	LC-6284	BC-560
AT-51	A-3025	C-201-16411	TV-108	IF-5290	BC-352	LI-19	BC-352
AT-52/A	A-3025	C-201-18843	HVO-10(2,3)	IF-5291	BC-353	LI-41	BC-352
AT-62	A-2928	C-201-19250	MDF-70(4)	IF-5292	FM-254	LI-42	FM-257
AT-63	A-2902	C-201-19269	HVO-10(2,3)	IF-5293	FM-255	LL-51	BC-419
AT-68	A-2934	C-201-21025/-1	HVO-49(3)	IF-6290	BC-352	LL-60	BC-419
AT-70	A-3031	C-201-21130	MDF-70(4)	IFM	BC-575	LL-61	BC-419
AT-71	A-3031	C-201-21514	MDF-70(4)	IFT	BC-574	LO-21	BC-387
AT-75	A-2902	C-6449	FM-254	J-6252	BC-574	LO-26	BC-393
AT-78	A-3026(29)	C-6450	FM-253	J-6252	BC-575	LS-A	BC-574
AT-81A	A-2998	C-6451	BC-352	J-6252	BC-576	LS-B	BC-575
AT-1410	A-3025	C-6452	BC-353	J-6255	BC-574	LS-C	BC-576
B-1.507	TV-163	CH-6457	BC-561	J-6255	BC-575	LS-5283	BC-419
B-12C-10074-4	A-2928	CH-6458	BC-561	J-6255	BC-576	LT-1F	BC-574
B-12C-10235	A-2931	D5-0C	BC-572	J-6256	BC-574	LT-2F	BC-575
B-12C-16050	A-3038	D5-1F	BC-574	J-6256	BC-575	LT-3F	BC-576
B-12C-17303	A-3036	D5-2F	BC-575	J-6256	BC-576	N-7694	BC-347
B-12C-18743	A-2931	D5-3F	BC-576	L-80A	TV-120	N-7697	BC-419
B-12C-19048	A-3038(18)						
B-12C-19728	A-3026						

PART NUMBERS		PART NUMBERS		PART NUMBERS		PART NUMBERS	
MFGR.	MERIT	MFGR.	MERIT	MFGR.	MERIT	MFGR.	MERIT
TRUETONE		TRUETONE		TRUETONE		TRUETONE	
O-1F	BC-574	12A-19942/-1	P-3053(10,28)	16A-26991	TV-151(37)	63T22	MWC-12
O-2F	BC-575	12C-18743-1	A-2931	16B-25146/-3	C-4084	63T23	TV-115
O-3F	BC-576	12C-19849	A-3036	16B-26052	C-2996	64T4	MDF-70(8)
O-1631	BC-393	12C-21215	A-2928	16B-26438	C-4084	67P079-B/-2	A-3026
O-5282	BC-393	12C-23704/-1/-2	A-2998	20-1005	TV-121	75A601	C-4095(2)
O-6241	BC-393	12C-24015	BC-352	24-43	BC-569	75A602A	A-4094(2)
OC-6454	BC-393	12C-24170	A-2931	24X60016	MDF-108(4)	75A604	A-4094(2)
R-1630	BC-419	12C-25148-1	A-2928	25-05	BC-419	79A14-1	A-2928
RT-6293	FM-255(63)	12D-19250	P-3097(2,45)	50-688	TV-126(1)	85C079	A-2931
S-1F	BC-574	12D-23699/-3	P-2959(20)	50A372-1	TV-116	85C082	A-2931
S-2F	BC-575	12D-25563	P-2963(2)	50A431	TV-116	90T4A/C	P-3076
S-3F	BC-576	12D-26582	P-3097(2)	50A432	TV-108	91T3	A-3036
S-38A1003	TV-165	12E-19048-2	A-3038(18)	50B406	TV-110	91T4	A-3026
SPK-1	A-3025	12E-23726/-1	A-3037	50B411	TV-163(37)	91T5/A/B	HVO-10(2,3)
SPK-89B	A-3025	12E-23939	HVO-58	50B688	TV-126(1)	91T6	A-3003
SPK-135	A-3025	12E-24440	TV-165	50C242	BC-352	130-114	BC-352
T-2	BC-574	12E-25101-1	A-2815(2,46)	51-2100	TV-184(5)	130-117	BC-348
T-3	BC-576	12E-25423	HVO-89	51-2101	TV-201(5)	130-117	BC-349
T-4T64	A-3025	12E-25424	HVO-89	51-2102	TV-206	130-148	FM-254
T-6-0	BC-572	12E-26993	TV-165(2)	51-2167	TV-131	132-161	BC-419
T-6-1	BC-569	12E-27097	HVO-163	51-2169	TV-163	136-141	BC-393
T-6-2	BC-570	12E-27149	HVO-58(7)	51A1857	TV-121	138-129	A-2757(2)
T-6-3	BC-571	12E-27149-1	HVO-163	51A2184	TV-196(5)	138-160	A-2928
T-451	A-3026	12E-27156	A-2829	51B1071	MWC-12	201-15612	TV-102
T-700-305	C-4124(2)	12E-27189	A-3037	51B1072/-1	MWC-7	201-15652	TV-102
T-700-310	BC-638	12M-18241/-1	A-3003	51B1153	TV-167	201-19490/-1	MDF-70(4)
T-700-311	BC-639	13A-19514	TV-154	51B1205	MWC-12	201-19533	HVO-10(2,3)
T-6201	A-3025	13A-24203	TV-132(19,37)	51B1857	TV-121	201-19817/-1/-3	HVO-10(2,3)
T-6213	A-3025	13A-24224	TV-130(37)	51B1996	TV-120	201-19947-1	MDF-70(4)
T-6250/-A	A-2928	13A-24937	TV-243	51B2167	TV-131	201-20186	MWC-5(6)
T-6441	A-2905	13A-25139	TV-116	51B2169	TV-163	201-20186-1	MWC-4(6)
TM-0C	BC-577	13A-25140	TV-116	53-396	MDF-108(4)	201-20291	TV-163
TM-1F	BC-574	13A-26994	TV-130(37)	53A180	MD-12	201-20696	TV-151
TM-2F	BC-575	13A-26995	TV-243(37)	53B140	MD-12	201-20782	TV-102
TM-3F	BC-576	13A-26998/-1	TV-132(19,37)	53B190	MDF-70	201-20936	MDF-70(4)
TO-6033	A-3025	13B-17731	BC-352	53C338	HVO-9(7)	201-21111	TV-103
TO-6133	A-3025	13B-23887	TV-139(1)	55-05	FM-257	201-21398	TV-151
TR-24	HVO-141	13C-24963	TV-120	55-06	BC-356	201-23727	TV-121
TR-25A	A-4089(2)	13D-19540	TV-163	55-07	BC-357	201-23729/-1	TV-120(19)
TR-26B/C	A-2823	13M-18233	MWC-7(6)	55-301	HVO-134	201-23744	MDF-70(4,87)
TR-36A	A-2822(2)	13M-19521	TV-102	55-303	A-2822(2)	201-23829	TV-103
TR-50A/B	A-2986	13M-19643	TV-110	55-306	A-3026	201-23873/-1	TV-149(37)
TR-51/A	HVO-152	13M-21644	TV-110	55-307	HVO-134	201-24043	TV-132(19,37)
TR-52A/B	P-2881	13M-23755	MDF-70(4,87)	55-308	A-2815	201-24056	MDF-70(4,87)
TR-53/A	HVO-185	13M-24085	TV-166	55-329	A-2822(2)	201-24472/-1	TV-165
TR-57	HVO-133(7,29)	13M-24086	TV-165	55A128	A-3037	201-24473-1/-2/-3	TV-166
TR-72	HVO-133(7,29)	13M-24441	TV-166	55A303	A-2822(2)	201-24563-1	MDF-70(4,9,87)
TR-73	HVO-152	13M-26083	TV-126(1,2)	55A318	A-3026	201-24748	MDF-70(4,87)
TR-77/A	A-2988	13M-26242	TV-113	55A333	HVO-134	201-24749	TV-151
TR-78/B	A-2822	13M-26243	TV-115	55B115/-A	A-3000	201-25360/-1	MDF-92(4,87)
TS-916	A-3026	13M-26268	MWC-18	55B128-O	A-3037	201-25566	MDF-70(4,87)
TT-0	BC-572	13M-26310	TV-163	55C113	HVO-3	201-26019	MDF-75(4,87)
TT-1	BC-569	13M-26988	TV-121(37)	55C114	A-3035	201-27120	MDF-92(4,75,87,92)
TT-2	BC-570	13M-26992	TV-166(2)	55C133	HVO-52(3)	250C-001	BC-567
TT-3	BC-571	14-265	BC-350(3)	55C134	A-2931	251A-002	TV-121
TVL-174B	MDF-130	14-267	BC-354	55C144	HVO-52(3)	251-100003	TV-205
TVL-177	MDF-130	16A-17959	C-2991(2)	55C304	HVO-134	251-100004	TV-206(5)
TVL-178A	MDF-92(90)	16A-19365	TV-190	55C306	A-3026	251-100005	TV-196(5)
TVL-186	MDF-108(7)	16A-20970	TV-185	55T3	A-2998	251-100008	TV-120
TVL-200	MDF-130	16A-21214	C-2996	56A250	C-4115	251-200006	TV-120
YLO-44	MDF-77	16A-21391	TV-199	56A251	C-4115	253-300003	MDF-92(4,8)
051-201857	TV-121	16A-22427	BC-565	56A253	C-4115	255-100012	A-3026
051-201996	TV-120	16A-22923	TV-192	56A264	C-4115	255-300005	A-3026
051-202167	TV-131	16A-23889/-1	C-4115(2)	60T1	TV-163	255-300007	A-2855
051-202169	TV-163	16A-24019	TV-203	61T3	TV-116	255-400008	HVO-180
053-300396	MDF-108(4,75)	16A-24020	TV-184	61T4	TV-116	256-200002	C-4115
055-100303	A-2822(2)	16A-24090	BC-566	61T5	TV-116	256-200008	C-4084
055-300301	HVO-134	16A-24505	TV-151	63T12	TV-151	550-006A	BC-356
055-300303	A-2822(2)	16A-24998	TV-196	63T18	C-2991	550-007A	BC-357
12A-18839-1	P-3059(16)	16A-25441	TV-151	63T20	MWC-8	1158-1	A-3025

MERIT COIL AND TRANSFORMER CORPORATION

PART NUMBERS		PART NUMBERS		PART NUMBERS		PART NUMBERS	
MFGR.	MERIT	MFGR.	MERIT	MFGR.	MERIT	MFGR.	MERIT
WELCOR Webster Chicago		WELLS-GARDNER		WELLS-GARDNER		WELLS-GARDNER	
R15083	BC-571	B51X208	A-2930	9A2169	TV-150	9A2385/-1	MDF-92(4,8)
65P147	BC-419	B52X104-1A	C-4084	9A2170	TV-113	9A2387-1B/-1C	MDF-125
65P165	BC-418	C9A2403	MDF-125	9A2171	TV-110	9A2388/-1B	MDF-92(4,8)
65P182	BC-419	D9A2484-1A	MDF-131	9A2172	MWC-4	9A2389	TV-131
65P183	BC-393	ELC-001	BC-393	9A2183	MWC-8(6)	9A2390	TV-130
66P022-2	C-2977(2)	ELC-003	BC-564	9A2193	MDF-72(4)	9A2392	BC-352
66P023	BC-560	ELC-004	BC-562	9A2194	MDF-72(4,54)	9A2393	BC-353
66P024	BC-561	ELC-006	BC-561	9A2195	MDF-72(4,54)	9A2400	TV-154
66P025	BC-564	ELC-008	BC-419	9A2201	TV-154	9A2401	BC-356
66P028	BC-561	ETD-001	FM-253	9A2203	BC-352	9A2402	BC-357
66P029	BC-564	ETL-001	FM-254	9A2204	BC-353	9A2403	MDF-125(90)
66P035	BC-549	ETL-002	BC-352	9A2221	MDF-72(4)	9A2405	BC-419
67P040	A-3031	9A1359	BC-311	9A2225	TV-103	9A2406	BC-393
67P047-3	A-2928	9A1368	BC-308	9A2226	TV-101	9A2408	BC-393
67P052	A-2928(22)	9A1959	BC-353	9A2230	TV-116	9A2412	BC-418
67P060-3	A-3019	9A1961	BC-352	9A2255	MDF-72(4)	9A2413	TV-151
67P061-1	A-2904	9A1963	BC-352	9A2256	MDF-72(4)	9A2414	TV-245
67P064	A-2928(22)	9A1970	FM-255(1)	9A2257	MDF-72(4,75,92)	9A2415/B	MDF-131
67P065/-3	A-3025	9A1976	MWC-7	9A2260	FM-252	9A2416	TV-165
67P069/-4	A-2904(2)	9A1979	TV-180	9A2261	MDF-72(4)	9A2423	MDF-121(4,8)
67P073	A-2901	9A1980	TV-103	9A2262	MWC-6	9A2425	TV-120(19)
67P076/-2	A-2902	9A1981	MWC-12	9A2263	BC-381	9A2426	TV-121(62)
67P079/-2/-B	A-3026(2)	9A1982	TV-136	9A2269	TV-110	9A2427	TV-131
67P081-1/-C	A-2928	9A1983	TV-106	9A2273	TV-163	9A2430	TV-163
67P086-B	A-2902	9A1984	TV-161	9A2274	MDF-72(4)	9A2432/-000/-001	BC-565
67P087-1	A-2902	9A1985	TV-150	9A2276	FM-254	9A2434	TV-155
67P089-2	A-3026(2)	9A1986	TV-105	9A2292	MWC-12(6)	9A2435	TV-247
67P092-1	A-3019	9A1987	MD-12	9A2293	MWC-6	9A2436	TV-156
67P097-B	A-2902	9A2022	BC-400(2)	9A2294	TV-162	9A2437	BC-418
67P101	A-2900(2)	9A2025	BC-388	9A2295	TV-110	9A2438	BC-393
67P-103/A	A-4105	9A2029	BC-352	9A2302	BC-381	9A2440	FM-254
67P105/-A	A-2900	9A2030	FM-254	9A2307	BC-355	9A2442	FM-253
67P109/-B	A-3026(22)	9A2034	FM-254	9A2308	BC-352	9A2443	BC-352
67P119/-B	A-2902	9A2035	TV-107	9A2309	FM-254	9A2444	TV-130
67P121	A-2900	9A2042	BC-353	9A2310	FM-254	9A2446	BC-352
67P136/-1	A-2902	9A2043	FM-254	9A2312	TV-133	9A2448	BC-561
67P139	A-2900	9A2047	TV-151	9A2316	TV-125(41)	9A2450	FM-253
68P028-5	P-3147	9A2048	MD-12	9A2317	TV-128	9A2452/C	MDF-125
68P035-1	P-3151(2)	9A2049	TV-106	9A2318	TV-126	9A2453	MDF-131
68P046	P-2884(2,10)	9A2055	TV-142(83)	9A2319	TV-126	9A2454	MDF-131
68P081	P-3134(2)	9A2057	TV-162	9A2320	TV-131	9A2458/-B	MDF-125(90)
68P085/-6	A-2902	9A2060	FM-254	9A2321	TV-132	9A2461	TV-153
69P007	BC-352	9A2061	FM-254	9A2323	TV-113	9A2466	TV-165
68P014	BC-356	9A2062	BC-352	9A2327-2	MDF-72(4)	9A2469	BC-352
69P017	FM-257	9A2063	BC-353	9A2332-2	MDF-72(4)	9A2470	BC-353
69P018	FM-256	9A2064	FM-254	9A2334-1/-2/-3/-4	MDF-72(4,8)	9A2472	BC-393
69P019	FM-256	9A2069	MD-12	9A2336	TV-151	9A2474	BC-419
69P020	BC-356	9A2071	TV-101	9A2343	BC-352	9A2476	MDF-131
69P021	BC-357	9A2072	TV-118	9A2344	BC-355	9A2477-A	MDF-131
69P023-D	BC-569	9A2073	TV-150	9A2363	TV-243	9A2477/-1/-1B	MDF-127
69P024-D	BC-570	9A2074	TV-151	9A2364	TV-245	9A2477/-1C/-E	MDF-127
69P025-D	BC-571	9A2075	MWC-7	9A2365	TV-131	9A2477-001/-00-1D	MDF-127
69P026	FM-254	9A2076	TV-107	9A2366	TV-151	9A2477-002/C	MDF-127
69P027	FM-255	9A2080	MDF-72	9A2367/B	TV-121	9A2481/-A	TV-165
69P028	BC-352	9A2082	MWC-6	9A2368	TV-113	9A2482/-1/-A	MDF-125(90)
69P029	BC-355	9A2086	TV-181	9A2369	TV-152	9A2483	TV-247
		9A2096	TV-163	9A2370	TV-247	9A2484/-1/-1F/-2	MDF-125(90)
		9A2105	MDF-70	9A2371	TV-165	9A2485/-1D/-1F	MDF-125(7,90)
		9A2106	MD-12(4,8)	9A2372	MWC-12	9A2485-2B/-2C/-2D	MDF-125(4)
		9A2108	BC-352	9A2372-F	TV-166	9A2487/A	MWC-12
		9A2111	MWC-12	9A2372-1	MDF-92(4,8)	9A2491	BC-353
		9A2112	BC-352	9A2373-1	MDF-125	9A2492	FM-254
		9A2113	BC-393	9A2374	TV-180	9A2493	FM-254
		9A2115	MDF-70	9A2375	TV-180	9A2495	BC-393
		9A2149	MDF-70(4,54)	9A2379	BC-381	9A2496	BC-419
		9A2161	FM-255(1)	9A2380/-000/-001	BC-562	9A2504	TV-151
		9A2165	TV-137	9A2381	MWC-6	9A2505	BC-419
		9A2166	TV-136	9A2382	TV-151	9A2507/-001	BC-394
		9A2167	TV-101	9A2383	TV-154	9A2508	BC-352
		9A2168	TV-154	9A2384	TV-161	9A2509/-001	FM-254
WEBSTER-ELECTRIC							
242-21783-1	A-2935(32)						
242-25333	A-2900(2)						
0074	BC-352						
1287-01	A-2929						

MERIT COIL AND TRANSFORMER CORPORATION

PART NUMBERS		PART NUMBERS		PART NUMBERS		PART NUMBERS	
MFGR.	MERIT	MFGR.	MERIT	MFGR.	MERIT	MFGR.	MERIT
WELLS-GARDNER		WELLS-GARDNER		WELLS-GARDNER		WELLS-GARDNER	
9A2510	FM-254	36A94-3	BC-675	51X186/A/-2/-2B	A-2855	53X311	HVO-10(2,3)
9A2513/B	MWC-12	36A94-8	BC-680	51X188	A-3018(2)	53X313	P-3067(14,16)
9A2514-1/-2	MDF-125(90)	36A94-9	BC-674	51X191-2/-B	A-2988	53X315	HVO-10(3)
9A2514-002-C	MDF-125(90)	36A94-10	BC-672(5)	51X192/-2/-3/-4	A-3026	53X318	P-3067(15,16)
9A2518	BC-564	36A94-11	BC-676	51X192-5	A-3026	53X319	HVO-44
9A2520	BC-394	42X95-5	C-4115	51X193-2/-3	A-2822(2)	53X320	HVO-44
9A2522/-00-C	MDF-143(4,7)	43X303	HVO-43	51X200-A	A-2904(2)	53X321	P-4071(2)
9A2522/-0010	MDF-143(4)	50-688	TV-126(2)	51X202-A	A-2905	53X324	P-3055
9A2522-1-B	MDF-143(4)	50A372-1	TV-102	51X206/-A/-B/-C	A-3026	53X325	P-3055
9A2543/-000/-001	BC-563	50A372-1	TV-103	51X207/-1/-A	A-4090	53X326	HVO-41
9A2544-001/-B	MDF-125(90)	50A431	TV-116	51X207-2/-A	A-4090	53X328	HVO-41
9A2544-1/-1B/-2	MDF-125(90)	50A432	TV-120	51X208	A-3026	53X329	HVO-41
9A2546	FM-254	50B406	TV-110	51X209	A-2988	53X330	HVO-41
9A2550	FM-253	50B411	TV-163	51X220/-1/-2/-3	A-2935	53X331	P-3069
9A2576-001	MDF-144C	50B688	TV-126(2)	51X220/-4/-5	A-2935	53X332	P-2837
9A2577/-001	BC-352	51-2167	TV-131	51X223-1/-2/-2A	A-2988	53X334	P-2839
9A2578/-001	BC-353	51-2169	TV-163	51X223-3	A-2984	53X336	P-3058
9A2584-001	MDF-143	51-2184	TV-196(5)	51X224/-1	A-2988(2)	53X337	HVO-9(7)
9A3267	TV-121	51A1037	TV-119(12)	51X225/-1/-A	A-2901(2)	53X338	HVO-9(7)
9A3272	TV-166	51A1857	TV-121	51X228/B/C	A-2902	53X339/A/B	P-3073(11,14)
9A3366	TV-151	51B1037	TV-119(12)	51X233-1/-1B/-2	A-2853(35)	53X340/A	P-3049
35A6	BC-562	51B1038	TV-230(2)	52C170	P-3169(2,14)	53X342	HVO-41
35A8	BC-564	51B1071	MWC-12	52C196	P-2836	53X346	HVO-41
35-396	MDF-92(4,8)	51B1072/-1	MWC-7	52X0102-003/A	C-4125	53X347	HVO-41
36A02	TV-184(5)	51B1150	TV-230(2)	52X0102-004/-005	C-4125	53X350	HVO-182(7)
36A0094-001	BC-672	51B1153	TV-167	52X0111-001	C-4125(1)	53X353	P-3051(2)
36A0094-002	BC-680	51B1857	TV-121	52X0112-003	C-4084	53X354/-A	P-3058
36A0094-003	BC-675	51B1996	TV-120	52X0114-000/-001	C-4133	53X355	HVO-88
36A0094-008	BC-680(5)	51B2169	TV-163	52X87	C-2991	53X359/A	HVO-182(7)
36A0094-009	BC-674	51X0102-005	C-4115	52X88/A	C-2991	53X360	P-3051(2)
36A0094-010	BC-672(5)	51X0192-004/-005	A-3026	52X90/A	C-2991	53X362/B/C/G	HVO-182
36A1	TV-194	51X0220-005	A-2901	52X91/A	C-2991	53X366/A	HVO-132
36A2	TV-184	51X0223-003/-004	A-2984	52X93B	C-2977	53X368/E	HVO-134(34)
36A5	TV-206	51X0228-001	A-2902	52X94	C-2996	53X369A	P-2876(10)
36A10	TV-193	51X0233-003	A-2821	52X95/-2/-3/-4	C-4115	53X372	HVO-134(34)
36A11	TV-188	51X0235-000/-001	A-3025	52X95-5/-6/-7/-9	C-4115	53X377	P-3154(2)
36A12	TV-184(5)	51X0235-001A/-002	A-3025	52X95-10/-11/-12/-13	C-4115	53X382/A	HVO-186
36A16	TV-181	51X0235-003	A-3025	52X102/-2/-3/-4/-A	C-4115	53X383/A	P-4082(2)
36A19	TV-182(5)	51X0236-000/-001	A-2901	52X104/-1/-2/-3	C-4084	53X389	HVO-174
36A22	TV-199	51X0237-000/-001	A-4140C	52X104-1-B/-2A/-3A	C-4084	53X390	HVO-192
36A23	TV-181(5)	51X0238-001	A-2902	52X111-1	C-4115(2)	53X391/A/-2/-2A	P-2873
36A25	TV-181(5)	51X89	A-2901	52X112-1/-3	C-4084	53X394	HVO-186
36A27	TV-200	51X104-2A	C-4084	53-396	MDF-108(4,75)	53X395/A/B	P-4083
36A28	TV-190(5)	51X134	A-3019	53A180	MD-12	53X397/A/-2	HVO-192
36A29	TV-184(5)	51X137	A-2930(2)	53B140	MD-12	53X398/A/C/F	HVO-134
36A30	TV-193	51X139	A-2931	53C301	HVO-43	53X399	HVO-174
36A33	TV-185(5)	51X140	A-3035	53X0397-002/-003	HVO-192	53X404/B/C	P-3052
36A34	TV-190	51X142	A-2936	53X0397-2	HVO-192	53X408/A/000A	HVO-174(7)
36A35	TV-181(5)	51X145	A-3035(2)	53X0408-000A/-001	HVO-174(2,19)	53X408/A/-2	HVO-174(2,19)
36A36	TV-194	51X146	A-2931	53X0408-002	HVO-174(2,19)	53X415/-A	P-4082(2)
36A37	TV-185(5)	51X147	A-3036	53X0414-001/-A	P-4141C	54X0024-000/-001	P-2846(2)
36A39	TV-198	51X149	A-3037	53X0416-001	HVO-234C	54X4	A-4000
36A40	TV-186(5)	51X150/A/H	A-2930	53X10	A-3003	54X5	A-3003
36A41	TV-194(5)	51X151	A-3037	53X180	MD-12	54X6	A-4000
36A42	TV-180(5)	51X152	A-2931(2)	53X232	P-4071(2)	54X7	A-3003(20)
36A43	TV-196(5)	51X154	A-2930	53X286	P-2953	54X8	A-3003(20)
36A45	TV-198(5)	51X156	A-3039	53X290	P-3052(2)	54X9	A-3003(20)
36A46	TV-201(5)	51X159	A-2854	53X294	P-4071(2)	54X10	A-3003
36A47	TV-207	51X162A	A-3019	53X295	P-4071(2)	54X16	P-2964(2)
36A48	TV-196(5)	51X165/A	A-3019	53X297	P-3063	54X17	P-2964(2)
36A49	TV-194	51X166/B	A-2930	53X296	HVO-3	54X19/-A	A-3003
36A50	TV-185	51X167/A	A-3026	53X298	P-3078(2,10)	54X20	P-2964(2)
36A51	TV-201(5)	51X168	A-3039(2)	53X299	HVO-3	54X24	P-2846(2)
36A52	TV-201(5)	51X171A	A-2905	53X301	HVO-43	55-303	A-2822(2)
36A53	TV-206(5)	51X173/A	A-4090	53X302	P-3057(10)	55-304	HVO-134
36A56	TV-203(5)	51X174	A-3026	53X303	HVO-43	55-307	HVO-134
36A57	TV-207(5)	51X17	A-2930	53X306	HVO-10(2,3)	55A128	A-3037
36A94-008	BC-680	51X180	A-4080(2)	53X307	HVO-43	55A303	A-2822(2)
36A94/-1	BC-672	51X181	A-4080(2)	53X308	P-3067(14,16)	55A318	A-3026
36A94-2	BC-680(5)	51X185	A-3026	53X309	HVO-10(3)	55A333	HVO-134

MERIT COIL AND TRANSFORMER CORPORATION

PART NUMBERS		PART NUMBERS		PART NUMBERS		PART NUMBERS	
MFGR.	MERIT	MFGR.	MERIT	MFGR.	MERIT	MFGR.	MERIT
WELLS-GARDNER		WESTINGHOUSE		WESTINGHOUSE		WESTINGHOUSE	
55B080-3	A-2928	V-6612	MD-12	V-10586-1	TV-152	230V010H09	TV-203
55B114	A-3035	V-6764-1	TV-163	V-10619	BC-352	230V010M03	TV-185
55B115	A-3000	V-6851	P-2951	V-10771/-1	TV-153(12)	230V010M09	TV-188
55C113/-1	HVO-3	V-6852	A-2901	V-10909-1/-2	A-3039	230V012H04/M04	TV-151
55C114	A-3035	V-6981-1/-2/-3	A-3038	V-10911-1/-3/-4	MDF-70	230V019H01/M01	TV-186
55C117	HVO-3	V-6981-6/-7	A-3038	V-10945-1/-2	BC-352	230V019H06	BC-561
55C133	HVO-52	V-6981-8	A-4089	V-11264/-1	FM-254	230V019H09/M09	TV-188
55C134	A-2931	V-6987	A-2902	V-11360-1	A-3018(2)	230V019H10	BC-566
55C304	HVO-134	V-8201	MD-12	V-11396-1	TV-124	230V019H11	TV-180
55C306	A-3026	V-8298	MDF-71	V-11544-1/-2/-3	P-3064(14)	230V019H12	TV-185
56A251	C-4115	V-8621/-1/-2	TV-172	V-11544-3N/-4	P-3064(14)	230V019H13	BC-561
56A253	C-4115	V-8621-3/-4	TV-172	V-11545-1	MWC-6	230V019H15	BC-566
56A264	C-4084(2)	V-8621-5	TV-173	V-11546-2	MWC-4	230V019H16	TV-195
56C093	C-2991(2)	V-9210-2/-3	MDF-71	V-11546-3	MWC-5	230V019M03	BC-514
		V-9231	MDF-103(37)	V-11548-1/-2/-3	HVO-45	230V023H02/M02	TV-153
		V-9238/E-1/D-2	A-2931	V-11566-2	MWC-4	230V028H05	BC-563
		V-2938/-1/-2	A-2931	V-11571-1	MDF-73(87)	230V028H07	BC-564
		V-2938-3/-D	A-2931	V-11579-1	BC-352	230V030H08	TV-119(12)
		V-9340	TV-110	V-11579-1	BC-353	230V034H01	TV-207
		V-9370	TV-113	V-11789-1	MWC-6(6)	230V034H02	TV-194
		V-9371	TV-113	V-11791-1	MWC-4(6)	230V034H03	TV-196
		V-9395	P-3083	V-11973-1	TV-153	230V034H04	TV-188
		V-9574	TV-110	V-12072-1	MDF-92(8,4)	230V034H06	TV-202
		V-9584-1	A-2823(2)	V-12073-1	HVO-36(2,7)	230V034H07	TV-208
		V-9586-1/-2/-3	TV-139	V-12102-1	MWC-6(6)	230V034H08	TV-196
		V-9591	TV-151	V-12103-1	MWC-6(6)	230V034H09	TV-200
		V-9592	TV-150	V-12170-1	C-4084	230V034H10	TV-207
		V-9594	TV-154(19)	V-12218-1/-2/-3/-4	MDF-73(8,4)	230V034H11	TV-206
		V-9596-1	MDF-13	V-12605-1/-A/-D-2	P-3083	230V034H13	TV-185
		V-9642	FM-254	V-12605-4/-4C/-5	P-2830(27)	230V034H16	TV-195
		V-9681-3	A-3038	V-12974-1	MWC-3	230V038H07	BC-564
		V-9685	A-2928(2)	V-12988-1	C-2996	230V049H01	BC-561
		V-9688	FM-254	V-14080-2/-4/-5/-G	A-2998	230V056H01/H02	BC-561
		V-9723	P-3061(53)	V-14346-1	HVO-45(7)	230V056H-4	BC-561
		V-9778	C-2996(2)	V-14601-1	MWC-6(2)	230V065H04	TV-239
		V-9798	TV-139(2)	V-14602-1/-2	MWC-5(6)	230V066H01/H02	BC-514
		V-9807	A-2928(2)	V-14609-1	A-4098(18)	230V076H01/H02	TV-153
		V-9814	A-2931(2)	V-14627-1	HVO-36(2,7)	230V117H01	TV-186
		V-9828	FM-255	V-14639-1	BC-393(2)	230V117H01	TV-206
		V-9879/-1/-4	TV-126	V-14645-1	A-3025(2)	230V117H02	TV-196
		V-9880/-2	TV-126	V-14662-1/-2	MDF-92(4,8)	230V117H02	TV-188
		V-9881-2	TV-131	V-15068-1/-2	TV-130	230V117H03	TV-203
		V-9882-1/-2/-3	TV-151	V-15271-1/-2/-4/-6	MDF-92(4,7,8)	230V117H03	TV-195
		V-9882-4/-6/-7	TV-131	V-15324-1/-2/-3	HVO-54(7,2,17)	230V928H07	BC-564
		V-9882-5/-9	TV-151	V-15325-1/-2/-3	A-2823	235V013H11	BC-356
		V-9882-8	TV-131	V-15325-4/-6	A-2823	235V023H11	BC-356
		V-9883	TV-115	V-15480-2	TV-195	235V023H11	BC-357
		V-9883/-1/-3	TV-151	V-15480-3	TV-196	235V033H04	BC-356
		V-9884	TV-115	V-15480-4	TV-184	235V037H01	FM-254
		V-9885	TV-115	V-15480-5	TV-198	235V037H03	FM-256
		V-9899/-2	P-3053(27)	V-15480-6	TV-190	235V038H01	BC-355
		V-9904/-1	HVO-56	V-15490-1/-2	TV-151	235V039H01/H03	FM-254
		V-9958/-1/-2/-3	P-3053	V-15547-1	BC-356	235V040H01	FM-255
		V-9958-4/-5/-6	P-3053	V-15557-1	A-3025	235V042H01	BC-356
		V-9960	MWC-6	V-15650-1/-2/-3	HVO-54(7,2,17)	235V042H02	BC-357
		V-9982/-2	A-2930	V-15685-1	TV-125	235V043H01	BC-356
		V-9983	A-2938(2)	V-15791-1	TV-164	235V043H02	BC-357
		V-10045-1/-3/-4	MDF-70	V-15795-1	TV-151	235V044H01	BC-356
		V-10046	MDF-70	V-15796-1	TV-181	235V053H01	BC-356
		V-10049-2	MDF-70	V-15796-3	TV-196	235V053H02	BC-357
		V-10077-1	TV-113	V-15796-4	TV-184	235V053H03	BC-357
		V-10078-1	TV-113	V-15796-5	TV-198	235V053H04	BC-356
		V-10204-1	HVO-56	V-15796-6	TV-190	235V053H05	BC-356
		V-10213-1	HVO-56	V-15796-7	TV-185	235V053H06	BC-357
		V-10214/-1	HVO-56	V-15995-1/-6	MDF-92(7,8)	235V056H01	FM-257
		V-10288-1/-2	A-2928	V-16036-1	MDF-92(7,8)	235V057H01	BC-352
		V-10350-1	BC-355	230V005A01	TV-164	235V057H02	BC-353
		V-10351-1	BC-355	230V007M02	TV-234	235V058H01	FM-256
		V-10538-1/-6/-7	MDF-70	230V010H02	TV-184	235V059H01	FM-256
		V-10560-3	MDF-70	230V010H04	TV-190	235V073H01	FM-256

MERIT COIL AND TRANSFORMER CORPORATION

PART NUMBERS		PART NUMBERS		PART NUMBERS		PART NUMBERS	
MFGR.	MERIT	MFGR.	MERIT	MFGR.	MERIT	MFGR.	MERIT
WESTINGHOUSE		WESTINGHOUSE		WESTINGHOUSE		WOLLENSAK	
235V092H01	BC-569	430V088H03	A-4080	690V039H16	TV-201	27131130	A-3018
235V092H02	BC-570	430V088H05	A-2900(2)	690V039H32	HVO-234C		
235V092H03	BC-571	430V095H01/H02	A-4101	690V039H33	A-4140C		
235V095H01	FM-257(63)	430V099H01	C-4115	690V039H34	P-4141C		
235V097H02	BC-575	430V110H01	A-4105	690V039H61	BC-679		
235V097H03	BC-576	430V115H01	C-4115	690V039H62	TV-205(5)	YORK	
235V092H04	BC-574	430V116H01	A-2928	690V040H48	BC-569	5512	BC-574
235V118H01	BC-574	430V116H02	A-4096	690V040H50	BC-570	5513	BC-575
235V118H02	BC-575	430V116H04	A-4096	690V040H53	BC-571	5514	BC-576
235V118H03	BC-576	430V116H05	A-4097	690V044H66	A-3032		
310V051H01	BC-419	430V116H06	A-2998	690V045H50	P-4141C		
310V054H01	BC-418	430V116H07	A-4097	690V045H51	A-4140C		
310V055H01/H02	BC-419	430V117H01/H03	C-4115	690V045H52	A-3018		
310V056H01	BC-419	430V117H02	C-4084(2)	690V047H37	BC-575		
310V063H02	BC-419	430V121H01/H02	C-4115	690V047H38	BC-576	ZENITH	
310V064H01	BC-419	430V123H01	A-4105	759V007M01/M02	MDF-92(4,90)	S-10011	TV-185
310V069H01	BC-419	430V128H01	A-4097(2)	787V245H01	A-3025	S-11830	BC-394
310V09H02	BC-419	430V128H02	A-2902(2)	280084	A-3025	S-12251	BC-377
310V072H01	BC-419	430V130H01	A-4103	300226-1	P-4141C	S-12505	BC-394
310V074H01	BC-419	430V133H01	A-4103	320111-4	A-4140C	S-13048	TV-150
317V012H01	BC-419	430V134H01	C-4084(2)	320124-2	C-4133	S-13765	BC-394
317V013H01	BC-419	430V145H01	A-4097	320312-1	A-3018	S-13799	BC-381
317V013H02	BC-419	430V150H01	A-4097	360947-1	MDF-144C	S-13970	BC-377
317V013H03	BC-419	433V088H05/H06	A-2900(2)	903562-507	MDF-144C	S-13972	BC-377
370V063H02	BC-419	483V007H01	HVO-154(29)	906152-501	HVO-234C	S-13973	FM-250
410V026H01	P-3045	490V001H04	MDF-109(8)	906153-501	P-4141C	S-13997	BC-566
410V029H01	P-2897(2)	490V001H05	MDF-92(4,8)	961415-3	A-4140C	S-14192	BC-387
410V040H01	P-2964(2)	490V001M01	MDF-92(4,8)	961429-3	A-3019	S-14403	BC-564
410V051H01	P-2964(2)	490V004H01/M01	MDF-109	1104665-3	C-4133	S-14481	BC-381
430V02	A-2930	490V005M01	MDF-92(4,7,8)			S-14482	BC-387
430V005H02/H03	A-4089	490V006H01/H02	MDF-111	WHITE		S-14509	FM-251
430V005H04/M04	A-4089	490V007H01	MDF-122	(See Philco)		S-14521	BC-377
430V005H05/M05	A-4089	490V008H01/H02	MDF-111(88)			S-14832	BC-388
430V005H06/H07	A-4089	490V008H03/H04	MDF-111(88)			S-15015	HVO-53(3)
430V005H08/H09	A-4089	490V011H01	MDF-143			S-15048	TV-150
430V005M01/M02	A-4089	493V001M01	HVO-54(2,7)			S-15051	TV-102
430V005M02C/M04	A-4089	493V003H04/M04	HVO-177	WHITLEY		S-15052	TV-102
430V006H01/M01	C-4133(2)	493V003H05/M05	HVO-168	L-473	FM-255	S-15055	TV-103
430V026M01	A-2931	493V004H07/M07	HVO-154(7)	L-477	BC-561	S-15057	TV-151
430V027H01/M01	A-2930	493V004M02/M03	HVO-154	L-576	BC-352	S-15242	TV-103
430V031H01/M01	A-3025(22)	493V004M04	HVO-154	18-3	BC-563	S,5429	BC-387
430V032H01/M01	C-4115	493V006H01/H05	HVO-199	18-12-1	BC-393	S-15694	BC-381
430V032H02/M02	C-4115	493V007H01	HVO-154(7,29)	28-1		S-15709	HVO-53(3)
430V032H03/M03	C-4115	496V003H07	MDF-111	28-2	FM-254	S-15911	HVO-53(3)
430V033H02/H03	A-2815	496V003H09	MDF-109(8)	1895	FM-254	S-15981	BC-377
430V033M01/M02	A-2822	496V003M06	MDF-92(4,7,8)	35002	A-3027	S-16009	TV-102
430V034M01	A-2706(2)	570V050H01	A-2998	300001	A-2904	S-16011	TV-185
430V038H01/M01	A-2931	570V053H02	A-3025		P-2952	S-16013	TV-121
430V039H01/M01	A-4098	570V077H01	A-3026	WILCOX GAY		S-16015	TV-190
430V039H02/H03	A-4098	570V086H01/H02	A-3025	(See Majestic)		S-16047	TV-180
430V039H04/H05	A-4098	570V109H01	A-3025			S-16186	TV-169
430V039H06/H07	A-4098	690V037H23	HVO-233C			S-16186	MWC-13
430V041H01	A-2931	690V037H24	A-3019	WILLYS		S-16204	HVO-53(3)
430V045H01/M01	A-3020	690V037H25	A-4139C	DC-70264	A-2930(2)	S-16274	TV-126
430V048H01	A-3025	690V037H26	P-4141C	DC-70267-C	P-2971(2)	S-16275	TV-130(1,37)
430V051H01	A-3025(22)	690V037H27	TV-190	24C485553	BC-352	S-16276	TV-130(37)
430V053H01	A-2822	690V037H27	TV-195	24K485555	BC-355	S-16276	MWC-5
430V058H01	A-2901(22)	690V037H29	TV-157	25B472533	P-4071	S-16556	HVO-53(1)
430V063H01	A-3025	690V037H40	BC-565			S-16604	TV-130(37)
430V064H01	C-4084(2)	690V037H41	C-4133			S-16605	TV-130(37)
430V065H01	A-3025	690V037H44	BC-562			S-16624	TV-151
430V066H01	A-2928(22)	690V037H45	BC-566	25B500727	A-2930	S-16652	TV-120
430V067H01	A-3020	690V037H47	TV-180	6062	A-2901(2)	S-16751	MWC-8(2)
430V069H01	P-3096	690V037H48	BC-56	1218725	BC-350	S-16756	TV-119
430V083H01	A-4105	690V037H52	BC-566	1218726	BC-354	S-16855	TV-120
430V084H01	A-3026	690V037H53	TV-205	2090907-8	BC-596		
430V085H01	A-2900(2)	690V037H54	TV-193	2090908-6	BC-599	S-17097	TV-127
430V085H04	A-3025	690V037H55	TV-195(5)			S-17112	MWC-5
430V086H01	A-2900(2)	690V038H46	MDF-144C			S-17114	TV-169
430V088H01/H02	A-4080	690V039H15	TV-186			S-17116	TV-151

PART NUMBERS		PART NUMBERS		PART NUMBERS		PART NUMBERS	
MFGR.	MERIT	MFGR.	MERIT	MFGR.	MERIT	MFGR.	MERIT
ZENITH		ZENITH		ZENITH		ZENITH	
S-17140	HVO-53(3)	S-21078	HVO-57	S-40824	TV-130	S-47071	HVO-179
S-17175	MWC-5	S-21085	TV-181	S-40836	TV-152(12)	S-47660	MWC-12
S-17176	MWC-2(6)	S-21219	HVO-105	S-41196	HVO-143	S-47662	HVO-184
S-17233	HVO-53(3)	S-21261	HVO-105	S-41198	HVO-120	S-47699	BC-419
S-17265	HVO-53(3)	S-21264	HVO-108	S-41303	BC-387(33)	S-47702	TV-121
S-17435	HVO-53(3)	S-21317	HVO-106	S-41304	BC-388(33)	S-47722	BC-419
S-17472	TV-130(37)	S-21345	HVO-106	S-41365	BC-387(12)	S-47905	TV-185(5)
S-17906	TV-126	S-21492	TV-149(37)	S-41398	TV-130(2)	S-47906	TV-202
S-17907	TV-130(37)	S-21563	TV-195(5)	S-41676	TV-201	S-47912	BC-394
S-17908	TV-128	S-21691	BC-394	S-41684	TV-180	S-47968	TV-130
S-17913	TV-130	S-21718	TV-153(12)	S-41690	BC-552	S-48045	TV-131(67)
S-17927	HVO-53(3)	S-21719	TV-152	S-41691	TV-192	S-48045	TV-152(68)
S-17933	BC-381	S-21888	BC-565	S-41874	TV-181	S-48046	TV-132
S-17939	HVO-53(3)	S-21888	TV-181	S-41879	TV-181	S-48157	BC-394
S-17954	TV-238	S-22130	HVO-107	S-41880	TV-196	S-48197	HVO-196
S-17955	TV-121	S-22154	HVO-108	S-41887	TV-131(67)	S-49113	BC-419
S-17956	TV-151	S-22169	HVO-107	S-41887	TV-131(68)	S-49134	BC-419
S-18125	HVO-53(3)	S-22322	BC-394	S-41890	TV-153(12)	S-49594	TV-131(67)
S-18209	TV-131	S-22343	TV-130(37)	S-41891	TV-130	S-49594	TV-152(68)
S-18210	TV-153(37)	S-22344	TV-126	S-41899	TV-149(37)	S-49789	BC-419
S-18211	TV-152	S-22345	TV-126	S-41906	HVO-143	S-49822	BC-388
S-18421	MWC-2(6)	S-22347	TV-149(37)	S-41974	HVO-128	S-49918	HVO-187
S-18426	TV-120	S-22348	TV-149(37)	S-41979	TV-181	S-50095	HVO-188
S-18537	HVO-53(3)	S-23350	TV-149(37)	S-41986	TV-149(37)	S-50126	BC-387
S-18566	HVO-57	S-22352	TV-163	S-41988	HVO-144	S-50127	BC-394
S-18567	HVO-57	S-22444	TV-192	S-41990	TV-149(37)	S-50128	BC-393(2)
S-18568	TV-120	S-22448	HVO-109	S-42042	TV-120	S-50474	TV-130
S-18570	MWC-2(6)	S-22451	HVO-109	S-42054	TV-149(58)	S-50485	TV-119(2)
S-18589	TV-131(37)	S-22475	TV-204	S-42153	TV-120	S-50486	TV-119
S-18590	TV-130	S-22575	BC-387(2)	S-42624	TV-194(5)	S-50487	TV-149
S-18616	BC-387	S-22709	BC-381	S-42795	TV-153(2,12)	S-50488	TV-120(37)
S-18730	TV-128	S-22719	HVO-110	S-42872	TV-149(37)	S-50489	TV-120
S-18737	TV-131	S-22720	HVO-110	S-42874	TV-130(2)	S-50604	BC-531
S-18740	TV-130	S-22777	BC-566	S-42875	TV-149(37)	S-51445	TV-149(37)
S-18744	TV-152	S-22777	BC-565	S-42878	HVO-147	S-51445	TV-149(37)
S-18748	MWC-10(6)	S-22996	HVO-111	S-42912	TV-206	S-51460	BC-388
S-18990	HVO-57	S-23049	HVO-112	S-43067	BC-381	S-51461	BC-394(79)
S-19001	TV-121	S-23237	M-51-70-90	S-43091	M51-70-90	S-51583	HVO-208
S-19006	TV-119(12)	S-23348	TV-113(1)	S-43104	BC-393(7)	S-51643	TV-130
S-19020	TV-121	S-23424	TV-204	S-43125	TV-149(37)	S-51647	TV-149(37)
S-19032	HVO-57	S-23438	HVO-109	S-43442	TV-131(67)	S-51748	TV-194(5)
S-19079	HVO-57	S-23984	HVO-107(7)	S-43442	TV-131(68)	S-51749	TV-132
S-19264	BC-387	S-23989	HVO-107(4,7)	S-43615	TV-195	S-51750	TV-132
S-19342	MWC-2(6)	S-23992	TV-130	S-43616	TV-195	S-51754	TV-130
S-19408	HVO-63	S-23993	TV-130	S-43617	TV-184	S-51755	TV-130
S-19409	MWC-10(6)	S-23995	HVO-156	S-43618	TV-184(5)	S-52322	HVO-176
S-19411	MWC-14(6)	S-23998	HVO-156	S-43619	TV-184	S-52346	BC-419
S-19486	MWC-6(6)	S-23999	TV-130(2)	S-43624	TV-134	S-52410	TV-132
S-19699	BC-387	S-24095	HVO-156(5)	S-43694	TV-195(5)	S-52645	TV-184(5)
S-19712	TV-238	S-24654	BC-394	S-43717	TV-149(37)	S-52669	TV-180
S-19728	HVO-57	S-24659	BC-419	S-43875	TV-120(37)	S-53053	TV-152(2)
S-19736	TV-131(37)	S-24700	BC-393	S-43892	TV-131(67)	S-53053	TV-153(1,3)
S-19743	TV-169	S-24736	TV-120(12)	S-43910	BC-387	S-53066	TV-206
S-19854	HVO-57	S-24978	HVO-160	S-44279	TV-165	S-53071	TV-132
S-19952	TV-130(37)	S-40019	HVO-107(7)	S-45000	TV-186	S-53072	TV-152
S-19958	TV-131	S-40124	HVO-143(5)	S-45229	TV-121	S-53072	TV-153
S-19959	TV-120	S-40125	HVO-156(5)	S-45510	HVO-176	S-53097	HVO-187
S-19962	TV-149(37)	S-40235	TV-153(12)	S-45529	TV-130(2)	S-53099	TV-132
S-19993	BC-381(12)	S-40275	TV-169	S-45539	TV-130	S-53354	HVO-176
S-20099	HVO-69	S-40275	MWC-13	S-45543	TV-165	S-53617	TV-198
S-20219	TV-149(37)	S-40276	TV-149(37)	S-45677	TV-153(12,69)	S-54083	TV-193
S-20231	BC-394	S-40279	TV-130	S-45678	TV-165	S-54155	BC-394
S-20290	TV-152	S-40280	TV-130	S-45679	TV-165	S-54500	BC-419
S-20686	BC-393(2,7)	S-40284	HVO-128	S-45680	HVO-213	S-54773	BC-419
S-20843	BC-563	S-40294	TV-130(2)	S-45831	TV-121	S-54829	HVO-187(29)
S-20844	BC-382(2)	S-40486	TV-172	S-46564	HVO-196	S-54840/C	HVO-208(82)
S-20880	TV-182	S-40818	TV-120	S-46592	HVO-179	S-54860	HVO-176
S-20880	TV-195(5)	S-40820	TV-152	S-46741	TV-130(37)	S-55139	TV-134
S-20993	HVO-57	S-40822	TV-130(2)	S-46875	TV-130	S-55140	TV-247
S-21019	TV-127	S-40823	TV-130(2)	S-47002	TV-121	S-55842	HVO-187(29)

MERIT COIL AND TRANSFORMER CORPORATION

PART NUMBERS		PART NUMBERS		PART NUMBERS		PART NUMBERS	
MFGR.	MERIT	MFGR.	MERIT	MFGR.	MERIT	MFGR.	MERIT
ZENITH		ZENITH		ZENITH		ZENITH	
S-56508	TV-108	20-2007	TV-192	95-1200	BC-352(1)	95-1383	A-3020(2)
S-56689	TV-149(37)	20-2008	TV-180	95-1201	FM-251	95-1384	A-2825(2)
S-56752	HVO-176	20-2013	TV-185	95-1217	MD-12	95-1386	P-2887
S-56875	TV-159	20-2013	TV-181	95-1218	C-2996	95-1389	C-2994
S-56876	TV-169	20-2014	TV-184	95-1219	A-3035(2)	95-1392	P-3148(2)
S-57498	BC-387	20-2015	TV-181	95-1227	A-3020(2)	95-1395	A-3130
S-57621	TV-134	20-2017	TV-206	95-1233	A-3020(2)	95-1397	A-3033
S-57622	TV-134	20-2023	TV-192	95-1238	A-2902	95-1398	A-3027
S-57623	TV-130	20-2024	TV-204	95-1239	A-3038	95-1400	P-2883
S-57624	TV-130	20-2026	TV-208	95-1240	A-3038(2)	95-1406	MDF-72
S-57625	TV-247	20-2028	TV-200	95-1241	MDF-72	95-1410	P-3152(2)
S-57630	HVO-208	20-2501	TV-196(5)	95-1242	P-2886	95-1413	MDF-72(4,8,9)
S-58035	TV-149	20-2502	TV-199	95-1245	P-3179(2)	95-1421	A-2855
S-58047	TV-153	20-2504	TV-195(5)	95-1246	MDF-72	95-1422	BC-352
S-58110	TV-149	20-2505	TV-184	95-1247	A-2902	95-1423	BC-355
S-58348	TV-120	20-2506	TV-206(5)	95-1250	BC-347(1,19)	95-1427	MDF-91(4,8,9)
S-58350	HVO-176(29)	20-2512	TV-197(5)	95-1251	FM-251(2)	95-1428	A-2998
S-58355	TV-149	20-2514	TV-185	95-1252	A-3027	95-1431	A-2821
S-58377	TV-121	20-2515	TV-198(5)	95-1253	P-3173(2)	95-1432	MDF-91(4,7)
S-58613	TV-130(37)	20-2516	TV-181(5)	95-1254	BC-353(1)	95-1434	P-3134(2)
S-58725	TV-156	20-2518	TV-181(5)	95-1260	P-2886	95-1435	MDF-123(73)
S-58737	TV-156	95-821	BC-308	95-1263	MDF-72	95-1436	A-3033
S-58738	TV-156	95-822	BC-311	95-1267	MDF-72	95-1437	MDF-91(4)
S-58742	TV-130	95-912	BC-339	95-1271	C-2994	95-1438	BC-352
S-58821	TV-131	95-915	A-2900(2)	95-1272	A-3018	95-1439	BC-353
S-58824	TV-247	95-916	BC-367	95-1274	A-2936	95-1440	P-2885
S-58826	HVO-208	95-917	BC-354	95-1275	A-3038	95-1441	A-2855
S-60984	HVO-187(29)	95-937	BC-352	95-1277	P-2884	95-1443	MDF-123
S-61001	HVO-187(2)	95-942	BC-354	95-1280	C-2991(2,6)	95-1446	MDF-123
S-61348	BC-419	95-945	BC-354	95-1292	MDF-72	95-1448	MDF-123
S-61505	BC-394(79)	95-956	P-3165(2,11,16)	95-1294	A-3020	95-1452	MDF-123(73)
S-61512	BC-419	95-957	C-2974(2)	95-1297/E	MDF-72	95-1453	A-2901(2)
S-61621	TV-130(32)	95-1014	A-2999	95-1298	P-3134	95-1453	A-2902(2)
S-61622	TV-130(37)	95-1023	P-2971(2)	95-1300	A-3018	95-1454	A-4090
S-61623	TV-130(37)	95-1024	P-2971(2)	95-1301	A-2927(2)	95-1457	A-2928(22)
S-62229	HVO-176	95-1026	A-2900(2)	95-1306	MDF-72	95-1459	BC-323
S-63278	HVO-187(2)	95-1060	BC-354	95-1307	MDF-72	95-1460	BC-326
S-63279	HVO-187(2,3)	95-1062	P-3173(2)	95-1309	A-3033	95-1466	MDF-123
S-63280	HVO-208	95-1063	A-2931	95-1310	C-2996	95-1467	A-2900
S-63638	TV-149(19,62)	95-1078	BC-354	95-1311	P-3135	95-1469	P-2882(2)
S-64003	TV-120(32)	95-1085	BC-308	95-1312	BC-352(1)	95-1471	P-2883
S-64278	TV-131(2)	95-1088	BC-354	95-1313	BC-355(1)	95-1473	P-2882(2)
S-65092	HVO-176(2)	95-1101	BC-352(1)	95-1318	BC-352	95-1475	A-3039(2)
S-65172	TV-130	95-1102	BC-352(1)	95-1319	BC-347	95-1476	MDF-123
S-65352	HVO-176(2)	95-1102	BC-355(1)	95-1319	BC-353	95-1478	A-3031(33)
S-66705	TV-149(37)	95-1108	A-3019	95-1324	A-3027	95-1479	A-3039(2)
WC11752	A-3025	95-1109	C-2974	95-1326	A-3033(2)	95-1480	A-4090
WC11876	A-3026(2)	95-1110	MD-12	95-1328	FM-254	95-1483	A-2932
WC12221	A-2902(2)	95-1112	A-3038	95-1334	C-2974	95-1484	BC-355
WC13705	A-3025	95-1113	A-4000	95-1335	MDF-72(8)	95-1485	A-2927(22)
WC13706	A-3025	95-1114	A-3019	95-1337	MDF-72(8)	95-1488	A-2902(2)
WC13969	A-3025	95-1115	P-3169(2,61)	95-1339	A-3020	95-1495	A-3031(2)
WC14163	A-3025	95-1124	P-3169(2,61)	95-1340	A-2930	95-1497	P-2882(2)
WC14164	A-3025	95-1132	BC-368	95-1346	C-2996	95-1498	P-2882(2)
WC14245	A-2901	95-1133	BC-355	95-1348	C-2996	95-1501	BC-327
WC-15099	A-2936	95-1135	BC-354	95-1349	BC-368	95-1502	BC-641
WC15100	A-2998	95-1137	BC-355(1)	95-1350	BC-355(1)	95-1503	P-2882(2)
WC15732	A-2928	95-1148	BC-352(1)	95-1352	A-3033(2)	95-1504	BC-356
WC16123	A-3025	95-1149	BC-355(1)	95-1353	P-2887	95-1505	BC-641
20-333	BC-566	95-1150	FM-251	95-1355	A-3027	95-1506	A-2902(2)
20-337	BC-564	95-1152	FM-251(2,12)	95-1357	MDF-72(8)	95-1509	MDF-123
20-355	BC-561	95-1154	C-2974	95-1358	MDF-72	95-1520	P-2882(2)
20-682	BC-561	95-1165	MD-12	95-1359	MDF-91(4,92)	95-1522	A-2928
20-764	BC-561	95-1166	A-3035	95-1361	A-2853	95-1523	C-2974
20-2001	TV-202	95-1167	A-3020	95-1367	A-3031(2,7)	95-1525	P-3153(33)
20-2002	TV-181	95-1168	P-3169(2,61)	95-1375	P-3136(2)	95-1527	MDF-123
20-2003	TV-206	95-1170	C-2994	95-1376	C-4084	95-1534	A-2998
20-2004	BC-565	95-1189	A-3018	95-1377	A-4090	95-1535	A-3039(2)
20-2005	BC-566	95-1195	BC-319	95-1378	MDF-72(4,8,9)	95-1536	C-2996(2)
20-2006	TV-192	95-1198	MDF-72	95-1379	A-2932	95-1541	P-2882

MERIT COIL AND TRANSFORMER CORPORATION

PART NUMBERS		PART NUMBERS		PART NUMBERS		PART NUMBERS	
MFGR.	MERIT	MFGR.	MERIT	MFGR.	MERIT	MFGR.	MERIT
ZENITH		ZENITH		ZENITH			
95-1543	C-2996(2)	95-1740	A-3035	95-2061	P-4082(2)		
95-1544	P-2882(2)	95-1743	P-3152(2)	95-2067	MDF-144C(96,97)		
95-1546	MDF-123	95-1757	A-3031	95-2069/-T	A-3031		
95-1547	BC-356	95-1759	A-3025	95-2083/-A	A-2998(2)		
95-1548	A-2998(2)	95-1763	A-3025(2)	95-2091	MDF-136		
95-1549	BC-347	95-1768/-M/N	MDF-124(87)	95-2092/A	A-2855		
95-1552	A-4090	95-1769	A-3031(2)	95-2093/C	MDF-124(87)		
95-1553	C-4084	95-1771	MDF-124(8)	95-2094	P-4082(2)		
95-1554	MDF-123(8)	95-1781	A-3031(2)	95-2095	A-2855		
95-1555	P-2881(2)	95-1782	MDF-136	95-2096/AG	A-2932		
95-1556	BC-355(33)	95-1784	A-3031(2)	95-2098	A-2900(2)		
95-1557	A-3020(2)	95-1791	P-3150(2)	95-2100	A-3026(2)		
95-1558	A-2821	95-1793	MDF-144C(75,96)	95-2104	A-3033(35)		
95-1559	C-4084	95-1794	A-3025	95-2110	P-4082(2)		
95-1560	MDF-123(8)	95-1795	MDF-136	95-2112	P-4082(2)		
95-1569/W	A-2932	95-1803/F/G	A-2815(2,25)	95-2116	P-4082(2)		
95-1571	A-2936	95-1804	A-3031(2)	95-2118	C-2991		
95-1579	MDF-123(4,8,9)	95-1805	C-4084	95-2120	FM-256		
95-1581	C-4115	95-1806	A-3031(2)	95-2122	A-2936		
95-1588	A-2702	95-1823/A/B	A-3033(35)	95-2123	A-3026		
95-1591	A-3031(2)	95-1825/-L	MDF-124(87)	95-2134/-D	A-2998(2)		
95-1593	A-4090	95-1837	P-3173(2)	95-2136	A-3025		
95-1600	BC-323	95-1838	C-4084	95-2137	A-3025		
95-1601	BC-323	95-1839/-C	MDF-123(4,88)	95-2141	P-4082(2)		
95-1602	BC-326	95-1840	P-2885(2)	95-2142	A-3026		
95-1603	P-3152(2)	95-1841/-C	A-4090	95-2144	A-3026(2)		
95-1610	MDF-123(8)	95-1842	C-4115	95-2146	A-2853(86)		
95-1613	A-3020(2)	95-1864	FM-256	95-2154	A-3031(2)		
95-1614	BC-323	95-1879	BC-571	95-2156	A-2998		
95-1615	BC-323	95-1880	A-3031(2)	95-2157	MDF-136(9)		
95-1616	BC-326	95-1881	A-3031(2)	95-2158/-AT	A-2902		
95-1617	A-3031	95-1892	A-2935	95-2159/-AT	A-2902		
95-1622	A-2905	95-1894	P-2885(2)	95-2168/AH	A-2928		
95-1627	A-3031(2)	95-1904/-A	A-2900(2)	95-2177/-A	P-2846(2)		
95-1636	BC-357	95-1913	A-2905	95-2185	A-3025(2)		
95-1637	A-3025(22)	95-1915	BC-356	95-2186/-A	A-2821		
95-1643	A-3025(22)	95-1917	BC-641	95-2187	C-4084		
95-1646	A-4090	95-1918	FM-256(83)	95-2188	MDF-136(9)		
95-1648	MDF-123(8)	95-1919	FM-256	95-2190/-X	A-3020		
95-1650	A-4105	95-1920	FM-258	95-2201	A-2930		
95-1651	P-3152(2)	95-1928	A-3031	206CZ706	A-2932		
95-1652	A-2900	95-1941	A-2931	206CZ709	A-2932(2)		
95-1654	MDF-124(75)	95-1942	MDF-136	206-454	A-2901		
95-1655	A-4090	95-1944	MDF-123(4)	206-517	A-2901(2)		
95-1656/G/J	A-2821	95-1945	P-2885(2)	206-523	A-2901		
95-1658	A-2900(2)	95-1953	P-3152(2)	206-540	A-2932		
95-1659	A-2900	95-1954	P-3050(2)	206-600	A-2935		
95-1663	C-4084	95-1970	A-2821	206-631	A-2931(2)		
95-1665	A-3036(2)	95-1971	C-4084	206-658	A-2932		
95-1666	MDF-136(4)	95-1973	A-3019(2)	15099	A-2936		
95-1680	P-2881	95-1974	MDF-144C(96,97,98)	15100-A	A-2998		
95-1681	C-2996	95-1975	MDF-123(3,4,87)	15732	A-2928		
95-1682	C-4084	95-1981	C-2996(2)	17801	A-3025		
95-1694	C-4084	95-1984	MDF-136(3,9)	49918	HVO-187		
95-1695	MDF-136(4)	95-1986	C-4084	50095	HVO-188		
95-1696	A-2854	95-1988	A-2998	706050	A-3025		
95-1700	A-2854	95-1990	A-2821				
95-1703/-D	A-2902	95-1991	C-4115				
95-1704	A-3025	95-1995	A-3025				
95-1705	FM-256	95-1998	A-3031(2)				
95-1706	FM-257	95-2018/-B/-F	A-3033(35)				
95-1708	A-3025	95-2023	MDF-136				
95-1712	A-2900	95-2024	P-3084				
95-1714	A-3027	95-2025/-B	A-3033(35)				
95-1715	A-2900	95-2026/-D	A-2821				
95-1718	BC-356	95-2038-A/-D	A-2853(35)				
95-1719	BC-357	95-2039	C-4084				
95-1721	MDF-136	95-2040	MDF-136				
95-1728	C-4084	95-2052/-AR/-AS	A-2935				
95-1735	BC-327	95-2059	P-2844(2)				

MERIT COIL AND TRANSFORMER CORPORATION

FOOTNOTES



1. Mount with adapter plate.
2. Mounting difference.
3. Use instruction sheet packaged with unit.
4. May require use of original network.
5. Shunt with appropriate resistor.
6. Requires use of original slug or re-mount through chassis.
7. Requires terminal wiring change.
8. Use original yoke cover and centering device.
9. Use with IN35 insulator sleeve.
10. Parallel and phase 6.3 volt windings.
11. Use high current 6.3 volt winding.
12. Ignore center tap.
13. Parallel and phase 5 volt windings.
14. Use high secondary tap. Use high current filament winding.
15. Ignore low current 6.3 volt winding.
16. Use high current 5 volt winding.
17. Requires 2 turns for filament winding.
18. Connect as auto transformer.
19. Add capacitor externally.
20. May require shielding.
21. Use one-half of 12.6 volt winding to obtain required 6.3 volts.
22. Use original channel mounting frame.
23. Use tap which provides 50:1 turns ratio.
24. Use tap which provides 25:1 turns ratio.
25. Use tap which provides 7:1 turns ratio.
26. Reverse coil in can.
27. Use the two 6.3 volt high current windings in lieu of the 12.6 volt center tap winding.
28. Use low secondary tap.
29. Use original mounting bracket.
30. Use proper secondary tap.
31. Omit the resistor-capacitor combination in the primary.
32. Use original copper shield.
33. Fabricate new mounting bracket.
34. Remove 1 turn from filament winding.
35. Cut and tape blanking winding lead.
36. Connect both filament leads from original 12.6 volt center tapped winding to single high current 6.3 volt filament winding.
37. Remount in original can.
38. Use tap which provides an 8:1 turns ratio.
39. Remove circuit shunt capacitor.
40. Use tap which provides 6:1 turns ratio.
41. Use one winding only.
42. Use tap which provides 20:1 turns ratio.
43. Use tap which provides 9:1 turns ratio.
44. Use tap which provides 18:1 turns ratio.
45. Use tap which provides 6.3 volt output.
46. Use tap which provides 5:1 turns ratio.
47. Use tap which provides 10:1 turns ratio.
48. Use 7K ohm primary impedance tap.
49. Replaces Horizontal Oscillator and phasing coils.
50. If insufficient sweep add capacitor (approx. 100mmf) across horizontal yoke.
51. Jumper terminals No. 2 and No. 3 connect a 1.8 ohm 1/2 watt resistor in series with the 1B3 filament lead.
52. Use tap which provides 12:1 turns ratio.
53. Ignore 5 volt winding.
54. Requires use of original attachment plug.
55. Detune trap.
56. Alter width control shaft to fit extension.
57. Tape 6.3 volt, 10 amp. winding.
58. Remove 47 uuf and replace with 120 uuf for 3.58 MC trap.
59. Use tap which provides 15:1 turns ratio.
60. Use tap which provides 44:1 turns ratio.
61. Ignore additional filament windings.
62. Add resistance externally.
63. Connect two crystals externally.
64. Use with TV-151.
65. Use with TV-120.
66. Use with TV-119, ignoring center tap.
67. Replacement for Video IF only.
68. Replacement for 41.25 MC trap only.
69. Replacement for 47.25 MC trap only.
70. Replacement for 39.75 MC trap only.
71. For trap only. Drill 5/16 inch hole.
72. Remove horizontal damping network from yoke.
73. Connect horizontal damping capacitor across horizontal yoke terminals 3 and 7.
74. Connect 1K, 1/2 W. resistor in series with horizontal yoke center tap lead.
75. Connect as in original circuit.
76. When replacing a 2-3/4 inch diameter yoke, use original rear cover. When replacing a 3-1/4 inch diameter yoke, use M47-110 cover in conjunction with MDF-118.
77. Tape 6.3V, 1.2A winding.
78. Use 140V secondary winding.
79. Disregard primary.
80. Disregard AGC-AFC winding.
81. Remove yoke plug.
82. Lengthen lead to horizontal output.
83. Disregard secondary.
84. Use trap only.
85. Lengthen H. V. rectifier plate lead.
86. Cut and tape green lead.
87. Use with M 51-70-90.
88. Use with M 47-110.
89. Remove unused terminal.
90. Use with M-238.
91. Use with MWC-1.
92. Use original plug.
93. Use with BR 263 mounting bracket.
94. Extend leads.
95. Use original pin cushion magnets.
96. Requires use of original centering assembly.
97. Delete 560 ohm resistors from terminals 4-12, 5-11.
Delete 560 mmf capacitors from terminals 1-7, 3-8.
Delete 47 mmf capacitor from terminals 2-3, jumper terminals 8-2.
98. Use original 1 meg. thermistor and connect as original.
99. Use with MWC-12.
100. Mount with leads out bottom.



Refer to Page 37 for description of available Merit rear covers and centering rings.

MERIT Sales REPRESENTATIVES

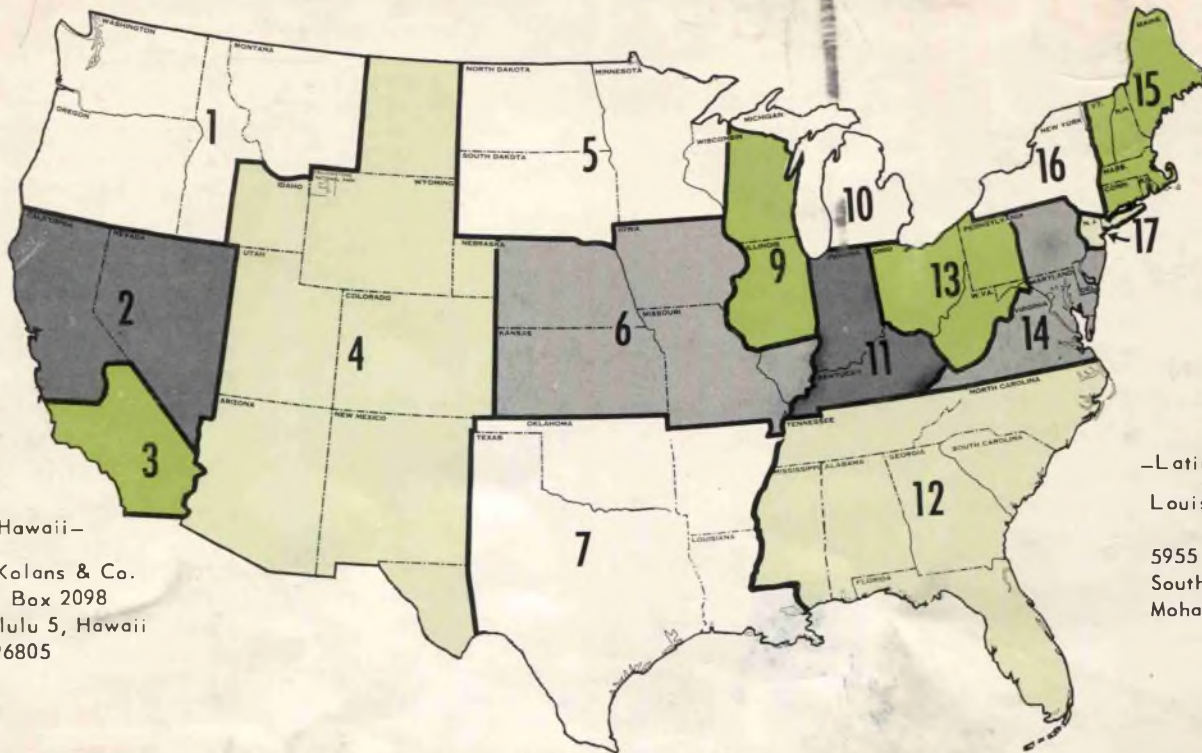

-Hawaii-

Bill Kolans & Co.
P. O. Box 2098
Honolulu 5, Hawaii
Zip 96805

-Latin America-
Louis D. Cohen
& Cia.
5955 S.W. 64th Ave.
South Miami, Florida
Mohawk 7-0100

1 Dale Weber Company
8 S.E. Clay Street
Portland 14, Oregon
Belmont 4-7671

12 Stanley K. Wallace & Assoc.
P. O. Box 67
Lutz, Florida
Tel: (Tampa) 949-1817

2 F. W. Moulthrop & Assoc.
1530 East 12th Street
Oakland 6, California
ANdover 1-7676

7 Lund & Company
2215 N. Olive
Dallas, Texas
Riverside 8-8839

13 Les A. Morrow Company
3123 West 117th Street
Cleveland, Ohio
CLearwater 1-5700

3 Bassett & Moore
12045 Magnolia Blvd.
N. Hollywood, Calif.
Triangle 7-7129

9 Mike Bermann Sales
8631 East Prairie Rd.
Skokie, Illinois
ORchard 5-3740

14 Brown-Frederick & Associates, Inc.
Box 235
Glenside, Pa.
Turner 7-1325

4 Connors, Inc.
2241 Stacey Drive
Denver 21, Colorado
Tel: 428-1575

10 ABM Sales, Inc.
10116 Puritan Ave.
Detroit 38, Michigan
(313) University 2-1300

15 Robert S. Reiss Assoc.
70 Jessie Drive
West Haven, Connecticut
WEst 3-8542

5 Marvin H. Kirkely
204 Sunnyridge Lane
Minneapolis 22, Minnesota
Franklin 7-3239

11 Thomas & Sukup, Inc.
2060 East 54th Street
Indianapolis 20, Indiana
CLifford 1-4574

16 Marsey Sales, Inc.
179 Winton Road North
Rochester 10, New York
Hubbard 2-4133

6 Kelly-Schmitz-Winkler Assoc.
7546 Troost Avenue
Kansas City 31, Missouri
EMerson 1-5651

17 The Newhope Corporation
6 East 39th Street
New York 16, New York
Lexington 2-7372

* * * * *



COIL & TRANSFORMER CORPORATION • MERIT PLAZA, HOLLYWOOD, FLORIDA

MERIT Sales REPRESENTATIVES

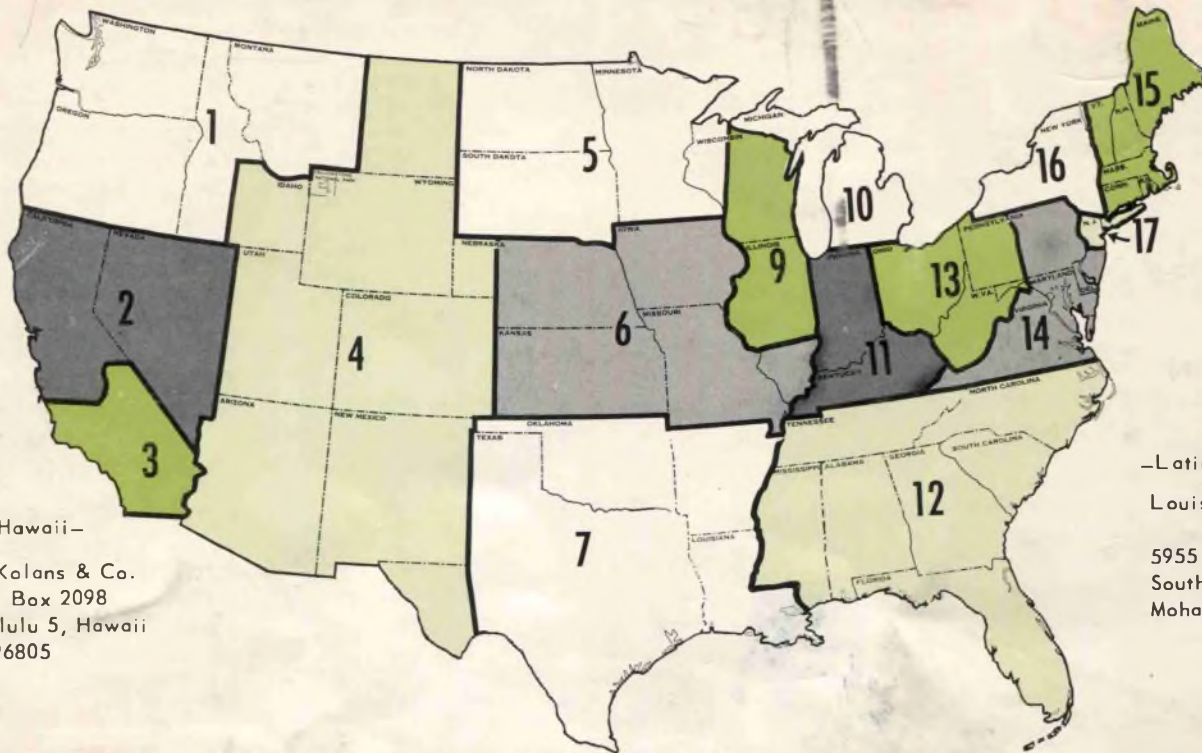

-Hawaii-

Bill Kolans & Co.
P. O. Box 2098
Honolulu 5, Hawaii
Zip 96805

-Latin America-
Louis D. Cohen
& Cia.
5955 S.W. 64th Ave.
South Miami, Florida
Mohawk 7-0100

1 Dale Weber Company
8 S.E. Clay Street
Portland 14, Oregon
Belmont 4-7671

12 Stanley K. Wallace & Assoc.
P. O. Box 67
Lutz, Florida
Tel: (Tampa) 949-1817

2 F. W. Moulthrop & Assoc.
1530 East 12th Street
Oakland 6, California
ANdover 1-7676

7 Lund & Company
2215 N. Olive
Dallas, Texas
Riverside 8-8839

13 Les A. Morrow Company
3123 West 117th Street
Cleveland, Ohio
CLearwater 1-5700

3 Bassett & Moore
12045 Magnolia Blvd.
N. Hollywood, Calif.
Triangle 7-7129

9 Mike Bermann Sales
8631 East Prairie Rd.
Skokie, Illinois
ORchard 5-3740

14 Brown-Frederick & Associates, Inc.
Box 235
Glenside, Pa.
Turner 7-1325

4 Connors, Inc.
2241 Stacey Drive
Denver 21, Colorado
Tel: 428-1575

10 ABM Sales, Inc.
10116 Puritan Ave.
Detroit 38, Michigan
(313) University 2-1300

15 Robert S. Reiss Assoc.
70 Jessie Drive
West Haven, Connecticut
WEst 3-8542

5 Marvin H. Kirkely
204 Sunnyridge Lane
Minneapolis 22, Minnesota
Franklin 7-3239

11 Thomas & Sukup, Inc.
2060 East 54th Street
Indianapolis 20, Indiana
CLifford 1-4574

16 Marsey Sales, Inc.
179 Winton Road North
Rochester 10, New York
Hubbard 2-4133

6 Kelly-Schmitz-Winkler Assoc.
7546 Troost Avenue
Kansas City 31, Missouri
EMerson 1-5651

17 The Newhope Corporation
6 East 39th Street
New York 16, New York
Lexington 2-7372

* * * * *



COIL & TRANSFORMER CORPORATION • MERIT PLAZA, HOLLYWOOD, FLORIDA