

HUDSON



RADIO

OWNERS MANUAL

DB48

**INSTALLATION AND OPERATING
INSTRUCTIONS**

**HUDSON MOTOR CAR CO.
DETROIT, MICH., U.S.A.**

OPERATING INSTRUCTIONS

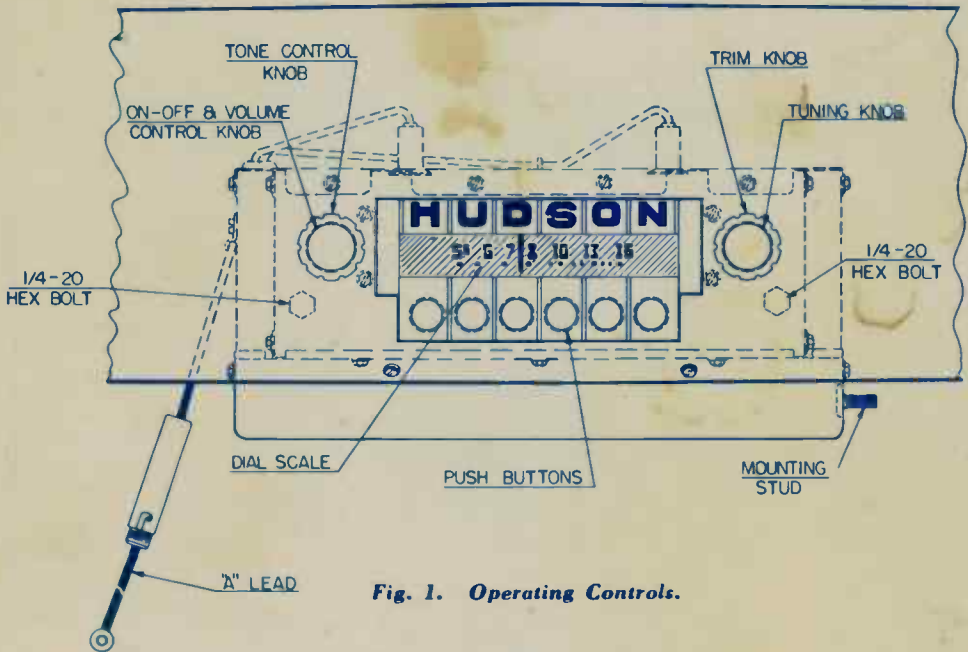

Fig. 1. Operating Controls.

Off-On Switch and Volume Control

To turn the receiver on, turn the volume control knob to the right until it clicks and the dial is illuminated. Allow the receiver to reach operating temperature. (Approximately 20 seconds.) To increase the volume, continue to turn this control knob to the right. To turn the receiver off turn the volume control knob to the left until it clicks.

Tone Control

The tone control is located directly behind the volume control knob (Fig. 1). Rotating this control to the right or left will change the tone of the receiver. The treble position is useful in overcoming wind, noise, etc., when driving, while the bass position brings out the full mellow tones of musical programs. With the tone control set midway, the full tonal range is obtained. Turning to the right will emphasize the high notes, while turning to left will emphasize the bass notes.

Manual Tuning

To tune manually it is only necessary to turn the manual tuning knob (on the right side of the receiver, see Fig. 1). Tune to exact frequency for the best tone quality. This can be done at any time without disturbing the automatic setting.

INTERFERENCE ELIMINATION

IMPORTANT: Use the utmost care in the following operations to insure freedom from motor noise. Be sure that good ground contacts are made between the interference condensers and the car body. If necessary, clean away paint or dirt with emery paper. Tighten all nuts and bolts securely.

1. Remove the mounting screw of the voltage regulator and under this screw mount the condenser No. 22-1537. Connect the lead to the voltage regulator "A" terminal. (Fig. 1)

2. Install suppressor No. 63-1252 in center of hole of distributor cap. Place high tension lead in top of suppressor. Be sure the suppressor and the lead are fastened securely. (Fig. 2)

3. Remove bolt on the right side of the ignition coil. Mount condenser No. 22-1537 under this bolt. Connect lead to coil terminal marked (-). (Fig. 3.)

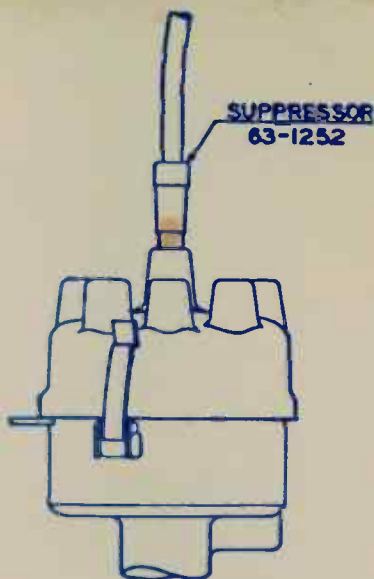

Fig. 2

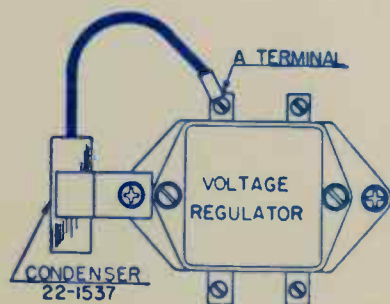

Fig. 1

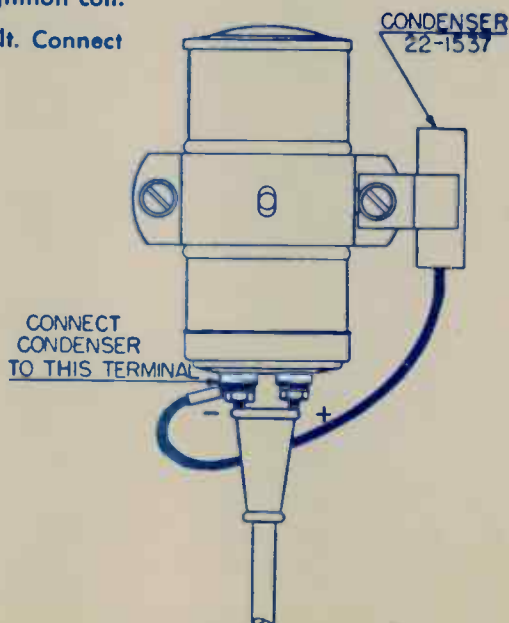
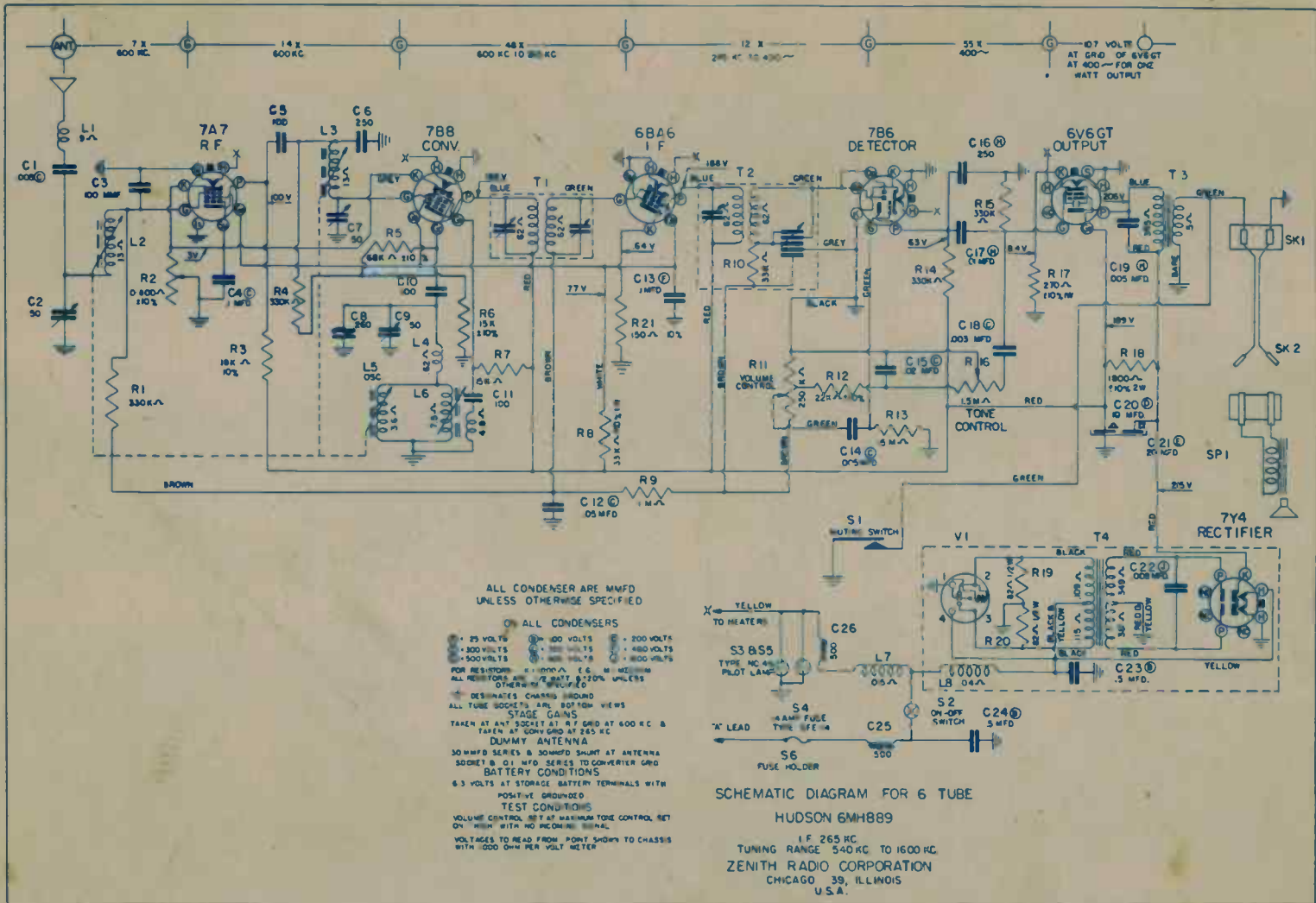

Fig. 3



Automatic Tuning

There are six automatic tuning positions, each of which may be adjusted to any desired station. In order to simplify the identification of the stations, it is advisable to set the automatic tuning mechanism in sequence according to frequencies of the stations, beginning with the station broadcasting on the lowest frequency, and progressing to the station broadcasting on the highest frequency. If the positions have not been previously adjusted, proceed as follows:

1. Loosen the first push button by turning it counter clockwise with your fingers.
2. Turn the manual tuning control knob (Fig. 1) to tune in the desired station. Carefully tune to the middle of the signal for clearest reception.
3. Push the first push button in as far as it will go. Release the button, and tighten securely by turning it clockwise with the fingers.
4. Repeat the above procedure for the remaining five push buttons.

Installation Instructions

1. Install the antenna. (Complete instructions are furnished with each kit.)
2. Remove door on left hand side of instrument panel by removing the three screws from the back.
3. Remove ornament from center of trim panel above radio opening by removing the two face screws.
4. Remove the instrument finish panel and remove the escutcheon plug from the panel.
5. Remove the two bolts, Hudson No. 71717, from the fire wall and install the rear mounting bracket No. 12-1410. Do not tighten the bracket at this time.
6. With the dial end of the receiver up, push the receiver up between the instrument panel and the air hopper. Turn the radio until the knob shafts slide through the openings in the instrument panel and the tapped spacers provided on the front plate of the set line up with the two corresponding holes in the instrument panel. Bring the receiver forward as far as it will go.
7. With the receiver held in this position start the two $\frac{1}{4} \times 20 \times \frac{1}{2}$ fillister head screws, with lockwashers, into the holes.
8. Slip the elongated hole in mounting bracket over the stud on the set and install lock washer and nut.
9. Before locking the receiver securely in position, place the instrument finish panel into position over the clock and speedometer and note whether or not the radio and trim panel are centered correctly. If not, move the radio until the dash trim panel and radio dial escutcheon assembly are in alignment. Then permanently fasten set in position by tightening the two front screws and the nut and bolts on the rear mounting bracket. Replace instrument finish panel and fasten securely.

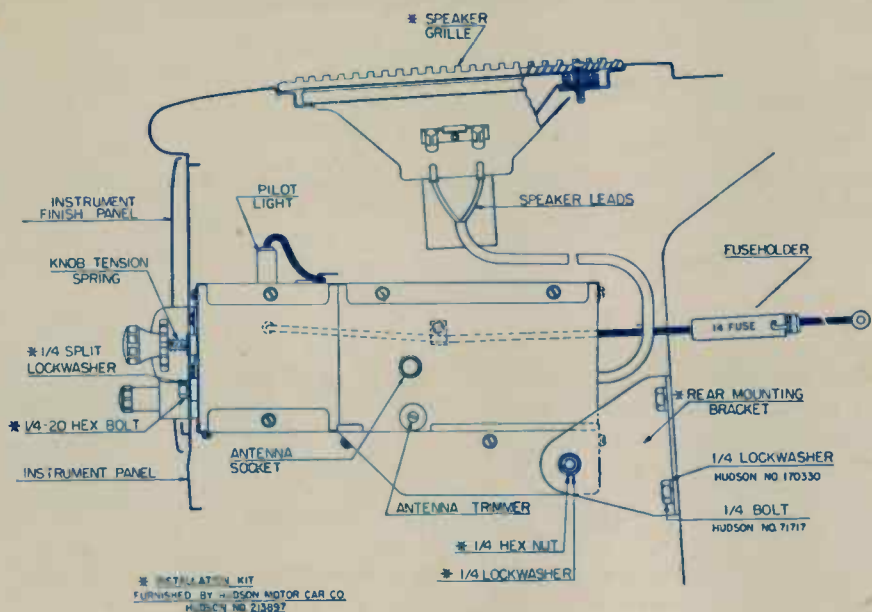

Fig. 2

10. Connect the "A" lead of the set to the battery terminal of the circuit breaker, mounted on the instrument panel brace over the steering column (Fig. 3).
11. Plug in antenna cable (Fig. 2).
12. Remove speaker cover plate, and pull speaker leads through open ing in dash.
13. Plug speaker leads into pin jack mounted on speaker. Make sure green lead plugs into green spotted pin jack.
14. Lower speaker into position, and line up with holes in the instrument panel. Place speaker grille, included in radio package, over speaker, making sure the mounting holes line up, then fasten securely with the four chrome plated screws provided in kit.
15. Place tone control knob onto shaft, put on volume control knob, tighten set screw (Fig. 1). Be sure there is no binding.
16. Place knob tension spring No. 80-594 over the tuning shaft. Put on trim ring and press on tuning control knob as far as it will go. Tighten set screw (Fig. 1).
17. Replace ornament and door.

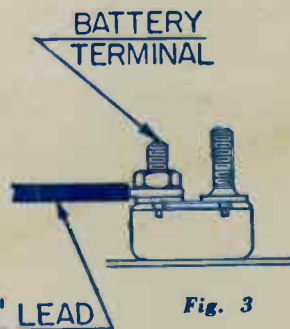

Fig. 3

18. IMPORTANT: Turn the receiver on and allow it to operate for approximately fifteen minutes in order for it to reach normal operating temperature. Tune in a weak station near 1200 Kc. With a small screw driver adjust the antenna trimmer, located on the right side of the receiver for maximum volume. (Fig. 2).

Warranty and Service

Your Hudson Receiver is covered by warranty against defect in material and workmanship for a period of 90 days after retail delivery.

This warranty covers a receiver installed at the factory, also a receiver installed in the field as an accessory.

IMPORTANT

A warranty registration tag is furnished with your receiver. This tag must be filled in and attached to the unit at the time of retail delivery in order that auto radio service stations may have the proper information when you require service during the warranty.

How To Obtain Service

Return to your Hudson dealer, or if you are traveling go to the nearest Hudson dealer. Do not contact any other source for warranty service.

In case you are traveling, the dealer, to whom you apply for service, will render a small charge for the removal and reinstallation of the radio equipment.

Radio Receiver Kit

Model DB-48 Part No. H.A. 213898

Radio receiver

Screws, lockwashers, knobs

Speaker and screen assembly

Distributor suppressor

Voltage regulator condenser

Ignition coil condenser

Support bracket and attaching parts

Antenna Kit

Part No. 213890

Note: Above Kits available only at Hudson Dealers