

THE PRACTICAL MAGAZINE FOR PERSONAL COMPUTERS & MICROCONTROLLERS

ComputerCraft

Formerly

**MODERN
ELECTRONICS**

July 1991 \$2.95

(Canada \$3.95)

Power On Computers From Any Location

Using Nonvolatile Memory ICs

Upgrade Your 286 PC To 386 Power



Circuit Design Software For PCs

Seeing Signals An Oscilloscope Would Miss

Heath's 286/386SX Convertible Computer Kit



Systems 50%-70% Off

386SX LAPTOP

- 1 MB RAM • VGA Port
- 40 MB Hard Disk Drive
- Major Manufacturer

Mfr. List
\$3195

\$22-Billion
Manufacturer



- 80386sx processor • 16 MHz • 1MB RAM (Expandable to 2MB) • 40 MB Hard Disk Drive
- One 3.5" 1.44 MB Disk Drive • VGA Video Port (640x480 resolution) • Backlit LCD Display 640 x 400 resolution EGA/CGA compatible • MS-DOS 3.3
- Serial and Parallel ports • Clock/Calendar
- Rechargeable Battery and AC adaptor • Made by a \$22-billion manufacturer • 1 yr. Mfr. Warranty

\$ **1399**⁹⁹

Plus S&H

Includes FREE Carrying Case

386

"Don't settle for an 'SX'
You can have a real 386
for even less money!"

Complete
Systems

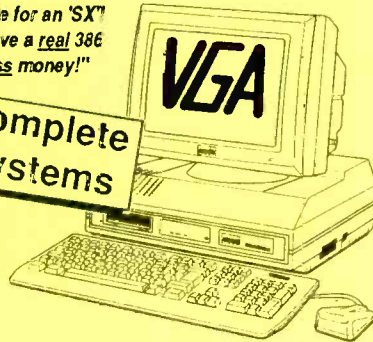

- 20 MHz
- 1 MB RAM (4 MB Optional)
- 40 MB Hard Drive
- VGA Monitor & Adaptor

Over 150,000 in
Use Worldwide

\$ **1199**⁹⁹

Plus S&H

FREE!

- FREE Hard Drive
- FREE VGA Monitor
- FREE Software
- FREE Mouse
- FREE Technical Support

The Professional Series 386 Features: Intel 80386 Processor • 20 MHz • 80387 Co-Processor Socket • 1 MB of RAM, LIM 4.0 Compatible (4 MB optional) • On-Board RAM Cache Controller • Expandable to 16 MB on the Motherboard • 5 Expansion Slots • 40 MB (28ms) Western Digital Hard Drive • 1-3.5" 1.44 MB Disk Drive • Built-in VGA, EGA, CGA, Hercules Compatible Video Adaptor • Monochrome VGA Monitor or Optional Color VGA Monitor • 1- Parallel Port & 1- Serial Port • 101 Key Keyboard • Mouse • MS DOS 4.01, GW Basic

Monochrome VGA Monitor Features: 64 Levels of Grey Scale • Paper White Display • 640x480 Resolution • Tilt & Swivel Stand • 12" Anti-Glare Screen

Color VGA Monitor Features: .29 Dot Pitch • 256 Colors • 640x480 Resolution • Tilt and Swivel Stand • 14" Anti-Glare Screen

with: **Color VGA Monitor** \$1399⁹⁹
• .29 Dot Pitch • 640 x 480

386 with 80 MB Hard Drive.....add \$150
386 with 4 MB RAM.....add \$200

TREDEX

800-338-0939

Monday-Friday 7am-5pm, Saturday 8am-1pm (Pacific Time)

1875 Century Park East, Suite 2633
Los Angeles, California 90067

In California

213-277-4168

Fax

213-551-3143

Customer Service

213-551-3139

Over 50,000 Satisfied Customers
Free Technical Support
Prompt Shipment
Volume Discounts
No Extra Charge For Credit Cards



CIRCLE NO. 109 ON FREE INFORMATION CARD



10

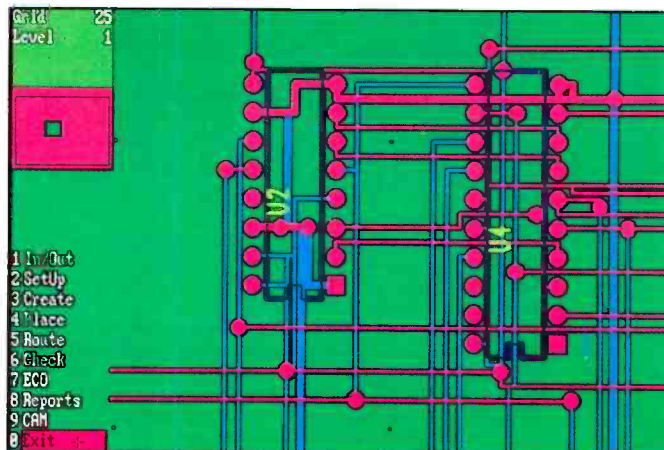

24

UPGRADING & ENHANCING

- 18 Upgrading Your 286**
By Roger C. Alford
Do-it-yourself alternatives allow your 80286-CPU PC to run advanced programs designed for '386 machines.
- 42 Computer "Wake-Up" By Phone**
By Nick Goss
Turns your telephone into an automatic computer power switch!
- 48 A Parallel-Port EPROM Programmer, Conclusion**
By Stuart Ball
Voltage checks, adjustments and using the Programmer.

APPLICATIONS

- 24 Circuit Design Software for PCs**
By TJ Byers
High-end schematic capture and PCB layout programs don't have to be expensive, as our look at seven interesting ones proves.
- 34 Using Nonvolatile Memory ICs**
By Jan Axelson
EPROMs, EEPROMs and Nonvolatile RAMs, ROMs and PROMs.

- 52 Choosing the Right Tools**
By Hardin Brothers
Languages, compilers and assemblers that help you to understand the inner workings of your computer.

- 60 Looking at Signals Impossible to See With an Oscilloscope**
By Martin Meyer
Using the *Modern Electronics* DSO/Eight-Channel Logic Analyzer to study, test and troubleshoot microprocessor circuits.

REVIEWS

- 68 Heath's Convertible Computer Kit**
By Alexander W. Burawa
Features assembled processor plug-in board, backplane design and small footprint.

COLUMNS

- 73 Forrest M. Mims III**
Optical Fiber Sensors.
- 80 Ted Needleman**
Road Warrior Tele-Toolkit and a Digital Imaging Primer.

- 82 Joseph Desposito**
NEC Speeds Up the V20 and V30; Fast Video DACs; CRT and Stepper Motor Drivers.

DEPARTMENTS

- 6 Editorial**
By Art Salsberg
Computer Jocks.
- 7 Letters**
- 8 What's Happening?**
By John McCormick
Latest PC News.
- 10 What's New!**
By Peter R. O'Dell
A roundup of new computer and electronic products.
- 90 Advertisers Index**

ON THE COVER: Choosing from among a rich assortment of video, audio, telecommunications, permanent and transient storage, process-control/data-acquisition, networking, etc., hardware can be perplexing experience. But if you know what you want and do your homework properly, the experience will reward you with a system custom-tailored to your needs.

Photo by Lorinda Sullivan

Electrified

WE WILL TRY TO BEAT ANY PRICE ON ANYTHING FROM ANYWHERE !!!
A TRULY PROFESSIONAL STAFF WITH A COMMITMENT TO SERVICE !!!

COMPUTER COUNTRY

386-33MHz / 64K CACHE SYSTEM

1 MB Installed - Expands to 32 MB — Mini Tower Case w/ Digital Display
Hard Wired Technology — AMI BIOS — 7 Slots (1-32 Bit, 4-16 Bit, 2-8 Bit)
Socket for Intel 80387 or Weitek 3167 Math Coprocessor
Page Interleave Memory Controller — Keylock Interface
Real Time Clock/Calendar w/Battery Back-up — CPU Speed is Switchable by
Hardware or Software — Up to 5 Storage Devices - ONE - 3-1/2" Half Ht. Bay
Four 5-1/4" Half Ht. Bays (3-Open, ONE Hidden)
Turbo-Power-Hard Disk LED's — Reset-Power Switches
200 Watt Power Supply — 101 Deluxe Keyboard
1-Year Warranty Parts and Labor

UNBELIEVABLE!!

\$995

Full Size TOWER Case Available! Quantity Discounts Available!!!

BONDWELL B-200 LAPTOP BRAND NEW

Fast - 80C88-8MHz - 640K-RAM-(2) 3.5" - 720 Drives - High Definition Super
Twist LDC Nonglare Display 640x200 C.G.A Resolution - 81 Key - Keyboard -
Parallel/Serial/RGB1 Video Port - Clock Calendar - Rechargeable - Removable
Nicaid Battery Pack - AC to DC Power Adapter - DR DOS Included - Only 6.9 lbs.
- 13"x12"x2.2" Full One Year Warranty From BONDWELL - Options Available.

MORE LAPTOPS from BONDWELL

80286-12-20 MB Hard Drive - 1.4 Floppy - 1MB
RAM — SUPER TWIST LCD ONLY \$899
Same as above with 40MB Hard Drive \$979

AMAZING

\$499

386-25MHz

1 MB Installed - Expands to 8MB
Mini Tower Case w/Digital Display
Hard Wired Technology - AMI BIOS
8 Slots (1-32 Bit, 5-16 Bit, 2-8 Bit)
Socket for Intel 80387 or
Weitek 3167 Math Coprocessor
Real Time Clock/Calendar w/ Battery
Back-up - CPU Speed is Switchable
by Hardware or Software - Up to 5
Storage Devices - One 3-1/2" - Half Ht.
Bay - Four 5-1/4" - Half Ht. Bays (3-Open,
One Hidden) - Power-Hard Disk LED's -
Reset-Turbo-Power Switches - 200 Watt
Power Supply - 101 Deluxe Keyboard
1-Year Warranty Parts & Labor

AMAZING

\$795

Full Size TOWER Case Available -
Quantity Discounts Available!!!

386SX - 16MHz

512K Installed - Baby AT Case
200 Watt Power Supply - AMI BIOS -
ZERO WAIT STATE
80387SX - Socket - Clock/Calendar
Up to 20 MB on the Motherboard
101 Deluxe Keyboard - 8-Slots
Reset and Turbo Buttons - Keylock
3 (1/2HT, 5 1/4") and
2 (1/2HT, 3 1/2") Drive Bays
Mini Tower or Full Tower Available
1-Year Warranty

\$549

Goldstar 386/286/XT-Turbo Systems Available — On Site Service on Goldstar Systems is Available!

8088 TURBO SYSTEM

SUPER SYSTEM

NOW 10/12MHz

8088-1-TURBO COMPUTER SYSTEM

1-Drive IBM Compatible System with 256K Memory

• 1-Half Height, 360K, 5 1/4" Drive INSTALLED
• Dual Speed - 4.77 MHz and 10/12 MHz - TURBO
• 256K Installed - 8 Slots - 8087 Socket - 150 Watt Power
Supply - Deluxe Keyboard - Full Size Case for 4 1/2 HT
Drives - 1 Year Parts & Labor Warranty on Base Unit
Produced by JCC

NOW 10/12MHz

IMPOSSIBLE PRICE!!!

Quantity Pricing
Available

\$249

286 SYSTEMS

QUADRANT 286/6 MHz System

512K - Full Size Case - BRAND NEW
200 Watt Power Supply - Deluxe Keyboard
- 8 Slots - 8-16 Bit and 2-8 Bit
Clock Calendar w/Battery Backup

Quantity Discounts

CALL

\$249

AWESOME

80286-TURBO 10/16 MHz

Fully IBM Compatible Zero Wait State!!!

512K Installed - Full Size Case - 200 Watt Power
Supply - Award BIOS - 101 Keyboard -
Up to 4MB on Motherboard
• 8 I/O Slots - 80287 Socket -
Reset and Turbo Button
• Keylock and 3 LED's - Clock/Calendar
1 YEAR WARRANTY

NOW
16MHz

\$349

SYSTEM OPTIONS

SUPER SYSTEM OPTIONS

Add a 2nd 360K 5 1/4" Drive	\$ 79	Clock Calendar Card	\$29
Add a 10MB Drive — Incl. Controller	\$149	Par/Ser/Ck/Game Card	\$49
Add a 20MB Drive — Incl. Controller	\$199	Memory Upgrade to 512K	\$69
Add a 30MB Drive — Incl. Controller	\$229	Memory Upgrade to 640K	\$99
Add a 40MB Drive — Incl. Controller	\$299		

386/386SX/286 SYSTEM OPTIONS

512K Upgrade for 386SX/286 (1 Full Meg)	\$ 99	40MB — Hard Drive (SPECIAL)	\$189
MEMORY Upgrades Available	CALL	60MB — Hard Drive	\$279
Controller — Dual HD-FD	\$ 79	80MB — Hard Drive	\$499
1.2MB or 360K - 5 1/4" Drive	\$ 79	110MB - Hard Drive - SPECIAL	\$999
720K — 3 1/2" Drive	\$ 79	LAGER HARD DRIVES AVAILABLE	CALL
1.44MB — 3 1/2" Drive - requires DOS 3.3	\$ 99	IRWIN 20MB — Tape Back-Up System	\$149
20MB — Hard Drive	\$ 169	AT&T 40 MB Tape Backup Kit	\$199
30MB — Hard Drive	\$ 179	AT-Parallel/Serial/Game Card	\$ 29

386/386SX or 286 or SUPER SYSTEM OPTIONS

DOS 3.1, 3.2, 3.3, 4.01	\$39/49/69/79	NCR 15" GREEN with NCR Card	\$99
Parallel or Serial Card	\$19	AT&T 12" Black & White TTL and AT&T Card	\$99
VGA Monitor and VGA Card	\$349	12" Monochrome Hi-Res — TTL	\$59
14" RGB Color Monitor w/Color Card	\$149	Monochrome Graphics Card with Printer Port	\$39
Color Graphics w/Printer Port	\$39	DRIVE WARRANTIES VARY —	

CALL FOR DETAILS

HARD DRIVE DEALS

AT&T 40 MB Tape Backup Kit - Internal	\$199
MICROSCIENCE 4070-62MB-MFM-18MS	
3-1/2" w/5-1/4" Frame - 1 Year Warranty - NEW	\$349
MINISCRIBE 3675-62MB-RLL-5 1/4"-NEW	\$229
MINISCRIBE 8450-40MB-RLL-3 1/2"-NEW	\$199
SEAGATE-ST-138R-32MB-RLL-3 1/2"	\$199
SEAGATE-ST-238-30MB-RLL-5 1/4"-1/2HT	\$179
SEAGATE-ST-225-20MB-MFM-5 1/4"-1/2HT	\$149
WESTERN DIGITAL-MFM-XT Cont. w/Cables	\$ 49
RLL Controllers for XT and AT's Available	CALL

MINISCRIBE Warranty - 6 Months - NEW DRIVES
Seagate Warranty - 90 Days - OEM Pulls
QUANTITY PRICING AVAILABLE — CALL

MICROSCIENCE MODEL 4090

111MB (Unformatted) 93 MB (Formatted)

Access Speed - 18 MS

\$399

3-1/2" w/5-1/4" Frame-RLL

Quantity
Discounts

• 4 MS Access Track to Track

Available!

8 Bit & 16 Bit —

VOICE COIL DRIVE • 1 Year Warranty

RLL Controllers Available

MINISCRIBE 30MB HARD CARD

Fits in a 8-Bit slot - No Controller Required

Low Voltage - 3-1/2" - Design for PC/XT/AT

\$229

Brand New 15 Month Warranty

SEAGATE ST-4051 \$189

40MB - Full Ht. - 40 MS - Seagate Pulls

15 Month Warranty

Brand New Condition

COMPUTER PRODUCTS

- Computers**
 - Acer • A-100 • Apple • Citizen • Compaq • Goldstar • JCC
 - Leading Edge • Quadrant • Mitsubishi • NEC
 - Packard Bell • Panasonic • Samsung • Sharp • Toshiba
 - Trinity • Unisys • WYSE
- Laptops**
 - Bondwell • Compaq • Goldstar • Leading Edge • Mitsubishi
 - NEC • Packard Bell • Panasonic • Samsung • Sharp
 - Texas Instruments • Zenith
- Monitors**
 - Amdel • Apple • AT&T • Goldstar • Hitachi • IBM
 - Magnavox • Mitsubishi • NCR • NEC • Packard Bell
 - Panasonic • Princeton Graphics
 - Samsung • Seiko • Sony • Tatung • Zenith
- Printers**
 - ALPS • Apple • Brother • Canon • Citizen • C-ITOH
 - Diablo • Diconix (Kodak) • Epson • Fujitsu • Genicom
 - Hewlett Packard • IBM • Mannesmann Tally
 - NEC • Okidata • Panasonic • Printronics
 - Seiko • Televideo • Texas Instruments • Toshiba

Financing Available!

Electrified Discounters

HOURS: Mon-Thurs 9AM-7PM
Fri-Sat: 10AM-6PM
1066 Sherman Avenue
Hamden, CT 06514
FAX 203-248-8680
FAX ORDERS AND BIDS ACCEPTED!

Orders
Only

(800) 678-8585

Customer Service & Technical Support (203) 287-1976
Mon-Fri 9:00 am - 5 pm EST

30-DAY MONEY

BACK GUARANTEE!

Full Refund of HARDWARE

Price on all Advertised Products

Catalog Sent With All Orders

Master Charge

VISA

AMERICAN EXPRESS

Dealer Inquiries Invited

All Prices listed are Cash Discounted. Add 2 1/2% for
MasterCard, VISA, or AMEX. Not responsible for
typographical errors. Prices are subject to change
without notice. Conn. residents add 8% sales tax. N.Y.
Sales add NY Tax. Quantities are limited! Prices do
not include freight. Allow 3 weeks for personal
company check clearance. Compatibility is not guar-
anteed. IBM is a registered trademark of International
Business Machines, Inc.

DENON CD-ROM DRIVES

Mass Amounts Of Information Are At Your Finger Tips
Waiting To Be Unleashed — YOU NEED IT NOW!!

- 600 MB Storage Capacity • Embedded SCSI Controller with Versatile Command Message Sets • High Capacity, High Transfer Rate Buffer — Up to 176 KB/Sec
 - 5.25" Half Height Drive • Quick Access Time
 - 400 MS Typical Seek Time • 32 K Disk Buffer • Front Loading Cartridge System For Easy Handling and Disc Protection
 - Horizontal and Vertical Installation Compatibility
 - High Fidelity Audio Output
 - Stereo Headphone Jack • Includes CD Caddy
- One Year Parts and Labor Warranty**

Kits also Available for Apple Macintosh Computers — Call for Price and Availability

Internal Kit For PC/XT/AT
Complete Hardware Kit
- Internal Mounting
LIST PRICE \$799

External Kit For PC/XT/AT
Complete Hardware Kit
- External Mounting Kit Includes Case and Power Supply
LIST PRICE \$999

YOUR COST

\$369

YOUR COST

\$469

Electrified

WE WILL TRY TO BEAT ANY PRICE ON ANYTHING FROM ANYWHERE !!!
A TRULY PROFESSIONAL STAFF WITH A COMMITMENT TO SERVICE !!!

We Currently Have The Following

CD ROM Bundle Available

ONLY

\$169

ENCYCLOPEDIA - From Grolier - All 21 volumes of the *Academic American Encyclopedia* with 33,000 entries, over 1,000 pictures and more than 9 million words. **REFERENCE LIBRARY** - Includes *Webster's New World Dictionary*, *Dictionary of Quotable Definitions*, *Dictionary of 20th Century History*, *New World Guide to Concise Writing*, *National Directory*, and *J.K. Lasser's Legal Forms for Smaller Businesses*. **WORLD ATLAS** - Over 240 Detailed EGA/VGA color maps and thousands of facts on government, economy, communications, and over 70 other topics. **US ATLAS** - Maps and information on more than 200 US regions. **GAME PACK** - Includes the 5 following games: *Beyond The Black Hole*, *Life & Death*, *Gun King*, *Bruce Lee Lives*, and *Chessmaster 2000*. The Software Bundle is Sold ONLY With CD-ROM Hardware Purchase. Software Bundles Are IBM Compatible.

Additional Titles Available CALL!

HITACHI - CDR-1503S - External CD-ROM System

Refurbished - Like New Condition - 6 Month Warranty

\$379

SCANNING SCANNERS

BRAND NEW XEROX - FLATBED

FULL PAGE SCANNER - Model 730 GS

IBM Compatible 64 Levels of Gray Scale

LIMITED QUANTITIES

27 Variable Resolutions to 450 DPI - 16 Programmable

Contrast Control - Includes PC Image Software - 3 1/2" Format **List \$1,995**

6 Preset Sizes - Internal Diagnostics - Removable Cover

for Larger Original - Complete Installation Kit

OCR Software Available **\$699**

CHINON FULL PAGE SCANNER FLAT BED CAMERA TYPE

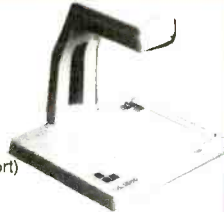

Includes: Utility Software
Serial Scanner Cable (Hooks Up To Your Serial Port)
No Kit Required
Resolution: 200, 150, 120, 100 DPI
PCX and TIF Format-Zoom In Image
Character Mode or Graphics Mode/Contrast Control
OCR Compatible Software **Only \$169**
Macintosh Interface Option Available
Parallel Interface Option Available
FAX Boards Are Available
Full Manufacturers Warranty To The End User
Quantity Discounts Available

Model DS-2000
List \$595

\$349

AT&T FULL-PAGE SCANNER **SAVE OVER 75%**

MODEL SC-60 **BRAND NEW**
Sheet Feed Series



Includes - IBM Compatible Interface Card
Not Micro Channel Compatible
Includes - AT&T PAGE POWER SOFTWARE
(Draw, Scan and Fax Package)
Includes - Microsoft Runtime Windows • Resolution
200 DPI Full-Page/
400 DPI Half-Page - OCR Compatible
OCR Software Now Avail. ONLY \$169
Half-Tone feature for Photographs

List \$1190

1 Year Warranty **List \$1190**

AMAZING ONLY

\$299

FREE Microsoft Windows 3.0 Upgrade

PRINTER POWER

IBM 5182 COLOR PRINTER

Heavy Duty • Wide Carriage (132 Column)
• 200 CPS Draft - 110CPS Correspondence • 35 CPS NLQ
• Prints Black, 4 Colors, and 8 Colors • BiDirectional Dot Matrix
BRAND NEW • 9 Wire-Parallel Interface • Tractor Included

FRONT - BOTTOM - REAR PAPER FEED
Paper Rack Available - Only \$12.95

List \$1,995

Easy Change Cartridge Ribbons - Available

Quantity Pricing — CALL 90 Day Warranty

\$399

DIABLO-D801F	\$ 499	80 CPS-Ltr, Qty-w/Sheet Feeder-Refurbished
PANASONIC KXP-1695	New \$ 369	330 CPS - 66 NLQ - Wide Carriage
CENTRONICS-136B	New \$ 299	180 CPS -34 NLQ - Wide - Heavy Duty
CITIZEN MSP-50	New \$ 249	300 CPS-50 NLQ - Narrow - Color Optional
TOSHIBA 301(Below Cost)	New \$ 199	Laptop Printer - 24 Pin - 180 CPS
SEIKOSHA SL-80AI	New \$ 199	24 Pin - Narrow - 135 CPS-54 NLQ
SEIKOSHA SL-1600AI	New \$ 139	160 CPS - 40 NLQ - Narrow - 2 Year Warranty
RITEMAN by C. ITOH	New \$ 119	120 CPS - 60 CPS Exp -Narrow Carriage

MONITOR MANIA

Panasonic 1381 - 13" - MultiSync, .28 DP, 1024 x 768 -NEW\$349

Magnavox 9CM082- 14" VGA Color, 31DP, 800x600 2 yr Warranty...Mint \$299

Magnavox CM-9032 - 14" VGA Color - 720x480 - Tilt/Swivel...Mint \$239

AMSTRAD COLOR VGA

ULTRA-Res-12" VGA-PC-Model 12HR

Tilt & Swivel-720x480-Anti-Glare Screen

1 YEAR WARRANTY

.28

BRAND NEW

\$299

DOT PITCH

STB-VGA Extra Card ONLY \$99

HI-Res
800x480

AT&T CRT-327-12" TTL

Tilt & Swivel

Black & White Monitor

BRAND NEW

90 Day Warranty INCLUDES AT&T 1024HP Card

List \$1390

Works on All IBM AT/XT's & Compatibles

6-\$115, 12-\$109, 24-\$105, Over 24-CALL ONLY **\$119**

NCR - 15" - Green - TTL BRAND NEW

with NCR - Monitor Card 640x400

1 YEAR List **\$99**

Save over 75% Warranty \$438

Financing Available!

Electrified Discounters

HOURS: Mon-Thurs 9AM-7PM

Fri-Sat: 10AM-6PM

1066 Sherman Avenue

Hamden, CT 06514

FAX 203-248-8680

FAX ORDERS AND BIDS ACCEPTED!

Orders Only

(800) 678-8585

Customer Service & Technical Support (203) 287-1976
Mon-Fri 9:00 am - 5 pm EST

30-DAY MONEY

BACK GUARANTEE!

Full Refund of HARDWARE

Price on All Advertised Products

Catalog Sent With All Orders

Dealer Inquiries Invited

All Prices listed are Cash Discounted. Add 2-1/2% for MasterCard, VISA, or AMEX. Not responsible for typographical errors. Prices are subject to change without notice. Conn. residents add 8% sales tax. N.Y. Sales - add NY Tax. Quantities are limited! Prices do not include freight. Allow 3 weeks for personal/company check clearance. Compatibility is not guaranteed. IBM is a registered trademark of International Business Machines, Inc.

MasterCard

VISA

AMERICAN EXPRESS

CIRCLE NO. 96 ON FREE INFORMATION CARD

EDITORIAL STAFF

Art Salsberg
Editor-in-Chief

Alexander W. Burawa
Managing Editor

Dorothy Kehrwieler
Production Manager

Emily Kreutz
Production

Elizabeth Ryan
Art Director

Barbara Terzo
Artist

Pat Le Blanc
Florence V. Martin
Phototypographers

Hal Keith
Illustrator

Bruce Morgan
Photographer

**Roger C. Alford, Jan Axelson,
Hardin Brothers, TJ Byers, Joe Desposito,
Nick Goss, John McCormick, Martin Meyer,
Forrest Mims III, Ted Needleman,
Peter R. O'Dell, SF Sparrow**
Contributing Editors

BUSINESS STAFF

Richard A. Ross
Publisher

Art Salsberg
Associate Publisher

Dorothy Kehrwieler
General Manager

Frank V. Fuzia
Controller

Catherine Ross
Circulation Director

Melissa Kehrwieler
Data Processing

Carol Minervini
Data Processing

Denise Pyne
Customer Service

ADVERTISING SALES

ELECTRONIC ADVERTISING
Jonathan Kummer
(516) 681-2922
FAX: (516) 681-2926

COMPUTER ADVERTISING

Ken L. Wood
(407) 264-0545
FAX: (407) 264-0473

Offices: 76 North Broadway, Hicksville, NY 11801. Telephone: (516) 681-2922. FAX (516) 681-2926. ComputerCraft (ISSN 1055-5072) is published monthly by CQ Communications, Inc. Subscription prices (payable in US Dollars only): Domestic—one year \$18.97, two years \$36.00, three years \$53.00; Canada/Mexico—one year \$21.00, two years \$40.00, three years \$59.00; Foreign—one year \$23.00, two years \$44.00, three years \$65.00. Foreign Air Mail—one year \$76.00, two years \$150.00, three years \$224.00.

U.S. Government Agencies: Subscriptions to ComputerCraft are available to agencies of the United States government, including military services, only on a cash with order basis. Requests for quotations, bids, contracts, etc. will be refused and will not be returned or processed.

Entire contents copyright 1991 by CQ Communications, Inc. ComputerCraft or CQ Communications Inc. assumes no responsibility for unsolicited manuscripts. Allow six weeks for delivery of first issue and for change of address. Printed in the United States of America.

Postmaster: Please send change of address notice to ComputerCraft, 76 North Broadway, Hicksville, NY 11801.

Computer Jocks

Most people are pretty passive about equipment they own. For them, most equipment is merely modern-age conveniences. If its an automobile, they'll never lift the hood to check out things, replace worn parts or, perish the thought, refine its innards to improve acceleration time. Yet, a substantial number, if not percentage, do indeed repair their own cars and modify them.

For those who do it, it's an adventure with rewards: intellectually, it improves their understanding of how things work; financially, it saves them money; psychologically, it bolsters their ego; socially, it brings them into contact with like-minded people. And, finally, their equipment works better than the original product did.

More and more personal-computer owners are following this path, too. They've got even more reason to do so because, every time they turn around, some manufacturer changes its design to make it more powerful in one way or another. Facing equipment that is continually being outdated, the user/owner must either dump/sell/give away his old (a few years) machine and buy a new, costly one or endure not being able to run new, better software (or do so at a slow snail's pace) . . . or upgrade his computer himself so that it runs with the modern pack.

Thanks to the open architecture of most PCs, upgrading a personal computer isn't too difficult to do, though it's sometimes challenging. There are a host of caveats to watch out for, though. These include signal timings that might be different, mismatched interfaces, boards that don't fit properly, and so on. There are a lot of ways to make computer upgrading easier, however.

One way is to deal with a supplier who caters to computer upgraders, with a technical department that will hold your hand should you run into trouble. You'll pay a little more for parts here, but for most people it's worth it. Another way is to be an active member of a local computer user's club, where you can glean in-

formation from associates who have already been down the road. Experience counts heavily.

But aside from the foregoing is the question of money. How much will it cost to upgrade to the point you wish to reach? How does this compare with the cost of actually buying a new, more powerful machine? Can you do it piecemeal, savoring better and better performance in discrete steps, while building up some bucks for the next improvement? Do keep an eye peeled toward the latest "standards" or trends—say, LIM EMS 4.0 or SIMM devices or IDE drives. Try to avoid upgrading to a point that will clearly soon be antiquated. After all, you don't want to start upgrading making major modifications that will soon have to be redone.

Another consideration concerns what you hope to do with a computer in a year or so. Do you plan to move into desktop publishing? Multimedia? Device control? OS/2? Each might require different configurations. Lots of extra memory might be on the horizon, for example. If so, make sure that RAM expansion is adequate. Then, again, you may require a host of expansion slots in time. Be sure that your present chassis can handle such needs. Perhaps a refinement of the product type you want for a particular purpose is just around the corner, as is the case for CD-ROM drives employed with multimedia applications. In this case, you might do well to just wait awhile before rushing in to buy one if this is your eventual goal.

There's no doubt that upgrading a computer can be most rewarding. But you've got to give some serious thought to a host of things to be confident that you're making the right move. Just put a pencil to it, laying the whole thing out. If it makes sense from both a financial and performance-improvement perspective, then by all means go for it. You'll be a computer jock in no time.



On Changing Our Name

• What a surprise! The new title and changes you announced are closer to my interests. Best wishes for success with the new *ComputerCraft*.

Duane M. Perkins
Mt. Gretna, PA

• The new name and format are great, and great interest was expressed by the members of our hardware SIG.

Thomas F. Trocco
Editor, NYCig News
New York, NY

• I like the change! It's good to see *Modern Electronics* evolve into *ComputerCraft*. With all the other MS-DOS computer magazines, it's nice to see a hardware-oriented magazine like *ComputerCraft* for readers with some technical knowledge, or who are interested in getting some.

Unsigned
Earth News
Titusville, FL

• O.K., you all changed your title and format. Sounds great, and I am sure I should anxiously await next month's copy. But what about the series of articles titled "The Modern Electronics Computer Experimenter Lab"? Will Part 4 concerning the prototyping station still be covered? Also, I would like to see a review article comparing the various PC diagnostic cards and software from such companies as Ultra X (R.A.C.E.R., QuickTech); Vista Microsystems, Inc. (V-ATE 2000, etc.); and Landmark (Kickstart 2, PCProbe). Thanks for the fine publication and your time.

Jose Quinton
Saratoga Springs, NY

Yes, the Experimenter Lab series will continue.—Ed.

• It seems that the concept and format of *Modern Electronics* has reached its coda. This is somewhat disheartening, but your new magazine, *ComputerCraft*, does seem to fill a niche that is currently neglected by other publications.

Bob Mostafapour

And Other Matters

• I would like to congratulate you on a fine article, "Single-Board Computers" by Jan Axelson, in the premiere (April 1991) issue of *ComputerCraft*. Single-boards computers and embedded controllers have been overlooked by most

computer magazines, and your series will fill that need.

James Campbell
Reedsville, WI

• I have seen several projects that require a 1-Hz signal source. Why not use the National Semiconductor 5368 chip and a crystal (Unicorn Electronics, Chatsworth, CA) to obtain it? The circuit arrangement is as follows:

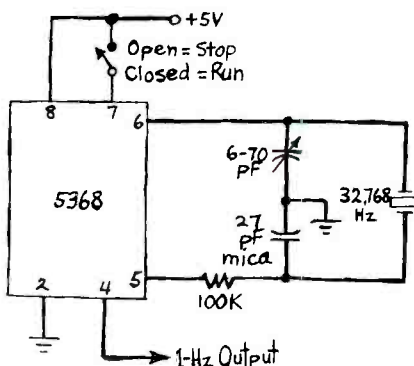

This clock and several 74C192s and 74C48 common-cathode display drivers can count down, up, start, stop and reset to or from any preset value in seconds.

Charles Johnson
Lake Geneva, WI

Coming In August

- How to Install a CD-ROM Drive
- Build a \$50 Lab Function Generator
- Working with BASIC & QuickBASIC
- Uninterruptable Power Supply Guide
- Experimenting with 8051 Microcontrollers -and more

**Safety,
Security,
Convenience,
Entertainment
and Energy
Management**

**Home Automation
from Heath,
the catalog
that has it all...**

Enter the world of Home Automation. Remote lighting and appliance controls. Security alarms and lighting. Automated thermostats. Video monitoring systems. Whole-house security systems. They're all yours in the Heath Home Automation Catalog. To receive your FREE copy, call today toll-free.

**1-800-44-HEATH
(1-800-444-3284)**

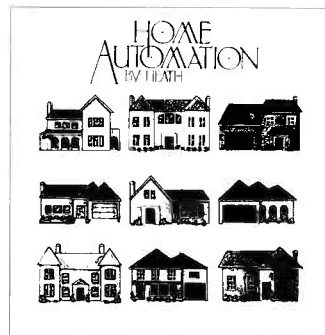

Heath Company

Marketing Dept. 079-070
Benton Harbor, MI 49022

079-070

CIRCLE NO. 100 ON FREE INFORMATION CARD

Big Blue Bites Bullet. IBM announced that it will drop its long-time word processor, *DisplayWrite*, in favor of a very fast program being developed by *XyWrite*'s creator, XyQuest, Inc. Although once a major player in the word-processing field, IBM's *DisplayWrite* is now antiquated and has only about 5% of the market versus nearly 62% for *WordPerfect* and 18% for *Microsoft Word*.

The new program, *Signature*, will replace both *DisplayWrite* and *XyWrite IV* with a graphical user interface word processor that users can also run in a text or character-based mode.

Spreadsheets. On the spreadsheet front, Computer Associates just announced a 70% price reduction on its powerful *SuperCalc5* spreadsheet. *SuperCalc5* is compatible with Lotus 1-2-3 but adds many enhancements, such as spreadsheet linking that enhances its power. In addition to high power and low price is its ability to run on all MS-DOS systems from the latest 486 to the earliest 8088-based PCs. Company spokesmen assuredly say that the lowered price isn't a prelude for the spreadsheet being dropped; they're just repositioning it in the marketplace.

Tandy Breaks Barriers. Tandy Corp. has recently broken two major price barriers in the computer world by mass-marketing a full MS-DOS-compatible computer, with DOS in ROM, video controller and even a 3.5" floppy drive for less than \$200. The only thing users need to add to the 1000 HX is a monitor.

While this \$199 price (marked down from \$699) is only a sale price and may not be in effect when this column is published, the price reduction is still significant because Tandy often extends or repeats such pricing. It's interesting to note that the recommended CM-8 monitor now carries a list price \$100 higher than the sale price of the complete computer.

A permanent price break has been achieved in the CD-ROM field with Tandy's recent announcement of its \$400 CDR-1000 internal CD-ROM drive. List prices for other CD-ROM drives generally range from about \$600 to well over \$1,100.

New Terminal For Disabled. Trident Technologies of Stamford, CT, has teamed up with Paris, France-based Alcatel to produce an inexpensive desktop terminal designed specifically for use by the hearing- and speech-impaired user either at home or in business situations. A Trident spokeswoman said that the Personal Communications Terminal, or PCT, will be available this fall at a price in the \$500-to-\$600 range. The PCT measures about 10" square, with a 9", 40-character by 25-line display and 32 kilobytes of memory.

Compatible with both older TDD/TTY systems and ASCII systems such as public bulletin-board systems and home/office computers, the PCT connects directly to standard telephone lines. Alcatel has produced more than 3-million terminals for French households as part of the telephone company's elimination of telephone directories.

Telephone Assistance. Speaking of telephone directories, although there seems little chance that the Bell Operating Systems in this country will switch to giving away free terminals, rather than publishing phone books, as the French have, you can already access most telephone numbers by computer.

If you sign up for CompuServe and type GO PHONEFILE, you'll find the entire U.S. White Pages available for instant searching at a very reasonable cost (I located an old school buddy in New Hampshire in less than 2 minutes at a cost of 75 cents). If it's Yellow Pages that are most useful for you, try Cambridge, MA-based Datatware Technology's (617-621-0820) *SpeedDial* CD-ROM which contains all U.S. Yellow Pages directories on a single

disk. North American fax numbers are also available on a CD-ROM disk published by two companies, Quanta Press, St. Paul, MN (612-641-0714) for PC systems and Wayzanta Technology, Prior Lake, MN (800-735-7321) for Macintosh systems.

Sounds Good to Me. Look for some great new consumer devices soon after the introduction of Information Storage Devices' single-chip tape recorder. Adding only a microphone, speaker and battery to the San Jose, CA-based company's microchip gives you the ability to store and play back up to 20 seconds of speech, music and other sounds. The new device is the first to break the analog/digital barrier, providing analog storage, rather than the digital storage used by other similar playback chips. Also usable for recording medical or industrial data and as a storage device to play back prerecorded messages, expect this chip to show up soon in everything from hobbyists' kits to toys and industrial devices. Sound quality is said to rival the best telephone handset, and the company reports that an unpowered chip will retain its recorded sounds for up to 10 years in storage.

Black Bag. If you think bulletin-board systems (BBSs) are just places to get shareware programs, then this one will make you think again. Black Bag BBS is operated by a physician and is a major source of the latest medical information, science reports and lists of other medically-oriented BBS systems around the world. By phoning 302-731-1998, you can connect to the BBS (use 8N1, or eight-bit word, no parity, one stop bit settings on your communications program) and take a peek at a slew of useful information. Dr. Edward Del Grosso runs this BBS for free. However, he has limited resources and offers special benefits for those who join and especially those who can contribute hardware or money to keep his BBS operating for everyone.

Monitoring Developments. Hong Kong-based Sygnos Ltd. has shown an eight gray-level LCD (liquid-crystal display) VGA graphics monitor panel named the Sygnos S8, a less-expensive version of its 16 gray-level LC models. These aren't intended for laptop systems, but rather are meant for regular office use. It should be of great interest in the San Francisco area where the first VDT or video display terminal workers' safety laws have gone into force.

Book-Sized 386. The new Carry-1 9000 series of notebook computers, from Taiwan-based Flytech Technology, are 9.5" by 7.3" by less than 2" thick and have 286 and 386SX microprocessors with up to 4 megabytes of RAM memory, one floppy disk and accept an optional hard drive up to 80 megabytes in size. An optional LAN or local-area network adapter is available, and there's room for a half-size expansion card in the unit.

Boardwatch. If you want to get your feet wet in BBS systems but don't know much about them, then Littleton, OR-based Boardwatch magazine might interest you. Besides support about sophisticated BBS hardware and software for SYSOPS (SYStem OPERatorS), the people who run BBS systems, Jack Rickard's *Boardwatch* also lists hundreds of BBS systems in each issue, including super boards that carry files listing other BBS systems around the world.

Intel. Something you haven't heard much of yet but will by this fall is the new Intel 386SL chipset, designed for high-performance laptops. A chip off the old 386SX and DX lines, the SL, introduced late last fall and going into volume shipment as I write

this column, integrates an SX, a small cache, main memory controller and a 387SX coprocessor interface. The other half of the chipset is the 82360SL I/O subsystem chip, which handles power management and such things as serial and parallel port drivers. Putting everything in two chips makes the SL slightly faster than the same clock speed SX, reduces power consumption and could radically reduce system size since all that's missing is memory. Expect prices for laptop systems based on the SL to hover around \$4,500 until the chips get into the hands of low-price clone makers sometime early next year.

True Colors. nView, the Newport News, VA maker of the unusual Toteboard, a \$395 square keyboard with remote IR (infrared) capabilities, has just introduced the ViewFrame Spectra panel, which sits on an overhead projector and, using output from Macintosh or PC-compatible computers, can show computer screens projected in up to 4,096 colors. Combining the two would give teachers, salesmen and others who make presentations to small rooms of people a way to sit with the audience and remotely control a computer that's simultaneously projecting either a color graphics presentation or perhaps a programming example.

Driving a Hard Bargain. For \$5,000, you can load up your favorite system, either PC or Mac-compatible, with the world's largest portable hard disk drive, a 425-megabyte unit made by Los Angeles, CA-based Mega Drive Systems. Weighing in at 2.5 pounds, the drive is designed to operate in computers with the one- or two-drive Mega Drive base units.

New HP Palm-Top. Rumors have it that Lotus and Hewlett-Packard have joined forces to produce a Lotus 1-2-3 compatible, \$695 calculator/computer called the HP 95LX which will also have e-mail software, a phone number directory and appointment calendar.

Electronic Glasnost. It must be a sign of the times, or at least an e-mail, that the Soviet Union now has FIDOnet bulletin board systems in operation in Minsk, Byelorussia, Kuanus, Paniveges and Vilnius in Lithuania, along with Kiev and Kharkovin in the Ukraine. According to my Moscow contact, the computer business there has totally stopped as of the first of April when the new monetary regulations went into effect. Kirill Tchaschin told me that there are no longer any advertisements for computers or microchips in any of the Moscow publications, whereas just a month earlier, it was a thriving black-market activity. He reports that it isn't an official crackdown, just a matter of total economic upheaval that has left everyone afraid to invest in anything.

IBM Laptop Ships. IBM's new 7.7-pound laptop, designated the PS/2 L40SX, is now shipping with a list price just a shade under \$6,000. It was carried around at the Harvard Business School, where it was seen by a number of students prior to its official introduction in late March. The VGA-compatible screen uses the same aspect ratio as desktop systems, making graphics appear realistic on the laptop instead of "squished." A 20-MHz. 386SX-based system, the L40SX comes with a 60-megabyte hard disk and 2 megabytes of memory standard, but can carry a whopping 18 megabytes of RAM. An external keypad supplements the 101-key keyboard, as well as a cigarette-lighter adapter and a carrying case. With a battery life of about 3 hours, the L40SX is very competitive in price to other high-end computers in its class.

The Lawsuit Beat Goes On. *Prodigy*, the IBM/Sears joint venture into commercial BBS systems, has been sued in Los Angeles

County Superior Court for deceptive advertising because the company instituted charges for previously free electronic mail messages. The suit was filed after similar charges were settled out of court in Texas last year and just after the Consumer Protection Division of the Los Angeles District Attorney's office had begun an investigation of similar charges.

Users contend that *Prodigy* censored messages from those protesting the imposition of a 25-cent-per-letter over a 30-letter-per-month limit, while *Prodigy* officials charge that a small minority were harassing other users with unwanted bulk e-mail. A major marketing premise for the *Prodigy* service was always that it was a flat-fee system that was able to offer unlimited usage because it carried advertising.

CD-ROMs for Disabled Users. A new SIG or special-interest group called SIGTEAL has been formed as an offshoot of the world's largest CD-ROM users' group, SIGCAT, based at the U.S. Geological Survey Headquarters in Reston, VA. The new working group will address special needs of disabled users who want to access information using the low-cost CD-ROM as a distribution method. A major aim of the group will be to pursue granting special copyright wavers for CD-ROM publications targeted at the disabled, much as large print and talking-book recordings have been made able to use copyrighted information without paying any fees.

40-MHz '386. Newsbytes News Network's Norman Wingrove reports that Chips and Technologies, San Jose, CA, has started shipping its 40-MHz clone 386-compatible microprocessors in small quantities and expects to ship the clone chips in quantity by May. Both 25-MHz and 33-MHz chips are already available. Advanced Micro Devices is also now shipping its AM386DX-40, a 40-MHz 386-compatible chip. Also from AMD is the AM386DXL-40, a low-power chip suitable for laptop systems. A special standby mode is claimed by the company to reduce battery power consumption to practically nothing.

AMD has been in a court battle with Intel for a long while over use of the "386" designation in its new chip's name, but a recent court ruling seems to have opened the way for AMD to use that number as part of the product's name. A final decision on whether the new clone chips violate Intel patents and copyrights hasn't yet been settled.

Low Voltage Chips. International Microelectronic Products has pretty well dropped out of the ASSP or application-specific-standard products chip market to concentrate on broader applications. . . their first one is the IMP23LVxxx line of 2.6 volt, 250-ns memory chips with a standby current draw of only 5 microamperes. Also introduced was the IMP23Lxxx chip family, which is used in hard-disk drive controllers and operate on low power, such as that available in battery-operated systems.

Get a GRIPS on the Planet. Meridian Data, a major supplier of CD-ROM publishing systems, has just released the second of its *Government Raster Image Processing Software* (GRIPS) CD-ROMs. It's packed with more than 250 images obtained from NASA, the Jet Propulsion Laboratory, the National Center for Supercomputing Applications and the U.S. Army Topographic Laboratories. For only \$49.95, you can view images of Alaska's Hubbard Glacier, various oceanographic, geologic, meteorological phenomena and Earth images from the Apollo 17 flight and Voyager-Viking missions.

The CD-ROM contains more than 140 megabytes of images, conforms to the ISO 9660 standard and is usable on IBM, Macintosh and VAX minicomputer systems.

Hard-Drive Security

Renton Products' (Seattle, WA) Version 2.1 *PC Access* hard-drive security system provides password access security for IBM PC/XT/AT/386 and compatible computers with

word and up to 15 user passwords. Access to the password list and selection of security system functions can be made only with use of the master password. The security system does

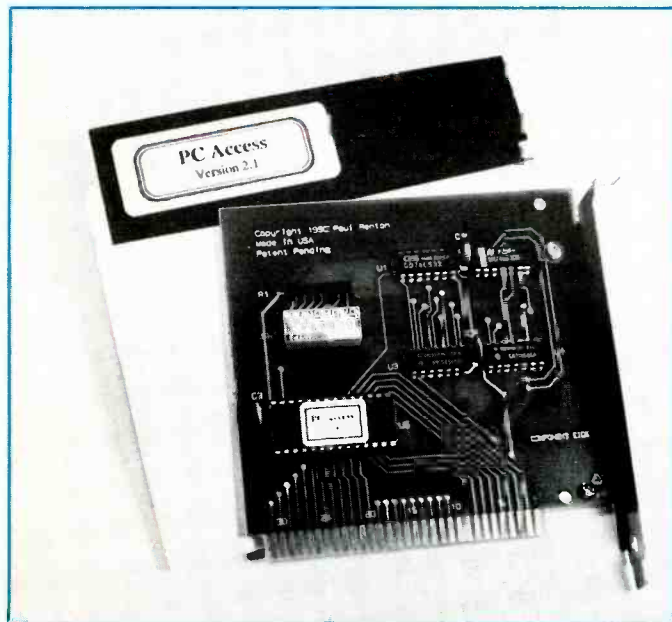

built-in hard-disk systems. The system consists of a plug-in card and a set of programs on diskette. Both are claimed to be easy to install.

A password (or, optionally, a user ID and password) must be entered each time the computer in which *PC Access* is installed is booted. DOS does not load or execute until a valid password has been entered. The security system permits one master pass-

not modify *COMMAND.COM* or any system files and does not interfere with operation of any other software.

Version 2.1 features menu-driven selections for establishing passwords and other system settings, DIP-switch selections of the security board's address, a half-size card with bracket and improved and simplified installation procedures. \$79.

CIRCLE NO. 12 ON FREE CARD

Super-High-Resolution VGA Package

JDR Microdevices now bundles a Relysis model 9514 1,024 × 768 VGA color monitor, a Modular Circuit Technology model 1,024 × 768 VGA card (512K) and software drivers for *Windows 3.0* and other popular software packages. The card is expandable to 1M with the addition of four 414256-100 chips. It can be operated as an eight-bit card in an XT bus or as a 16-bit card when installed in an AT bus slot. For software not



having the appropriate driver, the card is downward-compatible with VGA, EGA, CGA, HDC and MDA. \$600.

CIRCLE NO. 13 ON FREE CARD

Enhanced W4W

An enhanced Microsoft *Word for Windows* (W4W) version 1.1a includes filters for *WordPerfect 5.1*, *Word for Macintosh 4.0*, EPS, TIFF, PCX and "smart ASCII." The EPS filter reads, displays and prints EPS files that contain either a *Windows* metafile or a TIFF display. For users composing electronic-mail messages in *W4W*, the smart ASCII filter allows the user to retain formatting while converting the file to an ASCII format. Microsoft enhanced *W4W* with faster printing of table borders on HP LaserJet series printers, faster scrolling and printing of tables and faster display printing of TIFF images. All registered users of *W4W* versions 1.0 or 1.1 can upgrade to the new version for just \$10.

CIRCLE NO. 14 ON FREE CARD

Windows 3: The Complete Reference

By Tom Sheldon

(Osborne McGraw-Hill. Soft cover. 756 pages. \$29.95)

A GUI may be easier to use than a command-line interface, but if *Windows 3* can be used as a gauge, it is not easier to setup and fine tune. This manual serves a dual purpose of being a tutorial on the setup and use of *Windows* as well as an information resource for those situations in which a problem arises. The author provides many useful examples and "daily activities," including multitasking under *Windows*.

Electronic Circuits Database

Version 1.08 of the Circuit Search (Breslau, Ontario, Canada) database contains reference to practical-electronic-circuit articles. The file is *dBASE III+* compatible and references more than 12,000 articles. Circuits can be located by keywords from journals in fields as varied as electronics, astronomy, agriculture, physics, chemistry, nuclear science and biomedicine. The Circuit Search Database installs on a hard disk and can be accessed through a built-in menu-driven front end or a *dBASE*-compatible database management program. \$375 (includes one semi-annual update).

CIRCLE NO. 16 ON FREE CARD

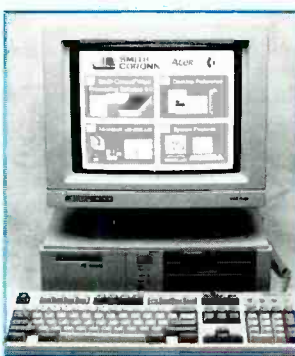

stalled on the hard disk. The PC 100 ROM/monochrome model is priced at \$1,000, the PC 320 hard-disk/color (0.39-mm VGA) model at \$1,900.

CIRCLE NO. 11 ON FREE CARD

Two Free Catalogs

Contact East has two catalogs free for the asking. The *Premiere Catalog* features a comprehensive selection of products for servicing electronic equipment and is designed with the service engineer, manager, installer, technician and maintenance director in mind. The full-line catalog is packed with listings for thousands of test instruments and tools, including DMMs, soldering/desoldering systems, static protection products, workbenches, test equipment and more.

CIRCLE NO. 10 ON FREE CARD

New PC Line Aims At Home Worker/Student

Smith Corona and The Acer Group introduced a line of "Simply Smart" IBM-compatible computers to be distributed through Smith Corona's typewriter distribution channels. Seven models comprise the line, with six based on 286 processors and one on a 386SX. Units without a hard disk have DOS in ROM along with Smith Corona *Word Processing 6.0* and a reference program. Hard-disk units have this software, along with Microsoft *Works 2.0*, prein-



Lycocomputer

Marketing & Consultants



PRINTERS

- Panasonic**
- 1123 \$229.95
 - 1180 \$149.95
 - 1124 \$CALL
 - 1695 \$409.95
 - 1624 \$369.95
 - 4450i Laser \$1225.95
 - 4420 Laser \$849.95
 - 4455ps Laser \$2049.95
- Star**
- NX-1001 \$134.95*
 - NX-2420 \$269.95
 - NX-1020 Color \$184.95
 - NX-2420 Color \$289.95
 - NX-1500 \$297.95
 - NX-2410 \$219.95
 - NX-2415 \$379.95*
 - XR-1500 \$415.95
 - XR-1000 \$297.95
 - XB-2410 \$415.95
 - XB-2415 \$539.95

Star NX-1001

- 180CPS draft
- 12cpi
- 45CPS NLQ
- 12cpi
- 4 resident fonts
- 2 year warranty

\$134.95*

Brother

- M1209 (NEW) \$155.95
- M1324L (NEW) \$229.95*
- M1809 \$309.95
- M1824L \$399.95
- M1809 \$409.95
- M1924L \$539.95
- M2518 \$799.95
- M4018 \$1075.95
- HL8ps(Post Script) \$2259.95
- HL8v \$NEW
- HL4 Laser \$895.95
- HL4PS Laser \$1689.95

- Citizen**
- 120 D \$139.95
 - 120 D Serial \$159.95
 - 200GX \$159.95
 - 200GX Color \$199.95
 - GSX-140 \$288.95*
 - GSX-140 (COLOR) \$327.95*
 - GSX-145 \$395.95
 - HSP-500 \$319.95
 - HSP-550 \$449.95

- Okidata**
- 172 \$185.95
 - 182 Turbo \$219.95
 - 320 \$317.95
 - 321 \$445.95
 - 390 Plus \$448.95
 - 391 Plus \$595.95
 - 393 Plus \$595.95
 - 393C (color) \$1019.95
 - Laser 400 \$629.95
 - Laser 800 \$942.95
 - Laser 820 \$1239.95
 - Laser 840 \$1885.95

- Epson**
- LX-810 \$184.95
 - LO-510 \$279.95
 - FX-850 \$309.95
 - FX-1050 \$429.95
 - LO-850 \$469.95
 - LO-1010 \$399.95
 - LO-1050 \$629.95
 - LO-2550 \$899.95

*QUANTITIES LIMITED

HARD DRIVES

By SEAGATE

MODEL	SIZE	SPEED	TYPE	PRICE
3 1/2" Half Height:				
ST-124	21 Meg	40 MSEC	MFHM	\$159.95
ST-157A	44.7 Meg	28 MSEC	IDE AT	\$193.95
ST-1102A	89 Meg	19MSEC	IDE AT	\$239.95
ST-1144A	120 Meg	15MSEC	IDE AT	\$429.95
ST-1162A	143 Meg	15MSEC	IDE AT	\$539.95
ST-1201A	177 Meg	15MSEC	IDE AT	\$669.95
ST-1239A	211 Meg	15MSEC	IDE AT	\$705.95
ST-125N	20 Meg	40 MSEC	SCSI	\$214.95
ST-138N-1	30 Meg	40 MSEC	SCSI	\$225.95
ST-157N-1	48 Meg	28MSEC	SCSI	\$241.95
ST-177N	80 Meg	24MSEC	SCSI	\$325.95
ST-108N	80 Meg	24MSEC	SCSI	\$349.95
ST-1126N	111 Meg	15MSEC	SCSI	\$591.95
ST-1162N	142 Meg	15MSEC	SCSI	\$659.95
ST-138R	30 Meg	40 MSEC	RL	\$204.95
ST-157R-1	49 Meg	28 MSEC	RL	\$213.95
ST-138 RP	30 Meg	40MSEC	RL	\$247.95
ST-157 RP	49 Meg	28MSEC	RL	\$260.95
5 1/4" Half Heights:				
ST-225	20 Meg	65 MSEC	MFHM	\$177.95
ST-251-1	40 Meg	28 MSEC	MFHM	\$333.95
ST-238R	30 Meg	65 MSEC	RL	\$184.95
ST-277R-1	65 Meg	28 MSEC	RL	\$254.95
ST-225 RP	20 Meg	70MSEC	RL	\$195.95
ST-238 RP	30 Meg	65MSEC	RL	\$219.95
ST-250 RP	40 Meg	70MSEC	RL	\$229.95
ST-298N	84 Meg	28 MSEC	SCSI	\$299.95
ST-2125N	110 Meg	18MSEC	SCSI	\$619.95
ST-2198E	84 Meg	18MSEC	ESD	\$596.95
ST-2383E	337 Meg	16MSEC	ESD	\$1228.95
ST-260A	71 Meg	16MSEC	IDE AT	\$269.95
ST-2274A	241 Meg	16MSEC	IDE AT	\$1198.95
5 1/4" Full Heights:				
ST-409E	80 Meg	79MSEC	MFHM	\$527.95
ST-4144R	122 Meg	28MSEC	RL	\$595.95
ST-4182E	160 Meg	16 MSEC	ESD	\$815.95
ST-4384E	329 Meg	14 MSEC	ESD	\$1289.95
ST-4766E	776 Meg	15 MSEC	ESD	\$1469.95
ST-4702N	613 Meg	16MSEC	SCSI	\$1469.95
ST-4385N	337 Meg	10 MSEC	SCSI	\$1449.95
ST-41200N	1050 Meg	16 MSEC	SCSI	\$2499.95

* Price Includes Seagate Controller Card
Controllers Available from Western Digital & Seagate. Call for Pricing on models not listed.

Seagate

89 Meg Drive

ST-1102A
 AT/IDE 19msec
\$329.95

FLOPPY DRIVES

By TOSHIBA

Toshiba disk drives offer you the latest in VLSI technology & low power consumption.

- 5 1/4" 360 KB PC/XT Compatible \$62.95
- 5 1/4" 1.22 MB PC/AT Compatible \$69.95
- 3 1/2" 1.44 MB PC/AT Compatible \$67.95*

* Universal Installation Kit Included.

By CHINON

- FZ-502 5 1/4" 360K PC/XT Compatible \$57.95
- FZ-506 5 1/4" 1.2MB PC/AT Compatible \$65.95
- FZ-354 3.5" 720K PC/XT Compatible \$56.95*
- FZ-357 3.5" 1.44MB PC/AT Compatible \$62.95*

MONITORS

- Magnavox**
- 78M749 VGA Mono \$129.95
 - 1CM135 RGB Analog \$244.95
 - CM9032 VGA 640x480 \$229.95
 - 9CM062 VGA 720x480 \$267.95
 - 9CM082 VGA \$305.95
 - 6CM320 Super VGA \$349.95
 - 7CM320 Super VGA \$349.95
- GoldStar**
- 2105 A Composite \$74.95
 - 1210A TTL Amber \$79.95
 - 1401A 14" Amber TTL \$109.95
 - 1220W VGA Mono \$99.95
 - 1405 Plus Paper White \$145.95
 - 1423 Plus VGA \$206.95
 - 1425 Plus VGA .39DP \$262.95
 - 1430 Plus VGA .31DP \$269.95
 - 1450 Plus VGA 800x600 \$299.95
 - 1460 Plus VGA 1024x768 \$324.95
 - 1610 Plus VGA 16" 1024x768 \$689.95
 - 1440 Superscan \$CALL
- NEC**
- MultiSync GS-2A White VGA \$202.95
 - MultiSync 2A VGA \$449.95
 - MultiSync 3D VGA \$585.95
 - MultiSync 4D VGA \$979.95
 - MultiSync 5D VGA \$2239.95

Panasonic

C1381 Panasync Multimode \$379.95

GoldStar 1460 +

The Highest Star in Fraction

- VGA
- 14" display
- 1024x768
- 16x256 colors

\$324.95

Everex Video Cards

- Evergraphics \$53.95
- Viewpoint VGA \$139.95
- Viewpoint VGA 512K \$175.95

Cardinal Video Cards

- Cardinal VGA 40K \$89.95
- Cardinal 700 512K \$114.95
- Cardinal 700 1MB \$134.95
- Cardinal VGA 732 1MB \$168.95

MODEMS

- Everex Modems**
- Evercom 12 (INT) \$49.95
 - Evercom 24 (INT) \$104.95
 - Evercom 24 + MNP (INT) \$139.95
 - Evercom 24E + MNP (EXT) \$189.95
 - Everfax 24/96 MNP (INT) \$245.95
 - Everfax 24/96 MNP (EXT) \$299.95

- Cardinal Modems**
- MB2400EX EXT \$94.95
 - 2400 MNP Ext. MNP 5 \$154.95
 - 2450 MNP Int. MNP 5 \$115.95
 - MB2450 INT \$72.95
 - MB1200EX EXT \$CALL
 - MB1250 INT \$CALL
 - MB2250F SendFax \$77.95
 - MB2296F 9600 bt SendFax \$89.95
 - 9650 V32 Int. \$449.95

COMPONENTS

- Build your own computer clone with components manufactured by DTK computer.
- You Specify**
- *System Memory
 - *Drive Configuration
 - *Video Card
 - *Add-on Cards
 - *Keyboard
- Base Systems Include:**
- Motherboard, Case, & Power Supply**
- 8086 4 7710MHz System \$129.95
 - 80286 8 12MHz System \$235.95
 - 80286 16MHz System \$259.95
 - 80386SX 16MHz \$469.95
 - 80386SX 20MHz \$559.95
 - 80386 10-25MHz \$739.95
 - 80386 10/33MHz Tower W/64K Cache \$899.95
 - 486 25MHz W/64K Cache \$1589.95
- Base models have 0 memory
- Memory** - Installed memory prices available upon request. Call for friendly sales staff.
- Video Cards**
- Advanced VGA 16 bit 800x600 \$19.95
 - XT Multi I/O \$37.95
 - 286 Multi I/O \$47.95
 - Parallel Printer Port \$11.95
 - RS-232 Port \$14.95
 - Game I/O \$14.95
 - Clock/Calendar \$17.95
 - Floppy Controller \$24.95
 - IDE/Floppy Controller 286 \$27.95
- Customized Hardware Service Available.
 386, SX, 486 are trademarks of Intel Corporation.

TAPE BACK-UPS

- By EVEREX**
- INTERNAL**
- Excel-60F 60 MB \$199.95*
 - Excel-40 T 40 MB PC/XT/AT \$529.95
 - Excel-60 MB half height 5 1/4" \$669.95
 - Excel 250 250 MB \$769.95
- *Uses system's floppy controller. Not included.

- EXTERNAL**
- Excel-40T 40 MB 5MB/min \$599.95
 - Excel-60 60MB Full Height 5MB/min/799.95
 - Excel 250 250 MB \$889.95

All tape back-up systems include controller, software and data cartridge

EVEREX Excel 60F

60MB (Internal)

\$199.95*

LAPTOPS

Bondwell

Bondwell 310 + \$1259.95

Leading Edge

Leading Edge SX \$1969.95

Panasonic

CF 150B \$584.95*

CF 270 \$CALL

Full Toshiba Line Available Call for Models and Prices.

SALES: 1-800-233-8760 or 717-494-1030

Fax: 717-494-1441

Hours: Mon.-Fri. 9a.m.-9p.m. Sat. 10a.m.-6p.m.

Customer Service: 717-494-1670

Hours: Mon.-Fri. 9a.m.-5p.m.

1-800-233-8760

Since 1981, we have led the industry by continuing to offer the lowest national prices while providing quality service. Many companies have come and gone trying to imitate our quality and service. If by some oversight, we do not have the lowest prices advertised on the products you desire, then we would appreciate the opportunity to rectify this oversight!

CIRCLE NO. 44 ON FREE INFORMATION CARD

Radio Shack Bonanza

Radio Shack has been quietly showing several products that will come to market soon. The CDR-1000 is a rework of what's said to provide superior multimedia capability, especially for video display. Since multimedia data tends to be stored sequentially on a



CD, Tandy engineers focused on data throughput at the expense of access time. The CDR-1000 comes with a proprietary bus card. By placing the drive in a sliding-rail system, Tandy eliminated the need for a disk carrier. Price is \$400, and units should be available by publication.

CIRCLE NO. 17 ON FREE CARD

Radio Shack is also demonstrating a Digital Compact Cassette (DCC) player/re-

recorder, which is being developed in concert with Phillips Consumer Electronics. Tandy's DCC player/recorder has the advantage of being capable of playing a user's existing library of ordinary analog cassettes with sound quality equivalent to top-of-the-line analog tape decks. Switching to a DCC cassette produces sound equivalent to that of a CD player. The special DCC cassettes required for digital recording will be manufactured by Tandy and marketed under its Radio Shack and Memorex labels. Look for pricing to start around \$500.

CIRCLE NO. 18 ON FREE CARD

The home management software programs bundled with the Tandy 1000 RL series computers are now available separately as the *DeskMate Home Organizer Companion* and priced at \$100. Future models in the 1000 RL series will include capability for user choice of voice or written messages in the message center. Another feature being added to the RL series is remote programming of Tandy's home security Plug'n Power controllers and switches.

CIRCLE NO. 19 ON FREE CARD

Remote Keyboard & Monitor

Network Technologies offers an eight-port switch, the SE-6M15V-8, that allows eight computers to be accessed individually up to 500 feet away from a single keyboard and monitor. It is compatible with VGA video boards and PS/2-

style keyboards. An SE-RMT-8 remote-control unit is required for operation. Retail cost of the SE-6M15V-8 is \$1,180, the SE-RMT-8 \$230, including a 25-foot cable.

CIRCLE NO. 20 ON FREE CARD

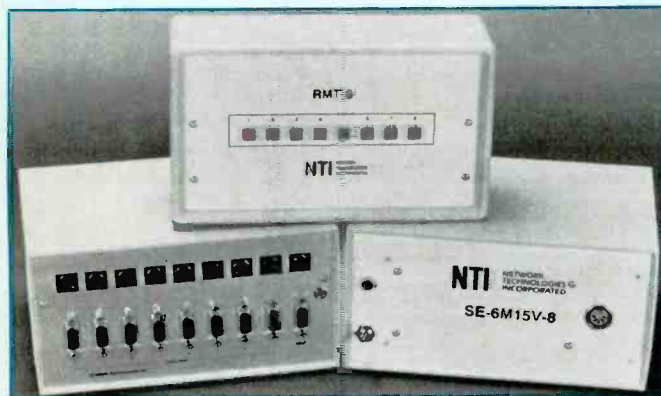

Powerful Engineering Pocket Calculator

A new Sharp Electronics PC-E500 programmable calculator features built-in engineering software, equation reference library, graphics capabilities, high-speed performance and expanded storage capacity for custom equations or BASIC programs. In total, over 1,100 functions are built in. The PC-E500 weighs one-half pound and measures 7" x 3". A serial I/O interface is built in, and options include a



thermal printer with cassette interface and plug-in RAM cards. RAM cards allow users to store BASIC programs or data, similar to computer disks. \$250.

CIRCLE NO. 21 ON FREE CARD

Monitor Tester Brochure

A free Network Technologies (Cleveland, OH) brochure describes the company's line of hand-held computer monitor testers. With a video monitor tester, the user can test, align and repair monitors and projectors at the job site. Most common video monitor formats are covered.



CIRCLE NO. 24 ON FREE CARD

Computer Theft Alarm

PC Screamer from Vantage Point Technologies resides inside a PC. When it senses unauthorized removal, it sounds an ear-piercing siren to discourage thieves. Reset occurs 30 seconds after the last unauthorized movement. The design keeps the siren silent during normal computer operation but blasts the siren continuously when someone attempts to remove the computer from the premises. PC Screamer installs in-line with a disk-drive power ca-



ble. Sized at 3 1/4" W x 2 1/8" H x 1", PC Screamer fits inside most desktop and tower cases.

CIRCLE NO. 22 ON FREE CARD

Economical Printer

The Epson LQ-200 provides 80-column, 24-pin printing with seven built-in LQ fonts, convenient paper handling and a choice of three paper-loading paths. Along with rear- and top-feed paths for continuous and single-sheet paper, users can also feed paper through a bottom-feed path for continuous paper. An optional cut-sheet feeder accommodates stationery or



bond paper. The unit prints at speeds of up to 192 characters per second in draft mode and 64 cps in LQ mode. \$400.

CIRCLE NO. 2 ON FREE CARD

GPIB Port Extender

Engineers and technicians can use L-com's Slimline IEEE-488 port extender to solve problems frequently encountered when interconnecting GPIB systems. The extender makes cable access to narrow port spaces and recessed port connectors easier.

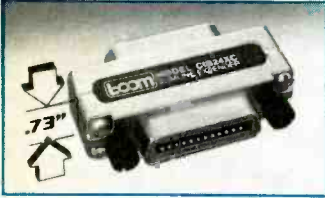

Interference with other panel components can be eliminated. Model CIB24XC is only 0.73" wide, 20% narrower than standard IEEE-488 connectors, and provides a 1.125" extension between port and cable connector. The nickel-plated cast aluminum housing preserves grounding-shield integrity. The CIB24XC is priced at \$22.50 for up to nine pieces.

CIRCLE NO. 5 ON FREE CARD

An Improved Money Manager

Andrew Tobias' *Managing Your Money* has undergone its most substantial update since its initial release in 1984. Version 7.0 provides a character-based "Windows-like" interface that provides users with improved visual appeal and speed of navigation. It also features a new database, report generator and graphics engine supporting EGA and VGA monitors.

CIRCLE NO. 6 ON FREE CARD

Tracking DC Supply

B&K-Precision's model 1651 is an economical triple-output dc bench power supply that delivers maximum power output in continuous operations without overheating. The 1651 has two variable 24-volt supplies rated at 0.5 ampere each and a single 5-volt supply rated at 4 amperes. To supply greater voltage or current needs, the 24-volt supplies are switch-selectable for series, parallel or independent operation. In any of these configurations, autotracking provides

UPS for LANs

Tripp Lite introduced the OMNI-750 LAN UPS that combines effective ac voltage regulation with a LAN-compatible battery back-up system. The OMNI-750 LAN conserves battery power until a total blackout occurs, giving greatly extended backup times for a complete, safe system shutdown. Equipped with a DB9



LAN remote interface connector, the OMNI-750 LAN also provides automatic network shutdown during a power failure when used with UPS monitoring software available from Tripp Lite.

The LAN interface signals power failure and low-battery warning, and the unit features inverter shutdown. This enables the computer to shut off the OMNI-750 LAN and conserve battery power after all files are safely closed. Other features include spike and line-noise filtering. Price is \$749.

CIRCLE NO. 7 ON FREE CARD



voltage control of both supplies with a single adjustment. It has reverse-polarity, overload and short-circuit protection and current limiting, the last infinitely variable from 0 to 500 mA with automatic recovery. \$395.

CIRCLE NO. 8 ON FREE CARD

New dBASE IV Books

Using dBASE IV 1.1

By Edward Jones

(Osborne McGraw-Hill. Soft cover. 803 pages. \$24.95)

Most dBASE users make little use of the relational and programming features offered by the program. Jones provides the new user of dBASE with a very easy to follow tutorial. It starts with the "Control Center," a menu-driven interface that replaces the anemic dBASE III+ "Assistant." Menus in a program as complex as dBASE IV can be bewildering, and Jones does a good job of laying out a road map. The book thoroughly covers the basics. Once they are out of the way, Jones gently exposes the reader to the dot prompt, relational concepts and dBASE programming. This is an excellent auxiliary book for the newcomer to dBASE IV 1.1.

Liskin's dBASE IV 1.1

Programming Book

By Miriam Liskin

(Osborne McGraw-Hill. Soft cover. 1,337 pages. \$34.95)

Liskin has skillfully prepared a course for the intermediate dBASE user who is familiar to some extent with dBASE but has not moved beyond the flat-file level of sophistication. The 1200 text pages are divided into 40 chapters that carry the reader from the most simple operations to the most complex. She not only tells the reader what to do and how to do it, but she tells them why she feels her way is the best. The writing is clear and concise. Plenty of hands-on examples are included to round out the learning process. This book should be of interest to anyone who wants to take advantage of dBASE IV's relational and programming capabilities.

Serial Protocol Analyzer

Global Specialties' Model GS500 battery-powered portable Analyzer is used for troubleshooting asynchronous serial data communication systems. It can assist in baud-rate analysis, data word formatting, ASCII and hex data monitoring and testing data generation. It operates in both automatic and manual modes and is small enough for field-service applications.

The system consists of a GS500 Protocol Analyzer, GS501 Display Module and GS502 Break-Out Box. The analyzer can be used independently or be connected to a standard

oscilloscope to provide a display of alphanumeric text. Attaching the Display Module allows the Analyzer to be used independently of an oscilloscope. The Break-Out Box provides full breaking and patching of 25 lines plus data monitoring of the transmit and receive lines via the Analyzer. Using the test data generation mode, the system can check operation of printers, terminals and other devices when a transmitting device is not available. \$179.95, basic GS500 Analyzer; \$99.95, GS501 Display Module; \$119.95, GS502 Break-Out Box.

CIRCLE NO. 9 ON FREE CARD

PC Test Card

The ICE PC Test Card, available from Jensen Tools, diagnoses problems on any IBM/compatible, even if the problem is on the motherboard. With the ICE card plugged into a standard ISA slot, the user sees all address bus lines, data bus lines, data bus action, interrupt lines and control signals. The full-length card features an eight-bit con-



nect and works with any ISA-bus machine that accepts its form factor.

CIRCLE NO. 3 ON FREE CARD

New 8-Bit Trainer Kit

Heath introduced a new eight-bit microprocessor trainer kit (ET-3800) in its Spring 1991 catalog. The trainer can be used with many of the latest eight-bit microprocessors simply by switching plug-in CPU modules. An RS-232 interface allows use of the trainer with a terminal, and a built-in sonic logic probe lets the user check high, low or pulse signals, both visually and audibly. The ET-3800 base price is \$200; the catalog is free.

CIRCLE NO. 31 ON FREE CARD

Two Low-Cost DMMs

Beckman's DM25XL is a 3½ digit, 0.8% accuracy digital multimeter that features 11 functions and 37 ranges. The large LCD includes 0.68" digits with annunciators for all available ranges. Other features include an audible continuity beeper, diodes test, logic



functions and transistor hFE measurements. Auto-off is standard to conserve battery life. In addition to the DM-25XL standard features, the DM27XL also performs Go/No-Go tests on LEDs and has the ability to measure frequency up to 20 MHz. DM-25XL, \$109; DM27XL, \$129.

CIRCLE NO. 1 ON FREE CARD

Battery Booklets

Gates Energy Products offers booklets describing installation and usage of rechargeable batteries. "Taking Charge" is a handsomely produced four-color book that provides an introduction to economic, environmental and convenience ad-

Touch-Screen-Interface Module

C Sys Labs offers the TVM100 intelligent LCD touch-panel display. Each TVM100 contains a 240 × 64-dot graphics LCD, 10" × 3" touch-panel matrix, EL back-light and driver, sound transducer, voltage converters for creation of LCD-required voltages and a 16-bit microprocessor. A single 5-volt supply is required, and all components are housed in a 6.35" × 2.9" × 1.2" module.

Communication with the TVM100 is easily accomplished via an eight-bit instruction and data bus from the main CPU. Read/write communications is done via status-bit lines and a status register. This allows the main CPU to dump the display RAM, check touch-panel-switch status, determine cursor location and perform hardware handshaking. Applications that require additional non-touch-panel switches can be interfaced to the TVM100 using a 14-pin connector on the module. Main CPU signals are sup-



plied via a 20-pin connector.

The CPU defines active key areas (either actively or manually), monitors touch-panel inputs and controls the EL back-light, LCD contrast and sound transducer. Text commands are converted to pixels using special fonts. Multiple-font text and graphics can be mixed on-screen and manipulated independently or together.

A designer's kit is available. It includes a TVM100 module, demonstration programs, software library, designer's manual, software manual and hardware for interfacing to PCs.

CIRCLE NO. 35 ON FREE CARD

Software Reference Guide

New England Software Library's 1991 Reference Guide to Public Domain Software lists and describes software the Library distributes by shareware authors. Among the listings are word processors, database systems, spreadsheets and graphics. The collection includes disks for electrical, mechanical and civil engineering, mathematics and statistics, utilities for programmers and engineers, CAD, expert systems, electrical filter design, Fourier transforms, equation processors and more.

CIRCLE NO. 33 ON FREE CARD

Data Logging

System Woods Electronics manufactures Count Logger, a data-logging system that consists of a module that connects to the serial port of an IBM/compatible and menu-driven software that runs in real-time. Each time a pulse is applied to the module, Count Logger "tricks the serial port

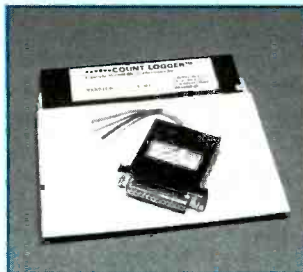

into thinking" a valid RS-232 data byte has been received. The software interprets each data byte as one count. Over 50 different option combinations can be selected from the on-screen menu. The last options settings used are saved to file for initialization when the program is next run. \$169.

CIRCLE NO. 10 ON FREE CARD

LAN Balun & Adapter

Telebyte provides a means for replacing coax with unshielded twisted pair (UTP) as the wiring medium for most LANs. The transition from coax to UTP is accomplished by the Model 171 Ethernet Balun. The twisted pair cables from the Model 171 Ethernet Baluns are interconnected by the Model 170 Ethernet Passive Star Wiring Concentrator. Model 171 Ethernet Baluns are small devices that con-

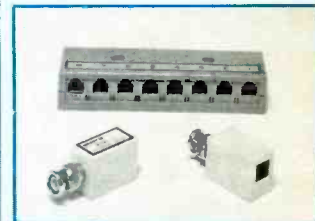

tain both female BNC and RJ-11 connectors. The model 170 Ethernet Passive Star Wiring Concentrator sells for \$120, while the 171 Ethernet Balun sells for \$45.

CIRCLE NO. 36 ON FREE CARD

BCD/Binary Interface Card

The ICS 2323A card from ICS Electronics accepts serial messages and outputs latched BCD/HEX or binary data. It



also can input BCD/HEX or binary data and output serial messages. The 2323A is delivered with the parallel interface configured for 10 BCD/HEX digits (40 lines) of input and 10 BCD/HEX digits of latched output. A plug-in EPROM allows this configuration to be altered to fit almost any application. The 2323A serial interface operates with any RS-232/RS-422 or RS-485 communications port and can accept a wide array of asynchronous formats. \$360.

CIRCLE NO. 2 ON FREE CARD

Now! Experience the electronics behind the MIDI revolution as you build your own computer-controlled music center

Only NRI's innovative, at-home training in Electronic Music Technology gives you hands-on experience with the equipment that's revolutionizing the music industry—Atari ST Series computer with built-in MIDI ports, Casio HT-3000 synthesizer with advanced MIDI operations, and ingenious MIDI software that links computer keyboard to synthesizer keyboard—all yours to train with and keep!

This year, over \$1.5 billion worth of digital electronic music instruments, from keyboards to drum machines, will be sold in the U.S. alone. Enthusiasts everywhere—professional musicians and recording technicians, even people who have never touched a musical instrument before—are discovering the excitement of today's electronic music technology.

At the heart of this excitement is MIDI (Musical Instrument Digital Interface), an innovation that's transformed musical instruments into the ultimate computer peripherals...and opened up a whole new world of opportunity for the person who knows how to use, program, and service this extraordinary new digital equipment.

Now NRI's breakthrough Electronic Music Technology course puts you at the forefront of this booming new technology with exclusive training built around a MIDI-equipped computer, MIDI synthesizer, and MIDI software you keep.

Dynamic new technology opens up new career opportunities

The opportunities are unlimited for the person who's trained to take advantage of today's electronic music phenomenon. Now you can prepare for a high-paying career as a sound engineer, recording engineer, or road technician... even start your own business selling and servicing today's high-tech musical instruments. Or simply unleash your own musical creativity with the breakthrough training and equipment only NRI gives you.

Only NRI gives you hands-on training with today's MIDI technology

The Atari ST Series computer included in your course becomes the heart of your own

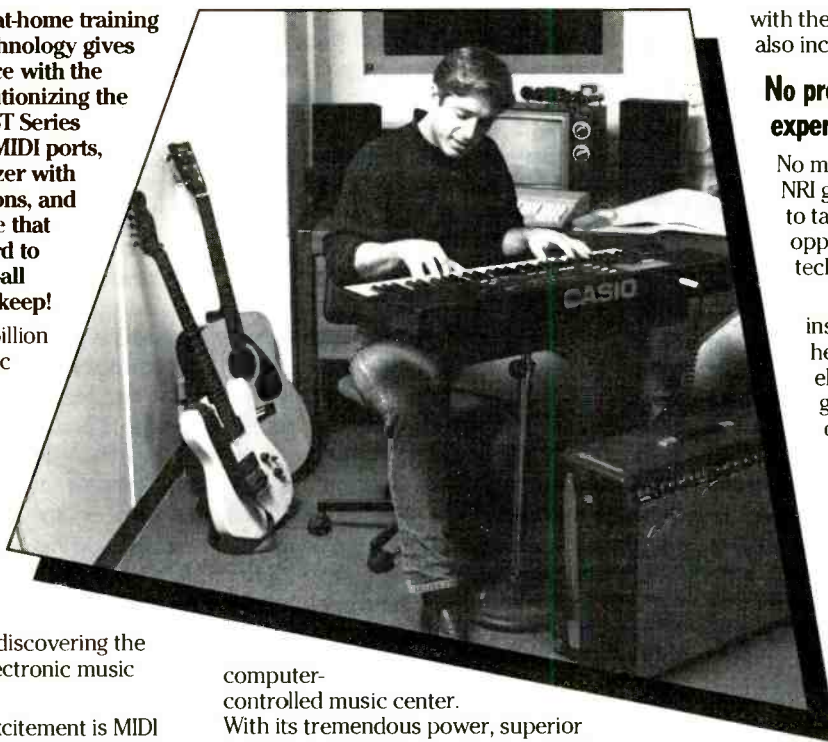

computer-controlled music center.

With its tremendous power, superior graphics capabilities, and built-in MIDI interface, the 16/32-bit Atari ST has almost overnight become the computer of choice for today's most knowledgeable electronic musicians.

Your Casio HT-3000 synthesizer features a five-octave, MIDI-compatible digital keyboard with built-in monitor speakers, advanced tone editing and writing, pattern memory, keyboard split, tone and rhythm banks, chord memory, and dozens more state-of-the-art capabilities.

Plus you get ingeniously designed MIDI software that opens up amazing new creative and technical possibilities... you actually build your own 4-input audio mixer/amplifier... and you test the electronic circuits at the core of today's new equipment



NRI training includes an Atari ST computer, Casio synthesizer, exclusive MIDI software, and much more—all yours to train with and keep! (TV not supplied)

with the hand-held digital multimeter also included in your course.

No previous electronics or music experience necessary

No matter what your background, NRI gives you the skills you need to take advantage of today's opportunities in electronic music technology.

With your experienced NRI instructor always available to help, you master the basics of electronic theory step by step, gaining the full understanding of electronics that's now so essential for technicians and musicians alike.

You move on to analyze sound generation techniques, digital logic, microprocessor fundamentals, and sampling and recording techniques... ultimately getting first-hand experience with today's explosive new technology as you

explore MIDI, waveshaping, patching, sequencing, mixing, special effects, and much more.

Plus, even if you've never been involved with music before, NRI gives you enough basic training in music theory and musical notation to appreciate the creative potential and far-reaching applications of today's electronic music equipment.

Send today for FREE catalog

If the coupon is missing, write to NRI Schools, McGraw-Hill Continuing Education Center, 4401 Connecticut Avenue, NW, Washington, DC 20008.

NRI Schools

McGraw-Hill Continuing Education Center
4401 Connecticut Avenue, NW, Washington, DC 20008



Check One FREE Catalog Only

- | | |
|--|--|
| <input type="checkbox"/> Electronic Music Technology | <input type="checkbox"/> Computer Programming |
| <input type="checkbox"/> Microcomputer Servicing | <input type="checkbox"/> Desktop Publishing and Design |
| <input type="checkbox"/> TV/Video/Audio Servicing | <input type="checkbox"/> Fiction/Nonfiction Writing |
| <input type="checkbox"/> Security Electronics | <input type="checkbox"/> Bookkeeping & Accounting |
| <input type="checkbox"/> Basic Electronics | |

For Career courses approved under GI bill check for details

Name _____ Age _____

Address _____

City/State/Zip _____

Accredited Member, National Home Study Council

4-071

Upgrading Your 286

How three do-it-yourself alternatives can allow your 80286-CPU personal computer system to run advanced programs designed for '386 machines

When IBM introduced its PC/AT system in 1984, with its 6-MHz 80286 microprocessor, 20M hard disk, EGA video adapter and ability to access more than 1M of RAM, I knew that the future of microcomputing had arrived. While the 286 really did offer a substantial performance improvement over its 8088-CPU predecessor, it soon became apparent that very little of the 286's special capabilities—protected-mode operation, in particular—would be tapped by most users; the 286 was destined to spend most of its useful life as a glorified 8088. Much of the reason for this, it turns out, is the brain-damaged design of the 286.

For a "next-generation" processor, the 286 lacked a number of features and capabilities that would normally be expected, such as larger segments, a virtual 8086 protected operating mode and the ability to easily switch between real-mode and protected-mode operation. It's no wonder that IBM insisted on helping out with the architectural definition of Intel's follow-up 80386 processor. Happily, the 386 overcame all of the glaring deficiencies of the 286, in addition to incorporating other improvements, such as easy memory remapping and faster math-coprocessor operation. This combination of features has made the 386 the architecture of choice in today's volatile PC marketplace.

The 386 architecture is now available in three basic flavors and many different speeds. Flavors include the 386DX and the 486, both having a 32-bit data path, and the 386SX with a 16-bit data path. Intel is also preparing to introduce some new variations on the 486. An ever-increasing number of programs are becoming available that can take advantage of the 386's special features, and even many conventional programs can benefit from a 386 simply by using a

386-based memory remapping utility, such as QEMM386 from Quarterdeck or 386MAX from Qualitas.

Although the 286 is still fine for many applications, there's an increasing justification to move to the power and flexibility of the 386. The popularity of Microsoft *Windows* 3.0 will no doubt spur the move to 386 architecture; while *Windows* will operate on a 286 machine, it really comes into its own only when running on a 386.

If you are among the growing crowd of 286 users yearning for 386 functionality, you may be closer to it than you think. You don't need to retire your 286 machine and spring for thousands of dollars on a new system just to move up to the next generation in computing power because there are several ways you can upgrade your existing system to obtain the features and performance of a 386.

Motherboard Replacement

Perhaps the most obvious way to upgrade your system—and the most difficult—is to replace your system motherboard. This approach has several benefits over other alternatives. It achieves the highest possible level of software and hardware compatibility, and it offers the greatest amount of flexibility as far as which processor you put into your system.

By taking the motherboard-replacement approach, you can choose any processor for your system, from a 16-MHz 386SX to a 33-MHz 486. Your choices are more limited with other upgrade alternatives. In general, replacing your motherboard also obviates the mechanical problems that may occur with the other alternatives and is also the *cleanest* and most-reliable approach to upgrading your system.

The cost of upgrading your system motherboard, of course, depends on

the particular replacement motherboard you choose. In general, you can expect to pay about the same amount as or a little more than the other alternatives I'll discuss here, but less than the cost of a new system.

Last month, I described how to upgrade an XT system to an AT motherboard. You'll follow a similar procedure to replace your 286 motherboard with a newer model, with the notable exception that all your existing expansion boards and peripheral devices (including disk drive controllers, disk drives and keyboard) will be usable with the new motherboard(!); so upgrading is relatively straightforward. Since I described the motherboard replacement procedure in detail last month, I won't go into it again here.

The exceptional memory management flexibility offered by 386 architecture is one of its biggest selling points, and is used to advantage by Quarterdeck's *DesqView* and Microsoft's *Windows*, among many other programs. With the appropriate software (such as QEMM386 or 386MAX), a 386 can easily convert existing *extended* memory (memory above the 1M boundary) into expanded memory, conforming to the Lotus-Intel-Microsoft Expanded Memory Specification 4.0 (LIM EMS 4.0). The myriad programs currently available that are capable of using expanded memory will then run happily on any 386 processor by simply using this technique.

The All ChargeCard

All Computers of Toronto developed a clever approach for providing 386-like memory management on 286 systems. The company's 1.9" × 2.8" All ChargeCard plugs into the 286 processor's socket, and the 286 is then placed onto the ChargeCard. Thus the ChargeCard is essentially

inserted between the 286 processor and motherboard.

The ChargeCard can configure existing extended memory in different ways to allow application programs to take advantage of it. The ChargeCard can *backfill* the base system memory if less than 640K is there and can convert the remaining extended memory into expanded memory for EMS-oriented programs to use. The ChargeCard can also place certain programs into the reserved memory space between 640K and 1M and can shadow the BIOS ROM (placing it into RAM for faster operation).

The All ChargeCard is functionally transparent to the system when it's first powered up, but becomes fully functional when initialized by any one of several device drivers included with the ChargeCard. The most common driver used with the board is ALLEMM4.SYS, the board's expanded memory manager. The ChargeCard does, however, also include special utilities for using the device with *PC-MOS/386* and *Multi-Link*, two multi-tasking operating systems from The Software Link.

Installation of the All ChargeCard is complicated by the fact that there are three different IC packages for the 286 processor and any number of mechanical variations in the system implementations. The 286 processor comes in pin-grid array (PGA), plastic-leaded chip carrier (PLCC) and leadless chip carrier (LCC) packages. To accommodate these various packages, and their associated sockets, All Computers sells two versions of its All ChargeCard packages.

The basic CC2 model includes only the ChargeCard and is designed to plug only into a PGA socket, like that found in IBM's Models 50 and 60 machines. The CC2/A model includes additional adapters for connecting the ChargeCard to a PLCC or LCC socket (Fig. 1). The ChargeCard's manual also explains how to use the included flex cable adapter to install the unit into a 286 socket even when there are mechanical conflicts.

The All ChargeCard uses on-board circuitry to remap 286 real-mode memory accesses (within the first 1M) to various portions of the extended-memory space, using paging and address translation. It does the remapping quite well, but keep in

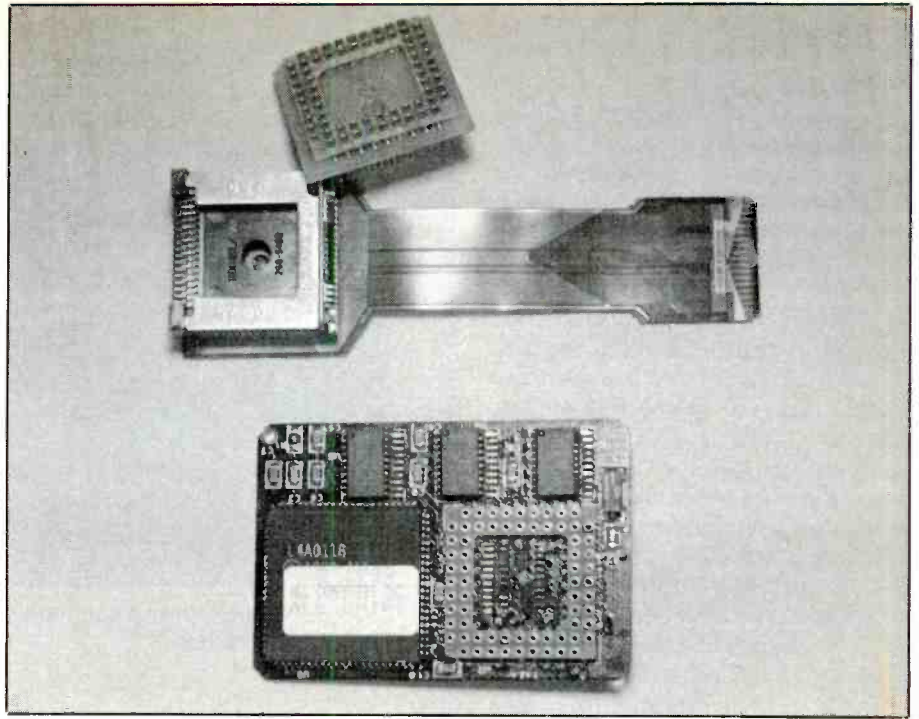

Fig. 1. All Computers' Model CC2/A includes adapters for connection the ChargeCard to a PLCC or LCC socket.

mind that it isn't the same as having a 386 processor in your system. While the ChargeCard will allow you to use your system's extended memory as expanded memory for many applications, it won't allow you to run 386-specific software—software that uses the 386's 32-bit and protected-mode instructions.

Since circuitry on the ChargeCard needs only monitor and translate memory addressing, the ChargeCard doesn't have to synchronize to the system clock the way 386SX processor replacement boards do. This keeps the circuitry simpler and, in some cases, probably more reliable. In summary, with its flexible memory-management capabilities, the \$199 All ChargeCard (\$299 for the CC2/A model) provides a relatively cost-effective upgrade for adding advanced capabilities to your 286, although it fails to take you all the way to 386 horsepower.

386SX Processor Replacement Boards

Since Intel's introduction of the 386SX microprocessor, a number of manufacturers have introduced 386SX-based processor replacement boards designed to upgrade 286 sys-

tems. The 386SX moved the functionality of the 32-bit 386 processor to the 16-bit data bus of the 286. Most of the 386SX's signals are functionally identical to those of the 286, keeping the upgrade from the 286 to the 386SX relatively straightforward.

An important challenge of the design, though, is making sure the 386SX can run synchronized with the system's processor clock being generated for the 286. This isn't a problem at 16 or 20 MHz, since the 386SX can use exactly the same clock the 286 used. In a 6- or 8-MHz AT, though, it will be expected that the new 386SX will run much faster than the 6- or 8-MHz system clock. Therefore, a clock frequency multiplier circuit must be employed to achieve the higher performance while maintaining synchronization.

Figure 2 shows 386SX processor replacement boards from Cumulus Corp. and Tessco Computer Laboratories. Others are available from SOTA Technology, Zeny Computer Systems, Hypertec, MicroWay, AOX and 3Est, among others.

The real beauty of the 386SX processor replacement boards is that they provide true 386 functionality in place of your 286 processor, and they provide a simple upgrade path for

your system. Unfortunately, the nature of their design tends to be more complicated and sensitive than the All ChargeCard, and compatibility issues become more apparent. They also have the same socket drawbacks as the ChargeCard, which is trying to accommodate the PGA, PLCC and LCC sockets.

While most replacement boards support the PGA and PLCC sockets, not all support the LCC socket. There's also a split as to how these boards connect to the 286 socket. Most are small daughterboards that plug directly into the 286 socket (as long as there are no mechanical impediments), while a few use a flex cable to connect the board to the 286 socket (offering more mechanical freedom to place the board). Some of these replacement boards, like MicroWay's FastCache-SX board, also include a small amount of cache memory for an extra performance boost. A 387SX math-coprocessor socket is also typically present on the 386SX boards.

Although 386SX processor replacement boards offer true 386 functionality, they're also costly. Some are available for as little as \$300, although most are in the \$500-to-\$600 range. With complete 386SX motherboards (without memory) costing around \$400, it seems that the main thing the 386SX processor replacement boards you buy is upgrade ease and convenience. If you're not afraid to grit your teeth and replace the entire motherboard, that's probably a better way to go. (Who knows, you might even be able to get a few bucks from your old 286 motherboard by helping out a desperate XT upgrader.)

Selecting and Installing

Having been given three alternatives for overcoming the 286 blues, you must now choose the one that suits you best. The motherboard alternative results in a superior upgrade, with selectable processor and speed, high reliability and unmatched compatibility at a moderate price, but it also requires the greatest amount of installation effort.

If you're on a tight budget and your primary need is for improved memory management, particularly

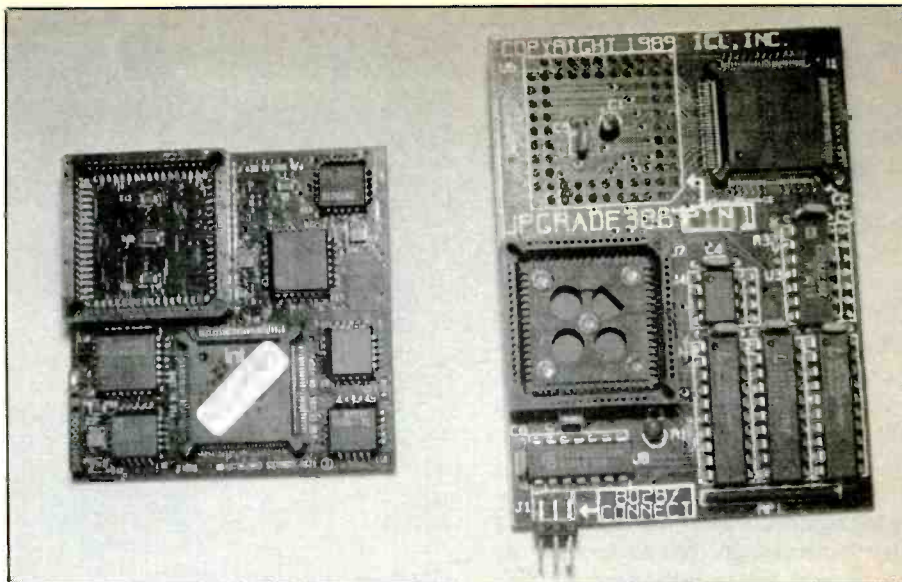

Fig. 2. 386SX processor replacement boards from Cumulus Corp. and Tessco Computer Laboratories.

in the form of expanded memory, the All ChargeCard is a good alternative. If you're not ready to roll up your sleeves and go for a motherboard replacement but still want true 386 functionality, you have to choose from among the many 386SX processor replacement boards available. This approach will provide you with a relatively simple upgrade, but will cost about as much as an entire 386SX motherboard.

Once again, refer to last month's motherboard replacement discussion if you're planning on taking that upgrade approach. Here, let's take a closer look here at how to install an All ChargeCard or a 386SX processor replacement board. Since the installation procedure for both re-

placement board types is essentially the same, I'll differentiate between them only when necessary.

Before you rush out and buy a replacement board, though, make sure you first look inside your machine and find out where your 286 processor is, how many obstacles are in its immediate vicinity (to see, for example, if the area will accommodate the nominal 2" x 4" replacement board size) and what IC package it uses.

Pin-grid arrays are ceramic with an array of pins protruding from the bottom of the chip. LCCs are also ceramic but have no leads; instead they have pads around the perimeter of the part and are placed face-down into a socket with a lid. The lid may be flat, or it may be a protruding heat

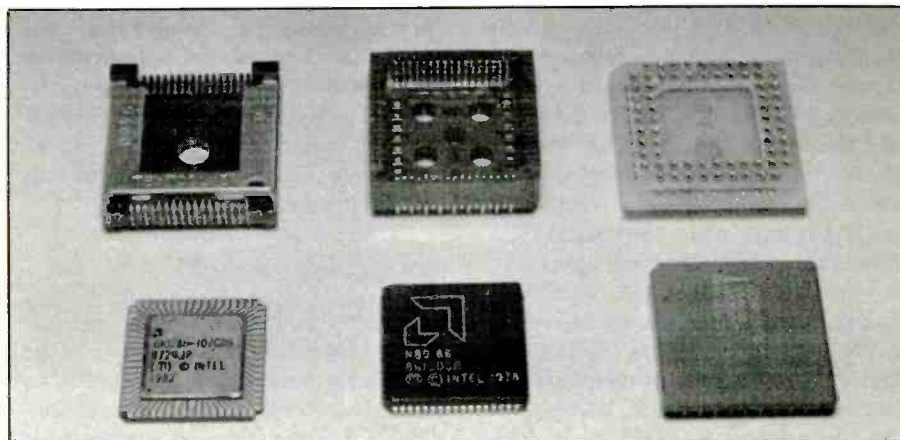

Fig. 3. Various 80286 processor package types and their associated sockets.



SUMMER SPECIALS

FEATURING QUALITY SYSTEMS BY EVEREX, CLUB AMERICAN & AGI

**LEASING OPTIONS
NOW AVAILABLE.**
BUDGET YOUR LOW
MONTHLY PAYMENTS
CALL FOR DETAILS

Call for Custom
Configuration on
Everex,
Club American,
AGI & DTK

DTK SYSTEM SPECIALS

DTK 386SX

- 2 MB RAM
- 1.2, 1.4 Floppy
- 44 MB SEGATE Drive I/O
- VGA PACKAGE (640X480)
- 101 Keyboard
- 2 Serial/1 Parallel Port

\$ 1549

DTK 286-16MHZ

- 2 MB RAM
- 1.2, 1.4 Floppy
- 44 MB SEGATE Drive
- VGA Package (640 X 480)
- 101 Keyboard
- 2 Serial
- 1 Parallel Port

\$ 1379



DTK 386-25 DESKTOP

- 4 MB
- 1.2, 1.4 Floppy
- 125 MB IDE Drive
- VGA Package (640X480)
- 101 Keyboard
- 2 Serial, 1 Parallel Port

\$ 1999

DTK 486-25

- 4 MB RAM
- 1.2, 1.4 Floppy
- 125 MB IDE Drive
- VGA Package (640X480)
- 101 keyboard
- 2 Serial, 1 Parallel Port

\$ 3479



ALL ABOVE SYSTEMS ADD \$200 FOR TSUNG, 1 MB CARD & SUPER VGA

VIDEO CARDS

- EVEREX VIEWPOINT \$139
- RENAISSANCE GRX2+ . . . \$99
- PARADISE 1024 512K . . . \$199
- VEGA 1024 \$199
- MONO GRAPHICS W/PRINTER \$35
- COLOR GRAPHICS W/PRINTER \$35
- ATI WONDERPLUS \$189
- VEGA VRAM 512K \$409
- EVEREX VRAM, 512K . . . \$259
- SPEEDSTAR 1MB \$199
- BOCA BASIC VGA \$89

HARD DRIVES

- SEAGATE ST225 (20 MB KIT) \$235
- SEAGATE ST238 (30 MB KIT) \$255
- SEAGATE ST251-1 (40 MB) \$239
- SEAGATE ST4096 (80 MB KIT) \$489
- SEAGATE ST277 (60 MB RLL) \$269
- SEAGATE ST125 \$249
- SEAGATE ST157A (40 MB IDE KIT) \$269
- SEAGATE ST4144 (120 MB RLL) \$585
- SEAGATE ST138 \$279
- SEAGATE ST296N (SCSI Host 2) \$379
- SEAGATE ST151 (40 MB) . . . \$299
- SEAGATE ST4182 (160 MB) ESDI \$879
- SEAGATE ST1144A (125MB IDE KIT) \$449
- SEAGATE 1239 210 MB IDE . . \$675

PRINTERS

- EPSON ALL MODELS \$CALL
- STAR ALL MODELS \$CALL
- PANASONIC ALL MODELS . . \$CALL
- CITIZEN ALL MODELS . . . \$CALL

HP LASER PRINTERS

- HP LASERJET III \$1579
- 425-1 FONT CARTRIDGE . . . \$229
- LASERJET TONER CARTRIDGE \$87
- HP LASERJET IID \$2775
- HP LASERJET IIP \$969
- HP LASERJET II \$1069

MONITORS

- SAMSUNG IMTEQ MONO . . . \$79
- SAMGUNG MULTIMODE . . . \$419
- INTEQ VGA RELYSIS . . . \$339
- SEIKO 1450 \$629
- QUME 1024 \$359
- QUME MULTISYNC \$469
- ICOMM VGA 1024 \$369
- RELYSIS VGA BASIC \$299
- RELYSIS SUPER VGA . . . \$349
- RELYSIS PAPERWHITE VGA \$129

NEC MONITORS

- NEC 2A 800x600 \$455
- NEC 3D 1024x768 \$589

CALL for NEC
pricing on NEC 4D & 5D

EXPANSION CARDS

- XT DISK I/O CARD \$45
- AT I/O CARD \$45
- XT TURBO MOTHERBOARD \$72
- 384K MULTIFUNCTION . . . \$72
- 1.4 XT FLOPPY CONTROLLER \$45

NETWORKS

- LANTASTIC ETHERNET Startup Kit \$639
- SMC ARCNET PC 130 \$95
- SMC ARCNET PC 130E . . . \$119

EVEREX PRODUCTS

- MAXI MAGIC 2 MB EMS for XT or compatible \$75
- EVERCOM 1200 BAUD internal Modem \$65
- EVERCOM 2400 BAUD internal Modem w/MNP +5 \$139
- EVERCOM 2400 external modem w/MNP + 5 \$189
- EVERFAX plus internal modem \$249
- EVERFAX plus external modem \$309
- RAM 3000 Intel 4.0 EMS 3 MB Ram for AT \$90
- RAM 8000 Intel 4.0 EEMS 8 MB Ram \$239
- RAM 10000 Intel 4.0 EMS 10 MB Ram \$129

CALL FOR OTHER
EVEREX PRODUCTS

FLOPPY DRIVES

- TEAC 55B 360K \$69
- TEAC 55G 1.2 MB \$79
- TEAC 1.4 MB \$79
- FUJITSU 360K XT \$61
- FUJITSU 360K AT \$65
- FUJITSU 1.2 MB AT \$72
- TOSHIBA 3-1/2" 720K . . . \$69
- TOSHIBA 3-1/2" 1.4 MB . . . \$72

LOGITECH/DFI

- 256 GREY SCAL SCANMAN . . \$292
- SERIAL C-9 MOUSE \$69
- BUS C-9 MOUSE \$79
- SCAN MAN \$159
- CATCHWORD OCR \$109
- LOGITECH TRACKBALL SER . . \$79
- LOGITECH TRACKBALL BUS . \$89
- DFI HAND SCANNER \$169
- CARRET PROFESSIONAL . . . \$159

HP LASER MEMORY

- 1 MB II \$139
- 1 MB IIP \$139

CALL FOR PRICING ON 2MB OR 4MB
MEMORY UPGRADES. CALL FOR
PRICING ON ALL PACIFIC DATA UP-
GRADE PRODUCTS FOR YOUR
LASERJET. MEMORY UPGRADES
NOW AVAILABLE FOR IIP.



FD MICROSYSTEMS
144 CHURCH STREET, N.W. WENNA, VIRGINIA 22180
FOR ORDERING CALL...
(800) 548-2660



FOR INQUIRES & SUPPORT (703) 281-0001 FAX LINE (703) 255-3359
(15% Restock charge on all returned merchandise. 3% Surcharge on all Credit Card Orders)

Please note that prices are subject to change without notice.
All "specials" are available only while current supplies last.
CIRCLE NO. 97 ON FREE INFORMATION CARD

FDM SPECIALIZES IN ANY & ALL PARTS
NEEDED TO CUSTOM BUILD YOUR PC
FROM THE GROUND UP. INCLUDING
MOTHERBOARDS, CACHE, POWER
SUPPLY'S, FLOPPY AND HARD DRIVES,
MONITORS, KEYBOARDS AND POWER
UPS SYSTEMS

sink with fins to dissipate heat from the chip. PLCC parts are plastic and have "J"-shaped legs around the perimeter of the part; they reside in a PLCC socket, which is open at the top but surrounds the device like a small cup. See Fig. 3 for a view of the various 286 package types and their associated sockets.

Replacement board sizes vary, with most manufacturers moving to all-surface-mount construction to minimize board area. Some, like the Cumulus 386SX replacement board, approach 2.25" on a side. You must determine how much room around the 286 CPU socket is available to accommodate a replacement board. If things are tight mechanically, or there are expansion boards immediately above the 286, a replacement board that uses a flex cable may provide easier placement in your system.

Once you've determined requirements for your replacement board and purchased an appropriate model, you can begin installation. While I'll provide some basic installation guidelines here, you should also refer the manual provided with your replacement board for more specific installation information.

Remove the cover of your system unit to provide access to the motherboard. This usually involves removal of about five screws at the rear of the system unit and then sliding the top of the chassis forward and up.

With the system-unit cover top removed, find the square 286 micro-processor and remove any expansion boards and other obstacles as required to provide easy access to the 286 area. Before touching any ICs, ground yourself to get rid of any static build-up by touching the power-supply case. Then remove the ac power cable from the power supply to prevent any possible power hazard.

The next step is *critical*: Note the pin-1 orientation of your 286 processor. Most problems experienced when installing replacement boards stem from improper pin-1 orientation. PGA chips have a beveled corner to indicate the pin-1 corner, usually with a dot also printed on top of the part at the corner. PLCC parts also have a beveled corner and may also have a dimple in the top of the plastic case at the pin-1 corner. The LCC chip similarly has a beveled

pin-1 corner, but it won't be visible until the lid is (carefully) removed.

With the pin-1 position carefully noted, remove the 286 from its socket. This may be easier said than done. Removing the LCC part is straightforward (usually by moving a retaining clip), but PGA and PLCC parts can be difficult to remove without damaging chip or socket. The PGA device can be removed using a medium-size flat-blade screwdriver. Gently pry the 286 up from its socket, little by little, on each of its four sides until the chip can be easily lifted from the socket. Some replacement boards include a special tool for prying up the PGA 286.

The PLCC is the trickiest of the parts to be removed. Removal of these chips should be done only with an extraction tool designed for 68-pin PLCC parts. Again, some replacement boards include the required tool. Figure 4 shows the PGA and PLCC extraction tools included with the All ChargeCard (model CC2/A).

With the 286 removed, install the replacement board, following the instructions provided by the board manufacturer. Again, *be sure to get the pin-1 orientation correct!* Particularly with boards using a PLCC or LCC adapter, be sure the installed replacement board is secure in its new home. If it seems loose or unstable it may not provide reliable operation. Also, make sure the board won't be disturbed by installing expansion boards, disk drives and other devices in your system.

With the replacement board installed according to the manufacturer's instructions, it's time to try the smoke test. Re-install any removed expansion boards, replace the ac power cord and power up the machine. If you maintained the proper pin-1 orientation, your system should boot up happily in celebration of its new-found power.

Install any utilities provided with the replacement board as required to verify complete operation of the new board. If you experience difficulties, verify correct installation of the board according to its manual, then call the company's technical support line if further assistance is needed. The 386SX processor replacement boards in particular exhibit varying

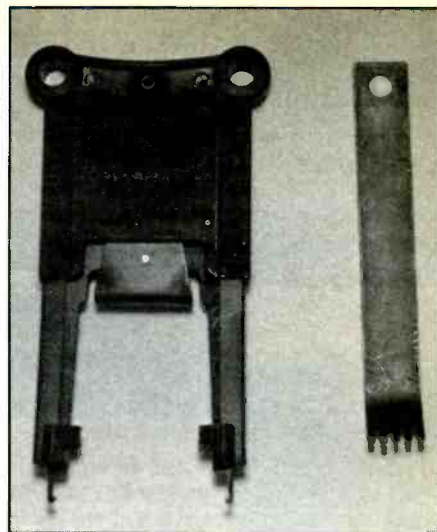

Fig. 4. PGA and PLCC IC extraction tools included with All ChargeCard.

levels of compatibility and proper operation in different AT machines—although they work fine in most machines.

Some replacement-board manufacturers have a "no-questions-asked" return policy if they can't help you make their board work in your system. If everything appears to work okay, power down your system and replace the chassis top.

Conclusion

Several alternatives are now available to perk up your sleepy 286 system with the advanced features of the 386 architecture. You don't have to scrap your 286 investment to move up to greater power and flexibility. Whether you choose a new motherboard, the All ChargeCard from All Computers or a 386SX processor replacement board, you'll give your system new strength to tackle the more-advanced programs available for today's new-generation machines.



Roger Alford

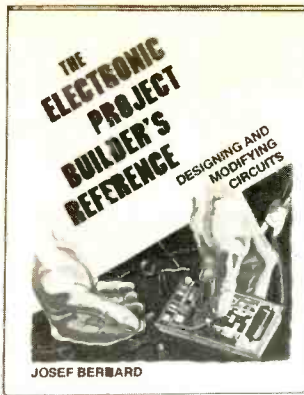

3260P \$14.95

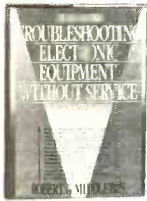

9290 \$36.00
Counts as 2



3321P \$16.95



3457 \$29.95
Counts as 2



3279 \$36.95
Counts as 2



3031P \$17.95

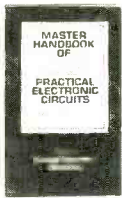

2980P \$19.95



2790P \$14.95



3485 \$27.95
Counts as 2



3540 \$26.95
Counts as 2



2707P \$17.95



2800P \$16.95



2613P \$17.95

SELECT 5 BOOKS for only \$4.95 (values to \$116.75)

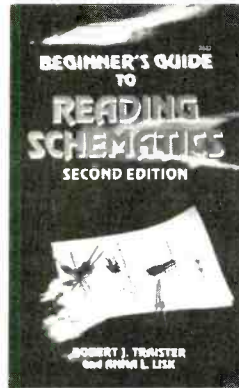
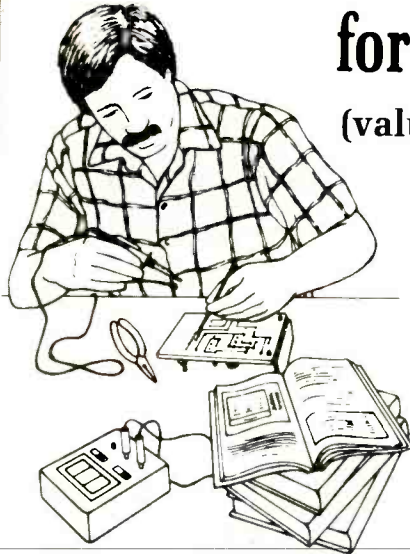

3632 \$18.95



3329 \$29.95
Counts as 2

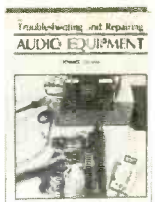

2867P \$18.95

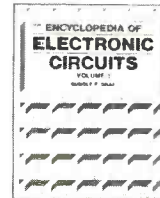

1938 \$60.00
Counts as 3



2925P \$9.95



3445 \$21.95



2995 \$25.95

Your most complete source for electronics books for over 25 years.



3414 \$39.95
Counts as 2

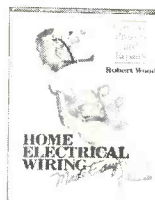

3072P \$16.95



2865P \$14.95

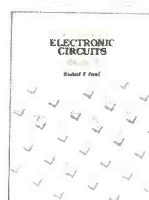

3138 \$60.00
Counts as 3

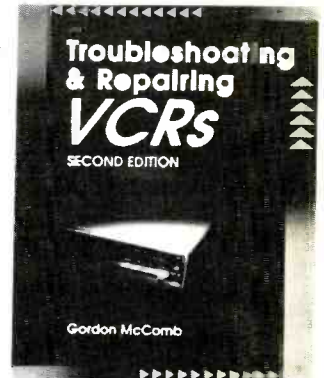

3777 \$32.95
Counts as 2

Membership Benefits • Big Savings. In addition to this introductory offer, you keep saving substantially with members' prices of up to 50% off the publishers' prices. • **Bonus Books.** Starting immediately, you will be eligible for our Bonus Book Plan, with savings of up to 80% off publishers' prices. • **Club News Bulletins.** 15 times per year you will receive the Book Club News, describing all the current selections—mains, alternates, extras—plus bonus offers and special sales, with scores of titles to choose from. • **Automatic Order.** If you want the Main Selection, do nothing and it will be sent to you automatically. If you prefer another selection, or no book at all, simply indicate your choice on the reply form provided. You will have at least 10 days to decide. As a member, you agree to purchase at least 3 books within the next 12 months and may resign at any time thereafter. • **Ironclad No-Risk Guarantee.** If not satisfied with your books, return them within 10 days without obligation! • **Exceptional Quality.** All books are quality publishers' editions especially selected by our Editorial Board. (Publishers' Prices Shown)



1367P \$24.95
Counts as 2



3275 \$22.95

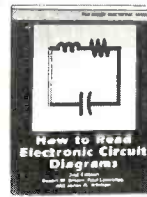

2180P \$14.95

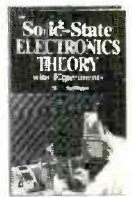

2925 \$25.95



3343 \$29.95
Counts as 2



3475 \$27.95
Counts as 2



ELECTRONICS BOOK CLUBSM
Blue Ridge Summit, PA 17294-0810

Please accept my membership in the Electronics Book Club and send the 5 volumes listed below, billing me \$4.95. If not satisfied, I may return the books within ten days without obligation and have my membership cancelled. I agree to purchase at least 3 books at regular Club prices during the next 12 months and may resign any time thereafter. A shipping/handling charge and sales tax will be added to all orders.

--	--	--	--	--

Name _____
Address _____
City _____
State _____ Zip _____ Phone _____
Signature _____

Valid for new members only. Foreign applicants will receive special ordering instructions. Canada must remit in U.S. currency. This order subject to acceptance by the Electronics Book Club. MDNE791

All books are hardcover unless number is followed by a "P" for paperback.

©1991 ELECTRONICS BOOK CLUB
Blue Ridge Summit, PA 17294-0810

Circuit Design Software for PCs

High-end schematic capture and PCB layout programs don't have to be expensive. We look at seven interesting ones.

For electronics-oriented readers who have yet to decide on which schematic-capture or printed-circuit-board (PCB) layout program to buy for use with their personal computers, we serve up another batch of circuit-design programs for your consideration. They are *CapFast*, *DC/CAD*, *FutureNet-5*, *PADS-PCB*, *PCB II*, *Schema-Quik* and *Supersketch Plus*. (Other similar products were examined in December 1990 and January/February/April 1991.)

Programs discussed here were selected because of their excellent high-end performance. Of the seven pack-

ages reviewed, only *DC/CAD* is a fully-integrated design system, with schematic-capture and printed-circuit-board design capabilities. *CapFast*, *FutureNet-5*, *Schema-Quik* and *Supersketch Plus* are solely schematic-capture programs. Except for the last, they interface intimately with PADS's PCB layout program reviewed here. (If *PADS-PCB* looks familiar, it's because PADS' OEMs sell the program to Omaton and Phase Three Logic, among others, for use in their *Schema-PCB* and *CapFast* CF/PCB layout applications.) *PCB II* is Labcenter's PCB

layout software package, which mates with the company's aforementioned *Supersketch Plus*.

Because many of these high-end programs bring a premium price, we chose to look at their budget-priced versions when available, which vendors refer to as university or student packages. They do everything the professional versions do, but on a smaller scale. Savings of up to \$500 can be realized by going this route. Here's what to expect. Prices of programs examined range from \$99 to \$995. We'll start with the least costly one and work our way up in price.

Schema-Quik from Omaton

Schema-Quik is Omaton's student-version schematic-capture program of *Schema III*. But low price doesn't mean low performance: *Schema-Quik* does everything *Schema III* does, but on a smaller scale.

Like *Schema III*, the drawing and editing features are more limited than some mainstream schematic-capture programs, but at \$99 (as opposed to *Schema III*'s \$495) it's a lot easier to swallow. Unlike *Schema III*, *Schema-Quik* doesn't support LIM memory, a fact that limits *Schema-Quik* drawings to about 200 ICs or less. A hardware-protection device isn't required, and the software isn't copy protected.

The program is easy to learn and use. Commands are called from simple menus that are only one level deep; no winding paths here. A context-sensitive Help screen that matches the help message to the highlighted command is available. Autopan is smooth scrolling, and scroll speed is

user adjustable, as is spacing of the grid dots. Zoom has an 8:1 range that can be invoked from a menu or the function keys.

Schema-Quik has a single component library that comes with about 1,000 devices, mostly TTL chips with similar part numbers like 74LS00 and 54LS00. A count of different devices is something closer to 100. However, you can add up to 3,400 additional devices of your own making using the supplied library editor, and you don't have to quit the schematic program proper to use the editor.

Components are called from the library by typing in the device names from the keyboard. The drawing editor has a browse feature that lets you look through the library and select a part for placement by clicking on it. You can assign complete schematic references at this time, including part value and up to six lines of additional text. Reference text can be modified at any time using the image editor,

but the reference lines can't be moved or hidden.

You can use the draw-repeat or the copy command to place more than one part of the same kind. When using copy, however, you'll have to invoke the image editor to change part references because they, too, are duplicated.

Wires are drawn by holding down the left mouse button and scooting the rodent to the desired location. Releasing the button places the wire on the drawing; pressing the button again starts a new wire. Diagonals aren't supported, nor are buses. But there's a thick wire-drawing function that lets you create the look of a bus, though it's not electrically correct and appears as a single wire in the output netlists.

Editing features are average, and consist of Move, Delete and Copy, and objects can be edited individually or as blocks. Absent from the program is mirror imaging.

Altex Electronics, Inc.



Mail Order Dept., 11342 IH-35 North, San Antonio, Texas 78233 • (512)637-3200 • Hours 7am-7pm Monday-Friday, 10-2pm Saturdays. FAX: (512) 344-2985
 TERMS: For C.O.D. orders add \$3.75. Minimum \$25. For orders under \$99 add \$3.00 handling charge plus FRT. For orders over \$99, actual FRT charges apply. Federal Express your order \$8 up to 20lbs. - 2nd Day Economy, \$17.50 up to 20lbs. - Overnight. P.O.'s accepted from approved accounts. Texas residents add 8-14% sales tax. All returns require RMA# and must be returned in original condition. Subject to 15% restocking fee. Prices subject to change without notice. Prices and product descriptions subject to change. We are not responsible for typographical errors.

SWITCHBOXES



Part#	Description	Each
AB25-2	2 Way	\$18.95
AB25-2E	2 Way Economy	11.95
AB25-3	3 Way	23.95
AB25-4	4 Way	26.95
AB25-4E	4 Way Economy	18.99
AB25-5	5 Way	37.95
AB25-6	6 Way	49.95
AB25-X	X-Over	27.95
AB25-XE	X-Over Economy	16.99



Part#	Description	Each
AB36-2	2 Way	\$21.95
AB36-2E	2 Way Economy	14.99
AB36-3	3 Way	28.95
AB36-4	4 Way	33.95
AB36-4E	4 Way Economy	22.99
AB36-5	5 Way	44.95
AB36-X	X-Over	36.95
AB36-XE	X-Over Economy	19.99



Part#	Description	Each
AB09-2	2 Way	\$19.95
AB09-2E	2 Way Economy	9.99
AB09-4	4 Way	29.95
AB09-X	9 Pin X-over	32.95



Part#	Description	Each
ABMKB-2	2 Way	\$29.95
ABMKB-4E	4 Way Economy	35.95



Part#	Description	Each
ABTWX-2	2 Way	\$31.95
ABTWX-4	4 Way	38.95



Part #	Description	Each
AB24-2	2 Way	\$39.95
AB24-4	4 Way	49.95



Part#	Description	Each
ABRJ11-2	2 Way	\$18.95
ABRJ11-2E	2 Way Economy	11.99
ABRJ11-4	4 Way	26.95
ABRJ11-4E	4 Way Economy	15.99
ABRJ45-2	2 Way	19.95
ABRJ45-2E	2 Way Economy	12.99
ABRJ45-4	4 Way	29.95
ABRJ45-4E	4 Way Economy	17.99

SPECIALIZED SWITCHBOXES

Part#	Each
AB252-36	\$29.95

2 DB25 connectors to a 36 pin Centronics connector
 AB362-25 \$33.95
 2 36 pin Centronics connectors to a DB25 connector
 AB253-X2 \$46.95
 All DB25 connectors, switches 3 input to 2 output devices
 AB15HD-2 \$33.95
 15 pin high density type connector switchbox
 AB5750-2 \$56.95
 50 pin Telco type switchbox
 AB50-2 \$56.95
 50 pin "D" sub type switchbox



Part#	Description	Each
ABBNTN-2	2 Way	\$31.95
ABBNTN-4	4 Way	46.95



Part#	Description	Each
ABMD8-2	2 Way	\$24.95
ABMD8-4	4 Way	33.95
ABMD8-X	X-Over	37.95

AUTOMATIC SWITCHBOXES



Part#	Description	Each
MP-401	4 in 1 cut	\$ 89
MP-801	8 in 1 cut	139

Serial Auto Switchboxes

Part#	Description	Each
MS-401	4 in 1 cut	\$ 89
MS-801	8 in 1 cut	139

These automatic switchboxes are used to connect up to 8 pcs to one peripheral such as a printer or modem. They come in either serial or parallel formats. All units come with DB-25 25 pin female connectors for the output and input ports.

LINE BOOSTERS



These line boosters double the distance you can run between your computer and peripherals.

Part#	Description	Each
PB-1	Parallel line booster (36S-36S)	\$29.95
SB-1	Serial line booster (25S-25S)	29.95

Part#	Description	Each
AB15-2	2 Way	\$25.95
AB15-4	4 Way	36.95

BNC COAXIAL



Part #	Description	Each
ABBN-2	2 Way	\$23.95
ABBN-4	4 Way	29.95
ABBNC-2E	2 Way Economy	10.00

Part #	Description	Each
AB37-2	2 Way	\$25.95
AB37-4	4 Way	39.95

CABLES



Part#	Description	Each
PPC301-6	DB25-36P 6 ft.	\$6.95
PPC301-6RA	DB25-36P 6 ft. (Rt. angle)	8.95
PPC301-6D	Diablo API 10 ft. (DB25-50P)	14.95
PPC301-10	DB25-36P 10 ft.	7.95
PPC301-10RA	DB25-36P 10 ft. (Rt. angle)	10.95
PPC301-15	DB25-36P 15 ft.	11.95
PPC301-20	DB25-36P 20 ft.	14.95
PPC301-25	DB25-36P 25 ft.	17.95



Part#	Description	Each
25MM-6	6 ft.	\$6.95
25MM-10	10 ft.	8.95
25MM-15	15 ft.	11.95
25MM-20	20 ft.	14.95
25MM-25	25 ft.	17.95
25MM-50	50 ft.	33.95
25MM-100	100 ft.	62.95



Part#	Desc.	Each	Part#	Desc.	Each
36MM-6	6 ft.	\$7.95	36MF-6	6 ft.	\$7.95
36MM-10	10 ft.	9.95	36MF-10	10 ft.	9.95
36MM-15	15 ft.	12.95	36MF-15	15 ft.	12.95
36MM-20	20 ft.	14.95	36MF-20	20 ft.	14.95
36MM-25	25 ft.	17.95	36MF-25	25 ft.	17.95



Part#	Description	Each
9MM-6	6 ft.	\$5.95
9MM-10	10 ft.	9.95
9MM-25	25 ft.	14.95



Part#	Description	Each
DFC-XTS	Dual floppy cable (34S-34E-twist-34E)	\$4.95
DFC-XTE	Dual floppy cable (34E-34E-twist-34E)	4.95
HDC-XT	Single hard drive cable set (20S-E & 34S-E)	4.95
2HDC-22	Dual hard drive cable set (2/20S-E & 34S-E-twist-34E)	7.95
DFCEX-XT	External dual floppy cable (37P-34E-twist-34E)	12.50
TEXD-4	Toshiba external drive cable (25P-34E)	16.95
YAD-4	Drive power "Y" cable	2.50
HD-IDE	40S-40S Single IDE Hard Drive Cable	2.95
2HD-IDE	Dual IDE Hard Drive Cable	3.95



Part#	Description	Each
25MF-6	6 ft.	\$6.95
25MF-10	10 ft.	7.95
25MF-15	15 ft.	11.95
25MF-20	20 ft.	14.95
25MF-25	25 ft.	17.95
25MF-50	50 ft.	33.95
25MF-100	100 ft.	62.95



Part#	Description	Each
ATM-1	AT to Modem 1 ft. (9S-25P)	\$4.95
ATM-6	AT to Modem 6 ft. (9S-25P)	6.95
ATM-10	AT to Modem 10 ft. (9S-25P)	7.95
25MF-6	PC to Modem 6 ft. (25S-25P)	6.95
25MF-10	PC to Modem 10 ft. (25S-25P)	7.95



Part#	Description	Each
KEC-6	Keyboard extension cable 6 ft.	\$3.95
MEC-6	Monitor extension cable 6 ft. (9M-9P)	5.95
PS2-MEC6	VGA monitor extension cable 6 ft. (HD15P-HD15S)	14.95
PS2-KEC6	PS2 Keyboard extension cable 6 ft.	7.95
9P-RCA	Composite video cable 6 ft. (9P-RCA)	6.95
VMC-6	RCA-RCA 6 ft.	1.95



Part#	Description	Each
488-1	1 meter	\$39.95
488-2	2 meters	43.95
488-4	4 meters	49.95



Part#	Description	Each
ACPC-02	PC power cord	\$3.95
ACPC-03	PC power adapter cable	4.95
ACPC-04	Monitor power ext. cable, 6 ft.	4.95

TO ORDER CALL 1 (800) 531-5369



CIRCLE NO. 25 ON FREE INFORMATION CARD

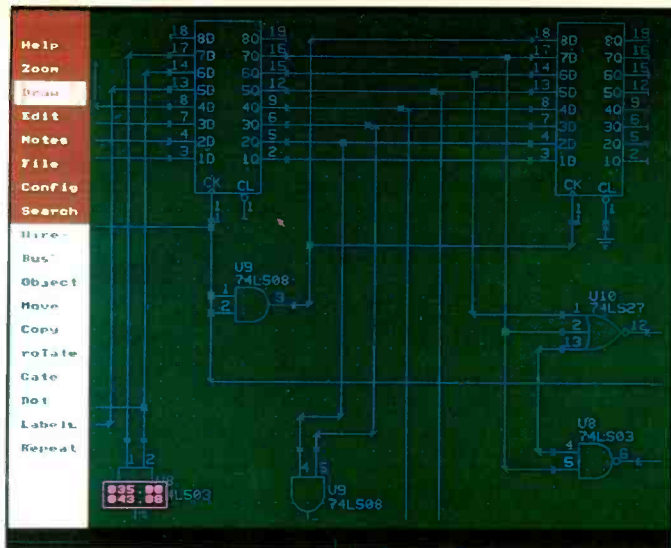

Schema-Quik from Omaton.

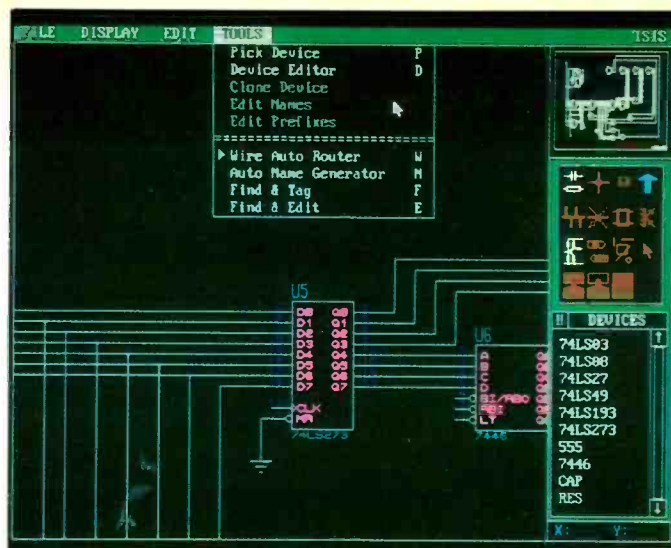

ISIS Supersketch from Labcenter Electronics.

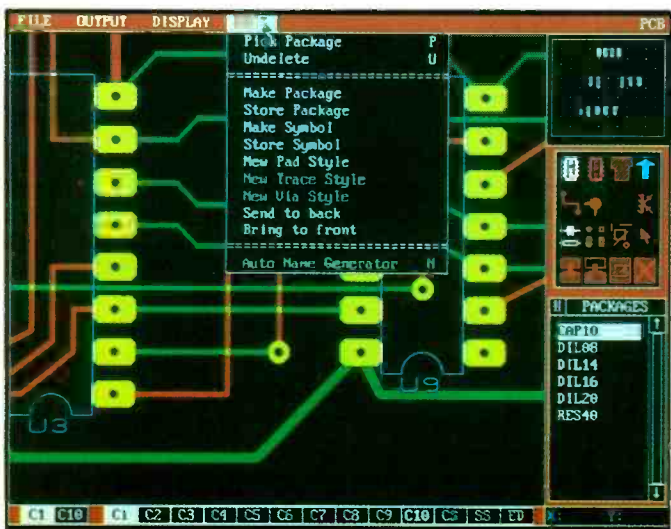

PCB II from Labcenter Electronics.

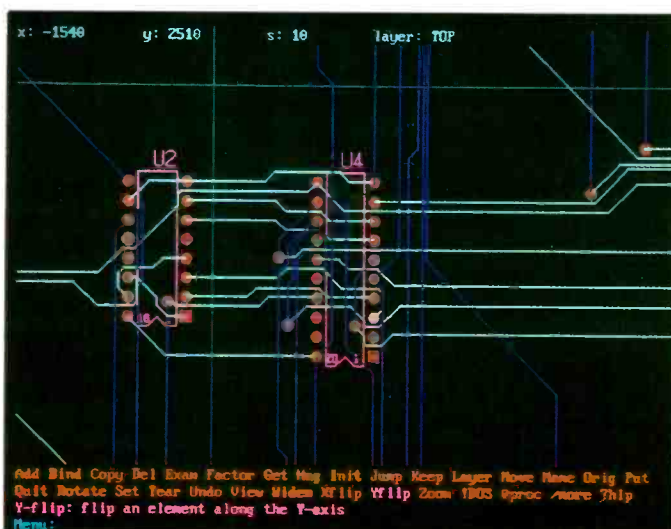

Typical PCB layout using Design Computation's DC/CAD.

Schema-Quik supports several popular netlist formats for use with PCB layout and circuit simulation software. Among the 14 netlist formats supported are SPICE, EE Designer and PADS-PCB. In addition to the ASCII form of the Bill of Materials (BOM), there are Lotus, dBASE and SDF formats that can be imported into a spreadsheet or database for cost analysis and inventory control. There are two DOS-based design-rule checkers that look for

and report on floating inputs, duplicate part references, shorted outputs and dangling wires.

While Schema-Quik supports a large number of printer types, the program has little control over the final hardcopy. That means you'll end up doing a lot of taping if the drawing is larger than your printer paper. By contrast, its plotter utility gives you full control over page sizing, reduction and offset. Both utilities are run from DOS.

Summary. Although Schema-Quik doesn't have as many refined drawing and editing capabilities as other programs in this review, it's a well-rounded schematic-capture package that interfaces with many popular PCB-layout and circuit-simulation programs. It's only real drawback is the small component library, but for 99 bucks you can afford to spend some time tailoring the library to your needs.

CIRCLE NO. 81 ON FREE INFORMATION CARD

ISIS Supersketch & PCB II from Labcenter Electronics

Labcenter Electronics serves up a two-package circuit-design deal that's aimed squarely at the performance- and budget-conscious hobbyist.

Both ISIS Supersketch schematic-capture and PCB II printed-circuit board layout programs are easy to

learn and use, support several drawing and editing features, work with either floppy or hard disks and sell for a low \$149 each. If you buy the two together, Labcenter throws in ISIS's optional extended components library of over 3,300 parts for a

mere dollar more (it's CADPACK, \$299). Furthermore, Supersketch is available alone with the additional components library as Supersketch Plus, costing \$199. Note that each program, schematic and PCB, stands on its own; they aren't interconnected.

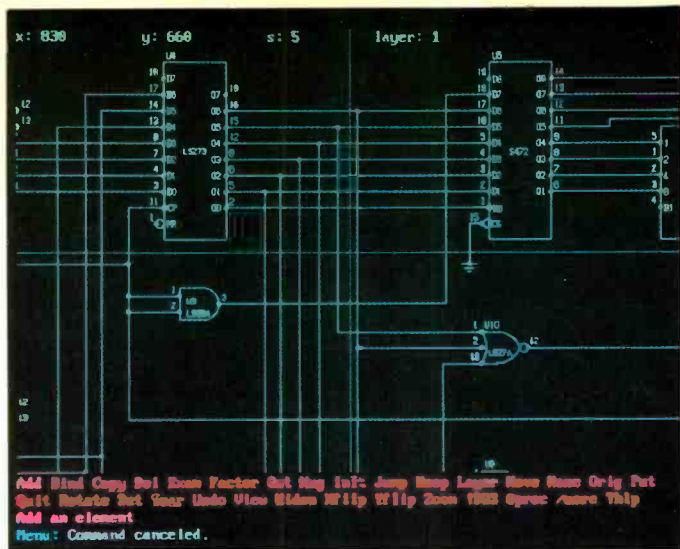

A Schematic-capture from Design Computation's *DC/CAD*.

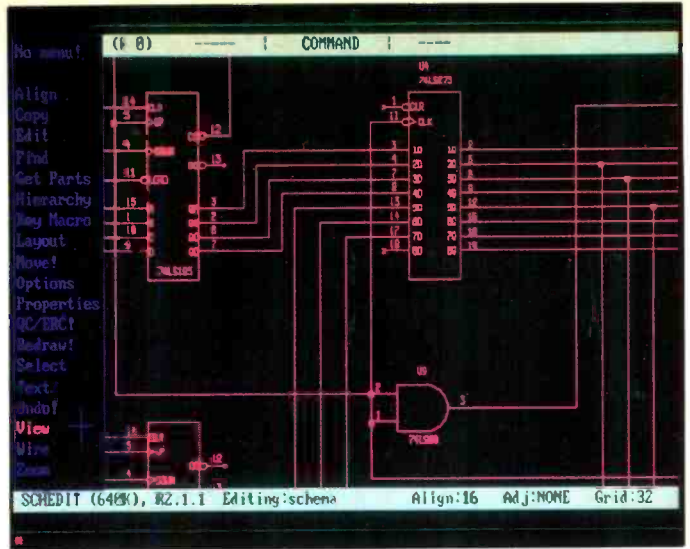

CapFast from Phase Three Logic.

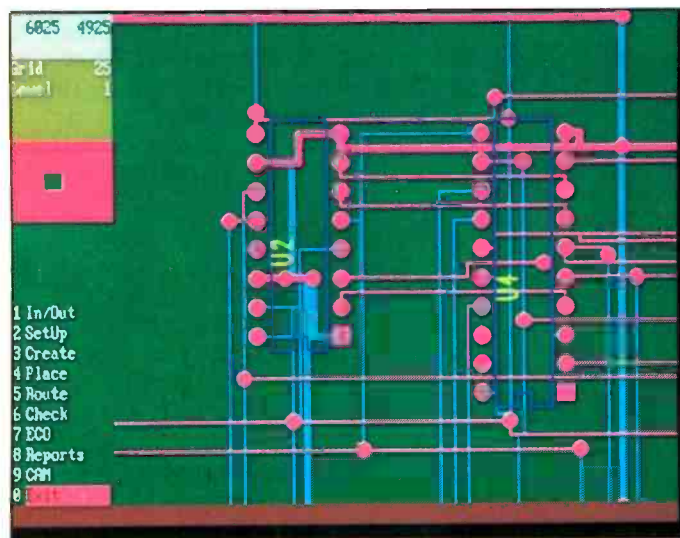

PADS-PCB from CAD Software.

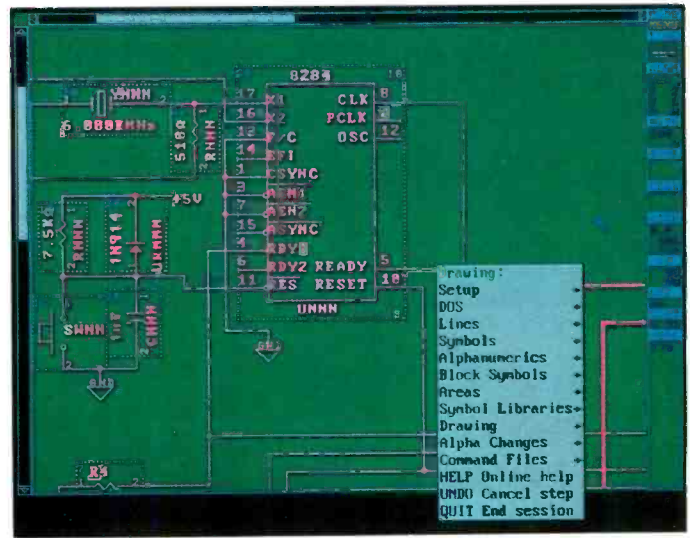

FutureNet-5 from Data I/O.

Supersketch can't produce netlists and *PCB II* doesn't read them. But Labcenter has an industrial line of fully-interactive schematic capture and PCB layout programs, called *ARES*, that are compatible with *Supersketch* and *PCB II* files should you decide to upgrade; prices for these start at \$599.

Either program can run on a single floppy disk with just 512K of RAM, but most users would opt for two floppies or a hard disk. Expanded RAM and a math coprocessor are neither needed nor used. A hardware-protection key isn't required, nor is the program copy protected.

Commands are invoked from a combination of pull-down menus, dialog boxes, icons and keyboard strokes—an arrangement that's familiar to any Macintosh user or IBM user of Microsoft *Windows*. As such, the programs are easy to learn and

use. A Help screen is not provided, nor did we find one necessary. Use of European symbols and terminology takes getting used to.

Two methods of panning are provided. With no Place command in effect, you pan by clicking on the overview display found in the upper right-hand corner. This moves the working window around to all areas of the drawing. However, autopan is activated when placing a component, trace or wire, causing the screen to jump by about one-half its view when the cursor bumps against a screen edge. Zoom range for *Supersketch* is 20:1, while zoom range for *PCB II* is 50:1. Zoom can't be used when placing a part or wire. Neither program supports macros.

Individual differences in the way the foregoing individual schematic-capture and PCB-layout programs use the drawing and editing com-

mands are noted below, as are other distinguishing features.

ISIS Supersketch Plus. *Supersketch Plus* (\$199) lets you draw schematic diagrams on pages up to A0 in size, which is the European equivalent of an E-size drawing. It has six libraries, for a total component count of over 3,000. (Except for a greatly reduced library that contains only 58 generic devices, another model, plain old *Supersketch*, at \$149, is identical to the company's \$199 *Supersketch Plus*.) The libraries serve up a healthy portion of logic, analog and memory devices. But the bulk of the component count is in TTL chips with different prefixes, like 74LS00 and 74ALS00. A count of different device types puts the number at 600—more than sufficient for most drawing chores.

Table 1. Programs Evaluated to Date

Program Name	Type	Company
<i>CapFast</i> (Jul. 1991)	Schematic-Capture	Phase Three Logic, Inc.
<i>DC/CAD</i> (Jul. 1991)	Integrated System	Design Computation, Inc.
<i>EE Designer II</i> (Jan., Apr. 1991)	Integrated System	Visionics Corp.
<i>FutureNet-5</i> (Jul. 1991)	Schematic-Capture	Data I/O Corp.
<i>HiWIRE II</i> (Jan., Apr. 1991)	Integrated System	Wintek Corp.
<i>ISIS Supersketch</i> (Jul. 1991)	Schematic-Capture	Labcenter Electronics
<i>OrCAD/PCB II</i> (April 1991)	PCB-Layout	OrCAD Systems
<i>OrCAD/STD III</i> (Jan. 1991)	Schematic-Capture	OrCAD Systems
<i>PADS-PCB</i> (Jul. 1991)	PCB-Layout	CAD Software, Inc.
<i>PCB II</i> (Jul. 1991)	PCB-Layout	Labcenter Electronics
<i>PCBoards</i> (April 1991)	PCB-Layout	PCBoards
<i>ProCAD</i> (Jan., Apr. 1991)	Integrated System	Interactive CAD Systems
<i>Protel-Autotrax</i> (April 1991)	PCB-Layout	Protel Technology, Inc.
<i>Protel-Easytrax</i> (April 1991)	PCB-Layout	Protel Technology, Inc.
<i>Protel-Schematic</i> (Jan. 1991)	Schematic-Capture	Protel Technology, Inc.
<i>Schema III</i> (Jan. 1991)	Schematic-Capture	Omatation
<i>Schema-PCB Layout</i> (April 1991)	PCB-Layout	Omatation
<i>Schema-Quik</i> (Jul. 1991)	Schematic-Capture	Omatation
<i>SuperCAD</i> (Jan. 1991)	Schematic-Capture	Mental Automation, Inc.
<i>Tango-PCB Plus</i> (April 1991)	PCB-Layout	ACCEL Technologies Inc.
<i>Tango-Schematic</i> (Jan. 1991)	Schematic-Capture	ACCEL Technologies Inc.

Note: Dates in parentheses following Program Name indicate issues in which evaluation appeared.

New library parts can either be made from scratch or by modifying an existing part using *Supersketch's* library editor. The editor is available from a pull-down menu, which means you don't have to interrupt the drawing process to create a new device. There's an on-screen listing of the library's contents. You extract parts from the libraries by highlighting the desired part from the list and clicking on it. This transfers the component to a device window, where it's

stored. After you finish selecting the parts, you close the library window.

At this point, no devices are on the drawing. You now go into the device window and select the part you wish to place. As long as a device remains highlighted, it can be placed as many times as you wish by simply clicking on the mouse. The components in the device window become a permanent part of the drawing's database file, and need to be loaded only once.

Commonly used symbols, like in-

put/output terminals and ground, aren't included in the device window but are, instead, available from a toolkit window as icons. Clicking on any of these dozen-or-so devices makes them available for placement.

Components can be rotated in 90° increments or mirrored right to left before or after placement—but not during the actual placement. References to a device are done after the part is in place. Automatic numbering of reference numbers is available, but you can do only one component type at a time (resistors or ICs, for example), and the program doesn't check for duplicate entries.

Most annotation is done by hand, using the device editor to change, move or delete reference lines. There's no limit to the size of the font or the reference's location on the drawing. To draw a wire, all you do is click once on its origin and once on its destination.

Supersketch has a wire autorouter that draws the line for you, automatically selecting the best route and adding whatever corners are needed to make it ortho. Lines can also be drawn manually by clicking the mouse button once for each time you wish to change direction, including drawing diagonals at any angle. The line automatically terminates and is placed when you click on a component terminal or another wire; no dangling or unterminated wires are permitted. There are no design-rule checks, nor are buses supported.

Editing commands let you move, delete, rotate, mirror and copy symbols. When a part is moved, the connected wires rubberband (expand or contract to their new positions). Once the part is placed, the autorouter automatically cleans up the rubberband lines into short, ortho lines. Lines can be moved manually, too. Wires and symbols can be locked in place to prevent their editing.

Parts defined as a block can be moved, deleted, rotated, copied and saved. The Undo command sequentially replaces all deleted parts with each use, back to square one if needed. Jump and Find are supported, but not Locate.

Supersketch supports a wide array of printers and plotters, including many popular dot-matrix and Postscript laser printers. A schematic can

be printed in portrait or landscape orientation, and a 4:1 scaling factor lets you print an A0-size drawing on an 8½" × 11" page.

Summary. *For drawing schematics, Supersketch is unquestionably excellent. It's easy to use, has a fairly good component library in its \$199 Supersketch Plus version, abounds with drawing and editing features, although not overly rich, and supports a wide range of print and plot options. But the lack of netlist output is a drawback for serious users, and one that's corrected only by spending a lot more money.*

CIRCLE NO. 82 ON FREE INFORMATION CARD

PCB II. *PCB II* is Labcenter's low-end PCB-layout package. The \$149 program is closely related to the higher-level *ARES PCB* layout package (\$599), except that *PCB II* is totally manually operated. Its ease of use is on par with *Supersketch*, as are the editing features, but placing of parts and tracks requires more work than drawing a *Supersketch* schematic.

The program comes with a library of 70 component outlines that include several DIP and PLCC footprints. Included, too, are footprints for a number of relays, switches and several different-size resistors and capacitors. Not included in the library are pads or vias. These are found in the toolkit window, along with the track widths. Like the ground sym-

bol of *Supersketch*, these are commonly used items that can be placed by clicking on an icon.

Also supplied is a list of 20 common pad sizes and patterns, but you can add as many of your own design as you wish. Like *Supersketch*, component outlines are called from the library, using a parts list. Again, selected outlines are stored in a component window, which is then used to place outlines on the board. As long as the device in the component window remains highlighted, it can be placed on the board as many times as you wish.

Because *PCB II* doesn't read netlist files, each design is started from scratch by hand. However, sub-circuits like memory arrays can be saved in a block file and used again in any number of layouts. Parts can be rotated in 90° increments or mirrored for SMD use before or after placement, but not during placement. A board outline is not needed before parts are placed. Maximum board size is 30" × 30".

Unlike *Supersketch's* wire autorouter, *PCB II* tracks have to be laid down manually from start to finish. Tracks can be placed at any angle and any width, and via placement is automatic when changing from one layer to another. However, the board is limited to just two layers of copper: top and bottom. Grid snap is incrementally variable between 5 and 100 mils, and can be turned off for near-gridless routing. Copper fill for cur-

rent guards and ground planes is supported. Devices moved after tracks have been attached drag their tracks along with them. But unlike *Supersketch*, you do the clean-up work yourself.

Track routing and width are changed by laying down a new track over the old. *PCB II* recognizes it as a short-circuit and removes the old track, leaving only your new path. You can remove vias and neck-down using the same procedure. Find and search are supported. There are no design-rule checks, and all mistakes simply pass through to the final board product.

PCB II generates Gerber, N/C drill, and PostScript files, as well as silkscreen and solder masks. *PCB II's* printer and plotter interface is identical to *Supersketch's*, which means you can produce final artwork at scaled sizes (up to 4:1) on dot-matrix or laser printers and several pen plotters.

Summary. *PCB II has a lot of nice features, including a large library of device outlines, an unlimited number of pad shapes and track widths, Gerber and N/C drill file output and a low \$149 price tag. But its lack of netlist input and limit of two copper layers makes it suitable only for occasional projects with few parts. For \$450 more, you can buy the ARES PCB package that will do those things for you.*

CIRCLE NO. 83 ON FREE INFORMATION CARD

DC/CAD from Design Computation

DC/CAD is the only integrated schematic-capture and PCB-layout circuit design program examined here (others were looked at in earlier issues, as previously cited). It sells for an astonishingly low \$495. Even more amazing is that this low price includes automatic parts placement and a rip-up autorouter! It's easy to use and very versatile. However, it's not the easiest program to learn, nor is it the fastest. Moreover, if you want to lay out PC boards with any of the other popular PCB-design programs, you need a \$195 software translator.

The program requires 640K of system RAM and can use up to 3MB of LIM memory if available. A hard disk is required. Happily, a hardware-protection key isn't needed to run the program, and the program isn't copy protected.

Learning to use *DC/CAD* is no easy task. It has a rather unusual menu-driven command structure that's unlike anything else in the industry. But once you get the hang of it, using the program is really quite simple. Although *DC/CAD* uses the same screen to do both schematic capture and PCB layout, transfer of

data between the two isn't seamless. Many circuit design functions—including netlist generation and autorouting—are done in DOS, which means you have to quit the program frequently during the design process.

Among *DC/CAD's* features is an autopan that moves the screen by ¼ of the viewing area when the cursor bumps against an edge, and autopan can be disabled. Zoom is infinitely variable and can be used on the fly while placing parts, nomenclature and wires or tracks. There's a macro recorder for both schematic capture and PCB layout that remembers

commands you make and replays them on demand. Macros save a great deal of time when drawing or placing memory arrays and other repetitious patterns.

A Help command that provides detailed information on all aspects of the program is available, but it's arranged as an index, rather than being context sensitive. If you don't need help, just a gentle reminder of the command's function, there's a command description line at the bottom of the screen that briefly describes the function of the command selected.

When starting *DC/CAD*, the program defaults to schematic capture mode. The component library consists of about 2,000 parts distributed among 11 libraries, all of which are active at the same time. However, many of the devices in the libraries are identical, differing only in name. For example, contents of the 74LS library are identical to that of the 74AS library—which is identical to the 74ALS library.

A count of different device types reveals a true library size of only 150 devices, a remarkably small number. Fortunately, making new components is as simple as modifying an existing part by using drawing elements found in the schematic-capture mode. Parts can also be made from scratch using this method. No special library editor is required, but everything on the screen becomes part of the new component when saved. While this is an excellent way to cre-

ate sub-circuits, it requires clearing the screen of everything not related to the new part.

Design Computation also has a bulletin board that has many-schematic and PCB devices made by *DC/CAD* users that are free for the downloading. Parts are called up from the library by typing their name at the ADD SYMBOL prompt. Each part must be typed in separately because *DC/CAD* doesn't support multiple placements, and you'll need to use the reference manual for the part numbers.

Components can be rotated or mirrored only after they're initially placed; the degree of rotation is infinitely variable between 0° and 360°. Part references are also added to the devices only after they're placed on the schematic. Devices with multiple gates can be assigned at the time the part is named. Each device has two lines of text associated with it: part reference and part value. Text size and location are infinitely variable.

Lines and wires (treated separately) are started by moving crosshairs to the beginning of the line and pressing the ENTER key. Thereafter, each click of the mouse changes direction of the line or wire while maintaining connectivity.

Pressing ENTER again ends the line. You can draw 45° diagonals while in the ortho mode, and buses are supported. Schematic editing features are good. Parts can be moved, deleted, rotated and copied as either

single objects or blocks. Find, Locate and Jump commands are available, too. There's an Undo command that restores the last deletion.

Schematic netlists are generated outside the program using a DOS utility. The netlist format is proprietary and recognized only by *DC/CAD*'s PCB-layout program. The BOM netlist can include pricing and vendor sources for the components. PCB-layout mode is actuated manually after the program is started. The menu is identical for both schematic capture and PCB layout. Going into PCB mode simply turns off some menu commands and activates others.

Although the program can read only *DC/CAD* netlists, you can buy a \$195 software conversion option that translates many popular netlist formats into *DC/CAD* format for PCB layout, including *OrCAD* and *FutureNet*. But like most translators, it can't convert device outlines, which means you have to go into the netlist and manually add *DC/CAD* outlines yourself. Forward and backward annotation is provided between the *DC/CAD* schematic-capture and PCB-layout netlists.

The PCB library contains outlines for about 70 devices. There's a good sampling of DIP (dual inline), SIP (single inline), PGA (pin grid array) and SMD (surface-mount device) packages, but many popular outlines are missing, and resistor and capacitor outlines are limited to a single ½-watt-sized device.

But again, new outlines are easy enough to make by using the schematic-capture tools. No special library editor is needed. Before you can place parts, you must define the circuit-board outline. Maximum board size is 32" × 32". Parts are placed by first extracting their outlines from the schematic-capture netlist.

An automatic parts-placement routine is available. However, it's a rudimentary placement routine that needs a lot of manual clean-up. Parts can be glued in place prior to auto placement, and forbidden zones where parts aren't allowed can be defined. Parts can be rotated or flipped to the other side of the board for SMD applications, but only after placement. A ratsnest isn't available for parts placement, but is available for routing. The autorouter is a cost-

Table 2. Schematic-Capture Program Ratings

Program	Drawing	Editing	Library	Netlist Support	Ease of Use
<i>CapFast</i>	A	A	A	A	C
<i>FutureNet-5</i>	A	A	A	A	B
<i>DC/CAD</i>	B	A	B	D	B
<i>EE Designer III</i>	A	A	B	D	C
<i>HiWIRE II</i>	C	C	C	C	C
<i>Supersketch Plus</i>	A	A	B	F	A
<i>OrCAD/STD III</i>	B	B	A	A	B
<i>SuperCAD</i>	B	B	C	C	B
<i>ProCAD</i>	A	A	B	A	C
<i>Protel-Schematic</i>	A	A	A	D	A
<i>Schema III</i>	B	B	B	A	B
<i>Schema-Quik</i>	B	B	C	A	B
<i>Tango-Schematic</i>	B	A	A	D	B

Note: Ratings are descending order of value, from Excellent (A) to Poor (D).

ed rip-up router. You tell the router what tracks are permitted and which aren't, and it does its best to complete the job. Routing is gridless, which means the router adheres exactly to your clearance specifications; if you say 10 mils between tracks, 10 mils is what you get—every time.

Although track width is limited to one size per session, you can specify which nets you want routed at the current width. For example, you could specify wider tracks for the power-supply and ground paths on your first pass and follow up with a narrower track for signal paths on your next pass. Up to 32 copper layers can be autorouted at the same time, and eight of those layers can be used for common planes or ground planes. All 64 drawing layers can be defined as copper.

Unfortunately, the rip-up router is much slower than the Lee routers found in most mid-priced PCB-layout programs. What's worse is that the autorouter is a DOS utility—which means you have to exit the program to run it. And while the autorouter allows for manual intervention, you must stop the router, go back into *DC/CAD* to make your changes, then return to DOS to con-

tinue with the autorouting sequence.

DC/CAD has a semi-automatic routing routine that finds the best path between two pads. Unfortunately, the gridless strategy of the rip-up router often has the tracks hug close to pads and other tracks, resulting in tracks that meander, rather than taking a preferred shorter, more-direct route.

The solutions are to manually place the first few tracks yourself or edit them after the routers are finished. Fortunately, you don't have to delete a track to change it. *DC/CAD* allows you to move a track without breaking its connectivity.

Design-rule checks are built into the program at each stage of operation—and can sometimes be a real pain. For instance, when compiling the netlist in DOS, the least infraction aborts the procedure and directs you back to the schematic-capture program to correct it. The same is true for all PCB-layout and ratsnest netlists used by *DC/CAD*. You often find yourself constantly switching between the program and DOS.

DC/CAD generates DXF, Gerber and N/C drill files. All three output options are available from the *DC/CAD* main menu. Component, sol-

der and silkscreen masks are also available from the main menu. Printer output is limited to a select few dot-matrix printers, notably Epson's FX80 and LQ-1000 printers, and is done through a sequence of events that has you create an intermediary file from *DC/CAD*'s main menu. A DOS utility is then used to convert the file into printer format for printing. Plotter support is broader but is mainly limited to HP-compatibles, and it doesn't require a DOS conversion utility.

Summary. *DC/CAD has everything you could ask for in a circuit-design program: schematic capture, PCB layout, autoplacement, a rip-up autorouter, Gerber and N/C file output and a super-low \$495 price tag. However, the libraries are small, autorouting is slow, printer support is limited and an optional \$195 software translator is required to use other popular PCB-layout programs instead of the one that's combined in the package. But for the serious electronics hobbyist, electronics tech writer, student or fledgling business, it's a bargain that's hard to pass up.*

CIRCLE NO. 84 ON FREE INFORMATION CARD

CapFast from Phase Three Logic

CapFast is an extremely comprehensive schematic-capture program that can be used with virtually all circuit-design software. Its huge component library contains device parameters for every schematic-capture want, plus every post-schematic processing need, whether hardcopy or for third-party printed-circuit board layout or circuit simulation.

But at \$799, it's not cheap. Luckily for those of us who envy *CapFast*'s versatility but can't afford it, Phase Three offers a university version of *CapFast* that performs everything the professional version does for just \$299. The tradeoff is fewer parts per drawing (200 ICs or less) and decreasing drawing speed as the design grows more complex.

That's because the professional version can use up to 16MB of extended (not expanded) memory and

needs at least 2MB of RAM to run. In contrast, the university version uses only 640K. Needed by both versions is an AT-compatible PC (286 or better) and a hard disk with about 14MB of free space. A hardware protection key isn't required, and the software isn't copy protected.

CapFast is moderately difficult to learn, but fairly easy to use. Commands are in hierarchy menus that may be as many as five levels deep. Choosing a root command usually has you select from a sub-menu, which may or may not lead to another menu. A completed command moves you back one menu so that it can be repeated; you can exit to the main menu at any time.

Unless you have a three-button mouse, most commands are entered via the keyboard. Fortunately, macros that remember command se-

quences are supported. Another feature, Zoom, has an infinitely variable range of 1000:1, with the highest magnification displaying about 1/4 of a logic gate. There is an adjustable autopan that moves the viewing screen by a user-defined amount whenever the cursor bumps against an edge. An important user aid that's missing, however, is a Help screen. As a result, you'll probably have to keep the command reference manual under your nose for at least the learning period.

Capfast's enormous component library consists of about 9,000 devices—5,000 of which are uniquely different. DeMorgan and IEEE equivalents exist for many of the devices, which when added pushes the total to over 10,000 parts. The part count includes 5,000 TTL devices (1,000 different types), 700 logic chips (CMOS,

(Continued on page 85)

Using Nonvolatile Memory ICs

EPROMs, EEPROMs and nonvolatile RAMs, ROMs and PROMs

Just about all computer systems require some form of permanent storage for programs and other information that must be retained after the system is powered down. In desktop computers, this storage is usually provided by floppy and hard disks, which can store large amounts of information at a low per-byte cost.

Smaller dedicated or embedded computers usually store correspondingly smaller amounts of information—quantities that are measured in kilobytes rather than megabytes. For these situations, permanent storage is often provided by nonvolatile memory ICs, a category that includes EPROMs, EEPROMs, nonvolatile RAMs, ROMs and PROMs.

All nonvolatile memory ICs store information permanently, or at least semi-permanently (10 years or more), even when power is removed from the chip. They can store programs or data, including digitized sensor outputs, look-up tables, configuration information or any information that must be saved after powering down. Unlike disk storage, memory ICs don't require bulky mechanical drives or complex control circuitry to interface with a microprocessor.

ROMs and PROMs can be programmed only once, while EPROMs, EEPROMs and nonvolatile RAMs are reprogrammable. Reprogrammable types are especially convenient, since they provide easily alterable, yet permanent, storage.

We take a look here at some reprogrammable, nonvolatile memory IC options, including their differences and similarities, how to use them and how to decide which type to use. We'll examine examples of popular EPROMs, EEPROMs and nonvolatile RAMs.

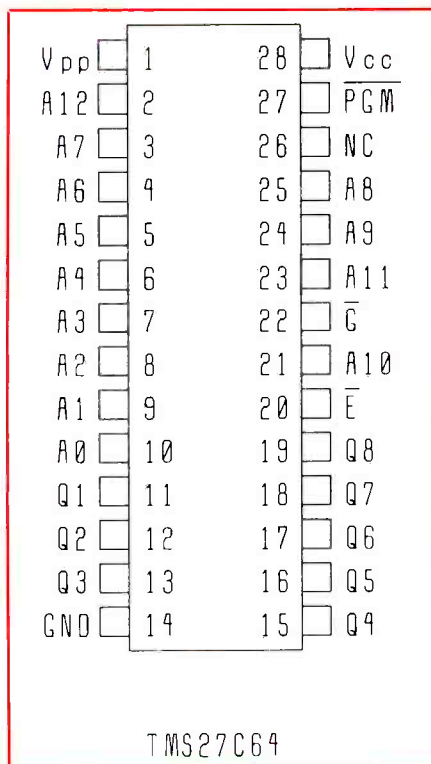

Fig. 1. This 64K EPROM stores 8,192 eight-bit words.

The Classic EPROM

Traditionally, the EPROM (Erasable Programmable Read-Only Memory) has been the preferred method for permanent storage of data in single-board computers. Like other memory ICs, EPROMs store information as electric charges (or the absence of a charge) that represent 1s and 0s.

An EPROM contains a matrix of MOS (metal-oxide semiconductor) transistors with floating polysilicon gates. A memory location is programmed by applying voltages that cause electrons to collect on a float-

ing gate, where they remain, even after the programming voltages are removed. Exposing the EPROM to ultraviolet energy causes the programmed locations to return to their unprogrammed states. A programmed memory location is read as a 0, an erased location as a 1.

EPROM technology has advanced considerably since it was first developed at Intel Corp. in 1971. The original 1702 EPROM stored just 2,048 bits of information, required five power supplies ranging from -9V to +48V(!), consumed up to 65 milliamperes of current and had access times of up to 1.5 microseconds.

Modern EPROMs are much improved. They are easier to power, requiring only a +5-volt supply for normal operation plus a higher voltage used only for programming. Programming voltages have dropped to as low as +12.5 volts, and CMOS technology has reduced power consumption. Compared to older versions, modern EPROMs hold thousands of times more data and can be accessed much faster.

Figure 1 shows the pinout for Texas Instruments' TMS27C64, a typical CMOS EPROM. This chip stores 8,192 bytes and can be referred to as a 64K EPROM (since it stores approximately 64,000 bits) or as an 8K × 8 EPROM (since it stores approximately 8,000 eight-bit words). Many other manufacturers make EPROMs that are compatible in pinout and function with this chip.

Most EPROMs, including the TMS27C64, have a transparent window that permits the memory circuits to be exposed to ultraviolet energy. Exceptions are one-time-programmable (OTP) EPROMs, which use EPROM technology but have no

windows and, thus, are not erasable.

The TMS27C64 has 13 address inputs (A0 through A12), eight data inputs/outputs (Q1 through Q8) and three control inputs: PGM $\bar{}$ (program), G $\bar{}$ (output enable) and E $\bar{}$ (chip-enable). The designation " $\bar{}$ " indicates that a signal is active-low. Power-supply pins include V_{cc} (+5 volts), GND and V_{pp} (+5 volts for normal operation, +12.5 volts for programming).

The chip is organized so that each of 8,192 bytes is stored at a unique address, from 0 to 8,191 (0 to 1FFF in hexadecimal).

Reading data from the TMS27C64 follows this process:

(1) PGM $\bar{}$ is high and V_{pp} is at +5 volts.

(2) Address inputs A0 through A12 are brought high or low to form the desired address.

(3) Inputs E $\bar{}$ and G $\bar{}$ are brought low.

(4) After a short delay, the data stored at the requested address can be read on Q1 through Q7.

EPROM is a little more complicated than reading one. Programming can only change 1s to 0s; it cannot change 0s to 1s. For this reason, before an EPROM is programmed, its contents must be changed to all 1s by exposing the EPROM's transparent window to ultraviolet energy. The programming process then changes all 1s that should be 0s to 0s.

Programming an erased EPROM follows these steps:

(1) The desired address is placed on A0 through A12, and the desired data is placed on Q1 through Q8.

(2) V_{pp} is raised from +5 volts to the programming voltage.

(3) E $\bar{}$ is brought low.

(4) PGM $\bar{}$ is pulsed low for a specified time (typically 50 milliseconds).

(5) After programming a byte, it can be verified by bringing low G $\bar{}$ and reading the data that appears on Q1 through Q8.

You don't have to program an entire EPROM at once, and it's possible to store multiple programs in a single chip, as long as each is stored at different addresses. But once a bit has been programmed to 0, it can't be changed back to 1 unless the entire chip is erased.

At 50 milliseconds per byte, the time it takes to program an EPROM can add up—7 minutes for a 64K EPROM, 27 minutes for a 256K EPROM, and on up. To speed the process, several faster closed-loop programming techniques have been developed. They have names like *Quick-Pulse*, *Fast*, *SNAP!* and *Intelligent* programming. Some of these can reduce the programming time for an IC to 1 second or less!

Let's look at *SNAP!* programming as an example. To use it, V_{cc} must be raised to +6.5 volts and V_{pp} must be at +13 volts. PGM is initially pulsed for just 100 microseconds, instead of 50 milliseconds. Each memory address is programmed with a short pulse, then each is read to find out if the desired byte has been stored in the EPROM. If not, PGM is pulsed again and is repeated until the byte reads back successfully. After all bytes are programmed, each is verified to ensure that programming was successful.

EPROM erasers consist of a shielded source of ultraviolet energy and a tray or slots for holding the EPROM devices. To erase an EPROM, you insert the IC into the

Programming EPROMs

Writing to, or programming, an

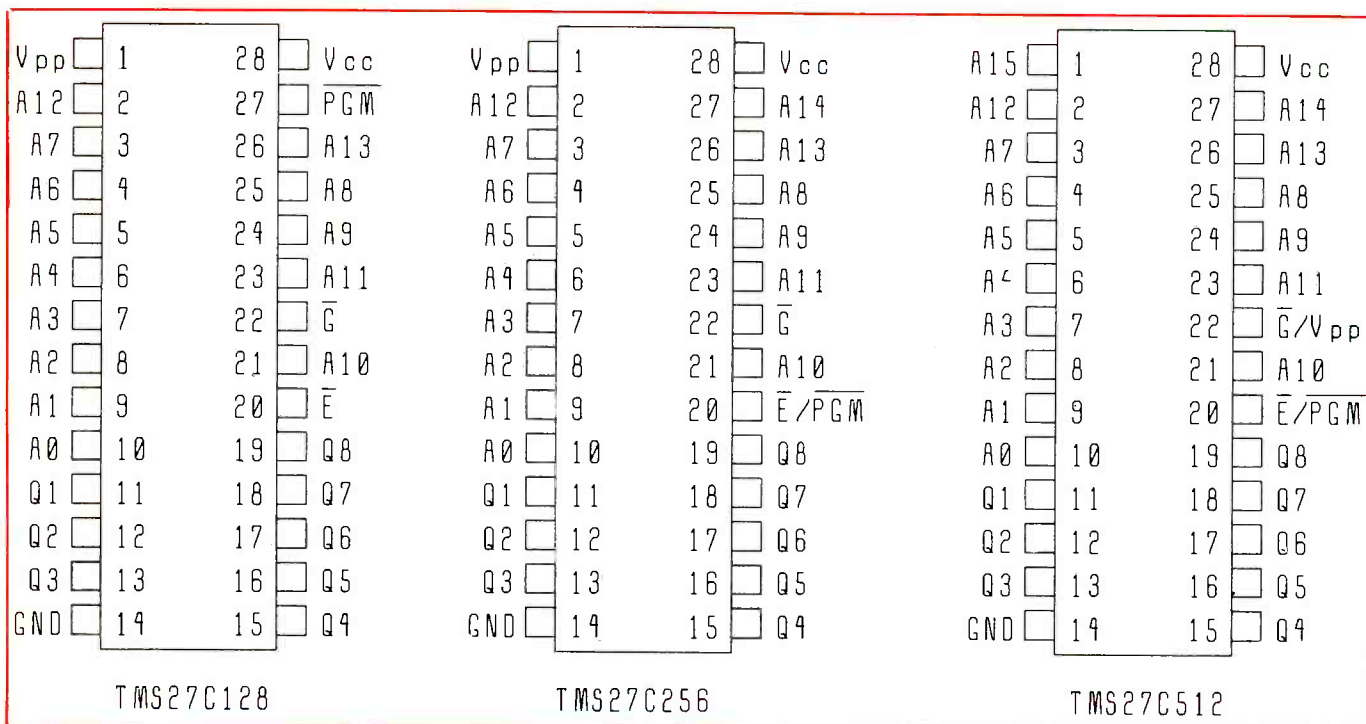

Fig. 2. The TMS27C128 EPROM stores 16,384 bytes, TMS27C256 32,768 bytes and TMS27C512 65,536 bytes. All use the same 28-pin package. Each time the capacity doubles, another address input is required. Pins 20 and 22 must do double duty on higher-capacity EPROMs.

eraser and turn on the ultraviolet source for the specified time (10 to 30 minutes is typical).

Recommended wavelength and intensity for EPROM erasing is 2537 angstroms at 15 watt-seconds per square centimeter, applied at a distance of 1". You can construct an EPROM eraser from an ultraviolet lamp, but the light source must be in a light-tight enclosure, to protect your eyes from harmful UV energy.

Room fluorescent lights and sunlight will also erase an EPROM eventually, though it may take weeks to do so. To protect against erasure from ordinary lighting, windows of programmed EPROMs should be covered with opaque labels.

There is a limit to how many times you can erase and reprogram an EPROM. After around 100 erase/re-write cycles, storage of data may be less reliable.

EPROM Types

In addition to the TMS27C64, other EPROMs are available in smaller and larger storage capacities. Figure 2 shows three EPROMs that use the same 28-pin package as the TMS-27C64 but have different capacities. EPROMs of larger capacity use a 32-pin package, while those with smaller capacity use a 24-pin package. The pinouts in Fig. 3 are standard ones, shared by most 28-pin EPROMs, although signal names may vary among different manufacturers.

The main difference among the devices is the number of address inputs required. The TMS27C128 stores 16,384 bytes and requires 14 address inputs; so A13 is added on pin 26. The TMS27C256, in turn, stores 32,768 bytes by adding A14 on pin 27 and combining the functions of E $\bar{\backslash}$ and PGM $\bar{\backslash}$ on pin 20. And the TMS-27C512 stores 65,536 bytes by adding A15 at pin 1 and combining G $\bar{\backslash}$ and V $\bar{\text{pp}}$ on pin 22.

Many manufacturers follow the same general scheme for designating part numbers. So you can often tell something about an EPROM from its part number. An optional first letter or letters are the manufacturer's designation (TMS, NMC, etc.). A "27" indicates that the device is an EPROM. A "C" following the 27 means the device is CMOS, while no letter means NMOS.

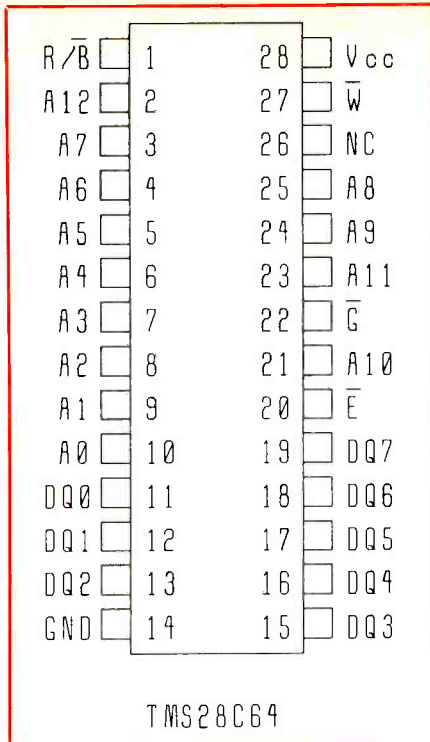

Fig. 3. This 28C64 EEPROM is pin-compatible with the 27C64 EPROM.

The next numbers tell you the storage capacity of the device in kilobits, rounded off to the nearest power of 2 (64 means 65,536 bits or 8,192 bytes; 128 means 131,072 bits or 16,384 bytes, and so on.) Finally, the device's access time may be indicated in nanoseconds or nanoseconds/10. (In other words, either -15 or -150 may indicate an access time of 150 nanoseconds.)

Using these conventions, an IC with the designation NMC27C512-20 is a CMOS EPROM with a capacity of 65,536 bytes and access time of 200 nanoseconds.

Prices for EPROMs continue to drop, with devices up to 512K now available for between \$4 and \$10 in single quantities.

The EEPROM Option

Drawbacks to using EPROMs are their need for out-of-circuit erasing by ultraviolet energy and their all-or-nothing erasability. The entire IC must be erased before reprogramming even a single byte (unless by chance the new byte does not require changing any 0s to 1s). An interesting (and popular) alternative to EPROMs is the EEPROM (Electrically Eras-

able Programmable Read-Only Memory).

EEPROMs use a floating-gate technology similar to that used by EPROMs, but they use a process called Fowler-Nordheim tunneling that allows the EEPROMs to be electrically erased.

EEPROMs can be erased selectively

As with EPROMs, an EEPROM byte must be erased before programming, and programming an EEPROM requires applying a special, higher programming voltage. But modern EEPROMs automatically erase each byte before programming and also generate their own programming voltages on-chip. This allows the EEPROM to be powered from a single +5-volt source for both reading and writing operations. Their in-circuit erasability also means that EEPROMs can be erased selectively, a byte at a time, instead of all or nothing.

Figure 3 illustrates the pinout for a Texas Instruments' TMS28C64 CMOS 64K EEPROM. With the pinout being much like that for the TMS27C64 EPROM, the two chips are interchangeable in many circuits (although the EEPROM's pin 1 should never be subjected to the EPROM's higher-magnitude programming voltage).

Like the TMS27C64, the TMS-28C64 EEPROM can store 8,192 bytes. Other manufacturers make equivalent devices, and EEPROMs are available with smaller and larger capacities. Like its comparable EPROM, the TMS28C64 has 13 address inputs (A0 through A12) and eight data input/outputs (DQ0 through DQ7). Control signals are W $\bar{\backslash}$ (write), G $\bar{\backslash}$ (output enable), E $\bar{\backslash}$ (chip enable) and R/B $\bar{\backslash}$ (ready/busy).

Reading information from an EEPROM is much like reading from an EPROM. An address is placed on A0 through A12, W $\bar{\backslash}$ is high, E $\bar{\backslash}$ and G $\bar{\backslash}$ are brought low and, after a short delay, the desired data appears at DQ0 through DQ7.

Writing to an EEPROM, however, is much simpler than writing to, or programming, an EPROM. Depending on the device, writing a byte to an EEPROM can take as long as 10 mil-

liseconds, which is a long time in the microprocessor world. However, in current EEPROM versions, once the write cycle is initiated, the EEPROM takes over and completes the process on its own. This leaves the system microprocessor free to perform other tasks, although the EEPROM may not be read or written to until its write operation is complete.

Programming an EEPROM follows these steps:

(1) The desired address is placed on A0 through A12.

(2) The E\ and W\ inputs are brought low, and G\ is brought high. The address is latched on the last falling edge of E\ or W\.

(3) The desired data is placed on DQ0 although DQ7.

(4) The E\ and W\ inputs are brought high, and R/B\ goes low. The data is latched on the first rising edge of E\ or W\.

(5) When the write operation is complete, R/B\ goes high to indicate that the chip is no longer busy and can be read or written to.

Not all EEPROMs have an R/B\ output to show when the EEPROM is able to be accessed. Some

EEPROMs permit you to determine ready and busy states by monitoring DQ7, which inverts the value of its last received bit until the write operation is completed. If all else fails, you can use software delays to ensure that the EEPROM is not accessed until a write operation has had enough time to complete.

As with EPROMs, there is a limit to how many times you can erase and reprogram an EEPROM, but the limits of the latter are much higher. They are typically 10,000 erase/write cycles, after which performance is not guaranteed.

EEPROMs are widely available in 8K, 64K and 256K capacities. Prices range from 2 to 10 times as much as those for an EPROM with the same capacity and access time. In particular, higher-capacity EEPROMs are expensive compared to EPROMs.

For many manufacturers' devices, EEPROM part numbering is similar to the conventions used for EPROMs, with "28" signifying an EEPROM device. Sometimes, 1 is added to the capacity to signify that the IC has a ready/busy output. For example, a Samsung KM2864 does

not have a ready/busy output, while a KM2865 does.

Battery-Backed RAM

A third memory IC option that permits fast, easy writing and reading is the nonvolatile RAM, or NVRAM. It consists of a static RAM (Random Access Memory) and battery backup circuitry. You can buy the RAM and backup circuitry in a single encapsulated package or create your own nonvolatile RAM by plugging an ordinary static RAM chip into a "smart" socket with battery backup.

A major manufacturer of nonvolatile RAMs and smart sockets is Dallas Semiconductor. Figure 4 shows the pinouts for a Hitachi HM6264LP 64K CMOS static RAM, a Dallas Semiconductor DS1213C SmartSocket and Dallas DS1225 64K nonvolatile RAM. Plugging the HM6264LP into the SmartSocket gives the equivalent of the DS1225. Other manufacturers make chips that are compatible in pinout and function with the HM6264LP, and RAMs of different capacities are also available.

Let's look at the HM6264LP RAM

MITSUBISHI ELECTRIC
Cobionetic
EMINENCE LOUDSPEAKERS
EPC PIONEER
JENSEN
VIOLET
ULTIMATE

BOSE
Tru-Spec
ALPS
GE
MG
PYRAMID
SK Series

DSC
PIC
SHER
chemtronics
SAR
MATSUSHITA
RAM

BK PRECISION
SAMS
comma
UNIVERSAL
NESTA
ZENI
SANYO

arista
Ev
LD
atatus
Or
COAX-SEA
FIS

SONY
Welle
GC ELECTRONICS
atatus
Or
COAX-SEA
FIS

NGAR
DURACELL
RCA
EVEREADY
Rocket
IBM
Acelite

CRAMOLIN
Switchcraft
AUTORAGE
FLUKE
Bib
audio-technica

MCM Electronics

We Can't Help Mentioning A Few Names

Although name-dropping is usually frowned upon, we'll risk it so you'll know the kind of company we keep...and that you can get almost any part you could ever want from our huge MCM Catalog. Choose from more than 17,000 items, most of them in stock and ready to ship within 24 hours! Talk to friendly, knowledgeable sales reps, get technical help when you need it and enjoy convenient, TOLL-FREE ordering. All GREAT reasons why you should be keeping company with MCM too!

Call TOLL-FREE, 1-800-543-4330, NOW to get your FREE SUBSCRIPTION to the MCM Electronics Catalog

MCM ELECTRONICS
850 CONGRESS PARK DR.
CENTERVILLE, OH 45459-4072
A PREMIER Company

SOURCE NO. ME-54

chip first. Then we'll see how the SmartSocket comes into play to make it nonvolatile.

Static RAMs store binary information in a matrix made up of flip-flops. Unlike dynamic RAM (DRAM), static RAM (SRAM) needs no periodic refresh signal.

The HM6264LP has 13 address inputs (A0 through A12), eight data input/outputs (I/O1 through I/O8) and four control inputs: OE\ (output enable), WE\ (write enable), CS1\ (chip select 1) and CS2 (chip select 2). Its pinout should look familiar to you because it also follows the standard used by the EPROM and EEPROM, with the exception of its second chip-select input.

To store a byte in the chip, the following process must occur:

- (1) The desired address is placed on A0 through A12.
- (2) Inputs CS1\ and WE\ are brought low and CS2 is brought high. The write process begins at the last transition among these.
- (3) The desired data is placed on I/O1 through I/O8.
- (4) The write ends when CS1\ or WE\ goes high or CS2 goes low.

To read a byte from the RAM, this process must occur:

- (1) Input WE\ is high.
- (2) An address is placed on A0 through A12.
- (3) Inputs CS1\ and OE\ are brought low and CS2 is brought high.
- (4) After a short delay, I/O1 through I/O8 contain the data stored at the specified address.

Unlike the case with EPROMs and EEPROMs, when power is removed from a static RAM, all data is lost. Thus, many static RAMs include a standby mode that makes it easy to provide battery backup for the chip.

On the HMS6264 and other static RAMs, when the chip is not selected (CS1\ is high or CS2 is low), standby mode is activated. As long as V_{cc} is at least 2 volts, all data is retained, but current consumption is reduced drastically, to as little as 1 microampere.

This is where the SmartSocket comes in! The SmartSocket contains a control circuit and a 3-volt lithium energy source. The control circuitry is provided by Dallas Semiconductor's DS1210 controller chip. The controller chip is mounted on a small printed-circuit board between the pins

of the SmartSocket. All pins on the SmartSocket pass directly through to the installed chip except pin 20 (conditioned chip enable) and pin 28 (V_{cc}).

To use the SmartSocket, you solder or wire it into a circuit in place of a memory IC and plug a static RAM into the socket. If V_{cc} should fall lower than 3 volts, pin 28 switches automatically to the lithium source, preventing the RAM's data from being lost.

In addition, the SmartSocket continuously monitors V_{cc}. If V_{cc} falls below 4.75 volts (or 4.5 volts, depending on the SmartSocket version), CS1\ is brought high to prevent reading and writing to the chip.

The data sheet for the SmartSocket specifies that 10 years or more of battery backup will be provided. To ensure that you get the full lifetime of the device, the battery is not activated until the socket is powered for the first time. The DS1225 NVRAM provides the same function as the DS-1213C and HMC5264LP, but in a single package. Prices for a SmartSocket and static RAM or NVRAM are comparable to EEPROM prices.

The 1213B SmartSocket can be

EASY TO USE CAD TOOLS

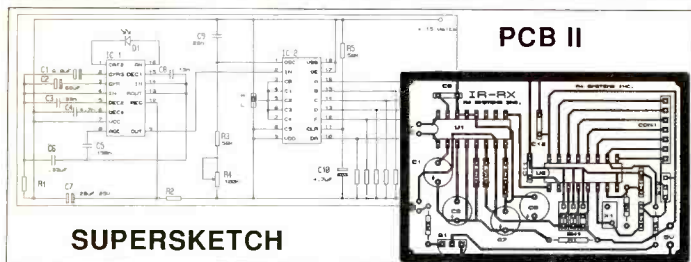

Easy to Use PC Software - ICON Based
 Ultra Fast Performance - Mouse Driven
 Complete With Advanced Editing Tools
 Output to Printers, Plotters & Lasers

PCB Design and Schematic Capture tools for the
 Hobbyist. Other packages for the Industrial User.

PRICES START AT \$149 US !!!

R4 SYSTEMS Inc.
 P.O.Box 451
 West Hill, Ontario
 Canada M1E 4Y9
 (416) 439-9302

Free Evaluation Package
 Write or Call To-Day

Download Demo from BBS at 416 289-4554 (2400/8/N/1)
 CIRCLE NO. 43 ON FREE INFORMATION CARD

COMPUTER SHOW SCHEDULE

PRODUCED BY KGP PRODUCTIONS SINCE 1980

- | | |
|-----------------------------|--|
| June 1
Sat.
10 to 3 | Edison, NJ - Raritan Center Expo Hall
NJ Turnpike Exit #10 - Rte. 514 West
700 Indoor Vendor Tables - BIG SHOW! |
| June 22
Sat.
10 to 3 | Willow Grove, PA - Geo. Wash. Conf. Ctr.
PA Turnpike Exit # 27 - Left at Toll
200 Tables - Near Philadelphia, PA |
| July 13
Sat.
10 to 3 | Parsippany, NJ - Aspen Manor Conv. Ctr.
Rte. 46 West - Past Wendys - Near I-80
400 Tables - in Northern New Jersey |
| July 27
Sat.
10 to 3 | Edison, NJ - Raritan Center Expo Hall
NJ Turnpike Exit #10 - Rte. 514 West
700 Indoor Vendor Tables - BIG SHOW! |
| August 3
Sat.
10 to 3 | Marlborough, MA - Royal Plaza Trade Ctr.
West of Boston - I-495 Exit 24-B-1 mi.
400 Tables-Fully Air-Conditioned Hall |

**SHOW OFFICE: (908) 297-2526
 OR FAX US AT (908) 422-0076**

CIRCLE NO. 32 ON FREE INFORMATION CARD

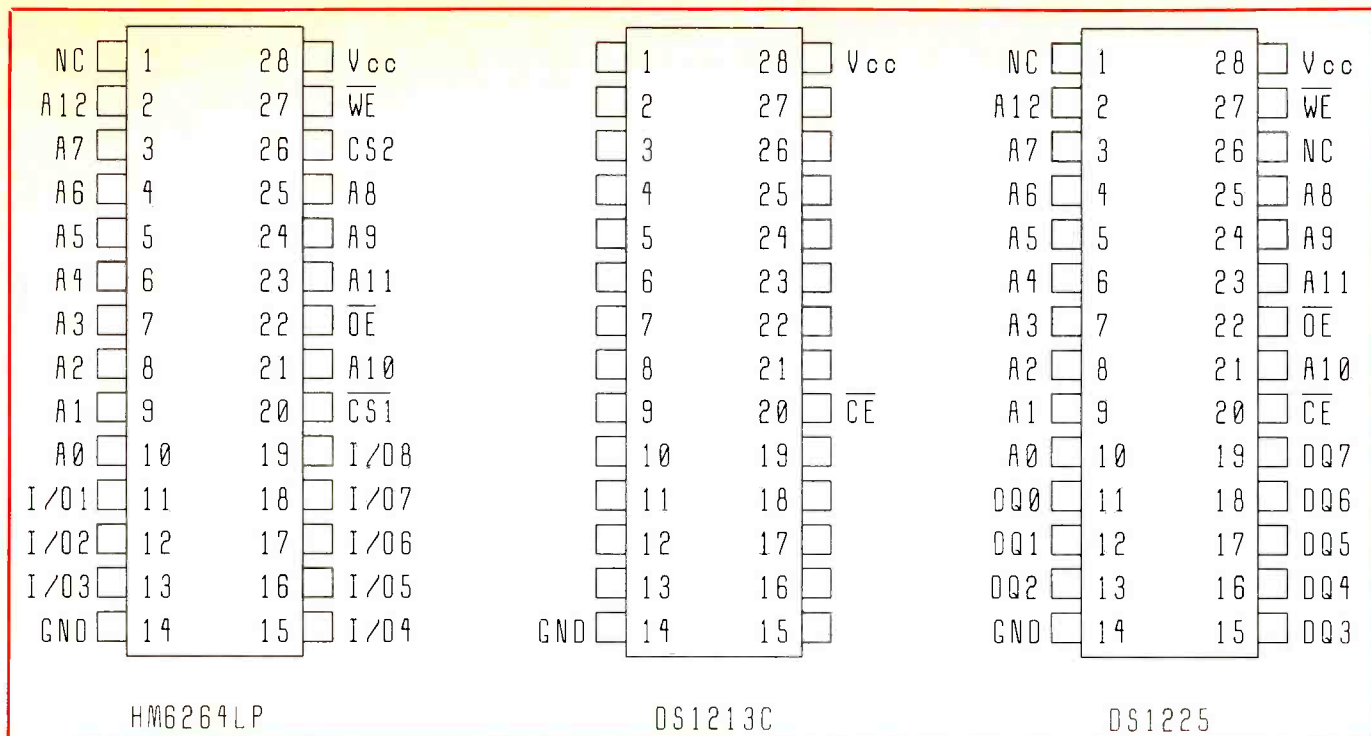

Fig. 4. The DS1225 64K nonvolatile RAM is the equivalent of plugging a static RAM like the HM6264LP into a DS1213C SmartSocket.

used with 16K and 64K RAMs. The 1213C version is suitable for 64K or 256K RAMs, and the 32-pin 1213D version will hold a 64K, 256K or 1,024K RAM. Complete NVRAM modules are available in capacities of 8K, 64K, 256K and 1,024K.

Unfortunately, the higher-capacity RAMs and NVRAMs differ slightly in their pinouts when compared to equal-capacity EPROMs. For example, on the 256K RAM, pin 1 is A14 and pin 27 is WE, while on a 256K EPROM, pin 1 is V_{pp} and pin 27 is A14. When the pinouts vary, if you want to allow EPROMs and NVRAMs of the same capacity to be interchangeable in a socket, you must provide movable jumpers or another means of swapping the affected lines.

Interfacing Memory ICs

For the most part, interfacing memory ICs to microprocessors is a straightforward procedure. Reading and writing to memory is done under microprocessor control, with the exact interface varying with the microprocessor and the memory ICs used.

Typically, the memory IC's ad-

dress and data pins connect to the microprocessor via the system's address and data buses. On a multiplexed address/data bus, where address and data share some of the same signal lines, the lower eight address lines can be stored in a digital latch during read and write operations. Output-enable pins of EPROMs, EEPROMs and RAMs are controlled by a READ output on the microprocessor, and the WRITE inputs of EEPROMs and RAMs are controlled by a WRITE output on the microprocessor.

With the memory-mapped input/output used by many microprocessors, each memory IC is seen as a set of addresses. Thus, address decoding circuitry controls the memory IC's chip-enable inputs.

When the microprocessor executes a read instruction, it places an address on the address bus, selects the desired memory IC and enables the memory IC's outputs. The memory IC then causes the data stored at the requested address to be placed on the data bus, where the microprocessor can read it.

When the microprocessor executes a write instruction, it places the data to be written and its desired address

on the data and address buses. A memory IC is selected, and a WRITE signal causes the data on the data bus to be written to the requested address in the selected memory IC.

Although EPROMs generally cannot be written to, or programmed, in-circuit, separate device programmers are available for programming EPROMs (and other nonvolatile memory ICs). Many device programmers interface to desktop computers. This allows you to write a program using a personal-computer-based assembler or compiler, and then download the assembled or compiled code from your desktop computer to the EPROM programmer, which, in turn, programs the EPROM with the code you have given it.

Choosing Memory ICs

Table 1 summarizes some differences among EPROMs, EEPROMs and nonvolatile RAMs. When choosing memory ICs, you must specify the following parameters:

- **Capacity.** Popular capacities for small systems are 8K (2,048 bytes), 64K (8,192 bytes) and 256K (32,768 bytes). A doubling of capacity often costs little.

Table 1. Device Comparisons

Device	EPROM	EEPROM	NVRAM
Cost	Low	High	High
Special Write/Programming Voltage Required	Yes	No	No
Erasure	Ultraviolet	Electrical	Electrical
Number of Erase/Write Cycles	100+	10,000+	Infinite

• *CMOS or NMOS Process.* The choice of manufacturing process for memory ICs is usually between CMOS and NMOS, with CMOS having lower power consumption and higher noise immunity, but slightly greater cost.

Low power consumption is especially important in battery-powered circuits. But even in circuits that are powered by ac line voltage, CMOS can help to reduce the size of your power supply's transformer and voltage regulator, as well as heat-sinking and cooling requirements.

• *Programming Voltage.* Many modern EPROMs use a +12.5-volt programming voltage, but some require +21 or +25 volts. Few modern EEPROMs require special programming potentials, and non-

volatile RAMs operate entirely from a +5 volt potential.

• *Access Time.* The address access time tells you how quickly a byte can be read from the IC. More specifically, it defines the amount of time between when an address is placed on the address inputs of a memory IC and when valid, stable data is available on the data outputs. Access times range from a low of 15 to a high of 450 nanoseconds.

Maximum allowable access time for a memory IC depends on its system microprocessor and clock speed. The microprocessor's data sheet will specify a maximum allowable time between when the microprocessor places an address on the address bus and when valid data must be present for reading on the data bus.

For example, the data sheet for the 8085 microprocessor calls this value t_{AD} and specifies that with a 6-MHz clock, t_{AD} must be 225 nanoseconds or less. So memory ICs that interface with the 8085 clocked at 6 MHz must have access times less than this value.

To find the answers to questions about a particular IC, your best bet is to consult its data sheet. Data sheets are available from the IC manufacturer. For a small charge, some vendors will send you a photocopy of the data sheet for a particular IC sold by them. At the end of this article is a list of vendors with good selections of memory ICs.

New developments for memory ICs include even greater capacities and faster access times at lower cost, made possible by such new technologies as flash memory and ferroelectric film. Also newly available are plug-in credit-card-sized memory modules that permit easy swapping of memory.

Future Topics

I welcome your comments, suggestions and questions on topics that relate to designing, building and programming microcontrollers and other small, dedicated computers. Send correspondence to Jan Axelson at *ComputerCraft*, 76 North Broadway, Hicksville, NY 11801. If you'd like a reply, please include a self-addressed stamped envelope. Though I cannot guarantee a personal response, I will try to cover requested topics in future installments.

Next time: reviews of two products for the popular 8051 family of microcontrollers—a low-cost board that uses the 80C32 chip and a new book on the 8051 that includes an assembler and simulator for the 8051 microcontroller on-disk. ■



Jan Axelson

Sources

Dallas Semiconductor
(NV RAMs, SmartSockets, data book)
4401 S. Beltwood Pkwy.
Dallas, TX 75244-3292
214-450-0448
FAX: 214-450-0470
Orders: 1-800-336-6933

1990 Memory Component Handbook
(No. 210830-009)

Intel Books
P.O. Box 58130
Santa Clara, CA 95052-8130
1-800-548-4725
FAX: 408-765-1596

Jameco
(static RAMs, EPROMs, EEPROMs)
1355 Shoreway Rd.
Belmont, CA 94002
415-592-8097
FAX: 415-592-2503

JDR Microdevices
(static RAMs, EPROMs, EEPROMs)
2233 Branham Lane
San Jose, CA 95124
408-559-1200
FAX: 408-559-0250

Newark Electronics
(static RAMs, EPROMs, NVRAMs, SmartSockets)
Local branch or write to:
4801 N. Ravenswood Ave.
Chicago, IL 60640-4496
312-784-4496
FAX: 312-784-5100, ext. 3107

MOS Memory Databook (1988, No. SMYD008)
Texas Instruments Inc.
Data Book Marketing
P.O. Box 117692
Carrollton, TX 75011-7692
214-242-0864

Why take chances in today's job market?

Graduate as a fully trained electronics professional.

To get ahead and stay ahead in today's economy, you need the electronics training CIE has been providing its 150,000-plus successful graduates with for nearly 60 years.

Meet the Electronics Specialists.

When you pick an electronics school, you're getting ready to invest time and money. And your whole future depends on the education you receive in return. That's why it makes so much sense to go with number one... with the specialists... with CIE!

There's no such thing as a bargain education.

If you talk to some of our graduates, and we recommend you do, chances are you'd find a lot of them shopped around for their training. Not for the lowest priced, but for the best training available. They pretty much knew what was available when they picked CIE as number one.

Because we're specialists we have to stay ahead.

At CIE we have a position of leadership to maintain. Here are just a few of the ways we hang onto it...

Programmed Learning.

That's exactly what happens with CIE's Auto-Programmed Lessons®. Each lesson uses famous "programmed learning" methods to teach you important electronics principles. You explore them, master them completely, before you start to apply them. You thoroughly understand each step before you go on to the next. You learn at your own pace.

And, beyond theory, some courses come fully equipped with electronics equipment to actually let you perform hundreds of hands-on experiments.

Experienced specialists work closely with you.

Even though you study at home, CIE's faculty and staff stand ready to assist via CIE's toll free number. And, each time you return a completed exam you can

be sure it will be reviewed, graded and returned with the appropriate instructional help, you get it fast and in writing from the faculty technical specialist best qualified to answer your question in terms you can understand.

Pick the pace that's right for you.

CIE understands people need to learn at their own pace. There's no pressure to keep up...no slow learners hold you back. If you're a beginner, you start with the basics. If you already know some electronics, you move ahead to your own level.

"Same Day" grading cycle.

When we receive your lesson, we grade it and mail it back the same day. You find out quickly how well you're doing!

State-of-the-art laboratory equipment.

Some courses feature the CIE Microprocessor



Training Laboratory. An integral part of computers, microprocessor technology is used in many phases of business, including service and manufacturing industries. The MTL gives you the opportunity to program it and interface it with LED displays, memory devices and switches. You'll gain all the experience

needed to work with state-of-the-art equipment of today and tomorrow.

New Courses!

CIE now offers two new career courses: Automotive Electronics and Computer Operation and Programming.

CIE offers you an Associate Degree.

One of the best credentials you can have in electronics — or any other career field — is a college degree. That's why CIE offers an Associate in Applied Science in Electronics Engineering Technology. And all CIE career courses earn credit toward your degree.

Which CIE training fits you?

Beginner? Intermediate? Advanced? CIE home study courses are designed for ambitious people at all entry levels. People who have: No previous electronics knowledge, but do have an interest in it; Some basic knowledge or experience in electronics; In-depth working experience or prior training in electronics.

At CIE you start where you fit and feel comfortable where you start, then go on from there to your Diploma, Associate Degree and career!

Today is the day. Send now.

Fill in and return the postage-paid card attached. If some ambitious person has already removed it, cut out and mail the coupon below. You'll get a FREE CIE school catalog, plus complete information on independent home study. Mail in the coupon below or, if you prefer, call toll-free 1-800-321-2155 (in Ohio, 1-800-623-9109).

YES! I want to get started. Send me my CIE school catalog including details about the Associate Degree program. (For your convenience, CIE will have a representative contact you — there is no obligation.)

AO13

Print Name _____

Address _____ Apt. _____

City _____ State _____ Zip _____

Age _____ Area Code/Phone No. (_____) _____

Check box for G.I. Bulletin on Educational Benefits Veteran Active Duty

CIE CLEVELAND
INSTITUTE OF
ELECTRONICS, INC.
1776 East 17th Street • Cleveland, Ohio 44114 • (216) 781-9400



A school of thousands.
A class of one.
Since 1934.

Computer "Wake-Up" By Phone

Turns your telephone into an automatic computer power switch!

Last month, we covered construction and operation of the Electrical-Storm Monitor. The Phone Monitor accessory presented here mounts inside the Storm Monitor and provides "wake-up" service for your computer system from any telephone in the world!

With this device, you get "around-the-clock" computer availability without leaving your computer on all day and night. This allows you to continuously service incoming phone calls, whether for dial-up databases, bulletin boards, electronic voice mail or other applications.

As you recall, the Storm Monitor provides your computer with early warning of approaching electrical storms. Because the unit can power up or down your system, it's logical to extend the project to include protection for your modem as well. After adding the extra relay required to disconnect the modem from the phone line, it was a simple matter to give the Storm Monitor the additional ability to turn on system power to your computer from your telephone. The circuit is straightforward.

Circuit Description

Notice the arrangement of "phone" relay *K2* in Fig. 1. When this relay is deenergized, it disconnects incoming phone lines from your computer's modem. It also shunts the modem phone-line inputs together and to earth ground. In the event that lightning strikes near your home or office, this will help bypass some of the induced electrical energy to ground. Relay *K2* is wired in parallel with relay *K1* on the Logic Card in the Storm Monitor project.

Now locate *C1*, a 1- μ F, 250-volt nonpolarized dc-blocking/ac-cou-

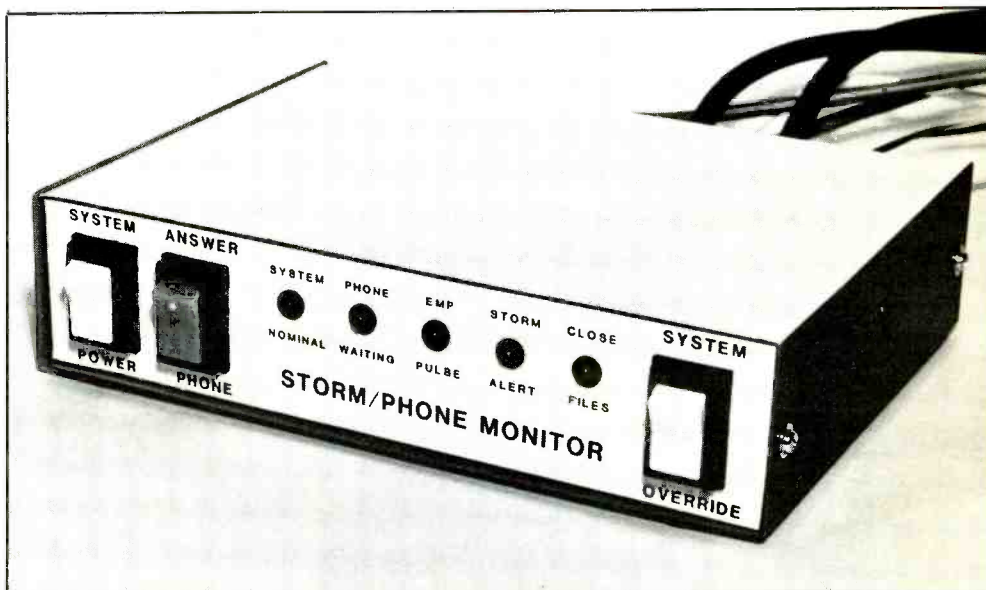

pling capacitor. When the telephone rings, a ring current is rectified by bridge rectifier *BR1*. The resulting pulsating dc signal is applied directly to optical isolator *U1*.

The value of *C1* was selected to provide ample but not excessive ring current through the LED inside *U1*. During normal telephone operation, *C1*'s dc-blocking action keeps *U1* from triggering. However, when the ac "ring" cycle occurs, the signal is coupled through *C1* and through *BR1* to trigger *U1*. This pulsating dc is isolated from the rest of the circuit by *U1*. It isn't desirable to connect any device from either side of the incoming phone lines to system ground inside your computer, let alone to the 117-volt ac line.

As the LED inside *U1* flashes, an open-collector phototransistor, also inside *U1*, pulls to ground the gate of *Q2*. This cuts off *Q2* and lets charge-current-limiting resistor *R5* begin to

source current through *D1* into integrating capacitor *C3*. This circuit integrates the ring pulses into a dc voltage that rises quickly, as each successive pulse adds more voltage to the charge on accumulated *C3*.

Notice that the positive (+) side of *C3* is connected directly to the noninverting (+) input of *U2*. This chip is a dual op amp configured to provide a comparator function in the circuit. Pin 2 of *U2* is biased to half the value of *V+* by the resistive divider made up of *R6* and *R7*.

As the telephone line rings and the ring pulses are integrated, the input voltage at pin 3 of *U2* increases until it exceeds the comparator threshold set by *R6* and *R7*. As this input voltage passes about 6 volts, the output of *U2* at pin 1 snaps high. This high output is routed to the Storm Monitor ANSWER PHONE switch mounted on the front of the project. Resistor *R8* provides positive feedback to the

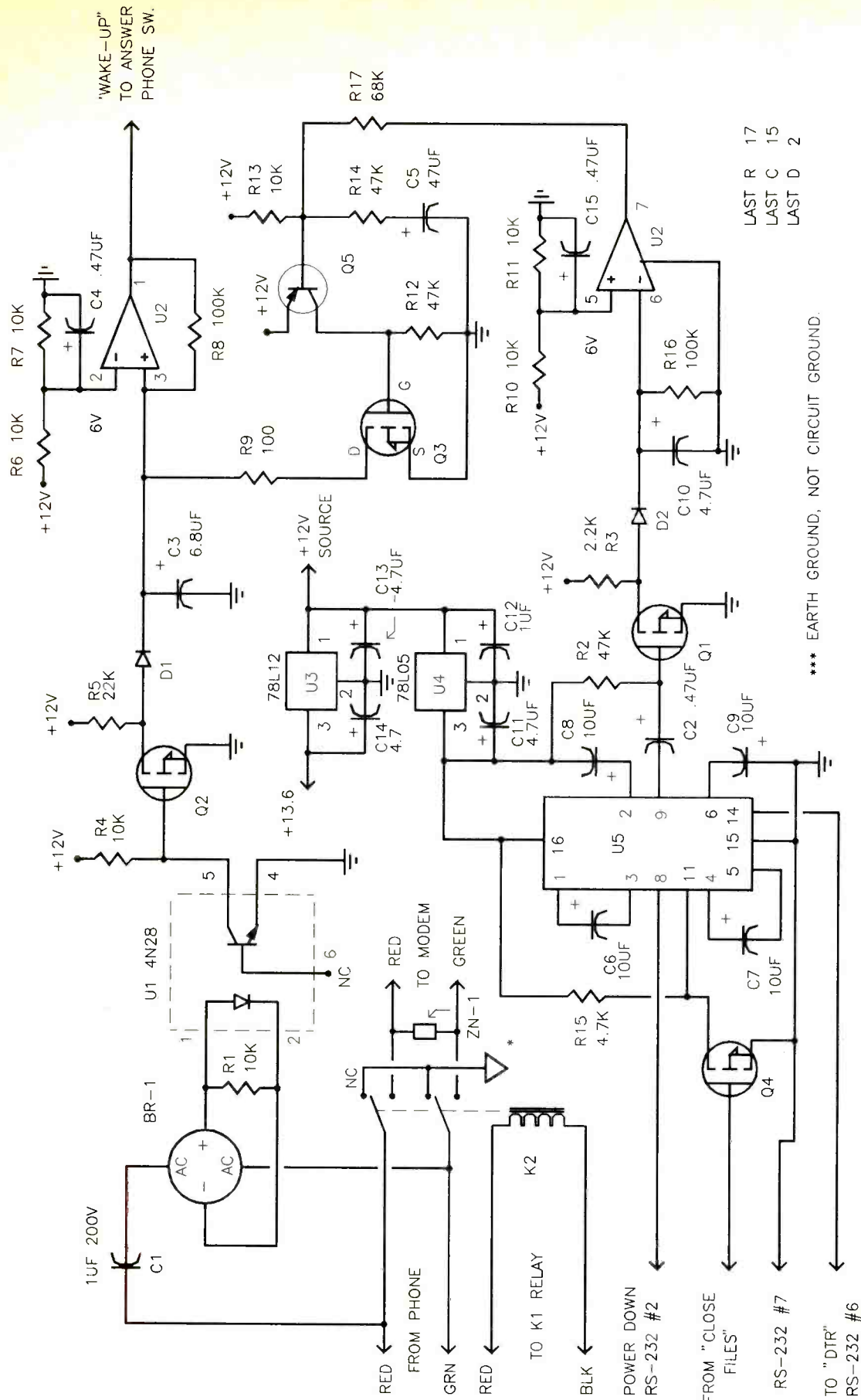

Fig. 1. Complete schematic diagram of the Telephone Interface card circuitry.

PARTS LIST

Semiconductors

BR1—1-ampere full-wave bridge-rectifier assembly
 D1,D2—1N4148 switching diode
 Q1 thru Q4—VN0300 field-effect transistor (Siliconix; Cyberlab Part No. 3124)
 Q5—MPSA56 silicon pnp transistor
 U1—4N28 optical isolator
 U2—LM358 dual operational amplifier
 U3—78112 fixed +12-volt regulator
 U4—78105 fixed +5-volt regulator
 U5—MAX-232 logic/RS-232 driver
 ZN1—Zener-type transient-voltage suppressor (Cyberlab Part No. 3124)

Capacitors (16-volt tantalum or electrolytic)

C2,C4,C15—0.47- μ F
 C3—6.8- μ F
 C5—47- μ F
 C6 thru C9—10- μ F
 C10,C11,C13,C14—4.7- μ F
 C12—0.1- μ F
 C1—1- μ F, 250-volt nonpolarized

Resistors ($\frac{1}{4}$ -watt, 5% tolerance)

R1,R4,R6,R7,R10,R11,R13—10,000 ohms
 R2,R12,R14—47,000 ohms
 R3—2,200 ohms

R5—22,000 ohms
 R8,R16—100,000 ohms
 R9—100 ohms
 R15—4,700 ohms
 R17—68,000 ohms

Miscellaneous

K2—12-volt dc relay with dpdt contacts (Aromat No. HB2E-DC12V)
 Printed-circuit board or perforated board with holes on 0.1" centers and suitable Wire Wrap or soldering hardware (see text); sockets for DIP ICs; male DB-25 connector with cover; 5' length of three-conductor cable; 10' telephone cable with male and female connector terminations.

Note: The following items are available from U.S. Cyberlab, Inc., Rt. 2 Box 284, Production Facility, West Fork, AR 72774 (501-839-8293): Complete kit of parts for Phone Monitor, including pc board, both cables and connectors, all ICs and other components, \$59.95; assembled Phone Monitor card, \$79.95. Also available separately is the pc board, \$9.95. Add \$2.95 P&H for pc board only, \$4.95 for full kit or assembled unit. (All orders shipped UPS ground, unless otherwise requested.) Arkansas residents, please add 5% state sales tax.

noninverting input of *U2*, creating a "latching" effect and essentially turning *U2* into an analog latch.

As you can see, when the Phone Monitor Interface card detects a ring signal, output pin 1 of *U2* goes high

and remains there. This assures you that power to your computer remains on until such time as you wish to shut down the system from software.

Shut-down action is provided by the next portion of the Phone Moni-

tor circuit. Locate *U5* in Fig. 1. This chip level shifts the incoming and outgoing RS-232 signal levels to and from the digital logic levels of 0 and +5 volts. RS-232 signal levels swing from about -12 to about +12 volts, and have been used for years as *the* serial-interface standard. The RS-232 interface allows you to use the Phone Monitor with *any* computer that supports the RS-232 interface.

Consider first the operation of *Q4*, which receives its input from the Storm Monitor Logic Card through the CLOSE FILES line. When the Storm Monitor detects an approaching electrical storm, it takes this line high. FET *Q4* inverts this signal and applies it to *U5*. In turn, this signal is converted into an appropriate RS-232 signal.

By connecting the "close files" signal to pin 6 of the RS-232 DB-25 connector, you can signal your computer system that power will be turned off in a few minutes. You can write a simple driver for your particular computer to have it flush the contents of RAM to disk before system power-down.

Pin 2 of the RS-232 connector connects through MAX-232 chip *U5* to *C2*. This line from your computer permits software control of the "hang-up" operation. By pulsing pin 2 (the output data on the serial port), a signal can be "pumped" through *D2* into integrating capacitor *C10*.

This circuit should look familiar to you by now. It's almost identical to the other section of *U2*. In this case, however, rather than acting on ring pulses from the phone line, it's a series of "power-down" pulses from your computer that cause output pin 7 of *U2* to drop from high to low. When pin 7 goes low, *Q5* conducts, pulling the collector up to near the +12-volt rail. This action at the gate of *Q3* causes this FET to also conduct, shunting the charge on *C3* to ground through *R9*. In this manner, the Phone Monitor can be made to power down your computer.

Construction

Construction of the Phone Monitor presumes you've already built last month's Storm Monitor. If you haven't already done so, finish build-

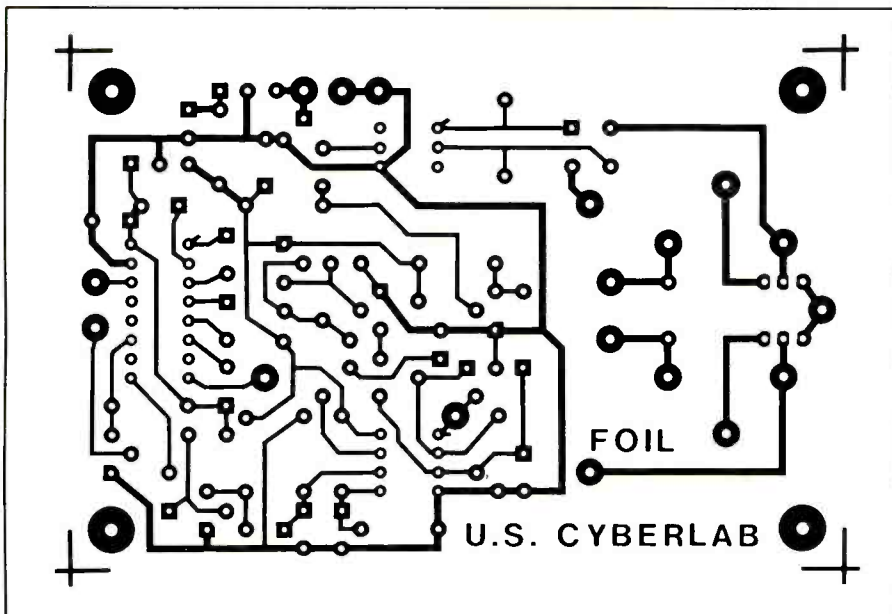

Fig. 2. Actual-size etching-and-drilling guide to use for fabricating your own printed-circuit board.

ing the Storm Monitor before tackling the Phone Monitor add-in. You need the Storm Monitor as a "platform" for the Phone Monitor.

A single-sided printed-circuit board accommodates all components that comprise the Phone Monitor circuit. If you wish, you can fabricate the pc board yourself, using the actual-size etching-and-drilling guide shown in Fig. 2. Alternatively, you can purchase a ready-to-wire pc board from the source given in the Note at the end of the Parts List. Another alternative is to build the circuit on perforated board that has holes on 0.1" centers, using suitable Wire Wrap or soldering hardware.

Whichever construction method you choose, use sockets for the three DIP ICs. From this point on, we'll assume you're using a pc board. Make whatever adjustments are needed in the instructions that follow if you build the project on perforated board.

Begin construction by installing and soldering into place the IC sockets. Do not plug the ICs into the sockets until after you've checked out the circuit and are certain that your wiring is correct. With the sockets in place, proceed to installation of the resistors and capacitors. Continue with installation of the transistors, bridge-rectifier assembly and relay.

As you install the electrolytic capacitors and diodes, make sure they're properly polarized before soldering their leads into place. Similarly, make sure the basings of the transistors and bridge rectifier are correct before soldering their leads and pins into place.

Set aside the Phone Monitor Interface card. Drill the four mounting holes for the card through the floor of the Storm Monitor enclosure. Retrieve the Interface card and solder the incoming phone line leads to it at the indicated hole locations. Solder the outgoing modem leads to the appropriate points on the card as well, followed by the coil leads for K2. Keep in mind that these two leads are connected in parallel with the relay coil leads of K1 in the Storm Monitor.

Next, connect the power and ground leads from the Logic Card to the Phone Interface card. Finally, connect the remaining five leads (ANSWER PHONE output, CLOSE FILES input, power-down pin 2 of the RS-232

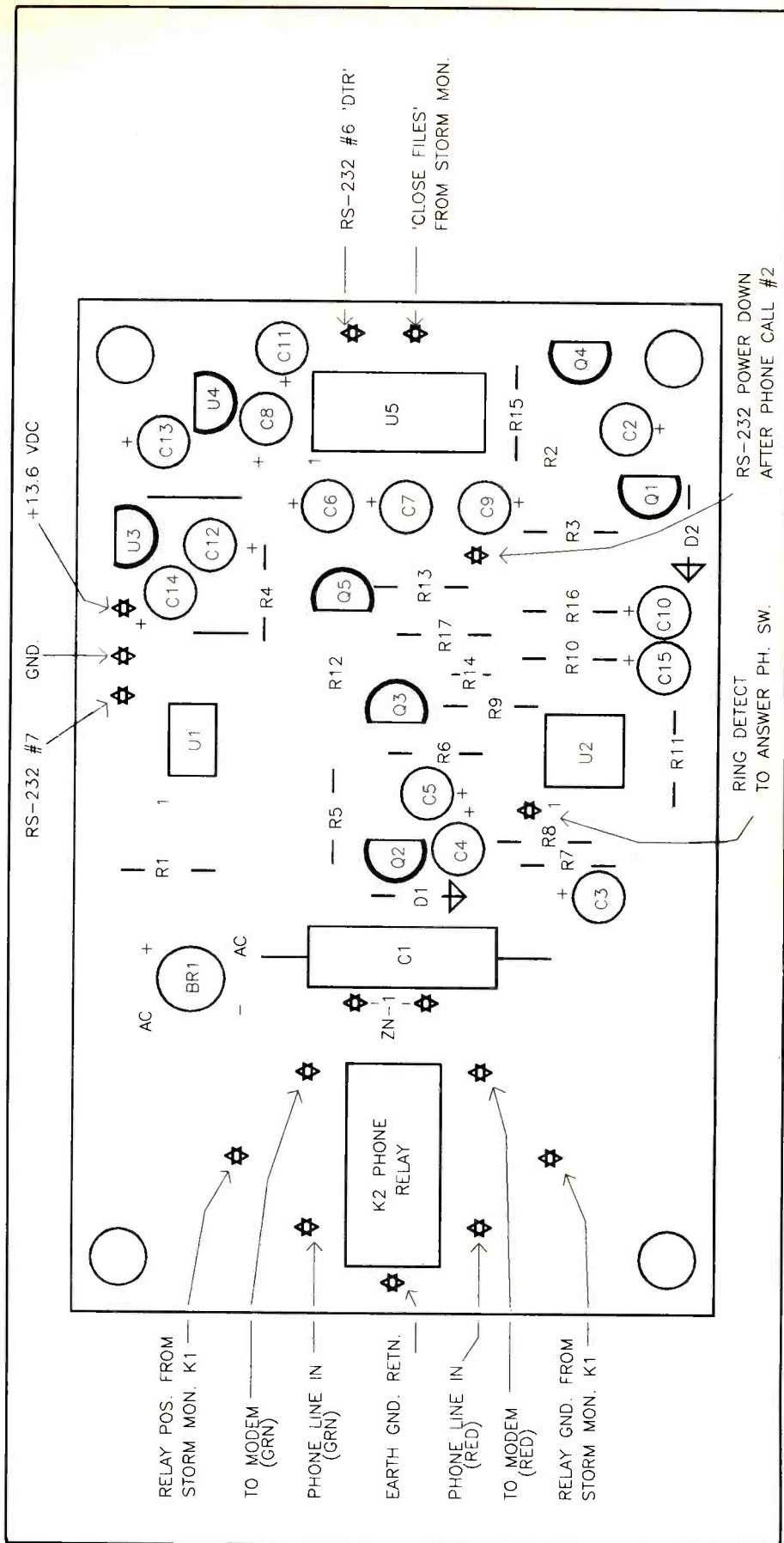

Fig. 3. Wiring guide for circuit-board assembly.

connector, DTR CLOSE FILES pin 6 of the RS-232 connector and signal ground pin 7 of the RS-232 connector to the Interface card.

Testing & Using It

Begin testing the project by applying power to the Storm Monitor. Use a dc voltmeter or multimeter set to the dc-volts function to check out the Phone Interface card. Clip the common lead of the meter to a convenient circuit-ground point in the project. Touch the "hot" lead to pin 8 of the *U2* socket and pin 16 of the *U5* socket. In both cases, you should obtain a reading of approximately +5 volts. Then touch the "hot" probe to pin 1 of regulator *U3* and pin 3 of regulator *U4*. You should obtain readings of approximately +12 and +5 volts, respectively.

If you fail to obtain the proper reading at any cited point, power down the project and correct the problem before proceeding.

Once you're certain that the project is properly wired, power it down and allow the charges to bleed off the

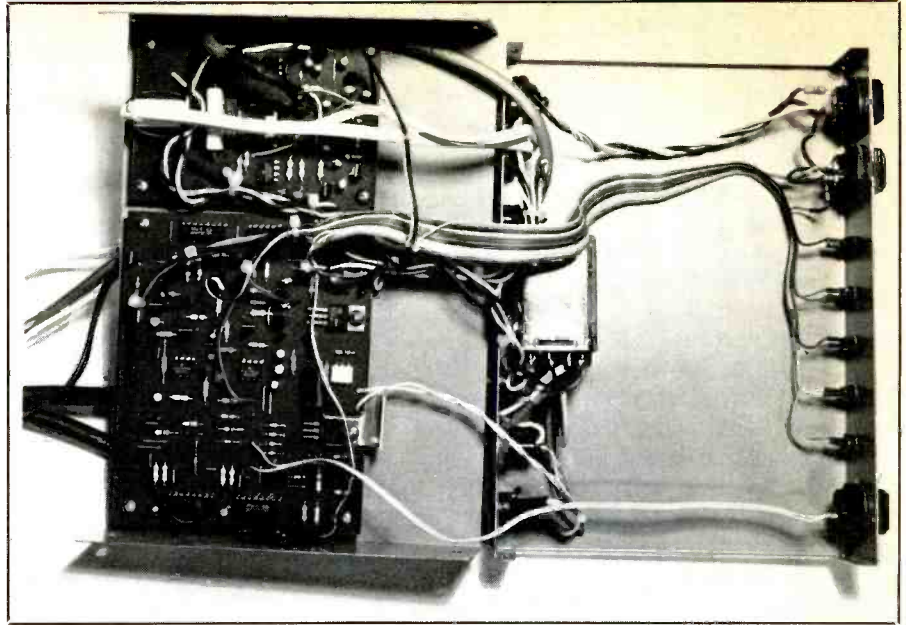

Interior view of author's completed Storm Monitor with Telephone Interface card installed.

electrolytic capacitors. Then plug the ICs into their sockets. Make sure each is properly oriented and that no pins overhang the sockets or fold under between ICs and sockets.

Power up the Storm Monitor and set the ANSWER PHONE switch to its up position, have someone call you to check the ring-detect circuit. As you first hear the phone ring, the relays in both sections of the project should audibly close and remain in this condition. This automatically powers up your computer system. At this point, it's up to your "batch" file to take over operation of your computer system. (AUTOEXEC.BAT on your IBM PC or compatible computer will load your modem or voice-mail software.) When your computer's software is up and running, it will detect the third or fourth ring incoming from the phone line and invoke an auto-answer via your regular modem or voice-mail peripheral card.

The Phone Monitor will continue to supply power to your computer system until you send a power-down "bit stream" to it over the RS-232 serial port. In the event a storm should approach while your computer is servicing a phone call, the Storm Monitor will automatically move into action. First, it signals your host computer that a storm has been detected (by sending a DTR signal to its

serial interface). Then it removes all power from your computer and isolates it from the incoming 117-volt ac power line.

Having checked out system operation, power down the project and install the Phone Interface card inside the enclosure, using appropriate hardware. When you're up and running again, you might try writing some utilities of your own to take advantage of all the features available in the Storm Monitor. For example, write a routine that automatically restores your RAM contents from disk after a storm-induced power down occurred. It's even possible to continue execution at the point where the program was interrupted. If you develop some unique application software for the IBM, Apple or Amiga computer, feel free to leave it on the U.S. Cyberlab Data Network (501-839-8293). We'll make it available to other Storm Monitor users. ■



Nick Goss

LEARN VCR

CLEANING/MAINTENANCE/REPAIR

EARN UP TO \$1000 A WEEK, WORKING PART TIME FROM YOUR OWN HOME!



Secrets Revealed!

NO Special Tools or Equipment Needed.

EARN UP TO \$60 AN HOUR AND MORE!

THE MONEY MAKING OPPORTUNITY OF THE 1990'S

IF you are able to work with common small hand tools, and are familiar with basic electronics (i.e. able to use voltmeter, understand DC electronics) . . .

IF you possess average mechanical ability, and have a VCR on which to practice and learn . . . then we can teach YOU VCR maintenance and repair!

FACT: up to 90% of ALL VCR malfunctions are due to simple MECHANICAL or ELECTRO-MECHANICAL breakdowns!

FACT: over 77 million VCRs in use today nationwide! Average VCR needs service or repair every 12 to 18 months!

Vlejo's 400 PAGE TRAINING MANUAL (over 500 photos and illustrations) and AWARD-WINNING VIDEO TRAINING TAPE reveals the SECRETS of VCR maintenance and repair—"real-world" information that is NOT available elsewhere!

Also includes all the info you'll need regarding the BUSINESS-SIDE of running a successful service operation!

FREE INFORMATION
CALL TOLL-FREE 1-800-537-0589
Or write to:
Vlejo Publications
5329 Fountain Ave., Dept. ME
Los Angeles, CA 90029

CIRCLE NO. 42 ON FREE INFORMATION CARD

B. G. MICRO

P. O. Box 280298 Dallas, Texas 75228

(214) 271-5546

FAX (214) 271-2462

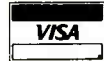

FAN

Brand New from McLean Eng.
A Division of Zero Corp.
Square 4-11/16" by 1.5"
Thick 10" Wire Leads
120V - 60Hz - 12 amps - 110CFM
Metal Housing - 5 Plastic Blades
UL and CSA Approved
\$5.95 ea.

BATTERY

Brand New - '91 Date Code
Rechargeable Sealed Battery
6 Volts @ 4 Amp/h
Measures: 4" Tall - 2-3/4" Wide
1-3/4" Thick - A Steal at
\$6.95 ea. or 4 for \$25.50

DISPLAY DEVICES

4MT07 By Futaba
Vacuum Fluorescent Clock
And Timer - 4 Digit Display
Easy to Read - Easy to Use.
.3" Character Height
With Data 79¢

LPT 1157AE
1.2" 5x7 Matrix Displays
5x7 Array with x,y select.
This Red Orange Matrix Can Be
Stacked Horizontally. Choice of
Two Matrix Orientation-Cathode
Column, Anode Row. Great For
"Moving Message" Signs.
\$1.19 Ea., 8/\$6.95, 100/\$75.00

74LS

LS00	.14	LS122	.35	LS241	.60
LS02	.14	LS123	.45	LS242	.65
LS03	.14	LS125	.30	LS243	.50
LS04	.14	LS126	.35	LS244	.55
LS05	.14	LS132	.35	LS245	.55
LS08	.14	LS133	.25	LS251	.45
LS09	.14	LS138	.35	LS253	.40
LS10	.14	LS139	.35	LS257	.35
LS11	.14	LS145	.75	LS258	.45
LS12	.20	LS148	.35	LS259	1.00
LS13	.25	LS151	.35	LS260	.40
LS14	.30	LS153	.35	LS266	.30
LS15	.20	LS154	.85	LS273	.75
LS20	.14	LS155	.50	LS279	.30
LS21	.16	LS156	.42	LS280	.80
LS26	.14	LS157	.30	LS283	.35
LS27	.20	LS158	.25	LS290	.70
LS28	.15	LS160	.25	LS298	.65
LS30	.14	LS161	.35	LS323	2.25
LS32	.16	LS162	.45	LS353	1.00
LS33	.25	LS163	.36	LS357	.80
LS37	.24	LS164	.45	LS363	.75
LS38	.24	LS165	.60	LS365	.30
LS42	.35	LS166	.75	LS367	.35
LS51	.15	LS169	.90	LS368	.30
LS54	.20	LS173	.60	LS373	.50
LS55	.20	LS174	.35	LS374	.45
LS74	.22	LS175	.35	LS375	.35
LS75	.25	LS181	1.25	LS377	.75
LS83	.30	LS191	.45	LS378	.80
LS85	.45	LS192	.65	LS390	.80
LS86	.20	LS193	.65	LS393	.75
LS90	.35	LS194	.40	LS399	1.00
LS92	.30	LS195	.52	LS541	1.20
LS95	.30	LS196	.55	LS645	.75
LS107	.28	LS197	.75	LS646	.75
LS109	.20	LS221	.50	LS670	.80
LS112	.25	LS240	.50		
LS113	.25	26LS32	.75		
LS114	.25	25LS2569	1.50		

THE \$25 NETWORK

Try The 1st Truly Low Cost LAN

- Connect 2 or 3 PCs, XTs, ATs
- Uses serial ports and 5 wire cable
- Runs at 115 K baud
- Runs in background, totally transparent
- Share any device, any file, any time
- Needs only 14K of ram

Skeptical? We make believers!

SUPER BUYS

2016 P-15
2K x 8 N-MOS
Trimmed Leads,
But will Fit in Sockets.
Super Buy
10/2.95 105/22.00

2N4401
Super 2N3904 NPN
Switching Transistor
40V-TO-92 - P.C. Leads
15/1.00 1000/20.00

80C32
C-MOSS By Matra
12MHZ
3.95

LM350T	2.65
LM338K	4.95
16L8-15 TI-B-PAL	1.25
8088-2	3.25
8742	7.00

CLOCK CIRCUITS

SAF3019	2.50
58321	2.50
146818	3.50

SOCKETS

Low Profile SOLDER TAIL	
6 Pin	14/1.00
8 Pin	13/1.00
14 Pin	13/1.00
16 Pin	13/1.00
18 Pin	13/1.00
20 Pin	13/1.00
22 Pin	13/1.00
24 Pin	8/1.00
28 Pin	7/1.00
40 Pin	7/1.00

BUY \$10
GET \$1.00 - FREE CHOICE

6500/6800

6502	2.00	6821	1.00
6520	1.25	6845P	2.20
6522	2.70	6845S	2.20
6530	3.00	6850	1.75
6532	4.25	6852	3.50
6545	2.10	6860	3.95
6551	2.40	68681	3.00
6800	1.40	68A09EP	1.29
6802	2.50	68A40	4.00
6803	3.00	68A54	3.00
6805	2.95	68B09	4.00
6809EP	2.75	68B10	2.00
6809P	2.50	68B45	4.95
6810	1.25	68B54	4.00

TEXT TO SPEECH BOARD

PC/XT COMPATIBLE. MAKE YOUR COMPUTER TALK!

PRICE CUT
\$69⁹⁵

ASSEMBLED & TESTED
ADD \$3.50 SHIPPING
& HANDLING



A VERY POWERFUL AND AMAZING SPEECH CARD. USES THE GENERAL INSTRUMENTS SPO256-AL2 SPEECH CHIP AND THE CTS256A-AL2 TEXT TO SPEECH CONVERTER.

THIS BOARD USES ONE SLOT ON THE MOTHERBOARD AND REQUIRES A COM SERIAL PORT. BOARD MAY ALSO BE USED IN A STAND ALONE ENVIRONMENT (EXTERNAL POWER SUPPLY) WITH ALMOST ANY COMPUTER THAT HAS A RS232 SERIAL PORT. TO USE THE BOARD IT IS ONLY NECESSARY TO SEND ENGLISH TEXT TO THE RS232 INPUT ON THE BOARD. THE BOARD INCLUDES A 1500 BYTE TEXT BUFFER AND HANDSHAKE LINE TO ALLOW YOU TO SEND DATA TO THE BOARD; THE SAME AS YOU WOULD SEND DATA TO AN RS232 SERIAL PRINTER. YOU CAN SET UP BATCH FILES THAT WILL MAKE YOUR COMPUTER GREET YOU WITH "GOOD MORNING MASTER," ETC. EVERY TIME YOU TURN IT ON. DEMONSTRATION SOFTWARE AND A LIBRARY BUILDING PROGRAM ARE INCLUDED ON A 5/4 INCH PC/XT DISKETTE. FULL DOCUMENTATION AND SCHEMATICS ARE ALSO INCLUDED.

FOR INFORMATION ON A LOW COST SPEECH SYNTHESIZER SYSTEM FOR THE VISUALLY IMPAIRED, PLEASE SEND FOR FREE PACKET T.M.1.

STAND ALONE POWER SUPPLY
FOR ABOVE
ADD \$2.50 SHIPPING & HANDLING

\$19⁹⁹

STATIC RAM

2016-2KX8 200 n.s.	1.00
2101-1 - 256X4 500 n.s.	.75
21L02-1 350 n.s.	.65
2102AL-4 L.P. 450 n.s.	.49
2111-1 256X4 500 n.s.	1.00
2112A-2	2.50
2114L-3 1KX4 300 n.s.	.45
2125A-2 1KX1 70 n.s.	1.70
2147 4KX1	1.95
6116P-4	1.20
6117	1.20
6264-15	1.40
62256 32KX8	6.50

EPROM SPECIAL

We bought a large quantity of 2708s, 2716s, 2532s, 2732s, 2764s, 27128s, 27512s and 27256s from a computer manufacturer who redesigned their boards. We removed them from sockets, erased and verified them, and now we offer the savings to you. Complete satisfaction guaranteed.

Your Choice	
2708	1.20 10/ 8.00
2716	1.75 10/15.00
2532	2.00 10/17.50
2732	2.00 10/17.50
2764	2.25 10/20.00
27128	3.20 10/27.50
27256	3.85 10/32.50
27512	5.50 10/48.50

DYNAMIC RAM

2108-4 8KX1	1.50
2118-4 16KX1-5Volt	.70
4027-4KX1-250 n.s.	.80
4116-16KX1-250 n.s.	.40
4116-16KX1-200 n.s.	.75
4116-16KX1-150 n.s.	.90
4164-64K 200 n.s.	.80
4164-150 n.s.	1.00
4164-120 n.s.	1.30
4164-100 n.s.	1.60
TMS4416-16KX4-150 n.s.	2.75
4464-150 n.s.	1.75
4464-120 n.s.	1.90
4464-100 n.s.	2.10
4464-80 n.s.	2.25
41256-150 n.s.	1.50
41256-120 n.s.	1.60
41256-100 n.s.	1.65
41256-80 n.s.	1.75
41256-60 n.s.	2.55
1 Meg - 100 n.s.	5.25
1 Meg - 80 n.s.	5.40
44256-80 n.s. 256 x 4	5.75

SIPPS & SIMMS AVAILABLE

THREE CHIP SET

16450, 1488, 1489

B.G. SPECIAL

\$6.95

8000/80000

8031	2.95	8251	1.10
8035	1.00	8253-5	1.75
8039	1.00	8254	1.80
8085	1.55	8255	1.50
8086	1.55	8255-5	1.75
8087	87.50	8257	1.50
8087-1	167.50	8259A	1.85
8087-2	127.50	8259C-5	2.10
8088	2.70	8275	10.95
80C98	.40	8279	2.25
8155	2.25	8284	1.49
8156	2.25	8286	3.50
8202A	8.00	8287	2.49
8212	1.25	8288	3.50
8214	2.00	8530	3.00
8216	1.25	8741	7.00
8224	1.25	8742	7.00
8228	1.75	8748	7.00
8237-5	2.80	8749	7.00
8243	1.75	8755	7.00
8250	2.95	80286-8 PLCC	8.50
(16450)	6.50	80287-8	125.00
(16550)	12.00	80287-10	135.00
		V-20-10MHZ	6.50

TERMS: (Unless specified elsewhere) Add \$2.50 postage, we pay balance. Orders over \$50.00 add 85¢ for insurance. No C.O.D. Texas Res. a 8 1/4% Tax. 90 Day Money Back Guarantee on all items. All items subject to prior sale. Prices subject to change without notice. Foreign order - US fun only. We cannot ship to Mexico. Countries other than Canada, add \$4.50 shipping and handling.

CIRCLE NO. 87 ON FREE INFORMATION CARD

SEND FOR FREE CATALOG!

SEND FOR FREE CATALOG!

A Parallel-Port EPROM Programmer (Conclusion)

Voltage checks, adjustments and using the Programmer

Last month, in Part 1 of this article, we discussed theory of operation and construction. In this concluding part, our focus is on getting the Programmer ready for using it and actual use.

Voltage Checks

Whichever method you chose to wire together the components, place the circuit-board assembly component side up on an insulated surface, and plug the free end of the three-conductor cable into *J2*. Place a fuse in the fuse holder, and set the POWER switch to OFF. Plug the line cord into an ac outlet.

Clip the common lead of a dc voltmeter or multimeter set to the dc-volts function to a convenient circuit-ground point in the project. Set the POWER switch to ON and touch the "hot" probe of the meter to the following points while noting the meter reading obtained: pin 20 of the *U1*, *U3*, *U4*, *U6*, *U11* and *U12*, and pin 16 of the *U2*, *U5*, *U7*, *U8*, *U10* and *U17* sockets. You should obtain a reading of about +5 volts. Touching the "hot" probe of the meter to pin 4 of the *U9* socket and the collectors of *Q1* and *Q2* should yield a reading of approximately +25 volts.

If you fail to obtain the proper reading at any of the points cited above, immediately power down the project and unplug it from the ac line. Rectify any problem encountered before proceeding.

When you are certain your project has been properly wired, power down and disconnect it from the ac line. Allow sufficient time for the charges to bleed off the electrolytic capacitors. Then plug all ICs, except

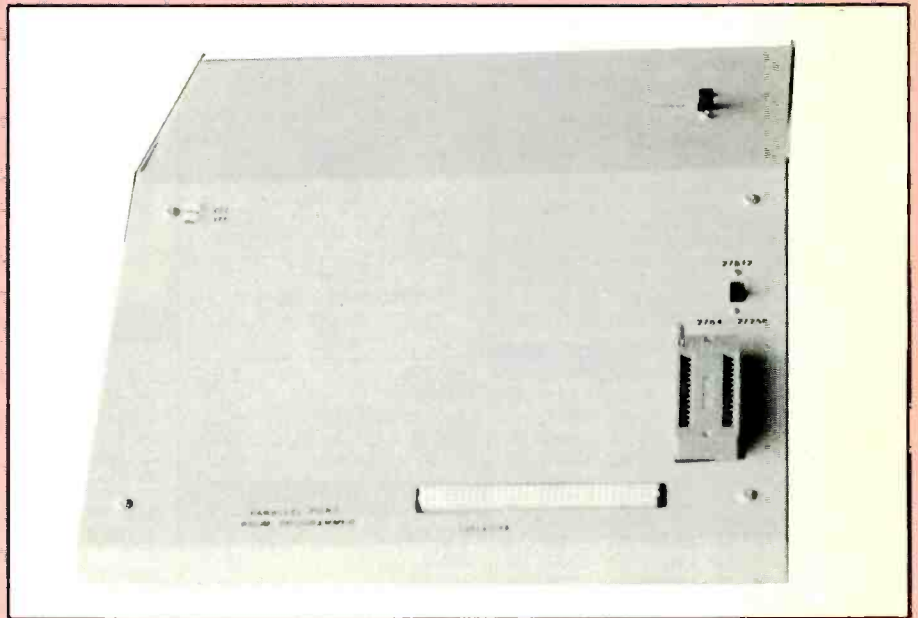

optional noise filter *UF*, into their various sockets. Make sure each IC plugs into the appropriate socket in the correct orientation and that no pins overhang the sockets or fold under between ICs and sockets.

Plug the LEDs into the holes you drilled for them in the front panel. If they fail to remain in place by friction, use a small spot of fast-setting epoxy cement to hold them in place.

Install a solid bare wire in jumper location *JP1*. Then mount the circuit-board assembly in place inside the enclosure using spacers and 4-40 machine screws, lockwashers and nuts. Spacer length should be the same as the height of the mounting tabs of *S1* above the surface of the board. When the circuit-board assembly is in place, plug the ribbon cable from the rear-mounted DB-25 connector

into the *J1* connector on the circuit-board assembly.

Adjustments

The software for the Programmer (see Note at end of Parts List) includes a diagnostic program for debugging the hardware. It provides some basic checks of the programmer circuits. The program "walks" a logic 1 through each of the data and address lines to permit you to use a voltmeter or oscilloscope to verify that each bit of the EPROM socket is wired correctly. It also provides a "Data Read Step Test" that writes a data value to the EPROM data register and then reads it back via the read shift register. This permits the entire write/read data path to be verified.

Four adjustments are required to get the Programmer working proper-

PARTS LIST

Semiconductors

LED1,LED2—Light-emitting diode
 OSC—2- to 4-MHz TTL DIP oscillator (optional for noise filter—see text)
 Q1,Q2—MJE3055 npn silicon power transistor
 Q3,Q4,Q5—2N2222 general-purpose npn silicon transistor
 U1—74LS244 tri-state octal line driver
 U2—74LS138 expandable 3-to-8 decoder
 U3,U4,U6,U11,U12—74LS374 tri-state octal D flip-flop
 U5,U8—74LS175 quad D flip-flop
 U7—74LS165 eight-bit parallel/in serial out shift register
 U8,U10—74LS175 quad D flip-flop
 U9—LM324 quad operational amplifier
 U13 thru U16—MPQ2222 quad 2N2222 in DIP package
 U17—74LS123 dual monostable multivibrator
 UF—74LS164 eight-bit parallel out shift register (optional for noise filter—see text)
 Z1,Z2—1N751 or similar 0.5-watt zener diode

Capacitors

C1—0.01- μ F Mylar
 C2—0.1- μ F Mylar

C3 thru C11,C13,C14,C15—0.1- μ F
 C12—Not used
 C16, C17—5- μ F, 50-volt electrolytic

Resistors ($\frac{1}{4}$ -watt)

(5% tolerance)

R1,R40,R42,R43,R30,R31,R40,R42,
 R43,R44—10,000 ohms

R2,R3—4,700 ohms

R20—150 ohms

R21—56 ohms

R22,R23—330 ohms

R32,R35,R38,R41—6,800 ohms

R39—1,000 ohms

(1% tolerance)

R6,R13—402 ohms

R7,R14—806 ohms

R8,R15—1,620 ohms

R9,R16—3,240 ohms

R10,R17—6,490 ohms

R11,R18—12,700 ohms

R12,R19—25,500 ohms

R24 thru R29—3,090 ohms

R33,R36—1,000 ohms

R34,R37—5,110 ohms

R4,R5—20,000-ohm, 10-turn pc-mount trimmer potentiometer

RP1,RP2—150- to 1,000-ohm eight-position resistor network in DIP package (see text)

Miscellaneous

J1—DP-25P connector (consists of

IDC DB-25P, 26-conductor ribbon cable, 26-pin IDC socket and 26-pin header)

J2—Three-pin MTA connector

J3—96-pin DIN connector (T&B Ansley No. FC096-031-3 or AMP No. B532504-1)

S1—Dpdt slide or toggle switch

SO1—28-pin ZIF DIP socket

Double-sided printed-circuit board or perforated board with holes on 0.1" centers and suitable Wire Wrap or soldering hardware (see text and Note below); sockets for all DIP devices; heat sinks for Q1 and Q2 (see text); small-diameter heat-shrinkable tubing; suitable enclosure (see text); components for power supply (see Fig. 2); terminal strips; rubber grommet; spacers; machine hardware; hookup wire; solder; etc.

Note: The following items are available from Stuart R. Ball, 741 Okie Ridge, Yukon, OK 73099: ready-to-wire double-sided pc board with plated-through holes, \$60; software on 5 $\frac{1}{4}$ " DSDD diskette, \$11.50. Oklahoma residents, please add state sales tax. For copies of the etching-and-drilling guides for both sides of the printed-circuit board, send a SASE (29 cents postage) to: ComputerCraft, PC Guides, 76 N. Broadway, Hicksville, NY 11801.

ly: V_{pp} and V_{cc} reference voltages and the time constants for the reference timers.

The V_{pp} and V_{cc} reference voltages need to be set to 4.2 volts. Though Z1 and Z2 are nominally rated at 5.1 volts, the actual voltage can vary somewhat. As a result, adjustment will probably be needed.

To adjust V_{pp} , use the diagnostic program to turn on the V_{pp} voltage. Use your dc voltmeter or multimeter set to the dc-volts function to measure the potential at pin 3 of U9. If the measured potential is between 4.1 and 4.3 volts, everything in this circuit is okay.

If pin 3 of U9 registers a potential that is greater than 4.3 volts, install a resistor in location RP (in parallel with R34) to bring the potential at this pin into the correct range. The value of this resistor will probably be in the range between 33,000 and 100,000 ohms.

To adjust V_{cc} , use the diagnostic program to turn on the V_{cc} voltage. Measure the potential at pin 5 of U9. If the measured potential is between

4.1 and 4.3 volts, no V_{cc} adjustment is necessary. If it is greater than 4.3 volts, install a resistor in location RC (in parallel with R37) to bring the voltage at this pin into the correct range. Again, the value of the resistor will probably be in the range between 33,000 and 100,000 ohms.

The two timers that are used by the software to control the width of the programming pulse also require adjustment. Run the diagnostic timer adjustment program. Connect an oscilloscope to pin 11 of the DB-25 connector, and adjust R4 for a low pulse width of 1 millisecond. Connect the oscilloscope to pin 13 of the DB-25 connector, and adjust R5 for a low pulse width of 100 microseconds.

It is possible that noise problems will occur on the cable that connects the Programmer to your PC, particularly if the interconnecting cable is long and especially if it is unshielded. Check for noise by running the diagnostic Data Read Step Test, holding down the space key on the computer keyboard to force the test to continuously repeat. If noise exists, the pro-

gram will report a data verify error, probably within a few seconds of starting the test. If an error is reported, you probably have noise on the -STB line to the programmer.

The optional noise filter consisting of UF and OSC is will eliminate the noise problem. To activate this circuit, remove or cut through the wire you installed at JPI and plug a 74LS164 in the UF socket and 4- to 10-MHz TTL DIP oscillator in the OSC socket on the circuit-board assembly. The noise filter filters rising edges on the -STB line.

Using the Project

The software that controls the Programmer consists of two parts. The main program, PROG, provides an interface to the user via the PC keyboard and display. There is also a PROM definition file for each EPROM type to be programmed. PROM definition files have a file-name extension of .PRG. For example, the software supports two versions of the 2764: 2764A.PRG and 2764B.PRG.

PROM definition files all have the same interface to PROG. Hence, adding new EPROM types is simply a matter of writing a .PRG file or modifying an existing file.

PROG lets you program, verify, blank check and read an EPROM. PROG accepts input files that are a binary image of the PROM data (like a .COM file) or files in Intel Hex format. Either standard or extended hex is accepted.

One important point about the Programmer: Since the Programmer redefines the functions of the pins on the printer port, PROG must directly manipulate the printer port registers. For this reason, the Programmer cannot be connected to a printer port that is not the standard LPT1: port, nor can it be used with print spooler programs.

This Parallel Port EPROM Programmer uses the PC keyboard and display to communicate with you. An EPROM can be programmed by entering all parameters on the command line that invokes the control program, or the programmer can be menu driven. To program a PROM

without using the menu, the command line should look like this:

PROG <ptype> <addr> <ptype>

<file> is the name of the input file to be programmed into the EPROM. PROG permits filenames to be up to 16 characters long, including extension.

<ftype> is the input file type; H is for hex and B is for binary.

<addr> is a hex offset address of up to four digits. An address entered here will be added to the EPROM programming address, permitting code to be moved up in the PROM. For example, if you have a binary file that is 8K long and you want to program it into the upper 8K of a 27256 (32K x 8) EPROM, you would enter an offset address of 6000.

<ptype> is the name of the EPROM type. PROG will add a file extension of .PRG to the name and then look for an EPROM definition file with that name. To program a 2764A, for example, <ptype> would be 2764A. PROG would then look for an EPROM definition file of 2764A.PRG.

This command line:

PROG CODE.HEX H 30 2764B

programs the hex file CODE.HEX into a 2764B with an address offset of 0030h.

When programming an EPROM, PROG first prompts you to install an EPROM (in the ZIF socket). PROG checks that the EPROM is blank and then programs it. After programming, the EPROM is verified against the input file.

You will probably find that, in developing embedded firmware, you frequently program updated versions of the same file, but with EPROMs from different manufacturers. This can be simplified with PROG by creating a batch file with the command line on it, as above. The last parameter, the EPROM type, is left off. This is then entered when programming, and is the only parameter that must be entered.

If you enter the PROG command line and leave off one or more parameters, PROG will prompt you for the missing information. If you enter no parameters, PROG will

display the main menu as follows:

PROG - PROM PROGRAMMER
CONTROL PROGRAM

1 = PROGRAM A PROM
2 = READ A PROM INTO A DISK FILE
3 = VERIFY A PROM AGAINST
A DISK FILE
4 = BLANK CHECK A PROM
5 = REPEAT THE PREVIOUS
OPERATION
6 = TURN ON PROM VCC READ
VOLTAGE
7 = TURN ON PROM VPP VOLTAGE
ESC = RETURN TO DOS

Option 1 programs an EPROM. Option 2 reads the contents of an EPROM into a disk file. The output file is in binary format, where the first byte of the file is the first byte read from the EPROM. Option 3 verifies an EPROM against a disk file. (The file can be in hex or binary format.) Option 4 checks an EPROM to ascertain that it is blank. Option 5 repeats the last operation, using the same parameters. This option is particularly useful if you must program several EPROMs with the same information. Options 6 and 7, included to simplify development of new EPROM personality hardware, turn on the V_{pp} and V_{cc} voltages so they can be measured.

When you select a menu option, PROG prompts you for the necessary information to perform the operation.

PROG prints various messages while running. While performing a blank check of the EPROM, PROG prints the message:

BLANK CHECKING BLOCK xx

where xx is the block that is being checked. The value of xx is derived from the upper eight bits of the 16-bit PROM address and is displayed whenever the lower eight bits of the address are 0s. This approach has the advantage of displaying an indication of where in the EPROM the data is going. The disadvantage is that it may not be regular. For example, if you had a hex-format file that programmed only odd PROM addresses, the message would never be displayed.

When programming or verifying an EPROM, PROG displays a block message similar to the blank check message. Locations that are not blank during blank check, or locations that fail to program and verify cause an error message to be generated and displayed. ■

**LEARN TO
CLEAN/MAINTAIN/REPAIR
FAX MACHINES**

HUGE NEW UNTAPPED MARKET!



**EARN
\$65/HR!**

Over 8 million Fax machines in homes/ offices - predictions are for over 25 million by 1992!

- Work from your home/van
- Home study program gets you started servicing fax machines in 2 weeks!
- No special tools/equipment needed
- Earn additional profits selling fax supplies!
- Fax machines are not cheap - therefore, you can get good \$\$ for the repair
- Average Fax machine requires professional service every 18 months.
- Home study training program includes full instructions on EVERY ASPECT of Fax maintenance/repair. FULL COVERAGE of how to set up your home-based service business

FREE DETAILS
CALL 1-800-537-0589
Or Write to: Viejo Publications, Inc.
5329 Fountain Ave. Dept. FX400
Los Angeles, CA 90029

CIRCLE NO. 41 ON FREE INFORMATION CARD

TOP SECRET

CONSUMERTRONICS

2011 CRESCENT DR., P.O. DRAWER 537
ALAMOGORDO, NM 88310
1-505-434-0234
FAX 1-505-434-0234 (orders only). Mon.-Sat.
8AM-9PM MST Voice & Manual FAX 9PM-8AM
Auto. FAX. Add \$4 ship (USA, Canada). All items
are in stock. COD (UPS cash only), VISA, Master-
Card OK. FREE CATALOG with order, else \$2.
In business since 1971. As seen on TV John
Williams - former Senior Engineer (Lockheed),
NMSU Professor of Computer Science.

OFF-THE-SHELF HARDWARE

Van Eck System, Shriek Module, Voice Dis-
guisers, Hearing Assistant, Diabets Alarm, 6th
Sense Communicator, The Levitator, Resonant
Coils, Biomedical Stimulators, Fax Junk Call
Killer, Long Range Eavesdropper - mono/Assem-
bled and tested (no kits). \$7 for descriptions.

COMPUTERS

HARD DRIVE MANUAL

Relates to all hard drive and controller implemen-
tations (emphasis on PCs). How to select, interface,
initialize, set up, use, maintain, troubleshoot and
repair them. How to protect them from mistakes,
sabotage, prying eyes, sticky fingers. How to
recover damaged and lost files. Includes software
reviews. Loaded with info, advice and tips. \$29.

DISK SERVICE MANUAL

Maintain, troubleshoot, repair, adjust, align floppy
drives without special equipment or software -
5.25"/3.5"/8", PC/XT/AT/386/486, Apple, Com-
modore, Kaypro, Tandy, Epson, Atari, TI, HP, DEC,
etc. systems. All floppies need regular upkeep. \$29.

DISK DRIVE TUTORIAL

Theory and practical facts on floppy drives,
disks, FDCs, formatting, software protection
Systems described above. Invaluable advice and
tips on how to best select, interface and use
drives and disks. \$19.

PRINTER/PLOTTER MANUAL

Types, descriptions, specs and 100+ interfaces
(parallel, serial). Detailed plans for X-switchers,
buffers, and serial-to-parallel and parallel-to-
serial interfaces, breakout devices. Many buy,
use, service, repair tips. \$19.

SUPER RE-INKING METHOD

Re-ink cloth ribbons for about 50 cents and 10
minutes each. Plans for el cheapo motor-driven
re-inker. Commonly used ink (5 colors) and
carrier described. \$9.

COMPUTER PHREAKING

20+ COUNTERMEASURES, VIRUSES, WORMS, etc. and
countermeasures. Includes disk with 250K+ of
hacker text files and utilities and legendary
FLUSHOT+ protection system (Ed. Choice, PC
Magazine). Dozens of computer crime and abuse
methods and countermeasures. How systems
are penetrated, BBS advice, password defeats,
glossary, much more! Manuals + Disks* \$39.

BEYOND VAN ECK PHREAKING

Eavesdropping on VDT and TV video signals
using an ordinary TV! Ranges up to 1 KM. Plans,
countermeasures. Includes legal Van Eck uses,
and original Top Secret Van Eck design! \$29.

ABSOLUTE COMP. SECURITY

Dozens of simple, versatile, secure computer
security methods and tips. Plus our invulnerable
Cipher Program (in COM and its BAS source).
Plus \$1,000 CIPHER CONTEST rules
with ciphertext. Manual + Disk* \$29.

CRYPTANALYSIS TECH.

Five powerful menu-driven crypto programs (in
COM and their BAS sources) to analyze, decrypt
"secure" ciphertexts. Worked-out examples.
Recommended in the prestigious COMPUTERS
& SECURITY. Manual + Disk* \$29.

SOFTWARE PROTECTION

Unique system that highly discourages costly
software piracy while not interfering with legit
archival copies. No known way to defeat. No
special equipment required. Easy, automatic to
install on your disks. Can be used with any other
protection system. Manual + Disk* \$59.

BRAIN VIRUS ANTIDOTE

The PAKISTANI BRAIN VIRUS plagued dozens
of institutions, businesses. The mildly destructive
original version has been hacked into highly vir-
ulent strains. BVA consists of the antidote, source
code and write-up. Disk* (NOT infected) \$19.

AL DEVELOPMENT SYSTEM

Powerful program for creating/editing AL source
code. Like sophisticated wordprocessor with many
unique and powerful AL features. Includes tutorial
and program for integrating AL routines into
compiled BASIC programs. Manual + Disk* \$29.

C DEVELOPMENT SYSTEM

Powerful program for creating/editing C source
code. Like sophisticated wordprocessor with
many unique and powerful C features. Manual +
Disk* \$29.

*Software supports PC DOS, MSDOS, PS/2;
Mono., Herc., CGA, EGA, VGA; 5.25", 3.5", hard
(specify your floppy drive size).

ELECTRONICS

PHONE COLOR BOXES

Designed by Phone Phreaks! 15 phone color boxes
described. Dozens circuits, programs. Plus call for-
warding, conferencing, phreak history Plus 50 useful
and legal phone circuit plans. More! Manual \$29.

ROBOFONE AUTODIALER

Powerful, versatile, menu-driven program allows
you to dial any number (up to 10K) or mix of local and
long distance numbers in any order, over any length
of time, whether busy or answered (your choice) and
log the times, commands and results to monitor,
printer and/or disk. Quick-dial directory of up to 600
numbers. BUSY redial options. Direct modem com-
mand and control. All result codes, including Voice
and Ringing. Optional shell to terminal program
under Connect. Exit to menu or DOS (for batching).
Ideal "Wargames" power dialer, phone call logger
and telemarketing dialer. Manual + Disk* \$29. With
compatible LABELS and LETTERS programs \$49.

VOICE MAIL BOX HACKING

How Voice Mail Box (VMB) systems are used and
the specific ways they are hacked. Includes
ASPEN, MESSAGE CENTER, BIX, EZ, SYDNEY,
PHONE MAIL, AUDIX, etc. Absolutely required for
all vsops, userst! \$29.

VOICE DISGUISER

Plans for neat devices to change voice pitches.
Effective against snoops using voice analyzers; to
conceal gender for women living alone; for anti-
intrusion systems; for music accompaniment, for
gags. Voice sounds natural. \$19.

PHONE RECORD. INTERFACES

Plans for undetectable (ultra-hi input impedance),
indestructible TELERECORDER to record phone
conversations. Also monitors for bugs and taps
Plus simple FM xmtr addition and the ear-
piercing SHRIEK CIRCUIT plans. \$14.

RADIONICS MANUAL

Exciting electronic and electromagnetic therapeutic
and diagnostic devices (mostly experimental).
History, descriptions, plans (dozens), availabilities
of Radionics Devices from early to modern. \$29.

HEAL THYSELF

Many electronic medical devices are now licensed
by the FDA for therapies. Plans for three major
different devices that you can build and use
yourself. Save \$ Thousands! Plus details on many
other devices. \$19.

BIO-SPECTRUM ANALYSIS

Summary of the biologic effects of electromagnetic
fields from DC to the near-infrared (0-300 GHz).
Bands include 6 ELF, VLF, LF, MF, HF, VHF, UHF,
SHF, EHF. Special emphasis on DC, 50 Hz, 60 Hz,
2.45 GHz (microwave ovens), 3 GHz (radar).
Graphical spectrum display includes frequency,
researcher, date, source, effects, subject type and
signal attributes. Also includes FCC assignments
and physical properties. \$29.

EM BRAINBLASTER

Tutorial and plans for powerful ELECTROMAG-
NETIC WEAPONS and LAB DEVICES. Optimum
circuits, freqs, waveforms, intensities. Compre-
hensive. MIND BOGGLING! \$29.

UNDER ATTACK!!

ELECTROMAGNETIC INTERFERENCE (EMI) and
ELECTRONIC WEAPONS cause INEXPLICABLE
MANIFESTATIONS! These attacks can cause
cancer, birth defects, psychological and neurological
disorders, cardiovascular and immune system
failures, etc. Destructive to people, pets, livestock,
plants, equipment. INCLUDES ACTUAL CASES
(which we have investigated and documented) OF
ATTACKS ON PEOPLE BY EM WEAPONS! And
includes how you can verify and pinpoint the source
of the EMI/electronic attack, and specific counter-
measures you can take. \$39.

HIGH VOLTAGE DEVICES

HV devices plans: Stun Gun, Taser, Prod, Cane,
Umbrella, Zapper, RF/Radar/Audio Jammer,
Flasher, Blaster, Jacob's Ladder, Plasma and Van
de Graaff Gens., Fence Charger, Geiger Counter,
Ozone Gen., Fish Stunner, Pest Killer, Plant Stimu-
lator, Kirlian, Magnetizer, etc. SHOCKING! \$29.

SECRET & SURVIVAL RADIO

Optimum survival and security radio equipment,
methods, frequency allocations and voice/data
scrambling/encoding. Includes small receivers/
xmtrrs, telemetry, antenna optimizations, remote
monitoring and control, security, surveillance, and
ultrasonic, fiberoptic and infrared commo. More!
70+ circuit plans, tables. \$29.

TV DECODERS/CONVERTERS

Tutorial and plans for several TV decoders and
converters. Plus satellite TV component purchase
and use tips. \$14.

STEALTH TECHNOLOGY

Police radar is fascinating. It also has error rates of
10%-20%! Every known: Error mode - Method and
material to minimize radar reflections - Strategy
and tactic to fight unjust radar tickets (that cost
you a fortune in insurance) - Method to detect and
jam signals - fully described! \$19.

THE "GOLDFINGER"

Tired of digging up rusty nails and bottle caps?
The "Goldfinger" detects GOLD, SILVER, PLAT-
INUM, COPPER and ALUMINUM while rejecting
all ferromagnetics. Plans. \$14.

THE "SILKWOOD"

The "Silkwood" detects X- and Gamma Rays, and
Alpha and Beta particles. Simple, pocket-size, 9-
volt battery-operated rad detector requires no
Geiger-Mueller tubes or high voltages. 95%
linearity between 10-1,000 rads/min. Indicates to
less than 0.1 rad/min. Check out your job, home,
possessions. Prospect for minerals. And a lifesaver
for nuclear survival situations. Plans. \$14.

POOR MAN'S SUPER LASER

Ruby rod laser plans. Used in intrusion systems,
weapons targeting, precise optical alignments,
seismography, signaling and commo, strobes,
holography, science projects, etc. Includes a list of
dozens of sources for ruby rods and other parts. \$14.

AIR COILS

AIRCOKLS is a powerful scientific program for
designing round and square air coils. Returns
inductance/number-of-turns when number-of-
turns/inductance and dimensions are specified.
Returns min. wire gauge for any current, and
capacitance for LCs. Disk* \$19.

ENERGY

KW-HR METERS

How watt-hour meters work, calibration, error
modes (many), ANSI Standards, etc. Demand, Pole
and Polyphase Meters. Experimental results. \$19.

STOPPING POWER METERS

As reported on CBS 60 MINUTES! How certain
electrical loads (simply plugs into an outlet) can
slow down watt-hour meters - even stop them -
while drawing full load! Also describes meter
creep, overload drop. \$19.

THE I.G. MANUAL

External magnetic ways to slow down and stop
watt-hour meters while drawing full loads. \$19.

GAS FO' ALL

Every known vulnerability of gasoline and diesel
fuel pumps and dispensers. \$19.

LIBERATE GAS & WATER

How gas and water meters can be reversed using
simple household equipment. \$19.

VORTEX GENERATOR

Heat/cool with simple, amazing 3-port device. Uses
no moving parts, electricity, fossil fuel, liquid or freon.
Guaranteed scientifically sound. Plans. \$14.

LOADFINDER

Quick, simple, accurate and inexpensive method to
determine the inductance and resistance of any AC
load (in situ) between 0.1 and 100 amps, and the
capacitance for PF=1. Real power, imaginary power
and apparent power explained, and how each affects
your bill! Requires only an AC voltmeter, the simple
circuit described and high school algebra ability.
Completely worked out example. Save energy! \$9.

MDVR METHOD

Plans for the effective and inexpensive MDVR
Method to legally save electrical energy (30%-
60%!): Develops optimum efficiency, safety and
versatility, and saves wear and tear - all without
significant loss of performance or service. \$12.

RIPPLED OFF!

Line ripple and transients waste money, cause
equipment to malfunction, lose data and endanger
users. And utilities use line current ripple to
remotely control your equipment and the dreaded
Peak Demand Meter! Includes plans for ripple/
transient eliminator. \$9.

FINANCIAL

ATM'S

ATM crimes, abuses, security, vulnerabilities. 100+
methods described - from Reg. E to ciphers. Case
histories, law, countermeasures, detailed security
checklist. Internal photos, figures! Still unsolved. One
crook stole \$237,000 from one bank's ATM's! \$39.

CREDIT CARD SCAMS

Cardholders, merchants and banks suffer \$ Billions
losses annually because of credit card fraud.
Describes every known means of credit card fraud
and scams. Protect yourself! \$29.

CREDIT REPORTING ENTITIES

Giant commercial and government databases
now contain millions of financial, employment,
medical, family history, lifestyle, criminal, religious
and political files on most Americans. These files
are instantly accessible to thousands of people.
Data is often erroneous, incomplete, obsolete or
repetitious - often costing people credit and jobs -
even their freedoms! How to protect your privacy
and security. Comprehensive. \$29.

ULTIMATE SUCCESS MANUAL

Underpaid? Harassed? Manipulated? Sluck in a
dead end job? Expect to be laid off or fired? Sick of
office politics? Job/division/company moving to
Timbuktu? The ultimate no-hold-barred Machiavel-
lian techniques for finding, obtaining, optimizing
and keeping top jobs and benefits. THE RULES OF
THE GAME FOR A GAME WITHOUT RULES!
From resume to CEO. \$29.

GOVERNMENT LAND GRAB

You can force the Government to sell you prime
land at ridiculously low prices with no competing
bids allowed because of a little-known 100+ year
old Federal Law! One man legally forced the Gov-
ernment to sell him 160 acres of prime forest land
for \$400 - appraised at \$1,600,000! Another got
19 prime acres in Phoenix, AZ for \$47 - appraised
at \$376,000! Complete details and proof. \$19.

STOCKPRO

Unique, powerful, shrewd, unconventional
common stock investment strategy. Created for
NMSU, and basis of expensive consulting
system. Manual + Disk* \$29.

PHYSICAL SURVIVAL

ORDER OF THE MAGNITUDE

THE MOST COMPREHENSIVE SURVIVAL BOOK
EVER WRITTEN! Topics include electronics, com-
puters, energy, weapons, concealment, revenge,
alarms, etc. Helps you survive today and in the
Day After. Absolutely required! Field-expedited
use of technology typically in a lower-intensity
conflict environment. C4I emphasis. \$49.

SURVIVAL GUNS & AMMO

THE ULTIMATE FIREARMS SURVIVAL MANUAL!
Describes optimum guns and ammo, conversions,
silencers, explosive devices, improvised
weapons, End Times scenarios, retreats, etc. \$19.

SILENCE IS GOLDEN

How acoustic silencers are designed from simple,
cheap, commonly-available materials. \$9.

ROCKET'S RED GLARE

How to design and build solid-propellant amateur
and survival rockets. Special emphasis on the
formulation, manufacture and installation of
propellants, motors, igniters, etc. Includes list of
commonly available materials. And the design of
launch pads and electronics. \$29.

COMBAT/SURVIVAL FITNESS

Weight training for combat, survival, police,
martial arts, contact sports, crawling and street
fighting! Scientifically designed to maximize the
explosive power, speed, quickness, agility,
endurance and hardness for combat and survival.
SURVIVAL OF THE FITTEST - There are no
second-place winners! \$19.

FIREWORKS!

Describes how firecrackers (M-80s, block-
busters, cherry bombs), rockets (match, bottle,
large), volcanoes and fountains, sparklers and
safety fuses are made and colored. \$9.

MISCELLANEOUS

TECH. RESEARCH SERVICES

Unique 51+K electronic and computer design
articles in database accessed by title and
subject. Digital, uP, uC, analog, hybrid, noma-
graph, software. Provide us keys, we return list.
\$25 search fee (1-20 keywords/phrases; you
may combine unrelated topics). Saves you R&D
\$\$\$. Powerful RES-SNAP program will allow
your own searches thru popular electronic
books, magazines and your files. Disk* \$95.

SPECIAL PROJECTS

We design, build, repair, modify, maintain and
consult on any device, system or project - computer-
ized, electronic, electrical, mechanical, optical.
Many invention prototypes. Confidentiality guaran-
teed. Describe and include \$25 fee (does not obli-
gate you). We then provide you cost, time estimates.

MMPI PERSONALITY GAME

What exactly is your personality? How does it
compare with others you care about? Do you
have more than one? Much more than just a
game, the MPG is a zany, satirical, insightful,
realistic and critical hands-on education about
personality testing. Mind-boggling and a real
blast! Manual + Disk* \$49.

NUMEROLOGY PROGRAM

Religion and science are filled with numbers that
have special meanings. Enter a name or phrase
into NUMERNAM and watch the dozens of
equivalent numbers displayed - derived from
ancient and modern algorithms. Whether numbers
have special meaning to you or just for fun and
games, NUMERNAM is numero uno! Disk* \$19.

PREVENT/CURE

DENTAL DISEASE

About 70% of all tooth losses are caused by
"gum disease" - not tooth decay! Simple little-
known method developed by a Government
scientist is inexpensive and really works. \$9.

TAP NEWSLETTER

TAP was a controversial technological survival
newsletter published by the Yuppies until the
mid-1980s, and is a goldmine of hard-to-find
technological information from ATMs to Zapping
(just about everything). And of great historical
and nostalgic value. Issues 1-91. \$2 per back
issue. \$150 for entire set.

SOLD FOR EDUCATIONAL PURPOSES ONLY.

Choosing the Right Tools

Languages, compilers and assemblers that help you to understand the inner workings of your computer

Some unexpected capabilities and a lot of surprises are lurking in your computer, waiting to be discovered. A typical computer user doesn't care about what happens inside the case. He merely wants a spreadsheet or word-processing application to get the necessary work done before 5 p.m. But some of us find the inner activities almost more interesting than the application programs that make computers useful. For many of us, the desire to understand how things work is a fundamental human need.

To understand the inner workings of your computer, it helps to write short experimental programs that will exercise one part of the computer's circuitry or another. Once you have such a program running, you can make small changes and rerun the program several times while you watch the computer react. Such programs give you a better understanding of how things work than a pile of books and magazine articles.

Small, experimental programs can be written in a variety of languages and created with nearly any compiler. However, some computer languages seem to fit the experimenter's toolbox better than others. I'll try to answer which you should choose and why by the end of this article.

Languages and Compilers

Although it's neither the only micro-processor nor the only programmable chip in your computer, the CPU is both the star and director of the show that plays daily in your computer. The CPU does the real computing, and it sends instructions to almost all the other programmable chips. Viewed in this light, it's an incredibly intelligent chip, since it al-

lows your computer to run useful programs like *1-2-3* and *dBASE*.

But from another point of view, the CPU is very simple. It consists of a small data storage area, some arithmetic and logic circuitry, an instruction decoder and a way of communicating with the memory addresses and I/O ports that define the limits of the CPU's world. Most of the instructions it understands are equally simple: move some data from one place to another, test some data or add one piece of data to another.

The instructions that tell the CPU what sequence of actions to perform are stored in memory (ROM or RAM) as a series of bytes of "machine language." Each instruction requires one to six or more bytes. A programmer's job is to create a sequence of bytes that make the CPU—and computer as a whole—perform some activity that humans find interesting or useful.

Many of the instruction bytes are made up of individual bit fields, and, theoretically at least, it would be possible for a programmer to create and enter a program one bit at a time. Unfortunately, it would take the same programmer thousands of years to find and correct errors in the stream of a million or more bits that make up a modern application.

Virtually all programmers use compilers to create programs. A compiler is nothing more than a translator program that accepts program text in human-readable form and writes the appropriate machine-language bits and bytes to a file or memory. Every compiler is built around a specific computer language, which is nothing more than a series of rules about how a programmer can express the activities the CPU should perform. Every lan-

guage has strengths and weaknesses, jobs for which it's well-suited and others for which it's ill-suited. It makes as little sense to argue about which is the "best" computer language as it does to argue about what's the best human language.

However, one of the best languages for small, experimental programs that will help you understand what's happening inside your computer is assembly language. In assembly language, each line of a program is usually translated into one machine instruction. An assembly-language programmer has complete control over the instruction bytes the CPU receives—and complete responsibility for the consequences of those instructions.

Selecting an Assembler

Writing a program in assembly language is assumed to be difficult. It is if you're trying to develop a full, modern application. But for short programs, assembly language is often easier to use than other languages. It's also the language of choice for the time-critical routines that are repeated thousands or millions of times by large applications.

To write a program in assembly language, you need an assembler or assembly-language compiler. There are many compilers to choose from, with prices ranging from zero to several hundred dollars.

Users of most versions of MS-DOS and many versions of PC-DOS already have a simple assembler: a program called *DEBUG.COM*, which is included on the DOS diskette. *DEBUG* is designed as a utility for tracing and making modifications to *.COM*-style programs. Its built-in assembler is useful for making changes

Assembly Language Program Development Process

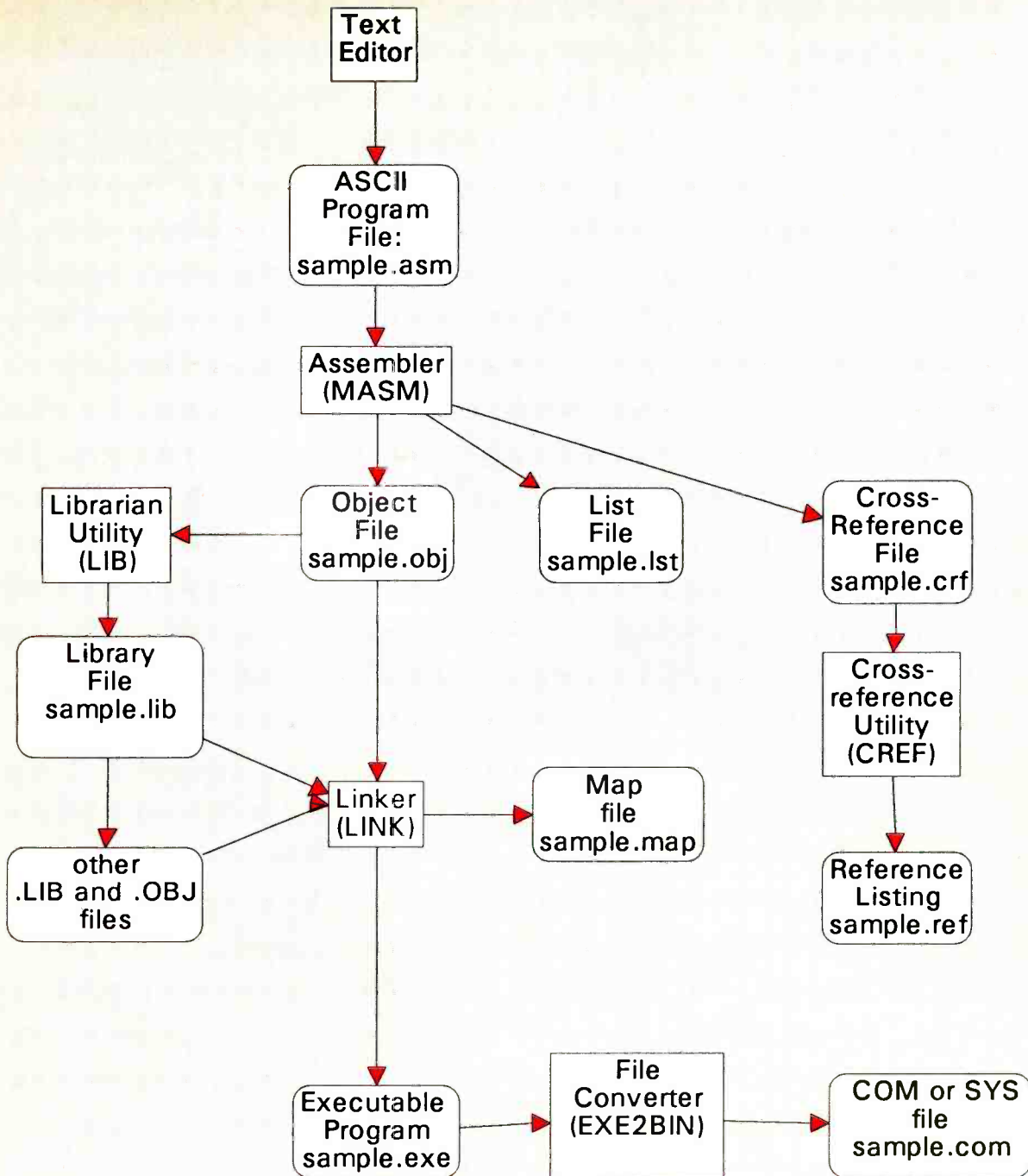

to such programs or entering very short utilities often published in magazines. But DEBUG's assembler is difficult to work with if you want to create programs of your own.

Unlike every "real" assembler, DEBUG has no support for labels and, instead, requires that the programmer know every address a program refers to. This means DEBUG

can never conveniently refer to data or branch to code that you haven't yet written because it doesn't know where that code or data will reside in your program.

I don't mean to imply that DEBUG is useless; I've used it countless times to fix errors in programs, perform hard disk low-level formats and exercise hardware ports. But don't

expect DEBUG to be a very useful assembler for general use. DEBUG is clumsy to work with. As a result, many DEBUG scripts you see in a publication have probably been written and tested with a real assembler and then translated into a DEBUG routine for publication.

A big step up from Debug are a group of shareware assemblers that

A compiler works by changing program source code, written in human-readable form, into machine-code format. Many assemblers produce an .OBJ file, which has program instructions in relocatable form. Another program, called a linker, combines one or more OBJ files into an executable program.

An assembler is a compiler that expects source code written in assembly language, which uses a mnemonic for each machine instruction. For example, suppose you wanted to write an assembly-language program to perform the profound task of printing "Hello" on-screen and waiting for a user to press the ESC key.

The first step would be to use a programmer's text editor, or a word processor in ASCII mode, to create a file called SAMPLE.ASM. The program could be written as in Fig. A.

Notice that everything following a semicolon is a comment. Well-written assembly-language programs tend to have a lot of comments! Also notice that this program uses DOS services for printing, getting a keystroke and ending.

Once the program is written, an as-

sembler turns it into an OBJ file. The commands for each assembler are different, but the most direct command for Microsoft's MASM is:

```
MASM /W2 SAMPLE;
```

The /W2 switch sets MASM's error-reporting to "tell me anything that you think looks vaguely like an error." MASM doesn't report any errors with this program.

MASM creates SAMPLE.OBJ and can optionally create a listing file (SAMPLE.LST) and cross-reference file (SAMPLE.CRF). The listing file shows the program plus the machine-language bytes that the assembler produces. For our short program, it looks like Fig. A (I've removed the comments to make it easier to read):

The first number on each line shows the address (in hexadecimal format) the instruction will occupy in the finished program. Then MASM displays the machine-language translation of each line. At the conclusion, it shows each line as it was written.

The last part of the listing file shows every symbol used in the program and

some information about each.

MASM created a file called SAMPLE.OBJ as it assembled the program. That file contains some ASCII text (the segment name, any symbols that need to be shared with other OBJ files, etc.) and the machine-language code.

Notice the line that begins 0104 in the list above. The machine language ends with an R, which says that the address of the string is relocatable. This information is also placed in the OBJ file.

To create a finished program, SAMPLE.OBJ must first be turned into an .EXE file with the utility (included with MASM) called LINK. This program takes one or more OBJ files plus LIB files (collections of OBJ files stored for easy handling) and puts them all together to form an .EXE program. It also makes sure that all relocatable addresses and all references from one OBJ file to another are correct in the final program. In our case, the correct command for this is shown in Fig. B.

```
LINK sample;
```

LINK will warn that the program has no stack segment. In this case, because we're creating a .COM file, we can ignore the warning.

Finally, the finished program can be turned into a .COM file so that it uses less disk space and loads slightly faster. The MS-DOS utility EXE2BIN will create the COM file (or you can use a shareware program called EXE2COM). The correct command is:

```
EXE2BIN sample.exe sample.com
```

Finally, you can test the program by typing SAMPLE at the DOS prompt.

The entire assembly and link process can be automated with batch files or with a utility called MAKE that's included with the commercial assemblers discussed in this article. Once you create the appropriate batch or make file, one command will assemble, link and convert the program for you. If you're using a hard disk, the entire process should take less than a minute.

Assembly-language programming combines several different skills. You must understand the CPU and its regis-

```

smpl      segment
          assume cs:smpl, ds:smpl

          org 100h                ;This is in .COM file format
start:
          mov ax,cs                ;Get our segment value
          mov ds,ax                ; and place in the ds register

show_msg:
          mov dx,offset string     ;Now DS:DX points to the string
          mov ah,09h              ;DOS service 9 prints a string
          int 21h                 ;Call DOS to print

          mov ah,08h              ;DOS service 1 gets a keystroke
          int 21h                 ;Call DOS for keystroke

          cmp al,1bh              ;Look for ESC key
          jne show_msg            ;Loop until user presses ESC

          mov ah,4ch              ;DOS service 4Ch ends a program
          mov al,0                ;End with errorlevel of 0
          int 21h                 ;Call DOS to end the program

string    db 13,10, "Hello -- Press ESC to end.$"

smpl      ends                    ;End the program segment
          end start                ;End the file and tell MASM the
                                   ;address of first instruction
    
```

Fig. A. Listing file shows program and machine-language bytes assembler produces.

you can find on many bulletin boards and computer information services. Some are also available through shareware disk distributors. I was able to locate three of these assem-

blers recently on CompuServe: CHASM (or "Cheap Assembler"), WASM and A86.

I gave each a quick test and recommend A86 as the shareware assem-

bler that gives the best service. It's the only one of the three that can create OBJ files for linking with high-level language programs, for example. The other two programs are only

```

Microsoft (R) Macro Assembler Version 5.10                               3/26/91 15:55:23
                                                                           Page      1-1

0000          smpl segment
              assume cs:smpl, ds:smpl

0100          org 100h
0100          start:
0100 8C C8          mov ax,cs
0102 8E D8          mov ds,ax

0104          show_msg:
0104 BA 0119 R      mov dx,offset string
0107 B4 09          mov ah,09h
0109 CD 21          int 21h

010B B4 08          mov ah,08h
010D CD 21          int 21h

010F 3C 1B          cmp al,1bh
0111 75 F1          jne show_msg

0113 B4 4C          mov ah,4ch
0115 B0 00          mov al,0
0117 CD 21          int 21h

0119 0D 0A 48 65 6C 6C string db 13,10, "Hello -- Press ESC to end.$"
        6F 20 2D 2D 20 50
        72 65 73 73 20 45
        53 43 20 74 6F 20
        65 6E 64 2E 24

0136          smpl ends
              end start

                                           Symbols-1

Segments and Groups:

      Name           Length   Align   Combine Class
SMPL . . . . .      0136  PARA  NONE

Symbols:

      Name           Type    Value   Attr
SHOW MSG . . . . .  L NEAR  0104  SMPL
START . . . . .    L NEAR  0100  SMPL
STRING . . . . .   L BYTE  0119  SMPL

@CPU . . . . .     TEXT    0101h
@FILENAME . . . . . TEXT    sample
@VERSION . . . . . TEXT     510

27 Source Lines
27 Total Lines
9 Symbols

47458 + 279481 Bytes symbol space free

0 Warning Errors
0 Severe Errors

```

Fig. B. OBJ and LIB Files are linked to create a finished EXE program.

ters, know all of (or at least most of) the mnemonics that apply to your CPU and know how to use DOS and BIOS services. This sounds like a tall order, but

with a little study and some experimentation, programming in assembly language soon seems as easy as any other computer activity.

suitable for creating short .COM programs, and will probably end up limiting you more than helping you.

One shortcoming of CHASM and WASM is that they aren't "MASM

compatible." Microsoft's assembler, MASM, along with the same assembler with an IBM label on the cover, has long been the standard for PC programming. Virtually every ar-

ticle and book that has assembly-language listings follows MASM conventions and syntax.

If you select WASM or CHASM, you may find yourself wishing that it were more like MASM as you struggle to convert programs to its unique syntax. A86, on the other hand, has as much MASM compatibility as you'll probably ever need and is a good choice if you want to try a shareware assembler.

I know of four commercial assemblers that are readily available. Each is "MASM compatible" and each has its uses and a few drawbacks. The first is Microsoft's Macro Assembler (MASM) 5.1. If the rumors I've heard are true, Version 6 will be available by the time you read this. MASM is a powerful assembler that has a reputation for some unusual bugs in advanced, multi-level macro commands. These bugs, and the required work-arounds, have made some code written for one version incompatible with the next version of the same assembler. You'll rarely come across any of those bugs, however, unless you really push an assembler to the limit of its capabilities.

MASM has two faults that have opened the market for competing packages: it's relatively slow and it plagues programmers with reports of phase errors. Compilation speed is important, but not nearly as important as MASM's competitors like to claim. After all, if you save 10 seconds on an assembly, what are you going to do with that extra time at the end of the day? MASM is slower than some of its competitors but fast enough to satisfy most of us.

On the other hand, MASM's reports of "phase errors" is more troublesome. A phase error means that the assembler had to guess at the size of an object on its first pass through your source code and, on its second pass, found out that it had guessed incorrectly. As a result, address references change between the first and second passes, and the assembler becomes confused. Unfortunately, sometimes neither MASM nor programmers can easily determine what instruction caused the phase error; you sometimes have to study listings from each assembler pass to find out what went wrong.

Microsoft's Quick Assembler,

currently available only with Microsoft's Quick C compiler, is similar to MASM 5.1, except that it has no support for 80386, 80387 and OS/2 instructions. These limitations probably won't bother very many users, but the lack of clear assembler documentation is troubling. Quick Assembler, meant to be run from inside the Quick C programming environment, is documented by an on-line hypertext help system, not with separate manuals.

If you have or are planning to purchase Quick C, Quick Assembler should fulfill your assembly-language needs quite nicely, but be prepared to buy a good book or two to use as a substitute for the documentation that Microsoft should have provided.

At least two other companies produce professional-quality assemblers. SLR, Inc. was well-known in CP/M days for its fast and professional program development tools.

Today, it produces OptAsm, an assembler that can emulate MASM 3, 4, 5 and 5.1. It's an extremely fast assembler, and because it makes as many passes over your source code as necessary, it should never report a phase error. For those reasons, plus some of the convenient extensions to standard assembly-language that OptAsm has developed, it's the assembler of choice for many professional programmers.

Borland International's Turbo Assembler (TASM), like OptAsm, is claimed to be completely compatible with MASM through version 5.1. (It's possible to create source code that will assemble with MASM 5.1 but which will cause either TASM 2.0 or OptAsm 1.6 to choke.) TASM is intermediate in compilation speed between OptAsm and MASM.

With the appropriate option switches, TASM achieves very good compatibility with versions 4.0 and later of MASM; it also has a special mode

of its own that uses a unique assembly-language syntax that some programmers prefer. TASM is a single-pass assembler (so is Quick Assembler, if you want it to be). This makes it fast but also can cause it some confusion with forward references in large source files.

Both MASM and TASM are shipped with debuggers (SLR, Inc. sells a debugger separately, and A86 has a companion debugger called D86). A good debugger is essential if you want to do any serious programming. I prefer Borland's Turbo Debugger to Microsoft's CodeView debugger, but it's a close call for most debugging chores, and you can conveniently choose whichever catches your fancy.

Which assembler should you choose? All four of those mentioned will do a good job with most source code. I'd suggest you look at A86 because of its lower price if you aren't sure you want to put a lot of effort into assembly-language programming. You can move up later if you find it necessary to do so.

Pick MASM or TASM if you use Microsoft's or Borland's other language tools. For example, MASM and CodeView will be the most help if you use QuickBASIC; TASM and Turbo Debugger will suit you best if you use Turbo Pascal. And, if you're a professional assembly-language programmer working on large projects, you probably have a copy of OptAsm in your software library.

Whichever assembler you choose, it will be better than DEBUG for writing assembly-language programs of any size. With your new assembler, you'll be able to create fast routines for your favorite high-level language, write assembly-language programs that take full advantage of your computer's inherent power and create all the test programs you want to show you what's happening inside your computer.

No matter what reason you use to justify purchasing an assembler, it will ultimately lead you to learn more about your computer than pure BASIC, Pascal or C programmers will ever know. If you're interested in how your computer works and how to get the most from it, an assembler and its associated debugger are essential tools that you will never outgrow.

BUILD A DIGITAL STORAGE SCOPE

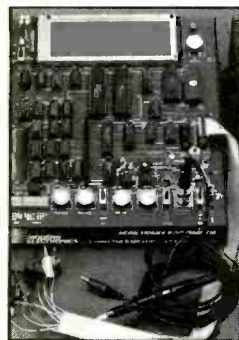

As Part Of
The Complete **\$199.95**
Modern
Electronics Computer Lab.

FEATURES

- 20 Mhz/sec Sample Rate
- .5 us to 5 sec/div Sweep Rates
- LCD with 64 x 240 Dot Resolution
- Provisions for Adding Optional Second Channel (Requires 5V, +/-12V Power Supply)
- Vertical Sensitivity .01 v/div AC/DC Coupled
- Ext. Trigger Input
- Single Sweep Mode
- Screen Freeze Mode

\$199.95

Postage & Handling (\$6.50)

OPTIONS: Add an 8 channel Logic Analyzer and view up to 8 digital signals simultaneously. . . perfect for viewing CPU Bus signals . . . **\$59.95** + Postage & Handling (\$3.00)

Power Supply Kit . . . **\$34.95** + (\$4.00) P.H. • Matching Black Steel Cabinet . . . **\$37.50** + (\$4.50) P.H.

Deluxe 100 Mhz Scope Probe with 10:1 Switch . . . **\$27.50** + (\$3.50) P.H.

EXPAND YOUR LAB . . . Add A Dual Channel Function Generator With An Add On 23 Channel Digital Signal Generator

- The Function Generator features two separate Sine, Triangle, Ramp and Square wave generators. 10 Hz to 100 KHz. Ideal for upcoming Analog and Modulation theory experiments. (Requires 5V, +/-12V Power Supply)

\$69.95 Postage & Handling (\$4.00)

- Add a 23 channel Digital Signal Generator + an 8088 based Computer Experimenter Platform to the Function Generator Board . . . This project operates as a stand alone Digital Signal Generator, capable of generating 23 different digital signals simultaneously. Custom signal generator programs, as well as 8088 based computer experiments can be down loaded from any IBM compatible. Learn about Computers, Digital Circuits and Assembly Language Programming in upcoming articles. . . . **\$69.95** Postage & Handling (\$4.00)

OPTIONS: Power Supply Kit . . . **\$34.95** + (\$4.00) P.H. • Matching Black Steel Cabinet . . . **\$37.50** + (\$4.50) P.H.

COMPLETE YOUR LAB . . . With A Prototyping Station

- Features both solderless and wire wrapping prototyping systems. With cables connecting 80 signals from the Digital Signal/8088 Computer Experimenters Platform to the Prototyping Station.

\$69.95 Postage & Handling (\$4.00)

OPTIONS: Power Supply Kit . . . **\$34.95** + (\$4.00) P.H.
Matching Black Steel Cabinet . . . **\$37.50** + (\$4.50) P.H.

MasterCard / Visa Accepted

(203) 355-2659



**NETRONICS RESEARCH
AND DEVELOPMENT LIMITED**
333 Litchfield Road • New Milford, CT

CIRCLE NO. 37 ON FREE INFORMATION CARD

Solving Power-Up Problems

How to approach troubleshooting an apparently dead computer

There are a host of things that can go wrong with a personal computer. The most frustrating one to me has always been the apparently totally dead PC. I say apparently because there are a many defects that can stop a PC from operating that makes it look totally inoperative. In this respect, I'll talk about powering-up problems, one of the more dominant scenarios.

When you turn on a computer, it may at first seem to be completely inactive, but even this can give you an idea of where to start looking for the solution. Troubleshooting is something of an art, of course. An experienced technician moves adeptly around his prey with a meter, oscilloscope or some other preferred tool, assimilating all readings to the level of his knowledge and experience. This seemingly intuitive action can be learned. Good troubleshooting is just a seasoned approach toward the process of elimination.

The obvious place to start when troubleshooting a power-up problems is the power supply. But before that, you should make sure you have power coming in to the unit. So check the ac outlet into which the computer is plugged and the computer's fuse. Having done this, let's assume you now have power to your PC and it still appears to be completely inoperative. The next logical step is to see if the required voltages are being delivered by the power supply. To do this, you need to know what voltages are needed. But first, let's examine the processor's start-up cycle.

We'll use the Intel 8088 microprocessor for our discussion. This IC is the one IBM used to launch its first personal computer. Another reason we will use it is that it's the forerunner of the 80286, 386, 486 and so on. Each of those later versions has maintained what is called downward

compatibility. This means that anything that can run on a PC can run on a 386, but not necessarily the other way around. Consequently, they all operate similarly, even though each generation brings with it more enhancements.

The 8088 is a 16-bit microprocessor that's brought out to an eight-bit data bus. A 16-bit microprocessor would have been too costly at that time. Moreover, appropriate software would have been more difficult to come by. Besides, no one anticipated the PC boom that followed.

Eventually, many of these machines break down and become a servicing problem. Now we're given the responsibility to bring new life to these amazing products.

Let's begin with the actual start-up

sequence of the microprocessor. In Fig. 1, is shown the pinout diagram of the famous Intel 8088 processor. In dealing with a suspected dead machine, there are only a few things you're initially interested in here. You need a couple of tools to start troubleshooting. At this level, all you require is a good digital voltmeter (or a multimeter set to the dc-volts function), a logic probe and some common sense. Although this may not sound like the perfect test arsenal, you can and will accomplish much with these tools.

On pin 40 of the 8088 is the V_{cc} voltage. Testing pin 40 with your meter should yield a reading of +5 volts dc $\pm 10\%$. (All readings here are referenced to ground. That is, the common lead of your meter must be con-

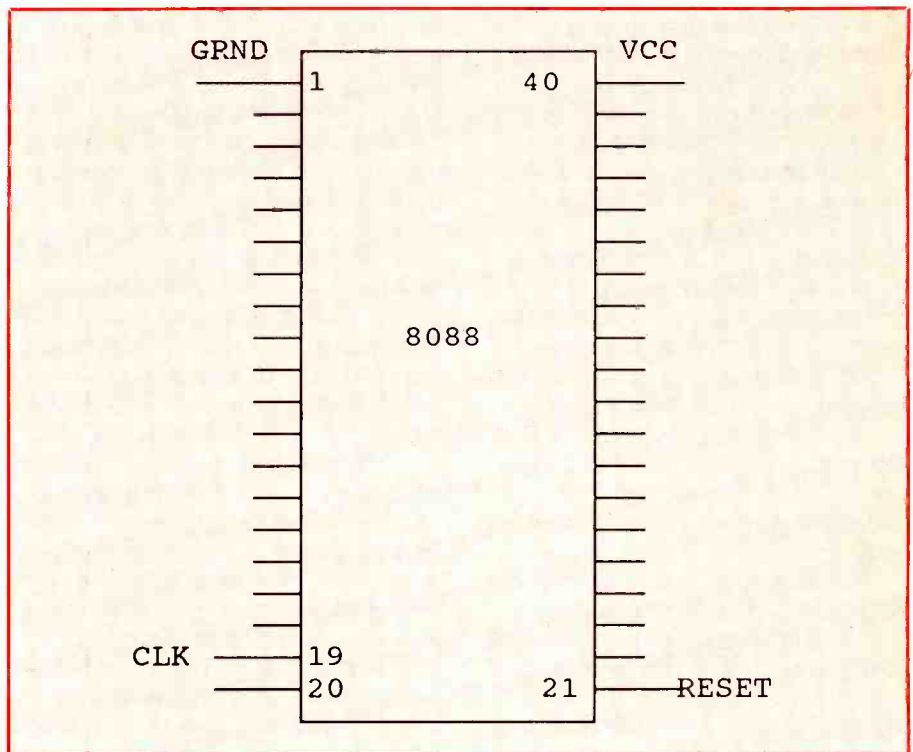

Fig. 1. Pinout diagram for 8088 microprocessor.

nected to ground and all readings are taken by touching the “hot” probe of the meter to the indicated point.) Because pin 1 connects to ground, you should obtain a reading of zero ohm, using the ohmmeter function of your meter here. If you fail to obtain a reading of essentially zero ohm, a trace may be blown on the board.

The clock signal appears on pin 19 of the processor. Though you won’t be able to accurately tell what the frequency of the clock is (4.77 MHz), an indication or no response on your logic probe here will be enough to tell you whether or not a clock signal is present at this point. For now, this is all the information you need. To obtain a more accurate reading, you need a frequency counter or a good oscilloscope. If after the rest of your troubleshooting has yielded no solution, it may be necessary to go back and find out the exact frequency at which the system clock is operating.

Pin 21 is the reset pin on the microprocessor. The reset signal is used to initialize the processor, along with many other controllers on the system board. Without this signal, the processor and controllers could and would start up in just about any state possible, creating mass confusion on the data and address buses.

When power is first applied to the system board, pin 21 is immediately brought high. It must remain high for a minimum of four clock cycles. After that time period elapses, it goes low. On the high-to-low transition, the internal reset sequence is initiated. After the sequence has reset and initialized all internal functions, the processor goes to address FFFF0H and executes the instruction at this location. That is the location in which the instruction for loading the BIOS (Basic Input/Output System) into the computer’s memory so that the computer can function. Once the BIOS is loaded, the computer will, among other actions, begin to boot up.

Two important things the processor requires to accomplish this start sequence properly. The first is a good power source, and the second is an operating 8284 clock-generator IC, as shown in Fig. 2. This drawing is a basic block diagram of how the 8284 connects to the system. As shown

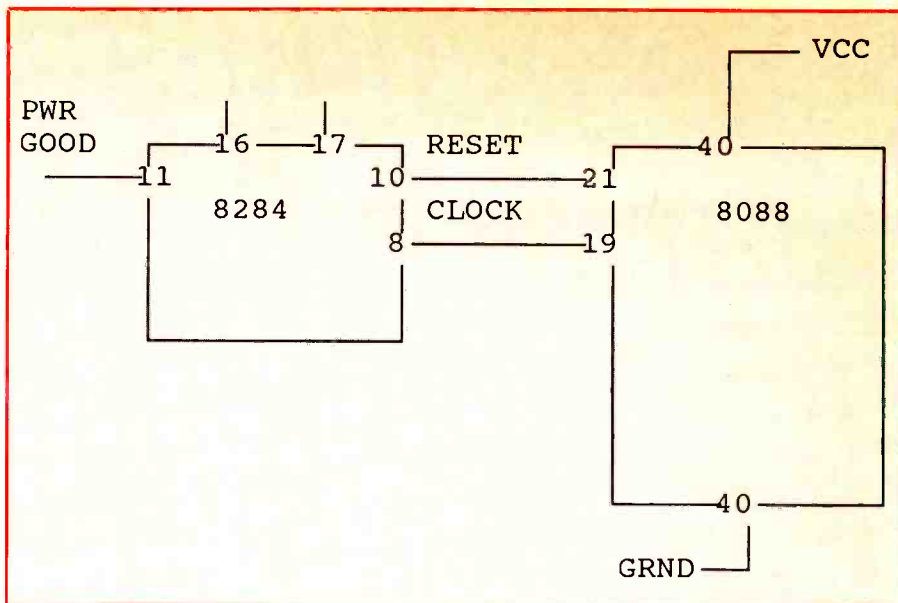

Fig. 2. Details of connections between 8088 microprocessor and 8284 clock-generator chips.

here, there is a power source, an 8284 that generates the clock signal, the reset signal and the main processor.

The 8284 generates a 4.77-MHz signal that drives the microprocessor by taking the crystal frequency of 14.31818 MHz and dividing it roughly by 3. The crystal connects to pins 16 and 17. The reset signal output is located on pin 10 of the 8284, while the clock output is on pin 8. Then there is a curious signal on pin 11 called “power good,” which is actually being applied to the input of a Schmitt trigger that gives a desired output on pin 10. This is the signal required to reset the processor.

With the foregoing as a foundation, let’s look at the power supply and find out what the status of it is. Figure 3 displays the connectors and their pinouts for the system’s power connections. Assume that a power-good signal appears on pin 1 of P8, where the orange wire is. Reading from left to right starting there, the next wire is red and the potential on its connection reads +5 volts dc. The next wire is yellow and its connection is at +12 volts dc. Following that wire is a blue one whose connector is at –12 volts dc. From there, the next four wires to P9, all black, obviously go to ground. Finally, one white wire is at –5 volts dc, and all remaining wires (red) are at +5 volts dc.

Because the power-good signal is

so important, let’s see how it’s derived and how to test for it. Without going into detail on the power supply at this time, it’s just what it says. The power-good signal is a low-to-high transition output produced by the power supply once it has sensed that all of its required voltages have reached their assigned values, no more, no less. The process runs through very quickly, but it’s somewhat of an internal diagnostic. Now this transition is applied to the input of the 8284.

To test the power-good signal, simply touch the tip of the “hot” probe of your meter (set to the dc-volts function) or the signal tip of your logic probe to pin 1 and turn on your computer. It should show a clear transition to roughly +5 volts dc. Once you’ve done this, test the rest of the voltages on the proper pins of the power connectors. Having determined that the voltages are correct and you have the proper power-good signal, you can move on to the 8284.

At the 8284, you can quickly check pin 10 of this chip or pin 21 of the 8088 for proper reset. It may be simpler to go directly to the processor and check these signals, however, as they must ultimately go there. For the sake of understanding the power-up procedure, though, we’re taking this one step at a time.

Now you can see what it takes to

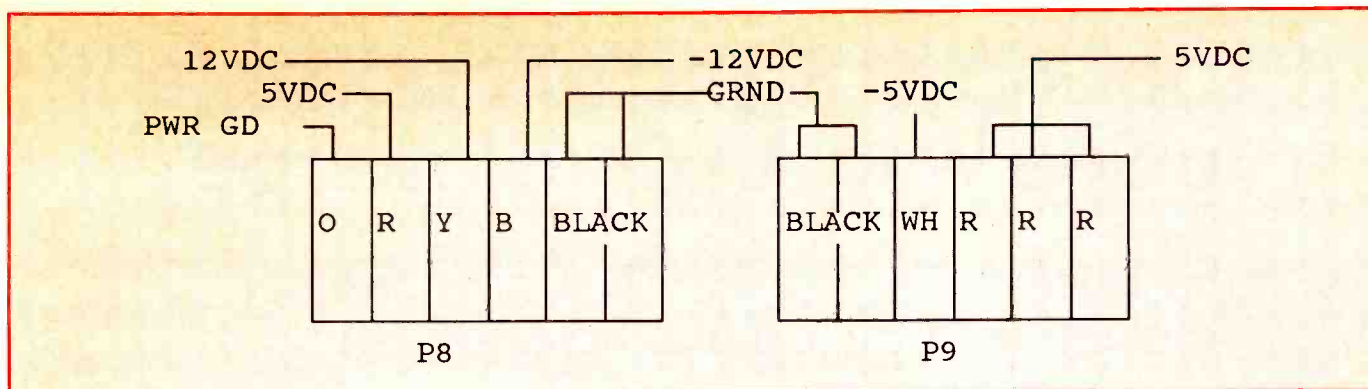

Fig. 3. Voltage details for power connectors in an IBM PC or compatible computer.

make a proper reset in order for the microprocessor to run correctly. As you troubleshoot your system, let's assume you'll see all the proper signals at the proper places and the computer still appears to be dead. What next? Well, there are a number of things that can now be wrong. What's important, though, is that you've eliminated the power supply as the culprit by the process of elimination. Observing activity at the processor output pins, you can assume that the processor is okay since such activity during the start-up procedure is a sign of proper operation.

Given the foregoing, the next thing I'd do is remove all peripheral cards from the system board. Any one or more of them may be forcing the processor into what is commonly called a hold state. Overall system design is such that if a short circuit of some kind exists somewhere in the system, it can put the microprocessor in a hold state until the short is removed. This occurs if the processor isn't allowed to complete certain processes for a predetermined amount of time.

If you can, substitute the video card for a known-good card when moving on to this step. If you successfully eliminated the problem, it was obviously one of the peripheral cards. You would now get some video when you power up the system. If you don't get video, the problem is definitely on the main board.

Alternatively, if you do get video, you can reinstall the cards, one by one, in their expansion slots until the system fails to get video when you power up. This may sound redundant, but whenever you remove or install a card, make absolutely certain that you first power down. If you fail

to do this, you can damage the electronics on the card or/and main board. You might think that no one would ever forget to power down, but you'd be surprised at how many 74LS244s or LS373s I've replaced along the extended bus connectors that mysteriously shorted out.

One other thing you might want to look into is the system RAM. An XT must have access to the first 64K of RAM to load its BIOS code into. If it can't get to it for whatever reason, you'll never obtain a video signal. On an AT-style machine built around an 80286 chip, the processor requires even more RAM—128K—into which to load its BIOS.

I mention RAM because it's a volatile product and has a tendency to fail. Another reason is because most RAM in today's machines is socketed. Thus, as a computer heats and

cools over a period of time from being on and off, the expansion and contraction slowly works the ICs out of their sockets. Once a RAM chip moves far enough out of its socket to break electrical contact, it ceases to work. I've restored many non-working computers by simply cleaning and reseating socketed RAMs.

If you determine that it is, in fact, a system-board problem, it may now be time to delve a little deeper and check to see if our clock is operating at the correct frequency. The processor may also have a thermal problem; so you may just have to pull out all the stops and go after it.

It's amazing what a technician will learn when he has to tough out those hard-to-find problems. Good luck! I hope to serve up some more troubleshooting tips and system knowledge concepts down the road. ■

Subscribe Now and Save

AWARD BIOS ROMS

Upgrade your IBM XT, AT, or XT/286/386 Compatible. Add support for 3.5" 1.44Mb Floppies, 101/102 Keyboard F11 & F12 keys, ESDI and IDE Hard Drives. Full Technical Support - Call or write for FREE Catalog.

Authorized Award Distributor.

KOMPUTERWERK

851 Parkview Blvd., Pittsburgh, PA 15215

Orders 800 423-3400 - Technical Support (412) 782-0384

CIRCLE NO. 34 ON FREE INFORMATION CARD

Looking At Signals Impossible To See With An Oscilloscope

Using the *Modern Electronics* DSO/Eight-Channel Logic Analyzer to study, test and troubleshoot microprocessor circuits.

This month, we investigate how to use a logic analyzer to study the microprocessor, I/O and display circuits. This includes operation of the 8085 microprocessor, an address latch, a shift register and signals generated by the timebase generator. Circuits that will be tested all reside in the Digital Storage Scope/Logic Analyzer presented in the January 1991 issue of *Modern Electronics* (now *ComputerCraft*).

The Logic Analyzer

A logic analyzer is a test instrument that displays many digital signals at the same time. (By comparison an oscilloscope generally can display only two analog signals simultaneously.) This generally is necessary when looking at microprocessor circuits, because a host of different signals occur at the same time. It's important to be able to look at address, data and control signals as they occur in order to check timing relationships between them.

The logic analyzer described here is a combination digital storage oscilloscope (DSO) and eight-channel logic analyzer. Displays can be frozen and can be viewed indefinitely. The basic operation of a logic analyzer is very similar to an oscilloscope. This design features eight channels and triggers on either slope of the logic on channel 0. Inputs are TTL, pulled high by 10K resistors.

The 8085 CPU

The DSO design uses an 8085 CPU to supervise collection of test data to a high-speed RAM from either the analog-to-digital (A/D) converter or the logic analyzer inputs. Data is then

gathered by the 8085 and reorganized in system RAM in a format that can be presented to the LCD display. The CPU then uses the 8155 I/O ports and timer to generate the signals and data required by the display. The 8085 also controls the high-speed RAM address generator, as well as logic circuit switches that set up the various operating modes.

To better understand the experiments, let's first examine signals generated by the 8085. You'll then be able to understand the role and operation of supporting hardware and how the logic analyzer can be used to test the circuits.

Figure 1 is the basic timing dia-

gram for the Intel 8085 microprocessor. We'll compare the displays generated by the logic analyzer with these diagrams. Figure 2, the 8085 machine cycle chart, shows logic levels present at status and control pins during the listed CPU operations. These signals synchronize peripheral circuits with the CPU.

This may seem complicated at first, but after a few measurements it will all make sense. Before you connect the logic analyzer, look at Fig. 1 again to get an idea of what to expect. The timing diagrams are divided into three types M1, M2 and M3. Column M1 signals are generated during an instruction-code fetch operation.

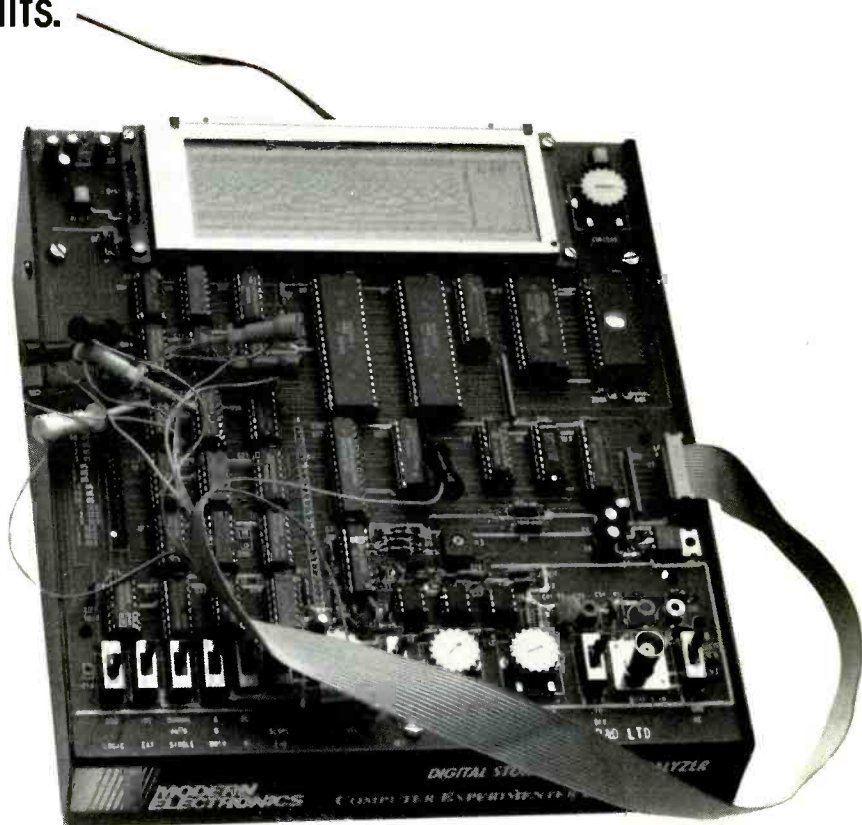

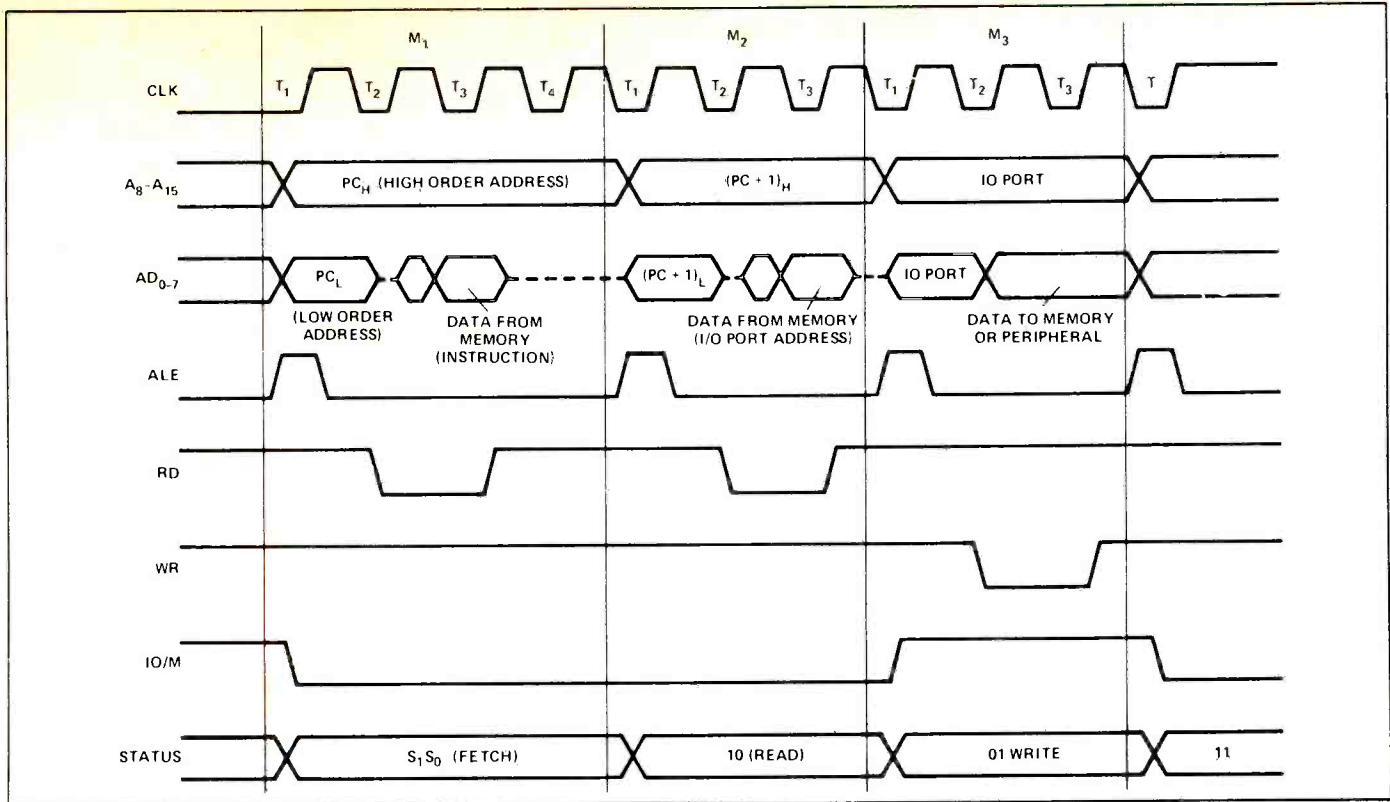

Fig. 1. 8085 basic system timing.

(Courtesy Intel Corp.)

Column M2 signals are I/O or memory-read signals, while Column M3 signals are generated during I/O or memory-write operations.

The first waveform is the CLK signal. The CPU divides by 2 the 10-MHz input at pin 1, generating a 5-MHz CLK signal that is available at pin 37. This signal is used to synchronize internal CPU operations, as well as external devices. In this design, the CLK signal is connected to the timer input of the 8155 I/O chip, as shown in Fig. 3.

The next row is high-order address lines A8 through A15. These signals could be either a logic high or low. The point at which they change levels appears as an X, or crossover point, in the waveform diagram.

The third row is the multiplexed address/data bus that contains both address and data information. The first part of the waveform contains either the low-order memory or I/O port address. This is followed by the data flowing to or from a memory or I/O port location.

The next signal is the ALE (address latch enable). The falling edge (high-to-low transition) is used to latch or store the low-order memory or port

MACHINE CYCLE	STATUS			CONTROL		
	IO/M	S1	S0	RD	WR	INTA
OPCODE FETCH (OF)	0	1	1	0	1	1
MEMORY READ (MR)	0	1	0	0	1	1
MEMORY WRITE (MW)	0	0	1	1	0	1
I/O READ (IOR)	1	1	0	0	1	1
I/O WRITE (IOW)	1	0	1	1	0	1
ACKNOWLEDGE OF INTR (INA)	1	1	1	1	1	0
BUS IDLE (BI): DAD	0	1	0	1	1	1
ACK. OF RST, TRAP	1	1	1	1	1	1
HALT	TS	0	0	TS	TS	1

Fig. 2. 8085 machine cycle chart.

(Courtesy Intel Corp.)

address into an address latch (see *UI* in Fig. 3). The next two signals, RD and WR , are the read and write lines. Data is transferred to or from the CPU at the rising edge of these signals. Note that the rising edges of these signals coincide with the data being ready as shown in the AD_0 through AD_7 signals.

The IO/M signal is used to direct data to either a memory or an I/O location. A low indicates that the CPU wants to talk to memory, while a high indicates that an I/O activity is in progress. The last two signals are CPU status lines used, in conjunc-

tion with the other control lines, to indicate to peripherals the exact status of any CPU operation.

Figure 2 lists logic levels at all status and control pins as a function of CPU activity. As an example of how to use this chart, look at the Memory Read line. Note that IO/M is low, S_1 is high, S_0 is low, RD is low, WR is high and $INTA$ (interrupt acknowledge) is high. Compare these levels with the signals shown in the M2 column in Fig. 1. You'll observe that the chart by itself doesn't tell the whole story. The key missing element is the timing relationship between the sig-

nals. This information is required so that peripherals are ready to receive or send data to the CPU at the proper time.

Connecting The Analyzer

Now let's hook up the logic analyzer inputs to the CPU as follows:

- Channel 7 to S1 (pin 33)
- Channel 6 to S0 (pin 29)
- Channel 5 to A0 (UI pin 2)
- Channel 4 to AD0 (pin 12)
- Channel 3 to IO/M\ (pin 34)
- Channel 2 to RD\ (pin 32)
- Channel 1 to WR\ (pin 31)
- Channel 0 to ALE (pin 30)
- (Channel 0 is the trigger input.)

Set the DSO to LOGIC mode, trigger to NORMAL mode, trigger slope to trigger on the + slope and timebase to $0.5 \mu\text{s}/\text{div}$. Remember that the analyzer samples inputs 10 times during each horizontal division. This means that, with the timebase set to $0.5 \mu\text{s}$, sampling rate is 20-million times per second and that time between samples or dots on the display is 50 ns.

On power-up the display should resemble that shown in Fig. 4. Press FREEZE to capture the display.

The Display shown is the part of the program that outputs data to the display. Details of the program aren't important at this time. Let's now study the signals to verify the timing diagram (Fig. 1), witness the address latch working and learn how to determine the exact CPU operation that is in progress. (Future articles that use the 8088 Digital Signal Generator featured in the March issue will display specific short program loops that allow you to analyze data, address and chip selects, as well as the control and status signals.)

Referring to Fig. 4, note that each dot represents 50 ns (10 dots per division). The time of and period between events can be measured using the horizontal graticule or by counting dots. Let's start by looking at the ALE signal (Channel 0). Notice that the pulses aren't evenly spaced. This is because an instruction-fetch machine cycle (Fig. 1 Column M1) takes four CLK cycles, compared to three cycles for normal I/O or memory reads and writes.

To identify which machine cycle we're discussing, we'll call machine cycle 1, which is the area between the

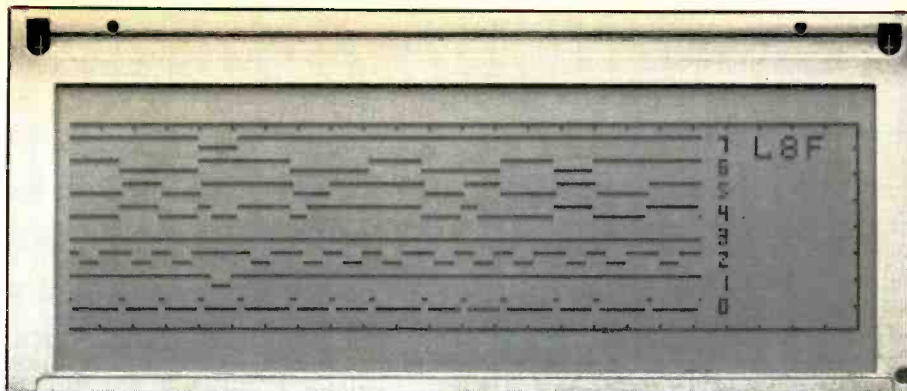

Fig. 4. Logic Analyzer Experiment 1.

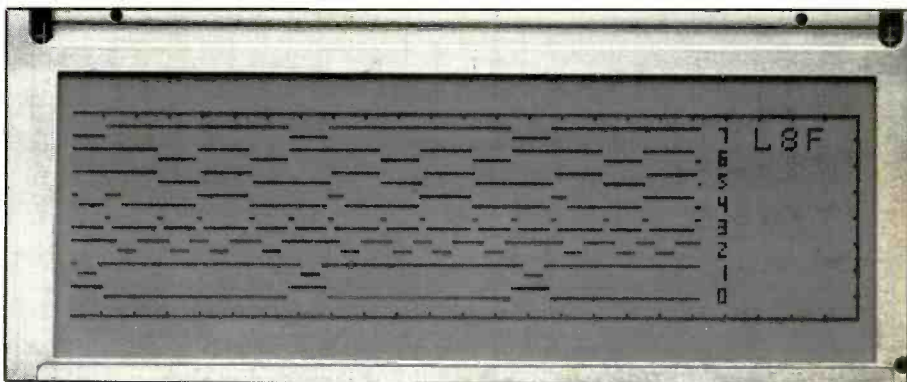

Fig. 5. Logic Analyzer Experiment 2.

first falling edge of ALE and rising edge of the second ALE, and so on. Notice that machine cycles 1, 5, 8, 11, 13 and 14 are fetch cycles. You can verify this by referring to Fig 3.

Fetch cycles must have S0 (Channel 6) and S1 (Channel 7) high, IO/M\ (Channel 3) low and a read signal that goes low (channel 2). Verify on your display or on Fig. 4 that this is indeed the case. All remaining machine cycles are memory-read cycles. You know this because the IO/M\ line is always low, preventing IO activity for these cycles.

Now note that machine Cycle 4 is a write to memory. This can be verified by status signals that require IO/M\ and S1 to be low and S0 to be high during a memory-write cycle. Observe that status and control signals are valid at the beginning of each cycle (at the falling edge of ALE) and, therefore, can be used as advance signals to peripheral devices.

Before we leave this display, look at AD0 (Channel 4) machine Cycles 4 and 10. These cycles illustrate the multiplexing action of the combination of both address and data appear-

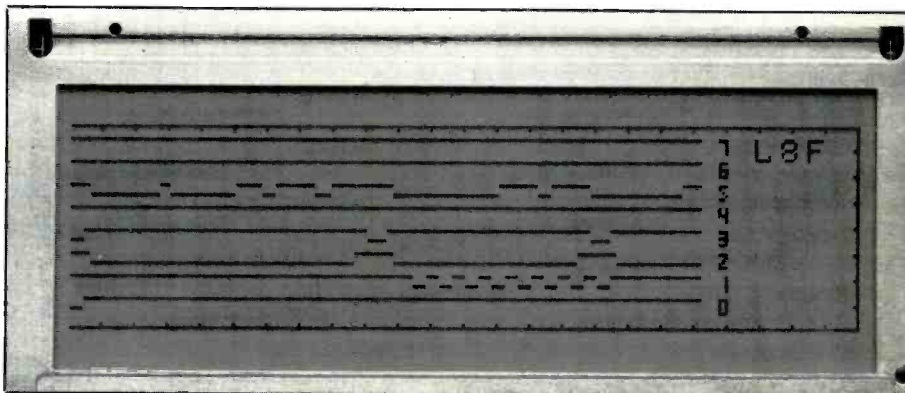

Fig. 5. Logic Analyzer Experiment 3.

ing on the same pin. In both Cycles 4 and 10, the address portion is high and data portion is low. During the falling edge of ALE, the address value is latched into integrated circuit *U1*. Address line A0 (Channel 5) clearly reveals that the address value has been extended by the latch to the entire machine cycle. This process is, of course, occurring for all cycles but is noticeable only in Cycles 4 and 10.

Now connect Channel 0 to IO/M\ (pin 34) and Channel 3 to ALE (pin 30). The analyzer will now trigger on the rising edge of the IO/M\ signal. ALE will now be displayed on Channel 3. This allows you to verify machine cycles for I/O operations.

Referring to the display or Fig. 5, note that every time IO/M\ is high, the CPU in an IO write machine cycle. Verify this by consulting Fig. 3 for the status logic conditions that indicate an IO write. Also, compare the display IO write cycles with what we expect to find in Fig. 1 Column M3. Observe that machine cycles that follow the IO write cycles are instruction fetch cycles. This tells you that the program is fetching a new instruction after writing out to the port.

Study AD0 (Channel 4). Notice that ALE is latching the low-order address into latch *U1*, as before. Confirm that machine cycles between IO writes are all either instruction-fetch or memory-read cycles. If you want to focus on read cycles, connect Channel 0 to the CPU read line. In general, simply connect the Channel 0 input to the signal on which you want to trigger and Channel 1 through Channel 7 to the signals to be observed. Setting the trigger mode to AUTO position causes random triggering that generates some interesting effects.

The LCD Data Shift Register

We'll now view operation of the LCD data generator. Connect the Logic analyzer as follows:

Channel 5 CPU AD7 to *U9* pin 19
 Channel 4 LCD data to *U2* pin 9
 Channel 3 CPU WR\ to *U9* pin 31
 Channel 2 CPU IO/M\ to *U9* pin 34
 Channel 1 Shift CLK to *U2* pin 2
 Channel 0 Shift/LD\ to *U2* pin 1

Set the controls as above, except set SLOPE to trigger on -.

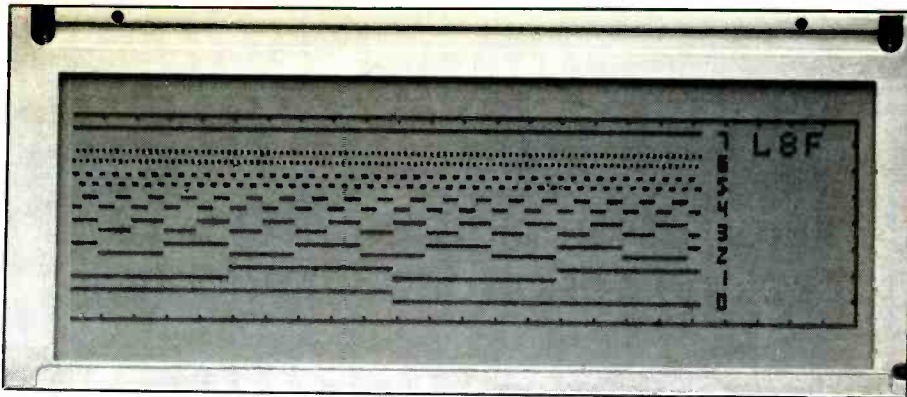

Fig. 8. Logic Analyzer Experiment 4.

The program outputs the serial data in the format required by the display via a 74HC165 shift register, which is configured as an output port at location C0.

When the CPU writes to port C0, SHIFT/LD\ pin 1 goes low. The eight bits of data on the bus are then loaded into the register. The program then uses an output instruction to port 88 (8155 command register) to start the timer in the 8155. The timer produces eight pulses and is then turned off by another output instruction to the command register.

We'll trigger on the - edge of the SHIFT/LD\ signal. Turn on the power and freeze the display. Compare the results with Fig. 5. Channel 0 should start low and go high in about 0.2 μ s. During this time, data on the bus (in this case, all 1s) is loaded into the register. You can connect Channels 6 and 7 to the data bus to verify that the data lines are indeed high during the SHIFT/LD\ cycle time.

Notice that IO/M\ is high and the WR\ lines are low, indicating that an IO write is actually in progress. Note that the just before the timer starts, the IO/M\ line goes high. This is the output to the command register, port 88, that turns on the timer. Just before the end of the timer signal, the CPU issues another output signal to the command register that turns off the timer.

Data to the command register sets bit 7 high to turn on the timer and low to turn it off. You can verify this by looking at Channel 5 and noting the logic level on AD7 at the point where the WR\ line (Channel 3) is going from low to high. Looking at Channel 4, you can see that the data being shifted into the display is always high

at this point in the program. You can really see what's happening. None of this would be possible if you were using an oscilloscope.

The Horizontal Timebase Generator

The last Experiment we'll present is examination the timebase generator (Fig. 7). This circuit generates the clock for the CPU, as well as all timebase reference signals that permit the DSO to sample the inputs from 20-million times per second all the way down to two times per second. A 20-MHz crystal clock is divided by 10 in the 74HC390s and is further divided by two and four in the 74HC393s. To check the dividers, set the analyzer timebase to 0.5 μ s/div. and trigger slope to +.

Connect the inputs as follows:

Channel 6 to *U15* pin 3
 Channel 5 to *U15* pin 4
 Channel 4 to *U11* pin 3
 Channel 3 to *U15* pin 11
 Channel 2 to *U15* pin 10
 Channel 1 to *U16* pin 1
 Channel 0 to *U16* pin 3
 (Channel 0 is the trigger input)

Compare the display with Fig. 8. Note the divide-by-2, -4 and -10 scheme produces a divide-by-2, -5 and -10, which is the industry-wide standard.

To calculate the frequency of any of the waveforms use the formula: Frequency = 1/time (time is based on a complete period).

We'll have many more experiments using the logic analyzer. In a following issue, we start digital experiments using the Digital Signal Generator and Logic Analyzer to learn how TTL logic elements work.

Heath's Convertible Computer Kit

Features assembled processor plug-in board, backplane design and small footprint

Heath Company's recently introduced HS-5100 computers represent practically the last bastion of computer kits. As you will see, though, they're really plug-in-and-operate machines since you needn't even lift up a soldering iron while assembling the kit.

We call these kits "convertible" since you have a choice of an assembled 80286 (12 MHz) or 80386SX (16 MHz) processor board (Heath calls it a paddle) that simply plugs into a main board through a connector. Everything else remains the same.

Unlike traditional personal computer companies that copied IBM's large motherboard design, Heath employs a backplane so that small circuit-board sections can be plugged in and unplugged with ease. If you've ever tried to work with a typical motherboard, often requiring virtual disassembly of a machine to get at it, you'll certainly appreciate this type of construction, so popular in the industrial world.

Heath has some other nice touches in this new computer line. To begin with, the system-unit enclosure takes up little work space with its 15½"W × 14"D footprint. Furthermore, a 6" enclosure height makes for a stable vertical mini-tower if one wishes to set the box on-end on a desktop beside his video monitor or on a platform beside his desk.

The machine features five full-length 16-bit expansion slots, all available for use since a separate main board already contains video and hard/floppy-disk drive controllers and two serial and one parallel ports built onto it.

Heath's catalog doesn't include prices for these computers (HS-5100-A, with 286 processor; HS-5100-X, with 386SX processor) or accessories for them. Instead a toll-free "800"

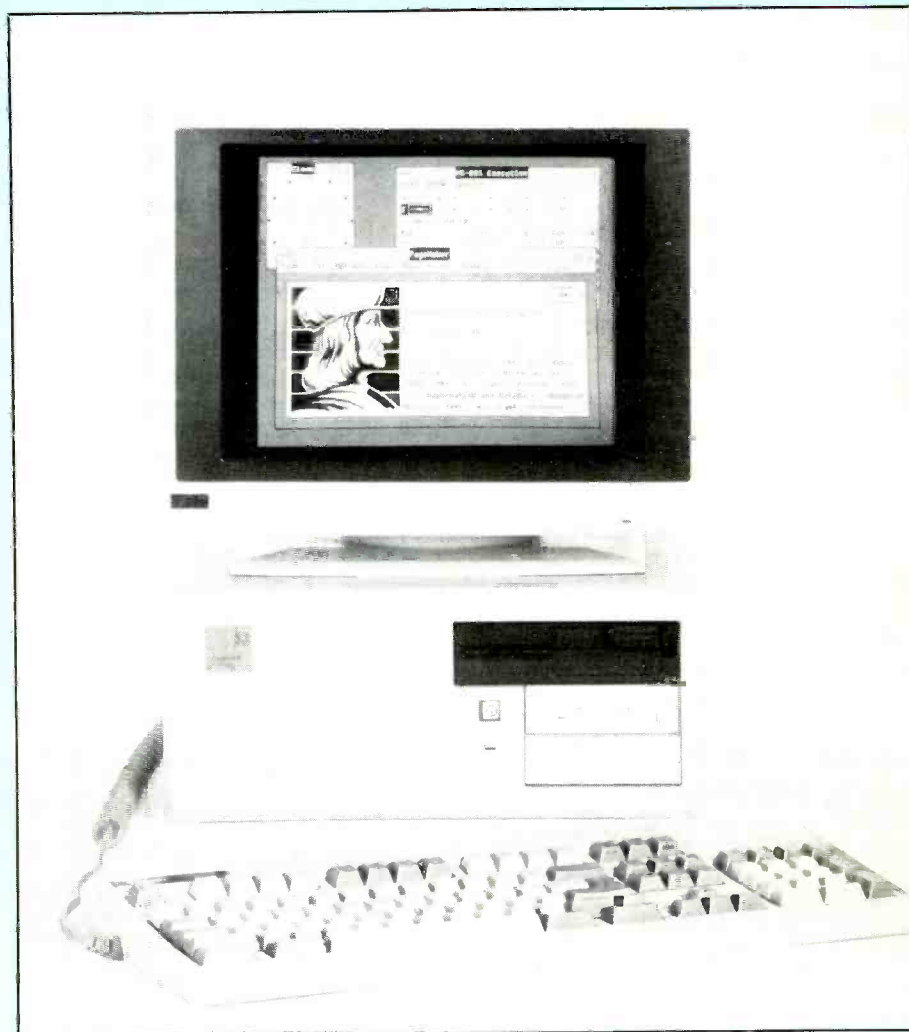

phone number is provided to learn about costs. At this writing, a basic system (includes built-in VGA video controller, 1.4M 3½" floppy drive, 1M of RAM and MS-DOS 4.0, MS Works and Windows 3.0 and disk-based Diagnostix) costs \$999 for the 286 version and \$1,199 for the 386SX version.

Ordering a basic system along with an optional 40M, 25-ms hard drive

adds only \$230 to the 286 kit (\$1,229 total) or only \$188 to the 386SX kit (\$1,387 total). Adding Zenith Data Systems' 14" flat-screen VGA color monitor boosts the cost another \$512 (\$595 if bought separately).

The Heath computer examined here was the 386SX version with hard-disk drive and VGA color monitor. I added 2M of RAM, a 5¼" 1.2M floppy disk and a trackball.

Configuration

As cited, this computer doesn't have a traditional motherboard. Instead, it has a main board with eight sockets for RAM SIMMs, the serial and parallel ports, video and floppy/hard-drive interfaces and various other support circuitry. The processor, its immediate support circuitry and a numeric coprocessor socket are on a separate smaller board that plugs into the main board via a special connector. This arrangement makes it possible to simply transpose a 286 processor board (if that was your choice) and be up and running with a new 386SX processor without having to make any other changes.

A single expansion slot on the main board accommodates a plug-in backplane board that has five ISA expansion connectors on it. Because the I/O ports and video and disk-drive controllers are integrated onto the main board, all full-length 16-bit slots are available for use.

Only the first four RAM sockets provided on the main board permit 256K or 1M SIMMs to be installed. The remaining sockets accommodate only 1M SIMMs. Since the kit comes with four 256K SIMMs (for 1M total of supplied RAM), memory can be expanded via pairs of 1M SIMMs to 3M and 5M with the 256K SIMMs in place. Replacing the 256K SIMMs with 1M SIMMs permits memory expansion to the 8M maximum on the main board. Socketed ROM provides firmware that contains routines for booting, system diagnostics and a Setup/Configuration program. A real-time clock contains 50 bytes of battery-backed CMOS RAM that stores hardware configuration information, and a separate EEPROM stores an optional user password.

Three disk-drive bays are available. One of two bays accessible from the front of the system unit accommodates only a 3½" drive, while the other can be used for either a second 3½" or a 5¼" drive if a two-floppy configuration is desired. The cramped internal-only bay accommodates a 1"-high 3½" 40M, 25-ms Conner IDE hard drive. There's no room internally for a larger-capacity or larger-size or second hard drive, nor is there any way to access a second drive internally via the ROM in

the built-in controller. Any mix of 5¼" and/or 3½" floppy drives in standard and/or high-density formats can be accommodated by the disk controller on the main board.

Video memory is 256K and isn't expandable. Though limited, this is sufficient to support VGA resolutions up to 640 × 480 and 256 colors from a palette of 256,000 hues. Compatible with analog monochrome monitors that operate at 31.49 kHz and standard PC display modes, the on-board video system can drive just about any color or monochrome monitor that meets VGA, EGA, CGA, HGC or MDA.

The power supply is rated at only 125 watts.

Options directly available from Heath include: the alternative processor paddle; 40M Conner IDE hard disk; 1.44M 3½" floppy drive; 360K and 1.2M 5¼" floppy drives; a variety of color and monochrome video monitors; 1M SIMMs; 80287 and 80387SX numeric coprocessors; and a dual-port video card that supports VGA, EGC, CGA, MDA and Hercules TTL monitors.

Putting it Together

This kit is nothing like the Heath H-89, H-120 and H-150 computer kits I've assembled in the past. With those earlier models, I had to use a soldering iron and an assortment of hand tools. With the HS-5100-X (386SX version) I assembled, all I needed were slotted and Phillips screwdrivers and ⅙" and ¼" nut drivers. Because all circuit boards and subassemblies came factory-assembled and tested and all wiring was terminated in appropriate connectors, I never had the opportunity to plug in my soldering iron. So this is basically a mechanical-assembly kit, and with far less mechanical work than I've become accustomed to.

Assembly began with securing a panel to the bottom of the system-unit box, choosing horizontal or vertical orientation and affixing rubber feet to the system-unit box. Installation of the 256K RAM SIMMs in the sockets on the main board was next, with the manual giving details for installing both the basic 1M of RAM and expanding upon this. I followed up by mounting card guides and in-

stalling the main board in the chassis.

Before the processor paddle board is installed, the manual details installation of the coprocessor in a socket on this board, if this was a selected option. The next step was installation of the paddle card on the main board via its 96-pin connector and a screw.

Mounting the main board in the system-unit box was followed by mounting the battery that backs up the system setup CMOS RAM, keyboard connector assembly, speaker/LED/power-switch assembly and speaker and connecting them to the main board via factory-prepared cabling and connectors.

Installation of the floppy-disk drive went without a hitch. The assembly manual gives details for installing drives in all three bays, including optional hard and floppy drives. Since I had the optional 40M hard disk from the outset, I installed it at this time as well.

At this point, kit assembly was more than 90% complete. Only a few things remained to be done before power-up: mounting the power supply and plugging its output cables into the appropriate locations on the main board and disk drive; fixing a couple of peel-and-stick labels on the rear panel of the system-unit box; preparing and mounting the front panel to the system-unit box; making sure a switch on the keyboard was set to the AT position (there's an alternate XT position that doesn't work with this kit); and placing a logo label over the switch well on the keyboard.

Assembly time, including installing an additional 2M of SIMM RAM, a 5¼" 1.2M floppy-disk drive and the 40M hard drive, consumed just 1½ hours. I encountered no problems with assembly, thanks to the fully detailed step-by-step instructions in the assembly manual and excellently rendered illustrations booklet. It helped, too, that all parts meshed perfectly.

Up and Running

In its usual nothing-overlooked manner, Heath details step-by-step procedures for setting up the computer after assembly. On power-up, I entered the ROM-based monitor and keyed in setup information. Still in the ROM monitor program, I was di-

rected to perform a number of diagnostic tests to make sure the system was operating properly. Then I conducted system diagnostics, using the disk provided with the basic kit. Everything in the system, except the hard disk, is covered by these tests.

After making backup copies of the MS-DOS disks, I used these to check out and prepare the hard disk. I had only to perform a warm boot to load MS-DOS to reconfirm that everything was operating as it should.

From power-up to final confirmation, the whole procedure consumed a grand total of 2 hours and 10 minutes. Adding to this the 1 hour and 30 minutes or so required to assemble the kit, I was up and running in less than 4 hours. Since I put myself in the position of someone who had little or no experience in electronics and computing, double-checking every step and triple-checking some, as such a person would certainly do, I'd say that 5 hours would be more than sufficient time for anyone to get this computer up and running.

How It Performed

Performance tests on the HS-5100-X revealed this computer to be an average performer for 16-MHz 80386SX systems in most areas. For these tests, I used the more or less standard Core International Disk Performance Test Program (V. 2.8), Peter Norton's SI—System Information, Advanced Edition and the Database Group, Inc. Power Meter (V. 1.3).

Using the Core test, the HS-5100-X registered a data-transfer rate of 522.3 KB/s, average seek time of 25.2 ms and track-to-track seek time of 4.6 ms, for an overall Performance Index (PI) of 5.249. Table 1 illustrates how the HS-5100-X ranks in this test against other machines in the 80386 family. The numbers show that the Conner hard disk is an excellent performer, ranking just ahead of that in the Compaq 386/20, but it's, as you can see, no match for the drive in the IBM PS/2-80.

Using Peter Norton's SI test, the HS-5100-X registered respectable figures as well. Relative to the IBM PC/XT, it registered a Computing Index (CI) of 15.3. This is an average figure for similarly equipped 16-MHz 386SX computers.

Table 1. Core Disk Performance Test Results

Computer Make	Transfer KB/s	Seek ms	Track-Track ms	Performance Index
IBM PS/2-80, 70M ESDI	800.0	14.0	4.0	9.6
Heath HS-5100-X 40M IDE	531.1	25.2	4.6	5.346
Compaq 386/20 60M	485.0	83.0	20.0	3.2

I used Power Meter to test system CPU/memory and some hard-drive parameters. The results of these tests are summarized in Table 2. Comparing these figures with those published for other 386SX-16 computers reveals the Heath HS-1500-X to be an average performer.

Adding Options

To obtain maximum flexibility and the ability to run some fairly sophisticated software (including *Windows* 3.0 provided with the kit), I decided to flesh out the HS-5100-X by adding a 1.2M 5¼" floppy drive, 2M of RAM and a trackball. The disk drive and RAM SIMMs were purchased from typical computer mail-order sources, the trackball from a general-merchandise mail-order house. I tried to simulate purchase conditions

of a typical user who would ordinarily shop around for the best prices he could find.

With the trackball, I had no problems, either in obtaining it or installing the hardware and software. With the floppy drive and RAM, I experienced no difficulties with delivery, but both gave me installation problems. The floppy drive hung up the system on boot-up, and the computer refused to recognize the added RAM.

To see how a typical consumer would be handled, I gave Heath's technical-assistance people a call and described my problems. The Heath technician suggested a number of things I might try, even though I told him that the drive and RAM I was installing weren't purchased from Heath. He seemed to be very familiar with the HS-5100 and offered possible solutions to my problems.

Table 2. Power Meter CPU/Memory Tests

Test	Results	
	HS-5100-X	PC/XT
Aggregate Instructions	238.502 PMUs	64.752 PMUs
ADD (add)	0.787 μ s	3.642 μ s
DEC (decrement)	0.125 μ s	0.429 μ s
DIV (divide)	1.438 μ s	14.395 μ s
JMP (jump)	0.805 μ s	1.889 μ s
LODSW (load to register)	0.801 μ s	1.783 μ s
MUL (multiply)	0.750 μ s	11.796 μ s
MOV (move)	0.591 μ s	2.782 μ s
OR (inclusive-or)	0.787 μ s	3.642 μ s
PUSH/POP (push and pop)	0.733 μ s	2.988 μ s
RCR (rotate thru carry right)	0.813 μ s	5.661 μ s
NOPs	187.558 ns*	429.422 ns*
Sieve	1.369 seconds	5.000 seconds
Whetstone (no math coprocessor)	36.93	9.499
MIPS	2.448	0.645

* Time is in nanoseconds/instruction.

Notes: PMU is a measure of relative performance, expressed in Power Meter Units, with the larger the number, the better the performance; μ s is microseconds (millionths of a second) and ns is nanoseconds (billionths of a second). With all times listed, a smaller number means better performance.

I then called the mail-order companies from which I purchased the Teac drive and RAM SIMMs. Again, the technicians appeared to be knowledgeable about their products (though not the particular computer I was trying to install them in) and just as eager to help me find solutions. Both suggested I try essentially the same things as the Heath technician did. The advice all around was competent. Also, representatives of the mail-order companies from which I purchased the drive and RAM advised me that, if I couldn't get them to work, I should return the items for full refund.

I solved the floppy drive problem by twisting the controller cable 180°. The Heath and mail-order company technicians had indicated that the problem might lie in this area.

The person I spoke to at the parts mail-order house suggested that I might have gotten "bad" RAMs and told me to ship them back for testing. I did just that and received replacement SIMMs by overnight delivery. The new SIMMs weren't the same kind I'd originally received, and no explanation was given in the paperwork that accompanied them.

When I plugged the replacement SIMMs into the HS-5100-X and booted up, however, the computer recognized and let me access them when needed. I conclude that the wrong type of SIMMs had been shipped to me originally and that the mail-order company had simply rectified the problem. I'm not complaining, just happy that I have 3M of working RAM. All told, I spent more than an hour on the phone with the three technicians.

Super Monitor & Keyboard

I use a computer every day of the week, mostly for word processing in the office and also for other things in the office and at home. Sitting in front of a computer for hours on end, I can appreciate the value of a fast processor and a fast hard disk in terms of productivity. For me, though, just as important are the video monitor and keyboard I use with my computer.

My office keyboard is a Northgate OmniKey/102. Having worn out three other keyboards in less than a

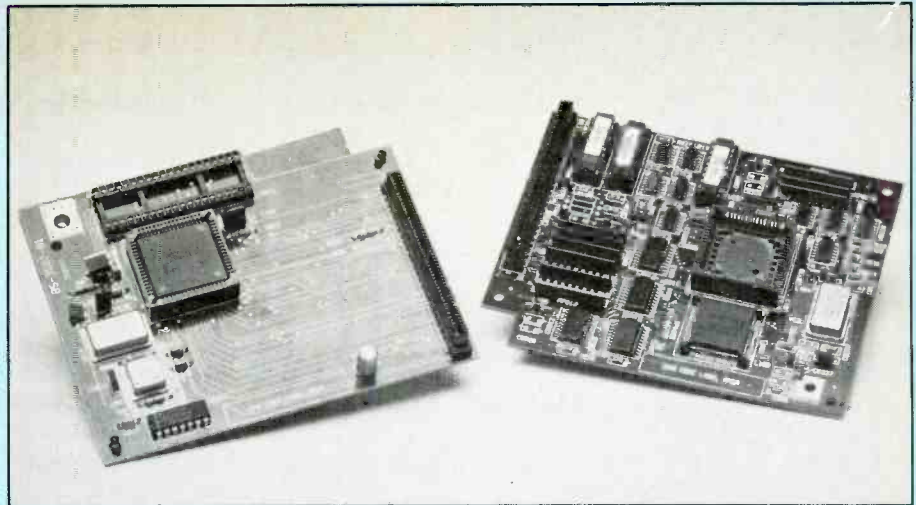

Two different "personalities" are possible for Heath's HS-5100 series of computers with choice of processor "paddle" card. The 286 card (right) is like the family car, while the 386SX (left) puts the power of a speedy roadster under the hood. Both cards are designed to plug into a special connector on the main board in the computer, and both feature a socket for installation of an optional companion math coprocessor.

year and a half, I appreciate the dependability of the OmniKey/102 that I've been using for a year or so without encountering problems. I like its solid keystroke action and tactile feedback. Also, the layout of the function keys along the left side of the main keyboard and the Ctrl, Shift, Alt and Caps Lock keys clustered at the lower-left of the main keyboard in an arrangement that I find comfortable seems to be custom-designed for my particular method of left-handed hunt-and-peck typing.

The keyboard supplied with the HS-5100 series computers has the function keys arrayed above the number-key row and the special keys mentioned above in a different pattern that slows me down a bit as I'm typing. This is something I just have to get used to with time. Fortunately, I don't have to get used to inferior key action or tactile feedback with the Heath keyboard, because it has both to my liking.

One thing the Heath keyboard gives me that the OmniKey/102 doesn't is automatic high-speed repeat that kicks in whenever a key is held down for more than a second or so. Like Heath keyboards I've used in the past, I'm not about to trade in the one supplied with the HS-5100 in a hurry. If it's built anything like the keyboard in my Heath H-120 computer, which I've been using for 11

years on an average of 3 hours per day, I probably never will, either.

The video monitor used with the HS-5100-X is a 14" Zenith ZCM-492 color VGA monitor. Heath's price is \$599 if purchased separately, which is par from mail-order houses.

This analog RGB video monitor accepts a standard 0-to-0.7-volt peak-to-peak input. Horizontal sync is 31.49 kHz and vertical sync is 70 Hz in 350-line mode and 60 Hz in 400- and 480-line modes. CRT diagonal measurement is 14", and viewable screen area is 9.65" × 7.28", which remains constant with changes in video mode.

The ZCM-1492 can display 80 characters × 25 rows using the video interface built into the HS-5100 and 132 characters × 25 or 43 rows using a separate video card. Maximum resolution is 640 × 480 VGA and MCGA; 320 × 200 double-scan VGA and MCGA; 640 × 350 EGA and VGA; 720 × 350 VGA; 720 × 400 VGA; and 1,056 × 352 or 400 VGA in 132-column mode. Dot pitch is 0.28 mm.

This monitor measures 15.5"D × 14.9"W × 12.6"H and weighs a hefty 37 lbs. It comes with a tilt/swivel base and an input cable terminated in a 15-pin D-type male connector.

Subjectively, the performance of the ZCM-1492 monitor is nothing short of spectacular. The flat-screen

technology displays what appear to be absolutely straight lines. I verified that the lines are indeed straight with a straightedge. Displayed images are brilliantly colored and sharp, and black areas exhibit no trace of "graying" contamination. The black is so deep, in fact, that I had the sensation of looking into limitless space when displaying a star map.

No leading or trailing edge blur and no image flickering or any other optical effects that detract from the purity of the displayed image were evident in all the many hours I used the ZCM-1492. I found this monitor a pleasure to use and very easy on the eyes, even after hours of constant viewing.

Conclusions

Building the HS-5100-X computer kit is an easy task since it's only an assembly kit, not a parts-intensive soldering job. For less than 2 hours work, I know all about the innards of the machine, which will undoubtedly be helpful when expanding or troubleshooting it.

This is a beautifully designed and solidly constructed computer. First class! But it does have some inadequacies. Firstly, its power supply is rated at only 125 watts, which can conceivably be pushed to the limit and beyond if all five slots on the ex-

pansion bus are occupied by heavy-drain cards. It's fortunate that the HS-5100 can accommodate only one hard drive on-board, because a second drive might limit the number of expansion cards that could be used in this computer.

Because the ROM in the on-board disk controller contains instructions to control only one hard disk, you can't simply add an external drive to the system. However, you do have other options to increase hard-disk capacity. One is to write the on-board controller out of the Setup instructions and use a separate drive controller that does accommodate two hard drives, one inside and one external to the computer. The controller would preferably be an IDE type so that you can use the Conner drive inside the computer.

Another alternative is to use a large-capacity hard card that plugs into the expansion bus. This last option may or may not permit you to use the highly reliable Conner drive with a hard card, though it should if both are IDE drives.

The convertible nature of the Heath HS-5100 computer kit is interesting. At least if someone made a buying misjudgment or couldn't lay hands on another \$200 and got the 286 version, upgrading later to a 386SX with Heath's "paddle" card

In Brief

HS-5100-A 12-MHz 80286

Computer Kit

HS-1500-X 16-MHz 80386SX

Computer Kit

The Heath Company

Benton Harbor, MI 49022

Phone Orders: 1-800-253-0570

Technical: 616-982-3309

Fax Orders: 616-982-5577

In Short: The 80386SX HS-5100-X is a solidly built mini-AT-cased basic computer that delivers average performance for its processor type. Backplane design and small footprint are decided pluses, as are the floppy/hard-disk controller, video controller and serial and parallel ports built onto the main boards.

costs only \$270; \$70 more than if the 386SX model had been bought in the first place.

As with other Heath/Zenith computers, The HS-5100 displays innovative thought, especially the backplane design, which is superior to the large motherboard mainstay of most personal computers. The model's horizontal or vertical mini-tower positioning, disk-based diagnostics, small footprint and open layout are commendable. I like the thumbscrew system-unit cover releases, too. Placing I/O ports and the video and disk-drive controllers on the main board makes available five full-length expansion slots that can accommodate all 16-bit, all eight-bit or any mix of both types of cards. Moreover, the machine's solid construction gives me a sense of confidence in the overall package.

Prices are fairly competitive with IBM compatibles in the marketplace, though certainly not among the lowest. You're locked into a few devices that are uniquely Heath's, of course, but the same can be said for any computer with VLSI and other chips that are proprietary designs.

In sum, if you want a soundly designed AT or 836SX computer, are willing to put in a few hours assembling it and aren't looking for a rock-bottom price for nameless machine, I can highly recommend the HS-5100. It's not for the power user who really wants to rise to a 386DX or i486 down the road, though, since expansion to such heights isn't in the cards with these models.

CIRCLE NO. 22 ON FREE INFORMATION CARD

CALL DOCTOR DESCRAMBLER

...for symptoms relating to scrambled cable T.V. signals. We have JERROLD • TOCOM • ZENITH • HAMLIN OAK • SCIENTIFIC ATLANTA. Six month warranty! We ship C.O.D. Lowest retail/wholesale prices. FREE CATALOG: Global Cable Network 1032 Irving St. Ste 109 S.F., CA 94122 NO CALIFORNIA SALES!!! OPEN SATURDAYS

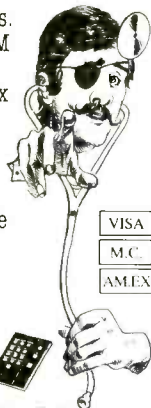

VISA
M.C.
AMEX

1-800-327-8544

CIRCLE NO. 31 ON FREE INFORMATION CARD

WHY PAY SKY HIGH MONTHLY FEES?



If you find a better deal, We'll beat it! JERROLD • TOCOM • HAMLIN • OAK • SCIENTIFIC ATLANTA • ZENITH • ask about our warranty program C.O.D. Visa, M/C, AMEX, welcome. FREE CATALOG • FREE CALL • OPEN SATURDAYS

GTV 1464 Garner Station Blvd #315 Raleigh, NC 27603

1 800 328-0198

CIRCLE NO. 29 ON FREE INFORMATION CARD



Optical Fiber Sensors

Although telecommunications is by far their most important application, optical fibers also find use in flexible image conduits and illumination sources. Their most interesting and unusual applications are as various kinds of sensors.

Optical-fiber sensors can be simple to make, they respond to many different stimuli and they can often operate in hostile environments, where conventional electronic sensors might fail or give false signals. This time around, I'll show you how to make and experiment with some simple optical-fiber sensors, including a sensitive vibration detector and a microphone that can be made from nothing but plastic. First, though, let's examine the two principal classes of optical-fiber sensors and how they work.

Fiber-Optic Sensors

Most optical-fiber sensors can be classified as either direct- or indirect-mode devices. Indirect-mode sensors are those in which an optical fiber serves merely as a transmission medium for light rays that perform some kind of sensing operation. The fiber itself plays no role as a sensor.

Direct-mode fiber-optic sensors are considerably more interesting since the fiber itself serves as the sensor. Fibers can serve as sensors because the light passing through them can be attenuated or otherwise altered by mechanical bending or stress and by the presence of liquids on the surface of an exposed fiber.

Indirect-Mode Sensors

Figures 1 through 4 illustrate three basic kinds of indirect-mode fiber-optic sensors. Many different kinds of fiber can be used. In most cases, inexpensive plastic or glass fiber with a large core diameter

works best. Each of these sensors requires a light source and a light detector. Depending on the application, the light source can range from natural illumination to many kinds of artificial sources like lamps and LEDs. This kind of sensor can even detect whether or not a pixel on a computer monitor has been illuminated. Suitable detectors include photoresistors, phototransistors and photodiodes.

Figure 1 illustrates the simplest fiber-optic sensor. Here the fiber serves to transmit ambient light to a detector. A simple circuit connected to the detector can switch on an alarm or trigger another circuit when the exposed end of the fiber receives light from any external source, or when light being received is momentarily blocked. If the light source is stable or if its intensity changes slowly and if the exposed end of the fiber is free to move, this simple arrangement can serve as a vibration detector (more about that later). If the fiber is pointing at a pixel on a computer display, it can indicate when that pixel has been illuminated.

Figure 2 is a drawing of an interesting sensor in which a phosphor has been applied to the exposed end of the fiber. When the phosphor is stimulated to emit light, some of the photons travel through the fiber to a detector. Various kinds of chemically-sensitive, light-emitting substances can also be applied to the end of a fiber to provide simple detectors that respond to the absence or presence of particular chemicals.

Figure 3 shows an indirect-mode sensor in which the external ambient light source has been replaced by a fixed light source connected directly to one end of a fiber. The fiber is aligned with respect to a second fiber connected to a detector. Any misalignment of one fiber with respect to the other is easily detected by this

arrangement. Indeed, this simple system is so sensitive that it can form the basis of a sensitive vibration detector. If one fiber is suspended from a fixed point to form a pendulum, this arrangement can function as a seismometer for detection of distant earthquakes and underground nuclear tests.

My son, Eric Ryan Mims, built a novel optical-fiber seismometer several years ago. The pendulum was made up of a fiber with a small lead fishing weight attached to its end. Instead of a second fiber at the detector, he used a pinhole aperture placed directly over a sawed-off LED. When the fiber was aligned with respect to the pinhole, light from the LED passed into the fiber and to a detector. The signal at the detector was then amplified and passed to the joystick port of a Radio Shack Color Computer connected to an x-y plotter. This combination performed like a computerized chart recorder. Slight movements of the fiber with respect to the pinhole produced deflections of the plotter pen.

This optical fiber seismometer, which was bolted to the concrete slab in Eric's bedroom, was very difficult to align but exceptionally sensitive. It detected all three principal shock waves generated by each of two underground nuclear tests in Nevada (we live in South Central Texas). It also earned Eric scores of science-fair awards and a trip to the International Science and Engineering Fair.

The Fig. 3 arrangement can also be used to detect the presence of objects and fluids between two fibers. For example, the gap between the two fibers can be immersed in water so that the signal at the detector will be related to the water's optical clarity. Or the sensing gap can be used simply to indicate the presence or absence of water or some other fluid.

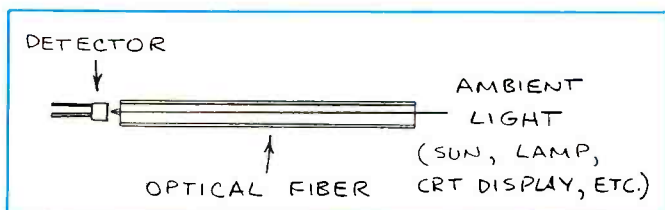

Fig. 1. Details of the simplest indirect-mode fiber-optic sensor.

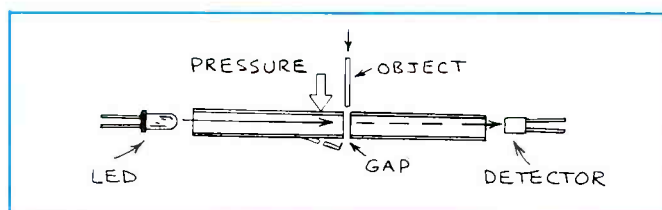

Fig. 2. A phosphor-activated fiber-optic sensor.

Figure 4 illustrates two more kinds of indirect-mode fiber-optic sensors. In (A) is shown a reflective sensor that uses individual fibers to carry light from a source to a surface and from the surface back to a detector. In this application, the fibers are fixed in place. The reflector is free to bulge, bend, vibrate or move. If the reflector is flexible so that it can bulge in or out, this system can be used to detect pressure changes and vibrations in the surrounding air or liquid. As you'll soon see, it can even function as a microphone. If the reflector is free to move or vibrate, this system can serve as a sensitive detector of motion, acceleration, vibration and pressure. If the color of the reflector changes with temperature changes, this system can monitor temperature.

Figure 4(B) illustrates a modification of Fig. 4(A), in which the two fibers are spliced into a single fiber (or bundle of fibers) at a Y-joint. This provides a single fiber or bundle of fibers that carries light in both directions to and from a reflector. The result is a very compact sensor that can be inserted into tiny openings. Incidentally, a bundle of fibers with a Y-joint is often called a bifurcated fiber-optic cable. Bifurcated fiber-optic cables are very expensive when purchased new. You can make your own using some heat-shrinkable tubing, or you can buy them at a dis-

count from surplus parts dealers.

Look back at Fig. 1 through Fig. 4. Notice that no electronic components or wires are present at the sensing region of each of the five illustrated indirect-mode sensors. This means these sensors can operate in the very harsh environments of pressure chambers, furnaces, freezers and when immersed in corrosive fluids. They can also operate in the presence of electromagnetic pulses and other kinds of electrical noise.

Direct-Mode Sensors

Passage of light through an optical fiber can be significantly altered when the fiber is bent. The most important result of bending is that some of the light passing through the core can "leak" into the cladding, where it's quickly attenuated. If the light is generated by a laser, bending will change the speckle pattern that emerges from the opposite end of the optical fiber.

Several kinds of direct-mode fiber-optic sensors are illustrated in Fig. 5 and Fig. 6. In each of these sensors, it's the optical fiber itself that responds to an external stimulus.

Illustrated in Fig. 5(A) is a simple movement or pressure sensor. Light passing through a fiber is slightly attenuated when the fiber is bent, even slightly. This attenuation can be detected by means of a photodetector and amplifier. A comparator connected to the output of the amplifier can be adjusted to trigger a LED or beeper when the fiber's movement exceeds a desired threshold.

The sensitivity of the fiber to pressure can be increased by placing it between two rough surfaces, as shown in Fig. 5(B). Pressure applied to the fiber will then cause many tiny bends (or micro-

and reduces the signal intensity at the detector. I once read where researchers used sandpaper for the rough surfaces. Sandpaper, however, is coated with very hard, sharp-edged particles designed especially for grinding. A better solution is to sandwich the fiber between a pair of surfaces covered by smooth bumps.

The sensitivity of both methods shown in Fig. 5 can be greatly increased if a laser diode or helium-neon laser is used as the optical source. Very slight movements of the fiber will cause significant changes in the speckle pattern that emerges from the fiber. You can see these changes if the laser beam is visible; just point the end of the fiber at a piece of paper.

Speckle pattern changes can easily be detected by a photodiode connected to an amplifier. If the amplifier is connected to a speaker, no sound will be heard when the fiber is undisturbed. Movements of the fiber, however, will cause various kinds of audible squeals and howls.

I've experimented with this arrangement and have learned that different disturbances generate very different sounds. For example, a bicycle tire rolling over the fiber (I used a jacketed fiber) produced a very different sound than that produced by a person stepping on the fiber. This would make an interesting subject to explore, especially if you know anything about various kinds of signature analysis using computers or dedicated circuits.

Figure 6 illustrates how a direct-mode optical-fiber sensor can detect the presence or absence of a fluid. In Fig. 6(A), a fiber with no cladding is used as a sensor. When a liquid comes in contact with the core, some of the light rays will be coupled into the liquid because the index of refraction of the liquid is greater than that of air.

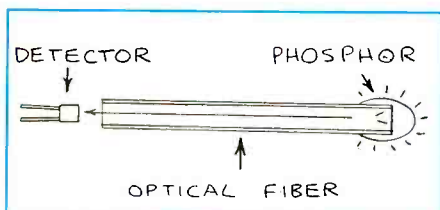

Fig. 3. An indirect-mode in-line fiber-optic sensor.

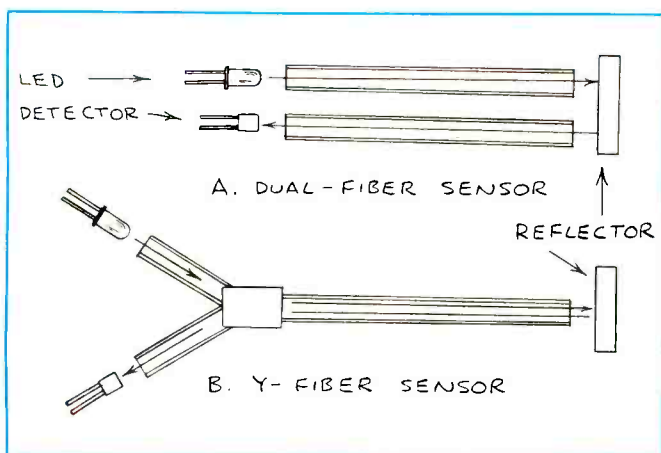

Fig. 4. An indirect-mode reflective fiber-optic sensor.

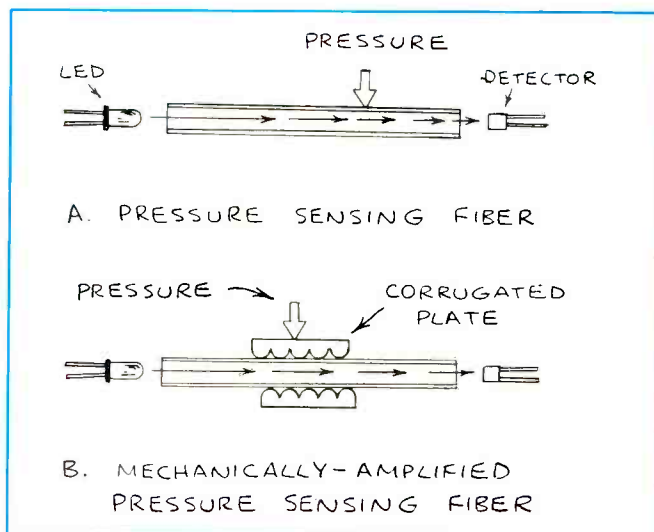

Fig. 5. A direct-mode fiber-optic pressure sensors.

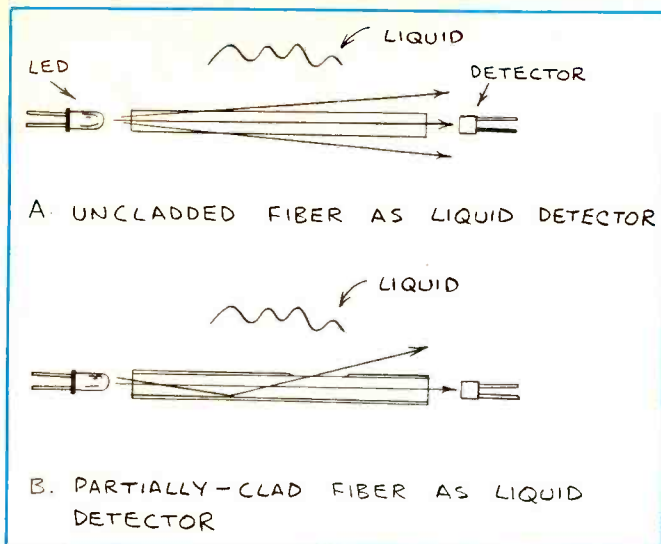

Fig. 6. Direct-mode fiber-optic liquid sensors.

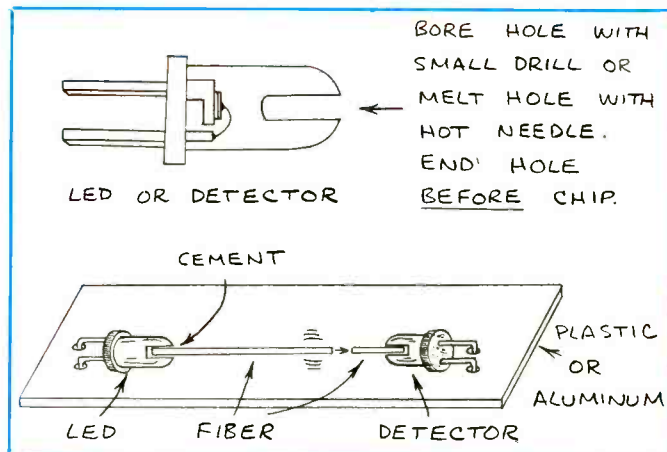

Fig. 7. A fiber-optic vibration sensor.

If why this happens isn't clear, remember how a fiber transmits a ray of light. Optical fibers ordinarily consist of a core surrounded by a cladding. Most of the light travels through the core because its index of refraction is greater than that of the cladding. This means light rays arriving at the interface between the core and cladding at less than a certain critical angle are reflected back into the core (step-index fiber) or are refracted back into the core (graded-index fiber).

Since the index of refraction of air (1) is less than that of plastic or glass, light travels through a plastic or glass fiber that has no cladding. The cladding isolates the core from any outside influences that might cause the light to leak away—like liquids.

Illustrated in Fig. 6(B) is how a standard optical fiber with a cladding can be used as a liquid detector. All that's needed is to remove some of the cladding from the portion of the fiber intended to sense the absence or presence of a liquid. This can be done with very fine sandpaper. Bending the section of the fiber where the cladding has been removed increases the sensitivity of the detector. (Can you figure out why?)

Direct-mode fiber-optic sensors have many other applications, one of the most interesting of which is the fiber-optic gyroscope. This device consists of a coil of optical fiber through which a laser beam is transmitted. Movements of the coil cause phase changes in the arrival of the laser light at a detector. Another interesting application is the fiber-optic hydrophone in which a coil of submerged optical fiber functions as a pressure-sensitive microphone.

Experiments

Now that we've covered the basic cate-

gories of fiber-optic sensors, let's experiment with some actual sensors. First, it's important to know how to cut (or cleave) plastic, glass and silica fibers. Various books and literature provided by manufacturers describe different ways of accomplishing this.

Plastic fibers can be easily cut with a sharp hobby knife. Place the fiber on a hard, flat surface and press the knife blade straight into the fiber and roll the fiber with your fingers until the fiber separates. In many applications, there's no need to polish the cut end of the fiber.

Glass and silica fibers should be cleaved, rather than cut. A good cleave leaves a perfectly smooth face on both ends of the cut fiber.

Many methods and techniques have been developed for cleaving glass and silica fibers. One method I've found to work fairly well is to wrap the fiber partially around a cylinder (such as a plastic 35-mm film canister) and to nick the rolled fiber with a glass cutter or carbide edge. If you apply some tension to the portion of the fiber wrapped around the cylinder, the fiber should cleanly separate where you nick it.

You can use a 50× phonograph stylus microscope to inspect the cleaved end of a fiber. If light is entering the opposite end, a perfectly cleaved end will appear like a solid circle of light.

As noted last month, you must exercise caution when cleaving optical fibers. I'm unaware of any hazards associated with using or working with plastic fibers, unless you use solvents or bonding agents to polish or bond the fibers. Glass and silica fibers are another matter.

Caution: You must be very careful when working with unterminated fiber cables and when cleaving glass and silica fibers! These fibers may have a diameter

of 100 micrometers or less. While a long length of such fiber is very flexible, shorter pieces are very stiff and can become very sharp, almost invisible splinters.

When cleaving glass and silica fibers, always wear eye protection. And be sure to pick up and dispose of fiber splinters immediately afterwards. Otherwise, one may end up stuck in your elbow the next

ATTENTION! ELECTRONICS TECHNICIANS



**EARN YOUR
B.S.E.E.
DEGREE**

THROUGH HOME STUDY

Our New and Highly Effective Advanced-Placement Program for experienced Electronic Technicians grants credit for previous Schooling and Professional Experience, and can greatly reduce the time required to complete Program and reach graduation. No residence schooling required for qualified Electronic Technicians. Through this Special Program you can pull all of the loose ends of your electronics background together and earn your B.S.E.E. Degree. Upgrade your status and pay to the Engineering Level. Advance Rapidly! Many finish in 12 months or less. Students and graduates in all 50 States and throughout the World. Established Over 40 Years! Write for free Descriptive Literature.

COOK'S INSTITUTE OF ELECTRONICS ENGINEERING

4251 CYPRESS DRIVE
JACKSON, MISSISSIPPI 39212

CIRCLE NO. 27 ON FREE INFORMATION CARD

SUPER LONG PLAY TAPE RECORDERS
12 Hour Model — USES 120 TAPE
\$119.00*

Modified Panasonic Slimline, high quality AC-DC provide 6 continuous hours of quality recording & playback on each side of cassette for 12 hours total. Includes • Voice level control • Digital counter, etc. TDK - 120 Cassette Furnished.

PHONE RECORDING ADAPTER
 Records calls automatically. All Solid state connects to your telephone jack and tape recorder. Starts recording when phone is lifted. Stops when you hang up. **\$28.50*** FCC APPROVED

VOX VOICE ACTIVATED CONTROL SWITCH
 Solid state. Self contained. Adjustable sensitivity. Voices or other sounds automatically activate and control recorder. Uses either recorder or remote mike. **\$28.50***

* Add for ship & handling Phone Adapter & Vox \$2.00 each. Recorders \$5.00 each. Calif. Res. add tax. Mail order, VISA, M/C, COD's OK. Money Back Guarantee. Quantity discounts available. Dealer Inquiries invited. Free data

AMC SALES INC. Dept. M 9335 Lubec Street
 Box 928, Downey, CA 90241
 Phones (213) 859-8519 1-800-926-2488
 FAX (213) 923-1478
 Mon-Fri 8-5 PAC TIME

CIRCLE NO. 23 ON FREE INFORMATION CARD

FREE CATALOG

Call (800) 992-9943

Over 35,000 Electronic Components

Call Today for Your FREE SUBSCRIPTION

If You Order Today, WE SHIP TODAY!!

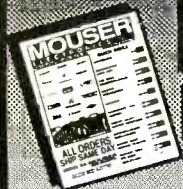

MOUSER ELECTRONICS

(800) 992-9943

Stocking Locations Across America.

CIRCLE NO. 36 ON FREE INFORMATION CARD

time you sit down to work. I usually dispose of such splinters by picking them up with the sticky side of a piece of masking tape and folding the tape over them.

It's not practical to cleave individual fibers in a bundle or cable of fibers. If you must cut a bundle, I suggest that you make the straightest possible cut using a fine saw. Then apply epoxy or some other suitable adhesive to the end of the bundle. After the epoxy hardens, you can polish the cut end of the bundle. You can begin by using carborundum paper. For a final polish, use polishing compounds available from lapidary shops. Employees at lapidary shops might also give you tips about how to achieve the best polish.

Vibration Sensor

Figure 7 illustrates an ultra-sensitive vibration sensor arrangement you can make from readily available materials. This arrangement is just a general guideline; many variations of this basic format are possible.

The light source for the sensor can be a standard LED, into which you've bored a small hole to receive one end of an optical fiber. Make the hole with a small drill or a hot needle. Be sure to avoid boring all the way to the tiny gold bonding wire above the semiconductor chip that emits light. Cement the fiber in place with cyanoacrylate adhesive.

It's not absolutely necessary to install the fiber in a hole bored into the LED. You don't even have to use a LED; a small incandescent lamp can also be used. One way to attach the fiber without making a hole is to slip a piece of heat-shrinkable tubing over the end of the LED, shrink it in place and insert the fiber into the opening. Squirt some cement into the opening to hold the fiber in place.

Figure 7 shows a fiber also installed on the detector. This can be skipped if you mount the light-source fiber close to the detector and place some kind of pinhole aperture between the fiber and the detector. One solution is to poke a pinhole in a piece of aluminum foil and wrap the foil over the detector with the pinhole centered over the sensitive region. Another is to dip the detector in black paint. After the paint dries, remove a tiny bit of paint from over its sensitive surface.

In other words, be flexible. You can use any assembly technique you want. You can even mount the movable fiber on the detector and the pinhole on the LED. All that matters is that the light reaching the detector be deflected by movements of a fiber.

In Fig. 8 are shown some basic circuits for supplying current to the LED and amplifying the signal from a phototransistor detector. For initial tests and experi-

ments, connect the output of the amplifier to an external amplifier with a speaker. When the sensor is still, all you hear will be a soft hiss. Tap the table on which the sensor is resting and the speaker will emit a distinct tone burst. Depending on your arrangement, the tone might sound like a bell or gong.

One way to increase the sensitivity of the sensor is to attach a small weight to the end of the fiber. A small lead split-ball used for fishing leaders is ideal. Don't crimp the ball over the fiber too tightly, though, or you may damage or break the fiber.

The weight will change the alignment of the fiber and the detector. One way to solve this problem is to turn the sensor on its end so that the fiber functions as a pendulum.

As you experiment with the basic sensor illustrated in Fig. 7, you'll soon discover that its response is very much determined by its position and the level of vibration. You will also find that it can detect moving air and acceleration.

Fiber-Optic Microphone

In the fall of 1977, I sketched in a notebook a microphone made entirely from plastic or glass. The idea was to illuminate a flexible diaphragm with an optical fiber. Some of the light reflected from the diaphragm would be reflected back into the fiber, where it would be carried to a detector. Sound waves striking the diaphragm would cause it to vibrate, thereby modulating the level of the reflected light that reached the detector.

By January 1978, I managed to build several prototype fiber-optic microphones. I haven't described them in print until now.

In Fig. 9 is shown a simplified drawing of one of them. This particular microphone is transparent. The plastic tube is a 1.75-inch (4.4-centimeter) length of clear acrylic. The plastic insert at the diaphragm end of the microphone is a short section of clear tubing that slips inside the outer tube. A piece of aluminized plastic film is placed over this insert, and the insert is pushed into the tube from the back end until the aluminized plastic film is flush with the end of the outer tube.

A second insert is formed by drilling a coaxial hole in a short rod of acrylic. This insert is then pushed into the back of the outer tube. The end of a bifurcated optical fiber bundle is then inserted into the hole until its end is within a millimeter or so of the aluminized plastic film. Ideally, the fiber-optic cable should fit snugly in the hole so its position can be adjusted by slightly pushing it toward or pulling it away from the diaphragm.

Although I have yet to measure the fre-

Earn Your B.S. Degree in ELECTRONICS or COMPUTERS

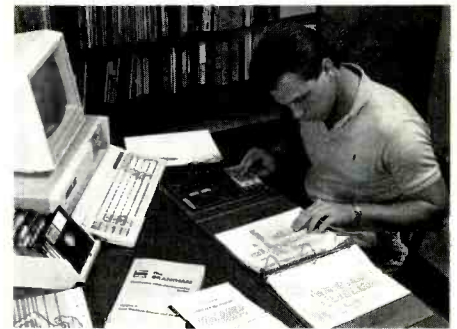

By Studying at Home

Grantham College of Engineering, now in our 41st year, is highly experienced in "distance education"—teaching by correspondence—through printed materials, computer materials, fax, and phone.

No commuting to class. Study at your own pace, while continuing on your present job. Learn from easy-to-understand but complete and thorough lesson materials, with additional help from our instructors.

Our Computer B.S. Degree Program includes courses in the BASIC, PASCAL, and C languages — as well as Assembly Language, MS DOS, CADD, and more.

Our Electronics B.S. Degree Program includes courses in Solid-State Circuit Analysis and Design, Control Systems, Robotics, Analog/Digital Communications, and more.

An important part of being prepared to *move up* is holding the right college degree, and the absolutely necessary part is knowing your field. Grantham can help you both ways—to learn more and to earn your degree in the process.

Write or phone for our free catalog. Toll free, 1-800-955-2527, or see mailing address below.

Accredited by
the Accrediting Commission of the
National Home Study Council

GRANTHAM
College of Engineering
Grantham College Road
Slidell, LA 70460

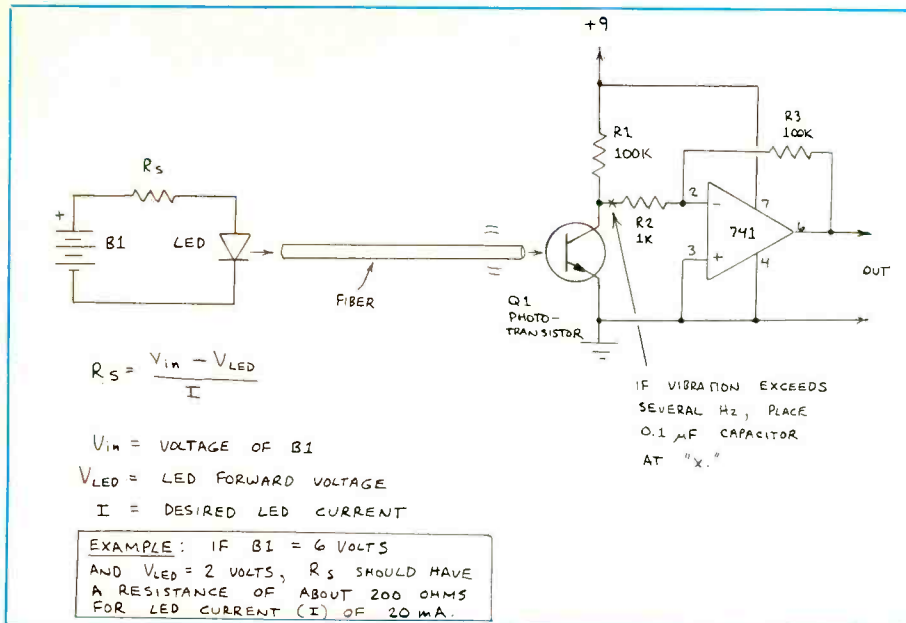

Fig. 8. Details of light source and receiver circuits for a fiber-optic vibration sensor.

quency response of a fiber-optic microphone, the sound quality seems fairly good. The position of the end of the fiber cable isn't nearly as critical as I thought it might be. Of course, this makes sense when you consider that the same method can be used to send your voice hundreds of feet via sunlight reflected from a flexible mirror.

The Fig. 8 circuit can be used to operate the fiber-optic microphone in Fig. 9. Although this circuit specifies a LED biased at 20 milliamperes, much better results were achieved when I used an incandescent lamp as a source. Indeed, a two-cell penlight produced better results than a near-infrared LED biased at 100 milliamperes.

You can experiment with the basic microphone design in Fig. 9 to improve its quality. For example, a small circle of shiny aluminum foil attached to the inside surface of the diaphragm provides much more sensitivity and reduces the need for a bright light source. I've also

found that a suitable diaphragm can be made from a disk of self-adhesive paper pressed over the end of the outer tube. A small circle of foil placed at the center of the disk provides the reflective surface.

You might also want to experiment with a modulated light source and a pulse-frequency-modulated detector circuit. This might reduce the average power consumption of the system.

Going Further

As you can see from the foregoing, optical-fiber sensors have many fascinating applications. Optical fibers, even terminated ones, are available for reasonable prices from various sources. Therefore, anyone with basic electronics skills can design and experiment with various kinds of fiber-optic sensors.

For more information about fiber optics and names and addresses of suppliers of fiber-optic materials, see my June 1991 column. ■

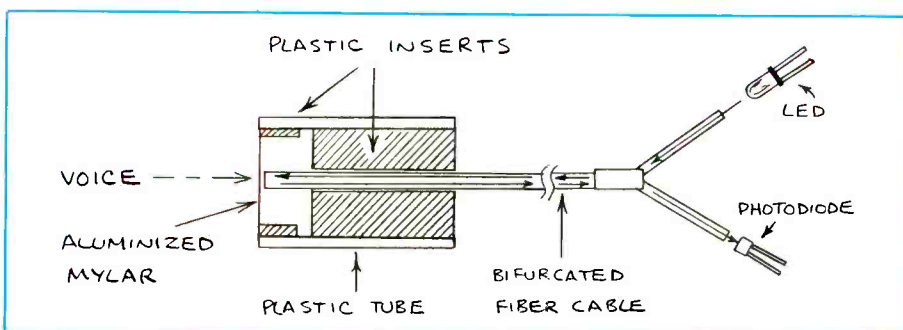

Fig. 9. A fiber-optic microphone made entirely of plastic.



Road Warrior Tele-Toolkit and a Digital Imaging Primer

If you've followed this column, you know that I frequently use portable PCs. A product that I use almost every time I hit the road with a PC, and which was mentioned briefly in passing a few columns back, is the Road Warrior Tele-Toolkit from Computer Products Plus. Housed in a small 10" x 4" nylon zippered bag, it contains just about everything you need to let your portable's modem or fax card "reach out and touch someone" from just about any typical user-hostile hotel room phone.

You might think that in today's high-tech world of advanced communications, it would be an easy task letting your computer "phone home." Unfortunately, this doesn't seem to be the case. Out there in the real world. In the past year, I've taken a half-dozen business trips and stayed in some very nice hotels. These included two Marriotts, a Hilton, a very large Holiday Inn, a Hyatt and even a specialized conference center. None of these hotels could be considered anything other than first-rate. Yet in all of these hotels, only the Hyatt Regency Embarcadero in San Francisco had a telephone easily usable with a modem.

The Hyatt's room telephone came with a data port (actually a standard RJ-11 modular outlet) into which a modem or fax card could be plugged. I still had to play with the phone's buttons to get an outside line and reconfigure my communication software to provide the phone credit card information while placing the calls. But this was heaven compared to some of the contortions I've had to go through in the past. In fact, many hotel-room phones are completely hard wired, both on the wall side and the instrument side, rather than the common modular approach used in your home and office.

Over the years, I've picked up bits and pieces to help connect my on-the-go PCs to recalcitrant hotel phones, but CP+'s kit is the first of its kind I've seen that has everything you might need in one ease-to-carry travel bag. The Tele-Toolkit has several devices and adapters that should let you get through on just about any phone, no matter where.

The simplest "tool" in the kit is a length of standard modular phone cord with a modular plug on one side and two

alligator clips on the other. Instructions that come with the Toolkit explain how the clips can be connected either inside the mouthpiece of a phone, within the instrument itself, or at a connector block at the wall. The RJ-11 plug is plugged into a cord coupler and a standard modular cord is plugged both into the coupler and your modem. In most cases, this solves the problem.

If you need to hook into a digital phone system and it uses a modular handset cord, the CP+ Connection is used. This is a small box that plugs between the handset and phone instrument and also has a jack for connection to your modem. There are two switches on the Connection, and when they're set according to instructions, you can usually get through. I use the word "usually" because there have been occasions where the Connection just didn't work. The CP+ Connection, by the way, is made by Konnex and is available directly from the manufacturer, Traveling Software, and a number of other vendors in addition to CP+.

Finally, if all else fails, you're simply not in the mood to start disassembling phones and wall jacks, or are trying to use a battery-powered PC with a public telephone, the Tele-Toolkit includes the Telecoupler. The Telecoupler is a 2,400-baud acoustic coupler into which your modem or fax card plugs. Rather than the old acoustic couplers, which consisted of two foam muffs in a box, the Telecoupler is a compact instrument that uses a Velcro band to fasten it to just about any handset configuration.

The endpieces that contain the speaker and microphone are adjustable and conform to just about any handset I've yet encountered, including my Panasonic hand-held cellular phone. The Telecoupler is powered by four AAA alkaline cells, which give between 7 and 10 hours of use. I carry an extra four-pack of Duracells in the travel bag, just in case. In addition to the above, the Tele-Toolkit has an assortment of small tools, including a screwdriver, lighted magnifying glass and even a razor knife (though the acoustic coupler has so far saved me from having to slice through hotel-room wires and walls).

At \$279.96 for the whole shebang, the

Road Warrior Tele-Toolkit isn't cheap. You can get the Toolkit without the Telecoupler for \$139.95, or without the coupler or CP+ Connection for \$49.95. The CP+ Connection is available separately for \$99.95 and the Telecoupler for \$149.95. I wouldn't travel without the whole kit, but for many less critical applications, I'd recommend just the coupler. By itself, it should get your PC communicating up and running in almost any situation. If you travel with a laptop, you owe it to yourself to at least take a look at CP+'s catalog.

Digital Imaging Primer

One of my favorite areas of experimentation over the past few years has been with digital imaging and image manipulation. This fascination probably grows out of my interest in photography. I'm not really very skilled with a camera, but I really enjoy composing in the enlarger and seeing a color print come out of the processing tube. The same seems to hold true when the image is a digital one.

I tend to point the camera (whether film or video) everywhere and edit and compose afterwards. Several years ago in this column, I took a look at what hardware and software were available to capture video images and manipulate them. In two short years, the technology has greatly improved, and prices have fallen precipitously. It's time to take another look, and we'll do that over this and the next several columns. But first, a quick review of some of the principles involved might help you make a bit more sense of what some of the issues are in the field of computer imaging.

Digital imaging is actually a lot simpler, at least conceptually, than film-based imaging. When you shoot a photo in your camera, light bouncing off your subject is collected by the camera's lens and focused on the film's emulsion in the camera. The exact effect this light has on the emulsion depends on the type of film you're using (black-and-white, color print, color slide), but in all cases, some activation takes place in proportion to the amount of light energy. In the case of color films, the light's frequency or color falls on each particular area of the film. When this film is developed, chemical re-

actions take place that leave or wash away grains making up the emulsion, or with color films, allow colored dyes to migrate from one film layer to another.

To print this film, light is projected through the film, and a similar type of process takes place on the photographic paper. The process is actually somewhat more complex (especially chemically) than this simple explanation, but it lays enough groundwork to introduce the two most important differences between digital imaging and standard photography. With standard photography, the individual grains that make up a black-and-white image (or the dye spots that make up a color image) are so small that they're usually discernible only under magnification. That's number one.

The second major difference is that each grain in a black-and-white photo image turns black in proportion to the light energy it absorbs. Between pure black and pure white, there are an infinite number of shades of gray. The same principle holds true in color photography. Everyone learned about the primary colors in school, and how every particular shade is a mixture of one or more primary color (and possibly white). The human eye is capable of differentiating several million different shades of color, and a typical color photograph may have thousands, even millions of separate shades. The points of color dye, however, are so small and closely packed, that the transition from one color to another is very subtle.

Digital imaging, on the other hand, is very simple compared to film photography. A black-and-white video camera or image scanner consists of a sensor array, most often a CCD (Charge-Coupled Device) these days. As with a film camera, light bouncing off the subject is gathered and focused by the camera's lens onto this sensor array.

The sensor array in a video camera consists of a number of individual areas laid out in a square. Each of the sensing elements is called a pixel (which stands for picture element). Each pixel senses two things. First, the presence or absence of light at the moment the element is polled by the camera's control circuitry. If light is falling on the element, the control circuitry determines the amount (intensity) relative to the other pixels it has scanned in the frame.

The sensor is scanned horizontally from left to right across the array. When one line of elements has been scanned, the next line down is next scanned. When the entire element has been scanned, one frame of video is recorded on the recording medium. A scanner, whether it's a hand scanner or page scanner, works in a

similar fashion, except that the sensor array is a single horizontal line of individual elements. When the entire line of elements has been polled, the scanner head is positioned a bit farther down on the document or photo being scanned, and the process repeated.

Color imaging is accomplished in very much the same manner, except that you must find the amount of each of the primary colors for each pixel. This can be done in several ways. On a scanner, it's most often done by making three passes over the same area and filtering the scanner light source to a different primary color on each pass. Another method, used in some high-end video cameras, is to have three very small sensor elements for each pixel, with the triad having red, green and blue filters. When you reassemble the RGB values for each pixel, you get back pretty much the same color that was originally sensed.

When digital imaging is being performed, either by grabbing a frame of video from a video camera or VCR or by using a scanner, the results of polling the sensor array are converted into a file and stored on-disk. This image has several very important differences from a conventional photo. The first is resolution.

If you examine a photograph, you'll notice that shades of gray and areas of black and white blend into each other. The same goes for colors in a color photo. Unless you look at the photo under a magnifying glass, it's difficult to see exactly where one shade of gray (or color) ends and another begins. This is why photographs are called "continuous-tone images."

A digitized image, on the other hand, is limited in resolution by three factors—the complexity (the number of elements) of the imaging sensor, the resolution of the device on which the image is displayed and the storage capabilities of the medium onto which the digital image is recorded.

At the present time, we can (and do) make sensor arrays with many more elements than the standard CCD used in a video camera offers. But they're very expensive to produce (in addition to needing much more complex and expensive control circuitry) and still don't begin to approach the very small size of an individual grain or dye spot in photographic emulsion. And even if we could capture more information, the question is, how would we display it?

A standard VGA monitor has a resolution of only 640 by 400 pixels. Phototypesetters have resolutions approaching five times this but still fall short of continuous-tone capabilities. Most standard computer printer technologies limit re-

production to between 300 and 600 dots per inch, again far short of being able to effectively reproduce continuous tones.

Most importantly, each pixel of an image has to be recorded with an intensity (gray scale) or a shade of color. We can differentiate between very subtle differences in shades of gray and color, but as the information from *each* pixel has to be stored in a binary format, each time we narrow the definition, the amount of storage space needed to record the image goes up.

In the real world, we bring image storage requirements down to a reasonable amount by compromising on the number of gray scales or shades of color we capture for each pixel. Early digital imaging systems recorded each pixel as being either pure black or pure white. This allowed each pixel to be represented by one bit of memory.

Today, many digital imaging products distinguish between 64 shades of gray (requiring six bits of memory) or 256 shades (which needs eight bits of memory). Color digitizers offer four-bit resolution (16 colors), eight-bit resolution (256 colors) or 24-bit resolution (approximately 16-million colors).

File-compression techniques can reduce storage requirements somewhat, but image files still tend to take up a lot of space, in some cases millions of bytes.

Before you get too discouraged about not being able to play with photographic-quality images on your computer, give some thought as to what most people use digitized images for. I've used these captured images in newsletters, to help a friend put together a catalog and to create presentations on my PCs. In all these instances, resolution of the output device—whether a laser printer, computer display or photo-offset printer—was more of a limiting factor than resolution of the image or the number of gray scales or color shades captured.

In the next couple of columns, we'll take a look at some reasonably priced gray-scale scanners, some color video digitizers for the PC and Mac and even a still video camera. I'll also explain how image editing and manipulation software, along with the techniques of dithering and halftoning that take advantage of the mechanics of vision, will let you get a more pleasing digital image. ■

Products Mentioned

Tele-Toolkit
Computer Products Plus, Inc.
16351 Gothard St.
Huntington Beach, CA 92647
800-274-4277



NEC Speeds Up the V20 and V30; Fast Video DACs; CRT and Stepper Motor Drivers

Contrary to popular belief, the 8088/8086 processor type isn't dead yet. NEC has just pumped up its versions of the chip to operate at 16 MHz. This should mean that low-cost notebook computers will be around for a while. These new devices head this month's column subjects.

Low-power 16-MHz CPUs

NEC Electronics' (401 Ellis St., Mountain View, CA 94039) V20H and V30H microprocessors, operating at a clock frequency of 16 MHz, are fully static 16-bit devices that draw only 8 milliamperes/MHz. They operate from just about any 5- or 3-volt power source. Applications for the V20H and V30H include any low-power, battery-powered PC-compatible systems, such as pocket computers, portable PCs, laptop/notebook computers and hand-held terminals.

Critical to these low-power applications is a microprocessor's ability to stop the clock and maintain operation. The V20H and V30H CPUs accomplish this with a clock-stop mode that allows the designer to bring the clock frequency down to zero without disturbing flow of a running program.

The V20H offers a 16-bit internal architecture with an external eight-bit bus. Its counterpart, the V30H, has an internal structure that's 16 bits wide both internally and externally. Instruction sets and other features are the same.

Both microprocessors are code-compatible with their predecessors, the V20 and V30 (8088- and 8086-type) microprocessors. At 16 MHz (5 volts), minimum instruction execution time is 125 ns, while at 8 MHz (3 volts), minimum instruction execution time is 250 ns. Maximum addressable memory is 1 MB.

Other features of these new CPUs include 14×16 -bit register sets; bit, byte, word and block operations; maskable and non-maskable interrupts; IEEE-796 bus-compatible interface; 101 different instructions; 1.20- to 3.55-microsecond multiplication/division instructions at 16 MHz; and high-speed block-transfer instructions at 16 MHz (2-million transfers

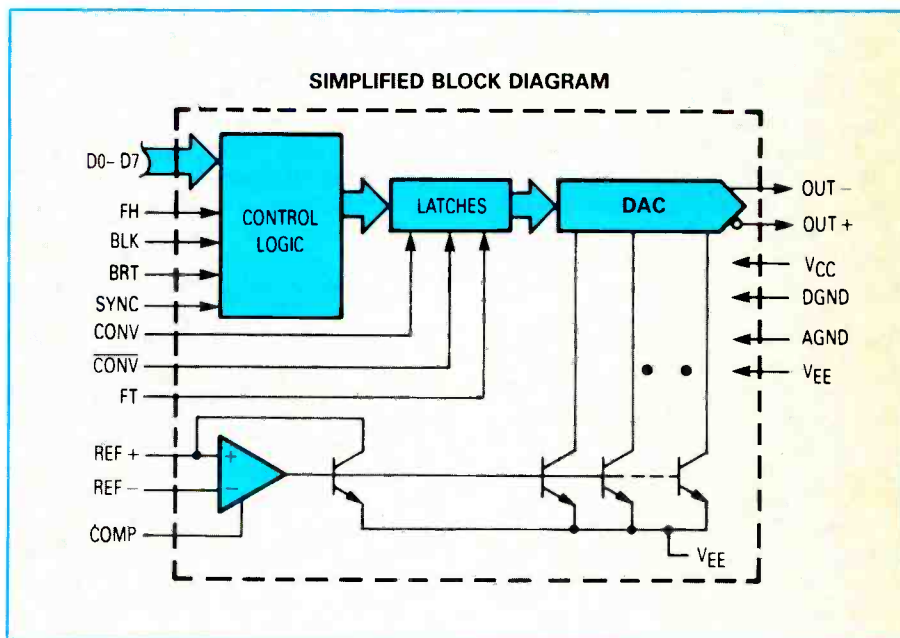

Fig. 1. A simplified block diagram of Motorola's 40 MS/s eight-bit video-speed D/A converters.

per second). Pricing for these chips is \$6 each in 10,000-piece quantity.

Video DACs Sample to 40 MHz

Motorola (Bipolar Analog IC Div., 2100 E. Elliot Road, Tempe, AZ 85284) has a pair of 40-megasample-per-second (MSPS) eight-bit video-speed digital-to-analog converters (DACs) capable of driving a 75-ohm cable, with appropriate terminations, to EIA-170 and EIA-343-A video levels. Their functional block diagrams are identical (see Fig. 1), but the MC10322 has TTL-compatible logic inputs, while the MC10324 has ECL-compatible logic inputs. These devices are designed for high-speed digital-to-analog conversion applications, including RGB graphics, high-resolution video, raster graphic displays and test equipment.

The MC10322 and MC10324 both have input registers that eliminate the need for external latches, unless transparent mode is selected. Video controls

(Force High, Blank, Bright and Sync) permit an easy interface to standard video systems. The TTL-compatible MC10322 DAC can interface directly with Motorola's MC10319 (eight-bit) and MC10321 (seven-bit) high-speed analog-to-digital flash converters (ADCs) that have been available for some time. These new DACs have convert (clock) inputs that can be either differential or single-ended. Complementary outputs are provided for interfacing to custom displays and obtaining special effects.

Both chips require a minimum of external components, and the standard video levels interface directly to a monitor without the need for amplifiers. These ICs are fabricated with Motorola's MOSAIC process, which provides high-speed performance at low power consumption.

A microprocessor interface can be accomplished with standard video levels through the use of logic inputs, and there are no critical timing specifications and no required minimum clock frequency.

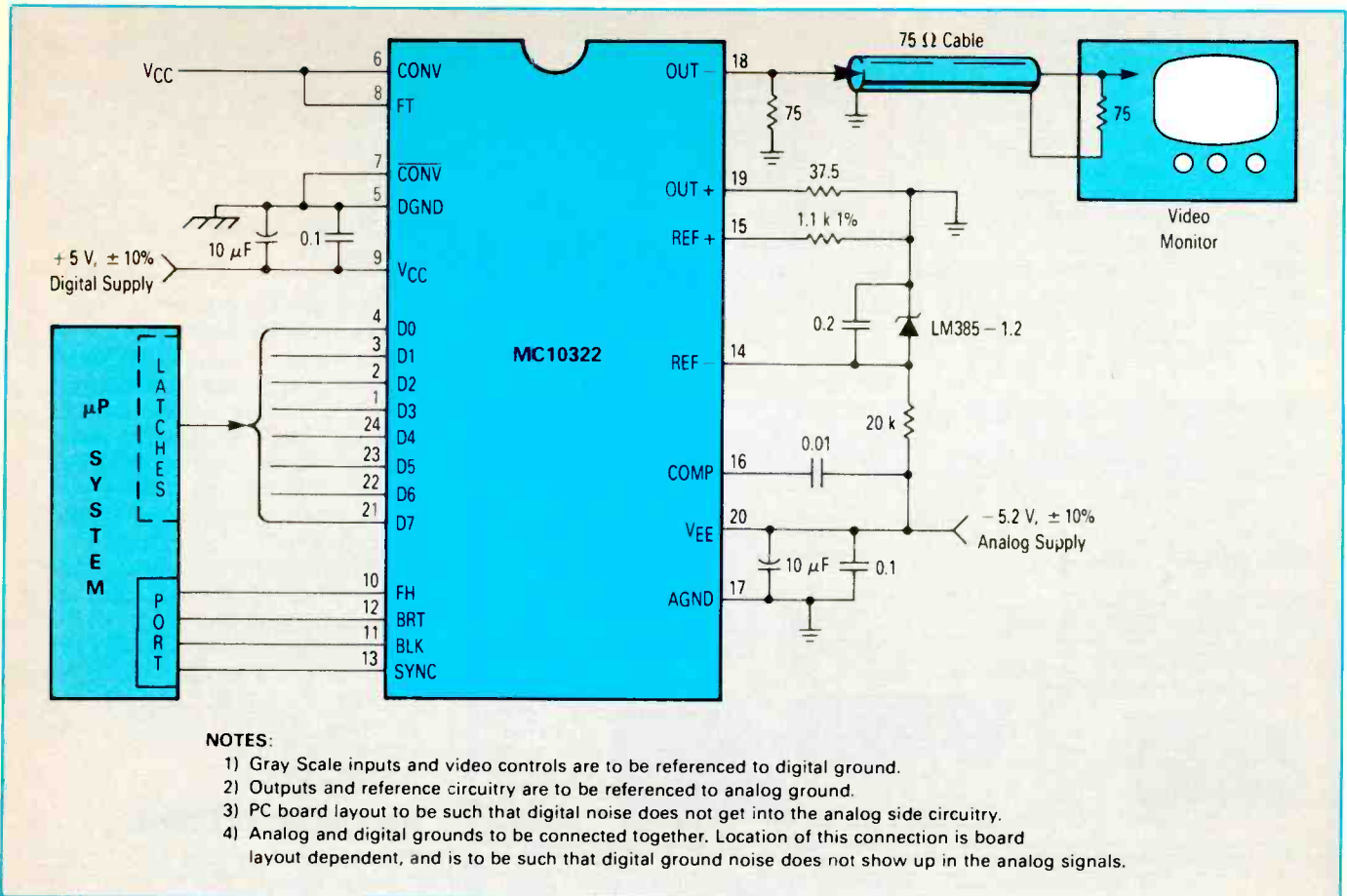

Fig. 2. A typical application circuit, in transparent mode, for the Motorola MC10322 video DAC with TTL inputs.

The MC10322 and MC10324 have very-low power dissipation (less than 350 mW), which eliminates the need for heat sinks. Figure 2 shows a typical application circuit for the MC10322.

Both devices are available in 24 pin DIPs. They're specified for operation over the extended temperature range of 40°C to +85°C. Price for either device is \$4.36 in 250-to-999-piece quantity.

Expanded CRT Chip Family

National Semiconductor (2900 Semiconductor Dr., Santa Clara CA 95052) has added five new devices, with seven total part types, to its family of High-Resolution Video (HRV) products. The new HRV CRT drivers span the performance range from VGA graphics to CAD/CAM-resolution levels.

The five new devices include the LM2416C triple driver for VGA and low-end Super VGA (SVGA) applications, the LH2416 for high-end SVGA applications, the LH2426 triple driver for IBM 8514 uses, the LH2440 combined driver/preamp and the LH2422 and LH2424 single drivers for very high-end mainstream applications.

The LH2424 features a 150-MHz bandwidth and rise/fall (on-to-off transition) time of 3 ns. The device is well-suited for driving high-resolution monochrome or color graphics monitors used in CAD/CAM applications and workstations.

With a 30-MHz bandwidth and rise/fall times of 15 ns, the LM2416C triple driver is well-suited for VGA and low-end SVGA applications. The LM2416 (50-MHz bandwidth, 13-ns rise/fall

time) is targeted at higher-end SVGA and IBM 8514 applications. The LH2426 completes National's coverage of the 8514 standard.

The LH2440 driver/preamp is designed for monochrome applications that have significant space constraints.

Monitor designers will find the newest members of the HRV family capable of directly driving the electron gun (cathode) on the back of CRT displays. These drivers take a low-level input (0.5

**I'LL HAVE MINE
DESCRAMBLED**

If you find a better deal, We'll beat it! JERROLD • TOCOM • HAMLIN • OAK • SCIENTIFIC ATLANTA • ZENITH • ask about our warranty program C.O.D. Visa, M/C, A.M.E.X. welcome. **FREE CATALOG • FREE CALL • OPEN SATURDAYS**

1 800 562-6884

VIDEO TECH
3702 S. Virginia St. Ste. 160-304
Reno, NV 89502

CIRCLE NO. 40 ON FREE INFORMATION CARD

★★★★ PRESENTING ★★★★★

**CABLE TV
DESCRAMBLERS**

★★★★ STARRING ★★★★★

JERROLD, HAMLIN, OAK
AND OTHER FAMOUS MANUFACTURERS

- FINEST WARRANTY PROGRAM AVAILABLE
- LOWEST RETAIL/WHOLESALE PRICES IN U.S.
- ORDERS SHIPPED FROM STOCK WITHIN 24 HRS.
- ALL MAJOR CREDIT CARDS ACCEPTED

FOR FREE CATALOG ONLY **1-800-345-8927**
FOR ALL INFORMATION **1-818-709-9937**

PACIFIC CABLE CO. INC.
7325½ RESEDA BLVD., DEPT. 1212
RESEDA, CA 91335

CABLE-MATE, INC.
Are You Tired of Paying
Outrageous Fees?

All makes and models of cable equipment shipped within 24 hrs. Quantity discounts. For free catalog send S.A.S.E. to: Cable-Mate, Inc., 450 Shag Bark Algonquin, IL 60102 C.O.D. orders accepted **CALL FOR PRICES TODAY!!** 800-422-0525 (708) 658-2121 *No Illinois orders Hours—8:00 am-5:00 pm central time



K.D. VIDEO

FOR ALL YOUR CABLE TV NEEDS
WE SPECIALIZE IN DEALER PRICING

QTY	1	10	20
Jerrold (Type) SB-3	89.00	56.00	48.00
Jerrold (Type) Tri-Bi	119.00	69.00	65.00
Scientific Atlanta SA-3	129.00	80.00	75.00
Hamlin MLD-1200	99.00	59.00	45.00
Oak N-12 Vari-Sync	99.00	59.00	58.00
Jerrold 550 Converter	99.00	75.00	68.00
Jerrold 400 DRX-3DIC (With Built in SB-3)	169.00	109.00	100.00

1-800-327-3407

Call us for prices on large quantities
K.D. Video PO Box 29538, Mpls., MN 55429

48 HOUR SHIPPING

ELENCO & HITACHI PRODUCTS
AT DISCOUNT PRICES

48 HOUR SHIPPING

Hitachi RSO Series

VC-6023 - 20MHz, 20MS/s	\$99/mo*
VC-6024 - 50MHz, 20MS/s	\$120/mo*
VC-6025 - 50MHz, 20MS/s	\$138/mo*
VC-6045 - 100MHz, 40MS/s	\$125/mo*
VC-6145 - 100MHz, 100MS/s	\$200/mo*

RSO's from Hitachi feature roll mode, averaging, save memory, smoothing, interpolation, preranging, cursor measurements. These scopes enable more accurate, simpler observation of complex waveforms, in addition to such functions as hardcopy via a plotter interface and waveform transfer via the RS-232C interface. Enjoy the comfort of analog and the power to digital.

20MHz Elenco Oscilloscope



\$375

- Dual Trace
- Component Tester
- 6" CRT
- X-Y Operation
- TV Sync
- 2 P-1 Probes

LEASING AVAILABLE

For all Hitachi Scopes - Call for details
 * Based on 24 months lease V-1150, VC-6045, VC-6145 (36 months)

Hitachi Portable Scopes

DC to 50MHz, 2-Channel, DC offset function, Alternate magnifier function

V-525 - CRT Readout, Cursor Meas.	\$1,025
V-523 - Delayed Sweep	\$995
V-522 - Basic Model	\$895
V-422 - 40MHz	\$795
V-223 - 20MHz delayed sweep	\$695
V-212 - 20MHz	\$425

HITACHI COMPACT SERIES SCOPES

This series provides many new functions such as CRT Readout, Cursor measurements (V-1085/1065/665), Frequency Cr (V-1085), Swepttime Autoringing, Delayed sweep and Trigger Lock using a 6-ech CRT. You don't feel the compactness in terms of performance and operation.

V-660 - 60MHz, Dual Trace	\$1,195
V-665 - 60MHz, DT, w/cursor	\$1,345
V-1060 - 100MHz, Dual Trace	\$1,425
V-1065 - 100MHz, DT, w/cursor	\$1,605/mo*
V-1085 - 100MHz, QT, w/cursor	\$1,225/mo*
V-1100A - 100MHz, Quad Trace	\$1,255/mo*
V-1150 - 150MHz, Quad Trace	\$1,115/mo*

Elenco 35MHz Dual Trace



Good to **\$495**

- High luminance 6" CRT
- 1mV Sensitivity
- 8KV Acceleration Voltage
- 10ns Rise Time
- X-Y Operation + 2 Axis
- Delayed Triggering Sweep
- Includes 2 P-1 Probes

FREE DMM
 with purchase of
ANY SCOPE

SCOPE PROBES
 P-1 65MHz, 1x, 10x \$19.95
 P-2 100MHz, 1x, 10x \$23.95

All scopes include probes, schematics, operators manual and 3 year (2 yrs for Elenco scopes) world wide warranty on parts & labor. Many accessories available for all Hitachi scopes. Call or write for complete specifications on these and many other fine oscilloscopes.

B + K TEST EQUIPMENT
 All Models Available

Call for special price

Digital Capacitance Meter
 CM-1550B
\$58.95
 9 Ranges
 1pF-20,000pF
 5% basic acy.
 Zero control w/ Case
 Big 1" Display

Digital LCR Meter
 LC-1801
\$125
 Measures:
 Coils 1uH-200uH
 Caps 1pF-200uF
 Res .01-20M

Multimeter with Capacitance & Transistor Tester
 CM-1500B
\$55
 Reads Volts, Ohms
 Current, Capacitors,
 Transistors and
 Diodes w/ case
 Big 1" Display

FLUKE MULTIMETERS
 All Models Available
 Call for special price

Quad Power Supply XP-580
\$59.95
 2-20V @ 2A
 12V @ 1A
 5V @ 3A
 -5V @ 5A
 Fully regulated and short circuit protected

Triple Power Supply XP-620
 Assembled \$65
 Kit \$45
 2 to 15V @ 1A,
 -2 to -15V @ 1A
 (or 4 to 30V @ 1A)
 and 5V @ 3A
\$26.95
 14 Transistors + 5 Diodes
 Makes a great school project

AM/FM Transistor Radio Kit
 with Training Course
 Model AM/FM 108
\$26.95
 14 Transistors + 5 Diodes
 Makes a great school project

True RMS 4 1/2 Digit Multimeter
 M-7000
\$135
 0.5% DC Accuracy
 1% Resistance
 with Freq. Counter
 and Deluxe Case

Soldering Station
 Temperature Controlled
 SL-30 \$99
 Digital display
 Temp range:
 300F-900F
 Grounded tip
 Overheat protect

Color Convergence Generator SG-200
\$69.95
 Finest in the industry
 10 rock steady patterns

Digital Triple Power Supply XP-765
\$249
 0-20V @ 1A
 0-20V @ 1A
 5V @ 5A
 Fully Regulated, Short circuit protected with
 2 Limit Cont., 3 Separate supplies
XP-660 with Analog Meters \$175

Four-Function Frequency Counters
 F-100 120MHz
\$179
 F-1000 1.2GHz
\$259
 Frequency, Period, Totalize,
 Self Check with High Stabilized Crystal Oven
 Oscillator, 8 digit LED display

GF-8016 Function Generator
 with Freq. Counter
\$249
 Sine, Square, Triangle
 Pulse, Ramp, 2 to 20MHz
 Freq. Counter: .1 - 10MHz
 GF-8015 without Freq. Meter \$179

Function Generator
 Blox
\$9600
\$28.95
 Provides sine, triangle, square
 wave from 1Hz to 1MHz;
 AM or FM capability

STANDARD C-228A 144/220 MHz
True Twin Band Handheld
First TWIN BAND HT MADE For U.S. Market

Learn to Build and Program Computers with this Kit
 Includes: All Parts, Assembly and Lesson Manual
 Model MM-8000
\$129.00
 Starting from scratch you build a complete system. Our Micro-Master trainer teaches you to write into RAM, ROMs and run a 8085 microprocessor, which uses similar machine language as IBM PC.
 Robotics Kit for above (MM8010) 71.95

Wide Band Signal Generators
SG-9000 \$129
 RF Freq 100K-450MHz AM Modulation
 SG-9500 w/ Digital Display & 150MHz built-in Counter \$249

- Wide Band Receive Coverage
- 40 Memory Channels
- Receives Both Bands Simultaneously
- Versatile Scanning Modes
- DTMF Memory Stores Favorite Telephone Numbers
- Full Cross Band Repeater Mode
- Up To 5 Watts Output
- Includes 700 mAh Battery And Charger
- 1 Year Warranty

CALL FOR PRICING



WE WILL NOT UNDERSELL!
 UPS Shipping: 48 States 5%
 (\$3 Min \$10 Max) Shipping
 IL Res. 7% Tax FAX: 708-520-0085

C & S SALES INC.
 1245 Rosewood, Deerfield, IL 60015
 (815) 292-7711 (708) 541-0710

15 Day Money Back Guarantee
2 Year Warranty Prices Subject to Change
WRITE FOR FREE CATALOG

to 3.0 volts) from the preamplifier and amplify it to the 40 to 80 volts needed to drive the cathode of the CRT.

These new parts significantly reduce the complexity of video board layouts, especially for color monitors. The simplified layout is also easier to manufacture, due to reduced component count on the video board and fewer parts to mount on the heat sink.

In high-resolution monitor systems, board layout becomes much more complex as operating frequencies and bandwidths increase. By reducing the CRT driver to one package, instead of several discrete transistors (even more for color), National's HRV drivers help reduce this problem. To further simplify layout, all the HRV drivers work with other HRV family members, such as the LM1201 single preamp or the LM1203 triple preamp.

All HRV family members are available from authorized National distributors. In quantities of 100, the new devices are available at the following prices: LM2416CT, \$8.10; LM2416T, \$9.20; LM2422J/S, \$12.90; LH2424J, \$15.06; LH2426S, \$18.00; LH2440S, \$15.00; LH2440AS, \$10.60.

Stepper Motor Drivers

Fujitsu Microelectronics, Inc. (Integrated Circuits Division, 3545 N. First St., San Jose, CA 95134) has a new series of four-phase stepper motor drivers. The MBH90101-5 devices are constant-voltage stepper motor drivers/controllers that use hybrid technology. Built to reduce board space and facilitate designs, each device integrates a universal gate array controller, four power MOSFET transistors and four protection diodes on a single 24-pin DIP. This arrangement allows it to perform all the control/drive/protection circuit functions for a four-phase stepper motor.

The MBH90100 series offers several additional features, including provision of output signal delay excitation to prevent abnormal motor currents. The stepper motor driver also receives digital drive signals from the CPU, enabling users to change to single-phase, two-phase or one- to two-phase easily. The series uses a Schmitt-trigger circuit in every input signal terminal. Each device runs on a + 5-volt power supply, reducing the power requirements of a design.

Stepper-motor drivers are designed for applications that require mechanical movement, including facsimile equipment, copiers, laser printers, dot-matrix printers and hard-disk controllers.

The MBH90100 series is packaged in a 24-pin plastic DIP. Prices range from \$3.43 to \$4.88 in quantities of 1,000.

CIRCLE NO. 26 ON FREE INFORMATION CARD

ECL, memory, etc.), 2,400 diodes and transistors, 400 analog or passive devices and 300 miscellaneous items like switches and connectors.

The library is divided into 17 menu selections. Included are libraries for Spice, Susie, and Xilinx devices. New parts can be added using the library editor. *CapFast's* strength isn't only in its sheer number of library devices, but in the information each device model contains. For example, each logic chip comes with 33 lines of data. Included are the typical device type, schematic reference, component value and physical outline entries. Not so typical are instruction on which pins can be swapped during PCB layout, propagation times and alternate package configurations. If this isn't enough for your needs, you can add an unlimited number of data lines of your own using a non-formatted word processor or *CapFast's* library editor.

Parts are called from the library by bringing up a parts list and clicking on the device for placement on the drawing. A listing of device parameters then appears. At this time, you can specify the part value, schematic reference or any of the many parameters the device has to offer. You can also specify which parameters to display (all if you wish), plus each one's text size and placement. But you may want to hold off on this until later because placement editing, like rotation, can be made only after the part is in place, and your text could end up looking mighty strange. After the part is placed, you're returned to the parts list, where you can select another device for placement.

Wires can be drawn manually or automatically. Manually, you call up the Wire command and scoot the

mouse from start to finish, clicking whenever you wish to change direction. Diagonals are permitted when ortho is turned off. For automatic wire routing, you can either mark the wire's course by clicking the mouse on critical turning points and then activating the Wire command, or by simply clicking on destination and end points while letting *CapFast* find a route for you. Unfortunately, that route may be through the body of a component or on top of another wire. Whether wiring by the manual or automatic method, a separate series of keyboard commands is needed for each wire placed.

You can also draw a wire manually and then have *CapFast* copy it as many times as you wish by simply tagging each wire's origin. This is most useful when working with buses or wiring memory arrays. But, again, *CapFast* frequently places wires atop other wires, unless the path is a direct route (no bends).

Although the wire connections are electrically correct and can be used for netlist generation, you'd never know it by looking at the schematic drawing. However, each wire is individually labeled and can be identified if you choose to display the wire's name. This is called piping of wires by heavy users of this technique. *CapFast* supports buses, too.

CapFast has an excellent selection of schematic-editing features, including Move, Delete, Copy, Rotate and Mirror. These tools are also available for block functions. When a part or block is moved, rubberband connections follow along, with *CapFast* doing its best to clean up the mess into an ortho drawing. But, too often, it misses the mark, making the electrically-correct connection, ra-

ther than the more visually correct separation of wires. Individual wires can be unstacked and rerouted if you can locate an elbow and move it to a new location.

There's a Find command, but no Locate or Jump. An Undo command reverses your last command. When it comes to generating netlists, *CapFast* is second to none. If the schematic models don't contain the information your PCB-layout or circuit-simulation program needs, you can add it. All netlists are generated in DOS, using a *CapFast* conversion utility. While *CapFast* comes with an assortment of popular conversion formats, most notably *PADS* (see elsewhere in this article) and *Schema*, you may need to pay extra for the conversion program.

Error checks for floating inputs, shorted outputs and the like are provided. Hardcopy output is decent, with support for 9- and 24-pin Epson printers, plus Hewlett-Packard and Houston Instrument plotters. However, software printer and plotter control is limited to scaling (which lets you reduce drawing size) and page orientation.

Summary. *As a stand-alone schematic capture program, CapFast is pricey and exhibits overkill in some respects. But for front-end use in a complete circuit-design package, it has no equal. It supports a huge device library and can interface with virtually every PCB-layout and circuit-simulation program around. If you work with a lot of different post-processing circuit design packages, this is the schematic-capture program for you.*

CIRCLE NO. 85 ON FREE INFORMATION CARD

PADS-PCB from CAD Software

PADS-PCB is one of the best PCB-layout programs around. It supports automatic parts placement, three autorouters and an array of editing tools second to none. But get your pocketbook ready, because its \$975 base price is just the beginning. A full-blown package can cost \$2,300

and more. The program can support up to 8MB of LIM memory if available, but it requires only 640K to run. A hard disk is needed, and the supplied hardware-protection key must be plugged into the parallel port before the program will run.

Access to the program is via a com-

mon main menu that lets you access other *PADS*-related programs, like schematic-capture and the library editor. Going from PCB layout to artwork generation isn't exactly seamless, but the main menu keeps you from having to run each program from a DOS prompt.

The program is easy enough to learn but more difficult to use because commands are stacked in a hierarchic structure that has you accessing layer after layer when searching for a command. What's worse, is that you have to follow the menus backwards, one by one, when exiting. Fortunately, the process can be expedited by pressing the first letter of the command from the keyboard, saving you having to race the mouse around the desktop.

Zoom and pan are manual, not automatic. However, both can be used during parts placement and routing. Zoom range is 64:1. A Help screen isn't provided. The library contains outlines for 159 devices, including several SMDs, that are electrically linked with 2,160 components, mostly logic chips. Parts can be added to the library, using a library editor that's accessible from the main menu.

PADS has an excellent automatic parts-placement program (\$350 extra) that can even properly place decoupling capacitors. But before devices can be extracted from the netlist for automatic placement, you have to define both a board outline and a parts matrix.

Maximum board size is 32" × 32". The matrix isn't sized to the board; so you can place sections of the board according to device type, such as assigning one area to memory chips only. While this is a great asset, it takes some planning to avoid getting the layout cluttered or too spread out.

A matrix isn't required for manual placement. Parts can be rotated or flipped to the solder side of the board for SMD layout after auto-placement. Any part can be glued in place and automatic placement run again for improved placement. There are three autorouter options, all at extra cost. The standard autorouter (\$750) uses a mix of user-selectable heuristic and Lee algorithms. You can choose from 15 routing modes, and run them either separately or as a batch. The autorouter runs through the list, beginning with power supply tracks and ending in via optimization. However, you can autoroute only two layers and one track width at a time. Each different layer pair or new track width requires a separate route.

Autorouting can be confined to a net or specific area of the board and

Program	Place	Route	Library	Netlist Support	Ease of Use
<i>PADS-PCB</i>	A	A	B	A	C
<i>DC/CAD</i>	B	B	B	B	B
<i>EE Designer III</i>	A	A	D	C	C
<i>HiWIRE II</i>	D	B	C	B	C
<i>PCB II</i>	B	D	A	F	A
<i>OrCAD/PCB II</i>	C	B	A	A	B
<i>PCBoards</i>	D	C	D	D	C
<i>ProCAD</i>	C	A	C	D	C
<i>Protel-Autotrax</i>	A	A	B	C	A
<i>Protel-Easytrax</i>	D	C	B	F	A
<i>Schema-PCB Layout</i>	A	A	B	B	C
<i>Tango-PCB Plus</i>	D	A	A	D	B

Note: Ratings are descending order of value, from Excellent (A) to Poor (D).

can be interrupted at any time for manual intervention. The router grid is variable between 1 and 800 mils and can be changed on the fly. A rip-up router that can route 12 layers simultaneously sells for \$3,500 and a shove-aside router goes for \$1,495.

For manual routing, tracks are started by clicking on a pad and moving the pointer to the connecting pad. A ratsnest, which can hide power supply nets, is always visible. Changing track width for necking-down can be done on the fly. Curved tracks aren't supported, but 30 copper layers are, each of which can have both a power and a ground plane.

PADS-PCB is one of the very few PCB-layout programs that let you change package types (like from DIP to SMD) after parts are placed. It's also one of the few that let you do gate and pin swapping. Editing tools include move, rotate, delete, mirror and copy for both individual tracks or parts and blocks of components. Blocks can also be saved to a disk file for use again. Track connectivity is maintained when moving a single device or block.

A design-rule checker checks for air-gap violations, as well as floating inputs and shorted outputs. There's also a density map that displays the concentration of tracks on the board and a histogram that plots track density on a screen chart. Both can be used to open up congested areas or in

conjunction with optional thermal analysis programs (prices start at \$1,995) for cooling analysis.

The program can produce a full range of output netlists and files—at extra cost, of course. The Gerber and N/C drill utilities are \$300 each, and the DXF (*AutoCAD*) file generator is \$495. The only thing you don't have to pay extra for are the layer masks, which include all 30 copper layers, solder and SMD paste masks, and top- and-bottom layer silkscreen.

A dot-matrix or laser printer can be used to produce artwork that's good enough for limited production and prototype work. A good assortment of Hewlett-Packard and Houston Instruments pen plotters are also supported. Artwork can be sized to fit the page, scaled to a model size or printed actual-size.

Summary. *PADS-PCB is an excellent PCB-layout package that has automatic part placement, support for up to 30 layers of copper and permits package, pin and gate swapping. There are three autorouter options, and the program can be used with nearly all schematic-capture programs, using one of the many optional netlist conversion utilities. The bad news is its price, which can add up to a tidy sum by the time you buy all the needed options. If your company pays for it, go for it.*

CIRCLE NO. 86 ON FREE INFORMATION CARD

FutureNet-5 from Data I/O

FutureNet-5 is the industry standard for schematic-capture software. It interfaces with virtually all PCB-layout and circuit-simulation software, comes with a large component library and is chock-full of drawing and editing features. But at \$995, it's among the most expensive.

The program requires only 640K of RAM to run, but it will use up to 16MB of LIM memory, if available. A hard disk with 6.5MB of free space is required, and a supplied hardware-protection device must be plugged into the parallel port.

The program is moderately easy to learn and use. Commands are run from a two-level menu structure, using either the keyboard or mouse. Many of the command screens are structured like Microsoft *Windows*' dialog boxes and command menus.

FutureNet-5 has both autopan and *Windows*-like scroll bars for moving around the drawing. Autopan abruptly jumps about half a screen when the cursor bumps against a screen edge. Zoom range is 10:1 and is available from the keyboard during parts and wire placement. A context-sensitive help screen is available, and there's a macro recorder that remembers keyboard strokes and mouse clicks for later playback. Macros can be assigned to the top-row function keys for fast execution.

The component library consists of about 4,000 parts stored in 18 modules. The types of parts are quite diverse, ranging from TTL chips to microprocessors to Xilinx devices. Library modules must be loaded individually into the drawing session after the program is started, but all can be active at the same time. Parts can be modified or added to any of the modules using the library editor.

Parts can be transferred from library to drawing by selecting them from a scrolling parts menu or typing their name at the command prompt. Components can be rotated and mirrored, but only after they're initially placed. Device references are also added only after a device is placed. Size and location of the annotation text is infinitely variable.

Among other features, there's an automatic numbering routine that se-

quentially numbers the parts in a raster-scanning pattern, starting with the upper-left corner and ending in the lower-right corner. Only ortho lines and wires can be drawn, not diagonals.

FutureNet-5 supports electrical wires, buses and eight forms of lines, such as dotted, dashed and so forth. Lines or wires are started by selecting the line command from the menu, placing the crosshairs at the beginning of the line and clicking the mouse. Each successive click of the mouse changes the direction of the line and places the previous line segment on the drawing. Drawing editing features are excellent, with support for Move, Delete, Rotate and Copy commands.

Blocks are also supported, and can be moved, erased, rotated, copied and saved to file for use again. Connectivity is maintained when a part is moved, but you'll have to approve new wire placement one wire at a time. An Undo command undoes commands in the reverse order they were entered; a Redo command reverses the undo command by redoing actions that have been undone. Undo and Redo are available only if LIM memory is present.

The program outputs the schemat-

ic in the popular *FutureNet* netlist standard. This netlist format is supported by a large number of PCB-layout programs. Netlist generation is done in DOS. A DOS-based error checking utility checks for floating inputs, shorted outputs, and broken wires. *FutureNet-5* supports almost 200 dot-matrix and laser printers. If the drawing is larger than the page, it's printed on multiple pages that must be taped together. Plotters aren't supported.

Summary. *FutureNet-5 is an excellent schematic-capture program that can be viewed as a yardstick by which other schematic programs are compared. It's a standard in the sense that so many PCB-layout and circuit-simulation programs interface to it. The component library is large, and the editing features are plentiful. It's not the easiest program to use, though not the most difficult, either. Its price is quite high, compared to competitors, too. But a combination of its output being at the ready for use with so many different PCB-layout and simulation programs and a corporate daddy to pay for it makes it a versatile contender.*

CIRCLE NO. 87 ON FREE INFORMATION CARD

BIOS Upgrades

For The IBM PC, XT, AT & 386 Or Compatible.

AMI, Phoenix & Award
Latest Versions

- 1.2 & 1.44 Floppy Support
- Complete Set Up In ROM
- Supports VGA
- Novell & Netware Compatible
- User Defined, Hard Drive Support
- 101 & 102, Keyboard Support
- Complete Documentation
- 30-Day Money Back Guarantee

CALL FOR PRICE

1-800-TEL-BIOS

1-800-835-2467 Good In Both U.S.

& Canada

603-432-1532 In N.H.

ADVANCED SOFTWARE

CIRCLE NO. 86 ON FREE INFORMATION CARD



Program
6805
Chips

Design & Test on your
PC . . . From \$349

TECI's MCPM-1 system allows your IBM PC and Compatibles to be used as a complete development system for the Motorola 6805 family of single chip microcomputers. Many time saving features at an affordable price.

Also available - Programmer for 68HC05, in-circuit emulators, "How-to" Primer, and many software tools to help you.

Call Toll Free
1-800-336-8321

TECI

The Engineers Collaborative, Inc.
Rt. #3 Box 8C Barton, VT 05822 USA
TEL: (802) 525-3458 FAX: (802) 525-3451

CIRCLE NO. 45 ON FREE INFORMATION CARD

PAY TV AND SATELLITE DESCRAMBLING ALL NEW 1991 EDITION

Our best yet. The very latest in descrambling circuits, bypasses, turn-ons for cable, wireless and satellite. Only \$14.95. Other pay TV editions, Vol. 1 (Basics of All Systems) \$14.95. 1989 Edition \$14.95. Build satellite systems under \$600 \$12.95. Wireless Cable Handbook \$9.95. Any 3/\$29.95 or 5/\$44.95. Scrambling News Monthly has all info on the new "Plain Vanilla" descramblers which emulate B-Mac, VCI, Plus and Orion. \$19.95/yr. All new catalog \$1.

Scrambling News, 1552 Hertel Ave.,
Buffalo, NY 14216. COD'S ARE OK. (716) 674-2088

CABLE TV CONVERTERS Attention Cable Viewers!

Jerrold, Zenith, Oak, Scientific Atlanta,
Hamlin, Tocom, and many others.

BEST PRICES! • 1-800-826-7623
B&B Inc. • 4030 Beau-D-Rue Dr., Eagan, MN 55122



CABLE-TV BOXES

Descramblers • Converters
FREE CATALOG

TRANS-WORLD CABLE CO.
12062 Southwest 117th Ct., Suite 126
Miami, Florida 33186
800-442-9333

CABLE TV

DESCRAMBLERS
ALL TYPES 800-582-1114
FREE CATALOG
M.K. ELECTRONICS • 7958 Pines Blvd
Suite 276 • Pembroke Pines, FL 33024

PICKS UP A WHISPER 50 FEET AWAY!

The model WAT-50 miniature FM transmitter uses a 4-stage circuit NOT to be confused with a simple wireless microphone. Simply snap the unit on top of a 9V battery and you can hear every sound in an entire house up to 1 mile away! Use with any FM radio. Tunes to any frequency from 70mhz - 130mhz. Easy to assemble kit includes all parts and instructions. Only 29.98 tax incl.

The **WIRELESS TELEPHONE TRANSMITTER** model WTT-20 is only about the size of a dime, yet transmits both sides of a telephone conversation to any FM radio with crystal clarity. Completely automatic. Uses power from the telephone line itself - never needs a battery! Up to 1/4 mile range. Tunes from 70mhz - 130mhz. Easy to assemble kit includes all parts and instructions. Only \$29.98 tax incl.

Call or send MO, VISA, MC for immediate delivery. Single kit orders include \$1.50 S&H. **FREE SHIPPING** on orders of 2 or more. All orders shipped by U.S. Mail. COD add \$4.00. Personal checks allow 21 days.

DECO INDUSTRIES
BOX 607, BEDFORD HILLS, NY 10507
914-232-3878

CIRCLE NO. 28 ON FREE INFORMATION CARD

Classified Commercial Rates: \$1 per word, 15-word minimum (\$15.00) prepaid. (Word count includes name and address; ZIP code and abbreviation each count as one word; P.O. Box number and telephone number count as two words each.) Indicate free category heading (**Computers, Communications, Electronics, Video or Miscellaneous**). A special heading is available for a \$6 surcharge. First word only is set boldface caps at no charge. Add 20% for additional boldface words.

Non-Commercial Rates: FREE to subscribers, as space permits; maximum 15 words. A recent **COMPUTERCRAFT** mailing label must accompany ad.

(All advertisers with P.O. Box addresses must supply permanent address and telephone number. Copy is subject to publisher approval.)

Mailing Information: Copy must be received by the publisher by the 25th of the third month preceding the cover date. Send Advertising material with check or money order or credit card information (Visa or MasterCard only) with number and expiration date to: **COMPUTERCRAFT**, Classified Department, 76 N. Broadway, Hicksville, NY 11801.

VIDEO

VHS-VCR Repair Solutions Sets I, II, III, IV, V, VI. Each contains 150 symptoms and cures, updated cross reference chart, free assistance, \$11.95 each all six \$59.95. Eagle Electronics Box A, 52053 Locks Lane, Granger, IN 46530.

ELECTRONICS

KINETIKITS from **KINETICO**: electronic kits outputting light or sound. Free catalog: **KINETICO**, P.O. Box 1634, NY, NY 10114-0508.

MINIATURE FM TRANSMITTERS! Tracking Transmitters! Voice Disguisers! Bug Detectors! Phone Devices! More! Available in kits or assembled and tested! Catalog \$2.00: **XANDI ELECTRONICS**, Box 25647, "B13", Tempe, AZ 85285-5647.

SURVEILLANCE / COUNTERSURVEILLANCE devices catalog. Cameras, bug detectors, video camera detectors, transmitters, communications, and much more. Catalog \$3.00. DSP, P.O. Box 1275-ME, Redondo Beach, CA 90278.

SURVEILLANCE—Audio/Video/Infra-red/Laser Equipment. Industrial or Private. 500 Item Catalog \$7.00. Security Systems, 3017D Hudson, New Orleans, LA 70131.

SURVEILLANCE - COUNTERSURVEILLANCE. Guaranteed lowest prices! Unbelievable, Detectors, Jammers, Transmitters, Phone Security, Cameras, Personal Protection, Books, More! Huge catalog \$5.00 (Refundable) **PROTECTOR** P.O. Box 520294-B, Salt Lake City, UT 84152.

SWR and POWER METER, assembled, kit or plans, with Alarm and Set Points. **FREE** information. Rupp Electronics, 5403 Westbreeze, Fort Wayne, IN 46804 219-432-3049.

SAMS books and Photofacts, TV, VCR, and Computer, new and surplus, ARRL books. Aim audio and video accessories and connectors, EKI Kits, NTE replacement parts, Surplus tubes. **ATKINSON & SMITH, INC.**, 17 Lewis St., Eatontown, NJ 07724 1-800-542-2447.

DAZER Personal Protection Devices! Lasers! AM/FM/Infrared Transmitters! Detectors! More! Kits/Assembled. Catalog \$2.00. **QUANTUM RESEARCH** 16645-113 Ave., Edmonton, Alberta T5M 2X2.

NEGATIVES/positives from your originals. SASE for information. J & E Enterprises, 2457 N. Marmora, Chicago, Illinois 60639.

REMOTE CAR STARTER PLAN. UNIVERSAL, SIMPLE, EASY, 30PGS; ILLUSTRATIONS, SCHEMATICS, EMPLATE, INSTRUCTIONS, PHOTOS. INEXPENSIVE, WORKS! \$12.75. **SCHLITZER**, 414 ALVA, GRAND PRAIRIE, TX 75051.

TELEPHONE Caller Identifiers displays incoming callers telephone number. Kit \$49.95 ppd. **SURVEILLANCE** catalog \$5.00, EDE, P.O. Box 337, Buffalo, NY 14226.

NEW AGE TECHNOLOGICAL NEWSLETTER Antigravity, Free Energy, Ray Guns, UFO's, Time Travel, ESP. Information And Plans! \$3.00 Per Issue \$15.00 For Six Month Subscription **TODISH ENTERPRISES** P.O. Box 356, Marquette, Mich 49885.

Miniature Electronic Surveillance Devices, Catalog \$5.00, refundable. F & P Enterprises, Box 51272, Palo Alto, CA 94303-H.

SENSATIONAL Stereo Sound! Circuit upgrades any TV (Yours!). Free Details! **JLB Innovations**, P.O. Box 72011, Kanata, Ontario, Canada K2K 2P4.

LOGTROLLER Data logger and controller. 80C52 Basic. Plans software, \$9.00. **TENSOR**, Box 2543, Thunder Bay, Ontario P7B 5G1.

PAN-COMM INT'L CATALOG. Over 350 Kits, Plans, Books about Licensed/unlicensed AM/FM broadcasting, Ham/CB/SW/DX electronics amplifiers, 1750M transmitters, Surveillance devices, Computers/Software, Science Projects, MORE. \$1.00 refundable. Box 130-ME5, Paradise, CA 95967.

COMPUTERS

THE ULTIMATE BUDGET COMPUTER IBM compatible, 286 brain, VGA color monitor, 1 meg RAM, 40 meg IDE HD, high density floppy, Enhanced keyboard, 200 watt power supply, built in self diagnostics, much much more, New with warranty and free software. \$900.00 Other options available. Visa, MC, check, or cash COD accepted. Florida residents add 7% sales tax. Office World, P.O. Box 87C, Bradenton, FL 34206

WANTED TRS-80 expansion interface and disk drives for Model-I Ghislain Groleau, Box 483, Chandler, P.Q. Canada G0C 1K0.

TAKE CONTROL of your PC's speaker. Turn it **OFF** or **ON** when desired. Plug in headphones for private listening or an external speaker for extra volume. **Easy** step-by-step instructions, \$5. Davis Computing, Box 20043, Ft. Worth, TX 76102.

NEW checkers game for IBM and Compatible PC owners. Challenge your mind! Great Family Game, Easy to Play, Relaxing. \$23.95, Shipping cost included. PC DAMIER, P.O. Box 8132, South Hills Mall, Poughkeepsie, NY 12601.

COMPUTER owners never buy software again borrow or rent. Send \$2.00 for catalog. T.E. Suite 353, 164-11 89th Ave., Jamaica, NY 11432.

ALPHA/THETA BRAINWAVE STIMULATION SOFTWARE for IBM or 100% clones. Requires color monitor and EGA or VGA. Select colors, patterns and frequencies, **WARNING EPILEPTICS MUST NOT USE!** 5 1/4" \$19.95, 3 1/2" \$21.95. Templehof, Dept 113-CC, Box 19300, Austin, TX 78760-9300.

COMMUNICATIONS

8052-AH-BASIC microcontroller board. 32K RAM, 16K EPROM, RS232 interface, audio out, EPROM programmer, expansion connector. Bare board with manual \$19.95 + \$3 P&H. MD. residents add \$1 sales tax. SASE for details. Prologic Designs, P.O. Box 19026, Baltimore, MD 21204.

WIRELESS CD player car or home for schematic send M.O. \$5, SASE, to Yanik, P.O. Box 147, Gorham, Maine 04038

MORSE Code? No Problem. You can increase your speed, no matter how many times you've failed before. **Results guaranteed** when you follow the instructions. PASS Publishing's **CW Mental-Block Buster** program helps you **explode mental blocks** that hold you back. Based on 40 years of research, the **CW Mental-Block Buster** uses guided meditation, dynamic visualizations, and powerful affirmations to blast through mental blocks. **You can do code!** That means new bands, more contacts, more fun! (This is not a CW practice tape.) The **CW Mental-Block Buster** audio cassette and practice booklet are only \$24.95 ppd. in the US (NY residents add \$1.87 sales tax). (Quantity discounts available for classes.) PASS Publishing, P.O. Box 570, Stony Brook, NY 11780.

HUGE COMMUNICATIONS CATALOG. 88 pages including amateur, shortwave and scanner equipment. Universal Radio, 1280 Aida Drive #ME, Reynoldsburg, OH 43068.

CLUBS

P.C. MODEM CLUB Correspond with **Business and Enthusiast, Link/UP** with Creative members, Free Details, P.O. Box 4534, Waterbury, CT 06704. Also, List **FAX** and **1-900** numbers.

FOR SALE

USED Technical Books: Radio, Electronics, Math, Military, Magazines, Catalogs, Etc., Large List: \$1.00, (Stamps OK), Software, Dept ME, 1515 Sashabaw, Ortonville, MI 48462.

CLASSIFIED ADVERTISING ORDER FORM

Mail this form with payment to **COMPUTERCRAFT**, Classified Dept., 76 N. Broadway, Hicksville, NY 11801.

Name: _____

Street Address: _____

City: _____ State: _____ Zip: _____

Free Boldface	2	3	4
5	6	7	8
9	10	11	12
13	14	15 (\$15)	16 (\$16)

TOTAL PAYMENT ENCLOSED (Check or Money Order): \$ _____

Payment may also be made by MasterCard or Visa. For this, please fill in information below.

Credit Card Number _____ Expire Date _____

Print Full Name _____ Signature _____

*If a box number is used, please supply your permanent address and telephone number for our records.

SAVE MONEY. DON'T RENT!

CABLE TV DESCRAMBLERS, CONVERTERS, & ACCESSORIES.

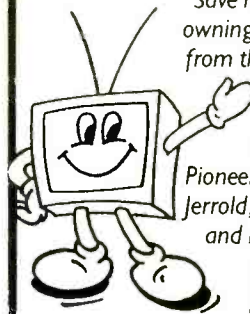

Save hundreds of dollars owning instead of renting from the cable company.

Easy to order and install.

Name brands—Pioneer, Oak, Panasonic, Jerrold, Scientific Atlanta and more.

We're famous for lowest prices, excellent service and immediate delivery. All products fully warranted. Your satisfaction is 100% guaranteed.

CABLE READY Company

CALL FOR FREE FULLY ILLUSTRATED
16-PAGE COLOR CATALOG.
(800) 234-1006

COMPUTER KITS

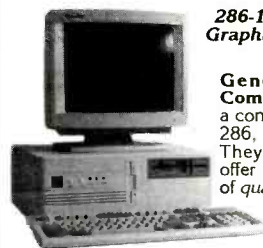

286-12 VGA Color Graphics Kit

General Technics Computer Kits include a complete line of 8088, 286, and 386 models. They are designed to offer the highest degree of quality and reliability available today. They're also fun, easy to build, educational,

fully **IBM compatible**, very powerful, and at wholesale prices. All kits are pre-tested and include a step by step assembly manual, software, one year warranty and our 24 hour support/order phone line. Assembly available.



386-25 CAD/Desk Top Publishing Kit

ask for your free catalog

General Technics

Quality Computer Systems
Post Office Box 2676
Lake Ronkonkoma, NY 11779

(516) 981-9473

VISA - MasterCard - American Express
accepted with no surcharges

CIRCLE NO. 30 ON FREE INFORMATION CARD

Advertisers' Index

RS#		Page #
23	AMC Sales.....	76
86	Advanced Software.....	87
25	Altex Electronics.....	25
-	B & B Electronics.....	88
87	BG Micro.....	47
-	CIE.....	Cov.III,41
26	C&S Sales.....	84
-	Cable-Mate Inc.....	84
-	Cable Ready Company.....	89
87	Consumertronics.....	51
27	Cook's Institute.....	75
28	Deco Industries.....	88
96	Electrified Discounters.....	4, 5
-	Electronic Book Club.....	23
97	Fd Microsystems.....	21
29	GTV.....	72
30	General Technics.....	89
31	Global Cable Network.....	72
32	Gordon, Ken.....	38
-	Grantham.....	79
100	Heath Co.....	7
-	KD Video.....	84
-	Kelvin Electronics.....	90
34	Komputerwerk.....	59
44	Lyc0 Computers.....	11
35	MCM Electronics.....	37
-	M.K. Electronics.....	88
105	Microsphere.....	Cov.IV
36	Mouser Electronics.....	76
-	NRI Schools.....	17
37	Netronics R & D Ltd.....	56
-	Pacific Cable Co., Inc.....	83
43	R4 Systems, Inc.....	38
-	Scrambling News.....	88
-	Smith Design.....	90
45	TECI.....	87
-	Trans World Cable Co.....	88
109	Tredex.....	Cov.II
39	U.S. Cyberlabs.....	90
40	Video Tech.....	83
41, 42	Viejo Publications.....	46,50
-	Visitect Inc.....	90

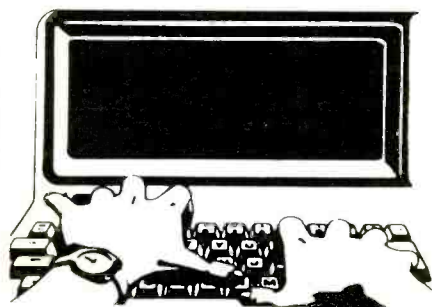

We'd like to see your company listed here too. Contact Jonathan Kummer at 516-681-2922 (Electronic Advertising) or Ken Wood at 407-264-0545 (Computer Advertising) to work out an advertising program tailored to suit your needs.

107 SPECTRUM PROBE™ \$249.
 converts any scope into a
100MHz spectrum analyzer
 60dB display dynamic range
SMITH DESIGN 30 day refund, VISA/MC
 1324 Harris, Dresher, PA 19025 (215) 643-6340

PRO 400
 AC/DC VOLTAGE
 AC/DC CURRENT
 DIODE TEST
 LOGIC TEST
 LED TEST GOOD/BAD
 5 FREQ RANGES
 5 CAPACITANCE RANGES
 LOW BATTERY Warning
 CONTINUITY TEST/BUZZER
 TRANSISTOR CHECKER
20 MHZ FREQ COUNTER
 Stock No. 990092
\$69.95
30 DAY MONEY BACK GUARANTEE!
 VISA M/C
KELVIN Electronics
 7 Fairchild Ave. Plainview, NY 11803
 (516) 349-7620 1(800) 645-9212
 FAX (516) 349-7830

REMOTE CONTROL KEYCHAIN
 Complete w/mini-transmitter and +5 vdc RF receiver
 Fully assembled including plans to build your own auto alarm
 Quantity discounts available
 Check Visa or M/C Add \$ 3 shipping
ONLY \$24.95
 VISITECT INC. BOX 5442, SO. SAN FRAN., CA. 94080
 (415) 531-8425 Fax (415) 531-8442

U.S. CYBERLAB

'EXTREME' HIGH TECHNOLOGY
 KITS, PRODUCTS, MATERIALS
 Nick Goss says, "This catalog is a 'must' for every serious Scientific Experimenter! Better order your copy today. These are the products you have been waiting for!" Come join the Cyberlab Team and start living the adventure by building scientific kits that contribute directly to your own personal technological power base!
 U.S. CYBERLAB, INC.
 RT 2 BX 284, CYBER FACILITY
 WEST FORK, AR 72774
 (501) 839-8293 VOICE MAIL

CIRCLE NO. 39 ON FREE INFORMATION CARD

FOR SALE

FREE CABLE AND SATELLITE DE-SCRAMBLER PLANS. Send SASE. MJO Industry, Box 531, Bronx, NY 10461-0208.

FOR SALE

MAKE \$\$\$! Become an American Electronics Dealer! Profit opportunities since 1965. Call Jerry Norville, 1-800-872-1373.

CABLE

TOCOM VIP TEST CHIP. For Models 5503 VIP and 5507. Unlike any other turn-on, this one works! Easily installs in just seconds. \$50.00 each. No Calif. sales. Call (213) 867-0081.

CABLE DESCRAMBLERS - Jerrold 400, 450, Tri-Bi SB-3. Scientific Atlanta, Oak, Tocom. Lowest Prices. Example: Jerrold from \$25.00. No Calif. Sales. Call us last and see! (213) 867-0081.

ZENITH Z-Tac. Special "test" board installs easily in minutes, and turns-on decoder for all modes. Great for "flashing" problems. Only \$50.00. No Calif. Sales. Call (213) 867-0081.

CABLE TV EQUIPMENT

CABLE. TV converters and descramblers discount center. Jerrold, Tocom, Hamlin, Scientific Atlantic, Oak, Zenith. Order yours today 800-962-6836.

CABLE EQUIPMENT

CABLE TV SECRETS — the outlaw publication the cable companies tried to ban. HBO, Movie Channel, Showtime, Descramblers, Converters, etc. Suppliers list included. \$9.95. Cable Facts, Box 711-ME, Pataskala, Ohio 43062.

CABLE Converters ALL MAJOR BRANDS
 • For information & orders call 1-800-782-0552
 • FREEWAY, INC. s.m.p. P.O. Box 5036, Burnsville, MN 55337.

MISCELLANEOUS

ASIAN LADIES want correspondence for friendship, marriage. SUNSHINE INTERNATIONAL-Dept. TW, Box 5500, Kailua-Kona, Hawaii 96745. (808) 325-7707.

AMATEUR RADIO no Morse code requirement license approved by FCC effective Feb. 14, '91. Complete details with question and answer pools, rules & regulations. Send \$15.00 for everything you need to obtain Amateur license to Dan Mobley, 1800 Williams St., Valdosta, GA 31602.

ROBOTICS! Engines! Inventions! Muscle Wires contract with amazing strength when powered. Send business SASE for latest flyer. MONDO-TRONICS %ME, 2476 Verna Ct., San Leandro, CA 94577.

OLD ELECTRIC TRAINS WANTED: I PAY TOP CASH FOR TRAINS AND ACCESSORIES. WRITE: HENRI CABANNES, 10636 MARGATE, CINCINNATI, OHIO 45241.

THAILAND Women seek Marriage, Correspondence. Photographs Brochure \$2., Escorted Tours. Club Thai, Miami, Florida 33233-0974.

Learn to Use Your Computer's Full Potential.

New Career Course from CIE!

If you've been hesitating about upgrading your computer skills because you couldn't find the time or locate the right program to teach you everything you need to know to be successful in today's world of computers, you'll be happy to hear that CIE's new career course can provide you with the computer technology curriculum you seek in an independent study program you can afford to invest your time in.

CIE's COMPUTER OPERATION and PROGRAMMING course was designed and developed by CIE to provide a complete overall understanding of the unlimited potential today's computers offer, once you learn and discover their full capabilities, in today's high tech environment. CIE's new computer course quickly provides you with the electronics fundamentals essential to fully understand and master the computer's technological potentials for your personal and professional advancement. Upon mastering the fundamentals you will move into high level language programming such as BASIC and C-Language and then use that programming in order to relate the interfacing of electronic hardware circuitry to programming software. As a graduate of the Computer Operation and Programming course, you will be able to successfully understand, analyze, install, troubleshoot, program and maintain the various types of electronic equipment used in business, manufacturing, and service industries.

Since 1934, CIE has been the world leader in home study electronics by providing our 150,000-plus graduates with the curriculum and hands-on training they've needed to become successful in



today's highly competitive and computer oriented society. As a CIE student you'll receive a first rate education from a faculty and staff with only one desire. Your future success!

We encourage you to look, but you won't find a more comprehensive computer course anywhere!

And it's a course designed to fit around your lifestyle and commitments today, so you can be assured of professional successes and financial gains tomorrow.

Please, do yourself a favor and send the attached card or fill out and mail the coupon below for more information about CIE's

Computer Operation and Programming course. Do It Today!

Computer not included with course



YES! I want to get started. Send me my CIE school catalog including details about the Associate Degree program (for your convenience, CIE will have a representative contact you - there is no obligation).

Print Name _____

Address _____ Apt. _____

City _____ State _____ Zip _____

Age _____ Area Code/Phone No. _____

Check box for G.I. Bulletin on Educational Benefits Veteran Active Duty



CLEVELAND INSTITUTE OF ELECTRONICS
1776 East 17th Street
Cleveland, Ohio 44114
(216) 781-9400



*A school of thousands.
A class of one.
Since 1934.*

AO14

1

Your Upgrade Headquarters

TENEX makes it easier than ever to enhance your existing system. Imagine more hard disk space, more RAM, modems, VGA boards, sound and video boards. They're all in our catalog—all at the lowest prices! And all with TENEX customer service reps and technicians ready to help. There's never been a better time to upgrade so call 1-800-776-6781 now for our FREE catalog!

2

Your Best Resource for IBM-Compatible Hardware & Software

The more you know about computers and catalog sayings, the more you'll love TENEX. In 9 years we've built the best team of friendly professionals in computing. We use our buying power to offer you the lowest prices possible without sacrificing support. We make computing what it should be: powerful, worry free, and fun!

FREE!! Upgrade Guide



TENEX™ Computer Express

starting at
\$429⁰⁰

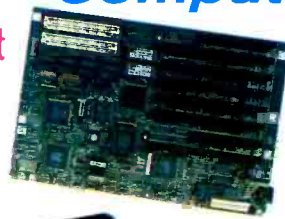

SX Motherboard

The board has 1MByte RAM memory, **Chips and Technologies'** chip set, and the advanced DTK BIOS with shadow RAM, LIM EMS, and utilities. The board is available in a 16MHZ version for \$429.00 and a 20MHZ version for \$549.00.

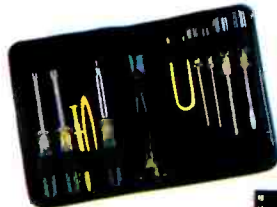

\$13⁹⁵

Tool Kit

Kit includes a chip insertion tool, chip extraction tool, tweezers, four screwdrivers, four nutdrivers, and a Torx screwdriver, all in a zippered vinyl case.

\$324⁰⁰



ComputerEyes Professional

Easily capture full-color and grayscale still video images from any source at up to 640x480 pixels, 24 bits/pixel. VGA compatible.

starting at
\$139⁹⁵

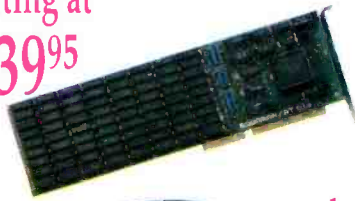

BOCARAM /AT+

Add RAM using a simple plug-in board with five-year warranty. Includes RAM disk and print-spooler software.

Bare board available for \$139.95.
Board with 2MByte for \$319.00.
Board with 4MByte for \$479.00.
Board with 6MByte for \$639.00.
Board with 8MByte for \$819.00.



only
\$7⁹⁵

Monitor AC Adapter

Just plug your monitor cable into the female power socket at the back of your computer and turn on your monitor when you turn on your computer.

starting at
\$99⁹⁵



Stacker

The Cadillac of disk compression tools! Stacker is the fastest and easiest way to "double" your disk space. Software version available for \$99.95. Coprocessor version available for \$199.95.

Ultimate Floppy Controller Board

Four-drive controller for use with any combination of 360KByte, 720KByte, 1.2MByte, and 1.44MByte drives. Includes all cables.

\$49⁹⁵



For Fast Service call our Toll-Free Number
8a.m.-8p.m. Weekdays
10a.m.-2p.m. Saturdays

1-800-PROMPT-1
(1-800-776-6781)

No fee for Visa, Mastercard, and Discover.
Shipping and handling 2.5%.

CIRCLE NO. 105 ON FREE INFORMATION CARD