

MODERN ELECTRICIAN

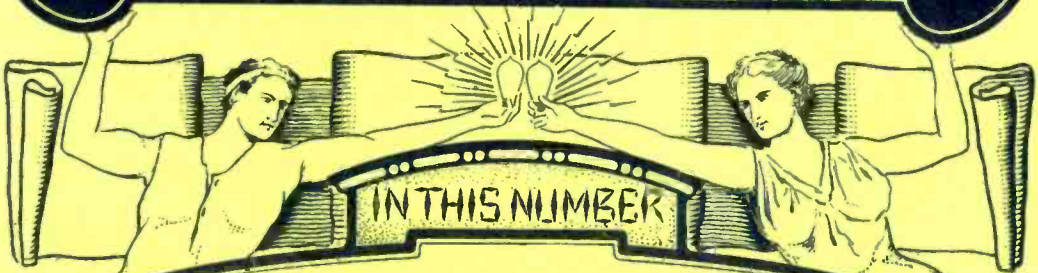

MAJORANA AEROPHONE WORK
By A. C. Marlowe.

A CADMIUM STORAGE BATTERY
By H. Gernsback

LOUD TALKING TELEPHONES
250-WATT CLOSED CORE TRANSFORMER
By Carleton Haigis

A TELEPHONE SYSTEM
By Spencer Roberts

A WIRELESS CONTROL RELAY
By H. W. Secor

REVOLVING CONDENSER
By A. Ward

CONDENSER PHENOMENA
By C. C. Whittaker

AEROPHONE AUTOMATIC SIGNALLING
By René Homer

WIRELESS REGISTRY. ORACLE

"THE ELECTRICAL MAGAZINE FOR EVERYBODY"

NEW ENGLAND GETS FIRST SERVICE



RESIDENTS of Portland, Me., Old Orchard, Me., Saco, Me., Biddeford, Me., Dover, N. H., Portsmouth, N. H., Exeter, N. H., Haverhill, Mass., Lawrence, Mass., Lowell, Mass., Boston, Mass., and adjacent points, are now communicating by wire at rates so low and service so accurate and prompt that they are wondering at their former patience with exorbitant rates and inadequate service.

☞ New lines will be opened as rapidly as physical and financial conditions permit until every city in the United States will be sending—

- 25-word TELEGRAMS, any distance, for 25c.
- 50-word TELEPOSTS, any distance, for 25c.
- 100-word TELETAPES, any distance, for 25c.
- 10-word TELECARDS, any distance, for 10c.

☞ An interesting illustrated booklet has been prepared, describing in detail the invention, its operation, its economy, its rapidity and its accuracy. Mailed without cost to anyone asking for Booklet No. 359.

TELEPOST COMPANY 225 Fifth Ave., New York

When writing please mention "Modern Electrics."

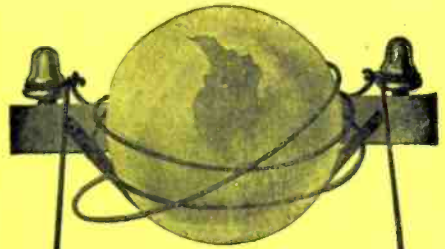

ELECTRICITY Girdles the Globe

It is the giant force of the Century. Electricity offers larger rewards to PRACTICALLY trained followers than any of the other professions.

Learn it and you have mastered the most fascinating and BEST PAID calling of to-day.

Our school, the most thoroughly equipped in the United States, teaches PRACTICAL ELECTRICITY in all its branches, and nothing else. Individual instruction, day or evening by skilled teachers.

Write for 64 p. illustrated book. It's free.

The New York Electrical Trade School

39½ West 17th Street, New York

No connection with any other School or Institute.

The "ELECTRO"-LYTIC BARE POINT DETECTOR (PATENT PENDING)

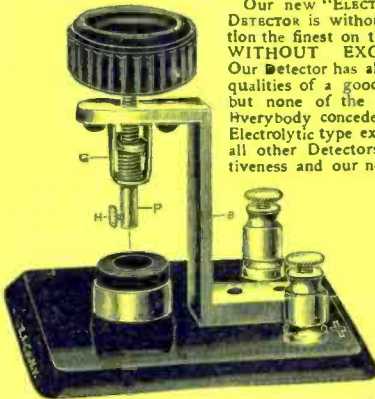

Our new "ELECTRO"-LYTIC DETECTOR is without a question the finest on the market WITHOUT EXCEPTION. Our Detector has all the good qualities of a good Detector but none of the bad ones. Everybody concedes that the Electrolytic type excels by far all other Detectors in sensitiveness and our new type—already adopted by two of the leading wireless companies—is without doubt the acme of perfection. Please

bear in mind that our new Detector has been designed for hard commercial work, it is not an amateur contrivance. Here are a few points: Hard rubber base ½ in. thick, hard rubber thumb nut 1 in. diameter, graphite-carbon cup moulded in brass cup (under hydraulic pressure,) heavy cast brass standard, etc. The most important part is that the 1-10,000 inch Wollaston wire does not need to be soldered, as in all other Detectors, a screw holds it in a unique manner. The last 1-16 inch piece of wire is utilized, new wires inserted in 10 seconds, etc. By means of an ingenious plunger movement, the fine wire is raised and lowered with greatest precision—less than 1-10,000 inch at a time. The wire cannot turn in a circle, (as wires do, directly attached to thumb screws,) it can only move up or down, not sideways, etc. This has been found is of tremendous importance. ALL METAL PARTS ARE HEAVILY SILVER PLATED, as we found that silverplate is not attacked by fumes of the acid. We also furnish bottle to hold acid, and and one pipette to fill acid in cup.

Introduction price, \$1.50 By mail extra 12 cents

Write for new Pamphlet on this Detector.

Electro Importing Co., 86-Z.W. Broadway, New York

When writing please mention "Modern Electrics."



WE MANUFACTURE MOULDED AND SPECIAL RUBBER GOODS OF EVERY DESCRIPTION AND CAN FURNISH ANY SPECIAL RUBBER ARTICLE TO YOUR SATISFACTION.

NEW YORK BELTING & PACKING CO. LTD.
91-93 CHAMBERS STREET,
NEW YORK.

Send for our large Catalogue "M" containing 94 pages, with useful information.

When writing please mention "Modern Electrics."

"Modern Electrics" guarantees the reliability of its advertisers.

The Wireless Telephone

in its present stage of development offers a greater field for profitable investment than did the Bell Telephone thirty years ago. One hundred dollars invested in Bell Telephone stock, when that company was starting to introduce its system, would have returned the fortunate owners over two hundred thousand dollars.

ATLANTIC RADIO COMPANY

using the DeForest Wireless System, is erecting stations along the south Atlantic coast and at important interior points, and plans to equip several hundred boats this coming season. If you can invest \$10.00 or more a month write for full particulars.

THE ELLSWORTH COMPANY

49 Exchange Place, New York

CUT THIS OFF AND MAIL AT ONCE.

THE ELLSWORTH COMPANY

49 Exchange Place, New York

Please send me full particulars relative to an investment of about \$ in the ATLANTIC RADIO COMPANY.

Name.....

ME Street.....Town.....State.....

When writing please mention "Modern Electrics."

THIS IS THE WONDERFUL RED STYLO INK PENCIL

Impossible to leak, even if carried upside down. Writes like a pencil. Has a platinum-iridium feed wire and we therefore guarantee each and every pencil. Order now.

Over 2 Million of these Pencils now in use.

All editorials and text matter of MODERN ELECTRICS are written with

Red Stylo
Ink
Pencils

To introduce this marvelous ink pencil to readers of MODERN ELECTRICS we will send one sample prepaid for \$1.00. Regular price strictly \$2.00. Dealers and Agents write for interesting proposition. We also make electric flash lights, batteries, the famous Universal dry cells, electric scarf pins, Alladin electric gas lighters, electric magic lanterns; also the marvelous DRY alcohol (in chunks) Universal flaming cigar lighter, sample sent by mail for 50c., etc. CATALOGUE FREE. Special prices for July and Aug.

Universal Novelty Co.

165 W. 20th St., New York, N. Y.

When writing please mention "Modern Electrics."

ROYAL STORAGE BATTERY STYLE # 3 6 Volts, 60 Ampere Hours

Size 6 1/2 x 7 1/2 x 7 in. Weight 27 lbs

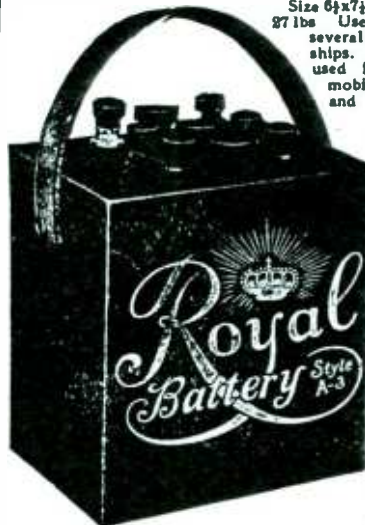

Used on board of several U. S. Battleships. Same type used in the Oldsmobile, Pullman and a number of other high-class automobiles for ignition and lighting. Six plates in each cell, 8 positives and 8 negatives, 18 plates in one battery.

Through a fortunate deal with the makers, we have purchased several hundred of these batteries, all in perfect condition except that they are of the 1908 style. As the makers have brought out

a new 1909 type they did not wish to keep the 1908 type in stock and we bought the whole block. If you wish to know more about this wonderful ROYAL BATTERY, send 2c stamp and we will send you a 20 page book entitled: "Treatise on Storage Batteries." The type B-3, exactly as cut, only wider and bigger lists at \$7 Dollars (see book.)

Our PRICE NOW, to M. E. Readers ONLY \$9.00. This is a chance of a lifetime. We can ship at once; two styles. One Enamel steel case, the other treated wood case. Fine rubber-belted handle, patent gas vent, etc. etc. Speak quick, only about 50 left.

ELECTRO IMPORTING CO., 862 W. Broadway, N. Y.

When writing please mention "Modern Electrics."

PATENTS

TRADEMARKS AND COPYRIGHTS
SECURED OR FEE RETURNED

Send model or sketch and description of your invention for free search of the U. S. Patent Office records.
Our Four Books mailed Free to any address. Send for these books; the finest publications ever issued for free distribution.

HOW TO OBTAIN A PATENT

Our Illustrated eighty page Guide Book is an invaluable book of reference for inventors and contains 100 mechanical movements illustrated and described.

FORTUNES IN PATENTS

Tells how to invent for profit and gives history of successful inventions. Also list of Patent buyers.

WHAT TO INVENT

Contains a valuable list of Inventions Wanted and suggestions concerning profitable fields of inventions. Also information regarding prizes offered for inventions, among which is a

PRIZE OF ONE MILLION DOLLARS
offered for one invention and \$10,000 for others.

PATENTS THAT PAY

Contains fac-similes of unsolicited letters from our clients who have built up profitable enterprises founded upon patents procured by us. Also endorsements from prominent inventors, manufacturers, Senators, Congressmen, Governors, etc.

WE ADVERTISE OUR CLIENT'S INVENTIONS FREE in a list of Sunday Newspapers with two million circulation and in the *World's Progress*. Sample Copy Free. Electrical Case a Specialty.

VICTOR J. EVANS & CO.

(Formerly Evans, Wilkens & Co.)

Main Offices, 200 "P" Street, N. W.
WASHINGTON, D. C.

When writing please mention "Modern Electric."

Wireless Apparatus



Coco Transformer—Closed Core Type

A 350 watt closed core transformer as powerful as the ordinary 8 in spark induction coil for wireless work, and costs but \$30. It is especially adapted to tuned transmitting circuits and can be run from any lamp socket giving alternating current. We also build larger sizes up to 10 kw. capacity at moderate prices. Complete parts for a 50 mile tuned transmitting set consisting of 350 watt transformer, large capacity glass plate condenser, oscillation transformer with adjustable primary and secondary inductances, and adjustable spark-gap making an accurate model of a modern commercial station. Complete for \$80. Send for our descriptive folder of experimental apparatus for receiving and transmitting, including

Transformers Telephone Head Receivers
Tuners Condensers Oscillation Transformers
Detectors Spark-Gaps Potentiometers

CLAPP-EASTHAM CO.

730 Boylston Street BOSTON, MASS.

When writing please mention "Modern Electric."

TUNING COILS



From
\$2.25
Up

**Spark
Gaps**

From
60c
Up

\$4.00

"If it is Wireless we have it"

Only house in Washington, D. C. carrying a COMPLETE line of Wireless experimental apparatus in stock.

Come and look over our stock and judge for yourself. Will gladly demonstrate all goods.

JOHN C. RAU
ELECTRICAL SUPPLIES

526 12th St. N. W. Washington, D. C.

All information free and good treatment assured

When writing please mention "Modern Electric."

Model Library Series

The Three Latest.

Static Electricity. Simple Experiments in. By P. G. Bull. 73 pages, 51 illustrations. 25cts.

The Wimshurst Machine. How to Make and use it. By A. W. Marshall. 112 pages, 30 illustrations. 25cts.

Inventions. How to Protect, Sell and Buy Them. A practical instruction book for the Inventor. By F. B. Wright. 114 pages. 25cts.

Our New List

Nearly 60 Books Sent Free.

SPON & CHAMBERLAIN,

123 G Liberty St., New York

When writing please mention "Modern Electric."

MODERN ELECTRICS

Vol. II.

APRIL, 1909.

No. 1.

Majorana Aerophone Work

BY A. C. MARLOWE.

Paris correspondent MODERN ELECTRICS.

Prof. Majorana, of the Telegraphic Institute of Rome, is one of the leading workers on the Continent in the aerophone field, and he has been making experiments for some time past with his new transmitter, which he calls "hydraulic microphone." As the Italian Government is interested in having the system developed, the inventor used the different wireless posts which are operated by the Government, generally by the Marine Department, working from the Rome station as a center. In this way he is now able to cover a distance of 250 miles and more in his latest experiments, using in this case a station located in Sicily. In all this work he has been very successful, and this is largely due to the use of the new microphone. By the kindness of the inventor, I am able to give the readers of MODERN ELECTRICS an account of the most recent experiments and also a brief description of the apparatus, this being probably the first account to be published in America, as the last experiments, and especially the 250-mile transmission, were carried out quite recently.

In Fig. 1 will be seen the arrangement of the transmitting apparatus, with the wave generator placed at G, and it is mounted in a circuit which contains a condenser C and the primary coil of a transformer T (this being made of two parallel inductances). Such a circuit is thus made to receive electrical oscillations of a certain period. The secondary of the transformer is mounted together with the antenna A and the microphone transmitter M; the other end of the microphone is connected to ground. Thus the microphone circuit enters into vibration by resonance. The two circuits which are shown here are arranged so that we have an exact concordance of the vibration periods in these circuits, this being obtained by making the proper adjustments of the apparatus. It is found much better to place the microphone at

the point M than at any other point on the circuit. Were it placed in the circuit of the generator G, it would be obliged to carry a too heavy current, and on the other hand placing it between the secondary coil and the antenna we would have certain disadvantages owing to the position which the secondary would take between the microphone and the ground.

The success of Prof. Majorana's ex-

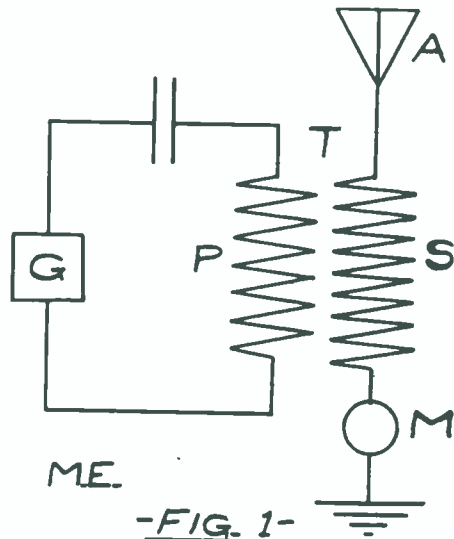

periments is largely due to the kind of microphone transmitter which he uses, and it was designed by him for this purpose. A different principle from the ordinary is used here, and as the instrument uses the action of a liquid, it is known as the "hydraulic microphone." Its action will be clear from the present diagrams, Figs. 2 and 3. At T is a tube in which there is water or another liquid flowing in the direction of the arrow. As the bottom of the tube is contracted so as to give a small opening at this point the water will come out of the bottom of the tube in a somewhat fine stream. Such a stream continues in regular smooth form for some distance below the tube,

and then at G it begins to break up and fall in drops. It is found that when we give a shock or other disturbance to the main tube, this favors the breaking up of the water stream to form drops, and the shocks, especially if they are sudden and frequent, act so as to shorten up the distance of the breaking point G from the tube end. The tube is also sensitive to sound vibrations, so that when a sound is made in the tube there is an action on the water stream which depends on the nature of the sound. Prof. Majorana was thus able to make the water column sensitive to the sounds of the human voice, but it was only after a considerable amount of experimenting that he succeeded in using such a device as a micro-



-FIG. 2.-

phone transmitter. This he carries out in the arrangement seen in Fig. 3, his design being to make the voice act directly on the water inside the tube so as to change the pressure, and this very near the lower opening of the tube. To do this, he makes the tube of a very strong and solid material, except at one part A,

where he makes an opening and places across it a thin and elastic partition. This is connected by a cross rod with a diaphragm of the usual kind belonging to the transmitter mouthpiece M. Speaking into the mouthpiece or making any kind of sound will cause the diaphragm to vibrate, and this movement is transmitted to the liquid within the tube and has an action on the stream of water. In the usual condition of the stream when there is no sound made, there is a straight and unbroken water column from E to F, as the drops commence to form below F. However, when we make a sound of a given rate, such as a musical note, in the microphone, the water column is found to contract in a certain way, as seen in the dotted lines, and the contractions increase as we come to the lower part of the column near F. The drops commence to form higher up in this case.

We insert a pair of fine wires B C in the column near the lower part where the contractions are the strongest, and they are connected across by the liquid. A current passing in the wires will thus depend upon the shape of the water column at this point, as when the stream is narrow we will have a higher electrical resistance between the points than when the stream is expanded out from the effect of the vibrations, as in the dotted lines. On the other hand, this action of the water is variable and depends on the kind of sound given in the microphone, so that the electrical resistance between the points depends on the sound in the transmitter. When we speak into the apparatus, we thus have a varying current in the line going from the points, and this current can be made to work an ordinary telephone receiver over a line. In fact, this was done not long since with great success, and the hydraulic microphone is found to be much stronger than the usual kind, as it will carry a heavier current. Experiments were made with it between Rome and London at a distance of 1,200 miles, and it showed a good performance, especially in the measurements of the amount of current which was sent over the line. A higher current than usual can be employed in this case, seeing that the part of the liquid which carries the current is always renewed, so that it does not heat up to any extent. We are also able to regulate the conductivity of the stream by changing the nature of

the liquid (acidulated or salted water, mercury, etc.), and also the diameter of the stream, and we can furthermore adjust the distances between the metal points as well. For these reasons the new microphone is very well adapted for use in aerophony, and in fact it can be placed in the circuit of the antenna (Fig. 1) without any danger of burning or heating up.

For the apparatus in the receiving station, Prof. Majorana first tried a Marconi electro-magnetic detector, but found that it was not suited for the purpose, nor would a pair of carbon contacts or an electrolytic cell serve for receiving the waves. The proper apparatus for receiving the waves is either a bolometer on the thermo-electric principle or the audion of De Forest, and the latter gives the best results. He also uses the bolometer with success, and it is designed, as will be seen

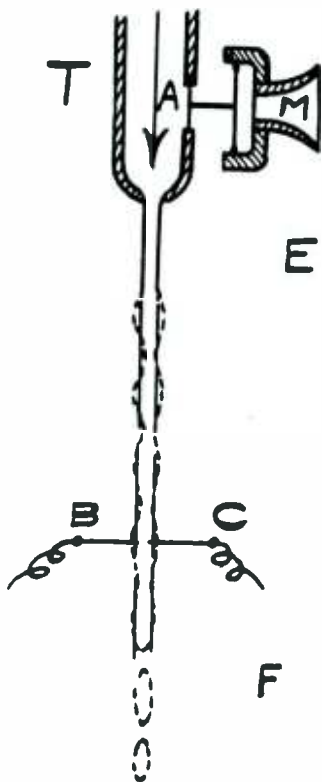

-FIG. 3-

M.E.

in Fig. 4, using a thermo-electric couple of iron and platinum. The receiver antenna A is connected to ground through an inductance I, which can be adjusted.

It sets up oscillations, by means of the second inductance J, in the circuit of the latter containing a variable condenser C. In shunt on the condenser is a second

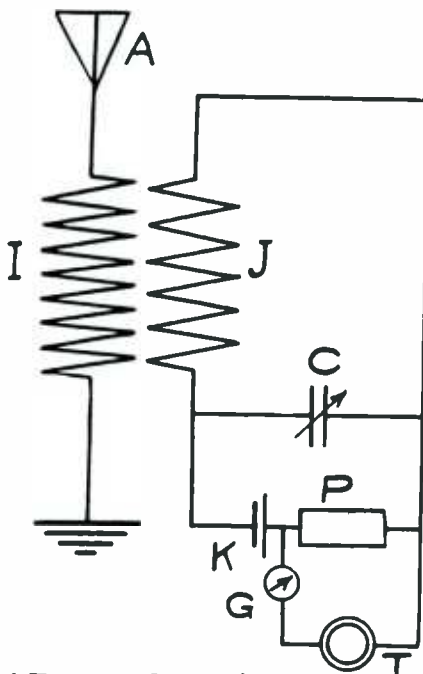

M.E. -FIG. 4-

condenser K of very small capacity (a few millionths of a microfarad) in series with the thermo-electric couple P. Placed in shunt on the thermo-couple is a circuit having a telephone receiver T and a galvanometer G. When the waves from the first station arrive at the antenna, its circuit and also the second circuit receive oscillations, and a part of the energy passes in the thermo-couple. This becomes heated and it gives rise to a current, which passes in the circuit of the telephone receiver. The current is regulated by observing the galvanometer, which is sensitive for such currents. In this way the telephone receives currents which correspond to the waves sent out from the transmitting station, and the original sounds are reproduced at this end.

Prof. Majorana has been making experiments between Rome as a centre and a number of stations lying at various distances from the city in order to see what distance he can cover by the present method. The Italian Government, represented by the Minister of Marine, is interested in this work, and the central point is the Monte Mario wireless tele-

A Cadmium Storage Battery

By H. GERNSBACK.

It is surprising to find that very few experimenters know of the Cadmium storage battery, and it is equally surprising that there is not to be found a single article on same in the technical press for several years back. This in spite of the fact that the Cadmium cell is perhaps the best one the experimenter could use, as it does not give rise to

ly pure, there are always currents passing between the plates of opposed polarity, which in time completely discharges a battery. The action is sometimes accelerated by formation of "mud" in the bottom of the cell, which, being a very good conductor, discharges the cell rapidly. This mud is usually formed of small particles due to "shedding" of the plates; in other words, small pieces of the active material of both plates falling away from their supports and accumulating at the bottom of the cell. If it were practicable to lift the plates out of the electrolyte while the cell is not in use, there could be of course no secondary action between the plates; however, this plan is not feasible, as the plates sulphate rapidly in the open air and become useless. This is especially true of the negative plate, which hardens in the air and besides losing its porosity, can never be brought back to its former capacity once it was dried while not completely discharged previously.

With the Cadmium cell this is vastly different. We do not use a spongy lead plate for the negative, but a "dummy." The simplest experiment is as follows: Take a common storage battery and dis-

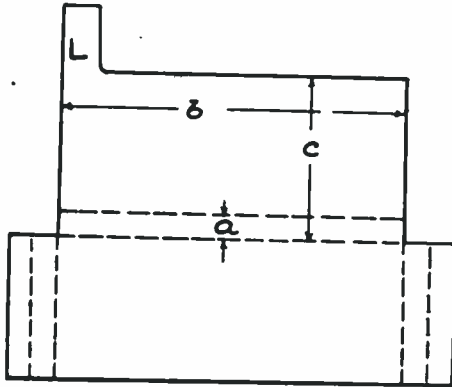

M.E. -FIG. 1-

secondary action while idle, as for instance the regular storage battery. Not alone that, the Cadmium battery gives 2.30 volts average voltage, while the regular cell only gives 1.9-2.00 volts.

That these great advantages should have remained hidden to the average experimenters is a profound mystery to the writer, as there is absolutely no reason why the subject was neglected, considering its importance from the standpoint of the experimenter.

If we take the usual lead storage battery, composed of peroxide of lead as active matter for the positive, and spongy lead as active matter for the negative plate, both immersed in dilute sulphuric acid, it will be found that the cell discharges within one month to six weeks if left standing unused. If the cell is not a first class make and the acid not absolutely pure, the battery will frequently discharge within 10 days, notwithstanding it having been fully charged previously.

The reason for this is found in the local action between the negative and positive plates. As it is practically impossible to keep the electrolyte chemical

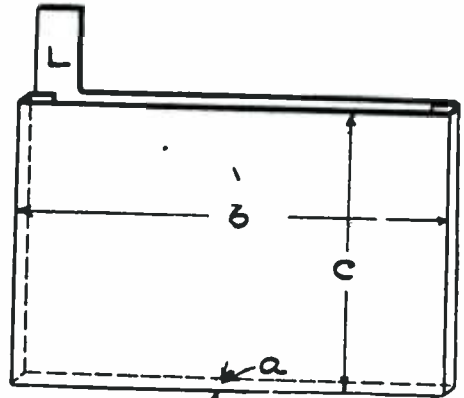

M.E. -FIG. 2-

charge it completely. Now replace the negative plate with a thin piece of sheet lead and charge the battery in the usual manner. The positive plate will then be charged but the negative will not because of it being not porous. In other words,

we have only positive electricity. This is best shown by substituting the negative dummy with another similar dummy.

A voltmeter connected to the cell will barely show any voltage at all. If, however, we take a piece of cadmium metal and immerse it in the electrolyte, taking care that it makes good contact with the dummy, the voltage of the cell will be

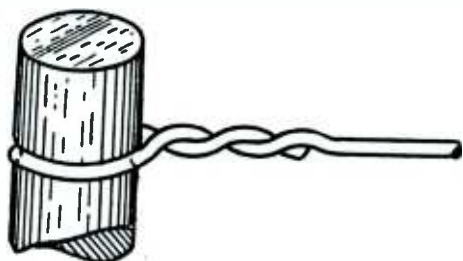

M.E. -FIG-3-

at once about 2.30-2.40. As long as the cadmium remains in the electrolyte, in contact with the dummy, we can discharge the battery in the usual manner. The cadmium, however, dissolves at the rate of 1 lb. for every 500 ampere hours. If we do not wish to use the battery we take out the cadmium. The storage battery cannot discharge now, as the local action between the charged positive and the dummy is practically zero, on account of the lack of porosity of the latter. The cadmium will not disintegrate when removed from the cell and may be replaced at any time desired, in order to discharge the battery.

As soon as the positive plate is discharged, it must of course be recharged again in the usual manner, with the dummy as negative. The cadmium during charge is of course to be removed.

The simplest way to change the ordinary storage battery to the cadmium type is by using one or two positive plates. It is not always practicable to use more than two positive plates, for reasons which will become apparent by following the construction below.

It is self-evident that the cadmium does not increase the capacity, nor amperage of the old cell; only the voltage is increased. A two-plate lead storage battery having usually 20 ampere hours, will only give 20 A. H. when changed to cadmium. If two 20 A. H. positive plates are used with the cadmium, the capacity will be 40 A. H., if a positive plate is on each side of the dummy carrying the cadmium.

To construct a good cadmium cell proceed as follows:

Remove the negative plate from the cell and cut from thin sheet lead 1/16 inch thick a piece as shown in Fig. 1.

It is impossible to give dimensions, as the size changes for every type cell, all depending on the size of same.

The idea is to construct a box-like container which must fit in the storage battery jar without touching the positive plate. In fact, it must be at least 1/8 inch or, better, 1/4 inch away from it. Distance B is the length, C the height and A the width of the lead container. The dotted lines show where the lead is to be folded in order to make the container, as shown in Fig. 2. L is the lug to which afterward a binding post or wire is fastened.

Before the sheet lead is folded the entire surface is to be punched full of holes about 1/16 inch to 1/8 inch in diameter, in order to let the electrolyte circulate freely in the container. A nail may be used to punch the holes and care should be taken that the rough edges of the punched holes come all in the inside of the completed container.

Cadmium comes usually in form of sticks about 6 to 8 inches long and about 1/4 inch in diameter. It sells at about \$3.15 per pound. The width of container (A, Figs. 1 and 2) therefore in most cases is about 1/4 inch. If this

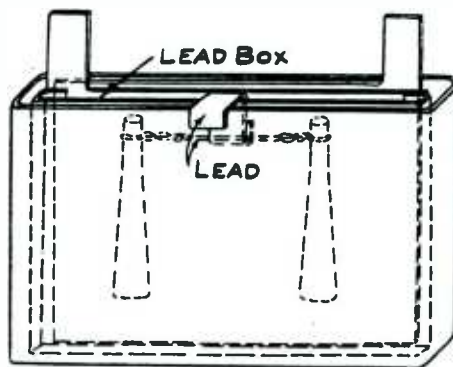

M.E. -FIG 4-

should be too much, the cadmium may be hammered out flat and the width of container reduced to suit requirements.

The container is next inserted in the cell, and the usual hard rubber separator is placed between the container and the positive plate to safeguard against short

circuits. Where there is a positive plate on each side of the container, separators must of course be used on both sides of the container.

The cell is then charged and the lead container treated as if it were the negative plate. After charging the cadmium sticks are placed in the container if the battery is to be discharged.

As it is desirable to remove the cadmium when battery is not in use, the writer adopted the following idea, which proved quite handy and very satisfactory:

As usually two sticks of cadmium are used, a groove is filed around the upper part of the metal sticks, in which a piece of lead (fuse) wire No. 10 is laid and then twisted around (Fig. 3). This safeguards the wire from slipping. The wire should be of lead, as other metals corrode under the action of the electrolyte. The other end of the lead wire is twisted around the other cadmium stick as seen in Fig. 4. A piece of sheet lead is then bent in S shape. The lower part holds the lead wire while the upper one hangs from the edge of container. This enables one to lift out the cadmium rapidly without any trouble whatsoever.

If the battery is left unused, and care is taken that the electrolyte does not evaporate, it is possible to discharge it even after it stood idle for over a year, as soon as the cadmium is inserted.

NEW EXPERIMENTS PRODUCING ELECTRIC SLEEP.

BY FRANK C. PERKINS.

The accompanying illustration shows the latest apparatus of Professor Stephane Leduc and method of application for producing electric sleep.

Recent important experiments have



been made on dogs and other animals and the operation producing sleep by electricity has been very successful with human beings.

Electric sleep is produced by using an intermittent electric current. The circuit is interrupted 100 times per second by means of a disc arranged in such a manner that each time it revolves four interruptions are made. An electric motor is utilized for rotation the disc and 100 interruptions per second are therefore produced to 25 revolutions per second.

It is maintained that the human brain is very sensitive to electrical current and as Dr. Erb, Von Liemsen and others have shown, the brain is the most sensitive organ in the human body to electricity.

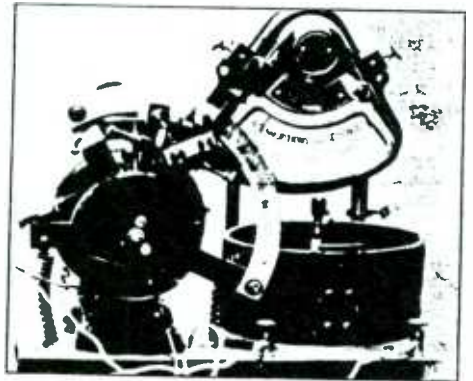

The experiments in producing electric sleep with rabbits and dogs show that it is absolutely harmless to these animals. It is necessary to produce a current which is very weak at first, the potential being increased little by little until the animal falls asleep under the influence of the current. As soon as the subject is asleep the current is cut off. It is stated that only six volts is required to produce electrical sleep, which may be continued without harm from three to four hours. It is stated that the longest experience was eight hours, produced by Miss Louise Robinowitch. Experiments have been made on Professor Stephane Leduc himself, who was kept under the influence for 20 minutes at two different times. It is stated that Professor Leduc has been able to produce electrical coma or epilepsy by this apparatus for producing electrical sleep.

It is maintained that these experiments are of the greatest value to the medical professor, as it is very desirable that a safe and satisfactory substitute be obtained to replace ether and chloroform for surgical operations.

Loud Talking Telephones

BY OUR BERLIN CORRESPONDENT.

Loud speaking phones, better known under their German name "Lautsprecher" (loudtalker), are coming into extensive use during the past months, especially in large offices, etc.

These phones when used in connection with an especially sensitive microphone transmitter, the so-called "Lauschmicrophon" (whispering transmitter), talk with such surprising strength and clearness that it is possible to understand the words spoken into the far-off transmitter with ease in all parts of a large room.

The new phones embody no new principles, but are all of rather low resistance; 10 to 15 ohms is the usual resistance, which is necessitated, as rather a strong current must be used, to create the great volume of sound.

Especially strong electromagnets, and special diaphragms are used in order to obviate the scratching noises usually experienced with similar phones.

The entire construction of the instruments is made very carefully and the acoustic properties are carried out to such precision that every one who hears the phones talk is invariably astonished on account of the purity and strength of the reproduced voice.

The instrument shown in Fig. 1 is used to a great extent now in factories, stock rooms, cellars, etc., and is mostly used to transmit orders to employees, etc.



Fig. 1

The phone as shown in Fig. 2 is mostly used in offices, especially for dictating letters. It is usually placed alongside the stenographer, who takes down the notes, while the person dictating the let-

ter of the great demand for them they can soon be had at a lower figure.

ters may be in another part of the building supervising employees at the same time as dictating the mail. The stenographer, may also have a sensitive trans-



Fig. 2

mitter in order to be able to "talk back." In this instance the party dictating the letters must of course also have a loud talking phone.

The instruments are now being perfected to such an extent that by means of a switch they may be switched directly onto the city telephone. This is of highest importance, and it will unquestionably appeal to every American business man who loses considerable time every day by "holding the wire" for long minutes. He does not dare to lay down the receiver, as he could not then hear when the other party was ready to talk. If he could, however, switch on the "loud talker" as soon as he heard "Hold the wire," he could calmly go about his business, as the "loud talker" would call his attention to it in due time.

The new phones sell now from \$15 to \$30. but it is expected that on account



A Magazine devoted entirely to the
Electrical Arts.

PUBLISHED MONTHLY BY

Modern Electrics Publication
NEW YORK CITY, N. Y.

H. GERNSBACK, EDITOR.

Subscription Price: For U. S. and Mexico
\$1.00 per year, payable in advance.

New York City and Canada, \$1.25.

Foreign Countries, \$1.50 in Gold

Stamps in payment for subscriptions not accepted.

Checks on out of town Banks cannot be accepted unless the usual exchange is added.

SINGLE COPY, 10 CENTS.

Forms close the 20th of the month preceding date of publication. Advertising rates on application.

The Editor is always pleased to receive original contributions of timely interest pertaining to the electrical and the affiliated arts. Articles with good drawings and clear photographs especially desired. If accepted, articles will be paid for on publication, at regular rates. No manuscripts will be returned unless return postage is enclosed. Address all communications to:

MODERN ELECTRICS PUBLICATION
84 West Broadway, New York, N. Y.

European Office:
23 Rue Henri Maus, BRUSSELS

Copyright, 1909, by MODERN ELECTRICS
PUBLICATION.

Entered as Second Class matter March 31, 1908, at the New York Post Office, under the Act of Congress of March 8, 1879.

Vol. II. APRIL 1909. No. 1

EDITORIALS.

With this issue the second year of MODERN ELECTRICS begins.

Once a magazine begins to print "Vol. 2" on its cover, it is safe to say that it is past the experimental stage. During the past twelve months the editor had occasion to thoroughly study the tastes of his readers, and he congratulates himself that during the past three months

not a single complaint, as far as the text matter is concerned, has come to his notice. It may therefore be safely assumed that the readers are satisfied with the kind of "brain food" served them monthly.

MODERN ELECTRICS' readers have grown accustomed to expect *real* news, *real* information, and *real* achievement through the columns of their magazine.

While other popular paste-pot-and-scissors magazines enjoy themselves copying each other's articles—usually a rehash of antiquated matter—MODERN ELECTRICS stands out distinctly as a leader now. By perusing competing papers it becomes evident at once that in almost every case, new inventions, new achievements, etc., were published in MODERN ELECTRICS from one to three months ahead of the other periodicals. This is especially the case with European news, which is invariably printed first in MODERN ELECTRICS. Four European correspondents are now regular contributors, their articles being eagerly sought each month. Frequently, if the closing date is near, the news is cabled, if feasible—in short, readers of the magazine know by this time that if it is electric and new, it is published first in MODERN ELECTRICS.

A few figures given below will make the situation clearer:

Total number of articles on wireless printed during the last 12 months, in the following periodicals:

Modern Electrics	115
Electrician & Mechanic	36
Popular Electricity	33

During a period of twelve months 37 articles were published for the first time in MODERN ELECTRICS; these were published later by the following periodicals:

Electrician & Mechanic, Popular Electricity, Popular Mechanics, Scientific American.

If MODERN ELECTRICS ran ahead of the best magazines in the country, when it was one year old, what will it do during the second year?

It is not surprising that the big dailies such as *The New York Times, The New York World, The Boston Transcript*, and a score of smaller newspapers have grown accustomed to quote from MODERN ELECTRICS when occasion arises "There is a reason!"

Some people have come to think that MODERN ELECTRICS is a purely wireless

magazine. This is not so. While it published in the last twelve months more wireless matter than all other popular electrical periodicals combined, it will be found that other electrical matter is far from being neglected. The reason of giving so much space to wireless is chiefly because the art being new, more achievements are made than in other electrical branches, and also because the majority of the readers ask for wireless just now.

In conclusion, the old motto of this magazine is brought forward again, as on it the immense success of MODERN ELECTRICS is built, namely: "To print what our readers WANT, not what strikes the editor's fancy."

TO SUPERVISE WIRELESS.

Washington.—Government control of the air, so far as wireless telegraphy is concerned, is not improbable. The agitation for such control is likely to be taken up in the coming Congress and pushed, for the clashes between different wireless stations and the confusion resulting from a commingling of messages have convinced the wireless experts of the Government that some action must be taken. Control of wireless operations is exerted by practically all of the European Governments, but nothing has been done in this direction by the United States. The growth in number and in the importance of the wireless stations established here, and especially along the coast, makes the need of supervision more and more urgent.

A concrete example of the necessity for such supervision was given during the recent blizzard which on inauguration day almost isolated Washington from the outside world. Most of the communication with adjacent cities was by way of a wireless station on top of a leading hotel. This link with the world was sufficient until the powerful Government station in the navy yard here got into action. The instruments were similarly tuned, and the result was that all messages from both stations were rendered unintelligible for several hours.

If there had been a Government rule governing the tuning of instruments, it is contended such a clash would not have been possible.

THE WIRELESS AGE.

Our history is moving on,
Has turned another page
Upon the top of which we note
The words, A Wireless Age.

The farmer's wildest cattle will
Securely graze inside
The new barbed wireless fences which
Some genius will provide.

The fowls, unhampered by the sight
Of firm, unyielding guard,
Most happily will strut within
A chicken-wireless yard.

Our pet canary bird will sing
More sweetly, I'll engage,
And cheerfully will hop about
Within a wireless cage.

Then, in our windows, to debar
Mosquitoes gaunt and lean,
And flies and other insects, too,
We'll have a wireless screen.

And, best of all, we ought to find,
Before this page is full,
That when it comes to pulling wires,
There'll be no wires to pull.

NEW WIRELESS RECORD.

A new record in the transmission of wireless messages from ship to shore was made by the United Wireless Company's operator on board the steamship Northwestern, of the Alaska Steamship Company, when he sent and received replies to several messages between the Northwestern's anchorage in Fitzhugh Sound and the wireless station at Honolulu, 2,500 miles away.

W. A. O. A.



The Wireless Association of America, headed by America's foremost wireless men, has only one purpose: the advancement of "wireless."

If you are not a member as yet, do not fail to read the announcement in the January issue. *No fees to be paid.*

Send today for free membership card. Join the Association. It is the most powerful wireless organization in the U. S. It will guard your interest when occasion arises.

250-Watt Closed Core Transformer

BY CARLETON HAIGIS.

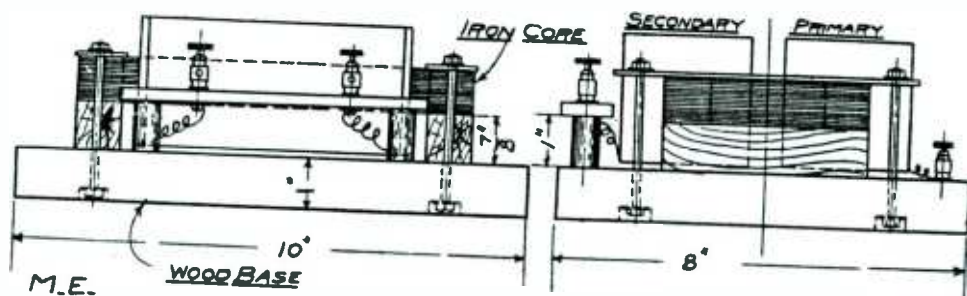

This transformer is designed to operate direct from 100-110 volt alternating current supply and with suitable sending instruments and an 80-foot antenna will send 30 miles overland and a much greater distance over water.

For the core that of an old lighting transformer could be used, but in the absence of that, sheet stove-pipe iron of the dimensions shown at Figs. 1, 2, 3 and 4 is very satisfactory. Enough of each size should be made to make a pile $7/16$ inch thick, when pressed tightly together. These are easily cut out with a pair of tinner's shears and the rough edges should be smoothed with a file. Now, beginning with one of the pieces with the longer leg on the bottom place one with a shorter leg on top and continue alternately intermeshing them until you have them all assembled. They should make a pile $7/8$ inch thick, and each leg should be $7/8$ inch square. The pieces in Figs. 3 and 4 are to be intermeshed between the openings left between the U-shaped pieces at the open end after the coils are in place.

Now we come to the hardest part in the whole construction—that of making the secondary sections. For this purpose a special winder will have to be made as follows: Having obtained a square piece of wood $1 \times 1 \times 8$ inches, proceed to cut down the ends to the dimensions shown at Fig. 5, making the mandrel $1/2$ inch square at the ends. Now, cut 2 pieces of wood $1/4$ inch thick and $2 1/2$ inches square and make a $1/2$ inch square hole in the center of each. One of these should be screwed permanently to the shank of the mandrel, as in Fig. 5, and

the other should be secured in place by a pin passing through it so as to be able to remove the coils after they are wound.

Obtain a quantity of filter paper (such paper may be obtained at any druggists) and from it cut 40 sections $2 1/2$ inches square with a hole 1 inch square in center. Each of these sheets should be paraffined with a good quality of paraffine. After they are dry place two of them on the mandrel and secure the movable piece in place. The whole should now be placed in a lathe or other suitable appliance for winding.

Procure 3 pounds of No. 31 single cotton covered copper wire (B. & S. gauge). Since all cotton has considerable moisture in it, the wire should all be dried in an oven the temperature of which should not exceed 100 degrees, as temperatures above this tend to carbonize the insulation. After the wire is dry wind 1,250 turns on the mandrel between the two sheets of paraffined paper. The wire must also pass through a dish of melted paraffine as it passes onto the mandrel. After the section is wound it should be removed, and in this manner 20 such sections should be made. After these are completed paraffine enough filter paper 6 inches wide to cover one leg of the core $1/16$ inch deep. This should be placed on the core while still warm, so as to make the paraffine hold it in place. Now, make two ebonite pieces $2 1/2$ inches square and $1/8$ inch thick, with a 1 inch square hole in center (Fig. 7), and after having placed one on the core proceed to assemble the

other secondary section upon it, and after all are in place, the other ebonite piece. Now they should all be connected care being taken that the current will flow through each in the *same direction*. The connections should all be soldered with a non-corrosive soldering fluid and wire solder by means of a small alcohol lamp. The two end terminals should be connected to heavier wires (about No. 18) and tied together temporarily.

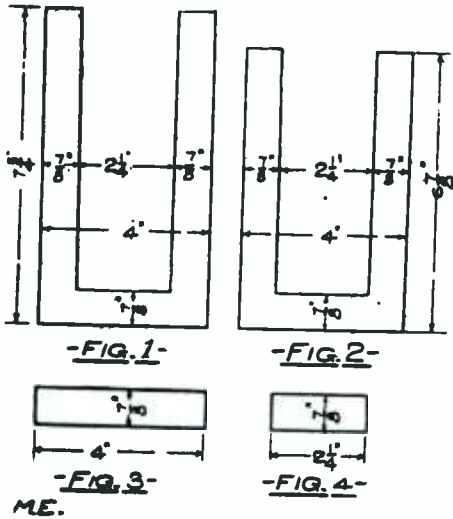

On the other leg of the core wind 100 turns of No. 16 S. C. C. wire, having bound a strip of paper around the core first. These terminals should also be tied together. Now we are ready to place the rest of the core in its place at the open end; these pieces (Figs. 3 and 4) will be found to go into the places left by the longer and shorter legs. After they are all in place a 1/8 inch hole should be bored in the 4 corners and a

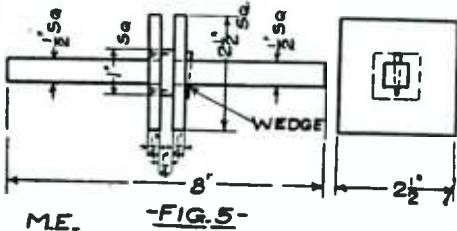

small bolt inserted. The sections should thus be securely bolted together. All that now remains is to mount the transformer on a suitable baseboard of any hard wood 10x8 inches and 1 inch thick. Make 4 cubical blocks 1 inch on a side and place one of them under each corner of the core. Obtain 2 pieces of iron 3/16

inch thick, 1 inch wide and 6 inches long and bore a 3/16 inch hole 1/2 inch from each end (Fig. 6). One of these should be placed across each end of the core and by means of bolts passing down through the holes into the base secure the whole firmly to the baseboard. Now get a piece of ebonite 1/4 inch thick, 1 inch wide and 6 inches long. Two large binding posts should be placed 1 1/2 inches from each end (Fig. 8) and the whole supported on 2 ebonite rods 1 inch high and 1/2 inch in diameter (Fig. 9), which in turn are fixed to the base. The two secondary terminals are now connected to the two binding posts supported on the ebonite and the primary terminals are also connected to two binding posts which pass directly through the base.

The primary is to be connected in series with an ordinary telegraph key direct to the 100 volt alternating current and should develop a 1/2 inch spark at the secondary terminals. It should never be run with a spark gap of 1/2 inch, as

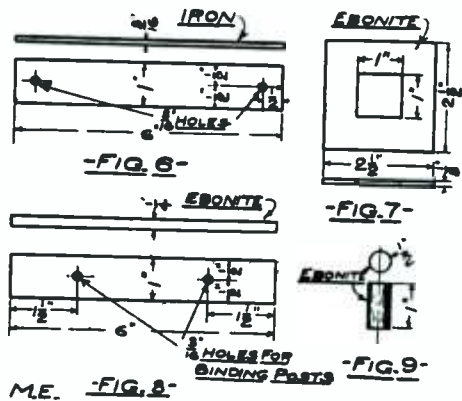

it might injure the secondary winding. For wireless it should only have a 3/16 inch gap with condensers bridged across it.

WIRELESS ENGINEER WANTED

The United States Civil Service Commission will hold an examination April 21st to secure eligibles for a position as assistant electrical engineer, expert in wireless telegraphy, in the United States Signal Service. The salary will be \$1,500 to \$1,800 per annum. Information as to the various places of examination are to be obtained from the United States Civil Service Commission, Washington.

A Telephone System

By SPENCER ROBERTS.

The following is a description of a system which has been found entirely satisfactory and which has afforded the owners much convenience, pleasure and instruction.

Any reader who has several friends in his neighborhood will find much pleasure in having a line among them.

The outside wiring is of galvanized iron or aluminum wire (No. 14), which

WIRING OF STATIONS

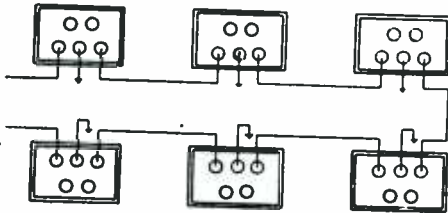

Fig. 1

can be purchased at a small price. One wire is carried from the subscriber at one end of the line to each other subscriber in succession until the other end is reached. A wire is grounded by each subscriber, thus completing the circuit (Fig. 1).

As many phones as desired can be in series; there are seven on the author's line. The wire may be attached at short intervals to trees or houses by means of insulators and brought into each house through a porcelain tube, thereby insuring good insulation throughout. If there are any wires to cross, it is advisable to use covered wire. The inside wiring of each subscriber's station is identical. The instruments can be procured from any supply house. They consist of—

Telephone	\$2.00
Polechanging switch (binding posts at back, rubber base)80
Union lightning arrester65
Three-point switch10
Two one-point switches15
	—
	\$3.70

The pole-changing switch is to reverse the current to conform with that at the station to whom the person is talking.

The three-point switch is to cut down the batteries while talking and to increase while ringing, as the ringing requires more current. The instruments can be mounted upon a board (Fig. 2) and attached to the wall.

Procure a good white pine or spruce board 16x12x1 inches and bevel edges. Then give it three coats of shellac, applying each after the previous one has dried. Then with an auger bore holes for wires so that they are all out of sight and behind the board. The only visible wiring will be where the wires come out to connect with the binding posts of the telephone and pole-changing switch. When this is completed wire according to diagram (Fig. 3). Then screw instruments upon the board. All inside wiring should be of No. 18 annunciator wire. The finished board is ready to be screwed to the wall. Round-headed screws should be used, being about 2 inches in length.

Four new dry cells will be sufficient for each subscriber's telephone. One, two and four is the best way to connect to the

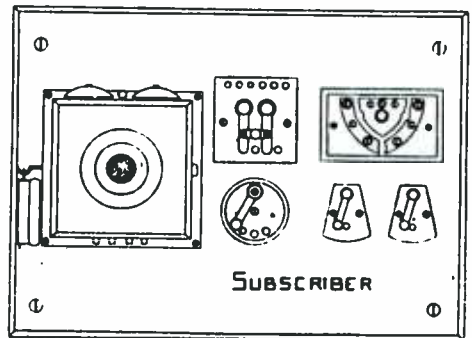

Fig. 2

points of the switch. The wires are led to lightning arrester from the porcelain tube. The two outside wires go to the subscriber on each side and the middle wire is grounded. Wires are led from underneath the board to the batteries, which can be kept in some out-of-sight place. All information can be gained from the diagrams.

The subscribers at each end will have use for only one of the one-point switches but it is advisable to wire in this manner

because there might be some new subscriber join the line whose wire will come to the other switch. Before a subscriber goes away from home or during a lightning storm he puts his arrestor plug in the bottom hole and throws off both one-point switches, thereby cutting out his instruments yet not breaking the circuit of the line. By doing this other subscribers are allowed to talk right through his station without ringing his bell.

By using this system no control is required. Each subscriber has his own ring or rings. When a subscriber does not want another subscriber on one side of his line to listen when he is talking to one on the other side, he throws off the switch which controls that side. (Fig. 2.)

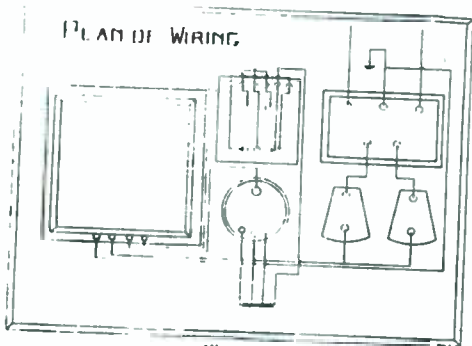

Fig. 3

Those who have wireless stations will find this a handy addition to circulate any news that they might receive.

NEW AMATEUR CODE.

By JOHN N. MAHLMEISTER.

There has always existed in the minds of those using wireless a desire to use a simpler code than the one now in use, namely, one composed only of dots, as the amateur finds it difficult to master the Morse or Continental codes, and on account of this reason some have either given up experimenting or else they have used a code of their own. The writer has found out from experience that the code shown below is a very simple and easily mastered one, as it contains only dots.

The key to the code is as follows:

	1	2	3	4	5
1	A	B	C	D	E
2	F	G	H	I	K
3	L	M	N	O	P
4	Q	R	S	T	U
5	V	W	X	Y	Z

Suppose the letter B was to be sent; we find that B is in the first line and in the second column, making B 1—2, so the sender would tick out . . . , or 1—2; the letter P is on the third line, fifth column, so P would be 3—5, or

To send the words "come home," the sender would tick out 1—3, 3—4, 3—2, 1—5, 2—3, 3—4, 3—2, 1—5, or
 1—3 C, 3—4 O, 3—2 M, 1—5 E, 2—3 H, 3—4 O, 3—2 M, 1—5 E.

A password can also be used in connection with this code, by the use of which only the station knowing the password can understand the message, which would be very useful in time of war.

There could be any number of stations using the code, each station having a different password, and if a message was sent to a certain station using that certain station's password, none of the other stations would understand the message. I will now endeavor to explain the method of using a password in connection with the code.

We will suppose the above "come home" is to be sent with a password (which to illustrate we will say is Arc). We will have to write the numbers of the letters of "come home" on one line and then write the numbers of the password on a second line, adding both lines and then sending the resulting numbers received by adding both, thus:

13	34	32	15	23	34	32	15
11	42	13	11	42	13	11	42
24	76	45	26	65	47	43	57

To decipher a message received with a password it is only necessary to subtract the password (for which any word can be used) and the remainder will be the original message. It will be noticed in the code that the letter J is omitted, which is done to make the code come out evenly and for which the letter I can be used.

It is unnecessary to use a password for ordinary work, as it makes the code complicated, while the code is very simple and easy to learn.

PHILADELPHIA CITY WIRELESS.

The city of Philadelphia will install a wireless plant on the top of the tower of the City Hall, which is more than 500 feet above the street level.

Wireless Department

How to Make a Wireless Control Relay.

By H. W. SECOR.

No 1 - 3 3/4"	10 - 1/8"	31 - 3/8"	46 - 3"
2 - 3 3/8"	17 - 1/2"	32 - 8 7/16"	47 - 0-32 Thrd
3 - 1/16"	19 - 1/2"	33 - 2 1/2"	48 - 1 7/16"
4 - 1"	19 - 1/4"	34 - 1/4"	49 - 3/16"
5 - 1/16"	20 - 1 3/16"	35 - 1/16"	50 - 1/16"
6 - 1 1/8"	21 - 1/16"	36 - 7/8"	
7 - 3/8"	22 - 3/16"	37 - 1/2"	
8 - 3/16"	23 - 1/8"	38 - 1 3/4"	
9 - 3/16"	24 - 1/2"	39 - 2 1/8"	
10 - 1 7/16"	25 - 1/8"	40 - 3/16"	
11 - 1/8"	26 - 2"	41 - 1/16"	
12 - 1/16"	27 - 1/2"	42 - 2 1/2"	
13 - 1/8"	28 - 1/4"	43 - 1 1/2"	
14 - 3/8"	29 - 1/4"	44 - 1 1/2"	
15 - 1/16"	30 - 2 3/4"	45 - 1 7/16"	

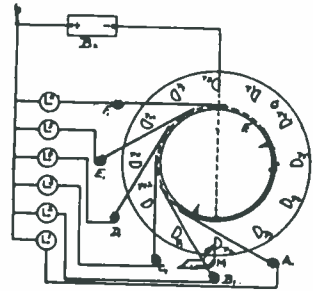

Fig 3

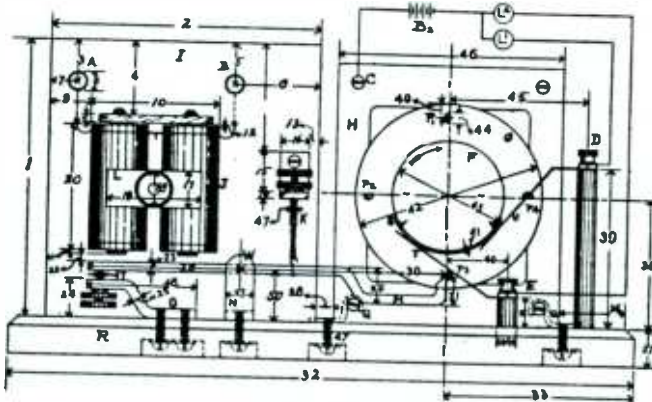

Fig 1

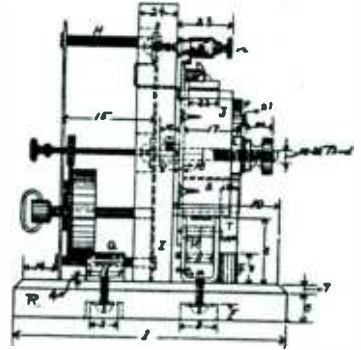

Fig 2

No 1 - 3 3/4"	8 - 3/8"	17 - 3/8"
2 - 3/8"	10 - 1/8"	18 - 3/16"
3 - 1/16"	11 - 3/8"	19 - 1 7/16"
4 - 1/16"	12 - 1/16"	20 - 3/8"
5 - 1/8"	13 - 1/2"	21 - 1/16"
6 - 3/8"	14 - 3/16"	22 - 3/8"
7 - 1/8"	15 - 1 1/8"	23 - 3/8"
8 - 3/8"	16 - 1/4"	24 - 1/2"

"Selective Relay," for Wireless Telegraphy.

First procure an old clock; an alarm clock will do. Remove the wheels between the hand shaft and balance wheel, so when the clock is wound up the minute hand shaft will rotate rapidly.

Now make a disc of 1/16 inch brass (see G, Fig. 1), having a stud in the center (V, Fig. 2), to fit the minute hand shaft. Four release pins are inserted in the disc (P1, P2, P3, P4, in Fig. 1). They should extend 1/4 inch above the surface of the disc. These pins may be made by threading four pieces of 10-32 brass rod into the disc, soldering them in place and filing flat sides on them as shown.

A small wood cylinder (F, Fig. 1) is now fastened to the brass disc, by wood screws, from the back (see Fig. 2). This cylinder should have a piece of brass (S, Fig. 1) fastened to its surface. The brass is the same length as the wood, and covers about 1/3 of the circumference of it. Where it meets the brass disc it is soldered to it.

Two brass pillars (E and D, Fig. 1) are now made, having two brass springs 1/4 inch wide fastened to their upper ends (see T and U, Fig. 1). The springs are secured by means of the brass nuts threaded onto the pillars. The pillars are fastened to the base by means of two

8-32 screws threaded into them (not shown in Fig.).

The clock frame is fastened to the base by the clamps Q, Q, Figs. 1 and 2. This completes the switching end of the instrument.

The releasing end has now to be made.

The first thing required will be an old bell magnet (J, Fig. 1). This is clamped to a vertical wood upright (I, Fig. 1) by means of the 10-24 screw (see Fig. 2) and the fibre piece L, Fig. 1. This makes the magnet adjustable.

The next part is the armature lever (M, Fig. 1), which is made of 1/8 x 3/8 inch wrought iron, bent to the shape shown. A small hole is drilled through it at W, Fig. 1, through which a trunion pin is passed, supported by the trunion block N, Fig. 1.

O, Fig. 1, is a piece of brass bent as shown and fitted with a brass back stop screw, which regulates the play of the lever M. At K, Fig. 1, is placed a right-angle piece of brass, having an adjusting screw threaded through it and attached to the spiral lever spring as shown. This regulates the lever action. To connect the instrument, proceed as follows: Connect the magnet terminals A and B, Fig. 1, to the local circuit of the regular relay. To control two lights, connect lamps L1, L2 and battery B2, as in Fig. 1. Now adjust the instrument so that the lever M intercepts one of the disc pins P1, P2, etc.; this will hold the disc G from rotating. If the lever M catches P1, both lamps are off. If the magnet circuit is now closed for an instant, the lever M will release P1, but the next instant the magnet circuit is opened, and the lever M flies up and intercepts P2. Now No. 1 lamp is on (L1, Fig. 1). Repeating the above operation will release P2 and intercept P3, which puts both lamps on. Releasing P3 and catching P4 turns off L1; releasing P4 and catching P1 turns off L1 and L2. By removing P4 both lights may be turned off together.

To control 1 lamp only (L1, Fig. 1), remove pins P2 and P4. Now, releasing P1 will light L1, and releasing P3 will extinguish it.

Fig. 3 shows the construction and connection of a 12-pin disc, to control consecutively 6 lights. The brass plate S covers about 170 degrees of the periphery of the wood cylinder. If all the 12 pins are used, as shown, when the lever M intercepts P8, Fig. 3, lamp 1 will be

turned off. When M intercepts P9, lamps 1 and 2 will be extinguished, etc. After lighting all the 6 lamps, one by one, to extinguish the whole 6 at once, remove disc pins P8, P9, P10, P11, P12. Now, when lever M intercepts P7, all 6 lamps will be on. Release P7 now, and the first pin is P1, which, being intercepted by M, stops the disc, and the lamps are all out.

The 6-lamp disc and cylinder, Fig. 3, should be made larger than the 2-lamp, as the pins would be so close together it would be nearly impossible to operate it. This disc may be used to regulate the speed of motors, besides starting and stopping them. In operating the above instrument, the transmitting key must be depressed and released very quickly, as in sending a fast code dot.

WIRELESS MARCH.

Well, of course. It was inevitable. First the wireless play, then the wireless march! Wireless seems to be in the air.

The title of the new march is "C. Q. D.," words and music by Wilson & Jackson. The music is full of "sparks," "flashy," and "etheric"; the words by no means "shocking." Quite the contrary.

The march is published by the Co-operative Music Pub. Co., Los Angeles, Cal.

A GREEN WRAPPER

means your time is out. Renew your subscription to-day without fail. Positively no copies sent to expired subscriptions. MODERN ELECTRICS is mailed always before the first of the month. If your copy is not received in due time drop us a postal and we will send another copy.

NIGHT AIR FULL OF WIRELESS

A. L. Deitz, a young electrical engineer, says the air above Manhattan at night is filled with wireless messages. Mr. Deitz's apparatus is on top of the apartment building, No. 100 West Eighty-sixth street, in which he lives.

"I pick up messages from all sorts of places," he says. "There must be hundreds of experimental stations in New York, and the messages are going through the air all night long. My apparatus has a radius of seventy-five miles."

French Wireless Telegraph and Aerophone Devices

The Popoff-Ducretet wireless telegraph and aerophone, as shown in the accompanying illustrations, have been used extensively by the Russian Government at their land stations as well as on board their men-of-war. On the Mediterranean Sea, ships have communicated with

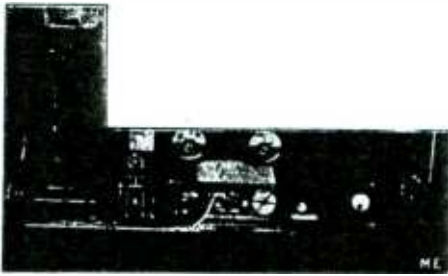

Fig. 1

each other at distances of nearly 150 miles, and on the Black Sea, two shore stations have communicated with each other over land and sea at a distance of 200 miles.

The transformer with two periodic interruptors may be noted at the left as well as the motor and vertical interruptor, also the Wehnelt electrolytic interruptor. The oscillator is connected with the coil and the terminals are connected with the antenna for the transmission of the Hertzian waves into space. At the right may be seen the relay receiver, recorder and radio-conductor as well as the radio-telephone.

In the course of recent experiments last October distinct radiotelegrams were transmitted two miles with perfect clearness without the use of antenna, the receiving apparatus being placed on a table without any exterior communication. Messages were also sent with the antenna at the latter station fixed on the level of the roof, the height of the same being 72 feet from the ground. Notwithstanding the moderate height of the antenna, radiotelegrams were received 27 miles away, showing the great sensitivity of the Popoff-Ducretet receiving apparatus. The Morse recording apparatus of the automatic type is used and with single masts 175 to 200 feet in height, the distances have been greatly increased. The portable apparatus provided is said to have

given excellent service on land as well as sea over great distances. Communication can be established from vessel to vessel over 120 miles and between shore and vessel 150 miles, these distances being surpassed with special antenna and apparatus available.

The drawing, Fig. 2, shows the military type of interruptor connected with a Rhumkorff coil having a sparking length of about eight inches. In certain cases it is necessary to have a very great number of interruptions per minute, and this is obtained by the rotary interruptor noted in the illustration. An electric motor with speed regulator places the interruptor in operation plunging same into receptacle containing mercury covered with petroleum, giving 3,200 contacts per minute with a motor speed of 800 revolutions per minute.

At Paris there are 15 clocks connected with the Observatory of Paris by electrical conductors, the clocks being located in different sections of the city, for providing the correct time. A master clock

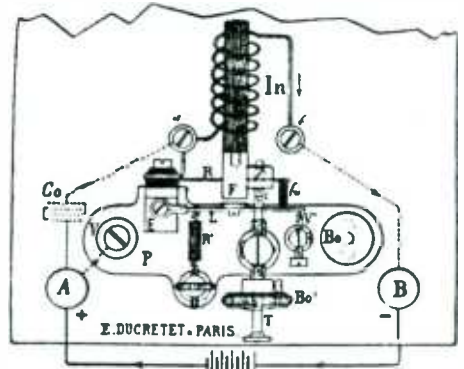

Fig. 2

makes the necessary corrections electrically and many villages have installed this apparatus, the correct time being sent from the Observatory of Paris. In Washington the exact time is sent daily throughout the United States by means of the present telegraphic system. It is claimed that M. C. Bigourdan has made interesting experiments on the transmission of time to a distance, using the Ducretet wireless telegraph apparatus.

(Continued on Page 20)

How To Make a Revolving Condenser

By A. WARD.

The writer having had some trouble in receiving with his station, suspected the cause to be in condenser not being of sufficient capacity, constructed the one described here, and as soon as it was connected signals were received much stronger and clearer.

To construct it, first procure a piece of wood 8 inches square and $\frac{3}{8}$ inch thick and screw some strips of wood $\frac{7}{8}$ inch by $\frac{5}{8}$ inch around it so as to form a box $\frac{7}{8}$ inch deep and $6\frac{3}{4}$ inches square inside, as shown in Fig. 1.

Now procure some 22 gauge sheet aluminum and cut four pieces like Fig. 3. These are to be piled up on baseboard or bottom of box, as shown in side view, Fig. 3 (in which sides of box are removed), and separated by collars $\frac{3}{16}$ inch thick cut off $\frac{7}{16}$ brass rod. They are held in place by two $\frac{8}{32}$ brass screws,

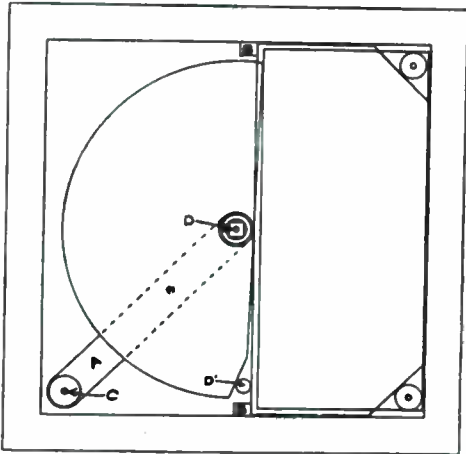

Fig. 1

which are countersunk in base. The top collars are $\frac{1}{8}$ inch thick and tapped to fit screws. One screw is left projecting to receive a binding post.

Next cut 7 pieces of glass out of old 5×7 negatives of the size and shape shown in Fig. 4. Six of these are to be cemented together in pairs with strips of $\frac{1}{32}$ inch hard rubber $\frac{1}{4}$ inch wide between them at each end, as shown in side view, Fig. 4. A little thick shellac on rubber strips and heat over a lamp to expel all moisture will hold them firmly. These are to be slipped between aluminum plates in Fig. 3 and are for the revolving plates to slide in between.

The remaining glass is laid on top and all are held in place by two blocks (B, Fig. 1) $\frac{1}{4}$ inch by $\frac{3}{16}$ inch and $\frac{7}{8}$ inch long tacked inside the box.

Now, cut out 4 pieces of the sheet aluminum like Fig. 5 for the revolving

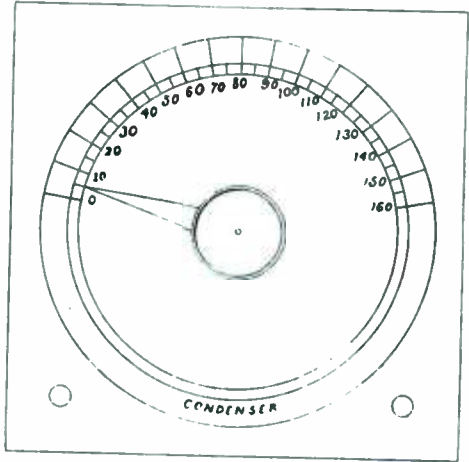
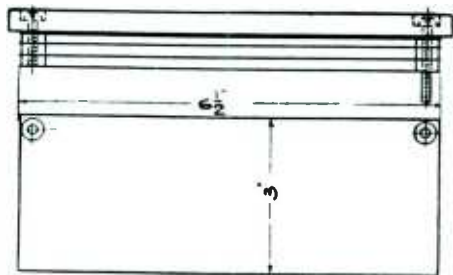

Fig. 2

plates. These are to be put on an arbor made of $\frac{1}{4}$ inch square brass rods (Fig. 6). The ends are turned down and threaded with a 10×32 die leaving the square part $\frac{11}{16}$ inch long. The collar A is $\frac{1}{16}$ inch thick and $\frac{1}{2}$ inch diameter, and is screwed and sweated on. The projecting stem is then turned down to size of No. 20 drill. The top collar is to journal arbor in top plate. C is cut off $\frac{5}{8}$ brass rod $\frac{3}{16}$ inch thick and turned down to $\frac{1}{2}$ inch diameter. $\frac{1}{8}$ inch of its thickness with a $\frac{3}{8}$



M.E.

-FIG. 3-

inch hole. Over this slip a washer C $\frac{1}{32}$ thick, which goes on top of plate and under it the indicator hand (Fig. 7).

Hand is cut out of 16 gauge sheet aluminum. A hole is drilled at D to receive stop pin D, Figs. 1 and 6. A knurled thumb nut (Fig. 8) screws on top of this. Also make 3 collars to separate

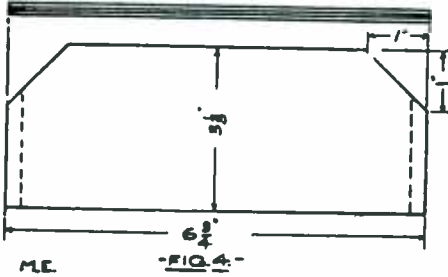

aluminum plates on arbor 1/2 inch diameter 3/16 thick with a 3/8 inch hole in them. Cut out a strip of 16 gauge brass 1/2 inch wide and 5 inches long and drill a No. 20 hole in each end and a hole about the center to receive a 3/8-4 flat-head wood screw. This is screwed

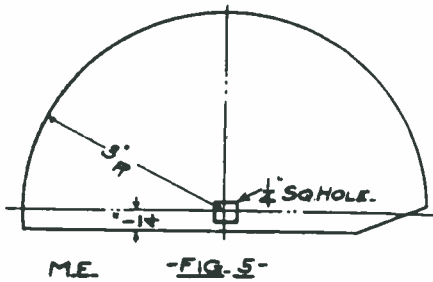

in bottom of box A, Fig. 1, and serves as lower journal of arbor and to connect revolving plates with other binding post. An 8/32 brass screw 1 3/8 inches long extends up through bottom of box at C for this purpose, and has a sleeve slipped

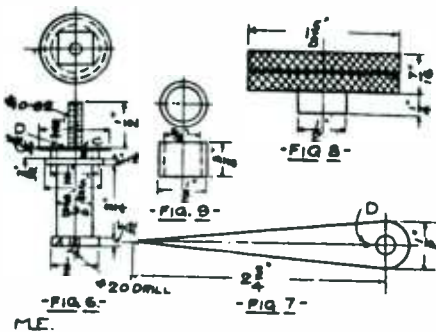

over it, cut off 7/16 brass rod 7/8 inch long. A wooden peg D1 1/4 inch diameter is driven in a hole drilled in bottom

of box to act as a stop pin to prevent revolving plates being turned out of glass plates when turned to zero.

The cover of box is a piece of 3/32 hard rubber 8 inches square. A dial is scratched in with dividers as shown in Fig. 2, and a little Chinese white rubbed in the scratched circles. The circles are 5 inches, 5 3/8 inches and 6 inches in diameter. They are divided in spaces of 5 degrees, starting and ending 10 degrees from the horizontal. The cover is then screwed on with round-head brass wood screws 3/8-4. Place indicator hand on and screw knurled head (Fig. 8) on tight, also two binding posts, and the condenser is complete.

MAJORANA AEROPHONE

(Continued from Page 5)

graph station at Rome. The Marine Department had a second station for the aeropphone experiments erected at Porto d'Anzio, which used a 150-foot four-wire antenna, at 35 miles distance. In the Rome station the four-wire mast is about 280 feet high. Speech could be heard very well at this distance. Then it was desired to work on a larger scale, and the Marine Department placed the torpedo destroyer Lanciere at the disposition of the inventor. The vessel proceeded to the island of Ponza, lying at 75 miles from Rome, where there was located a wireless post belonging to the Government having a four-wire antenna about 200 feet high. After fitting out the post with the new apparatus, it was found that the results were even better than in the latter case.

The Lanciere was then taken to Maddalena, in the island of Sardinia, and the apparatus was placed in a wireless post lying near this port, the station being like the one just mentioned which is located at Ponza. The distance from Rome in a straight line is about 170 miles. However, this last point is surrounded by mountains, so that it is not well placed. This limit only refers, however, to the size of the antenna at Rome and the power which is used there (about 3.5 amperes), and is not by any means the farthest distance which can be reached. Seeing that the hydraulic microphone gives excellent results, there is nothing to prevent us from covering much greater distances by increasing the power of the apparatus at the sending station.

The Aerophore Automatic Signaling Device

BY RENE HOMER.

One of the earliest discoveries bearing upon the generation of Hertzian waves was that the waves were much stronger between a diagonal antenna and the ground than above it. The waves thus radiated go much further, therefore, in the direction of the slanting wire, so that an inclined wire attached to a boom extending from a mast will radiate a distance proportionate to the proximity of the waves to the line of the boom. Several other methods have been successfully employed to give a definite direction to Hertzian waves. The method employed by Bellini and Tosi is, perhaps, the latest. This theory was employed even by Bell in his photophone, which sent the Hertzian waves along a beam of light. This principle of the projection of these waves in a given direction forms the basis of Dr. De Forest's wonderful aerophore.

In accordance with this principle of linear projection of ether waves, light-houses can send out an electrical impulse detectable by any properly equipped boat which comes within range. This wave can be constantly changed in its direction by revolving the projecting apparatus, so that any boat which receives the signal can tell its direction from a dangerous spot equipped with the aerophore, when this device is equipped to transmit intelligible signals differing automatically with the constantly changing direction of the projected waves. Thus, when the waves are thrown in a northerly direction, a certain telegraphic or telephonic signal is automatically transmitted to any receiver which crosses the line of projection. When the wave is thrown in an eastern direction, this signal, of course, will be different.

This same principle is applicable to an equipment for vessels, which will prevent collisions. Two approaching vessels sending out ahead intelligible signals cannot come within dangerous proximity without at least one of the vessels being warned of its danger, thus enabling pilots to determine their position and respective courses by a wireless telephone conversation.

The type of aerophore device upon

which Dr. De Forest is experimenting at present, consists of an apparatus which causes a boom to revolve about a mast. This movement is stopped momentarily at the points of the compass, while a phonograph announces over the wireless telephone the direction the wave is thrown. In connection with this apparatus is a set of bells tuned to the quarters of the octave, which are constantly struck, one after the other, several times a minute. Each of these bells sounds into a microphone transmitter, and is sent over the wireless telephone with varying range of penetration; thus, when a boat hears the entire four bells, it is obviously within range of the fourth bell, a distance which has been already calculated, and is charted beside the instrument. When only three bells are heard the boat must, of course, be outside the range of the fourth bell, and so on. This process enables the navigator to determine within a very close distance just how far he is from the point of danger.

At first the difficulty encountered was the fact that when the instrument was sending over a single antenna, it was impossible to receive, so that a vessel might possibly miss the signals of another aerophore, simply because it was sending at the same time as the other instrument. With the advent of De Forest's new multiplex sending and receiving system, it becomes possible to both send and receive over the same antenna at once. Thus, in actual practice, every receiving machine would be tuned to a certain point, while each of the sending mechanisms would have a "common tune," which would differ widely from that of the receiving part of the apparatus. Each machine has a pilot lamp, which is made to glow by induction whenever the apparatus receives a signal, so that the vessel is safe as long as the lamp does not light. The same mechanism which lights the lamp can also be made to operate a buzzer, which calls the operator to the instrument. Whenever the lamp glows, or the buzzer sounds, the operator places the head phones to his ears until he makes out the name and distance of the com-

municating station. If the call comes from another vessel, he uses the telephone to determine its course.

The aerophore will be placed in operation some time during the coming season by the Great Lakes Radio Telephone Company, in conjunction with the wireless telephone. This company has already completed its stations at Chicago, Milwaukee, Toledo and Cleveland, while stations at nearly twenty other places are in progress.

Many steamship owners have contracted for the installation of the telephone, and after the wireless telephone has been put into successful operation, the installation of the aerophore will be commenced. Aerophore stations will be

An apparatus along similar lines is being constructed now for a thorough trial upon several Western railroads, and should prove very effective in preventing collisions and similar accidents.

In Fig. 1, J represents a prime mover of any suitable type which, by any convenient means, such as the belt 14 passing around the pulleys, 13, 13', may drive the generator G. M represents a transformer interposed between said generator and the spark-gap S, and C is a condenser which may be connected across the terminals of said spark-gap. In Fig. 1, the prime mover J rotates the signal wheel Q by means of the shafts 2, 3 and any appropriate gearing, and in-

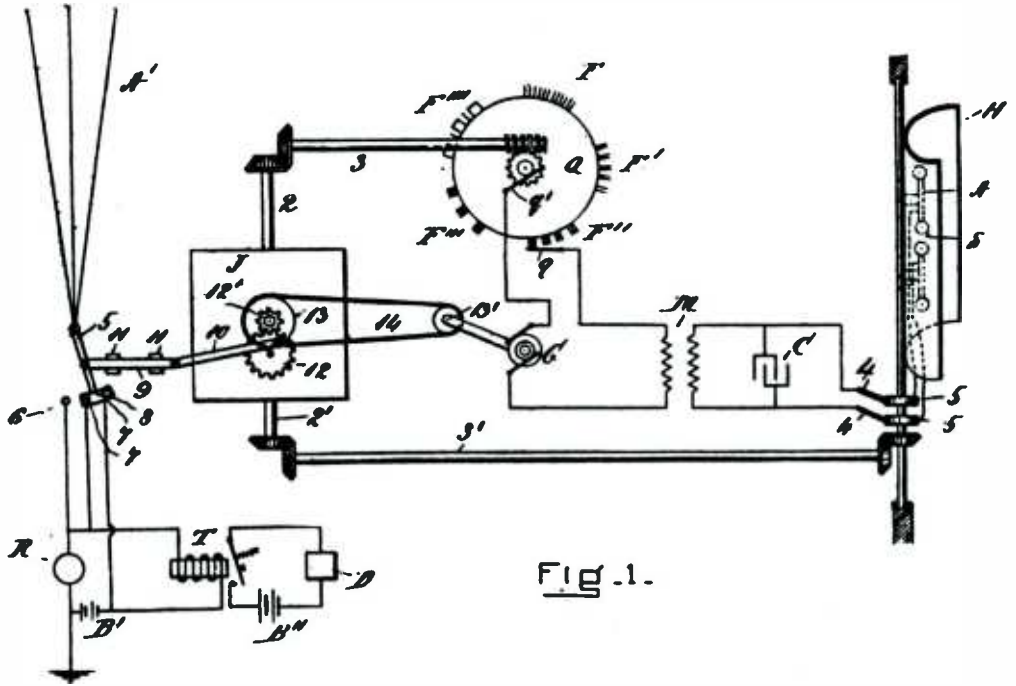

Fig. 1.

erected at all of the principle points of danger. The first stations to be thus equipped will be those at the Straits of Mackinac, Outer Island, Island Royal, Sault Ste. Marie and Georgian Bay. These stations will be followed rapidly by installations in all of the towers of the Atlantic Radio Company along the South Atlantic Coast, and later upon the North Atlantic and the Pacific coasts. The United States Navy is deeply interested in De Forrest's devices, and the Hydrographic Office has asked for an appropriation to demonstrate the utility of the invention upon the Great Lakes.

termittently rotates the reflector H by means of similar shafts 2', 3' and gearing, although any suitable means may be employed to communicate motion from the motor J to the wheel Q and reflector H. The secondary of the transformer M is connected to the antenna A by means of the brushes 4, 4', and rings 5, 5'. Geared to a pinion 12' which is operatively connected to the motor J, is a wheel 12 which operates the crank arm 10 connected to the switch 5 by means of the rod 9 which reciprocates in the guideways 11, 11, and so communicates an intermittent movement to

said switch. When the generator circuit is closed through any of the contacts F, F', etc., of the signal wheel Q, the switch 5 is in such position that its contact 8 co-operates with the contacts 7, 7, thereby connecting a shunt circuit around the responder R and at the same time breaking the connection of the receiving antenna A' with said responder R at the point 6, so as to protect said responder from the effects of the transmitted waves.

The mechanism which operates the reflector is connected and arranged in any suitable manner to rotate said reflector through an arc of, say, 225 degrees, and back again. The signal wheel is rotated continuously and its signaling contacts are so arranged with respect to the position of the reflector H that when the reflector is directed so as to concentrate the radiated waves in a particular predetermined direction, a distinctive signal is produced. Thus, for example, when the reflector is directed to the starboard, a signal consisting of a series of dots is emitted; when it is directed to the starboard-quarter, a series of two-dot signals is emitted; when the reflector points to the bow, the signal consists of a series of three dots; when it points to the port-quarter, the signal consists of four dots; and when it is directed to the port, a signal dot-dash signal is produced.

The circumference of the signal wheel Q is divided as shown into ten parts, although it may be divided into any other number of parts, herein shown as five, are provided with the signaling contacts F, F', etc., while the remaining parts are left blank. When the reflector H is directed as above indicated, the circuit of the generator is closed through the brush q, one set of the contacts F, the wheel Q and the brush q', and when the circuit of said generator is broken by a set of the contacts F breaking connection with the brush q, the switch 5 is in such position that the shunt around the responder R is broken at the contacts 7, 7, and the antenna A' is connected to earth E by way of said responder at the point 6. In such position of the apparatus, any signal which may be emitted by an aerophore on another ship may be received by the responder R and thereby energize the magnet T, connected in series with said responder and the battery B'. This magnet T may be a telephone

magnet, or as shown, it may be the magnet of a relay which, when energized, will close the circuit of the signal-indicating device D and the battery B". The signal-indicating device D may be a bell or an incandescent lamp or any other device which will give an audible or visible signal. The pilot of a vessel receiving such signal by referring to a table or chart can determine the position of his ship with respect to the ship from which the signal was transmitted. For example, in the diagram shown in Fig. 2, the ship K' which is on the starboard side of the ship K would receive the standard signal indicating "starboard," which, as above set forth, might be a series of single dots, but would not receive the signals indicating starboard

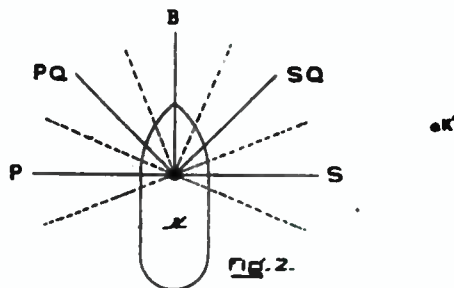

quarter, bow, etc.; while if a vessel were ahead of the ship K its pilot would receive the standard signal indicating "bow," but would not receive the others.

THE SENSITIVITY OF THE TELEPHONE.

It is truly marvelous how sensitive an ordinary telephone receiver is. Preece calculates that a sound is produced in a telephone by a current equal to .000,000,000,000,6 (six ten trillionths) of an ampere in intensity, or such a current as could deposit about .000,000,000,000,03 (three hundred trillionth) of a cubic inch of pure copper in each second of time.

Pellatt calculates that with a voltage of .0005, representing the difference in potential, between the two terminals an audible sound is maintained in the receiver. In other words, it would take 10,000 years for such a force to raise one gram of distilled water from zero centigrade, to one degree above.

Above values may be multiplied 10 to 25 times if the instrument is a modern wireless telephone receiver.

Wireless Banquet



1.—Dr. Lee de Forest. 2.—James D. Smith. 3.—E. E. Burlingame.
4.—Captain J. E. Darby. 5.—H. Gernsback.

At a banquet given February 13th last, in the historic Fraunce's Tavern, New York, in honor to Dr. Lee De Forest's work in aerophony, and on account of the successful financing of the Great Lakes Radio Telephone Co., the inventor, Dr. De Forest, spoke of his achievements. He stated that with his new sparkless wireless (undamped, such as used with his aeroplane) the possibility of interference is reduced enormously, as much sharper tuning may be achieved. This, as is well known, is a very difficult thing to-day with spark wireless.

Dr. De Forest also spoke of his early work and stated that with his new aeroplane system a much greater amount of despatches can be handled in a much shorter amount of time than with the present wireless telegraph.

Mr. E. E. Burlingame was toast-master and complimented the inventor on his work. Mr. Smith, the president of the company, announced plans for the immediate erection of a chain of wireless stations along the Atlantic and Pacific coasts, as well as at certain points in the interior.

Mr. H. Gernsback spoke of the achievement of amateur wireless telegraphy in the United States, and demonstrated that the young experimenters

have done a great deal to further the new art. He also spoke of the Wireless Association of America, which he founded, and of which Dr. De Forest is president. Mr. Gernsback closed with a fantastic account entitled "Wireless on Mars," which created universal applause.

Over 100 wireless men attended the banquet.

NEW ENGLAND WIRELESS SOCIETY.

This society was incorporated under the statutes of the Commonwealth of Massachusetts on February 4th for the study and improvement of wireless communication. The regular meeting is to be held the first Friday in each month. Mr. Gordon S. Wallace, 563 Massachusetts avenue, Boston, is acting secretary.

FRENCH STUDY WIRELESS.

Paris.—The French Government, as a result of the use made of wireless telegraphy following the sinking of the steamer Republic off Nantucket January 23, is studying the entire question of wireless communication.

The idea in view is to introduce a bill to oblige French navigation companies to install wireless apparatus on all their ships above a certain tonnage.

Condenser Phenomena

By C. C. WHITTAKER.

The most common condenser is that of the plate form, which is a descendant of the original and classical condenser, the Leyden jar. Whatever the form may be, the parts are essentially the same; they are conducting plates separated by an insulating plate called the dielectric.

Before proceeding farther it will perhaps not be out of place to present a few definitions of terms used in connection with condensers.

A unit "capacity" is the capacity of a conductor which contains a unit charge of electricity at unit potential. Using practical units, this means that a condenser whose potential is raised one volt by a current of one ampere flowing into it for one second has "unit capacity" or one "farad" capacity. This unit is much too large for practical work, so the microfarad is used. This is one one-millionth part of a farad.

A condenser is said to be charged when the alternate plates have the opposite kinds of electrification. It is discharged when the two opposite charges are allowed to unite.

With these definitions in mind we shall proceed to the discussion of some of the more important features of the action of the condenser.

In general the discharge of a condenser is oscillatory. In Fig. 1 let A and B be two condensers, the lower plates of which are connected to the ball E and to the earth. If F and G are connected by some conductor of low resistance, such as a heavy wire, and the whole system charged by bringing a charge to C until a spark passes at D—E, both condensers will be discharged at the same time. This is, however, quite different when F and G are connected by a conductor of high resistance such as a wet string. Now, if C is charged until a spark passes between D and E, we shall find that there will be a spark at F—G which is much longer than that at D—E. The following is the explanation:

The time of charging was relatively long compared to that of discharge. Therefore the current had plenty of time to overcome the high resistance at F—G

and to charge A with the same quantity as that of B. Now, when the discharge takes place the charge from A cannot overcome the resistance at F—G in the time of the discharge at D—E. But as the two plates of condenser B are connected by a good conductor, the charge on the upper plate, assuming it to be charged positively, overruns itself, as it were, to neutralize the negative charge on the lower plate. Now, if the potential difference between F and G was the same as that between D and E, the spark length would be the same. But the length between F and G was observed to be greater than that between D and E. This shows that the potential of the top plate of B must have been less than zero. Since this is so, the potential of the lower plate, which was always zero since it was connected to the earth, must

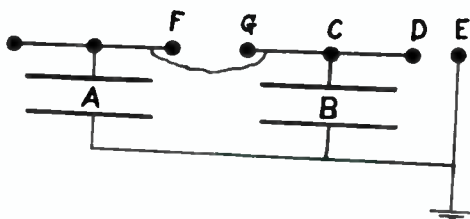

Fig. 1

now be greater than the top plate. Consequently the direction of the flow will be reversed. This process is repeated many times in the small fraction of a second, the actual time being 1/20,000 part of a second.

It is now evident that the discharge is oscillatory only when the plates are discharged through low resistance conductors; if discharged through conductors of high resistance, the potential gradually, so to speak, falls to zero and remains there.

The oscillatory discharge may be easily shown by the use of an induction coil. If an exhausted tube is connected to the terminals of an induction coil in operation, one terminal is seen to glow more brightly than the other. This bright one is the cathode, or negative terminal. If a condenser is placed in the circuit in parallel with the tube it will be seen that the latter glows with equal radiance at both electrodes. This can be readily ac-

counted for by the oscillatory action of the condenser.

We shall next turn our attention to the capacity of a condenser. This may be readily calculated by the aid of the formula, $C = \frac{K S}{4 \pi D}$ where K equals the dielectric constant, S equals the total area of the conducting plates, π equals the mathematical constant 3.14159, and D equals the thickness of the dielectric. (The metric system must be used for S and D.)

This formula gives the capacity in C.



Fig. 2

G. S. (centimeter, gram and second) units. The practical working unit, the microfarad, is 1/1,000,000,000,000,000 part of the C. G. S. unit.

The following is a partial list of the values of the dielectric constant:

Air	1.
Paper	1.9
Paraffine	2.
Ebonite	2.5
Shellac	3.5
Plate glass	6.5
Mica	6.6

Condensers may be arranged in series, parallel or any combination of these arrangements.

When arranged in series, the capacity is decreased. For, in Fig. 2, the effect is the same as one condenser with the

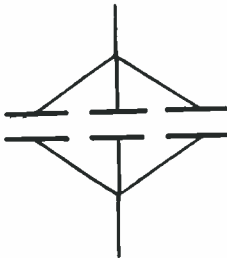

Fig. 3.

dielectric three times as great in thickness. Thus in the series arrangement the capacity is lowered and resistance is added to the circuit.

The effect is quite different, however, when condensers are connected in parallel.

In Fig. 3, if the capacity of each condenser is equal to x, then the capacity of the system equals 3x, for the only

variable is the area of the active plates and this varies as the number of condensers.

Therefore the total capacity of a system of condensers coupled in parallel is equal to the sum of the separate capacities.

NOISY AERIALS.

Very few people know that large aerials actually produce sound when a message is sent over them.

This is actually the case, and it can be observed very well, especially on ship aerials. However, nothing can be heard unless the power used is at least 1 K. W.

When one stands directly under a ship aerial, and far enough away from the sending station, so that one does not actually hear the spark from the gap, and when a message is being sent, a low crackling noise can easily be made out. In fact, every dot and dash can be heard quite well and the message can be actually read by sound by an operator.

The explanation is that there is a certain amount of leakage from the wires into the salty air, which is a fairly good conductor.

If there is a dense fog, or when the air is very moist during the night, a luminous discharge can be seen all along the wires on a ship aerial; frequently in fact every inch of the entire aerial may be outlined, due to the glow discharge.

"FIPS" PROTESTS.

There are some people who always do the wrong thing at the wrong time. I am talking of the boss.

Did you see the new cover this month? Do you remember that I told the boss last fall that the lady on the old cover needed a warmer dress? Do you also remember that he almost made pulp out of my anatomy when I told him about it? And what does he do now? He goes and puts a dress (?) on the lady, *just when it gets nice and warm*, and when she doesn't need it at all! It's needless to say that the other lady—poor girl—died of consumption last month on account of "exposure," just as I predicted. Another case of covering the well after the elephant had fallen in it.

I would furthermore suggest to supply the new gentleman on the cover with a coat, at least up to June first. He looks kind o' chilly just now.—"FIPS"

Wireless Telegraph Contest

Our Wireless Station and our Laboratory Contest will be continued every month until further notice. The best photograph for each contest is awarded a monthly prize of Three (\$3) Dollars. If you have a good, clear photograph send it at once; you are doing yourself an injustice if you don't. If you have a wireless station or a laboratory (no matter how small) have a photograph taken of it by all means. Photographs not used will be returned in 30 days. This competition is open freely to all who may desire to compete, without charge or consideration of any kind. Prospective contestants need not be subscribers for (the publication) in order to be entitled to compete for the prizes offered.

FIRST PRIZE, THREE DOLLARS

I have of late completed a wireless telegraph set and I thought that readers of MODERN ELECTRICS may like to read about it.

Sending Station.—The spark coil used gives a 6-inch spark and may be seen to the right of picture on the farther side of the table. The sending helix is standing in front of the spark coil. The condenser used in connection with the helix is a common 1-quart Leyden jar. The telegraph key is a heavy model of the common type, on the left of the helix. I use three cells, type R. E., for sending, not shown in picture.

Receiving Station.—The large tuning coil may be seen to the extreme left of the picture. In front of it and just behind the telegraph receiver is an electrolytic detector, not plainly shown in the picture. To the right of the receiver is a potentiometer, and to the right of it is a common dry cell used for receiving only. Between the dry cell and the telegraph key, but not plain in the picture,

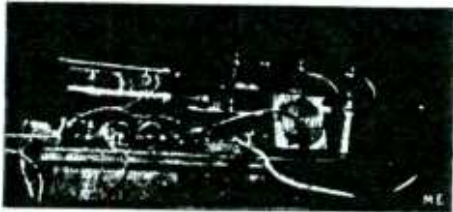

is my aerial switch, from which can plainly be seen the ground wire. This completes my set, which, though simple, is very sensitive and satisfactory.

EDWIN R. WILLARD.

Chicago, Ill.

HONORABLE MENTION.

Enclosed herewith find a photograph of my wireless telegraph station. The antenna I use is two hundred feet long and fifty feet high at both ends.

In my transmitting set I use a 1 1/2 inch spark coil. Two condensers made of lamp chimneys and a sending helix made like a transformer. I run the spark

through transformer, which steps the potential of the current up. The terminals of the secondary of the transformer lead to the antenna and the earth, thus forming an open circuit oscillator.

My receiving set consists of four detectors, carborundum silicon, pericon and electrolytic which are all mounted on a hard rubber base. I use a tuning coil with a secondary on one end of it. A variable condenser helps me greatly to tune, as it keeps me from having to move the slide on the primary of the tuning coil. The telephone receivers are

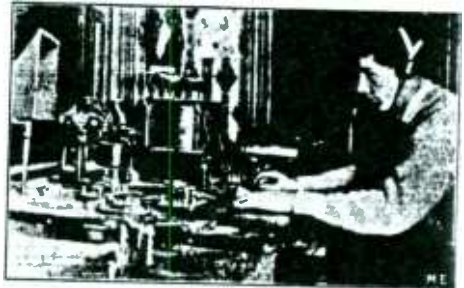

wound to a resistance of two thousand ohms.

With this set of instruments which I constructed I can send about ten miles. But on the other hand I can receive from Pensacola, Fla., and Cape Cod very easily. Most of the navy stations on the Atlantic Coast I can pick up with little trouble by careful tuning. All of these stations have long wave lengths and are easy to tune to.

Many of the merchant ships and coasters have wireless on them. These ships all have short wave lengths. They may be picked up at night, but it takes a fine operator to read them, as they don't lose any time in sending out their messages.

I have been taking your magazine since November and have gathered much wireless news from it.

W. R. BURDETT.

Washington, D. C.

HONORABLE MENTION.

Enclosed find photograph of my wire-

less apparatus, which is home-made except the receivers. The switches and fuse plugs do not show, as I have the whole apparatus in a large closet when working, but had to remove them to be able to take the photo on account of it being dark in closet. On farther end of table from me are some of the batteries, in front of which is a small motor which I built, also a potentiometer made of German silver wire. Next comes a small magneto which I made from old files and block gears; then my tuning coils made of bare copper wire No. 22, with strand of thread wound between. I have

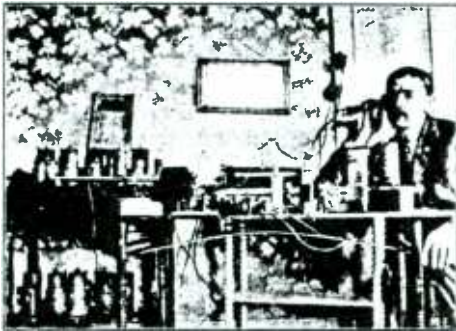

about one pound of wire on same. In front of magneto you will see a galvanometer.

A 1/2 inch coil with spark balls may be seen, also my detector, which is of the electrolytic kind; it is partly hidden behind a standard, on which you will see a spool; this piece of apparatus has a sounder and tape attachment worked by a block arrangement that records the dots and dashes so I need not be at the receiver to know if same is working. This piece of apparatus I consider my best piece of work, as it works quite well. The frame on the wall contains the stations in the United States. The magazine on the batteries tells its own story, to which I owe a great deal for the success of my plant. My aerial wires are 4 strands, 50 feet long, 18 inches apart, 45 feet high, No. 16 bare copper wire. Leading in wire is No. 12 rubber covered wire. Ground wire, No. 12, connected to water pipe. I have a magnet arranged on my camera with a flexible cord and push, which I worked with my foot to take the picture.

New Jersey. GEO. H. NIXON.

HONORABLE MENTION.

My wireless consists of a sending and

receiving set. My sending set consists of a spark coil, which you see in the center of the picture; my tuning coil to the right in the picture, which I made myself; also condenser. Receiving set consists of tuning coils, shown at left of picture; variable condenser, shown behind the coil. My spark coil, to the right of that, has zinc spark gap, which I made myself. The variable condenser has eight plates, 3 1/4 inches by 4 1/4 inches.

The last part of the receiving set is the filings coherer and relay, which is seen in the lower part of the box-like place; two choke coils and a small motor. In the top box is my electrolytic receiver, 1,000 ohm receiver, and a telegraph instrument. In the lower box is also a 15 ampere switch. The small double pole double throw switch in front of the coil changes batteries on the coil. I also have two sets of carbon cells. The batteries are not shown in the picture.

A friend of mine has a set about a mile away. We can receive all right when it comes to the electrolytic, but the fil-

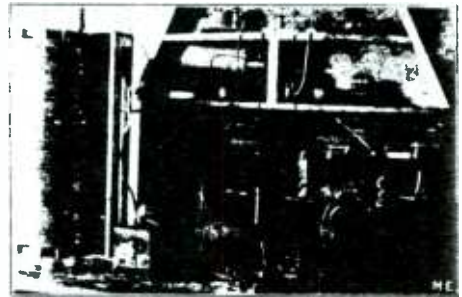

ings coherer will hardly respond. My aerial is 40 feet high. I have been experimenting with wireless for four years.

Iowa. OSCAR PETERSON.

HONORABLE MENTION.

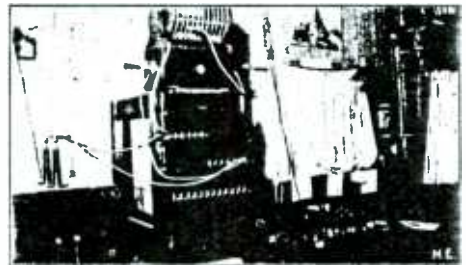

Enclosed find photos of my wireless station.

Photo No. 1 shows complete station.

Photo No. 2 shows complete receiving outfit.

I use the Massie connections, which give excellent results.

In photo No. 2, on the left, is a 3-slide tuning coil; on the right is the Massie tuning coil, with 2 slides and adjustable condenser. In the center is an electrolytic detector; the switches are for throwing in either tuning coil. Part of the head phones, which are the Massie type,



can be seen in front of the two switches.

JAS. WATMER.

Montana.

A NEW SPEED INDICATOR.

We are in receipt of a new and unique counter for taking the revolutions of shafting, dynamos, motors, etc., which has just been brought out.

The notable feature pointed out in this instrument is the clutch, consisting of two parts, which, in their normal position, are held apart by a spring provided for the purpose. When the point of the instrument is placed against the end of the shaft whose speed it is desired to measure—the counter being held in one hand and a watch in the other—the operator, at the beginning of a minute, presses on the end of the counter, whereupon the count commences. At the expiration of the minute, upon the pressure being released, the counter immediately stops. This effect, it is mentioned, is due to the separation of the two parts of the clutch by the spring mentioned above. The difference between the readings of the counter at the beginning and end of the minute represents the number of revolutions of the shaft, no arrangement being provided for setting the counter back to zero.

The company states it has purposely omitted to include a set-back device so as not to complicate the apparatus and in the belief that any such contrivance now

on the market would make the counter unreliable.

Apart from these arguments, according to our judgment, there is a great advantage in this: that it is obviously easier to jot down the readings on a piece of paper, as is necessary in the present case, than to have to set back each time the



counter in an instrument calling for that somewhat tedious operation.

It is pointed out further that the counter operates equally well in either direction, adding when running one way and subtracting when running the other.

The device can also be adopted for use in connection with generators and motors as the indicator is non-magnetic. Soft rubber tips are furnished with the counter, which, being insulators, enable one to take readings of high tension dynamos and motors.

FRENCH WIRELESS TELEGRAPH AND AEROPHONE DEVICES.

(Continued from Page 14)

the transmitter, induction coil, and relays being so arranged at the master clock that signals are sent periodically by proper contacts being made at regular intervals. The Hertzian waves causing these signals to be received at the various stations provided for the purpose.

Electrical Patents for the Month

918,718 SPACE TELEGRAPHY. LAW OF FROST, New York, N. Y., assignor to the Farn-Hull Telephone Co., a Corporation of New York. Filed June 23, 1907. Serial No. 346,455.

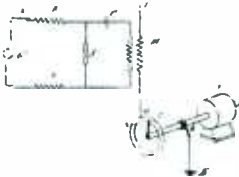

1 In a space telegraph system, a source of practically continuous electrical oscillations of frequency higher than the limit of audibility, an elevated condenser connected with said source, and means for varying said oscillations according to a simple harmonic law of a rate lower than the limit of audibility.

918,998 ELECTRIC CIGAR-LIGHTER. JOHN W. TUCK, Jr., Jackson, Minn., assignor to O. S. Johnson and C. M. Cuts, Jackson, Minn. Filed Jan. 4, 1904. Serial No. 400,884.

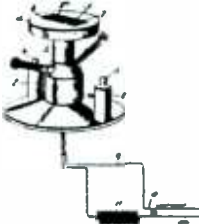

1 The combination with a casing, said casing having the top thereof, two metallic contact strips arranged thereon, said strips being substantially parallel to each other and transverse to the slot and each providing a tortuous passage for an electric current, electric wires connected respectively to said strips, and insulating material packed between and around the said strips.

918,280 ELECTRIC SIGNALING. RICHARD A. PEARSON, New, Washington, D. C. Filed Feb. 8, 1907. Serial No. 356,987.

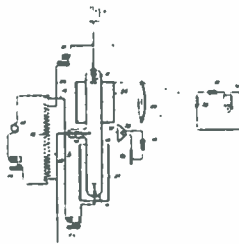

1 A receiver for electromagnetic waves comprising an exhausted tube containing one of the helium group.

914,468 DEVICE FOR PREVENTING COLLISIONS AT SEA. GEORGE EDWARDS, Berlin, and CLARA FISCHER, Charlottenburg, Germany, assignors to Gottfried Fischer, an Inland German. Filed Oct. 21, 1907. Serial No. 386,322.

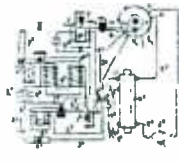

1 Apparatus for preventing collision of two comprising in combination a self-acting transmitter of electric waves located on a navigable object, means for continuously operating said transmitter, a receiver for such waves located on another navigable object being a ship, an electric circuit adapted to be closed by the action of said waves on the receiver, mechanism actuated by current flowing through the receiver circuit for stopping the motion of the ship, a second transmitter of electric waves located on the ship, and an automatic make and break switch controlled by the receiving circuit, adapted to alter battery break the receiver circuit and second transmitter circuit.

918,146 TELEUTOGRAPH. EDWARD BEHN, Paris, France. Filed Jan. 17, 1906. Serial No. 411,884.



1 Apparatus for transmitting to a distance by telegraphic or telephonic methods any graphic representation having a surface to rotat to a slight extent, comprising means for translating the variations in the rotat into variations in electric intensity, means for transmitting said electrical variations to a distance, means for translating said electrical variations into variations of light intensity, and means for recording the said mentioned variations.

918,429 RECEIVER FOR ELECTROMAGNETIC WAVES. RICHARD A. FARRINGTON, Washington, D. C., assignor by direct and mesne assignments to The National Electric Signaling Company, Pittsburg, Pa., a Corporation of New Jersey. Original application filed July 8, 1905. Serial No. 164,735. Pending and this application filed Jan. 1, 1908. Serial No. 324,571.

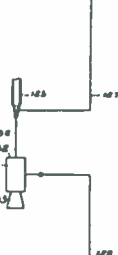

1 A receiver for electromagnetic waves consisting of a moving liquid beam.
2 In a receiver for electromagnetic waves, a receiving circuit composed in part of a liquid movable to a definite point.
3 In a receiver for electromagnetic waves, a detector means including a flowing liquid.

912,880 ELECTRIC SWITCH. ERNEST M. CANN, New, Canada. Filed Mar. 10, 1906. Serial No. 421,040.



1 A switch comprising a pair of conductors having adjacent portions embedded in an insulator, and a movable member carried by one of said conductors and adapted to be moved into and out of contact with the other conductor.

914,878 ELECTRICAL INSECT-DESTRUCTOR. PETER J. PETERSON, Oakland, Cal. Filed June 13, 1907. Serial No. 414,367.

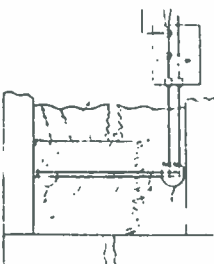

1 In a device of the character described, the combination with a window glass, of a supplemental transparent plate fixed parallel to the surface of the window glass, two pairs of parallel wires extending transversely between said glass and plate, the pair of the wires being continuous to one surface, and the other continuous to the other surface, and insulators by which the ends of the wires are supported.

917,414 MEANS FOR CONTROLLING DIRECTED TORQUE. LEWIS E. CURTIS, Ingersoll, Ohio. Filed July 22, 1908. Serial No. 327,294.

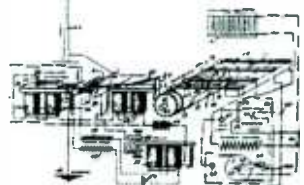

In a system of wireless telegraphy, a transmitting station, a receiver, a single-tapping condenser engaging said receiver, an auxiliary rotating condenser engaging said receiver and adapted to create a series of vibrations in the receiver while the current is passing through said condenser said condenser being interrupted, and means whereby said single-tapping condenser and said auxiliary rotating condenser are actuated when the receiver receives impulses from the transmitting station.

914,989 CURRENT-INDICATING APPARATUS. JOHN S. J. LILLIE, Denver, Colo. Filed Mar. 24, 1906. Serial No. 307,887.

A current indicating apparatus comprising a shaft, a shaft therein, a propeller mounted on the shaft, a tail piece connected to the shaft, a base upon which the shaft is mounted and which is designed to rest upon the bottom of a stream of water by the current of which the propeller is actuated, a make and break device carried by the shaft a contact to engage said device, a pivoted link connected to the upper end of the shaft, a telephone receiver, and an adjustable hood spring for holding the receiver to the ear, a pocket battery carried by the operator.

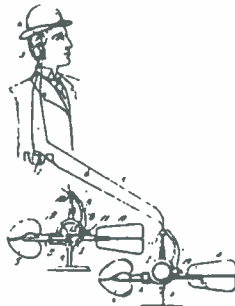

and electrical conductors connected to the link, one of which is connected to the casing and the other to the contact, said conductors being also connected to the battery and receiver, whereby electric impulses corresponding to the revolution of the shaft are transmitted to the receiver substantially as specified.

912,904 GALVANIC CELL. RICHARD JONAS TRODGE, Ohio, assignor, by mesne assignments, to The Jonas Battery Company, Toledo, Ohio, a Corporation of Ohio. Filed Apr. 2, 1904. Serial No. 201,353.



1 In a galvanic cell, the combination of the tank and outer receptacle of carbon, provided with a vented cover, and internally fitted with a perforated bottom with a series of vertical tubes extending up through criss means the strainer, and said tubes in turn into a carbon filling, and means for filling the tubes and forming a series of porous bars provided with a partial filling of iron particles and a silvered ribbon suspended therein, said bars alternating with carbon plates packed in rows with a filling of granulated carbon and covered carbon rings, all submerged with an electrolyte solution composed of caustic of iron dissolved in water; the said silvered ribbons all connected by wire forming a negative terminal and the said carbon plates supported by wire forming a positive terminal, substantially as shown and described.

Laboratory Contest



DR. LEE DE FOREST IN HIS LABORATORY

FIRST PRIZE THREE DOLLARS.

Please find enclosed a flashlight photograph of my electrical laboratory, including switchboard and wireless apparatus. To make the description more



clear I will divide same into three parts, namely: 1. Source of power; 2. Means of controlling; 3. The apparatus.

1. Power.—The power is procured from two large 6-volt 60-ampere storage batteries with a reserve of six dry cells.

2. Controlling.—Each instrument is controlled by individual snap switches (indicating). To protect the instruments and batteries I use a double-fuse block.

3. Apparatus.—My wireless consists of a two-inch spark coil, a key, two Leyden jars, condenser and spark gap.

The receiving apparatus consists of a 500 ohm relay and a Tesla coil. So far the apparatus are young, because I have just started. In the center of the switchboard is a 1/4 inch Rhumkorff coil, a voltmeter, ammeter, reversing switch, rheostats, Geissler tubes and a small fan motor. On the shelves can be seen a large motor driving an 8-inch fan, home-made induction coil, electrical library, medical coil, etc. The windows and doors of my room are equipped with burglar alarms.

I owe many thanks to MODERN ELECTRICS, and I always try to get the first one sold in our town. I am now attending Lewis Institute, of Chicago, for the purpose of taking up electrical engineering.

HAROLD E. GREEN.

Chicago, Ill.

HONORABLE MENTION.



Please find enclosed two pictures of

my laboratories, which contain both chemical and electrical supplies. I have taken great interest in wireless telegraphy and constructed a set for home use, but as I am not allowed to erect an aerial, I also have a set of telegraph instruments, motors and others. My small wireless consists of: For sending: a spark coil, and helix: for receiving, an electrolytic detector, an auto coherer, relay, the last of which I do not use for wireless as yet. In the chemical laboratory is such apparatus as crucibles, test tubes, flasks, retorts, blowpipes, beakers, Bunsen burners, supports, etc. I have all the common chemicals, as sulphur, phosphorous, iron pyrites, iodine, mercury, arsenic, also platinum, silver, sodium, and other substances and chemicals. In all I have the collection of about a hundred elements or substances all told. I keep the principal chemicals in glass stoppered reagent bottles and the other chemicals in cork stoppered

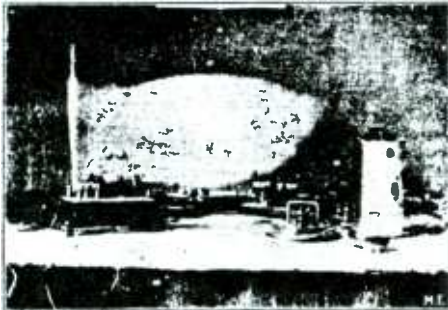

bottles. I have manufactured hydrogen, oxygen, iodine, etc., on a large scale. My laboratory grows daily, and soon will have a major part of the elements. The accompanying picture of my chemical laboratory does not show the vial case in which are kept many vials of the more costly chemicals. I use MODERN ELECTRICS every day, and have gained much information and instruction from same. JAMES D. MACFARLAND.
Mass.

W. A. O. A.

The Wireless Association of America, headed by America's foremost wireless men, has only one purpose: the advancement of "wireless."



If you are not a member as yet, do not fail to read the announcement in the January issue. *No fees to be paid.*

Wireless Registry

This Department has been started with the idea of bringing the wireless amateur in closer touch with commercial land and ship stations. Each month a list of new members will be printed here and once each year an official BLUE BOOK will be issued by MODERN ELECTRICS, giving a list of all the members who registered during the year. Each member will receive the Official Blue Book free of charge. The Blue Book will also contain a complete list of commercial and government stations, their call letters, wave length, etc.

To register a station requires: Total length of aerial (from top to spark balls), spark length, call letter (if none is in existence M. E. will appoint one), name and address of owner.

Fee for Registry (including one Blue Book) 25 cents.

For other particulars see June issue of this magazine.

NAME AND ADDRESS OF OWNER.	CALL LETTER	APPROXIMATE WAVE LENGTH IN METERS.	SPARK LENGTH OF INDUCTION COIL.
----------------------------	-------------	------------------------------------	---------------------------------

William Wilson, New York City,	W.W.N.	300	4 ins.
F. R. Breck, Bayonne, N. J.	F.P.S.	300	2 "
W. N. Broz, Cape May, N. J.	F.B.Z.	46	1 "
Alpha M. Koester, North Powder Ore.	M.Z.R.	35	4 "
Edward T. Eastman, West Webster, N. Y.	E.E.T.	40	1 "
R. P. Wilson, Metuchen, N. J.	R.P.W.	70	1 "
Edwin Justin, Jr., Bloomsburg, Pa.	E.T.J.	100	4 1/2 "
C. Raymond Miller, Baldwinsville, N. Y.	C.R.M.	77	14 "
H. Bassett, Shorthills, N. J.	B.C.T.	35	1 "
J. R. Cartv, Shorthills, N. J.	B.C.T.	35	1 "
A. W. Pratt, Noroton, Conn.	A.P.T.	135	2 "

BLUE BOOK.

The annual official blue book will be ready for mailing by May 1st. It contains not alone all Commercial and Government stations of the U. S. (about 500 in all), but also all stations of experimenters having registered up to May 1st, 1909.

The blue book will be of great assistance to all wireless experimenters, as it will be the only book having a complete and up-to-date list of ALL stations in the United States.

The book will have about 64 pages; pocket size. Price by mail, 10 cents each (free to members who registered). Place your order to-day.



Queries and questions pertaining to the electrical arts addressed to this department will be published free of charge. Only answers to inquiries of general interest will be published here for the benefit of all readers. Common questions will be promptly answered by mail. On account of the large amount of inquiries received, it may not be possible to print all the answers in any one issue, as each has to take its turn. Correspondents should bear this in mind when writing, as all questions will be answered either by mail or in this department. If a quick reply is wanted by mail, a charge of 15 cents is made for each question. Special remuneration requiring a large amount of calculation and labor cannot be furnished without promptly as to the charges involved.

Name and address must always be given in all letters. When writing only one side of question sheet must be used; not more than three questions answered at one time. No attention paid to letters not observing above rules.

If you want anything electrical and don't know where to get it, THE ORACLE will give you such information free.

CONDENSER TROUBLE.

(182.) CLARENCE KRUG, Pa., asks:

1.—I bought a 1-2 inch primary and secondary. I have the coil connected as in the cut below. The condenser consists of 3 plates of glass with four sheets of tin foil. I have the secondary well insulated, but I can hardly get a 1-4 inch spark from it. There seems to be much sparking on the vibrator. Could you tell me what is wrong with this coil?

A. 1.—Your condenser is connected

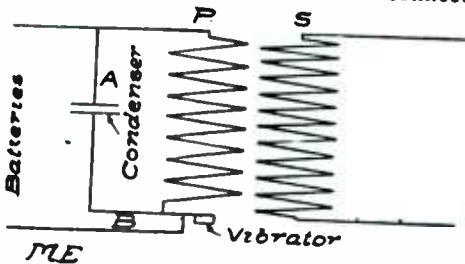

wrong. The wire A should be connected to wire B. This will obviate the trouble. **CALL BELL.**

(183.) NORMAN HUFFAKER, Chicago, Ill., asks:

1.—How can a bell be attached so that it will ring when a message is coming in? What instruments are necessary?

A. 1.—You will have to use a coherer and decoherer in connection with the relay. This is the only way you can work the bell or sounder.

2.—I have a relay such as used in the block system on railroads. There are two parallel coils of 1,000 ohm resistance each. Can this with the filings coherer be connected so that it will ring a bell?

A. 2.—If the adjustment is made very carefully this will work satisfactorily.

CHARGING CONDENSER.

(184.) CLARENCE A. RUPPEL, Toledo, O., writes:

1.—Why couldn't a Tesla coil be used for wireless work?

A. 1.—Tesla coils have never been used extensively for wireless work, as it is too difficult to insulate the wiring on account of the enormous high voltage which is used. Such coils cannot be made to radiate for great distance.

2.—How many volts will I need for a relay with 1,000 ohms resistance.

A. 2.—About 3 volts.

3.—I made a Leyden jar to use on a 1-2 inch spark coil and with the arrangement given on page 144, July issue, I can't get the jar charged. I have tried charging 5 minutes and then 1 minute. The tin foil is not very straight, but it is well shellacked down; it is a pint jar, and I have followed up the instructions very carefully, but all to no success.

A. 3.—It is a mistake to try to charge a Leyden jar with a coil the same way as if you were to charge it from a static machine. To charge a Leyden jar with the coil the two brass balls connected to the Leyden jar must come very close together as the Leyden jar spark will only jump while the coil is working. No spark can be had when the coil stops working.

SPARK COIL WINDING.

(185.) O. C. T., Cleveland, Ohio, writes:

1.—In winding the secondary of an induction coil in sections, must the wire be wound on regularly like thread upon a spool or may it be wound on without regard to regularity, providing the sections are boiled in paraffine after winding?

A. 1.—Uniform winding in spark coils goes a great way. Some experimenters make the mistake to wind wire irregularly on sections and thereby lose much power from the coil when completed. It is desirable to wind the sections uniform to get best results.

2.—What size wire and how much of it will be required for a coil to give a 4 inch spark?

A. 2.—Primary 16 ounces, secondary 4 1-2 pounds.

3.—Would single cotton covered wire be all right for the secondary?

A. 3.—You should use D C C wire.

MAGNETO.

(186.) F. W. BARTH, Texas, writes:

1.—I have a large size telephone magneto wound with No. 34 wire. It was run by belt at the central station. The bipolar armature is 2 inch diameter by 4 1-2 inches long. The core around which the wire was wound is 2 3-4 inches long by 3-8 inch thick (allowing for shaft, which is 3-8 inch thick at core). The two permanent magnets are 5 1-2 inches high, 1 3-4 inches wide by 1-2 inch thick steel rod (horseshoe shape).

The wire space on armature is 1 3-4 inches wide by 4 1-2 inches long.

What size magnet wire must I wind on the armature to produce the proper current to operate a 4 inch jump spark coil, with vibrator (Pittsfield) for Franklin auto; the magneto to run at high speed from fly-wheel.

A. 1.—We would advise you to use No. 20 or No. 22 wire, and we think this will possibly do if you wind enough wire on the armature.

WEHNELT INTERRUPTER.

(187.) SAMUEL BEEMAN, Calif., writes:

1.—If an alternating current of 110 volts be used on a Wehnelt-Caldwell interrupter for an induction coil, what is the voltage received by the coil after it has passed the interrupter?

A. 1.—The resistance of the Wehnelt interrupter is rather low. By inserting a voltmeter it will be found that the voltage in most cases is 75 to 90 volts if the main voltage is 110 volts.

2.—What is the resistance of the lead in a lead pencil 6 inches long?

A. 2.—It is impossible to answer this, as all makes vary considerably. The resistance may be sometimes as much as 100 ohms, but is in most cases 60 to 75 ohms.

STORAGE BATTERY.

(188.) CHESTER BAKER, Mass., writes, describing a battery, and asks:

1.—About how many ampere hours is it?

A. 1.—Capacity of your battery is possibly 100 ampere hours, if the battery is new. If it has been used for some time the capacity will, of course, be smaller.

2.—What is the charging current?

A. 2.—Six to eight amperes.

3. Do you suppose that the plates are packed with the same active material, both + and —?

A. 3.—Red lead is used on the positive plate, Litharge on the negative one.

WIRELESS QUERIES.

(189.) L. A. EICHMANN, Iowa, asks:

1.—I intend to construct a set of wireless instruments to communicate with a friend who lives about one-third of a mile from my house. My friend is going to use a one-half inch coil in the sending apparatus, while I don't want to use any coil but a two inch one at least. Will this combination work successfully?

A. 1.—The combination is all right, but of course you understand that your friend cannot send as far as you can. However, you can both communicate with each other perfectly well. The signals received at

your station will not be as strong as at your friend's station.

2.—There are two hills between my friend's house and mine. Is it necessary that the aerial be higher than the highest hill?

A. 2.—Unless the hills are very high a thirty or forty foot aerial will do.

3.—What is meant by working a spark coil with open secondary, as in Ans. 1 to query 86 in "The Oracle," October number?

A. 3.—If no spark occurs at the secondary terminals there is an open circuit which is harmful to the coil.

COIL QUERIES.

(190.) THOS. W. GARDNER, Tenn., writes:

1.—I have a quantity of No. 32 enameled wire with which I wish to make an induction coil to give a 5 inch or 6 inch spark. Would you recommend using shellac to hold this wire in place? I presume this would be all right in case the separate coils, which I am planning to make about 1 1-2 inches thick, be baked thoroughly before assembling. Are any bad defects likely to result from baking the shellac too dry?

A. 1.—Some coils are made with enameled wire, but we do not think that better results can be had by shellacing same, as the baking afterward would result in blisters, which, holding air, would make poor insulation. If we were you we would wind the coil regularly and insulate with paraffine.

2.—I desire to equip an automobile with electric lights and wish to use a storage battery which I intend maintaining in a charged condition by means of a low voltage magneto driven from the fly-wheel of the engine. I would like to use some form of automatic switch that would protect the battery, when the engine is running slow, from discharge through the magneto. I would also want this automatic switch to connect the batteries again in circuit as soon as the speed of the engine gets high enough to generate a sufficient voltage in the magneto to charge the battery. The same battery will also be used for operating the induction coils. The circuit closing switch is the part of the equipment that I am having the most difficulty with. Will you please advise if there is such an automatic device made as I require? If not, can you tell me how to make one?

A. 2.—If you will write to the Electric Storage Battery Co., in Philadelphia, we think they can supply your wants.

SENDING HELIX.

(191.) J. R. JOINER, N. Y., writes:

1.—Is a sending Helix necessary?

A. 1.—A sending Helix is necessary if you wish to tune your sending instruments.

2.—Can a receiving tuning coil be used as one?

A. 2.—No; the insulation would break down.

3.—Is the length of aerial figured from the instruments, or from the ground?

A. 3.—The wave length may be figured approximately in the way mentioned in our June issue. The length figured should

be from the top of the aerial to the instruments.

3-4 INCH SPARK COIL.

(192.) EDWARD R. CULLEN, N. Y.:

1.—What are the dimensions of a three-quarter (3-4) inch spark coil? Also amount of wire for secondary, etc.?

A. 1.—We give you below dimensions of a 3-4 inch spark coil.

Core 6 inches long, 3-4 inch diameter; secondary, 4 1-2 inches long, 2 9-16 inches diameter; No. 36 wire, 1 1-8 pounds; condenser, 5x2 3-4; 40 sheets tin foil.

2.—Also where I could buy an interrupter (state price), and oblige?

A. 2.—From the Electro Importing Co., New York.

NOVEL CALL BELL.

(193.) HUGH S. AYERS, Ills., writes:

1.—Give a diagram of a wireless telegraph using a 4 ohm giant sounder.

A. 1.—We give you below diagram how to connect sounder, coherer and decoherer system.

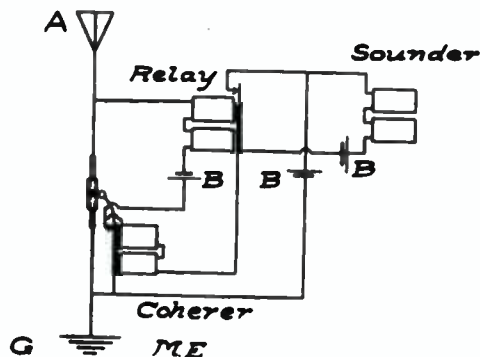

2.—Give a receipt for making bichromate solution.

A. 2.—Mix 1,000 parts water, 370 parts best oil of vitriol, 130 parts bichromate of potash.

3.—If I would put a vibrator on a small telephone induction coil and connect the secondaries on the line wires, could not it be used for a call system? I find when I do this it makes quite a noise in the telephone receiver.

A. 3.—We do not see how you can use the small induction coil for calling apparatus, unless you leave the telephone receiver at the receiving station in circuit all the time, as then the noise produced by your coil will possibly be sufficient to call.

RECEIVING OVER MOUNTAINS.

(194.) JAMES C. GOTTENBERG, Calif., writes:

1.—Will you please tell me how to make a machine for using paper tape, that I can use in learning to receive?

A. 1.—This will be described in the next issue.

2.—Can I receive wireless messages at Madera from the Pacific Coast? Madera is in the San Joaquin Valley, between the Coast Range and Sierra Nevada Mountains and is within two hundred (200) miles of San Francisco. Would the mountains stop the messages?

A. 2.—We hardly think the mountains would stop the messages if sensitive instruments are used. We would advise you to use a sensitive electrolytic detector, 2,000 ohm head phones, variable condenser, Potentiometer and an aerial not lower than 65 feet, preferably flat top. We are confident that with this arrangement you can receive messages.

AUTO COIL.

(195.) GEO. DUST, Salt Lake City, Utah, writes:

1.—What other instruments are necessary to use with a 1-2 inch spark coil, a microphone detector, and an ordinary telephone receiver for a wireless telegraph over the distance of about 2,000 feet?

A. 1.—We hardly think that you can cover 2,000 feet with your 1-2 inch spark coil. We should advise the use of a 1 inch coil at least.

2.—My spark coil is made for an automobile with one of the secondaries connected to one of the primaries. Does that make any difference?

A. 2.—For wireless telegraph work it is considered much better to have primary and secondary circuits not metallically connected.

3.—There are some wires crossing between the two stations carrying about 5,000 volts. Can I pass them?

A. 3.—If you have a variable condenser it is very easy to overcome the inductive effect of the wires carrying a high voltage.

WAVE LENGTH.

(196.) SEARLE ANDREWS, St. Paul, Minn., writes:

1.—Is the wave length in meters of a wireless station changed by connecting Leyden jars to the secondary of the induction coil?

A. 1.—Yes.

2.—If so, will you give me a rule for finding the wave length?

A. 2.—It is impossible to give you this information in the Oracle for lack of space. We refer you to Mavers' Wireless Telegraph Book, which treats on this subject.

3.—The enclosed sample of wire is what size?

A. 3.—Enclosed wire is No. 14 S C C.

4.—Is it suitable to be used in making a tuning coil used at the receiving station? I am going to use four pounds of it.

A. 4.—This wire is too heavy. No. 20 or No. 24 should be used.

SENDING APPARATUS.

(197.) RALPH TERRY, Wis., asks:

1.—Can I make an induction coil to work on 50 volts direct current with an electrolytic interrupter? Coil supposed to send 50 miles with 60 foot pole and 125 foot aerial.

A. 1.—An induction coil to work 50 miles in connection with an electrolytic interrupter would have to give a 6 or 8 inch spark.

2.—Would a 250 watt transformer be more practical for 50 miles than the above coil?

A. 2.—We consider a transformer better than a coil.

IDEAL BATTERY.

(198.) CLINTON DEWITT, Nebr., asks:

1.—Will there be a description of how to make an alternating current motor of about 1-2 horse power in some early issue of MODERN ELECTRICS?

A. 1.—We hardly think there are many experimenters who have the means to construct such a motor.

2.—Can you give me the name and address of some company who buy electrolytic copper in small quantities?

A. 2.—Most companies buy this material in large quantities.

3.—How long will the "Ideal battery," described in August issue of MODERN ELECTRICS, last, using two amperes continually and having 1-8 inch zinc plate?

A. 3.—The battery in question gives about 350 ampere hours. By using zinc plate only 1-8 inch thick the capacity will only be about 150 to 200 ampere hours.

TWO-INCH COIL CONDENSER.

(199.) HARRY DUNAVAN, Ft. Scott, Kan., asks:

1.—How many square inches are necessary for a condenser for a two (2) inch induction coil, and will the paper, a sample of which I enclose, be O. K. to use between the tin foil sheets?

A. 1.—You will need 2,160 square inches of tin foil for a 2 inch coil. Sample you enclosed, if well paraffined, will do.

2.—What is the principle or theory of a variable condenser connected between the aerial wire and the detector?

A. 2.—To change the capacity of the circuit.

3.—In figuring the wave length of a station do you figure the distance above the ground and also the wire on your tuning coil and aerial, or just the wire or tuning coil and aerial alone and not count the distance above ground at all?

A. 3.—We refer you to the June issue of this magazine.

WIRELESS QUERIES.

(200.) R. O. KRUSE, Pa., writes:

1.—A friend and I are building a wireless set as follows: Four inch spark coil, Leyden jars and Helix. Receiving set, tuning coil, electrolytic detector, variable condenser, potentiometer and 350 ohm receivers, as sold by Electro Importing Co., with a 25 foot aerial. I am on a hill 500 feet above my friend's, 15 miles apart. Could I send to him and receive? Would 32 D C C wire be as good as 36 D C C for a 4 inch spark coil?

A. 1.—By using No. 32 D C C wire you will reduce the spark length a great deal, but with the coil, as far as wireless is concerned, you can send further on account of the spark being much heavier. It will deliver a great deal more amperage than if the wire was No. 36.

2.—There are a lot of street car lines and high buildings between us. Would it affect us?

A. 2.—We hardly think that the street car lines will affect you if suitable and sensitive instruments are used.

SELENIUM RELAY.

(201.) RAYMOND SYLVESTER, Mass., asks:

1.—Would a galvanometer of the Deprez D'Arsonval type having a resistance of 150 ohms respond when used instead of a receiver in a wireless outfit having either an electrolytic detector or a silicon detector?

A. 1.—No, this would not work.

2.—If so, would it be as sensitive as a pair of 1,000 ohm head receivers?

A. 2.—No, the telephone receiver of today is the most sensitive receiver.

3.—If so, could the galvanometer not be used for a selenium relay in connection with a selenium cell, it having of course a swinging mirror.

A. 3.—No.

ENAMELED WIRE.

(202.) FRANK H. STANDISH, Mass., asks:

1.—How many feet to a pound of No. 24 enameled copper wire?

A. 1.—About 765 feet.

2.—How many feet is there to a pound of No. 20 enameled copper wire?

A. 2.—About 300 feet.

1-4 INCH WIRELESS COIL.

(203.) LOUIS TEMPLE, Chicago, Ill., asks:

1.—What is the greatest possible distance that a message could be sent with a 1-4 inch spark coil, using dry batteries and having an aerial wire about 35 feet high?

A. 1.—About one-half mile.

2.—If condensers were used, how many and what kind would be the best to use?

A. 2.—Leyden jars will be the best to use. You cannot use more than about two pint Leyden jars with 1-4 inch coil.

3.—What would be the best antenna to use with the above coil?

A. 3.—A two wire aerial 35 feet high will possibly do. We refer you to the October and November issues of this magazine on construction of aerials.

TRANSFORMER.

(204.) GEO. MCBRIDE, Mich., asks:

1.—I have about 30 pounds of No. 20 D. C. copper magnet wire. Can I use this as a secondary for a transformer from 110 volts A. C. to high frequency current for wireless transmission, as I want a powerful spark if possible? And if this will answer, please give me the size I would have to make the core and what size primary it would take, and about how large should the condenser plates be and how many.

A. 1.—We do not think you will have much success building a transformer of this kind, as we have explained in several previous answers. It is very hard to procure the right kind of iron, and the machinery used for winding the coil of the transformer is very expensive.

AUTO-COHERER.

(205.) W. E., New York City, asks:

1.—I have an Auto-coherer with one carbon and one iron arm and a drop of mercury between them and do not get any results at all but a loud click in the telephone receiver. The connections are all bright and clean and am using one dry cell. Can you give directions how to remedy it?

A. 1.—It is plain to us that you are using too much mercury in your detector. Use only a small drop about as large as a pinhead and be very careful so that the mercury barely touches both arms.
 2.—Will an aerial as per enclosed sketch answer to receive messages about 200 miles

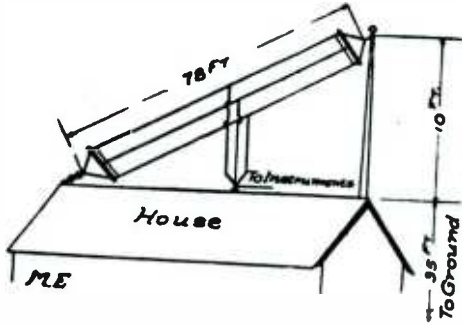

distant, using in connection with same a sensitive receiving set?

A. 2.—Yes; providing that the house is not surrounded by steel buildings or steel structures.

Instructions in Wireless Telegraphy

Send 5c for the best wireless instruction book published—construct your own outfit. Tells how much material to use, etc. NO RED TAPE—Facts only.

Electrical Experimenters Supply House

Dept. A, 622 Wells St. Chicago, Ill.
 (Succ. to Joerlu Electric Novelty Co.)

Dealers and Manufacturers of All Kinds of Wireless Apparatus at Low Prices.

Send Stamps for Illustrated Catalog.

When writing please mention "Modern Electrics."

Anything Electrical.

OUR NEW CATALOGUE—100 Pages of Electricity.

Send 3 cent stamp—postage.

Flash-lights to Dynamos. Containing also the largest assortment of unexcelled German toys.

Highest Quality. Lowest Prices.

J. J. DUCK, 432 St. Clair Street, Toledo, O.

When writing please mention "Modern Electrics."

"Oh! Rats"

you often say, when you see a new piece of apparatus, and wished you could dispose of your old style instruments, to enable you to buy the up-to-date kind. Well, why don't you spend 20 cents and try a "For Sale" Ad in the classified columns of MODERN ELECTRICS? Remember there are 15,000 people reading this magazine, and it is absolutely impossible not to dispose of your apparatus, if your conditions are right. Better try it this month. Remember, rate is only 2 cents a word. 14 cents for 2 lines, 21 cents for 3 lines, etc.

Modern Electrics Publication, 84 W. Broadway, N. Y.

When writing please mention "Modern Electrics."

The "Electro" Ground Clamp



The most ingenious clamp ever invented. Invaluable to every wireless experimenter. 50% of All Wireless Trouble are due to a poor ground.

Our new clamp fit any gas or water pipe from 1/2 in. to 2 in. diameter. Binding post provided to attach wires.

Clamp installed in less than two minutes. No soldering to be done, no wires to be wrapped around pipes, which method always gives trouble. The contact-band of our clamp (1 inch wide) is of pure copper. Price of Clamp 10 cents each. By mail 3 cents extra. Per dozen 85 cents.

ELECTRO IMPORTING CO.
 86-Z West Broadway, New York City, N. Y.

When writing please mention "Modern Electrics."

PATENTS

SPECIALTY:

PATENTS AND TRADE MARKS
 Good Work at Reasonable Prices
 Highest References

GEO. A. HOFFMAN

COUNSELLOR-AT-LAW

U. S. Express Bldg. 2 Rector Street
 NEW YORK CITY

When writing please mention "Modern Electrics."

Electric Light Fixtures

For Residence, Boat and Camping.

We construct special designs to order. We manufacture all specialties of metal goods in quantities only. Write us your requirements. We issue no catalogue.

Gothberg Manufacturing Co.

112 Duane Street, - - New York City

When writing please mention "Modern Electrics."

.. TRANSFORMER ..

250 watt 10,000 volt transformer for use in wireless telegraphy. Special price delivered to any part of U. S., \$30.00. Will send up to fifty miles. Speaking arcs, transformers, etc. supplied for use in wireless telephony. Drawings and plans furnished. Send for descriptive matter.

VICTOR H. LAUGHTER

BYHALIA, MISS.

When writing please mention "Modern Electrics."

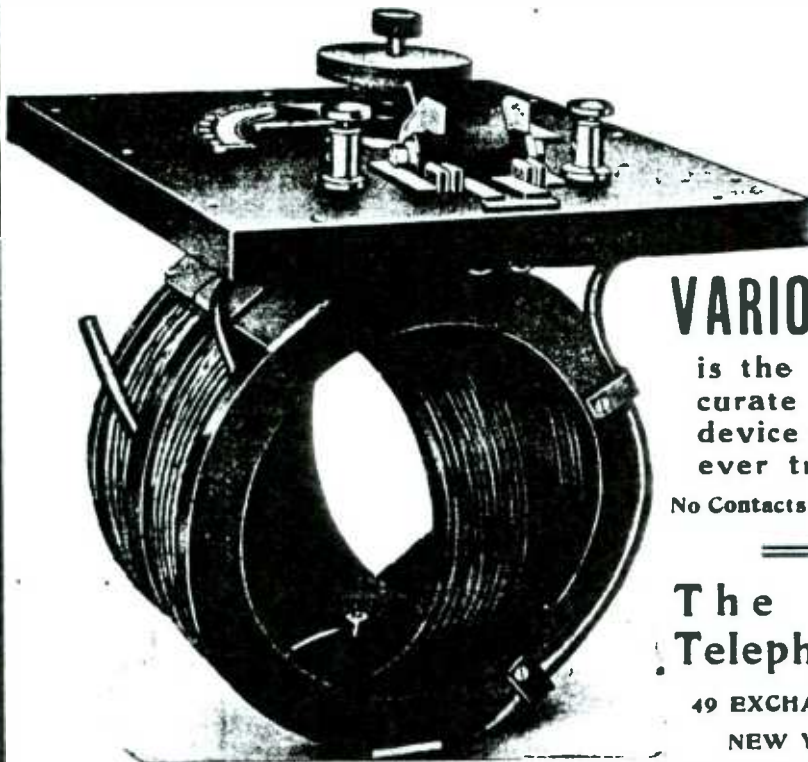

**THE
"R-J"**

VARIOMETER

is the most accurate tuning device you have ever tried

No Contacts Low Prices

The Radio Telephone Co.

49 EXCHANGE PLACE
NEW YORK CITY

When writing please mention "Modern Electrics."

Patent What You Invent

THIS BOOK

Giving full information in Patent Matters, and two others telling what to invent and a history of successful inventions

MAILED FREE

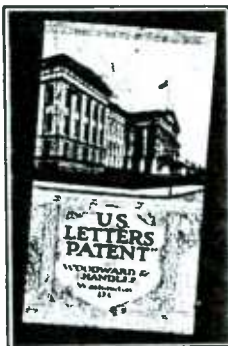

Send Us a Sketch

of an invention for our opinion as to patentability which will be rendered without charge. If we believe it to be new, we will issue a contract under which

WE REFUND ALL FEES IF WE FAIL TO OBTAIN A PATENT : : :

We Advertise Patents of Our Clients For Sale in Prominent Dailies At Our Expense

CONSCIENTIOUS SERVICE

WRITE FOR OUR BOOKS

WOODWARD & CHANDLEE

Registered Attorneys

1268 F Street, Washington, D. C.

When writing please mention "Modern Electrics."

CLASSIFIED ADVERTISEMENTS.

Advertisements in this column 2 cents a word, no display of any kind. Payable in advance, stamps not accepted. Count 7 words per line. Minimum, 2 lines. Heavy face type 4 cents a word. Minimum, 3 lines.

Advertisements under "Wireless" 5 cents a word. Minimum, 4 lines. Wireless books and blueprints not listed under "Wireless" 2 cents a word.

Advertisements for the May issue must be in our hands by April 25.

ELECTRICAL APPARATUS.

STUDY ELECTRICITY AT HOME—A complete electrical course at home, containing 80-page detail book, 220-page text-book, 300 experiments and over 100 pieces of apparatus. Price, complete, only \$5.60. Catalogue "M. E. 8." explains this and other remarkable offers. Thomas M. St. John, 849 Ninth Ave., New York.

When writing please mention "Modern Electrics."

CHEMICAL RECTIFIER, how to make, 25 cents. Slate for wireless work, cheaper than wood. Electro Shop, Barker, N. Y. (5).

When writing please mention "Modern Electrics."

POLARIZED RELAYS NOW ON SALE at one-third their cost; they are especially adapted for receiving long distance wireless calls. Write for particulars. Meacham Coil Winding Co., Oklahoma City, Okla.

When writing please mention "Modern Electrics."

ELECTRICAL BOOKS, BLUEPRINTS, ETC. **WIRELESS CODES**, send 10c. for blue print showing Morse, Continental and Navy Codes. A. C. Austin, Jr., Hasbrouck Heights, N. J.

When writing please mention "Modern Electrics."

WIRELESS EXPERIMENTERS: If you are contemplating building a long distance station this spring, get our set of ten blueprints of tuned transmitting and receiving stations for 25 cents. Four wireless telephone blueprints, 15 cents. Construction blueprint of Electrolytic Detector, 15 cents. Imperial Wireless Co., 230 S. Pacific avenue, Pittsburg, Pa.

When writing please mention "Modern Electrics."

SEND FOR my blue prints of 1 K. W., 20,000 volt transformer. Can be built for \$20.00. Blue prints of 1/4 K. W. transformer, price to build, \$12.00. Either set sent for fifty cents. What you don't know about wireless, ask me, no charge. J. H. White, Ross, California.

When writing please mention "Modern Electrics."

HOW TO BUILD A WIRELESS TELEGRAPH. Set directions and blue prints, 25 cents. Miller Electric Co., Syracuse, N. Y.

When writing please mention "Modern Electrics."

GRAPHITE RODS, 50 to 1,000 ohms, six inches long, for potentiometers, 25 cents, 3 for 50c., silver. C. E. Hale, 644 W. King, Decatur, Ill.

When writing please mention "Modern Electrics."

? WIRELESS ?

Of course we have it. Coherers, Detectors, Auto Coherers, Rheostats, Matic Machines, in fact all the Electrical "klick-knacks" you have been looking for. All apparatus carried in stock in St. Louis. Why pay freight and expressage to get goods from the East? Come and look over our stock. **HANCE ELECTRIC CO., Olive Street, St. Louis, Mo.**

When writing please mention "Modern Electrics."

WIRELESS EXPERIMENTERS, ATTENTION! I keep the highest grade wireless and electrical supplies in stock. A call to my store will convince you of this. All up-to-date supplies. Detectors, Condensers, Spark Coils, Helices, Gaps, Tuners, Receivers, etc., etc. Send 2c. stamp for large catalogue. M. Tanchbaum, 723A Broadway, Brooklyn, N. Y.

When writing please mention "Modern Electrics."

WIRELESS TELEGRAPH, complete set, \$10.00. Zinc spark gap, by mail, 7c. Send 2c for catalogue. Miller Electric Co., Syracuse, N. Y. Dept. K.

When writing please mention "Modern Electrics."

SPECIAL PRICES—1,000-ohm single pole wireless receiver, \$1.35; double pole, thin diaphragm, \$1.75. "Eclipse" double slide 12 in. tuning coil, \$2.00. Receivers postpaid. Waterhouse Bros., 5 Main street, Bourne, Mass.

When writing please mention "Modern Electrics."

WIRELESS. New England wireless amateurs can obtain high grade wireless goods from me. All supplies kept in stock. All material guaranteed. Send 2-cent stamp for printed matter on New Detector. Springfield Wireless & Morse Institute, Room 31, 476 Main street, Walker Building, Springfield, Mass.

When writing please mention "Modern Electrics."

A CHOICE STOCK and the finest assortment of Wireless Telegraph supplies for the experimenter and the amateur in Philadelphia. We can save you money on all these goods and shall be only too pleased to demonstrate and explain you the philosophy and working of the apparatus: tuners, detectors, condensers, high resistance phones, coherers, etc. J. Elliott Shaw, 682 Arch St., Philadelphia, Pa.

When writing please mention "Modern Electrics."

WIRELESS EXPERIMENTERS, NOTE, FOR THIS MONTH ONLY. Wollaston wire, .0005, 15c., .0001, 25c.; silicon fused, large piece, 15c.; Molybdenite, more sensitive than silicon, 10c. large piece; aluminum wire, No. 14, for antennae, used by all up-to-date wireless stations, 60c. per pound, 249 feet; telephone cords, two conductors, with tips for receivers, 3 feet long, 15c. each, graphite carbon cup for Electro-Lytic detector, 20c.; aluminum foil, better than tin foil, \$3 per pound. **EXHAUSTED MARCONI COHERERS**, standard German navy, \$3; selenium metal in sticks, for selenium cells, large piece, 25c. Enclose 2-cent stamp for article weighing over one ounce, if same is to be mailed. Electro Importing Co., 86-Z, West Broadway, N. Y. City.

When writing please mention "Modern Electrics."

TWO-POLE 1,000 Ohm RECEIVERS, \$1.75. Zincite and chalcopyrite, \$3.35, or free with every two receivers bought before the 20th. Alden Wireless Co., Campello, Mass.

When writing please mention "Modern Electrics."

YOU BET

we have all up to date wireless supplies. We carry more wireless goods for the amateur than any other house on the Coast. Why pay express and freight, when you can get the goods right here at right prices? Detectors, Tuners, Condensers, Spark Coils from 1-2 to 4 inch spark, oscillators, coherers, lamps, static machines, in fact, anything electrical you want. Call or write. It will pay you. **PAUL SEILER ELECTRIC WORKS, Market St. San Francisco, Cal.**

When writing please mention "Modern Electrics."

LEFT OVER FROM A CONTRACT AND FOR SALE CHEAP, a number of tested wireless receiving sets, consisting of tuning coils, silicon detectors and condensers. New and in perfect condition, all ready for use; low price on application to Jerome Redding & Co., 40 Hanover street, Boston.

When writing please mention "Modern Electrics."

FOR SALE.

1-3 K. W. Transformer, \$20.00; 10,000 volt secondary, 110 volt primary, finished complete, with all fittings, in oak case. This transformer I guarantee to send 50 miles with fair conditions. Address F. W. Falck, 204 Emerald street, Los Angeles, Cal.

When writing please mention "Modern Electrics."

A VERY FINE Portable Wireless Receiving Set for sale; nearly new, in excellent condition, \$25. Write for particulars. Allen E. Dudley, Milford, Mass.

When writing please mention "Modern Electrics."

WANTED. Electrical and wireless apparatus for amateur. Second hand, good, and cheap. Sidney Allen, 630 Graymont, Birmingham, Ala.

When writing please mention "Modern Electrics."

MAGNET WIRE, 10 lbs., D. C. C., new, sent prepaid for only \$10.50. Write at once. Walter W. Hartman, Clay Center, Kan.

When writing please mention "Modern Electrics."

BARE WIRE

ENAMELED WIRE

SINGLE SILK COVERED WIRE.

DOUBLE SILK COVERED WIRE.

SINGLE COTTON COVERED WIRE.

DOUBLE COTTON COVERED WIRE.

AMERICAN BLACK ENAMELED MAGNET WIRE
All sizes from No. 16 to 40 B. & S.

American Electric Fuse Co.
NEW YORK. MUSKEGON, MICH.

When writing please mention "Modern Electric."



The "Electro" Pole Indicator

This new little tester is a wonder. It is used every day in the week by all experimenters, electricians and amateurs. It is the neatest device we have ever seen. Is used on currents from 1-250 volts. A marvel of simplicity. The tester at each end has an ingenious wire clip for attaching wires or cords. Connect them to a current supply and one of the platinum foils inside the tube will turn red. This is the NEGATIVE Pole. Shake the tube and the color vanishes. The tester is ready for a new test. Always ready. Can never wear out. Absolutely reliable. So small it can be carried in the vest pocket. Size 8x3/4 inch. Every tester guaranteed or money refunded. Introduction price 50c by mail.

ELECTRO IMPORTING CO.
86-Z WEST BROADWAY, NEW YORK CITY, N. Y.

When writing please mention "Modern Electric."

PATENTS That Protect and Pay

WATSON E. COLEMAN,

Registered Patent Attorney.

Advice and Book Free; Highest References;
Best Service

612 F Street, N. W. WASHINGTON, D. C.

When writing please mention "Modern Electric."



GROBET SWISS FILES

And Other High Grade Tools

Are shown in our catalog. Send your name and address on postal and mention this paper and we will send free our catalog.

MONTGOMERY & CO.,
103 Fulton Street, New York City

When writing please mention "Modern Electric."

American Wireless Institute

offers the only adequate course of instruction in Wireless Telephone and Telegraph Operation and Engineering. Joining the navy in order to learn the art of wireless is a long, expensive and round about way, but until the establishment of the American Wireless Institute, that was the only satisfactory way of acquiring a wireless education.

In six weeks the American Wireless Institute can give to the earnest student as great knowledge of wireless operation as he could acquire during the four years of hard work required of all who enlist in the navy.

The demand for competent wireless operators and engineers is insistent. Several wireless companies have stated to us that they will undoubtedly have places for several hundred operators during the next season.

The great wireless companies are just entering an era of tremendous commercial development which will provide thousands of lucrative positions to men with sufficient wireless training to carry on the work.

For full particulars see our two page advertisement in February MODERN ELECTRICS, or write to

American Wireless Institute

27 WILLIAM STREET, NEW YORK

When writing please mention "Modern Electric."

CIGARETTE ROLLING MADE EASY

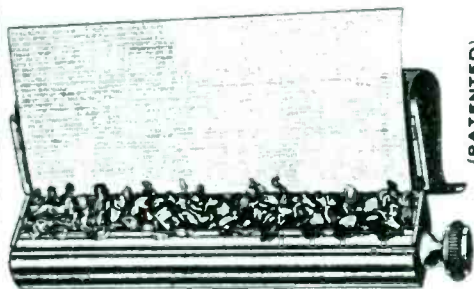

(PATENTED)

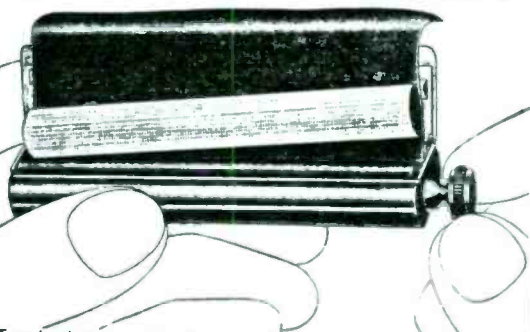

Place tobacco and paper as above. Close cover and moisten edge of paper.

Turn knob and a perfect cigarette will be delivered as shown above.

AGENTS and Dealers write for terms. Make your own cigarettes of tobacco and paper of your choice. Make them any time. No waste of tobacco. Machine pays for itself in a short time. Weighs one ounce. Size twice that of an ordinary cigarette. **PRICE 25c PREPAID. Money returned if you want it.**

SIGARET ROLLER WORKS.

40-42 W. QUINCY ST., CHICAGO, ILL.

When writing please mention "Modern Electrics."

KNAPP DYNAMO-MOTOR

ASK UP-TO-DATE DEALERS
6V. 4A.

Efficiency-finish unsurpassed. Lights lamps, drives motors, etc. Easily attached to other drive. Fine as power motor. S. Dynamo, only \$8.00, weight 6 lbs. Hand drive, only \$8.00, weight 20 lbs.

STAMP FOR SPECIALTY CATALOG.

Knapp Electric & Novelty Co., 517 W. 51st St., N. Y.

When writing please mention "Modern Electrics."



A Sensational Novelty. Will Last a Lifetime THE IMPROVED FLAMING POCKET LIGHTER.

Patented July 9, 1907, and Sept. 10, 1907. Infringers cautioned.

Every smoker wants it. Will light in windy weather. Better than matches. A little deodorized wood alcohol once in a while does the trick. Nothing to wear out. Sample mailed upon receipt of 55c. Special prices to dealers in dozen or gross lots. If you wish to make big money this summer write at once to

The Auto Igniter Co., 1947; B'dway, N. Y. Cit

When writing please mention "Modern Electrics."

THE ONLY MAGAZINE PUBLISHED IN THE SERVICE AND DEVOTED EXCLUSIVELY TO THE INTERESTS OF THE ENTIRE NAVY



MAILED TO ANY ADDRESS IN THE UNITED STATES OR TO ANY SHIP IN THE NAVY FOR \$1.50 PER YEAR

An Illustrated Monthly Magazine written and published by men in the U. S. Navy

YOU are interested in our great American Navy; all Loyal Americans are, but you do not get the inside news—the real facts about the life aboard ship. You do not get close enough to the men with their joys and troubles. You may know the movements of all the Naval Vessels each month. You may know what their crews are doing—what they are seeing. You may follow the great fleets around the world. You may read Naval news written by Naval men who know what they are writing. In short, you may be on the inside of everything pertaining to the great battleships and the men who run them, by reading the navy magazine, "Our Navy." Published monthly at the Naval Training Station, San Francisco, California.

The Advertising Medium that reaches the Navy



Pat. Apl. For.

Wireless Experimenters

ATTENTION

OUR CIRCUIT DETECTOR will be a most valuable addition to your equipment. Just the instrument for testing your apparatus and connections. DETECTS all circuit and connection troubles. **MAKES AN IDEAL AND RELIABLE WIRELESS OPERATORS HEAD RECEIVER**

COMPLETE—with high grade receiver—leather covered head band—battery and 5 foot green cord. PREPAID to any part of the U. S. or Canada on receipt of \$2 50. Our watch case style "W" telephone receiver sent POSTPAID on receipt of 80 cents. Three foot cords for same 20 cents.

WE ARE THE MANUFACTURERS. SEND US YOUR ORDERS.

WM. J. MURDOCK & CO., 50 Carter St., CHELSEA, MASS.



When writing please mention "Modern Electrics."

NEW PREMIUMS.

We wish to make the month of April a record breaker, as far as new subscriptions are concerned. We want your co-operation and therefore are again offering a new premium assortment to our readers. It is not necessary to be a subscriber to get any of the premiums listed below; anybody can win same. For instance: The article given for one new subscription will be given to anybody who sends in even his own subscription, but you must ask for the premium when you send the subscription. Claims for premiums after subscriptions have been received, cannot be recognized under any circumstances.

ZINC SPARK GAP

If you have a sending station, you cannot possibly afford to be without it. The peculiar properties of zinc—now used in all wireless stations all over the world—increases the sending distance from 10 to 20 per cent. Heavy zinc rods $\frac{3}{4}$ inches long are used. Hard rubber handles, oak base. The best Spark Gap on the market. Gap sells for 60 cents. 3 cents postage must be included for mailing.

Given Free For One Subscription

UNIVERSAL DETECTOR STAND

The best all around experimental Detector stand on the market. This Detector stand may be used with any sensitive substance, old, new and as yet to be discovered. Especially to be recommended with molybdenite (one ounce lbsct.)

This new substance is more sensitive than silicon or carborundum. Detector is finished finely. Brass nickel plate metal parts. Ingenious spring arrangement to clamp substance between silver-plated discs, and nickeled tweezers to put substance in place. Hard rubber handles, oak base, etc. This detector stand sells for \$1.00. 10 cts. postage must be included.

Given Free For Two Subscriptions

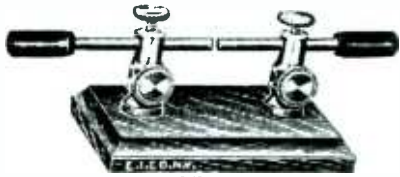

SPARK GAP

ADJUSTABLE SENDING CONDENSER

(PATENTS PENDING)

We guarantee that the Adjustable Condenser increases the sending range of your station from 25 to 50 per cent. By using the Condenser you can tune the sending end of your station. Can be used in connection with coils from $\frac{1}{4}$ to 4 inches. If used with $\frac{1}{4}$ or 1 inch coil the blue crackling spark produced with this Condenser can be heard for blocks. It sounds like business and acts like it. Cut shows six jars. For three subscriptions we only give two jars and the rack. Extra jars list at 35c. This condenser, rack and 2 jars sells for \$1.20. Can be sent by express only. Height 6 in., width $2\frac{1}{2}$ in., length 9 in.

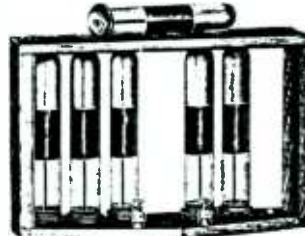

SENDING CONDENSER

Given Free For Three Subscriptions

If you desire further information on these goods send 2c stamp for large illustrated Catalog No. 61

NOTE. Above Premiums will be given also on Renewal Subscriptions

MODERN ELECTRICS PUBLICATION - - 84 West Broadway, New York City

When writing please mention "Modern Electrics."

MY BOOK FREE

Memory the Basis of All Knowledge

Stop Forgetting

THE KEY TO SUCCESS

You are no greater intellectually than your memory. Easy, inexpensive. Increases income; gives ready memory for faces, names, business details, studies, conversation; develops WRITING TO-DAY will, public speaking, writing, personality.

Dickson Memory School, 942 Auditorium Bldg., Chicago

When writing please mention "Modern Electrics."

SEND US YOUR NAME AND ADDRESS so as to be at the head of the list to receive our new **STORAGE BATTERY CATALOGUE** now in blossom. Just the thing for the wireless experimenter. A new low priced complete storage battery of any capacity. We have almost anything you can wish for and a few specials you can get nowhere else. Send the stamps today and state just what you are most interested in. Storage batteries and storage battery work is our specialty.

ELECTRICAL MAINTENANCE AND REPAIR CO.
200-202 MARRET ST., NEWARK, N. J.

When writing please mention "Modern Electrics."

A Book Worth Having—it's FREE



A book packed full of new ideas in labor-saving "YANKEE TOOLS" for all classes of Mechanics. Tools that appeal to any man, no matter what his profession or calling. The book is the embodiment of Yankee ingenuity and invention, illustrated with photographic reproductions of the Tools in use.

A postal brings it if you say "Modern Electrics" Your dealer sells "YANKEE TOOLS"

NORTH BROS. MFG. CO.

Philadelphia, Pa.

When writing please mention "Modern Electrics."



TYPEWRITER Sacrifice Sale

Greatest bargains ever offered, UNDERWOODS, OLIVERS, REMINGTONS,

SMITHS (all makes) rebuilt \$16. to \$38, worth double; sent subject to examination and trial. Send for "Bargain List"

Consolidated Typewriter Exchange

248 BROADWAY, NEW YORK

Old reliable. Established 27 years on Broadway. Don't miss this chance to get a good typewriter at half price. Write immediately.

When writing please mention "Modern Electrics."

By Special Arrangement with the

WIRELESS SPECIALTY APPARATUS Co., OF NEW YORK,

Owners of U. S. Patents Nos. 836,531, 877,481, and 833,701, covering the Silicon Detector, I have the Exclusive Right to Sell the Types of Detectors covered by these Patents. THE

Improved Silicon Detector

now sold to Experimenters, is of the Type heretofore used only by the Government and Commercial Stations. Requires no Battery; no Acid or Acid Fumes to Ruin other Instruments; and is fully 500% more sensitive than the cheap makeshifts now being sold.

INFRINGEMENTS WILL BE PROSECUTED
Send at once for Special Circular.

W. C. GETZ,

348 N. Charles St.,

Baltimore, Md.

When writing please mention "Modern Electrics."



THIS FINE
Rheostat, 10 Ohms, 2 Amperes capacity, will be sent to you on receipt of 50 CENTS (postage 5 cents extra.) The best experimental Rheostat ever made. Used to regulate light of

small lamps *gradually* not by steps, for electroplating, as potentiometer, etc. etc.

We have a full line of Wireless goods in stock—all modern, all up-to-date. Send 2c stamp for new 100 page Catalog, Over 100 illustrations.

FRANKLIN ELECTRIC CO.

2828a Susquehanna Ave.

Philadelphia, Pa.

"THE EXPERIMENTERS HOUSE"

When writing please mention "Modern Electrics."

ACCURATE

COMPACT

INEXPENSIVE

Voltmeters, Ammeters
and Volt-Ammeters

Send for Complete Catalogue of

PORTABLE and SWITCHBOARD
PATTERNS



L. M. PIGNOLET

82 CORTLANDT ST.,

NEW YORK

When writing please mention "Modern Electrics."

FREE--Two Books:

84-Page

"Inventor's Guide"

AND

76-Page

"Proof of Fortunes in

Patents--

What and How to

Invent."

Trade-Marks, Copyrights,

Prints, Labels, Registered.

ADVICE FREE

Correspondence Solicited

PROTECT YOUR IDEA! Patents That Pay

SPECIAL OFFER: Send sketches or model and description of invention for **FREE SEARCH** of Patent Office Records and Report as to patentability. You will save **TIME** and **MONEY**.

EXPERT--PROMPT SERVICES.

E. E. VROOMAN,

HIGHEST REFERENCES

Registered Patent Attorney

Patent Lawyer (Patent Litigation)

1109 F STREET,

WASHINGTON, D. C.

REFERENCES:

American National Bank,

Washington, D. C.

Little Giant Hay Press Co.,

Dallas, Texas.

Gray Lithograph Co.,

New York City, N. Y.

Farmers Mfg Co.,

Norfolk, Va.

New Era Mfg Co.,

Peirfield, Iowa.

The Parry Stationery Co.,

Oklahoma City, Okla.

Bell Show Print Co.,

Sigourney, Ia.

When writing please mention "Modern Electrics."

60 YEARS' EXPERIENCE

PATENTS

TRADE MARKS
DESIGNS
COPYRIGHTS & C.

Anyone sending a sketch and description may quickly ascertain our opinion free whether an invention is probably patentable. Communications strictly confidential. HANDBOOK on Patents sent free. Oldest agency for securing patents. Patents taken through Munn & Co. receive special notices, without charge, in the

Scientific American.

A handsomely illustrated weekly. Largest circulation of any scientific journal. Terms, \$3 a year; four months, \$1. Sold by all newsdealers.
MUNN & Co. 365 Broadway, New York
Branch Office, 625 F St., Washington, D. C.

When writing please mention "Modern Electrica."

TELEGRAPHY TAUGHT

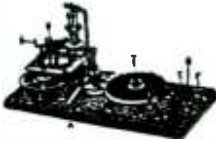

In the shortest possible time. The Omnigraph Automatic Transmitter combined with standard key and sounder. Sends you telegraph messages at any speed just as an expert operator would. 8 styles \$2 up; circular free.

Omnigraph Mfg. Co.
89 1/2 Cortlandt St., New York

When writing please mention "Modern Electrica."

INDUCTION COILS OUR SPECIALTY



All sizes from 1 in. to 20 in. Spark Testing Instruments, Telegraph Apparatus, Experimental Work of all kinds.

Foots, Plerson & Co.
160 Duane St., New York

When writing please mention "Modern Electrica."

B O O K S

We carry the best book assortment in this country. Our specialty is to publish electrical books—just what you are looking for. Here are a few: Storage Batteries, by A. E. Watson. Ph. D. E. E. Theory, Construction and Use. Price postpaid, cloth, \$1.50.

How to Make a 1-Kilowatt Dynamo, by A. E. Watson. Profusely illustrated. Price postpaid \$1. The Gas Engine, How to Make and Use It, by P. B. Warwick, including discussion on gasoline engines. Price, cloth, postpaid 75 cents.

A B C of Wireless Telegraphy, by E. Trevert. An excellent book for the amateur. Price postpaid \$1.00

New Experimental Electricity, by E. Trevert. A book every experimenter should possess. Price postpaid \$1.00.

X-Rays for Everybody, by E. Trevert. Unquestionably the best book printed for the amateur and experimenter. Price postpaid 50 cents. These are only a few books from our large assortment. Send for free list containing over 70 best electrical books in existence.

M. Bubier Publishing Co., Lynn, Mass.

S K O O B

When writing please mention "Modern Electrica."

ANNOUNCEMENT



Our New Wireless and Novelty Catalog No. 3, 100 pages will be off the press when this issue reaches you.

Don't fail to get it.

It contains hundreds of articles in which you are interested.

One of the most complete Catalogs ever issued.

A Postal Card Brings It

FLETCHER-STANLEY CO.
36 Frankfort St., New York

When writing please mention "Modern Electrica."

Wireless Telegraphy Taught Quickly by Correspondence.



Positions secured.

BOSTON SCHOOL OF TELEGRAPHY

18A Boylston St., Boston, Mass.

The largest and best Telegraph School in New England. We make a specialty of qualifying ambitious young men and women for Railroad, Commercial, Brokerage and Wireless Telegraph service. Send 10c postage cash or stamps for free wireless telegraphic book. With this we furnish FREE OF CHARGE two handsome Telegraph codes, mounted on fine cardboard, one showing the Wireless Telegr. code, the other Morse code. Size 6 x 6 inches.

When writing please mention "Modern Electrica."

Faucet WATER MOTORS



Complete with emery \$2.50 wheel, buff wheel, pulley to run sewing and washing machine, polish. In some cities where we have no agents, and where the water pressure is good, a sample motor will be given free; apply at once if you want to make some extra money, or if you can devote your whole time, liberal salary and commission will be paid.

ALCOHOL STOVES, LAMPS AND FLAT IRONS.

ENGINEERS WANTED to send for catalog of indicators, Reducing Wheels, Planimeters. Address,
LIPPINCOTT M. S. CO.,
52 Columbia St.,

Newark, :: :: New Jersey

When writing please mention "Modern Electrica."

PRINTING.

If it's printed we do it—and do it well. No matter where you are located We Can Save You Money. Our work is clean, our services more than prompt, our prices reasonable. Catalogs, Circulars, Pamphlets specialty. Write us your requirements to-day. Schoen Printing Co., 13 Vandewater St., New York City

When writing please mention "Modern Electrica."



Franklin Discovered It—Edison Developed It—The Cyclopedia Applies It.

Cyclopedia of Applied Electricity

Is a practical guide for every man who wants information regarding electrical appliances. This work presents in compact, practical form, and in simple, non-technical language, the results of the best work of the best men in the electrical profession; it lays the foundation of electrical progress for years to come.

THE ELECTRICAL WORKER, whether "trouble shooter" or expert, will find this Cyclopedia especially valuable as an index to what he knows and a ready reference to what he has forgotten.

THE BUSINESS MAN AND HOUSE OWNER can gain from it a knowledge of electricity that will save him many a dollar.

This Cyclopedia covers the whole electrical field more completely than any other group of volumes. It comprises 2,896 pages of up-to-date, authoritative information; it treats 23 general subjects; its detailed index includes over 4,000 different topics. It contains hundreds of special photographs, diagrams, sections, etc., besides condensed tables and formulas, containing information that it would require years of time and a fortune to collect. The pages are 7x10 inches in size, printed on special paper, in large, clear type, carefully bound in half morocco. **FREE FOR EXAMINATION.** Fill in and mail the coupon. We will send you a set of these practical books for five days' FREE examination. Examine the books carefully. If satisfactory send \$2 within five days and \$2 per month until you have paid the special \$18.00 price. The regular list price \$36. If you don't keep the books, advise us and we will send for them. Remember! You can examine the books without expense or obligation—we pay all charges.

IMPORTANT SUBJECTS COVERED.

Electric Telegraph—Theory, Calculation, Design and Construction of Generators and Motors—Types of Dynamos and Motors—Elevators—Dynamo-Electric Machinery—Alternating Current Machinery—Wireless Telegraphy—Storage Batteries—Wireless and Automatic Telephony—Power Stations and Transmission—Telantograph—Electric Lighting and Wiring—Electric Railways—Telegraphone—Direct Current Motors—Direct-Driven Machine Shop Tools—Alternating Current Motors, etc.—Single-Phase Electric Railway—Electric Welding—Mercury Vapor Converter—Management of Dynamos and Motors—Central Station Engineering—Central Station Design.

FREE! IF YOU ORDER PROMPTLY

With all orders before May 1st, we will include FREE for one year, as a monthly supplement, the

TECHNICAL WORLD MAGAZINE

An ideal American family monthly—regular price \$1.50. Clean, instructive, helpful and true—with the whole round world as its field. Present day, scientific facts and inventions are treated in a manner so clear and comprehensive that any one can understand and every one can learn.

FREE OFFER COUPON

American School of Correspondence, Chicago, U.S.A.

Please send Cyclopedia of Applied Electricity for FREE examination, also T. W. for 1 year. I will send \$2.00 within five days and \$2.00 a month until I have paid \$18.00; otherwise I will notify you and hold the books subject to your order. Title not to pass until fully paid.

Name
Address
Employer

(Mod. Elec. 4-09)



MY BOY!

HERE'S YOUR CHANCE

It's more than a chance—you can make it a certainty because it depends entirely upon yourself. It's your opportunity to rise to one of the countless positions open to the trained man and obtain a trained man's salary.

The man who sits in his private office and "hires and fires" and lays out your work, was no more qualified to fill that position a few years ago than you are to-day. He saw *his chance* and made the most of it. He obtained his training and knowledge by study. You can do the same—the American School will help you.

Don't be afraid to mail the coupon, you won't be bothered by agents or collectors. Like all strictly educational institutions the American School depends, for growth, upon reputation and the success of its students.

Don't let a little thing like filling in and mailing a coupon stand between you and success, congenial work and more pay. *Accept your chance to-day.*

We Help Men Help Themselves

FREE INFORMATION COUPON

American School of Correspondence,

Chicago, U. S. A. :

Please send me your free Bulletin of Engineering Information and advise me how I can qualify for position marked "X."

... Electrical Engineer ... Heating and Vent. Engr.
... Draftsman ... Plumber
... Civil Engineer ... Architect
... Mechanical Engineer ... Hydraulic Engineer
... Stationary Engineer ... Textile Boss
... Structural Engineer ... Sheet Metal Pattern
... Municipal Engineer ... Draftsman
... Railroad Engineer ... College Preparatory
... Structural Draftsman ... Course

NAME
ADDRESS
OCCUPATION
Mod. Elec. 4-09.

"Modern Electrics" guarantees the reliability of its advertisers.

When writing please mention "Modern Electrics."