



# ELECTRICAL COMMUNICATION

1941

VOL. 19

No. 3



# ELECTRICAL COMMUNICATION

A Journal of Progress in the  
Telephone, Telegraph and Radio Art

H. T. KOHLHAAS, Editor

EDITORIAL BOARD

E. A. Brofos    H. H. Buttner    G. Deakin    F. Gill    W. Hatton    E. S. McLarn  
Frank C. Page    H. M. Pease    F. W. Phelan    H. Pratt    W. F. Repp

Published Quarterly by the

*International Standard Electric Corporation*

67 BROAD STREET, NEW YORK, N.Y., U.S.A.

H. M. Pease, President

S. G. Ordway, Secretary and Treasurer

Subscription, \$3.00 per year; single copies, 75 cents

Volume XIX

1941

Number 3

## CONTENTS

	PAGE
ELECTRICAL COMMUNICATION IN 1940 .....	3
OPERATIONS OF THE INTERNATIONAL TELEPHONE AND TELEGRAPH GROUP OF COMPANIES IN THE AMERICAS .....	11
<i>By Col. W. F. Repp</i>	
THE INVERTED AMPLIFIER .....	32
<i>By C. E. Strong</i>	
PARLIAMENTARY SOUND SYSTEM IN THE ARGENTINE CHAMBER OF DEPUTIES .....	37
<i>By S. D. Wilburn and S. C. Tenac</i>	
MOUNTAIN EFFECTS AND THE USE OF RADIO COMPASSES AND RADIO BEACONS FOR PILOTING AIRCRAFT .....	44
<i>By H. Busignies</i>	
DEVELOPMENT OF THE RUMANIAN TELEPHONE SYSTEM: 1930- 1940 .....	71
<i>By L. B. Tucker</i>	
RECENT TELECOMMUNICATIONS DEVELOPMENTS .....	78



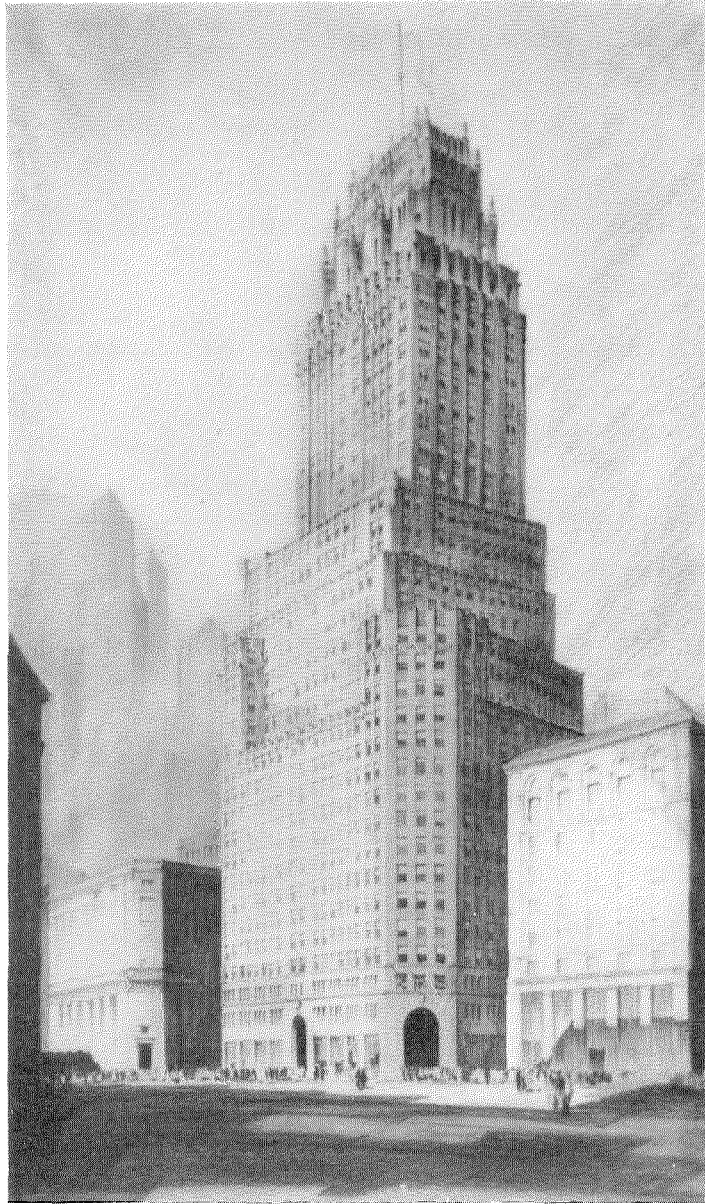

INTERNATIONAL TELEPHONE BUILDING

67 Broad Street, New York, N. Y.

## Electrical Communication in 1940

AT the beginning of each year this journal has endeavored to present an account of communication activities from an international viewpoint. In 1941 this task, comprehensively considered, is impracticable. While the vital importance of communications is enhanced by the stress of war, details of developments and operations in general are known to comparatively few. Further, the tendency is towards postponement of less immediately urgent, even though fundamentally important, activities. A conspicuous exception is the expansion of radio broadcasting, both nationally and internationally. In marked contrast to 1914-18, war developments, diplomatic activities and speeches are broadcast by short wave in many languages so that even the remotest hamlet becomes a listening post on a par with metropolitan areas. Much of this information, insofar as it factually reflects conditions, should ultimately prove constructive.

While discussion of reconstruction problems at this stage would be futile, it seems certain that following cessation of hostilities many current communication developments will be adapted to the pursuits of peace, and the tendency to coordinate or unify communication services, such as wire and radio, will increase because of inherent advantages and the pressure of economic conditions. Meanwhile description must be postponed, though to a lesser extent with respect to the western hemisphere. Here, it may not be amiss to record, the Republics of the Americas are benefiting from increased mutual collaboration and are actively pursuing the problem of achieving improved communications.

While greater inter-American solidity is notable, it should be pointed out that inter-American cooperation is nothing new essentially. Frank W. Phelan, President of All America Cables and Radio, Inc., for example, told the Eighth American Scientific Congress at Washington, D. C., in May, 1940, that in his forty-five years in the communication business serving the American Republics he did not recall one instance where it had been necessary to resort to arbitration in making adjustments with any of the Governments. He pointed out the Cable Company was one of the first large U. S. enterprises in Latin America, serving all the countries, and stressed that the friendly dealings between Government and the

communication companies give an accurate pattern of the highly honorable plane of business relationships in the Americas.

### *Long Distance Transmission*

A complete compilation of toll facilities added during 1940 to cable and open wire plant throughout the world obviously is impossible under existing international conditions. Any comprehensive resumé of toll plant expansion must, therefore, be deferred.

The U. S. A. long distance traffic in 1940 was greater than at the peak of the 1914-18 war activity. Fortunately, the availability of recently developed 12-channel carrier systems afforded a ready means of realizing many important additions. On the Boston-New York route, the first group of 12-channel cable systems was completed, and many additional 12-channel carrier systems were installed on various links of the cable and open wire route from New York to Florida. High-grade carrier channels of the broad band type thus have been made available for through communication from Boston, Massachusetts, to Southern Florida.

Existing carrier systems on the fourth trans-continental route were supplemented by additional systems of the broad band type. Similar systems were added to many other important trunk routes.

The installation of broad band cable carrier systems between Helsinki and Turku, Finland, was completed after interruption of installation due to hostilities.

In Nicaragua a single-channel open wire carrier telephone system was placed in operation between Managua and Corinto, a distance of 140 kilometers. This equipment represents the first carrier system to be installed in Nicaragua.

In Venezuela, a modern open wire telephone line, 110 miles in length, connecting the two important centers of Guanta and San Tome, was constructed. It is entirely supported by Truscon steel poles.

A number of single-channel open wire carrier equipments and repeaters, and sizable quantities of printing telegraph apparatus were supplied for the extension of the communication systems of Mexico.

To augment long distance facilities to meet an

ever increasing demand for such services, I.T. & T. Operating Telephone Companies added physical circuits and carrier equipment to existing toll lines and made extensions to toll boards in the Argentine and in Chile. In southern Brazil a new toll line (250 kilometers) was constructed west of Santa Maria as part of a toll development program for this territory. This long distance program for Brazil is expected, over the next few years, to provide a toll line across the State of Rio Grande do Sul from Porto Alegre to Uruguayana, where inter-connection has been made with the long distance network in the Argentine.

Twelve-channel cable carrier systems were installed from Bucharest to Brasov, Rumania; they represent the first 12-channel cable carrier systems installed in Continental Europe. Open wire type carrier systems also were added in Rumania during the year.

The long distance underground cable, which was installed between Bucharest and Ploesti in 1939 and which represented the first long distance underground cable installation in Rumania, was extended in 1940 eastward to Buzau and westward to Brasov close to the present Russian and Hungarian borders.

### ***Alternate Routes***

Emergency provisions to maintain communications under all circumstances are being more generally employed. A distinctive example of such provisions is the stand-by radio link between Buenos Aires, Argentina, and Santiago, Chile, intended to supplement The International System's trans-Andean cable in the event of interruption of the latter. Another example, also illustrating the value of coordinated wire-radio networks, is the unique ability of Mackay Radio to reach certain continental European countries after the trans-Atlantic cables were interrupted due to the war. In the U. S. A., the A.T.T. has provided numerous alternate routes and, among others, is laying a new Baltimore-Washington (D.C.) cable which will follow an entirely different path from existing circuits.

### ***Radio***

#### ***Point-to-Point***

Compania Internacional de Radio (Argentina), (C.I.D.R.A.), an associated I.T. & T. company,

just before the Christmas holiday season inaugurated a new single side band transmitter and receiver (Western Electric types) providing two high quality telephone circuits between Buenos Aires and New York. Operating experience with the new equipment indicates that fading, static, and other distortion have been greatly reduced, even during periods heretofore regarded as unfavorable for radio transmission.

Through I.T. & T. associated company facilities, telegraph service was inaugurated from Buenos Aires with ships of the "Good Neighbor Fleet" (Moore-McCormack Line, Inc.).

To care for an increased demand for multiple address press service Sociedad Anonima Radio Argentina (S.A.R.A.) found it necessary to extend the service period to twenty hours a day and to increase the transmitting power to reach satisfactorily the eleven cities to which this service is rendered throughout South America for the United Press Association.

At Rio de Janeiro, a second terminal and privacy equipment were installed in August, 1940. This enables Companhia Radio Internacional do Brasil, an I.T. & T. associated company, to operate two radio telephone channels simultaneously.

The International Standard Electric Corporation sold to the Swiss Government single side band telephone transmitter-receiver equipment similar to the above mentioned Buenos Aires equipment for use in the trans-Atlantic radio telephone service. Part of the equipment is in service and the remainder is expected to be in use early in 1941.

All America Cables and Radio, Inc. is erecting a radio telegraph station at Guayaquil, Ecuador, for inauguration of service with Quito and Lima, Peru. It will connect with other stations through Lima.

A.A.C. and R. also is installing for the Ecuadorian Government at Quito a radio telegraph station for connection with Guayaquil and New York.

A 35 kW short wave telegraph transmitter is being manufactured by the Federal Telegraph Company and will be installed by A.A.C. and R. at its radio station in Lima, Peru for inauguration early in 1941.

A radio telephone circuit was installed to provide communication between Guayaquil and Quito, Ecuador.

### Aviation

In July 1940, the International Telephone Development Company, an I.T. & T. subsidiary, received a substantial order from the Civil Aeronautics Administration to manufacture and install airplane instrument landing systems at the airports of six cities in the U. S. A.: La Guardia Field, N. Y.; Municipal Airports at Chicago, Cleveland, and Kansas City; Mines Field, Los Angeles and Meacham Field, Fort Worth. Previous to the award of the contract, a special committee set up by the National Academy of Sciences at the request of President Roosevelt had endorsed the Administration's program, and a demonstration had been given of the latter's landing system (known as the "Indianapolis System") concurrently with a meeting of the Air Transport Association's operations committee (February, 1940).

With the exception of experimental installations these landing systems are the first ever contracted for in the United States and mark a decided advance in the application of ultra-high frequency radio to aerial navigation. They will enhance the safety of flying as well as relieve the congestion caused at busy airports due to delayed landings under unfavorable weather conditions.

This CAA (Indianapolis) instrument landing system provides the pilot with complete guidance to the airport runway, both horizontally and vertically. Through beams of ultra-short wave energy transmitted from highly directive equipment at the airport, the pilot by means of a conveniently placed instrument on his instrument panel is provided not only with the exact line of approach laterally to the concrete runway but also with the exact line of descent, when five miles or more away, to the runway so that the airplane settles upon the latter as in normal landing. Further, two "marker beacons" are provided along the line of approach to the landing runway: one indicates to the pilot arrival at a certain point, some distance from the runway, when he should be at a prescribed altitude and in line with the instrument landing apparatus so as to be headed directly for the runway; the other informs the pilot when he passes the boundary of the airport. With these facilities, pilots can land with consistent safety even

when weather conditions are extremely difficult.

It is recognized that the Indianapolis System does not embody the final solution to the problem of instrument landing of airplanes. It does, however, represent "a complete and unified system 'frozen' at a practicable stage of development in order to enable pilots and the industry to start accumulating first-hand knowledge of its technique and operation."

Installation of this equipment is now in progress, and will be placed in operation about the middle of 1941.

Linea Aeropostal, Venezuela, is installing a complete network of radio stations for twelve airports. Each station is arranged for communication with airplanes and other stations, the equipment consisting of a Federal Telegraph type 270-C telephone-telegraph transmitter, a receiver and a directional antenna supported by steel masts.

### Radio Broadcasting

The 20th anniversary of the first regular broadcasting was celebrated in the U. S. A. in 1940. A number of the broadcasting companies prepared special programs in commemoration and the Press commented favorably, emphasizing the great social and economic influence of radio broadcasting.

Paul Scott Mowrer, Editor of the Chicago *Daily News*, expressed the belief that broadcasting has done a great service to newspapers by stimulating interest in foreign and national news. In connection with increased circulation of daily and Sunday newspapers in the U. S. A. during 1940, *Editor and Publisher* declared:

The fact that radio furnishes at least one news broadcast on one or more spots on the dial every quarter hour has not reduced the public's appetite for printed news; it may indeed have whetted the desire for news presented for the reader's convenience and easy understanding—a quality which the newspaper has to an immeasurable degree over any medium limited to vocal communication.

In 1940, more than 11,000,000 radio broadcast receivers were produced in the U. S. A., nearly 2,000,000 for automobiles. Over 500,000 workers received pay of more than \$500,000,000 during the year.

The Federal Communications Commission required short-wave broadcasters to maintain a minimum power of fifty kilowatts and sponsored programs were authorized.

Frequency modulation (FM) at frequencies between 42 and 50 megacycles for high quality noiseless reception is making marked progress in the U. S. A. FM advocates have been energetic in stimulating its commercial introduction and a large number of broadcast receiver manufacturers are offering sets capable of receiving these transmissions. Some difference of opinion, nevertheless, exists as to whether the public will appreciate the higher quality attainable by the use of ultra-high frequency waves plus the great freedom from noise inherent in FM.

The Columbia Broadcasting System, Inc., has completed arrangements with the Federal Telegraph Co. and the Mackay Radio and Telegraph Company for the construction and installation of two 50 kW short wave radio broadcasters with directive antennae recently developed by Mackay Radio. These transmitters will be located at the large radio station of Mackay Radio near Brentwood, Long Island, for high efficiency beam service to Central and South America and Europe. It is expected that they will be inaugurated during the late summer of 1941.

Compania Radiodifusora del Ecuador installed a modern broadcasting station for connection with the Columbia Broadcasting System's Pan-American network. A Western Electric 353E1 transmitter with the necessary speech input equipment and accessories is utilized.

The Venezuelan newspapers, Ondas Populares and La Religion, installed new broadcast transmitters. Both are 1 kW, the former including a Doherty high efficiency amplifier circuit and stabilized feedback.

### Television

Due to prevailing conditions, European and British commercial television is practically at a standstill. In the U. S. A., due to changes in wavelength assignments and the lack of agreement on standards to be chosen, television also has been marking time. Development work, notwithstanding, is continuing and two companies have announced television in colors. The Columbia Broadcasting System (C.B.S.) has given a number of public demonstrations which show remarkable fidelity in color reproduction. As compared with black and white reproductions, the viewer gets the impression that the colored pictures are larger than they really are. It seems

probable, at least under normal conditions, that color television will become a commercial reality within a few years. High amongst radio experimenters is the C.B.S. Chief Television Engineer, Dr. Peter Goldmark, who introduced outside pictures and scenes from motion picture films in color through the utilization of vari-colored whirling discs.

A novel method, employing many small cathode-ray tubes rather than one large tube, to increase the size of projected television images was devised by Dr. Alfred Goldsmith, New York consulting engineer. The mechanism is designed for plugging into home television sets or for utilization with large screens in theaters.

### Public Address

For the past several years, the demand has been growing for improved sound installations for public address purposes, especially where permanent installations are required to overcome unsatisfactory auditorium acoustics. Although applications of sound reproduction systems for a wide variety of purposes have increased since the early days of broadcasting, and notable installations, both indoor and outdoor, have been achieved, many have fallen short in quality, in convenience to the user, and in operating and attendance costs.

In May, 1940, a unique and highly successful installation was inaugurated simultaneously with the opening of the Argentine National Congress. It is an overall high fidelity system, providing 191 individual microphones inconspicuously mounted on the desk of each speaker, practically instantaneous auto-manual switching of microphones, and concealed loudspeakers located so as to distribute the sound as though coming directly from the individual speaker. The stability and margins of the system are such that it requires no attention during operation. The equipment (described elsewhere in this issue of *Electrical Communication*) was designed and installed by the United River Plate Telephone Company, Buenos Aires, and has received the unanimous approval of the Chamber of Deputies as a most satisfactory means of overcoming the unusually bad acoustic conditions in the Chamber.

### I. T. T. Telegraph Operations

In considering how the year 1940 dealt with four companies—All America Cables and Radio,

the Commercial Cable Company, the Mackay Radio and Telegraph Company and the Sociedad Anonima Radio Argentina—the determining factor throughout the year was the war.

The immediate effect of a major war on communications, in many cases, is interruption of the traffic flow along lines regarded as normal in peace time and the adoption of substitute routes to meet changing conditions. Controlling factors are censorship and restrictions in belligerent countries determined by considerations of national defense. Physical ability to handle the public's messages is often not a governing consideration, particularly in the case of companies operating coordinated cable and radio services. In such cases messages of a confidential nature ordinarily are sent by cable; if the latter be interrupted, routing is often possible by radio which is less restricted by international boundaries.

All America Cables and Radio in 1940 handled a substantially increased volume of traffic between North America, on the one hand, and Central and South America and the West Indies on the other. Traffic between South America and Europe decreased in volume.

The Commercial Cable Company is operating its usual services to Newfoundland, the Azores, Eire (Ireland) and Great Britain and is accepting traffic through Great Britain to certain other European countries and to points beyond Europe, but its services to countries under German military occupation and to Italy are temporarily discontinued.

The Mackay Radio and Telegraph Company reestablished service to Denmark over its New York-Copenhagen circuit, the operation of which ceased for a time upon the occupation of Denmark by the German armed forces. It also opened a New York-Rome circuit in addition to the previously existing New York-Vatican City circuit. It is now handling over its New York-Vienna circuit traffic which the Commercial Cable Company would normally carry to Germany and certain other parts of Europe. In the past year the Company also established service with Greenland and limited service with Eire.

Mackay Radio's shore to ship traffic has increased in the Pacific and decreased approximately 50% in the Atlantic. Due to war conditions, distress calls have been received or intercepted from ships at sea in number far exceeding

those of peace times. When distress calls are received the U. S. Navy and Coast Guard are immediately notified and all available details are supplied. The information is also immediately relayed to other ships known to be in the vicinity of the ship from which the distress call originated.

Sociedad Anonima Radio Argentina's facilities from Buenos Aires to Madrid at times have been taxed to the utmost in handling a considerable volume of traffic involving the U. S. A. and certain European points which under normal conditions would circulate over North Atlantic routes.

### *Telegraph*

While there have been no startling or radically new developments in the telegraph field during the past year, there is increasing evidence of active interest in the modernization of telegraph plants throughout South America. Several projects looking toward this end have been actively pushed, and, it is expected, will go forward during the coming year. The application of Creed Teletype Printers to national telegraph services in South America has continued unabated.

### *Facsimile Transmission*

Facsimile as a convenient and useful tool in the field of record communications has established its place more firmly than ever. Following an extensive and successful trial in the New York metropolitan area, the Western Union Telegraph Company is installing automatic facsimile transmitters and facsimile transmitter-recorders in many of the larger cities in the United States for use in picking up telegrams from agencies and small branch offices, and for picking up and delivering telegrams for private customers. From the results so far obtained, it is evident that facsimile provides a very convenient service from the standpoint of the user, and an economical one from the standpoint of the communication company.

The facsimile duplicator, which is an offshoot of facsimile transmitters and recorders, is finding extended application in the field of a commercial duplicating machine. This machine is capable of making facsimile copy of all sorts of material up to approximately 11×16" in area. In general, it will handle printed matter in which the type is no finer than 6 Point.



The dry recording paper, which can be marked by the passage of an electric current through it and which was developed primarily for use on facsimile machines, is finding added applications in the recording instrument field.

Finch Facsimile, which operates on the "start-stop" principle and can therefore be operated from any power source, has made considerable progress during the past year. A satisfactory duplex machine, capable of simultaneous transmission and reception, has been successfully demonstrated and is now being widely exploited. Several of these machines have been sent to Europe and South America for demonstration purposes.

The International Standard Electric Corporation has arranged to make the two above mentioned types of facsimile equipment available outside of the U. S. A. and has furnished necessary demonstration equipment.

### ***I. T. T. Operating Telephone Companies***

#### *Largest Yearly Station Gain*

The total gain in telephones for the telephone operating companies comprised in The International System, during 1940, exceeded that of any previous year—more than 92,000 telephones compared with 73,532 in 1939. This gain brings the total to more than 1,200,000 stations, a new high, and includes the Spanish Telephone Company which added over 34,000 telephones during the year.\* In Argentina, the United River Plate Telephone Company reported a growth of over 25,000 telephones.

#### *Long Distance Traffic*

Long distance calls handled by International System Companies in 1940 increased about 7%. Excluding the Spanish Telephone Company for which figures were not available when this resumé was prepared, preliminary figures indicate that toll calls handled approximated 32,500,000 as compared with 30,400,000 in 1939.

#### *Radio Telephony*

Bolivia was brought into the international telephone network in April, 1940, by the inauguration of radio telephone service from La Paz

\* The above figures include the Rumanian Telephone Company, which was sold in 1941 as noted hereinafter.

through the facilities of Compania Internacional de Radio (Buenos Aires), an I.T. & T. subsidiary, and the American Telephone and Telegraph Company.

The Compania Telefonica Nacional de Espana, in September, 1940, resumed international radio telephone service, which had been suspended in 1936. In addition to a direct link to North America, calls for which previously had been routed through Paris, Berlin or London, service was reestablished with Venezuela, Brazil and the Argentine as terminal and as switching points to other South American countries. More recently service was also extended to Portugal, Spanish Morocco, Melilla, Balearic and Canary Islands via Madrid.

Radio telephone service between the Swiss Telephone Administration on the one hand, and the Bell (U. S. A.) and International Systems (Argentina) on the other was inaugurated in 1940.

#### *Equipment Additions*

During 1940 International System Companies added 60,000 new subscribers' lines together with the associated central office equipment, also numerous outside local and toll plant facilities.

A great majority of new equipment installed was of the automatic type; approximately 75% of all telephones now in the International System are automatic.

#### *Special Activities*

Several hundred private automatic switchboards were installed during 1940 in association with the International System network, which contains a large P.A.B.X. development, including switchboards of the most modern and complete type. Installations varied from small automatic boards of two or three lines to many large automatic types providing great flexibility and a variety of special features for private intercommunication and connection to the public network.

International System Companies cooperate with local authorities to enable the offering of service whereby telegrams can be telephoned to expedite delivery. In 1940 this service was extended to include the cities of Santiago and Valparaiso, Chile, and Bucharest, Rumania.

During 1940, International System Companies offered many special services to the public, the principal ones being the following:

Colored telephones, weather-proof outdoor telephones, elevator telephones, supervisory telephones, telephone amplifiers for the hard of hearing or for noisy locations, and loudspeaking telephones enabling anyone in the room to hear a telephone conversation. Included also were supplementary visual signals and automatic dialing instruments.

#### *Storms and Earthquakes*

Severe storms and major earthquakes in Rumania and Peru resulted in losses which, however, were not large; repairs were quickly made and service was restored promptly. In Peru, despite damage to the telephone plant in Callao and Lima in May, 1940, service to all strategic points was maintained, and the rapid restoration of service brought commendation from the Government and the Press. In the recent Rumanian earthquake, the main service was re-established within a few hours. In such cases the modern, American designed, re-enforced concrete buildings, standard with International System Companies, have proven their worth many times over both in safeguarding personnel and in protecting equipment.

#### *Compania Telefonica Nacional de Espana*

Final steps in the complete reinstatement of the International Telephone and Telegraph Corporation in the management of its Spanish subsidiary, the Compania Telefonica Nacional de Espana, which operates the Spanish local and long distance telephone system, were taken at a meeting of the Board of Directors of the C.T.N.E. in Madrid on August 19, 1940. Four Americans were elected directors, making a total of five American representatives of the I.T. & T. on the Board out of a total of twenty-one.

When civil war broke out in Spain in July, 1936, the Spanish Government, in accordance with the provisions of its contract with the I.T. & T., took over the operation of the C.T.N.E. telephone system, which covers the entire country. Although the corporate interest of the I.T. & T. in its Spanish Company never was questioned, it was felt by the new Spanish

Government after the close of the war that it was desirable for the management to continue in its own hands through the early period of reconstruction. With the election of American members to the Board of Directors and the appointment of certain American executives, the property is being operated under the terms of the contract which was made in 1924 between the Company and the Government.

The C.T.N.E. was organized by the International Telephone and Telegraph Corporation in 1924 to build up and operate the Spanish National Telephone system. Large and sustained programs of reconstruction and expansion initiated in that year, together with public appreciation of the reliable and speedy telephone service, brought the total number of telephones operated by the Company in Spain from 91,737 in 1924 to 327,078 at the close of 1940.

About 66% of the telephones and 50 of the exchanges are automatic. Company owned buildings total 80, including the General Office Building in Madrid, one of the tallest in Europe.

At the beginning of the War there were 8,720 employees in the Spanish Company, operating exchanges in over 3,000 localities, and an extensive system of toll lines reaching all points in the country. International connections were available by direct landlines and cables to Spanish Morocco, Portugal and France, and, through radio telephone stations operated by the Company, to the Canary Islands in the Atlantic, the Balearic Islands in the Mediterranean, and to South America. Through these direct connections the telephones of the Spanish Company had access to 90% of the telephones in the world.

Except in cases where lines or equipment were hit or cut for strategic reasons, the telephone system throughout Spain gave service continuously during the entire War.

Relatively few cases of serious damage either to buildings or large exchanges occurred during the Civil War; the \$7,000,000 Madrid General Office Building, which was outstandingly vulnerable because of its conspicuous location and size, was hit many times, but the actual repairs came to less than \$225,000. Actual damage to the entire property, including toll lines and other outside plant, is estimated at much less than 10% of its value. Much of the damage has already been repaired.

### *Rumanian Telephone Company*

The I.T. & T. on January 6, 1941, announced the sale of its entire interest in the Societatea Anonima Romana de Telefoane (the Rumanian Telephone Company) to the National Bank of Rumania. The payment of \$13,655,000 in U. S. A. currency covered the approximate amount of I.T. & T. investments in capital stock and advances on current account together with the equity in the Telephone Company's undistributed earnings.

The I.T. & T. entered the Rumanian telephone field in 1931, when there were about 50,000 telephones in operation in the network acquired. At the time of sale this figure had expanded to approximately 108,000, and a comprehensive system for handling local, national and international telephone traffic had been constructed.

The telephone manufacturing property in Rumania, having a value of about \$500,000, was not included in the sale.

### *Selenium Rectifiers*

To meet increasing demands for Selenium Rectifiers, manufacturing facilities in several European companies of the International Telephone and Telegraph Group have been expanded.

National acceptance of Selenium Rectifiers on the part of large American electrical equipment manufacturers also has resulted in an increase in output of the New York rectifier plant operated by the International Telephone Development Company, Inc. This company now has a substantial number of regular customers.

### *In Memoriam*

On February 24th, 1940, Colonel A. H. Griswold, Vice President and Director of the International Telephone and Telegraph Corporation, died in New York after a brief illness. He was born at Milo, Illinois, U. S. A., in 1879.

In 1901, after graduating from the University of Illinois with a degree in Electrical Engineering,

he entered the Chicago factory of the Western Electric Company. In 1905 he became associated with the Pacific Telephone and Telegraph Company.

In 1917 he entered the United States Army as Director of Long Lines, subsequently becoming Director of all telephone and telegraph services of the American Expeditionary Force in Europe. He was promoted to Lieutenant Colonel, decorated by the French Government (Legion of Honour), cited by General Pershing, and decorated by the American Government. After the War he served as Chairman of the Engineering Commission which assisted the French Government in restoring communication services in the devastated areas.

Remaining in Europe, he was appointed Assistant Chief Engineer of the International Western Electric Company in 1920 and contributed substantially to the engineering and installation of the Stockholm and Gothenburg Cable, the first modern long distance telephone and telegraph cable in Europe.

He returned to the United States in 1921 as Assistant Vice President of the American Telephone and Telegraph Company. In 1924 he became head of the Southern California Telephone Company, and later Vice President and operating head of the Pacific Telephone and Telegraph Company.

He joined the International Telephone and Telegraph Company in 1928 as Vice President and simultaneously became Executive Vice President of the Postal Telegraph and Cable Corporation, a position which he held until 1938 when he was placed in charge of all telephone and radio operating properties of the I.T. & T. During his twelve years of service as an officer of the I.T. & T. Corporation, he assisted materially in shaping the development of its properties all over the world.

His sympathetic and friendly attitude, combined with a broad outlook, endeared him to his many friends by whom his memory will long be cherished.

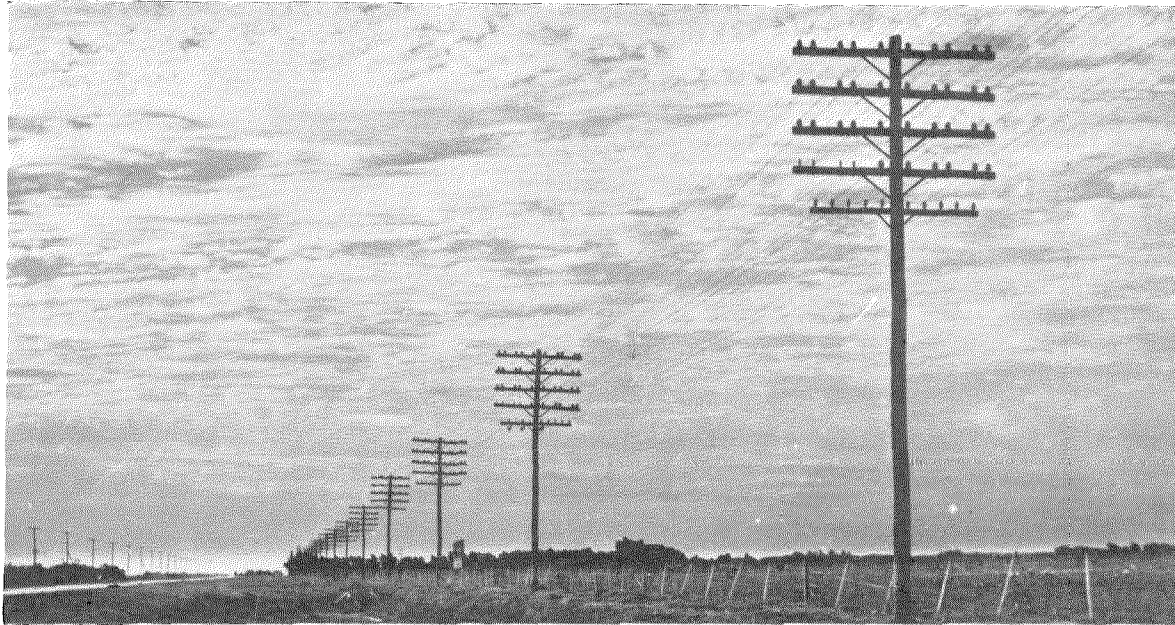

## Operations of the International Telephone and Telegraph Group of Companies in the Americas

By Col. W. F. REPP

*Vice President in Charge in South America, International Telephone and Telegraph Corporation, New York*

### **Introduction**

**F**RIENDLY collaboration amongst the Republics of the Americas has long been considered fundamentally beneficial by the relatively few who view international relations broadly and at longer range. Today, however, the great potential advantages of Western Hemisphere collaboration are being given wider recognition, and the best minds in all countries are devoting the most serious attention to problems involving coordination of national policies, travel, cultural and commercial interchange, and international collaboration. Moreover, since such collaboration inevitably will stimulate constructive activities, social and cultural as well as commercial, the forward march of all Western Hemisphere countries should be greatly accelerated in the coming decades.

In the furtherance of these laudable objectives, reliable and rapid communications are indispensable; indeed, they are so closely linked with human activity in general that they may be re-

garded as furnishing a key to progress. In the past, the art of electrical communications has kept pace with and often anticipated expanding national and international needs; in the more auspicious and challenging future, it must render corresponding yeoman service.

Contributions to the communication art have come from many and varied sources. It is believed to be a fact, however, that the contributions of the International Telephone and Telegraph Corporation together with its associated companies (collectively known as The International System) have been unique. The whole story, interesting, colorful and even romantic, cannot be attempted by the present author; but, because of achievements in Western Hemisphere communications, and enhanced interest in the general subject imposed by world events, it is felt that some indication of what The International System is, what it does, and, by implication, its potentialities, is of timely interest.

This article, accordingly, describes in some detail I.T. & T. Western Hemisphere activities.

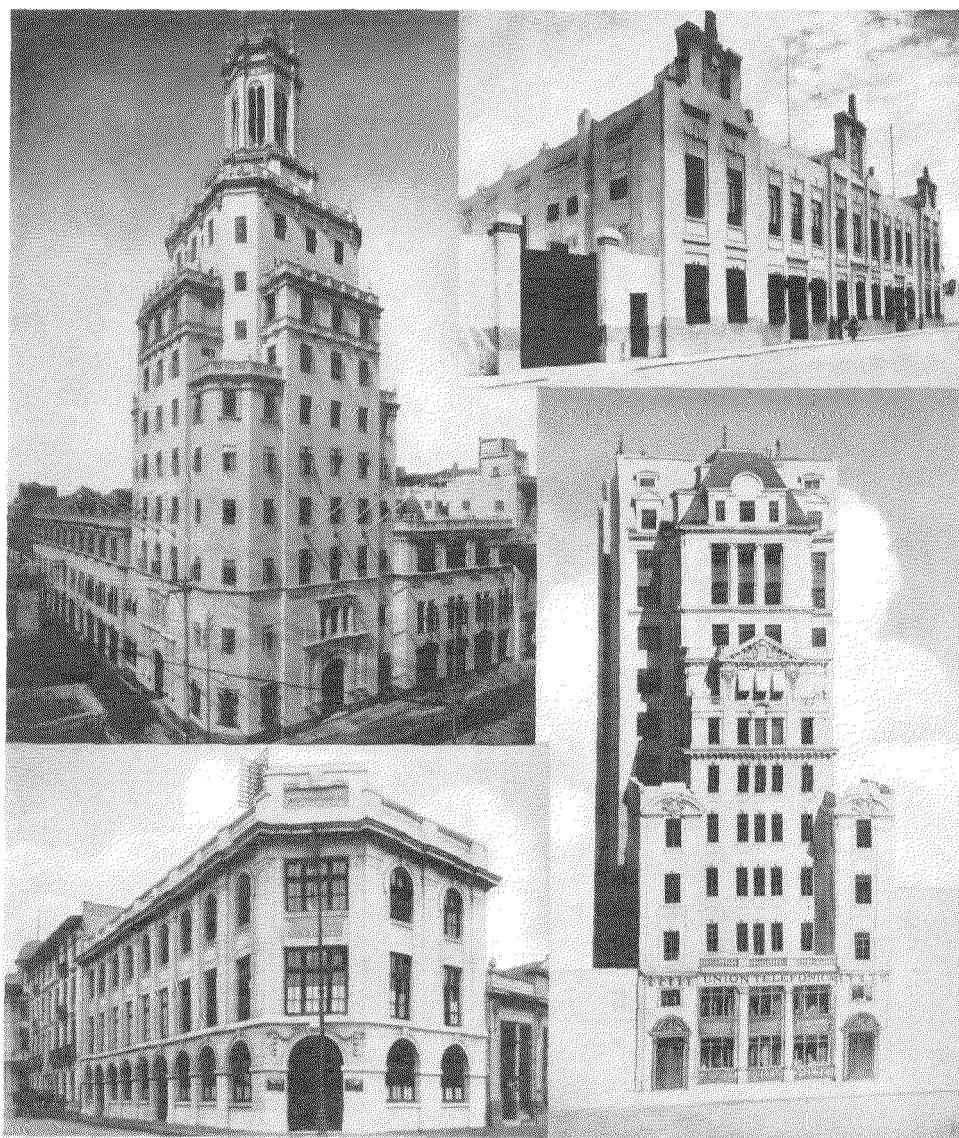

Top left: Cuban Telephone Company; top right: Compania Peruana de Telefonos, Ltda. (included in this building is the Washington Rotary Automatic Central Office); bottom left: Chile Telephone Company; bottom right: United River Plate Telephone Company.

*Four I. T. & T. Operating Telephone Companies' Headquarters Buildings.*

They include the manufacture and distribution of communication equipment; the operation of telephone systems; the operation of radio telephone, telegraph, and broadcasting stations; and the operation of land and marine cable systems.

All America Cables and Radio, Inc., an I.T. & T. associated company, has served the American Republics as the principal intercommunication medium for 62 years, mainly over its submarine telegraph cables. More recently, it has become active in the radio field, both telegraphic and telephonic. Linkage of the Americas with Europe is provided via the U. S. A. by the associated Commercial Cable Company and the Mackay Radio and Telegraph Company.

In 1929, during the early stages of international radio telephony, a high powered radio station was constructed in Buenos Aires as an initial step in offering telephone communications between South America and other parts of the world, principally the United States. Subsequently, approximately 800,000 of the 900,000 telephones in South America proper gained access to the 21,000,000 telephones in the United States and also to the telephones of all other countries comprised in the international radio network; that is, 93% of the world's telephones: the U. S. A., Canada, Great Britain, Continental Europe, Australia, New Zealand, South Africa, the Far East, etc. Mexico, Cuba and Puerto Rico, similarly, gained access to these telephones.

While less spectacular, a not less important activity is the development and operation of telephone properties in the Western Hemisphere. Telephone operations include Argentina, Southern Brazil, Chile, Cuba, Mexico, Peru and Puerto Rico. High class modern equipment, installed according to scientifically pre-determined plans, and the best operating practices have been introduced. The aim, always, has been to furnish the highest quality, economical service.

The International System, with research and development laboratories and manufacturing plants spread over the world, as well as contractual relations\* with the Western Electric Company, enjoys the advantage of interchange of manufacturing, technical, and patent information involving the manufacture and exploitation

of W. E. products in all countries except the U. S. A., Canada and Newfoundland. Thus, The International System is in a position to furnish customers and its own Operating Companies with equipment representative of the highest quality, and up-to-date technical standards, not only in the telephone and telegraph fields, but also in allied fields such as telegraph printers, remote control of power plants and railway dispatching and communication systems. Despite the importance of its strictly telephone products, such as sub-station, central-office, toll-cable and associated equipment, it is interesting to note, incidentally, that I.S.E.C., together with its affiliated companies, is active in all branches of radio: point-to-point, broadcast and television transmitters and receivers, radio broadcast receiving and television sets, fire, police, marine communication and direction finding equipment, as well as aviation communication, navigational and instrument landing equipment.

The accomplishments indicated above were made possible only by international collaboration along financial, managerial, and technical lines, supplemented by cooperation in individual countries and the forward looking policies of governmental authorities.

The collective designation, The International System, was chosen for the name of the I.T. & T. Corporation and its associated companies because of the international scope of their activities, touching every important country of the world and comprising all phases of electrical communication and its allied arts.

### *Part I. General Survey*

#### 1.1 TELEPHONE OPERATING ACTIVITIES IN THE WESTERN HEMISPHERE

The following International Telephone and Telegraph subsidiaries operate more than fifty per cent of the telephones in the Western Hemisphere, not including Canada and the United States. They include Argentina, Brazil, Chile, Cuba, Peru, Puerto Rico and Mexico. (For Company names, see the Summary at the end of this article.)

In addition to providing a complete, modern local telephone service, fully automatic in many cities, the respective systems include extensive networks of toll and long distance lines. Inter-

\* Through a subsidiary, the International Standard Electric Corporation.

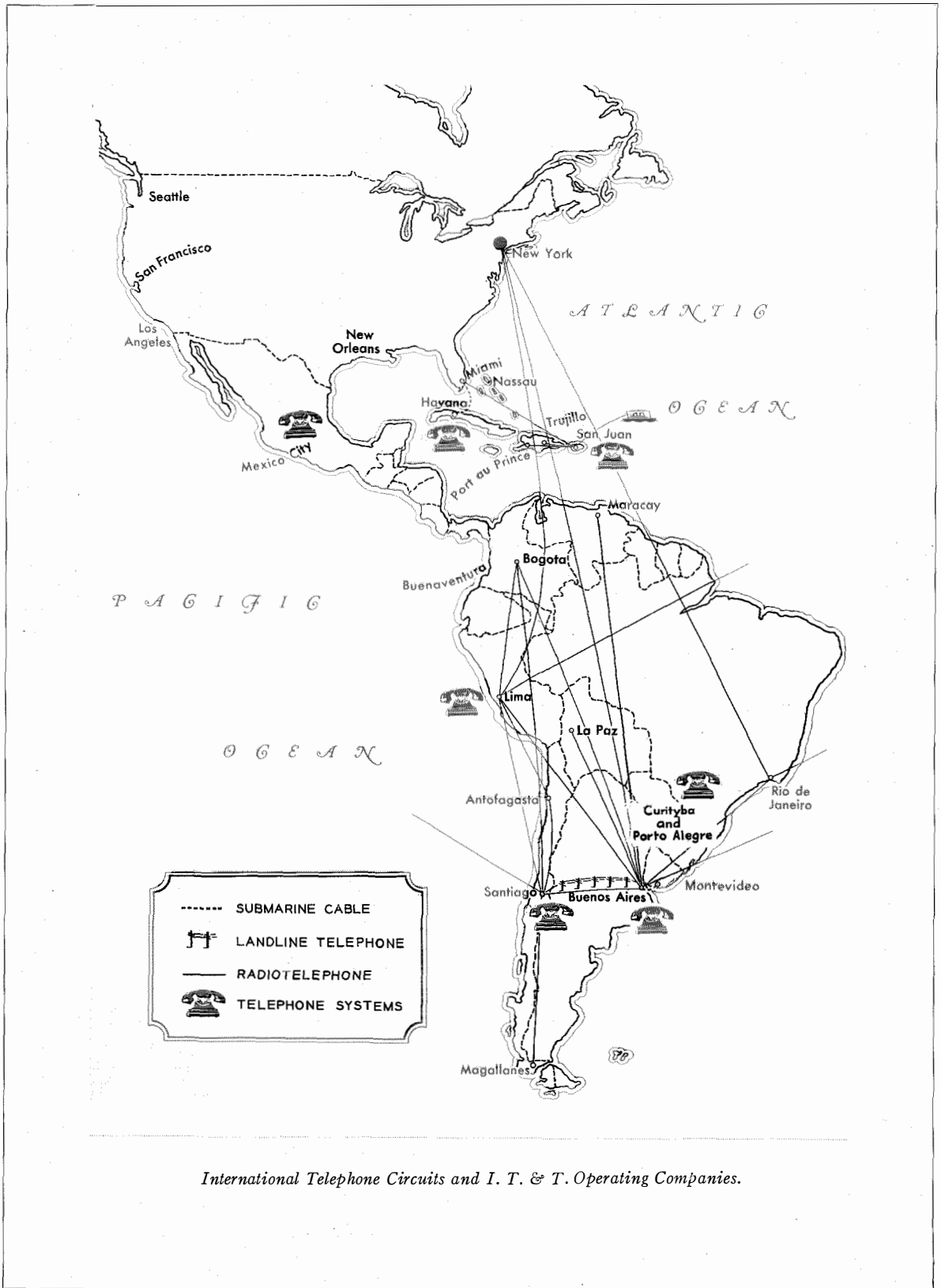

*International Telephone Circuits and I. T. & T. Operating Companies.*

national connections, both Western Hemisphere and elsewhere, are, moreover, available to practically all subscribers, either over open wire or cable circuits or by means of International System radiotelephone links.

In the four years prior to 1940 the number of telephones operated by these I.T. & T. subsidiaries increased by 196,214, or 42%. During 1940 and the following three years up to December 31, 1943, a conservative forecast indicates a growth of 179,120 telephones, or a total of 843,427 International System telephones in the Western Hemisphere. With increasing telephones connected, toll business has expanded proportionately and, normally, should continue on the upward trend.

Fig. 1 shows data on telephones in service, and completed toll and long distance connections, both domestic and international outgoing. For the years 1935–1939, figures are taken from company records; for 1940 from preliminary reports, partially estimated, and for 1941–1943 (broken lines), they represent conservative forecasts.

Telephone connection between Cuba and the United States is provided by the submarine telephone cables of the Cuban American Telephone and Telegraph Company, owned jointly by the International Telephone and Telegraph Corporation and the American Telephone and Telegraph Company.

Mexico and the United States are interconnected over the landlines of the Mexican Telephone and Telegraph Company, an I.T. & T. subsidiary, connecting with the American Telephone and Telegraph Company lines at Laredo, Texas.

International System telephones in Argentina, Chile, Peru, and some in Brazil, are linked with the United States and other countries by means of radiotelephone stations operated by I.T. & T. subsidiaries.

Brief information on each Telephone Operating Company is given in Part II of this article.

## 1.2 CABLE, RADIOTELEGRAPH AND RADIO-TELEPHONE OPERATIONS IN THE WESTERN HEMISPHERE:

### *All America Cables and Radio, Inc.*

All America Cables and Radio, Inc., an I.T. & T. subsidiary, operates the principal system of telegraphic communication connecting the United

States with the countries of Central and South America and the West Indies.

The creation of this Company, which dates back to 1878, was one of the earliest undertakings in the United States to provide a real means for developing social and commercial interchange within the Western Hemisphere.

Today All America Cables and Radio, Inc. maintains offices at all important points in twenty-four countries or islands and is by far the largest system of telegraphic communication connecting the U. S. A. and Latin America. It wholly owns its terminals, both cable and radio, and its system comprises 24,000 nautical miles of submarine cables, operated duplex, and over 3,000 statute miles of telegraph land lines. It also operates radiotelegraph and radiotelephone stations at Bogota, Colombia, and Lima, Peru.

All America Cables and Radio stations are located as follows:

Argentina—Atalaya, Buenos Aires, Mendoza, Rosario, Villa Mercedes  
 Bolivia—La Paz, Oruro  
 Brazil—Rio de Janeiro, Santos, Sao Paulo  
 Chile—Antofagasta, Arica, Iquique, Los Andes, Santiago de Chile, Tocopilla, Valparaiso  
 Colombia—Barranquilla, Bogota, Buenaventura, Cali, Cartagena, Medellin  
 Costa Rica—Port Limon, Puntarenas, San Jose  
 Cuba—Guantanamo, Havana, Santiago de Cuba, U. S. Naval Reservation at Guantanamo Bay  
 Dominican Republic—Ciudad Trujillo, La Vega, Puerto Plata, San Pedro de Macoris, Santiago de los Caballeros  
 Dutch West Indies—Oranjestad (Aruba) Willemstad (Curacao)  
 Ecuador—Esmeraldas, Guayaquil, Quito, Santa Elena  
 El Salvador—San Salvador  
 Guatemala—Guatemala City, San Jose  
 Haiti—Cap Haitien, Port au Prince  
 Mexico—Salina Cruz  
 Nicaragua—Managua, San Juan del Sur  
 Panama Canal Zone—Balboa, Cristobal  
 Peru—Callao, Lima, Paita, Piura, Tacna, Trujillo  
 Puerto Rico—Mayaguez, Ponce, San Juan  
 Rep. of Panama—Panama City, Colon  
 Uruguay—Montevideo  
 United States—New York  
 Venezuela—Caracas, Coro, La Guayra, Maracaibo  
 Virgin Islands—St. Thomas

### *Commercial Cable Company*

The Commercial Cable Company operates six cables between the United States and Europe and connects in Europe with other cable systems for providing telegraph service to all other parts of the world. These cable circuits, along with those of All America Cables and Radio, Inc., terminate at the operating center in the International Telephone and Telegraph Building in New York. The



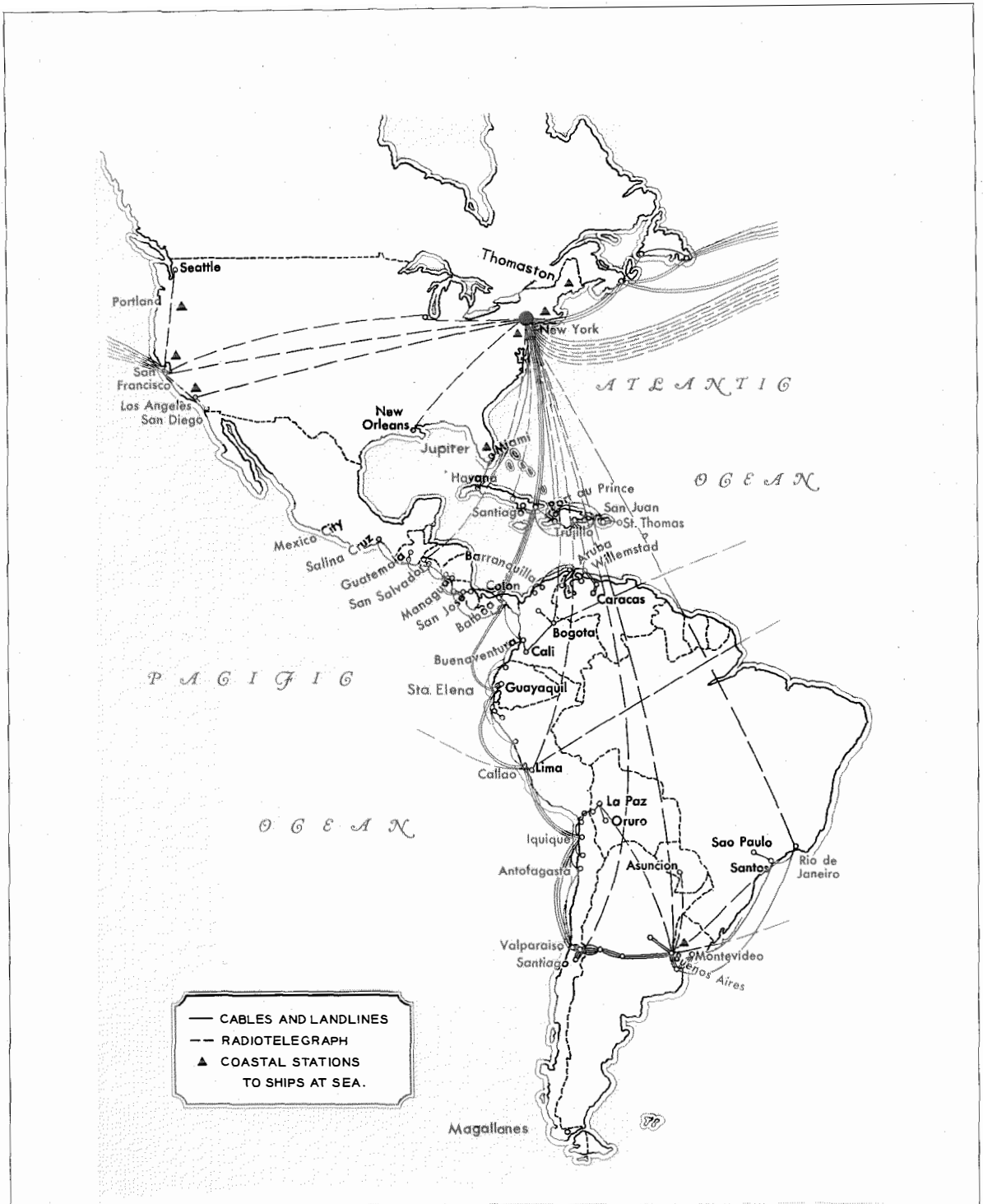

International Cable and Radio Telegraph Connections.

Commercial Cable Company, through its own and interconnecting networks, is thus in a position to furnish very fast service to all parts of Canada and the United States, Latin America, Europe and (via the affiliated Commercial Pacific Cable Company) to the Far East.

#### *Mackay Radio and Telegraph Company*

The Mackay Radio and Telegraph Company, an I.T. & T. subsidiary, was organized under the name of the Federal Telegraph Company in 1911. With headquarters at New York, the company operates a national radiotelegraph network interconnecting the following sixteen cities in the United States: Boston, New York, Philadelphia, Camden, Washington, Baltimore, Chicago, Detroit, New Orleans, San Diego, Los Angeles, San Francisco, Oakland, Seattle, Tacoma, and Portland (Oregon).

Seven powerful coastal stations, four on the Atlantic and three on the Pacific, maintain radio telegraph communication with ships at sea. These stations are interconnected by means of a transcontinental radio circuit terminating in New York and San Francisco.

Internationally, the Company's radiotelegraph service interconnects the United States (through New York), Argentina, Brazil, Colombia, Chile,

Cuba, Peru, and Puerto Rico. The non-U. S. A. stations are owned by other I.T. & T. subsidiaries. The Company's operations also include Haiti, El Salvador, six circuits to Europe, and five circuits (from San Francisco) to the Far East.

A marine department sells or leases, operates and maintains all types of ships' radiotelegraph equipment, providing radiotelegraph service to other ships, airplanes and land stations, as well as navigational aids, such as direction finding apparatus.

#### *Sociedad Anonima Radio Argentina*

The Sociedad Anonima Radio Argentina, an I.T. & T. subsidiary, is an Argentine Corporation and maintains its headquarters at Buenos Aires. It operates a radio telegraph service from its own radio station at Buenos Aires, with circuits to Mackay Radio at New York, to its own radiotelegraph station at Madrid, Spain, to Asuncion, Paraguay, and to Rio de Janeiro where it connects with the station of Companhia Radio International do Brasil, an I.T. & T. subsidiary. It also gives service to ships at sea. This Company has been in operation since 1929.

Radio activities of I.T. & T. subsidiaries in South America and the West Indies are indicated in Part III of this article.

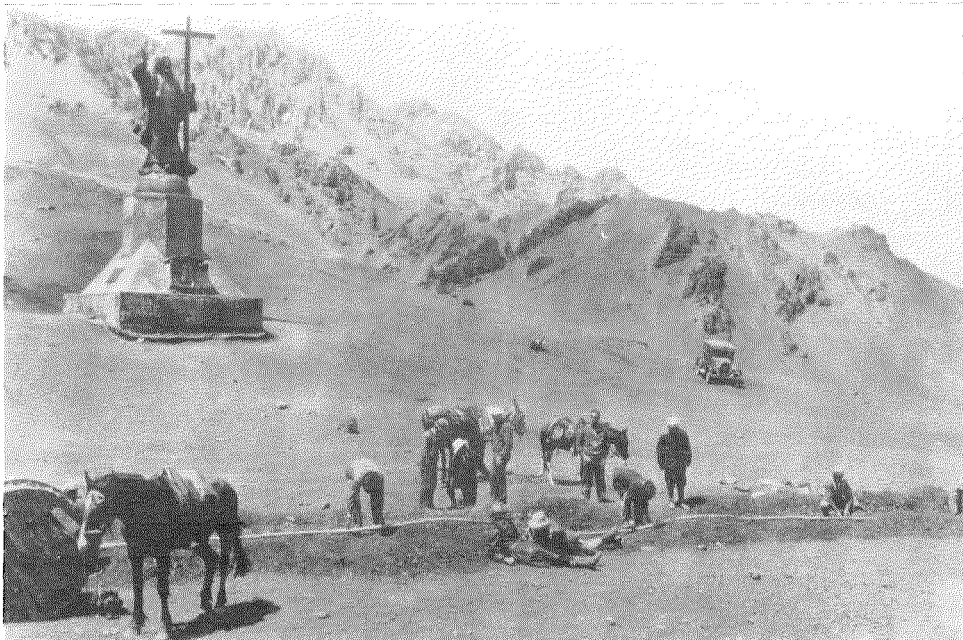

*Construction of the Trans-Andean Telephone and Telegraph Cable between Buenos Aires, Argentina and Santiago, Chile. In the background is the famous statue of Christ of the Andes.*

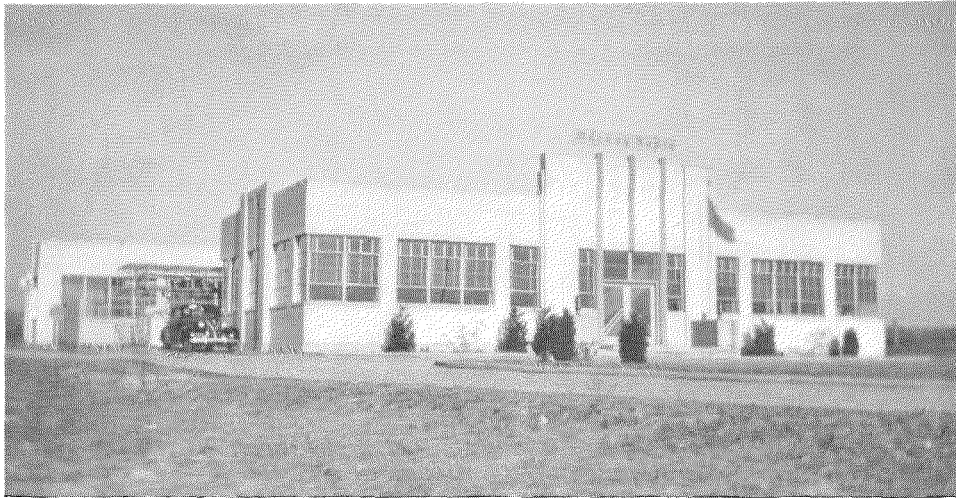

*Mackay Radio and Telegraph Company's Radio Station near Brentwood, Long Island.*

### 1.3 MANUFACTURE AND SALES:

*International Standard Electric Corporation  
Federal Telegraph Company  
International Telephone Development  
Company*

The manufacturing operations of the I.T. & T. are carried on mainly through the International Standard Electric Corporation. Annually it has furnished large quantities of material to South America, Central America, Mexico and the West Indies, including International System Operating Companies and many private and governmental organizations. Approximately one-third of the material shipped has represented exports from the United States, the balance having been supplied principally from I.S.E. factories in Europe. I.S.E. equipment has gone into practically all Western Hemisphere countries with the exception of Canada and the United States. The I.S.E. also acts in an advisory capacity in furnishing technical information and operating advice. Indications are that all of these activities will be continued regardless of world developments.

The Federal Telegraph Company and the International Telephone Development Company manufacture equipment in the United States, chiefly in the radio field. A large portion represents Government business. Orders on hand are

well over twice the annual sales and the prospects, at least during the next few years, point to a rapid growth in business volume.

### **Part II. Telephone Operating Activities by Countries**

#### ARGENTINA

The United River Plate Telephone Company, operating in the Republic of Argentina, was purchased by the International Telephone and Telegraph Corporation in 1929. At the time of acquisition, the United River Plate Telephone Company operated 194,566 telephones; on Dec. 31, 1940 it had 412,931 telephones.

In addition to the United River Plate Telephone Company, which is the largest telephone plant in the Americas south of the United States and also the largest I.T. & T. telephone operating subsidiary, there are in Argentina two smaller I.T. & T. telephone subsidiaries.

Argentina in area is about equal to the eleven Mountain and Pacific States of the U. S. A., and has approximately 13 million inhabitants. Approximately 70% are in the area served by the Companies referred to above.

Buenos Aires, the capital of Argentina, metropolis of South America, third largest city in the

Western Hemisphere and sixth largest city in the world, is the center of communications for South America. It is served by a highly developed multi-office automatic plant comparable in size and facilities with similar installations in large cities of the United States.

From Buenos Aires an extensive, up-to-date toll and long lines system radiates through the rich grain and cattle raising districts, connecting other important centers and lesser communities. Of the total telephones in Argentina, 90% are included in The International System.

Experience clearly indicates that despite the heavy expansion programs already completed, a large unsatisfied demand for telephone service still exists. At the end of 1935 the United River Plate Company had 279,396 telephones; at the end of 1940, as mentioned above, there were 412,931, an increase of 133,535 or 47%. Forecasts indicate that at the end of 1943 the total will be half a million.

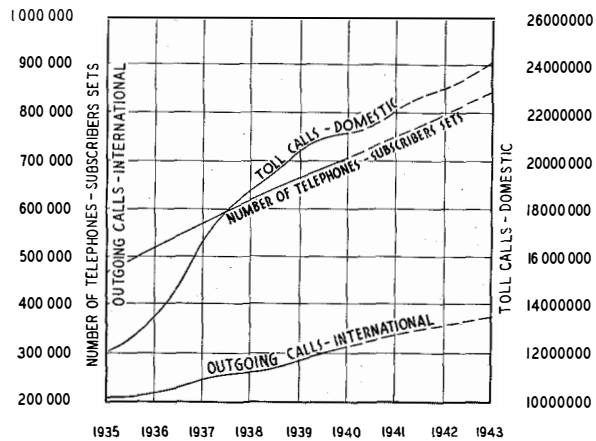
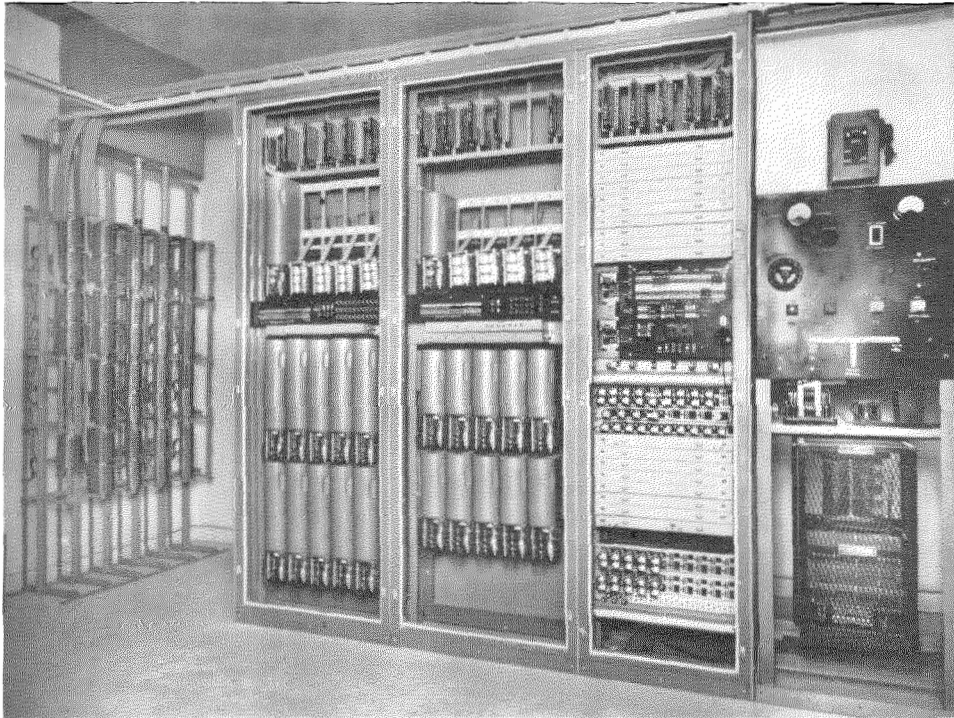

Fig. 1—Telephone Operating Companies in Western Hemisphere. Broken lines in above curves represent forecasts. Data for 1940 (as of end of year) are preliminary and partially estimated.

Along with the growth in telephones in the I.T. & T. Argentina system, the volume of toll business is increasing simultaneously; new lines and circuits, both aerial and cable, must con-



Standard Telephones and Cables, Ltd., London, P.A.B.X. Equipment for 106 Stations. Installed in the Kavanagh Apartment Building, Buenos Aires.

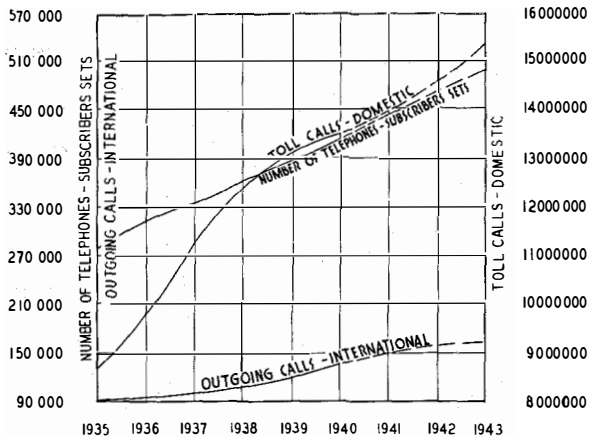

Fig. 2—United River Plate Telephone Company (Argentina). Broken lines in above curves represent forecasts. Data for 1940 (as of end of year) are preliminary and partially estimated.

stantly be added to the toll plant. In 1935, 8,705,000 domestic toll calls were completed; in 1940 the total was 13,446,000 (preliminary figures); and, in 1943, estimates indicate over 15,000,000 from the then 500,000 stations.

International outgoing completed calls were 90,000 in 1935; in 1940, there were 137,000 (preliminary figures). Indications point to 165,000 in 1943.

Connection with Chile is ensured by a buried cable—the highest in the world—passing over the Andes Mountains. It was laid by All America Cables and Radio, Inc.

Data on the United River Plate Telephone Company (Argentina) showing actual and anticipated growth is given in Fig. 2.

Montevideo, the capital of Uruguay, on the other side of the River Plata from Buenos Aires, is reached through submarine cables of the Compania Telegrafico-Telefonica del Plata, in which the I.T. & T. has an interest. Through this interest, the I.T. & T. also participates in the Montevideo Telephone Company operating in Uruguay outside of the City of Montevideo.

Telephone connection to other South American countries, Europe, the United States, etc., is given from the Argentine telephones of the I.T. & T. over the radiotelephone circuits of the Compania Internacional de Radio (Argentina), also an I.T. & T. subsidiary.

## BRAZIL

The Companhia Telephonica Rio Grandense in the State of Rio Grande do Sul and the Cia.

Telefonica Paranaense in the State of Parana, Brazil, are subsidiaries of the I.T. & T. Both of these States are in the southern part of Brazil. Each company operates long distance lines as well as the local telephone service, while the Cia. Telephonica Rio Grandense also gives telegraph service. Telephones of these I.T. & T. subsidiaries on Dec. 31, 1940 totaled 24,197.

### Cia. Telefonica Paranaense

The Cia. Paranaense operates a local and long distance telephone system in Curityba, the capital of the State of Parana, and in cities including Paranagua, Punta Grossa, Antonio, Castro, and Irati, all of which are interconnected by toll lines. The State of Parana has an area of 93,209 square miles and a population of 1,095,664, largely in the territory served by the Cia. Telefonica Paranaense. Principal products of this region are timber, coffee, cereals and beans.

Parana is separated only by the State of Santa Catharina from the State of Rio Grande do Sul in which the Cia. Telephonica Rio Grandense operates.

From the end of 1935 to the end of 1940 the number of telephones in the Cia. Telefonica Paranaense increased from 2,781 to 5,095; and, in the same period, completed toll calls rose from 61,689 to 148,000 (preliminary figures). On the basis of minimum growth, 5,995 telephones are projected for 1943; completed toll calls for that year are expected to reach 178,000 (Fig. 3).

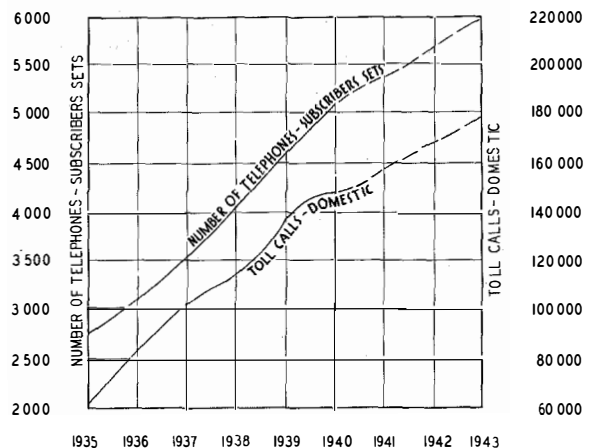
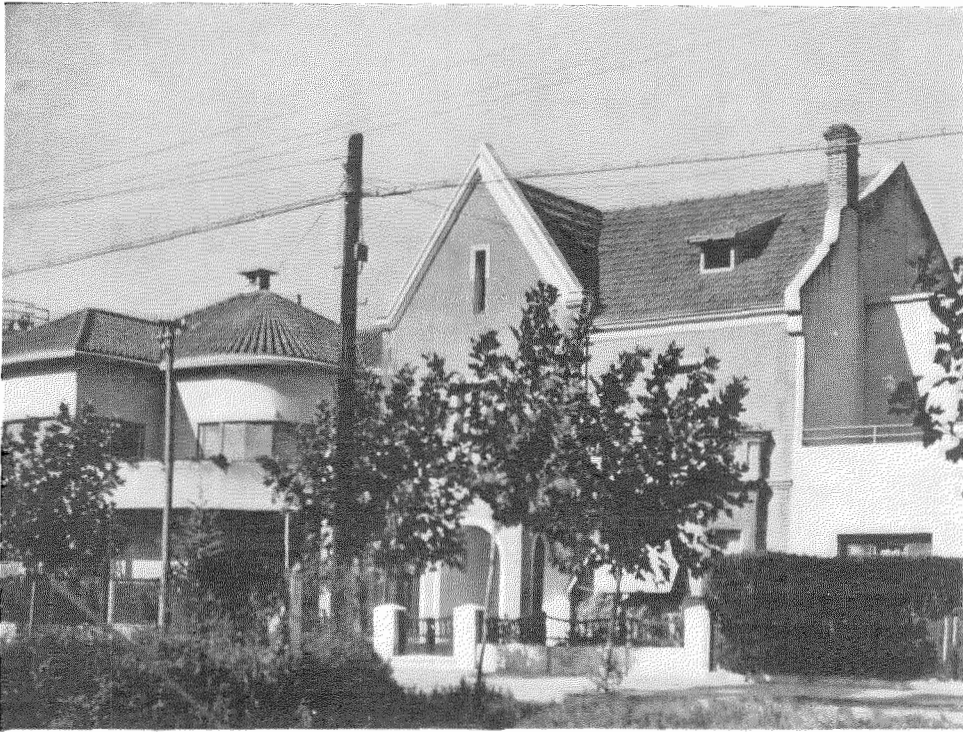

Fig. 3—Cia. Telefonica Paranaense (Brazil). Broken lines in above curves represent forecasts. Data for 1940 (as of end of year) are preliminary and partially estimated.



*Aerial Cable Distribution in the Suburbs of Buenos Aires.*

### *Cia. Telefonica Rio Grandense*

Under the terms of its original concession in the State of Rio Grande do Sul, the Cia. Telefonica Rio Grandense, subsidiary of the I.T. & T., operates a telephone service in Porto Alegre, the capital, and the various principal municipalities of the State, interconnected by toll lines. Subsequently, permission for the operation of intrastate telephone and telegraph services was granted by an additional concession which, more recently, was amplified to include international communication with Argentina and Uruguay.

Rio Grande do Sul has an area of 91,310 square miles and a population of about 2,200,000. The climate is temperate, the pastures are rich, and the soil arable. Principal products are meat, wool, fruits and cereals.

At the end of 1935 there were 13,309 stations in the Telefonica Rio Grandense network. At the end of 1940 the number of telephones was 19,102

and it is estimated, on the basis of actual growth figures, that there will be 23,002 at the end of 1943 (Fig. 4).

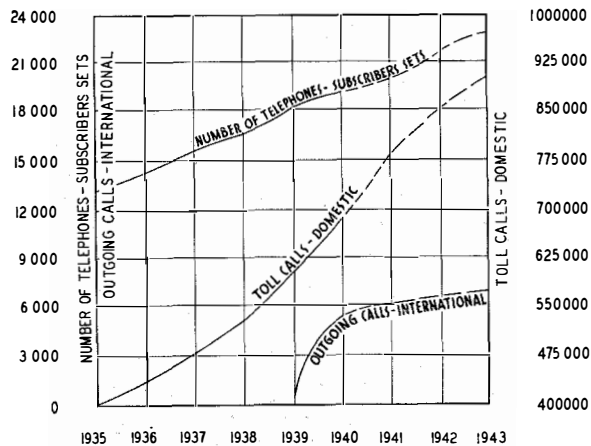

*Fig. 4—Cia. Telefonica Rio Grandense (Brazil). Broken lines in above curves represent forecasts. Data for 1940 (as of end of year) are preliminary and partially estimated.*

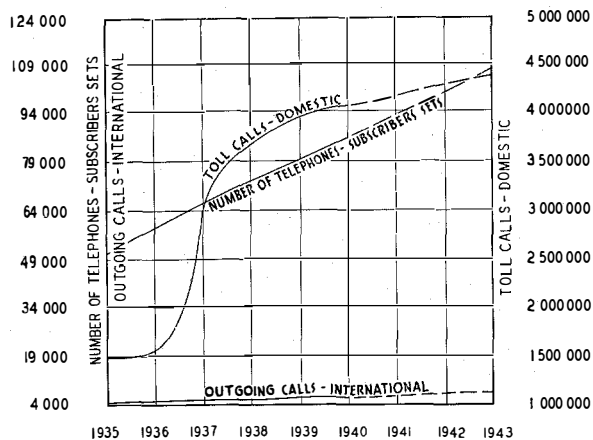

Fig. 5—Cia. de Telefonos de Chile. Broken lines in above curves represent forecasts. Data for 1940 (as of end of year) are preliminary and partially estimated.

First steps toward furnishing international toll service were taken in 1939 when company lines in the western city of Uruguayana were linked up with Argentina. Partial results to date indicate that in 1943 there will be 7,000 completed outgoing international calls over the new lines.

#### CHILE

The Compania de Telefonos de Chile, an I.T. & T. subsidiary, under the terms of a fifty year contract negotiated in 1929, owns and operates the Chilean local and long distance telephone system.

Chile has a population of 4,626,508 and the elongated formation of the country presented an unusual telephone problem. An extensive system of long lines supplemented by radio telephony has been provided to interconnect the most distant and widely separated points. At the end of 1940 the Chilean Company had 86,159 telephones. The networks comprise three main nuclei: first and most important, the cities of Santiago and Valparaiso, and immediately adjacent territory; second, the cities of Talca, Concepcion, Temuco and nearby areas, all of which are interconnected by land toll routes and with the main system in and around Santiago and Valparaiso; and third, Antofagasta and Iquique, centers of the great nitrate and copper mining industries. Antofagasta is connected by radiotelephone with Santiago, as is the far southern Magellanes station of the Chilean Air Force.

The telephone plant in all the towns and cities is modern. Santiago, Valparaiso and its suburb, Vina del Mar, are provided with full automatic service.

From the end of 1935 to the end of 1940, the number of telephones increased by 35,007, a growth of 68%. By the end of 1943, forecasts indicate that there will be a further growth of 21,000, or a total of 107,159 telephones.

Completed domestic toll calls in 1935 were 1,498,000; in 1940 preliminary figures indicate 4,061,000. Since the volume of toll business may be expected to expand as the number of telephones increases, further additional toll circuits will undoubtedly be required. The forecast for 1943 indicates 4,382,000 completed domestic toll calls or 321,000 more than in 1940 (Fig. 5).

International radiotelephone service is given from Chile to Bogota (Colombia), Lima (Peru), and Tokyo (Japan). The main outlet for international toll traffic from Chile is over the landlines and trans-Andean cable to Buenos Aires where Chile is linked to the United States and other parts of the world by radio. Radio links include the I.T. & T. subsidiaries: Cia. International de Radio (Chile) and Cia. International de Radio (Argentina). In case of emergency or trouble on the trans-Andean cable, a radiotelephone circuit is available between Santiago and Buenos Aires.

During 1940, the 86,159 telephones then in Chile originated 6,800 international toll calls; during 1943 forecasts indicate that 107,159 telephones will originate 7,500 international calls.

#### CUBA

The Cuban Telephone Company, one of the first two Operating Telephone Companies to join the International System family, was acquired by the I.T. & T. in 1920. The management has consistently and systematically built up a modern local and long distance plant extending over the entire island. On Dec. 31, 1940, there were 59,158 telephones in the Cuban network; automatic service is furnished to 92% of these stations.

Automatic equipment has been installed in Havana and its environs and in all of the other principal cities. In addition to Havana, there are

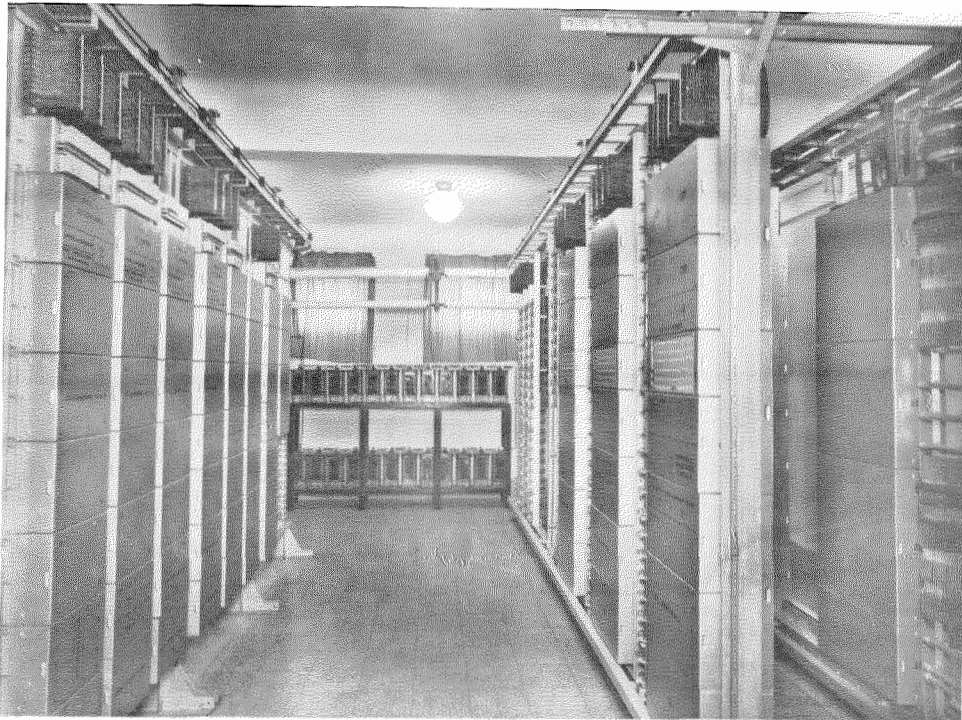

General View of 350 Line Ministerio Obras Publicas de la Nacion 7-D P.A.B.X. Equipment. Supplied by Bell Telephone Manufacturing Company, Antwerp, Belgium.

ten cities with automatic exchanges and 139 offices with manual service.

By the end of 1938, in some localities, growth had exhausted the capacity of the plant which had been left spare by the adverse economic conditions prevailing in the early 1930's. During 1940, 2,000 lines of equipment were added and, by the end of 1943, it is estimated that further additions totaling 8,000 lines will be needed to provide for expansion. From 37,943 telephones in Cuba in 1935, an increase occurred up to the end of 1940 of 21,215. In the period from 1941 to 1943 a further gain is anticipated, bringing the total to 68,158.

A substantial and comprehensive toll plant interconnects the various exchanges. Completed domestic toll calls in 1940 totaled 900,000 (preliminary figures); during 1943, 1,100,000 are indicated. International outgoing completed toll calls are expected to increase from 11,000 in 1940 to 14,000 in 1943 (Fig. 6).

Cuba's telephones are connected with the United States and the rest of the world through the previously mentioned (four) Havana-Key West telephone-telegraph cables.

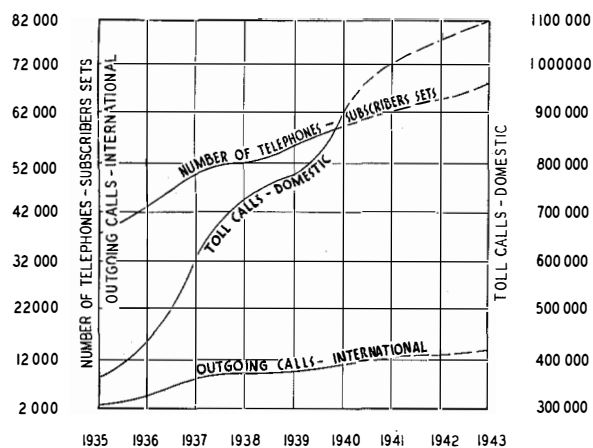

Fig. 6—Cuban Telephone Company. Broken lines in above curves represent forecasts. Data for 1940 (as of end of year) are preliminary and partially estimated.



MEXICO

The Mexican Telephone and Telegraph Company, one of the two principal telephone systems serving Mexico, was acquired by the I.T. & T. in 1925. Since then a system of toll and long distance lines, including facilities from Mexico City to Laredo, Texas, has been constructed. In 1927 service was inaugurated between Mexico and the United States and, subsequently, with the rest of the world.

In 1935 there were 89,324 completed outgoing calls from the Mexican Telephone Company to the United States; in 1940, nearly 115,000. A continuation of this steady increase points to a volume of 129,846 during 1943.

Over the same period, the domestic toll traffic has likewise increased; in 1935 there were 467,312 completed domestic toll calls; in 1940 there were 736,900.

Growth in telephones of the Mexican Telephone and Telegraph Company from 1935 to 1940 was 25,149, an increase of over 50%. At the end of 1943, 84,794 telephones are forecast (Fig. 7).

Automatic telephone service is rendered in Mexico City, Tampico, Guadalajara and Puebla. Modern manual service is provided in other communities.

PERU

The Compania Peruana de Telefonos was formed by the I.T. & T. in 1930 to take over the

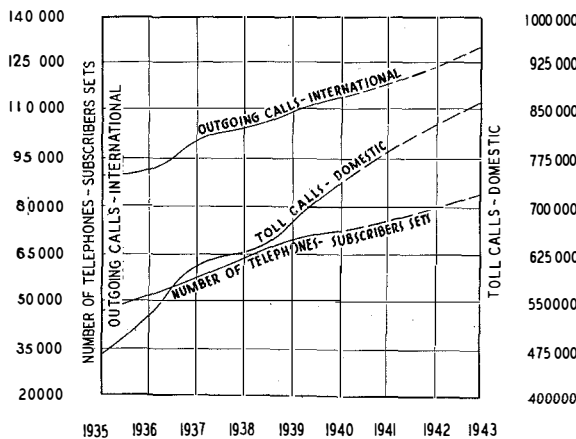

Fig. 7—Mexican Telephone Company. Broken lines in above curves represent forecasts. Data for 1940 (as of end of year) are preliminary and partially estimated.

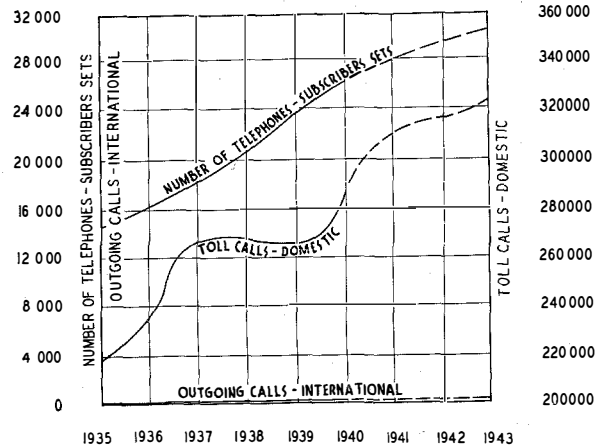

Fig. 8—Cia. Peruana de Telefonos. Broken lines in above curves represent forecasts. Data for 1940 (as of end of year) are preliminary and partially estimated.

operation of the telephone system in Lima, the capital, Callao, the main seaport on the Pacific Ocean, and the surrounding territory. There were then only 10,072 telephones in the area served. Plans were immediately drawn up, and in due course executed, to replace the antiquated and obsolete plant by completely new, modern automatic equipment. This undertaking was fully justified by subsequent developments: by Dec. 31, 1940, telephones in service, over 99% automatic, had increased to 26,084.

Greatest concentration of the 6,600,000 population of Peru is in the area served by the Compania Peruana de Telefonos. In the four years preceding 1940, the growth in telephones was 8,975, an increase of 60%. While such a rate of growth is too high to continue indefinitely, it is indicative of a large potential demand for telephone service. During 1940 and the three years including 1943, it is anticipated that the gain in telephones will be 7,288, bringing the total up to 30,924 (Fig. 8).

Completed domestic toll calls amounted to 286,800 (preliminary figures) in 1940. With the growth in telephones, the toll business is likely to increase proportionately, and it is estimated at 322,000 completed calls in 1943.

International telephone connections are available to subscribers of the Compania Peruana de Telefonos over the radiotelephone circuits of the Lima radio station of All America Cables and Radio, Inc. This station serves as a link to the

United States and Canada through interconnection with the Bell System; also to Bogota, Santiago, Buenos Aires, and other points in South America through interconnection with other I.T. & T. subsidiaries.

PUERTO RICO

The Porto Rico Telephone Company, an I.T. & T. subsidiary, operates a complete local and long distance telephone system providing service over the entire Island of Puerto Rico. About half of the telephones in Puerto Rico are in the adjoining principal cities of San Juan and Santurce. Plans are under way to convert this area to automatic working.

The Porto Rico Telephone Company had 13,555 telephones in service at the end of 1935. An increase of 28% brought the number of telephones to 17,454 at the end of 1940. Indications are that at the end of 1943 there will be 19,529 telephones in service.

During 1935 completed domestic toll calls totaled 508,734; for 1940 and 1943 (partially estimated) comparable figures are 639,000 and 690,000, respectively (Fig. 9).

Puerto Rican telephones connect with the rest of the world via the United States through the radiotelephone station of the Radio Corporation of Porto Rico, an I.T. & T. subsidiary. During 1940, some 2,100 completed outgoing international calls were handled; 2,500 are indicated for 1943.

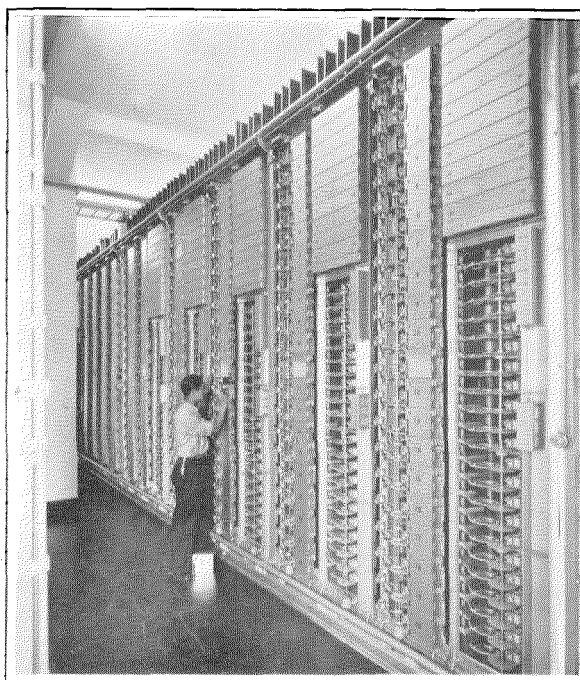

7-A.2 Rotary Automatic (Bell Tel. Mfg. Co., Antwerp, Belgium) Equipment, Washington Office, Lima, Peru.

Part III. Radio Activities by Countries

ARGENTINA

The Compania Internacional de Radio (Argentina), an I.T. & T. subsidiary, inaugurated radiotelephone service with the United States on April 3, 1930, thus interconnecting telephone subscribers in Argentina, the United States and Canada. The service developed slowly with an initial usage of approximately three calls a day at a rate of \$10.00 per minute. Through the years of improved service and rate reductions, the need for radiotelephone service increased to the extent that in 1940 the New York-Buenos Aires circuit handled approximately 14 calls a day at a rate of \$5.00 per minute.

Through the Argentina station the 40,000 telephones in Uruguay were made accessible to subscribers in North America over the previously mentioned submarine cable between Argentina and Uruguay.

The facilities of the Compania Internacional de Radio (Argentina) were developed as the hub of South American radiotelephone communications. Service has been extended from Buenos Aires to Rio de Janeiro (Brazil), Maracay (Vene-

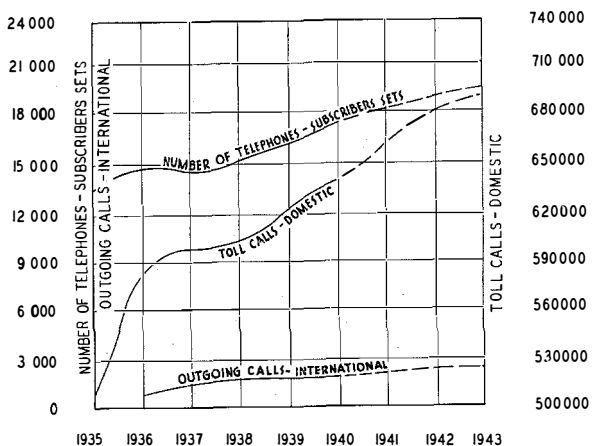
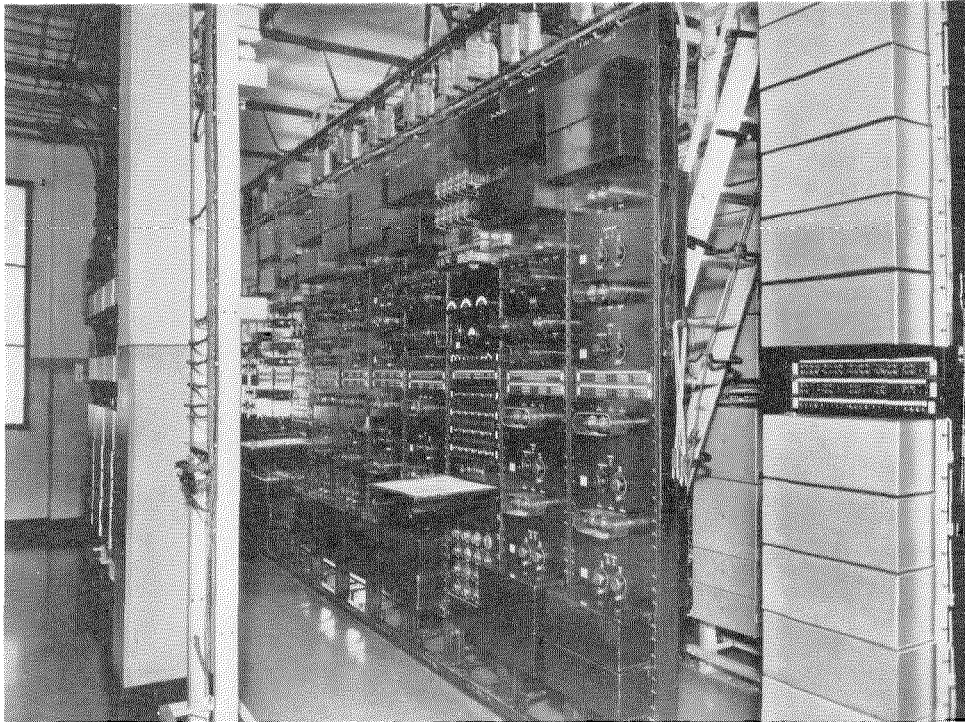

Fig. 9—Porto Rico Telephone Company. Broken lines in above curves represent forecasts. Data for 1940 (as of end of year) are preliminary and partially estimated.



*Lujan Repeater Station at the Terminal of One of the Buenos Aires Toll Entrance Cables. Three-channel Carrier Terminals, Type C3 (Standard Telephones and Cables, Ltd., London) Equipment with Broadcast Type Carrier Line Filters.*

zuela), Lima (Peru), Bogota (Colombia), and La Paz (Bolivia) as well as to ships at sea.

Services have not been confined wholly within the Western Hemisphere. Circuits have been established to Madrid, Paris, Berlin, and London.

In addition to radiotelephone service, the company inaugurated radiotelegraph service as an adjunct communication development within the Western Hemisphere.

Through close cooperation with the Department of Posts and Telegraphs, the Compania Internacional de Radio (Argentina) has devoted the use of a powerful short wave transmitter to evening broadcasts for the Argentine Government. These broadcasts are non-commercial and devoted to programs of peace and good will throughout the Americas.

The dissemination of local and foreign news amongst the South American countries has increased consistently. The company has rendered substantial assistance in working out distribution

for the United Press of short wave telegraphic news broadcasts.

The company's facilities have proved useful in furthering technical, political and humanitarian development. Cooperation to the fullest extent in developing interchanges of programs between the Americas is an established policy.

Radiotelegraph services to New York, Madrid, Rio de Janeiro and Asuncion, Paraguay are supplied from its main radiotelegraph station by the Sociedad Anonima Radio Argentina. A radiotelegraph service was also established by this Company with Prague, Czechoslovakia, some years ago.

#### BOLIVIA

In 1939 the I.T. & T. subsidiary, Compania Internacional de Radio Boliviana, constructed a station in La Paz, offering radiotelephone and radiotelegraph services to Buenos Aires. Radio-

telephone service later was extended through Buenos Aires to other South American Republics, Canada and the United States.

#### BRAZIL

In 1930, the Companhia Radio Internacional do Brasil, an I.T. & T. subsidiary, constructed a high-powered station in Rio de Janeiro, offering service from the 200,000 telephones of Brazil's federal capital to the United States and Canada. Subsequently, its services were extended to Buenos Aires and Madrid.

Initially (1930), the company averaged less than one call a day at a rate of \$10.00 per minute. In 1940, the Rio de Janeiro-New York circuit handled approximately ten calls a day at \$.50 per minute.

Through the cooperation of the Companhia Radio Internacional do Brasil and the Columbia Broadcasting System, broadcast programs were exchanged in 1939 and 1940 between Brazil and the United States. These non-commercial pro-

grams of a high musical and cultural standard were undertaken solely to foster good will between the two countries.

To supplement the radiotelephone service offered by the Companhia Radio Internacional do Brasil, radiotelegraph circuits have been opened to the United States and to Argentina.

Population distribution in Brazil has developed in concentrated but widely separated areas so that telephone intercommunication is not available in many of the principal points of the Republic. Since the need for closer coordination is evident, the Companhia Radio Internacional do Brasil has now pending before the Brazilian Government applications for the establishment of a number of new radio stations in order that Rio de Janeiro and widely separated areas may be interlinked telephonically.

#### CHILE

In 1929, prior to the laying of the trans-Andean cable, the Compania Internacional de

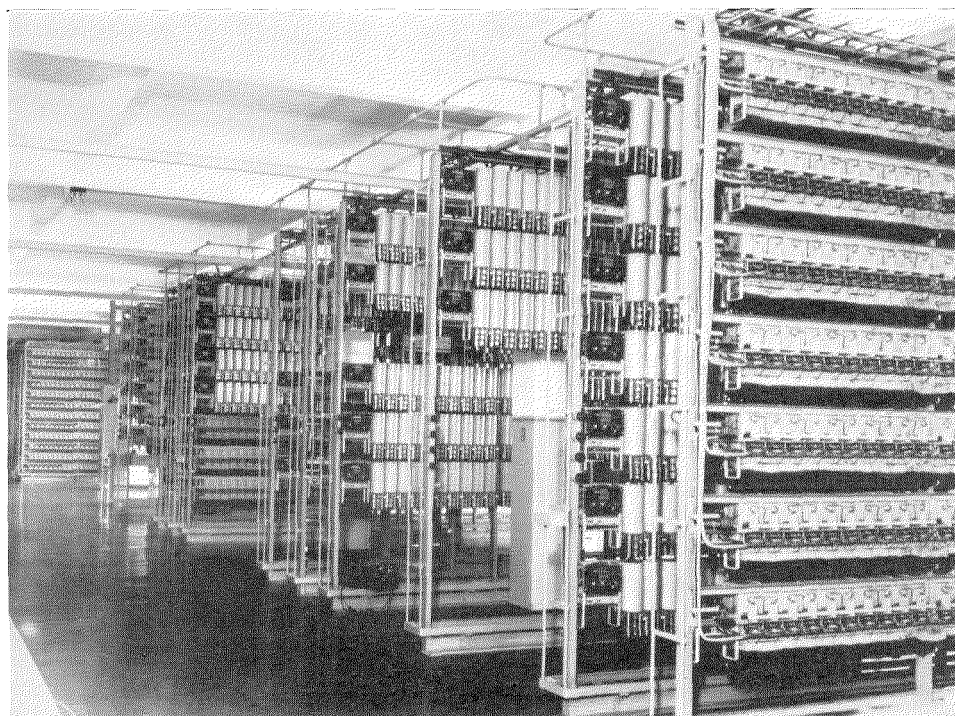

*Gomez Office, United River Plate Telephone Company. View of Selector Racks and Relay Panels. Standard Telephone and Cables, Ltd., London, Step-by-Step Automatic Equipment.*

Radio (Chile), an I.T. & T. subsidiary, constructed a radio station at Santiago and offered temporary service to Buenos Aires.

Service from the Santiago station subsequently was opened to Bogota and Lima. Facilities also were made available for direct service to New York and Buenos Aires as emergency routes in the event of interruption of communications via the trans-Andean cable.

Chile represents a geographical problem of communications between widely separated areas, similar to Brazil. Through cooperation with the Chilean Government, radiotelephone service was established with the southernmost point, Magallanes. Similarly, the northern areas, Antofagasta and Iquique, so well known for their production of nitrate and copper, were included in the plan by the establishment of a radio station at Antofagasta, providing communication to Santiago.

The Compañia Internacional de Radio (Chile) also established direct radiotelephone communication to Tokyo and radiotelegraph service to New York.

The company has been instrumental in assisting the Chilean Government in nation wide, short wave broadcasts, as well as program transmissions including the Magallanes and Antofagasta areas.

#### COLOMBIA

Colombia was interconnected telephonically with her sister South American republics only after All America Cables and Radio, Inc. constructed its radio station at Bogota in 1930. Direct radiotelephone circuits were opened with Buenos Aires, Santiago and Lima; also, by indirect routing, with other South American countries.

As an additional public service, radiotelegraph service was established with New York and Berlin. Circuits also were inaugurated with the cities of Medellin and Cucuta (Colombia).

#### PERU

In 1931, All America Cables and Radio, Inc. constructed a radio station in Lima, opening service with the American Telephone and Telegraph Company on October 14, 1932, thus making the 23,000 telephones of Lima and Callao

available for communication with Canada and the United States.

The company extended its radiotelephone services to Santiago, Buenos Aires, and Bogota, and also relayed traffic to other South American points with which direct circuits are not maintained.

The Lima station, in addition, inaugurated a circuit with Rome and, via Santiago, extended its service to Japan.

Radiotelegraph circuits also have been opened with New York, Rome, Berlin and, more recently, Tokyo.

#### PUERTO RICO

The Radio Corporation of Porto Rico, incorporated in 1922 as a subsidiary of the I.T. & T., constructed the broadcast station WKAQ. It operated as the sole broadcaster in Puerto Rico until 1934 and has continued to offer a valuable public service not only in Puerto Rico but also to the surrounding islands in the Caribbean. In 1936 the Corporation constructed a new station for radiotelephone service, connecting with the American Telephone and Telegraph Company's station in Miami, Florida, thus making the 17,000 telephones in Puerto Rico available for service to the United States and Canada, as well as to the South American countries previously mentioned. Radiotelephone service also has been inaugurated with the Republic of Santo Domingo, the Republic of Haiti, and with ships at sea. The steady growth of radiotelephone service from Puerto Rico has increased the number of calls from an average of seven a day at a rate of \$5.00 per minute to approximately sixteen a day at a rate of \$2.00 per minute.

Broadcast station WKAQ has become affiliated with the Columbia Broadcasting System and has contributed substantially towards promoting interchange of Puerto Rico and United States programs.

#### Summary

To indicate in perspective the scope of The International System in the Americas, its pertinent constituent companies are listed below. In most cases their names convey some indication of the character of their activities.

### THE INTERNATIONAL SYSTEM

---

INTERNATIONAL TELEPHONE AND TELEGRAPH CORPORATION  
 INTERNATIONAL STANDARD ELECTRIC CORPORATION  
*Licensee Manufacturing and Sales Companies*  
 INTERNATIONAL TELEPHONE DEVELOPMENT CO., INC.



UNITED RIVER PLATE TELEPHONE Co., LTD. (Argentina)  
 COMPANIA TELEFONICA ARGENTINA  
 COMPANIA TELEGRAFICO-TELEFONICA COMERCIAL (Argentina)  
 COMPANHIA TELEFONICA PARANAENSE LIMITADA (Brazil)  
 COMPANHIA TELEFONICA RIO GRANDENSE (Brazil)  
 COMPANIA DE TELEFONOS DE CHILE  
 CUBAN TELEPHONE COMPANY (Cuba)  
 MEXICAN TELEPHONE AND TELEGRAPH COMPANY (Mexico)  
 COMPANIA PERUANA DE TELEFONOS LIMITADA (Peru)  
 PORTO RICO TELEPHONE COMPANY (Puerto Rico)



COMPANIA INTERNACIONAL DE RADIO (Argentina)  
 COMPANHIA RADIO INTERNACIONAL DO BRASIL  
 COMPANIA INTERNACIONAL DE RADIO BOLIVIANA  
 COMPANIA INTERNACIONAL DE RADIO, S. A. (Chile)  
 RADIO CORPORATION OF PORTO RICO



ALL AMERICA CABLES & RADIO, INC.  
 SOCIEDAD ANONIMA RADIO ARGENTINA  
 COMMERCIAL CABLE COMPANY  
 MACKAY RADIO AND TELEGRAPH COMPANY  
 FEDERAL TELEGRAPH COMPANY



### ROY C. HOPGOOD

General Patent Attorney of the International Telephone and Telegraph Corporation, passed away at East Orange, New Jersey, on November 26, 1940. His services to the telephone industry covered a period of thirty-one years as cable engineer and patent attorney for the Western Electric Company in Chicago and New York; patent attorney for the I.T. & T. and its subsidiaries in Europe; and, for the past five years, General Patent Attorney for The International System.

Mr. Hopgood was a native of Morganfield, Kentucky, and was graduated in 1906 from the University of Kentucky as a Mechanical Engineer. He immediately entered the employ of the Western Electric Company at its Hawthorne, Illinois, factory as a cable engineer and in four years became cable development engineer. During this time he studied law and qualified

as an attorney. This led to his transfer to the Patent Department, Western Electric headquarters in New York, where he distinguished himself in the handling of patent matters concerned with the development of electrical communications.

In 1924 Mr. Hopgood was assigned to London, England, as Patent Attorney for the International Western Electric Company. After the properties of the International Western Electric Company were purchased by the I.T. & T. in 1925, and the International Standard Electric Corporation was organized, Mr. Hopgood remained in Europe in the service of the latter corporation.

He returned to New York to the I.T. & T. Patent Department in 1930 and was appointed General Patent Attorney for The International System in 1936. He was well known and highly regarded in the communications industry throughout the world.

Mr. Hopgood was 54 years of age and formerly First Reader of First Church of Christ Scientist, Montclair, New Jersey. He is survived by his widow, Mrs. Margaret Brown Hopgood, and two sons, Roy C. Hopgood, Jr., and Robert B. Hopgood, a flying cadet in the U. S. Navy.

### WILLIAM H. CAPEN

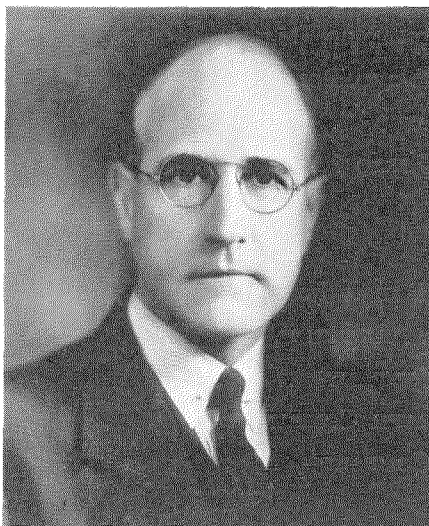

Assistant Vice President and Assistant General Technical Director of the International Telephone and Telegraph Corporation and of the International Standard Electric Corporation, died at Orange Memorial Hospital, East Orange, New Jersey, on January 15, 1941, after a brief illness. He was a specialist in transmission engineering and, amongst his other duties, he had acted in an advisory capacity in connection with communication transmission problems of Government administrations and private companies in Europe, South America, and Japan, as well as in the United States.

Mr. Capen was born in Newton, Mass., on August 13, 1890, and was graduated by Harvard, cum laude, in 1913; in 1914 he was awarded the Master's Degree in Electrical Engineering by Harvard University. He

entered the employ of the Western Electric Company in New York in 1914, and in 1921 was made Engineer in Charge of Transmission Problems. In 1922 he was transferred to the International Western Electric Company. When the International Telephone and Telegraph Corporation purchased the International Western properties in 1925 and the International Standard Electric Corporation was organized, Mr. Capen's services became available not only to the International Telephone and Telegraph Corporation's manufacturing companies (mainly the I.S.E.C. group of companies) but also to the I.T. & T. operating telephone companies.

Mr. Capen has been President of the School Board, President of the Art Association, Member of the Board of Governors and Chairman of the Board of Trustees of the First Church of Christ Scientist, Mountain Lakes, New Jersey. He was a member of Pi Eta, Downtown Harvard Lunch Club, Institute of Radio Engineers, American Institute of Electrical Engineers, Radio Club of America, Acoustical Society of America, New York Electrical Society, the Association of American Railroads and the Telephone Pioneers of America.

His straightforwardness and spirit of helpfulness will long be keenly missed by his professional associates and friends in many countries.

He is survived by his two daughters, Priscilla Marsten and Joanne Raymond Capen of Mountain Lakes, and his sister, Mrs. Charles J. Bryan of Nutley, New Jersey.



### LOUIS JEAN JOSEPH SCHREIBER

Works Manager of the Bell Telephone Manufacturing Company, Antwerp, passed away on January 31, 1941 in New York City at the age of fifty-nine. He was a native of Antwerp, Belgium.

His entire business and professional career, extending over forty-four years, was devoted to the International Telephone and Telegraph group and their predecessor companies.

Mr. Schreiber was perhaps best known for his work as a telephone apparatus designer. Particularly during the period 1927-1934 when he was engaged in development engineering in Laboratoires L.M.T., Paris, he contributed substantially to the design of the apparatus for the 7-A2 Rotary Automatic System as well as to the development of subscribers' sets, including dials, handsets and the component transmitters and

receivers. The internationally known "Antwerp" telephone set is a product of his ingenuity.

In 1934 he returned to Antwerp and filled the position of Works Manager of the Bell Telephone Manufacturing Company. Here he did much to further the application of thermoplastics and die-casting to the communication art and also introduced the most up-to-date shop practices, including progressive assembly and modern inspection methods. Patents to his credit total forty-six.

During his career Mr. Schreiber visited numerous manufacturing plants in a number of countries and made several trips to the United States. He was well known in communication circles, including administrations, telephone operating companies, and manufacturers. His personality was quiet, unassuming, and friendly; his cooperative spirit was always in evidence. He was receptive to the ideas of others and was well liked and greatly respected. His memory will long be cherished by his family and his many friends.

He is survived by his wife, the former Miss Catherine Martin, a son, Paul, and a daughter, Mrs. Robert Van Beurden.



# The Inverted Amplifier\*

By C. E. STRONG

*Standard Telephones and Cables, Ltd., London, England*

***By Applying the Input Excitation in Series with the Cathode of a Power Amplifier, with the Grid Grounded, Important Advantages for High-frequency Operation are Gained Since the Grid Acts as a Shield and the Output Capacitance is Reduced***

THE term "inverted amplifier" is applied to vacuum tube amplifiers in which the grids are grounded and the driving excitation is applied to the cathodes. The basic form of the arrangement and its equivalent circuit are shown in Fig. 1.

It is evident from first principles that if the grid is maintained at zero potential and the cathode is driven in the positive direction, then the anode becomes more positive with respect to the cathode and, therefore, still more so with respect to zero. Therefore, the anode circuit e.m.f. is developed in series and in phase with the driving voltage and the driver and amplifier operate in series to feed power to the load resistance. It follows that the power delivered to the load is the sum of the powers delivered by the driver and by the amplifier less any power from the driver which might be absorbed in the amplifier grid circuit. It follows also that the power delivered by the driver into the output load is equal to the power delivered by the amplifier multiplied by the ratio between the alternating cathode-to-grid and the anode-to-cathode voltages.

Since the amplifier is effectively in series with the driver, the output current passes through the resistance of the driver, causing a voltage drop in that resistance in the sense to subtract from the original driving voltage. This means that reverse feed-back is inherent in the system if the driver has appreciable resistance.

When the amplifier is used at high frequencies the cathode-to-grid and grid-to-anode capacitances must be considered and the circuit becomes as shown in Fig. 2A. From this it appears that the grid acts as a screen between the input and output circuits and hence, for the simplified

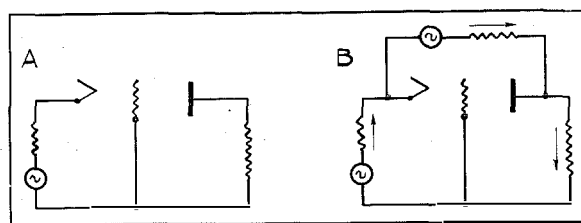

Fig. 1—Actual and Equivalent Circuits of the Inverted Amplifier. The Input and Output Effectively Operate in Series, as Shown in (B).

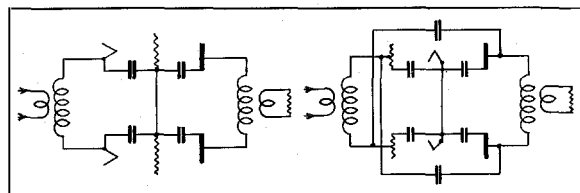

Fig. 2—Simplified Inverted Amplifier (A—left) and Conventional Neutralized Balanced Amplifier (B—right). In the Inverted Amplifier the Output Capacitance is Halved.

case shown, reaction due to the interelectrode capacitances is avoided.

A conventional high frequency amplifier neutralized by the classical capacitance bridge method is shown for comparison in Fig. 2B. It will be observed that the minimum output circuit capacitance in this case is twice that for the equivalent inverted amplifier shown in Fig. 2A, consequently for equivalent operating conditions the minimum output circulating current for the case of the inverted amplifier is only half the value for the conventional amplifier and the maximum permissible output circuit inductance is twice that for the conventional amplifier.

Summarizing the foregoing, the principal features of the inverted amplifier may be stated as follows: First, the driver feeds power in series with the main amplifier into the output load. Consequently, a driver of higher power is required than would be necessary in the case of a normal amplifier. Secondly, reverse feed-back is

\* Reprinted from *Electronics*, July, 1940.

inherent if there is any impedance in the driver. Thirdly, the grid forms a screen wholly or in part between the input and output circuits and, finally, the minimum output circuit capacitance is considerably less than in an equivalent normal balanced amplifier.

Of these features the two latter, namely, the screening effect of the grids and the reduction of output circuit capacitance, are of considerable value in relation to the design of high frequency amplifiers, particularly amplifiers involving high-power tubes operating, for example, at frequencies of the order of twenty megacycles as utilized in high-power short wave broadcasting transmitters or amplifiers working on still higher frequencies as required for television and other purposes.

The advantages of the system as applied to high-power short wave equipment appear when the difficulties arising in the design of conventional balanced amplifiers involving large tubes are considered. First, there are difficulties in the design of the neutralizing (balancing) condensers which, while they may not be physically large, must withstand a high voltage and must be located in restricted positions with respect to the tubes. Secondly, there is increasing tendency to instability because as the size of tubes is increased with resulting increase of interelectrode capacity, the resonant frequency of balancing condenser circuits becomes nearer and nearer to the frequency of operation with the result that selective damping becomes less and less practicable. Thirdly, with increasing anode-to-grid capacity and balancing capacitance, the output circuit capacitance increases to the point when efficiency is impaired and when the resulting reduction of output circuit inductance leads to design limitations.

These difficulties are reduced by use of the inverted arrangement. High voltage balancing capacitances are reduced if not eliminated, and the difficulties of balancing condenser circuit resonances are practically avoided. Also, larger tubes may be used before final limitation due to reduced output circuit inductance is reached. In the case of television amplifiers the reduction of output circuit capacitance simplifies the problem of passing the necessary wide spectrum of side-band frequencies.

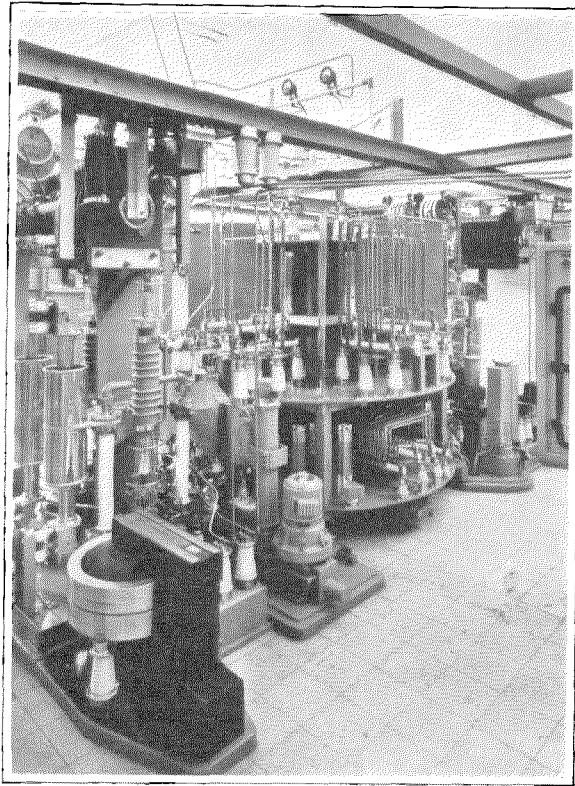

*Two inverted amplifiers, operated in parallel and capable of delivering 100 kw carrier power.*

In practice, particularly with large tubes, the inverted amplifier is more complicated than that shown in Fig. 2B. In the first place, owing to the dimensions of the tubes and the spacing required between tubes in push-pull, there is no possibility of avoiding inductance in the connections between the grids and ground. This means that there would be reactance common to the input and output circuits and there would be feedback on that account unless measures were taken to counteract the effect. Secondly, there is in general leakage capacitance within the tubes from anode to cathode and, finally, there is inductance in the cathode leads within the tubes.

The effect of grid lead inductance can be cancelled by inserting condensers in the grid leads to series tune the inductances and so effectively connect the grids to ground through zero impedance. The condensers must, of course, be variable in an amplifier required to work on several frequencies. The adjustment is sharp, but is easy to control.

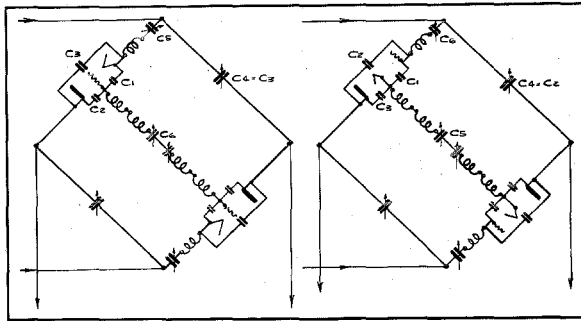

Fig. 3—Neutralization of Inverted Amplifier (A—left) and Conventional Amplifier (B—right). Similar Methods are Used, but the Inverted Amplifier Requires Smaller Balancing Capacitances.

The stray anode-to-cathode capacitance can be neutralized either by shunt inductance, or in the case of a push-pull circuit, by crossed balancing condensers. The former method consists in the insertion of an inductive reactance from anode to cathode of such value as will transmit back to the input circuit a current equal to that transmitted back through the capacitance, but in opposing phase. The second method is the well known capacitance-bridge method generally used in conventional amplifiers to balance the anode to grid capacitances. The shunt inductance method is useful in single-ended amplifiers, and it has the advantage of not giving rise to any increase of output capacitance, but it has the disadvantage of requiring adjustment of the inductance for each working frequency. The balanced capacitance-bridge method is more convenient, at least in the case of push-pull amplifiers. As the values of the capacitances involved are comparatively small, the effect of the inductance of leads in the bridge is not very important and, consequently, sufficient balance can be obtained with fixed balancing condensers over a wide band of frequencies. Furthermore, for the same reasons the bridge has little tendency to give rise to spurious oscillations contrasting favourably in that respect with the higher capacitance bridge in a normal amplifier. The circuit of an inverted amplifier including the provision for neutralizing the grid lead inductance and the cathode to anode capacitance is shown in Fig. 3A. There are also shown in the circuit capacitances to tune out the cathode lead inductances.

The effect of cathode lead inductance, if not tuned out, would be to give rise to feed-back

even if the bridge were perfectly balanced for the condition that current in the output circuit should give no voltage across the corners of the bridge to which the input circuit is connected. The output circulating current traversing the bridge would set up voltages across the cathode lead inductances which would represent excitation of the cathodes. The requirement is, not only that the bridge should be balanced, but also that the cathodes should be at the electrical potential of the corners to which the input circuit is connected; hence it is necessary for perfect neutralization to tune out the cathode lead inductances.

It has appeared from the foregoing that there are three separate measures required to eliminate feed-back due to unavoidable reactances, namely, series tuning of the grid leads, neutralization of the anode-to-cathode capacitances and series tuning of the cathode leads. These are exactly equivalent measures to those required for the neutralization of a normal balanced amplifier as will be seen by reference to Fig. 3B, but there is the difference that in the inverted amplifier the capacitance bridge has to deal only with the relatively small anode-to-cathode capacitances as compared in the other case with the considerably larger anode to grid capacities.

It is an important requirement in the case of an amplifier to be modulated in amplitude for telephony that there should be avoidance of spurious phase modulation. It is evident that an amplifier with constant drive and having modulation applied to the anodes would be subject to this defect if there were feed-back in any phase resulting in a component in quadrature with the driving voltage. The magnitude of the component in quadrature would vary with modulation and, consequently, the resultant driving voltage would be modulated in phase. It is, therefore, of interest to consider the effects arising in an inverted amplifier through imperfect adjustment either of the grid-to-ground condenser or of the neutralization of the anode-to-cathode capacitance.

The effect of grid-to-ground impedance will be considered with reference to Fig. 4. Assume in the first instance that  $C_1$  and  $L_1$  are absent. Then if  $Z$  is a capacitive reactance at the working frequency, the current through the capacitance

leg  $C_2$  and  $Z$  in series leads the terminal voltage of the generators by  $90^\circ$ , and the voltage across  $Z$  lags that current by  $90^\circ$  and hence is in phase with the plate-to-ground and cathode-to-ground voltages. Consequently, when the cathode is positive with respect to ground the grid will also go positive with respect to ground due to the drop across  $Z$  and, therefore, the cathode-to-grid voltage is reduced due to the flow of circulating current in the output circuit. This means that the capacitive reactance between grid and ground gives rise to reverse feed-back.

If, on the other hand, the grid-to-ground impedance is an inductive reactance and if it is of lower value than the reactance of  $C_2$  as would be normal in practice, then the current in the  $C_2Z$  branch is  $90^\circ$  in advance of the plate-to-ground and cathode-to-ground voltages, and the voltage across  $Z$  is  $90^\circ$  in advance of that current and so  $180^\circ$  in advance of the generator voltage and, therefore, when the cathode is positive the grid goes negative. The cathode-to-grid voltage is thus increased by the flow of output circulating current and hence there is positive feed-back. So far there is no feed-back in quadrature under the conditions considered. The result, however, is different when account is taken of  $C_1$ , the grid-to-cathode capacitance. Then the voltage set up across  $Z$  by the output circulating current aids or opposes the voltage of the driver in its effect on the capacitive branch of the input circuit so that there is more or less capacitance current. Thus the power factor of the input circuit is dependent on the value of the output circuit current and anode modulation of the amplifier would give rise to spurious phase modulation.

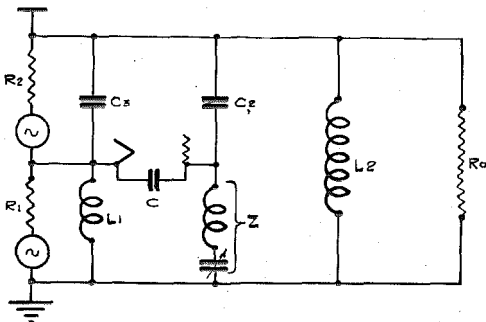

Fig. 4—Effect of Grid-to-ground Impedance, Which may Give Rise to Positive or Inverse Feedback According to Whether the Impedance is Inductive or Capacitive.

As regards the effect of unbalanced anode-to-cathode capacitance, the current through the small plate-to-cathode capacitance  $C_3$  (Fig. 4) would be  $90^\circ$  in advance of the anode voltage and the resulting voltage set up across the driver resistance  $R_1$  would therefore be  $90^\circ$  in advance of the driving voltage. There would therefore be feed-back in quadrature if  $R_1$  were not negligibly small. This feed-back would give dynamic phase modulation if the amplifier were anode modulated and if the driving stage were not also modulated to an equal degree. As the effects in this case are different from those of reaction arising from impedance between grid and ground, it would evidently not be advisable as a rule to attempt to compensate for anode-to-cathode capacitance by adjustment of grid to ground impedance. The feed-back in both modes should be dealt with independently.

Having compensated all feed-back due to the tube reactances we are left with the reverse feed-back inherent to the inverted amplifier due to the passage of the load current through the resistance of the driver. In the case of a linear amplifier it is to be anticipated this effect could be applied for the reduction of distortion. In the case of a fully-excited anode-modulated amplifier the effect is hardly appreciable. The driver is then usually an amplifier driven fully to plate voltage limitation under which circumstances the internal resistance is very low at the operating frequency and the degree of feed-back is therefore small. In this connection, however, it is well to observe that complications are introduced if the driver is connected to the amplifier through a transmission line. It is not very easy to ensure correct termination of the line, and if that is not done the regulation of the driver is impaired and the degree of feed-back is uncertain. It is better to couple the driver to the inverted amplifier through circuits of high kva to kw ratio.

It has been pointed out that it is a characteristic of the inverted amplifier that the driver delivers power into the main load in series with the amplifier. Consequently, if it is required to apply anode modulation for telephony it is necessary, in order to obtain full modulation satisfactorily, to modulate the driver as well as the final amplifier. This, as has been seen, must tend also to reduce the risk of phase modulation.

In the inverted amplifier the filament heating current has to be fed to filaments which are at comparatively high radio frequency voltage. One method is to feed the filaments through shielded transformers having small capacitance between primary and secondary. This is very easily done, but experiment has shown that heating the filaments of a high-power short wave amplifier by alternating current can give rise to serious phase modulation at the fundamental and harmonics of the mains frequency even if the amplitude noise level is sufficiently low. The result is that noise is apparent under conditions of multi-path transmission. It is therefore more satisfactory to adopt d-c heating for the filaments.

The direct current can be fed to the filaments through insulated cables. These can be of a length such that their inductive reactance remains high compared to the capacitive reactance in the amplifier input circuit over a wide band of frequencies. Experience shows, for example, that one fixed length of cable is satisfactory for the whole band of frequencies normally utilized for short wave broadcast transmission.

It is, in some cases, a disadvantage of the inverted amplifier that the driver must be able to deliver considerably more power than would be demanded in an equivalent normal amplifier system, but it is not always disadvantageous as the extra power is usefully transferred to the load giving a higher output power than would otherwise be obtainable with given tubes in the final stage.

The efficiency of the combination of a driver and inverted power amplifier can be somewhat higher than for an equivalent combination utilizing a normal amplifier owing to improved efficiency in the output circuit resulting from the lesser output capacitance, and also in practice there is a further small improvement due to the

fact that there is no necessity to provide a load resistance to ensure stability of the driver, since the latter is loaded by the output resistance.

#### *Examples of Performance*

The following figures exemplify the performance of certain 50 kw Class B modulated inverted amplifiers at present in service in a number of shortwave broadcasting transmitters:

Number of tubes in final amplifier . . . . .	2
Filament emission per tube . . . . .	40 amps
Amplification factor . . . . .	36
D-c anode voltage . . . . .	11,000
D-c grid voltage . . . . .	-1,000
Anode input . . . . .	70 kw
Tube efficiency . . . . .	70%
Power delivered by final stage to output circuit	49 kw
Peak grid swing per tube . . . . .	2,500 volts
Peak anode swing per tube . . . . .	9,500 volts
Power delivered to output circuit by driver . . .	13 kw
Approximate power absorbed by final amplifier grids . . . . .	4 kw
Total output from driver . . . . .	17 kw
Efficiency of driver . . . . .	66%
Input to driver . . . . .	26 kw
Total input to driver and final amplifier . . . .	= 96 kw
Total power in output circuit . . . . .	= 62 kw
Approximate efficiency of output circuit . . . .	95%
Total useful output power . . . . .	59 kw
Overall conversion efficiency . . . . .	62%

It will be noted particularly from the above that of the total carrier power of 59 kw delivered, 13 kw is furnished by the driving stage.

In addition to its application at high power, the inverted amplifier system promises to be of value for low power work at very high frequencies, for example, at frequencies exceeding 300 megacycles. For such applications it has been found effective to utilize special double triode valves constructed so as to have a very low impedance connection between the grids of the two sections, thus eliminating the necessity of providing means to tune out the grid to grid inductance.

# Parliamentary Sound System in the Argentine Chamber of Deputies

By S. D. WILBURN

and

S. C. TENAC

*Unión Telefónica Del Río de La Plata, LTDA., Buenos Aires, Argentina*

**SYNOPSIS:**—*Description of a system of microphones and loudspeakers designed by the Unión Telefónica for the Argentine Chamber of Deputies in Buenos Aires and installed in late 1939. It is believed that this is the first sound installation of similar proportions having all of the following features:*

1. Overall high fidelity reproduction.
2. Individual microphones for each speaker.
3. Practically instantaneous automanual switching of microphones by means of relays actuated by the momentary operation of individual non-locking push buttons mounted with the microphones.
4. Concealed loudspeakers.
5. Stability and margin sufficient to require no attention during operation.

*The system also includes other essential features which it is thought have not been used previously in sound installations.*

FROM the standpoint of appearance, the architecture, furnishings and decorations of the Argentine Chamber of Deputies leave little to be desired. An observer is at once impressed with its atmosphere of stability, utility, quiet, comfort and beauty. However, it would be difficult to find an auditorium with acoustic qualities less suitable for parliamentary purposes. The voice of a speaker at any point on the floor of the Chamber is muted to an unusual degree due to the almost total absence of reverberations.

Fig. 1 is a partial view of the Chamber, looking from above and to the right of the President's chair toward three sectors of deputies' seats and the semi-circular table of the eight ministers.

The National Capitol building in Buenos Aires was constructed during the period 1896—1906; and, beginning with the inauguration of the Chamber of Deputies in the latter year, acoustical difficulties were the subject of frequent complaints and discussions during congressional sessions. A number of investigations were made and, early in 1936, definite steps were taken to improve the acoustical conditions. A system of loudspeakers and microphones was installed. Unfortunately, due to defects in design and the

use of unsuitable equipment, that system proved entirely unsatisfactory, members of the Chamber considering that it made matters worse instead of better. The failure of this first effort toward a solution of the problem left considerable feeling of skepticism as to the utility of loudspeaker installations for this purpose and resulted in general pessimism in regard to the final solution of the particular problem in the Chamber of Deputies.

In December, 1936, the Unión Telefónica installed in the Chamber of Deputies for the use of the Inter-American Congress for the Consolidation of Peace a combined high fidelity translating and loudspeaker system. The success of that installation in overcoming the unfavorable acoustic properties of the Chamber impressed the deputies with the possibilities of a properly designed sound system; hence, they asked the Unión Telefónica engineers to make a full investigation of their problem and to submit a recommendation for its solution. The investigation was immediately carried out and it was found that the acoustical difficulties were due solely to the absence of reverberation, brought about mainly by the following conditions in the Chamber:

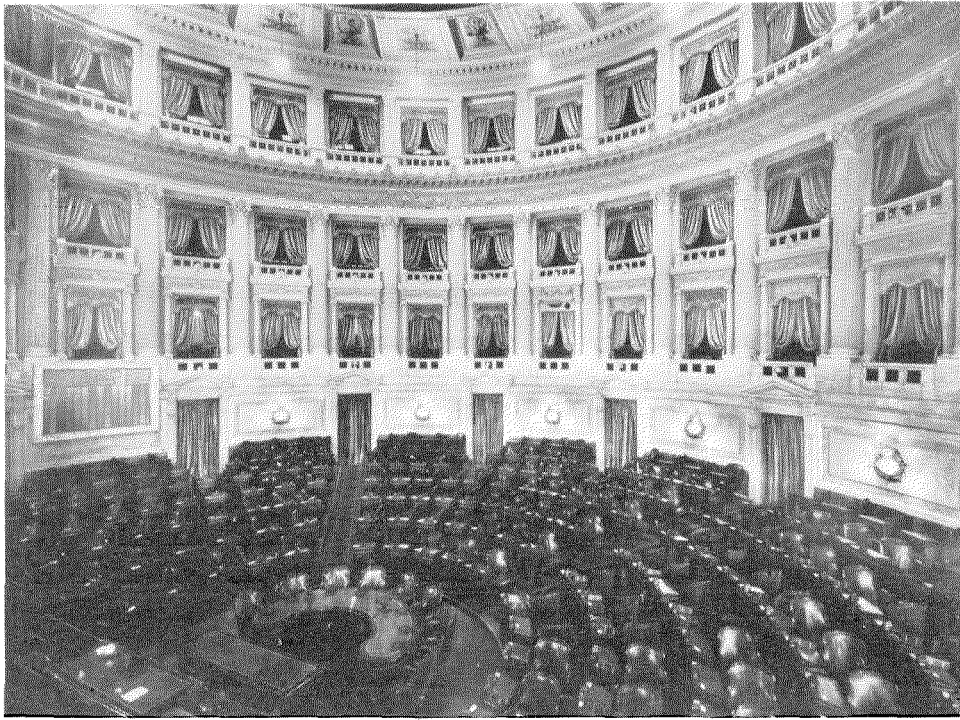

*Fig. 1—Partial View of the Argentine Chamber of Deputies.*

1. Floor completely covered with soft carpeting;
2. Irregular horizontal ceiling of frescoed panels and stained glass 21 meters above the floor, only 5 meters less than the greatest horizontal dimension of the auditorium;
3. Practically no hard, smooth reflecting wall surface;
4. Cushioned chairs closely spaced and sloped top desks covered with relatively soft leather.

The report of the investigation, which was sent to the President of the Chamber of Deputies on December 22nd, 1936, indicated that it would not be feasible to improve acoustical conditions by structural changes in the Chamber or by changes in the furnishings and decorations, and recommended a loudspeaker system along the lines indicated by the following brief translation from the report:

A loudspeaker system for a permanent parliamentary auditorium of this character should be designed to meet the following requirements:

1. It should amplify the normal speaking voice to sufficient volume to be heard from any point to all other points in the auditorium.

2. It should transmit the voice with clearness and naturalness so that individual voices coming from the loudspeaker will have practically the same quality and timbre as the same voices without the loudspeaker. In order to accomplish this with some degree of perfection, the system as a whole should transmit with reasonable fidelity voice tones ranging from approximately 40 to 10,000 cycles per second.

3. If practicable, the loudspeakers should not be visible from the auditorium and should be so located that at no point will there be confusion between the voice going into the microphone and that coming from the loudspeaker.

4. On account of the close spacing of the desks and chairs of the deputies, it is not possible to move about freely in the Chamber when the seats are occupied. For this reason it is desirable that the microphones be so located that each deputy can speak with comfort and in a moderate tone of voice without moving from his normal speaking position. To accomplish this, individual microphones should be provided for each deputy. This also applies to the President, the secretaries and the ministers, as it is not practicable for them to move from their seats during the proceedings and normally there would not be

sufficient time between usage to move the microphone from one to the other.

5. The microphones should be inconspicuously and permanently located and the mounting arrangement should harmonize with existing furniture, changing as little as possible the excellent general appearance of the auditorium.

6. The system should function simply and rapidly and should not require an attendant for its operation.

In September, 1939, the recommendation of the engineers was accepted and the installation was made on the basis of the above requirements. The system was first used officially at the opening session in 1940; it has given the utmost satisfaction and has received unanimous approval. As might be expected from the practical viewpoint of the users, the most attractive features of the system proved to be the rapidity and ease with which the individual microphones can be switched, and the naturalness of reproduction which leaves no indication that the amplified voice is not coming directly from the lips of the speaker. This latter is due to the high fidelity reproduction, distribution of sound from properly located loudspeakers and, it is thought, the concealment of the loudspeakers.

The system comprises 193 microphones and four loudspeakers in the Chamber. It has two independent channels of transmission: one with five microphones consisting of one each for the President of the Chamber and the two secretaries, and two on the ministers' table; the other channel is equipped for 188 individual microphones for the deputies. This corresponds to the total number of seats for deputies in the Chamber, including 160 now occupied and 28 for future additions. Relay switching equipment and cabling to the benches were provided for these 28 but the benches were not equipped with microphones. The two transmission channels are connected to the group of four loudspeakers by means of a network of six attenuators of proper impedance and loss, so arranged that each channel has one individual loudspeaker and uses two others in common with the other transmission channel. Fig. 2 shows in block schematic the two transmission channels, the arrangement of the attenuators and the location of the loudspeakers with respect to the plan of the Chamber. Loudspeakers *A*, *B* and *D* are used by the deputies' channel and correspond, respectively, to the center, left-hand and right-hand sectors of deputies' seats, one loudspeaker being located behind

and about five meters above the center of each sector. These three loudspeakers emit the same volume of sound. The presidential transmission channel uses loudspeakers *B*, *C* and *D*, *C* being located about 2.5 meters back of and five meters above the President's chair. Loudspeakers *B* and *D* reproduce equal volume from microphones connected to the presidential channel but about six db below that of loudspeaker *C*. Speech coming from the presidential channel is approximately 46 db down in loudspeaker *A* as compared to *B*, *C* and *D*. From the deputies' transmission channel, speech is approximately 40 db down in loudspeaker *C* as compared to *A*, *B* and *D*.

The Chamber, which corresponds to four floors in height, is completely surrounded by two walls with a three-meter corridor between. The corridors on the three upper floors are provided with chairs and serve as galleries for visitors who observe the proceedings in the Chamber through the 24 curtained-openings in the inner wall on each floor. The four loudspeakers are located behind the horizontal curtains in the upper part of four of these openings into the Chamber from the first gallery. In Fig. 1 the seventh horizontal curtain from the left is raised to expose the front of the loudspeaker corresponding to *A* in Fig. 2. Loudspeaker *D* is behind the lower horizontal curtain second from the left. The locations of speakers *B* and *C* are not shown in Fig. 1. The curtains are of heavy, soft plush material and have a thick lining. The portion in front of the loudspeakers was cut out and replaced with a thin material of the same surface appearance and

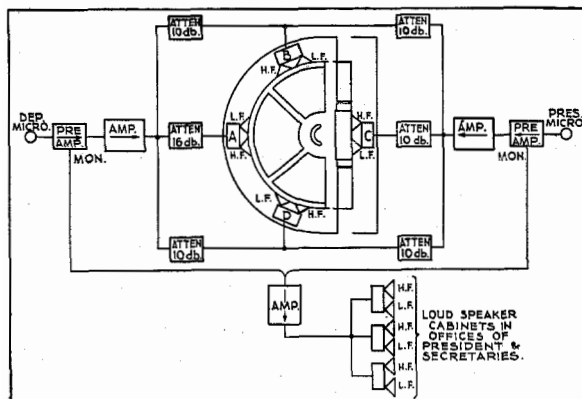
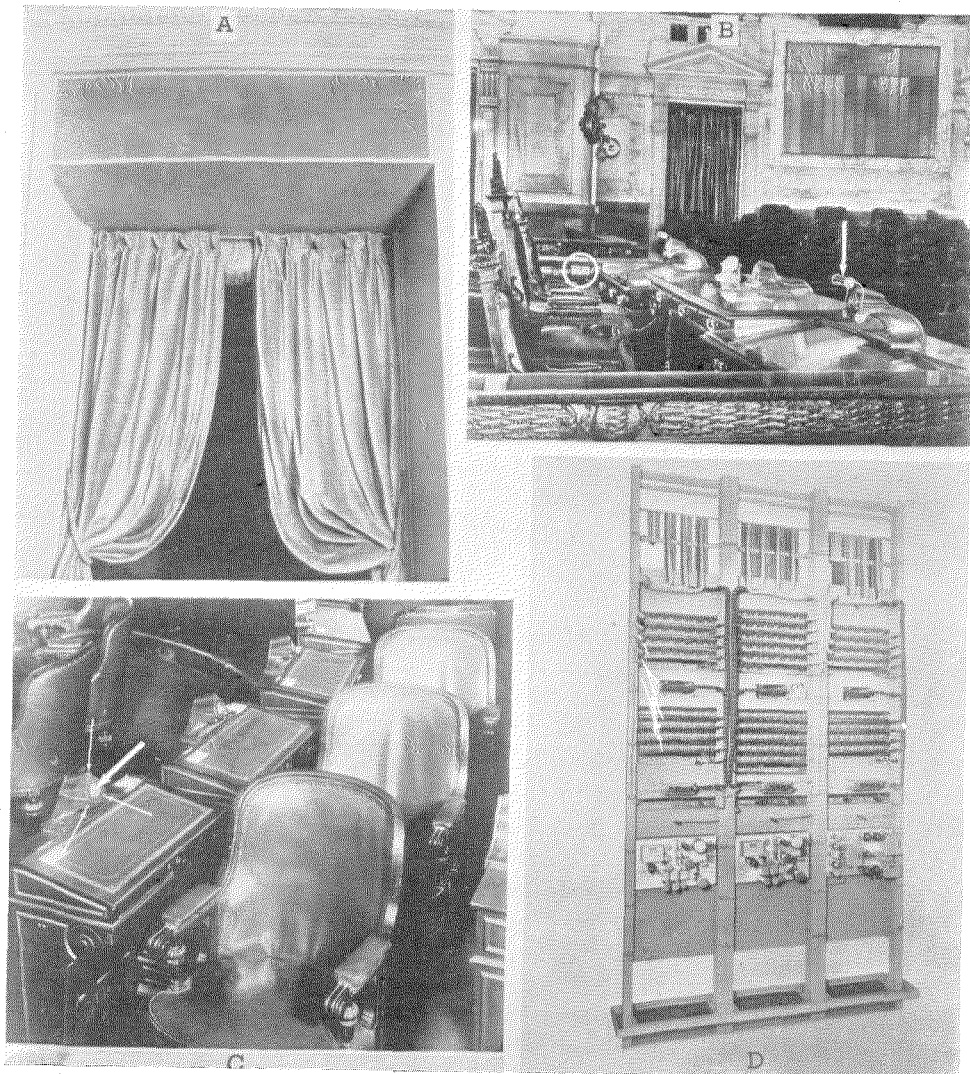

Fig. 2—Block Schematic Showing Arrangement of Microphones, Amplifiers, Attenuators and Loud Speakers.



color. The depth of the loudspeaker cabinets is the same as the thickness of the wall, which is 53 centimeters. Fig. 3-A gives a rear view of a cabinet in place. The back of the cabinet is closed with a fine and coarse wire gauze. The heavy vertical curtains were cut down at the top and

hung under the loudspeaker cabinets, as shown in this figure. The front elevation and plan of the loudspeaker cabinets are shown at *A* and *B*, respectively, in the upper portion of Fig. 4. The horn of the high frequency speaker is inclined downward ten degrees.



*Fig. 3—A. Rear View of Loudspeaker Cabinets Installed in Balconies.*  
*B. Microphones of the President of the Chamber and the Two Secretaries. Circle Indicates Small Control Cabinet for Use when Required by the Executive Secretary and Arrow Shows Tubular Reading Light above Microphones of Secretaries.*  
*C. Section of Chamber Showing Some of the Deputies' Desks. Arrows Indicate the Microphone with Two Control Buttons Below and a Pilot Light Above.*  
*D. Rear View of Equipment Racks.*

In the lower portion of Fig. 2 there is indicated in block form the connections to three loudspeaker cabinets in the private offices of the President, the Parliamentary Secretary and Executive Secretary of the Chamber. These offices are located in another wing of the building. Either one of the secretaries or the President may be in his office engaged in routine or administrative matters during less active periods of a session, but it is necessary for them to return to the Chamber when there is a resumption of activities. The loudspeaker cabinets provide a means for keeping in touch with the Chamber so that they may return to the session when it becomes desirable. These cabinets are supplied from the monitoring windings of the pre-amplifier of the two transmission channels in series through a separate main amplifier which is so arranged that during secret sessions it may be put out of action with lock and key. The structural details of the cabinets in the private offices are shown at *C* and *D*, Fig. 4. *C* is a cross-section of the inner cabinet which serves for properly mounting the loudspeaker units. This cabinet slips into the *D* cabinet from the rear. The control consists of a small toggle switch located in the upper part of the outside cabinet for turning on the loudspeaker; immediately below this switch is a dial connected with a bridged T network for volume control. The outer cabinet and the dial are made of peterebí, a fine Argentine wood similar to walnut; the front of the cabinet is closed with cloth of suitable texture and color.

Each of the loudspeakers in the installation is made up of one permanent magnet dynamic speaker of the cone type and a Western Electric 594-A unit equipped with a Western Electric Company 31-A horn. These are connected to a dividing network so that the cone speaker handles frequencies from about 35 to 400, and the 594-A unit frequencies from 400 to above 10,000 cycles per second.

The individual microphones are Western Electric 633-A and are mounted in a felt-lined fixture carved from mahogany with a design and finish matching the mahogany desks on which they are located. Immediately below and above the face of the microphone there are two non-locking push-button type keys, located in the mahogany fixture, and a small green pilot light,

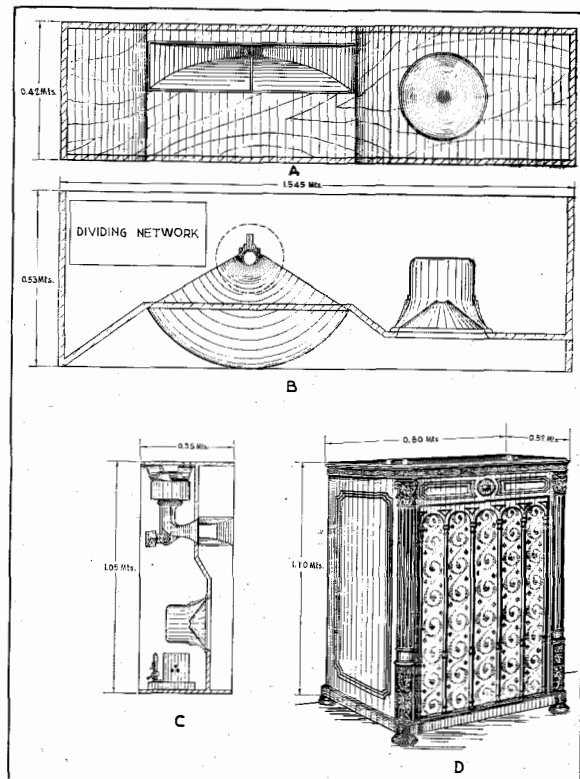

Fig. 4—Front Elevation (A) and Plan of Loudspeaker Cabinets (B).  
Structural Details of Loudspeaker Cabinets (C and D).

respectively. By momentarily operating the key on the right the microphone is connected to the system and, at the same time, the green pilot light is lit to indicate that the connection has been established. The microphone is disconnected by momentarily operating the key on the left. The connection and disconnection of the microphones is very nearly inaudible in the loudspeakers. Only one microphone can be connected to each transmission channel at the same time. Fig. 3, at *C*, is a section of the Chamber showing some of the deputies' desks with the microphone mountings in place. The key buttons are of red fiber similar in color to the mahogany fixture and are therefore inconspicuous, but in the picture they appear white. The microphone mountings on the desks of the President and secretaries are shown at *B*, Fig. 3. Those for the secretaries are provided with adjustable tubular reading lights. The connect and disconnect keys of the presidential microphone are multiplied to two other keys mounted in a small movable wooden holder

which may be placed forward on the desk for convenient use. The President's microphone is wired through a jack in the base of the mounting so that an auxiliary pedestal microphone may be plugged in. This pedestal microphone is placed on top of the presidential desk at one side for the use of the President of the nation when he stands and reads his message to the congress at its inaugural session. The President of the Chamber, the deputies, the ministers and the secretaries invariably remain seated when speaking. On the semicircular table of the eight ministers, two microphones are placed in movable mahogany mountings.

The overall frequency characteristic of the transmission channels is smooth and practically horizontal from 35 to 10,000 cycles.

Fig. 5 shows a schematic circuit diagram of the system. This diagram includes only one microphone and switching circuit for each of the three sectors of deputies' seats and one for the presidential transmission channel. The other microphone and switching circuits are multiplied at the *A* and *B* relay contacts, respectively, as indicated.

The system contains 406 switching relays but, as will be seen from Fig. 5, the circuit is relatively simple, involving no complicated operations. The only switching features which might be considered special are those of the *F* relay and the *H* relay. When a microphone is disconnected, contacts 3 to 9 of the *F* relay function in sequence to prevent noise in the loudspeaker by first connecting a 60-ohm resistance across the microphone circuit and then reducing it to 0 in consecutive steps of 30, 20 and 10 ohms. The *F* relay is fast operating and slow releasing. By the time it has released, the microphone circuit is short-circuited at the *D* relay contacts, the amplifier circuit opened at the *SR* relay contacts, and the microphone disconnected at the *A* relay contacts. The function of the *H* relay is to avoid the possibility of more than one microphone being connected at the same time to the deputies' transmission channel. As indicated, relay *H* is differentially wound with permanent biasing current in one winding. Battery for the *A*, *B* and *C* relays is supplied in an opposite sense through the other differential winding. The current for the operation of one set of *A*, *B* and *C* relays is not sufficient to overcome the biasing current in

the *H* relay, but should two or more connect keys be operated at the same time and before the *E-1* contact is broken, the operating current overcomes the biasing current, operates the *H* relay which, in turn, operates relays *J* and *K* which remove the battery for the pilot lights, short-circuit the microphone leads at the *F* relay contacts and open the circuit between the amplifiers, thus making the channel inoperative. When the last connect key is released, the circuit goes back to normal without any microphone having been connected. Ordinarily, the microphone of the deputy to whom the floor has been given is connected to the circuit, but in the case of a general discussion, where several deputies may attempt to use the channel, one connect key normally will be operated sufficiently (a few thousandths of a second) in advance of any other to allow the *E-1* contact to open, after which all connect keys become ineffective.

Within easy reach of the Executive Secretary an 8×10×15 centimeter control cabinet is provided (see small circle, Fig. 3-*B*). In this cabinet there is located a switch for turning on the system, indication of the functioning of the system being given by a red light; a green pilot light indicates when any microphone is connected to either channel. The operation of one of two master push-button keys disconnects any microphone which may be connected to the presidential channel; the other key disconnects any microphone which may be connected to the deputies' channel. These master keys are not intended primarily as controls but merely as a convenience so that if anyone on either transmission channel, by oversight, fails to disconnect his microphone and might be absent from his seat, the Secretary can clear the circuit for the use of someone else. The master clearing button of the deputies' channel also has a small toggle switch in multiple which may be left permanently operated and thus prevent any microphone being connected to that channel. This is intended for use on special occasions when the Chamber is used for other than parliamentary purposes, such as international conventions, where important addresses are delivered from the presidential microphone and might be inadvertently interfered with by the connection of a microphone to the transmission channel of the deputies.

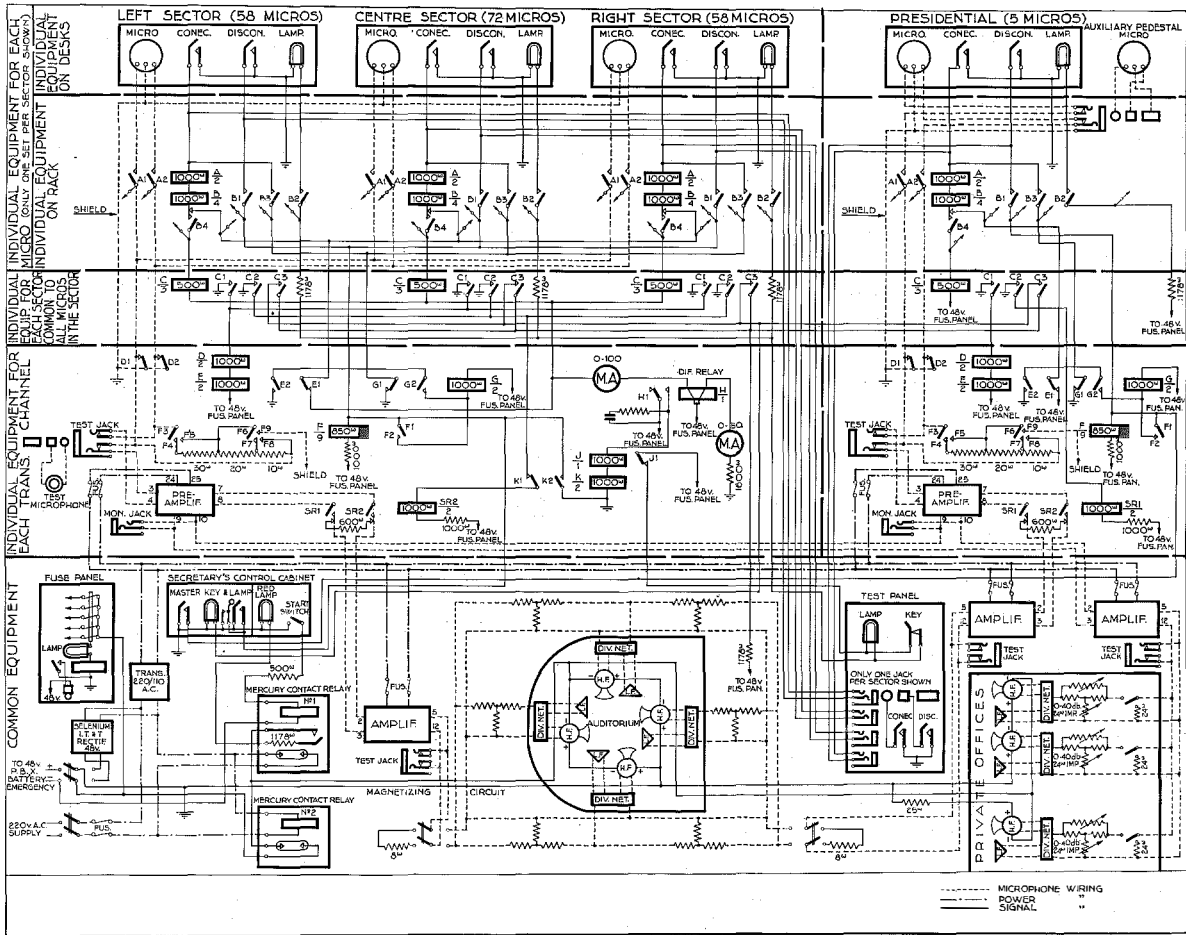

Fig. 5—Schematic Circuit Diagram of Transmission, Switching and Power Circuits.

The relay equipment, amplifiers and power equipment for the system are located in a small room immediately below the Chamber on the ground floor of the building. Fig. 3-D shows a view\* of the back of the racks on which the equipment is mounted. The light colored forms at the top of the racks are the shielded microphone leads. These and the signal wires are terminated on blocks at the top of the racks where they connect with small individual lead-

\*Subsequent to taking the (Laboratory) photographs from which Fig. 3-D was reproduced, two main amplifiers were added to the lower portion of the end bays and a panel of 200 test jacks mounted in the left-hand bay just above the lower connecting block in the center of the bay.

covered cables each containing one shielded pair and four signal wires. One cable is provided for each microphone in the Chamber, where they terminate in an eight-point jack mounted in the floor flush with the surface. A corresponding plug is concealed in the base of the desk which is screwed firmly to the floor. Thus, the removal of the desks for a general cleaning in the Chamber automatically disconnects the wiring, which is again reconnected when the desks are put in place. A thin metal plate is provided to protect the jack when the desks are not in place. No wiring is exposed on any part of the desks.

The power consumption of the system is 1.1 kilowatts.

# Mountain Effects and the Use of Radio Compasses and Radio Beacons for Piloting Aircraft\*

By H. BUSIGNIES

*Laboratoires L.M.T., Paris*

*SYNOPSIS:—On the occasion of automatic radio compass demonstrations made on one of the American Air Lines airplanes in New York and Washington, D. C., and during flights made between Salt Lake City and Chicago on the "Flight Research Plane" of the United Air Lines, most interesting effects were noted in the combined use of radio beacons and radio compasses. These effects, including direction finding observations in the Rocky Mountains, form the subject of the present study.*

*First, errors and fluctuations in the indications obtained with loop radio beacons and vertical antennae in direction finding are examined, and it is shown that the results of calculations are in accord with the phenomena observed. Then mountain effects are considered—reception on a directional loop aerial of a "direct" wave and of a "reflected" wave. It is shown that calculated results are in agreement with experiments made whilst flying across the Rocky Mountains, and the regular fluctuation in the bearing noted in the mountain effect is explained. Corresponding details are given with regard to similar observations made in Switzerland between Berne and Basle. A description follows of demonstrations of the mountain effect on a reduced scale by means of an ultra-short wave direction finder and a system of reflectors. Further, the observation of the "cone of silence," as well as the detection of flight above a station (broadcasting or radio beacon) by means of a radio direction finder or a radio compass is discussed. The paper concludes with remarks on the advantages of the radio compass and radio beacon combination as shown, for example, by the results of tests made in the United States.*

## 1. Introduction

EARLY in May, 1937, following practical results obtained in France by Laboratoires L.M.T. with automatic direction finding on board aircraft, the International Telephone Development Company, New York, asked the Laboratories to give demonstrations in the United States. These demonstrations, it was thought, could subsequently be followed by special tests on the part of the American Air Lines, and also of Government Agencies, assuming the existence of sufficient interest in the problem of aircraft navigation by automatic direction finding methods.

A number of RC.5 special radio compasses<sup>1</sup>

\* Paper presented at San Francisco, Annual Convention, I.R.E., June 27, 1939.

<sup>1</sup> For the principle and design of this apparatus see *Electrical Communication*, No. 2, Vol. 15, October 1936; and "Wireless Direction Finding" by R. Keen, 3rd Edition, pp. 694-7.

were prepared, and Mr. L. C. GALLANT, Engineer of the L.M.T. Laboratories, and the author visited the United States in September, 1937, to carry out the proposed programme with the collaboration of I.T.D.C. engineers. From the very first demonstrations, remarkably interesting phenomena were noted. The technical work was consequently extended beyond the original programme, continuing over a period of some three months during which aircraft radio direction finding under difficult circumstances was investigated, such as during flights over the Rocky Mountains. The results of these experiments are described hereinafter. They have been confirmed during the months which followed by experiments made during flights between Berne and Basle, and by experiments on the reflection of waves on a reduced scale, thus reaffirming the interpretation of the first results.

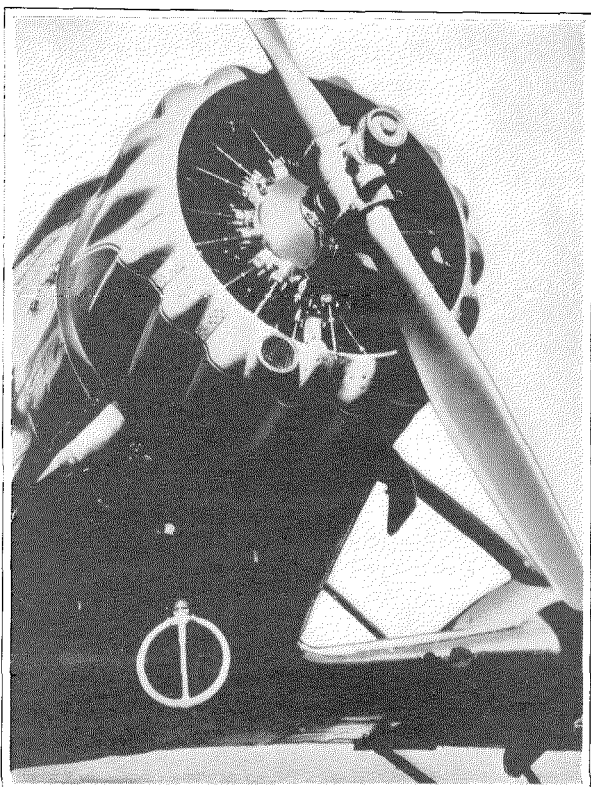

Fig 1—Position of the Loop Aerial on the Stinson Machine.

## 2. Demonstrations at Newark and Washington

An RC.5 radio compass was installed (Figs. 1 and 2) on a STINSON triple-engined airplane loaned by the American Air Lines, and demonstrations were made at Newark, N. J., and Washington, D. C., during the first two weeks of October, 1937. The purpose of this first series of demonstrations was to stimulate interest in the equipment, the ultimate intention being to carry out more extensive experiments under practical conditions of operation in the United States.

During this period about 40 flights were made, each lasting approximately an hour and representing (1) a "homing" flight towards a broadcasting station with control route above the station, and (2) a "homing" flight over a radio beacon with a verified route above it. Positions were determined by lateral readings, either on the broadcasting stations or on the radio beacons. Some fifty bearings were thus taken, giving the position of the airplane within a few miles. On

several occasions procedures proposed by visiting aircraft navigation experts were followed. The aggregate number of passengers carried on these flights was about 100.

During one of the first flights made as a "homing" flight towards a loop radio beacon, considerable variation in signal direction within a few kilometres of the radio beacon was noted. Bearings taken on transmission A and N, respectively, differed more and more until they reached a divergence of some ten degrees within a short distance from the radio beacon. This represented a particular case of a general phenomenon which is discussed in the following section.

## 3. Effect of Combination of Transmitter and Receiver Loop; Experiments Made in Kansas City on a Radio Beacon and Spaced Antenna

### General Considerations

On the occasion of the direction finding tests made in Spain in 1929 at Castellon de la Plana, an opportunity was offered of confirming in a

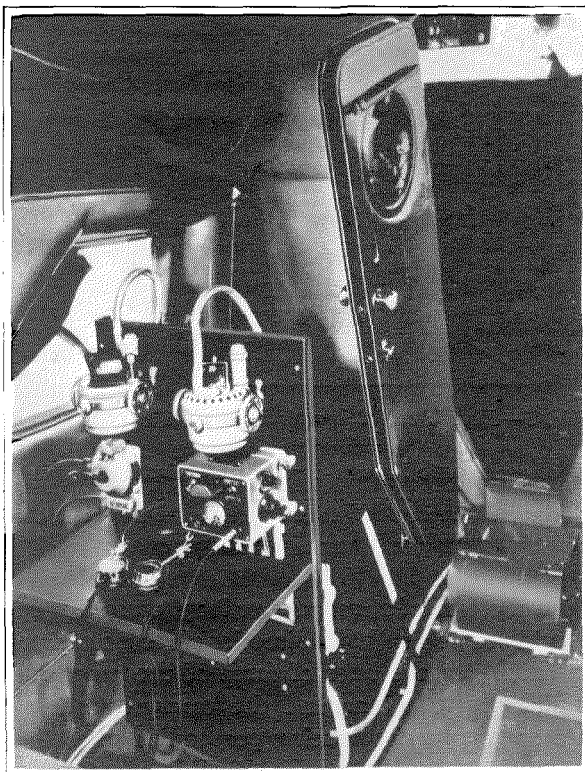

Fig. 2—Inside the Stinson.

RC.5 radio compass, pilot type and navigator type indicators, with control unit.

practical manner those phenomena which occur when, for example, a loop receiver direction finding system approaches a transmitter system within a distance of less than two or three wavelengths.

Fig. 3 shows the lines of force of the electric field and the magnetic field around a vertical antenna. At a considerable distance from the antenna, the magnetic and electric vectors expressed in c.g.s. electro-magnetic units are in the ratio  $c$  (speed of light) and are in phase (outside and far from any conductor barrier). These conditions do not apply in the neighbourhood of the transmitting antenna where the electric field is considerably more intense than the magnetic field and out of phase by  $\pi/2$  with respect to the latter. These fields may be compared with induction fields in electric or magnetic couplings.

In the Spanish tests an RC.1 automatic direction finder was used, requiring a fixed ratio between the intensities of reception on a small vertical antenna and on a loop oriented to its maximum. When this direction finder approached the transmitting antenna, the ratio was destroyed in favour of the vertical antenna on which the intensity of reception easily exceeded that of the loop by 20 db.

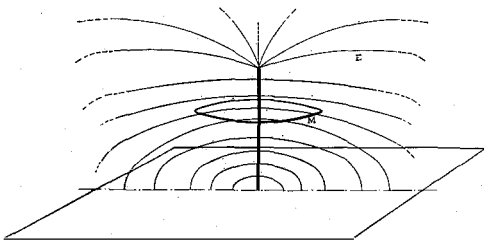

Fig. 3—Electric and Magnetic Lines of Force Around a Vertical Antenna.

The magnetic lines of force  $M$  are circles concentric about the antenna. The electric lines of force  $E$  are similar to those of the vertical plane shown, and occur in all the vertical planes passing through the antenna.

In the case of a transmitter loop, complication would result due to a directional phenomenon, inasmuch as the lines of force of the magnetic "induction" field around the transmitter loop are always far from being perpendicular to the transmission radii (see Fig. 4). When repeating the experiment with the same direction finder but with a transmitter loop, the magnetic field

definitely was found to be more intense in the neighbourhood of the transmitter loop; nevertheless, readings were subject to considerable error since the apparatus always indicates a direction

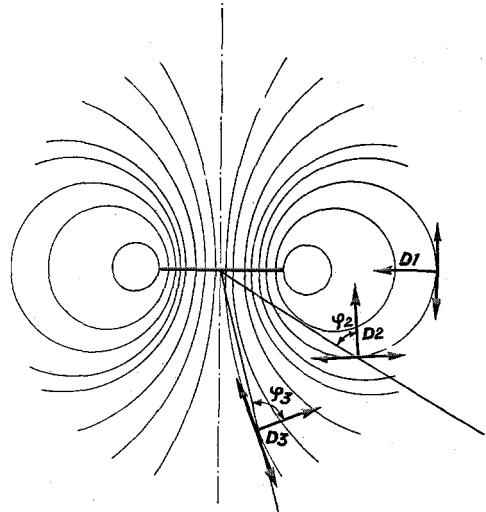

Fig. 4—Magnetic Lines of Force of a Loop in the Horizontal Plane.

$D_1, D_2, D_3$  are bearings taken perpendicular to the tangents at the lines of force.  $\phi_2, \phi_3$  are the angles of error. In the case of  $D_1$  the error is nil.

perpendicular to the lines of force. Fig. 4 shows the extent to which the indicated bearing may be inaccurate, depending on the relative positions of the transmitter and receiver loops.

This phenomenon is quite general and appears as soon as a guiding radiating system is set up. It is, however, considerably less pronounced with an electric radiating (open) system than with a magnetic radiating (closed) system.

Later this phenomenon was reproduced experimentally, not during transmission, but around a conducting body placed in the field of an electromagnetic wave. This conductor, in its turn, radiates a field which, observed locally, is more predominantly magnetic or electric according to the form of the obstacle. In particular, closed circuits, plate-circuits, etc., give rise to markedly magnetic fields, whilst filiform or threadlike bodies produce pronounced electric fields. In 1929, a practical application of these local magnetic fields was found in the compensation of the quadrantal deviation on board ships by arranging metal plates around direction finding receiving loop.

These phenomena may be directly deduced from the formulae for the field around Herz's doublet as a function of  $R$ , the length of the vector beam between the centre of the doublet and the point in space under consideration. According to Bouasse<sup>2</sup> the vertical electric field on the horizontal plane ( $x, y$ ) may be written:

$$\frac{R}{\delta_0 \phi^2} = \frac{\omega'^2}{r} \sin(\omega t - \omega' r) - \frac{\omega'}{r^2} \cos(\omega t - \omega' r) - \frac{1}{r^3} \sin(\omega t - \omega' r).$$

The first term  $1/r$  is influential at a distance, whilst in the vicinity of the antennae the terms  $1/r^3$  and  $1/r^2$  predominate. Above the antenna (on the  $Z$  axis), the term  $1/r$  does not exist (no radiation); the terms  $1/r^3$  and  $1/r^2$  are present but become negligible as the distance increases.

The magnetic field in the horizontal plane may be written:

$$M = -\frac{\omega \omega'}{r} \cdot \delta_0 \sin(\omega t - \omega' r) + \frac{\omega \delta_0}{r^2} \cos(\omega t - \omega' r),$$

<sup>2</sup> "Herzian Waves" by H. Bouasse, p. 172. Edit.: Delagrave.

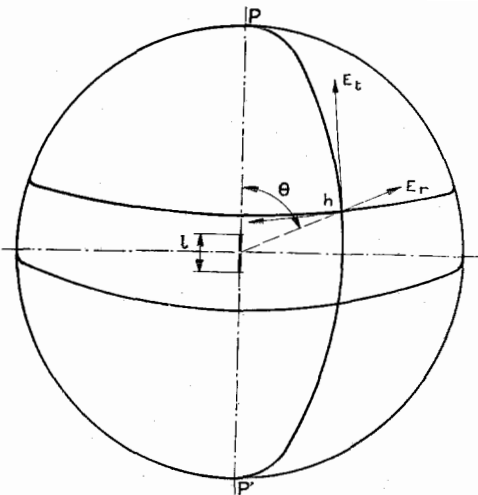

Fig. 5—Electric and Magnetic Vectors of the Doublet on a Sphere Centered on the Doublet.

The axis of the doublet is  $PP'$ .

$E_r$ =radial electric field, prolonged in the direction of the vector radius shown, and parallel therefore to the direction of propagation.

$E_t$ =electric field tangential to the meridian and perpendicular to the direction of propagation.

$h$ =magnetic field, which is always tangential to the parallel.

The ratio  $E_r/E_t$  is constant at any point on the same parallel.

where the term  $1/r$  characterizes the radiation, and the term  $1/r^2$  the local field. The magnetic lines of force are concentric circles around the antenna; no  $1/r^3$  term exists since there is no radial magnetic vector. The sine and cosine factors indicate the variations in phase which occur according to the relative magnitudes of the different terms. Following R. Mesny<sup>3</sup> it is convenient to express the equations with the angle  $\theta$  as a factor (Fig. 5) in order to show the values of the field at all points of the sphere. The advantage of this presentation is apparent; however, in this paper, the above formulae are quoted only in this  $x-y$  plane, since they show most clearly the terms  $1/r$ ,  $1/r^2$  and  $1/r^3$ . Mesny's formulae<sup>4</sup> are:

$$\left. \begin{aligned} \epsilon_r &= -\frac{c\lambda I}{\pi} \cdot \frac{\cos \theta}{r^3} (\cos \nu - \alpha r \sin \nu) \\ \epsilon_t &= +\frac{c\lambda I}{2\pi} \cdot \frac{\sin \theta}{r^3} (\cos \nu - \alpha r \sin \nu - \alpha^2 r^2 \cos \nu) \\ h &= -II \cdot \frac{\sin \theta}{r^2} (\sin \nu + \alpha r \cos \nu), \end{aligned} \right\}$$

all quantities being in c.g.s. electro-magnetic units. In vacuo,  $c$ =speed of light,  $\alpha=2\pi/\lambda$  and  $\nu=(\omega t - \alpha r)$ .

Three terms for the tangential electric field are again obtained; two refer to the radial electric field (terms in  $1/r^2$  and  $1/r^3$ ) and, accordingly, this field at a distance is practically zero. Two terms represent the magnetic field.

Mesny<sup>5</sup> calculated the values of the ratios between the magnetic and electric vectors for distances between  $0.01\lambda$  and  $5\lambda$  as well as the phase angles between these vectors and between the radial and tangential electric vectors. On the occasion of the Castellon tests, a practical measurement of these ratios was made within the above range, in particular towards  $0.1\lambda$ .

The deviation in phase between the resulting electric vector and the magnetic vector is considerable at a distance of  $0.3$  to  $0.5\lambda$  ( $10^\circ$  to  $30^\circ$ ). It only becomes negligible towards  $\lambda$ . This is a matter of fairly considerable importance for the

<sup>3</sup> "Use of Frame Antennae and Direction Finding" by R. Mesny, 1925. Edit.: Chiron.

<sup>4</sup> All these formulae assume dimensions of the doublet which are small with regard to the wavelength and distance. The doublet is in space. If it is on a good conducting ground, one can in practice take double the values given.

<sup>5</sup> "General Radioelectricity," R. Mesny, 1935 (Vol. 1)—Edit.: Chiron.



detection of passage above a station by means of a radio compass or a radio direction finder, particularly in the case of instruments with the receiver loop combined with a vertical antenna (homing systems). In this latter case, the phenomenon can be detrimental or, on the other hand, may be utilized.

#### *Effect of the Combined Receiver and Transmitter Loop*

When an increasing deflection was noted in the indications of a radio compass on approaching a radio beacon loop transmitter, this was ascribed to the effect illustrated by Fig. 6. Under these conditions, an airplane, following a beam, enters the magnetic induction field of the latter; the radio compass, as this field becomes stronger relative to the electro-magnetic field, tends to indicate a direction which is increasingly perpendicular to that of the lines of force of the magnetic induction field.

These radio beacons, of course, function on the principle of a "signal resultant" transmission of  $A$  on one loop, and of a complementary  $N$  on

the other perpendicular loop, thus yielding a continuous signal in the beam  $F$  on the course to be followed. The radio compass, therefore, tends to indicate a direction to the right of the transmitter sending transmission  $A$ , and to the left of the transmitter sending transmission  $N$  (or inversely for the beams  $F_2$  and  $F_4$ ). However, an hypothesis, which perfectly explains the variations at distances less than  $2\lambda$ , would not appear to suffice as an explanation of the observed variations in the readings at greater distances.

According to Mesny<sup>3</sup> the magnetic field of a loop (small relative to the distance)  $H_r$ , following the vector beam may be written:

$$H_r = -\frac{2IS \cos \theta}{R^3} (\sin u + \alpha R \cos u);$$

the magnetic field  $H_n$ , normal to the vector beam (see Fig. 7), is similarly:

$$H_n = -\frac{IS \sin \theta}{R^3} (\sin u + \alpha R \cos u - \alpha^2 R^2 \sin u),$$

where

$$\alpha = 2\pi/\lambda \quad \text{and} \quad u = (\omega t - \alpha R).$$

This expression for  $H_n$  includes the field at a distance. Since the first two terms rapidly approach zero with increasing distance, the ratio  $H_n/H_r$ , for an angle of  $45^\circ$  (radio beacon beam), for example, depends essentially on  $1/\alpha R$ , that is,  $\lambda/2\pi R$ . It will be seen that in the vicinity of two wavelengths from the antenna (approximately 2 km in the present case) the effect becomes fairly weak, and the considerable variations noted at greater distances must be imputed to other causes.

In fact the loop radio beacon in practice has a further disadvantage. The bearings taken in an airplane at a certain altitude, and at a distance sufficiently great to be free of the effect just mentioned, are considerably falsified in certain directions as a result of the horizontal component of the electric field;<sup>6</sup> or, to put it another way, by the fact of the inclination of the magnetic field (see Fig. 7).

Fig. 8 represents the horizontal projection of the vector  $H_n$  and of the meridian  $m$  of Fig. 7. The vertical loop receiver no longer receives a

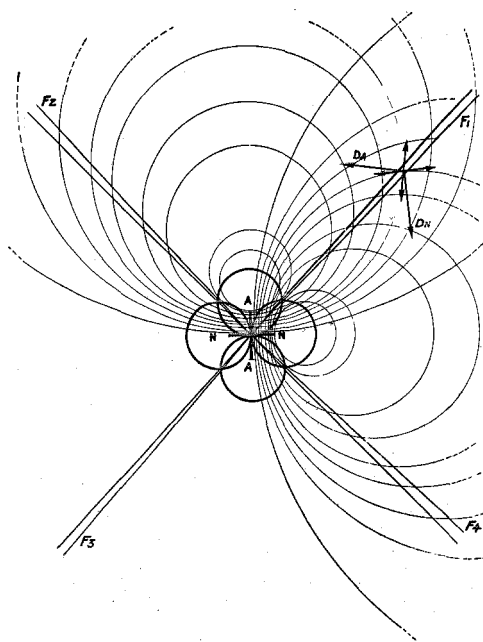

Fig. 6—Difference in Direction Found between the Transmission of  $A$  and that of  $N$  Near a Loop Radio Beacon.

The airplane following the beam  $F_1$  of the loop radio beacon, the radio compass successively shows the direction  $D_A$  on the transmission of  $A$  and the direction  $D_N$  on the transmission of  $N$ . The effect is identical for the beam  $F_3$ ; it is reversed in the case of beams  $F_2$  and  $F_4$ .

<sup>6</sup> In his "Use of Frame Antennae and Direction Finding" (Ref. 3) Mesny has dealt with the apparent displacement of the beam of a loop radio beacon, in the case of antenna reception on board an airplane.

signal when the vector  $H_n$  is contained in its plane; that is to say, when in Fig. 8 the horizontal projection of  $H_n$  and the plane of the loop merge on the tangent to the ellipse at  $M'$ .

The error in the bearing, therefore, will be equal to the angle  $\delta$  between the plane of the

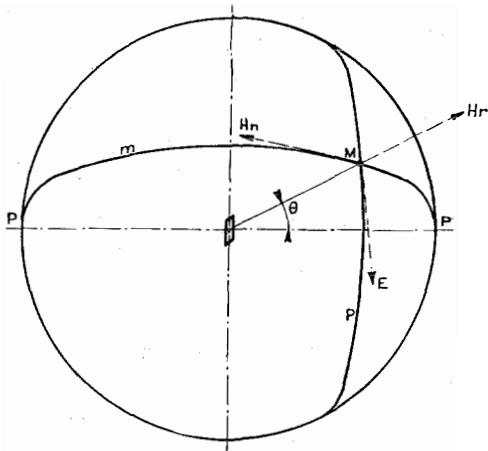

Fig. 7—Magnetic and Electric Vectors of an Elementary Loop on a Sphere with Its Center on the Loop.

The axis of the frame is  $PP'$ .  
 $H_r$  = magnetic radial field, parallel to the direction of propagation.  
 $H_n$  = magnetic field tangential to the meridian  $m$  and perpendicular to the direction of propagation.  
 $E$  = electric field tangential to the parallel  $p$ .  
 The ratio  $H_r/H_n$  is constant at all points on the same parallel.

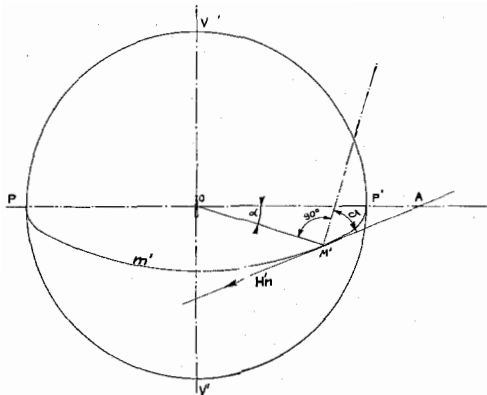

Fig. 8—Horizontal Projection of the Magnetic Vector for a Loop Transmitter.

In any part of the vertical plane passing through  $PP'$ , which contains the direction of zero radiation, the error is  $90^\circ$  except in this direction.

In the vertical plane  $VV'$ , containing the loop, the error is nil. In other directions the error varies from  $0^\circ$  to  $90^\circ$  in accordance with the curves of Fig. 9b.

$m'$  = projection of the meridian.  
 $H'_n$  = projection of  $H_n$  (Fig. 7), and of the loop when the signals are faded out.  
 $\delta$  = angle of error.

loop and the perpendicular to the vector beam at  $M'$ . The form and sign of these errors may easily be seen at every point of the sphere by means of this graphical construction.

In order to find the value of  $\delta$ , let  $\alpha$  be the angle of the horizontal bearing of the receiver loop placed at  $M$  taken with reference to  $OA$  as in practical direction finding, and  $\beta$  the angle of elevation of the receiver loop placed at  $M$ . It is seen from Fig. 9(a), where the radius of the sphere is unity, that  $OM' = \cos \beta$ .

Now in the triangle  $AOM'$ ,  $\alpha$  and  $OM'$  are known; it will suffice to determine  $OA$  to know  $\phi$  and  $\delta$ .

It should be noted that:

$$MB = M'B' = \cos \alpha \cos \beta = \cos \theta,$$

and

$$OA = \frac{1}{\cos \theta} = \frac{1}{\cos \alpha \cos \beta}.$$

Hence from the triangle  $AOM'$  one obtains:

$$\frac{OA}{OM'} = \frac{\sin \phi}{\sin [\pi - (\alpha + \phi)]}$$

or

$$\frac{1}{\cos \alpha \cos^2 \beta} = \frac{\sin \phi}{\sin (\alpha + \phi)},$$

which gives, after some transformation:

$$\begin{aligned} \cot \phi &= \cot \alpha \cos^2 \beta - \cot \alpha \\ &= -\cot \alpha \sin^2 \beta; \end{aligned}$$

and, since  $\delta = (\phi - \pi/2)$ , this becomes

$$\tan \delta = \cot \alpha \sin^2 \beta.$$

Fig. 9(b) shows the curve of error  $\delta$  in terms of  $\alpha$  for a few values of the angle of elevation  $\beta$ .

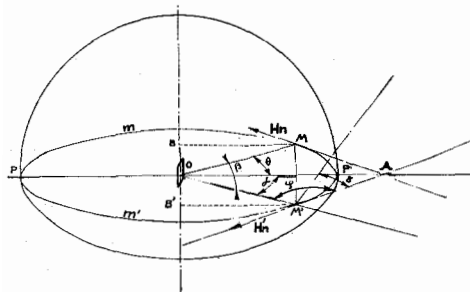

Fig. 9a—Geometrical Representation of the Projections Whereby the Angle of Error  $\delta$  May be Calculated.

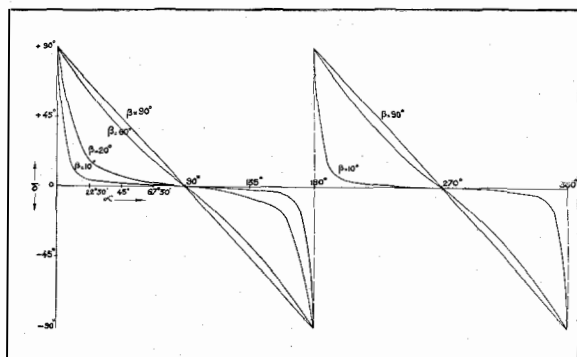

Fig. 9b—Curves of Values of  $\delta$  in All the Azimuths for Different Angles of Elevation.

Value of the errors arising from the loop radio beacon around the latter, and for different angles of elevation  $\beta$ .

At  $0^\circ$  and  $180^\circ$  the sense is indeterminate as the electric vector of the field is horizontal. A slight variation of  $\alpha$  in one direction or in the other from these two points causes a vertical component of the electrical field to appear, thus symmetrically changing the phase to give a direction  $(90^\circ - \epsilon)$  or  $(90^\circ + \epsilon)$ .

It is obvious that direction finding systems using a loop-antenna combination are greatly affected, and even become inoperative, over the vertical plane perpendicular to a transmitter plane and in the neighboring zones.

The table below <sup>7</sup> shows the value of these errors.

It is seen that there is an error  $\delta$  of  $6^\circ 45'$  for  $\alpha = 45^\circ$  and  $\beta = 20^\circ$ , which produces in the beam of a loop radio beacon a variation in the indication of a radio compass of  $\pm 6^\circ 45'$ , since the error changes in sign when the transmission changes frame in passing from  $A$  to  $N$ .

Fig. 9(c) shows how this variation increases, on approaching in the beam of a loop radio beacon, for two different fixed altitudes. At short distances this error and the resulting variation in indication are added to the effect previously

<sup>7</sup> The last line in the table shows the angle read on the radio compass when passing immediately over the transmitter loop.

described. It is interesting to note that the error is constant at any distance (usual) if  $\alpha$  and  $\beta$  are constant.

The values frequently observed in the airplane coincide with the values calculated to within a few degrees. It will be understood that the calculation of the values was made with an unnecessary degree of precision in order to establish suitable curves, but that fractions of a degree are of no practical interest for the moment. On the other hand, it is assumed all along that the transmitter loop is small compared with the wavelength. This is not absolutely realized in practice, but the approximation obtained, particularly in the case of errors produced by distance, would appear to be quite sufficiently accurate.

When these effects are present, it is also possible to follow the false beams around a loop radio beacon with an ordinary direction finder on board.

Fig. 10 shows that on the beam itself it is possible to note four positions of the loop equalizing the signals  $A$  and  $N$ , two of these corresponding to the direction of the transmitter and two others to a  $90^\circ$  error.

If the pilot leaves the beam or searches for it again, one of the signals will be more intense than the other, but the angular difference between the two is then also greater; and, therefore, as will be seen from Fig. 11, although the airplane is outside the beam, the pilot may find an apparent beam again by rotating the loop and placing it in positions  $D_1, D_2, D_3, D_4$ , where the signals are equalized. If conditions are difficult and if he has not observed this phenomenon beforehand, he presumably will be completely

Table of Values of  $\delta$  According to the Formula  $\tan \delta = \cot \alpha \sin^2 \beta$ .  
(Error calculated in the usual radiogoniometrical sense)

$\alpha = \left\{ \begin{array}{l} 0^\circ \\ 180^\circ \end{array} \right.$	$0^\circ$	$22^\circ 30'$ $202^\circ 30'$	$45^\circ$ $225^\circ$	$67^\circ 30'$ $247^\circ 30'$	$90^\circ$ $270^\circ$	$112^\circ 30'$ $292^\circ 30'$	$135^\circ$ $315^\circ$	$157^\circ 30'$ $337^\circ 30'$
$\beta = 0^\circ$	$0^\circ$		$0^\circ$	$0^\circ$	$0^\circ$	$0^\circ$	$0^\circ$	$0^\circ$
$\beta = 10^\circ$	$90^\circ$	$4^\circ 10'$	$2^\circ$	$0^\circ 45'$	$0^\circ$	$- 0^\circ 45'$	$- 2^\circ$	$- 4^\circ 10'$
$\beta = 20^\circ$	$90^\circ$	$15^\circ 45'$	$6^\circ 45'$	$2^\circ 45'$	$0^\circ$	$- 2^\circ 45'$	$- 6^\circ 45'$	$- 15^\circ 45'$
$\beta = 40^\circ$	$90^\circ$	$45^\circ$	$22^\circ 30'$	$9^\circ 45'$	$0^\circ$	$- 9^\circ 45'$	$- 22^\circ 30'$	$- 45^\circ$
$\beta = 60^\circ$	$90^\circ$	$61^\circ$	$36^\circ 50'$	$17^\circ 15'$	$0^\circ$	$- 17^\circ 15'$	$- 36^\circ 50'$	$- 61^\circ$
$\beta = 90^\circ$	$90^\circ$	$67^\circ 30'$	$45^\circ$	$22^\circ 30'$	$0^\circ$	$- 22^\circ 30'$	$- 45^\circ$	$- 67^\circ 30'$

off his course. Certainty of being in the beam, therefore, can result only from the fact that, in rotating the loop,  $A$  and  $N$  do not appear very quickly.

It is thus easy to trace the false courses which the airplane might follow. In order to avoid these dangerous effects to a considerable extent, it is essential that the plane of the receiver loop be rigidly fixed in the direction of the long axis of the airplane when this loop is used as a collector of radio beacon signals. Inasmuch as this fact was not generally appreciated during the initial application of loop direction finding,

it is hardly probable that these loops were invariably placed in the most favorable position.

If it be objected that the beam can be followed by means of a normal antenna receiver, a reminder may be given that loops were installed in order to permit of reception of radio beacons during rain or snow static when antenna reception is impossible, and to make radio direction finding practicable. It is exactly in the difficult circumstances provoked by rain or snow static that the consequences of an error in navigation are most serious.

The alternation of the transmission of  $A$  and

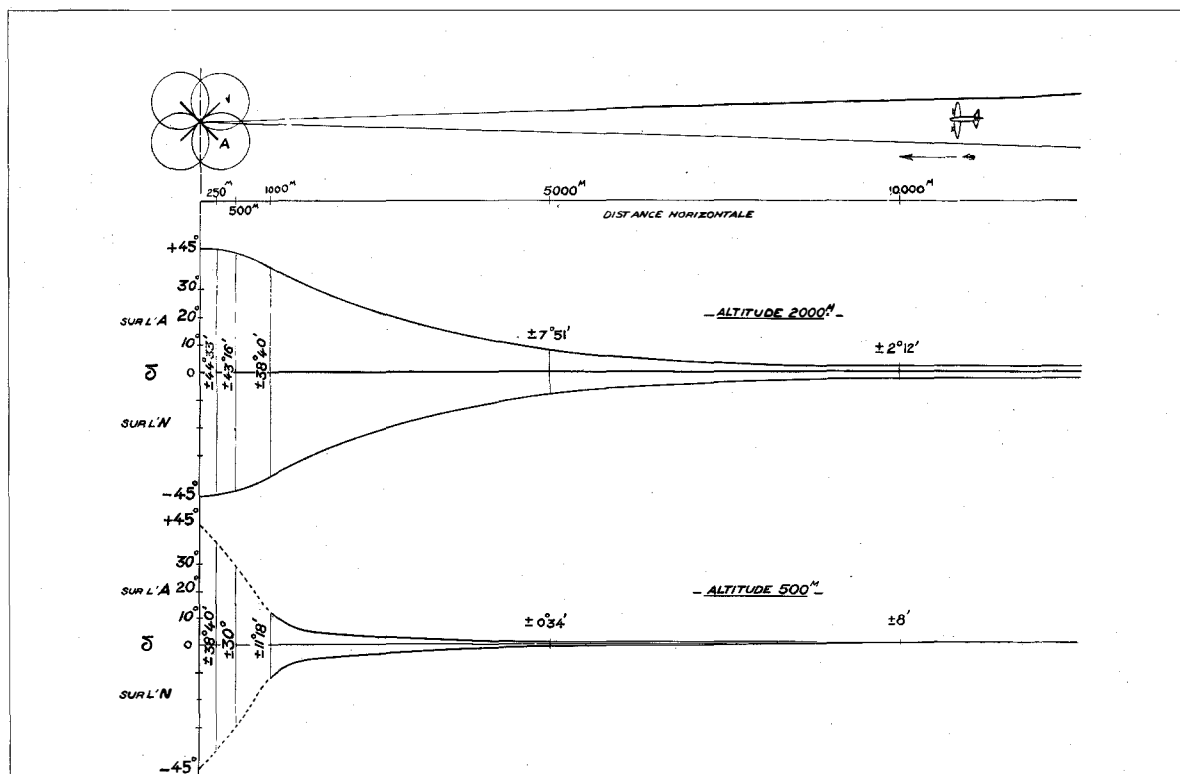

Fig. 9c—Progressive Errors in Alternate Directions of Approach in the Beam of a Loop Radio Beacon.

Amplitude of the change in bearing from transmission  $A$  to transmission  $N$  of a loop radio beacon as a function of the distance, and at heights of 2000 and 500 metres.

Altitude 2000 m: The effects of the magnetic field of induction may be ignored; the appearance of the curve approaches reality very closely at short horizontal distances (wavelength of the order of 1000 metres).

Altitude 500 m: The effects of the magnetic field of induction are no longer negligible between 1000 m and zero horizontal distance; this is why the curve has been continued by the dotted line at short horizontal distances (wavelength of the order of 1000 metres).

The effect shown by this figure is independent of the wavelength; in particular, on fairly short waves the induction effect becomes negligible as the result of the effect here described. The curves may be considered accurate up to very small horizontal distances.

$N$  is sufficiently rapid for these effects to be passed unperceived by pilots who simply found it impossible to take bearings under certain conditions, inasmuch as it was impracticable for them to turn the manual reduction radiogoniometrical loop sufficiently quickly to obtain a bearing on  $A$ , and then a bearing on  $N$ . This procedure, however, is easily possible with the automatic radio compass.

These variations make navigation by radio-compass difficult during the last few kilometres of "homing" flight towards a loop radio beacon, or the taking of bearings at a certain altitude. But there is no need to emphasize this point

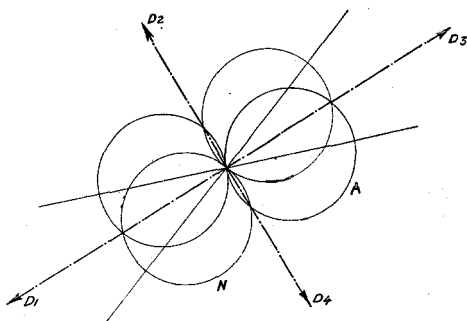

Fig. 10—Appearance of  $A$  and  $N$  on the Beam Whilst Rotating the Loop Receiver.

$D_1, D_2, D_3, D_4$ =directions of the loop in which the signals  $A$  and  $N$  are observed to cancel out.

$A$ =reception diagram of  $A$ .

$N$ =reception diagram of  $N$ .

In all other directions,  $A$ 's or  $N$ 's are received.

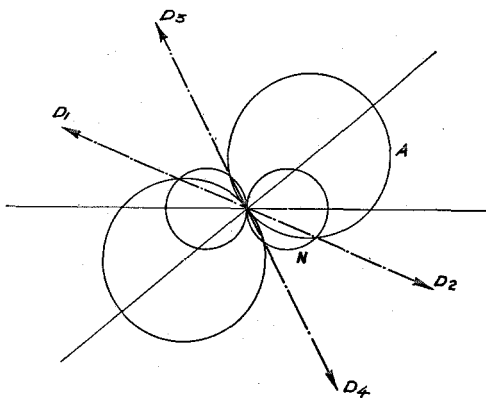

Fig. 11—Appearance of False Beams at the Loops When Rotating the Loop Receiver.

Outside the beam of the radio beacon—

$D_1, D_2, D_3, D_4$ =directions of the loop in which the signals  $A$  and  $N$  are observed to cancel out.

$A$ =reception diagram of  $A$ .

$N$ =reception diagram of  $N$ .

further inasmuch as loop radio beacons have been relegated to positions of minor importance, being replaced by simultaneous radio range beacons with improved vertical antennae.

These serious disadvantages are avoided in practice by the radio beacon with vertically spaced antennae.

#### *Experiments Made in Kansas City on a Radio Beacon with Vertically Spaced Antennae*

An opportunity presented itself of demonstrating a radio compass on the ground in Kansas City. It was found that, in the beam from the spaced antenna radio beacon in Kansas City, at a distance of a few miles, a slight swing of about  $2^\circ$  was produced by the  $A$  and  $N$  signal alternations which were scarcely heard since readings were taken in the exact zone where the signals were equalized.

It was shown that this swing could not be ascribed to the radio compass, but was due to the transmitting system. Thanks to the courtesy of the T.W.A. and to the C.A.A. radio authorities, the  $A$  and  $N$  signal commutation of the radio beacon was actually stopped on one and then on the other antenna plane, and the  $2^\circ$  difference in bearings was thus clearly evident.

Another experimental fact noted in the air-plane was a variation in the indications between transmissions  $A$  and  $N$ , reaching about ten degrees when very close to the beacon.

Between the beams, on the other hand, the greatest error originated from the antenna transmission plane which was the most perpendicular to the direction of observation.

If examination be made of the distribution of the lines of force of the magnetic "induction" field at a short distance from a transmitter with two antennae connected in phase opposition, it will be seen that distribution in the horizontal plane is identical to that of the loop radio beacon, provided the distance between the antennae is small compared with  $\lambda$ . It is thus possible to ignore the dephasing of the two fields due to the difference of distance with respect to the  $180^\circ$  feeding dephasing. The magnetic "induction" field is nevertheless much smaller, compared with the electric field and the field at  $1/R$ , than is the case with the loop radio beacon.

Close to the radio beacon (less than  $\lambda/2$ ), phenomena similar in nature to those observed at greater distances with the loop radio beacon may be expected.

Differences in the bearings observed some miles from the antenna, nevertheless, require explanation; the following permits analysis at any distance. Spacing of the antenna not being negligible with respect to  $\lambda$ , it is logical to compare this case with that of two vertical spaced dipoles by establishing the resultant of the existing fields for the point in space considered, i.e., treating the problem as though it were concerned with the interference of two fields (Fig. 12).

It will be noted that, by restricting consideration of one antenna plane to near and medium distances (say, up to  $5\lambda$ ), the resultant of the two magnetic fields  $1/R$  is no longer perpendicular to the direction of the transmitter centre 0, the deviation decreasing as the distance increases. By compounding the magnetic fields  $1/R$  and allowing for their differences in phase and amplitude due to the difference of the distances  $R_1$  and  $R_2$  an elliptic rotating field is obtained, the axis of which is not perpendicular to the direction of the centre 0.

Compounding the magnetic fields  $1/R^2$ , an identical result is obtained with a phase difference relative to the field  $1/R$ . This means that in the case of short distances, where the field  $1/R^2$  is pronounced, there are four vectors to be

compounded in order to obtain the polarization ellipse of the magnetic field.

According to formulae and table of ratios calculated by Mesny, the field  $1/R^2$  is negligible beyond  $\lambda$ . The error due to the presence of these two fields at and beyond  $\lambda$  will now be determined.

- Let  $A$  equal the amplitude of the field due to the antenna  $A$ ,
- $B$  equal the amplitude of the field due to the antenna  $B$ ,
- $\delta$  their angular difference in direction, and
- $\phi$  their difference in phase.

The error  $\Sigma$  calculated in relation to the direction of  $A$  and with the sign usual in direction finding, is given by:

$$\tan 2\Sigma = \frac{B^2 \sin 2\delta + 2AB \cos \phi \sin \delta}{A^2 + B^2 \cos 2\delta + 2AB \cos \phi \cos \delta}$$

The reader is referred to Section 4 for the establishment of this formula which, in the case just considered, gives the position of the maxima and minima of the polarization ellipse of the magnetic field. If

- $\frac{1}{R}$  be the amplitude of  $A$  at  $M$
- $\frac{1}{R+d \sin \alpha}$  be the amplitude of  $B$  at  $M$
- 0 be the phase of  $A$  at  $M$
- $\pi - \frac{2\pi d}{\lambda} \sin \alpha$  the phase of  $B$  at  $M$
- $\alpha$  the direction of  $M$  seen from  $A$
- $\delta$   $\tan \delta = \frac{d \cos \alpha}{R}$ .

The simplifications introduced permit of an approximation sufficient for the relative values of  $R$  and  $d$ .

The table below shows the values of the errors thus calculated from  $\lambda$  to  $5\lambda$  in the beam ( $\alpha = 45^\circ$ ).

$$d = 0.2\lambda$$

	$\delta$	$\phi$	$\Sigma$	$\delta/2$ measured from 0	Error
$\lambda$	8° 3'	129° 6'	2° 33'	4° 1½'	-1° 28½'
2 $\lambda$	4°	129° 6'	1° 38'	2°	-0° 22'
3 $\lambda$	2° 40'	129° 6'	1° 10'	1° 20'	-0° 10'
5 $\lambda$	1° 37'	129° 6'	0° 48'	0° 48½'	-0° ½'

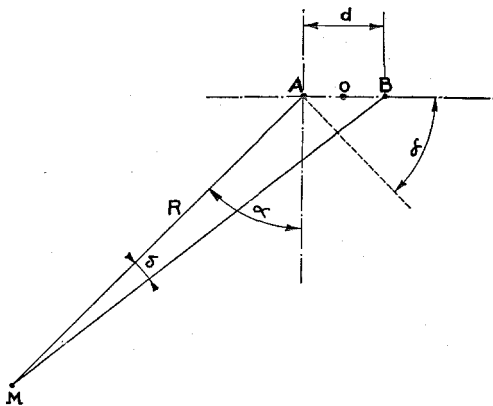

Fig. 12—Representation of the Geometrical Elements: Causes of Error at a Few  $\lambda$  Distance from a Spaced Antenna Radio Beacon.

$A$  and  $B$  = transmitting antennae fed in phase opposition.

$R$  and  $(R+d \sin \alpha)$  = distances from  $M$  to the two antennae  $A$  and  $B$ .

It may be concluded that at a distance from the radio beacon equivalent to 15 times the distance between the antennae and for a wavelength equal to five times this latter distance, the error is negligible.

A wavelength of the order of five times the antenna spacing substantially represents the case of American beacons where the spacing is 180 metres, with a wavelength of about 900 metres.

In order to explain the major errors, such as those observed, it is necessary to show the influence of a supplementary dephasing introduced between the antennae and intended to adjust the beams of the radio beacons to the routes to be served. The four beams frequently form angles which differ from  $90^\circ$  amongst themselves, a result obtained by dephasing. The effect of the latter is indicated in the following table:

$$d=0,2\lambda; \quad R=3\lambda$$

Phase of Antenna B	$\phi$	Error $\Sigma$
$180^\circ$	$129^\circ 6'$	$-10'$
$190^\circ$	$139^\circ 6'$	$-14'$
$200^\circ$	$149^\circ 6'$	$-25'$
$210^\circ$	$159^\circ 6'$	$-52'$

The last value clearly explains the variation of  $\pm 1^\circ$  noted at approximately  $3\lambda$  from the radio beacon in Kansas City.

The second antenna plane with transmission complementary to that of the first gives rise to an error of an inverse sign, producing variation in the indication when passing from the transmission of the  $A$  to that of the  $N$  signal.

Reverting to the case where the beams from the beacon are perpendicular, it will be found that at a distance greater than  $\lambda$  the errors are very small in all directions except in the vicinity of the direction perpendicular to the plane of the antennae at 0. In this case the error increases very rapidly and tends towards  $90^\circ$  when the angle  $\alpha$  approaches zero; at the limit, moreover, the resultant field is very weak. Around and beyond  $10\lambda$ , directions obtained with a loop direction finder are absolutely true.

At a distance of one wavelength, the error tending towards  $90^\circ$  close to the perpendicular to the plane of the antennae at 0 was clearly shown by experiment.

If the antenna phases are modified in order to adjust the beams to the aerial routes to be

served, the line where the phases are equal is no longer perpendicular to the plane of the antennae. It is near this new line that the effect mentioned is noted close to the beacon.

At any altitude the magnetic field is always horizontal; the bearings taken with a loop, therefore, are stable and without error. A vertical plane of the zero field perpendicular to the plane of the antenna at 0 also is encountered.

The bearings taken in flight confirm these conditions as well as the results previously mentioned. The smallness of certain angles made their calculation with adequate accuracy necessary despite the fact that these fractions of a degree are not of practical importance.

#### 4. *Cheyenne and Salt Lake City Experiments—Mountain Effects: Explanation of the Rapid Variations in Bearings and the Simultaneous Variations of the Beam—Mountain Effects in Switzerland Between Berne and Basle*

United Air Lines engineers were present at the Washington demonstrations and asked that experiments be carried out with the equipment under the most difficult direction finding and aeronautical conditions encountered in the United States, i.e., on the Cheyenne-Salt Lake City route of the New York-Chicago-Cheyenne-Salt Lake City-Los Angeles or San Francisco line. This Company, with a view to increasing the safety of aerial navigation, had made extended studies and investigations with a twin-engine Boeing airplane, "The Flight Research Plane," equipped with first-class mechanical, electrical and radio equipment (automatic piloting, various recording apparatus, etc.). Using this airplane, its radio engineers, some months previously, had flown over 20,000 miles in the mountains investigating snowstorms in order to study "rain static" (electrified rain and snow), which interferes considerably with radio reception in the United States.

Studies giving the results of these experiments have been published.<sup>8</sup> They showed that the

<sup>8</sup> "Snow Static Effects on Aircraft"—A report on United Air Lines study of the problem of snow static as it affects aircraft radio reception, and a discussion of counter-active methods being developed: Presented by H. M. Hucce, Superintendent of Communications Laboratory, United Air Lines, before a Meeting of the Institute of Aeronautical Science and the American Association for the Advancement of Science at Denver, Colo., June 22nd, 1937.

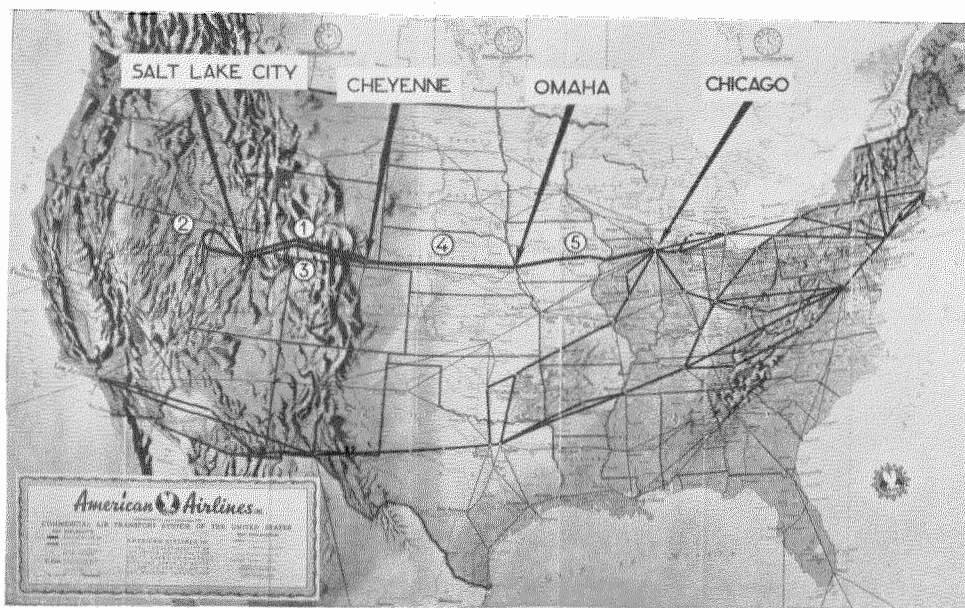

Fig. 13—Map Showing Route of Flight.

shielded receiver loop on the one hand, and the discharge conductors trailed by the airplane on the other hand, made it possible to obtain maximum protection against this type of interference. They also showed the advantages obtained by placing the receiver loop as close as possible to the head of the airplane.

The radio compass was installed on the "Flight Research Plane" at Cheyenne (Wyoming) and after one or two test flights on 2nd December, 1937, the airplane was flown towards Salt Lake City. Below is a brief resumé of the test results, which will subsequently be examined. For itinerary of flights 1, 2, 3, 4, and 5, see Fig. 13. Arrival of the "Flight Research Plane" at Salt Lake City is shown in Fig. 14.

#### 1. Cheyenne (C X) to Salt Lake City (S L)

Bearings were taken from Salt Lake City beacon (distance 280 miles—450 km), from Pueblo (200 miles—320 km), and from North Platte (200 miles—320 km). The position was frequently checked within one or two miles using the loop beacons at Laramie, Medicine Bow, and Cherokee, over which the plane flew at 12000 feet (3600 m). The geographical position

of the above mentioned radio beacons can be seen on the map of Fig. 15.

The usual oscillation at the approach of a loop radio beacon occurred and reached  $\pm 30^\circ$  at a distance of some miles.

After Eagle Buttes, Rock Springs was flown over at 12000 feet (3600 m). The radio beacon at this point is of the spaced antenna type, so that variations on approach were not great. Passage overhead gave rise to the usual oscillations of  $15^\circ$  to  $20^\circ$  amplitude, thus marking the passage. The same indications applied when flying over Knight.

"Homing" towards Salt Lake City, following the beam of the radio beacon, the United Air Lines engineers recorded the output power on the radio beacon's normal receiver. The output then varied continuously, and the radio compass oscillated regularly over  $\pm 8^\circ$  and sometimes up to  $\pm 20^\circ$ , the error in the mean bearing being from 5 to  $10^\circ$ . At intervals, reception passed from *A* to *N*, and vice versa; false cones of silence were produced, giving the impression of being over the radio beacon. Then, over groups of mountains, the lateral reflections were very great. In the valley leading to Salt Lake City, inter-





Fig. 14—The "Flight Research Plane" at Salt Lake City.

From left to right: The Airplane Mechanic; Mr. Dewese, U.A.L. Engineer; Mr. Treher, Pilot; Mr. Tuckerman, Engineer of the "Federal Telegraph Company"; Mr. Hodgson, Assistant to Director of Communications, U.A.L.; and Monsieur Gallant, Engineer, "L.M.T. Laboratoires." (Photograph taken by the author.)

ference decreased progressively and operation became normal some ten miles before reaching the Salt Lake radio beacon. The latter was passed over three times in order to verify the indication of passage.

### 2. From Salt Lake West and back to Salt Lake

During this flight, bearings were taken on several stations without noting any considerable rapid variations. The angles found were correct on Bridge Buttes and Locomotive Springs.

### 3. Night Flight from Salt Lake City to Cheyenne

This flight confirmed the variations noted in approaching Salt Lake City. After the difficult part of the route was passed, good bearings were obtained over Rock Springs, Cheyenne, Walcott and other broadcasting stations where the night effect made itself evident by variations of  $\pm 5^\circ$ .

It is in this difficult region that several aircraft accidents have occurred. Crashes on the moun-

tains during bad visibility would appear to be attributable to the anomalies of propagation and to the interference caused by snow static.

### Study of Mountain Effects

The screening effect of mountains, as is well known, is a relatively simple one. Mountain effect, with regard to direction finding, is produced by the simultaneous reception of several waves coming from the same transmitter after traversing paths of different lengths. In the majority of cases, a direct wave is received, but it is impossible to separate it from one or several superimposed reflected waves. In general, whenever two or more waves originating from a single source are present in space, the envelope curve of vector amplitudes represents a stationary wave in space. Its amplitude is limited to that of the lowest amplitude wave, and its form depends essentially on the directions of the waves and their polarizations.

By way of example, Fig. 16(a, b and c) shows the direction and amplitude of the magnetic and electric vectors for a given fixed direction, that of flight, in the case of two vertically polarized wave propagations forming angles of 40°, 90° and 180°, respectively. The elements of Fig. 16(a) correspond to a case which will be studied in greater detail later on. All the configurations corresponding to any particular polarization can readily be traced by compounding independently, at each chosen point in space, the magnetic and electric vectors of the constituent waves.

If the amplitude of a given wave is clearly greater than the amplitude of another wave or waves, the dephasing of the resulting vectors and their variations in amplitude will obviously be greatly attenuated.

It is likewise easy to trace the configurations corresponding to the presence of several waves of different polarizations at a fixed point. The novelty of the case under examination arises from the fact that the airplane cuts through the zone of interference rapidly and the indication of direction obtained with a loop receiver, for example, varies constantly since the resulting magnetic field changes direction regularly (Fig. 17). According to the direction in which the airplane flies in relation to the system of interference, the variations noted will be slow or rapid.

In the case of greatest interest here, the airplane flies towards the transmitter or towards the radio beacon, and it then cuts through an interference pattern which produces a regular

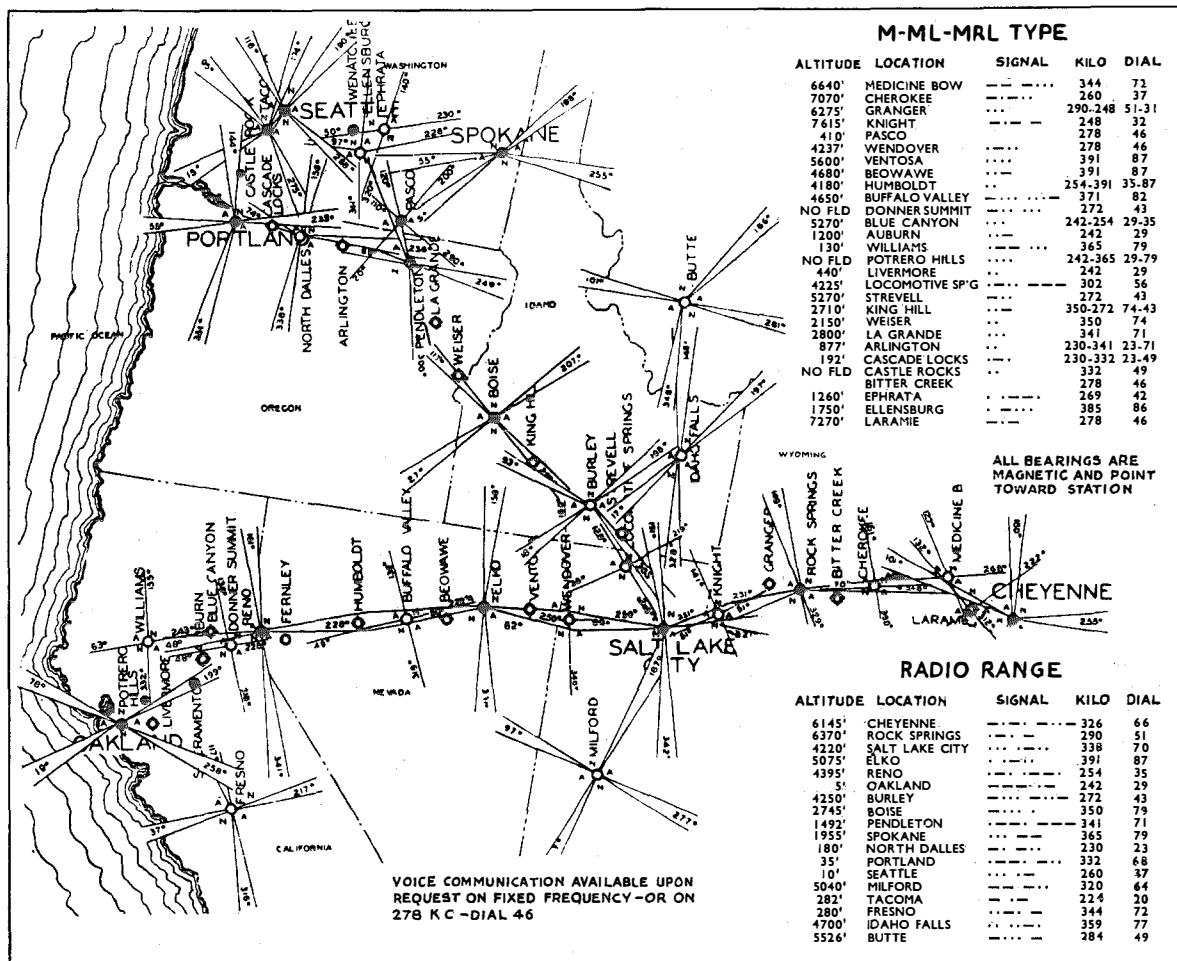

Fig. 15—Partial Map of the Cheyenne-Oakland-Portland-Seattle Radio Beacons.

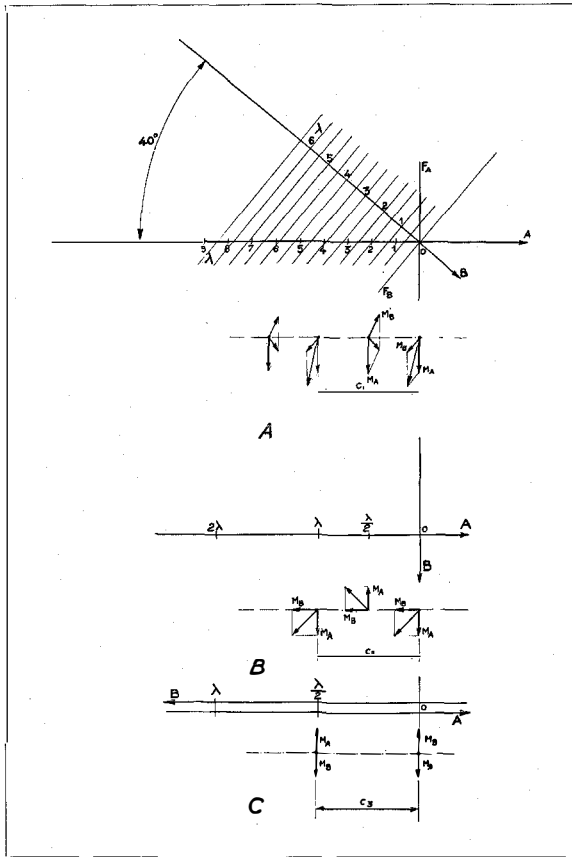

Fig. 16—Interference of Two Waves in Different Cases.  
Fig. 16a

$F_A$  = wave front in direction A.  
 $F_B$  = wave front in direction B.  
 $A$  and  $B$  = amplitudes:  $A/B = 2$ .  
 $C_1$  = length of the oscillation cycle of the bearing.  
 $M_A$  = magnetic vector of A.  
 $M_B$  = magnetic vector of B.  
 The resultant vectors are shown in the figure.

Fig. 16b

Same notation as in Fig. 16a but  $A = B$  and an angle of  $90^\circ$  exists between them.  
 $C_2$  = length of oscillation cycle.

Fig. 16c

Same notation as in Fig. 16a but  $A = B$  which are in opposite directions.  
 $C_3$  = length of the oscillation cycle.

swing in the indication, accompanied by a fixed deviation from the mean value.

In Fig. 16, if the distance be studied in wavelengths calculated on the direction of A, for which the vectors of the two waves are produced with identical phase, corresponding to a complete cycle of the signal oscillation, a number  $n$  may

be found as follows:

$$n = \frac{1}{\frac{1}{\cos \delta} - 1} + 1.$$

For Fig. 16(a),  $n = 4.23$ . If the airplane speed is 240 km per hour, the following durations will be obtained for a single cycle:

$\lambda$	Length of Cycle in Space	Duration of Cycle in Seconds
1000 m	4230 m	63.5
100 m	423 m	6.3
10 m	42.3 m	0.6
1 m	4.2 m	0.06

In Fig. 16(b), where the propagation directions form an angle of  $90^\circ$ ,  $n = 1$ , and accordingly one obtains for the same plane speed:

$\lambda$	Length of Cycle in Space	Duration of Cycle in Seconds
1000 m	1000 m	15.
100 m	100 m	1.5
10 m	10 m	0.15
1 m	1 m	0.015

In Fig. 16(c), where the propagation directions are opposed, and for the same speed,  $n = 0.5$ , and no further oscillation in the bearings is to be noted. Considerable variations, however, occur in signal strength at the rate indicated in the following table:

$\lambda$	Length of Cycle in Space	Duration of Cycle in Seconds
1000 m	500 m	7.5
100 m	50 m	0.75
10 m	5 m	0.075
1 m	0.5 m	0.0075

Due to irregular reflection, the amplitude and the duration of oscillation, as a rule, vary very rapidly as a function of displacement.

Stated in an equivalent manner, the general effect may be explained as a function of the displacement of the airplane: the direct distance towards the transmitter and the distance traversed by the reflected waves do not vary equally and, due to this fact, the reflected wave is peri-

odically reversed in phase with respect to the direct wave. Thus the variation in bearing indications results.

This is accompanied by another effect: between the extreme positions corresponding to the magnetic field of the reflected wave (in phase or in phase opposition with the direct wave), there is interposed the case where the two vectors are at 90° difference in phase which, in the loop receiver, represents a very poor minimum for signal direction finding (Fig. 17). A radio compass operating under these conditions will therefore indicate deviations around a mean position which is inexact, the passage to the mean position

being accompanied by a very blurred minimum, whilst this minimum is transformed into a perfect zero for extreme positions of deviation. If there are several reflected waves, the phenomenon may be investigated by the same method, but is then more complicated. In practice, a predominant reflected wave seems to be most often encountered.

It would appear useful to examine the general case of reception on a direction finding loop of two waves which are out of phase and of differing direction and amplitude.

If  $A$  and  $B$  are the amplitudes of these two fields,  $\phi$  their difference in phase,  $\Sigma$  and  $(\Sigma + \delta)$  the angles made by the direction of propagation of the waves  $A$  and  $B$ , respectively, with the loop, the induced e.m.f.  $E$  is:

$$E = A \cos \omega t \cos \Sigma + B \cos (\omega t + \phi) \cos (\Sigma + \delta).$$

In order to find the maxima and minima of this function with respect to  $\Sigma$ , it is necessary to differentiate with respect to  $\omega t$ , eliminate  $\omega t$ , differentiate with respect to  $\Sigma$ , and then find the values of  $\Sigma$  for which the resulting expression becomes zero.

From the final expression  $d(E)^2/dt$  one obtains

$$\tan 2\Sigma = -\frac{B^2 \sin 2\delta + 2AB \cos \phi \sin \delta}{A^2 + B^2 \cos 2\delta + 2AB \cos \phi \cos \delta} \quad (1)$$

The tangents of an angle and of the same angle plus  $\pi$  being identical, two values of  $\Sigma$  are found which satisfy the equation, namely,  $\Sigma$  and  $(\Sigma + \pi/2)$ . The first corresponds to maximum reception, and the second to minimum reception. There are thus obviously two maxima and two minima, respectively, at 180° from one another.

The value of  $\Sigma$  in the above equation gives directly the angle of error due to the presence of the field  $B$ , the field  $A$  being considered as the field of exact bearing.

A particular case must be noted for which  $\phi = 90^\circ$ ,  $\delta = 90^\circ$ , and  $A = B$ . A perfect rotating field free from maxima or minima is then obtained.

Another particular case is that for which  $\phi = 0^\circ$  when the equation yields a result identical with that obtained by another more easily established formula. If, then, the fields are in phase or in opposition when extinction is obtained by turning the loop, the following relation obtains:

$$A \cos \Sigma \pm B \cos (\Sigma + \delta) = 0,$$

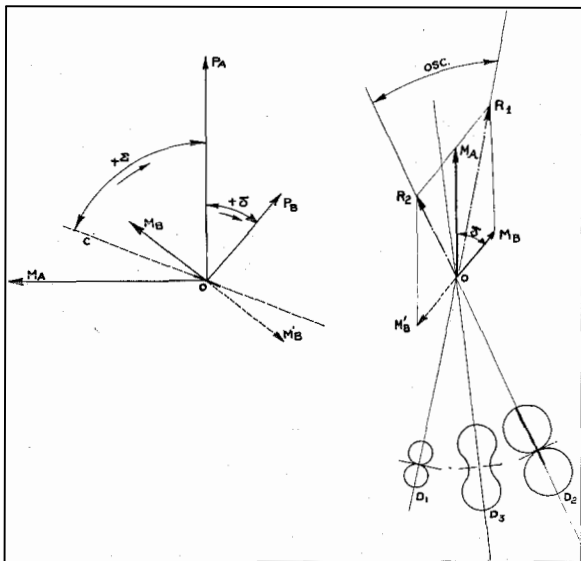

Fig. 17—Rotating Field Produced by the Interference of Two Waves.

*Left Hand Figure:*

$P_A$  = direction of propagation of the wave of amplitude  $A$ .

$P_B$  = direction of propagation of the wave of amplitude  $B$ .

$M_A$  = magnetic vector of the wave  $A$ .

$M_B$  = magnetic vector of the wave  $B$ .

$O_c$  = plane of the receiver loop.

In the diagram  $A/B = 2$  and  $\delta = 40^\circ$ .

*Right Hand Figure:*

Same value of  $A$ ,  $B$  and  $\delta$ .

Osc. = amplitude of oscillation in indication for 180° change in phase.

(From  $\phi = 0^\circ$  to  $\phi = 180^\circ$ , from  $R_1$  to  $R_2$ , and conversely.)

$R_1, R_2$  = limiting resultants of the magnetic vectors.

$D_1$  = reception diagram of resultant vector  $R_1$  (good direction finding zero).

$D_2$  = reception diagram of resultant vector  $R_2$  (good direction finding zero).

$D_3$  = intermediary diagram for a mean position with very bad direction finding minimum, due to the presence of a component in phase-quadrature.

which gives

$$\tan \Sigma = \frac{A}{B \sin \delta} + \cot \delta.$$

Without error  $\Sigma$  should be found equal to  $90^\circ$  since extinction must occur when the plane of the loop makes an angle of  $90^\circ$  with the direction of propagation.

The error will, therefore, be given directly with the sign usual in direction finding, by:

$$\cot \epsilon = \frac{A}{B \sin \delta} + \cot \delta. \quad (2)$$

In equation (1) given above and, referring to Fig. 17,  $P_A$  and  $P_B$  are the directions of propagation of the fields  $A$  and  $B$ ,  $M_A$  and  $M_B$  the magnetic vectors; then, if  $\phi = 0$ , the vectors  $M_A$  and  $M_B$  are in relation to each other as shown in the figure; also,

if  $\phi = \pi$  the vector to be considered for  $P_B$  is  $M'_B$ ;

for  $\phi \pm \epsilon$  the equation gives the same value and the same sign because it does not show the alternative sinusoidal variation of the magnitude of the vector on its direction.

Values  $+\Sigma$  are calculated clockwise as from  $c$ ; values  $-\Sigma$  are calculated anti-clockwise as from  $c$ .

The direction finding error in the standard sense is  $\Sigma$  with a changed sign. This is the error which is found in the following tables.

Table I below shows some values of the error for fields in phase and in opposition (Fig. 17), corresponding to the extreme positions of the radio-compass variation due to mountain effect.

TABLE I

$\delta = 10^\circ$	Error	$\Sigma = 3^\circ 20'$
$\delta = 10^\circ + 180^\circ$		$\Sigma = -9^\circ 30'$
(Change of phase)		
$\delta = 40^\circ$		$\Sigma = 13^\circ 5'$
$\delta = 40^\circ + 180^\circ$		$\Sigma = -27^\circ 28'$
(Change of phase)		

$$\frac{A}{B} = 2;$$

$\Sigma$  and  $\delta$  are calculated in the usual direction finding sense.

Table II gives one or two values of the error for fields of intermediary phase between  $0^\circ$  and

$180^\circ$  for the last example in the foregoing table. These values correspond to the intermediate positions of the signal deflections (Fig. 17) under conditions where the mountain effect is experienced.

TABLE II

$\phi = 0^\circ$	Error $\Sigma = 13^\circ 5'$
$= 10^\circ$ and $350^\circ$	$= 13^\circ 2'$
$= 45^\circ$ and $315^\circ$	$= 11^\circ 40'$
$= 90^\circ$ and $270^\circ$	$= 6^\circ 58'$
$= 100^\circ$ and $260^\circ$	$= 4^\circ 15'$
$= 112^\circ 30'$ and $257^\circ 30'$	$= 0^\circ$
$= 135^\circ$ and $225^\circ$	$= -11^\circ 15'$
$= 170^\circ$ and $190^\circ$	$= -26^\circ 37'$
$= 180^\circ$	$= -27^\circ 28'$

$$\frac{A}{B} = 2; \quad \delta = 40^\circ;$$

$\Sigma$  and  $\delta$  are calculated in the usual direction finding sense.

In order to obtain the value of  $\phi$  corresponding to the zero error,  $\Sigma = 0$ , it will suffice to make:

$$B^2 \sin 2\delta + 2AB \cos \phi \sin \delta = 0;$$

that is,

$$\cos \phi = -\frac{B^2 \sin 2\delta}{2AB \sin \delta} = -\frac{B}{A} \cos \delta.$$

The amplitude and character of the oscillations noted under mountain effect are clear from these quantities which correspond to recognized physical cases. The oscillations are accompanied by synchronous signal strength variations, which are not observed if the receiver is equipped with automatic volume control.

The reflecting body may be situated in a direction which is opposed to the transmitter with relation to the airplane. In this event only slight variations should be noted in the bearings if the reflected field is vertically polarized (electric field in a vertical plane containing the direction of propagation). Regular and considerable variation of reception would then occur. The reflected field may, nevertheless, be partially polarized horizontally, and the horizontal component of the electric field thus existing may produce an error in the loop comparable to the night error. As direct and reflected wave-phases are inverted in relation to one another during operation, the error thus produced changes its sign and a swing in the indications is produced around a position of mean error as in the foregoing cases.

This is, however, fairly generally the case with a transmitter giving circular radiation. Trans-

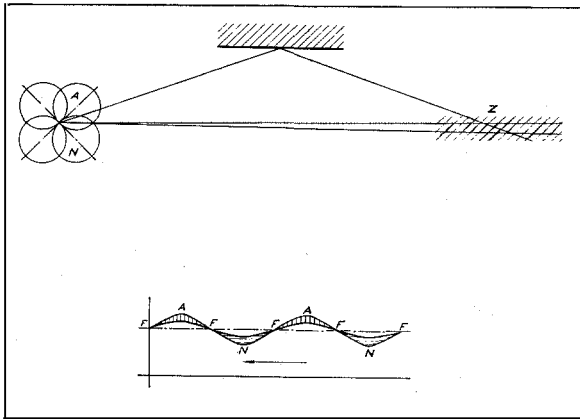

Fig. 18—Reflections on the Two Successive Radiation Diagrams of a Radio Beacon with Multiple Signal System.

Z = zone where interference is produced.

A = reception of the A signal.

N = reception of the N signal.

F = points of equal signal strength corresponding to the beam.

mitters with directional radiation give rise to more complicated phenomena since, according to the directions of maximum and minimum radiation, radio beacons producing a multiple system of signals give rise to reflections which are much higher for one system than for another, as is shown in Fig. 18, where system A radiation is greater towards the reflecting mountain. Consequently, in a zone Z, the radiation of system N is much less affected by reflections than the radiation of system A. The practical result on board the airplane, as regards the direction finder or the radio compass, is a swing in the indication between the transmission of N and that of A, thus adding complication to that described above and appearing, this time, in the form of oscillations in indication which, a priori, seem to obey no fixed law.

This phenomenon also has a considerable repercussion on the beam. The beam is, in fact, affected simultaneously by the two phenomena just described. If a position is taken up, as shown in Fig. 18, at successive points of the theoretical beam in the direction of flight a series of zones will be encountered where the interference of the two waves produces successive maxima and minima of reflection on the two transmissions; but no simple relationship will exist between the variations in the mean field intensities of system A and of system N, the waves not being sub-

jected to the same reflections. The distortion of the beam, upon examination, appears to be very complex although, actually, the phenomenon is quite capable of interpretation, at least in principle.

For another type of reflection, the successive maxima and minima reception of system A and system N are shown in Fig. 19. When the signals are equal, there is an apparent beam and reception, on either side, of the A and the N signals.

The transmission of a frequency spectrum corresponding to a modulated wave, instead of a pure wave, is an additional cause of complication and distortion, as the phases of the components are affected differently by the reflections. It is, however, in the carrier that the principal effect is apparent.

During experimental flights made between Berne and Basle by Monsieur Gallant on a plane of the Alpar Co. equipped with a radio compass, effects (which are identical with those at Salt Lake City) were noted in connection with the Berömunster transmitter when crossing the Jura. The regular variations in these bearings around a slightly inexact mean position are

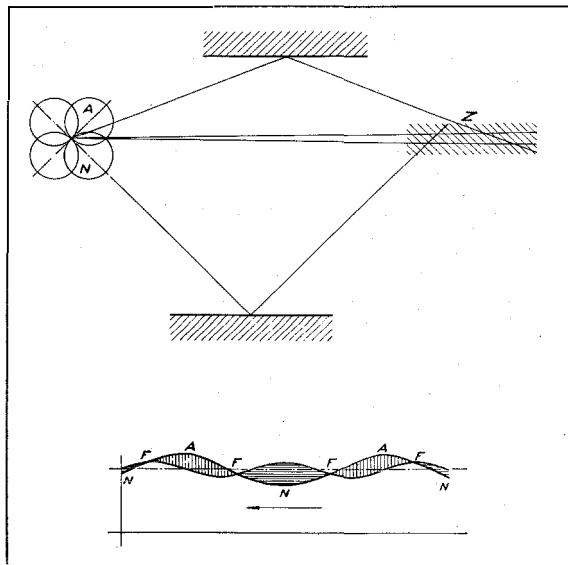

Fig. 19—Reflections of the A System with Shorter Period of Oscillation than on N

Weaker reflections of the N system.

Z = zone where interference is produced.

A = reception of the A signals.

N = reception of the N signals.

F = points of equal signal strength corresponding to the beam.

clearly explicable in view of the foregoing paragraph, the phenomenon being much simpler than that observed at Salt Lake City since the transmitter had a circular radiation diagram.

The points and paths along which these variations occurred are shown in the map of Fig. 20.

The table (Fig. 21) shows the amplitude and the nature of the variations noted.

The following relating to the mountain effect is presented:

1. The oscillation period in the indication depends on the wavelength and the speed of the

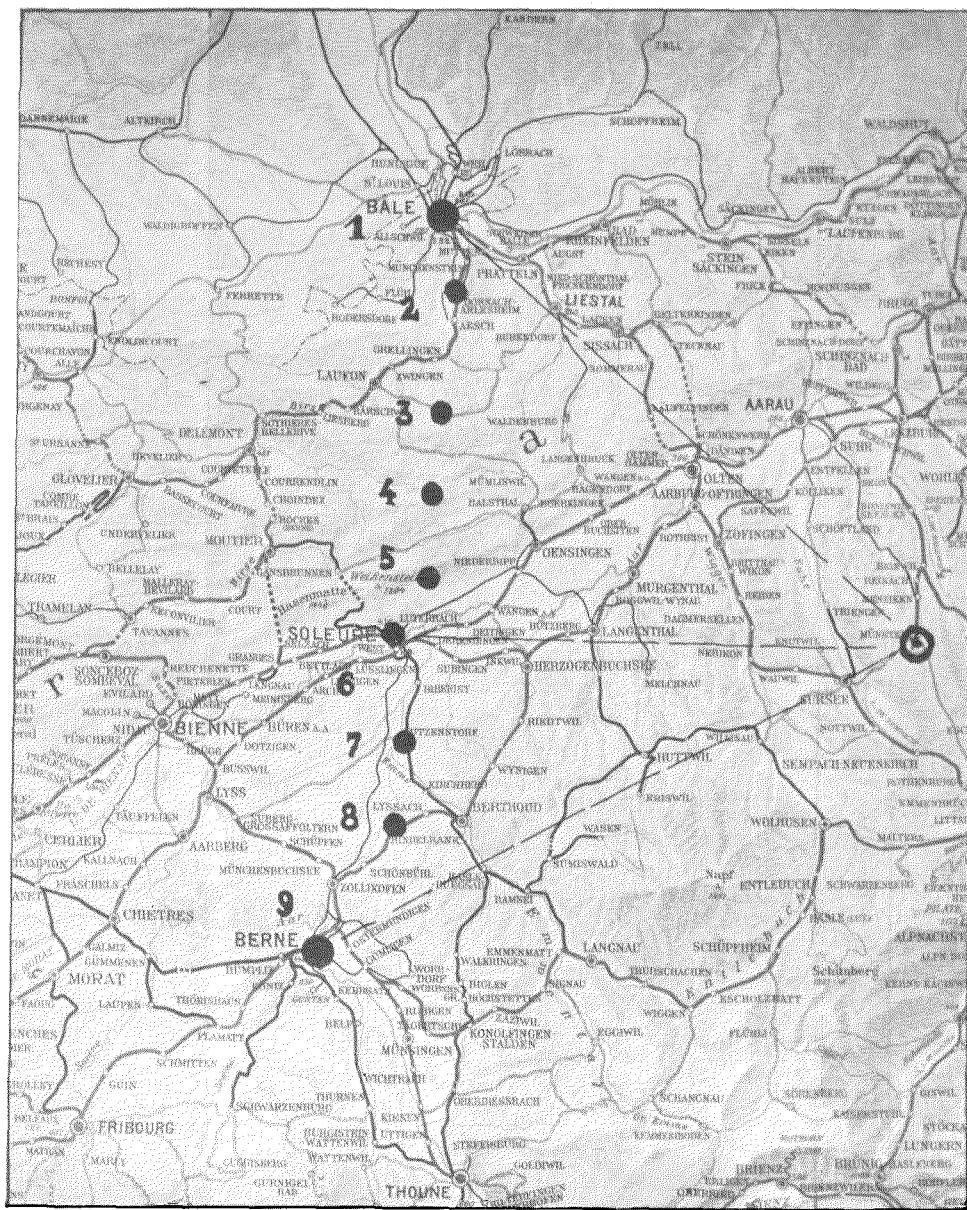

Fig. 20—Map of the Flights Between Berne and Basle Showing the Zones Where Oscillations Occurred.

plane. The amplitude of the oscillation depends on the relative amplitudes of the two waves.

2. The mean of the extreme values of the oscillations is in error in relation to the true bearing, except in the case where the direction of the reflected wave differs from that of the direct wave by 90°. The speed of the displacement of the indication in the course of oscillation does not vary as a sinusoidal function.

3. Using a single loop antenna, the bearing always lies between the extreme positions of deviation; a collector antenna of this kind, therefore, is to be preferred to the permanent loop-antenna combination.

4. The absence of an indication oscillation is a guarantee of accuracy; the presence of oscillations a warning.

It must not be assumed that it is impossible to apply direction finding in mountainous regions. On the contrary, engineers could exploit the effects observed by making a diagram of oscillations for given directions and speeds in good weather for the purpose either of determining the zone of flight, or of defining the mean precision of the radio beacon bearings with respect to their reliability.

In the operating field, improvement doubtless could be effected by additional research, as well as analysis involving the consistency of results obtained during flight and application of experience gained.

A cathode-ray oscillograph, instantaneous type direction finder will give information which is very much more useful than an indicator with finite inertia; the manual direction finder here is entirely useless.

A complex apparatus would make it possible to deduce from an examination of the successive intensities and directions of the resultant magnetic vector, in the course of an oscillation cycle, the directions of the component fields. A simultaneous examination of the variations of the resultant electric field would supply additional information.

So-called "homing" devices permanently using a loop-antenna combination are much more affected by mountain effect than loop direction finders or radio compasses with a single loop. Actually, the amplitude of the resultant magnetic and electric vectors never remains in the

desired ratio for satisfactory operation. This ratio varies constantly for the stationary wave and also—which is more serious—as regards relative phase. In these "homings," in addition to the effect of alternative deviation as explained in the foregoing, the periodic disappearance of the indications will be noted, accompanied by internal errors in the apparatus, as well as reversals of the indication of 180°.

On short waves, and even ultra-short waves, the phenomenon is similar except for the oscillation period which, on ultra-short waves, may become smaller than the operating alternations at *A* and *N* and thus give distorted indications. Reflections are very intense on ultra-short waves but, the diffraction being less, they only affect cones which are narrower than on long waves. Engineers studying instrument landing have at times experimented with short-distance reflections.

Identical effects are noted when taking bearings on airplane transmission at a ground D.F. station. These were noted on long, short, and ultra-short waves with reflections coming laterally or from the ionosphere.

Fig. 21—Table Showing the Effect of the Jura During the Flights from Berne to Basle, and Back Again (July 22, 1938).

Transmitter used: Beromünster  
Frequency *f*: 556 kc/s  
Wavelength  $\lambda$ : 539.6 m.

*Traveling from Berne to Basle:*

Points	Radio Bearings		True Bearings	
	Extreme	Mean	On the R.C.5	Map
8 Hindelbank	48–52	50	74	71
7 Utzenstorf	stable	60	82	81
6 Soleure	75–85(+)	80	94	93
5(x) Rothliffuh	75–95(+)	85	98	98
4(x) H. Winde	95–115(+)	105	110	111
3(x) Nunningen	stable	120	120	118
2 Dormach	stable	127	125	126
1 Basle	134–140	137	134	133

*Return Journey Basle to Berne:*

2 Dormach	306–320(+)	314	306	306
3(x) Nunningen	stable	300	296	298
4(x) H. Winde	280–300(+)	290	293	291
5(x) Rothliffuh	270–280(+)	275	283	278
6 Soleure	255–259	257	276	273
7 Utzenstorf	249–251	250	272	261
8 Hindelbank	221–225	223	256	251
9 Berne	210–215	212.5	241	239

Oscillations were on an average  $\pm 3^\circ$ .  
Above the Jura, they attained  $\pm 10^\circ$ .  
Considerable variation in signal strength was noticed, using headphones, when the amplitudes of the oscillations were at a maximum (above the Jura).  
Mean speed of the airplane = 180/200 km/h.  
Oscillation frequency = about  $\frac{1}{2}$  cycles per second.  
The points marked (x) were above the Jura.  
The points marked (+) corresponded to maximum oscillations.  
Altitude: 1500–2000 metres.



Before concluding this section, a brief survey will be made of the result of these effects in permanent direction finding stations located in mountains or their vicinity. One is sometimes inclined to think that a mountain will give rise to a fixed deviation in a determined direction throughout a region; in short, the case of mountain effect is compared with that of deviation on board ships and airplanes. This is a grave mistake inasmuch as the direct and indirect paths, as well as the vector phases, are such that these deflections may be positive at a certain position and negative at a position relatively adjacent, the change in phase taking place at an intermediate point (see Fig. 16-A).

Another effect, found in a large number of direction-finding stations, may perhaps have been inadequately explained: A slight change in the frequency of a transmitter (3 kc/s in 300 kc/s, for example) will suffice to produce a change in the bearing of some few degrees in a direction finding station. This is an indication of a reflection. This difference of frequency (1%) reverses the phase of a reception vector if the direct path, for example, amounts to  $300\lambda$  when the indirect path amounts to  $350\lambda$ , and produces between the bearings on the first and second wavelengths a considerable difference which may easily be calculated by means of the formulae already developed. It will reach one or two degrees, in the case of the example given, for a reflected energy which is equal only to 2 or 3% of the energy directly received.

It is not necessary, in order to produce a deflection, that a phase should be reversed by  $180^\circ$ ; a much smaller angle is sufficient. On short waves this effect may be particularly marked.

Two other effects might be explained in regard to direction finding: The first consists of a slight irregularity in bearing with a variation of the compensation when the transmitter frequency is not stable. This effect is produced by weak reflections, as previously mentioned. In order to explain the variations of the compensation which accompany this effect, it is sufficient to recall that the phase of the reflected vector may have any value, and usually contains a component  $90^\circ$  out of phase with the direct vector, varying in amplitude with the variation in frequency; hence the variations in compensation which

must be effected to maintain a satisfactory zero.

The second effect relates to direction finding on modulated and damped waves. When transmission is effected by these waves, it may be compared with the transmission of a frequency spectrum comprising a predominant frequency—the carrier; the other frequencies of the spectrum differ as a rule by some kc/s. from the carrier, say 2 to 3% for stations broadcasting on long waves, or 0.5 to 1% for medium-wave broadcasting stations.

As an example, the frequencies of the side bands differ by 0.3% from the carrier for a transmitter modulated at 1000 cycles, and transmitting on 300 kc/s.

This difference, in the presence of a reflection, results in direction finder minima being obtained at angles which differ by some tenths or some degrees; it is thus impossible to fade out the signals. Moreover, it is not possible to find a compensator position which will eliminate the effect of the different vectors of the frequency spectrum disposed at angles which differ with regard to one another and with regard to the carrier. It is, therefore, sometimes impossible to obtain clean minima on modulated and damped waves; in connection with the latter, this fact has already been observed. On modulated waves, at the minimum signal, distortion of the modulation accordingly arises. This originates from the fact that certain but not all frequencies are extinguished, the maximum distortion obviously corresponding to extinction of the carrier.

If, under such conditions, the modulated transmission is replaced by a pure continuous wave transmission (or interspersed by intervals of modulation), a clean minimum is again observed for a definite position of the compensator, the latter being capable of eliminating a vector which is slightly dephased with regard to the principal vector and which originates from a reflection.

##### ***5. Demonstration of Mountain Effect on a Reduced Scale with a Short-Wave Direction Finder and a Reflector System***

It seemed interesting to make a few experiments of reflection on a reduced scale in the course of which one could easily vary the distances and relative positions of a reflector system and a radio direction finder.

Having had an opportunity of producing an ultra-short-wave direction finder, it was easy to make these experiments by using either the television transmissions from the Eiffel Tower (7.14 m–6.52 m) or the field produced by a small transmitter situated some hundreds of metres away. The direction finder was installed in the grounds of the Laboratories experimental station in Trappes, where satisfactory bearings (within about  $1^\circ$  or  $2^\circ$ ) were obtained on the two transmissions of the Eiffel Tower at a distance of 30 km.

The first experiment consisted in erecting a reflector of about 25 m<sup>2</sup> area about 50 metres from the direction finder during reception of transmission from the Eiffel Tower. By moving the reflector backwards and forwards through a certain distance, it was possible to produce positive and negative deviations in the bearing according to the phase angle with which the reflected wave combines with the direct wave.

Using the local transmitter and modifying the distance in the same direction, positive and negative variations of the bearing were obtained accompanied by a mean deviation of the bearing, as shown in Section 4.

By selecting the correct distance between the reflector and the direction finder, it was possible to obtain a negative deviation of the bearing on a 6.52 m wave while a positive deviation was obtained on a 7.14 m wave.

Fig. 22 shows the nature of the variations as a function of the distance of the reflector for these two wavelengths. The greater the extent to which the indirect path comprises wavelengths in excess of the direct path, the less is it necessary to vary the frequency of the transmitter in order to reverse the direction of the deviation.

Assuming that the transmitter is not considered as placed at infinity, the bearing varies regularly as a function of the displacement of the transmitter in the direction of the direction finder.

If the reflector be placed behind the direction finder, there will be no deviation; but, according to the distance between the finder and the reflector, zones of maximum and minimum intensity will be produced, depending on whether the fields are in phase or in phase opposition.

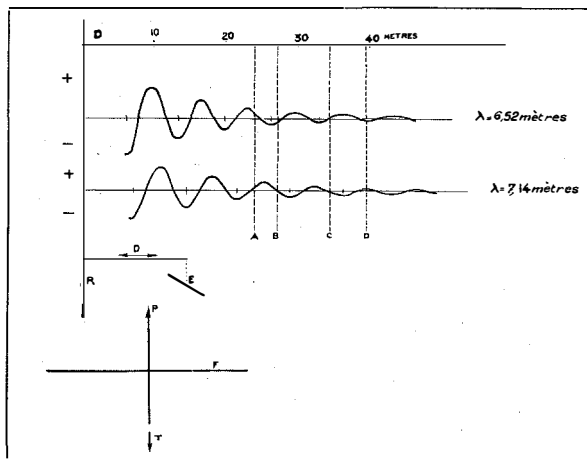

Fig. 22—Reflections and Direction Finding on Ultra-short Waves.

Deviations as a function of the distance from a reflector for two different wavelengths.

R = radiogoniometer.

E = reflector.

P = direction of propagation.

F = wave front.

T = direction of distant transmitter.

D = distance in metres between the radiogoniometer and the reflector.

A = distance at which the deviations are equal and of the same sign on 6.52 and 7.14 metres.

B = distance where the deviation is negative on 6.52 m and zero on 7.14 m.

C = distance where the deviations are zero on the two waves.

D = distance where the deviations are equal and opposite on the two waves.

While experimenting between Berne and Basle, as well as in the Rocky Mountains, the transition between maximum deviations was found to correspond to a very poor direction finding minimum, due to the quadrature phase difference between the two waves. This blurred minimum was clearly demonstrated with the ultra-short-wave direction finder.

The variations in bearing produced by a tuned doublet moving away from the direction finder, perpendicularly to the direction of wave propagation, were identical to those obtained by the displacement of a reflector under the same conditions. Variations were furthermore noticeable at a distance of 10 wavelengths (65 metres), as shown in Fig. 23. The results of this reduced scale experiment correspond entirely with those obtained on longer wavelengths and on a larger scale, as was shown above.

A reflector with a surface area of 25 m<sup>2</sup> at a distance of 50 metres, using 5 metre waves, is

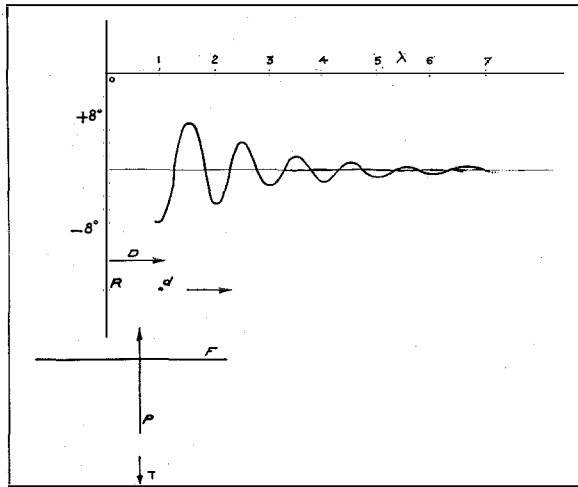

Fig. 23—Deviation as a Function of the Distance of a Tuned Doublet.

$R$  = radiogoniometer.  
 $d$  = tuned vertical doublet.  
 $P$  = direction of propagation.  
 $F$  = wave front.  
 $T$  = direction of the distant transmitter.  
 $D$  = distance between the radiogoniometer and the doublet.

equivalent to a larger reflector about 2 km long by 500 metres high at a distance of 10 km, using 1000 metre waves.

During the author's visit to the United States there appeared to be a widespread opinion that ultra-short wave radio beacons would give better results than medium-wave radio beacons, particularly in mountainous regions, because of the decrease in lateral interfering reflection. The author is of the opinion that a reduction of the reflection effects on ultra-short waves can only be obtained with directional systems which are not directed towards reflecting bodies. In the case of ordinary systems, results with ultra-short waves would perhaps be worse than on medium waves; also, in so far as direction finding in flight is concerned, variations in the bearings might perhaps be 100 times more rapid, resulting in actual modulation of the reception at low frequency.

It should not be inferred that the use of ultra-short waves in aerial navigation is limited; however, particular effects resulting from their application must not be forgotten, i.e., considerable reflections and a weak or zero field on the surface of the ground at a certain distance from fixed transmitters.

## 6. The "Cone of Silence" and the Detection of Flight Over a Station

In the United States, detection of flight over a radio beacon depends on the observation of a decrease in signal strength observed above the station. The determination of this point is essential before landing, yet observations have for a long time been found to be contradictory and confused.

Consideration of Section 3 makes clear the many different cases which may occur, according to the nature of the transmission and the method of reception (open or closed aerials). An airplane usually passes above the radio beacon at a distance which has considerable influence on the results, i.e., less than  $\lambda$ .

An attempt has been made to condense the different cases which may arise into a table (Fig. 24). The values in the table correspond only to the fields' values in conjunction with a specific type of collector-antenna. It must, however, be noted that the receiver plays a considerable part in the appraisal of results. For example, in the case of a receiver with automatic volume control, the author has never noted the slightest "silent point," either above a radio beacon or over broadcasting stations. The silent point in question is, therefore, entirely relative with regard to the preceding or succeeding intensities of reception.

To sum up: a relative decrease in signal strength will only be noted above a station if the precaution has been taken of progressively decreasing the receiver gain during a period of increase of signal intensity. This has the advantage of rapidly suppressing reception and thus calling attention to any inadvertent direction of the airplane away from the station. The ultra-short wave markers in course of installation, moreover, give a positive passage indication which is much preferable.

Another effect which is clearer than the "cone of silence" is that which has been demonstrated with a radio compass while passing above a vertical antenna station. There then arise oscillations of indication as shown in Fig. 25. If the route is sufficiently to one side, the indicator makes a complete revolution, showing a variation of  $180^\circ$  in direction; but, if the flight has

Fig. 24—Table of the Variations of the Cone of Silence According to the Type of Transmitter and Receiver Aerials.

	Reception on:	Antenna
Loop Radio Beacon	Loop	
	Above $\lambda$	With a single loop transmitter it would be possible to obtain silence for a certain position of the loop receiver; the fact of operation on both loops is an obstacle to this silence; equally, if the loop receiver rotates. The intensity will increase in a normal way upon approach.
Antennae Radio Beacon	Loop	
	Below $\lambda$	With a single loop transmitter it would be possible to obtain silence for a certain position of the loop receiver; the fact, operation on both loops is an obstacle to this silence; equally, if the loop receiver rotates. The intensity increases considerably upon approach, no silence is noted.
Vertical Antenna	Antennae	
	Above $\lambda$	Fairly sharp cone of silence, intensity increases normally.
Antenna, Ordinary Types	Antennae	
	Below $\lambda$	Fairly sharp cone of silence just above the transmitter only; the intensity increases normally.
Antenna, Ordinary Types	Vertical	
	Above $\lambda$	Fairly sharp cone of silence; the intensity increases normally.
Antenna, Ordinary Types	Vertical	
	Below $\lambda$	Fairly sharp cone of silence just above the transmitter. The intensity increases normally.
Antenna, Ordinary Types	Antenna	
	Above $\lambda$	Less clear than the above and more irregular.
Antenna, Ordinary Types	Antenna	
	Below $\lambda$	ditto

The expression "cone of silence" is not satisfactory since this cone is open to an infinitely small amount; it is used here because it is the current expression in the United States. We define this region as the volume containing signals whose strength is below a certain value. It will, however, be noticed that this volume is not a cone. Moreover, above and below  $\lambda$ , the transition is obviously not sudden, and these references must be taken only as a matter of guidance.

been directly above the station, the symmetrical effect shown in the figure will always be observed.

A considerable number of experiments and tests show that the rapidity of the oscillation, like the amplitude, depends little upon the altitude. The simplicity of the form of the lines of force of the magnetic field around the antenna do not at first sight coincide with the effect itself. The experimental determination of the exact reasons for this effect is a difficult matter inasmuch as it is not possible to remain stationary above the station or to pass slowly over it. It is thought, however, that the speed of passage in conjunction with the relative inertia of the magnetic indicator of the radio compass is an influencing factor.

The following explanation is therefore suggested in the absence of more accurate experiments: The magnetic field (although less intense than the electric field) has nevertheless a con-

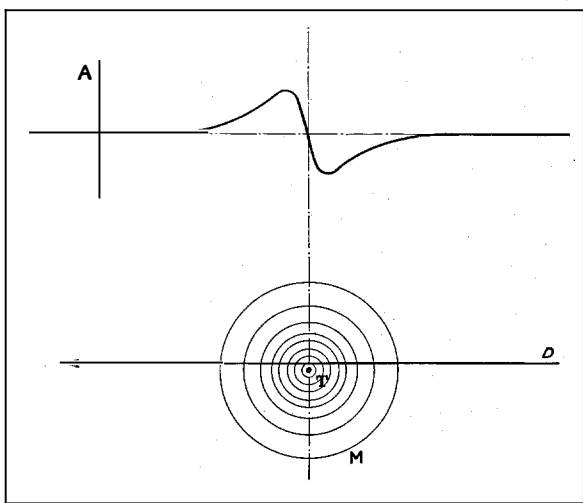

Fig. 25—Swing of the Needle of the Radio Compass Above a Station.

A = Oscillation amplitude of the indication above station with vertical antenna.  
 T = Transmitter antenna.  
 M = Lines of force of the magnetic field.

siderable value above the transmitter antenna. It is zero only on the theoretical vertical line; everywhere else it has a finite value ensuring strong signals. Irrespective of the accuracy of piloting, the airplane always flies some metres or tens of metres to the left or right of the ideal vertical line. The radio compass deflects very rapidly to one side but, turning less rapidly than the field, it acquires a sufficient lag to tend towards recapturing its zero position by a movement in the opposite direction, which follows rapidly upon the zero position to which it finally reverts. Without the  $180^\circ$  uncertainty, which results in the positions of  $0^\circ$  and  $180^\circ$  being the same, this would not occur; a half-turn would probably be observed in all these cases.

### ***7. Advantages of the Radio Compass Combined with the Radio Beacon for Aerial Navigation***

During the tests made on the United Air Lines' "Flight Research Plane" it was possible to ascertain and demonstrate advantages in convenience and reliability accruing from the combined use of radio compasses and radio beacons. The radio compass is now more useful with radio beacons than it is with ground direction finders which, as a rule, can define the position of an airplane which has lost its bearings.

Taking the radio beacon by itself the pilot, who for some reason (temporary interference, rain or snow static, possible cessation of the radio beacon), finds himself outside the beam, knows on reverting to normal conditions that he is no longer in the beam. He, however, has great difficulties in getting into it again, and in the course of this manoeuvre finds himself out of control and in serious danger in mountainous country.

The airplane radio compass, which is directed to this same radio beacon, makes it possible for him to define with certainty in what direction—in what quadrant of the beacon—he is flying, and what he must do to get into the beam again. If he is in the beam, the pilot can control his position by a sum-total of indications, giving him a high degree of safety. The radio compass should indicate the angle  $0^\circ$  (in the absence of drift), the directional gyroscope should indicate the geographical direction corresponding to the

beam, and the radio beacon receiver should show that the airplane is in its beam. Any deviation should be discerned immediately by rapid differences between the three indications.

If the airplane should be outside the beam from the radio beacon, and if the pilot rejoins it by cutting it at any angle, the only way of obtaining the direction of the beam consists in veering round from the point of entry of the beam until the radio compass is made to indicate the angle  $0^\circ$ .

In the beam of a radio beacon, and whilst flying towards it, the pilot is sufficiently accurately aware of his longitudinal position in the beam by bearings taken on the lateral radio beacons. Their exceptional density in American territory permits frequent recourse to this method of location.

In accordance with landing orders which have been particularly well studied, the pilot who wishes to land, after having noted his passage over the radio beacon, should make a circular movement around the latter in a fixed position during which operation he will have occasion to cut the four beams. This is a very simple operation if the radio compass is tuned on to the radio beacon. It will, in fact, suffice to read an angle of about  $90^\circ$  or  $270^\circ$  on the radio compass and to cut the four beams at this angle, a circle being described around the radio beacon.

It is in these two latter applications that the superiority of the indication of the direction of  $360^\circ$  is most clearly followed. The last operation mentioned is far too rapid to be accomplished with a manual direction finder and it is not easy with a "homing" device.

To quote one or two practical tests made in Cheyenne, Omaha and Chicago: Successive use was made of all the radio beacons, of which certain ones situated well to one side, like Kansas City, gave bearings at 163 miles (260 km) distance (see section map Cheyenne-Chicago, Fig. 26).

In Chicago an opportunity was utilized of checking up generally on the accuracy which may be expected in respect of bearings with a radio compass or a manual direction finder during flight at a distance of about 20 miles (32 km) around the Rockford radio beacon. The geo-

graphical positions were noted with the greatest care.

The table of Fig. 27 shows the precision which may be obtained. It is to be remarked that the error values are generally very similar on the two instruments and that this is a very clear demonstration, if one were required, that the majority of errors are due to the inexact knowledge of the airplane course. If this course is not known with a high degree of precision, errors will be found in the position determined; all pilots, in fact, are agreed that the most necessary condition to make a "fix" on board an airplane is to know the airplane's course within about one degree whilst taking bearings.

Another factor is revealed by these figures, viz., the successive courses of the airplane are all affected by a regular error, probably of 5°.

Actually, by adding 5° to all values of the courses it will be found that the total error in miles is divided by 2 or 3.

The taking of all these bearings by hand was a long and delicate operation. It suffices to note the values indicated with the radio compass; and the use of a small circular calculating apparatus makes it possible to establish the true bearings with relation to the North within a few seconds, including all corrections.

8. Conclusion

In this article various phenomena relating to aerial navigation have been considered. They include simultaneous directivity on transmission and reception, as well as the more troublesome effects due to wave reflections encountered in

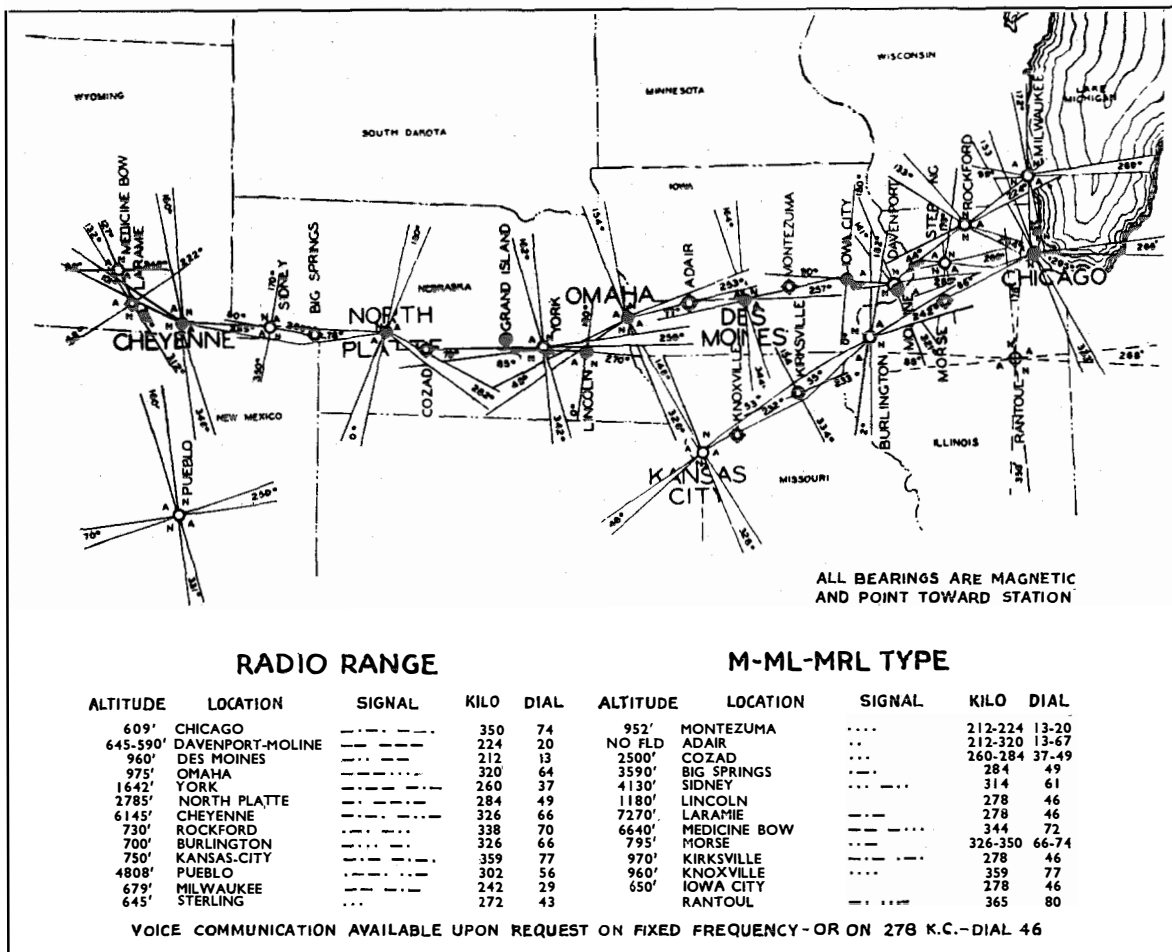

Fig. 26—Section Map of the Cheyenne-Chicago Radio Beacons.

Fig. 27—Bearings Taken Around the Rockford Radio Beacon at About 20 Miles.

Head	Position	Radio Compass Bearings	True Bearings	Error in Miles	Direction Finder Bearings	True Bearings	Error in Miles
267°	Genoa	23	302.5	9	35.5	302.5	9
	Fairdale	37	319	6	49.5	316.5	6 $\frac{1}{4}$
	Kill Brush Creek	71	345	2 $\frac{1}{2}$	81.4	348.4	2
313°	On river on course	61	26	1 $\frac{1}{2}$	73.3	26.6	1 $\frac{1}{2}$
	All worth	92	44	$\frac{1}{2}$	92	45	$\frac{1}{4}$
	Pecatonia	139	78	1 $\frac{1}{2}$	118	71	4
358°	N. of 3 miles	94	90	1	88.2	86.2	2
	Durand	120	105	4	104	102	4 $\frac{3}{4}$
	S. Avon	143	127	3	123	121	4 $\frac{1}{2}$
43°	Hanover on tracks	144	172.5	0	123	166	2 $\frac{1}{2}$
	Jamesville	152	181	3	134.5	177.5	4 $\frac{1}{2}$
88°	E. Jamesville	118	193.5	$\frac{3}{4}$	99.5	187.5	1 $\frac{3}{4}$
	Emerald	123	196.5	3 $\frac{1}{2}$	106	194	4 $\frac{1}{2}$
133°	Darion	67	209	5	78.7	211.7	4 $\frac{1}{2}$
	Shaven East 3 miles	117	237.5	2	100.8	234	3 $\frac{1}{4}$
177°	Harvard	58	247.5	3	75.5	252	1
	Bend in Road	81	261.5	2 $\frac{3}{4}$	87		1 $\frac{3}{4}$
	Marengo over river	101	272.5	3 $\frac{1}{2}$	95.5	272.5	3 $\frac{1}{2}$
	Average Error (miles)			2.86			3.34

mountainous regions and their reaction on the radio compass and the radio direction finder.

It is hoped that, in some small way, this work may contribute to the safety afforded by radio to aerial navigation, and that it will be completed by the practical observations of pilots who, in addition to their daily tasks, thus aid in promoting the safety of air communications.

Appreciation is extended to the several Government agencies and to American engineers and their collaborators who, in a spirit of perfect cooperation, facilitated the task in general and the experimental investigations in which they constantly participated. The author's thanks are due to Mr. J. G. Flynn, Jr., Mr. J. C. Franklin, and Mr. J. R. Cunningham, the respective Communications Directors of the following companies:

American Airlines, Inc.,  
Transcontinental and Western Air, Inc.,  
United Air Lines;

also to their colleagues, in particular,

Messrs. P. H. Redpath, J. McC. Hodgson and  
H. Deweese,

as well as to Messrs. H. H. Buttner and E. N. Wendell of the International Telephone Development Co., Inc., and to Mr. L. P. Tuckerman of the Federal Telegraph Company.

The author would express his special thanks to Monsieur Gallant for his participation in all these tests and to Monsieur de Maertelaere who made the experiments relating to reflection on ultra-short waves. Both are engineers in Laboratoires L.M.T.

# Development of the Rumanian Telephone System: 1930-1940

By L. B. TUCKER

*Plant Operations Engineer, International Telephone and Telegraph Corporation, New York*

**A**FTER ten years of successful operation and development of the telephone system in Rumania, the International Telephone and Telegraph Corporation sold to the National Bank of Rumania its operating subsidiary, the Societatea Anonima Romana de Telefoane.

In 1930 the I. T. and T. Corporation obtained the concession to operate all of the telephone services, local as well as long distance, throughout Rumania and immediately created the Societatea Anonima Romana de Telefoane as the national company. On January 1, 1931, the S. A. R. de T. took over operation of the existing telephone plant; the sale to the National Bank of Rumania was effected on January 6th, 1941, and the new Rumanian owners immediately entered into possession.

The Standard Fabrica de Telefoane si Radio with its factory in Bucharest, forming a part of the International Standard Electric group of companies, was not included in the sale of the telephone properties and continues as a manufacturing unit of The International System. It also will furnish technical information and advice to the new management of the telephone company.

During the ten years of I.T. & T. operation of the Rumanian telephone system, the Societatea Anonima Romana de Telefoane, benefiting by the technical, managerial and financial assistance furnished by the I. T. and T. Corp., was enabled, not only to extend widely the telephone facilities, both local and long distance, available to Rumania's entire population, but also, in carrying out this expansion, to install automatic equipment, toll cables and other plant embodying the latest advancements in the art of telephone communications. Thus, the telephone system which was turned over to the new Rumanian management is well on the way towards being one of the most modern and up-to-date units of its kind anywhere.

A brief review of the major accomplishments of the Societatea Anonima Romana de Telefoane



*Headquarters Building of Societatea Anonima Romana de Telefoane, Bucharest, Rumania.*

under the management and guidance of the I. T. and T. may be of interest.

## **Urban Installations**

In order to avoid complication, not pertinent to this description, which is historical in nature, the S. A. R. de T. operating area is treated as including cities and territories which, though no longer under its jurisdiction, were developed as an integral part of the Rumanian telephone system.

When the International Telephone and Telegraph Corporation obtained the concession for





*Splicing School, Bucharest, Rumania.*

the operation of the telephone system in Rumania, there were about 50,000 telephones in the country. Of these approximately one-fourth were in the City of Bucharest. In contrast to this, at the time of sale to the Rumanian National Bank, there were approximately 108,000 telephones in the entire system and of these about half were in Bucharest

Of the original 50,000 telephones, slightly over one-fourth had common battery service; a few in Bucharest, where in 1927 the International Standard Electric Corporation had installed 3,000 lines of Rotary equipment, were of the dial type; and the rest were magneto. By 1940 automatic service had been extended to 80,000, or 74%, of the 108,000 telephones and 8,400, or 8%, had improved common battery service.

Complete Rotary automatic exchanges of the latest type were installed in Bucharest and fourteen other areas, including all cities with more than 1,000 subscribers. Lines of automatic equipment, all Rotary, in service in 1940, totalled 63,600. Plans had been drawn up and a program scheduled to extend automatic service to several smaller localities, of less than 1,000 subscribers, which, in the interim, had been given new and improved common battery service.

Early attention was given to furnishing adequate local automatic telephone service in the City of Bucharest. Commercial surveys and detailed engineering studies dictated the establishment of a main office near the business center of the city, retaining for the adjacent residential area the Dacia office with 3,000 lines of Rotary 7-A1 equipment already installed. Pursuant to the fundamental plan evolved from the engineering studies, a modern underground conduit system was built with large sized underground cables extending throughout the city; unobtrusive small distribution cables installed on the walls of the buildings in the business districts and new aerial cable leads in the outskirts replaced bare wire construction. New dial instruments also were installed; and, when the entire outside plant had been renovated, the 12,000 lines of 7-A2 Rotary automatic, which in the meantime had been installed in the newly erected central office and headquarters building in the center of the city, were cut into service without incident, giving the entire city of Bucharest, in 1933, complete automatic service.

From that time on, frequent additions both to the cable plant and the automatic equipment were made. Bucharest now has 30,000 lines of



*Placing Clay Conduit in Bucharest.*

7-A2 Rotary automatic in the Victoria office, the office in the center of the city; and, in the Dacia office, one complete unit of 10,000 lines of 7-A1 Rotary automatic and the first 1,000 lines of a unit of 7-A2 Rotary automatic, making a total of 41,000 lines of Rotary automatic equipment serving the city.

It was particularly fortunate that, when the S. A. R. de T. commenced the task of converting the entire city of Bucharest to automatic operation, the 7-A2 Rotary Automatic System was available, inasmuch as this equipment, developed from the 7-A Rotary Automatic System and based on the continued use of the same time-proven fundamentals, incorporated important improvements resulting from research and development based on field experience with over a million and a quarter lines of Rotary equipment then in service. The conversion of Bucharest to complete automatic operation, incidentally, marked the placing in service of the first 7-A2 equipment anywhere. Operating results in the Victoria office have shown that 7-A2 equipment more than meets the requirements of the most exacting service and economic conditions. During the recent intense earthquake in Ru-

mania, the exchanges in Bucharest were not put out of commission and gave uninterrupted service.

In the heart of Bucharest the ten story headquarters building housing the Victoria central office stands as an enduring monument to the achievements of the S. A. R. de T. under the aegis of the I. T. T. Corp. Built in 1931-1932 it has a structural steel frame (skyscraper construction) resting on extra heavy foundations, and is of special design to withstand earthquakes. This precaution was proved justified when the building went through the recent quakes without suffering any structural damage.

Careful engineering study of the transmission requirements permitted the adoption of No. 26 B. & S. gauge (0.405 mm.) wire conductors for many of the subscribers loops, enabling the use of large size underground feeder cables with resultant economies. Bucharest has several kilometers of 2424 pair No. 26 gauge (0.405 mm.)



*Feeding 2424 Pair Cable into manhole, Bucharest, Rumania. This cable, containing the largest number of pairs ever manufactured commercially for a customer in any country in the world (1932), was supplied by Standard Telephones and Cables, Ltd., London.*

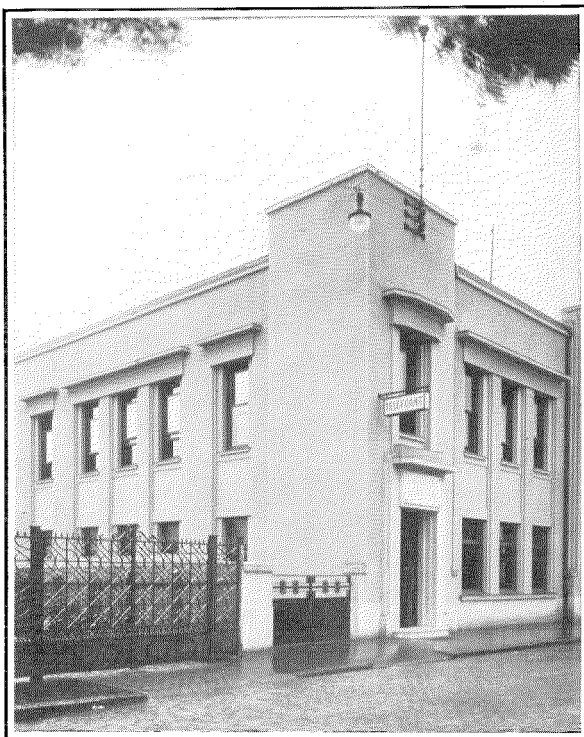

*Type of Average Size Local Exchange Building. Galatsi 7-D Rotary Automatic Central Office.*

subscribers cable which has been giving service without trouble for over seven years. This is the largest size local exchange cable in the world.

Development and expansion of the local telephone service in the other large centers of population in Rumania were on a scale proportionate to the development and expansion in Bucharest. In thirteen of the fourteen cities where automatic service was installed new buildings were constructed, designed especially as telephone offices. In all these cities extensive underground conduit systems were built under the important streets to carry the large feeder cables and neat block and aerial distribution cables superseded the unreliable and exposed open wire roof-top construction. New subscribers instruments and wiring were installed simultaneously with the conversion to Rotary automatic operation.

The 7-D Rotary automatic system installed in these exchanges incorporates all the improvements and added facilities developed to meet the telephone switching requirements of small or medium sized, but complete, urban areas, and is

comparable to the 7-A2 system for larger areas such as Bucharest.

Distinctive features of the 7-D Rotary System as evidenced in Rumania are uniformity of equipment components, flexibility, reduced floor space requirements, simplified installation, automatic routine testing, extended service observing facilities, completely unattended night service, etc. These resulted in low maintenance and low current consumption, combined with high operating efficiency.<sup>1</sup>

Improvements in the telephone service were not confined to the larger centers; modern common battery switchboards were installed in 21 localities which previously had not had this service, while improved magneto equipment was placed in operation in the great number of small exchanges where there was a low concentration of subscribers. In all of these areas the outside

<sup>1</sup> "7-D Rotary Exchanges in Rumania," by Jacque ter Sarkisoff and L. B. Tucker, *Electrical Communication*, October, 1938.

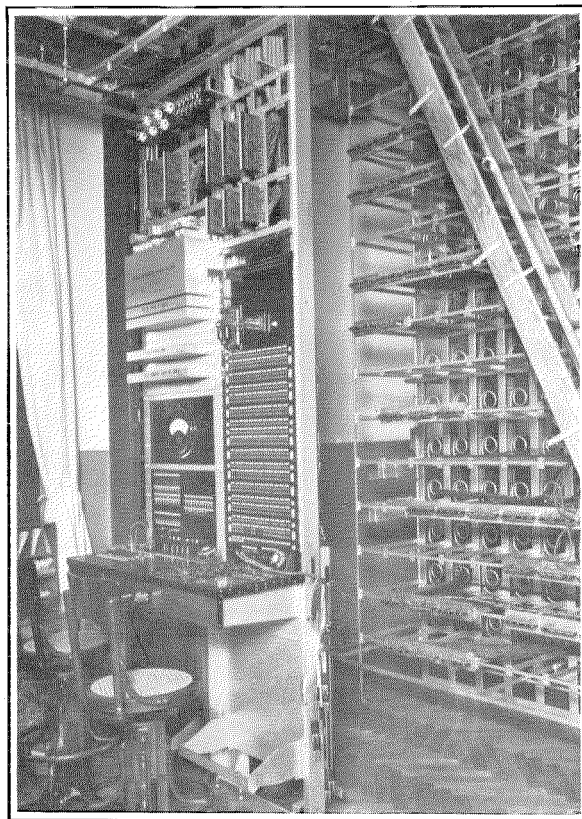

*Constantza Local and Long Distance Test Desk and Portion of M. D. F.*

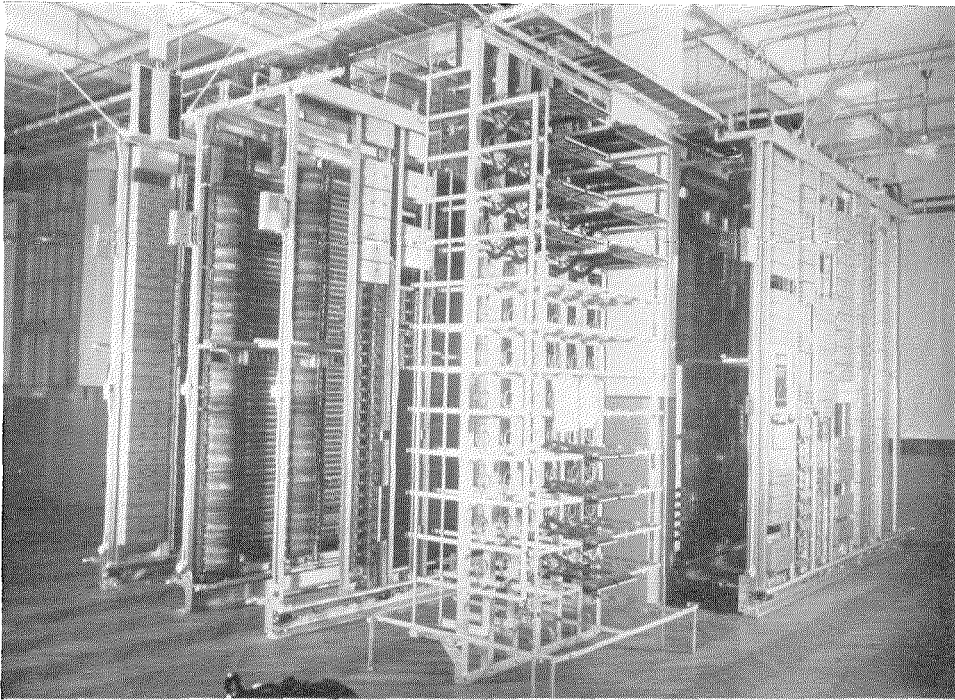

*Arad 7-D Rotary Automatic Central Office.*

plant was renovated and adequate facilities provided.

### **Toll Service**

Developments in the long distance services paralleled those of the local services. At the time of taking over in 1930, International toll connections were limited to Hungary and Jugoslavia, and then only from large centers. While the toll network within the country comprised extensive pole lines, the number of circuits was few, completely inadequate, of open wire and in many cases of iron wire with resultant poor transmission. Immediate alleviation of the circuit shortage was obtained by the I. T. and T. engineering specialists who worked out a plan for the application of numerous single and three-channel carrier systems, with minimum cost and delay, to the heterogeneous open wire leads involving completely different types of construction and circuit arrangement varying with almost every kilometer. In itself, this extensive application of carrier to obsolete open wire lines not

originally built for high frequency operation constitutes a major engineering feat.<sup>2</sup>

Within three months after taking over the plant, a CS3, 3-channel Standard Electric carrier system was installed between Bucharest and Timisoara, and a month later a second similar system was installed between Bucharest and Aradea. With these two systems, direct circuits of 6 db equivalent were inaugurated from Bucharest to Budapest and Vienna. With the opening of these direct circuits, International service to the majority of the countries in Europe became available to the public.

The installation of additional carrier systems soon followed and the program of expansion of the International telephone service from Rumania was continued at an accelerated pace so that by 1940 there were direct telephone circuits to Istanbul, Sofia, Warsaw, Prague, Belgrade, Milan, Budapest, Vienna, Berlin, Paris and Lon-

<sup>2</sup> "Application of Type C and Type D Carrier Systems to Non-Standard Lines," by Bruce H. McCurdy and J. H. Holmes, *Electrical Communication*, July, 1934.

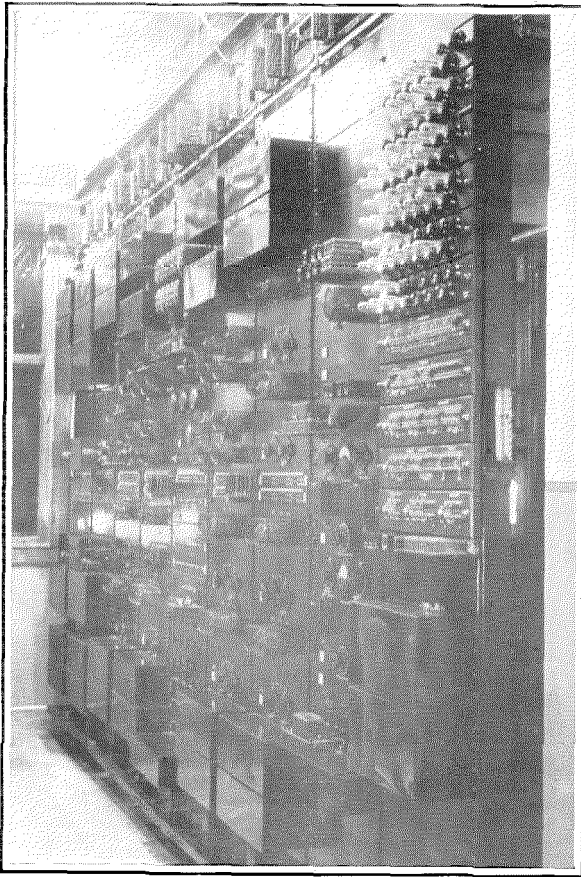

*Galatsi Three-Channel Carrier Equipment.*

don. Between Bucharest and the more important cities—Paris, London and Berlin—several direct circuits were established and, by connection with international radio circuits, Rumanian telephone users consequently gained access to 93% of the telephones in the world.

A practical demonstration of the efficacy of the International telephone service from Rumania was given at the time of the sale of the company when most of the negotiations were carried on by telephone communication between Bucharest and the United States.

Even greater progress was made in increasing the number of long distance circuits within the country. Most cities, such as Constantza, the Black Sea port, now have ten or a dozen high grade circuits to Bucharest in place of one or two inadequate lines. Not only were numerous single and three-channel systems installed, but copper physical circuits were provided on the main leads, all of which were reconditioned and many of which were entirely reconstructed along more satisfactory routes, permitting the use of motor vehicles for rapid trouble location and maintenance. The new lines are built of creosoted poles with standard 10-pin crossarms, transposed and spaced for the most efficient carrier operation.

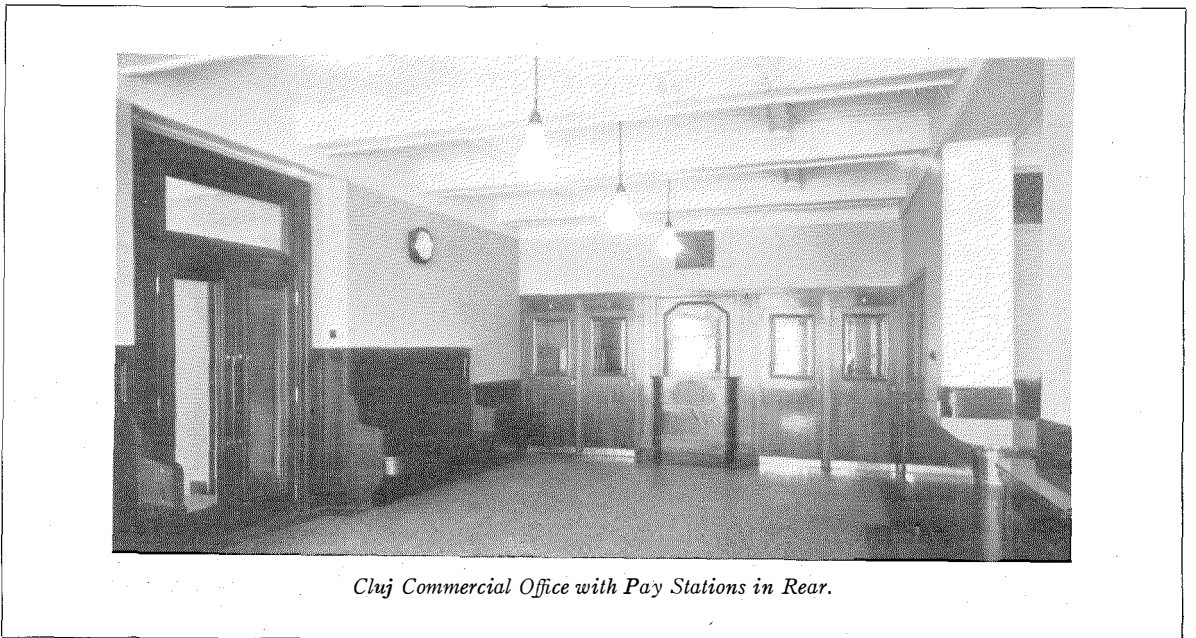

*Cluj Commercial Office with Pay Stations in Rear.*

Early in the development stage, it became apparent that the rapid increase in toll usage, as more facilities became available, would eventually require toll cable on certain of the backbone routes. Since winter weather conditions are extremely severe, with frequent sleet storms, buried cable was selected as most appropriate.

After a thorough engineering study, in collaboration with the technical staff of the I. T. and T., it was decided to lay a toll cable, designed for 12-channel carrier operation, from Bucharest up through the oil fields to Brasov on the far side of the Carpathian Mountains, and from there to the Hungarian border to link up with the Hungarian underground toll cable system. Thus Bucharest would have available underground toll cable connections, free from weather interference, across Europe to the Atlantic Ocean.

By 1940 this cable was installed and in operation up to Brasov (170 kilometers from Bucharest), and a voice frequency link 71 kilometers long was working between Ploesti and Buzau, where the major long distance leads serving the northeastern portions of Rumania are picked up.<sup>3</sup>

Between Bucharest and Brasov the "cable" consists of two cables laid in the same trench—

<sup>3</sup> "Bucharest-Ploesti Toll Cable," by A. C. Nano, *Electrical Communication*, April, 1939.

one "go" and one "return"—for the 12-channel carrier. Conductors also are included for way and and through voice frequency circuits.

Equipment for the 12-channel carrier to be applied to the cable has been installed between Bucharest and Brasov. Both the cable and the carrier equipment are among the first of their kind in continental Europe.

### Conclusion

This necessarily brief outline of the accomplishments of the Societatea Anonimă Română de Telefoane in the ten year period under I. T. & T. management would be incomplete without some mention of the splendid work performed by the national personnel of the Telephone Company.

Soon after taking over the property, schools were established for instructing hundreds of employees in line construction, cable splicing, installation and maintenance of automatic equipment, etc. Rumanian engineers and technicians were trained, working initially under the close guidance of I. T. & T. specialists. Their willingness to adopt new methods and their application in mastering the intricate functioning of modern telephone apparatus and equipment greatly facilitated the task of reconstructing and expanding the Rumanian telephone network.

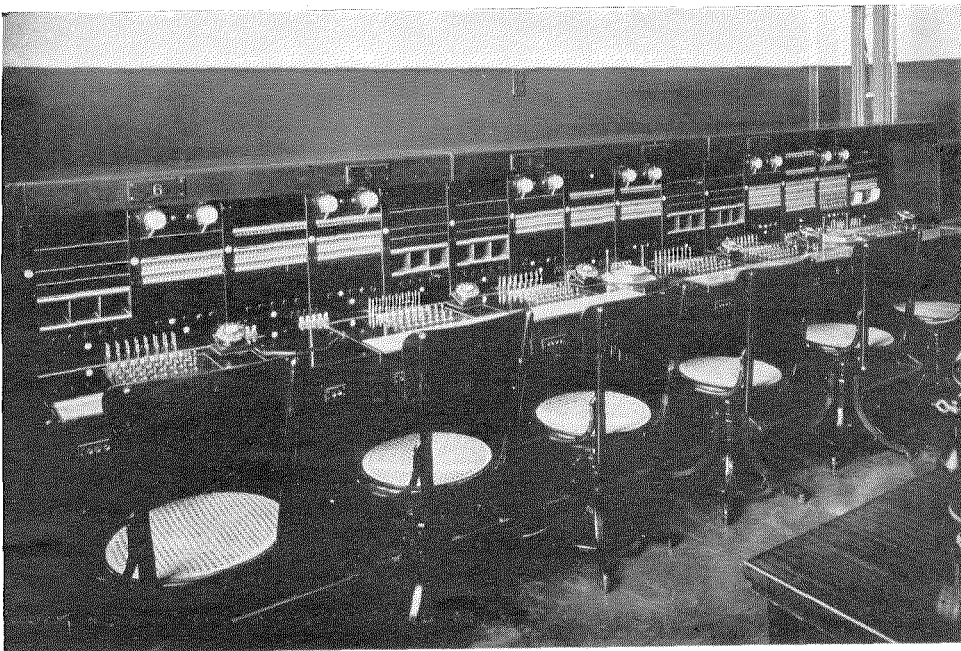

*Toll Switchboard, Ploesti, Rumania.*

## Recent Telecommunications Developments

**C**OLUMBIA BROADCASTING SYSTEM'S NEW INTERNATIONAL SHORT WAVE TRANSMITTERS. The Columbia Broadcasting System, Inc., has completed arrangements with the Federal Telegraph Co. and the Mackay Radio and Telegraph Company for two 50 kW short wave radio broadcasting transmitters with specially designed, directional antennas recently developed by Mackay Radio for achieving increased effectiveness in short wave broadcasting. They are to be installed at Brentwood, Long Island, for high efficiency beam service to South America and Europe.

CBS will share the 1,100 acre site at Brentwood with Mackay Radio's international radio transmitters. Mackay Radio will make extensive alterations in its main building to accommodate the equipment and personnel.

Plans call for placing the new station in operation during the late summer of 1941.



**S**MALL, FLAT LEAD-COVERED CABLE.—A new, small, flat type of lead-covered cable has recently been developed by the International Standard Electric Corporation, New York, for interior wiring in damp and hot locations. It contains two No. 22 AWG (0.64 mm. diameter) tinned, enameled copper conductors covered with

two oppositely wound servings of cellulose acetate yarn and a single serving of two-ply soft cotton yarn impregnated with cellulose acetate lacquer. The insulated conductors, which are color coded, are laid parallel and are covered with a .173 in.  $\times$  .123 in. lead antimony sheath.

Initial orders totaling 1,600,000 feet of this cable, coded LI.22P, have been received from the Netherland East Indies and from Mexico.



**B**ATTERY ELIMINATOR TYPE SELENIUM RECTIFIER.—For the direct operation of telegraph circuits, the International Standard Electric Corporation, New York, has recently developed a battery eliminator type Selenium Rectifier now being manufactured in the U. S. A. It is arranged to operate from 110, 150, or 220 volts, 60 cycles, single phase, and to deliver .250 amperes ( $2 \times 120$  volts), .5 amperes ( $2 \times 60$  volts), or .5 amperes ( $2 \times 30$  volts) for double current applications. For other uses, the device can readily be arranged to deliver .250 amperes at 240 volts, .5 amperes at 120 volts, or .5 amperes at 60 volts. The rectifier includes necessary filtering equipment and constitutes a unit functioning as a dependable source of power supply and requiring no maintenance.