



ELECTRICAL COMMUNICATION

APRIL

No. 4

1933

VOL. 11

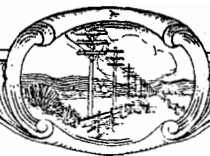

ELECTRICAL COMMUNICATION

A Journal of Progress in the
Telephone, Telegraph and Radio Art

H. T. KOHLHAAS, Editor

EDITORIAL BOARD

E. A. Brofos P. K. Condict G. Deakin E. M. Deloraine P. E. Erikson John W. Foard
James E. Fullam F. Gill Frank C. Page H. M. Pease G. E. Pingree

Published Quarterly by the

International Standard Electric Corporation

Head Offices

67 BROAD STREET, NEW YORK, N. Y., U. S. A.

European General Offices

CONNAUGHT HOUSE, ALDWYCH, LONDON, W. C. 2, ENGLAND

G. E. Pingree, President

S. G. Ordway, Secretary

Joseph A. Redegeld, Treasurer

Subscription, \$3.00 per year; single copies 75 cents

Volume XI

APRIL, 1933

Number 4

CONTENTS

	PAGE
7-A 2 ROTARY AUTOMATIC TELEPHONE SYSTEM.	179
<i>By L. Schreiber and W. Hatton</i>	
THE MEASUREMENT OF TELEGRAPH DISTORTION.	197
<i>By V. J. Terry</i>	
THE DESIGN OF FILTERS FOR CARRIER PROGRAMME CIRCUITS	204
<i>By F. Ralph, B. Sc., A. C. G. I., D. I. C.</i>	
VAST PUBLIC ADDRESS SYSTEM AT THIRTY-FIRST INTERNATIONAL EUCHARISTIC CONGRESS, DUBLIN, JUNE, 1932.	208
<i>By W. L. McPherson, B. Sc., (Hons.)</i>	
ELECTRON CONDUCTION IN THERMIONIC VALVES.	223
<i>By W. E. Benham</i>	
A NEW CRITERION OF CIRCUIT PERFORMANCE.	226
<i>By John Collard, Ph. D.</i>	

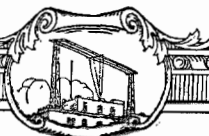



O'Connell Bridge Altar and Part of Street Area Catered to by Public Address System, Thirty-first International Eucharistic Congress, Dublin, June, 1932. (See page 208)

7-A2 Rotary Automatic Telephone System

By L. SCHREIBER and W. HATTON

Les Laboratoires, Le Matériel Téléphonique

PART I

Introduction

THE cutover of 12,000 lines of the new 7-A2 type Rotary Automatic telephone equipment, scheduled to take place in Bucharest, Rumania, in September, 1933, will mark the completion of an extensive program, started in 1929, calling for the complete redesign of the present 7-A Rotary Automatic system. A description of the improved system will be published in *Electrical Communication* in three parts: The present paper, Part I, covers the new apparatus and equipment; Part II will describe the switching system, junction diagram and floor plan; and Part III, the circuit fundamentals.

The objective in redesigning the system was not merely the introduction of minor improvements in the existing apparatus and circuits, but more particularly the production of an improved system, based on a thorough knowledge of the trend of automatic telephone practices and the continued use of the fundamental principles of the Rotary system, which would more than satisfy all operating and economic requirements for some years to come. In carrying out this work, many years of experience in the design and manufacture of Rotary equipment, together with the experience of numerous operating organizations having well over a million and a quarter lines of Rotary equipment in service, made it possible to employ improved materials and new manufacturing processes so as to best meet field conditions.

It is beyond the scope of this paper to completely describe all that has been done to fulfill the requirement of the 7-A2 system, but the following résumé will give some idea of the new features and the extent of the changes introduced:

APPARATUS AND EQUIPMENT

1. A redesigned line finder, selector and sequence switch, together with associated mounting bays, permit a substantial saving in space occupied, lower manufacturing costs and reduced maintenance expense.
2. New manufacturing processes make the character-

istic Rotary construction features more robust, and new finishes make both apparatus and wiring more impervious to humid atmospheric conditions such as obtain in tropical climates; an improved method of shielding also is used to serve for fire protection, together with a new type of switchboard wire which possesses greatly improved fire resisting qualities.

3. Radically improved methods for fusing and power distribution greatly facilitate maintenance and reduce first costs. To these same ends the tone and alarm distribution systems have been modified.
4. A new style of switchrack construction permits of considerable saving in space without sacrifice of rigidity which has always been a feature of the Rotary system.

SWITCHING SYSTEM FACILITIES AND CIRCUITS

1. While the new switches and circuits are considerably changed, the requirement that they must interwork with existing networks with a minimum amount of change was constantly kept in mind. As a result, extensions to present offices and networks can be made as readily as though the present system were continued in use.
2. Improvements have been made in the new circuits and apparatus regarding operating times and limits, voltage range and other similar factors with the result that the operating ability of the Rotary equipment has been further improved. A notable change of this type is the new selector commutator which produces an unusually uniform impulse and should require practically no maintenance.
3. The new switching scheme employed for the line finder makes use of a new 200 point switch together with special alternative outlets for completing overflow traffic during the peak load periods. Another important switching change has been made between the cord and register circuits, permitting considerable saving in equipment costs.
4. Provision is made in the selector switches to provide for converting two adjacent levels into one common group of trunks. This feature raises the number of trunks in one common group from the previous figure of 30 trunks to a new maximum of 60 trunks which should be more than sufficient for present or future requirements.
5. In redesigning the system, full recognition was given to the present tendency towards long distance dialing, CLR and other special toll services, together with the increasing demand for simplified facilities for interworking with rural and suburban automatic networks. Provision has also been made for connecting with

- other types of automatic systems and manual exchanges with a minimum amount of expense.
6. Time, zone and multi-metering features have been developed as an integral part of the system and can be applied to all conditions.
 7. Miscellaneous service features, such as paystations, party lines (with or without metering), direct working with apartment house satellites, and other similar arrangements can be provided to meet all requirements.
 8. Traffic recording and maintenance which already are noteworthy features of the Rotary system have been further simplified. Included in these improvements are centralized service observing and special facilities for the detection of malicious calls, automatic faulty line indication and delayed back release.

In developing the switch gear for the improved system, the following general requirements were established and more than met, as will be apparent from the description below.

The new equipment should require less space: All switches have been reduced in size—a point of major importance at the present time in view of the tendency of telephone administrations to limit the space assigned to automatic equipment in order to achieve a saving in building investment.

The apparatus must be cheaper: The fundamental design of the present Rotary switch has been retained and a reduction in cost, apart from that due to the increased efficiency of the improved switching system as hereinafter described, has been obtained by simplification of piece-parts and improved manufacturing methods and facilities.

Maintenance should be further simplified: Notwithstanding the fact that the new switches are smaller, they employ numerous new features

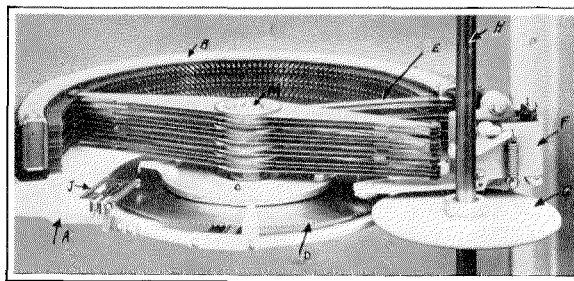

Figure 2—7200 Type Line Finder.

- | | | |
|-----------------|--------------------|------------------|
| A—Frame | E—Feeder Brush | J—Home Contact |
| B—Arc | F—Clutch | (Homing Switches |
| C—Rotor | G—Drive | Only) |
| D—Flexible Gear | H—Common Bay Shaft | M—Steel Pivot |

to facilitate maintenance. Routing testing has been made more automatic and the tracing of connections and false calls greatly facilitated.

The new switch gear must have a long service life: The new equipment retains all the robust features which are outstanding in the present system, and such new features as diecast parts, moulded assemblies and welded bay frameworks have made the long service life characteristic even more outstanding.

In addition, the new apparatus has been so designed that the various component parts of each switch are readily accessible and easily removed with the least disturbance of other parts or associated adjustments. All assembled units may be dismantled without necessitating the removal of any screw. This latter feature is particularly advantageous as it obviates any possibility of the parts being lost or dropping into adjacent or lower switches.

Special attention also has been given to improving the wearing qualities of all parts subject to friction, and to this end it can be said that the notably long life of the present system has been considerably lengthened in the new equipment.

Development work on the 7-A2 system was performed by Les Laboratoires, Le Matériel Téléphonique, Paris; manufacture and installation for the Bucharest equipment, by the Bell Telephone Manufacturing Company, Antwerp.

New Finder (7100 and 7200 Type)

Description

New finders have been developed for two capacities, one having an arc with 50 points per level, coded the 7100 type (maximum 100

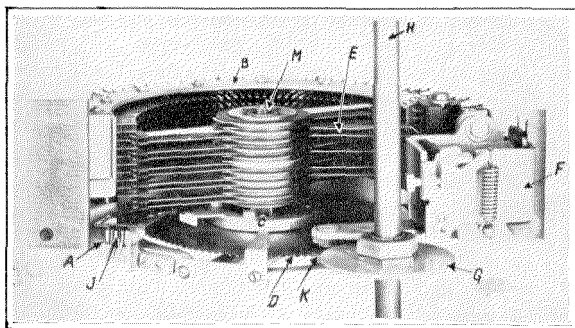

Figure 1—7100 Type Line Finder.

- | | | |
|-----------------|--------------------|------------------|
| A—Frame | E—Feeder Brush | J—Home Contact |
| B—Arc | F—Clutch | (Homing Switches |
| C—Rotor | G—Drive | Only) |
| D—Flexible Gear | H—Common Bay Shaft | K—Back Stop |
| | M—Steel Pivot | |

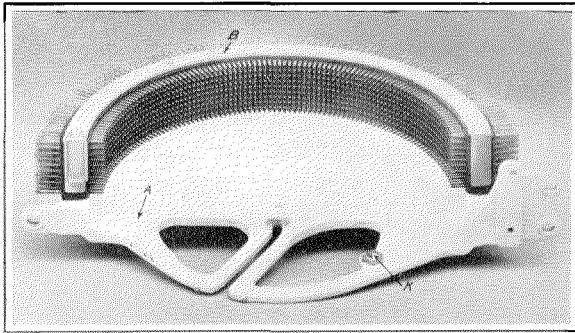

Figure 3—Arc and Frame of New Line Finder.

A—Frame B—Arc K—Back Stop

terminals per revolution), and the other for 100 points per level, coded the 7200 type (maximum 200 terminals per revolution). These switches are illustrated in Figures 1 and 2, and it will be noted that aside from the difference in capacity, the same general design features are employed in each case. They differ considerably, however, from the present 7002 finder switch in size, form, and mechanical details.

The 200 point finder is used in the improved system as a single line finder in place of the combination of 100 point first and second finders employed in the present system. This larger capacity switch permits of considerable saving in switches and associated equipment costs and provides means for making important changes in the switching schemes as will be described in another part of this paper.

Satisfactory service given by this type of switch in many working rotary exchanges has fully eliminated any question of reliability. Its wearing qualities have been high, the grade of contact unusually satisfactory, and the cost of maintenance very low. Therefore, these facts have fully justified the retention in the new switch of such fundamental features as: (1) the flexible gear drive, which gives a smooth positive motion not affected by pivot and brush friction and hence has a long life; (2) the nature and form of the contacting members which make for the total absence of vibrations and contact noise; and (3) the simple form of arc and rotor.

The mounting frame, as shown in Figure 3, is entirely new and consists of an aluminum alloy diecast base appropriately shaped to fit the component parts and provided with three lugs for fixing the completely assembled finder to

the bay. Use of a diecasting in this case produces an unusually rigid yet light frame requiring few machining operations. The rear half of the frame is free from openings and prevents any metal dust or other deposits from falling on the arc terminals of finders mounted in the lower positions on the bay. The rotor or rotating member is fastened in the center of this base by a solid steel pivot which permits of a very rigid mounting.

A slot is provided from the front edge of the plate into the central boring to allow the ready removal of the rotor assembly. The contour of this slot is such that it acts as a guide for the pin of the rotor when the latter is being removed, and in this way any danger of damaging the mechanism is completely eliminated. When the completed switch is installed on the bay, the slot front is normally covered by the position indicator arm.

The projecting edge of the frame serves as a protection for the flexible gear which is located between this edge and the lower brush of the rotor. This arrangement places the gear in a position where it is well protected from accidental damage.

The arc is essentially the same as in the present type of switch (refer to Figure 3), and is composed of a number of punched segments of Foudrinier paper between which the hard brass terminals are clamped. Metal segments placed between consecutive layers of terminals reinforce the arc. After assembly, the completed arc is heated to a point where the compound in the Foudrinier paper flows into the space between the terminals so that after cooling the arc is, in effect, a solid block. A piece of glazed non-

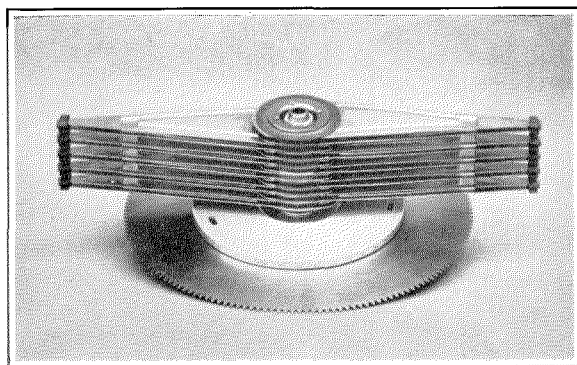

Figure 4—Brush Carriage of New Line Finder.

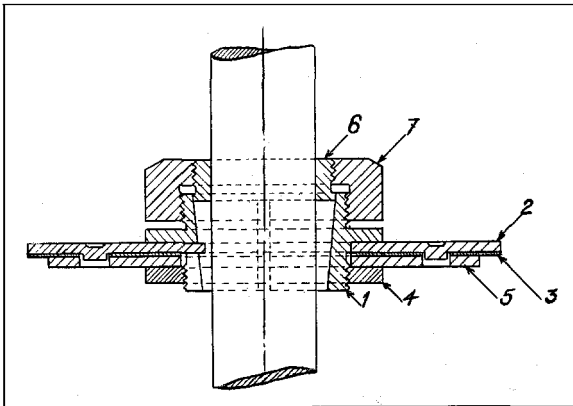

Figure 5—Diagram of New Line Finder Drive.

hygroscopic paper is then slipped over the inner ends of the terminals to give a glossy face to the inner part of the arc and thus facilitate dusting and cleaning operations.

Owing to the greater capacity of the new 7200 type finder, a larger frame is required to provide the necessary terminal arrangements. In order that the longer brushes used in this switch may have the same rigidity as has been the case with the 100 point switch, they are constructed of German silver and provided with punched stiffening grooves, as illustrated in Figure 4. Each set of two brushes which rub on either side of the arc terminal has a small projection located a short distance from the contact end. These projections face each other and normally are in contact under pressure when the brush is not actually touching an arc terminal. This design insures freedom from vibrating contacts, and provides sufficient contact pressure without increasing the weight, and thus keeps the inertia of the rotor small.

As in the case of the present type of finder, the brushes are made with phosphor bronze contact tips welded to the brush members. Each brush is provided with a removable fiber shoe slipped over the end, serving the following purposes: (1) Facilitates smooth rotation of brushes over the arc terminals by minimizing the butting effect of the brushes on the edges of the terminals; (2) Has a cleaning effect as it rotates over the arc and thus prepares the terminal for contact with the metal part of the brush.

The finders and all other switches employ a new type of drive construction which eliminates

any eccentricity of drive in relation to the shaft, as well as any danger of loose drives. It was found in the past that drives which were fixed to the shaft by means of set screws were liable to poor adjustment and furthermore, when readjustments were made, there was a tendency for the drive to seek its previous position due to the pitting of the shaft by the end of the set screw.

The new drive is shown in Figure 5, and consists of a hub (1) on which are clamped a supporting plate (2) and pinion (3) by means of a nut (4) and washer (5). The inner hole of the hub is conical and fits a slotted conical steel sleeve (6) with a left-hand screw thread at the wider end. The hub end is threaded right-hand and it therefore follows that turning the nut (7) in one direction releases the conical sleeve causing it to release its grip on the shaft, whereas turning it in the other direction pulls the sleeve inside the hub until it is tightly fixed to the shaft.

To provide means for rotating the finder by hand a maintenance tool is supplied consisting of a steel blade which fits between the finder gear and the pinion.

The clutch, shown assembled in its proper position in Figures 1 and 2, consists of a powerful single coil electromagnet with closed magnetic construction, a pivoting armature and a spiral type retractile spring with screw adjustment. This screw represents an improvement over the

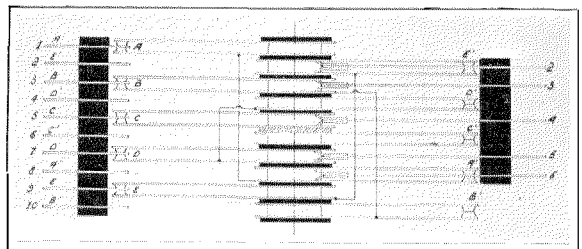

Figure 6—7200 Finder Arranged for 200 Points of Five Conductors.

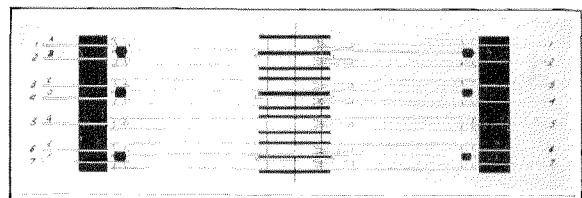

Figure 7—7200 Finder Arranged for 100 Points of Seven Conductors.

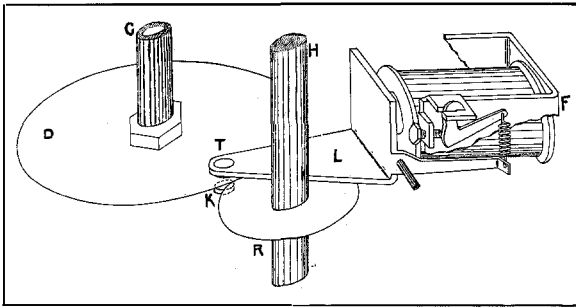

Figure 8—Diagram of New Finder.

present clutch in that very close adjustments may be readily made. One end of the spring is hooked to a lip on the armature and the other end to a small pivot lever, the position of which can be regulated by a screw and lock nut.

Another important improvement in the design of the clutch assembly is that it is mounted as a complete unit on the switch frame rather than on the bay framework as is the present practice. This feature makes it possible to adjust the switch completely before it is mounted on the bay, resulting in appreciable savings in adjusting and assembly expense.

The feeder unit (see Figures 1 and 2) consists of an insulated moulded assembly in which the feeder supports are encased, and is rigidly fastened to the frame by means of a single steel bolt. The advantage of this arrangement is that the complete unit pivots on the bolt so that the feeder contacting ends can be moved away from the rotor center when the rotor assembly is being removed for any purpose. The feeder arms are made of spring bronze and contact is established on the central part of the brush members.

A diagram of two different rotor combinations for the 7200 type finder is shown in Figures 6 and 7. The former shows a 5 split brush layout with the usual multiplying scheme employed for interconnecting the different sets of brushes to the single set of feeders. One set of brushes contacts on the even terminal rows, and the other set on the odd terminal rows to provide 200 five-conductor circuits in what is actually a ten-row 100 terminal per row bank. In the combination shown in Figure 7, the brushes are not split and the bank is arranged to provide 100 circuits of seven conductors each. It will be noted from this diagram that a stiffening brush is used in each case where a double contact is

not provided to even the tension on the terminal and thus eliminate any tendency toward distortion. Similar rotor arrangements are employed in the 7100 type finder.

Figure 8 indicates the method of operation for a complete finder switch. Closure of the electromagnet circuit causes the attraction of armature (L). Flexible gear (D) normally held pressed against its back stop (K) by armature (L) is released under its own tension and automatically meshes with the fixed gear (R) of the drive mounted on the common bay shaft (H) which is in continuous rotation. The rotor (mounted on shaft C) thus rotates on the steel pivot fastened to the switch frame.

When the brushes reach the terminal associated with the idle line or junction, the associated test circuit connected to the test brush immediately opens the clutch circuit. This releases armature (L) which is normally under tension by its retractile spring and instantly deflects the flexible gear (D) out of mesh with driving gear (R) and presses it against the back stop (K). In this position the armature stud (T) acts as a positive brake on the gear (D) and holds it rigidly in position during the time that the switch is not rotating.

The new finder is designed to rotate at a speed of 45 terminals per second. While this is a comparatively high speed, ample margin is available to stop the rotor securely on the proper arc terminal under the most unfavorable conditions of circuit, motor speed and battery voltage. Contact between the brushes and terminals during rotation is unusually reliable and free from vibration and is not influenced by the operation of adjacent finders. An example of actual contact conditions while the switch is in motion is shown in the brush contact oscillogram, illustrated in Figure 9, made with a

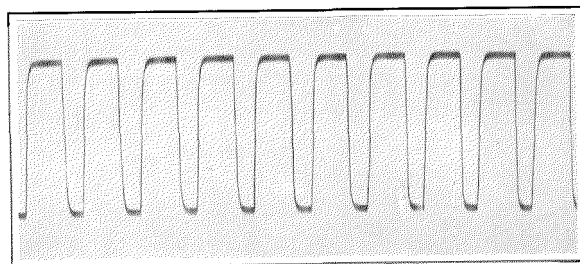

Figure 9—Oscillogram of New Finder Brush Contact.

200 point finder under actual service conditions. As of interest in this connection the contact pressure specified for the brushes on both finder switches is 35 grams minimum which is a further indication of contact reliability and is possible through the use of the power drive principle.

To summarize, the following table indicates the main mechanical differences between the present and new type finders:

PRESENT FINDER 7002	NEW FINDERS 7100 and 7200	ADVANTAGES OF NEW OVER PRESENT FINDERS
Punched frame	Diecast frame	More rigid construction
Doublecoilclutch mounted on the bay	Single coil clutch mounted on the switch frame	Space saving; greater accuracy in adjustment
To take rotor assembly out feeder unit must be removed from switch	Feederunit pivots on a pin	Facilitates removing of rotor and eventual inspection of feeder tips when required
Gear located below frame	Gear located above extending portion of frame	Better protection of gear
Clutch adjustment made by bending armature lip	Clutch adjustment controlled by screw and nut	Ease of adjustment
Drive fixed by set screws	Drive fixed with conical sleeve	Less eccentricity of drive; more reliable fixing on the shaft
Certain unit assemblies could not be removed without removing screws	All unit assemblies removed without removing screws	Facilitates maintenance

The following table shows the comparative size of the new 7100 and 7200 type finders as compared with the present 7002 finder.

	PRESENT 7002 TYPE (100 points)	NEW 7100 TYPE (100 points)	NEW 7200 TYPE (200 points)
Vertical mounting center of finder	90 mm.	80 mm.	82 mm.
Width of bay	330 mm.	275 mm.	395 mm.
Depth of bay	235 mm.	212 mm.	287 mm.
Occupied volume per bay	7000 dm ³	4650 dm ³	9600 dm ³
Weight per Finder	1 ^{kg} 960	1 ^{kg} 650	2 ^{kg} 960
Maximum number of finders per bay	30	36	35

Mounting and Wiring

A front and rear view of a line finder bay are shown in Figures 10 and 11. In this particular case a single frame contains twenty-three 200 point finder switches as well as the complete line and cutoff relay equipment for 200 subscribers' lines and associated starting relays.

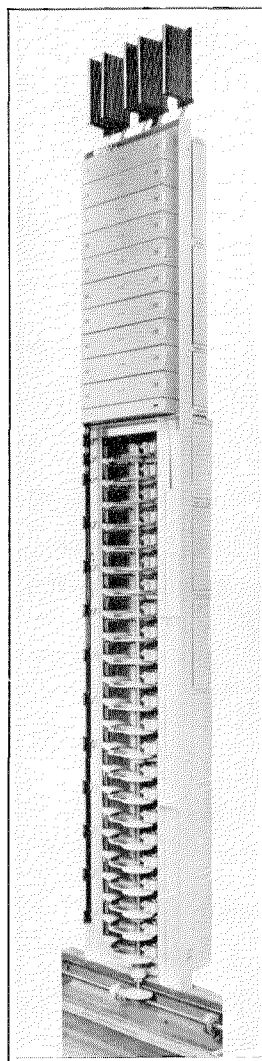

Figure 10—Line Finder Bay, Front View.

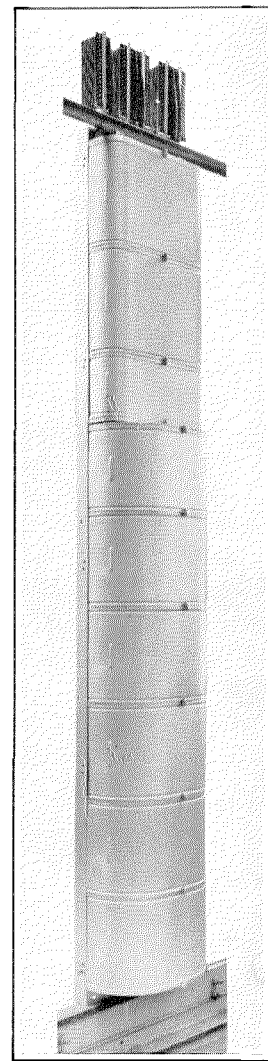

Figure 11—Line Finder Bay with Covers in Position, Rear View.

A closeup view of a cord finder bay, which is essentially the same as the line finder unit, is shown in Figure 12. On this bay twenty-six finder switches are mounted together with the associated relay equipment. This enlarged view clearly indicates the compactness and self-contained nature of the finder switches as mounted and also their accessibility and simplicity of design. The associated busy jacks are mounted on the right-hand side of the bay at a convenient height for the maintenance men. This feature is typical of the many changes made in the new system to facilitate maintenance activities.

Shielding provided on the rear of all bays is completely enclosed at the top and bottom and is arranged in removable sections for each group of four finder switches. This construction provides an efficient protection against accidental disturbance of the arc multiple wiring and is a safeguard against fire.

The multiple cabling for the new type finders is made of the usual silk braided ribbon cable which has always been an outstanding feature of the rotary equipment. Each flat cable pattern is folded over the corresponding vertical rows of terminals of each switch and is connected by inserting the bared section of wire in the notched ends of the terminal. As an added precaution the ribbon is protected from adjacent rows of terminals by means of glazed non-hydroscopic paper.

Circuit cabling is made with 0.5 mm. tinned copper wire insulated with artificial silk impregnated with acetate. This type of switchboard wire is considerably more fire resistant than ordinary silk and cotton covering and has a higher degree of insulation.

Since the new design permits the bays of equipment to be completely assembled in the shops with all outgoing connections connected to terminal strips at the top of the bay, it is possible to perform a complete test of the equipment before it leaves the factory. When the equipment reaches its destination it is only necessary for the installer to connect the incoming cables to the terminal strips and the bay is ready for operation.

Securing the bay to the top and bottom channels of the switchrack is now accomplished by means of suitable clamps which simplify the initial installation and at the same time provide

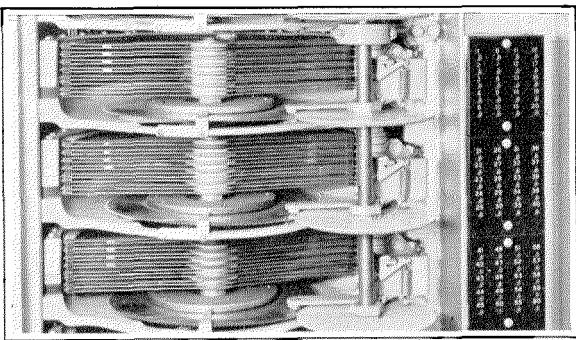

Figure 12—Close-up View of Cord Finder Bay.

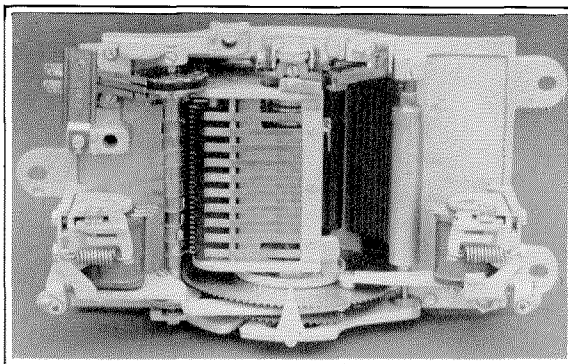

Figure 13—7120 Type Selector.

means for shifting or interchanging bays without having to modify the channel drilling. This feature is of particular importance in those cases where, after the equipment has been in service for some time, it is decided to make rearrangements and changes to suit traffic requirements.

7120 Type Selector

The new selector designated the 7120 type, shown in Figure 13, retains the fundamental principles on which the present 7009 type selector was based, although the new switch embodies numerous mechanical improvements. Both group and final selectors are of essentially the same design, the principal difference being the use of a commutator on the brush carriage of the final to control terminal selections. An illustration of the various component parts making up the new switch is shown in Figure 14.

The arc frame of the new selector consists of a single rigid diecast unit, arranged with three fixing lugs for attachment to the bay. This frame also carries all pivots for the rotating selector parts, together with the housing for terminal blocks and mounting positions for the two clutches and spring nests. As the casting is made in a single piece, all the above units are automatically located in relation to each other so that interchangeability of parts is possible with the minimum of adjustment to provide the desired accuracy. Another feature of the frame is the provision of small holes for mounting mechanical counters used in service observation and traffic studies. These devices are operated automatically by the trip spindle and brush carriage once for each revolution.

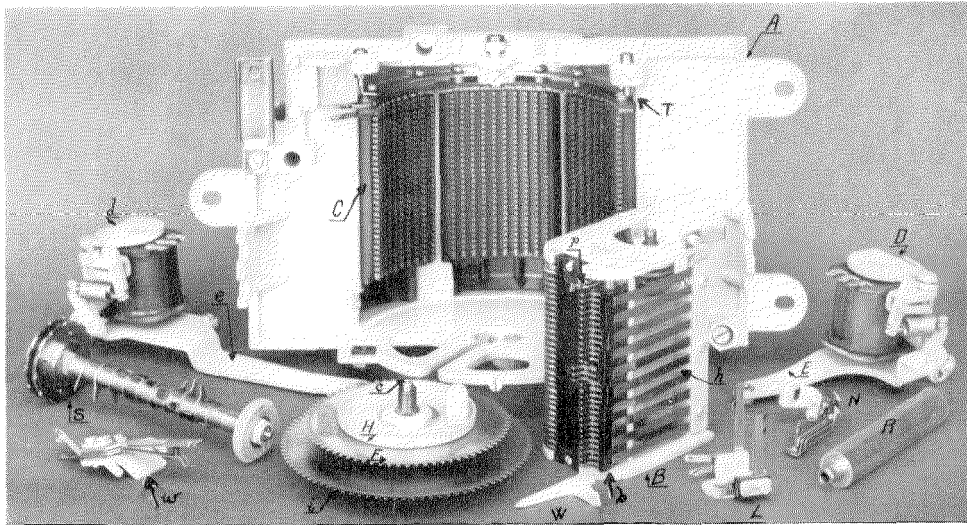

Figure 14—7120 Type Selector (Group Selector Dismantled).

- | | |
|----------------------------------|-------------------------------------|
| A—Frame | T—Special Commutator |
| B—Brush Carriage | W—Position Pointer |
| C—Terminal Block | b—Latch Blocks |
| D—Brush Carriage Clutch Magnet | c—Pivot Pin |
| E—Brush Carriage Clutch Armature | d—Trip Spindle Clutch Magnet |
| F—Brush Carriage Flexible Gear | e—Trip Spindle Clutch Armature |
| H—Position Indicator Wheel | i—Trip Spindle Flexible Gear |
| L—Collector Springs | h—Latch Block Spring |
| N—Brush Carriage Home Contacts | p—Grounding Brushes |
| R—Restoring Roller | w—Trip Spindle Home Contact Springs |
| S—Trip Spindle | |

A radically new method of manufacturing the terminal blocks has been employed, permitting greater accuracy in lining up the bank terminals on considerably closer centers. In the course of construction hard phosphor bronze strips are perforated in the form of a comb arranged with twenty-nine slots each, thus producing in effect thirty pins or terminals per strip. Ten of these strips are placed in a suitable fixture and then moulded into a single block. After cooling, the strip fronts (inner face of block) are cut through in a horizontal direction by a 29 blade multiple saw, thereby separating the 30 teeth of the ten strips into a terminal block of 10 x 30 terminals.

With this arrangement only two or three blocks per selector are required (depending upon type) as compared with 20 to 30 separate terminal rows for the present 7009 type switch. The new blocks are inserted in the selector from the rear and held in position by clamps in a manner similar to that employed in the past, although the number of clamps is considerably

reduced. The result is a considerable saving in manufacturing and assembly cost without sacrificing rigidity.

The selector employs the same improved method of mounting the brush carriage as previously described for the new finder. In the center of the arc frame is a countersunk hole which automatically locates the gear drive unit and in turn centers the brush carriage pivot with respect to the arc terminals.

The new gear unit shown in Figure 14 is composed of a steel spindle, trip spindle gear, brush carriage gear and indicating disc, the latter being provided with a slotted bracket for making a screwless coupling with the brush carriage. In operation, the trip spindle gear freely rotates on a bushing forming a part of the brush carriage gear which in turn rotates on the spindle supporting the brush carriage. To remove the complete gear unit from the selector frame, after removal of the brush carriage, it is necessary only to loosen the nut at the lower end of the

spindle and withdraw the unit along the guide slot cut in the frame. In this way any danger of damaging the gear teeth is reduced to a minimum.

The new brush carriage follows essentially the same design as the present unit except that it is made from a diecasting with the upper portion so shaped that it encloses the collector rings. Ten latch blocks are provided to control the ten sets of three brushes and are slotted to fit over a common pivot pin. Pressure from the latch block springs is applied to the side opposite to the slot and keeps the blocks in their proper position. A feature of the new construction is that any single latch block may be removed without the necessity of dismounting any other part of the brush carriage.

Three phosphor bronze comb shaped springs insulated from each other are arranged with ten reeds each for making contact with the ten sets of three brushes. One spring connects the ten A brushes together, the second spring the ten B brushes and the third spring the ten C brushes. Connections from the ends of these springs are extended to the collector rings where the circuit is carried to the stationary part of the switch.

In addition to the thirty regular circuit

brushes two new special grounded brushes are provided in the upper brush positions. One is used as a centering brush and the other forms a part of the brush carriage impulsing circuit of the final selector or of the routine test circuit in the case of the group selector. During rotation of the brush carriage these two brushes make contact with a special commutator located on the inside of the arc.

The bottom bearing of the brush carriage fits into a steel pivot pin of the gear unit which, as previously mentioned, is fixed in the counter-sunk hole in the switch frame. The upper end of the carriage spindle fits into a bronze bushing held in the top flange of the frame. To remove the brush carriage it is necessary only to loosen the screw holding the upper bearing, push it upwards, and then lift the spindle out of its lower bearing.

Collector rings are mounted inside the upper portion of the brush carriage frame and consist of a series of bronze rings encased in a bakelite moulding. Two sets of springs mounted on a common bracket on the arc frame are in continuous contact on these rings during rotation. When necessary this spring assembly can be removed from the selector frame by loosening one screw and without disturbing any other apparatus.

The new trip spindle assembly consists of a steel spindle on which are mounted ten tripping fingers, a commutator composed of two phosphor bronze cams (one connected to the impulsing circuit and the other to the centering circuit) and a cam controlling the home contacts of the trip spindle. Each tripping finger is provided with a colored folded lip with the odd positions black and the even positions red thus making it easier to check the setting of the trip spindle from a distance. Attached to the lower portion of the spindle is a pinion which is constantly in mesh with the flexible gear.

Restoration of the tripped brushes under control of the latch block is performed by the restoring roller located on the right-hand side of the frame. The setting of this roller in the frame is automatically located by a phosphor bronze pin fixed in the bottom flange. The upper part of the roller is held in a stud form bearing by a set screw in the upper flange. To remove the

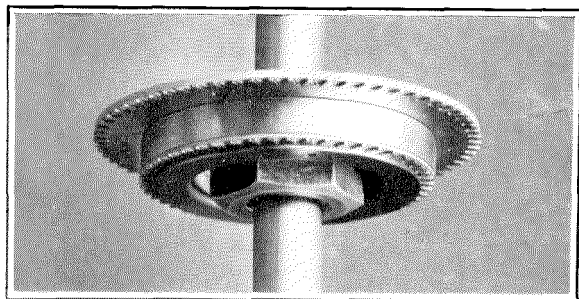

Figure 15—Drive of Group Selector.

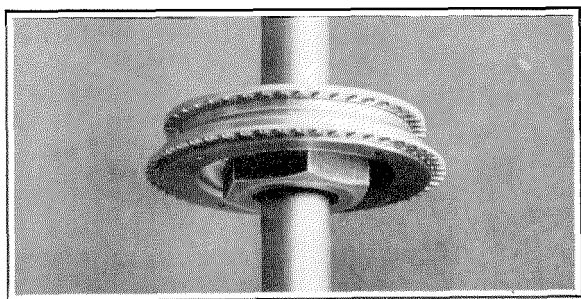

Figure 16—Drive of Final Selector.

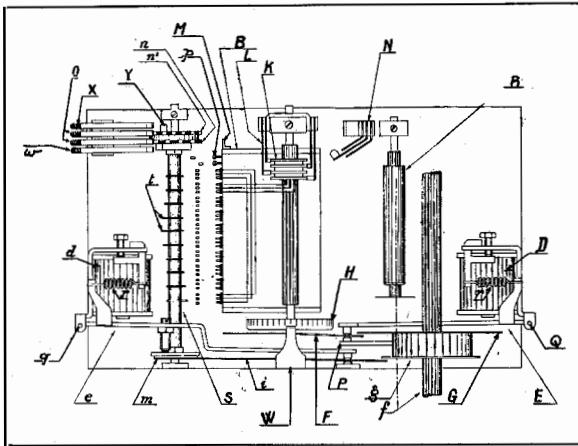

Figure 17—Diagram of New Type Selector.

restoring roller for any purpose it is necessary only to loosen the upper set screw and lift the roller off the bottom bearing pin.

The home contact to stop the rotation of the brush carriage is assembled as a complete unit and fixed by means of a single screw to the selector frame.

The clutches for driving the trip spindle and brush carriage are mounted directly on the switch framework and as previously explained are provided with screw adjustment for varying the armature tension. Bronze pivot pins and German silver bushings are used for the armature bearings and the right and left-hand coils are interchangeable. In addition to the 175 ohms inductive winding on each coil, a non-inductive winding of 200 ohms is provided as a spark quencher to protect the relay contacts controlling the clutch circuit.

Each clutch armature is arranged with a lip to which a spiral tension spring is attached. The other end of this spring is hooked on a small pivoting lever fitting a slot in the clutch frame. The position of this lever is readily adjustable by means of a screw and lock nut, thus providing easy regulation of the armature pressure.

The drives for the group and final selector are shown in Figures 15 and 16 and use the same type of conical sleeve construction, as described for the line finder, in order to prevent any eccentricity between the shaft and driving gear. In this case, however, it will be noted that two pinions are mounted on a common collar to drive the brush carriage and trip spindle.

On both the group and final selectors the trip spindle is operated at a speed of 14 steps a second. The brush carriage on the group selector rotates at 28 steps a second and the final selector at 14 steps a second.

When so desired, a final selector may be converted into a group selector by changing the gear ratios correspondingly and removing the brush carriage commutator which is required only when terminal selections are under control of the register.

A diagram of the new selector is shown in Figure 17. Its continuously rotating vertical shaft (f) is driven from the main horizontal shaft and is provided with two driving pinions (g) and (G). These pinions are out of contact with the selector when it is not in motion. When the selector is brought into use for completing a call, the trip spindle clutch magnet (d) is energized and on attracting its armature (e) allows the flexible gear (i) to spring into mesh under its own tension with the teeth of the driving pinion (g).

As the flexible gear (i) is free to rotate on the brush carriage gear bushing, the power from the driving pinion does not move the carriage out of its normal position. The trip spindle driven gear (m), however, is in continuous mesh with the flexible gear and starts to rotate the trip spindle. Mounted on the top of the spindle are commutators (n and n') which are in contact with the commutator brushes (o) attached to the arc frame.

These brushes provide the ground connections for counting out the register and for centering the selected trip finger in the proper position. After the spindle has made the required number of steps, the register opens the fundamental circuit which partially opens the circuit to the clutch magnet and thus places the further rotation of the trip spindle under control of the centering commutator brush. When the spindle is properly centered for tripping the selected group of brushes, the ground circuit through the centering brush is broken, opening the circuit to the clutch magnet. Release of the clutch armature (e) immediately deflects the flexible gear (i) out of mesh with the pinion (g) and stops rotation. A stud on the armature (e) presses against the back plate of the spindle gear (m) and acts as

a positive brake on the trip spindle. The pressure exerted by the armature is created by a spiral spring (r) and is approximately 2 kilograms (4.4 pounds).

Following the setting of the trip spindle the brush carriage clutch magnet (D) is energized. This clutch attracts its armature (E) which is pivoted at (Q) and held under tension by spring (r). The other flexible gear (F) springs upward under its own tension and meshes with the brush carriage driving pinion (G) fixed to the continuously rotating shaft (f). Flexible gear (F) is permanently attached to the position indicating wheel (H) which in turn is coupled to the brush carriage (B) so that the latter is now placed in rotation.

When the carriage passes the trip spindle, the trip finger releases the latch block of the selected set of three brushes and the selector searches for a free trunk on the corresponding level. Collector rings (K) and contacting springs (L) furnish the link between the brushes on the carriage and the stationary part of the switch.

When a free trunk is found, circuit changes cause the brush carriage clutch magnet (D) to open, with the result that its armature (E) is released under tension of its retractile spring (r) deflecting the flexible gear (F) out of mesh with pinion (G) and against the back top (P). The gear is clamped in this position between the armature and stop and thus the brushes are held in their proper position on the selected trunk.

The number of the particular trunk selected is indicated by the setting of the position indicating wheel (H) in relation to the fixed pointer (W).

When the call is completed, release of the switch takes place in the following manner: Clutch magnet (d) is again energized and trip spindle (S) advances to its home position where cam (w) causes two springs, known as the home contact springs, to open and stop further rotation. Likewise, the brush carriage clutch magnet (D) is also energized and brush carriage (B) restored. As the carriage passes roller (R) the unlatched set of three brushes is reset under control of their associated latch block. On reaching the home position the tongue (M) operates contact (N), known as the brush carriage home contact, which causes clutch magnet (D) to release and stop the carriage.

Springs (X) are provided when double level hunting of the selector is required. These springs close a local contact in certain positions of the trip spindle as determined by the setting of studs (Y) on the upper part of commutator (n'). An example of the use of this feature may be illustrated as follows: A stud located in position 1 of a trip spindle will close the contact of springs (X) when the trip spindle stands in this position. No further action takes place until the brush carriage has been placed in rotation in the usual manner. In the event that no idle trunk is found on the entire level, the carriage continues to advance until it reaches

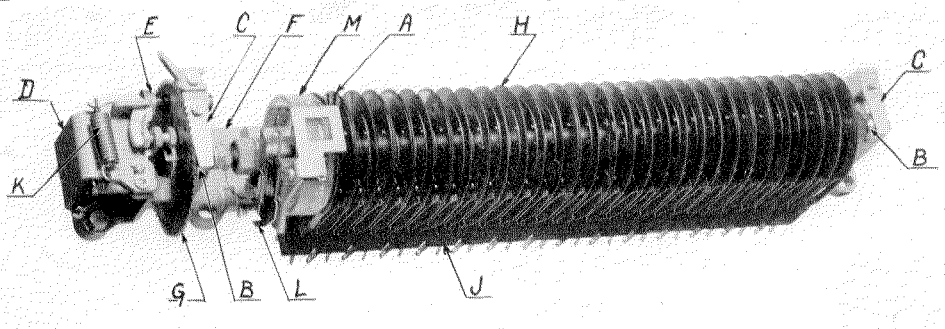

Figure 18—7101 Type Sequence Switch.

A—"A" Cam
B—Self-Aligning Bearings
C—Bearing Clamps
D—Clutch
E—Armature Adjusting Stud
F—Switch Frame

G—Flexible Gear
H—Regular Cams
J—Spring Nests
K—Armature Spring
L—Indicator Lamp
M—Translucent Position Indicator

its home position when a circuit is momentarily closed for the trip spindle clutch magnet over a contact of the brush carriage home contact unit (N). This causes the trip spindle to advance to position 2 in this particular instance and the brush carriage is again placed in rotation as previously described and the brushes corresponding to the second level released by tripping the associated latch block. Since the brushes associated with the first level were reset when the carriage passed the restoring roller on its first revolution, the selector is now in a position to hunt over the second level of arc terminals. This feature provides a maximum of 60 trunks for any single destination and can be applied to any two consecutive positions of the trip spindle.

A review of the improvements made in the new selector as compared with the present switch is provided in the following table:

PRESENT 7009 TYPE SELECTOR	NEW 7120 SELECTOR	ADVANTAGES OF NEW OVER PRESENT
Punched frame and brush carriage	Diecast frame and carriage	More rigid construction
Clutches mounted on bay framework; adjustment necessary to assemble component parts of switch	Clutch mounted on selector frame; setting of different moving parts automatically controlled by pivot type bearings permanently fixed in the frame	Saving in space; simple assembly and adjustment
Removing brush carriage required removal of other parts	Brush carriage pivots on the gear unit	Facilitates removal
Two gears required to drive the trip spindle	Trip spindle connected to drive by a single gear	One less gear required
Latch block not readily removed	Each latch block slotted to fit over common pivot pin	Individual blocks can be removed without disturbing brush carriage
Trip spindle brake on driving gear	Brake contacts directly on trip spindle gear	Any possibility of backlash eliminated
Separate common shaft used to drive selector	Single common shaft drives both selector and sequence switch	Less equipment required; saving in space
Traffic counts made on separate equipment	Mechanical counters can be mounted directly on switch	Simplifies traffic studies
Collector ring mounted on underside of top of switch frame	Collector ring mounted on brush carriage	Facilitates inspection and maintenance

Clutch adjustment made by bending armature lip

Certain unit assemblies could not be removed without removing screws

Clutch adjustment controlled by screw and nut

All unit assemblies removed without removing any screw

Ease of adjustment

Facilitates maintenance

In addition to the foregoing the following data is included on the comparative size of the two selectors:

	7009 TYPE SELECTOR	7120 TYPE SELECTOR
Maximum number of selectors per standard bay	15	20
Vertical mounting centers	190 mm.	144 mm.
*Width of bay	290 mm.	292 mm.
*Cube space per mounted selector	16 ^{dm³} 800	11 ^{dm³} 560
Weight per selector	4 ^{kg} 100	3 ^{kg}

*The new 7120 selector is built to provide space in front of its own frame for the clutch of the associated sequence switch.

7101 Type Sequence Switch

The sequence switch which always has been one of the fundamental features of the Rotary equipment has been retained in the improved system. Its principal advantages, which are now well known, are such points as (1) offering a large number of circuit combinations with a consequent reduction in relays required, (2) reduction in current consumption, and (3) facility of maintenance. This switch is employed in all selector circuits as well as in the register circuit.

As shown in Figure 18, the new sequence switch consists of a diecast frame which carries all component parts and is arranged with three fixing lugs for attachment to the bay framework. Self-aligning bearings held in place by two clamps are provided at each end to support the cam spindle. An improved clutch is mounted at the left end of the frame. This clutch has a pivoting armature with adjustable stud which normally holds the flexible gear out of mesh with the drive (not shown) and pressed against an adjustable back stop screwed into the frame. Tension on the armature is obtained by a steel spiral spring hooked to a pivoting lever which is adjustable by means of a screw and lock nut. The shaft on which the cams are mounted is

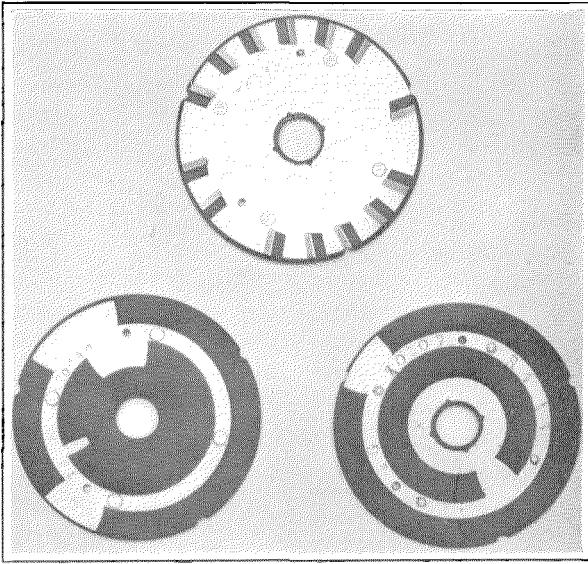

Figure 19—Sequence Switch "A" Cam and Regular Cams.

made from a rigid round steel rod insuring proper centering of the cams and freedom from eccentricity.

An interesting feature of the new switch is the use of a translucent position indicator. A small lamp is mounted next to the indicator disc in a socket with a small reflector. Directly in front of the indicator is an extending arm arranged with a small window in order that only the number corresponding to the position in which the switch is resting can be seen. When the lamp is lighted this number becomes quite conspicuous, and by using different colors for certain positions, the progress of the call is readily indicated to the maintenance man. In order that the lamp will be lighted only in the important positions, its circuit is controlled by a special cam which is paired with the "A" cam and cut as desired.

The spring nests of the new switch are mounted below the spindle instead of above as with the previous type. This change has been made to permit the sequence switch and selector to be driven from a common drive shaft, although this location should provide better protection from accidental damage and the collection of dust. Each brush nest is moulded as a unit in high-grade insulating material and fastened by a single screw to the switch frame.

The sequence switch cams, as shown in Figure 19, are identical to those employed in the present switch and are made of hard phenol

fibre with phosphor bronze discs riveted on each side. Each cam is cut for 18 positions and is provided with small notches in the outer rim for lining up the complete set on the spindle.

A schematic diagram of the complete sequence switch is shown in Figure 20. Spindle (S) carries a number of cams (C) consisting of discs of insulating material provided with metal rings on each side. These rings are electrically connected by rivets and are notched or cut out to form segments. A particular ring may have segments on either the inner edge or outer edge or both. Two insulated collector brushes mounted in spring nests attached to the switch frame contact against the inner and outer edge of each side of the cam. Adjacent cams may be insulated from each other or interconnected by means of a metal collar which is clamped between the cams and insulated from the spindle.

Associated with each switch is an electromagnetic clutch which, when energized, permits the flexible gear (G) to spring in mesh on its own tension with pinion (P). This pinion is permanently attached to the continuously rotating vertical drive shaft (A) and thus causes the sequence switch to start rotating. The switch is stopped at any one of its operating positions by means of the "A" or control cam on the spindle.

The new 7101 type sequence switch with the exception of the additional position indicator lamp is electrically the equivalent of the earlier 7011 switch. Mechanically, however, the two switches differ in the following respects:

PRESENT 7011 TYPE	NEW 7101 TYPE	ADVANTAGES OF NEW OVER PRESENT
Capacity— 8 cams " —12 " " —20 " " —24 "	Capacity—12 cams " —18 " " —28 "	Fewer types, increased capacity
Clutch mounted separately on bay	Clutch mounted directly on sequence switch frame	Saving in space; facility in assembling
Square shaft	Heavy round shaft	Less tendency for distortion during cam assembly; concentricity of cams improved
Blade type armature spring	Spiral type armature spring with screw adjustment	Easier to adjust
Indicator Wheel	Transparent indicator	Position indication improved

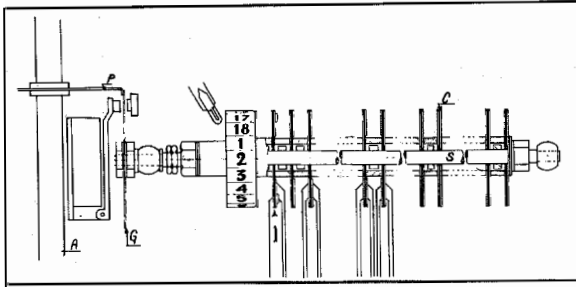

Figure 20—Schematic of Sequence Switch.

In addition to the foregoing, an outstanding improvement made in the new switch is the fact that it is now mounted directly adjacent to the selector switch and on the same bay. This arrangement permits the use of a single common drive shaft as compared with the present method where the selectors and sequence switches are mounted on different bays and use separate drive shafts. The advantages of this feature are described further in the following section:

Combined Selector, Sequence Switch and Relay Bay

An important feature of the improved system has been the development of the combined selector, sequence switch and relay bay. In the present system the selector equipment is mounted separately from the sequence switch and relay bay whereas under the new arrangement these different component parts of the selector circuit are combined on the same bay. The new unit has a capacity of 20 circuits and the selector and sequence switch, as previously mentioned, are driven from a single bay drive shaft.

In Figures 21, 22 and 23 are illustrated, respectively, a final selector bay, a group selector bay and a rear view of one of these units. In the latter figure will be noted the improved method of shielding which is arranged in two sections; one a removable cover over the selector arc wiring, and the other a hinged type cover over the sequence switch and relay wiring.

The new local cabling individual to each circuit contains all wiring between the selector sequence switch and relays. Since the entire circuit equipment is now assembled on a single bay, it is possible to completely connect this able in the factory before shipment to the job.

Outgoing wires leading to other circuits are terminated on small terminal blocks at the rear of each sequence switch. These individual circuit blocks are in turn connected to a common bay form which carries the wiring to terminal blocks at the top of the bay. At this point the regular incoming and outgoing cables are connected by the installer.

From the foregoing it will be noted that the new bay construction offers the following important advantages: (1) reduction in the number of shafts and bearings, (2) simplified installation work as all component parts of the selector can be interconnected in the factory, (3) actual installation of the bay merely requires that the unit be mounted in place and the incoming and outgoing cables connected to the terminal strips, (4) greater convenience in testing the complete circuit, and (5) maintenance further simplified since the apparatus composing a complete circuit is located on the same bay and at the same level.

An enlarged view of a combined bay is illustrated in Figure 24 which shows the common

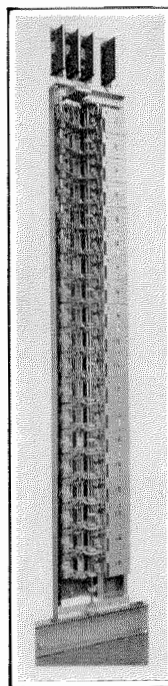

Figure 21—Combined Final Selector, Sequence Switch and Relay Bay (Front View).

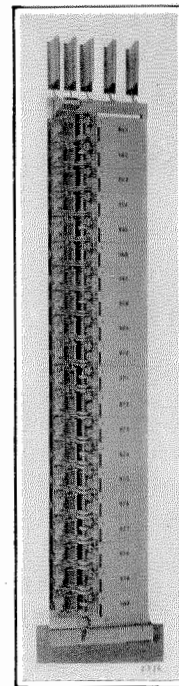

Figure 22—Combined First Group Selector, Sequence Switch and Relay Bay (Front View).

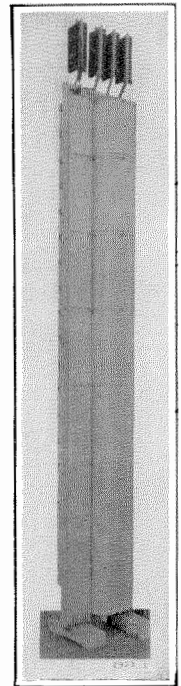

Figure 23—Combined Selector, Sequence Switch and Relay Bay (Rear View).

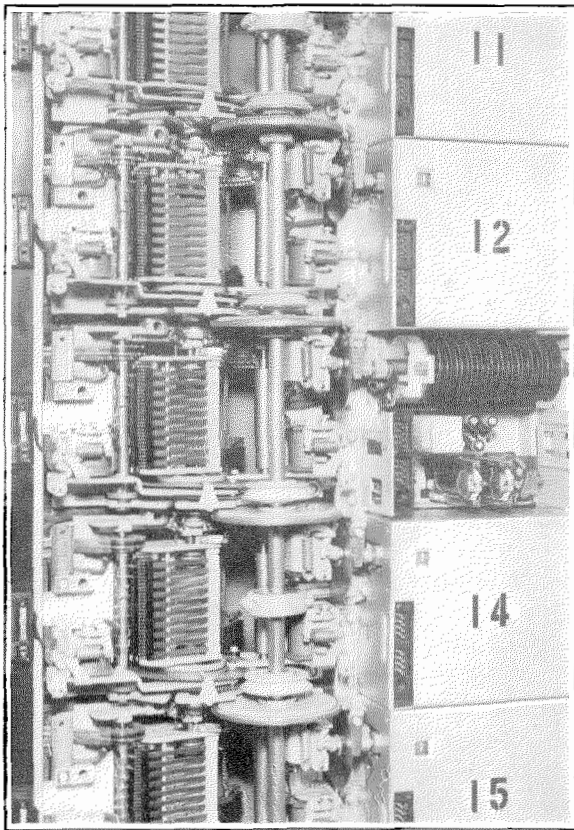

Figure 24—Combined Selector, Sequence Switch and Relay Bay (Enlarged Front View).

bay shaft carrying the drives for the selector and sequence switch. It will be noticed that a single metal cover protects both sequence switch and relays, only the position indicator of the former being exposed. The bearings of the sequence switch shaft extend outside the cover and are readily accessible for lubrication.

Each circuit unit is provided with a test block for making the individual circuit tests and a cutoff jack to disconnect the circuit from its associated trunk. Connections between the test circuit and test block are made by means of two patching cords. This method of testing, as well as the regular automatic routine test procedure, will be described in a later issue of *Electrical Communication*. The common routine test connections for the bay are located at a convenient height for the maintenance man on the right-hand bay upright.

Figure 25 shows an enlarged rear view of the new type bay with one selector cover removed and the hinged cover protecting the rear of the

relays and sequence switches open. Since this bay is equipped with final selectors, only two terminal blocks are installed to provide 200 subscribers' lines, the third position of the arc providing space for an additional 100 points being left vacant. This extra position may be used for additional P.B.X. lines when required.

If necessary a whole bay of switches may be thrown out of action by stopping the vertical shaft. A friction clutch is provided for this purpose on the main horizontal shaft, and by displacing its pinion to one side the teeth are thrown out of mesh with the vertical shaft bevel gear. The details of this friction clutch are shown in Figure 26 and may be explained as follows:

The vertical drive shaft bevel gear (a) is driven by a pinion (b) which is held in position by the pressure of springs (c) mounted in a sleeve (d) on the main shaft (e). Six of these springs are provided and above each is mounted

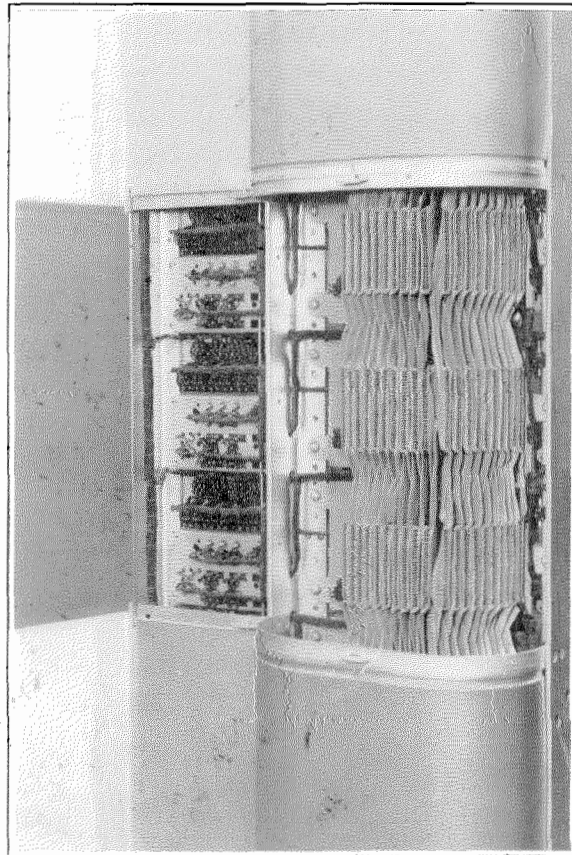

Figure 25—Combined Selector, Sequence Switch and Relay Bay (Enlarged Rear View).

a ball (f) which normally rests in a socket (g) cut in a collar (h) fixed to the main shaft (e). On moving the sleeve to the left, the balls are pushed out of their sockets and towards the back part of the collar (h) which throws the gears (a) and (b) out of mesh.

Another feature of the friction clutch is its operation as a safety release device in the event that the associated vertical drive shaft should become overloaded due to trouble. Under such a condition the additional load causes the balls in the sleeve to depress their associated springs and the gear is thrown out of mesh. This type of clutch also is employed on all finder bays and through its safety release feature it automatically isolates any section of vertical drive shafting which may develop trouble.

Circuit Fuses

The question of type and location of fuses in the new equipment has been given serious consideration. In the earlier equipments, circuit fuses are located on slate panels in the center of each switch row and small cables are run by the installer to connect these panels to the various circuits on each bay. Therefore, during adjustment or fault tracing, whenever it is desirable to disconnect the battery, the maintenance man is required to walk away from the circuit under observation and sometimes come down a ladder to reach the panel where the associated circuit fuses are mounted. Consequently, maintainers have at times worked on a circuit without removing the fuse, which frequently caused operation of the fuse. This procedure has been responsible in many organizations for unusually high fuse maintenance.

In the redesigned equipment the circuit fuse is

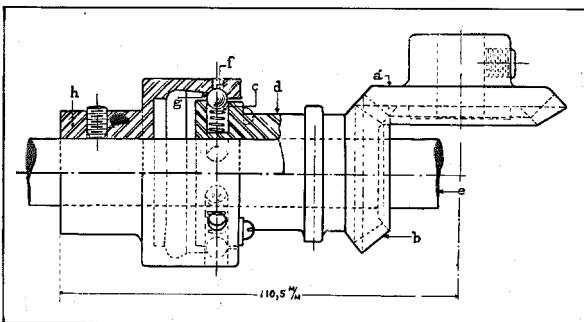

Figure 26—Friction Clutch for Main Shaft of all Bays.

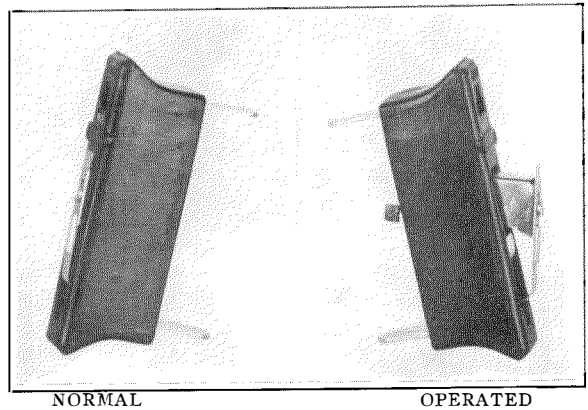

Figure 27—Enclosed Type of Fuse.

mounted directly on the combined bay immediately adjacent to the switch with which it is associated. This mounting arrangement may be clearly seen by referring to Figure 24 which shows an enlarged view of the combined selector, sequence switch and relay bay. The fuses are mounted in front of the left-hand upright and are connected to a common battery lead and alarm lead completely concealed under the fuse mounting and dummy strips between adjacent fuses.

The battery lead serving the entire bay is connected to a six ampere fuse at the top, and the alarm lead is connected through an alarm lamp mounted adjacent to this fuse and then extended to the common alarm circuit for each row.

In view of the serious troubles which may be caused by inadequate maintenance of fuses, it was found advisable in addition to the new mounting method to employ in the improved system a design of fuse which would be less liable to damage or improper repairing than the well-known "grasshopper" type fuse. This new fuse and its mounting are shown in Figure 27 and consist of a moulded bakelite hollow body having two flexible springs.

It will be noted that the top of the fuse is perfectly flat, thus precluding any possibility of damage during cleaning operations or from accidental contact. This improvement corrects a long standing objection to the present type fuse. The spring visible from the front is double folded over the fuse wire when the fuse is in its operated position and prevents any ejection of fused particles when the fuse is blown. An

alarm spring is located at the rear of the body and provides a reliable contact with the alarm lead.

The two springs are welded to terminal blades at the top and bottom, fitting into the spring clips of the bay fuse mounting. These blades are arranged in different widths which permit the fuse to be mounted only in its correct position. This construction precludes any possibility of the fuse being inserted "upside down." The carrying capacity of the fuse is indicated by an appropriately colored spot which is put on both fuse and mounting.

The advantages of the new fuse and mounting over the "grasshopper" type may be summarized as follows:

1. More robust construction of fuse; less liable to be distorted during handling.
2. Flush top surface; fuse springs cannot be accidentally damaged after being installed.
3. No danger of fused metal being splashed when fuse is blown.
4. Use of clip connection instead of screw connection; fuse more readily replaced.
5. Fuse cannot be inserted in reverse position, thus eliminating potential fire hazard.
6. Location of fuse near circuit facilitates testing in factory and maintenance work in the office, thus reducing fuse repairs.
7. Reduction in cabling on installation.
8. Reduction in total cost of fuses, panels and wiring.

Distribution of Power Leads and Leads for Tones and Alarms

In addition to the changes made in the method of circuit fusing, the power cabling for the various bays has been considerably simplified. The new arrangement should greatly facilitate maintenance as the various common leads can be easily followed and opened in the event of trouble.

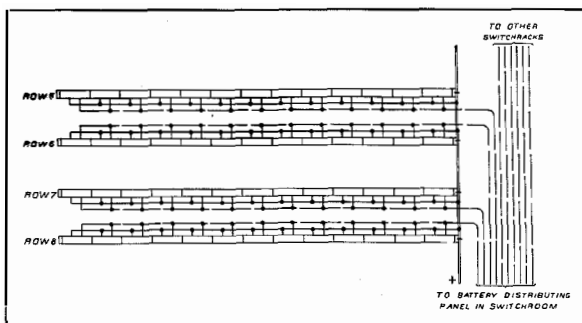

Figure 28—Schematic of Battery Feeds to Switchrack.

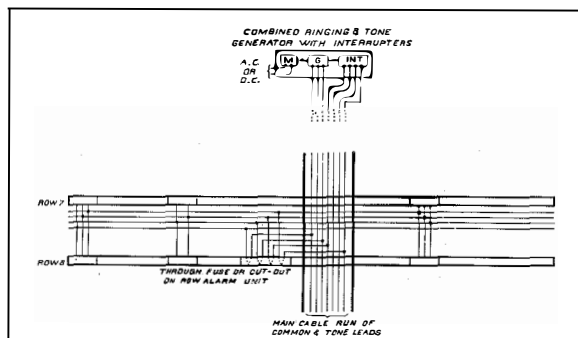

Figure 29—Schematic of Common Tone and Ringing Leads.

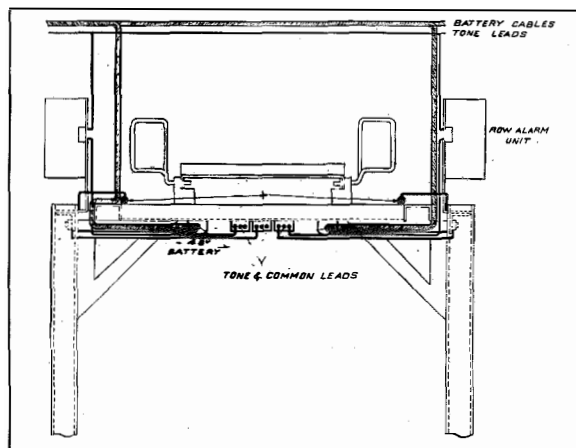

Figure 30—Sectional View of Switchrack with the Various Supply Leads in Place.

A common battery lead mounted on porcelain clamps, as indicated in Figure 28, is run along each switchrack beneath the fireproof roof. Soldered to this lead are the individual battery conductors coming from the six-ampere fuse associated with each bay. The common battery leads for each switchrack row terminate on fuses mounted in a centralized location. In cases where the centralized fuse arrangement is not required, the row fuse is mounted at the end of each switchrack and connected to the main common battery lead running along all switch rows.

All common leads such as tone and ringing feeders are run parallel to the battery lead beneath the roof of the rack, and when required shielded wiring is used to prevent inductive interference. These leads terminate on a special fuse and cutoff panel, one per row, which also contains the pilot alarm relays for the same row.

The other side of this fuse and cutoff panel is connected to the main run of common leads which extend to the ringing interrupters and tone generator. A schematic diagram of these leads is shown in Figure 29 and a sectional view of a switchrack with the various supply leads in place is shown in Figure 30.

It is evident that with this distribution scheme all runs of common leads can be easily traced as they are all exposed and properly tagged. To facilitate location of faults a cutoff jack is provided at the top of each bay and at the end of each switch row to isolate any section of the circuit.

Finishes

The equipment for the improved system is provided with the following standard finishes:

1. All frames and racks, bays and relay covers have been given an aluminum paint finish in place of the

previous gray paint as it reflects light better than any other finish and is easier to maintain.

2. All diecast parts of the switch frames are protected against oxidation by gray paint.
3. All coil windings are covered with oiled paper in place of the previous shellac cotton cover. This oiled paper is considerably cheaper and is superior from an insulation standpoint inasmuch as the cotton cover has a tendency to absorb moisture under humid atmospheric conditions.
4. All iron parts are given a zinc plated finish covered with a gray lacquer.

For tropical countries, additional protection against the effect of heat and humidity is provided as follows: (1) the use of one coat of special lacquer and a second coat of gray paint over all diecast parts; (2) all coils are covered with a layer of artificial silk treated with acetate to completely seal the winding.

With the exception of the above, and the use of special insulation on wiring and cables, the standard construction of apparatus and equipment is used throughout for tropical countries.

The Measurement of Telegraph Distortion

By V. J. TERRY

International Telephone and Telegraph Laboratories, Incorporated

SYNOPSIS: *The significance of telegraph distortion is explained by the aid of a notation in which changes from mark to space and vice versa, and changes of current from one value to another are regarded as the signals which compose a telegraph message. Reference is made to the use of an oscillograph for the measurement of telegraph distortion, and three machines better adapted to this purpose are described. One of these gives a permanent record and others use a stroboscopic method. In conclusion, mention is made of the method of determining the working margin of telegraph printers in terms of distortion.*

UNTIL quite recently the performance of a telegraph system was described in some such terms as, "using reperforators, faultless transmission was obtained at all speeds up to 100 words per minute," or "Wheatstone Tapes were legible at 120 words per minute."

The telegraph engineer interprets such information in the light of experience and will decide perhaps that the channel which on test gives "faultless operation" at 100 words per minute will operate satisfactorily in service at 80 words per minute. By this reduction of speed it is hoped to obtain a factor of safety or "margin" so that the development of trifling defects in lines or apparatus will not produce errors in the final message. It is the factor of safety at the speed at which a telegraph channel is actually required to work which is of importance; the ratio between the working speed and the maximum speed is only of value in so far as it is a guide to the factor of safety. The measurement of telegraph distortion is an attempt to determine the safety factor in a scientific manner and to safeguard service by discovering, before actual breakdown occurs, if the margin is seriously impaired.

The definition of telegraph distortion must be framed so that it shall be as far as possible applicable to all telegraph systems in extensive use. These fall into two categories which may be called for want of better names "two condition telegraphs" and "three condition telegraphs." The former use codes in which on two conditions "marking" and "spacing" are distinguished and the latter use three condition codes and distinguish between positive, zero, and negative currents (dots, spaces and dashes in cable

Morse). In all cases information is conveyed by the division of time between the various conditions in accordance with a code.

For the purpose of the present paper it is more convenient to take a different viewpoint and to regard the messages as composed of signals of differing sorts occurring at times determined by the code. These signals are the changes from one condition to another, and the separations between consecutive signals will be the intervals of time spent in one condition or another. In a two condition code there are two types of signals only: changes from spacing to marking, and changes from marking to spacing. These are generally known as positive and negative signals, respectively. In a three condition code there are six types of signals: zero to positive, positive to zero, zero to negative, negative to zero, negative to positive and positive to negative.

When a telegraph system suffers from disturbances or when it is worked too near its maximum speed, difficulty in deciphering the message arises first from errors in the timing of the signals, that is, from inaccuracies in the division of time between the conditions, and only in extreme cases will there be any uncertainty as to the condition indicated. Accordingly, uncertainty is disregarded and distortion is defined in terms of the error in timing.

In America, where distortion has been studied in relation to the aural reception of Morse messages, it was concluded that the permissible error in the length of a mark or space is proportional to its duration and, accordingly, the largest percentage error in the length of any mark or space was adopted as the definition of

maximum distortion. In Europe, on the other hand, the question has been examined in the light of the effect of errors upon automatic reception. For each different type of telegraph apparatus there might well be a different definition of distortion, but one definition, which though not exactly appropriate to any one system, has been found to be well suited to all. This is that adopted by the C. C. I.: *On appelle degré de distortion . . . le rapport de l'empiètement à la durée de l'intervalle élémentaire. Ce rapport est égal au produit de la valeur de l'empiètement (exprimée en secondes) par la valeur de la vitesse de transmission (exprimée en bauds).*

This definition is best illustrated by considering a train of signals in a telegraph code. If the instant at which the first signal occurs be taken as the zero of time, then depending on the code, message, and speed of signalling, there is a definite instant at which every other signal should occur. The period of "empiètement" is the sum of the longest period by which any signal is in advance of its proper time and the longest period by which any signal lags behind the proper time. The "elementary period" referred to is the shortest separation between signals demanded by the code and the speed of signalling. It is also called the "time unit." In Morse and multiplex systems all the intervals between signals and, in start-stop systems, most of the intervals are integral multiples of this unit. The speed of signalling expressed in bauds is the reciprocal of the time unit expressed in seconds.

It is apparent that before any measurements can be made of the divisions of time between the various conditions, the instant at which a change from one condition to another takes place must be precisely defined. Moreover, the definition applicable to telegraph signals at one stage of their transmission will not necessarily be applicable to another. This will be clearer if one considers the case of a telegraph message transmitted through a land cable by Wheatstone automatic apparatus and received upon a Wheatstone receiver. At the tongue of the transmitter marks are made by contact upon a marking stud, spaces by contact on another stud, but there are periods during which the tongue is upon neither contact both on account of the time taken for the tongue to travel from one stud

to the other and by reason of rebound when the transit is complete. In spite of this a mark may sometimes be considered to start at the first instant at which the tongue strikes the marking contact after leaving the spacing contact, and a space at the first instant at which the tongue after leaving the marking contact reaches the spacing contact, just as if there were neither contact travel period nor chatter. This is so in the case under consideration because the transmitter will be shunted by a considerable capacity which is very rapidly charged after the first instant of contact and which, once charged, maintains the current in the line during short periods when the transmitter contacts are open.

At the receiving end of the cable, marking is indicated by current in one direction in the line and spacing by current in the reverse direction; as an approximation, the changes from one condition to the other (called hereafter the "signals") may be considered to occur when the current passes through zero value. This would be quite accurate, were the signals to be received upon an ideal relay which would operate instantly to mark or space as the current rose above or fell below zero. In the example, however, there will be a series resistance and shunted condenser modifying the incoming current, and the Wheatstone receiver will commence to make marks or

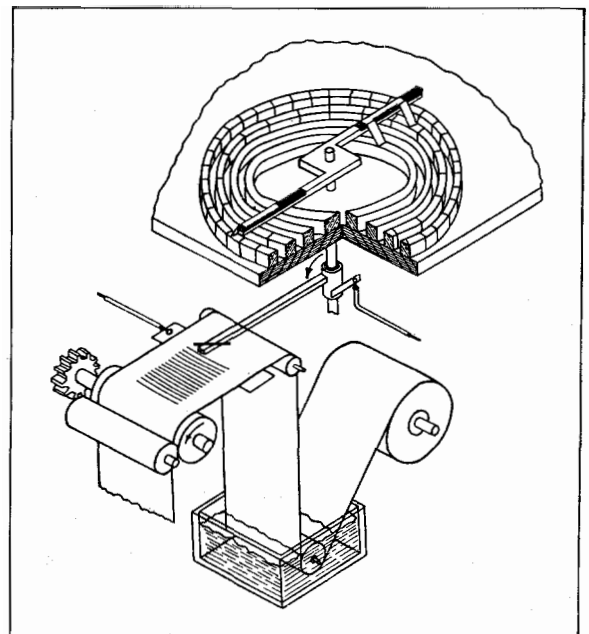

Figure 1

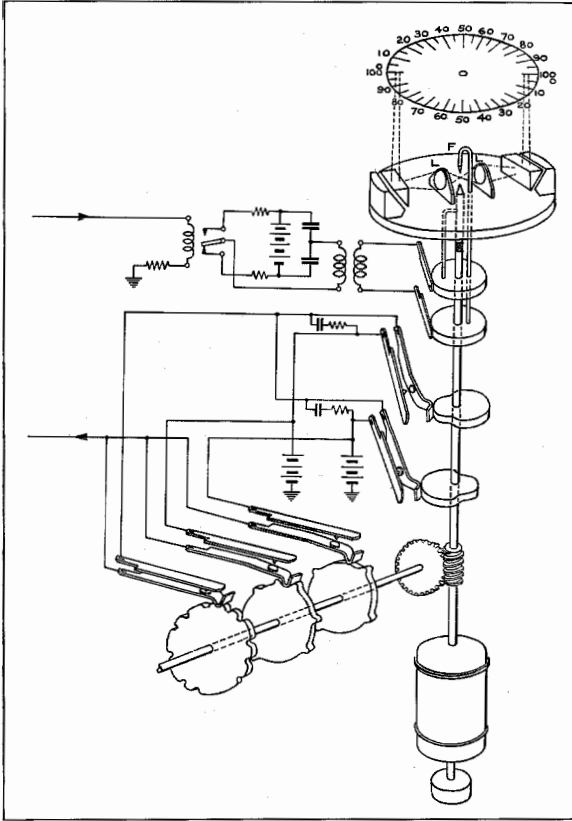

Figure 2

spaces at the time t when some function of time and current such as

$$A + B \frac{di}{dt} + C_i + D \int_0^t (i) dt$$

passes through zero value. Therefore to be exact the signals must be regarded as occurring when the appropriate function is zero, and the instants of their occurrence and the value assigned to the distortion of the current in the line will depend on the type of receiver to be used. If the current in the line be such as to operate an ideal relay in a perfect reproduction of the transmitted message, it must yet be considered distorted if it be intended to drive a practical relay.

For the measurement of distortion the essential requirements are a circuit or apparatus responsive to a signal (or responsive after a constant

delay to the condition existing after a signal) and some means of indicating the time at which the response occurs. When the signals are to be measured as they come from contacts of a transmitter or relay, the circuit or apparatus responding to the signals is usually simple, but for the measurement of signals coming from a line it may be necessary to add all the phase and attenuation equalisers (wave shapers), relays, and Gulstad circuits, etc., normally used, in order to build a circuit correctly indicating the instant when the signals occur. All this apparatus must, of course, be in perfect proportion and adjustment if it is not to add further distortion to the signal. It is not surprising, therefore, that almost all the work undertaken so far has been confined to measurements of signals as they come from contacts.

For timing the signals, an oscillograph recording photographically the current derived from transmitter or relay contacts has been extensively used. If the sensitive film or paper is uniformly driven this provides a record of the signals upon a linear time scale. The measurement of a train of signals of reasonable length is, however, a long and tedious process, often complicated by lack of uniformity in the time scale which must be corrected by comparison with the trace of a timing wave recorded upon the film at the same time as the signals. Moreover, measurements cannot be commenced until the oscillogram has been developed. The oscillograph method has an advantage, however, in the measurement of the distortion introduced by a telegraph channel which can be looped back so that the input and output terminals are close together. Simultaneous records of the signals transmitted and received can then be made on the same oscillograms and the distortion introduced by the channel can be measured directly by comparison of the two, even if the former be inaccurate in the first place.

To overcome the disadvantages of the oscillograph, Mr. F. B. Bramhall produced in America an interesting distortion measuring apparatus in which a permanent record of marks and spaces is made by an electric pen upon chemically treated paper using a time scale which traverses the roll of paper from the left hand edge to the right whilst the paper slowly unwinds so that a

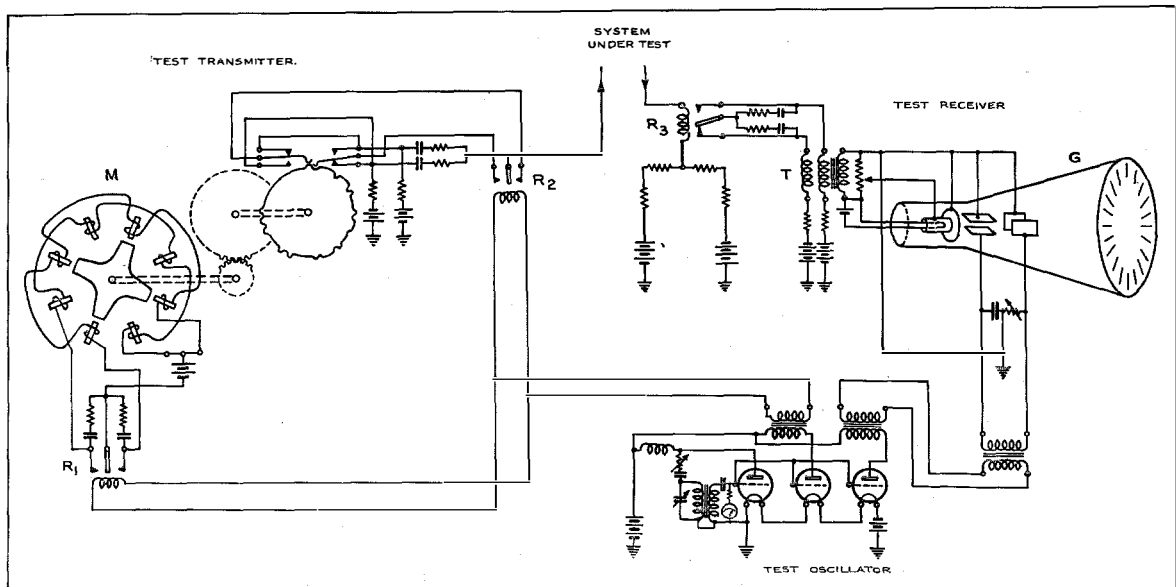

Figure 3

trace is produced resembling somewhat the lines of letter press on a printed page.

The arrangement is shown diagrammatically in Figure 1 which is taken from a paper describing this apparatus.¹ The mechanism consists of a synchronous motor, whose speed is controlled by an electrically maintained tuning fork driving an arm carrying an iron stylus. The arm traverses the paper in approximately two time units and the interval between the end of one line and the beginning of the next is approximately eight time units. A brush arm is mounted upon the same shaft as the pen arm and this sweeps over the segments of a distributor. The latter with its segments suitably connected serves as a source of test signals, perfectly synchronized with the pen arm which may be used for testing looped telegraph channels. The transmitter has ten segments and can therefore only send repeated messages of ten time units duration. A selection of messages is available and these can be so timed in relation to the receiver that any pair of adjacent time units may be selected for record. Obviously, this machine, selecting as it does samples from a short repeated message, is more suitable for research work than telegraph transmission testing for maintenance purposes.

¹ F. B. Bramhall, "Telegraph Transmission Testing Machine," *Trans. A. I. E. E.*, June, 1931, and "A Telegraph Testing Machine," *Electrical Engineering*, August, 1931.

Another and entirely different type of apparatus for the measurement of maximum distortion is that described by Messrs. Nyquist, Shank and Cory.² This measures maximum and minimum times separating adjacent signals only and therefore cannot give values of distortion in terms of any but the American definition. It is consequently now of historical interest only since the American definition of distortion is already obsolescent both because it is not suited to machine telegraphy and because of the fact³ revealed by Mr. J. Herman that maximum distortion is not an adequate criterion of the value of a telegraph channel for manual telegraphy.

The application of stroboscopic methods described⁴ by Messrs. A. Jipp and O. Romer to the measurement of telegraph distortion represents an enormous advance. A diagrammatic representation of their instrument is shown in Figure 2 which is adapted from their original paper.

The principle of the stroboscopic method is conveniently illustrated by imagining a telegraph

² "Measurement of Telegraph Transmission," *Journal of American Institute of Electrical Engineers*, Vol. XLVI, pp. 231-240, March, 1927.

³ "Effect of Signal Distortion on Morse Telegraph Transmission Quality," *Bell System Technical Journal*, Vol. 8, No. 2, page 267, April, 1929.

⁴ "Le Stroboscope pour les Mésures de Distortion en Télégraphie," *Documentation de la Troisième Réunion du C. C. I. T.*, Mai, 1931, Tome 1, pp. 30-35.

message to be transmitted at the rate of one time unit per hour and to be received upon some device by which each signal would produce an intense flash of light in a darkened room. In this room an observer faces a clock. Suppose that by the first flash the time is seen to be ten minutes past twelve. If the message is undistorted, every subsequent flash should occur at ten minutes past an hour with the minute hand of the clock in the same position. If, however, the message is distorted, some signals will be early and some late and the minute hand of the clock will be seen in various positions, varying perhaps between five minutes to the hour and twenty minutes past. Twenty-five minutes is then the "empiètement" and 25/60 or 41.6% the distortion of the message in accordance with the C. C. I. T. definition.

Another "stroboscope" distortion measuring apparatus⁵ is that due to Mr. A. W. Montgomery and the author, and is indicated in Figures 3 and 5. It is interesting in that in addition to measuring distortion it provides a standard distortion-free signal of sufficient length and complexity to be representative of actual working conditions; it is compact and portable in form and is suitable for routine maintenance purposes since it requires no special skill on the part of the operator. The receiver contains no moving parts except the tongue of a relay and a stream of electrons and ions. The Relay R_3 (Figure 3) responds to the telegraph signals to be measured and when its tongue reaches either the marking or spacing contact, one of two condensers is charged through the primary winding of the induction coil T. The voltage impulse thereby induced in the secondary winding of the coil is applied between the cathode and anode of a low voltage cathode ray oscillograph (a recent development from that described by J. B. Johnson⁶). A stream of electrons resulting from this application impinges on the fluorescent screen of the oscillograph giving the flash of light demanded by the stroboscopic method. To time these flashes a thermionic value oscillator entirely free from

sudden variations of frequency is made to produce two equal voltages differing in phase by 90° and these are applied between two pairs of parallel electrodes mutually at right angles within the cathode ray oscillograph. A rotating electric field is thereby produced which takes the place of the clock hand in our illustration and its position at the instant at which the relay R_3 responds to a signal is revealed by the direction in which it deflects the resulting cathode ray. The latter gives a radial line upon the fluorescent screen whose angular position may be readily observed through a transparent polar scale. The frequency of the rotating field is normally made equal to the signalling speed in bauds so that one complete revolution represents one time unit. Thus, the flashes produced by an undistorted train of signals will all appear in the same place but signals in an irregular train will produce flashes distributed over a section of the scale.

In use the number of flashes which appear on the scale in a second is about half the speed of signalling in bauds (depending on the message) and one is able to see not only the extreme length of the sector in which signals appear (whose length in divisions is equal to the percentage maximum distortion) but also to judge quite easily the average position of signals when these occur in groups, thus showing the magnitude of the bias or other systematic (repeated) distortion present. Because of absence of mechanical difficulties, the rate of rotation of the electric field can be increased almost without limit for the accurate measurement of very small values of distortion so that the complete revolution represents one-half or one-fifth, or even one-tenth of a time unit. Naturally, confusion will arise if the distortion exceeds the length of the time scale and one revolution per time unit allowing measurements up to 100% distortion is generally most convenient.

The constant frequency of a thermionic oscillator was also made the basis of a precise transmitter of test signals for use in conjunction with the above apparatus, employing an unusual expedient to make precision independent of mechanical adjustment within wide limits. The apparatus illustrated in Figure 4 and, diagrammatically on the left of Figure 3, con-

⁵ Known as the Telegraph Distortion Measuring Set. It will be described in a future issue of *Electrical Communication*.

⁶ "The Cathode Ray Oscillograph," *Bell System Technical Journal*, Vol. XI, No. 1, January, 1932, pp. 1-27.

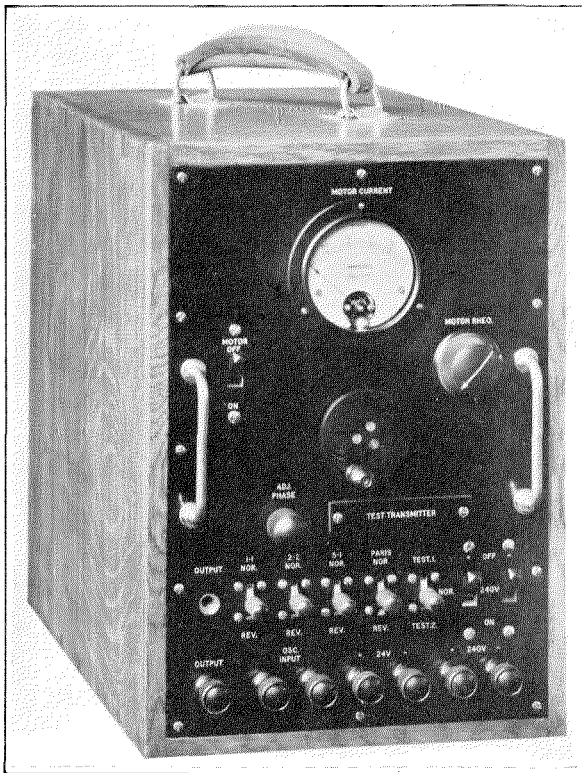

Figure 4

sists of two relays driven in parallel by an oscillator whose frequency in cycles per second is equal to the desired telegraph speed in bauds. One of the Relays R_1 is in effect an amplifier for producing current of sufficient power to drive the synchronous motor M . Through gearing, the motor drives a series of cams cut in accordance with different telegraph messages. Two sets of springs bearing on each cam with an angular separation corresponding to half a time unit produce two double current signals, one of which is a replica of the other but delayed by half a time unit. The second relay R_2 , which is called the "cleaning up" relay, connects the line to the tongue of the first set of cam springs during the middle part of every time unit of the first train of signals and to the other set of springs during the middle part of every time unit of the second train of signals. The line is therefore supplied with a message, each time unit of which consists of a period of marking or spacing current derived from the first set of springs during the period corresponding to contact between the tongue of the cleaning up relay

and its first contact, a period of current of the same polarity derived from the second set of springs whilst the tongue of the cleaning up relay rests against its second contact, and there are two intervals during which the tongue of the cleaning up relay is in transit between its two contacts. These four periods make up one cycle of the controlling frequency, or one time unit with very great precision. The spark suppressing condensers connected between the contacts of the cleaning up relay maintain the current in the line during the open circuit intervals so that the resulting train of signals is to all intents and purposes perfect. It will be seen that since only the middle part of each time unit is selected from each of the two trains of signals derived from the cams, these need not be accurate; and since each time unit of the final message includes the transit periods of the cleaning up relay in both directions and the duration of contact on both contact studs, a symmetry or bias in this relay has no effect on the final result.

With the exception of the oscillograph all the distortion measuring devices referred to herein have been intended for use in conjunction with

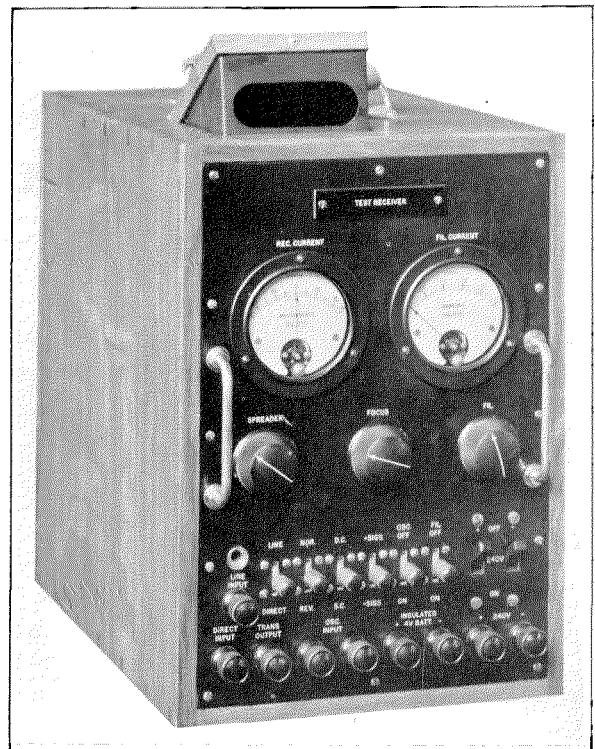

Figure 5

two condition telegraphs. Though they could be readily adapted to three condition telegraphs this does not yet appear to have been attempted.

This paper would not be complete without a passing reference to the measurement of distortion in the receiving apparatus of printing telegraph machines. Because in these machines the message is converted from a telegraph code to printed letters, the idea of distortion already considered is not applicable to their output. It is nevertheless possible to determine their effective margin of safety in terms of distortion by applying to them distorted signals having increasing degrees of distortion until they fail.

To facilitate this process a simple machine capable of producing continuously variable

amounts of distortion is now under development, although, hitherto it has been considered satisfactory if printing machines will accept signals distorted by a fixed amount such as 35%, these signals being derived, as a rule, from a distributor with unequal segments.

For purposes of research, Messrs. Stahl and Schallerer⁷ have also produced what is in effect a transmitter of distorted signals by subjecting normal signals to induction from other sources whilst they pass through a repeater, and have applied this scheme to find the operating margin of start-stop machines.

⁷ "Considérations sur la Marge de l'Appareil Start-stop Système Morkrum," *Documentation de la Troisième Réunion du C. C. I. T.*, Mai, 1931, Tome 1, pp. 42-53.

The Design of Filters for Carrier Programme Circuits

By F. RALPH, B.Sc., A.C.G.I., D.I.C.

International Telephone and Telegraph Laboratories, Incorporated

SYNOPSIS: *The important advantages over other types of circuit of a carrier telephone system of the single-sideband suppressed carrier type for meeting the increasing demand for high quality programme circuits are outlined.*

In such a carrier system the necessity of suppressing the unwanted sideband to a sufficiently great extent is explained as is also the difficulty of obtaining the desired degree of suppression in a system transmitting very low voice frequencies; and the application of quartz crystals to assist in obtaining the necessary sideband suppression is described.

Typical frequency-loss curves are given, showing experimentally, with a crystal used in the manner described, the effects of capacities in series and in parallel with the crystal.

Advantages of Carrier Systems for Programme Transmission

THE increasing extent to which telephone Administrations are being called upon to provide programme circuits for the inter-connection of broadcasting stations has brought into prominence the problem of obtaining circuits of the required high standard of transmission performance with the minimum outlay on construction work.

The low noise levels obtained on carrier telephone circuits with fairly high carrier frequencies give such circuits an important advantage over voice frequency circuits for high quality transmission. For long distance work the high velocity of propagation on open wire lines at high frequencies, and its uniformity over a wide frequency band give the carrier system a further advantage over voice frequency cable circuits.

With such a system, also, the desired programme channels may be obtained with minimum reaction upon the existing lines and facilities since, without any modification to the line except possibly additional transpositions, the carrier system may be put into operation without affecting the circuits (d.c. telegraph, physical telephone, phantom, or carrier telephone) already being provided by its pair of wires.

For a programme-transmission carrier system of the above type, the single-sideband suppressed-carrier method of operation recommends itself on the following grounds:

1. Economy in frequency band width required.

2. Economy in power transmitted to line for a given signal-to-noise ratio at the receiving terminal.

The economy in frequency band width is of considerable importance owing to the large frequency band covered by the programme material and the high attenuation of lines at high frequencies.

The importance of economy in transmitted power lies in the large range of level covered by the matter transmitted and the need for maintaining an adequate signal-to-noise ratio at the lowest transmitting levels.

The Filter Problem in a Single-Sideband Carrier System

Among the problems presented in the production of such a single-sideband system, that of the removal of the unwanted sideband is one of considerable importance. If the carrier frequencies at the transmitting and receiving terminals are not exactly synchronized, even though the difference be, for true single-sideband transmission, negligibly small, incomplete suppression of one sideband will produce undesirable beat effects.

Even if the two carriers are in syntony the phase displacement due to the suppressing filter, at some input frequencies, will cause harmonic distortion, while if the level difference between the two sidebands is less than about 30 decibels, the overall transmission characteristic may exhibit cyclic irregularities at the low frequency end.

To avoid the above effects it is necessary that in the frequency range between the upper and lower sideband frequencies, corresponding to the lowest voice frequency to be transmitted by the system, the attenuation in the sideband sup-

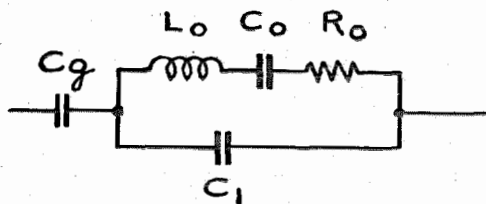

Figure 1

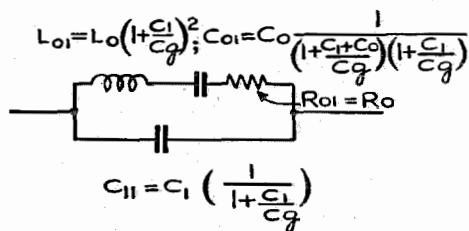

Figure 2

pression networks shall increase by at least 30 decibels. If this lowest frequency is 30 p:s, this increase in attenuation must be effected in 60 cycles, which with a carrier frequency of 40 kC. is only 0.15%.

Owing partly to the resistance losses in the coils and partly to the difficulty of obtaining a filter which will combine an extremely sharp cut-off with satisfactory image impedance characteristics, it is not practicable to meet such requirements with a filter consisting of ordinary coils and condensers. Because of the extremely low decrement of the equivalent electrical circuit by means of which it may be represented, the piezo-electric crystal suggests itself as a possible solution.

Since the applications of the piezo-electric effect so far have been limited chiefly to its use for purposes of frequency stabilisation, a theoretical investigation was made to determine to what extent existing technique could be directly applied and whether any special aspects of the present problem would necessitate any modification thereof.

It was also necessary to determine the relations between the constants of the crystal and the

characteristics of the equivalent electrical circuit by which it may be represented, to ensure that the fullest use was made of the degrees of freedom afforded in the choice of these constants, and to consider the possible reactions of external operating conditions.

The device desired was one which would provide the necessary additional attenuation over the frequency range in which the main filter was rising to the required value.

The results of the theoretical investigation, while stressing the inherent limitations of the quartz crystal for general application as a substitute for ordinary electrical circuit elements, showed that under suitable operating conditions the requirements of the existing problem could be satisfactorily met.

Equivalent Circuit of Piezo-Electric Crystal

It is well known that if a flat plate of quartz or other piezo-electric material be freely mounted between two conducting plates so as to be subjected to any electrostatic field existing between them, then in so far as its reaction upon

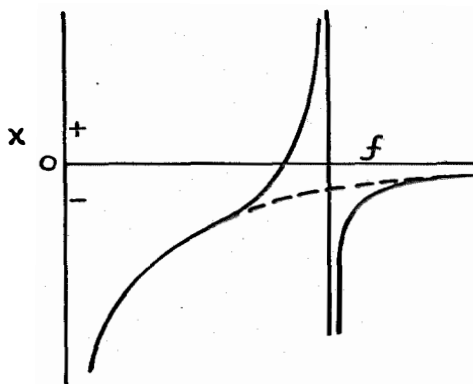

Figure 3

any electrical circuit into which it may be connected is concerned, the combination may be regarded as being equivalent to the electrical network shown in Figure 1. In this diagram, L_o , C_o , and R_o are constants depending only on the crystal itself. C_1 is substantially the electrostatic capacity which would exist between the electrodes having regard for the dielectric constant of quartz, if there were no air space between the electrodes and the quartz itself and

the crystal were not free to vibrate. C_g is a capacity which takes account of the above air space, becoming infinite when this space is reduced to zero.

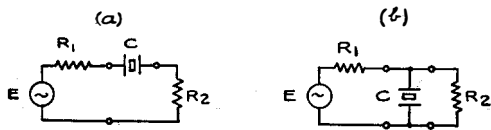

Figure 4

As, in general, the crystal will exhibit more than one resonance when the frequency of the electromotive force applied across the electrodes is varied, the values of L_o , C_o , and R_o will hold only in the frequency range in the neighbourhood of a particular resonance. By a suitable choice of the dimensions of the crystal, however, and its direction of cut with reference to the axes of symmetry of quartz, it can be arranged that only one resonance occurs within a wide range of frequency.

The network in Figure 1 may be simplified by omitting the capacity C_g since, provided that the crystal is only lightly damped mechanically so that the reactance of L_o is very large compared with the value of R_o , the values of the remaining quantities may be modified to include its effect. The modified values are shown in Figure 2.

The reactance-frequency characteristic of this network is of the type shown in Figure 3, the resonant frequency f_o and the anti-resonant frequency f_{oo} being given respectively by:

$$f_o = \frac{1}{2\pi \sqrt{L_{o1} C_{o1}}}$$

$$f_{oo} = \frac{1}{2\pi \sqrt{L_{o1} \frac{C_{o1} C_{11}}{C_{o1} + C_{11}}}}$$

Such a network might be made to form a part of any of a number of well-known types of filter section by associating it with ordinary coils and condensers. Owing, however, to the high cost of accurately ground quartz crystals and the large size of crystals required for frequencies less than, say, 50 kC., the cost of such complicated filters would be prohibitive for the present problem.

Attention, therefore, should be given to the possibilities of a single crystal inserted in series or in parallel with pure resistances. The two possible cases are shown in Figures 4a and 4b in which a source of alternating e.m.f. E , of internal resistance R_1 , is working into a load R_2 .

If α is the reduction, in decibels, of the voltage across R_2 due to the presence of the crystal, then the relations between α and frequency for the two cases are of the general form shown in Figures 5a and 5b, the points of minimum and maximum attenuation corresponding to the frequencies f_o and f_{oo} . The dotted lines indicate the corresponding attenuation obtained by replacing the crystal by a capacity equal to C_{11} in Figure 2.

By a suitable choice of R_1 and R_2 the small dip in attenuation at the minimum value may be made negligible. The rapid rise between f_o and f_{oo} is then of the type required by the present problem, provided the reduction in attenuation outside this range is not too rapid to permit the main filter to attain the required value before the crystal attenuation becomes negligible. The series arrangement is suitable for the case in

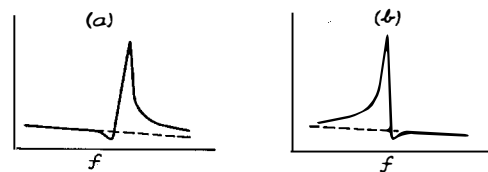

Figure 5

which the lower sideband is to be transmitted and the shunt condition for the upper sideband case.

If the attenuation due to the crystal in Figure 5 is expressed in terms of $(f_{oo} - f_o)$ it is found that the difference between the attenuation at f_{oo} and that at frequencies well remote from f_{oo} is greatest when $(f_{oo} - f_o)$ is greatest, while this quantity cannot possibly exceed a certain maximum value determined by the piezoelectric properties of quartz. Thus a family of curves for Figure 4a in which $f_{oo} - f_o$ is decreased by adding capacity in parallel with the crystal would be as shown in Figure 6.

As the effect of a capacity in series with the

crystal, such as that due to an air gap, may be shown to be equally adverse, it is evident that

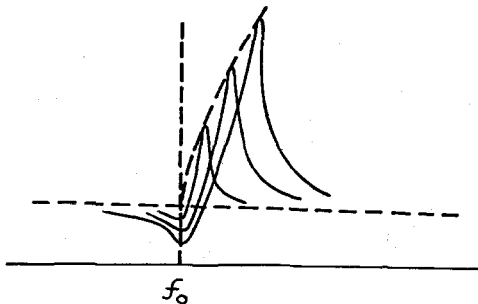

Figure 6

considerable precautions are necessary if the optimum results are to be obtained.

Operating Circuit

The crystal may be included between suitable resistances between the stages of a 2 valve resistance-coupled amplifier as shown in Figure 7. The resistances R_1 , R_2 and R_3 , together with the internal impedance of valve V_1 , are chosen to give a circuit of suitable impedance.

The value of R_3 must be kept small compared with that of the grid-filament impedance, in order to ensure that the effective series reactance of the combination is very low compared with that of C_1 for the crystal, since otherwise the effective resonant frequency f_0 will be increased.

The resistance R_4 serves to relieve the crystal of electrostatic stress due to the plate battery

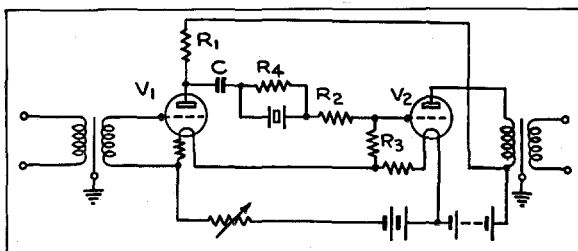

Figure 7

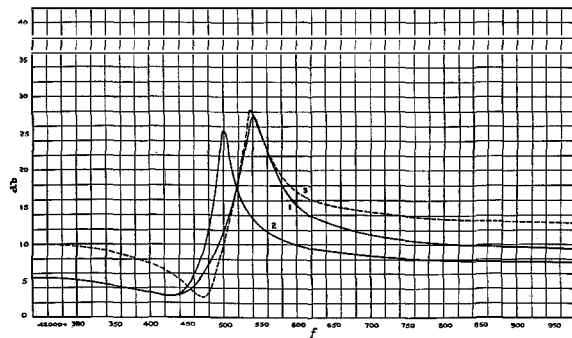

Figure 8

voltage, and the condenser C is merely a blocking condenser.

Results

Figure 8 shows three curves, obtained in the manner described, with the crystal in series with a total resistance of 200,000 ohms.

Curve (1) was taken with the crystal alone, i.e., as shown in Figure 7.

Curve (2) shows the effect of adding in parallel with the crystal a capacity having the value $\frac{1}{2}C_1$, the anti-resonant frequency being reduced but the resonant frequency remaining unchanged.

Curve (3) was taken with a small capacity in series with the crystal. It is seen that in this case it is the resonant frequency which is modified, the anti-resonant frequency being substantially unchanged. The importance of avoiding these capacities is thus experimentally verified.

With such a combination at each terminal of the carrier system working in conjunction with main filters in which a steep cut-off is obtained but undesirable reflection effects are minimised by means of suitable impedance correction,* adequate discrimination against the unwanted sideband, even when allowance is made for the effect of temperature variation, can be obtained for input voice frequencies as low as 30 p: s.

* H. W. Bode, "A Method of Impedance Correction," *Bell System Technical Journal*, Oct., 1930.

Vast Public Address System at Thirty-first International Eucharistic Congress, Dublin, June, 1932

By W. L. McPHERSON, B.Sc., (Hons.)

SYNOPSIS:—This paper describes preliminary investigations, equipment, arrangements, and results obtained with the vast, high quality public address system at the Thirty-first International Eucharistic Congress held in Dublin in June, 1932. At the Pontifical High Mass on the closing day of the Congress, the congregation numbered approximately one million, and occupied an area of about 200 acres. The equipment included street systems for reproducing speech and music over processional routes covering a distance of fifteen miles.

PUBLIC meetings have from time immemorial furnished the most effective method of pleading a cause or witnessing to a faith. Such corporate expressions of opinion have weight greater in its psychological action than the most reasoned writings however widely disseminated by the art of printing; greater even than the personal address made either direct to a single individual or to the multitude of isolated individuals who go to form a radio audience. For centuries the size of public meetings has had only one limit—that imposed by the vocal powers of a speaker; now that the art of electrical communication has stepped in and with the aid of the Public Address System removed this limit, meetings may be planned on a scale so tremendous as to have seemed utterly incredible even so recently as ten years ago. The Thirty-first International Eucharistic Congress held in Dublin during the month of June, 1932, is an outstanding example of a vast public meeting whose realization and success were made possible only by the reliable operation of a correspondingly vast Public Address System. Never before has one man addressed a visible congregation numbering one million.

When the Congress authorities were making plans for the Dublin meeting, the responsibility for obtaining an adequate Public Address System was laid on Mr. T. J. Monaghan, B.Sc., M.I.E.E., M.I.C.E. (I), the Engineer-in-Chief of the Irish Free State Department of Posts and Telegraphs. The system actually installed was designed jointly by Mr. Monaghan and the engineers of Standard Telephones and Cables, Limited, who undertook the supply and operation of the necessary equipment. Owing to the

unprecedented magnitude of the scheme, much preliminary experimental work was involved, particularly in connection with the sound distribution from alternative arrangements of grouping of loudspeakers; the interpretation of the results obtained in these experiments was a somewhat troublesome matter as of necessity it was impossible to simulate completely the working conditions owing to the absence of crowd-damping, the difference between Summer and Winter vegetation, and similar factors. The final decision was made on theoretical grounds backed by (relatively) small scale experiments and was found in due course to be entirely justified by the results. The general nature of the problems involved is discussed later.

The system demanded by the Congress authorities can be described under the following main headings:

- (a) Phoenix Park congregational area system for use during the mass meetings.
- (b) Street systems, for use during the Procession of the Sacrament.
- (c) Pro-Cathedral system, for opening ceremonies and special celebrations.
- (d) O'Connell Bridge system, for the closing Benediction ceremonies.

The four systems (a), (b), (c) and (d) listed above were each capable of independent operation, and were linked together by a distribution system (e), so that any one system could feed any of the others, and could also feed to interested broadcasting administrations, etc., over the toll cable network.

Figure 1 shows diagrammatically the relation between these main parts of the system. The necessary wire connections between the various

stations and the central distributing point were made by lines laid as part of the ordinary city network, working and spare lines being provided in all cases; and an additional network was used to furnish intercommunication between the stations over an L.B. telephone system with P.B.X. located at the central distribution point. A third L.B. telephone network was installed to enable the traffic control officials to get in touch with the amplifier stations for the purpose of issuing traffic control instructions over the loudspeakers in the event of an emergency.

Phoenix Park System

From the standpoint of the public, the most spectacular portion of the system was undoubtedly that located at Phoenix Park for the service of the congregations attending the ceremonies at the High Altar specially erected for the Congress. These ceremonies were spread over four days, and included a men's meeting, a women's meeting, a children's Mass, and Pontifical High Mass on the closing day, on which last occasion the congregation numbered approximately one million. The area allocated for this purpose bore the traditional but misleading name of "Fifteen Acres"; the ground reserved by the organizers actually covered some eighty acres, and the area occupied by the congregation on the final day of the Congress was somewhere about two hundred acres. The covering of such an area with speech and music presented

edly that located at Phoenix Park for the service of the congregations attending the ceremonies at the High Altar specially erected for the Congress. These ceremonies were spread over four days, and included a men's meeting, a women's meeting, a children's Mass, and Pontifical High Mass on the closing day, on which last occasion the congregation numbered approximately one million. The area allocated for this purpose bore the traditional but misleading name of "Fifteen Acres"; the ground reserved by the organizers actually covered some eighty acres, and the area occupied by the congregation on the final day of the Congress was somewhere about two hundred acres. The covering of such an area with speech and music presented

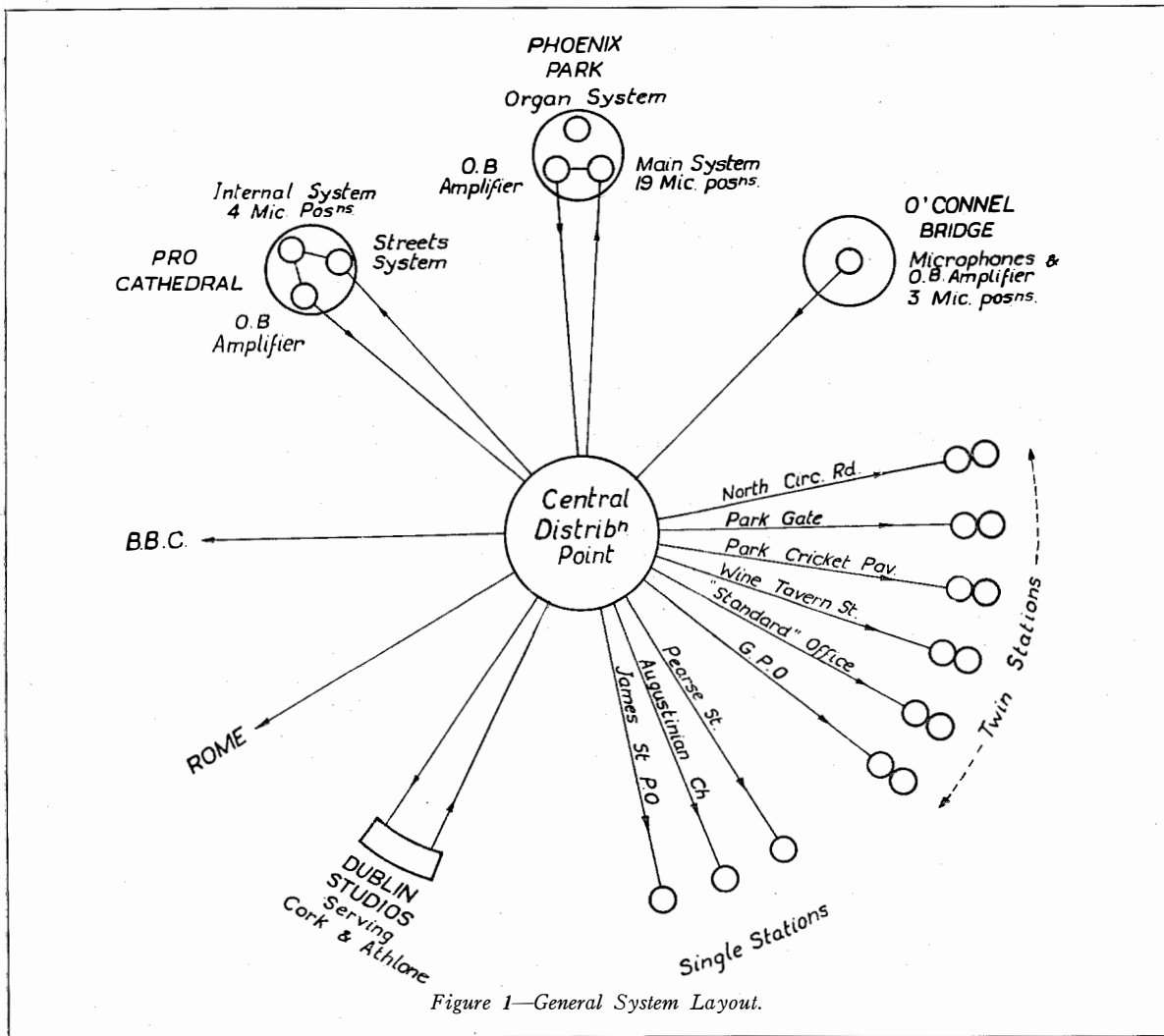

Figure 1—General System Layout.

a problem of the first magnitude, particularly as high music quality was essential.

In public address systems for large crowds the normal practice is to use a bank of projectors located together between the speaker and the crowd and fanned out so as to cover the necessary angle. In the case with which we are now dealing, this method could not be relied upon, as a "throw" of approximately half a mile against the prevailing wind would have been necessary, requiring an acoustic output not only difficult to produce but unbearably loud to those nearest the projectors, and certain to interfere to a most objectionable extent with the speakers and choirs even if it did not react through the microphones to set up a sustained "sing." The alternative is to distribute the loudspeakers throughout the crowd and work each loudspeaker at a lower level than is called for in the first case. This method involves the risk of listeners hearing the speeches, etc., not only from their nearest loudspeaker but also from other loudspeakers sufficiently distant in space to give rise to a noticeable time lag, approximately one second for every thousand feet of distance, giving rise to a species of "repetition" or "echo" effect ruinous to intelligibility of speech and intolerable from the musical standpoint. Nevertheless, the objections to the first or "group" system were so definite that only the "distributed" system was considered feasible, and a special study was made to determine what could be done to reduce the echo effect just mentioned.

The chief factor to be considered in this connection was the effect of the polar distribution of the field given by the loudspeaker horns which it was proposed to use. From this polar curve it is possible to obtain a relation between the spacing of the loudspeakers and the relative strength thereof at a point on the main axis of one of the horns such that the time lag between the two fields is a definite quantity.

In Table I is given the attenuation relative to maximum field as the point of observation is moved along a line at right angles to the axis of the horn, in terms of the angle made by the line joining the loudspeaker and the point of observation relative to the direction of the horn. (This is in effect the normal polar curve with an

TABLE I.
*Attenuation for angle Θ relative to axis of horn;
length of path = constant/cos Θ .*

Θ	Attenuation
0°	0
10°	2.0 db.
20°	5.5 db.
30°	9.1 db.
40°	13.2 db.
50°	17.3 db.
60°	22 db.
70°	27 db.

TABLE II.
*Attenuation of interference for various distances between two
loudspeakers, observation point in each case cor-
responding to time lag of 0.1 second.*

Spacing	Attenuation
700 ft.	5 db.
600 ft.	6 db.
500 ft.	7 db.
400 ft.	9.3 db.
300 ft.	13.3 db.
200 ft.	20.9 db.
150 ft.	26.7 db.

added correction to take account of the increase in distance as the angle increases.) Table II gives the attenuation and spacing between two loudspeakers for a point of observation such that for any given spacing the time lag due to the differing paths is .1 second. From this it will be seen that provided the spacing is 200 feet or less, the interference level will be at least 20 db. below the direct level if the time lag is .1 second or greater. This would appear to be satisfactory, and a spacing of 180 feet was provisionally adopted. In Table III are shown figures relating the time lag and the interference attenuation for various distances along the axis of one loudspeaker; at short distances the time lag is higher but so also is the attenuation, and as the distance increases, both time lag and attenuation are reduced so that at no point should the interference constitute effective disturbance. In order to cover the required area

with this spacing, a line of sixteen pairs of loudspeakers would be required, the two loudspeakers of a pair feeding in opposite directions, and all oriented at right angles to the line of the supporting poles.

Table IV shows the relation between the attenuation and time lags of the fields arriving from each pole at a point opposite the first pole and distant therefrom 1,000 feet. It will be noticed that the fields from the first three loudspeakers are practically in unison, that the lag of .13 seconds from No. 4 is accompanied by an attenuation of 9 db., and that thereafter the fields rapidly become negligible. Tests were therefore made with a line of six loudspeakers spaced every 180 feet and mounted at a height of 20 feet. Exploration of the whole field covered showed that the echo effect was unnoticeable, provided that the loudspeakers were of uniform efficiency and rigidly aligned in the correct direction. A deviation of only a few degrees invariably resulted in the production of zones in which the interference effect was definitely present; in fact, the presence or absence of interference zones was usually a much quicker guide to the accuracy of lining up than any casual examination from the foot of the supporting pole. It is very evident that the narrow angle radiation due to the horn plays a very important part in reducing such interference, and that non-directional loudspeakers or wide angle horns would have been utterly useless for this particular system. Cutting out one of the central speakers was immediately productive of zonal interference.

In view of the consideration outlined above and the satisfactory behaviour of the experimental six-speaker system, this type of layout was definitely adopted for Phoenix Park, and in due course found to be completely successful. The whole of the enormous field was well covered with sound, the intensity of which was a maximum at the pole line and then fell away rather slowly towards the edge of the field. The freedom from interference effects is best illustrated by the "complaint" of a listener that no matter where he stood he could hear only one loudspeaker. The decisiveness with which at any given spot a listener could pick out one particular loudspeaker as apparently the sole

source of sound was indeed remarkable, and is still not clearly understood; from the distribution of fields shown in Table IV one would expect at least two loudspeakers to be noticeable, but the ear insisted very definitely on picking out only one. Both speech and music quality were

TABLE III.

Time lag and attenuation of interference at various distances along axis of one loudspeaker arising from second loudspeaker with axis spaced 180 feet from the first speaker mounted parallel thereto.

Distance	Attenuation	Time Lag
50 ft.	29 db.	.124 sec.
100 ft.	22.5 db.	.097 sec.
200 ft.	14 db.	.062 sec.
300 ft.	9.5 db.	.045 sec.
400 ft.	7 db.	.035 sec.
500 ft.	5.5 db.	.029 sec.
600 ft.	4.4 db.	.025 sec.
700 ft.	3.4 db.	.022 sec.
800 ft.	2.8 db.	.019 sec.
900 ft.	2.3 db.	.016 sec.
1000 ft.	2.0 db.	.014 sec.

TABLE IV.

Time lag and attenuation of interference at a point distant 1000 feet along the axis of the first of a line of sixteen loudspeakers with 180 ft. spacing.

L.S. No.	Interference Attenuation	Interference Lag
1	0	0
2	2 db.	.009 sec.
3	5.5 db.	.055 sec.
4	9 db.	.127 sec.
5	11.5 db.	.21 sec.
6	14 db.	.32 sec.
7	16 db.	.43 sec.
8	18 db.	.55 sec.
9	19.5 db.	.68 sec.
10	21 db.	.83 sec.
11	22.5 db.	.96 sec.
12	23.5 db.	1.11 sec.
13	24.5 db.	1.25 sec.
14	25.5 db.	1.40 sec.
15	26.3 db.	1.55 sec.
16	27 db.	1.72 sec.

all that could be desired, and in general the performance was such as to indicate that the polar distribution of the loudspeaker horns gave even a narrower angle of radiation than had been thought, and that the theoretical studies had erred on the conservative side.

The general layout of the loudspeaker and microphone positions at Phoenix Park is shown in Figure 2. Two extra pairs of loudspeakers were installed to serve the enclosure for sermons, addresses and marshalling instructions, but these were cut out during musical items so as to avoid disturbing the choirs owing to the time interval between the actual singing and their hearing the sound from the loudspeakers.

All these loudspeakers were of the low impedance No. 555 type, moving-coil with polarised magnet system, and in conjunction with 6 ft. exponential horns had a frequency range of approximately 100 to 6000 cycles. Each pair of loudspeakers was connected to the low winding of a step-down transformer mounted on the

pole, the primary of the transformer being connected to a speech line, separate speech lines being used for groups of four loudspeakers and controlled from the volume distribution panels. All speech lines were run in steel conduit. The wires carrying the field magnet currents were run in separate steel conduits, the magnet systems being arranged in groups of eight in series, each group having its own particular pair of field current leads supplied through its own rectifier from the mains.

In order to lead the choir a harmonium was used; by the aid of a separate public address system, it had its sound output raised to organ level. A single folded horn 14 ft. long, seen in Figure 3, was employed in the system. The same type of moving coil loudspeaker was used as in the previous case, but with the longer horn, the range of reproduction being extended well below 100 cycles per second.

The placing of loudspeakers relative to microphones was such that no singing troubles were

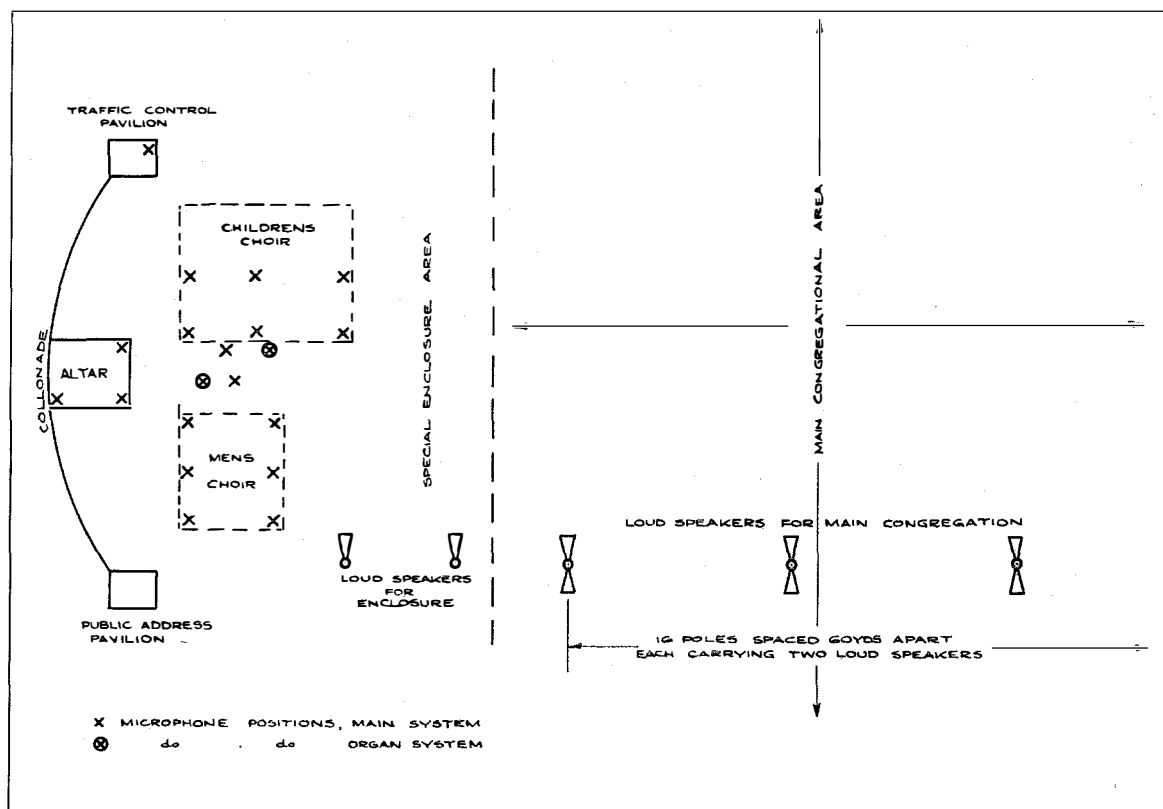

Figure 2—Loudspeaker and Microphone Layout at Phoenix Park.

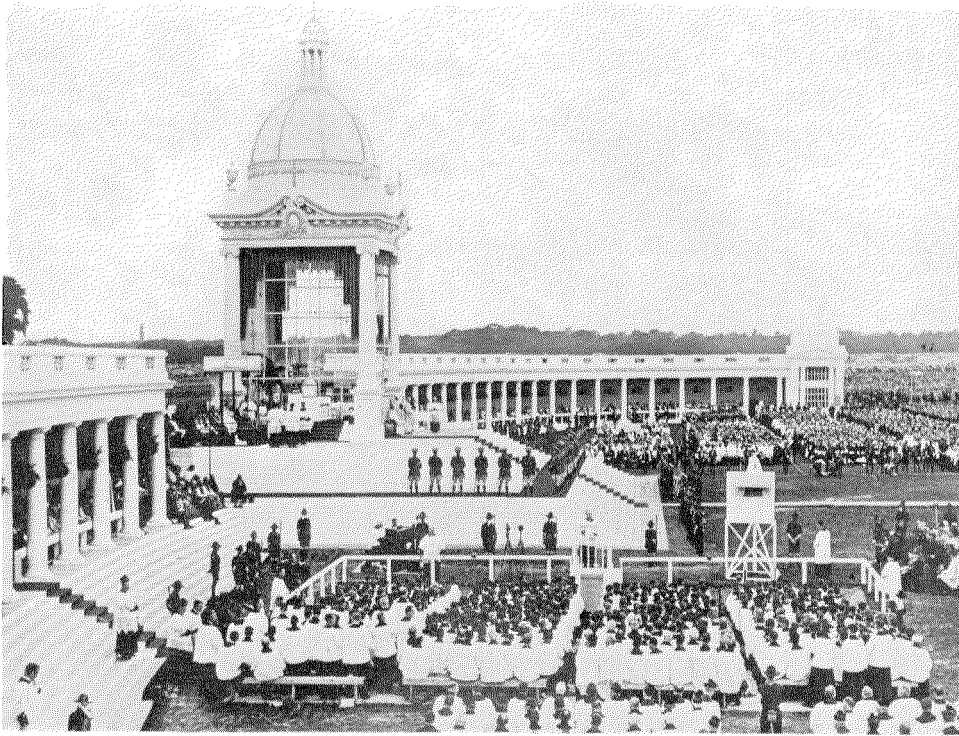

Figure 3—"Organ" Loudspeaker in Position for Men's Choir at Phoenix Park.

encountered. Echo effects had been anticipated from the Colonnade, but these were eliminated when all seats were filled as was the case during all except one meeting, and on that occasion the echo was experienced only when the two extra loudspeakers were switched on to serve those in the enclosure.

The microphones used throughout were of the No. 4014 double-button carbon type, chosen partly on account of their reliability and partly on account of their sensitivity. The carbon noise which might have been objectionable for broadcast studio work was swamped by the multitude of small noises inevitable with such large numbers of participants in an open air ceremony, and special arrangements were made with the ecclesiastical authorities whereby all microphones were placed in good positions so as to obtain a high signal/noise level. It is interesting to note that the nineteen microphone

positions involved no less than two miles of wiring to the control equipment.

With the exception of the microphones, loudspeakers and emergency power supply, all equipment used in connection with the Public Address System was housed in a pavilion located at the left ("Gospel") end of the Colonnade. Figure 4 shows the main amplifying and control equipment. This equipment occupied seven bays and included complete duplication of all amplifiers and the provision of switches so that in the event of a breakdown only a second or two would be lost in changing over. In view of the great emphasis placed on the necessity for maintaining the public address service, the operating staff were specially drilled in changing over, and reached a degree of speed such that on test a complete change-over of amplifiers, volume distribution panels and power supplies was made without losing more than the vowel sound in

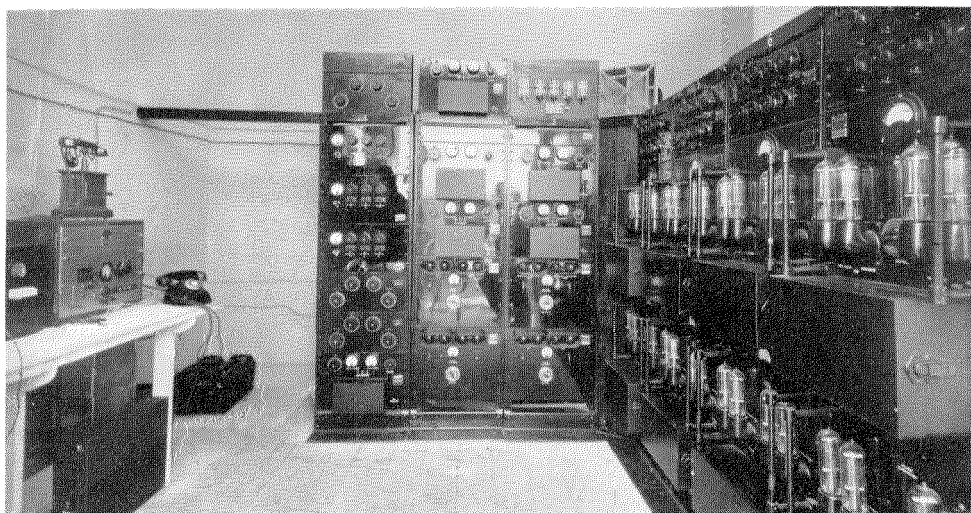

Figure 4—Main Amplifying and Speech Control Equipment at Phoenix Park.

the word "four." Fortunately the exercise of this particular art was never called for except in the one minor instance of a failure of the power supply immediately prior to a ceremony. Figure 5 shows in block schematic the operating units of the equipment, which were all of standard public address or talking picture pattern, and designed to operate over a reproduction range of 50 to 10,000 cycles.

The No. 4041-A Amplifier is a three-stage resistance-coupled amplifier using No. 4215-A Valves and is provided with a gain control; the No. 4042-A Amplifier is a single-stage push-pull amplifier which includes A.C. heating for the filament of its No. 4205-E Valves, and a full-wave rectifier (also using No. 4205-E Valves) which supplies the required plate and grid potentials and plate potential for the No. 4041-A Amplifier. The final No. 4043-A Amplifiers are generally similar to the No. 4042-A, giving a single-stage of No. 4211-E Valves in push-pull and equipped with full-wave rectifier, using No. 4211-E Valves, for plate and grid potentials. Filament current for the No. 4041-A Amplifier, and feed currents for the carbon microphones, were obtained from a 12-volt battery. In view of the large amount of amplification involved—

eleven stages—it is not surprising that the rack equipment became somewhat microphonic, so that thick mats had to be placed on the floor to lessen the vibration, and care had to be taken that the monitoring loudspeakers did not face the earlier stages or operate at any large volume. The 50-cycle, single-phase main power supply was taken either from the town mains, or alternatively from a petrol-electric generating set installed for the purpose at a distance of approximately 100 yards from the equipment, out of sight and out of sound of the congregation.

In addition to the main equipment, the pavilion contained the auxiliary "organ" equipment already mentioned. This equipment consisted of an M.S. 2985 Grp. 2 Two-Stage Amplifier driving an M.S. 2985 Grp. 3 Power Bank, both fed from the power mains through an M.S. 2984 Grp. 1 Rectifier, and an M.S. 2121 Grp. 2 Smoothing Unit. These are shown in Figure 6. Another item housed in the pavilion was the group of M.S. 2986 Grp. 2 Rectifier Units supplying polarising current to the loudspeakers. The organ amplifier equipment was completely duplicated to cover emergencies, and two spare rectifiers were provided for the loudspeaker fields.

Owing to the necessary proximity to each other of harmonium, microphone and loudspeaker imposed by the requirements of the choir conductor, this system tended to "sing" and needed constant and careful monitoring, there being little margin between the "sing" point and the operating level.

All the equipment so far mentioned was used only in connection with the loudspeakers at Phoenix Park. It was also necessary, however, to serve the loudspeakers in other parts of the system, and for this purpose the mixed microphone input was transmitted to the central distribution point at Crown Alley through an M.S. 3029 Outside Broadcast Amplifier. This is illustrated in Figure 7, while the schematic is shown in Figures 8-A and B. In view of the importance of the ceremonies originating in Phoenix Park, this amplifier also was duplicated together with its M.S. 3028 Supply Unit. Similar Outside Broadcast Amplifiers were used for the same purpose—feeding the central distribution point—at the Pro-Cathedral and at

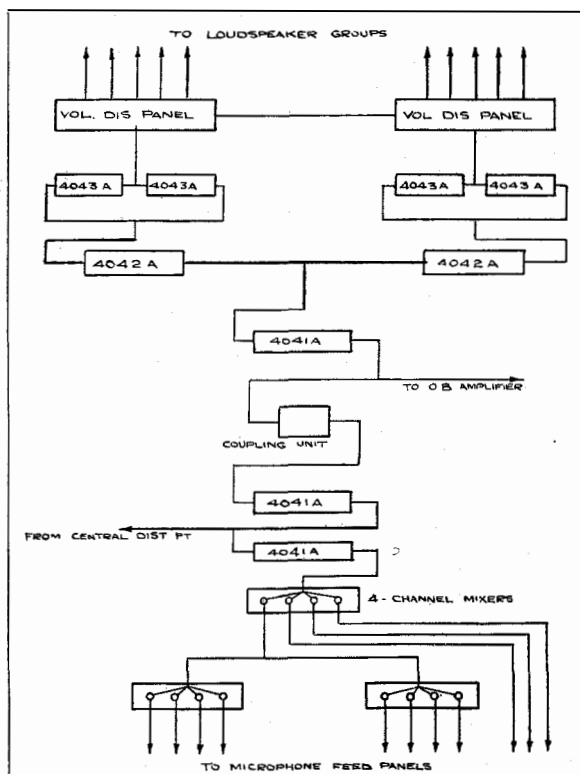

Figure 5—Block Schematic of Main Amplifying Equipment at Phoenix Park.

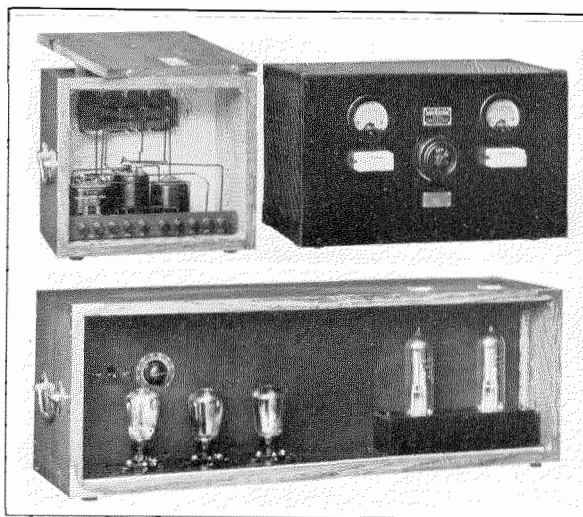

Figure 6—"Organ" Equipment. Upper—M.S. 2121 Grp. 2 Smoothing Unit and M.S. 2984 Grp. 1 Rectifier; Lower—M.S. 2985 Grp. 2 and M.S. 2985 Grp. 3 Amplifiers in Common Case.

O'Connell Bridge. The flexibility of this amplifier equipment, which can be run either from A.C. mains or from batteries, and which contains its own volume control and volume indicator, and attenuation pads, rendered it exceptionally convenient in coping with the various working conditions.

While the main object of the Park equipment was to pick up and reproduce ceremonies and speeches originating at the Park, it had also to reproduce ceremonies and speeches originating elsewhere and for this purpose incoming lines from the central distribution point at Crown Alley were arranged to be connected in between the first and second No. 4041-A Amplifiers. These incoming lines were quite distinct from those used to transmit programmes from the Park. In the case of the Papal message, two incoming lines were available, extended from the toll exchange, and used one as programme line and one for control purposes.

Mention has already been made of the importance of maintaining the Public Address System in operation. This importance arises not merely from the standpoint of serving that part of the congregation (about 99%) which would otherwise be completely outside the audibility range, but also from the necessity for maintaining control over the gathering. The

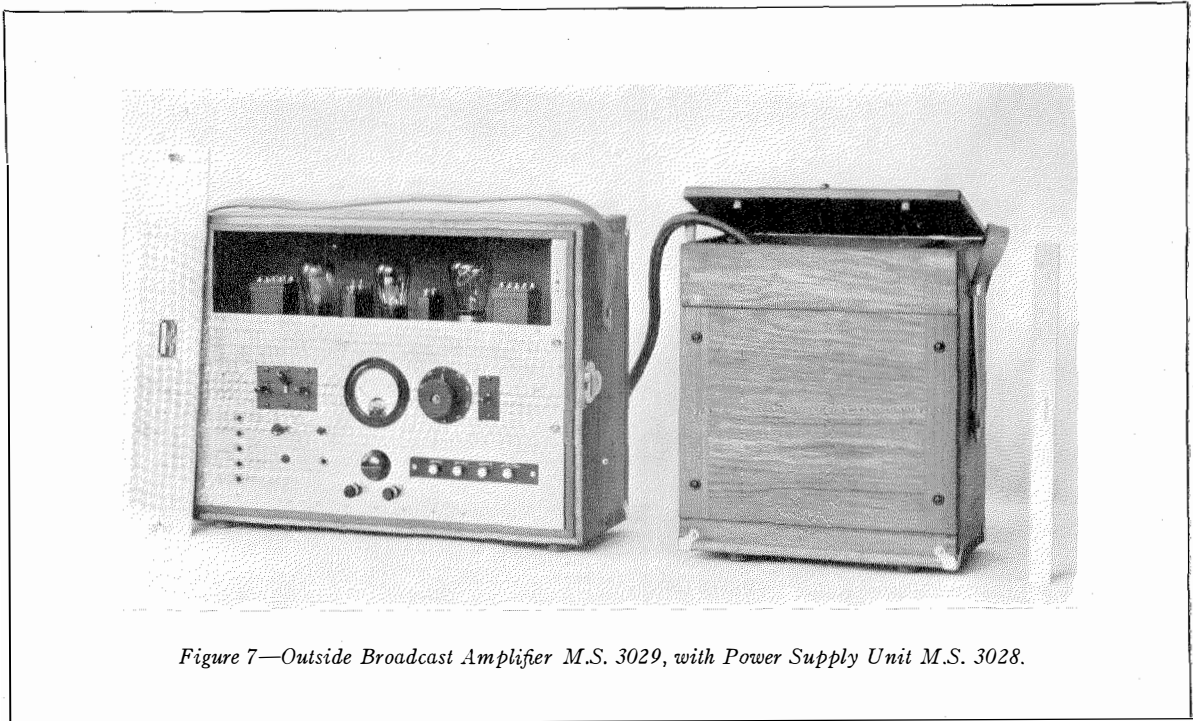

Figure 7—Outside Broadcast Amplifier M.S. 3029, with Power Supply Unit M.S. 3028.

very fact that a congregation of such tremendous size is rendered feasible by the Public Address System demands in return that the System shall be absolutely reliable, as it is the sole guarantee that order can be preserved and panic avoided. To allow a crowd a million strong to get even slightly out of hand, with room for movement to accumulate, might result in a disaster of the first magnitude; and the value of the Public Address System in maintaining order even with an exceptionally well-disciplined and organised people was made evident on several occasions during the Dublin ceremonies, and fully justified the very appreciable expense involved in duplication of plant and power equipment.

Street Systems

The main purpose of the street systems was to reproduce over the whole of the fifteen miles of processional route the music and singing originated at Phoenix Park during the Procession of the Sacrament from the Park to O'Connell Bridge, and subsequently to reproduce the final message and Benediction given by the Papal Legate at O'Connell Bridge. An auxiliary function was the broadcasting of the day's arrangements every morning in six languages for

the benefit of foreign visitors. In addition, the equipment was to be available for traffic control purposes.

Following on a certain amount of experimental work, the arrangement of loudspeakers finally adopted was generally similar to that used at Phoenix Park. The speakers were spaced every sixty yards and were arranged with their axes at right angles to the street. Their actual location depended, of course, on the presence of buildings and similar factors. Where possible they were mounted approximately 20 feet back from the road and at a height of 20 feet, and inclined at a small angle so as to bear directly on that part of the route which would be traversed by the procession. Where buildings prevented this setting back, the loudspeakers were mounted at heights of 20 to 40 feet and tilted accordingly. In certain cases severe "echo" effects were encountered from buildings on the opposite side of the road and in these cases it was necessary to incline the loudspeakers rather more than would otherwise have been done. The loudspeakers used were of the balanced armature, high impedance A.D. 8177 type with 3 ft. 6 in. horns, and were connected in parallel across the feeder lines. Actually, in

order to minimise the effects of possible line failure, two feeder lines were used in all cases over the whole length of the section, and the odd numbered loudspeakers connected to one feeder and even numbered loudspeakers connected to the second feeder. The total length of route was divided into sixteen sections, each section having its own amplifying equipment. In twelve cases it was possible to arrange for one station to handle two amplifying equipments and in these cases arrangements were made whereby in the event of one amplifier failing, the other amplifier could take the load of both sections at the expense, of course, of slightly reduced volume. At each station facilities were provided for communication with other parts of the Public Address System and also with the traffic control headquarters, while a microphone was fitted so that if necessary a traffic control officer could give directions over any one section without disturbing the others, a feature which was found of definite value. The amplifying equipments were of the same general type as that used for the organ equipment at Phoenix Park and comprised one M.S. 2985 Grp. 1 Three-Stage Amplifier with one M.S. 2985 Grp. 3 Single-Stage Amplifier, the total undistorted output being approximately 22 watts, the average load per amplifier being approximately twenty-five loudspeakers. Power supplies for these amplifiers were obtained from an M.S. 2984 Grp. 1 Rectifier Unit and an M.S. 2121 Grp. 2 Smoothing Unit. Connection to the feeders was made through Volume Control Units, either No. 4005 eight-way or E.S. 424 Grp. 1 four-way as required. In the case of two sections no mains power supply was available and recourse was had in these cases to batteries.

For normal operation each amplifier was fed by its own line from the central distribution point, the incoming level being approximately zero. Working and spare lines were supplied for this purpose in addition to working and spare lines to the P.B.X. for control purposes. Once the location of the loudspeakers had been definitely settled, no outstanding problems were involved in these stations apart from the difficulty sometimes experienced in obtaining a good ground and, in certain cases, "singing" due to coupling between the incoming speech line and

the outgoing feeder line. This last trouble was particularly evident in the only case where open wire lines following the processional route had to be used for the incoming speech and in this case the feeder line had to be moved back some 30 feet in order to reduce the induction. The feeders themselves were made of two-conductor cable, the conductors being approximately 20 S.W.G. and paired but not twisted.

In the case of the street system adjacent to the Pro-Cathedral, all services originating in the Pro-Cathedral were put out over this system, and on the occasion of the Midnight Mass, these streets were filled with people kneeling and taking part in the service which they could not see. Similar sights were witnessed when the service of the children's Mass originating in Phoenix Park was put out over the street system. On the day of the procession it is estimated that the street congregation amounted to about half a million and there is definite evidence that the broadcasting through the street systems of the music services in the Park contributed enormously to relieving the fatigue which might otherwise have been felt by those taking part in the procession which occupied a period of approximately four hours. A special feature of the operation of the street system was that as the Sacrament with its own special choir entered each section, the system serving that section was cut out of action so as not to interfere with the music rendered by that choir, and then cut in again when the Sacrament had reached the next section.

Pro-Cathedral System

This system had a twofold purpose, the first being to amplify sermons, addresses and prayers in the sanctuary so as to render them entirely audible over the whole building, despite the inherently poor audibility in many parts thereof consequent on the architectural layout, and secondly to pick up and deliver to the central distributing point the whole of the ceremony in the Cathedral, including not only the addresses already mentioned, but also the choir music. The acoustics of the Cathedral necessitated so disposing the loudspeakers that the choir lay in the direct field, and to prevent "singing back" the choir microphone had to be excluded from

the system feeding the Cathedral loudspeakers. In order to meet this situation the output from the "speech" microphones was fed through a mixing panel into an amplifying equipment similar to that used at a street station, the output from which operated the Cathedral interior loudspeakers in the normal manner. By means of a volume distribution panel a small part of the output was taken to an Outside Broadcast Amplifier fed simultaneously from the choir microphone, thus giving combined speech and music output to the central distribution point. From the latter the combined pick-up was re-distributed to the street amplifier positions, including that for the Cathedral streets. This

arrangement operated very satisfactorily, though at times care had to be taken to prevent the street system "singing back" through the choir microphone via the open windows and doors.

The ceremonies handled by the Cathedral system included the reception of the Papal Legate, the official opening of the Congress, two Pontifical High Masses, and a Midnight Mass. For this last the Cathedral street equipment was the only other part of the system brought into action, and since the central distribution equipment was not required for other purposes it was cut out entirely, the output from the Outside Broadcast Amplifier being strapped over to the input of the Cathedral street amplifier.

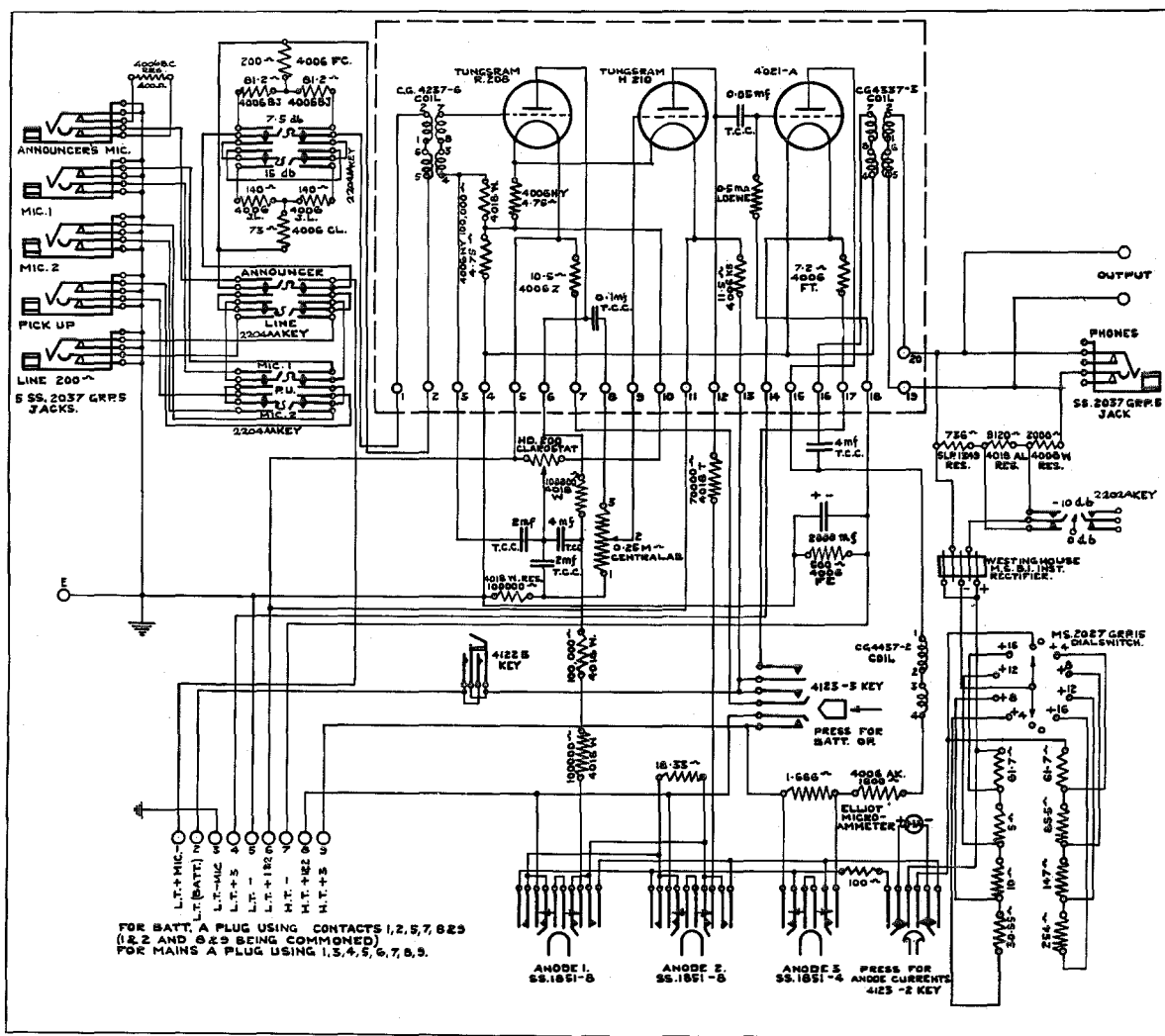

Figure 8A—Schematic of Outside Broadcast Amplifier M.S. 3029.

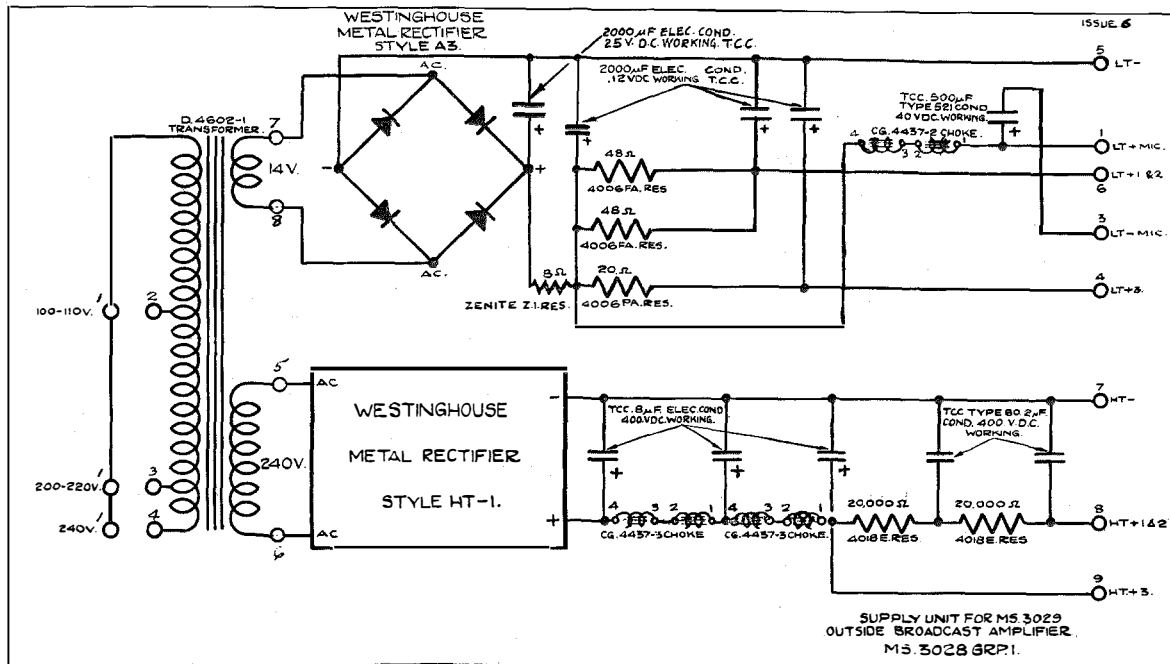

Figure 8B—Schematic of Outside Broadcast Amplifier Power Supply Unit.

With the exception of the microphones the whole equipment at the Cathedral was operated from the mains. The loudspeakers used internally were of the same type as those used on the streets, i.e., balanced armature No. A.D. 8177 units with 3 ft. 6 in. horns. Finding the most suitable positions for the loudspeakers presented some difficulty, as the acoustics of the building are peculiar, and indeed such as to render impossible the use of the wide angled "box" type horns which have been used successfully elsewhere, and whose appearance is generally more in keeping with church architecture. Once the right positions had been found, however, excellent quality was obtained together with an almost uniform distribution of intensity throughout the building, in the side chapels as well as at the rear of the Altar, while the echoes and resonances usually so noticeable in such buildings were completely absent.

The positioning of the choir microphone presented another difficulty, inasmuch as the choir was located in a gallery at the west end of the Cathedral and close to the organ. Only one microphone could be used, and eventually a satisfactory position was found by suspending it about two feet out from the gallery, where it

picked up a reasonable balance between choir and organ and was not too subject to the reverberation effects which were very marked in that part of the building. It will be appreciated that with the damping of the Cathedral varying enormously according to whether it was full or empty, practical tests presented some difficulty, and the advice of the Music Committee of the Congress, members of whom were familiar with the building and fully alive to its peculiarities, was a valuable factor in the final selection of the best position.

O'Connell Bridge

The equipment at this point consisted of microphones, mixer and outside broadcast amplifier. Mains power supply was available, but in view of the importance of the ceremonies (final address and Benediction) and of probable traffic control work it was considered advisable to instal a spare O.B. Amplifier and to feed it from batteries. With the exception of the microphones all equipment, telephones and operators were housed in a small compartment in the base of the Altar. The congregation surrounding the Altar and filling all the streets in the immediate neighbourhood were served by the appropriate

street systems, and it is worth noting that during the hymns sung by the choir at this point a case of "choir-interference" arose from one of the street loudspeakers. This possibility had, however, been foreseen, and at a signal the offending loudspeaker was cut out of action. Three microphones were used here, one at the Altar table, for Benediction and prayers, one at the stance for the final address, and one for the choir. The latter was accompanied by a brass band, and one of the interesting technical features here was the balance obtained by the band and choir using only one microphone, placed in the centre of the choir ring and distant about twenty feet from the band.

After the religious ceremonies were finished the final use of the entire system was made from O'Connell Bridge by Chief Marshal O'Duffy, who gave sundry traffic orders and announced changes in the railway time-tables made at the last minute in view of the procession having taken about an hour longer than had been planned. As already mentioned, all the streets were packed—the official estimate is half a million—and the gradual thawing of the crowd in response to the Chief Marshal's instructions and news, undoubtedly prevented what might have been unparalleled traffic disorder involving loss of life. Only those who saw that crowd and the state of the streets for an hour afterwards can appreciate fully the latent danger which was avoided by the use of the Public Address System.

Central Distribution Equipment

This was located at Crown Alley Exchange, and comprised essentially:

- (a) P.B.X. for control purposes.
- (b) Amplifying Equipment consisting of a two-stage M.S. 2985 Grp. 2 Amplifier with current supply from the mains through an M.S. 2984 Grp. 1 Rectifier Unit and M.S. 2121 Grp. 3 Smoothing Unit.
- (c) Two No. 4005 Volume Distribution Panels.
- (d) Spare M.S. 2985 Grp. 2 Amplifier with current supply from batteries.

The incoming lines from the microphone pick-up points at Phoenix Park, Pro-Cathedral and O'Connell Bridge were all jack-terminated on the P.B.X., while the two amplifiers, working and spare, were fitted with plug-ended cords on

their input terminals. The outputs of the amplifiers were wired through change-over switches to the Volume Indicator Panels, the tapping points on which were connected to the outgoing lines through No. 4006 Repeating Coils with the centre points of the line windings of the repeating coils grounded. The transmission level used was zero in all cases with one exception—the line to the Irish Free State broadcasting network; in this case the amplifier arrangements on the broadcast side necessitated a small lower level, of the order of -35 db. As this was a short and quiet line the low level was quite satisfactory, but on some of the other lines the higher level was definitely required owing to tone interference from traction substations. The level adopted overcame this interference and could be handled quite comfortably by the amplifiers at the street stations and at Phoenix Park, while there is no evidence that it gave sufficient cross-talk into the subscriber circuits to cause any nuisance, a point which at first had given rise to some qualms.

The interconnecting lines between the various parts of the system were all run in duplicate in lead-covered cable as part of the city network, the conductor used being approximately 10 lbs. per mile. The maximum length of cable was only about four miles so that equalisers were not considered necessary. Trunk lines to and from the Vatican were not taken through the amplifying equipment but were extended directly from the trunk terminals to Phoenix Park, but all other trunks were fed from a point on the Volume Distribution Panel.

In addition to its official functions, the central distribution point was used as a source of speech for system testing and was equipped with a high quality microphone for this purpose. This facilitated the carrying on of routine tests every morning over the entire system for the purpose of checking all lines and equipment.

Operation Schedule

The official periods of use of the system are given in the Appendix. In addition to the periods therein mentioned, however, the system was largely used for rehearsals, a matter of considerable importance. The necessity for rehearsals with the choirs in order to obtain mixer settings is obvious. Not quite so obvious is the

necessity for rehearsing the clergy who had to address the congregation. The natural tendency is for a preacher to pitch his voice in an endeavour to reach his hearers directly, and by dint of training and practice a very fair range can be attained, so much so that many of those in the enclosure "near" the pulpit would have heard both the direct voice of the preacher and the indirect voice through the loudspeakers with a confusing time lag between the two. It was therefore necessary to give the addressing clergy some instructions as to adapting their voice to the novel conditions, speaking into the microphone in a relatively low tone and relying entirely on the loudspeaker system for reaching their hearers. Other rehearsals were necessary in order to give the staff operating experience in the control of the system; this was particularly the case, for example, with the solo singer, and with the flare of trumpets at the Elevation of the Host. At the other extreme of solemnity came the rehearsal of cavalry who were to take part in the procession, and whose steeds had to be broken in to decorous behaviour when "under fire" from the loudspeakers.

Conclusion

It is difficult to convey an adequate impression of the magnitude of a Public Address Equipment operating as in the present case over virtually an entire city. The outward and visible signs of the installation were confined to the loudspeakers, dwarfed by the open spaces around them, or overshadowed by buildings (see Frontispiece), and scattered over miles of route. By massing together relevant figures it is possible to give some conception of the system as an operating unit, and such figures as are of general interest are given below:

Phoenix Park:

No. of Amplifier Units installed	24
No. of Valves for Amplifiers installed	82
No. of stages in main equipment	11
Power consumption under full working conditions	4.3 K.V.A.
No. of Microphone positions	19
Length of Microphone wiring	2 miles
Max. number of Microphones in use at one time	9
No. of Loudspeakers employed	34
Code No.	No. 555
Type	Moving Coil and Horn

Size of Men's Choir	600
Size of Children's Choir	2,700
Area covered by congregation at final Mass	200 acres (approx.)
Size of congregation (Men's meeting)	250,000
Size of congregation (Women's meeting)	250,000
Size of congregation (Children's meeting)	200,000
Size of congregation (final Mass)	1,000,000

Pro-Cathedral:

No. of Amplifier Units installed	4
No. of Valves	15
No. of Microphones used in Internal System	3
No. of Microphones used in External System	4
No. of Loudspeakers in Cathedral	8

O'Connell Bridge:

No. of Amplifier Units installed	2
No. of Valves	6
No. of Microphones	3

Crown Alley:

No. of Amplifier Units	2
No. of Valves	6
No. of Incoming Programme Lines	4
No. of Outgoing Distribution Lines (active and spare)	28
No. of Control Lines	14

Programmes supplied to: P.A. System

Cork and Athlone Broadcasting Stations, B.B.C. National and S.W. Stations, France, Belgium, Holland, Germany
The Vatican State

Street Systems:

No. of Twin Amplifying Stations	6
No. of Single Amplifying Stations (including Pro-Cathedral)	4
No. of Amplifier Units used	32
No. of Valves used	116
No. of Loudspeakers used	387
Code No.	A.D. 8177
Type	Balanced Armature
Processional routes covered	15 miles
Loudspeaker wiring	50 miles
Congregation at final Benediction (official figure)	500,000

Even these figures, however, do not tell the whole story; for the system overflowed into strange places, not catered for on the official programme—into press rooms, prisons, chapels, hospitals. It must be remembered too that in addition to driving the loudspeakers for the collected congregations, the system was responsible for supplying the pick-up to the broadcasting stations of Ireland and other countries, adding thereby to itself a load of uncounted hundreds of thousands of listeners. That each and every

part of the entire system should operate on all occasions with complete success and entire freedom from breakdown is, to say the least, no mean achievement; it reflects credit on the design of the system and on the material used, and was due above all to one other vital factor: the extremely close collaboration between the staffs of the Irish Post Office and the contractors, Standard Telephones and Cables, Limited. Collaboration is a common word in these days,

but the thing itself is not so common, nor is it easy to get even when it is sought; on this occasion it was given in full measure and running over, and the writer is glad of the opportunity to acknowledge gratefully the very helpful attitude and kindness of the members of the Irish Post Office staff, of all grades, with whom he came in contact in connection with the design, installation and operation of this vast Public Address System.

APPENDIX

Eucharistic Congress Public Address System

Periods of Official Use

DATE AND TIME	SERVICE	DISTRIBUTION
20th June: 10 a. m.—10:30 a. m.	Arrangements for day	Whole system, and Free State Broadcasters
4:30 p. m.— 5:30 p. m.	Reception of Legate at Pro-Cathedral	Whole system, and Free State Broadcasters
21st June: 10 a. m.—10:30 a. m.	Arrangements for day	Whole system, and Free State Broadcasters
22nd June: 10 a. m.—10:30 a. m.	Arrangements for day	
3 p. m.— 5:30 p. m.	Opening of Congress in Pro-Cathedral	Whole system, Free State Broadcasters and B.B.C.
23rd June: 11:30 p. m.— 1:30 a. m.	Midnight Mass at Pro-Cathedral	Cathedral Streets
10 a. m.—10:30 a. m.	Arrangements for day	Whole system, and Free State Broadcasters
11 a. m.— 0:30 p. m.	High Mass at Pro-Cathedral	Pro-Cathedral Streets, Free State Broadcasters
7:30 p. m.—10 p. m.	Men's Meeting, Phoenix Park	Park, two street stations, Free State Broadcasters
24th June: 10 a. m.—10:30 a. m.	Arrangements for day	Whole system, and Free State Broadcasters
11 a. m.— 0:30 p. m.	High Mass at Pro-Cathedral	Cathedral Streets, Free State Broadcasters
7:30 p. m.—10 p. m.	Women's Meeting, Phoenix Park	Park, two street stations, Free State Broadcasters
25th June: 10 a. m.—10:30 a. m.	Arrangements for day	Whole system, and Free State Broadcasters
11:30 a. m.— 1:30 p. m.	High Mass at Phoenix Park (Children's Meeting)	Whole system, and Free State Broadcasters
26th June: 11 a. m.— 1 p. m.	Traffic Control and Marshalling of Congregation	Phoenix Park
1 p. m.— 2:30 p. m.	High Mass at Phoenix Park	Whole system, Free State Broadcasters, B.B.C. and Continental Broadcasting
3 p. m.— 6:30 p. m.	Processional Service at Phoenix Park	Whole system
6:30 p. m.— 7 p. m.	Benediction at O'Connell Bridge, closing of Congress	Whole system, and Free State Broadcasters
7 p. m.— 7:15 p. m.	Traffic Control	From O'Connell Bridge to whole system

Electron Conduction in Thermionic Valves

By W. E. BENHAM

(1) The present paper is concerned with the physical nature of the medium constituted by the cloud of electrons passing between cathode and anode of a Thermionic Valve. Attention is directed primarily to the simple case of a high vacuum two electrode valve of plane geometry.

(2) In the theory of conduction in solids, liquids, and gases, it is of paramount importance to derive the conductivity and the dielectric constant or specific inductive capacity of the conducting medium. In solids, the carriers of electricity are believed to be "free" electrons. There are, however, electrons which do not play any part in conduction. These electrons are those which are capable only of restricted motion, being more or less "bound" to the parent atoms of the molecules. The "free" and "bound" electrons correspond to the mechanisms of conduction and of inductive capacity, respectively.

When we come to the case of conduction by a cloud of electrons, each electron being far outside the sphere of influence of atoms of any kind, there is nothing to correspond with the "bound" electrons, and at first sight it would appear that the dielectric constant of the electron cloud must be unity. This, however, is found to be true only as an approximation in the case of highly attenuated clouds.

In the case of electron clouds commonly obtained in practice, the electrons—all of which are conduction electrons—are sufficiently numerous to endow the electron cloud with a dielectric constant different from unity.¹ This state of affairs is brought about rather by distortion of the electric field due to the electronic charges than by any property analogous to inductive capacity, such as is possessed, for example, by ionised gases, in which the conduction electrons are to some extent "bound" to the relatively

inert gaseous ions. An analogy to the case of "bound" electrons which at first sight may appear far-fetched may be traced by considering the electrons of an electron atmosphere as "bound" to one another in a negative sense; the mutual repulsions of the electrons certainly constitute a factor of vital importance. It is probably a matter of the point of view taken, but the distortion of field in the case under consideration is brought about entirely by the presence of electrons in sufficient quantities for mutual repulsion to be effective. In the case where the electron atmosphere is imprisoned not between parallel planes but between spheres or cylinders, the field is non-uniform apart from the distortion arising from the electrons. Even in this more complicated case, however, there is nothing to suggest that the dielectric property may not be attributed to mutual repulsions occurring under different conditions of field distribution.

(3) In a recent paper² the dielectric constant and conductance of an electron atmosphere between the parallel electrodes of a Langmuir diode³ were evaluated as functions of pT , where p is the angular frequency of a small impressed alternating e.m.f. and T is the mean transit time of the electrons between the electrodes.

Figure 1 shows that the dielectric constant ϵ has a value less than unity for frequencies lying between 0 and $\frac{9}{2\pi T}$. Taking 10^{-9} seconds as a typical value for T , we see at once that the frequency range for which $\epsilon < 1$ embraces nearly all the frequencies so far obtained using thermionic valves (an angular frequency of nearly 10^{10} may be obtained under favourable conditions). Figure 1 may also be read as the value of ϵ for different values of T , p being held constant.

¹ This does not alter the fact that the ether between the electrons is of dielectric constant unity, so that the value of the "electric intensity," except in the minute proportion of volume occupied by actual electrons, is also the value of the dielectric displacement.

² W. E. Benham, "Theory of the Internal Action of Thermionic Systems,"—Part II, *Phil. Mag.*, February (Suppl.), 1931, p. 457.

³ Irving Langmuir, *Phys. Rev.*, 2, 1913, p. 450.

Read in this way it will be seen that as pT increases from zero up to about 1 or 2, the value of ϵ remains sensibly constant at the value 0.6, which means that in this case the value of ϵ is constant over the space included between the cathode ($T=0$) to the anode ($T=T_d$). This surprising result that (for a range of frequencies of practical interest) the dielectric constant of all points in the interelectrode space is $\frac{3}{5}$ must constitute the first known case of a "dielectric" which is distinctly non-homogeneous in constitution and yet homogeneous in respect of dielectric constant. Although on the above considerations ϵ is constant, the displacement current nevertheless varies from point to point. The space variation of displacement current and of potential combine to effect complete neutralisation of the space variation of dielectric constant in a Langmuir diode.

Experiments were carried out by the author² to verify that $\epsilon < 1$ in the case of a Langmuir diode. Independent experimental evidence of a confirmatory nature is to be found in a paper by Bergmann & During.⁴

(4) Figure 2 shows the relative change in conductance for values of pT between 0 and 22. Figure 2 also represents the conductivity c of the atmosphere of electrons at values of pT between 0 and 22. Just as in the case of the dielectric constant, Figure 2 may be read as the variation of conductivity over the space. It is seen that the conductivity for exceedingly high frequencies is alternately positive and negative at a number of regions between the plates. If the anode plate lies in any one of these regions, the diode as a whole exhibits negative conductance. Regarded another way, for any given anode voltage (fixing T_d), there are ranges of frequency for which the diode exhibits negative conductance. Mathematically, the number of such frequency ranges is infinite. Experimental difficulties are likely to limit the number obtainable in practice. Potapenko, in a recent publication⁵ of his investigations in the field of the ultra short electro-magnetic waves obtained in a single valve five types of waves the frequencies

of which stood in the ratios indicated by $\lambda b/\lambda$ in Table 1. The wave of lowest frequency is called "normal" by Potapenko, who calls the higher frequency waves the dwarf waves of the 1st, 2nd, . . . order. The fair constancy of the last column shows that Potapenko's waves have frequencies whose relation to one another is not very different from the ratios determined by taking the minima of Figure 2. (The minima beyond the range of Figure 2 occur very nearly at intervals of 2π —rough estimates therefore give pT 26.6 and pT 32.9.) It does not always follow that the frequencies observed coincide exactly with the minima of conductance (i.e., the maxima of negative conductance) owing to frequency variation of the conductance of the circuit associated with the valve. In Table 1, λb is the wave length calculated from Barkhausen's formula; by taking the ratio $\frac{\lambda b}{\lambda}$ the variable factor of grid voltage is effectively eliminated.

TABLE I.

Potapenko's Waves			Minima of Fig. 2	Exp./Theor.
Type of Wave	Range of λ (cms)	$\frac{\lambda b}{\lambda}$ (average)	pT	$\frac{1}{pT} \cdot \frac{\lambda b}{\lambda}$
Normal	74 — 54.2	1.145	7.6	1.505
1st Dwarf	43.7 — 35.6	1.965	13.85	1.420
2nd "	20.7 — 12.65	2.996	20.3	1.475
3rd "	18.8 — 12.55	3.975	(26.5)	1.495
4th "	12.4 — 9.4	5.035	(32.9)	1.532
				Mean 1.485

It will be seen that some of the wave ranges overlap. In general, it was necessary to use

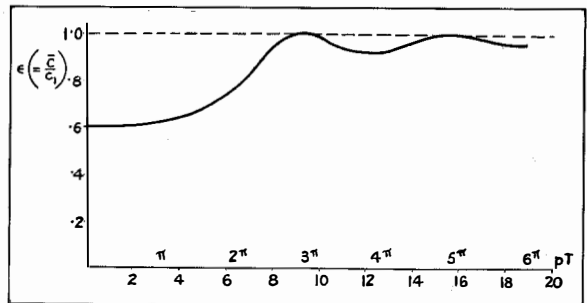

Figure 1

⁴ Ann. d. Phys. 5, i, 8, p. 1041, 1929.

⁵ Potapenko, Normal and Dwarf Waves, Phys. Rev., 39, 2, February 15, 1932, p. 638.

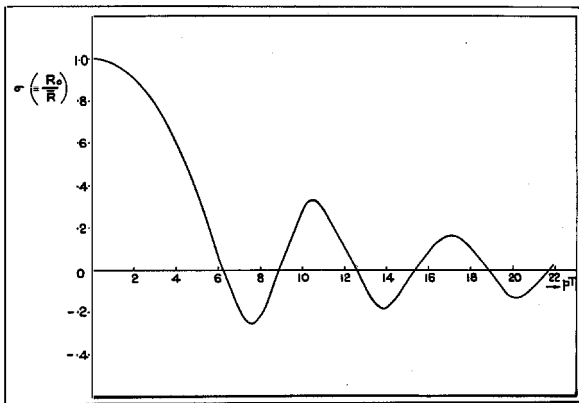

Figure 2

higher grid voltages to obtain the shorter waves, but the possible ranges of grid voltages overlap

in many cases. The mean value of 1.485 differs by 4.5% from the value of 1.420 for the 1st order dwarf wave, the discrepancy being 3% for the 4th order dwarf wave, 1.3% for the normal wave and less than 1% for the other two dwarf waves. In no case would Potapenko's waves lie outside the regions of negative conductance predicted by the theory which thus provides the clue to the mechanism of ultra-short waves. A significant feature of the theory, in contrast to previous conceptions, is that the generation of oscillations in an external circuit can take place with amplitudes of electron motion so small that if the motion in transit of the electrons under the influence of steady potentials could be followed with the eye, the super-imposed oscillatory motion would escape notice altogether.

A New Criterion of Circuit Performance

By JOHN COLLARD, Ph.D.

Introduction

SINCE the final aim of a telephone circuit is to take speech from one subscriber and transmit it in reasonably undistorted form to another, the success with which it does this is its justification for existence. It is curious, therefore, that while satisfactory quantities have been developed for the measurement of particular characteristics of a telephone circuit such as its attenuation, impedance or crosstalk, no really suitable quantity has yet been devised for expressing the overall capabilities of a telephone circuit for transmitting speech. That the need for such a quantity is fully realised is shown by the number of possible units which have been suggested in the past. None of these, however, can be considered as really satisfactory and the object of this present paper is to discuss the existing quantities and to put forward a proposal for an entirely new unit which seems to have certain advantages as a criterion of circuit performance.

Articulation

Probably the first method for rating the performance of a telephone circuit was to measure its articulation. Syllables formed at random out of the various speech sounds are called over the circuit and the percentage number of such syllables correctly received by the listener is defined as the Syllable Articulation of the circuit. In some instances the percentage number of individual speech sounds correctly received is determined and the result is called the Sound Articulation.

Various techniques for the determination of articulation have been developed and it is now possible to measure the articulation of a circuit with considerable accuracy. Articulation, however, has been criticised for being too artificial in character. The subscriber, as a rule, is not interested in transmitting random syllables or individual speech sounds, and it has been felt

that articulation is consequently not a satisfactory criterion of performance. This feeling is reinforced by the fact that quite a large change in the performance of the circuit may correspond to only a relatively small change in articulation.

An additional objection to the articulation measurement was that the value obtained on a given circuit depended not only on the characteristics of the circuit but also on the degree of training of the articulation crew and on the particular technique adopted for the test. Methods of eliminating the training effect have been developed, and by defining a particular technique the *Comite Consultatif Internationale* have endeavoured to standardise results. In spite of this, however, there always remains some doubt as to whether results obtained by different experimenters are directly comparable.

Intelligibility

To overcome the criticism of artificiality the intelligibility test has been used to a limited extent. This is similar to the articulation test except that complete sentences are used instead of random syllables. As might be expected the intelligibility test is more difficult to carry out accurately and is much more laborious than the articulation test. In addition, it suffers much more severely from the smallness of the change in value produced by a large variation in circuit performance. For instance, the intelligibility of a conversation taking place directly through the air between two people only a foot or so apart and in a quiet place is in the order of 99%. The intelligibility of an ordinary commercial telephone circuit may be as high as 92%. From the point of view of intelligibility, therefore, there is very little difference between these two cases. Yet anyone who compares the quality of speech in the two cases cannot fail to be struck by the fact that the difference of 7% in intelligibility is totally inadequate to express what he instinctively feels is an extremely large difference in the grade of transmission.

Repetition Rate

Recently this feeling of dissatisfaction with articulation and intelligibility results has led to an attempt to measure circuit performance under conditions of actual service. For this purpose use is made of a quantity called the repetition rate. This is determined by listening to a conversation between two subscribers and noting how often in a time of 100 seconds either subscriber asks the other to repeat a word or phrase. Since the number of repetitions depends, among other things, on the quality of the transmission, it is clear that the repetition rate will vary in some way with change of circuit performance. The disadvantage of repetition rate seems to be, however, that it depends so arbitrarily on such factors as the speed at which the subscriber talks and the time he takes to consider his reply. It is, therefore, necessary to take a very large number of observations before any reliance can be placed on the results. Furthermore, it would appear that the value of the repetition rate obtained for a given circuit would vary considerably depending on the country in which it was obtained.

Effective Transmission Rating

Some of the disadvantages of the repetition rate can be avoided by using it merely as an equality test to determine the effective rating of different commercial circuits in terms of a representative standard circuit of variable attenuation. By determining the repetition rate for the standard circuit with various amounts of attenuation and then the repetition rate for any given circuit, it is possible to determine the amount of attenuation required in the standard circuit to make it equivalent, from the point of view of the repetition rate, to the given circuit. It is clear, therefore, that what is to be taken as the criterion of circuit performance is not the variation of the repetition rate but the variation of the attenuation of the standard circuit. Effective transmission rating suffers, unfortunately, from being in terms of an arbitrary reference circuit. It is true that this standard circuit can be made typical of those encountered in service, but however suitable it may be at the present time, there will in the future undoubtedly be changes in circuit characteristics which will

cause ratings in terms of the standard circuit to lose their significance. Exactly the same cycle of affairs happened in connection with the transmission unit. At first, all values of attenuation were rated in terms of the mile of standard cable and, at the time, this was extremely convenient. As the characteristics of telephone circuits changed, however, the mile of standard cable ceased to have any very real significance and, in spite of attempts to retain it in service, it was finally dropped in favour of a much more fundamental unit, the bel or the néper. Furthermore, a reference circuit which is typical of commercial circuits in one country may not necessarily be typical of those in another. A complication must, therefore, be introduced by the use of different reference circuits in different countries.

Desirable Characteristics

Having discussed the disadvantages of the various quantities at present in existence as criteria of circuit performance, we are in a position to draw up a list of characteristics for a satisfactory unit.

In the first place it would seem desirable that the unit should be fundamental in origin so that it can be defined without reference to some particular standard circuit. If this can be done then the inevitable future changes in circuit design will leave the unit unaffected. Furthermore, if the new unit is independent of a particular circuit of reference, it can be used to rate the standard of performance of different types of circuit such, for example, as ordinary commercial telephone circuits and high grade broadcast circuits. It would obviously be a disadvantage to have to rate different types of circuits in different units, and to rate a high quality circuit in terms of an ordinary commercial circuit of reference, is clearly impracticable. We may, therefore, take as our first requirement that the unit should be fundamental in origin and independent of circuits of reference.

A further point of importance is that the unit should be as independent as possible of testing technique. This is particularly important in the case of a unit of this nature inasmuch as it must be connected intimately with speech yet must be capable of measurement in any country of the world.

Finally, it is extremely desirable that the new unit should be so chosen that its magnitude is really a measure of circuit performance as judged by a user. In other words, if the user considers circuit A to be very much worse than circuit B but slightly better than circuit C and just the same as circuit D, then the new unit must be such that the rating of circuit A in terms of the unit should be very much smaller than that for circuit B, slightly bigger than that for circuit C and equal to that for circuit D. The user will then feel that circuit performances rated in the new unit do agree with his own instinctive reaction to the circuits.

The New Unit

We have to consider the development of a logical and fundamental scale for the rating of the performance of telephone circuits and it seems reasonable, therefore, to choose as the limits of our scale, on the one hand, perfect performance and, on the other, zero performance. If we can then divide the range between these limits into a number of equal parts our scale will be complete.

Let us first of all consider in more detail the limits of the scale. The spoken language consists of a number of different sounds which in the course of time have become so modified that, under normal conversational conditions, they enable satisfactory intelligence to be interchanged. In this process of modification the organs of speech and hearing have been so adjusted that the optimum performance is obtained under normal conversational conditions. For instance, any increase in speaking level above the normal tends to overload the ear and so to degrade the performance, and any decrease in speaking level causes some of the speech components to reach the listener below his threshold and so again to degrade the performance. Let us, therefore, define as the upper limit of our scale the performance obtained between two people talking at ordinary conversation level when placed a few feet apart in a quiet room free from resonance and reflection effects. Under these conditions small changes in talking level do not appreciably affect the performance, so that it is unnecessary to be more precise in the specification. It is usually more

convenient, however, to specify this performance in terms of a telephone circuit. We shall, therefore, take as an alternative definition the performance provided by a telephone circuit which transmits all frequencies in the audible range without distortion, is free from asymmetric distortion and noise, and produces a speech level at the listener's ear of about 70 db. above threshold. Zero performance is obviously obtained by preventing all speech components from reaching the listener at a level above his threshold.

Having selected the limits of our scale we have now to divide it up into a number of equal parts and it is here that we encounter a difficulty. Since we have no inherent faculty for accurately assessing the standard of performance of a circuit, how are we to determine whether a given circuit has a standard of, say, one-tenth that of the perfect circuit? In this connection we can gain some assistance by considering a somewhat similar problem. Suppose that we had to establish a scale of weights, how could we set about it? Clearly, we could select an initial weight as a unit and subdivide it into a number of equal parts. The fact that we have no inherent faculty for assessing relative weights would not prevent us from doing this since we could make use of a test of equality. In the case of the weights this test of equality would consist of some simple balance which would enable us to say when any two weights were equal. By trial and error we could, by the use of this test of equality, construct ten weights such that each weight was equal to each of the other nine weights and such that all together were equal to the initial weight. We should then know that each of the smaller weights was equal to one-tenth the initial weight.

In dividing up our scale of standard of performance it is clear, therefore, that what we require is a test of equality which will tell us when two circuits have the same standard of performance. Since this point is of considerable importance in drawing up our scale it is worthy of detailed consideration. We could, of course, take the articulation measurement as our test of equality and say that two circuits have the same standard of performance when they give the same value of articulation. The articulation test has

been criticised as unnatural, however, so it might be thought more desirable to take the intelligibility as the test of equality. If we did this we should say that two circuits had the same standard of performance if they gave equal values of intelligibility. But the intelligibility test has also been called artificial, since it is not carried out under actual service conditions. We can, therefore, fall back on the repetition rate and take this as our test of equality. Even the repetition rate, however, has been criticised and it has been suggested that this rate is not necessarily completely representative of the subscriber's reaction to the standard of performance. In other words, it has been suggested that, on a very bad circuit, for example, the subscriber may succeed in obtaining a reasonably low value of repetition rate, but only by the expenditure of considerable effort and it is this amount of effort which influences his reaction.

There thus appears to be some doubt as to which, if any, of these quantities is a suitable criterion of circuit performance. On the other hand, the author has shown that perfectly definite formulae can be developed to express the relation between sound, syllable and word articulation and intelligibility, and these theoretical formulae have been shown to agree with experimental results.

Since the repetition rate has been used as a criterion of circuit performance it is of interest to see whether this quantity too can be expressed in terms of the others. If we call R the repetition rate for a circuit whose intelligibility is I , the relation between R and I can be obtained as follows: Suppose that during a conversation M sentences pass between two subscribers with an average time per sentence of t seconds. Then

of these M sentences $\left(1 - \frac{I}{100}\right)M$ will not be

understood, and will provoke a request for repetition. Hence in the time Mt there will be

$\left(1 - \frac{I}{100}\right)M$ repetitions so that $R = \frac{100 - I}{t}$.

Very few experimental values of repetition rate are at present available but such as are have been used to check this expression and appear to be in reasonable agreement with it.

If, therefore, as seems probable, there is a definite relation between all these quantities it is immaterial which we take as our test of equality. There still remains, of course, the doubt as to whether these quantities really represent the subscriber's reaction, but, since it appears so difficult to obtain any very precise information as to what his reaction really is, it is reasonable to neglect this effect and to take as our test of equality one of the above-mentioned quantities.

Since it is immaterial which of these quantities we choose and since sound articulation is the most fundamental and easily measured quantity, we will take it as our test of equality. Two circuits will, therefore, be said to have equal standards of performance if they give equal values of sound articulation.

Having chosen our test of equality, we have now to use it to divide up our scale of performance. Let us take a high quality circuit which complies with the definition of perfect transmission and suppose we add to it a filter having zero attenuation in the range from 0 to 500 cycles and infinite attenuation everywhere else. We shall find that this circuit has an articulation of about 40%. Let us next change the filter so that it passes only frequencies in the range 500 to 750 cycles. The articulation will again be about 40% and by suitably adjusting the frequency range of the filter we can arrange so that the articulation of the two circuits is exactly the same. By repeating this process we can eventually obtain ten circuits such that each alone gives exactly the same articulation and which altogether constitute the original high quality circuit. Then, since from our equality test each of the ten circuits alone has the same standard of performance while all together have the standard of performance of the high quality circuit, it follows that the standard of performance of each of the ten circuits is one-tenth that of the high quality circuit. By repeating this process we can, theoretically at any rate, again divide each of the circuits into 10 smaller circuits of equal performance. We should then have 100 circuits each having a standard of performance one-hundredth the standard of the high quality circuit. Let us take the standard of performance of one of these hundred circuits

as our unit which we call the "unit." Then each of the original ten circuits will have a standard of performance of 10 units while the high quality circuit will have a standard of performance of 100 units.

Practical Application

Having built up a scale for the measurement of the standard of circuit performance, we now have to determine how to make use of this scale in practice. In other words, given a certain telephone circuit, how do we evaluate its standard of performance in the new scale of units? Obviously, the logical method of applying the definition of the unit would be to set up a circuit in accordance with the definition of perfect transmission and then to carry out the process of determining ten band pass filters, each alone giving the same articulation and all together giving perfect transmission. By putting together various numbers of these band pass filters it would be possible to obtain circuits having standards of performance of 10, 20, 30 100 units. Then the articulation could be measured on these different circuits and thus a curve showing the relation between articulation and the corresponding number of units could be obtained. The next step would be to measure the articulation of the given circuit and thence by reference to the curve the corresponding performance in units could be obtained.

It should be clearly noted that the articulation test is here used again merely as a test of equality. Hence, although the relation between articulation and the performance in units will depend essentially on the technique adopted, the use of the same technique on the given circuit eliminates the effect of the technique. The final value of the performance of the circuit in units is thus entirely independent of the particular technique adopted in determining it. This constitutes one of the most valuable properties of the new scale.

In the following table a series of values will be found giving the relation between articulation as measured according to the technique of the C.C.I. and the standard of performance in units. To allow for the effect of crew training, values are given for different values of the crew factor. The method of measuring this crew factor has

been described¹ by the author and is also given in the red book of the C.C.I., 1931.

Sound Articulation	STANDARD OF PERFORMANCE (UNITS)					
	Z = 1.0	Z = .95	Z = .90	Z = .85	Z = .80	Z = .75
100	100.0	—	—	—	—	—
98	87.0	91.5	96.6	—	—	—
96	77.0	81.0	85.5	90.5	96.2	—
94	67.4	71.0	74.9	79.3	84.2	89.9
92	60.6	63.9	67.4	71.2	75.8	80.9
90	54.5	57.4	59.5	64.1	68.1	72.7
88	50.2	52.8	55.8	59.0	62.7	67.0
86	45.2	47.6	50.2	53.2	56.5	60.2
84	41.0	43.1	45.5	48.2	51.2	54.6
82	37.7	39.7	41.9	44.4	47.1	50.3
80	34.8	36.6	38.7	41.0	43.5	46.5
78	32.2	33.9	35.8	37.9	40.2	43.0
76	30.0	31.6	33.4	35.3	37.5	40.0
74	28.0	29.4	31.1	32.9	35.0	37.3
72	26.0	27.4	28.9	30.6	32.5	34.7
70	24.3	25.6	27.0	28.6	30.4	32.4
68	22.7	23.9	25.2	26.7	28.4	30.3
66	21.2	22.3	23.6	25.0	26.5	28.3
64	19.8	20.8	22.0	23.3	24.7	26.4
62	18.6	19.6	20.7	21.9	23.2	24.8
60	17.4	18.3	19.3	20.4	21.7	23.2
58	16.2	17.1	18.0	19.1	20.3	21.6
56	15.0	15.8	16.7	17.7	18.7	20.0
54	14.0	14.7	15.6	16.5	17.5	18.7
52	13.2	13.9	14.7	15.5	16.5	17.6

If the articulation of the given circuit is measured using the C.C.I. technique, then the corresponding value of the standard of performance in units can be obtained directly from the above tables or from curves plotted from them. Similar curves could, of course, be constructed for any other technique but will be unnecessary if the C.C.I. technique is adopted universally.

Before concluding this section it is of interest to note a peculiar property of this new scale of circuit performance. In connection with the calculation of the articulation of telephone circuits and the method of calibrating articulation crews referred to above, the author had occasion to introduce a new quantity called the "band" articulation. An examination of the frequency spectra of various speech sounds shows that while for each sound components occur over a large part of the audible range, they only rise to any prominence in one or two relatively narrow bands. These prominent bands occur

¹"The Accurate Measurement of Articulation," *Post Office Electrical Engineers' Journal*, Vol. 23, p. 25, April, 1930.

at different frequencies for the different speech sounds and, since it is by noting subconsciously at what frequency they occur that a listener is able to distinguish one sound from another, they have been called the characteristic bands of speech. Since the listener relies on detecting the frequency of the bands for recognition of the speech sounds, it is clear that anything which tends to distort the bands will necessarily increase the difficulty of recognising the sounds. There is thus a definite relation between the average probability that the listener will receive a characteristic band correctly (band articulation) and the average probability that he will recognise a sound correctly (sound articulation), and the author has been able to calculate this relation. If we take a high quality circuit in which all frequencies are transmitted without distortion and add to it a filter which suppresses all frequencies above 1,000 cycles, then only those characteristic bands whose frequencies lie between 0 and 1,000 cycles will be transmitted. If there are 50 bands altogether and 15 of them lie between 0 and 1,000 cycles, then the average ideal band articulation² will be 30%. Now if we change the filter so that it passes only those frequencies from 1,000 to 1,500 cycles, then if we assume that 10 of the characteristic bands have frequencies from 1,000 to 1,500 the average ideal band articulation for this second case will be 20%. Now suppose that we combine these two filters so that all frequencies from 0 to 1,500 cycles are passed. Clearly in this case the 15 bands from 0 to 1,000 cycles and the 10 from 1,000 to 1,500 cycles will reach the listener so that he will now receive 25 out of the total 50 bands. The ideal band articulation will therefore be 50%. A property of band articulation is, therefore, that if we combine in a circuit two or more frequency regions the band articulation of the resulting circuit is equal to the sum of the band articulations for the individual frequency regions. Furthermore, since the high quality circuit passes all the characteristic bands without distortion, it follows that the ideal band articulation for the high quality circuit is 100%. Finally, since there is a definite relation between band articulation and sound articulation, cir-

cuits which have the same sound articulation necessarily have the same band articulation.

But these three characteristics of ideal band articulation, i.e.,

- (a) Value of 100 for high quality circuit.
- (b) Equal value for circuits having same sound articulation.
- (c) Additive effect for different frequency regions.

are also characteristics of the new scale of units. It is clear, therefore, that numerically the standard of performance of a circuit in units is equal to the ideal band articulation of the circuit. This equality is a valuable property of the new scale since a complete technique for the evaluation of band articulation has been developed. In fact the author's method of eliminating crew factor from articulation results, provisionally adopted by the C.C.I., includes as one step the determination of the ideal band articulation for the given circuit. The standard of performance in the new scale of units is, therefore, automatically obtained when the C.C.I. calibration method is adopted.

Discussion

The new unit of circuit performance—the unit—has the great advantage of being fundamental in character, since it is obtained by taking the interval between no performance and perfect performance and dividing it into 100 equal parts. This fundamental conception and ease of definition frees the new unit from the necessity of coupling it with some complicated and arbitrary circuit of reference, and thus makes it of universal application. For instance, for the transmission of broadcast programmes it is necessary to use a much wider frequency range than usual. Circuits of this type can be rated in terms of units just as well as ordinary telephone circuits. On the other hand, if we choose to rate circuits in terms of an arbitrary circuit of reference which is chosen so as to approximate to an ordinary telephone circuit, it is meaningless to attempt to rate high grade broadcasting circuits in terms of such a reference circuit.

Furthermore, the scale of units need not be confined to telephone circuits; it can equally well be used to rate the performance of, say, a gramophone or other sound reproducing device.

²The ideal band articulation is that obtained after eliminating the crew factor.

A further advantage possessed by the new unit in virtue of its freedom from a circuit of reference is that ratings in terms of it still hold good if the trend of modern development should lead, as it undoubtedly will, to considerable modifications in the type of commercial telephone circuit employed.

Any system of rating employing a circuit of reference which approximates to the present day type of commercial circuit will inevitably be handicapped when modifications in telephone circuits occur, since it will be necessary either to go on rating circuits in terms of the then obsolete and meaningless reference circuit, or to re-evaluate all effective transmission ratings in terms of some more up-to-date reference circuit.

Another advantage of the new unit is that it gives a much better indication of the real quality of performance of a circuit. Suppose, for instance, that a subscriber is told that the circuit he is using has an effective transmission rating of 30 db. in terms of some circuit of reference. He will probably be quite unable to form any mental picture of the grade of transmission he is getting. If, on the other hand, he is told that the rating is 45 units, the nature of the new scale is so simple that he knows at once that this represents a grade of transmission which is only 45% of what it might be with a perfect circuit.

Another advantage of the new scale is that it gives values of circuit performance which are independent of the particular technique used in obtaining them and, hence, as a corollary, enables a simple test such as articulation to be used. In a unit which must necessarily be closely connected with speech but which, owing to its international use, must be determinable by many different nationalities, this independence of technique is an important asset.

Since one of the disadvantages of quantities such as articulation and intelligibility as direct criteria of circuit performance is the very small change in value brought about by a relatively large change in performance, it is of interest to study the corresponding variations of values in the new unit. The following table gives a general idea of the quality of transmission corresponding to various standards of performance in the new scale.

Standard of Performance (unit)	Quality of Transmission
100—95	Excellent
95—70	Very good
70—50	Good
50—30	Fair
30—15	Bad
15—0	Very bad

The ordinary commercial telephone circuit of today has a standard of performance varying from 30 to 50 units, while for conversations taking place through the air under ordinary conditions the value is between 80 and 100 units. The top value of 100 units, however, is only reached under quiet conditions.

To illustrate the change in standard with variation in circuit constants, Figs. 1 and 2 have been prepared. Fig. 1 shows the variation of both intelligibility and standard of performance with attenuation in the case of a high quality circuit, and Fig. 2 shows similar curves for an ordinary commercial telephone circuit. Fig. 3 is similar to Fig. 2 except that the variable quantity is line noise instead of attenuation. In each case the variation in intelligibility for practical values of the variable is very small. The corresponding variation in the standard of performance is much greater; in fact, over most of the range the variation of the standard of performance is practically linear. A scale having a linear variation of this nature obviously gives the greatest possible variation over the whole range.

Since the variation between standard of performance and attenuation is practically linear, as shown by Fig. 2, it follows that the relation between the standard of performance in units and effective transmission ratings will also be substantially linear. This point is of interest since it indicates that it would be a very simple matter to transform effective transmission ratings into the equivalent standard of performance in the new scale.

One of the advantages claimed for effective transmission ratings is that they are to a great extent directly additive. For instance, if we have a circuit with an attenuation of say 15 db. but which passes a wider frequency range than the reference circuit, then we can subtract so

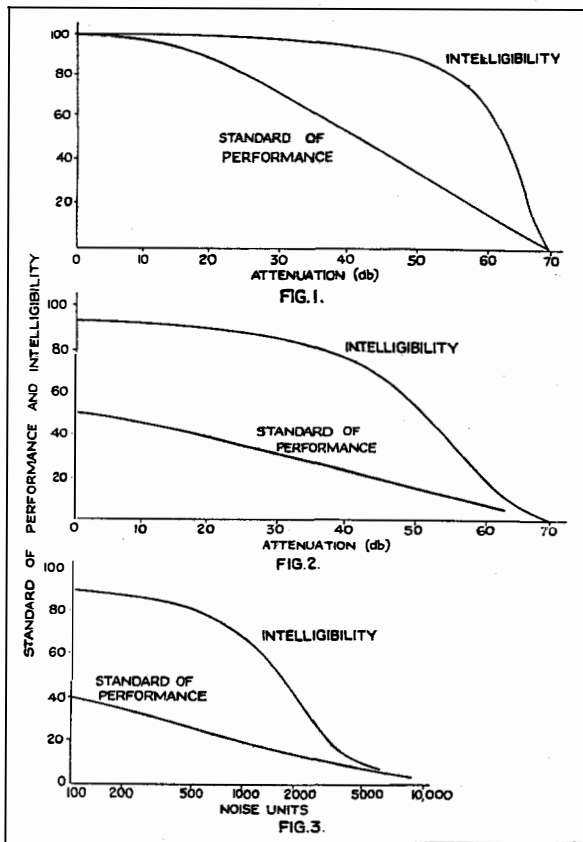

many db. from the 15 to allow for the extra frequency range. Suppose the allowance were 3 db. and suppose that the effective allowance for noise were 5 db.; then, if the allowances are directly additive we could say the effective transmission rating of the circuit was $15 - 3 + 5 = 17$ db. Since this property of direct addition is a valuable one it is of interest to show that the new scale of units also has it in the same degree as effective transmission ratings.

Take, first of all, the case of an extension in the frequency range transmitted. We know from the method of building up the new scale, that standards of performance for different frequency regions are directly additive. If, therefore, we have a circuit passing up to a frequency of, say, 3,000 cycles whose standard is 40 units, and we extend the range from 3,000 to 3,500 cycles then, if the standard of performance of the range from 3,000 to 3,500 is, say, 5,

we know that the standard of the extended circuit will be $40 + 5 = 45$ units.

In the case of attenuation, since the relation between the standard of performance and attenuation is approximately linear, we know that an increase of 5 db. will always reduce the standard by, say, 10 units, whether it is added to an initial attenuation of 5 or 30 db.

Since the relation between the standard of performance and noise is also approximately linear, provided the noise is measured in logarithmic units, we know that if a noise of N units reduces the standard by 10 units, $2N$ will reduce it by 20 units, $4N$ by 40 units and so on.

We see, therefore, that values of standard of performance in the new scale are directly additive and, indeed, we might have inferred this directly from the approximately linear relation between standard of performance and effective transmission ratings.

To illustrate the way in which the effect of different factors such as line noise, attenuation and cut-off frequency can be allowed for when using the new scale of units, the following example is given:

Suppose that a certain circuit gives a performance of 50 units and that it is desired to ascertain the performance obtainable when 100 units of noise are present in the circuit, when the attenuation is increased by 5 db. and when the cut-off is raised by 200 cycles per second. Then if the effect of 100 noise units reduces the performance by 5 units in the new scale, if the increase of attenuation of 5 db. reduces it by 7 units and if the raising of the cut-off frequency increases it by 10 units, then the resultant performance of the circuit will be $50 - 5 - 7 + 10 = 48$ units. These values are given merely to illustrate the simplicity of the method with the new scale of circuit performance; the actual allowances for different factors have to be determined, of course, for the range of such factors occurring in practice.

From what has been said it can be concluded that the new scale for rating circuit performance, while combining the advantages of previous methods, avoids to a large extent their disadvantages.

The latest devel in controlled single- **Rotary Switch**

Originally designed for telephone service in rural areas, the 7-D Rotary System has been developed to provide inter-connection between subscribers in different areas. This represents an important advance in the communication art in that automatic service by means of a single system is now available for local, for inter-area and even for nation-wide service.

Salient features of the 7-D Rotary System are:

A new 100-point gear-driven finder and improved circuits.

Floor space requirements reduced to a minimum.

Improved equipment layouts.

Fault signalling to the nearest regularly attended exchange, permitting exchanges of considerable size (even up to 700 lines) to remain unattended.

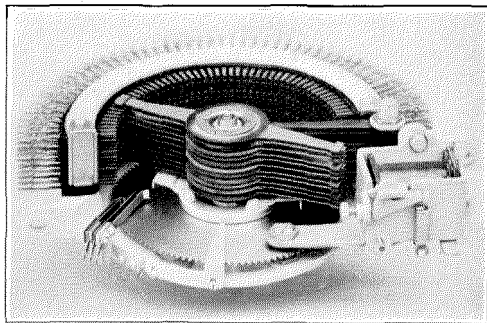

Improved Line Finder

The system is highly efficient in operation; economical in current consumption; easy and inexpensive to maintain.

In little more than three years, 7-D Rotary equipment is operating successfully in or on order for 286 exchanges, ranging from 10 to 3,000 lines, in eleven different countries.

Descriptive matter may be obtained from:

BELL TELEPHONE MANUFACTURING COMPANY

4 Rue Boudewyns, Antwerp, Belgium

or from any of the Companies listed on the inside rear cover

Development Automation Systems

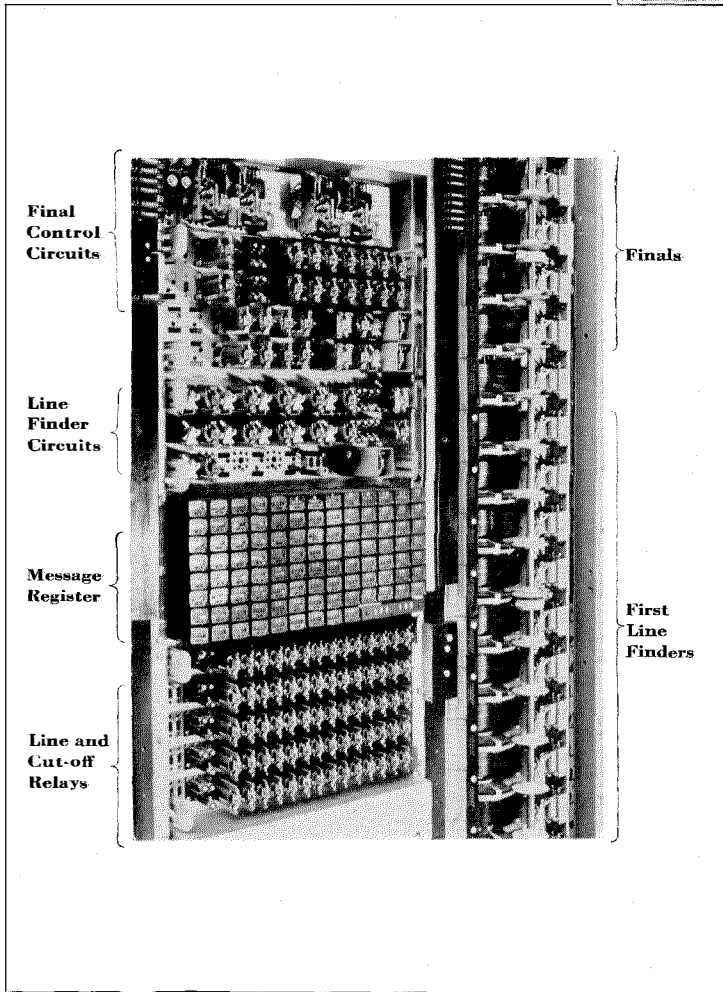
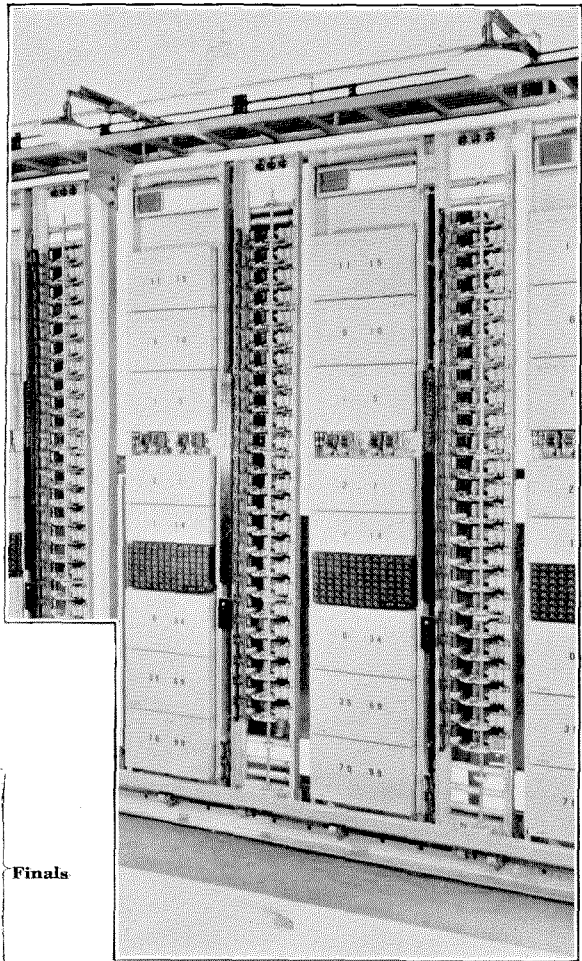

First Line Finders and Final Bays with Corresponding Relay and Other Apparatus Bays.

Close-up View of Line Finders, Finals, Line Circuit Equipment Including Line and Cut-off Relays and Message Registers, also Line Finder and Final Control Circuits.



*The Empire
Broadcaster
at Daventry*

After Rugby— **DAVENTRY**

Four STANDARD short-wave transmitters have been in use for some time past in the British Post Office Radio Station at Rugby. Now the latest of all short-wave stations, the British Empire Broadcaster at Daventry, has also been equipped with STANDARD apparatus, specially designed, manufactured, and installed, for the British Broadcasting Corporation.

Thus two of the most important short-wave stations in the world have been equipped with—

Standard Radio

Standard

CONDENSER CONES FOR SUPER-TENSION CABLES

This new Condenser Cone, which is based on the capacity grading theory, represents a definite advance over any cable termination equipment designed for voltages of 33kV and upwards.

APPLICATIONS

Condenser Cones may be used with advantage on High voltage cable tests up to 220 kV single phase.

*High voltage routine
High voltage endurance
High voltage breakdown
Power factor voltage*

Cable systems up to 132 kV three phase.

*Sealing Bells terminating
cable routes
Barrier Pressure Joints
Generally where insulated
conductors are jointed or
terminated.*

Write for illustrated booklet number 607/EC

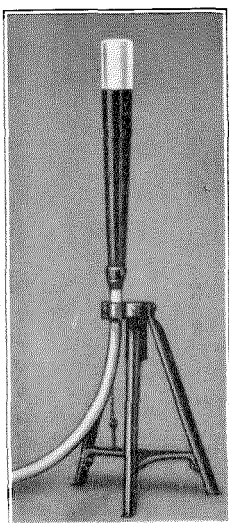

*Condenser Cone
Mounted on Testing
Stand.*

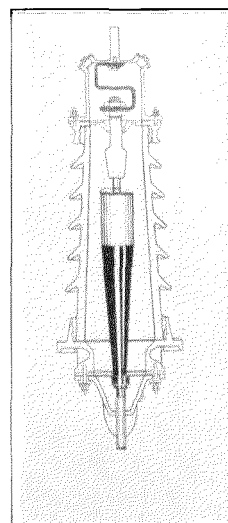

*Condenser Cone
within a Super-tension
Terminal Bell.*

Standard Telephones and Cables Limited

NORTH WOOLWICH, LONDON, E. 16, ENGLAND

Telephone: Albert Dock 1401

Home Branches: Birmingham, Glasgow, Leeds, Manchester

Overseas Branches: Cairo, Calcutta, Dublin, Johannesburg, Singapore

INTERNATIONAL TELEPHONE AND TELEGRAPH CORPORATION

BOARD OF DIRECTORS

<p>FREDERIC W. ALLEN</p> <p>ARTHUR M. ANDERSON J. P. Morgan & Co.</p> <p>HERNAND BEHN, President</p> <p>SOSTHENES BEHN, Chairman</p> <p>F. WILDER BELLAMY Dominick & Dominick</p> <p>EDWARD J. BERWIND Chairman, Berwind-White Coal Mining Co.</p> <p>EDWIN F. CHINLUND Vice-President and Comptroller</p> <p>JOHN W. CUTLER Edward B. Smith & Co.</p> <p>R. FULTON CUTTING Financier</p> <p>GEORGE H. GARDINER Davis Polk Wardwell Gardiner & Reed</p> <p>ALLEN G. HOYT Vice-President, The National City Bank of New York</p>	<p>RUSSELL C. LEFFINGWELL J. P. Morgan & Co.</p> <p>CLARENCE H. MACKAY Chairman of the Board, Postal Telegraph and Cable Corporation</p> <p>JOHN L. MERRILL President, All America Cables, Incorporated</p> <p>CHARLES E. MITCHELL</p> <p>WALTER E. OGILVIE President, Havana Terminal Railroad Company</p> <p>HENRY B. ORDE President, Shanghai Telephone Company</p> <p>BRADLEY W. PALMER Chairman of the Executive Committee, United Fruit Co., Boston</p> <p>GEORGE E. PINGREE President, International Standard Electric Corporation</p> <p>WOLCOTT H. PITKIN Vice-President and General Attorney</p> <p>LEWIS J. PROCTOR, Vice-President</p> <p>LANSING P. REED Davis Polk Wardwell Gardiner & Reed</p>
---	---

GEORGE H. GARDINER
General Counsel

OFFICERS

<i>Chairman</i> SOSTHENES BEHN	<i>President</i> HERNAND BEHN	
<i>Vice-Presidents</i> LEWIS J. PROCTOR GEORGE E. PINGREE PHILIP K. CONDUCT	<i>Vice-Presidents</i> JOHN L. MERRILL FRANK W. PHELAN WILLIAM F. REPP FRANK C. PAGE	<i>Vice-Presidents</i> A. H. GRISWOLD LOGAN N. ROCK GEORGE S. GIBBS
<i>Vice-President and General Attorney</i> WOLCOTT H. PITKIN	<i>Vice-President and Comptroller</i> EDWIN F. CHINLUND	<i>Vice-President and General Technical Director</i> GERALD DEAKIN
<i>Secretary</i> S. G. ORDWAY		<i>Treasurer</i> JOSEPH H. REDEGELD

THE International Telephone and Telegraph Corporation was organized to cooperate and assist technically and financially in the general development of electrical communications in a broad international sense, and, with respect to the organization and development of national communications systems, it is the purpose of the International Telephone and Telegraph Corporation to develop truly national systems operated by the nationals of each country in which the International Corporation is or may become interested. The International Corporation was not organized with the desire of imposing American practices in its foreign activities. There appeared to be a fruitful field of service to be rendered in bringing together under one gen-

eral organization electrical communications systems, and the extension by the International Corporation to the associated companies of the technical and financial facilities and direction that might be needed for their intensive and efficient development. The best American practices have been suggested but never imposed. On the contrary, the International Corporation has always been ready and quick to adjust American practices to local conditions and to adopt such local practices as were conducive to the successful development of the various entities. The combined and co-ordinated effort of the associated companies of the International System is today justifying the plans and purposes of the Corporation.

Licensee Companies

- BELL TELEPHONE MANUFACTURING COMPANY.....*Antwerp, Belgium*
Branches: Brussels.
- BELL TELEPHONE MANUFACTURING COMPANY.....*Berne, Switzerland*
- BELL TELEPHONE MANUFACTURING COMPANY.....*The Hague, Holland*
- STANDARD ELECTRIC DOMS A SPOLECNOST.....*Prague, Czechoslovakia*
Branch: Bratislava.
- CHINA ELECTRIC COMPANY, LIMITED.....*Shanghai, China*
Branches: Canton, Hankow, Harbin, Hongkong, Peiping, Tientsin.
- COMPAÑÍA STANDARD ELECTRIC ARGENTINA.....*Buenos Aires, Argentina*
- INTERNATIONAL STANDARD ELECTRIC CORPORATION, *Branch Office,*
Rio de Janeiro, Brazil
- INTERNATIONAL STANDARD ELECTRIC CORPORATION OF MEXICO....*New York, N. Y.*
- LE MATÉRIEL TÉLÉPHONIQUE.....*Paris, France*
Rabat, Morocco
- NIPPON DENKI KABUSHIKI KAISHA.....*Tokyo, Japan*
Branches: Osaka, Dalny, Seoul, Taihoku.
- FERDINAND SCHUCHHARDT, BERLINER FERNSPRECH-UND TELEGRAPHENWERK
AKTIENGESELLSCHAFT.....*Berlin, Germany*
- STANDARD ELECTRIC AKTIESELSKAP.....*Oslo, Norway*
AKTIESELSKABET SKANDINAVISKE KABEL- OG GUMMIFABRIKER....*Oslo, Norway*
- STANDARD ELECTRIC AKTIESELSKAB.....*Copenhagen, Denmark*
- STANDARD ELECTRICA ROMANA S/A.....*Bucharest, Rumania*
- STANDARD ELÉCTRICA, S. A.....*Madrid, Spain*
Branches: Barcelona, Santander.
- STANDARD ELECTRICA.....*Lisbon, Portugal*
- STANDARD ELETRICA ITALIANA.....*Milan, Italy*
Branch: Rome.
- STANDARD TELEPHONES AND CABLES, LIMITED.....*London, England*
*Branches: Birmingham, Glasgow, Leeds, Manchester, Dublin, Cairo, Johannes-
burg, Calcutta, Singapore.*
- STANDARD TELEPHONES AND CABLES (AUSTRALASIA), LIMITED.....*Sydney, Australia*
Branches: Melbourne, Wellington.
- STANDARD VILAMOSSÁGI RÉSZVÉNY TÁRSASÁG.....*Budapest, Hungary*
- SUMITOMO ELECTRIC WIRE & CABLE WORKS, LIMITED.....*Osaka, Japan*
- ÖSTERREICHISCHE TELEPHON-FABRIK AKTIENGESELLSCHAFT.....*Vienna, Austria*
- VEREINIGTE TELEPHON-UND TELEGRAPHENFABRIKS AKTIENGESELLSCHAFT,
CZEIJA, NISSL & CO.....*Vienna, Austria*
- STANDARD ELECTRIC COMPANY W POLSCE SP. z. O. O.....*Warsaw, Poland*

Sales Offices and Agencies Throughout the World
