

INSTITUTE OF RADIO  
ENGINEERS

STANDARDS COMMITTEES REPORTS  
RELATED STANDARDS  
INDEX TO PROCEEDINGS

YEAR BOOKS  
(Abstracted)  
1929-1933



# The Institute of Radio Engineers

Year Books 1929-1933

(Abstracted)

## Table of Contents

	<u>Year Book</u>	<u>Pages</u>
1933 Report of the Standards Committee		i - 225
Manufacturing Standards	1932	54- 71
References Relating to the Measurements of the Characteristics of Radio Receivers and Associated Apparatus	1929	129-143
Related Standards of Other Engineering Organization	1929	144-147
Related Standards and Definitions		
Mathematical Symbols	1930	45-48
Letter Symbols for Electrical Quantities	1930	49-50
Table of Preferred Nos.	1930	50
Electrical Measuring Instruments	1930	51-63
Telephony and Telegraphy	1930	64-79
Storage Batteries	1930	80-86
National Electric Code	1930	87-93
National Electric Safety Code	1930	94-105

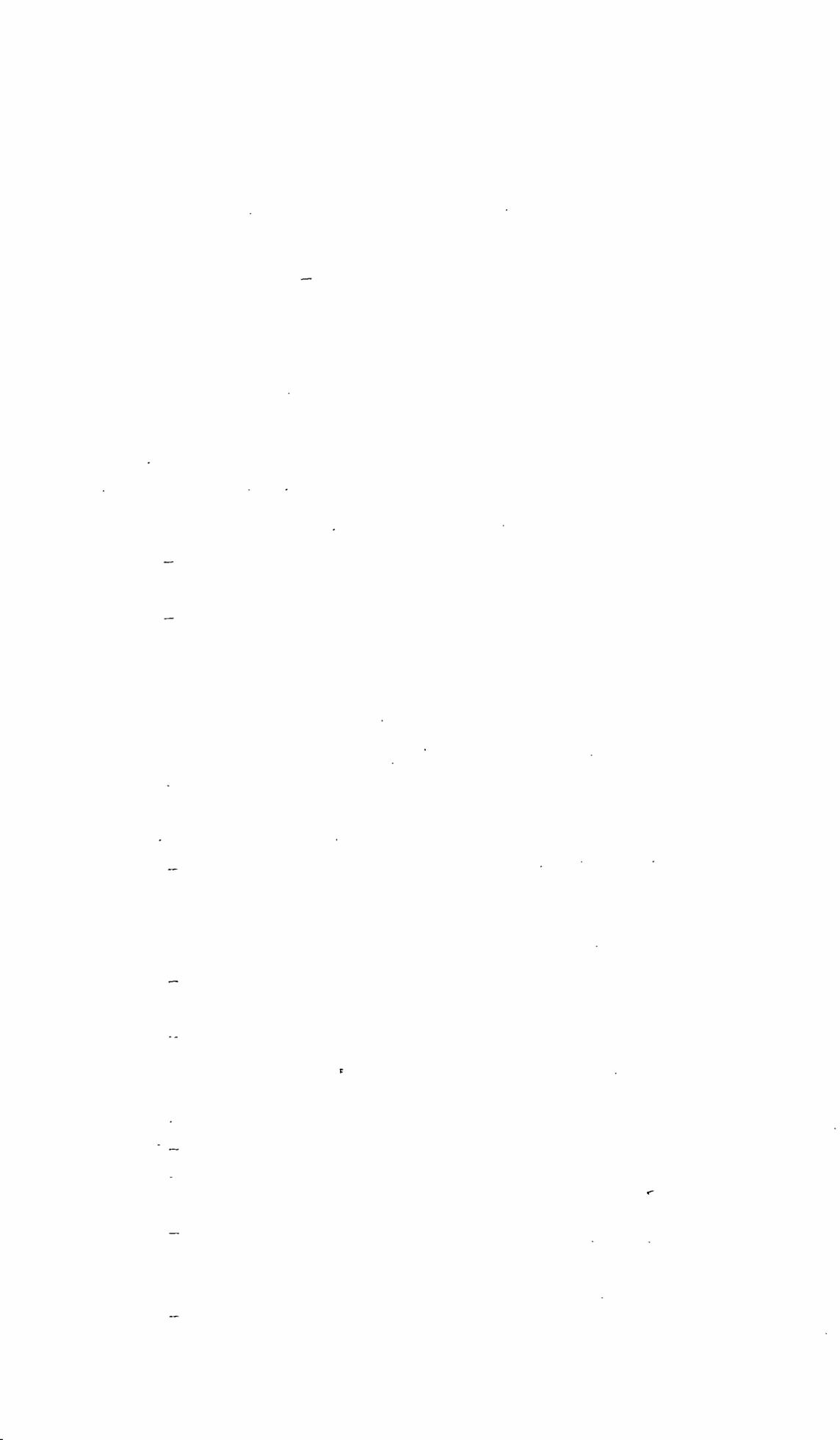

	<u>Year Book</u>	<u>Pages</u>
Index to Proceedings 1909 - 1930		
Numerical List	1931	206-241
Authors	1931	242-246
Subjects	1931	247-261
Current Publications of Interest to Radio Engineers	1931	262-264
Index to Proceedings 1909 - 1926		
Subjects	Suppl.	27-32

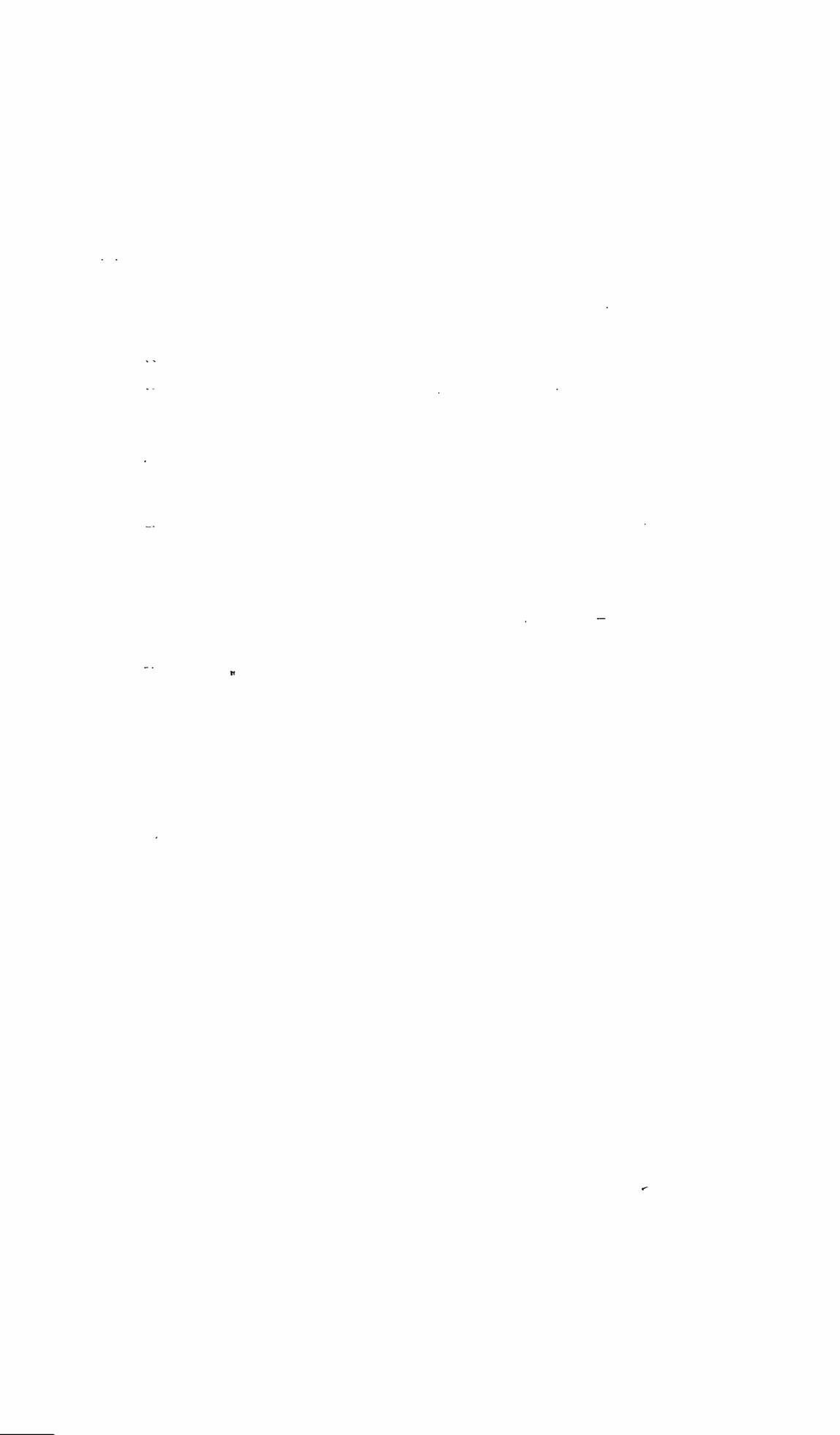

1933  
REPORT OF THE  
STANDARDS COMMITTEE

*of*

The Institute of Radio  
Engineers



THE INSTITUTE OF RADIO ENGINEERS  
33 West 39th St., New York, N.Y.

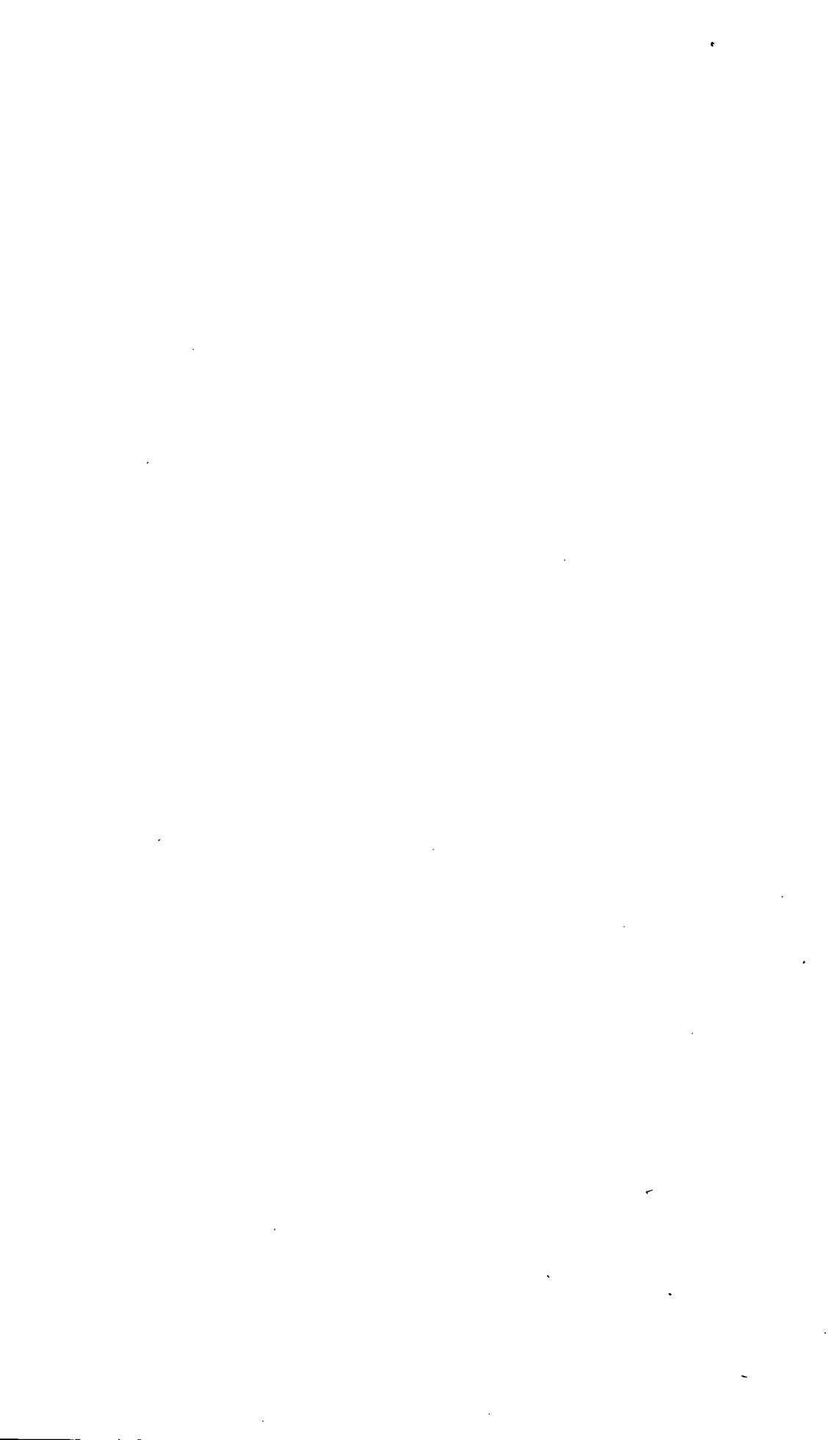

# The Institute of Radio Engineers

## TABLE OF CONTENTS

	Page
Introduction . . . . .	v
Membership of the Standards Committee . . . . .	vii
Definitions of Terms . . . . .	1
Section 1—Signal Waves . . . . .	1
Section 2—Generators . . . . .	4
Section 3—Amplification . . . . .	5
Section 4—Modulation . . . . .	5
Section 5—Rectification . . . . .	6
Section 6—Transmission . . . . .	7
Section 7—Circuits . . . . .	11
Section 8—Circuit Elements . . . . .	13
Section 9—Transmitters . . . . .	14
Section 10—Receivers . . . . .	14
Section 11—Antennas . . . . .	16
Section 12—Direction Finding . . . . .	18
Section 13—Vacuum Tubes . . . . .	20
Section 14—Instruments . . . . .	33
Section 15—Auxiliary Equipment . . . . .	34
Section 16—Electrovisual Devices . . . . .	35
Section 17—Electro-Acoustic Devices . . . . .	36
Abbreviations and Letter Symbols . . . . .	42
General Abbreviations . . . . .	42
Letter Symbols for Thermionic Tube Notation . . . . .	44
Letter Symbols for Phototubes . . . . .	48
Standard Graphical Symbols Used in Radio . . . . .	49
Methods of Measurement and Tests . . . . .	53
Tentative Suggested Methods of Testing and Rating Radio Transmitters and Antennas . . . . .	53
Standard Tests of Broadcast Radio Receivers . . . . .	75
Standard Tests of High-Frequency Receivers . . . . .	115
Standard Methods of Testing Vacuum Tubes . . . . .	127
Performance Indexes and Tests of Electro-Acoustic Devices . . . . .	163
The Measurement of Radio Frequency . . . . .	185
Radio Field Intensity Measurements . . . . .	198
The Use of Thermoelements at High Frequencies . . . . .	206
Safety Standards . . . . .	208
Provisions for Safety of Operating Personnel in Relation to Radio Transmitting Equipment . . . . .	208
Miscellaneous Reports . . . . .	210
Electromagnetic Units and Systems . . . . .	210
Index . . . . .	213



# The Institute of Radio Engineers

## MEMBERSHIP OF THE STANDARDS COMMITTEE

J. W. HORTON, *Chairman*

Stuart Ballantine	A. N. Goldsmith	D. E. Replogle
E. L. Bowles	V. M. Graham	B. E. Shackelford
W. W. Brown	J. V. L. Hogan	J. C. Shelleng
E. D. Cook	C. M. Jansky, Jr.	H. M. Turner
J. H. Dellinger	H. M. Lewis	K. S. Weaver
W. E. Downey	D. G. Little	H. A. Wheeler
Allen DuMont	E. L. Nelson	L. E. Whittemore
C. P. Edwards	Haraden Pratt	R. M. Wilmotte
Malcolm Ferris		William Wilson

## Committees Operating Under the Standards Committee

### TECHNICAL COMMITTEE ON FUNDAMENTAL UNITS AND MEASUREMENTS

H. M. TURNER, *Chairman*

E. T. Dickey	R. F. Field	H. B. Marvin
C. R. Englund	E. L. Hall	G. C. Southworth

### TECHNICAL COMMITTEE ON RADIO RECEIVERS

H. A. WHEELER, *Chairman*

H. H. Beverage	V. F. Greaves	V. D. Landon
C. E. Brigham	David Grimes	R. H. Langley
C. M. Burrill	F. A. Hinners	F. A. Polkinghorn
E. T. Dickey	W. E. Holland	J. H. Pressley
Lloyd Espenchied		A. E. Thiessen
V. M. Graham		Lincoln Walsh

### SUBCOMMITTEE ON SIGNAL GENERATORS

E. T. DICKEY, *Chairman*

Malcolm Ferris	A. E. Thiessen	Lincoln Walsh
----------------	----------------	---------------

### SUBCOMMITTEE ON RECEIVER OUTPUT

DAVID GRIMES, *Chairman*

Malcolm Ferris

### TECHNICAL COMMITTEE ON TRANSMITTERS AND ANTENNAS

WILLIAM WILSON, *Chairman*

W. W. Brown	H. E. Hallborg	D. G. Little
A. B. Chamberlain	F. G. Kear	Haraden Pratt
W. E. Downey	J. B. Knight	A. D. Ring
L. F. Fuller	J. J. Lamb	W. F. Diehl
Raymond Guy		Paul Watson

## TECHNICAL COMMITTEE ON VACUUM TUBES

B. E. SHACKELFORD, *Chairman*

N. P. Case	E. A. Lederer	E. E. Spitzer
E. L. Chaffee	George Lewis	B. J. Thompson
H. F. Dart	C. G. McIlwraith	Dayton Ulrey
F. H. Engel	W. M. Perkins	K. S. Weaver
J. F. Hanley	L. M. Price	P. T. Weeks
M. J. Kelly	Harold Snow	R. M. Wise

## SUBCOMMITTEE ON METHODS OF MEASUREMENT

F. H. ENGEL, *Chairman*

J. F. Hanley	Harold Snow	K. S. Weaver
--------------	-------------	--------------

## SUBCOMMITTEE ON DEFINITIONS

P. T. WEEKS, *Chairman*

N. P. Case	H. F. Dart	R. M. Wise
------------	------------	------------

## SUBCOMMITTEE ON PHOTOTUBES

DAYTON ULREY, *Chairman*

George Lewis	E. A. Lederer	E. W. Ritter
--------------	---------------	--------------

## SUBCOMMITTEE ON SYMBOLS

M. J. KELLY, *Chairman*

F. H. Engel	Dayton Ulrey	J. C. Warner	P. T. Weeks
-------------	--------------	--------------	-------------

## TECHNICAL COMMITTEE ON ELECTRO-ACOUSTIC DEVICES

E. D. COOK, *Chairman*

L. G. Bostwick	F. W. Kranz	G. W. Stewart
Carl Dreher	Benjamin Olney	W. N. Tuttle
C. R. Hanna	L. J. Sivian	W. West
E. W. Kellogg		

## TECHNICAL COMMITTEE ON ELECTRO-VISUAL DEVICES

J. V. L. HOGAN, *Chairman*

Stuart Ballantine	Harry Houck	R. H. Manson
Hollis Baird	W. J. Jarrard	R. H. Marriott
E. K. Cohan	C. B. Jolliffe	A. F. Murray
A. N. Goldsmith	E. F. Kingsbury	W. N. Parker
W. E. Holland	E. H. I. Lee	D. E. Replogle

STANDARD DEFINITIONS OF TERMS  
USED IN RADIO

SECTION 1—SIGNAL WAVES

1-001. **Frequency.** Frequency is the number of recurrences of a periodic phenomenon in unit time. In specifying electrical frequency the customary unit of time is the second.

1-002. **Cycle.** A cycle is one complete set of the recurrent values of a periodic phenomenon. A cycle, when used as a unit of frequency, is one cycle per second.

1-003. **Kilocycle.** A kilocycle, when used as a unit of frequency, is a thousand cycles per second.

1-004. **Megacycle.** A megacycle, when used as a unit of frequency, is a million cycles per second.

1-005. **Audio Frequency.** An audio frequency is a frequency corresponding to a normally audible sound wave.

Note—Audio frequencies correspond roughly to from 20 to 10,000 cycles per second.

1-006. **Radio Frequency.** A radio frequency is a frequency at which radiation of electromagnetic energy, for communication purposes, is possible.

Note—The present practicable limits of radio frequency are roughly 10 kilocycles to 2000 megacycles.

1-007. **Fundamental Frequency.** A fundamental frequency is the lowest component of a phenomenon where all of the original components are present.

1-008. **Harmonic.** A harmonic is a component of a periodic phenomenon having a frequency which is an integral multiple of the fundamental frequency. For example, a component, the frequency of which is twice the fundamental frequency, is called the second harmonic.

1-009. **Subharmonic.** A subharmonic is a sinusoidal phenomenon having a frequency which is an integral submultiple of the frequency of some other sinusoidal phenomenon to which it is referred. For example, a wave, the frequency of which is half the fundamental frequency of another wave, is called the second subharmonic of that wave.

**1-010. Wave.** A wave is:

- (a) A propagated disturbance, usually periodic, as an electric wave or sound wave,
- (b) A single cycle of such a disturbance, or,
- (c) A periodic variation represented by a graph.

**1-011. Wavelength.** A wavelength is the distance traveled in one period or cycle by a periodic disturbance. It is the distance between corresponding phases of two consecutive waves of a wave train. Wavelength is the quotient of velocity by frequency.

**1-012. Continuous Waves.** Continuous waves are waves in which successive cycles are identical under steady state conditions.

**1-013. Interrupted Continuous Waves.** Interrupted continuous waves are waves obtained by interrupting at audio frequency in a substantially periodic manner, otherwise continuous waves.

**1-014. Damped Waves.** Damped waves are waves of which the amplitude of successive cycles, at the source, progressively diminishes.

**1-015. Beating.** Beating is a phenomenon in which two or more periodic quantities of different frequencies react to produce a resultant having pulsations of amplitude.

**1-016. Beat.** A beat is a complete cycle in the phenomenon of beating.

**1-017. Signal.** A signal is the form or variation with time of a wave whereby the information, message, or effect is conveyed in communication.

**1-018. Signal Wave.** A signal wave is a wave the form of which conveys a signal.

Note—The signal wave frequently consists of a carrier and side bands as defined below.

**1-019. Modulated Wave.** A modulated wave is a wave of which either the amplitude, frequency, or phase is varied in accordance with a signal.

**1-020. Tone-Modulated Waves.** Tone-modulated waves are waves obtained by modulating at audio frequency in a substantially periodic manner otherwise continuous waves.

**1-021. Telegraph-Modulated Waves.** Telegraph-modulated waves are continuous waves the amplitude or frequency of which is varied by means of telegraphic keying.

- 1-022. **Marking Wave.** The marking wave, in telegraphic communication, is the emission which takes place while the active portions of the code characters are being transmitted.
- 1-023. **Spacing Wave.** The spacing wave, in telegraphic communication, is the emission which takes place between the active portions of the code characters or while no code characters are being transmitted.
- 1-024. **Carrier Wave.** A carrier wave is the unmodulated component of a signal wave.
- 1-025. **Carrier Current.** A carrier current is the current associated with a carrier wave.
- 1-026. **Carrier.** Carrier is a term broadly used to designate carrier wave, carrier current, or carrier voltage.
- 1-027. **Band of Frequencies.** A band of frequencies is the entire range of frequencies between two specified limits.
- 1-028. **Side Band.** A side band is a band of frequencies on either side of the carrier frequency, produced by the process of modulation.  
Note—A side band may consist of a single frequency in which case it is called a side frequency.
- 1-029. **Single Side Band Transmission.** Single side band transmission is that method of operation in which one side band is transmitted and the other side band is suppressed. The carrier wave may be either transmitted or suppressed.
- 1-030. **Carrier Suppression.** Carrier suppression is that method of operation in which the carrier wave is not transmitted.
- 1-031. **Fidelity.** Fidelity is the degree to which a system, or a portion of a system, accurately reproduces at its output the form of the signal which is impressed upon its input. (See page 77 for fidelity as applied to radio receivers.)
- 1-032. **Distortion.** Distortion is a change in wave form occurring in a transducer or transmission medium. The principal sources of distortion are:
- (a) Nonlinear relation between input and output at a given frequency,
  - (b) Nonuniform transmission at different frequencies, and
  - (c) Phase shift not proportional to frequency.

- 1-033. **Radio Circuit.** A radio circuit is a system for carrying out radio communications between two points.
- 1-034. **Radio Channel.** A radio channel is a band of frequencies of a width sufficient to permit of its use for radio communication. The width of a channel depends upon the type of transmission.
- 1-035. **Communication Band.** A communication band consists of the band of frequencies due to modulation (including keying) necessary for a given type of transmission.
- 1-036. **Frequency Tolerance.** The frequency tolerance is the extent to which the frequency of a station may be permitted to vary on either side of the frequency assignment.
- 1-037. **Interference Guard Bands.** The interference guard bands are the two bands of frequencies additional to, and on either side of, the communication band and frequency tolerance, which may be provided in order that there shall be no interference between stations having adjacent frequency assignments.
- 1-038. **Service Band.** A service band is a band of frequencies allocated to a given class of radio communication service.
- 1-039. **Radio Broadcasting.** Radio broadcasting is radio transmission intended for general reception.

## SECTION 2—GENERATORS

- 2-001. **Oscillator.** An oscillator is a nonrotating device for producing alternating current, the output frequency of which is determined by the characteristics of the device.
- 2-002. **Master Oscillator.** A master oscillator is an oscillator of comparatively low power so arranged as to establish the carrier frequency of the output of an amplifier.
- 2-003. **Radio-Frequency Alternator.** A radio-frequency alternator is a rotating type generator for producing radio-frequency power.
- 2-004. **Arc Converter.** An arc converter is a form of oscillator utilizing an electric arc for the generation of alternating or pulsating current.
- 2-005. **Impulse Excitation.** Impulse excitation is a method of producing damped oscillatory current in a circuit in which the duration of the impressed voltage is relatively short compared with the duration of the current produced.

### SECTION 3 --AMPLIFICATION

- 3-001. Amplifier.** An amplifier is a device for increasing the amplitude of electric current, voltage, or power, through the control by the input power of a larger amount of power supplied by a local source to the output circuit.
- 3-002. Voltage Amplification.** Voltage amplification is the ratio of the signal voltage available at the output terminals of an amplifier, transformer, or other four-terminal network, to the signal voltage impressed at the input terminals.
- 3-003. Current Amplification.** Current amplification is the ratio of the signal current produced in the output circuit of an amplifier, transformer, or other four-terminal network, to the signal current supplied to the input circuit.
- 3-004. Power Amplification.** Power amplification is the ratio of the power delivered by the output circuit of an amplifier or other four-terminal network containing a source of local power to the power supplied to its input circuit. (See 6-012 Attenuation.)
- 3-005. Vacuum Tube Amplifier.** A vacuum tube amplifier is one employing vacuum tubes to effect the control of power from the local source. (See page 27 for a discussion of amplifier classifications.)
- 3-006. Regeneration.** Regeneration is the process by which a part of the power in the output circuit of an amplifying device reacts upon the input circuit in such a manner as to reinforce the initial power, thereby increasing the amplification. (This is sometimes called feed-back or reaction.)

Note—Regeneration may be either positive or negative. The term negative regeneration is sometimes called degeneration.

### SECTION 4—MODULATION

- 4-001. Modulation.** Modulation is the process in which the amplitude, frequency, or phase of a wave is varied in accordance with a signal. The purpose of modulation generally is to obtain a signal wave the components of which fall within some specified frequency band.
- 4-002. Demodulation.** Demodulation is a term applied to the process of modulation when carried out in such a manner as to recover the original signal. In radio reception the term detection is commonly used for this process.

- 4-003. Modulator.** A modulator is a device to effect the process of modulation. It may be operated by virtue of some nonlinear characteristic or by a controlled variation of some circuit quantity.
- 4-004. Magnetic Modulator.** A magnetic modulator is one employing a magnetic circuit as the modulating element.
- 4-005. Vacuum Tube Modulator.** A vacuum tube modulator is a modulator employing a vacuum tube as a modulating element.
- 4-006. Double Modulation.** Double modulation is the process of modulation by which a wave of one frequency is first modulated by a signal and the resultant signal wave is then made to modulate a second wave of another frequency.
- 4-007. Intermodulation.** Intermodulation is the production, in a nonlinear circuit element, of frequencies corresponding to the sums and differences of the fundamentals and harmonics of two or more frequencies which are transmitted through that element.
- 4-008. Cross Modulation.** Cross modulation is a type of intermodulation due to modulation of the carrier of the desired signal by an undesired signal.
- 4-009. Modulation Factor.** The modulation factor is the ratio of the maximum departure (positive or negative) of the envelope of a modulated wave from its unmodulated value to its unmodulated value.
- Note—In linear modulation the average amplitude of the envelope is equal to the amplitude of the unmodulated wave provided there is no zero-frequency components in the modulating signal wave. For modulated signal waves having unequal positive and negative peak values both modulation factors must be given separately.
- 4-010. Percentage Modulation.** Percentage modulation is the term applied when the modulation factor is expressed as a percentage.

## SECTION 5—RECTIFICATION

- 5-001. Rectifier.** A rectifier is a device having an asymmetrical conduction characteristic which is used for the conversion of an alternating current into a current having a unidirectional component. Such devices include vacuum tube rectifiers, gaseous rectifiers, oxide rectifiers, electrolytic rectifiers, etc.

Note—In dealing with rectification in the reception of radio signals the term detector is preferred to rectifier.

- 5-002. Full-Wave Rectifier.** A full-wave rectifier is a double element rectifier arranged so that current is allowed to pass in the same

direction to the load circuit during each half cycle of the alternating-current supply, one element functioning during one-half cycle and the other during the next half cycle, and so on.

- 5-003. **Half-Wave Rectifier.** A half-wave rectifier is a rectifier which changes alternating current into pulsating current, utilizing only one half of each cycle.
- 5-004. **Linear Rectifier.** A linear rectifier is a rectifier the output current of which contains a wave having a form identical with that of the envelope of an impressed signal wave. Such rectifiers are used for detection.
- 5-005. **Ripple Voltage.** Ripple voltage is the alternating component of unidirectional voltage from a rectifier or generator used as a source of direct-current power.
- 5-006. **Per Cent Ripple.** Per cent ripple is the ratio of the effective (root-mean-square) value of the ripple voltage to the algebraic average value of the total voltage, expressed in per cent.

## SECTION 6—TRANSMISSION

- 6-001. **Power Level.** The power level at any point in a system is an expression of the power being transmitted past that point.
- 6-002. **Transmission Level.** The transmission level is the magnitude of the signaling power at any point in a communication system expressed either in some absolute unit or with reference to an arbitrary base value.
- 6-003. **Transmission Unit.** A transmission unit is a unit expressing the logarithmic ratios of powers, voltages, or currents, in a transmission system.

There are now in international use two transmission units, a napierian unit called the neper, and a decimal unit called the bel. Decimal multiples or submultiples of either of these units may be used, such as decineper and decibel.

The number of units of transmission in the case of a ratio of two powers,  $P_1$  and  $P_2$  is:

$$\begin{aligned} &\text{in the napierian system: } 1/2 \log_e \frac{P_1}{P_2} \\ &\text{in the decimal system: } \log_{10} \frac{P_1}{P_2} \end{aligned}$$

The number of units of transmission in the case of a ratio of two voltages  $E_1$  and  $E_2$ , or of two currents  $I_1$  and  $I_2$ , if the squares of these ratios are equal to the power ratio, is:

$$\begin{aligned} \text{in the napierian system: } & \log_e \frac{E_1}{E_2} \text{ or } \log_e \frac{I_1}{I_2} \\ \text{in the decimal system: } & 2 \log_{10} \frac{E_1}{E_2} \text{ or } 2 \log_{10} \frac{I_1}{I_2} . \end{aligned}$$

The unit based on the decimal system and having a size one tenth of that here defined is widely used in the United States. This unit is therefore, the decibel, (abbreviated db) and was formerly referred to as the transmission unit or TU.

The following table gives the numerical values of power, voltage, and current ratios corresponding to particular numbers of decibels:

POWER RATIO	TRANSMISSION UNITS IN DECIBELS (db)
1 ( $=10^0$ )	0 ( $=10 \log_{10} 1$ )
1.259 ( $=10^{0.1}$ )	1 ( $=10 \log_{10} 1.259$ )
10 ( $=10^1$ )	10 ( $=10 \log_{10} 10$ )
100 ( $=10^2$ )	20 ( $=10 \log_{10} 100$ )
1000 ( $=10^3$ )	30 ( $=10 \log_{10} 1000$ )

VOLTAGE OR CURRENT RATIO	TRANSMISSION UNITS IN DECIBELS (db)
0.001	-60.00
0.005	-46.02
0.01	-40.00
0.05	-26.02
0.1	-20.00
0.2	-13.98
0.5	- 6.02
1.0	0.00
1.5	3.52
2	6.02
5	13.98
10	20.00
20	26.02
50	33.98
100	40.00
500	53.98
1000	60.00

6-004. **Transducer.** A transducer is a device actuated by power from one system and supplying power in the same or any other form to a second system. Either of these systems may, for example, be electrical, mechanical, or acoustical.

6-005. **Passive Transducer.** A passive transducer is a transducer in which the power supplied to the second system is obtained exclusively from the power available from the first system.

6-006. **Active Transducer.** An active transducer is a transducer in which the power supplied to the second system is obtained from a local source and is controlled by the power from the first system.

- 6-007. Ideal Transducer.** An ideal transducer for connecting two specific systems is a passive transducer which conveys the maximum possible power from the first system to the second.
- 6-008. Overload Level of a Transducer.** The overload level of a transducer is that power level at which the transducer ceases to operate satisfactorily as a result of distortion, heating, breakage, etc.
- 6-009. Transmission Loss.** The transmission loss due to a network joining a load having a given impedance and a source having a given impedance and a given electromotive force is expressed by the logarithm of the ratio of the power delivered to the load to the power delivered to the load under some reference condition, the reference power being the greater.
- 6-010. Transmission Gain.** The transmission gain due to the network joining a load having a given impedance and a source having a given impedance and a given electromotive force is expressed by the logarithm of the ratio of the power delivered to the load to the power delivered to the load under some reference condition, the reference power being the lesser.
- 6-011. Insertion Loss.** Insertion loss is the term used for the transmission loss of a network when the direct connection of the source and the load impedance is used as the reference condition.
- 6-012. Attenuation.** Attenuation refers to the loss in a transmission system having such characteristics that, when connected either to the source or to the load circuit, the impedance presented to the other circuit has the same magnitude and phase angle as the impedance of that circuit. It is expressed by the logarithm of the ratio of the power delivered by the source to the power delivered to the load.
- The term is also used to refer qualitatively to the reduction in amplitude of a wave in a uniform transmission medium with increased distance from its source or from a specified point of reference.
- 6-013. Interference.** Interference is disturbance of reception due to strays, undesired signals, or other causes: also, that which produces the disturbance.
- 6-014. Multiplex Transmission.** Multiplex transmission is the simultaneous transmission of two or more signals using a specified common feature, such as a single antenna or a single carrier.

- 6-015. Duplex Operation.** Duplex operation is the operation of associated transmitting and receiving apparatus in which the processes of transmission and reception are concurrent.
- 6-016. Diplex Transmission.** Diplex transmission is the simultaneous transmission of two signals using a specified common feature, such as a single antenna or a single carrier.
- 6-017. Radio Transmission.** Radio transmission is the transmission of signals at radio frequencies by means of electromagnetic waves.
- 6-018. Radio Field Intensity.** Radio field intensity is the effective (root-mean-square) value of the electric or magnetic field intensity at a point due to the passage of radio waves of a specified frequency. It is usually expressed in terms of the electric field intensity in microvolts per meter or millivolts per meter. When the direction in which the field intensity is measured is not stated, it is to be taken that it is measured in the direction of maximum field intensity.
- 6-019. Radio Noise Field Intensity.** Radio noise field intensity is a measure of the field intensity, at a point (as a radio receiving station) of electromagnetic waves of an interfering character. In practice the quantity measured is not the field intensity of the interfering waves, but some quantity which is proportional to, or bears a known relation to, the field intensity.
- 6-020. Signal-Noise Ratio.** Signal-noise ratio is the ratio at a point of the field intensity of a radio wave to the radio noise field intensity.
- 6-021. Strays.** Strays are electromagnetic disturbances in radio reception other than those produced by radio transmitting systems.
- 6-022. Atmospherics.** Atmospherics are strays produced by atmospheric conditions. (In the United States the term static has come to be used quite generally as a synonym for atmospherics.)
- 6-023. Absorption.** Absorption is the loss of power in transmission of radio waves due to dissipation, such as atmospheric and ground absorption.
- 6-024. Fading.** Fading is the variation of the signal intensity received at a given location from a radio transmitting station as a result of changes in the transmission medium.
- 6-025. Swinging.** Swinging is a momentary variation in frequency of a received wave.

## SECTION 7—CIRCUITS

**7-001. Resonance.** Resonance is a condition which exists in a circuit containing inductance and capacitance when its equivalent reactance is zero. When the inductance and capacitance are connected in series, the current in the circuit is a maximum. When the inductance and capacitance are connected in parallel the external current is approximately a minimum.

**7-002. Resonant Circuit.** A resonant circuit is a circuit containing both inductance and capacitance whereby it is capable of exhibiting resonance phenomena.

**7-003. Oscillatory Circuit.** An oscillatory circuit is a circuit containing both inductance and capacitance, so that a voltage impulse will produce a current which periodically reverses.

**7-004. Logarithmic Decrement.** The logarithmic decrement is the napierian logarithm of the ratio of the first to the second of two successive amplitudes of the same sign for an exponentially damped alternating current. The logarithmic decrement can also be considered as a constant of a simple radio circuit, being  $\pi$  times the product of the resistance and the square root of the ratio of the capacitance to the inductance of the circuit.

**7-005. Damping Constant.** The damping constant is the napierian logarithm of the ratio of the first to the second of two values of an exponentially decreasing quantity separated by unit time. It is the coefficient  $\alpha$  appearing in the exponent of the damping factor,  $e^{-\alpha t}$ , which occurs in expressions of the following forms for damped currents:

$$\begin{aligned} i &= I_0 e^{-\alpha t} \\ i &= I_0 e^{-\alpha t} \cos 2\pi f_n t. \end{aligned}$$

In an oscillatory circuit containing resistance, inductance, and capacitance in series,  $\alpha = R/2L$ .

**7-006. Coupling.** Coupling is the association of two circuits in such a way that power may be transferred from one to the other.

**7-007. Coupling Coefficient.** The coupling coefficient is the ratio of the mutual or common impedance component of two circuits to the square root of the product of the total impedance components of the same kind in two circuits. (Impedance components may be inductance, capacitance, or resistance.)

**7-008. Direct Coupling.** Direct coupling is the association of two circuits by means of a self-inductance, capacitance, or resistance common to both circuits.

- 7-009. Inductive Coupling.** Inductive coupling is the association of one circuit with another by means of inductance common or mutual to both. (This term, when used without modifying words, is commonly used for coupling by means of mutual inductance, whereas coupling by means of self-inductance common to both circuits is called direct inductive coupling.)
- 7-010. Capacitive Coupling.** Capacitive coupling is the association of one circuit with another by means of capacitance common or mutual to both.
- 7-011. Resistive Coupling.** Resistive coupling is the association of one circuit with another by means of resistance common to both.
- 7-012. Direct Capacitance.** Direct capacitance is the quotient of the charge, produced on one conductor by the voltage between it and another conductor, by this voltage, all other conductors in the neighborhood being at the potential of one of the conductors.
- 7-013. Attenuation Equalizer.** An attenuation equalizer is a device for altering the total transmission loss of a circuit for various frequencies in order to make substantially equal the total transmission loss for all frequencies within a certain range.
- 7-014. Filter.** A filter is a selective circuit network designed to pass currents within a continuous band or bands of frequencies, or direct current, and substantially reduce the amplitude of currents of undesired frequencies.
- 7-015. Low-Pass Filter.** A low-pass filter is a filter designed to pass currents of all frequencies below a critical or cut-off frequency and substantially reduce the amplitude of currents of all frequencies above this critical frequency.
- 7-016. High-Pass Filter.** A high-pass filter is a filter designed to pass currents of all frequencies above a critical or cut-off frequency and substantially reduce the amplitude of currents of all frequencies below this critical frequency.
- 7-017. Band-Pass Filter.** A band-pass filter is a filter designed to pass currents of frequencies within a continuous band, limited by an upper and a lower critical or cut-off frequency, and substantially reduce the amplitude of currents of all frequencies outside of that band.

## SECTION 8—CIRCUIT ELEMENTS

- 8-001. **Rheostat.** A rheostat is a resistor which is provided with means for readily adjusting its resistance.
- 8-002. **Audio-Frequency Transformer.** An audio-frequency transformer is a transformer for use with audio-frequency currents.
- 8-003. **Radio-Frequency Transformer.** A radio-frequency transformer is a transformer for use with radio-frequency currents.
- 8-004. **Tuned Transformer.** A tuned transformer is a transformer whose associated circuit elements are adjusted as a whole to be resonant at the frequency of the alternating current supplied to the primary, thereby causing the secondary voltage to build up to higher values than would otherwise be obtained.
- 8-005. **Loading Coil.** A loading coil is an inductor inserted in a circuit to increase its inductance but not to provide coupling with any other circuit.
- 8-006. **Choke Coil.** A choke coil is an inductor inserted in a circuit to offer relatively large impedance to alternating current.
- 8-007. **Banked Winding.** A banked winding is a compact multilayer form of coil winding, for the purpose of reducing distributed capacitance, in which single turns are wound successively in each of two or more layers, the entire winding proceeding from one end of the coil to the other, without return.
- 8-008. **Stopping Condenser.** A stopping condenser is a condenser used to introduce a comparatively high impedance in some branch of a circuit for the purpose of limiting the flow of low-frequency alternating current or direct current without materially affecting the flow of high-frequency alternating current.
- 8-009. **By-Pass Condenser.** A by-pass condenser is a condenser used to provide an alternating-current path of comparatively low impedance around some circuit element.
- 8-010. **Voltage Divider.** A voltage divider is a device whose purpose it is to yield a fractional part of the applied voltage. (Devices employing mutual effects are not considered as voltage dividers.)
- 8-011. **Transrectifier.** A transrectifier is a device, ordinarily a vacuum tube, in which rectification occurs in one electrode circuit when an alternating voltage is applied to another electrode.

## SECTION 9—TRANSMITTERS

- 9-001. **Radio Transmitter.** A radio transmitter is a device for producing and modulating radio-frequency power, for purposes of communication.
- 9-002. **Spark Transmitter.** A spark transmitter is a radio transmitter which utilizes the oscillatory discharge of a condenser through an inductor and a spark gap as the source of its radio-frequency power.
- 9-003. **Spark Gap.** A spark gap is an arrangement of electrodes used for closing a circuit (usually oscillatory) at a predetermined voltage.
- 9-004. **Alternator Transmitter.** An alternator transmitter is a radio transmitter which utilizes power generated by a radio-frequency alternator.
- 9-005. **Vacuum Tube Transmitter.** A vacuum tube transmitter is a radio transmitter in which vacuum tubes are utilized to convert the applied electric power into radio-frequency power.
- 9-006. **Spurious Radiation.** Spurious radiation is any emission from a radio transmitter at frequencies outside of its communication band.
- 9-007. **Modulation Capability.** Modulation capability is the maximum percentage modulation that is possible without objectionable distortion.

Note—A number of definitions specifically pertaining to transmitters are given in "Tentative Suggested Methods of Testing and Rating Radio Transmitters and Antennas," page 53.

## SECTION 10—RECEIVERS

- 10-001. **Radio Receiver.** A radio receiver is a device for converting radio waves into perceptible signals.
- 10-002. **Monitoring Radio Receiver.** A monitoring radio receiver is a radio receiver arranged to permit a check to be made on the operation of a transmitting station.
- 10-003. **Detection.** Detection is any process of operation on a modulated signal wave to obtain the signal imparted to it in the modulation process. (See Demodulation, Rectification.)

- 10-004. Detector.** A detector is a device which is used for operation on a signal wave to obtain the signal imparted to it in the modulation process.
- Note—A number of definitions specifically pertaining to receiving sets are given in "Standard Tests of Broadcast Radio Receivers," p. 75.
- 10-005. Linear Detection.** Linear detection is that form of detection in which the output voltage under consideration is substantially proportional to the carrier voltage throughout the useful range of the detecting device.
- 10-006. Power Detecton.** Power detection is that form of detection in which the power output of the detecting device is used to supply a substantial amount of power directly to a device such as a loud speaker or recorder.
- 10-007. Heterodyne Reception.** Heterodyne reception is the process of receiving radio waves by combining in a detector a received voltage with a locally generated alternating voltage. The frequency of the locally generated voltage is commonly different from that of the received voltage. (Heterodyne reception is sometimes called beat reception.)
- 10-008. Autodyne Reception.** Autodyne reception is a system of heterodyne reception through the use of a device which is both an oscillator and a detector.
- 10-009. Homodyne Reception.** Homodyne reception is a system of reception by the aid of a locally generated voltage of carrier frequency. (Homodyne reception is sometimes called zero-beat reception.)
- 10-010. Superheterodyne Reception.** Superheterodyne reception is a method of reception in which the received voltage is combined with the voltage from a local oscillator and converted into voltage of an intermediate frequency which is usually amplified and then detected to reproduce the original signal wave. (This is sometimes called double detection or supersonic reception.)
- 10-011. Intermediate Frequency, in Superheterodyne Reception.** Intermediate frequency, in superheterodyne reception, is a frequency between that of the carrier and the signal, which results from the combination of the carrier frequency and the locally generated frequency.
- 10-012. Reflex Circuit Arrangement.** A reflex circuit arrangement is a circuit arrangement in which the signal is amplified, both before and after detection, in the same amplifier tube or tubes.

## SECTION 11—ANTENNAS

- 11-001. **Antenna.** An antenna is a conductor or a system of conductors for radiating or receiving radio waves.
- 11-002. **Aerial.** An aerial is the elevated conductor portion of a condenser antenna.
- 11-003. **Loop Antenna.** A loop antenna is an antenna consisting essentially of one or more complete turns of wire. (This is also called a coil antenna.)
- 11-004. **Condenser Antenna.** A condenser antenna is an antenna consisting of two conductors or systems of conductors, the essential characteristic of which is its capacitance.
- 11-005. **Directional Antenna.** A directional antenna is an antenna having the property of radiating or receiving radio waves in larger proportion along some directions than others. (An antenna of this type used for transmitting is often called a directive antenna.)
- 11-006. **Multiple-Tuned Antenna.** A multiple-tuned antenna is an antenna with connections to ground or counterpoise through tuning reactances at more than one point, these being so determined that their reactances in parallel present a total reactance equal to that necessary to give the antenna the desired frequency.
- 11-007. **Wave Antenna.** A wave antenna is a horizontal antenna, the length of which is of the same or greater order of magnitude as that of the signaling wave, and which is so used as to be strongly directional.
- 11-008. **Antenna Resistance.** Antenna resistance is the quotient of the power supplied to the entire antenna circuit by the square of the antenna current measured at the point where the power is supplied to the antenna.
- Note—Antenna resistance includes radiation resistance, ground resistance, radio-frequency resistance of conductors in antenna circuit, equivalent resistance due to corona, eddy currents, insulator leakage, dielectric power loss, etc.
- 11-009. **Effective Height of a Transmitting Antenna.** The effective height of a transmitting antenna is the length of a vertical conductor which may be substituted for the antenna such that if each point of the conductor carried current equal to that existing at the point where power is supplied to the antenna, the field produced in the horizontal direction would equal that produced by the antenna.

In the case of a grounded antenna, the effective height is given by the equation,

$$h = \frac{\mathcal{E}d}{1.25fI}$$

where,

$h$  is the height in meters,

$\mathcal{E}$  is the measured radio field intensity in microvolts per meter,

$d$  is the distance in kilometers at which  $\mathcal{E}$  is measured,

$f$  is the frequency in kilocycles, and

$I$  is the antenna current in amperes measured at the point where the power is supplied to the antenna, this point being ordinarily that at which the antenna current has its maximum value.

The field intensity,  $\mathcal{E}$ , is measured at a distance small enough to avoid ground absorption, and  $d$  is usually greater than one wavelength; in all cases sufficiently great so that the induction field is negligible.

**11-010. Meter-Amperes.** Meter-amperes is the product of the effective height  $h$  and the antenna current  $I$  in the formula given in the definition for effective height of an antenna. (See 11-009, Effective Height of a Transmitting Antenna.)

**11-011. Radiation Resistance.** Radiation resistance is the quotient of the power radiated by an antenna by the square of the antenna current measured at the point where the power is supplied to the antenna.

**11-012. Radiation Efficiency.** The radiation efficiency of an antenna at a given frequency is the ratio of the power radiated to the total power supplied to the antenna.

**11-013. Natural Frequency of an Antenna.** The natural frequency of an antenna is the lowest resonant frequency of an antenna, without added inductance or capacitance.

**11-014. Lead-In.** A lead-in is that portion of an antenna which completes the electrical connection between the instruments or disconnecting switches and the main portion of the antenna.

**11-015. Counterpoise.** A counterpoise is a system of wires or other conductors, elevated above and insulated from the ground, forming the lower system of conductors of an antenna.

- 11-016. **Ground System of an Antenna.** The ground system of an antenna is that portion of the antenna, below the antenna loading devices or generating apparatus, most closely associated with the ground, and including the ground itself.
- 11-017. **Ground Wire.** A ground wire is a conductive connection to the ground.
- 11-018. **Ground Equalizer Inductors.** Ground equalizer inductors are coils of relatively low inductance placed in the circuit connected to one or more of the grounding points of an antenna, to distribute the current to the various points in any desired manner.
- 11-019. **Antenna Array.** An antenna array is a system of elemental antennas, usually similar, excited by the same source, for the purpose of obtaining directional effects.
- 11-020. **Broadside Directional Antenna.** A broadside directional antenna is an antenna array directional substantially at right angles to the line along which its elements are arrayed.
- 11-021. **End-on Directional Antenna.** An end-on directional antenna is an antenna array directional substantially along the line in which its elements are arrayed.
- 11-022. **Antenna Reflector.** An antenna reflector is a portion of a directional antenna array which serves to reverse the direction of propagation of radio waves.
- 11-023. **Doublet Antenna.** A doublet antenna is an antenna consisting of two elevated conductors substantially in the same straight line, of substantially equal length, with the power delivered at the center.
- 11-024. **Artificial Antenna.** An artificial antenna is a device having all the necessary characteristics of an antenna with the exception that it dissipates in the form of heat instead of in the form of radio waves substantially all the power fed to it.

Note—A number of definitions applying particularly to the measurement of antenna characteristics are given in "Tentative Suggested Methods of Testing and Rating Radio Transmitters and Antennas," page 53.

## SECTION 12—DIRECTION FINDING

- 12-001. **Direction Finder.** A direction finder is a radio receiving device which permits determination of the line of travel of radio waves as received.

- 12-002. **Radio Compass.** A radio compass is a direction finder used for navigational purposes.
- 12-003. **Observed Radio Bearing.** An observed radio bearing is the angle between the observed direction of the line of travel of the received radio wave and an arbitrarily fixed line (such as the center line of a ship).
- 12-004. **Corrected Radio Bearing.** A corrected radio bearing is an observed radio bearing to which all known corrections have been applied.
- 12-005. **Direction Finder Deviation.** The direction finder deviation is the difference between the observed radio bearing and the corrected radio bearing. (It is the sum of all known corrections to the indication of the direction finder.)
- 12-006. **Direction Finder Calibration.** A direction finder calibration is the determination of the direction finder deviation at a number of scale readings.
- 12-007. **Sense Finder.** A sense finder is that portion of a direction finder which permits determination of direction without 180-degree ambiguity.
- 12-008. **Radio Beacon.** A radio beacon is a radio transmitting station in a fixed geographic location which emits a distinctive or characteristic signal for enabling mobile stations to determine bearings or courses.
- 12-009. **Radio Range Beacon.** A radio range beacon is a radio beacon which transmits directed waves by means of which departures from a given course may be observed.
- 12-010. **Equisignal Radio Range Beacon.** An equisignal radio range beacon is a radio range beacon which transmits two distinctive signals which may be received with equal intensity only in certain directions.
- 12-011. **Equisignal Sector.** An equisignal sector is a region in which two distinctive signals from an equisignal range beacon are received with equal intensity.
- 12-012. **Balancer.** A balancer is that portion of a direction finder which is used for the purpose of improving the sharpness of the direction indication.
- 12-013. **Compensator.** A compensator is that portion of a direction

finder which automatically applies to the direction indication all or a part of the correction for the deviation.

## SECTION 13—VACUUM TUBES

### General

- 13-001. **Vacuum Tube.** A vacuum tube is a device consisting of a number of electrodes contained within an evacuated enclosure. (This has also been called an electron tube.)
- 13-002. **Gas Tube.** A gas tube is a vacuum tube in which the pressure of the contained gas is such as to affect substantially the electrical characteristics of the tube.
- 13-003. **Mercury Vapor Tube.** A mercury vapor tube is a gas tube in which the active contained gas is mercury vapor.
- 13-004. **High Vacuum Tube.** A high vacuum tube is a vacuum tube evacuated to such a degree that its electrical characteristics are essentially unaffected by gaseous ionization.
- 13-005. **Thermionic Tube.** A thermionic tube is a vacuum tube in which the electron or ion emission is produced by the heating of an electrode.
- 13-006. **Phototube.** A phototube is a vacuum tube in which electron emission is produced directly by the radiation falling upon an electrode. (This has also been called photo-electric tube.)
- 13-007. **Thermionic Emission.** Thermionic emission is electron or ion emission under the influence of heat.
- 13-008. **Electron Emission.** Electron emission is the liberation of electrons from an electrode into the surrounding space. Quantitatively, it is the rate at which the electrons are emitted from an electrode.
- 13-009. **Secondary Emission.** Secondary emission is electron emission due directly to impact by electrons or ions.
- 13-010. **Grid Emission.** Grid emission is electron emission from a grid.
- 13-011. **Emission Characteristic.** An emission characteristic is a relation, usually shown by a graph, between the emission and a factor controlling the emission (as temperature, voltage, or current of the filament or heater).
- 13-012. **Ionization Current (Gas Current).** An ionization current is a current flowing to an electrode and composed of positive ions that have been produced as a result of gas ionization by an electron current flowing between other electrodes.

- 13-013. **Leakage Current.** A leakage current is a current which flows between two or more electrodes by any other path than across the evacuated space.
- 13-014. **Diode.** A diode is a two-electrode type of thermionic tube containing an anode and a cathode.
- 13-015. **Triode.** A triode is a three-electrode type of thermionic tube containing an anode, a cathode, and a control electrode.
- 13-016. **Tetrode.** A tetrode is a four-electrode type of thermionic tube containing an anode, a cathode, a control electrode, and an additional electrode ordinarily in the nature of a grid.
- 13-017. **Pentode.** A pentode is a five-electrode type of thermionic tube containing an anode, a cathode, a control electrode, and two additional electrodes ordinarily in the nature of grids.
- 13-018. **Cathode.** A cathode is the electrode which is the primary source of the electron stream.
- 13-019. **Indirectly Heated Cathode.** An indirectly heated cathode is a cathode of a thermionic tube to which heat is supplied by an independent heater element.
- 13-020. **Heater.** A heater is an electrical heating element for supplying heat to an indirectly heated cathode.
- 13-021. **Heater Voltage.** The heater voltage is the voltage between the terminals of a heater.
- 13-022. **Heater Current.** The heater current is the current flowing through a heater.
- 13-023. **Filament.** A filament is a cathode of a thermionic tube, usually in the form of a wire or ribbon, to which heat is supplied by current passing through it.
- 13-024. **Filament Voltage.** Filament voltage is the voltage between the terminals of a filament.
- 13-025. **Filament Current.** Filament current is the current supplied to a filament to heat it.
- 13-026. **Control Electrode.** A control electrode is an electrode upon which a voltage is impressed to vary the current to one or more other electrodes.
- 13-027. **Grid.** A grid is an electrode having openings through which electrons or ions may pass.

13-028. **Grid Voltage.** Grid voltage is the voltage between a grid and a specified point of the cathode.

13-029. **Grid Bias.** Grid bias is the direct component of grid voltage.

13-030. **Grid Current.** Grid current is the current passing from or to a grid through the vacuous space.

13-031. **Grid Conductance.** Grid conductance is the ratio of the change in the grid current to the change in grid voltage producing it, other electrode potentials being maintained constant. As most precisely used, the term refers to infinitesimal changes, as indicated by the defining equation,

$$s_{g\theta} \equiv s_g = \frac{\partial i_g}{\partial e_g}.$$

13-032. **Grid Characteristic.** A grid characteristic is a relation, usually shown by a graph, between grid voltage and grid current, other electrode potentials being maintained constant.

13-033. **Screen Grid.** A screen grid is a grid placed between a control grid and an anode, and maintained at a fixed positive potential, for the purpose of reducing the electrostatic influence of the anode in the space between the screen grid and the cathode.

13-034. **Control Grid.** A control grid is a grid ordinarily placed between the cathode and anode and to which the control or input voltage is applied.

13-035. **Space-Charge Grid.** A space-charge grid is a grid which is placed adjacent to the cathode and positively biased so as to reduce the limiting effect of space charge on the current through the tube.

13-036. **Suppressor Grid.** A suppressor grid is a grid (usually connected electrically to the cathode) which is interposed between two electrodes, both positive with respect to the cathode (usually the screen grid and plate) in order to prevent secondary electrons passing from one to the other.

13-037. **Anode.** An anode is an electrode to which an electron stream flows.

13-038. **Plate.** Plate is a common name for the principal anode in a vacuum tube.

13-039. **Plate Voltage.** Plate voltage is the voltage between the plate and a specified point of the cathode.

**13-040. Plate Current.** Plate current is the current passing to or from the plate through the vacuous space.

**13-041. Cathode Current.** Cathode current is the total current passing to or from the cathode through the vacuous space. (This term should be carefully distinguished from 13-022, Heater Current, and 13-025, Filament Current.)

**13-042. Mu-Factor.** The mu-factor is a measure of the relative effect of the voltages on two electrodes upon the current in the circuit of any specified electrode. It is the ratio of the change in one electrode voltage to the change in the other electrode voltage, under the condition that a specified current remains unchanged. As most precisely used, the term refers to infinitesimal changes as indicated by the defining equation,

$$\mu_{ji} = - \left[ \frac{\partial e_j}{\partial e_i} \right]_{i_i \text{ constant}}.$$

**13-043. Amplification Factor.** The amplification factor is a measure of the effectiveness of the control electrode voltage relative to that of the plate voltage upon the plate current. It is the ratio of the change in plate voltage to a change in control electrode voltage in the opposite direction, under the condition that the plate current remains unchanged. As most precisely used, the term refers to infinitesimal changes as indicated by the defining equation,

$$\mu = - \left[ \frac{\partial e_p}{\partial e_c} \right]_{i_p \text{ constant}}.$$

**13-044. Transfer Characteristic.** A transfer characteristic is a relation (usually shown by a graph) between the voltage on one electrode and the current in the circuit of another electrode.

**13-045. Electrode Conductance.** Electrode conductance is the ratio of the change in the current in the circuit of an electrode to a change in the voltage on the same electrode, all other electrode voltages being maintained constant. As most precisely used, the term refers to infinitesimal changes as indicated by the defining equation,

$$s_{jj} \equiv s_j = \frac{\partial i_j}{\partial e_j}.$$

**13-046. Transconductance.** Transconductance is the ratio of the change in the current in the circuit of an electrode to the change in the voltage on another electrode, under the condition that all other

voltages remain unchanged. As most precisely used, the term refers to infinitesimal changes as indicated by the defining equation,

$$s_{jk} = \left[ \frac{\partial i_j}{\partial e_k} \right] e \text{ constant.}$$

13-047. **Grid-Plate Characteristic.** A grid-plate characteristic is a transfer characteristic between the grid voltage and plate current.

13-048. **Grid-Plate Transconductance.** Grid-plate transconductance is the name for the plate current to grid voltage transconductance. Symbolically,

$$s_{pv} \equiv s_m = \frac{\partial i_p}{\partial e_g}.$$

13-049. **Control-Grid—Plate Transconductance (Mutual Conductance).** Control-grid—plate transconductance is the name for the plate current to control-grid voltage transconductance.

13-050. **Plate Conductance.** Plate conductance is the ratio of the change in plate current to the change in plate voltage producing it, all other electrode voltages being maintained constant. As most precisely used, the term refers to infinitesimal changes as indicated by the defining equation,

$$s_{pp} \equiv s_p = \frac{\partial i_p}{\partial e_p}.$$

13-051. **Plate Resistance.** Plate resistance is the reciprocal of the plate conductance. Symbolically,

$$r_p = \frac{1}{s_p} = \frac{\partial e_p}{\partial i_p}.$$

13-052. **Plate Characteristic.** A plate characteristic is a relation, usually shown by a graph, between plate voltage and plate current.

13-053. **Interelectrode Capacitance.** Interelectrode capacitance is the direct capacitance between two electrodes.

13-054. **Cathode Capacitance.** Cathode capacitance is the sum of the direct capacitances between the cathode and all other electrodes of a vacuum tube.

13-055. **Grid Capacitance.** Grid capacitance is the sum of the direct capacitances between a grid and all other electrodes of a vacuum tube.

**13-056. Plate Capacitance.** Plate capacitance is the sum of the direct capacitances between the plate and all other electrodes of a vacuum tube.

**13-057. Grid-Plate Capacitance.** Grid-plate capacitance is the direct capacitance between a grid and the plate.

**13-058. Grid-Cathode Capacitance.** Grid-cathode capacitance is the direct capacitance between a grid and the cathode.

**13-059. Plate-Cathode Capacitance.** Plate-cathode capacitance is the direct capacitance between a plate and the cathode.

Note—The following relations exist in a triode between the capacitances defined in 13-054 to 13-059:

$$C_k = C_{ok} + C_{pk}; \quad C_p = C_{pk} + C_{op}; \quad C_g = C_{ok} + C_{op}.$$

**13-060. Input Capacitance.** The input capacitance of a vacuum tube is the direct capacitance between the control grid and the cathode, together with such other electrodes as are ordinarily operated at the same signal frequency potential as the cathode. (This is to be distinguished from the effective capacitance which is the apparent control-grid capacitance when the appropriate loads are applied to the elements.)

**13-061. Output Capacitance.** The output capacitance of a vacuum tube is the direct capacitance between the output electrodes (usually the plate and the cathode) together with such other electrodes as are ordinarily operated at the same signal frequency potential as the cathode. (This is to be distinguished from the effective capacitance which is the apparent plate capacitance when the appropriate loads are applied to the elements.)

**13-062. Output Impedance of a Vacuum Tube.** The output impedance of a vacuum tube is the ratio of the externally applied alternating voltage impressed on the output terminals of a vacuum tube to the alternating current thereby produced.

**13-063. Output Admittance of a Vacuum Tube.** The output admittance of a vacuum tube is the reciprocal of the output impedance.

**13-064. Input Impedance of a Vacuum Tube.** The input impedance of a vacuum tube is the ratio of the alternating voltage impressed on the input terminals of the tube to the alternating current thereby produced.

**13-065. Input Admittance of a Vacuum Tube.** The input admittance of a vacuum tube is the reciprocal of the input impedance.

## Rectification and Detection

- 13-101. **Simple Rectification.** Simple rectification in a vacuum tube is the rectification taking place in an electrode circuit, as indicated by a change in the average direct current therein, when an alternating voltage is applied to the same electrode.
- 13-102. **Rectification Factor.** The rectification factor is the ratio of the change in average current in an electrode circuit (as indicated by a direct-current instrument) to the change in alternating sinusoidal voltage applied to the same electrode, the direct voltages of this and other electrodes being held constant. As most precisely used, the term refers to infinitesimal changes.
- 13-103. **Rectification Characteristic.** A rectification characteristic is a relation shown by a graph or family of graphs plotted between the average current in an electrode circuit (as indicated by a direct-current instrument), the direct voltage on that or another electrode, and the sinusoidal alternating voltage applied to the same electrode. These graphs are ordinarily plotted in two ways: (a) average currents as ordinates, direct voltages as abscissas, alternating voltages as parameters; (b) average currents as ordinates, alternating voltages as abscissas, direct voltages as parameters.
- 13-104. **Transrectification.** Transrectification is the rectification taking place in an electrode circuit, as indicated by a change in average current therein, when an alternating voltage is applied to another electrode.
- 13-105. **Transrectification Factor.** The transrectification factor is the ratio of the change in average current in an electrode circuit (as indicated by a direct-current instrument) to the change in the alternating sinusoidal voltage applied to another electrode, the direct voltages of this and other electrodes being held constant. As most precisely used the term refers to infinitesimal changes.
- 13-106. **Transrectification Characteristic.** A transrectification characteristic is a relation, usually shown by a graph or family of graphs, between the average current in an electrode circuit (as indicated by a direct-current instrument), the direct voltage on that or another electrode, and the sinusoidal alternating voltage applied to another electrode. These graphs are ordinarily plotted in two ways: (a) average currents as ordinates, direct voltages as abscissas, alternating voltages as parameters; (b) average currents as ordinates, alternating voltages as abscissas, direct voltages as parameters.

**13-107. Conductance for Rectification.** Conductance for rectification is the ratio of the change in the average electrode current (as indicated by a direct-current instrument) to the change in direct voltage applied to that electrode, a sinusoidal alternating voltage being applied to the same or another electrode and the direct voltages of the other electrodes being maintained at their specific values. As most precisely used the term relates to infinitesimal changes as indicated by the defining equation,

$$s_j' = \frac{\partial I_j}{\partial E_j}$$

**13-108. Plate Conductance for Rectification.** Plate conductance for rectification is the ratio of the change in average plate current to the change in direct plate voltage, a sinusoidal alternating voltage being applied to an electrode. As most precisely used, the term refers to infinitesimal changes as indicated by the defining equation,

$$s_p' = \frac{\partial I_b}{\partial E_b}$$

**13-109. Plate Resistance for Rectification.** The plate resistance for rectification is the reciprocal of the plate conductance for rectification,

$$r_p' = \frac{1}{s_p'} = \frac{\partial E_b}{\partial I_b}$$

**13-110. Grid Conductance for Rectification.** Grid conductance for rectification is the ratio of the change in average grid current to the change in direct grid voltage, a sinusoidal alternating voltage being applied to an electrode. As most precisely used, the term refers to infinitesimal changes as indicated by the defining equation,

$$s_c' = \frac{\partial I_c}{\partial E_c}$$

**13-111. Grid Resistance for Rectification.** The grid resistance for rectification is the reciprocal of the grid conductance for rectification,

$$r_c' = \frac{1}{s_c'} = \frac{\partial E_c}{\partial I_c}$$

#### Amplifier Classification

The operating point on the grid-plate characteristic determined by the grid bias and the amplitude of the exciting grid voltage varies over a wide range in amplifiers designed for different

fields of application. The plate efficiency of the amplifying tube and the degree to which the alternating component of the plate current is a reproduction of the alternating grid voltage depend upon the operating point on the grid-plate characteristic as determined by the grid bias and upon the magnitude of the exciting grid voltage.

Amplifiers are grouped into three general classes (A, B, and C) according to the region of the grid-plate characteristic in which the operating point, as determined by the grid bias, is located, and the magnitude of the exciting grid voltage. There is nothing fundamental in this classification. It is a recognition of current practices in amplifier design and offers a convenient terminology for the description of amplifiers. It is understood that this classification refers only to single-stage amplifiers; a multistage amplifier may consist of two or more classes.

**13-201. Class A Amplifier.** A class A amplifier is an amplifier in which the bias and exciting grid voltages are such that the plate current through the tube flows at all times.

The ideal class A amplifier is one in which the alternating component of the plate current is an exact reproduction of the form of the alternating grid voltage, and the plate current flows 360 electrical degrees.

The characteristics of a class A amplifier are low efficiency and output.

**13-202. Class B Amplifier.** A class B amplifier is an amplifier in which the grid bias is approximately equal to the cut-off value so that the plate current is approximately zero when no exciting grid voltage is applied, and so that the plate current in each tube flows during approximately one half of each cycle when an exciting grid voltage is present.

The ideal class B amplifier is one in which the alternating component of plate current is an exact replica of the alternating grid voltage for the half cycle when the grid is positive with respect to the bias voltage, and the plate current flows 180 electrical degrees.

The characteristics of a class B amplifier are medium efficiency and output.

**13-203. Class C Amplifier.** A class C amplifier is an amplifier in which the grid bias is appreciably beyond the cut-off so that the plate current in each tube is zero when no exciting grid voltage is present, and so that the plate current flows in each tube for appreciably less than one half of each cycle when an exciting grid voltage is present.

Class C amplifiers find application where high plate circuit efficiency is a paramount requirement and where departures from linearity between input and output are permissible.

The characteristics of a class C amplifier are high plate circuit efficiency and high power output.

### Phototubes

**13-301. High Vacuum Phototube.** A high vacuum phototube is one which is evacuated to such a degree that its electrical characteristics are essentially unaffected by gaseous ionization.

**13-302. Gas Phototube.** A gas phototube is one into which a quantity of gas has been introduced, usually for the purpose of increasing its sensitivity.

**13-303. Sensitivity of a Phototube.** The sensitivity of a phototube is the ratio of the short-circuit current through the tube to the incident radiant flux. It is usually expressed in terms of current per unit radiant or luminous flux. In general the sensitivity depends upon the voltage applied to the tube and upon the intensity and spectral distribution of the flux.

Note—In the special case of a simple vacuum phototube the relation between current and radiant flux is linear. Also in this case the specified voltage may be taken as any voltage sufficient for saturation current.

**13-304. Static Sensitivity.** Static sensitivity is the ratio of the direct current through a phototube operated at a specified voltage to the incident radiant flux of specified value.

**13-305. Dynamic Sensitivity.** Dynamic sensitivity is the ratio of the alternating component of current through a phototube operated at a specified voltage to the incident pulsating radiant flux of specified mean intensity, frequency of pulsation, and degree of modulation.

**13-306. Monochromatic Sensitivity.** Monochromatic sensitivity is the ratio of the short-circuit current through the phototube at the incident radiant flux of a given frequency, or very narrow frequency range. For a given frequency,  $\nu$ , this is the limit of the ratio of the current which flows through the tube at a specified steady voltage to the radiant flux of power (in watts) between the frequencies  $\nu$  and  $\nu + \Delta\nu$ , which is approached as  $\Delta\nu$  diminishes without limit. Mathematically,

$$S_{\nu} \equiv S(\nu, \Phi) = \lim_{\Delta\nu \rightarrow 0} \frac{1}{\Phi_{\nu}} \frac{\Delta i}{\Delta\nu}$$

where  $\Phi$  represents the mean value of radiant flux in the range  $\Delta\nu$ .

**13-307. Total Sensitivity.** Total sensitivity is the ratio of the current which flows through a phototube at a specified steady voltage to the total radiant flux (in watts) of specified spectral energy distribution entering the tube. Mathematically,

$$S = i/\Phi,$$

where  $\Phi$  is the total radiant flux. The total sensitivity depends upon the spectral distribution of energy of the radiation and is related to the monochromatic sensitivity as follows:

$$i = \int_0^{\infty} S_{\nu}(\nu, \Phi) \Phi_{\nu}(\nu) d\nu$$

where,

$\nu$  denotes the radiation frequency, and

$\Phi_{\nu}(\nu)$  the specific radiant flux (radiant flux per frequency interval).

Note—In the special case of a simple vacuum phototube,  $S_{\nu}$  is independent of the radiant flux and equals the Variational Sensitivity, 13-311. Also in this case the specified voltage may be taken to be a voltage sufficient for saturation current.

**13-308. Total Luminous Sensitivity.** Total luminous sensitivity is the ratio of the direct current through a phototube operated at a specified voltage to the total luminous flux in lumens. Mathematically,

$$S_F = \frac{i}{F},$$

where  $F$  is the total luminous flux.

**13-309. Luminous Tungsten Sensitivity.** Luminous tungsten sensitivity is the ratio of the current which flows through the tube at a specified steady voltage to the total luminous flux in lumens entering the tube from a tungsten filament lamp at a specified temperature.

**13-310. 2870 Tungsten Sensitivity.** 2870 tungsten sensitivity is the ratio of the current which flows through the tube at a specified steady voltage to the total luminous flux in lumens entering the tube from a tungsten filament lamp at a color temperature 2870 degrees Absolute.

**13-311. Variational Sensitivity.** Variational sensitivity is the ratio of the change in current which flows through the tube at a specified voltage to the change in the total flux entering the tube. As most precisely used, the term refers to infinitesimal changes as indicated by the defining equation,

$$S = \frac{\partial i}{\partial \Phi}, \text{ or } \frac{\partial i}{\partial F}.$$

Note—When the current changes linearly with flux, the variational sensitivity is independent of flux and is equal to the Total Sensitivity, 13-307.

13-312. **Variational Sensitivity Amplitude Relation.** The variational sensitivity amplitude relation is the relation between variational sensitivity of a phototube and the amplitude of the total steady radiant flux entering the tube.

13-313. **Current-Wavelength Characteristic.** Current-wavelength characteristic is a relation usually shown by a graph, between the direct current through a phototube and the wavelength of a steady radiant flux.

13-314. **Conductance of a Phototube.** The conductance of a phototube is the ratio of the current through a phototube at a specified radiant flux to the voltage at its terminals. Mathematically,

$$s_p = i/e.$$

Note—In a vacuum phototube this is a linear function of the illumination.

13-315. **Variational Conductance of a Phototube.** The variational conductance of a phototube is the ratio of the change in current through a phototube at a specified radiant flux to the change of voltage at its terminals. As most precisely used, the term refers to infinitesimal changes as indicated by the defining equation,

$$s_p = \frac{\partial i}{\partial e_p}.$$

13-316. **Resistance of a Phototube.** Resistance of a phototube is the reciprocal of the conductance. Mathematically,

$$r_p = \frac{1}{s_p}.$$

13-317. **Variational Resistance of a Phototube.** Variational resistance of a phototube is the reciprocal of the variational conductance. Mathematically,

$$r_p = \frac{1}{s_p} = \frac{\partial e_p}{\partial i_p}.$$

13-318. **Photo-Voltage Coefficient.** The photo-voltage coefficient is an expression of the open circuit voltage generated by a phototube in response to a unit variation in radiant flux when the tube is re-

garded as a constant voltage generator. It is the ratio of the variational sensitivity to the variational tube conductance at specified values of operating direct voltages at the terminals of the tube, and of radiant flux. Mathematically, it is defined as being equal to

$$\frac{\partial i}{\partial \Phi} / \frac{\partial i}{\partial e}$$

Note—For a simple phototube and with voltage sufficient to draw saturation current, this quantity becomes infinite. In this case the tube is more conveniently regarded as a constant current generator. The tube is likewise more conveniently regarded as a constant current generator when the impedance is very high. For this purpose definition 13-319, Photo-Current Coefficient is useful.

**13-319. Photo-Current Coefficient.** The photo-current coefficient is an expression of the short-circuit current generated by a phototube in response to a unit variation in radiant flux when the tube is regarded as a constant current generator. It is numerically equal to the Variational Sensitivity, 13-311.

**13-320. Gas Amplification.** Gas amplification is the ratio of the sensitivity of a phototube, measured at a voltage greater than the ionization potential of the gas, to the sensitivity measured at a voltage less than the ionization potential of the gas.

### Photometric Definitions

These definitions are abstracted from the list of photometric definitions standardized by the Illuminating Engineering Society and the American Standards Association. They are copied here for reference as being of interest in the phototube art.

**13-401. Radiant Flux.** Radiant flux is the rate of flow of radiation evaluated with reference to energy, and is usually expressed in ergs per second or in watts.

**13-402. Luminous Flux.** Luminous flux is the rate of flow of radiation evaluated with reference to visual sensation, and is expressed in lumens.

**13-403. Visibility.** The visibility of radiation of a particular frequency,  $\nu$ , is the ratio of the luminous flux at that frequency to the corresponding radiant flux. Defining equation,

$$K_{\nu} = \frac{F}{\Phi_{\nu}}$$

13-404. **Luminous Intensity.** The luminous intensity of a point source in any direction is the flux per unit solid angle (one steradian) emitted by the source in that direction. Unit, Candle. Defining equation,

$$I = \frac{\partial F}{\partial \omega}$$

13-405. **Illumination.** The illumination at any point of a surface is the luminous flux density at that point, or when the illumination is uniform, the incident flux per unit of intercepting area. Unit, Phot. Defining equation,

$$E = \frac{\partial F}{\partial A} = \frac{\cos \theta}{r^2}$$

13-406. **Candle Power.** Candle power is luminous intensity expressed in candles.

13-407. **Lumen.** The lumen is the unit of luminous flux. It is equal to the flux emitted in a unit solid angle by a uniform point source of one international candle.

13-408. **Phot.** The phot is a unit of illumination, and is equal to one lumen per square centimeter. Other units of illumination are the foot candle and lux.

## SECTION 14—INSTRUMENTS

14-001. **Frequency Meter.** A frequency meter is an instrument for measuring frequency. (Frequency meters used in radio work are sometimes called wavemeters.)

14-002. **Decremeter.** A decremeter is an instrument for measuring the logarithmic decrement of a train of waves.

14-003. **Thermoelement.** A thermoelement is a device consisting of a combination of a thermocouple and a heating element for measuring small currents.

14-004. **Thermocouple Ammeter.** A thermocouple ammeter is an ammeter dependent for its indications on a change in thermoelectromotive force in a thermocouple which is heated by the current to be measured.

14-005. **Hot-Wire Ammeter, Expansion Type.** A hot-wire ammeter, expansion type, is an ammeter dependent for its indications on a change in dimensions of an element which is heated by the current to be measured.

- 14-006. **Vacuum Tube Voltmeter.** A vacuum tube voltmeter is a device utilizing the characteristics of a vacuum tube for measuring alternating voltages.

### SECTION 15—AUXILIARY EQUIPMENT

- 15-001. **Relay.** A relay is a device by means of which contacts in one circuit are operated by a change in condition in the same circuit or in one or more associated circuits.
- 15-002. **Automatic Regulator.** An automatic regulator is a device for regulating a system in such a manner that changes in its functioning are initiated by changed conditions and carried out without the intervention of an attendant.
- 15-003. **Automatic Starter.** An automatic starter is a device for starting a system in such a manner that its functioning is initiated by changed conditions and carried out without the intervention of an attendant.
- 15-004. **Automatic Volume Control.** An automatic volume control is a self-acting device which maintains the output constant within relatively narrow limits while the input voltage varies over a wide range.
- 15-005. **Trickle Charger.** A trickle charger is a device designed to charge a storage battery at a low rate continuously or during a major portion of the 24-hour day.
- 15-006. **A Power Supply.** An A power supply is a power supply device which provides power for heating the cathode of a vacuum tube.
- 15-007. **B Power Supply.** A B power supply is a power supply device connected in the plate circuit of a vacuum tube.
- 15-008. **C Power Supply.** A C power supply is a power supply device connected in the circuit between the cathode and grid of a vacuum tube so as to apply a grid bias.
- 15-009. **Ripple Filter.** A ripple filter is a low-pass filter designed to reduce the ripple current, while freely passing the direct current, from a rectifier or generator used as a source of power supply.
- 15-010. **Protective Device.** A protective device is a device for keeping current, voltage, or power of undesirably large magnitude out of a given part of an electric circuit.

**15-011. Frequency Changer.** A frequency changer is a device delivering alternating current at a frequency which differs from the frequency of the supply:

**15-012. Frequency Divider.** A frequency divider is a frequency changer used to divide by an integer the frequency of an alternating current.

**15-013. Frequency Multiplier.** A frequency multiplier is a frequency changer used to multiply by an integer the frequency of an alternating current.

## SECTION 16—ELECTROVISUAL DEVICES

**16-001. Facsimile Transmission.** Facsimile transmission is the electrical transmission of graphic records having a limited number of shade values.

**16-002. Picture Transmission.** Picture transmission is the electrical transmission of a picture having a gradation of shade values.

**16-003. Television.** Television is the electrical transmission and reception of transient visual images.

**16-004. Frame.** A frame is a single complete picture.

**16-005. Framing.** Framing is the adjustment of the picture to a desired position with respect to the field of view.

**16-006. Synchronizing.** Synchronizing of images is the maintaining of the time and space relations between the transmitted and reproduced pictures.

**16-007. Scanning.** Scanning is the process of analyzing an area according to a predetermined method.

**16-008. Rectilinear Scanning.** Rectilinear scanning is the process of scanning an area in a predetermined sequence of narrow parallel strips.

**16-009. Scanning Line.** A scanning line is a single continuous narrow strip determined by rectilinear scanning.

**16-010. Picture Element.** A picture element is the smallest subdivision defined by the process of scanning.

**16-011. Frame Frequency.** Frame frequency is the number of times per second that the picture area is completely scanned.

- 16-012. **Line Frequency.** Line frequency, in rectilinear scanning, is the number of scanning lines traced in one second.
- 16-013. **Aspect Ratio.** The aspect ratio of a frame is the numerical ratio of the frame width to the frame height.
- 16-014. **Progressive Scanning.** Progressive scanning is rectilinear scanning in which scanning lines trace one dimension substantially parallel to a side of the frame, and in which successively traced lines are adjacent.
- 16-015. **Staggered Scanning.** Staggered scanning is rectilinear scanning in which scanning lines trace one dimension of the frame, and in which successively traced lines are separated by an integral number of line widths.
- 16-016. **Positive Modulation.** Positive modulation occurs when an increase in initial light intensity causes an increase in the radiated power.
- 16-017. **Negative Modulation.** Negative modulation occurs when a decrease in initial light intensity causes an increase in the radiated power.

## SECTION 17—ELECTRO-ACOUSTIC DEVICES

### General

- 17-001. **Electro-Acoustic Transducer.** An electro-acoustic transducer is a transducer which is actuated by power from an electrical system and supplies power to an acoustic system or vice versa.
- 17-002. **Blocked Impedance.** The blocked impedance of an electro-acoustic transducer is the impedance measured at the terminals of its electrical system when the impedance of the attached mechanical system is infinite, or vice versa.
- 17-003. **Normal Impedance.** The normal impedance of an electro-acoustic transducer is the impedance measured at the terminals of its electrical system when the mechanical system is connected to its normal load, or vice versa.
- 17-004. **Motional Impedance.** The motional impedance of an electro-acoustic transducer is the vector difference between the normal and the blocked impedance.
- 17-005. **Force Factor.** The force factor of an electro-acoustic transducer is a measure of the coupling between its electrical and

mechanical systems. It is the ratio of the open circuit force or voltage in the secondary system to the current or velocity in the primary system.

- 17-006. **Compliance of a Mechanical Element.** The compliance of a mechanical element is its displacement per unit of force. This is the reciprocal of its stiffness. Compliance in a mechanical system is analogous to capacitance in an electrical system and is expressed in centimeters per dyne. Negative compliance (reciprocal of negative stiffness) occurs in a case of unstable equilibrium where a small displacement results in a force tending to give a further displacement in the same direction.
- 17-007. **Mechanical Impedance of a Mechanical System.\*** The mechanical impedance of a mechanical system is the complex quotient of the alternating force applied to the system by the resulting alternating linear velocity in the direction of the force at its point of application.
- 17-008. **Mechanical Resistance of a Mechanical System.\*** The mechanical resistance of a mechanical system is the real component of the mechanical impedance. It may also be expressed as the quotient of the power absorbed by the system by the square of the alternating velocity at the point of application of the force.
- 17-009. **Mechanical Reactance of a Mechanical System.\*** The mechanical reactance of a mechanical system is the imaginary component of the mechanical impedance. It may also be expressed as the component of the mechanical impedance of the system resulting from its effective mass or compliance.
- 17-010. **Bar.** A bar is a pressure of one dyne per square centimeter.
- 17-011. **Acoustic Impedance of a Sound Medium.†** The acoustic impedance of a sound medium, on a given surface, is the complex quotient of the pressure (force per unit area) on the surface by the flux (volume velocity, or linear velocity multiplied by the area) through that surface. The acoustic impedance may be expressed in terms of mechanical impedance, acoustic impedance being equal to the mechanical impedance divided by the square of the area of the surface considered.

\* A mechanical impedance, reactance, or resistance is said to have a magnitude of one unit when a force of one dyne produces a velocity of one centimeter per second.

† An acoustic impedance, reactance, or resistance is said to have a magnitude of one unit when a pressure of one bar produces a volume velocity of one cubic centimeter per second.

- 17-012. **Acoustic Resistance of a Sound Medium.** † The acoustic resistance of a sound medium is the real component of the acoustic impedance. This is the component of the acoustic impedance associated with the dissipation of energy.
- 17-013. **Acoustic Reactance of a Sound Medium.** † The acoustic reactance of a sound medium is the imaginary component of the acoustic impedance. It is the component of the acoustic impedance resulting from the effective mass or compliance of the medium.

### Telephone Receivers and Loud Speakers

- 17-101. **Telephone Receiver.** A telephone receiver is an electro-acoustic transducer actuated by power from an electrical system and supplying power to an acoustic system, the frequency components in the acoustic system corresponding to those in the electrical system.
- 17-102. **Loud Speaker.** A loud speaker is a telephone receiver designed to radiate acoustic power into a room or open air. (The shorter term, speaker, is frequently used where no ambiguity will result, as in compound terms.)
- 17-103. **Motor Element.** The motor element is that portion of a telephone receiver which receives power from the electrical system and converts it into mechanical power.
- 17-104. **Acoustic Radiator.** An acoustic radiator is that portion of an electro-acoustic transducer which initiates the radiation of sound vibrations.
- 17-105. **Baffle.** A baffle is a partition which may be used with an acoustic radiator to impede circulation between front and back.
- 17-106. **Horn.** A horn is an acoustic transducer consisting of a tube of varying sectional area.
- 17-107. **Throat of a Horn.** The throat of a horn is the end with the smaller cross-sectional area.
- 17-108. **Mouth of a Horn.** The mouth of a horn is the end with the larger cross-sectional area.
- 17-109. **Exponential Horn.** An exponential horn is a horn whose sectional area varies exponentially with its length. It is defined by the following relation:

† See footnote on page 37.

$$\frac{S}{S_0} = e^{Tx},$$

where,

$S$  is the area of plane section of the horn normal to the axis at a distance  $x$  from the throat of the horn,

$S_0$  is the area of plane section of the horn normal to the axis at the throat, and

$T$  is a constant which determines the rate of taper of the horn.

- 17-110. **Conical Horn.** A conical horn is a horn whose equivalent sectional radius ( $\sqrt{S/\pi}$ ) has a constant rate of increase.
- 17-111. **Diaphragm.** A diaphragm is a vibrating sheet in an electro-acoustic transducer which initiates or is actuated by sound vibrations.
- 17-112. **Magnetic Speaker.** A magnetic speaker is a loud speaker in which the mechanical forces result from magnetic reactions.
- 17-113. **Moving Conductor Speaker.** A moving conductor speaker is a magnetic speaker in which the mechanical forces result from magnetic reactions between the field of the moving conductor and the steady applied field. (This is sometimes called a dynamic speaker.)
- 17-114. **Moving Coil Speaker.** A moving coil speaker is a moving conductor speaker in which the movable conductor is given the form of a coil which is conductively connected to the source of electrical power. (This is sometimes called a dynamic speaker.)
- 17-115. **Induction Speaker.** An induction speaker is a loud speaker in which the current which reacts with the polarizing field is induced in the moving member.
- 17-116. **Magnetic Armature Speaker.** A magnetic armature speaker is a magnetic speaker whose operation involves the vibration of the ferromagnetic circuit. (This is sometimes called an electromagnetic speaker.)
- 17-117. **Condenser Speaker.** A condenser speaker is a loud speaker in which the mechanical forces result from electrostatic reactions.
- 17-118. **Pneumatic Speaker.** A pneumatic speaker is a loud speaker in which the acoustic output results from variation of an air stream.
- 17-119. **Thermophone.** A thermophone is a telephone receiver in which

the temperature of a conductor is caused to vary in response to the current input, thereby producing sound waves as a result of the expansion and contraction of the adjacent air.

### Microphones

- 17-201. Microphone.** A microphone is an electro-acoustic transducer actuated by power in an acoustic system and delivering power to an electrical system, the frequency components in the electrical system corresponding to those in the acoustic system. (This is also called a telephone transmitter.)
- 17-202. Carbon Microphone.** A carbon microphone is a microphone which depends for its operation upon the variation in resistance of carbon contacts.
- 17-203. Condenser Microphone.** A condenser microphone is a microphone which depends for its operation upon variations in capacitance.
- 17-204. Magnetic Microphone.** A magnetic microphone is a microphone whose electrical output is produced magnetically.
- 17-205. Moving Conductor Microphone.** A moving conductor microphone is a magnetic microphone in which the electrical output results from the motion of a conductor in a magnetic field. (The conductor may be given the form of a coil or a ribbon. This device is sometimes called a dynamic microphone.)
- 17-206. Moving Coil Microphone.** A moving coil microphone is a moving conductor microphone in which the movable conductor is given the form of a coil. (This is sometimes called a dynamic microphone.)
- 17-207. Push-Pull Microphone.** A push-pull microphone is a microphone which makes use of two elements functioning 180 degrees out of phase.

### Electromechanical Devices

- 17-301. Phonograph Pick-up.** A phonograph pick-up is an electromechanical transducer actuated by a phonograph record and delivering power to an electrical system, the electrical currents having frequency components corresponding to those of the waves in the record.
- 17-302. Magnetic Pick-up.** A magnetic pick-up is a phonograph pick-

up whose electrical output is generated in a coil or conductor in a magnetic circuit or field.

**17-303. Carbon Contact Pick-up.** A carbon contact pick-up is a phonograph pick-up which depends for its operation upon the variation in resistance of carbon contacts.

**17-304. Condenser Pick-up.** A condenser pick-up is a phonograph pick-up whose electrical output is generated by a mechanical variation of its capacitance.

**17-305. Electrical Phonograph Recorder.** An electrical phonograph recorder is an electromechanical transducer actuated by power in an electrical system and supplying power to a recording mechanical system, the recorded waves produced by the mechanical system having frequency components corresponding to those in the electrical system.

Note—A number of additional definitions pertaining to electro-acoustic devices, of use in measurements and performance considerations, are given in "Performance Indexes of Electro-Acoustic Devices," page 163.

# ABBREVIATIONS AND LETTER SYMBOLS

## GENERAL ABBREVIATIONS

Ordinarily, all words, both technical and otherwise, should be spelled out. Certain circumstances arise, however, such as the headings of columns, the tabulation of data, and a very limited number of other occasions when abbreviations are required. In such unusual circumstances, the following list of abbreviations may be used.

Many of the abbreviations are given in lower case letters. Obviously, however, there will be occasions, such as when the abbreviations are used in titles of columns, where the original word would have been capitalized. In these cases, the abbreviations should be similarly capitalized.

A two-word adjective expression should contain a hyphen.

Term	Abbreviation
Alternating-current (adjective)	a-c
Alternating current (noun)	a.c.
Ampere	a
Antenna	ant.
Audio-frequency (adjective)	a-f
Audio frequency (noun)	a.f.
Continuous waves	cw
Cycle per second	~
Decibel	db
Direct-current (adjective)	d-c
Direct current (noun)	d.c.
Electric field intensity	$\mathcal{E}$
Electromotive force	e.m.f.
Frequency	f
Henry	h
High-frequency (adjective)	h-f
Intermediate-frequency (adjective)	i-f
Intermediate frequency (noun)	i.f.
Interrupted continuous waves	icw
Kilocycle (per second)	kc
Kilowatt	kw
Low-frequency (adjective)	l-f
Magnetic field intensity	H
Megacycle	Mc
Megohm	M $\Omega$
Microfarad	$\mu f$
Microhenry	$\mu h$

Micromicrofarad	$\mu\mu\text{f}$
Microvolt	$\mu\text{v}$
Microvolt per meter	$\mu\text{v}/\text{m}$
Millivolt per meter	$\text{mv}/\text{m}$
Milliwatt	$\text{mw}$
Ohm	$\Omega$
Power Factor	p.f.
Radio-frequency (adjective)	r-f
Radio frequency (noun)	r.f.
Revolutions per minute	r.p.m.
Root-mean-square	r-m-s
Volt	v
Watt	w

#### Abbreviations for Metric Prefixes

Prefix	Abbreviation
centi	c
deci	d
deka	dk
hecto	h
kilo	k
mega	M
micro	$\mu$
milli	m

## LETTER SYMBOLS FOR THERMIONIC TUBE NOTATION

The thermionic tube letter symbols in the 1931 Report of the Committee on Standardization were generally well received. However, the suggested symbols for plate and grid currents and voltages were too incomplete for the use of many engineers. This was especially true of vacuum tube development engineers and others primarily interested in the details of tube characteristics. It is believed that the more elaborate set of symbols given in this report is sufficiently comprehensive for the use of tube engineers, and yet sufficiently simple to meet the requirements of those who do not require a complex notation. The symbols given in this report have been chosen with regard to current practice and are consistent with other standardized letter symbols. In addition to the recommended letter symbols, this report includes a list of proposed generalized symbols for multigrid tubes, as well as proposed symbols for power supply voltages. The proposed symbols are also consistent with the recommended vacuum tube letter symbols and other standardized letter symbols for electrical quantities.

### THERMIONIC TUBE LETTER SYMBOLS

Quantity	Symbol
Instantaneous total grid voltage	$e_c$
Instantaneous total plate voltage	$e_b$
Instantaneous total grid current	$i_c$
Instantaneous total plate current	$i_b$
Average or quiescent value of grid voltage	$E_c$
Average or quiescent value of plate voltage	$E_b$
Average or quiescent value of grid current	$I_c$
Average or quiescent value of plate current	$I_b$
Instantaneous value of varying component of grid voltage	$e_g$
Instantaneous value of varying component of plate voltage	$e_p$
Instantaneous value of varying component of grid current	$i_g$
Instantaneous value of varying component of plate current	$i_p$
Effective or maximum value of varying component of grid voltage	$E_g^-$
Effective or maximum value of varying component of plate voltage	$E_p$
Effective or maximum value of varying component of grid current	$I_g$

Quantity	Symbol
Effective or maximum value of varying component of plate current	$I_p$
Filament or heater terminal voltage	$E_f$
Filament or heater current	$I_f$
Total electron emission	$I_s$
Conductance of electrode $j$	$s_j = \partial i_j / \partial e_j$
Resistance of electrode $j$	$r_j = 1/s_j = \partial e_j / \partial i_j$
Plate conductance	$s_p = \partial i_p / \partial e_p$
Plate resistance	$r_p = 1/s_p = \partial e_p / \partial i_p$
Grid conductance	$s_g = \partial i_g / \partial e_g$
Grid resistance	$r_g = 1/s_g = \partial e_g / \partial i_g$
Transconductance of electrodes $j$ and $k$	$s_{jk} = [\partial i_j / \partial e_k]$ $e_j$ constant
Grid-plate transconductance (mutual conductance)	$s_m \equiv s_{pg} = \left[ \frac{\partial i_p}{\partial e_g} \right] e_p$ constant
Plate-grid transconductance (inverse mutual conductance)	$s_n \equiv s_{gp} = \left[ \frac{\partial i_g}{\partial e_p} \right] e_g$ constant
Mu-factor, electrodes $j$ and $k$	$\mu_{jkl} = - \left[ \frac{\partial e_j}{\partial e_k} \right] i_l$ constant
Amplification factor	$\mu = - \left[ \frac{\partial e_p}{\partial e_g} \right] i_p$ constant
Grid-plate capacitance	$C_{gp}$
Grid-cathode capacitance	$C_{gk}$
Plate-cathode capacitance	$C_{pk}$
Grid-heater capacitance	$C_{gh}$
Plate-heater capacitance	$C_{ph}$
Grid capacitance	$C_g$
Plate capacitance	$C_p$
Cathode capacitance	$C_k$
Conductance for rectification of electrode $j$	$s_j' = \frac{\partial I_j}{\partial E_j}$
Resistance for rectification of electrode $j$	$r_j' = \frac{1}{s_j'} = \frac{\partial E_j}{\partial I_j}$

1. **Currents and Voltages.** Symbols are given for instantaneous total, average or quiescent, instantaneous varying component, and effective or maximum varying component values of grid and plate currents and voltages. When unvarying voltages alone are applied to the grid and plate, the instantaneous and average or quiescent values are identical. In these cases it is suggested that the symbols for the average or quiescent values be used, reserving the instantaneous symbols for use when the voltages are varying.

When current, voltage, and power vary with time, lower-case italics should be used for the instantaneous values, and capital italics for average or quiescent values. The capital letters may be used to designate either maximum, effective, average, or quiescent values. When necessary to distinguish between the maximum and effective values, the subscript  $m$  may be added to indicate maximum values, as,  $E_{pm}$ . When necessary to distinguish between average and quiescent values, the subscript  $o$  may be added to indicate quiescent values, as  $E_{bo}$ .

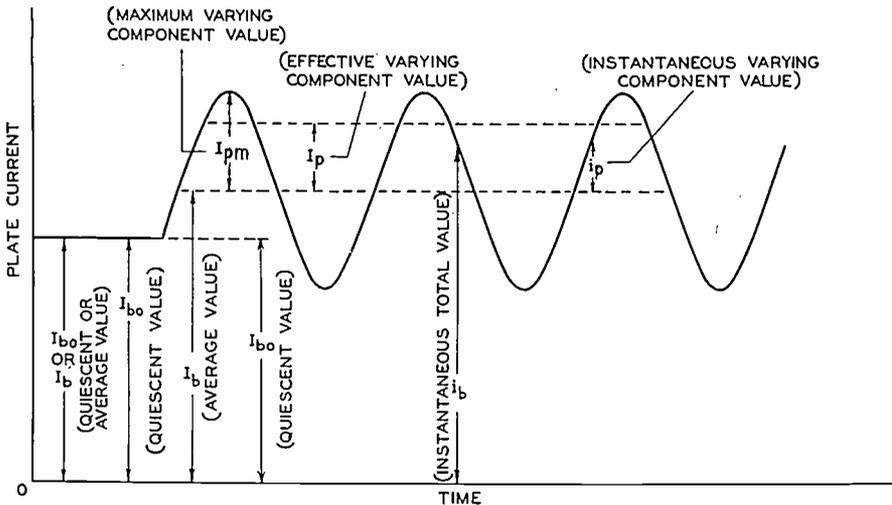

FIG. 1

2. **Vector Quantities.** In alternating-current circuit equations, bold-face italics may be used for complex or vector quantities. In typing, where it is desired to distinguish italics from Roman letters, under-scoring may be employed to indicate italicized letters and wavy under-scoring to indicate bold-face letters.

3. **Frequency Designation.** Whenever it is necessary to restrict the use of a quantity to a particular frequency, the quantity may be enclosed in parenthesis, and the frequency distinguished by a subscript outside the parenthesis; e.g.,  $(Z_b)_{2p+q}$  as indicating external plate impedance at the angular velocity  $2p+q$ .

In order to illustrate the use of the symbols given in this report, a diagram of the plate current of a tube with a small alternating-current input is given with the letter symbols properly indicated.

## PROPOSED GENERALIZED SYSTEM OF SYMBOLS FOR MULTIGRID TUBES

A general scheme of symbols for multigrid tubes is suggested which will avoid the extension of letter subscripts and which provides a framework of symbols for tubes with any number of grids. In this system the grids are numbered according to position, the grid immediately adjacent to the cathode or filament being No. 1, the second grid, No. 2, and so on. In designating the voltages or currents associated with a particular grid, the symbols given on the preceding pages will be used with the grid number used as a subscript. Thus for a screen-grid tetrode, the grid letter symbols would be as follows:

Instantaneous total control-grid voltage	$e_c$ or $e_{c1}$
Instantaneous total screen-grid voltage	$e_{c2}$
Average or quiescent value of control-grid voltage	$E_c$ or $E_{c1}$
Average or quiescent value of screen-grid voltage	$E_{c2}$

Control-grid symbols are frequently used where no other grids are referred to. The number of the subscript need not be used in this case. It will be understood that, when no number appears in the subscript, the control grid is referred to.

## PROPOSED SYSTEM OF SYMBOLS FOR TUBE POWER SUPPLY VOLTAGES

The following symbols are suggested where it is desirable to indicate the supply voltages of vacuum tube elements:

Plate supply voltage	$E_{bb}$
Control-grid supply voltage	$E_{cc}$ or $E_{c1}$
Screen-grid supply voltage	$E_{cc2}$
Filament or heater supply voltage	$E_{ff}$

## LETTER SYMBOLS FOR PHOTOTUBES

Quantity	Symbol
Current	$I, i$
Voltage at terminals	$E, e$
Monochromatic sensitivity	$S = \frac{1}{\Phi_\nu} \frac{\partial i}{\partial \nu}$
Total sensitivity (radiant flux)	$S = i / \Phi$
Total luminous sensitivity	$S_F = i / F$
Tungsten sensitivity	$S_T = i / F$
2870 Tungsten sensitivity	$S_{2870} = i / F$
Variational conductance	$s = \frac{\partial i}{\partial e}$
Variational resistance	$r = \frac{\partial e}{\partial i}$
Conductance per lumen	$s_F = \frac{1}{F} \frac{\partial i}{\partial e}$
Photo-voltage coefficient	$\frac{\partial i}{\partial F} / \frac{\partial i}{\partial e}$
Radiant flux	$\Phi, \phi$
Luminous flux	$F, f$
Average radiant flux between $\nu$ and $\nu + \Delta\nu$	$\Phi_\nu$
Average luminous flux between $\nu$ and $\nu + \Phi\nu$	$F_\nu$
Visibility	$K_\nu = F_\nu / \Phi_\nu$

STANDARD GRAPHICAL SYMBOLS USED IN RADIO

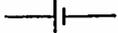
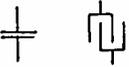
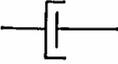
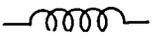
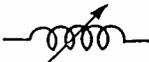
Antenna	
Ammeter	
Arc	
Battery (positive electrode indicated by the long line)	
Condenser, Fixed	*  
Condenser, Fixed, Shielded	
Condenser, Variable	
Condenser, Variable (moving plate indicated)	
Condenser, Variable, Shielded	
Counterpoise	
Crystal Detector	
Galvanometer	
Ground	
Inductor	
Inductor, Variable	

\* Preferred symbol for radio purposes.

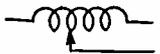
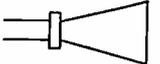
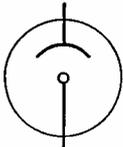
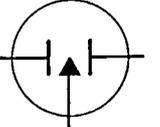
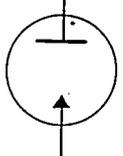
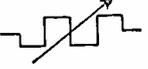
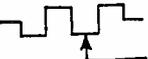
Inductor, Adjustable (by steps)	
Inductor, Iron Core	
Jack	
Key	
Loop Antenna	
Loud Speaker	
Microphone (Telephone Transmitter)	
Phototube	
Piezo-Electric Plate	
Rectifier Tube, Full-Wave (with cold cathode)	
Rectifier Tube, Half-Wave (with cold cathode)	
Resistor	*  
Resistor, Variable	*  
Resistor, Adjustable (by steps)	*  

\* Preferred symbol for radio purposes.

Spark Gap, Rotary



Spark Gap, Plain



Spark Gap, Quenched

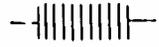

Telephone Receiver

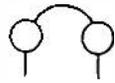

Thermionic Tubes

Diode (Half-Wave Rectifier)  
(with directly heated cathode)

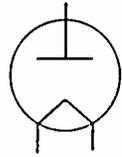

Full-Wave Rectifier  
(with directly heated cathode)

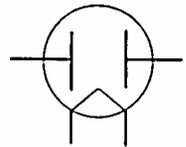

Triode  
(with directly heated cathode)

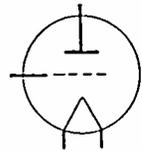

Triode  
(with indirectly heated cathode)

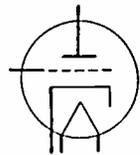

Tetrode  
(with directly heated cathode)

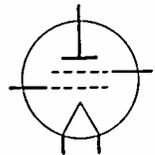

Screen-Grid Tube  
(with directly heated cathode)

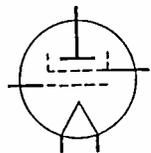

Screen-Grid Tube  
(with indirectly heated cathode)

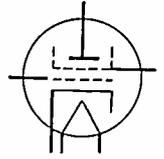

Pentode  
(with directly heated cathode)

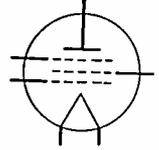

Thermoelement

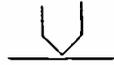

Transformer, Air Core

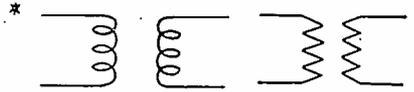

Transformer, Iron Core



Transformer, Variable Coupling

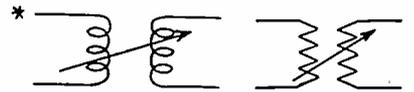

Transformer, Variable Coupling  
(moving coil indicated)

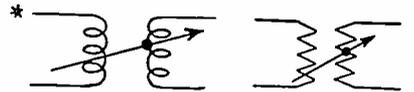

Voltmeter



Wires, Joined

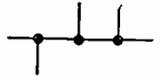

Wires, Crossed, not Joined



\* Preferred symbol for radio purposes.

# METHODS OF MEASUREMENT AND TESTS

## TENTATIVE SUGGESTED METHODS OF TESTING AND RATING RADIO TRANSMITTERS AND ANTENNAS

### Introduction

The purpose of this part of the report of the Standards Committee is to discuss, in a preliminary manner, the various factors which must be taken into consideration in specifying the performance of vacuum tube transmitters and antennas.

On account of its preliminary nature, the report has many obvious omissions and some of the subjects are treated inadequately. In view of the rapidly changing state of the art it does not seem desirable to suggest definite requirements at the present time. It is hoped, however, that this report will be useful in drawing attention to the major factors involved and that it may serve as a basis for the ultimate formulation of criteria of satisfactory transmitter and antenna performance.

### I. Transmitters

#### A. Power Rating

##### 1. GENERAL DEFINITION

The power rating of a radio transmitter is the power in watts available at the output terminals of the transmitter when the output terminals are connected to the normal load circuit or to a circuit equivalent thereto.

##### 2. RATING OF AMPLITUDE MODULATED TRANSMITTERS

The power rating of a modulated transmitter should apply to the unmodulated condition. An additional rating should be given specifying its modulation capability for the type of service involved.

##### 3. RATING OF CONTINUOUS WAVE TELEGRAPH TRANSMITTERS

A continuous wave telegraph transmitter should be rated by the power delivered with the key closed.

It does not follow that the transmitter need be able to withstand having the key closed for any great length of time. It is considered good engineering practice to design transmitters with a safety factor such that the transmitter will be capable of withstanding the key closed condition for a period long enough to permit tuning to be accomplished.

In telegraph service the key may be considered closed one half of the time, in so far as loading, from the standpoint of temperature rise of component parts, is concerned.

#### 4. METHODS OF POWER MEASUREMENT

There are several methods of measuring the radio-frequency power delivered by a transmitter. The following are typical methods of measurement:

##### a. Current-Resistance Method.

In this method the current through a known resistance is measured, a thermoammeter and noninductive resistor being the measuring instruments generally employed. This method lends itself well to the measurement of small amounts of power.

##### b. Photometric Method.

In this method a lamp filament heated to incandescence provides the resistive load. The direct-current or alternating-current power required to heat a similar lamp to the same brightness is a measure of the radio-frequency power dissipated in the load. This method is useful for the measurement of power up to a few kilowatts.

##### c. Calorimeter Method.

In this method of measurement a noninductive resistor carrying the radio-frequency power is cooled by water or other liquid surrounding and passing over it. The power dissipated is then calculated from the temperature rise, rate of flow measured in mass per unit time, and specific heat of the cooling fluid. This method is most advantageous for powers above two kilowatts.

##### d. Anode Dissipation Method.

In this method, which is applicable only in the case of transmitters using water-cooled tubes, the total power delivered to the filament and plate circuits is measured. The power dissipated by the cooling fluid is also observed and the difference between this and the total power delivered to the filament and plate circuits gives the sum of the radio-frequency power delivered by the transmitter into its load circuit, and the loss in the output or coupling circuits. The latter is usually relatively small and can be estimated by repeating the observations with the load disconnected. This method is particularly applicable to the measurement of higher powers at high frequencies where suitable resistance loads are not readily available. It has the advantage that measurements may be made while the transmitter is in service.

## B. Spurious Radiations

### 1. CLASSIFICATION

Any radiation from a radio transmitter, the frequency of which is outside the communication band of the transmitter, is considered spurious. The term will, therefore, include the following:

- a. Any component whose frequency is an integral multiple or sub-multiple of the carrier frequency (harmonics and subharmonics).
- b. Spurious modulation products.
- c. Key clicks and other transient effects.
- d. Parasitic oscillations which bear no definite relation to the operating frequency and which sometimes occur in poorly designed or improperly adjusted transmitters.

## 2. CONDITIONS FOR MEASUREMENT

Since many radio transmitters are designed for operation with particular antenna arrays and frequently for particular locations, measurements of spurious radiation are preferably made with the transmitter installed in its permanent location and working under normal conditions of power, modulation, etc.

## 3. HARMONICS AND SUBHARMONICS

Measurements of harmonics and subharmonics can best be made with a suitable field intensity measuring device which permits the desired frequency spectrum to be covered. The Committee on Broadcasting of the Institute of Radio Engineers<sup>1</sup> has already recommended that such measurements be made at a specified distance, say one mile from the transmitter, and that the harmonics be expressed in terms of harmonic field intensities and of percentages representing the ratio of the intensity of each harmonic to that of the fundamental at the same distance. This method is applicable down to the lowest radio frequencies but as discussed below its use at high frequencies may be misleading from the standpoint of interference.

In the case of high power transmitters the absolute values of the field intensities of the harmonics are more significant than the relative values. Owing to the irregularity of field intensity patterns such measurements should be made at several points about the station, all at the same distance and with approximately equal angular separation. The number of points taken should be large enough to make a suitable plot of any directional pattern which may exist in the harmonic radiation. The maximum value of the harmonic percentage and the maximum absolute value at a specified distance, as obtained by field intensity measurements, may be considered as indexes of the harmonic radiation. The relative value does not have significance in the case of transmitters with directional antennas.

Attention is called to the fact that when the harmonic frequency is sufficiently high (for example, 10,000 kc) measurements made on

<sup>1</sup> Reports of I.R.E. Committee on Broadcasting, Proc. I.R.E., vol. 18, p. 15; January, (1930).

harmonics at the surface of the earth a short distance from the transmitter are not necessarily significant from the standpoint of the interfering effect. These high frequencies are strongly absorbed in transmission along the surface but in directions elevated above the horizontal plane the field may be greater with resultant interference at greater distances. This effect may be accentuated by accidental directional effects which may become marked when the wavelength of the harmonic is small compared with the dimensions of the antenna. The question of interference from such harmonics may be considered in two parts: the development of a method for measuring the harmonic power put out by a transmitter, without regard to how it is radiated; and the determination through extended experience of a value such that if the harmonic is kept always below this value the probability of interference being produced is satisfactorily small.

A method of determining the harmonic power output consists of comparing, by means of a sufficiently selective measuring set, the unknown harmonic power which is present with the fundamental, to a known power of the same frequency as the harmonic which is supplied and measured in the absence of the fundamental. This method is directly applicable when the load system involves a single wire line with ground return.

The method may be readily extended to apply to the case of a two-wire load system which is approximately symmetric about ground. Here two modes of propagation must be considered: the series or push-pull mode, and the parallel or longitudinal mode which employs the ground return. The receiving set must be capable of distinguishing between the two modes. This may be done by the use and proper orientation of a shielded pick-up loop, similar to that used at longer waves in direction-finding equipment. It is also necessary that the source of substitution power be capable of supplying power in either mode alone.

In some special cases, such as that of airplane transmitters, it is not feasible to make tests under operating conditions. In such cases it may be helpful to make a frequency analysis of the harmonic output into an artificial antenna or to take observations of the harmonics around a model antenna, making such corrections as may seem desirable in view of the shortcomings of the model.

In the case of a transmitter designed to cover a range of frequencies, data should be taken for several points in the operating range.

#### 4. KEY CLICKS

The term key clicks is understood to mean those components of telegraphic radiation which are set up as transients by the opening or

closing of the signaling key and which are not essential for communication. They cover a band of frequencies extending above or below, or both above and below, the normal band of emission. They may be produced by an unnecessarily abrupt rise or fall of the current amplitude with keying, or by a transient shift of phase or frequency. The term key clicks, as used here, does not of course include the normal radiations due to the necessity of increasing the abruptness of current changes in the signaling circuit in order to secure satisfactory telegraph keying at very high speeds. The width of this band of spurious radiation varies under different circumstances, and the intensities of the radiation in different parts of the band may also vary. Cases have been observed where a considerable frequency interval exists between the band of frequencies occupied by the key click radiation and the normal communication band of emission of the transmitter. Due to the transient nature of key clicks, their total power averaged over a long period may be small although their interfering effect may be considerable due to high instantaneous amplitudes.

Generally, the conditions favorable to the production of key clicks, capable of causing interference, are due either to equipment of improper design, or to incorrect adjustments. Therefore, they should not be encountered where adequate precautions in these respects have been observed.

For the purpose of obtaining quantitative results in cases where work is being done to eliminate this source of interference, relative values of the interfering signal may be determined by making a comparison of the loudness of the key clicks with the intensity of a source of interference whose field intensity is adjustable and can be measured. This interference may be supplied by a local modulated oscillator.

Further work on standard methods of measuring interference due to key clicks is desirable. One of the main points to emphasize at this time is that the interfering effect of key clicks is much greater than would be expected from the total power in them.

## 5. HIGHER ORDER MODULATION PRODUCTS

Modulation in transmitter amplifiers produces not only harmonics of the frequencies being amplified but also other frequency components which may fall either within or outside of the communication band and thus may cause interfering effects. These products are due to the presence in the amplifier characteristic of terms of higher order than the second and are, therefore, called higher order modulation products. The higher order products falling within the communication band are discussed under Distortion, section I-F-1, page 62.

The higher order modulation products of a telephone transmitter may be measured in the same manner as key clicks, particularly when speech is being transmitted. In this case the procedure may be similar to that described in the preceding section, except that steady speech modulation is substituted for keying. For more accurate determination two equal tones whose total amplitude is equivalent to that of the speech may be applied simultaneously to the transmitter. The higher order products which result in this case are steady oscillations whose intensities may be measured.

## 6. PARASITIC OSCILLATIONS

Parasitic oscillations are due to faulty design or to improper operation. They should not be present in any commercial operating system. There appears to be no object in including a statement of their magnitude in a transmitter rating.

### C. Frequency Tolerance

#### 1. DEFINITION

As applied to a radio transmitter, the term frequency tolerance is defined as the extent to which the frequency of the station may be permitted to vary on either side of the frequency assignment.

#### 2. GENERAL

It should be recognized that the frequency generating system of some radio transmitters is of such design as to permit frequency maintenance to within close limits over a long period of time without adjustment, while in other transmitters the frequency is compared at intervals against a standard frequency and adjustments made if necessary. In checking station frequencies care should be taken that the measurements cover a length of time sufficient to include a large number of cycles of any recurrent deviation in order that the over-all performance of the transmitter as regards frequency variation may be determined. In specifying the frequency deviation of any particular transmitter information should be given which leaves no ambiguity as to its performance at any time during operation. It is also desirable to specify the means used for maintaining the frequency constant.

The measurement of frequency resolves itself into a procedure by which oscillations are counted for an accurately determined time interval. It should be borne in mind that present practice, except in special types of service, demands a high degree of precision in maintaining the transmitter frequency. In cases where the transmitter is maintained at constant frequency by reference to a frequency meter it is

advisable, therefore, that the meter should be referred at intervals, either directly or indirectly, to the mean solar second.

### 3. FREQUENCY MEASUREMENT

Meters suitable for the measurement of frequency with the required precision and methods of frequency measurement are dealt with in the section entitled, "The Measurement of Radio Frequency," page 185.

#### D. Operational Stability

##### 1. STABILITY AS RELATED TO ABNORMAL OPERATION

Spurious oscillations may be set up in a transmitter by improper setting of neutralizing condensers, improper location of adjustable coils, improper coupling to load, etc. Maladjustments of a lesser degree may cause abnormal operation without necessarily affecting the frequency. For example, a change in antenna impedance, due to weather conditions, may cause an unusually large or small amount of power to be delivered to the antenna. It may so change the impedance relations within the transmitter as to cause bad distortion. Similar results may come about from other causes, such as fluctuation of supply voltages, changes in resistance due to high temperature coefficients, carelessness in operation of the equipment, etc.

##### 2. DETERMINATION OF DEGREE OF OPERATIONAL STABILITY

The stability of a transmitter means, in a general way, its tolerance toward such maladjustments as are described above. In view of the present rate of development of the art, operational stability is incapable of definition or measurement in quantitative terms. A standard method of describing stability, however, would be of considerable use, both in comparing individual transmitters or types of transmitters, and in recording the progress of the art. Tentatively, the stability of a cw telegraph transmitter may be described in terms of the amount of maladjustment of particular elements required to produce certain changes in the power output. The stability of a telephone transmitter may be described in terms of the amount of maladjustment required to produce a certain amount of distortion in the side bands. In making tests for comparative purposes very simple criteria may be used, even though the maladjustments they entail would not actually be tolerated in commercial operation. For example, the variation in neutralizing capacity required to produce oscillations in an amplifier, the variation in a damping resistance required to produce spurious oscillations, or the variations in load impedance required to change the power output by a factor of two, may provide useful information to the engineering personnel in charge of a transmitter, although optimum adjustments

would be maintained during the normal operation of the transmitter.

In cases where facilities are available for more detailed tests, more stringent criteria may be used, for example, the amount of maladjustment required to increase the ratio of higher order side frequency amplitude to fundamental side frequency amplitude by a given amount.

## E. Amplitude Modulation

### 1. PERCENTAGE MODULATION

Percentage modulation is defined as the ratio expressed in per cent, of the maximum departure (positive or negative) of the envelope of a modulated wave from its unmodulated value, to its unmodulated value.

Percentage modulation is generally determined by measuring the instantaneous value of peak voltages either of the radio-frequency oscillations or of the rectified signal wave. Measurements made in this way may be vitiated by the presence of harmonics, especially under conditions of overloading. If the peak voltages are measured by means of oscillograph records these disturbing factors are of course apparent. The use of an oscillograph is difficult outside of a laboratory and it is therefore convenient to define a quantity which may be called the effective percentage modulation which, in the absence of distortion, is equivalent to percentage modulation but which is more convenient to measure.

### 2. EFFECTIVE PERCENTAGE MODULATION

Effective percentage modulation, as applied to the modulation of a carrier by a single sinusoidal signal wave, is the ratio of the amplitude of the fundamental component of the envelope to the amplitude of the carrier expressed in per cent. For the case of modulation by a simple sinusoidal wave, in the absence of distortion, it is evident that percentage modulation and effective percentage modulation as defined above are identical. Effective percentage modulation, as applied to the modulation of a single carrier by two or more sinusoidal signal waves, is the sum of the effective percentages associated with the individual signal waves, each measured in the presence of the others.

### 3. EFFECTIVE PERCENTAGE MODULATION AS APPLIED TO SPEECH

The definition of effective percentage modulation as applied to speech necessarily involves some arbitrary qualifications.<sup>2</sup> It is neither

<sup>2</sup> In the absence of a more fundamental method, that described here is thought to be justified by its simplicity and convenience. In view of the complex nature of speech, the variety in transmitter characteristics and the lack of standardization of power level indicators, an entirely satisfactory discussion of this subject is impossible at this time.

easy nor significant to apply the first stated definition to any particular syllable of extended speech. Speech intensity may be measured by means of power level indicators, a number of which are commercially available. These power level indicators give a measure of the average speech energy in arbitrary units and are capable of reproduction. Very good correlation with regard to distortion is obtained between the behavior of speech and of two tones of equal intensity which give the same reading on the power level indicator as the speech. Effective percentage modulation as applied to speech, therefore, may be taken as equivalent to that for two tones of equal intensity. The volume indicators measure the speech power, while percentage modulation is concerned with peak amplitudes. Two tones, the sum of whose amplitudes is double that of either, have together only twice the power of either. To obtain this double amplitude by a single tone involves multiplying the power by four. This gives a power ratio of two. Hence, the effective percentage modulation for speech may, without change of meaning, be defined as being the same as that for a single tone whose power reading on the power level indicator is double that of the speech.

#### 4. METHOD OF MEASUREMENT

Rectifiers suitable for making measurements of percentage modulation and effective percentage modulation are shown in Figs. 1 and 2.

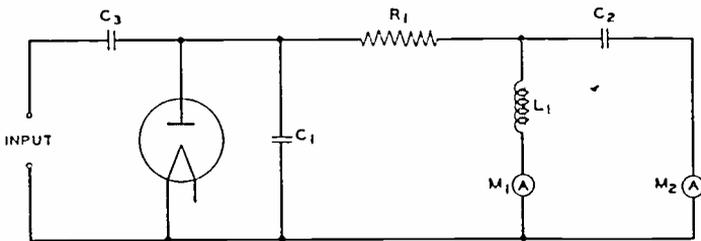

Fig. 1. Monitoring rectifier.

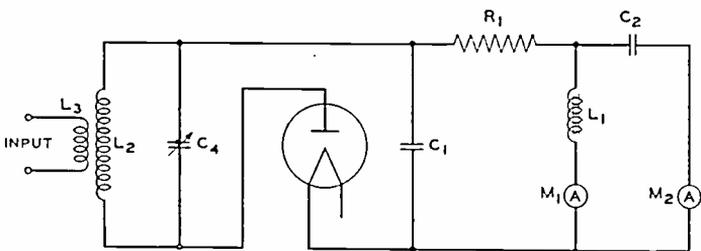

Fig. 2. Monitoring rectifier.

Both are essentially vacuum tube peak voltmeters which reproduce the carrier envelope.

The source of voltage to be measured is connected as in Fig. 1 if that source presents a high impedance at speech frequencies, or as in Fig. 2 if it presents a low impedance at speech frequencies. The impedance of  $R_1$  is high compared to the internal impedance of the tube when it is conducting. Compared to that of  $C_1+C_2$  the impedance of  $R_1$  is also high at the carrier frequency and low at speech frequencies. The current through  $R_1$  is, therefore, proportional to the amplitude of the radio-frequency voltage and follows variations in it at an audible rate. Since the instrument operates on peak voltages it reproduces the envelope of the radio-frequency wave and provides a detector of very satisfactory fidelity. Measurements of percentage modulation may be obtained by recording the instantaneous values of the current in  $R_1$  by means of an oscillograph.

Effective percentage modulation may be measured with simpler instruments. By means of the arrangement shown in Figs. 1 and 2, the direct-current and alternating-current components may be separated and measured by means of the ammeters  $M_1$  and  $M_2$ .  $M_2$  may be any of the usual forms of alternating-current measuring instruments for high frequencies such as a thermocouple or a low impedance vacuum tube voltmeter or a direct-current milliammeter used with a copper oxide rectifier. The net impedance of the circuit to the right of  $R_1$  should be either independent of frequency or small compared to  $R_1$ .

For modulation by a single tone the effective percentage modulation is  $100\sqrt{2} I_2/I_1$ , where  $I_1$  is the direct current and  $I_2$  the r-m-s. value of the alternating current. For  $n$  equal tones the effective percentage modulation is  $100\sqrt{2n} I_2/I_1$ . The effective percentage modulation for speech is best determined by substituting a steady tone equivalent to the speech as discussed above and making measurements as outlined above on this tone.

## 5. CARRIER NOISE

Commutator ripple, alternating-current hum, and other carrier noise may be expressed either in terms of percentage modulation or in decibels below 100 per cent modulation. It is preferable to express the noise in decibels below the maximum serviceable modulation of the transmitter, instead of below 100 per cent modulation, in order to take into account modulation capability.

## F. Distortion

### 1. CLASSIFICATION

Distortion as applied to modulation in a radio transmitter involves at least three important types:

- a. Distortion due to frequency discrimination, or differences in the

relative magnitudes of the components of a wave at different frequencies.

b. Distortion due to a nonlinear amplitude characteristic.

c. Distortion due to phase or frequency modulation, in which the carrier frequency, while maintaining a constant average value, varies within the speech frequency cycle.

## 2. NONUNIFORM TRANSMISSION AT VARIOUS AUDIO FREQUENCIES

This type of distortion is determined by comparing the percentage modulation at various audio frequencies for constant input. It is desirable that the input be about the same amplitude as in normal operation. The term fidelity is often used in this connection.

## 3. DISTORTION DUE TO NONLINEAR AMPLITUDE CHARACTERISTIC

Nonlinear distortion may be studied through the analysis of an oscillographic record. Simpler and more rapid ways involve the use of audio frequency filters. In one method a single modulating tone is first passed through a filter to suppress harmonics and is then applied to the transmitter. Some of the transmitter output is picked up and passed through a good linear detector, such as is described in section I-E-4, page 61. The output of the detector is effectively a measure of the fundamental except in cases of unreasonable distortion. The output of the detector is then passed through a high-pass filter which suppresses the fundamental, and the measure of the resultant output power gives the root-sum-square of the various harmonic components. For more detailed work, several band-pass filters may be used and the harmonics may be measured individually. This method is applicable only to amplifiers, simple modulation and detection systems, etc., since in cases which involve such operations as frequency inversion or single side band modulation the harmonic relation is destroyed at various points in the equipment.

Of more general application is a method in which two equal tones, of frequencies  $p$  and  $q$ , are impressed on the transmitter, and the distortion products are compared with the fundamentals at the output. It is usually convenient and satisfactory to measure only two representative distortion products: the second order product,  $p-q$ , and the third order product,  $2q-p$ . It is well to choose fundamentals and distortion products which lie in the important part of the transmitted frequency, since this avoids the question of frequency discrimination. For example, for speech frequencies, 1000 cycles and 1400 cycles are suitable for fundamentals and give 400 cycles and 600 cycles as the distortion products to be measured.

#### 4. DISTORTION DUE TO PHASE OR FREQUENCY MODULATION

Frequency or phase modulation may be a troublesome source of distortion in radio transmission when the signal simultaneously passes to the receiver over two paths of different lengths. It is well known that under such circumstances stability of the carrier frequency is very important. It is not necessary to discuss the distinction between phase modulation and frequency modulation. Obviously these terms refer respectively to variations during the audio cycle of phase and frequency, i.e., these quantities, as well as the amplitude, may be modulated. In this discussion these variations will be of concern only as a source of distortion. The simplest method of measuring phase modulation is by means of the oscillograph. The radio frequency is modulated by a low audio frequency (say one hundred cycles) and it is then heterodyned down to an audible frequency which is ten or more times the modulating frequency (say one thousand cycles). Precautions must be taken to have the frequency of the beating or heterodyne oscillator constant. This audible frequency is impressed on one element of an oscillograph, and a timing wave is applied to a second element. An oscillogram is taken and the distances along the time axis where the trace crosses the zero input line in the positive direction are measured with a microcomparator. For the frequencies assumed, a two-hundred cycle high-pass filter is needed to keep the rectified one-hundred-cycle current out of the oscillograph. The phase shift of the beat note during the audio cycle is the same in angular measure as that in the high-frequency wave. By comparing the actual intersections with those which would have occurred in the absence of phase modulation the maximum deviation,  $k$ , of the phase may be obtained in radians. If the deviation in phase is also simple harmonic the frequency modulation is then  $ka$ , where  $a$  is the audio modulating frequency, in this case one hundred. Various refinements of the method are of course possible.

## II. Antennas

In dealing with methods of testing and rating antennas it is convenient to recognize two major classifications, viz., those antennas whose dimensions are less than a half wavelength and those whose dimensions are of the order of a half wavelength or more. It is recognized that this division is somewhat arbitrary, and that there is no obvious line of demarcation. The first class includes most antennas used at low and intermediate frequencies. In the second class fall most high-frequency antennas.

## A. Antennas whose Dimensions are Small Compared to the Wavelength (Low-Frequency Antennas)

### 1. CLASSIFICATION

This class includes most of the conventional types of low-frequency antennas, such as the inverted L type, the T type, the umbrella type and the multiple tuned antenna. The aerial conductors may consist of one or several wires or wire cages.

### 2. NATURAL FREQUENCY

The natural frequency is defined as the lowest resonant frequency of an antenna without added inductance or capacitance. It is usually measured by means of a loosely coupled oscillator and an absorption type frequency meter.

### 3. STATIC CAPACITY

The static capacity of the antenna is that which is measured with direct current or low frequencies. In making the measurement it is often important to eliminate or correct for the effect of leakage currents.

### 4. EFFECTIVE CAPACITY AND INDUCTANCE

The effective (or equivalent) capacity and inductance at a given frequency are the lumped values of capacity and inductance which, when connected in series, give the same series reactances for frequencies near the given frequency, as does the antenna itself. The effective capacity and inductance may be calculated from two readings of the observed resonant frequency with inductances  $L_1$  and  $L_2$  successively inserted in series with the antenna, by the use of the following formulas:

$$C_a = \frac{\frac{1}{\omega_1^2} - \frac{1}{\omega_2^2}}{L_1 - L_2}, \quad (1)$$

and,

$$L_a = \frac{L_1\omega_2^2 - L_2\omega_1^2}{\omega_2^2 - \omega_1^2}, \quad (2)$$

where,

$\omega_1$  is  $2\pi \times$  frequency (in cycles per second) at which the inductance in henries of  $L_1$  is measured, and

$\omega_2$  is  $2\pi \times$  frequency (in cycles per second) at which the inductance in henries of  $L_2$  is measured.

The values of  $C_a$  and  $L_a$  are in farads and henries, respectively.

$f$  is the frequency in kilocycles,  
 $d$  is the distance in kilometers from the antenna at which  $\mathcal{E}$  is measured, and  
 $I$  is the antenna current.

It is assumed here that  $d$  is sufficiently small for absorption attenuation to be negligible. To assure this condition and at the same time to minimize errors due to the direct field from the antenna, it is preferable to make field strength measurements from 2 to 5 wavelengths from the antenna. In many cases it is found that the antenna has inherent directional effects. In order to take account of these effects it is necessary to make measurements in different directions from the antenna.

If absorption attenuation is not negligible it is necessary to introduce in the formula for the field intensity an absorption factor depending on the particular frequency and terrain being considered. In this case the above formula may be written thus:

$$\mathcal{E} = \frac{1.25IfhA}{d}, \quad (13)$$

from which,

$$h = \frac{\mathcal{E}d}{1.25IfA}, \quad (14)$$

where  $A$  is the absorption factor. Under certain conditions the absorption factor given by the Austin-Cohen formula may be used.

$$A = e^{-\alpha d \sqrt{f/300}}$$

where,

$e$  is the base of natural logarithms,  
 $d$  and  $f$  are as defined above, and  
 $\alpha$  is an absorption constant.

The following are approximate average values of the absorption constant  $\alpha$  for various types of terrain:

Sea water	0.0015
Fresh water	0.0025
Moist farm land, without rocks or sand	0.02
Gravelly, sandy loam	0.03
Dry sand	0.07
Dry sand, wooded	0.09

It should be emphasized that care must be taken in the use of these constants, especially in the case of overland measurements, and that

little reliance can be placed on the results if the absorption factor  $A$  departs very much from unity. Often the most satisfactory procedure is to take field intensity readings at two or more distances and solve for the effective height, or the meter-amperes ( $hI$ ), and the absorption factor simultaneously.

## B. Antennas whose Dimensions are of the Order of a Half Wavelength (High-Frequency Antennas)

### 1. GENERAL

The present discussion is confined to tests such as may be useful in examining the performance of a high-frequency directional antenna. While this subject is hardly ready for standardization, agreement regarding tests which have thus far proved useful may be helpful in approaching a standard test procedure.

The transmission line (if any) connecting the transmitting set with the radiating structure is usually regarded as part of the antenna. The tests to be described may be made with or without the line.

### 2. DEFINITIONS

#### a. Antenna Array.

An antenna array is a system of elemental antennas usually similar, excited by the same source, for the purpose of obtaining directional effects.

#### b. Broadside Array.

A broadside array is an array whose elements are arranged along a horizontal line, the currents in all the elements being in the same phase. Such an array has its maximum radiation in a direction perpendicular to the line of the array.

#### c. Tier.

An array is said to be arranged in tiers if it is made up of rows of elements placed one above another.

#### d. Reflector or Pseudoreflector.

A reflector or pseudoreflector is part of an antenna array not directly connected to the source of power, but deriving its power from the other parts of the array, and so designed as to increase the signal in one direction at the expense of that in the opposite direction.

#### e. Exciter.

In a directional system as defined in (d), an exciter is the section of the array connected directly to the source of power.

f. Gain of an Array.

The ratio of the power supplied to a standard comparison antenna to the power supplied to the directional antenna array when the signals at the distant terminal are equal is called the gain of the array.

g. Plane of Polarization of a Wave.

The plane perpendicular to the wave front and parallel to the electric vector of the wave is the plane of polarization of a wave.

Note—This is different from the convention used in optics, but for radio work it seems more logical and is already in general use among engineers.

### 3. TESTING FACILITIES

Some of the more special facilities for testing are the following:

a. Source of High-Frequency Power.

The source of high-frequency power may be a simple electric oscillator provided with adjustments sufficiently flexible to permit efficient coupling to loads having a wide range of impedance.

b. Field Intensity Comparison Equipment.

For making comparisons of field intensity a receiver capable of making a quantitative comparison of two signals is needed. A superheterodyne (double detection) receiver having a calibrated attenuator in the intermediate-frequency circuit is satisfactory. It is sometimes desirable to provide a field intensity measuring set capable of making absolute measurements in microvolts per meter, although this is usually not essential.

c. Comparison Antenna.

In the development of directional antennas and in the study of radio transmission there arises a need for a standard basis of comparison in terms of which the merit of the antenna can be expressed. This comparison may be satisfied by the use of a half-wave antenna which is alternated in the test with the antenna being studied. In antenna studies it is desirable to have the polarization of the two antennas the same and the height of the center of the comparison antenna one wavelength above the ground. In radio transmission studies the vertical half-wave antenna with its center a half wavelength above the ground is more readily available. It should be emphasized, however, that transmission phenomena are generally so complicated that it is not possible to specify any antenna which may be accepted as a standard in the ordinary sense. A statement of the results of a comparison should therefore include a specification of the comparison antenna used. The results may be given as the gain of the antenna under test with respect to the comparison antenna.

## 4. IMPEDANCE TEST

Only the important special case of impedance measurement in which the antenna input has previously been tuned, making the input impedance resistive, will be considered. This condition is obtained when the antenna input leads form a smooth line, the terminals being chosen at a current node or antinode. The input resistance,  $R_a$ , can then be obtained by the use of a second section of smooth line whose length is a quarter wavelength and whose characteristic impedance,  $Z_0$ , is any convenient value. The second section of smooth line is connected between the antenna input leads and the source of power. A device for measuring current or voltage is used at each end of the auxiliary line. If the currents or voltages so read are designated  $I$  or  $E$ , and subscripts  $s$  and  $r$  are used to denote, respectively, the ends of the line nearer to and more remote from the transmitter, the antenna impedance is given by the expressions,

$$Z_r = \frac{Z_0 I_s}{I_r} = \frac{Z_0 E_r}{E_s} \quad (15)$$

## 5. RADIATION TESTS

## a. General.

In measuring the effective radiation of an antenna array, the ideal method of test would involve an absolute determination of the radiation in any specified direction. Usually, however, the relative radiation in a specific direction is the important factor under consideration and recourse is had to comparison of the radiated field in this direction with that from a standard antenna.

For remote point tests, not involving the ground wave, the comparison with a standard vertical antenna gives significant results even when the short-wave structure under test emits horizontally polarized radiation. Usually, if not always, the polarization of a wave as it arrives from the ionized upper atmosphere is no indication of its polarization at the beginning of its journey. Remote point transmission tests are generally of more significance than are tests made locally.

For local tests the half-wave antenna is also useful, in particular when the structure under observation is a broadside array of elements similar to the standard and having a similar directional pattern in the vertical plane through the direction of transmission. When the components of the array differ from the standard, caution is needed in interpreting results. It is obviously impossible to employ the vertical standard in local tests in connection with antennas which radiate waves of horizontal polarization.

### b. Frequency Characteristics.

The purpose of the frequency characteristic test is to determine that the antenna is properly adjusted to the operating frequency. The test involves a variation of the frequency over a narrow band around the operating value. Proper adjustment is indicated by maximum front-to-rear ratio, defined below, and maximum gain over the comparison antenna.

As the operating frequency is varied it is desirable to keep the power input constant, for which purpose observations may be made of current or voltage associated with a section of the transmission line through which the power is supplied. These current (or voltage) measurements should be made at nodes and loops of a line with negligible loss, in which case the power transmitted is given by

$$P = Z_0 I_s I_r = \frac{E_s E_r}{Z_0} \quad (16)$$

where,

$Z_0$  is the characteristic impedance of the line,

$I$  is the current in the line, and

$E$  is the voltage across the line.

The subscripts  $s$  and  $r$  in this case refer to measurements made at nodes and loops, respectively.

For many purposes a sufficiently good indication of relative power is provided by the direct-current power supplied to the vacuum tubes in the last stage, assuming a careful tuning and efficiency adjustment to have been made. If, for different frequencies, the plate and grid couplings in the tube circuit have been adjusted to values such that the direct grid and plate voltages and currents are independent of frequency it may be assumed that the output is also substantially constant over the same range.

It is desirable to make field intensity observations at equal distances in front of the antenna and at the rear. In the case of an antenna designed to be unidirectional the measurements made at the rear are particularly useful, since they provide a sensitive indication of the degree to which back radiation has been reduced. If the antenna is equipped with a reflector these measurements, together with relative current measurements in exciter and reflector, indicate whether or not the position and tuning of the reflector are correct.

This test can be improved by the use of a comparison antenna, which is furnished power equal to that supplied to the antenna under test. In this way the gain in front and at the rear may be measured as a function of frequency. If the attenuator in the field intensity

measuring equipment is adjusted to give the same detector current for the antenna under test as for the comparison antenna, the antenna gain can be calculated from the difference in readings. The ratio of the gain in front to that in the rear is often referred to as the front-to-rear ratio.

#### c. Horizontal Plane Directional Pattern.

In the case of small antennas the surrounding land may permit of directional diagrams being measured nearby, in which case a comparison antenna is not needed. In the case of large installations the surface of the earth near the station may be irregular, not only because of the topography, but also because of artificial structures. Under such circumstances directional diagrams can best be obtained by two measurements in each direction, one of the field from the antenna under test and the other from the standard comparison antenna, which is nondirectional in the horizontal plane.

The angular location of the maxima and minima and the depth of the minima are usually good criteria of the correctness of the phase and amplitude relations of the currents in different sections of the antenna system.

#### d. Vertical Plane Directional Pattern.

This important test is difficult to make and for that reason it is often neglected. When made some form of aircraft is generally used to obtain requisite vertical angles of comparison.

#### e. Gain Measured at a Distance.

The gain measured at great distances is the most important to be made on an antenna because it enables information to be obtained concerning its performance under actual operating conditions. This test is more difficult to carry out than the local gain test since the presence of fading necessitates the averaging of a series of data over a considerable period of time. The gain at a remote point does not remain a constant quantity over a period of time, but varies irregularly depending upon the optimum inclination of the transmitted ray, which latter condition is dependent upon the transmitting medium. These variations, like fading, may be rapid or slow. In measuring field intensity it is customary to average a number of individual measurements over a period of several minutes. As usually carried out observations are made on the antenna under test and on the comparison antenna, this cycle being repeated several times. Significant results cannot usually be secured unless observations continue for at least half an hour. Since the gain is a variable, observations should continue over a pro-

longed period. The actual gain of an antenna at a distant point is also dependent on the transmission path and it is sometimes found that the gain of a directive antenna varies with transmission conditions.

## 6. ADDITIONAL TESTS

### a. Load and Breakdown Tests.

It is usually impossible to test antennas under overload or breakdown conditions similar to those employed in connection with the testing and rating of many other types of apparatus. Tests of this character should be made on the component parts before assembly.

### b. Antennas as Affected by Weather Conditions.

It is recommended that antennas be tested in different kinds of weather. Moisture or sleet on the wires and insulators can have a pronounced effect on the impedance characteristics of the antenna and transmission lines. The emphasis placed on this phase of testing will depend on the relative amount of rain or sleet encountered in the general region where the antenna is located. Usually, tests are made in dry weather.

### c. Measurement of Current in Radiating Wires.

In many types of antennas the gain tests may be supplemented to advantage by measurements of the currents flowing in the several radiating wires. This can be accomplished by cutting the wires and inserting meters, the indications of which may be observed using a telescope when necessary. The current distribution can also be secured by coupling a calibrated circuit of special design, which contains the indicating meter, to the radiating wires. This arrangement should be constructed so that it can always be located in the same position with respect to the wire near which it is placed. This method permits the examination of standing waves on the wire under observation, enabling the location of maximum and minimum current values to be readily determined. This device is particularly useful in securing information concerning transmission lines having an open wire termination.

# STANDARD TESTS OF BROADCAST RADIO RECEIVERS

## I. General

The purpose of the standard tests here proposed is to provide by general agreement a basis upon which the complete normal performance of any broadcast radio receiver may be described. It is believed that no simple "figure of merit" can properly be derived that will by itself give an index of complete performance. This follows from the varying weights that may be applied at different times and in different services to the fundamental properties of sensitivity, selectivity, and fidelity. Consequently it is believed to be essential to define and to provide for the separate measurement of each of these fundamental properties. Such information may be of somewhat too highly technical a nature to appeal directly to the average user of broadcast radio receivers, but it is thought to be useful to radio distributors and dealers in guiding their selection of apparatus for specific service conditions, and to engineers and manufacturers in aiding the comparison and improvement of their products.

It is recognized that the tests do not comprehend the entire range of service conditions that may be met in practice, and that peculiarities of design not reflected in the test data may, in special cases, affect the deductions to be made properly from the test results. It is also recognized that the three basic properties of sensitivity, selectivity, and fidelity are in some radio receivers dependent upon various adjustments, and consequently the three factors should be invariably measured at the same settings of the radio receiver adjustments. Nevertheless, it is thought that acceptance of the procedure outlined, together with proper interpretation and correlation of the results obtained by the tests, will serve to permit a standard comparison of normal radio receiver performance.

Most of the definitions appearing in this report are not fundamental, but are arbitrarily chosen in order to enable the use of certain terms without the ambiguity which would result from the absence of stated definitions. All voltages and currents are intended to be expressed by their root-mean-square values, unless it is otherwise stated.

It is recommended that the input voltage to a radio receiver be expressed in "decibels below one volt," as well as in microvolts as previously recommended. One advantage in favor of this change is that the sensitivity is then expressed as a number which is greater for a more sensitive receiver, which does not give undue importance to minor differences between two receivers, and which has a value near 100 for the more sensitive receivers which are now commonly used in broadcast reception. Another advantage is that voltages between 1,000,000

microvolts and one microvolt are between zero and 120 decibels below one volt. One decibel represents about the smallest difference between two voltages which is ordinarily important in input voltage measurements, so that decimal fractions of a decibel may usually be neglected. When the expression, decibels below one volt, is used, it should always be so designated, at least by the abbreviation "db." The number of decibels below one volt, which corresponds to a given voltage, is given by the formula,

$$N = 20 \log_{10} (10^6/E) = 120 - 20 \log_{10} E \quad (1)$$

where,

$N$  is the number of decibels below one volt and

$E$  is the voltage in microvolts.

The following table gives the number (accurate to 0.02) of decibels below one volt which corresponds to a given number of microvolts:

Voltage in Microvolts	Voltage in Decibels below One Volt
1,000,000	0
500,000	6
200,000	14
100,000	20
50,000	26
20,000	34
10,000	40
5,000	46
2,000	54
1,000	60
500	66
200	74
100	80
50	86
20	94
10	100
5	106
2	114
1	120

## II. Definition of Terms

**A. Broadcast Radio Receiver.** For the purpose of this report, a broadcast radio receiver is taken to be a radio receiver designed to receive from an antenna\* audio-frequency-modulated signals having carrier frequencies from 550 to 1500 kilocycles, and to reproduce these signals by means of a loud speaker. In special cases, the nature of the antenna may be varied, or the loud speaker may be replaced by some other device.

**B. Sensitivity.** Sensitivity of a radio receiver is that characteristic of the radio receiver which determines to how weak a signal it is capable of responding. It is measured quantitatively in terms of the input voltage required to give a prescribed output.

**C. Selectivity.** The selectivity of a radio receiver is the degree to which the radio receiver is capable of differentiating between the desired signal and signals of other carrier frequencies. This characteristic is not expressible by a single numerical value, but requires one or more graphs for its complete expression.

**D. Fidelity.** The fidelity of a radio receiver is the accuracy with which the radio receiver reproduces all audio-frequency modulation of the received signal.

**E. Standard Test Frequencies.** The standard group of seven carrier frequencies for testing is 550, 600, 800, 1000, 1200, 1400, and 1500 kilocycles per second. The standard group of three carrier frequencies for testing is 600, 1000, and 1400 kilocycles per second.

**F. Standard Input Voltages.** Three standard input voltages are specified for the purpose of certain tests, as follows:

1. A "distant-signal voltage" is taken as 86 decibels below one volt, or 50 microvolts.

2. A "mean-signal voltage" is taken as 46 decibels below one volt, or 5000 microvolts.

3. A "local-signal voltage" is taken as 14 decibels below one volt, or 200,000 microvolts.

**G. Sensitivity Test Input.** The sensitivity test input is the smallest signal input voltage of a specified carrier frequency, modulated 30 per cent at 400 cycles per second and applied to the receiver through a standard dummy antenna, which results in normal test output when all

\* The antenna is generally an open capacitive antenna which is not built into the receiver, and this is assumed unless it is otherwise stated. A receiver provided with a loop antenna may be tested in accordance with the special directions given under that heading.

controls are adjusted for greatest sensitivity. It is expressed in decibels below one volt, or in microvolts.

**H. Interference Test Input.** The interference test input is the interfering signal voltage of specified carrier frequency, which results in interference test output. It is expressed in decibels below one volt, or in microvolts. The nature of the interfering signal and of the interference output are determined by the type of interference, and are specified for certain interference tests.

**I. Selectance.** The selectance is the ratio of ordinates of a selectivity graph, between the resonant frequency and another frequency differing from the resonant frequency by a specified multiple of the width of one channel. (The width of one broadcast channel is 10 kilocycles.) It is expressed in decibels or voltage ratios. The ratio at a frequency  $n$  channels above the resonant frequency is denoted by  $S_{+n}$  and at a frequency  $n$  channels below the resonant frequency is denoted by  $S_{-n}$ . The geometric mean of these ratios is denoted by  $S_n$ . Expressed in decibels, the value of  $S_n$  is the average value of  $S_{+n}$  and  $S_{-n}$ .

**J. Band Width.** As applied to the selectivity of a radio receiver, the band width is the width of a selectivity graph at a specified level on the scale of ordinates.

**K. Normal Test Output.** The normal test output is an audio-frequency power of 50 milliwatts delivered to a standard dummy load.

**L. Interference Test Output.** The interference test output is an audio-frequency power of 50 microwatts delivered to a standard dummy load.

**M. Maximum Undistorted Output.** The maximum undistorted output is the least power output which contains under given operating conditions a total apparent power at harmonic frequencies equal to one per cent of the apparent power at the fundamental frequency. (This corresponds to a root-mean-square total voltage at harmonic frequencies equal to 10 per cent of the root-mean-square voltage at the fundamental frequency, if measured across a pure resistance.)

**N. Standard Antenna.** A standard antenna is taken as an antenna having an effective height of 4 meters and having at frequencies between 550 and 1500 kilocycles substantially the same impedance as a series circuit containing a capacitance of 200 micro-microfarads, a self-inductance of 20 microhenries, and a resistance of 25 ohms.

**O. Standard Dummy Antenna.** A standard dummy antenna is a series circuit having lumped components as specified for the impedance of a standard antenna.

**P. Standard Dummy Load.** The standard dummy load is a pure resistance whose value is equal to the 400-cycle impedance of the loud speaker which is (a) contained in the radio receiver, or (b) supplied therewith, or (c) recommended for use therewith. Where an output transformer is connected between the radio receiver and the loud speaker, the output transformer is to be treated as part of the radio receiver.

If the loud speaker impedance has pronounced irregularities at frequencies in the vicinity of 400 cycles, or if the preceding rule cannot be complied with, the standard dummy load is determined by one of the following rules:

1. The load resistance which gives the greatest value of maximum undistorted output.

2. The load resistance recommended by the manufacturer of the radio receiver or of the vacuum tubes used therein.

In case there is a transformer between an output vacuum tube and the load, the load impedance should be

$$R_2 = R_1 N_2^2 / N_1^2 \quad (2)$$

where,

$R_2$  is the standard dummy load resistance in ohms,

$R_1$  is the load resistance recommended for the output vacuum tube, in ohms,

$N_2$  is the number of turns on the transformer secondary, and

$N_1$  is the number of turns on the transformer primary.

In case  $n$  output vacuum tubes are connected in parallel, the standard dummy load is  $R_2/n$ .

In case  $2n$  output vacuum tubes are connected in push-pull, the standard dummy load is  $2R_2/n$ .

### III. Requirements and Characteristics of Testing Apparatus

The apparatus employed in testing radio receivers should be as simple as is consistent with accurate performance of the necessary

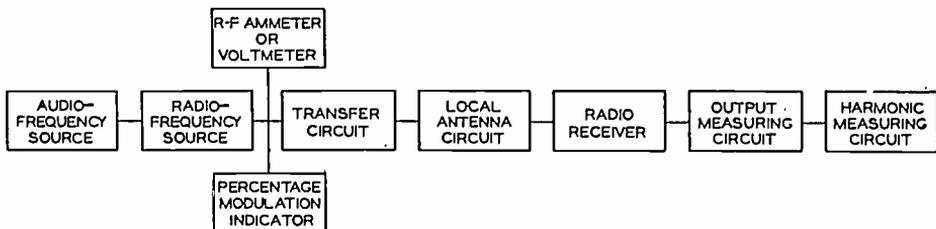

Fig. 1.—Schematic arrangement of apparatus used in tests of radio receivers functions. As far as possible, the same apparatus should be used in the different tests. The values of the electrical quantities and the calibra-

tions should not change with time, or if some change is unavoidable, means for checking should be provided.

The required apparatus for tests of sensitivity, selectivity, and fidelity, is indicated schematically in Fig. 1. Both frequency sources should be calibrated so that separate measurement of frequency is not needed. The requirements of the separate elements are stated in the following paragraphs. The audio-frequency source, the radio-frequency source, and the transfer circuit are referred to collectively as the standard signal generator.

**A. Audio-Frequency Source.** For sensitivity and selectivity tests this may be a mechanical oscillator of fixed frequency (400 cycles per second). A vacuum tube oscillator having a frequency range at least from 30 to 10,000 cycles per second is necessary for fidelity tests. The total harmonic content in the output of this oscillator should not exceed five per cent. The audio-frequency oscillator is arranged to modulate the radio-frequency oscillator to a known degree and preferably should furnish the same degree of modulation without readjustment at all carrier frequencies and all modulation frequencies. Means should be provided for adjusting the degree of modulation to at least the normal value of 30 per cent. If two beating oscillators are combined to produce the audio frequency, their frequencies should be filtered out of the audio modulating circuit, to such a high degree as not to affect selectivity observations.

**B. Radio-Frequency Source.** This consists of a modulated vacuum tube oscillator either fully shielded in itself or so shielded from the radio receiver under test that there is no coupling directly to the receiver. If the power supply is external to the shielding system which encloses the oscillator, all ungrounded leads to the oscillator should pass through shielded low-pass filters. The frequency should be adjustable by an external control to any desired value between 500 and 1500 kilocycles per second, and the frequency should not be affected by changes in output. Means should be provided for varying the frequency in small steps immediately on each side of any specified frequency. A second external control should be provided for varying the modulated radio-frequency output supplied to the transfer circuit, and an instrument should be provided which indicates the effective value of this output. The oscillator in conjunction with the transfer system used (part C of this section) should be capable of supplying in series with the receiving antenna system up to one volt at all carrier frequencies. Such defects as frequency drift, frequency modulation, radio-frequency harmonics, modulation distortion, and hum or noise modulation should be reduced

sufficiently so as not to affect the observed results in the tests for which this equipment is used. Reference is made to part E of this section.

**C. Transfer Circuit.** The radio receiver under test is provided with a local antenna circuit consisting of either a loop antenna (which may be self-contained) or a standard dummy antenna. In determining the receiver characteristics, modulated radio-frequency voltages of known value are impressed in series with the dummy antenna through a transfer circuit which should assume one of two forms as follows:

1. A coupling coil fed from the radio-frequency source and inductively coupled to the loop antenna or the 20-microhenry inductance coil of the dummy antenna. In the latter case the coupling coil is used as the primary of a calibrated mutual inductor, the secondary of which is the 20-microhenry coil.

2. A calibrated attenuator of the resistance or other type terminating in a low impedance of known value (preferably a resistance of about one ohm) which may be inserted in series with the dummy or loop antenna. This attenuator should be so constructed that all attenuation ratios are substantially independent of frequency within the broadcast band. It is preferably made variable in steps with additional provision for continuous variation between the steps. As an alternative to continuous variation within the attenuation network, provision may be

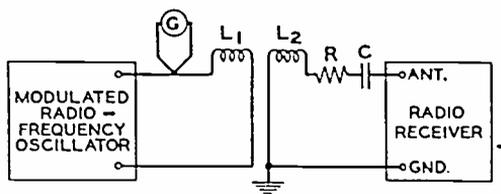

Dummy antenna

$L_2 = 20 \mu\text{h}$

$C = 200 \mu\mu\text{f}$

$R = 25 \text{ ohms}$  (including resistance components of  $L_2$  and  $C$ )

Fig. 2—Standard input circuit arrangement—mutual inductance coupling.

made for continuously varying the measured current or voltage supplied from the source to the attenuator over a sufficient range to cover all values of receiver input voltage which lie between the steps of the attenuator. Design details of attenuators fulfilling these requirements are available in the literature. The combined range of ratios on the attenuator and variable currents from the source should be such as to give a range of voltage across the terminating impedance of 120 to 0 db below one volt, or one microvolt to one volt.

**D. Output Measuring Circuit.** The components of the output measuring circuit should be as follows:

1. A noninductive dummy load resistor adjustable to any desired value between one and 20,000 ohms and capable of dissipating 10 watts at any setting.

2. An output filter to be used with any radio receiver normally having direct current in its output. This filter should by-pass a negligible audio-frequency current, and insert a negligible audio-frequency impedance in series with the dummy load. A recommended form consists of an inductance of 100 henries (when carrying 50 milliamperes direct current in the winding) and a capacitance of eight microfarads arranged as shown in Fig. 8.

3. A vacuum-tube voltmeter or an equivalent device which will accurately measure the root-mean-square values of output voltage. At normal test output the voltage is of the order of 10 to 20 volts for ordinary output vacuum tubes. For the sensitivity and selectivity tests the output meter need be calibrated only at these values. For the fidelity tests continuous calibration is required, and for some other tests calibration for much higher values is needed.

**E. Equipment for Two-Signal Test.** The two-signal interference tests (section IV-J, -K) require two signal generators, and also place special requirements on these generators and on the input connections to the radio receiver being tested. The following outline gives approximately the minimum requirements for a pair of signal generators which can be used in making the two-signal interference tests. Several methods are described for connecting both signal generators to the same radio receiver.

#### 1. REQUIREMENTS FOR THE INTERFERING-SIGNAL GENERATOR

This signal generator is the more elaborate, and may well be the one used for other tests and general purposes. The requirements outlined, however, are only those which are related to the use of this signal generator in the two-signal tests.

##### a. Frequency Range.

The frequency range of the interfering-signal generator should extend from 100 to 4000 kc.

##### b. Frequency Stability.

The changes in frequency due to all causes other than operating the controls should be, during one minute of use, less than 0.1 kc. The maximum effect of changes in the attenuator should be less than 1 kc plus 0.1 per cent of the carrier frequency.

##### c. Frequency Calibration.

The absolute frequency calibration should be accurate to within 2 kc plus 0.5 per cent of the carrier frequency. Means should be pro-

vided for varying the frequency of the signal generator in 10 kc steps up to 100 kc either side of each of the three standard test frequencies (600, 1000, and 1400 kc). The differential calibrations should be accurate to within 5 per cent of the frequency variation.

#### d. Frequency Modulation.

In the neighborhood of 600, 1000, and 1400 kc, the frequency modulation should not exceed a total swing of 1 kc times the modulation factor. At other frequencies, the total swing should not exceed the sum of 1 kc plus 0.1 per cent of the carrier frequency, times the fraction of modulation factor.

#### e. Output Voltage.

The signal generator, including the attenuator, should be capable of giving any output voltage from 120 to 0 db below one volt, or from one microvolt to one volt.

#### f. Type of Attenuator.

The type of attenuator should be selected with due regard for the factors discussed in part 3 of this section.

#### g. Output Calibration.

The output voltage should be continuously calibrated in decibels below one volt or in microvolts, accurate to within 1 db or 12 per cent at low attenuations and to within 2 db or 25 per cent at higher attenuations.

#### h. Modulation Frequency and Factor.

Thirty per cent modulation at 400 cycles should be provided.

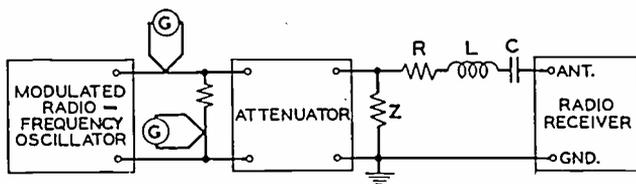

Dummy antenna

$$L + L_Z = 20 \mu\text{h}$$

$$CC_Z / (C + C_Z) = 200 \mu\text{mf}$$

$$R + R_L + R_C + R_Z = 25 \text{ ohms}$$

where  $L_Z$ ,  $C_Z$  and  $R_Z$  are series components of  $Z$ , and  $R_L$  and  $R_C$  are resistance components of  $L$  and  $C$ , respectively.

Fig. 3—Standard input circuit arrangement—impedance coupling.

#### i. Shielding.

The shielding should be sufficiently complete so that the unshielded coupling to the radio receiver, conveniently located with respect to the signal generator, will affect the radio receiver less than an input voltage 126 db below one volt, or 0.5 microvolt.

j. Radio-Frequency Harmonics.

The radio-frequency harmonics in the output voltage should be reduced in the signal generator as far as possible without undue complication. By the addition of special filters which may be external to the signal generator, harmonics which fall on the desired-signal frequency (600, 1000, or 1400 kc) should be made smaller than 126 db below one volt, or 0.5 microvolt, in cases where they would otherwise cause an appreciable error.

k. Audio-Frequency Harmonics.

The audio-frequency harmonics present in the modulation should be smaller than 20 db below the fundamental, or 10 per cent of the fundamental voltage.

l. Hum Modulation.

The hum or other noise modulation of the carrier should not exceed one per cent.

2. REQUIREMENTS FOR THE DESIRED-SIGNAL GENERATOR

This signal generator is the less elaborate, and may well be battery operated, making it well adapted for use also in hum and noise tests.

a. Frequency Range.

The desired-signal generator should be capable of operation at 600, 1000, and 1400 kc, and should be provided with a vernier control for exact line-up by zero beat against the other signal generator.

b. Frequency Stability.

The changes in frequency due to all causes other than operating the controls should be, during one minute of use, less than 0.1 kc.

c. Output Voltage.

The signal generator, including the attenuator, should be capable of giving any one of the three standard input voltages, calibrated with the following accuracy:

- (1)  $86 \pm 2$  db below one volt, or 50 microvolts  $\pm 23$  per cent.
- (2)  $46 \pm 1$  db below one volt, or 5000 microvolts  $\pm 12$  per cent.
- (3)  $14 \pm 1$  db below one volt, or 200,000 microvolts  $\pm 12$  per cent.

d. Type of Attenuator.

The type of attenuator should be selected with due regard for the factors discussed in part 3 of this section.

e. Modulation.

If modulation is provided in this signal generator, it should be 30

per cent at 400 cycles. No modulation is essential if the following procedure is employed: The receiver is first tuned to the other signal generator, in the manner required by the test. Then the output of this

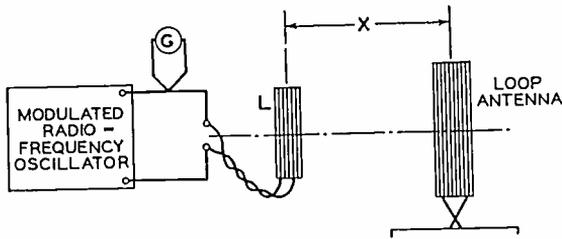

Fig. 4—Standard input to radio receiver with loop antenna.

signal generator is set at the same voltage and it is tuned to the same frequency by zero beat.

#### f. Shielding.

The shielding should be sufficiently complete that the unshielded coupling to the radio receiver, conveniently located with respect to the signal generator, will affect the radio receiver less than an input voltage 106 db below one volt, or 5 microvolts.

#### g. Radio-Frequency Harmonics.

The radio-frequency harmonics in the output voltage should be reduced in the signal generator as far as possible without undue complication.

#### h. Hum Modulation.

The hum or other noise modulation should total less than 0.3 per cent.

### 3. REQUIREMENTS FOR CONNECTING THE TWO SIGNAL GENERATORS TO THE RADIO RECEIVER

The connection of both signal generators to one radio receiver requires special attention. This problem affects the choice of attenuators in the signal generators or, having given attenuators, special connections may be required between signal generators and receiver.

There are three principal types of attenuators used in signal generators, which are respectively the resistance, mutual inductance, and capacitance types. Any type used should be designed to insert in series with the dummy antenna either (a) an impedance negligible compared with that of the dummy antenna, or (b) an impedance which can be treated as part of the dummy antenna impedance, as indicated in Fig. 3.

A resistance or capacitance attenuator generally has one output terminal connected to its shield, while a mutual inductance attenuator may have neither output terminal connected to its shield.

Figs. 5, 6, and 7 show three representative arrangements of two signal generators connected to a radio receiver through a dummy antenna. In Figs. 5 and 7, as in Fig. 3,  $R$ ,  $L$ , and  $C$  plus the effective im-

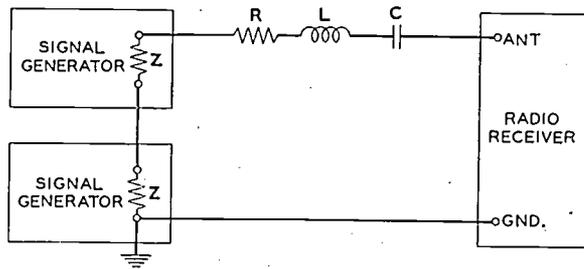

Fig. 5—Connection of two signal generators in a series circuit.

pedance inserted in series therewith by the signal generators should total the impedance prescribed for the dummy antenna. In Fig. 6, each of the parallel branches should total twice the impedance prescribed for the dummy antenna. The choice of one of these three arrangements depends on various factors which may be outlined as follows:

a. Requirements for the arrangement of Fig. 5. If the upper signal generator is operated by batteries contained in its shield, the attenuator may have its lower terminal connected to the shield; otherwise the shield should be grounded and the attenuator should be of the mutual inductance type with neither output terminal connected to the shield. The lower signal generator may have any type of attenuator, but the

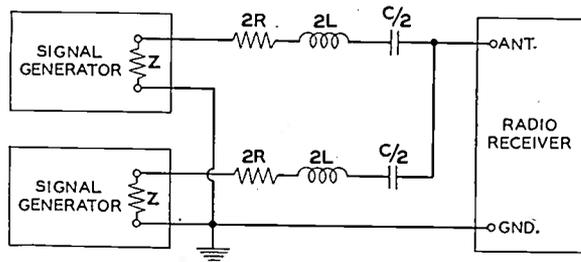

Fig. 6—Connection of two signal generators in parallel circuits.

impedance between its output terminals should be so small that its output voltage is unaffected by the capacitance added in parallel by the connections to the upper signal generator. It is suggested that the upper may be a battery-operated, desired-signal generator and the lower may be the interfering-signal generator.

b. Requirements for the arrangement of Fig. 6. Each signal generator may have any type of attenuator. The output voltage from each

signal generator must be twice the required effective value. Therefore the output voltage requirements for each are doubled.

c. Requirements for the arrangement of Fig. 7. The desired-signal generator may have any type of attenuator, but the impedance between output terminals should be very small. The interfering-signal generator may have any type of attenuator, but the impedance between output terminals should be so small that its output voltage is unaffected by the capacitance added in parallel by the connections to the output transformer. It is suggested that both signal generators have a low-resistance type of attenuator.

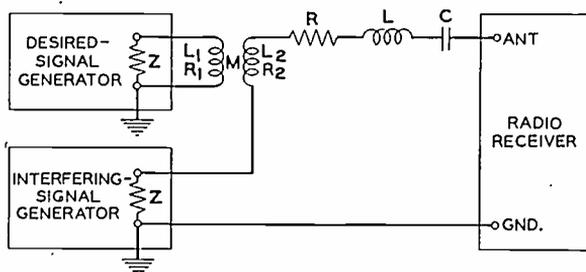

Fig. 7—Connection of two signal generators in a series circuit, one through an output transformer.

The output transformer  $L_1L_2$  in Fig. 7 is designed to induce in the dummy antenna circuit a voltage equal to the observed output voltage of the signal generator to which coil  $L_1$  is connected. When this signal generator has a pure resistance of  $R_0$  (not over 10 ohms) as its internal impedance, this output transformer may be designed according to the following rules, and will function with an error less than 0.5 db or 6 per cent over the frequency range of 550 to 1500 kilocycles.

- (1) The value of  $R_1$  should not exceed 5 ohms at 550 kc.
- (2) The value of  $L_1$  should be such that its reactance at 550 kc is greater than  $3(R_0 + R_1)$ , and at least 10 times the reactance of the wiring between  $R_0$  and  $L_1$ .
- (3) The value of  $(L_2 - M)$  should not exceed 20 microhenries.
- (4) The upper terminals of  $L_1$  and  $L_2$  should have like polarity.
- (5) The total capacity between  $L_1$  and  $L_2$  should not exceed 10 per cent of the value required to resonate with  $L_2$  at 1500 kc.
- (6) The value of  $M$  should be slightly (less than 20 per cent) greater than  $L_1$ , and should be adjusted to give an open-circuit voltage across  $L_2$  equal to the observed output voltage of the signal generator at about 1000 kc.
- (7) The transformer secondary introduces into the dummy antenna circuit an effective resistance of  $(R_0 + R_1 + R_2)$  and an effective inductance of  $(L_2 - M)$ .

- (8) The following values are suggested, for any value of  $R_0$  not exceeding 10 ohms:

$$\begin{aligned} L_1 &= 18 \text{ microhenries (approximately),} \\ M &= \text{about 20 microhenries (to be adjusted),} \\ L_2 &= 40 \text{ microhenries } (L_2 - M \text{ takes the place} \\ &\quad \text{of the dummy antenna inductance).} \end{aligned}$$

#### IV. Test Procedures

**A. Introduction.** The present day radio receivers vary so greatly in their manner of operation that it is difficult to set down a single test procedure for each fundamental characteristic and have the procedure include all the allowances that should be made for the peculiarities of different sets. It is simpler to describe in general the test set-ups and adjustments of input and output, the operating conditions, and the radio receiver adjustments as applied to any type of receiver. Then standard procedures for measuring sensitivity, selectivity, and fidelity, and other characteristics can be outlined.

#### B. Input Measurements

##### 1. RADIO RECEIVER DESIGNED FOR A STANDARD ANTENNA

Except where otherwise specified, all tests should be made with a standard dummy antenna. Standard input circuits are shown in Figs. 2 and 3. Either circuit may be used, depending on whether a conductive coupling or a mutual inductance is used to introduce the input voltage in series with the dummy antenna.

The mutual inductor is used as shown in Fig. 2. The input to the radio receiver is determined by the value of the current through the coil  $L_1$ , or the voltage across coil  $L_1$ , and by the mutual inductance between coils  $L_1$  and  $L_2$ . The resulting input voltage is

$$E_2 = 2\pi f M I_1 = E_1 M / L_1 \quad (3)$$

where,

$E_2$  is the receiver input voltage in microvolts,

$f$  is the carrier frequency in kilocycles,

$M$  is the mutual inductance between coils  $L_1$  and  $L_2$  in microhenries,

$I_1$  is the current through  $L_1$  in milliamperes,

$E_1$  is the voltage across  $L_1$  in microvolts, and

$L_1$  is the inductance of coil  $L_1$  in microhenries.

The circuit for use with a conductive coupling is shown in Fig. 3. The radio receiver input voltage is determined by the degree of at-

tenuation and the input to the attenuator. The resulting input voltage is

$$E_2 = K_1 Z I_1 = K_2 E_1 \quad (4)$$

where,

- $E_2$  is the receiver input voltage in microvolts,
- $K_1$  is the ratio of current attenuation independent of  $Z$ ,
- $Z$  is the coupling impedance in ohms,
- $I_1$  is the attenuator input current in microamperes,
- $K_2$  is the ratio of voltage attenuation including  $Z$ , and
- $E_1$  is the attenuator input voltage in microvolts.

## 2. RADIO RECEIVER WITH LOOP ANTENNA

Such receivers are tested like receivers designed for use with a standard antenna, except for the method of introducing and measuring the input voltage. In order to make the loop antenna measurements comparable with standard dummy antenna measurements, the input voltage to the loop antenna should be expressed in terms of the equivalent standard-antenna voltage corresponding to the same field intensity of a received signal. The input voltage to the loop antenna may be introduced and measured by either of the following two methods.

a. Voltage may be induced in the loop antenna from a coaxial coil inductively coupled thereto, as shown in Fig. 4. This method is preferred because it is independent of distributed capacity between the turns of the loop. The distributed capacity across coil  $L$  must be made so small as to be negligible. The distance  $X$  should be at least twice the largest dimension of either the coil  $L$  or the loop antenna. The relation between the observed current in coil  $L$  and the equivalent standard-antenna voltage is given by the formulas,

$$4\mathcal{E} = \frac{75.4 N_1 A_1^2}{X^3} I_1 \quad (5)$$

$$I_1 = \frac{4\mathcal{E} X^3}{75.4 N_1 A_1^2} \quad (6)$$

where,

- $\mathcal{E}$  is the equivalent electric field intensity in microvolts per meter at the loop antenna,
- $4\mathcal{E}$  is the equivalent standard-antenna voltage in microvolts,
- $N_1$  is the number of turns of coil  $L$ ,
- $A_1$  is the radius of coil  $L$  in centimeters,
- $X$  is the distance in meters between the center of coil  $L$  and the center of the loop antenna, and
- $I_1$  is the current in coil  $L$  in milliamperes.

b. A voltage may be introduced in the loop antenna by connecting the output terminals of a low impedance attenuator in series with the loop antenna at a point where this insertion will not appreciably affect the operation of the radio receiver. The loop antenna then acts in place of the dummy antenna shown in Fig. 3. The impedance  $Z$  should be small as compared with that of the loop antenna circuit. This method should be used only in cases where the distributed capacitance of the loop antenna is substantially smaller than the tuning capacitance. The relation between the receiver input voltage and the equivalent standard-antenna voltage is given by the formulas,

$$4\mathcal{E} = \frac{191,000E_2}{N_2hsf} \quad (7)$$

$$E_2 = \frac{4\mathcal{E}N_2hsf}{191,000} \quad (8)$$

where,

$\mathcal{E}$  is the equivalent electric field intensity in microvolts per meter at the loop antenna,

$4\mathcal{E}$  is the equivalent standard-antenna voltage in microvolts,

$N_2$  is the number of turns of the loop antenna,

$h$  is the height of the loop antenna in meters,

$s$  is the width of the loop antenna in meters (assumed much smaller than a quarter wavelength),

$f$  is the frequency in kilocycles, and

$E_2$  is the receiver input voltage in microvolts in series with the loop antenna.

## C. Output Measurements

### 1. CHOICE OF LOAD

Output measurements of a radio receiver are made in terms of the power delivered to a standard dummy load, except in special cases where other terms are specified.

A radio receiver not provided with a loud speaker should be tested with a standard dummy load. A radio receiver provided with a loud speaker may be tested with a standard dummy load only. Some tests will be described, however, which can be performed only with the aid of the loud speaker provided for the receiver.

### 2. RADIO RECEIVER WITH NO DIRECT CURRENT IN ITS OUTPUT

If the output of a radio receiver is free of direct current and is insulated from high direct voltages, a dummy load may be connected directly to the output terminals in place of a loud speaker.

### 3. RADIO RECEIVER WITH DIRECT CURRENT IN ITS OUTPUT

If the output of a radio receiver contains direct current, or if it is connected to high direct voltages, the dummy load should be insulated from the output terminals by condensers, as shown in Fig. 8, described

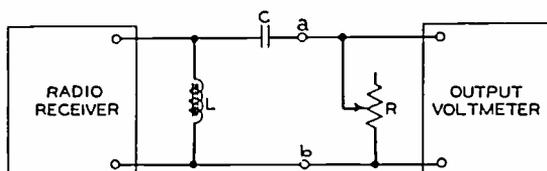

Fig. 8—Radio receiver with direct current in its output circuit.

in section III-D. If the receiver output terminals are connected to a high direct voltage, a condenser *C* should be inserted in series with each terminal *a* and *b*.

### 4. RADIO RECEIVER WITH PUSH-PULL AMPLIFIER OUTPUT

If the output terminals of a radio receiver are connected to the respective plates of two tubes operating as a push-pull amplifier, the standard dummy load may be connected at each end through a condenser to one of the output terminals, and may have a center tap. It is then advantageous to connect the cathode side of the vacuum tube voltmeter to the center tap and observe directly one-half the load voltage.

### 5. RADIO RECEIVER WITH BACKGROUND NOISE IN ITS OUTPUT

a. If the background noise power is smaller than the output power being measured, the incremental reading of the output meter may be used to measure the incremental output power resulting from a given external cause. If a thermocouple output meter is used, the incremental output power is equal to the observed total power minus the observed noise power. If another type of output meter is used, a calibration should be made in terms of incremental power.

Using a thermocouple meter the following formulas give the incremental output power of voltage in the presence of the noise background,

$$W_0 = W - W_n \quad (9)$$

$$V_0 = \sqrt{V^2 - V_n^2} \quad (10)$$

where,

$W_0$  is the output power being measured,

$W$  is the total power observed,

$V_0$  is the output voltage being measured,

$V$  is the total voltage observed, and

$V_n$  is the noise voltage observed.

b. If the background noise power is greater than the output power being measured, it is necessary also to use a band-pass filter tuned to the latter, and thereby to remove partially or wholly the background noise from the output meter. This filter should be connected between the load and the output meter.

## D. Operating Conditions

### 1. BATTERY-OPERATED RADIO RECEIVER

The *A* and *B* battery voltages supplied to the radio receiver should be held constant at the values specified for the receiver. If a battery cable is not furnished with the receiver, the leads to the batteries should be as short as possible. The batteries used should not have abnormally high internal resistance.

### 2. SOCKET POWERED AND ELECTRIC RADIO RECEIVERS

The alternating- or direct-voltage input to the radio receiver should be held constant at the value specified for the set at the mean value if a range of values is specified, or, if no value is specified, at 115 volts. If the receiver is provided with adjustments for reducing hum or ripple in the output, such adjustments should be made. In the case of an alternating voltage, its differential distortion factor as applied to the receiver during operation should not exceed 1.05.

The differential distortion factor may be measured, using the circuit of Fig. 9. The constants are chosen to make

$$R = 1/2\pi fC \quad (11)$$

where  $f$  is the fundamental frequency of the a-c line. The resistance

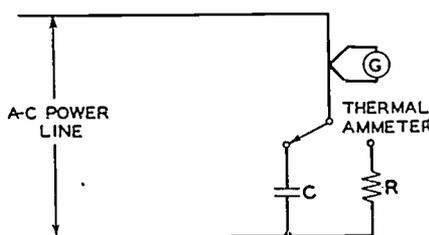

Fig. 9—Differential distortion factor measuring circuit.

of the thermal ammeter should be small compared with  $R$ . The differential distortion factor is then given by the equation,

$$\text{d.d.f.} = I_c/I_r \quad (12)$$

where,

$I_c$  is the current through the condenser, and  
 $I_r$  is the current through the resistor.

### 3. VACUUM TUBES

The vacuum tubes used should be selected to have the rated values of those characteristics which most affect the performance of the receiver.

#### E. Radio Receiver Adjustment

##### 1. TUNING CONTROLS

A receiver is tuned to a desired signal by adjusting the tuning controls until the desired audio-frequency output is obtained either with the least possible radio-frequency input voltage, or with the lowest possible setting of the volume control. When the receiver is tuned to a signal, any appreciable change of either the signal frequency or the tuning controls should cause a diminution of the output. Special care is sometimes required in accurately tuning receivers having automatic volume control; in such cases the receiver may be tuned to a relatively weak input voltage, after which the input voltage may be increased to the desired value.

##### 2. VOLUME CONTROLS

The adjustment of a single main volume control requires no special instructions. Where a receiver has in addition a sensitivity control or "local-distance" switch, special instructions are required. Where sufficient instructions accompany the receiver, they should be followed. Otherwise the following rules should be observed, insofar as they are applicable:

a. A "local-distance" switch should be set in the "distance" position for all tests except those in which the receiver is tuned to a local-signal voltage, as herein defined. In this case, the switch is set in the "local" position.

b. Any other sensitivity control is set at maximum sensitivity for all tests except where it is needed to control further the volume, or except where the test is made to determine the effects of the sensitivity control.

##### 3. TONE CONTROLS

During tests requiring output measurements at 400 cycles only, the tone control is adjusted to give maximum 400-cycle output. During other tests, the tone control must be adjusted to meet the requirements of the test.

##### 4. SUPERHETERODYNE RADIO RECEIVER

If a superheterodyne receiver has an independent control for its oscillator frequency, all tests should be made with the oscillator tuned

at the higher of the two alternative frequencies, unless the instructions with the receiver specify otherwise. Tests especially intended for superheterodyne receivers are found in other parts of this report.

## 5. REGENERATIVE RADIO RECEIVER

In testing a receiver having a regeneration or stabilization control, this control is regarded as a sensitivity control, for which instructions are given under "volume controls." This control should never be adjusted to or beyond the point where oscillations and whistles are produced.

### F. Tuning Range Test

Using the same operating conditions as in the sensitivity test, the radio receiver tuning control is set for the respective minimum and maximum carrier frequencies it is capable of receiving with normal operation. At each setting, the signal generator is tuned to the resonant frequency of the receiver, and the signal frequency recorded. This procedure may be extended to obtain a frequency calibration of the dial if this is required.

### G. Sensitivity Test

The sensitivity test input (definition G, section II) is measured at each test frequency with the aid of a standard signal generator connected as shown in one of Figs. 2 and 3. The group of seven test frequencies (definition E, section II) is recommended for use in this test.

The sensitivity graph is plotted with test frequencies as abscissas and sensitivity test input voltages as ordinates. A uniformly divided scale of abscissas should be used. A uniformly divided scale of ordinates should be used when the input is expressed in decibels below one volt. A uniformly or logarithmically divided scale of ordinates may be used when the input is expressed in microvolts.

### H. Spurious Response Test

With the radio receiver tuned to each of the group of three test frequencies (definition E, section II), the signal generator should be continuously varied over a wide frequency range (100 to 4000 kc) to discover if the receiver is simultaneously resonant at frequencies other than the test frequency. These other resonant frequencies are called spurious response frequencies and are most often found in superheterodyne receivers. Each spurious response frequency is noted and the spurious-response sensitivity test input is measured as in the sensitivity test, provided it is smaller than one volt. Its ratio to the desired-signal sensitivity test input may be computed, and is called the spurious

response ratio. This ratio may be expressed in decibels or as a numerical ratio of voltages. This test is properly classified as a selectivity or interference test, although its procedure is that of a sensitivity test.

A superheterodyne receiver is generally responsive to two frequencies whose difference from the local-oscillator frequency is equal to the intermediate frequency. One of these (usually the lower) is the desired-signal frequency, and the other is called the image frequency. This is a special case of a spurious response frequency, and is tested as such. Its observed characteristics are referred to as image sensitivity and image ratio.

### I. Selectivity Test

The radio receiver is tuned in succession to each of the group of three standard test frequencies (definition E, section II), as in the sensitivity test. The signal generator is then detuned each side of resonance, the radio input voltage which results in normal test output is observed, and its ratio to the sensitivity test input is computed. Observations are made at least every 10 kilocycles up to 100 kilocycles off resonance, or until the ratio exceeds 10,000 times, or until the observed input voltage exceeds one volt, whichever requires the least departure from resonance.

For each test frequency, a graph is plotted with carrier frequencies as abscissas and ratios of input voltage off resonance to input voltage at resonance as ordinates. The scale of abscissas should be uniformly divided and enlarged. The scale of ordinates should be uniformly divided when the ratios are expressed in decibels, or logarithmically divided when the ratios are expressed numerically.

The results of the selectivity test may alternatively be expressed and plotted in terms of selectance (definition I, section II), or in terms of band width (definition J, section II).

To express the selectivity in terms of selectance, a graph is plotted with resonant frequencies as abscissas and corresponding values of selectance as ordinates. One graph is plotted for each of  $S_1$ ,  $S_2$ , etc., or for each of  $S_{+1}$ ,  $S_{-1}$ ,  $S_{+2}$ ,  $S_{-2}$ , etc. The scale of abscissas should be uniformly divided. The scale of ordinates should be uniformly divided when selectance is expressed in decibels, or logarithmically divided if selectance is expressed numerically.

To express the selectivity in terms of band width, a graph is plotted with resonant frequencies as abscissas and with band widths as ordinates. A graph may be plotted for each of the levels, 6 db or 2 times, 20 db or 10 times, 40 db or 100 times, etc., referring to the selectivity curves. Both scales of abscissas may be uniformly divided, or the scale of ordinates may be logarithmically divided.

If the volume control substantially affects the selectivity curve, this test should be repeated with the volume control reduced until the sensitivity test input equals the mean-signal voltage, and, if desired, the other standard input voltages. If the radio receiver has automatic volume control, this test with reduced volume control should not be performed, since it gives misleading results. The two-signal crosstalk interference test is the only type of selectivity test which shows correctly the selectivity curve, at reduced sensitivity, of a radio receiver having automatic volume control.

This selectivity test is a simple means for determining the resonance curve of a radio receiver, and the curve so obtained has considerable value. This test does not give much information as to the interference between two signals being received at the same time, which may be observed by the two-signal tests outlined in parts J and K of this section.

#### J. Two-Signal Crosstalk Interference Test

In order to observe correctly the interference between two received signals, both desired and interfering signals must be present during the test. The crosstalk test deals with the type of interference in which the modulation of the interfering signal is heard in addition to that of the desired signal. This test is intended to indicate the greatest interference input which may be permitted without the interference modulation output power exceeding 0.001 of the desired modulation output power, assuming that both signals are modulated to the same degree.

The radio receiver is tuned to the desired signal set at one of the standard test frequencies and at one of the standard input voltages. The receiver volume control is adjusted to give normal test output when the signal is modulated 30 per cent at 400 cycles, after which the modulation is reduced to zero.

An interfering-signal input voltage is applied to the receiver, in addition to the desired signal carrier which remains unchanged. The interfering signal is modulated 30 per cent at 400 cycles. The interfering signal is tuned through a wide frequency range and the interference test input voltage, which gives interference test output at 400 cycles, is observed wherever its value is less than one volt. In particular, observations are made at least every 10 kc up to 100 kc above and below the desired signal frequency.

For a given standard test frequency and a given standard input voltage, a crosstalk interference curve is plotted, having as abscissas the frequency difference in kilocycles between the interfering signal and the desired signal, and having as ordinates the observed interference test input in decibels below one volt, or in microvolts. The scale

of abscissas should be uniformly divided. The decibel scale of ordinates should be uniformly divided and should increase in the upward direction on the page. The microvolt scale of ordinates should be logarithmically divided and should increase in the downward direction on the page. Additional crosstalk curves are plotted, or the above curve is extended, to present observations more than 100 kilocycles off the desired frequency.

It is ordinarily of little value to observe crosstalk with the interfering frequency less than 5 kc off the desired frequency, because more serious interference is caused by the beat note between the carriers.

### K. Two-Signal Whistle Interference Test

This test deals with the type of interference in which a beat-note whistle is heard, which depends mainly on the carriers of the desired and interfering signals, and on the radio receiver. It is especially applicable to superheterodyne receivers. More specifically, this test is intended to indicate the greatest interference input which may be permitted without the interference output exceeding the equivalent of approximately one per cent modulation of the desired signal. If the desired signal is modulated 30 per cent, the permitted interference output power is 0.001 of the desired modulation output power.

The signals are the same as for the crosstalk test, except that the interfering signal is unmodulated. The interfering signal is tuned through a wide frequency range, and the interference test input voltage, which gives interference test output at 400 cycles, is observed wherever its value is less than one volt.

For a given standard test frequency and a given standard input voltage, a whistle interference spectrum is plotted, having as abscissas the interfering frequency in kilocycles, and having as ordinates the interference test input in decibels below one volt, or in microvolts. The scales of abscissas and ordinates are the same as for the crosstalk interference curve.

It is ordinarily of little value to observe the whistle with the interfering frequency 400 cycles off the desired frequency, because this observation is independent of the radio receiver characteristics, the interference test input being approximately one per cent of the desired signal input voltage.

At any interfering frequency where a whistle is observed, the observation may be extended to give interference test output at other audio frequencies besides 400 cycles, and these observations may be on an enlarged scale of abscissas.

## L. Electrical Fidelity Test

The electrical fidelity test shows the manner in which the electrical output of a radio receiver depends on the audio frequency of modulation. It takes into account all characteristics of the receiver except the radiation of the loud speaker, which latter is of major importance. Because of this weakness, the test is essentially analytical in nature. Its value resides in the ease and accuracy with which the test is performed, and in its usefulness for comparative purposes.

The radio receiver is tuned to a signal at 1000 kc, modulated 30 per cent at 400 cycles, having a mean signal voltage 46 db below one volt or 5000 microvolts. The receiver output is measured in terms of current or voltage in a standard dummy load, or in terms of voltage across the loud speaker terminals. In the latter case, the loud speaker should preferably be located in its baffle or cabinet, with the receiver chassis in place. The data should include a statement of which load is used. The receiver volume control is adjusted to give normal test output. The modulation frequency is then varied continuously from 30 to 10,000 cycles, and the output variation is observed.

The electrical fidelity curve is plotted with audio frequency as abscissas and relative output voltage or current as ordinates. The ordinates are plotted in decibels or in per cent of voltage or current, taking normal test output at 400 cycles as zero decibels or 100 per cent. In the former case, the scale of ordinates should be uniformly divided; in the latter case, the scale may be logarithmically or uniformly divided. The scale of abscissas should be logarithmically divided.

The relative output in decibels is taken as  $20 \log_{10}$  of the voltage ratio, when the output is measured across the loud speaker.

It is frequently unnecessary to make or plot these observations below  $-20$  db or 10 per cent, although further observations may be desirable.

If hum or noise is present in appreciable amount during the fidelity test, a suitable correction should be made to prevent its affecting the accuracy of the fidelity observations.

If the fidelity changes substantially when the receiver is tuned to signals of different frequencies or voltages, this test should be repeated at 600 and 1400 kc, or at distant and local signal voltages. If the fidelity depends substantially on the output power level, this test should be repeated using different output power levels in place of normal test output.

If the receiver has a tone control, this test should be made twice at 1000 kc with mean signal voltage, with the tone control at its "high" and "low" settings, respectively. At other conditions, the fidelity test is made with the tone control at its "high" setting.

In order to determine the volume control effect of the tone control, it is set to give maximum output at 400 cycles, and any reduction of 400-cycle output is noted for the "high" and "low" settings. Each fidelity curve should be marked as follows: "Tone control high (or low); 400-cycle output reduced ——db," or "400-cycle output reduced to —— per cent of maximum."

### M. Acoustic Fidelity Test

The acoustic fidelity test shows the manner in which the acoustic (sound) output of a radio receiver depends on the audio frequency of modulation. It takes into account all characteristics of the receiver, including the radiation of the loud speaker. For this reason, it is more valuable than an electrical fidelity test. The acoustic fidelity test cannot easily be performed with high accuracy, nor is this generally required, since the performance of the loud speaker depends on its surroundings to such a great extent.

A discussion of the difficulties and desirable precautions in making acoustical fidelity tests will be found in the report entitled "Performance Indexes and Tests of Electro-Acoustic Devices." The following paragraphs outline only simple procedures for making approximate tests which furnish useful data, but these data should not be interpreted as completely or precisely describing the acoustical performance.

Sound pressure measuring equipment is required, and should include a calibrated microphone which is fairly nondirectional.

The radio receiver is placed in the room on the floor, if a console model, or on a suitable table, if a table model. Relative to the walls, it is placed in a corner, mid-wall or mid-room position, facing the center of the room. The corner position is taken as a diagonal position in a corner of the room, the receiver being within one foot of each adjacent wall, but not touching either wall. The mid-wall position is taken as a parallel position near the middle of one of the walls of the room, the receiver being within one foot of the wall but not touching the wall. The mid-room position is taken as a position in which the receiver is removed from every wall by a distance greater than the greatest horizontal dimension of the receiver. If the measurements are made in a narrow room or booth, it is preferable to locate the receiver in a mid-wall position at one end of the room. The observed data should include a statement of the position used in each test.

Acoustic fidelity curves should be made in pairs, with the microphone in different positions, to avoid misleading results due to directional sound radiation and interference patterns. It is recommended that the microphone be placed successively in horizontal and 45-

degree directions, the microphone diaphragm being in a vertical plane two feet in front of the loud speaker. When in the horizontal direction, the microphone is directly in front of the center of the loud speaker, at the same height. When in the 45-degree direction, the microphone is two feet vertically above the former position. The direction of the microphone should be indicated on each curve.

The radio receiver is tuned to a 1000 kc signal as in the electrical fidelity test. One watt output at 400 cycles is preferred if the receiver can deliver more than one watt undistorted output. The modulation frequency is then varied continuously from 30 to 10,000 cycles, and the sound pressure variation is observed with the microphone in the horizontal and 45-degree directions, respectively.

The acoustic fidelity curve is plotted with audio frequency as abscissas and relative sound pressure as ordinates. The ordinates are plotted in decibels relative to a chosen zero level, which should be the same for all tests on a given radio receiver. The curve for the 45-degree direction should be plotted on the same sheet and directly above the curve for the horizontal direction. The scale of ordinates should be uniformly divided and the scale of abscissas logarithmically divided.

If the receiver has a tone control, a pair of curves should be taken for each of the "high" and "low" settings thereof.

Other conditions for acoustic fidelity tests may be chosen according to the suggestions made for electrical fidelity tests.

## N. Overload Test

The overload test is intended to show the maximum power output delivered from a radio receiver, without regard for distortion, also the conditions for obtaining this output and the general behavior of the receiver under overloading conditions.

The radio receiver is tuned to a 1000 kc signal modulated at 400 cycles, and is adjusted for greatest sensitivity. The modulation is set at 30 per cent and 10 per cent successively. The signal input voltage is varied from 120 to 0 db below one volt, or 1 to 1,000,000 microvolts, and the 400 cycle power output is observed. Suitable corrections are made for noise background, if present in amounts sufficient to affect the observations:

The overload curve is plotted with input voltage as abscissas and output power as ordinates. The scale of abscissas should be uniformly divided for decibels or logarithmically divided for microvolts. The scale of ordinates may be either uniformly or logarithmically divided.

Other conditions for additional overload curves may be chosen as required.

### O. Automatic Volume Control Test

This test is intended to show the operation of automatic volume control under non-overloading conditions. The radio receiver is tuned to a mean signal input voltage at 1000 kc, modulated 30 per cent at 400 cycles. The volume control is adjusted to give normal test output. In other respects, this test is similar to the overload test. Other conditions for additional curves may be chosen as required.

### P. Harmonic Distortion Test

This test is intended to evaluate the spurious audio harmonics introduced in the radio receiver during normal operation. Great care must be taken to avoid appreciable harmonic distortion occurring in any part of the signal generating equipment, or in the output measuring circuit. Harmonic measuring equipment is required in the output circuit, which should not appreciably affect the output load conditions. This equipment may measure each harmonic individually or may measure all harmonics collectively.\*

No one complete set of conditions can be prescribed for this test, because harmonic distortion depends on so many details of radio receiver design and operating conditions. The receiver should be tuned to a signal at 1000 kc, modulated at 400 cycles. One of the standard input voltages should be employed. The test should be performed with various degrees of modulation from 10 to 80 per cent. Harmonic distortion is caused by overloading and many other phenomena, and is present under various operating conditions, especially at high degrees of modulation.

Total harmonic distortion may be measured in terms of the r-m-s total harmonic voltage across a standard dummy load. It is then expressed as the ratio of this value to the corresponding value of the fundamental frequency component. This ratio is stated as a percentage.

### Q. Maximum Undistorted Output Test

This test is intended to indicate the maximum power output which the receiver will deliver under given conditions, before appreciable overloading or other forms of distortion occur. The maximum undistorted output (definition M, section II) may be determined under given conditions by observing the total harmonic distortion, and continuously increasing the output from zero up to the least value which contains a total harmonic distortion of 10 per cent (r-m-s voltage). This value is designated the maximum undistorted output under the given conditions.

\* Irving Wolff, "Alternating current bridge as a harmonic analyzer," *Jour. Opt. Soc. Amer. and Rev. Sci. Instr.*, vol. 15, no. 3, pp. 163-170; September, (1927).

The data should include a statement of the operating conditions, including which condition was varied in order to increase the output during this test. It is suggested that the volume control of the radio receiver be varied, the other conditions being unchanged during a single test and being chosen as suggested for the harmonic distortion test.

It is understood that there is no sharp dividing line between appreciable and negligible distortion. The figure of 10 per cent has been chosen as a reasonable basis for the definition of maximum undistorted output.

#### R. Sensitivity at Maximum Undistorted Output

This test is intended to indicate the signal input voltage required to take full advantage of the power output which a radio receiver is capable of delivering. The sensitivity of the receiver is measured as in the sensitivity test, except that maximum undistorted output is obtained in place of normal test output. For this purpose, the value of maximum undistorted output is taken which has been measured under the conditions most favorable to large undistorted output. If this measurement has not been made, the maximum undistorted output may be taken as the rated value stated by the manufacturer of the tubes employed in the output stage of the receiver.

#### S. Volume Control Tests

These tests are intended to determine the effect of the manual volume control on the various characteristics of a radio receiver. In many of the other tests, the volume control is necessarily adjusted and its effect is implicitly included in the observations. In addition the following tests are suggested:

##### 1. EFFECT OF VOLUME CONTROL ON SENSITIVITY

The sensitivity test (part G of this section) may be repeated at various settings of the volume control, using 1000 kc and, if desired, other signal frequencies. The volume control setting may be expressed in per cent of displacement from the minimum toward the maximum setting. A graph may be plotted with volume control settings as abscissas and sensitivity values as ordinates. The scale of ordinates should be uniformly divided if in decibels, or logarithmically divided if in microvolts. The scale of abscissas should be uniformly divided.

##### 2. EFFECT OF VOLUME CONTROL ON SELECTIVITY

In a radio receiver having automatic volume control, this effect usually requires a two-signal test (parts J and K of this section) for

its determination. Otherwise, the selectivity test may be repeated with the volume control reduced until the sensitivity test input is equal to the mean signal voltage and, if desired, to the other standard input voltages.

### 3. EFFECT OF VOLUME CONTROL ON FIDELITY

In a radio receiver without automatic volume control, this effect is implicitly included in the electrical fidelity tests (part L of this section) suggested for the different standard input voltages. If the receiver has automatic volume control, the effect of the volume control is implicitly included in the electrical fidelity tests suggested at different output power levels.

#### T. Additional Tests

Some tests may be desirable which have not come to the attention of the Standards Committee, and for which that committee would welcome suggestions. This applies to the two following phenomena, for which the committee has not been able to prescribe satisfactory laboratory tests.

##### 1. DIRECT RADIO-FREQUENCY PICK-UP

It is desired to measure the effects in a radio receiver of signal pick-up through channels other than the antenna connection. This may occur through parts of the receiver being unshielded and exposed to the signal wave. Direct pick-up of the desired signal may deprive the volume control of the ability sufficiently to attenuate strong local signals. Direct pick-up of undesired signals may detract from the selectivity of the receiver.

##### 2. RADIATION FROM LOCAL OSCILLATOR

In a superheterodyne radio receiver, the local oscillator may radiate sufficient energy to cause interference in other radio receivers operating in the same neighborhood. The radiation may take place through antenna connections of the receiver, or through incomplete shielding of the oscillator circuit.

#### V. Noise Tests

The undesired noise produced in radio receivers can readily be classified under four headings, both as to cause and effect. Each kind of noise requires special test procedures, which will be described after pointing out the characteristics which determine the kinds.

**A. Random Noise.** Random noise is caused mostly by the "thermal agitation effect" in circuits preceding the first tube of a receiver, and

by the "shot effect" and the "flicker effect" in the first tube. It is identified as a steady "sh" sound, whose intensity increases when the receiver is tuned to a weak carrier.

**B. Hum.** Hum is the low-pitched composite tone generally produced by alternating-current socket powered and electric radio receivers. The tone may include a component at any integral multiple of the alternating-current frequency. The hum is due to either of the following causes:

1. Residual hum is produced when the volume control is at the minimum setting and no signal is being received. It is caused by disturbances in the audio-frequency circuits of the receiver.

2. Hum modulation is produced by disturbances which modulate a carrier being received, and its intensity generally increases with increasing carrier voltage.

**C. Hum Distortion.** Hum distortion is produced by disturbances similar to those which produce hum, where such disturbances in either radio-frequency or audio-frequency amplifiers modulate the audio-frequency tone produced in response to a modulated radio-frequency carrier. It is identified as side bands differing from the audio-frequency modulation frequency by an amount equal to the frequency of the hum disturbance causing the distortion.

**D. Whistle.** In a superheterodyne radio receiver, receiving only a single unmodulated carrier frequency, a whistle whose pitch varies rapidly with tuning may be produced by interactions between various parts of the receiver. Such a whistle occurs most often when the received carrier frequency is near an integral multiple of the intermediate frequency, but it may occur when the received carrier frequency is near a simple fractional multiple of the intermediate frequency, such as  $3/2$  or  $5/2$ .

**E. Miscellaneous Noise.** Under the heading of miscellaneous noise come the effects of microphonic disturbances, and various phenomena of defective operation. Listening tests are valuable in detecting such noise, and no other tests will be outlined in this report.

**F. Acoustic Measurement of Noise.** The actual audibility of random noise, hum and miscellaneous noise, is best determined by a listening test. Such observations are not capable of high precision, but are fundamentally sound, as distinguished from less direct electrical observations. The completely assembled and operating radio receiver is placed in a quiet room, and an experienced observer with normal hearing notes the greatest distance at which the noise is audible under stated conditions. This distance is used to express the audibility of the

noise. The room is preferably large, or very well deadened, such as used for the acoustic fidelity test. This method takes into account noise produced by both loud speaker radiation and mechanical vibration of parts. A brief description of the sound heard is useful, in addition to the audibility observation. Obviously, this method is suited only for observing a small amount of noise.

**G. Electrical Measurement of Noise.** Since the audibility of noise depends as much on its frequency distribution as on its intensity, noise of widely varying frequencies should not be expressed in terms of the total electrical output. Also the interference effects due to different kinds of noise vary greatly, so that a fairly complete analysis is required if misleading results are to be avoided. The electrical measurements may be divided into the following classes.

### 1. RANDOM NOISE

The random noise output is measured with the load and output measuring equipment connected as in the electrical fidelity test, because the proper interpretation of the noise observation requires some reference to the electrical fidelity curve. The meter used should be chosen to have small wave-form error, or should have a noise wave-form correction factor determined by comparison with a meter having small wave-form error. If appreciable hum is present at the same time, it should be filtered out before measuring the noise. This is accomplished by the use of a high-pass filter with a sharp cut-off below 300 cycles, which has very little effect on the random noise measurement.

### 2. HUM COMPONENTS

Except where otherwise recommended, the hum components are measured with the load and output measuring equipment connected as in the electrical fidelity test. A tuned filter or other harmonic analyzer is used to measure individually the hum output at each integral multiple of the alternating-current power-supply frequency which lies below 300 cycles. When 60-cycle power is used, the 60-, 120-, 180-, and 240-cycle components are measured. The observations should be converted to power output. If a reactive loud speaker load is connected, the apparent power (volt-amperes) is preferably computed after observing at each frequency the voltage and current, the voltage and impedance, or the current and impedance. (The impedance at any frequency is easily measured by the voltage-current method.)

### 3. HUM DISTORTION

The hum distortion is measured and expressed as the r-m-s total per cent modulation of the audio-frequency tone by the hum disturb-

ance. The hum modulation of the audio-frequency tone may be measured by any method used to measure the audio-frequency modulation of a radio frequency, the audio-frequency tone acting as the carrier, and the hum disturbance acting as the modulating factor. No specific test procedure for measuring hum distortion is being outlined in this report.

#### 4. WHISTLE

The whistle output is tuned to have a frequency of about 400 cycles, and is measured in the same manner as when using 400-cycle modulation. A filter tuned to 400 cycles may be used to suppress other noise output when necessary.

**H. Equivalent Noise Side Band Input.** The random noise produced in the radio-frequency circuits of a radio receiver may be expressed in terms of an equivalent noise side band input to the receiver. This is taken equal to the voltage of a single 400-cycle side band input which will produce an equal output from the receiver, other conditions being the same. This expression of noise has the advantage that its value in most receivers does not depend greatly on the carrier input voltage, the sensitivity of the receiver, or the volume control setting. Its value is most easily observed, and is most important, in highly sensitive receivers.

The equivalent noise side band input should be observed at each of the group of three standard test frequencies. All adjustments of receiver and measuring equipment are made as in the sensitivity test. In addition, the random noise with the same carrier unmodulated is measured electrically at each frequency. If the receiver has a tone control, it is set in the "high" position. The equivalent noise side band input is computed by the equation,

$$E_n = 0.3E_s(E_n'/E_s') \quad (13)$$

where,

$E_n$  is the equivalent noise side band input voltage,

$E_s$  is the signal input voltage,

$E_n'$  is the output voltage of noise alone, and

$E_s'$  is the output voltage of signal alone.

In practice, a received broadcast signal is nearly useless unless greater than 10 times the equivalent noise side band input. The ratio should be greater than 100 times for reception without perceptible background noise. This noise test has a definite meaning when interpreted in this manner and considered together with the sensitivity test.

**I. Noise Audibility.** The noise audibility test is intended to evaluate collectively random noise and hum under operating conditions. The

radio receiver is tuned in the normal manner to each of the three standard input voltages at 1000 kilocycles. If the receiver has a tone control, it is set in the "high" position. The volume control is adjusted to give normal test output with the signal modulated 30 per cent at 400 cycles, then the modulation is reduced to zero. The remaining noise is measured acoustically. The residual noise audibility is likewise measured, with no signal and the volume control set at minimum.

**J. Residual Hum.** The residual hum test is intended to evaluate the hum components in the output of a radio receiver, when no signal is being received and the volume control is set at minimum. If the receiver has a tone control, it should be set in the "high" position. The procedure depends on whether any part of the hum originates in the loud speaker. The observations should be converted to apparent power output.

If there is no appreciable hum voltage across the loud speaker terminals when disconnected from the radio receiver, the hum components are measured with the load and output measuring equipment connected as in the electrical fidelity test.

If there is appreciable hum voltage across the loud speaker terminals when disconnected from the radio receiver, the hum components should be measured in terms of the hum current through the loud speaker voice coil itself, and not in terms of the voltage across the loud speaker. The loud speaker is connected in the normal manner to the radio receiver when the observations are made. The current-measuring equipment should introduce into the voice-coil circuit an impedance which is negligible as compared with the voice-coil impedance. In the case of a loud speaker having a field coil carrying hum current, this procedure evaluates the combined effect of hum originating in the radio receiver itself and hum induced in the voice coil from the field coil, with due regard to their phase relations.

**K. Hum Modulation.** The hum modulation test is intended to evaluate the hum components introduced in a radio receiver by hum disturbances modulating the received carrier. In order to measure hum modulation as distinguished from residual hum, the former is accentuated by the adjustments of the receiver. The receiver is tuned in the normal manner to each of the three standard input voltages at 1000 kilocycles. If the receiver has a tone control, it should be set in the "high" position. The volume control is adjusted to give approximately the maximum undistorted output obtainable with the given signal voltage modulated 30 per cent at 400 cycles, then the modulation is reduced to zero. The hum components are measured with the load and output measuring

equipment connected as in the electrical fidelity test. The hum modulation at each component frequency is computed by the equation

$$m = 30E_h/E_s \quad (14)$$

where

$m$  is the hum modulation in per cent,

$E_h$  is the hum output voltage, and

$E_s$  is the signal output voltage.

This test can be made accurately only if the modulation hum becomes several times as great as the residual hum, but otherwise the test is relatively unimportant.

**L. Whistle Modulation.** The whistle modulation test is intended to evaluate the whistle noise which may be introduced in a superheterodyne receiver. In order to measure whistle modulation it is accentuated by the adjustments of the receiver. The receiver is tuned in the normal manner to a signal at one of the standard input voltages. If the receiver has a tone control it should be set in the "high" position. The volume control is adjusted to give approximately the maximum undistorted output obtainable with the given signal voltage modulated 30 per cent at 400 cycles, then the modulation is reduced to zero or to a very small value so as not to mask the whistle. The loud speaker load is used, with output measuring equipment, to enable the observer to listen for whistles. The signal generator and receiver are tuned together over the entire frequency band, and each frequency is noted where a whistle is heard near zero beat at the same time the receiver is exactly in tune with the signal. At each frequency noted, the signal input voltage and the volume control are again adjusted and the whistle output is measured electrically with the whistle tuned to about 400 cycles and the modulation reduced to zero. The whistle modulation is computed by the equation

$$m = 30E_w/E_s \quad (15)$$

where,

$m$  is the whistle modulation in per cent,

$E_w$  is the whistle output voltage, and

$E_s$  is the signal output voltage when modulated 30 per cent at 400 cycles.

This procedure is followed with each of the three standard input voltages. The whistle modulation need not be measured if it is so small as to be masked by random noise.

## VI. Receiver Performance Graph Sheets

In an engineering analysis of general trends in receiver design and performance, it is necessary to consider data on a large number of

receiver designs, and on a large number of particular receivers of each design, for it is well known that the performance of a random sample of a type of receiver may be far from representative of the type as a whole. In order to facilitate such analyses, and to aid in the evaluation of a particular design relative to the field, the receiver performance graph sheets to be described below were developed. It is hoped that they will be found useful and freely used. The Institute will welcome any comments or suggestions of the members relative to their improvement.

Great accuracy is not usually justified in plotting typical or average characteristic curves, for large probable errors are inherent in a determination of what is typical or average from the relatively small quantity of data usually available. And furthermore, the usefulness of the sheet as a summary for frequent reference would be decreased by including too much detail. Therefore, in the form shown in Fig. 10, advantage has been taken of these facts by making the sheet small—standard Lefax size,  $3\frac{3}{4}$  in.  $\times$   $6\frac{3}{4}$  in.—thus gaining the utmost in compactness without sacrifice of needed accuracy.

Curves plotted on this sheet may be easily read to an accuracy of five per cent, which should prove sufficient for the original record of many receiver tests which are made with test equipment not of the highest order of accuracy, or which are rapidly made when great accuracy is not required. However, this small sheet has been designed with the principal object in view of providing a means of recording average or typical data in summary form for ready reference. Tests made to disclose small differences in individual receivers, or to discover errors or defects, should be recorded in other ways more suitable for such tests.

The sheet consists of two ruled sections, one with logarithmic abscissas and linear ordinates, for fidelity curves, and the other with linear abscissas and logarithmic ordinates, upon which may be recorded sensitivity and band-width (selectivity) curves. The scales are all properly marked and are so chosen as to be universal, that is, they will be suitable for practically any present or contemplated broadcast receiver.

The use of universal scales is considered essential so that different receivers may be compared at a glance by noting the shape and location of their characteristic curves on the standard sheet, without the necessity of translating the curves back into figures. This requirement necessitates—if undue loss of accuracy is to be avoided—the plotting of the selectivity characteristic by means of the band width, derived from the inverse resonance curves (or measured directly) instead of the inverse resonance curves. It is obvious that to cover all types of re-

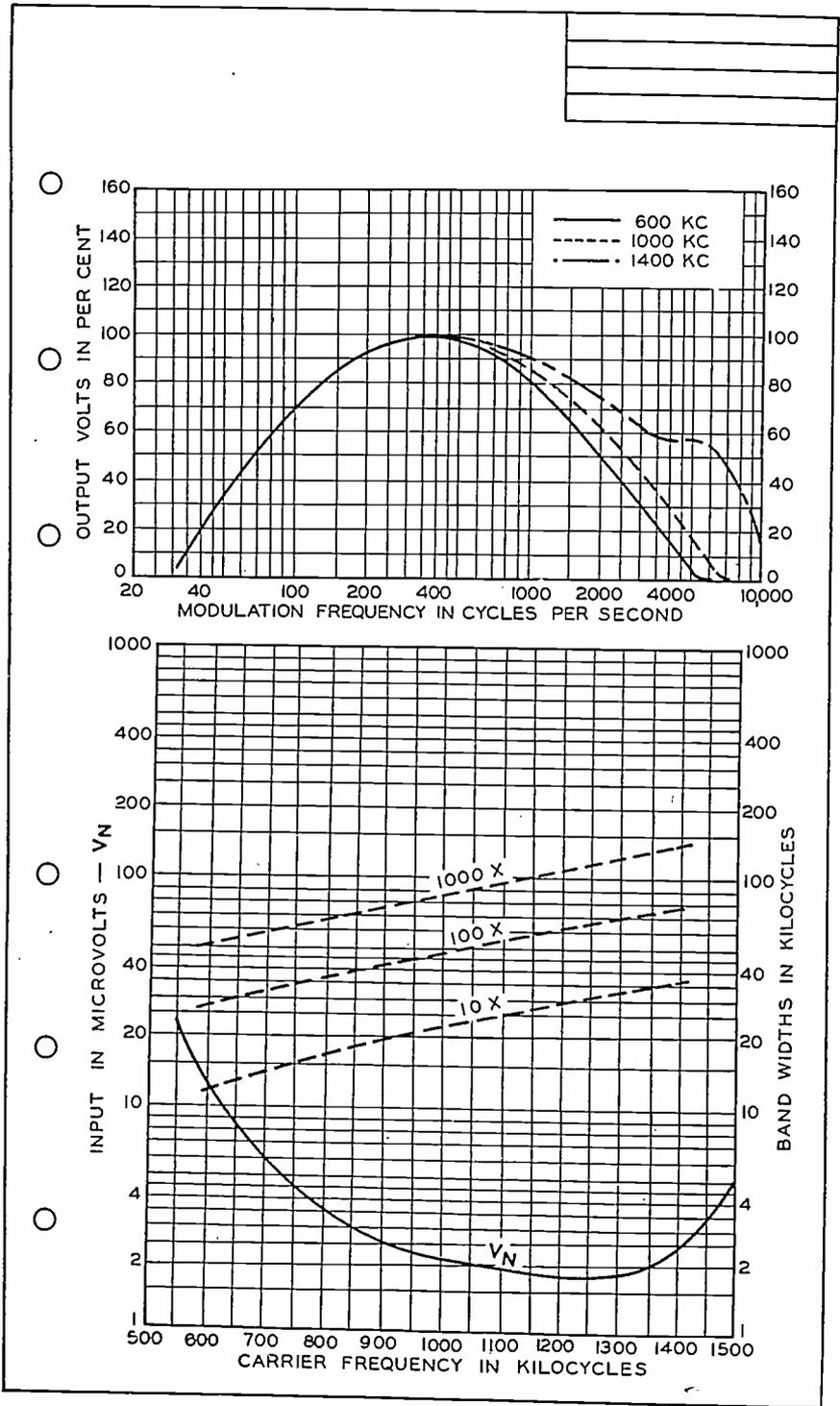

Fig. 10—Receiver performance graph sheet. (Full size.)

ceivers, a logarithmic scale for sensitivity and band width is required. Linear ordinates for the fidelity curves are chosen because, on a small sheet, they sometimes indicate with greater accuracy the essential fidelity characteristics.

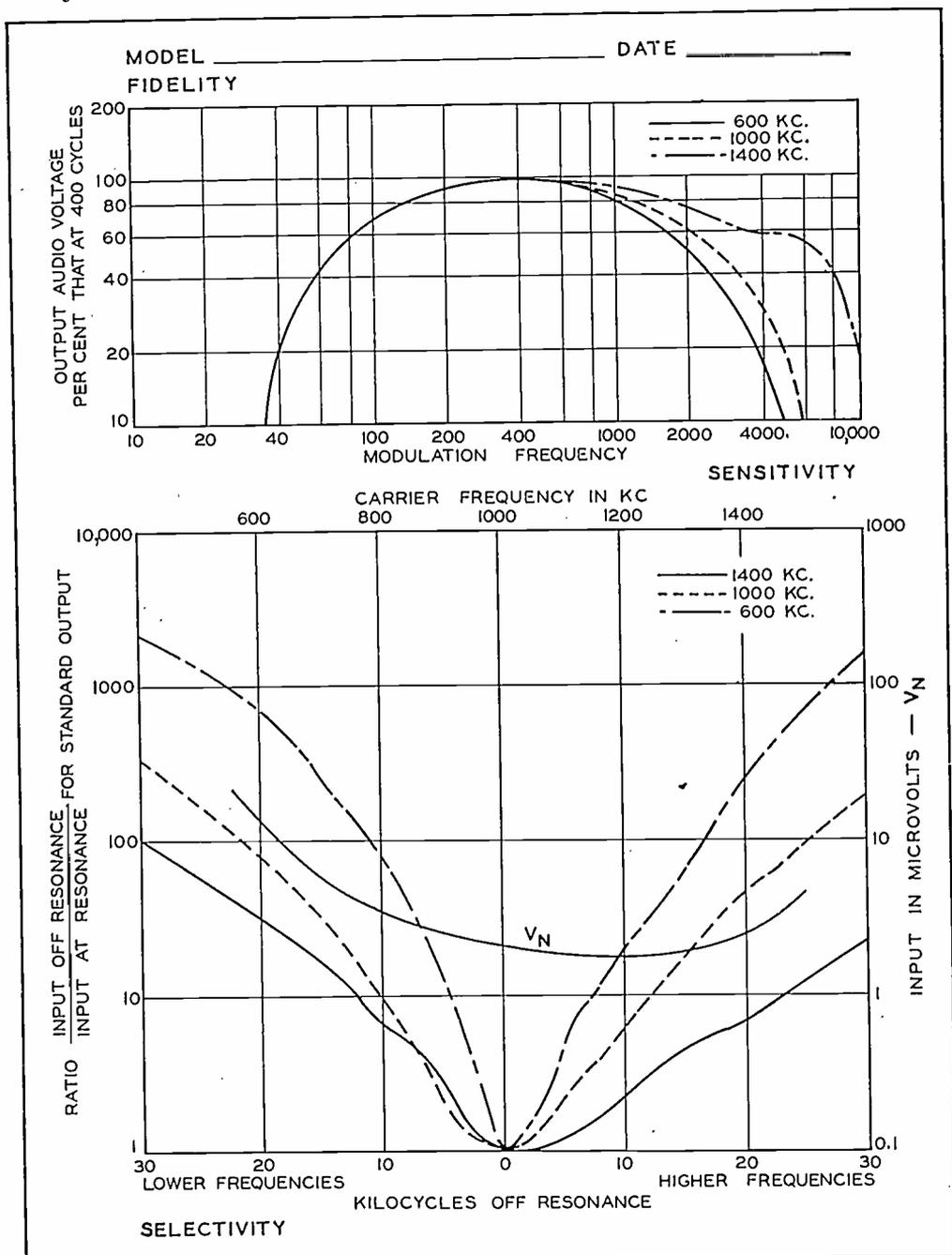

Fig. 11—Receiver performance graph sheet. (Half size.)

Space has been left at the top of the sheet for a title and any general memoranda which may be desirable. The standard Lefax index ruling

may be included in the upper right-hand corner of the sheet, if desired, subject to any legal restrictions there may be to the use of this ruling. The figure shows the proposed sheet, full size, upon which have been plotted, for the purpose of illustration, the basic characteristics of a receiver: sensitivity; band widths at 10, 100, and 1000 times normal radio input voltage at resonance; and fidelity, measured at the three standard test frequencies of 600, 1000, and 1400 kilocycles per second.

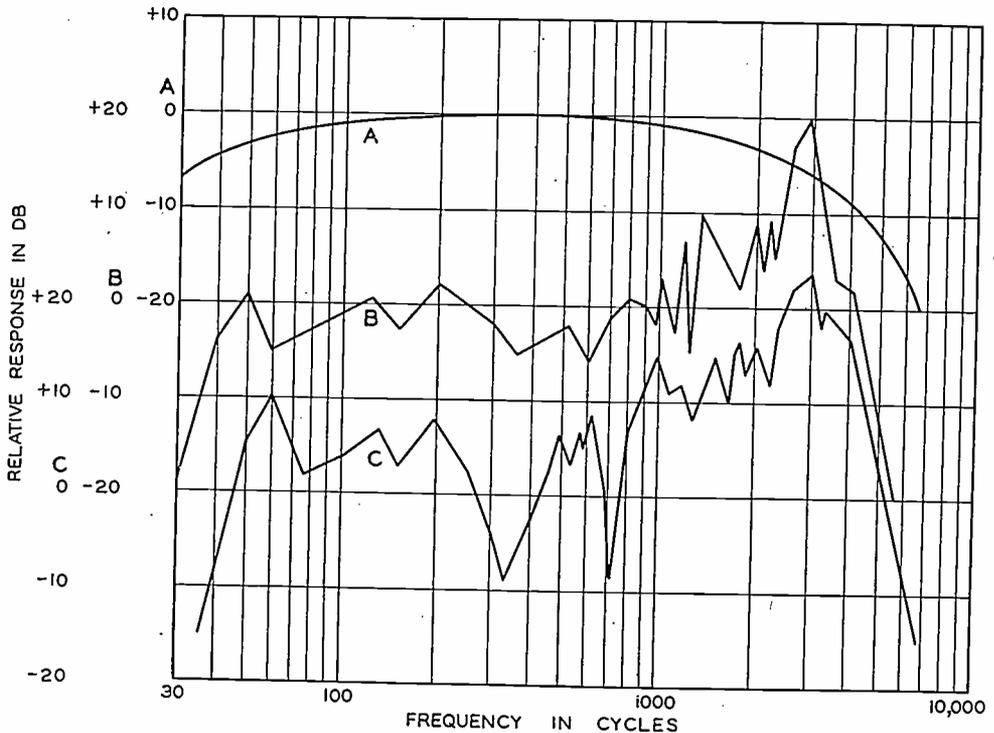

Fig. 12—Electrical and acoustic fidelity curves.

- A. Electrical fidelity curve.
- B. Acoustic fidelity curve (microphone in 45-degree direction).
- C. Acoustic fidelity curve (microphone in horizontal direction).

For those who prefer to plot complete selectivity curves, instead of band-width data, a different form has been prepared, and is shown in Fig. 11. This form is designed for standard letter size paper,  $8\frac{1}{2}$  in.  $\times$  11 in.

The lower part of the form provides for plotting complete selectivity curves, and also provides for a sensitivity curve. As in the smaller form, the upper section of the form is for fidelity curves. Logarithmic ordinates are provided for the fidelity curves, as many engineers consider these show the fidelity more nearly as it sounds.

The curves plotted on Fig. 11 are from the same data as those on Fig. 10.

Fig. 12 shows a specimen curve sheet on which are plotted the elec-

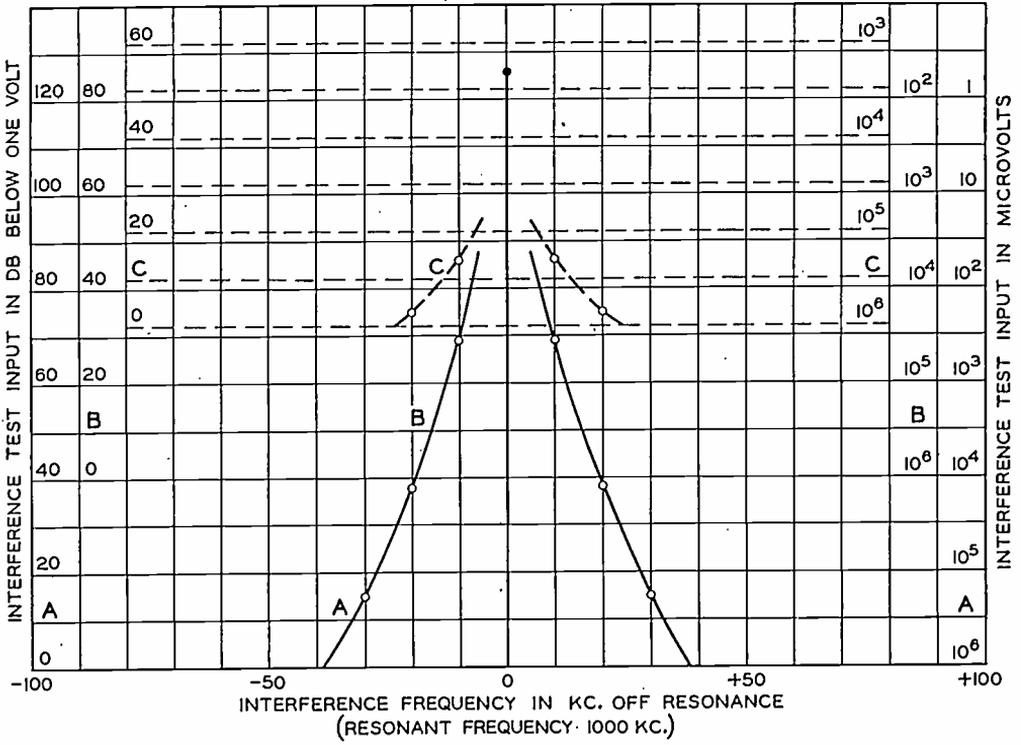

Fig. 13—Crosstalk interference curve.

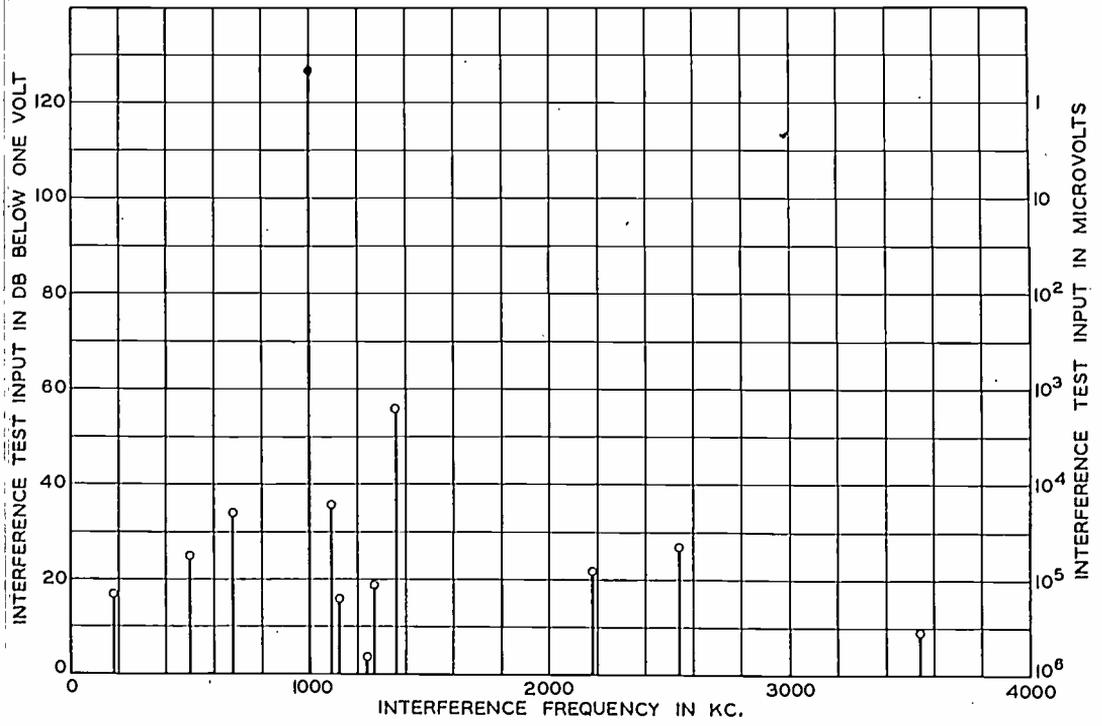

Fig. 14—Whistle interference spectrum.

trical fidelity curve (A) and a pair of acoustic fidelity curves (B and C), all taken under the same operating conditions of the radio receiver. The two acoustic fidelity curves are taken with the microphone in two different positions as recommended in section IV-M.

Fig. 13 shows a specimen curve sheet on which are plotted three crosstalk interference curves of a radio receiver tuned to 1000 kilocycles. The lower curves (A and B) are taken respectively with distant and mean desired-signal voltages, while the upper curve (C) is taken with a local desired-signal voltage. The scales of ordinates are so chosen that these curves should coincide to the extent that the selectivity of the receiver is independent of signal intensity and volume control. In general, the curves would all differ slightly. A distinct departure of the upper curve (C) usually indicates cross-modulation of the desired signal by the interfering signal.

Fig. 14 shows a whistle interference spectrum of a superheterodyne radio receiver tuned to 1000 kilocycles. The coordinates are laid out similar to those of Fig. 13, except for the marking of the scales.

In Figs. 13 and 14, the peak values at the desired-signal frequency depend only on the desired-signal input voltage, and are the same for all receivers. Therefore these points may be plotted on the sheet before the observations are made.

# STANDARD TESTS OF HIGH-FREQUENCY RECEIVERS

## I. Introduction

This report is intended as the beginning of a standardization program covering the testing of high-frequency (short wave) receivers, by which are meant those receivers designed to operate on frequencies from 1500 to about 20,000 kc. This report relates to those high-frequency receivers which are intended to deliver relatively low power output, suitable for operating telephone headsets, as well as to those which are intended to operate loud speakers.

At present the tests of high-frequency receivers made in one laboratory are rarely directly comparable with those made in another. Comparison of such data involves complicated calculations which are likely to lead to erroneous results. Because of this, numerical values expressing the performance of high-frequency receivers are lacking in general utility.

The problem of prescribing high-frequency receiver measurements is a difficult one, both because of the difficulties of the measurements themselves, and because of the diverse uses to which high-frequency receivers are put.

There is relatively little testing equipment generally available for the determination of high-frequency receiver performance. The formulation of standards in this field, both by aiding in the development of testing equipment, and by making more useful the data obtained from such equipment, should do much to advance the testing of high-frequency receivers.

It should be noted that much of the material here presented is generally applicable to all receivers for diverse and special uses, whatever their frequency range. Likewise some of it, notably that dealing with the treatment of controllable regeneration, and with tests relating to noise level, are applicable to some extent to broadcast receivers. It is hoped that the contents of this report, where applicable, will be freely used outside the field of high-frequency receivers, and will be transcribed, suitably modified, to the standardization material relating to these other fields.

It is also emphasized that this report is primarily an extension of the earlier and contemporary report entitled, "Standard Tests of Broadcast Radio Receivers." Reference to these other reports is essential to the full utilization of the material in the present report.

Wherever the material of this report deviates materially from practice already standardized in the field of broadcast receivers, such devi-

ation has been proposed only after careful consideration of the need for it in the broader field of high frequency receivers.

## II. Definitions of Terms

**A. Standard Dummy Antenna.** As applied to the testing of a high-frequency receiver, this term represents a nonreactive resistor of 400 ohms.

**B. Normal Test Output.** The normal test output depends on whether the receiver is designed to operate a telephone headset or a loud speaker. Two definitions are therefore given.

### 1. RECEIVER DESIGNED TO OPERATE A TELEPHONE HEADSET

In the testing of a receiver designed to operate a telephone headset, the normal test output is an audio-frequency power of 6 milliwatts delivered to a noninductive resistor arranged to carry alternating current only and connected between the output terminals of the receiver, the value of the resistor having been adjusted to the same value which gives the greatest power output in response to a given input which is substantially smaller than is required to overload the receiver. This value, in the case of a triode tube, may be assumed equal to the plate resistance of the tube, or to its value transferred to the secondary of the output transformer, if one is used and is contained within the receiver.

### 2. RECEIVER DESIGNED TO OPERATE A LOUD SPEAKER

In the testing of a receiver designed to operate a loud speaker, the normal test output is an audio-frequency power of 50 milliwatts delivered to a standard dummy load as defined in "Standard Tests of Broadcast Radio Receivers."

**C. Blocking.** This term refers to the almost complete loss of sensitivity of a receiver, resulting from some overloading effect, usually caused by a powerful undesired signal.

## III. Requirements and Calibrations of Standard Signal Generators

Standard signal generators for use on frequencies of 1500 to 20,000 kc are somewhat more difficult to construct than those for use at lower frequencies, but may be constructed along much the same lines if sufficient care is used in the design. It will not usually be found satisfactory to modulate directly the oscillator of the standard signal generator as the frequency modulation may be excessive. A master oscillator working into one or two stages of amplification, with the modulation ap-

plied to the last stage, will generally prevent frequency modulation of the oscillator.

The attenuating system of a standard signal generator for use on high frequencies must receive special attention as the errors inherent in an ordinary attenuator at 20,000 kc are excessive. Both variable mutual inductance and fixed resistance attenuators have been successfully used at high frequencies. The input to the attenuator may be measured with a thermovoltmeter or vacuum tube voltmeter. A vacuum tube voltmeter used for this purpose should employ plate curvature detection in order that its indication should be as independent as possible of the wave shape and frequency. There is a possibility that the calibration of the detector may change with frequency, although if the external plate circuit impedance is low compared with the internal plate resistance of the tube for all carrier frequencies under consideration, there should be no appreciable error from this cause.

The standard signal generator may be calibrated by one of the methods described in section A below.

**A. Methods of Calibrating Standard Signal Generators.** In obtaining a measurement of the sensitivity of a high-frequency radio receiver, it is necessary to have a source of known voltage. For routine measurements a standard signal generator consisting of an oscillator and high-frequency voltmeter followed by an attenuator is generally used. Since it is difficult to build an attenuator in which the attenuation can be calculated precisely it is necessary that the output voltage from the attenuator be checked by some accurate methods.

Three methods of calibration have been used successfully. Numerous other methods have been used, but the methods given here have been selected as simple and probably satisfactory.

1. The measurement of the output of the standard signal generator with a superheterodyne receiver having an attenuator in the intermediate frequency amplifier.

2. The step-by-step method.

Each of these methods is described in more detail and the sources of inaccuracy in each are pointed out.

#### 1. METHOD OF USING SUPERHETERODYNE RECEIVER

The attenuator of a high-frequency signal generator may be compared with an attenuator in the intermediate-frequency amplifier of a superheterodyne receiver. The input voltage to the former is usually measured in the normal operation of the signal generator, but if not, this voltage is easily measurable. Therefore, this furnishes an accurate method of checking the output voltage of the signal generator. The sig-

nal generator output is applied to the converter tube of the superheterodyne receiver, and the intermediate-frequency attenuator is adjusted to give a measurable output from the intermediate-frequency amplifier. The high-frequency and low-frequency attenuators are then varied in opposite directions, keeping the intermediate-frequency output constant. In this way, the high-frequency attenuation is measured in terms of the known intermediate-frequency attenuation.

This method assumes that the intermediate-frequency output of the converter tube is proportional to the high-frequency input. When the circuits are properly designed this is true over the moderate range of voltages used in practice.

## 2. STEP-BY-STEP METHOD

Another method which is employed, is the step by step method in which a large output that can be readily measured is first obtained. This output is applied to an amplifier having a variable gain which is adjusted until a meter in the amplifier output circuit is reading near the maximum. The input is then cut down by means of the standard signal generator attenuator until the meter indicates some fraction (say one quarter) of its former deflection. The gain of the amplifier is then increased until the meter again reads its original value and the process repeated. As the errors in all readings may accumulate in the final calibration, it is important that the number of steps should be the minimum consistent with accurate reading of the meter. The meter should also be calibrated accurately before starting the standard signal generator calibration.

**B. Modulation of Standard Signal Generators.** Standard signal generators, for use in testing high-frequency receivers, should be capable of from 5 per cent to 80 per cent modulation, because of the diverse uses to which such receivers are put. Unless otherwise stated, 30 per cent modulation will be used, except for tests of overloading, cross modulation, and the like.

## IV. Test Procedures

**A. Input Measurements.** A dummy antenna should be connected between signal generator and receiver when making input measurements. Three cases must be considered in the selection of the dummy antenna to be used:

1. In the case of a receiver designed for use with an antenna of known or specified constants, where it is reasonably certain that the receiver will actually be used with such an antenna, a dummy antenna having impedance characteristics equivalent to those of the specified

antenna should be used. In this case, a statement of the constants of the dummy antenna used should be included in the test data.

2. In the case of a receiver designed to operate from a transmission line, the dummy antenna used should be a nonreactive resistor whose resistance is equal to the characteristic impedance of the transmission line, or its value transferred through a coupling transformer if one is to be used external to the receiver. In this case, the resistance of the dummy antenna should be included in the test data.

3. In the case of receivers to be used with antennas of unknown or different characteristics, the standard dummy antenna—a non-reactive resistor of 400 ohms—should be used, and a statement of this fact should be included in the test data.

The input to the receiver should be expressed as the r-m-s voltage in microvolts applied to the receiver and dummy antenna in series. If a modulated input is required this should be modulated 30 per cent at 400 cycles, unless otherwise required by conditions of test and noted in the test data. The principal exceptions will be other depths of modulation for overloading tests, and 200-cycle modulation for tests of receivers at optimum standard regeneration.

**B. Output Measurements.** In making output measurements, a resistor arranged to carry alternating current only is connected between the output terminals of the receiver. The value of the resistor is determined as specified in the definition of normal test output. The value of this resistor depends on whether the receiver is designed to operate a telephone headset or a loud speaker, and the value should be noted in the test data.

The output should be expressed in watts dissipated in the output resistor. Unless otherwise called for and recorded in the test data, tests will be made at normal test output.

**C. Conditions of Regeneration or Oscillation.** In testing receivers having an adjustment of feed-back intended to be controlled by the operator to obtain the desired degree of regeneration (or amplitude of oscillation for autodyne reception), the method of setting this control must be specified. In adjusting regeneration to receive a modulated signal, the feed-back must be held less than that required to cause self-oscillation when the signal is reduced much below the test value, or when the signal is detuned. The following methods may be used:

1. OPTIMUM REGENERATION (ALSO CALLED CRITICAL REGENERATION)

Optimum regeneration is obtained by adjusting the feed-back or regeneration control until maximum output without oscillation is ob-

tained for a given input modulated 30 per cent at 200 cycles. This adjustment must be made with an input small enough to avoid overloading effects in circuits following the regenerative element. This setting will generally be as close to the oscillation point as possible, and therefore the amount of regeneration obtained will depend on the smoothness of the control and on the skill and patience of the test operator. Test data taken with optimum regeneration are generally more useful than data with other conditions of regeneration, but since the setting of the regeneration control is usually very critical at the optimum point, data taken at this setting may lack definiteness and reproducibility.

## 2. STANDARD REGENERATION

Standard regeneration is obtained by making the adjustment for optimum regeneration and then readjusting the regeneration control until the audio output is reduced 14 decibels—to 4 per cent of its former power or to 20 per cent of its former voltage. This reduction is made by reducing the feed-back below the optimum value. This setting is defined in order to provide a test condition more nearly approximating a practical operating condition than does optimum regeneration, and one where the receiver characteristics are more stable.

## 3. MAXIMUM REGENERATION

In case the range of the regeneration control does not permit reaching optimum regeneration, maximum regeneration may be used instead of optimum or standard regeneration.

## 4. MINIMUM REGENERATION

In some cases data with the regeneration control set at its mechanical minimum may be useful.

## 5. OPTIMUM OSCILLATION

Optimum oscillation is obtained by adjusting the feed-back or oscillation control for heterodyne reception until maximum audio-frequency output is obtained for a given unmodulated input. This adjustment must be made with an input small enough to avoid overloading effects in the heterodyne detector and following circuits. This setting, like that for optimum regeneration, may be somewhat critical, and test data may lack definiteness and reproducibility.

## 6. STANDARD OSCILLATION

Standard oscillation is obtained by making the adjustment for optimum oscillation, and then readjusting the oscillation control until

the audio-frequency output is reduced 3 decibels—to 50 per cent of its former power or to 70 per cent of its former voltage. This reduction is made by increasing the amplitude of oscillation. The beat frequency should be held substantially unchanged as the output is reduced. This setting is defined in order to provide a test condition more nearly approximating a practical operating condition than does optimum oscillation, and one where receiver characteristics are more stable.

## V. Standard Tests

### A. Sensitivity Tests

#### 1. HETERODYNE RECEPTION OF UNMODULATED (CW) SIGNAL

Sensitivity should be expressed as the r-m-s unmodulated input voltage in microvolts (impressed on the receiver through the dummy antenna) which gives normal test output. The output frequency (beat note) should be adjusted to 1000 cycles, except in the case of a receiver having an intentionally peaked audio-frequency characteristic, in which case the audio frequency for the best sensitivity may be used, and should be stated in the test data. If provision is made for adjusting the oscillator circuit, this may be adjusted for either optimum or standard oscillation, and a statement of the setting used included in the test data. It is considered preferable to conduct these measurements at standard oscillation. If the receiver is not capable of giving normal test output, the sensitivity test must be made at a smaller output and the sensitivity stated as  $x$  microvolts at a subnormal test output of  $y$  milliwatts.

#### 2. RECEPTION OF MODULATED SIGNAL

The sensitivity should be expressed as the r-m-s input voltage in microvolts, modulated 30 per cent (impressed on the receiver through the dummy antenna), which gives normal test output. If the receiver includes a regeneration control, this should be adjusted to one of the settings defined in section IV-C above, and the setting used should be stated as follows: "sensitivity with optimum regeneration," "sensitivity with standard regeneration," etc. It is considered preferable to conduct these measurements at standard regeneration. The frequency of modulation should be 400 cycles, except for tests made at optimum or standard regeneration, when a modulation frequency of 200 cycles should be used. If the receiver is not capable of giving normal test output, the sensitivity test must be made at a smaller output, and the sensitivity stated as  $x$  microvolts at a subnormal test output of  $y$  milliwatts.

## B. Selectivity Tests

### 1. HETERODYNE RECEPTION OF UNMODULATED (CW) SIGNAL

Either or both of the following two methods may be used, but the method used should be clearly stated in the test data. The two methods determine entirely different characteristics of the receiver and are not alternative methods in any sense. These tests may be made with either standard or optimum oscillation, preferably the former, and the setting used should be stated in the test data.

#### a. Modulated Signal Method.

A signal input modulated 30 per cent at 400 cycles should be used. The receiver should be tuned to the signal at the frequency for which the selectivity is desired, the oscillator adjusted to "zero beat," and the input adjusted until normal test output is obtained. The signal carrier frequency should then be varied and the input adjusted to maintain the output constant. The selectivity curve is then the graph of the ratio of the input voltage required off resonance for normal test output to the input voltage required at resonance for that output, plotted as a function of carrier frequency. A 400-cycle band-pass filter must be used in the output circuit to eliminate the beat between the heterodyne oscillator and the signal carrier, or else this method must not be used in the region where such a beat frequency would be transmitted by the audio-frequency amplifier of the receiver. This method does not take into account the audio-frequency selectivity of the receiver subsequent to the heterodyne detector. The peak of the selectivity curve cannot be observed by this method, but may be plotted by graphical interpolation, or may be computed.

#### b. Unmodulated Signal Method.

The receiver should be adjusted as in the sensitivity test described in section V-A-1 above, except that the signal is unmodulated, and then the signal frequency should be varied, leaving the receiver, including the heterodyne oscillator, unchanged. The input voltage is adjusted to maintain the output constant at normal test output, and the selectivity curve is formed as in the preceding method, a, from the ratio of the input voltage off resonance required for normal test output to the input voltage required at resonance for that output. This method gives a measure of the degree to which the receiver discriminates against unmodulated signals only.

### 2. RECEPTION OF MODULATED SIGNAL

Either of the following methods may be used, but the method used should be stated in the test data. If a regeneration control is provided,

this should be adjusted by one of the settings defined in section IV-C above, and the setting used should be stated as follows: "selectivity with optimum regeneration," "selectivity with standard regeneration," etc. It is considered preferable to conduct these measurements at standard regeneration. A modulation frequency of 400 cycles should be used where a modulated signal is specified, except for tests made at optimum or standard regeneration, in which case a modulation frequency of 200 cycles should be used.

a. One-Signal Method.

This test is like the standard selectivity test for broadcast receivers, except that a modulation frequency of 200 cycles is used for tests at optimum or standard regeneration. It does not take into account certain factors affecting selectivity, such as cross modulation and overloading effects, which are disclosed by the two-signal method described below.

b. Two-Signal Method.

One input voltage modulated 30 per cent, representing a desired signal, is applied to the receiver. The receiver is adjusted as in the sensitivity test described in section V-A-2 above, and then the modulation is removed from the signal. A second input voltage, modulated 30 per cent at 400 cycles representing an undesired signal, is then introduced, and its carrier frequency varied, adjusting the input so that normal test output is maintained. Then the selectivity curve is formed from the ratio of input voltages of the undesired signal off resonance which gives normal test output, to the input of the desired signal at resonance which gives the same output. A band-pass filter, designed to pass the modulation frequency only, must be used in the output circuit to eliminate the beat frequency or heterodyne note produced by the two carriers, or else this method must not be used in the region where such beat frequency would be transmitted by the audio-frequency amplifier of the receiver. Ordinarily there is no need for using this method in this region. The peak of the selectivity curve cannot be observed by this method, but may be plotted by graphical interpolation, or may be computed.

c. Fidelity Test.

This test is like the standard fidelity test for broadcast receivers, except that carrier frequencies for which the receiver is designed will be used. Certain portions of the audio-frequency spectrum may be of particular interest, depending on the use to which the receiver is to be put.

#### d. Input-Output Tests.

The input-output curve of a receiver may be obtained by measuring the output power in watts at various known values of input voltage, and at various settings of the volume control. The output circuit should be resistance loaded as stipulated in section IV-B above. The input should be introduced through a dummy antenna as in section IV-A.

If the receiver is designed for heterodyne reception of continuous wave signals, the input should be a pure continuous wave and the feed-back control, if any, adjusted to standard oscillation. The beat note should be adjusted as described above in section V-A-1.

If the receiver is designed for the reception of modulated signals, the feed-back control, if any, should be adjusted to standard regeneration. The input should be modulated 30 per cent at 400 cycles per second. Other depths of modulation may be of particular interest, in which case the depth of modulation used should be stated on the curve sheet.

When the receiver is sufficiently sensitive, the gain for continuous wave telegraph reception should be adjusted to a value such that the noise output for zero input will be approximately 10 decibels below the normal test output. Likewise, the gain for reception of modulated or icw signals should be adjusted to such a value that when the carrier, modulated 30 per cent, gives standard output, the noise output with modulation off but with the carrier left on will be approximately 10 decibels below the normal test output (32 per cent of normal test output voltage). It is assumed that maximum sensitivity will be used if, for this condition, the noise output does not exceed the stated value.

The data may be plotted, preferably on log-log coordinates, with input microvolts as abscissa and output watts as ordinate. A point on the curve corresponding to normal test output should be indicated. These data should be obtained over as great a range of input voltages as possible. The resulting curves will indicate the limitations of the receiver due to tube and circuit noise level at the low input and those due to overloading conditions at high input. This procedure may give misleading results when applied to receivers having automatic volume control.

#### e. Tests Relating to Noise Level.

Disturbances arising in the receiver which manifest themselves as noise are classified as receiver noise. These may be divided into two groups: (1) electrical in origin, such as power supply, hum, shot effect in vacuum tubes, and thermal agitation effect; and (2) mechanical in

origin, such as microphone noise, most often important in receivers operating under severe conditions of vibration, such as aircraft receivers.

Noise may be measured at its point of origin, or after amplification or modification by the receiving process. Usually the former is impractical because the original noise is usually so small as to be unmeasurable unless amplified. The noise of ultimate interest is that effective at the final indicating instrument, which in the case of audible reception is the noise sound pressure developed by the telephone receiver. For convenience in receiver testing, a more practical measurement is that of the r-m-s noise voltage at the output terminals of the receiver proper, since in this case difficult acoustic measurements are not required.

The following tests are intended to evaluate only the receiver noise which is random in nature and not such noise as hum and microphonic disturbances. Noise from other causes should be reduced as nearly to zero as possible. If the hum output is comparable with the noise output, the hum should be filtered out by the use of a high-pass filter having a cut-off frequency of about 200 cycles, interposed between the receiver and the output meter.

Since the noise to be measured is of a random nature, it can be measured only in terms of average or mean values. Average power or root-mean-square voltages and currents appear to be the most suitable. It must be remembered that to obtain the true r-m-s value of a voltage with very irregular wave form or with large peak values, as will be obtained with noise voltages, instruments which are truly r-m-s devices over a wide range must be used if serious error is to be avoided. Thermocouple meters are the most reliable for this purpose.

There is only one way that receiver noise can be expressed so that its value is relatively independent of the signal voltage and of the receiver control. This is in terms of equivalent antenna noise voltage. The figure obtained is the r-m-s value of the noise voltage which, if applied in series with the dummy antenna, and if comprised only of frequency components to which the receiver is responsive, would contribute the same noise output as is present in the receiver. Even this figure is somewhat arbitrary, due to the various undetermined factors involved, but it is considered to be the most useful simple expression. The various factors include the characteristics of almost every part of the entire receiver.

The receiver noise may best be measured in conjunction with the sensitivity test. All adjustments are first made as in the sensitivity test, after which one of the following procedures is employed:

## i. Unmodulated Signal Method

The total power output of signal and noise is observed. Then the signal is reduced to zero and the power output of noise alone is observed. The difference between these values is the power output of signal alone. The equivalent antenna noise voltage is then given by

$$E_n = E_s \sqrt{W_n / W_s} \quad (1)$$

where,

$E_n$  is the equivalent antenna noise voltage,

$E_s$  is the signal input voltage,

$W_n$  is the power output of noise alone, and

$W_s$  is the power output of signal alone.

## ii. Modulated Signal Method

The total power output of signal and noise is observed. Then the signal modulation is reduced to zero, without changing the signal carrier, and the power output of noise alone is observed. The difference between those two values is the power output of signal alone. The equivalent antenna noise voltage is then given by

$$E_n = 0.3 E_s \sqrt{W_n / W_s} \quad (2)$$

where,

$E_n$  is the equivalent antenna noise voltage,

$E_s$  is the signal input voltage,

$W_n$  is the power output of the noise alone, and

$W_s$  is the power output of the signal alone.

# STANDARD METHODS OF TESTING VACUUM TUBES

## I. General

A. **Scope.** This section of the Report of the Standards Committee deals with the methods of measurement of the important characteristics of vacuum tubes, including phototubes.

B. **General Precautions.** Attention is called to the necessity, especially in tests of apparatus of low power, such as vacuum tubes intended for reception, of eliminating or correcting for errors due to the presence of the measuring instruments in the test circuit. This applies particularly to the currents taken by voltmeters and other shunt connected apparatus, and to the voltage drops in ammeters and other series connected apparatus.

Attention is also called to the desirability of keeping the test conditions such as filament heating, plate potential, and plate current within the safe limits specified by the manufacturers. If the specified safe limits are exceeded the characteristics of the vacuum tube may be permanently altered and subsequent tests vitiated. When particular tests are required to extend somewhat beyond a specified safe limit (see sections II, A-E, pages 128-133) such portions of the test should be made as rapidly as possible and preferably after the conclusion of the tests within the specified safe limit.

C. **General Test Conditions.** Except when the nature of a test calls for varying or abnormal conditions, all tests should be made at the normal rated conditions specified by the manufacturers of the vacuum tubes. In case the manufacturer's rating is not specific, test conditions not specified should be selected in accordance with the best judgement of the tester, and should be clearly and fully stated as a part of the test data.

When a filament is rated in both voltage and current, the rated voltage should be employed in tests, except that in cases where filaments are to be used in series the rated current may be employed, this to be stated as a part of the test data. Direct current should be used for filament heating, except where the normal operating condition is with alternating-current heating, in which case the use of the latter should be stated. When direct-current heating is employed, the negative filament terminal should be taken as the datum of potential. If the proper filament terminal to be used as the negative is not indicated by the manufacturer or specified in any recognized standard manner for a given vacuum tube structure, the terminal used as the negative should be stated with the test data. When alternating-current heating is employed in the case of a filamentary cathode, the mid-point (i.e.,

the center tap on the filament transformer secondary, or the mid-point on a resistor shunting the filament) should be taken as the datum. It should be noted that these two potential datum conditions are not equivalent and should not be expected to give equivalent readings. If substantially equivalent readings are desired between the two cases (alternating- and direct-current heating), the datum of potential for alternating-current heating must be taken at a point whose direct potential is more negative than that of the filament mid-point by an amount numerically equal to one-half of the root-mean-square value of the filament voltage. In the case of indirectly heated equipotential cathodes, the cathode is taken as the datum of potential. The connection of cathode to any part of the heater circuit will usually be without effect upon the measured characteristics.

## II. Characteristic Graphs

The term characteristic or characteristic graph is employed in this report to designate the graphical relation between two or more variables such as voltage and current. As applied to any electrode circuit in a

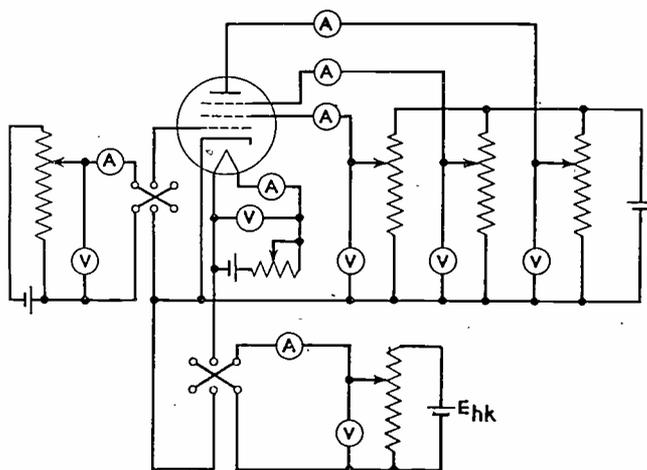

Fig. 1.—Circuit arrangement for measuring static characteristics.

vacuum tube it designates the relation between the voltage on an electrode and the current flowing in the circuit of that electrode. Another characteristic of fundamental importance is the transfer characteristic, which is the relation between the voltage on an electrode and the current in the circuit of another electrode.

A circuit arrangement for the determination of characteristics of vacuum tubes is shown in Fig. 1.

**A. Filament or Heater Characteristic.** Readings of filament, or heater, current and voltage, are taken for the conditions of zero grid

voltage and zero plate voltage. (Ordinarily the grid and plate electrodes simply may be left floating in potential.) Measurements should be made over a range of filament temperatures from values too low to give appreciable electron emission in service to at least the safe maximum temperature (see section I-B, page 127). Curves should be plotted with filament voltage as abscissa and filament current and filament power as ordinate.

**B. Cathode Heating Time.** Cathode heating time is defined, for purposes of measurement, as the time required for the rate of change of plate current with respect to time to reach a maximum value.

A sample plot of the plate current against time is shown in Fig. 2. From this it is seen that the plate current increases slowly at first, suddenly rises very rapidly, then slows down to reach gradually its final

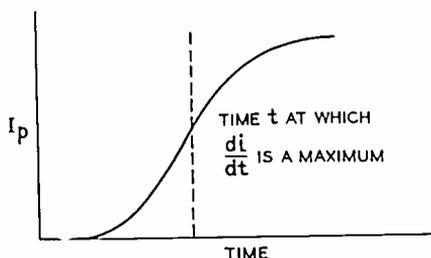

Fig. 2.—Relation between plate current and time.

value. The point referred to in the definition is the point of maximum slope or point of inflection of this curve, and is defined mathematically as the maximum value of the first derivative. Measurement under this definition is readily accomplished by means of the circuit shown in Fig. 3. The instantaneous current flowing in the secondary of the step-down transformer depends only on the rate of change of the current

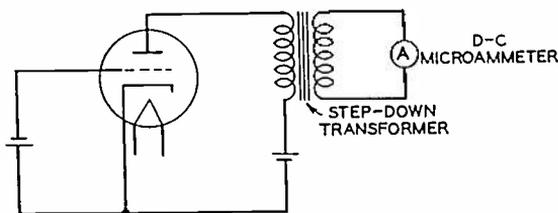

Fig. 3.—Circuit arrangement for measuring cathode heating time.

in the primary, and is independent of its finite value. Hence the time of the maximum rate of change will be indicated by the maximum deflection of the meter needle. The speed at which the meter needle moves is indicative of the acceleration and has no bearing on the problem; only the time required for the needle to reach the peak of the swing is

of importance. The voltage at the terminals of the heater should remain constant at the rated or specified value.

The characteristics of the output transformer or meter are not of great importance as far as the result is concerned, although the meter should have a low period, and the step-down transformer should be selected to give convenient deflections.

**C. Emission Characteristic (7-011).** Readings of emission current and filament power are taken for this characteristic. The emission characteristic is to be plotted with filament power as abscissa and emission current as ordinate. Since the emission current at normal filament power would ordinarily be so great as to damage the vacuum tube, readings are taken at lower filament powers only, and normal emission current may be obtained by extrapolation. A suitable procedure is as follows, the values applying to ordinary receiving vacuum tubes. Readings are taken with emission currents of 0.1, 0.2, 0.5, 1.0, 2.0, and 5.0 milliamperes, with 45 volts positive applied to the electrodes of the tube which are connected together to form a common anode. The results are plotted in Davisson coördinates (Fig. 4), which is a special system of curvilinear coördinates. If the emission follows Richardson's temperature law and the cathode follows the Stefan-Boltzmann law of radiation, the characteristic will be a straight line when plotted in these coördinates. The observed points may be extended or extrapolated to obtain the emission at normal filament power.<sup>1</sup>

According to Richardson's temperature law, the electron emission from a hot body varies with the Absolute temperature,  $T$ :

$$I_s = A\sqrt{T}e^{-b/T}. \quad (1)$$

Richardson has also derived the following law:

$$I_s = A'T^2e^{-b/T}. \quad (2)$$

The principal variation in emission is due to the variable exponential term, so that either of these equations may usually be employed.

According to the Stefan-Boltzmann law of radiation, the total energy radiated from a black body at Absolute temperature,  $T$ , is,

$$W = AT^4. \quad (3)$$

#### Precautions

If the curve is not straight, but bends downward, this may be an indication of: (1) departure from Stefan-Boltzmann cooling, (2) anode

<sup>1</sup> Suitable coördinate paper may be obtained from Institute Headquarters or from the publisher, Keuffel & Esser Co., 127 Fulton St., New York City.

voltage too low to draw off all the electrons, and/or (3) effect of cooling due to heat of evaporation of electrons. The cooling due to electron evaporation amounts to  $\phi I_s$  watts, where  $I_s$  represents the emission

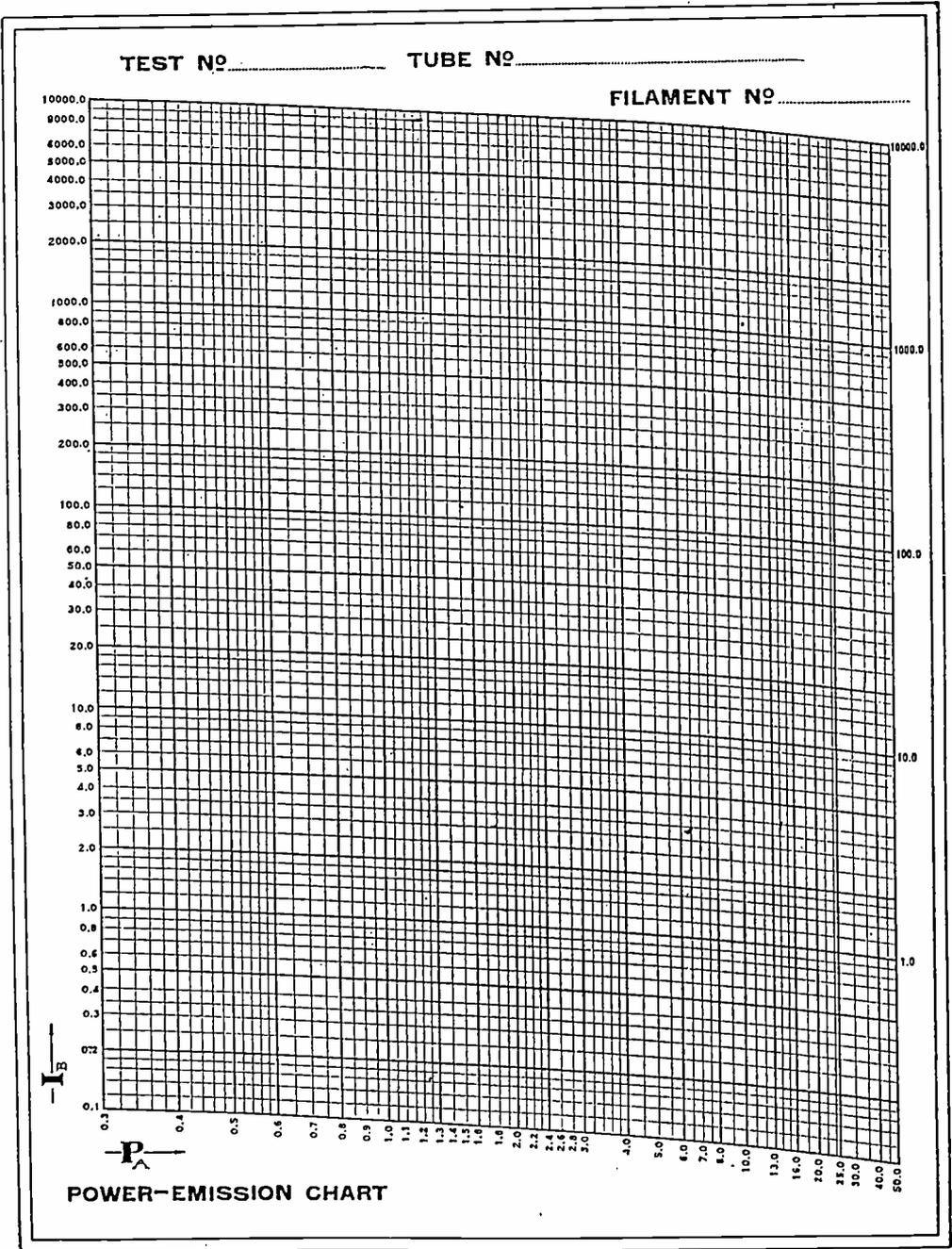

FIG. 4—Power emission chart.

current in amperes and  $\phi$  represents the work function of the cathode expressed in volts. This is particularly important in transmitting tubes,

where the currents are high, and with tungsten filaments where the work function is large. If the curve is bent upward, this may be an indication of: (1) poor vacuum (gas ionization effects), and/or (2) heating of the anodes by the electron current. In these cases reliable and analytical data cannot be obtained by this method.

**D. Electron Emission (7-008).** Normal electron emission is determined with the filament power adjusted to the normal operating value. All electrodes in the tube, excepting the cathode, are connected together and a sufficiently positive voltage with respect to the cathode applied to them to obtain the full electron emission.

#### Precautions

In some cases, particularly with large tubes, it is not always advisable to make this test on account of possible damage to the tube. The emission currents in these cases are preferably determined by extrapolation (see section II-C). For ordinary receiving tubes the test can be made safely if the time of application of the voltage is not permitted to exceed that required for rapid reading of the emission current meter. For ordinary receiving tubes an anode voltage of about forty-five is suitable. Since this test usually results in the liberation of gas and abnormal heating of the electrodes, it usually should be postponed until after the completion of other tests, or a sufficient time should elapse between this and other tests for clean-up and return to normal temperature conditions. For other effects see precautions in section II-C.

In practice where the complete emission characteristic is not usually desired, single point determinations of the relative emission of particular types of tubes are usually made in one of the following ways:

#### 1. METHOD A

All electrodes of the tubes, except the cathode, are connected together and a sufficiently positive voltage with respect to the cathode applied to them to obtain substantially the full electron emission. This test is made with normal rated filament or heater voltage. For ordinary receiving tubes an anode voltage of forty-five is suitable.

#### Precautions

In some cases, particularly with large tubes, it is not advisable to make this test on account of possible damage to the tubes.

#### 2. METHOD B

The following method of checking emission is particularly adapted for use in connection with tubes of extremely low power, particularly

tubes having filaments of small diameter where excessive heating may occur. In this method the emission is read by connecting the electrodes (except cathode and heater) together and applying a suitable voltage to them and the cathode. The cathode or filament voltage is then applied and gradually increased until a specified emission (for the particular type of tube) is obtained. The filament voltage or power required to obtain the specified emission is an indirect measure of the cathode or filament activity. This method is arbitrary and gives relative check results which are valuable only as long as tubes of the same type are compared.

**E. Grid Characteristic (7-032).** In a vacuum tube containing a number of grids, several grid characteristics may be obtained, but in most cases the control-grid characteristic principally will be required. Readings of the grid current and grid voltage are taken for the condition of constant plate voltage and constant voltage on other grids. These voltages should ordinarily be the normal rated values if only a single curve is to be obtained.

**F. Plate Characteristic (7-052).** The plate characteristic represents the relation between plate current and plate voltage, the voltages of all other electrodes being maintained at specified values. A family of such graphs may be obtained by selecting different voltages on other electrodes for each graph.

#### Precautions

The tube may be overloaded and unduly heated by attempting to make observations at high values of current and voltage. The part of the graph corresponding to abnormally high values of current and voltage is seldom used, but if the characteristic in this region is desired, the voltage should be applied only long enough to obtain and note the meter deflection.

**G. Grid-Plate Characteristic (7-047).** The control-grid voltage plate current transfer characteristic is generally all that is required, but the transfer characteristics for other grids may be of interest in special cases. Readings of plate current and grid voltage are taken for constant voltages on the plate and other grids, if present. These voltages ordinarily should be the normal rated values if a single curve is to be obtained. The graph is plotted with grid voltage as abscissa and plate current as ordinate. A family of graphs may be obtained by selecting different values of voltage for the plate and other grids.

#### Precautions

See precautions in section II-F, above.

### III. Thermionic Tube Coefficients

The coefficients, or differential parameters, of thermionic tubes which occur in circuit calculations, such as resistances, conductances, transconductances, and mu-factors, may be evaluated graphically from the characteristic graphs, or by direct measurement. The use of characteristic graphs is often of some descriptive and instructive value, but usually is less precise and less suited to the rapid testing of a large number of tubes than direct measurement. Both methods should yield concordant results, and the graphical method is often useful in roughly checking direct measurements for errors in technique.

Direct measurements are commonly made by balance or bridge methods employing an audio-frequency generator as the source of power. The null indicator is usually a telephone receiver, which may be preceded by an audio amplifier where most precise null indications are desired, the sensitivity (and to a certain extent the accuracy) of the method depending upon the amount of amplification used. The magnitude of the impressed alternating voltage should always be small enough so that the results of the measurement are unaffected by a reduction of the impressed voltage. Balance methods with an alternating-current source require that consideration be given to the effects of stray capacitances and couplings, which may render balance difficult, or may even cause a false balance and vitiate the results. The grounding and shielding of the apparatus should be given special attention.

In general, allowance must be made in balance networks for the effect of the network in lowering the direct voltage of the electrode below the battery electromotive force. This may be done conveniently by measuring the voltage directly at the electrode by means of a voltmeter of sufficiently high resistance. The effect of the network upon the alternating currents in the electrode circuits is also of occasional importance and proper values of circuit elements should be used or corrections made.

A. Conductance of an Electrode Circuit (7-045). The electrode conductance may be obtained from the graph of current in the electrode plotted against the voltage between that electrode and the cathode. The slope of this characteristic gives the conductance of the electrode circuit.

Electrode conductance may also be determined by a balance method, employing a Wheatstone bridge as shown in Fig. 5. When the bridge is balanced the electrode conductance is given by,

$$s_j = \frac{1}{r_j} = \frac{R_1}{R_2 R_3} . \quad (4)$$

The other electrodes of the tube are maintained at specified voltages.

### Precautions

A variable condenser across an adjacent arm may sometimes be necessary to secure a perfect balance in view of the capacity of the tube, as shown in Fig. 5.

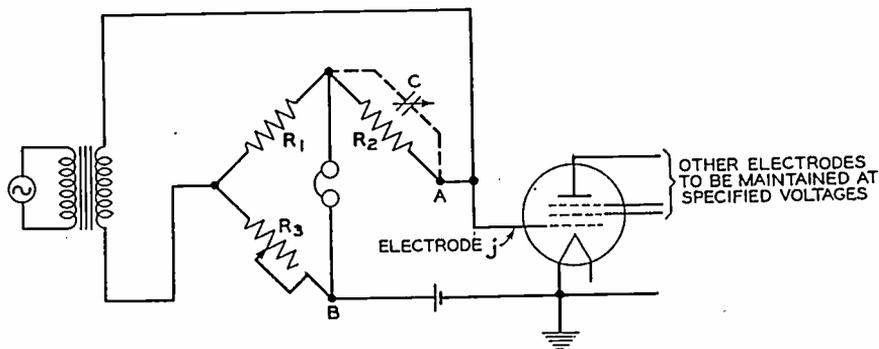

FIG. 5—Circuit arrangement for measuring conductance of an electrode circuit

B. Grid Conductance (7-031). Grid conductance may be determined graphically from the slope of the graph of grid voltages as abscissas plotted against grid currents as ordinates, other electrode voltages being maintained constant. The reciprocal of this slope is a measure of the grid resistance. Grid conductance and resistance may be measured directly by the general balance method shown in Fig. 5, the grid in this case being connected to point A and the cathode to point B.

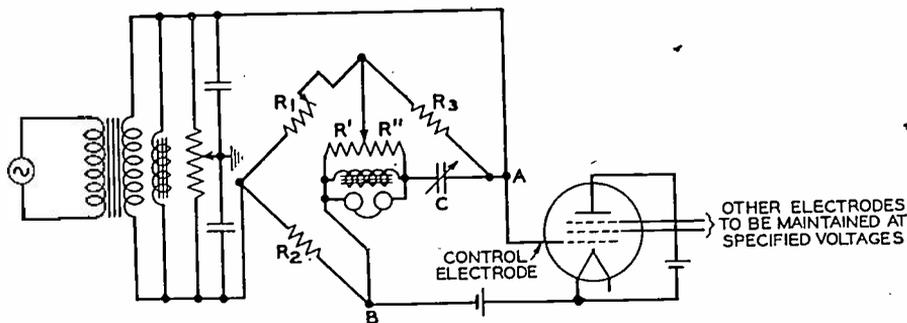

FIG. 6—Circuit arrangement for measuring control-grid conductance.

A second balance method which is especially suitable for this measurement is shown in Fig. 6.  $R''$  is adjusted to approximately  $R'/10$ , and with the cathode cold,  $C$  is adjusted for balance. The value of  $C$ , when balance is attained, is:  $C = R'(C_{gk} + C_{gp})/R''$ . Approximate values for the resistive arms of the bridge are  $R_3 = 10,000$  or  $100,000$  ohms,  $R_2 = 10$  or  $100$  ohms,  $R_1$  adjustable. Low resistance chokes shunt the source and the telephones to avoid direct voltage drops in the grid circuit. When the tube conductance is measured with the control grid at posi-

tive potential, a choke coil placed across the secondary is desirable. When balance has been attained,

$$r_o = \frac{R_2 R_3}{R_1}, \quad (5)$$

and,

$$s_o = \frac{1}{r_o} = \frac{R_1}{R_2 R_3}. \quad (6)$$

C. Plate Conductance (7-050) and Resistance (7-051). The plate conductance and resistance can be determined graphically from the slope of the plate characteristic, in the same manner as described in the preceding section. These values also may be measured directly by means of the balance method shown in Fig. 6, the plate being connected to point *A* and the cathode to point *B*. When balance has been attained,

$$s_p = \frac{R_1}{R_2 R_3}, \quad (7)$$

and,

$$r_p = \frac{1}{s_p} = \frac{R_2 R_3}{R_1}. \quad (8)$$

An alternative balance method is shown in Fig. 7.  $R_1$  is adjusted to the value required in the measurement of the mu-factor (see section

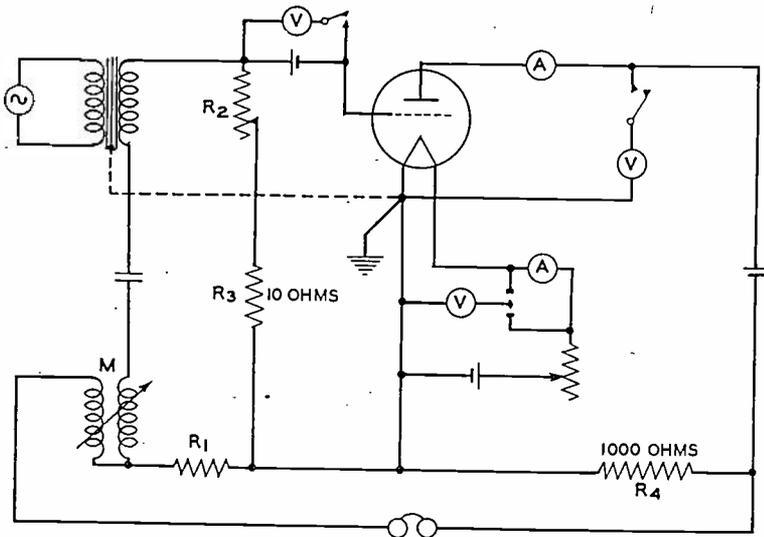

FIG. 7—Circuit arrangement for measuring plate resistance.

III-G, page 140). When balance has been attained by proper adjustment of  $R_2$  and  $M$ ,

$$s_p = \frac{0.01}{R_2}, \quad (9)$$

and,

$$r_p = \frac{1}{s_p} = 100R_2. \quad (10)$$

When  $r_p$  is high, as in the usual operation of the shielded tetrode, extreme care must be exercised to obtain accurate results. It is somewhat preferable in these cases to determine the plate resistance graphically from the slope of the plate characteristic.

Another method is available which lends itself to rapid testing of tubes such as the screen-grid type where the value of plate resistance is one-half megohm or higher. The circuit arrangement is shown in Fig. 8.

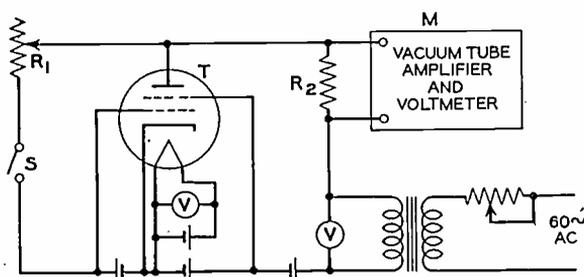

Fig. 8.—Circuit arrangement for determining plate resistance.

The tube  $T$  is operated at normal voltages. Switch  $S$  is open. Alternating voltage is applied as indicated and adjusted until a convenient deflection is obtained on the vacuum tube voltmeter,  $M$ . The tube is then removed from the circuit and a resistor,  $R_1$ , substituted for the internal resistance of the tube  $T$  by closing switch  $S$ .  $R_1$  is then adjusted to give the same deflection on  $M$  with the alternating voltage held constant at its original value. The value of  $R_1$  is then the value of the plate resistance of the tube.  $R_2$  should be made negligibly small in comparison with the plate resistance of the tube.

The arrangement can be made into a direct reading device in three ways.

#### 1. METHOD A

Keep the alternating voltage constant and calibrate  $M$  in terms of the plate resistance of the tube.  $R_1$  can be used in the manner described above for making calibration.

#### 2. METHOD B

Keep deflection of  $M$  constant and calibrate the alternating-current voltmeter in terms of the tube plate resistance using  $R_1$  for calibration purposes. This latter method gives a straight-line calibration between the alternating voltage and the tube plate resistance and is more conveniently used than Method A.

## 3. METHOD C

Keep the alternating-current signal constant and vary  $R_2$  to give constant deflection of  $M$ . In this case  $r_p$  will be proportional to  $R_2$ .

**D. Conductance for Rectification (7-107).** Conductance for rectification is most simply determined from the slope of the graph showing the relation between the direct voltage on an electrode as abscissa and the average direct current in the circuit of the same electrode as ordinate, a radio-frequency voltage being applied to the grids.

A balance method for measuring conductance for rectification is also available. An application to the case of the plate conductance for transrectification in a triode is shown in Fig. 9. In this case the alter-

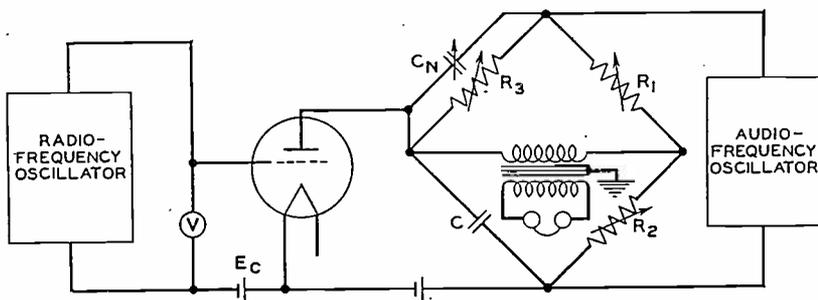

FIG. 9—Circuit arrangement for measuring (plate) conductance for rectification.

nating voltage is applied to the grid and is of radio frequency. When balance is obtained,

$$s_p' = \frac{R_1}{R_2 R_3} \quad (11)$$

The plate resistance for rectification,  $r_p'$ , is the reciprocal of the plate conductance for rectification, i.e.,

$$r_p' = \frac{1}{s_p'} = \frac{R_2 R_3}{R_1} \quad (12)$$

In Fig. 9 condenser  $C$  is a radio-frequency by-pass.  $C_n$  is necessary to balance the tube capacity and the capacity of  $C$ . The resistance elements of the bridge are balanced in the usual manner.

Although Fig. 9 shows only the application of measurement of plate conductance for transrectification of a triode, the method is applicable, of course, to the measurement of conductance of any electrode for ordinary rectification or transrectification. For multielectrode tubes, all electrodes not directly involved in the measurements should be maintained at constant and specified voltages.

## REFERENCE

Stuart Ballantine, Proc. I.R.E., vol. 17, p. 1164; July; (1929).

**E. Transconductance in a Tube of  $n$ -Electrodes (7-046).** Transconductance may be determined graphically from the slope of the graph of voltage on a specified electrode as abscissa plotted against current in another electrode circuit as ordinate.

Transconductance may also be measured directly by the balance method using the circuit of Fig. 10. When balance is attained,

$$s_{jk} = \frac{R_1}{R_2 R_3} \quad (13)$$

The electrodes, other than  $j$  and  $k$ , not directly involved in the measurement, are to be maintained at their specified voltages.

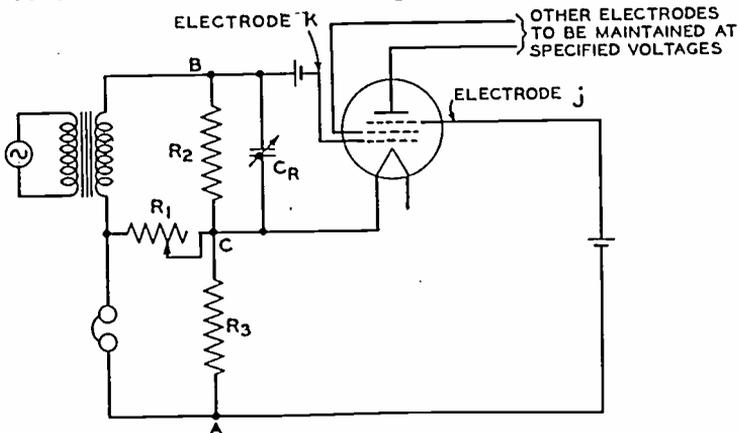

FIG. 10—Circuit arrangement for measuring transconductance.

#### Precautions

$R_2$  and  $R_3$  should be small so that their effects on the alternating currents in their respective electrode circuits may be within reasonable bounds. The effect of  $R_2$  and  $R_3$  upon the electrode direct voltage should be allowed for. A small capacity across  $R_2$ , or equivalently connected, may be necessary to balance the capacities in the tube and associated apparatus.

**F. Grid-Plate Transconductance (7-048).** The grid-plate transconductance, or mutual conductance, may be determined graphically from the slope of the grid-plate transfer characteristic (see section II-G, page 133). It may be also be calculated from measurements of the mu-factor and the plate conductance, since,

$$s_{p\theta} \equiv s_m = \frac{\mu}{r_p} \quad (14)$$

A direct measurement may be obtained by the method shown in Fig. 10, the control grid being connected to point B, the cathode to C, and the plate to A. When balance has been attained,

$$s_{p\theta} = \frac{R_1}{R_2 R_3} \quad (15)$$

It should be observed that the resistance  $R_3$  in series with the plate circuit, and a grid conductance  $s_g$  across  $R_2$  may cause errors. The true value of  $s_{p\theta}$  is given by,

$$s_{p\theta} = \frac{R_1}{R_2 R_3} \left( \frac{r_p + R_3}{r_p} \right) \left( \frac{r_g + R_2}{r_g} \right). \quad (16)$$

If the grid resistance is very large in comparison with  $R_2$ ,

$$s_{p\theta} = \frac{R_1}{R_2 R_3} \left( 1 + \frac{R_3}{r_p} \right). \quad (17)$$

The error due to  $R_3$  depends upon the magnitude of the plate resistance. It will usually be negligible in the case of a shielded tetrode where  $r_p$  is

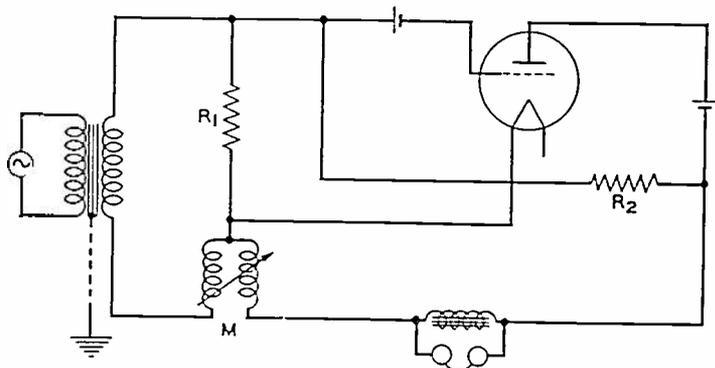

FIG. 11—Simplified circuit arrangement for measuring transconductance.

of the order of 500,000 ohms, but may be important in a tube of low plate resistance. In the case of power tubes, and in general when  $r_p$  is small, the method shown in Fig. 11 is convenient since it requires no corrections. When balance has been attained by variation of  $R_1$ ,  $R_2$ , and  $M$ ,

$$s_{p\theta} = \frac{1}{R_2}. \quad (18)$$

#### Precautions

The telephones are shunted by a low resistance choke, and the resistance of the secondary of the supply transformer should be low to provide low resistance paths for direct current.

**G. Mu-Factor in a Tube of  $n$ -Electrodes (7-042).** The mu-factor may be conveniently measured by a balance method such as that shown in Fig. 12. The electrode in which the current is to be held constant is connected to point  $A$ ; the other two electrodes entering directly in the measurement are connected to points  $B$  and  $C$ .  $R_1$ ,  $R_2$ , and  $M$  are adjusted for silence in the telephones, and when balance is attained,

$$\mu_{jkl} = \frac{R_2}{R_1}. \quad (19)$$

The small variable mutual inductor,  $M$ , compensates for any slight difference in phase of the currents caused by vacuum tube capacitances or slight residual reactances in the plate and grid circuits.

### Precautions

The remaining electrodes should be maintained at their specified potentials. The effect of the telephones in electrode circuit  $j$ , and of

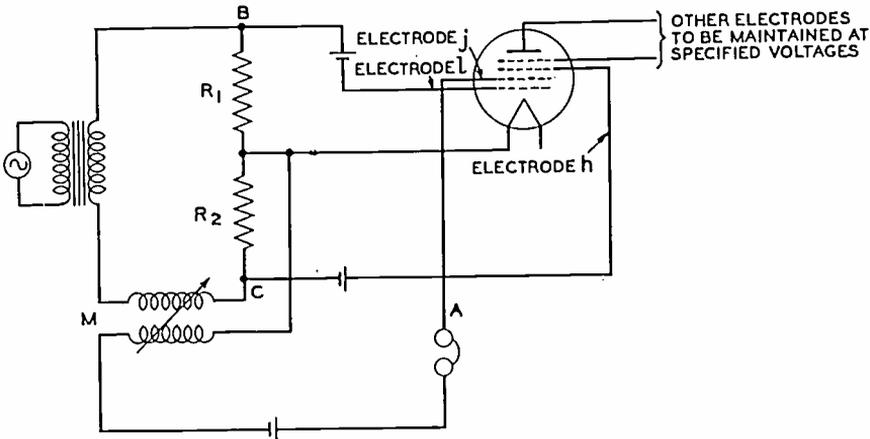

FIG. 12—Circuit arrangement for measuring mu-factor.

$R_1$  and  $R_2$  in the other circuits, on the electrode direct voltages should be allowed for when estimating these voltages from the battery electromotive forces. The effect of the conductances of electrode circuits  $k$  and  $l$  in shunting  $R_1$  and  $R_2$  should also be corrected for when necessary.

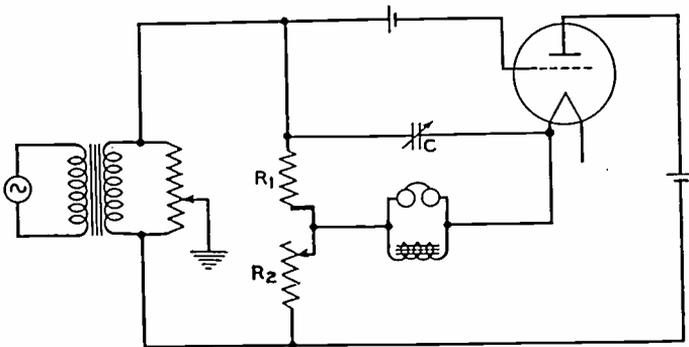

FIG. 13—Circuit arrangement for measuring amplification factor.

**H. Amplification Factor (7-043).** The amplification factor, a special case of the mu-factor applying only to triodes, may be measured with the circuit of Fig. 12 as described in the preceding section. In this case the plate is connected to point  $A$ , and the control grid to  $B$ . When balance is attained,

$$\mu = \frac{R_2}{R_1}. \quad (20)$$

A modification of this method, shown in Fig. 13, is useful when the control-grid current is zero. The capacity  $C$  balances the tube capacities, and its value must be changed each time  $R_2$  is changed since the condition of balance is,

$$\frac{R_2}{R_1} = \frac{C + C_{gk}}{C_{pk}}. \quad (21)$$

When balance is attained,

$$\mu = \frac{R_2}{R_1}. \quad (20)$$

#### Precautions

The direct voltage drop in  $R_2$  should be allowed for.

The circuit arrangement shown in Figs. 7, 10, and 13 are often combined in a single laboratory set-up, and by means of switches the proper circuit is selected for the measurement of transconductance, mu-factor, or plate resistance. (See page 203, "The Thermionic Vacuum Tube," by van der Bijl.)

#### REFERENCES

- Figs. 7, 13. J. M. Miller, Proc. I.R.E., vol. 6, p. 141, (1918).  
 Figs. 5, 10. Stuart Ballantine, Proc. I.R.E., vol. 7, p. 134, (1919).  
 Figs. 6, 11, 13. E. L. Chaffee, unpublished notes.

### IV. Ionization and Leakage Currents

**A. Control-Grid Current.** A sensitive method of measuring total control-grid current, which is especially useful when the current is too small for convenient direct measurement by ordinary deflection instruments, is illustrated in Fig. 14. With the switch,  $S$ , closed and the grid and plate voltages adjusted to the desired values, the reading of plate current is noted. The switch is then opened, placing  $R_c$  in the grid circuit, and the grid bias,  $E_c$ , is readjusted so that the plate current returns to its former value. The desired grid current can be computed from the change in grid voltage,  $\Delta E_c$ , necessary to maintain constant plate current, since,

$$i_g = \Delta E_c / R_c. \quad (22)$$

The necessary value of  $R_c$  will depend upon the current to be measured. A value of one hundred megohms will be found convenient. When a number of tubes of the same type are to be compared for grid current it is often sufficient to estimate the relative grid current by noting the change in plate current when  $S$  is opened and closed.

The sensitivity of the method can be greatly improved by balancing

out the normal plate current, by the connections shown in the dotted lines in Fig. 14, which will permit the employment of a more sensitive plate current meter.

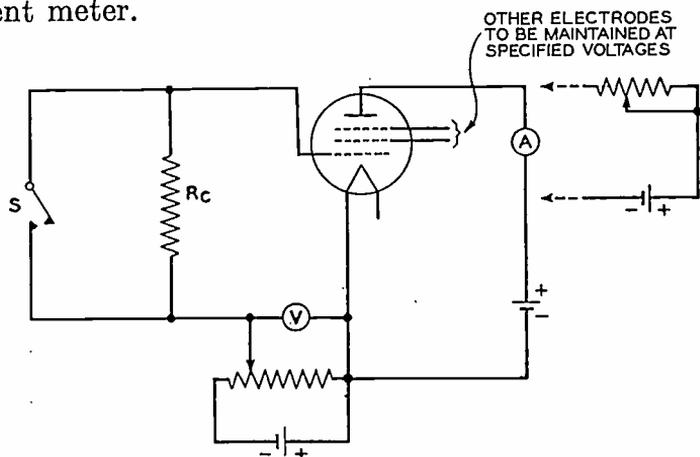

FIG. 14—Circuit arrangement for measuring small control-grid currents.

### Precautions

The customary precautions regarding leakage across the switch,  $S$ , should be observed when  $R_c$  is large.

### REFERENCES

M. von Ardenne, *Zeit. für Hochfrequenz*, vol. 29, p. 88; March, (1927).  
 Editorial, *Experimental Wireless*, vol. 4, p. 457; August, (1927).

**B. Ionization, or Gas, Current.** Two methods of measuring ionization or gas current are given. Method A may usually be advantageously employed, but where the anode dissipation is high, method B is preferable.

#### 1. METHOD A

The ionization in a tube containing gas at low pressure may be estimated by the current which flows in a negatively biased control-grid

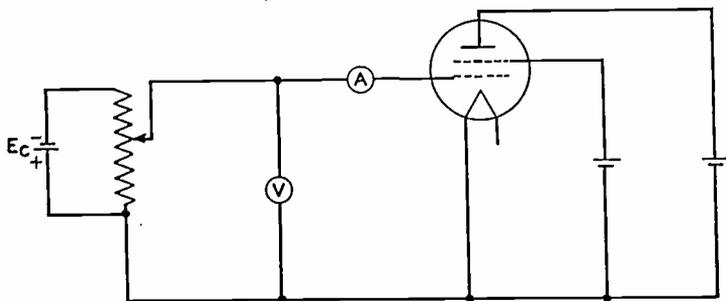

FIG. 15—Circuit arrangement for measuring ionization current—Method A.

circuit. The direction of the current due to this cause is opposite to the electron current from the cathode. The connections for measurement are shown in Fig. 15. The total current flowing to the negatively biased control grid is chiefly composed of:

- (1) Electrons from the cathode which reach the grid by virtue of contact potentials and initial velocities,
- (2) Electrons from other electrodes to the control grid,
- (3) Ionization current,
- (4) Leakage current, and
- (5) Electron emission from the control grid.

These may be separated as follows: Fig. 16 shows the contributions of the various sources enumerated with the exception of (2), which is generally negligible. The leakage current (4) may often be measured separately (see next section). The grid emission current can be esti-

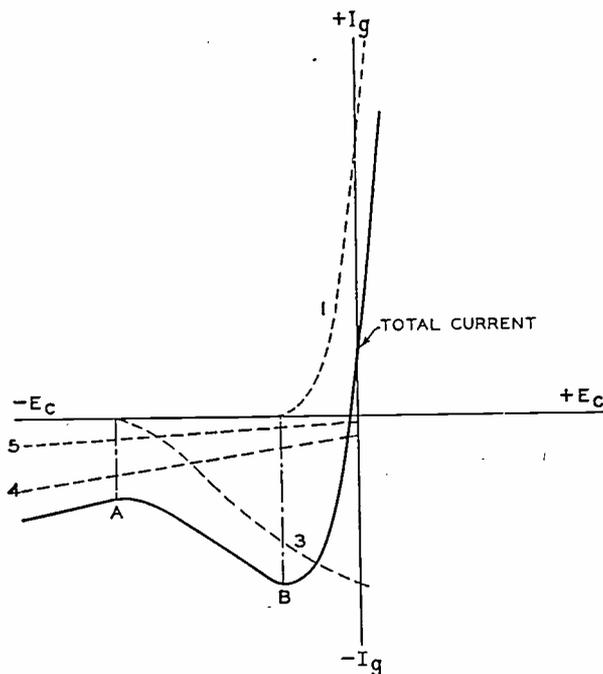

Fig. 16—Composition of total grid current.

mated by noting the current at a bias sufficiently negative (point A) to stop the plate current, since at this point (A) the ionization current (3), being proportional to the plate current, is negligible. The true ionization current (3) is the difference between the total grid current and the sum of (4) and (5) in the range of grid bias over which this difference is proportional to the plate current. The presence of current (1) is indicated by a failure of this proportionality.

#### Precautions

Since the emission current (5) is momentarily increased, and the ionization current (3) may be affected by the heating and release of gas following a test for normal emission (see section II-C) it is ad-

visible to make the test for emission from the grid prior to the test for ionization current, or to leave a sufficient time for cooling and clean-up between these tests. This applies to the application of a spark coil to reduce leakage with the same force as it does to the test for emission.

In the case of large (e.g., transmitting) tubes the anode dissipation during this test may be high enough to produce abnormal temperature conditions which may result in abnormal gas, emission, and leakage currents. In such cases the following method has the advantage of permitting the measurements to be made at lower anode dissipations.

## 2. METHOD B

An alternative method of measuring the ionization current in a tube consists in measuring the current flowing in the plate circuit which is produced by ionization due to electrons flowing in the grid circuit. The grid is maintained at a positive voltage and the plate at a negative voltage with respect to the cathode (Fig. 17). The cathode

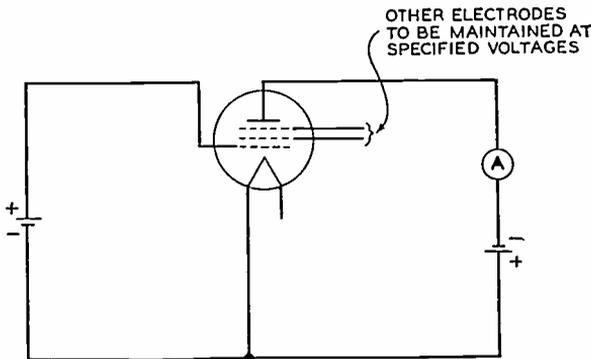

FIG. 17—Circuit arrangement for measuring ionization current—Method B.

temperature is then adjusted to give a suitably small electron current in the grid circuit. The resulting ion current in the plate circuit gives an indication of the gas pressure in the tube.

This measurement may be made with only a small current flowing in the grid circuit so there is but a slight chance of the evolution of gas from the electrodes.

### REFERENCES

- O. E. Buckley, *Proc. Nat. Acad. Sci.*, vol. 2, p. 683, (1916).
- C. G. Found and S. Dushman, *Phys. Rev.*, vol. 17, p. 7, (1921).
- S. Dushman, "High Vacua," p. 118, Schenectady, (1922).

**C. Leakage Currents.** Leakage currents should be measured with a voltage impressed between each two electrodes of the vacuum tube in turn, with the other electrodes floating. Measurements should be made immediately after the filament has been turned off so that all

parts (excepting the filament itself) will be as near their operating temperatures as possible. The vacuum tube should be in its complete form with its base, but without socket or holder. A voltage high enough to give convenient readings is suitable. From these readings, the insulation resistance between the various electrodes may be computed.

### Precautions

The results of this test may be obscured by thermionic emission from any electrode which is hot enough to emit electrons.

**D. Grid Emission Current.** Two methods are available for measuring grid emission current.

#### 1. METHOD A

If the leakage current can be measured separately, the grid emission current can be estimated by subtracting the leakage current from the reversed grid current at a grid bias sufficiently negative to reduce the plate current substantially to zero. (*A* in Fig. 16.) If the leakage current is negligible or can be made so by the application of a spark coil, the test gives the grid emission current directly.

#### 2. METHOD B

The connections for direct measurement of grid emission are shown in Fig. 18. During this test the electrodes should be at their normal

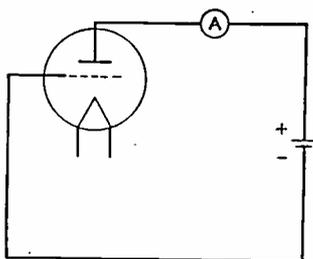

FIG. 18—Circuit arrangement for measuring grid-emission current—Method B.

operating temperatures. To this end it is recommended that the tube be operated in the usual way at its normal voltages for a time sufficient to attain normal temperature conditions. By means of switches the connections shown in Fig. 18 are then quickly made and the grid emission noted while the electrodes are still approximately at their normal temperatures. The cathode should be at its normal operating temperature throughout.

### Precautions

The above test gives the grid emission directly if the leakage between the grid and plate electrodes is negligible. If this is not negligible

but is known, the leakage current can be subtracted from the observed current to obtain the true grid emission current. The results of this test may be affected by leakage between cathode and grid.

#### REFERENCE

A. F. van Dyck and F. H. Engel, Proc. I.R.E., vol. 16, p. 1532; November, (1928).

### V. Interelectrode Capacitance

Interelectrode capacitance should be measured with the cathode cold and with no direct voltages present. The vacuum tube should be in its complete form with its base, but without socket or holder. For most precise results, it is necessary to mount the vacuum tube in a specified way, as with a form of shielding plate. In making capacity measurements of indirectly heated tubes, the heater should be connected to the cathode unless otherwise specified.

It is recommended that direct capacitances be measured, rather than total capacitances, which are each the sum of two direct capacitances (see definitions). It is particularly recommended that capacitances be not measured with one electrode floating in potential, as such capacitances are likely to be misleading of themselves and the calculation of the direct capacitances from them is indirect and laborious. The three direct capacitances of a triode are grid-plate capacitance ( $C_{gp}$ ), grid-cathode capacitance ( $C_{gk}$ ), and plate-cathode capacitance ( $C_{pk}$ ). The grid-plate capacitance is the most important on account of its relation to the stability of an amplifier. When the tube is active the direct interelectrode capacitances differ in general from the values obtained with a cold tube due to the effect of the space-charge limited electron current. This difference may be of importance in certain one-way radio-amplifier stages relying upon a balancing network for elimination of feed-back.

**A. Direct Interelectrode Capacitances.** A bridge method for the measurement of direct interelectrode capacitance in a triode is shown in Fig. 19. In this figure the capacity  $C_{gp}$  is shown under measurement and is connected across an arm of the bridge, the other capacitances being in shunt across  $R_2$  and the telephones. The method is based on the plausible assumption that the shunting effect of a capacity of the order of a few micromicrofarads across  $R_2$  is negligible. The other capacitances may be measured in turn by suitable interchanges of connections, the one under measurement being placed in the upper right arm of the bridge between points *A* and *B*.

The resistance  $R_1$  balances the capacitance  $C_{gk}$  which is in parallel with  $R_2$  and also corrects any accidental phase shifts present elsewhere in the bridge. It is small and does not enter into the calculation so it

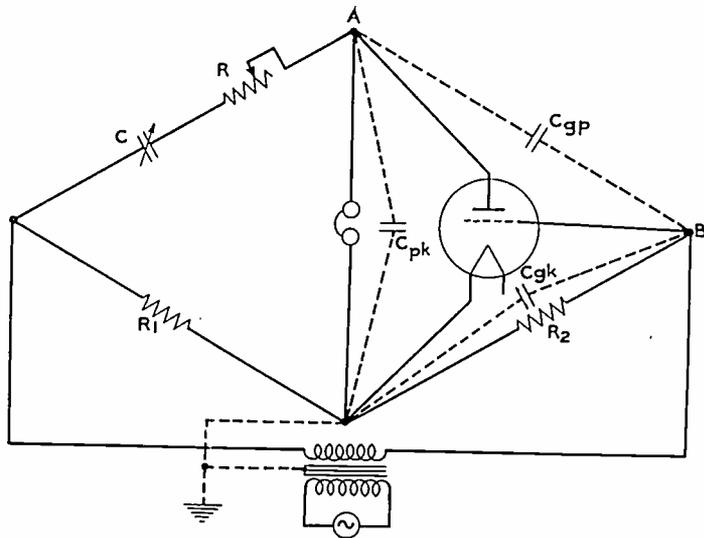

Fig. 19—Bridge method for measuring direct interelectrode capacity.

may be replaced by other phase-correcting means, such as a capacitance in parallel with  $R$ . When the bridge is balanced the capacity is

$$C_x \equiv C_{gp} = R_1 C / R_2. \quad (23)$$

#### Precautions

Leakage  $g$  across  $C_x$  will cause an error amounting to  $(g/\omega C)^2$ . With  $C_x = 5\mu\text{mf}$  and with an impressed voltage having a frequency of 1000 cycles per second, a leakage of 100 megohms will cause an error of approximately 10 per cent. When accurate results are required, the leakage should be taken into account.

#### REFERENCES

- Lincoln Walsh, Proc. I.R.E., vol. 16, p. 482; April, (1928).  
 E. T. Hoch, Proc. I.R.E., vol. 16, p. 487; April, (1928).

**B. Grid-Plate Direct Capacitance.** Fig. 20 illustrates a substitution method for measuring grid-plate capacitance  $C_{gp}$  using a radio-frequency oscillator as a source and a thermoelement  $TH$  and a galvanometer  $G$  as an indicator. The shielded condenser  $C$  is calibrated to read capacitance above an arbitrary reference point and should have a range as great as the largest capacitance to be measured. With  $C$  set at this reference point and the vacuum tube in the circuit, the galvanometer reading is taken. The vacuum tube is then removed, and  $C$  is adjusted until the galvanometer reading is the same as before. The added capacitance of  $C$  is then equal to the grid-plate capacitance  $C_{gp}$ . The radio-frequency oscillator should maintain constant voltage and frequency (or at least a constant product of these quantities). To verify that the oscillator is maintaining a constant product of the volt-

age times frequency a thermocouple with galvanometer and filter may be connected in series with a small capacitance across the oscillator terminals. The connection from the plate of the vacuum tube through the thermocouple  $TH$  to the filament should be short if it is not shielded. The condenser  $C'$  and coil  $L'$  constitute a filter system to keep radio-frequency current from flowing through the lead to the galvanometer  $G$ .

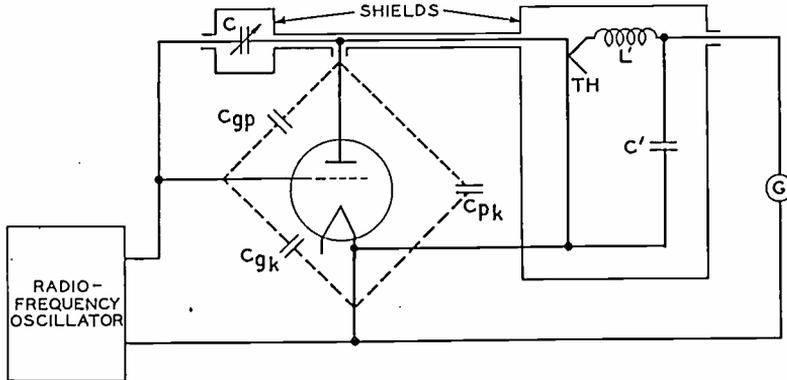

FIG. 20—Substitution method for measuring grid-plate capacity.

The arrangement of Fig. 20 may be modified to give a direct deflection method by omitting the condenser  $C$  and calibrating the galvanometer deflections in terms of capacitance. The galvanometer  $G$  is read before and after inserting the vacuum tube, the first reading (which may be negligibly small, with proper shielding of the plate lead) being a measure of the direct capacitance present between the wiring to the grid and plate terminals, and the second reading being a measure of this capacitance plus the desired grid-plate capacitance  $C_{gp}$ .

**C. Grid-Plate Direct Capacitance of Screen-Grid Tubes.** The small grid-plate capacity of screen-grid tubes presents some difficulty when measurements of this capacity are made on tetrodes with the usual capacity bridges. Substitution methods for this purpose are described below.

### 1. METHOD A

For screen-grid tubes, in which the grid-plate capacitance is small, the substitution method of Fig. 21 can be employed with a calibrated condenser  $C$  of suitable range, a radio-frequency source of suitable voltage and a detector of somewhat greater sensitivity than the thermocouple shown. Suitable apparatus is shown in Fig. 21.

Due to the great sensitivity required to measure the very small values of capacity, it is desirable that all disturbing influences be minimized. This is accomplished by keeping the capacities across the

oscillator and across the detector constant, by means of a balancing tube.

The low capacity switch  $S$  is first thrown to the tube under test  $T_1$ , and the reading of the microammeter noted. The switch is then thrown to  $T_2$ , the balance tube, which should be of the same type as  $T_1$ , and the condenser  $C$  adjusted to give the same reading of the microammeter as before. The feed-back capacity  $C_{gp}$  is then equal to the added capacity of  $C$ .

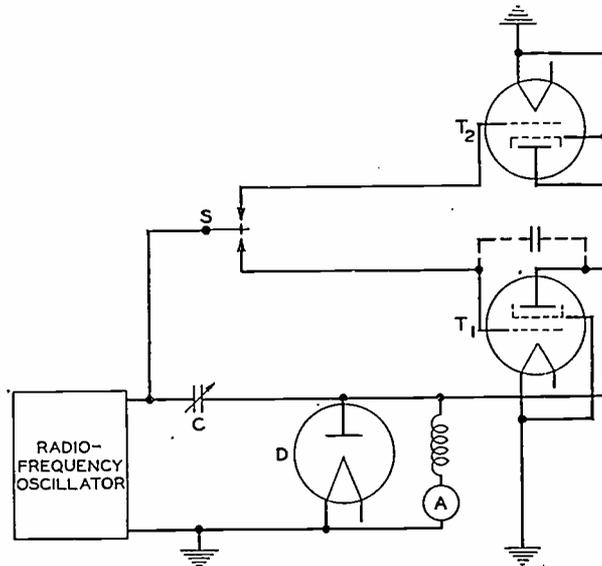

FIG. 21—Circuit arrangement for measuring grid-plate capacity of screen-grid tubes—Method A.

To obtain the required sensitivity, it is desirable to use a vacuum tube rectifier,  $D$ .

#### Precautions

Outside of the customary precautions of constant voltage supply and thorough shielding, no special precautions are necessary to obtain useful results. However, it is desirable that the oscillator be adjusted so that a small change in the capacity across it does not change the current through the substitution condenser, as indicated on the microammeter.

#### REFERENCE

A. V. Loughren and H. W. Parker, Proc. I.R.E., vol. 17, p. 957, (1929).

#### 2. METHOD B

An alternative substitution method for screen-grid tubes is shown in Fig. 22. This employs a calibrated variable voltage source and a fixed standard capacitor instead of the fixed voltage source and calibrated variable capacitor of Method A.

The output of a radio-frequency generator is led to an attenuator which may terminate in a slide-wire as shown. A standard signal generator, such as employed for receiver measurements, is convenient for this purpose. The current through the grid-plate capacitance of the tube produces a voltage across the antiresonant  $LC$  circuit. This voltage is amplified and measured in some convenient way; e.g., by a radio-frequency amplifier terminating in a vacuum tube voltmeter. In the arrangement shown in Fig. 22 a radio receiver is used for this purpose,

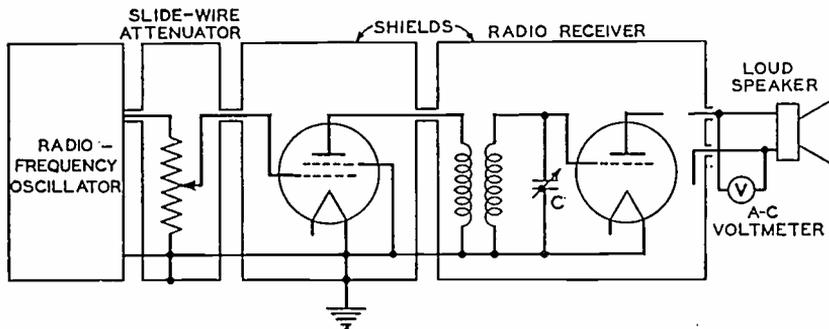

FIG. 22—Substitution method of measuring grid-plate capacity of screen-grid tubes—Method B.

the radio-frequency oscillator being modulated and an alternating-current voltmeter connected across the terminals of the loud speaker being used as an indicator.

A standard fixed condenser  $C_s$  of the order of one-half micromicrofarad, suitably shielded, is substituted for the tube shown in Fig. 22 and the attenuator set so that the impressed radio-frequency voltage is  $E_s$  with a standard audio output. The tube to be measured is next substituted for the standard condenser and the attenuator readjusted until an impressed radio-frequency voltage  $E_x$  produces the same deflection at  $V$ . Then the unknown grid-plate capacity is,

$$C_{gp} = C_s E_s / E_x. \quad (24)$$

The standard condenser can be enclosed within a vacuum tube blank of standard dimensions. Two circular disks, two centimeters in diameter and separated by eight-tenths of a centimeter, will provide a standard capacitor of the proper order. This may be calibrated by measurement on a differential capacity bridge.

#### Precautions

The variable condenser  $C$  should be readjusted for resonance for each tube being measured. The leads from the attenuator to the tube shield and from the latter to the voltage measuring unit should be completely shielded, and the tube itself should be enclosed in a rather closely fitting cylindrical shield. This is provided with a small con-

tactor to the control grid, with the lead to this contactor entering at the top. The lead from the plate leaves at a point near the bottom of the shield.

The input impedance of the detector (a radio receiver in this case) should be small compared with the reactance of the one-half microfarad standard condenser. Generally, this will be assured by connecting to the antenna-ground terminals of the receiver.

## VI. Undistorted Power Output

The measurements in this section relate to the power output characteristics of vacuum tubes operating as class A amplifiers. The output capabilities of such devices are conveniently rated as the power output into a resistance load under the conditions that there shall be no grid current during the positive part of the grid voltage excitation cycle and that the total generated harmonics with a sinusoidal excitation voltage shall not exceed five per cent. The power obtained under these conditions is conventionally called the undistorted power output.

The output power will depend upon the magnitude of the external output resistance as well as upon the electrode voltages other than the control-grid bias. The maximum undistorted power output which may be obtained is limited by the safe total anode dissipation. These conditions should be specified in determining the undistorted power output of a given tube or amplifier.

**A. Measurement of Harmonics.** The harmonic distortion is defined as,

$$D = \frac{(I_2^2 + I_3^2 + \dots + I_n^2)^{1/2}}{I_1} \quad (25)$$

where,

$I_1$  is the amplitude of the fundamental, and

$I_2, I_3, \dots, I_n$  are the amplitudes of the 2nd, 3rd, . . . .  $n$ th harmonics.

The distortion may be measured by a harmonic analyzer, of which several types have been described in the literature. When merely the value of  $D$  is desired, as in determining the undistorted output, those analyzers which measure the root-mean-square value of all harmonics present are preferable to those which measure the separate harmonics.

The method of C. G. Suits<sup>1</sup> is a particularly good example of the type of analyzer which measures the harmonics separately. The Suits method requires only the simplest apparatus, and where laboratory facilities are limited this advantage may outweigh the disadvantages involved in the computation of  $D$ .

<sup>1</sup> Proc. I.R.E., vol. 18, p. 178; January, (1930).

The Belfils analyzer<sup>2</sup> utilizes an alternating-current Wheatstone bridge balance for the suppression of the fundamentals and is particularly useful for direct measurement of  $D$ . For maximum convenience the frequency of the audio source should be very stable. This instrument can be operated so that it is direct reading by maintaining a constant input voltage.

In the McCurdy-Blye analyzer<sup>3</sup> low- and high-pass filters are used to separate the harmonics from the fundamental. This instrument is superior to the Belfils type in that the frequency of the source may vary somewhat without necessitating readjustment.

A differential analyzer especially designed for power output work has been described by Ballantine and Cobb<sup>4</sup>.

### Precautions

The sinusoidal electromotive force applied to the control grid should be free from harmonics. This can normally be assured by the use of a low-pass filter (see Fig. 23).

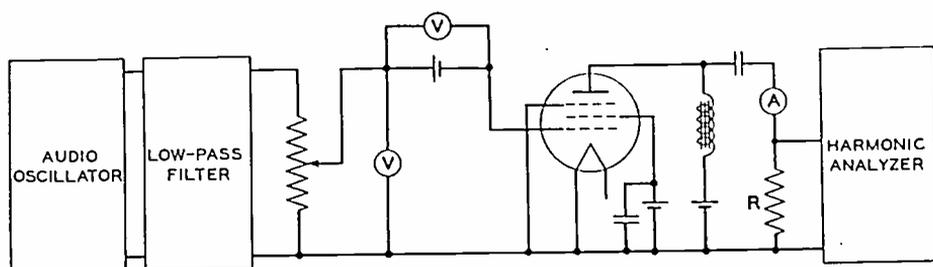

FIG. 23—Circuit arrangement for measuring undistorted power output of a pentode.

If an iron-cored choke is employed for shunt feed in the plate circuit (Fig. 23) care should be exercised in its selection or design to avoid the generation of harmonics in it due to the nonlinear and hysteretic behavior of the iron.

**B. Maximum Undistorted Power Output of a Triode.** Assuming constant plate voltage, the maximum undistorted power output of a triode is experimentally determined as follows: A value of load resistance equal to twice the estimated plate resistance is chosen, this being approximately the optimum value when the allowed percentage of harmonics is five per cent. A sinusoidal alternating voltage of peak value  $E$ , and a steady grid bias  $E_c$ , are applied to the grid of the tube and increased together ( $E = E_c$ ) until the percentage of harmonics in the output reaches five per cent. If the plate resistance at this value of bias

<sup>2</sup> G. Belfils, *Rev. Gen. d'Elec.*, vol. 19, p. 523, (1926); Irving Wolff, *Jour. Opt. Soc. Amer.*, vol. 15, p. 163; September, (1927).

<sup>3</sup> *Jour. A.I.E.E.*, p. 461; June, (1929).

<sup>4</sup> *Proc. I.R.E.*, vol. 18, p. 450; March, (1930).

differs from the estimated plate resistance the value of load resistance is readjusted to approximate more closely twice the actual plate resistance, and a second variation of  $E$  and  $E_c$  made. The final values of  $r_p$  and  $E_c$  are reached by successive approximations of this sort, the process being continued to obtain the accuracy desired.

If the grid bias is specified, the maximum output is found by repeating measurements with different load resistances. An alternating voltage having a maximum value equal to the grid bias is impressed on the grid circuit and successive measurements of output are made with increasing values of load resistance until the percentage of harmonics is reduced to five per cent. The output at this point is then the maximum for the given conditions. The load resistance for the maximum output will never be less than the plate resistance and will be greater or less than twice the plate resistance depending on whether the specified grid biases are greater or less, respectively, than the bias found for maximum output when there are no restrictions except plate voltage.

Limitation on plate power dissipation or on direct plate current may be expressed in terms of a specified grid bias, and the measurements made as just described.

#### REFERENCES

- E. W. Kellogg, *Jour. A.I.E.E.*, May, (1925).  
J. C. Warner and A. V. Loughren, *Proc. I.R.E.*, vol. 14, p. 735, (1928).  
C. R. Hanna, L. Sutherlin, and C. B. Upp, *Proc. I.R.E.*, vol. 16, p. 462, (1928).

**C. Maximum Undistorted Power Output of a Pentode.** This test relates particularly to the type of pentode containing a retarding grid next to the plate which is maintained at a potential near that of the cathode; it also applies to other tubes, such as the screen-grid tetrode, having a plate characteristic which is concave downwards.

Assuming the plate and screen voltages to be specified, two procedures may be followed:

(1) With the load resistance adjusted to some value, the sinusoidal grid voltage  $E$ , whose peak value is equal to the grid bias, and the grid-bias voltage  $E_c$ , are increased together until the harmonics total five per cent. The value of load resistance is changed and this process repeated; this is continued until the maximum power output is obtained.

(2) A sinusoidal alternating voltage is applied to the control grid, the load resistance is set at some large value and the grid bias is adjusted until the harmonic output is a minimum. This is judged by ear, listening to the harmonic output of the analyzer with the fundamental suppressed. Using this value of grid bias and load resistance, the grid

voltage is increased until the root-mean-square value of the harmonics equals five per cent of the fundamental (or as an approximation, the fundamental plus harmonics). The load resistance is then decreased and this process is repeated until the peak value of the alternating grid voltage required for five per cent harmonic production attains the value of the direct-current grid bias. The alternating-current power in the external plate resistance is then taken as the maximum undistorted power output at the plate and screen-grid voltage used.

**D. Normal Undistorted Power Output of a Pentode.** When the load resistance is specified the procedure is the same as in (1) above,  $E$  and  $E_c$  being increased together until the harmonics total five per cent. The power output at this voltage is the normal power output.

In the case of the pentode the effective plate resistance depends greatly upon the alternating voltage amplitude, and the value of load resistance for maximum power output must be selected by successive approximations.

#### REFERENCE

Stuart Ballantine and H. L. Cobb, Proc. I.R.E., vol. 18, p. 450, (1930).

### VII. Detection Characteristics

The following tube characteristics are of interest in connection with detection, particularly at high signal voltages.

**A. Rectification Characteristic (7-103).** The rectification characteristic is the relation between the average direct current in the electrode circuit in which rectification takes place, the amplitude (or root-mean-square value) of an alternating voltage impressed on the same electrode, and the value of the direct voltage on the electrodes. In the

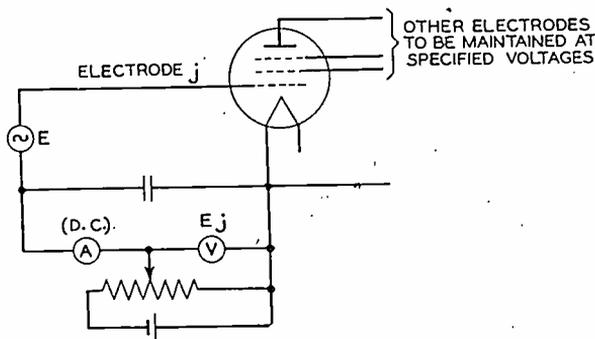

FIG. 24—Circuit arrangement for measuring rectification characteristic.

general case of a tube of  $n$ -electrodes, the connections are shown in Fig. 24.  $E$  is an alternating-current generator considered as having zero direct- and alternating-current impedance. All electrodes not entering directly in the measurements are maintained at steady and specified voltages.

The direct voltage  $E_j$  on the electrode is usually plotted as abscissa against the average current in this electrode circuit as read by a direct-current instrument as ordinate, for various values of  $E$  as a parameter; i.e.,  $E$  is held constant for each graph.

B. Transrectification Characteristic (7-106). The transrectification characteristic is the graph between the average current in the circuit of an electrode, the direct voltage on that electrode, and the amplitude (or root-mean-square value) of an alternating voltage impressed on another electrode. The connections for this test for a tube of  $n$ -electrodes are shown in Fig. 25. The electrode  $j$  and other electrodes are to be maintained at their specified values of direct voltage.

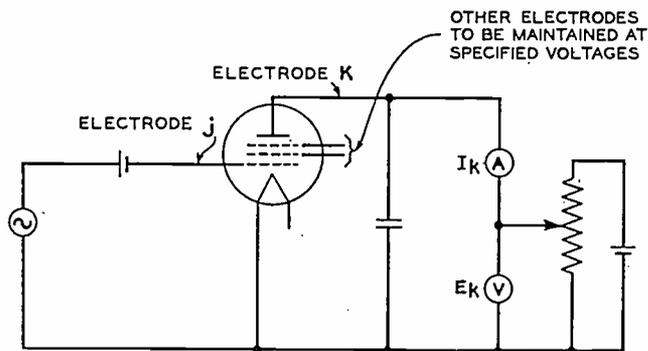

FIG. 25—Circuit arrangement for measuring transrectification characteristic.

The direct voltage  $E_k$  in the electrode circuit  $k$  is plotted as abscissa against the average current  $I_k$  in that circuit as ordinate for various values of alternating voltage,  $E$ , applied to the other electrode as a parameter (i.e.,  $E$  is held constant for each graph).

## VIII. Phototubes

The rapidly increasing technical importance of photo-electric devices makes it desirable to include in this report a description of the methods of measuring their more important characteristics. This art is young, and while the following material is based upon the actual experience of several laboratories and workers, it will be understood that complete standardization is undesirable and impossible at the present time. The methods are therefore set forth tentatively.

A. Technique and Apparatus. For measurements of the photo-electric response the following apparatus is necessary: a light source, a photometer box, and the electrical circuit.

### 1. LIGHT SOURCE

Considerable discretion is necessary in the selection of the light source. The proper light source to employ will be governed by the use

to which the phototube is to be put. For example, in the case of a lithium tube used to measure ultra-violet radiation, a mercury arc in quartz would be indicated as a suitable light source. If the phototube is to be used for sound on film reproduction a desirable source would be a tungsten lamp at the same temperature as the lamp used in the reproducing machine. In practice this temperature is not far from 2870 degrees Absolute, and for that reason this value is customarily employed in testing. For tests of this character a standard tungsten lamp should be obtained, preferably one with a concentrated filament (to approximate a point source), sufficiently heavy to insure a reasonable calibrated life. The calibration of this lamp should be checked at the end of every one hundred hours. The bulb should be large enough to allow the tungsten vapor from the filament to rise and deposit thinly over the unused area of the glass. The standardization laboratory should specify the filament current (or voltage) corresponding to a color temperature of 2870 degrees Absolute as well as the candle power at this temperature. The lamp should be operated at this specified value of filament current. The filament current should be accurately measured since a variation of one per cent in current will produce a variation in light intensity of about six per cent. The standard lamp should have its power supplied from a storage battery source and should be fitted with a prefocused base.

## 2. PHOTOMETER BOX

The phototube and lamp must be placed in an enclosure from which every trace of extraneous light is excluded. To insure precision in determining the luminous flux incident upon the phototube cathode, a mask should be provided directly in front of the phototube with an aperture exposing either the entire cathode or some definitely described portion of it. The minimum distance from aperture to filament must be great enough to permit the use of the inverse square law in computing the illumination. The value of the light flux in lumens may be calculated from the formula,

$$F = AC/d^2 \quad (26)$$

where,

$A$  is the area of the aperture,

$C$  is the candle power of the lamp, and

$d$  is the distance from the aperture to the filament.

$A$  and  $d$  must be measured in the same units. A scale should be provided by means of which  $d$  is accurately measured. The lamp socket may be conveniently mounted on a carriage which can be moved toward or away from the phototube just as in the usual photometer

practice. It is essential that baffles with central apertures be placed between the lamp and the phototube to exclude extraneous light.

### 3. ELECTRICAL CIRCUIT

The connections usually employed are those shown in Fig. 26.  $R$  is conventionally a one-megohm resistor whose function is to limit the current through the tube in the case of a glow discharge in gas phototubes. It is also useful in simulating the actual circuit conditions of the tube in use. The direct-voltage drop in  $R$  is ordinarily negligible, but may be corrected for where accurate results are desired. The ammeter  $A$  is a multiscale microammeter.

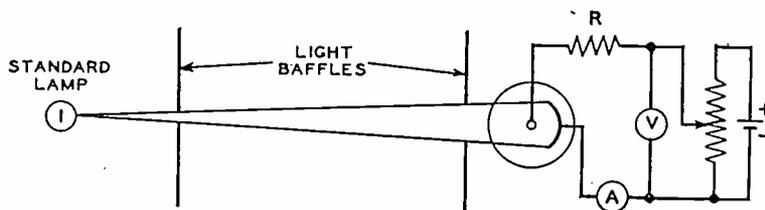

FIG. 26—Electrical circuit arrangement for phototube tests.

**B. 2870 Tungsten Sensitivity.** When the relation between light flux and current is known to be linear a test of sensitivity at one value of light flux and at the normal tube voltage is usually sufficient for a practical rating of the tube. For a vacuum phototube a light flux of one-half lumen is suitable, and for a gas phototube one-tenth lumen may be used. The standard tungsten lamp is adjusted to a color temperature of 2870 degrees Absolute.

The sensitivity is calculated from

$$S = I/F, \quad (27)$$

where,

$F$  is the light flux in lumens, and

$I$  is the current in amperes.

**C. Current-Voltage Characteristic.** With the light source adjusted for a given light flux into the phototube, the voltage across the tube is varied and the current noted. The voltage-current characteristic is usually plotted with voltage as abscissa and current as ordinate. A family of graphs may be obtained by repeating measurements with various values of light flux for each curve.

#### Precautions

If the tube has appreciable electrical leakage, the leakage must be read with zero light flux for each voltage. The leakage may be subtracted from the observed photo-currents to determine the true current-voltage characteristic.

When the observations are made on gas phototubes at the higher voltages, it is well to proceed cautiously in order to prevent the occurrence of a glow discharge, since even an instantaneous discharge will alter the cathode surface.

**D. Current-Illumination Characteristic.** At a given voltage, the light flux is varied and the corresponding tube currents are noted. A family of such graphs, each for a different tube voltage, is useful. The light flux is plotted as abscissa and the current as ordinate.

#### Precautions

A gas phototube may glow when the illumination exceeds a critical value, even though the rated maximum voltage is not exceeded. This should be guarded against.

**E. Current-Wavelength Characteristic (7-313).** For determining the current-wavelength characteristic some optical means of obtaining light flux having a known uniform energy distribution over a narrow range of frequencies is necessary. A convenient instrument for this purpose is the quartz monochromatic illuminator with a constant deviation optical system. The arrangement is shown in Fig. 27. The slits

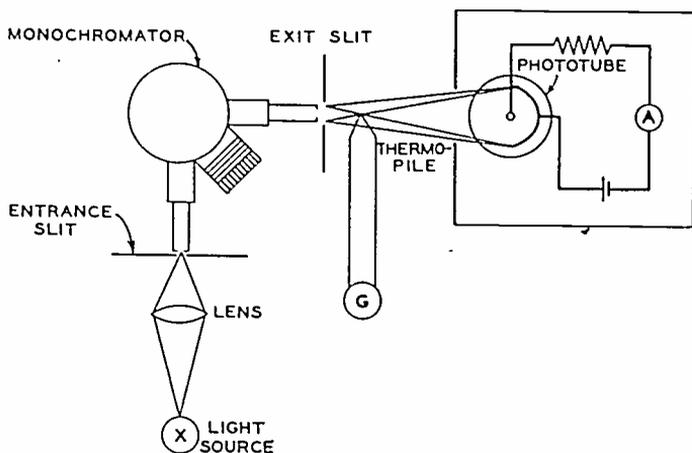

FIG. 27—Optical system for determining monochromatic sensitivity or response-color relation of a phototube.

should both be adjusted to about one hundred Angstroms effective width at 8000 Angstroms. A sensitive linear thermopile is mounted immediately in front of the exit slit and is connected to a sensitive, critically damped galvanometer of approximately equal resistance. The usual precautions must be observed to avoid vibration of the galvanometer and to prevent contact and spurious thermal electromotive forces. The energy which falls between the silver squares of the thermopile is proportional to that which falls on the squares and is transmitted to the phototube. The phototube is mounted in a light-tight box di-

rectly behind the thermopile, and is connected to a sensitive, direct-current single-stage or bridge amplifier. The current output of the amplifier must be proportional to the photo-current in the tube. The maximum phototube current will probably never exceed one-tenth microampere.

The data for the curve are obtained by dividing the output current reading of the amplifier by the thermopile galvanometer current reading for different wavelength settings throughout the spectrum, and the resulting ratios plotted against wavelength.

For the infra-red and visible ranges up to about 5000 Angstroms, an ordinary tungsten lamp with condensing lens serves as a source of energy. For the violet and ultra-violet, a mercury arc in quartz without a condensing lens is very satisfactory.

**F. Pulsation Frequency-Response Characteristic.** Curves of the dynamic response, or of the alternating-current output of the tube for various modulation frequencies of a modulated light flux, are of interest in the case of tubes, such as the gas types, which show inertia in response. The important requirement for this test is a light source whose

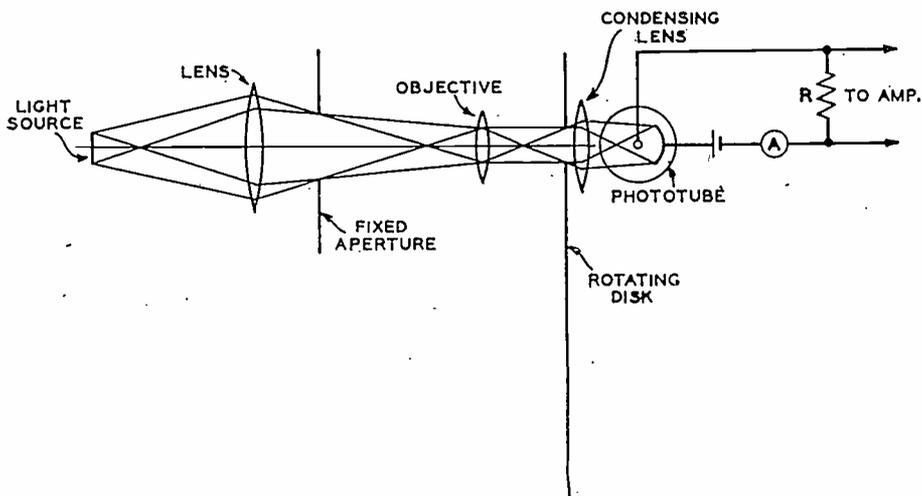

FIG. 28—Pulsating light source for determining pulsation frequency-response characteristic.

modulation can be varied over the required frequency range. Variation of the degree of modulation is seldom essential, and one hundred per cent modulation will generally suffice. The variation of the modulated light flux is of the type,

$$\phi = \Phi(1 + \sin \omega t). \quad (28)$$

Various methods of modulation may be employed, such as: (1) the Kerr cell, (2) properly excited neon, or other glow discharge lamps, or (3) a rotating disk system. Considerable care must be employed

with the first two methods to obtain accurate results. The sectored disk is accurate and convenient. A suitable disk arrangement is shown in Fig. 28.

The optical system of Fig. 28 avoids wandering of the light upon the light-sensitive surface of the tube. The shapes of the fixed and rotating apertures are shown in Fig. 29. That of the fixed aperture is approximately sinusoidal; that of the rotating apertures is approximately rectangular. The dimensions of the apertures should be chosen so that the dimensions of the image of the stationary aperture at the plane of the rotating disk are accurately equal to those of the apertures of the rotating disk. The image  $a'$  should equal  $a$  and the image of  $b'$  should not be larger than  $b$ . The modulation frequency may be varied by varying the speed of rotation. For a given speed range the frequency range can be extended by employing several sets of apertures in the rotating disk, proper fixed apertures being used with each set.

The alternating-current output of the tube is measured by a calibrated amplifier-voltmeter connected across the one-megohm resistor.

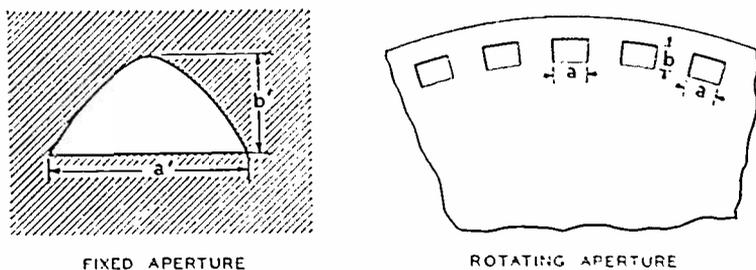

FIG. 29—Sine-shaped stationary aperture and rectangular rotating aperture for producing completely pulsating light flux.

To obtain a frequency-response characteristic, first adjust the rotating disk so that the deflection of the direct-current microammeter is a maximum. Then by consulting the static current-illumination characteristic of the tube adjust the light so that a deflection corresponding to twice the mean flux desired is obtained at this aperture setting. The rotating disk is then rotated to give the modulation frequencies desired.

#### REFERENCE

R. Moeller, *Fernsehen*, vol. 1, p. 127; March, (1930).

**G. Gas Amplification Tests.** In either gas or vacuum phototubes the residual gas pressure may be estimated by measuring the ratio of currents for a specified light flux at two different anode voltages. For example, with a tube intended to operate at 90 volts, the currents may

be noted at 90 volts and 15 volts. The ratio of the currents at these two voltages gives an indication of the gas pressure and should not exceed a specified maximum. No minimum limit is necessary since the sensitivity test eliminates danger of the gas pressure being too low.

**H. Primary Emission Test.** In order to compare the inherent emissivity of cathodes in gas tubes with that of cathodes in vacuum tubes, current readings should be taken at a specified light flux, preferably of the order of 0.1 lumen, and with an anode voltage such that ionization does not occur. For example, gas and vacuum tubes are closely comparable at 15 volts.

**I. Leakage.** The leakage should be measured with the tube in absolute darkness and with normal applied voltage.

#### PHOTOTUBE REFERENCES

- Campbell and Ritchie, "Photo-Electric Cells." (Pitman & Sons).  
Zworykin and Wilson, "Photo-Cells and Their Applications," (Wiley).  
Seiler, *Astrophys. Jour.*, vol. 52, p. 129, (1930).  
Olpin, *Phys. Rev.*, (A), vol. 33, p. 1081, (1929).  
Koller, *Jour. Opt. Soc. Amer.*, vol. 19, p. 135, (1929).  
Zworykin and Wilson, *Jour. Opt. Soc. Amer.*, vol. 19, p. 81, (1929).  
Burt, *Jour. Opt. Soc. Amer.*, vol. 11, p. 87, (1925).  
Metcalf, *Proc. I.R.E.*, vol. 17, p. 2064; November, (1929).  
Hughes and Dubridge, "Photoelectric Phenomenon," (McGraw-Hill Book Company).

# PERFORMANCE INDEXES AND TESTS OF ELECTRO-ACOUSTIC DEVICES

## Introduction

The purpose of the performance indexes and tests in this section is to define indexes by which the more important performance characteristics of electro-acoustic devices associated with radio can be specified and evaluated, to indicate the general method of procedure in determining these indexes, to point out the precautions which it is necessary to observe in order that the results obtained be not greatly influenced by extraneous factors, and to recommend a preferred form for presenting the data and necessary associated information. In general the performance indexes given specify the over-all performance of the devices in a form most readily associated with their ordinary usage. The determination of many of these performance indexes involves acoustic measurements which are complicated and on which the technique is in a state of development. As a result rigid standardization of testing technique does not appear advisable at this time since a complete specification of a suitable measuring method that would permit a close duplication of results by different individuals would be so involved and so arbitrary as to make adhering to such a specification quite impracticable. Furthermore such standardization would tend to discourage progress in developing better testing methods and be altogether adverse to the intended purpose of this work. On the other hand it is possible to indicate here a suitable method of procedure for determining these performance indexes so that by observing certain precautions and stating roughly the measuring conditions, the data obtained can be interpreted. It is, therefore, to encourage reliable and interpretable methods of measuring and expressing the performance characteristics of electro-acoustic devices that the following section has been prepared.

Many of the performance indexes defined may be expressed in terms of the transmission unit, decibel (db). This unit is logarithmic in nature. For comparison of tones of similar composition one decibel corresponds closely to the minimum perceptible change in loudness. The use of a logarithmic unit facilitates comparisons of curves since the shape of the curve is not altered by a change in the general level.

While the indexes defined indicate, in the majority of cases, the degree of perfection of an electro-acoustic device, it should be understood that a satisfactory rating according to these indexes does not necessarily assure a completely satisfactory device. For example, a loud speaker may possibly appear attractive from the response fre-

quency curve and from loudness efficiency data and at the same time have a strident rattle or excessive harmonics that completely disqualify it. If this rattle were due to excessive power levels and disappeared at low levels this difficulty would be signified by a low overload power rating. But if the rattle were present at all levels it could not be attributed to overloading and none of the quantities defined below would show the loud speaker to be unsatisfactory. It is very difficult to define and evaluate indexes relating specifically to such characteristics and until the more tangible indexes have been given more adequate consideration it is proposed not to attempt any such evaluation.

## I. General

**A. Absolute Efficiency.** The absolute efficiency of an electro-acoustic transducer for a given circuit condition is the ratio of the output of the transducer to the output of the ideal electro-acoustic transducer. This may be expressed as a ratio, a percentage, or in decibels relative to unity or one hundred per cent, for example:

Power Ratio	Percentage	Decibels
1.0	100	0.0
0.5	50	- 3.0
0.1	10	-10.0

## II. Loud Speakers

**A. Relative Loudness Efficiency.** The relative loudness efficiency is a comparative measure of the acoustic outputs of two loud speakers as observed aurally in the sound medium at a specified point relative to the location of the two loud speakers. It is expressible as a percentage or in decibels by the following ratio,

$$\frac{E_1^2 R_2}{E_2^2 R_1} \quad (1)$$

where,

$E_1$  is a voltage in series with the first loud speaker taken as a standard and a resistance  $R_1$  equal to the impedance to which this loud speaker is designed to be connected, and

$E_2$  is the voltage in series with the other loud speaker and a resistance  $R_2$  equal to the impedance to which the second loud speaker is designed to be connected.

The values of  $E_1$  and  $E_2$  are such that the two loud speakers give the same loudness of sound at the observer's position as judged by the ear.

## 1. Discussion

The purpose of this index is to give a suitable means for rating loud speakers on a basis of loudness for a specified type of input program, i.e., speech, orchestral music, single frequencies, etc. Although a curve showing the absolute efficiency as a function of frequency gives an indication of the loudness to be expected from a loud speaker, the comparative results to be expected from two or more loud speakers are sometimes difficult to determine since the frequency ranges that are covered and the shape of the curves may be different. While it would be desirable to compare the loudness of two loud speakers directly from objective measurements this is not possible at the present time.

Comparison of the relative loudness of several sounds directly by listening is also impossible. In a listening test we have no basis for stating that one sound is twice as loud as another and tests have shown that different observers would disagree on what twice as loud means. However, two sounds may be adjusted to have practically the same loudness, and different observers will agree closely as to their equality. For this reason the indirect method of adjusting the electrical supply to the loud speakers until the same loudness has been obtained is used rather than the more direct one of obtaining a comparison of the loudness with equal electrical inputs.

In this and some of the following performance indexes the electrical input to the loud speaker is expressed in terms of the open circuit voltage and impedance of the supply source rather than in terms of the current through the loud speaker, the voltage across it, or the actual power absorbed from the source, because in this way an important characteristic of the loud speaker, its ability to absorb power from the source, is given proper consideration. For example, a loud speaker having a normal impedance with a large reactive component can absorb relatively little power from an amplifier and the acoustic effect must be small although the ratio of the acoustic effect to the power actually absorbed may be large. Such a loud speaker, however, would not be considered as desirable as one that could produce a greater acoustic effect by absorbing more power; by expressing the electrical input by the voltage and impedance of the source the relative desirability is properly indicated.

In specifying the conditions for these and other tests a resistance equal to the impedance to which the loud speaker is designed to be connected is mentioned as being placed in series with the loud speaker. This is a convenient way of specifying or expressing the equivalent circuit condition that exists when the loud speaker is properly con-

nected to a vacuum tube either directly or through an impedance matching transformer. The specification of the source for purposes of testing loud speakers in terms of a voltage and a resistance is justified by the fact that the source of power for practically all loud speakers in present day use is one or more thermionic tubes whose internal impedance is a pure resistance and whose characteristics within sensible error may be duplicated by a supply voltage of  $E = \mu E_g$  in series with a resistance,  $r_p$ , where  $E_g$  is a voltage supplied to the grid,  $\mu$  is the mu-factor for the tube in question, and  $r_p$  is the internal plate resistance.

**B. Response.** The response of a loud speaker is a measure of the sound produced at a designated position in the medium with the electrical input, frequency, and acoustic conditions specified. It is expressible by the ratio,

$$\frac{p}{\frac{E}{\sqrt{R}}}, \quad (2)$$

where,

$R$  is a resistance equal to that of the source to which the loud speaker is designed to be connected,

$E$  is the voltage (at the specific frequency) supplied to the loud speaker in series with the resistance  $R$ , and

$p$  is the resultant sound pressure in the medium (at the specified frequency) at a specified point, or the average of the resultant pressures at specified points relative to the loud speaker.

The response may be expressed by a value equal to the above ratio or may be expressed in decibels relative to an arbitrary value of response corresponding to one volt, one ohm, and one bar. Thus the response of a loud speaker in decibels equals

$$20 \log_{10} \frac{\frac{p}{E/\sqrt{R}}}{1/\sqrt{1}} = 20 \log_{10} \frac{p}{E/\sqrt{R}} \quad (3)$$

### 1. Discussion

Frequency discrimination is probably the most frequent and dominant cause of distortion in present commercial loud speakers. While other factors are important the first consideration in loud speaker design is an attempt to reduce to a minimum variations in performance with frequency. Measured data showing quantitatively the performance at each frequency are probably the most important information

upon which to judge the merits of a loud speaker. A suitable and convenient manner of expressing this performance of a loud speaker at each frequency is provided by the above definition of response.

Measured response values on a loud speaker at a particular frequency may be widely different depending upon the acoustic measuring conditions. For this reason the phrase "under specified acoustic conditions" in the above definition is very important. A measured response value without a specification of the measuring conditions is not significant. Furthermore, it is possible to measure the response of a loud speaker under such acoustic conditions that the measured data will give little or misleading information regarding the performance of the loud speaker as it would be observed aurally. If, however, suitable precautions are taken and certain of the more important measuring conditions are specified the response data plotted as a graph provide the most useful index of the frequency discrimination in a loud speaker. The general procedure for obtaining a response-frequency graph of a loud speaker, important measuring precautions and expedients that must be observed, and a proposed form for a response frequency curve with its associated information are discussed below.

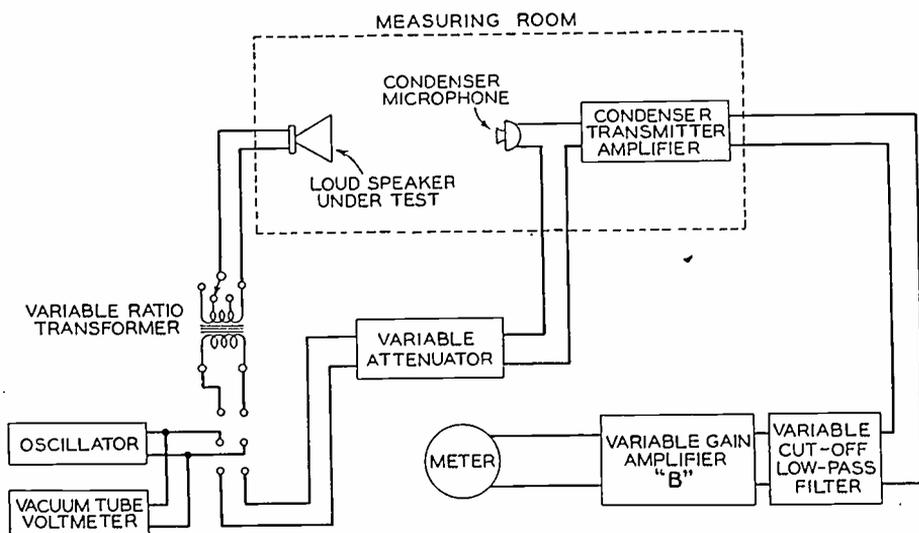

FIG. 1.—Loud speaker response measuring system.

## 2. Measuring Apparatus and General Procedure

Fig. 1 shows a circuit in schematic form for measuring the response of a loud speaker. With the possible exception of the condenser microphone the apparatus shown is in such general use that it requires little further comment. The condenser microphone is proposed for this purpose because of its ruggedness and the straightforward manner in which it can be used. A thermophone or other suitable calibration,

corrected if necessary to show the relation between the undisturbed root-mean-square pressure in a plane progressive sound wave in which the microphone is located and the root-mean-square open circuit voltage, should be obtained from the manufacturer of the microphone. This calibration graph is used as discussed later. A variable cut-off low-pass filter is shown in the amplifier circuit to insure that the performance at only one frequency is being measured. The variable ratio transformer between the oscillator and the loud speaker makes it possible to connect the loud speaker to an impedance equal to that for which it is designed. Care should be taken in the selection of this transformer to be certain that the impedance (looking back from the loud speaker) is practically a pure resistance for the frequency range over which measurements are made.

Although similar apparatus may be used for either step-by-step change of frequency or continuous variation of frequency with a recording meter the procedure of adjustment is somewhat different so that the complete procedure in each case will be described. The step-by-step method has the advantage that no output calibration of the amplifier *B* or of the oscillator is necessary and offers the possibility of readjusting the low-pass filter for all frequencies so that even though harmonics are present in the oscillator and loud speaker output the readings give a true indication of the output of fundamental frequencies. The continuous frequency variation method offers the advantage of speed in making measurements but requires an oscillator, microphone, and amplifier, which have been equalized over the frequency range to be covered and makes it difficult to use the harmonic reduction filter. If the harmonic reduction filter is not used a check of the output wave form of amplifier *B* by means of a cathode ray or other oscillograph is advisable.

The adjustment procedure for step-by-step measurement will first be described. The loud speaker under test and the microphone are suitably placed in a relatively large room or outdoors. The output or terminal voltage of the oscillator when open-circuited or connected to the attenuator is then adjusted to a suitable value by means of the vacuum tube voltmeter. The oscillator is then switched to the loud speaker and the sensitivity of the amplifier *B* adjusted until a satisfactory deflection of the indicating meter is obtained as a result of the sound pressure on the microphone. The oscillator is then switched from the loud speaker to the input terminals of the attenuator and the attenuator adjusted to give the same meter deflection. The attenuator is calibrated either in decibels or the corresponding voltage ratios and the response value is read directly from the attenuator. An adjustment of the attenuator such that there is no attenuation, however, does not

correspond to a response of zero decibels or unity power ratio, depending on the method of expression. This latter response is indicated by the attenuator setting when, with a unity value for the ratio of the oscillator open-circuit voltage to the square root of its impedance, the voltage at the attenuator output terminals is equal to that generated by the microphone with one bar pressure on the diaphragm. The generated volts per bar\* can be obtained from the microphone calibration and the total attenuation corresponding to zero decibels or unity response can thereby be readily calculated. If the attenuator input impedance is equal to the oscillator impedance the total attenuation in decibels corresponding to zero response is

$$db = 20 \log_{10} \frac{\sqrt{R_s}}{2m}, \quad (4)$$

where,

$R_s$  is the oscillator impedance, and

$m$  is the microphone sensitivity in volts per bar.

The response measurements are then expressed as a number of units above or below this reference setting, i.e., +17 db or -6 db, or as the corresponding current or voltage ratios, 7.1 or 0.5.

The procedure of adjustment, if continuous recording is used, can be as follows: In order to determine the proper equalization of the system the oscillator is connected to the attenuator and either the attenuator or the variable gain amplifier is adjusted until a convenient reading of the output meter is obtained. By varying the frequency of the oscillator the over-all frequency characteristic of the system can be recorded. The amplifier should be equalized until the output frequency curve with this connection has the same shape as the inverse of the condenser transmitter calibration curve. It is a good plan to check this equalization in a similar manner from time to time when taking a loud speaker graph.

Before taking a loud speaker graph the oscillator should be set at some convenient frequency and connected to the attenuator. Adjustment is then made, either by means of a variation in the gain of amplifier  $B$  or the oscillator output, until the recording meter reads

$$\frac{S\sqrt{R_s}}{nm} \text{ divisions}, \quad (5)$$

\* A value should be chosen that obtains over the greatest portion of the frequency range. Variations from this value should be corrected for in the measured response data.

where,

$S$  is the ratio of the attenuated output to the open-circuit voltage of the oscillator as determined by the attenuator setting,

$R_o$  is the output impedance of the oscillator,

$n$  is the numerical value of the response per division it is desired to record, and

$m$  is the microphone sensitivity in volts per bar at the frequency at which the adjustment is made.

After the adjustment has been made as described above the oscillator output is connected to the loud speaker and the frequency response of the loud speaker can be recorded.

While there are other circuit arrangements by which it is possible to obtain satisfactory results the above systems have the advantage of requiring the precise calibration only of the condenser microphone and the associated attenuator or resistances. The amplifiers and the meter serve only to compare the magnitude of the microphone voltage with the attenuator voltage and any variation in their sensitivity over a period of time can in no way affect the accuracy of the results. In the first method described it is also unnecessary to maintain a definite frequency characteristic in the amplifier. In the second method the frequency characteristic must be checked from time to time as has been indicated. Furthermore, if the loud speaker under test is not overloaded the results obtained will not be influenced even by large variations in the oscillator output with frequency. The change in the oscillator output changes both the sound intensity and the attenuator output in the same proportion so that the measured response value does not change. The loud speaker sound intensity may be of any magnitude below the overload power and well above any extraneous noise level. It should be remembered, however, that the microphone sensitivity depends upon the polarizing voltage and that the methods outlined do not compensate for changes in microphone sensitivity. Precautions therefore must be taken to make sure that the voltage at the microphone is maintained constant at the value used in the microphone calibration.

### 3. Acoustic Difficulties, Precautions, and Expedients.

In making loud speaker measurements it is desirable to eliminate, in so far as possible, any effect of the measuring room enclosure on the results. While the room may influence the aurally observed performance to a considerable extent, loud speakers are used under such widely varying conditions that measurements incorporating the peculiarities of any one room would not be of general interest. On the

other hand, if the measurements show the performance of the loud speaker only, allowance can be made at least qualitatively for the probable influence of the enclosure where it is to be used, and a more accurate prediction of the suitability of the loud speaker for the purpose can be obtained.

The most useful response measurements for many purposes are those in which the sound pressures are measured at some point (usually one directly in front of the loud speaker) and the radiation of the loud speaker in other directions is ignored. If, however, the loud speaker is to be used where a large part of the sound reaching the listener will have been reflected, the prediction of the result necessitates ascertaining not only the radiation directly toward the listener, but also that in other directions, in order that the reflected sound which will reach him may be estimated. For such purposes the forward response data may be supplemented by response measurements obtained at various positions around the loud speaker or by measurements of total sound power output as a function of frequency.

Sound reflections from the walls, ceiling, and floor of the measuring room may produce a large amount of sound energy at the microphone which it is not desired to include in the measurements and under steady state conditions may cause complicated standing wave patterns. These patterns change greatly as the sound source changes from one frequency to another. The result is that the pressure at the microphone goes through a series of maxima and minima which may differ widely from the actual response of the loud speaker. Reduction of the standing wave effect may be secured either by reducing the magnitude of the reflected sound as compared with the direct sound or by some method of averaging the sound pressures.

For a constant sound output from the loud speaker the intensity of the reflected sound in a measuring room is dependent upon the sound absorbing ability of the enclosing surfaces. As an approximation this intensity decreases as the sum of the products of the areas of the enclosing surfaces and their respective absorption coefficients increases. Thus, by increasing the size of the measuring room and by increasing the absorption at the walls with sound absorbing materials, the energy density of the reflected sound can be diminished until it is small compared to the outwardly radiated sound close to the loud speaker. The microphone can then be placed near the loud speaker and if the distance from the loud speaker and microphone to the walls, ceiling, and floor is considerably greater than their distance from each other, the resultant measurements will be essentially that of the direct radiation.

There is, however, a minimum satisfactory measuring distance that is dependent upon the size of the loud speaker radiating surface; the

larger the surface the larger must be the measuring distance. If the microphone is placed closer than this minimum satisfactory measuring distance, the measured response data will be influenced by peculiarities in the sound field near the radiating surface and will not give a true representation of the performance as it would be observed normally at a more remote point. It is recommended that the microphone be placed not less than  $d^2f/4500$  feet nor less than  $2d$  feet from the loud speaker,  $d$  being the maximum dimension of the radiating surface in feet, and  $f$  being the highest measured frequency. The first of these quantities is derived from an analysis<sup>1</sup> of diffraction effects and while based on the case of a circular piston in an infinite baffle, has been found a satisfactory guide for other radiating surfaces. The second expression is chosen so that radiation from some points on the radiating surface will not be too much attenuated in comparison with that from other points as would be the case if the microphone were placed too close. On the other hand, a distance greater than the normal listening distance should not be used because irregularities existing at the normal listening distance are indicative of the normally observed performance of the loud speaker. In making measurements at short distances care should be taken to prevent standing waves between the microphone and loud speaker by maintaining sufficient separation or by a suitable angular displacement of the plane of the microphone.

In practice, measuring rooms sufficiently free from reflections are usually difficult and expensive to obtain. Sound absorbing materials at present available vary in their absorption at different frequencies to such an extent that a very large measuring room (50,000 cubic feet or larger) with much absorbing material is generally necessary for a loud speaker with a broad frequency range if no other means of obviating the effect of reflections is to be employed. In many cases this is not attainable and it is, therefore, usual to use a moderate sized room (i.e., 5,000 cubic feet with a high ceiling), to cover the walls, ceiling and also the floor with the best obtainable absorbing material, to place the loud speaker and microphone well above the floor, and to use an averaging means. One such means<sup>2</sup> consists in swinging or rotating the microphone in order to obtain an average reading throughout a region having at least one dimension larger than one-half a wavelength at the measuring frequency. The indicating system for this purpose should preferably have a long period so that a fairly steady average reading is obtained as the microphone is rotated. The thermocouple meter is well suited in this respect. Another method

<sup>1</sup> I. B. Crandall, "Theory of Vibrating Systems and Sound," p. 137.

<sup>2</sup> L. G. Bostwick, *Bell Sys. Tech. Jour.*, vol. 8, no. 1, p. 135; January, (1929).

of averaging<sup>3</sup> consists in varying the frequency of the oscillator repeatedly over a frequency band sufficient to change materially the standing wave pattern. These two expedients, however, become rather inadequate at low frequencies, due, in one case, to the mechanical difficulty of moving the microphone more than one-half a wavelength and, in the other case, to the necessity of using a frequency band in which the frequency variation is so large that little information regarding the single frequency performance results. At very low frequencies measurements in a very large room or outdoors are most reliable and least influenced by standing wave difficulties.

A third method<sup>4,5</sup> of averaging consists in swinging through the frequency band in the continuous frequency measuring method described above, at such a rapid rate that the output indicating meter cannot follow the interference maxima and minima but indicates an average of these. This method assumes that the peaks and depressions in the loud speaker response are broad compared to those due to interference and does not give a true indication of a loud speaker's performance if the acoustic output varies sharply with frequency.

The above averaging methods measure the total average energy density due to both the reflected sound and that radiated directly from the loud speaker and therefore give measured response values that are larger than would be the case if the reflected sound were not present. While in general the error due to the inclusion of the reflected sound energy is much smaller than that due to standing wave interference patterns, it is still by no means negligible. For example, if a room 20' x 20' x 15' were lined with absorbing material having an absorption coefficient of 0.25 at 100 cycles (a typical value for available materials at this frequency), the average reflected energy density would be approximately 120 per cent of that outwardly radiated from a nondirectional source at a distance of four feet. This would cause the response to be about 3.4 decibels higher than if the reflected sound were not present. This error obviously varies with variations in the coefficient of the absorbing material with frequency and can only be reduced by diminishing the relative magnitude of the reflected sound as discussed above. The illustrative figures were calculated from the following formulas:

$$\text{Average reflected sound energy density} = \frac{4P(1 - A)}{CAS}, \quad (6)$$

$$\text{Sound energy density directly from sound at distance } R = \frac{P}{4\pi R^2 C}, \quad (7)$$

<sup>3</sup> E. Meyer and Paul Just, *Zeit. für Tech. Phys.*, vol. 10, p. 309, (1929).

<sup>4</sup> I. Wolf and A. Ringel, *Proc. I.R.E.*, vol. 15, p. 363; May, (1927).

<sup>5</sup> E. W. Kellogg, *Jour. Acous. Soc. Amer.*, vol. 2, no. 2, p. 157; October, (1930).

where,

$P$  is the power radiated by the sound source,

$C$  is the velocity of sound,

$A$  is the absorption coefficient of sound absorbing material, and

$S$  is the combined area of walls, ceiling, and floor of measuring room.

How far it will be necessary to go in reducing reflections depends upon the measurements to be made and the characteristics of the loud speakers to be tested. If the loud speakers are very directional and only the response within the concentrated sound field is to be measured, the difference between the direct and reflected sound would normally be greater than in the case of nondirective loud speakers in the same room and consequently the room might be suitable for the former but not suitable for the latter. On the other hand, if measurements outside the concentrated sound field are to be made, such as for determining directional characteristics, it is necessary that the reflected sound be of a very small magnitude, the exact magnitude, of course, depending upon how far from the concentrated field it is desired to measure. In general, measurements intended to show the sound field distribution should be made outdoors.

#### 4. Response-Frequency Graph

The response measurements at each frequency are most satisfactorily presented as a curve on rectangular coördinate graph paper with frequency values as abscissas and response values as ordinates. A logarithmic frequency scale is preferable. To obtain a satisfactory graph it is recommended that about ten measurements per octave be made except when the response curve is very regular, in which case the measurements should be made sufficiently close together to define the graph clearly.

As previously mentioned the response graph has little significance unless accompanied by information regarding the measuring conditions. This information should preferably be lettered on the graph paper as a caption. It should state briefly, or indicate by a sketch, the approximate dimensions of the measuring room and the extent and nature of the sound absorbing material in the room, the location of the microphone relative to the loud speaker when the measurements were made, and the method of minimizing standing wave effects. While it is not possible to give very explicit information in the caption, brief statements regarding these three conditions will enable a comparison of the response-frequency curves measured under different conditions and permit one familiar with such curves to interpret the significance

of any differences which may exist. Fig. 2 shows a response-frequency graph in its preferred form and illustrates the manner of expressing measuring conditions.

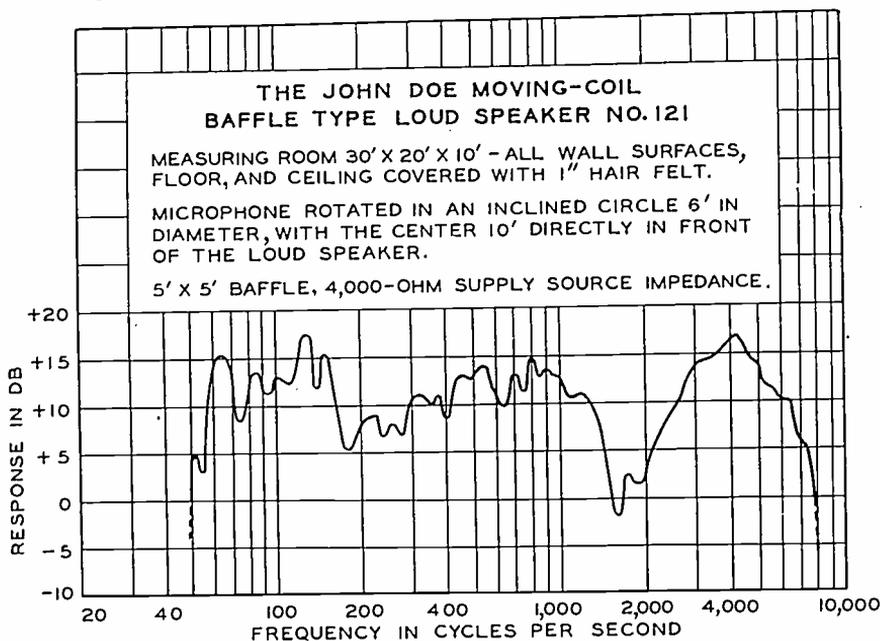

FIG. 2—Response-frequency graph of loud speaker.

C. **Input-Overload Power.** The input-overload power of a loud speaker at a specified frequency is

$$E^2/4R \text{ watts} \quad (8)$$

where,

$E$  is the maximum value to which the open-circuit root-mean-square voltage of the electrical supply source can be increased without any aurally perceptible change other than intensity occurring in the sound output, and

$R$  is the output resistance of the supply source to which the loud speaker is designed to be connected.

D. **Summary.** A complete specification of the performance of a loud speaker should include in general the following information:

(1) A response-frequency graph for a given microphone position, usually directly in front of the loud speaker.

(2) A series of graphs showing the directional distribution of the sound field in free space. These graphs may be either polar coordinate graphs showing the variation in response at each frequency in a series of microphone positions in both the horizontal and vertical planes, or they may be the complete response-frequency graphs on rectangular coordinate paper taken for each of several microphone positions. In the first case the frequency interval should be so small and in the second

case the microphone positions should be so close together as to show, in both cases, a gradual progression of one curve toward another. The curves should be taken throughout a sufficiently large angle in both the horizontal and vertical planes to subtend substantially the total radiation.

(3) An absolute efficiency-frequency curve, or in case of the comparison of two loud speakers, relative loudness efficiency data. A definite relation holds between the response and the absolute efficiency of a loud speaker. The absolute efficiency is equal to the surface integral, over a sphere with the loud speaker at the center, of the square of the response ratio, i.e.,  $p/(E/\sqrt{R})$  multiplied by  $10^{-8}$ . This integral can be approximately obtained by computation from the response-frequency curve and from the directional characteristics taken over a sphere sufficiently distant from the loud speaker that its ultimate directional characteristics have been obtained.

(4) A curve showing the input-overload power at different frequencies. When the loud speaker is limited in its power capacity by rattling, buzzing, overheating, or mechanical breakage due to vibration, this information should also be given.

### III. Microphones

**A. Relative Loudness Efficiency.** The relative loudness efficiency of two microphones (with their associated connecting circuits), when these are alternately connected to the grid-filament circuit of a vacuum tube, is a comparative measure of their useful outputs for these conditions when placed successively at the same position in the sound field. It is expressible as the necessary percentage or decibel change in the power output of the vacuum tube using one microphone as a standard in order that the output shall be of the same magnitude as when using the other microphone, equality of the output being judged by listening to a connected telephone receiver or loud speaker. In order that this quantity be significant the response of the apparatus following the microphone (and including the receiver) must be specified.

**B. Pressure Response.** The pressure response of a microphone is a measure of its electrical output for a specified frequency and pressure on the diaphragm. It is expressible by the ratio,

$$\frac{E}{p}, \quad (9)$$

where,

$E$  is the open circuit voltage generated by the microphone, and  $p$  is the sound pressure in bars at the specified frequency on the microphone diaphragm.

**C. Field Response.** This is the same as the above except that  $p$  is the pressure in a plane progressive wave in which the microphone is to be placed at a specified angle.

The sensitivity of microphones should not be compared on a basis of response only, but it is necessary to know also the impedance of the microphone. The response may be expressed by a value equal to the above ratio or may be expressed in decibels relative to an arbitrary reference condition of one volt per bar. Thus, the response in decibels is

$$20 \log_{10} \frac{E/p}{1/1} = 20 \log_{10} \frac{E}{p} \quad (10)$$

The field calibration differs from the pressure calibration because the microphone disturbs the sound field and causes the pressure at the diaphragm to be different from that which would exist in the undisturbed field. In general this difference is a function of the frequency and angle of incidence.

**D. Burning.** Burning is a rapid, transitory, and for the most part, nonperiodic resistance fluctuation in a carbon microphone. It is evidenced by a frying or sputtering noise sometimes heard from a connected receiver.

**E. Breathing.** Breathing is a slow and, for the most part, periodic variation in the resistance of a carbon microphone. It may be of relatively large magnitude and is not in general audible.

**F. Packing.** Packing in a carbon microphone is a condition caused by excess mechanical pressure between points of contact or by coherence between points of contact resulting from excessive voltages. It is evidenced by decreased resistance and sensitivity of the microphone.

#### IV. Calibration of Microphones\*

**A. Electromotive Force Generated by a Microphone.** In order to separate the performance of the microphone from that of the associated amplifier, or other circuit, the use of the open-circuit e.m.f. is to be preferred. Its value may be obtained as follows:—Under the influence of sound at a certain frequency a certain electrical output is obtained from the amplifier; if now the sound is switched off and a voltage applied at the same frequency in series with the microphone is adjusted to give the same output, the magnitude of this voltage is the open-circuit e.m.f. produced by the sound.

\* This material is not in finished form, but is being published here in order to obtain wide circulation and comments for the benefit of the succeeding committees.

**B. Applied Pressure Due to Sound.** The applied pressure may be quoted in terms of either the effective pressure on the diaphragm (pressure response) or the pressure in the progressive plane wave (field response). Several factors can operate to cause difference between the actual effective pressure on the diaphragm and the corresponding undisturbed field, for example:

(1) When a microphone is exposed to sound waves of low frequencies (wavelength large compared with the size of microphone) the pressure on the microphone is substantially equal to the undisturbed field pressure. At high frequencies, however, diffraction takes place at the face of the microphone. The ratio of the pressure at the diaphragm to that in the free wave becomes a function of the wavelength and of the angle of incidence.<sup>6,7,8</sup>

(2) When there is concavity at the face of the microphone, the diaphragm being recessed or fitted with a mouthpiece, the pressure on the diaphragm may, at certain frequencies, be still further increased, since in effect an acoustical resonator is formed.<sup>9,10,11,12,13</sup>

When a microphone is used in a room for transmitting or recording sound the exact conditions of use are indeterminate since the room itself forms a link in the transmission chain. Assuming that the microphone is facing the source of sound, the sound at the microphone may be divided into two components, namely the initial progressive wave and the sound due to reflections. The field calibration is accurately applicable only to the former for which direction of propagation is known. The applicability of the free wave calibration under these circumstances depends therefore on the relative magnitudes of the initial progressive wave and the resultant of the reflected waves; the accuracy decreases as the microphone is moved farther from the source or as the reverberation of the room is increased.

When a microphone is used as a telephone transmitter, the speaking distance being very small, the exact conditions of use are also difficult to specify. (The velocity component of the sound wave is larger in proportion to the pressure component close to a small source of sound than at a greater distance, and a greater conversion of kinetic to potential energy is to be expected). There appears to be no information available

<sup>6</sup> Stuart Ballantine, *Phys. Rev.*, vol. 32, no. 6, p. 988; December, (1928).

<sup>7</sup> W. West, *Jour. I.E.E.* (London), vol. 67, no. 393, p. 1137; September, (1929).

<sup>8</sup> L. J. Sivian, *Bell Sys. Tech. Jour.*, vol. 10, no. 1, p. 96; January, (1931).

<sup>9</sup> Stuart Ballantine, *Proc. I.R.E.*, vol. 18, no. 7, p. 1206; July, (1930).

<sup>10</sup> W. West, *Jour. I.E.E.*, (London), vol. 68, no. 400, p. 441; April, (1930).

<sup>11</sup> A. J. Aldrich, *Post Office Electrical Engineers' Journal* (London), vol. 21, part 35, p. 223; October, (1928).

<sup>12</sup> D. A. Oliver, *Jour. Sci. Inst.*, vol. 7, no. 4, p. 113; April, (1930).

<sup>13</sup> W. West, *Post Office Electrical Engineers' Journal* (London), vol. 24, part 1, p. 27; April, (1931).

at present as to the inaccuracy involved in the use of the free wave calibration for the close speaking condition.

The most important criteria of the performance of a microphone are the response in relation to frequency and the response in relation to the amplitude of the applied pressure. For a carbon microphone there are other important criteria, for example the response in relation to the noise generated by the microphone and response variations liable due to packing.

**C. Objective Measurements: Direct Calibrations.** There are three methods in common use at this time to obtain primary calibrations. These may be designated broadly as (1) the thermophone, (2) the electro-static actuator, and (3) the Rayleigh disk methods. In general, these do not yield the same calibration and not all of these methods are universally applicable to all types of microphones. Methods (1) and (2) apply to pressure calibration and for field calibration\* method (3) alone is applicable although this method applies to pressure measurements as well. Only method (3) is applied to microphones of the ribbon type.

### 1. THE THERMOPHONE

The thermophone as developed by E. C. Wentz<sup>14,15,16</sup> for microphone calibration usually consists of one or more strips of very thin gold leaf, mounted on a plate. This plate fits closely over the front of the microphone in such a manner that the air chamber in front of the diaphragm is small. This enclosure is generally filled with pure dry hydrogen at a steady pressure which is approximately atmospheric. The use of hydrogen permits a more nearly uniform distribution of pressure over the diaphragm even at high frequencies than would be the case if air were used.

In the usual method, the thermophone strip carries a known steady current upon which a sinusoidal alternating current is superimposed. In this case, the alternating pressure in the chamber occurs primarily at the frequency of the alternating current if the a-c component is small compared to the direct component. The absolute measurement of the a-c component may be eliminated by the use of an attenuator circuit which also serves to calibrate the amplifier voltmeter associated with the microphone by introducing a calibrating voltage in series with the microphone.<sup>17</sup>

\* See C. Field Response, page 177.

<sup>14</sup> E. C. Wentz, *Phys. Rev.*, vol. 19, no. 4, p. 333; April, (1922).

<sup>15</sup> H. D. Arnold and I. B. Crandall, *Phys. Rev.*, vol. 10, no. 1, p. 22; July, (1917).

<sup>16</sup> Harvey Fletcher, "Speech and Hearing," Appendix A, (D. Van Nostrand, Inc.).

<sup>17</sup> L. J. Sivian, *Electrical Communication*, vol. 3, p. 114; October, (1924).

To prevent the accumulation of any air leaking back into the enclosure a continuous circulation of the hydrogen is maintained, and by the use of equal pressure and exhaust heads, the steady pressure in the enclosure is kept equal to atmospheric pressure, a necessary precaution when calibrating condenser transmitters. Capillary tubes are used for the supply and exhaust ducts to reduce leakage of sound by these paths.

The thermophone method is not restricted to the calibration of condenser microphones. It may be used with a diaphragm of any shape which is not too large, relative to the shortest sound wavelength (in hydrogen) to be employed. It is required that the acoustic impedance of the microphone be known except when this impedance is large compared with that of the enclosure. The computations are considerably simplified when the latter is the case.

Wente's paper<sup>14</sup> gives the pressure generated by a thermophone in an enclosure with rigid walls which are heat insulators on the assumption that the alternating component of the temperature of the thermophone is uniform. It also gives a correction factor for the conduction of heat by the clamps supporting the thermal strips. Wente's solution includes the effect of heat radiation from the thermophone strips. Additional correction factors are required to allow for: (a) heat conduction by the walls of the enclosure, (b) mechanical yielding of the microphone diaphragm, and (c) leakage of sound through the capillary ducts. Factors (a) and (b) are discussed in papers by Sivian<sup>8</sup> and Ballantine.<sup>18</sup> The latter reference also gives a correction for the capillary ducts. Ballantine's paper discusses in detail many of the features of the thermophone method and gives numerical data including a list of some of the most authoritative values of the physical constants required in the computations.

## 2. THE ELECTROSTATIC ACTUATOR

The following methods are primarily applicable to condenser microphones in which a substantially uniform electric force can be applied by means of a plane electrode parallel to the diaphragm.

### a. Self-Actuator.

#### i. Sound Pressure Compensated by Electric Force Applied to Diaphragm

In this case the microphone is made to act as its own electrostatic actuator. The original publication of this method was given by Ger-

<sup>18</sup> Stuart Ballantine, *Jour. Acous. Soc. Amer.*, vol. 3, no. 3, p. 319; January, (1932).

lach.<sup>19</sup> An electro-acoustic device is required whose diaphragm motion can be detected by acoustic or electro-acoustic means, and which at the same time can have applied to its diaphragm an electrically produced force which is capable of calculation or measurement. The distribution of the electrical force over the diaphragm must be substantially like that of the acoustic pressure due to the applied sound.

The device is subjected to a sustained sound which causes the diaphragm to vibrate. If now the alternating force is applied at the same frequency and adjusted correctly in phase and magnitude, the diaphragm can be brought to rest. It is then only necessary to ascertain the magnitude of the electrically applied force in order to evaluate the magnitude of the force due to sound. A variation of this method is described by Hartmann.<sup>20</sup> The balance between acoustic and electric forces is judged by absence of variation in the microphone capacity. This is done by making the microphone a part of the high frequency modulation circuit similar to the one described in connection with the following method.

## ii. Microphone Capacity Variation Measured in a Frequency Modulated Circuit

The calibration is made in the absence of sound by observing the microphone output due to vibration of the diaphragm when it is actuated by the electric force. The method is described by Grutzmacher and Meyer.<sup>21</sup>

In this method the condenser microphone is used simultaneously in two circuits; (1) its normal polarizing circuit, and (2) the capacity between the electrodes of the microphone is made part of a high frequency oscillation circuit. There is inserted in the polarizing circuit an alternating voltage which causes the diaphragm to vibrate at audio frequencies. The resultant capacity variation of the microphone is used to produce frequency modulation (which is measured by suitable means) of the high frequency circuit. It remains to determine the factor of proportionality between the voltage applied in the polarizing circuit and the force which it exerts on the diaphragm. This is done by observing the voltage required to produce a capacity change equal and opposite to that produced by a known static air pressure.

<sup>19</sup> Erwin Gerlach, *Wiss. Veroff. Siemens-Konzern*, vol. 3, no. 1, p. 139, (1923).

<sup>20</sup> C. A. Hartmann, *Zeit. für tech. Phys.* vol. 10, no. 11, p. 553; November, (1929).

<sup>21</sup> Martin Grutzmacher and E. Meyer, *Elek. Nach. Tech.* vol. 4, no. 5, p. 203; May, (1927).

### iii. Auxiliary Electrode

This method is described by Sivian,<sup>8</sup> Grutzmacher and Just,<sup>22</sup> and Ballantine.<sup>18</sup> The electric force is applied by means of an auxiliary electrode in front of the diaphragm thus eliminating the necessity of using the frequency modulated circuit. This also permits a practically uniform distribution of electric force over the diaphragm area which is not possible with the usual shape of the back electrode of the microphone in the self actuator. The magnitude of the electric force is readily computed from the known separation between the diaphragm and auxiliary electrode. The latter is perforated in such a manner that it does not appreciably alter the impedance opposing the motion of the diaphragm when the latter vibrates in free air.

An alternative procedure is to obtain the relative frequency characteristics with the above method and then to make an absolute calibration at a single convenient low frequency by the pistonphone method.<sup>14</sup>

### 3. RAYLEIGH DISK

The Rayleigh disk is a purely acoustical instrument which is used to measure the particle velocity of a sound wave. It consists of a small circular disk suspended by a fibre against whose restoring torque it may rotate about a vertical axis. The disk tends to set its plane normal to the direction of air flow in the sound wave and, as generally used, its deflection is roughly proportional to the square of the particle velocity. Extreme care must be used to protect the disk from spurious air currents. It may be calibrated from the theoretical formula derived by Koenig<sup>23</sup> care being taken that the conditions of use approximate reasonably to those on which the formula is based.<sup>24</sup>

In order to use the Rayleigh disk for calibrating a microphone it is necessary to expose both instruments in a sound field of such simple character that the relation between velocity and pressure is known.<sup>7</sup>

#### a. Stationary-Wave Pressure Calibration.

The diaphragm of the microphone closes one end of a tube in which a plane stationary wave is maintained by a suitable source. A Rayleigh disk, suspended into the tube at a distance which is an odd number of quarter wavelengths from the diaphragm measures the velocity  $V$ . The magnitude of the pressure on the diaphragm is then  $\rho c V$  regardless of the diaphragm impedance. When the diaphragm impedance per unit

<sup>22</sup> Martin Grutzmacher and P. Just, *Elec. Nach. Tech.*, vol. 8, no. 3, p. 104; March, (1931).

<sup>23</sup> Walter Koenig, *Annalen der Physik und Chemie*, vol. 43, no. 5, p. 43; April, (1891).

<sup>24</sup> E. J. Barnes and W. West, *Jour. I.E.E.* (London), vol. 65, no. 359, p. 871; September, (1927).

area is large compared with  $\rho c$ , as is the case for condenser microphones, the point at which  $V$  is measured is also a point of maximum velocity in the stationary wave. In the above,  $\rho$  is the density of air and  $c$  is the velocity of sound in air.

#### b. Field Calibration by Rayleigh Disk.<sup>25,26</sup>

Practically, it is convenient to work with a progressive spherical sound wave in which the ratio between the pressure and velocity is known. The chief difficulty in applying this method is that of obtaining the spherical wave. Two requirements must be satisfied: reflection of sound other than that caused by the microphone under test must be practically eliminated, and (in the absence of a spherical source) the source of sound must be small as compared with the wavelength. The first condition is met over a restricted frequency range by the use of a testing cabinet with heavily absorbing walls.

Some error may occur due to sound reflected from the microphone if this is not small. The accuracy of measurement can be improved by taking a mean of results from different locations of the microphone in the cabinet. Alternatively, a larger cabinet would permit greater distance between the microphone and the source and disk.

This calibration is a field calibration. That the free wave calibration can be made by a Rayleigh disk is due to the fact that the disk itself offers no appreciable obstruction to the sound wave; i.e., it is effectively small at all frequencies used. The use of a spherical wave is not essential, but in view of the difficulty of obtaining a plane wave in free air, spherical radiation provides the simplest progressive wave that can be readily obtained in practice.

#### c. Rayleigh Disk Used as Torsional Pendulum.

This method is described by Sivian.<sup>27</sup> Its principal purpose is to increase the signal-noise ratio; i.e., to increase the ratio of the disk deflection caused by the sound measured to its erratic deflections caused by spurious air currents. The desired discrimination is affected by reading the amplitude of oscillation of the disk vibrating as a torsional pendulum at its resonant frequency. The oscillatory torque is produced by using a sound field whose amplitude is modulated with a frequency equal to that of the disk, which may be of the order of 0.4 cycle per second. The modulated sound field is obtained by: (a) feeding the sound source through a motor-driven potentiometer

<sup>25</sup> E. Mallett and G. F. Dutton, *Jour. I.E.E.* (London), vol. 63, no. 341, p. 502; May, (1925).

<sup>26</sup> B. S. Cohen, A. J. Aldridge and W. West, *Jour. I.E.E.* (London), vol. 64, no. 358, p. 1023; October, (1926).

<sup>27</sup> L. J. Sivian, *Phil. Mag.*, vol. 5, no. 29, p. 615; March, (1928).

which varies the current sinusoidally at the required rate (e.g., 0.4 cycle per second), or (b) feeding the sound source from two oscillators whose frequencies differ by the natural frequency of the disk (e.g., 0.4 cycle per second).

**D. Objective Measurements: Indirect Calibrations.** A high quality microphone, having been calibrated, may be used as a standard of comparison for calibrating other microphones. The acoustical conditions required for the test are essentially the same as those for measuring the free wave pressure at a point due to radiation by a loud speaker; this measurement may comprise the preliminary step towards the indirect calibration of a microphone, the final steps being taken by replacing the calibrated microphone by the one under test and repeating the measurement. If the sizes or shapes of the two microphones are dissimilar, it is desirable that the test be made with the microphone at such distance from the source of sound that sound reflected from the former should not appreciably affect the radiation efficiency of the latter. Measurements of this kind have been described, for example, in the publications of Cohen, Aldridge and West,<sup>26</sup> and by Grutzmacher and Just.<sup>22</sup>

# THE MEASUREMENT OF RADIO FREQUENCY

## I. General

The increased use of the radio spectrum has called for more stable operation of radio transmitters than was previously thought possible. Associated with this problem has been the accurate measurement of frequency. To this end many methods have been suggested, some of the more important of which are outlined below. A bibliography is attached which provides further information.

There are two general types of frequency meters. The first and simpler is the so-called absorption type which consists of an accurately calibrated resonant circuit together with an indicating device. This apparatus has been used very generally since the beginning of radio, and is often known as a wavemeter. Although the method is relatively inaccurate, the convenience and facility with which measurements may be made continue to make it one of the more useful methods of the radio laboratory. Wavemeters adaptable to a wide range of frequencies are often accurate to 0.5 per cent. Carefully constructed and calibrated wavemeters of limited range, maintained under very favorable conditions, may be relied upon to about 0.1 per cent. With suitable precautions this may be extended to better than 0.03 per cent. Considerable information is available on the design and use of wave-meters.<sup>91,53</sup> This together with the fact that they may be purchased at a nominal price from several of the radio supply houses makes it unnecessary to present further details at this time.

An absorption type of instrument consisting of a specially cut quartz plate in a rarified gas has been described.<sup>57</sup> Resonance is indicated by a glowing of the gas adjacent to the quartz. This method is not generally used in this country probably because of the disadvantage of requiring one unit for each frequency to be measured.

The second and more accurate method of frequency measurement depends on the heterodyning of an unknown frequency with some near-by known frequency. This calls for a suitable number of accurately known standard frequencies.

## II. The Fundamental Unit

The practical measurement of frequency is essentially that of comparing two time intervals, one of which is unknown. The most feasible reference standard of time is probably the solar day. Since the time intervals involved at radio frequencies are extremely short, the

<sup>91, 53</sup> Numbers refer to attached bibliography.

principal problem becomes that of accurately dividing the day into suitable subdivisions. This may be done by a properly designed clock-controlled by a device which marks off arbitrarily time intervals.

### III. The Frequency Standard

The device for accurately marking off time intervals of convenient length constitutes a frequency standard. If the desired intervals are relatively long this may be a vibrating pendulum; if the intervals are very short as must be the case in radio-frequency standards the element should be capable of a high rate of vibration. This requirement is met by the so-called quartz plate oscillators whose rates of vibration may be extended from perhaps 200 cycles up to several million cycles per second. Rates of vibration greater than those of pendulums may also be had from tuning forks and from magnetostriction oscillators.<sup>84</sup> Rates of vibration still higher than those of quartz crystals may be had from tourmaline plates.<sup>78,79</sup> By this means frequencies as high as 200 megacycles have been obtained.

In practical application of this method it is customary to translate the mechanical vibrations into alternating currents of the same or harmonic frequencies. Submultiples of this frequency are used to operate the synchronous motor drive of the clock mentioned above. Submultiple frequencies as well as harmonics of the fundamental source may also be available for comparison purposes.

Primary standards of frequency similar to the above are maintained under carefully controlled conditions of temperature, pressure and power supply at some of the larger research laboratories. One outstanding installation is that of the Bureau of Standards described briefly below and somewhat more extensively in reference 72 of the attached bibliography. Other standards maintained under slightly less favorable conditions are located at several other laboratories.

The accuracy of these standards is reflected in the large number of comparisons which have been made. These comparisons have been effected by independent measurements of the same radio signals, and have been in general agreement within one part in a million. Standard frequency signals derived from such sources may be transmitted either by wire lines or by radio for use at different distant points. Standards of high precision involve a considerable elaboration of apparatus which is not always warranted. Some simplification results from dispensing with the clock and its associated circuits. The accuracy then depends on the ability of the oscillator to remain constant between calibrations. Less elaborate temperature control effects further simplification. Such an oscillator then becomes moderately portable thereby making it

possible to ship it to other standardization laboratories for calibration. The constancy of such a semiportable oscillator may be of the order of one part in one hundred thousand. The elimination of all temperature control reduces the standard to relatively simple proportions. Its constancy is then about two or three parts in ten thousand or approximately that obtained by the most refined wave-meter. This figure may be improved considerably by measuring the crystal temperature and applying an appropriate correction based on its temperature coefficient.

#### IV. Comparison of Frequencies

Sources of standard frequency such as the above usually do not, in themselves, possess the flexibility needed for most measurement work. For instance, the reference frequency may be 1000 cycles per second whereas that to be measured is of the order of several million. To meet this situation it is feasible to pass this frequency through a distorting element such as a negatively biased vacuum tube from which a very large number of harmonics may be obtained, each spaced at intervals of one kilocycle. By a variation of this principle frequencies may be obtained spaced at wider intervals such as tens of kilocycles, hundreds of kilocycles or megacycles. It is also possible to produce submultiple frequencies.<sup>5</sup> It is at once apparent that with some ingenuity a band of discreet frequencies may be had analagous to the millimeter, centimeter, and decimeter lines on a meter scale. A determination of an unknown frequency then becomes a matter of finding where it falls on this scale and estimating the distance to the nearest reference point.

There are several methods of effecting the actual comparison between the known and unknown frequencies. One consists in passing the two frequencies, each adjusted to suitable levels, simultaneously into a tuned radio receiver where a beat note may be heard in the output. This tone may then be made to "zero beat" with an accurately calibrated audio frequency oscillator. Errors in the method will then depend on the latter's calibration. This may be made small when considered as a percentage of the total frequency. This differential may also be determined by a stroboscope, a cathode ray oscillograph, or by a frequency meter of the vibrating reed or bridge type.

#### V. Typical Standards of Frequency

The United States Bureau of Standards maintains a frequency standard of high precision with which substandards are compared for a nominal price. This apparatus also forms the basis of a standard carrier frequency of 5 megacycles which is regularly broadcast. The literature

does not as yet contain a detailed description of this standard. However, it is much the same as that described in reference (45) of the attached bibliography. In general, it consists of an oscillating quartz plate resonator so cut as to minimize temperature effects, enclosed in a bell jar inside of which the pressure and temperature are kept very constant. The bell jar and plate together with the associated circuit are enclosed in an outer chamber where temperatures are moderately well regulated. These precautions result in crystal temperatures maintained within  $\pm 0.01^\circ\text{C}$ .

To increase further the accuracy four oscillators are provided. One acts as an arbitrary reference point against which the other three are checked. Beats between the various oscillators are indicated on milliammeters. They may also be recorded graphically. To determine the absolute frequency a device known as a submultiple generator is used. It consists of four multivibrators<sup>8</sup> in which the original frequency of 100 kc per second is stepped down to one kc per second without a loss of accuracy. The 1000-cycle current is then amplified and drives a synchronous motor geared to a clock. The gear ratio is such that the clock keeps accurate mean solar time as long as the crystal vibrates at 100 kc per second. Provision is made for obtaining fundamental frequencies from 1 cycle up to 100,000 cycles per second in decimal steps. As mentioned above, harmonics of these frequencies may be produced, making it possible to measure almost any frequency.

The precision of this device is rather high. The random variations occurring inside of a period of perhaps an hour are estimated at about three parts in one hundred million. The absolute frequency is less certain but may be of the order of two parts in ten million. Less pretentious forms of this type of frequency standard are available commercially.\*

As mentioned above considerable simplicity in a frequency control may be effected by dispensing with the clock mechanism or using less elaborate temperature control. This makes the standard portable at the expense of accuracy. One form of such a standard consists of a self-contained unit involving a plate in a specially rugged mounting together with means for a fair degree of temperature control. The power supply may be derived from rectifiers contained in the unit. When needed the unit is plugged into an alternating current outlet. It is, of course, necessary to wait some time for temperature equilibrium before making measurements. Another oscillator of this general type is described in reference 56 below. Improvements in vacuum tube oscillators<sup>52, 65, 70</sup> permit of a constancy comparable with the less carefully controlled pie-

\* General Radio Company, Cambridge A., Mass.

zo-electric sources. Because of their flexibility they are in general preferable. Oscillators of most of the above types are available commercially.

Intermediate between the very simple and the very elaborate standards mentioned above there have been many others suggested. Some of these have been designed to facilitate speed of measurement. Others are aimed at simplicity and hence lower cost. Still others are intended for special purposes such as to record deviations of a transmitting station from its assigned frequency. In one method<sup>77</sup> a rather elaborate system is built around a million-cycle temperature controlled crystal operating a clock for checking purposes. Means are provided for producing both harmonics and submultiples of the fundamental. These components are combined with the unknown frequency to produce beats in successive stages. The beat frequency produced in each stage is of one less digit than that in the preceding stage. A calibrated electric oscillator is used to measure the frequency of the last stage. The measurement thereby becomes one of successive approximations. The accuracy is estimated at better than three parts in a million.

Another scheme<sup>88</sup> utilizes a similar crystal and clock but only two components of the primary source are used, namely, 100 kc and 10 kc. Harmonics 100 kc apart are introduced into an autodyne receiver along with the unknown frequency where their approximate tunings are noted. The 100 kc harmonics are next modulated by the 10 kc components, thereby providing still closer reference points. The interpolation of the unknown frequency relative to the two adjacent 10 kc side frequencies is effected by noting the micrometer reading of a condenser used to beat in the three frequencies.

## VI. Standard Frequency Transmissions

Radio transmissions of standard frequency such as those of the Bureau of Standards may be picked up at distant points for checks of substandards. Weekly transmissions both in daylight and darkness make the Bureau's service available over a large part of the country. This service is being extended from time to time. Details of the transmissions<sup>81</sup> together with information concerning their use<sup>92</sup> may be had by writing to the Director of the Bureau of Standards, Washington, D.C.

Under the sponsorship of the American Radio Relay League standard frequencies in the bands assigned to amateurs are transmitted several times each week from W1XP, the experimental station of the Massachusetts Institute of Technology, South Dartmouth, Mass., W9XAN, Elgin, Ill., and W6XK, Los Angeles, Cal. Transmissions from W1XP are obtained from a primary standard and are usually

accurate to one part in one million. Those from W9XAN and W6XK may usually be depended upon to one part in one hundred thousand.

A constant frequency service is provided in certain areas by the Bell System. At present this is derived from the carefully maintained standard of the Bell Telephone Laboratories<sup>45</sup> and transmitted to subscribers to this service over wire lines. This service has been used in connection with the synchronization of broadcasting stations, and on an experimental basis for the frequency control of large central power plants as well as in measuring work of various kinds. Other uses are projected.

### VII. Radio Monitors

It is sometimes necessary for the operator to watch carefully the frequency of a radio station to make certain that it does not depart more than some prescribed amount from its assigned frequency. This may, of course, be done by frequent measurements with apparatus such as the above. However, this departure can be measured with considerably simplified apparatus, sometimes known as a monitor. Several forms have been suggested.<sup>83,89</sup> In one the amplified output of a temperature controlled oscillator is impressed on a detector together with a similar amount of the carrier from the transmitter under observation. The detector output then contains a beat representing the difference frequency. This difference is indicated directly by a suitable output meter. A list of approved monitors is available from the Federal Radio Commission of the United States Government.

### VIII. Measurement of Extremely High Radio Frequencies

Ultra radio frequencies may be so high as to fall outside the scope of the above methods. In this case it is feasible to measure the wavelength by either of two methods depending upon the frequency. By one method<sup>69</sup> the lengths of standing waves on Lecher wires are measured. Refinements in the apparatus permit of observational errors of less than 0.1 per cent but care must be exercised if the constant errors are restricted to this limit. The velocity of propagation along wires only approximates that of light when the attenuation is low. Experience has shown that the speed is materially reduced by wires of iron or of resistance alloys or of copper wires of too small diameter.

The terminating bridges from which reflections take place should be conducting planes of considerable expanse, rather than simple short-circuit wires such as might be used ordinarily. In case reflection takes place from the open end of a Lecher system, corresponding to the famil-

lar open-end organ pipe, a correction to the length must be added. This correction is of the order of the wire spacing.

If the wavelength is sufficiently short it may be measured as a space wave rather than a guided wave. This is essentially an optical method. It may be done most advantageously in an open space such as on a flat roof. Waves from a source preferably equipped with a parabolic mirror are reflected at only slight incidence from a plane mirror capable of displacement along its perpendicular. The reflected beam is intercepted by a pick-up device such as a crystal detector and sensitive meter, preferably also equipped with parabolic reflector. As the plane mirror is displaced along its perpendicular, nodes and loops are detected. The wavelength is taken as four times the distance between successive maxima.

### IX. Direct Frequency Control of Radio Stations

A problem closely related to the measurement of frequency is that of control of transmitters. Frequency standards such as the above may, of course, be used to supply the carrier directly. However, economic considerations usually do not justify an elaborate layout. It is customary, therefore, to incorporate in the transmitter a quartz plate oscillator having moderate temperature control, separated from the power stages by one or more stages of amplification. Varying degrees of precision are obtained depending on the precautions observed.

Extremely accurate frequency control has been employed where it is desired that two or more radio stations broadcast the same program on the same assigned carrier frequency. This control has been effected by either of two general methods. In one method the same standard frequency is supplied to the same synchronized stations over a wire line. From this the carriers are independently derived. In another method one of the two stations has its frequency fixed while a second is adjustable over narrow limits. A receiver suitably located between the two stations is tuned to the operating frequency and indicates as beats any difference that may exist. This beat note or pulse is passed back over a wire line to the operator of the second station who uses it as a criterion for keeping his transmitter in adjustment. In still other cases accurately controlled crystals have been employed at the different radio stations with no provision for continuous synchronization or intercomparison.

## ABRIDGED BIBLIOGRAPHY MEASUREMENT OF RADIO FREQUENCIES

## 1924

1. D. W. Dye, "Self-contained harmonic wavemeter," *Roy. Soc. Lond., Phil. Trans.*, series A, vol. 224, pp. 259-301; November 13, (1924).

## 1926

2. C. B. Jolliffe and Grace Hazen, "Establishment of radio standards of frequency by the use of a harmonic amplifier," Bureau Standards Sci. Paper, no. 530, July 15, (1926).

3. Balth van der Pol, Jr., "On relaxation oscillations," *Phil. Mag.*, 7th series, vol. 2, no. 11, pp. 978-992; November, (1926).

## 1927

4. H. A. Affel and J. T. O'Leary, "High-frequency measurements of communication lines," *Trans. A.I.E.E.*, vol. 46, pp. 504-513; May, (1927).

5. Frederick Bedell and H. J. Reich, "The oscilloscope: a stabilized cathode-ray oscillograph with linear time-axis," *Trans. A.I.E.E.*, vol. 46, pp. 546-550; May, (1927).

6. R. Braillard and E. Divoire, "Exact and precise measurement of wavelength in radio transmitting stations," *Experimental Wireless*, vol. 4, pp. 322-330, 394-401; June (1927).

7. C. T. Burke, "Substitution method for the determination of resistance of inductors and capacitors at radio frequencies," *Trans. A.I.E.E.*, vol. 46, pp. 482-487; May, (1927).

8. J. K. Clapp, "Universal frequency standardization from a single frequency source," *Jour. Opt. Soc. Amer.*, vol. 15, no. 1, pp. 25-47; July, (1927).

9. A. Crossley, "Piezo-electric crystal controlled transmitters," *Proc. I.R.E.*, vol. 15, no. 1, pp. 9-36; January, (1927).

10. P. G. Edwards and H. W. Herrington, "Sensitivity characteristics of a low-frequency bridge network," *Trans. A.I.E.E.*, vol. 46, pp. 551-559; May, (1927).

11. C. R. Englund and H. T. Friis, "Methods for the measurement of radio field strengths," *Trans. A.I.E.E.*, vol. 46, pp. 492-497; May, (1927).

12. W. N. Goodwin, "Notes on the use of a radio frequency voltmeter," *Trans. A.I.E.E.*, vol. 46, pp. 479-481; May, (1927).

13. E. I. Green, "Methods of measuring the insulation of telephone lines at high frequencies," *Trans. A.I.E.E.*, vol. 46, pp. 514-519; May, (1927).

14. R. C. Hitchcock, "Mounting quartz oscillator crystals," *Proc. I.R.E.*, vol. 15, no. 11, pp. 902-913; November, (1927).
15. R. C. Hitchcock, "Radio frequency standards," *Elec. Jour.*, vol. 24, no. 9, pp. 430-438; September, (1927).
16. S. C. Hoare, "A new thermionic instrument," *Trans. A.I.E.E.*, vol. 46, pp. 541-545; May, (1927).
17. J. W. Horton, "The empirical analysis of complex electric waves," *Trans. A.I.E.E.*, vol. 46, pp. 535-541; May, (1927).
18. A. Meissner, "Piezo-electric crystals at radio frequencies," *Proc. I.R.E.*, vol. 15, no. 4, pp. 281-296; April, (1927).
19. Alexander Nyman, "Condenser shunt for measurement of high-frequency currents of large magnitude," *Trans. A.I.E.E.*, vol. 46, pp. 488-491; May, (1927).
20. H. D. Oakley, "Quantitative determination of radio receiver performance," *Trans. A.I.E.E.*, vol. 46, pp. 498-503; May, (1927).
21. Eugene Peterson, "Impedance of a non-linear circuit element," *Trans. A.I.E.E.*, vol. 46, pp. 528-534; May, (1927).
22. G. T. Royden, "Frequency checking station at Mare Island," *Proc. I.R.E.*, vol. 15, no. 4, pp. 313-318; April, (1927).
23. W. J. Shackelton and J. G. Ferguson, "High-frequency measurement of communication apparatus," *Trans. A.I.E.E.*, vol. 46, pp. 519-527; May, (1927).
24. M. S. Strock, "Standard frequency dissemination," *Proc. I.R.E.*, vol. 15, no. 8, pp. 727-731; August, (1927).
25. H. M. Turner, "Microammeter indication of high-frequency bridge balance," *Trans. A.I.E.E.*, vol. 46, pp. 559-563; May, (1927).

## 1928

26. C. B. Aiken, "Precision method for the measurement of high frequencies," *Proc. I.R.E.*, vol. 16, no. 2, pp. 125-136; February, (1928).
27. K. C. Black, "Dynamic study of magnetostriction," *Amer. Acad. Arts & Sci.*, vol. 63, no. 2, pp. 49-66; April, (1928).
28. R. Braillard and E. Divoire, "How broadcasting wavelengths are checked. A description of the International Listening Station at Brussels," *Wireless World*, vol. 22, pp. 219-222; (1928).
29. W. G. Cady, "Bibliography in piezo-electricity," *Proc. I.R.E.*, vol. 16, no. 4, pp. 521-535; April, (1928).
30. J. H. Dellinger, "Status of frequency standardization," *Proc. I.R.E.*, vol. 16, no. 5, pp. 579-590; May, (1928).
31. Carl Dreher, "Broadcast control operation," *Proc. I.R.E.*, vol. 16, no. 4, pp. 498-512; April, (1928).

32. E. Giebe and A. Scheibe, "Piezoelectrische erregung von dehnungs-, biegungs-, und drillungs-schwingungen bei quarzstabem," *Zeit. für. Phys.* vol. 46, no. 9-10, pp. 607-652; January 25, (1928).

33. J. W. Horton and W. A. Marrison, "Precision determination of frequency," *Proc. I.R.E.*, vol. 16, no. 2, pp. 137-154; February, (1928).

34. W. A. Marrison, "Thermostat design for frequency standards," *Proc. I.R.E.*, vol. 16, no. 7, pp. 976-980; July, (1928).

35. George Rodwin and T. A. Smith, "Radio frequency oscillator for receiver investigation," *Proc. I.R.E.*, vol. 16, no. 2, pp. 155-165; February, (1928).

36. L. P. Wheeler and W. E. Bower, "New type of standard frequency piezo-electric oscillator," *Proc. I.R.E.*, vol. 16, no. 8, pp. 1035-1044; August, (1928).

37. R. H. Worrall and R. B. Owens, "Navy's primary frequency standard," *Proc. I.R.E.*, vol. 16, no. 6, pp. 778-793; June, (1928).

#### 1929

38. H. L. Bogardus and C. T. Manning, "Routine measurement of the operating frequencies of broadcast stations," *Proc. I.R.E.*, vol. 17, no. 7, pp. 1225-1239; July, (1929).

39. R. Braillard and E. Divoire, "Measurement of wavelengths of broadcasting stations," *Experimental Wireless*, vol. 6, pp. 412-421; (1929).

40. P. P. Eckersley and A. B. Howe, "Operation at several broadcasting stations on the same wavelength," *Jour. I.E.E.* (London), vol. 67, pp. 772-785; (1929).

41. E. L. Hall, "System for frequency measurements based on a single frequency," *Proc. I.R.E.*, vol. 17, no. 2, pp. 272-282; February, (1929).

42. R. C. Hitchcock, "Direct reading radio-frequency meter," *Proc. I.R.E.*, vol. 17, no. 1, pp. 24-34; January, (1929).

43. L. M. Hull and J. K. Clapp, "Convenient method for referring secondary frequency standards to a standard time interval," *Proc. I.R.E.*, vol. 17, no. 2, pp. 252-271; February, (1929).

44. Seikichi Jimbo, "Measurement of frequency," *Proc. I.R.E.*, vol. 17, no. 11, pp. 2011-2033; November, (1929).

45. W. A. Marrison, "High precision standard of frequency," *Proc. I.R.E.*, vol. 17, no. 7, pp. 1103-1122; July, (1929). *Bell Sys. Tech. Jour.*, vol. 8, pp. 493-514; July, (1929).

46. G. Pession and T. Gorio, "Measurement of the frequencies of distant radio transmitting stations," *Proc. I.R.E.*, vol. 17, no. 4, pp. 734-744; April, (1929).

47. G. W. Pierce, "Magnetostriction oscillators," *Proc. I.R.E.*, vol. 17, no. 1, pp. 42-88; January, (1929).

48. "The A.R.R.L. official frequency system," *QST*, vol. 13, no. 9, p. 38; September, (1929).

## 1930

49. J. K. Clapp, "Temperature control for frequency standards," *Proc. I.R.E.*, vol. 18, no. 12, pp. 2003-2010; December, (1930).
50. B. Decaux, "Frequence metre etalon absolu du Laboratoire National de Radioelectricite," *L'Onde Electrique*, vol. 9, pp. 449-466; October, (1930).
51. F. Gerth, "German common frequency broadcast system," *Proc. I.R.E.*, vol. 18, no. 3, pp. 510-512; March, (1930).
52. Ross Gunn, "New frequency stabilized oscillator system," *Proc. I.R.E.*, vol. 18, no. 9, pp. 1560-1574; September, (1930).
53. W. H. F. Griffiths, "Accurate wavemeter design," *Wireless World*, vol. 26, no. 5, pp. 113-115; January 29, (1930); no. 6, pp. 148-150; February 5, (1930).
54. E. L. Hall, "Accurate method of measuring transmitted wave frequencies at 5,000 and 20,000 kilocycles per second," *Bureau Standards Jour. of Research*, vol. 5, no. 3, pp. 647-752; September, (1930). *Proc. I.R.E.*, vol. 19, no. 1, pp. 35-41; January, (1931).
55. E. L. Hall, "Method and apparatus used at the Bureau of Standards in testing piezo oscillators for broadcast stations," *Proc. I.R.E.*, vol. 18, no. 3, pp. 490-509; March, (1930). *Bureau Standards Jour. of Research*, vol. 4, no. 1, pp. 115-130; January, (1930).
56. V. E. Heaton and W. H. Brattain, "Design of a portable temperature-controlled piezo oscillator," *Proc. I.R.E.*, vol. 18, no. 7, pp. 1239-1246; July, (1930).
57. Seikichi Jimbo, "International comparison of frequency by means of a luminous quartz resonator," *Proc. I.R.E.*, vol. 18, no. 11 pp. 1930-1934; November, (1930).
58. Y. Namba, "Establishment of the Japanese radio-frequency standards," *Proc. I.R.E.*, vol. 18, no. 6, pp. 1017-1027; June, (1930).
59. "Official frequency system," *QST*, vol. 14, no. 1, p. 41; January, (1930).

## 1931

60. A. S. Angwin, "Chairman's address delivered November 4, 1931, before the Wireless Section," *Jour. I.E.E.*, (London), vol. 70, no. 420, pp. 17-35; December, (1931).
61. S. L. Brown and Sidon Harris, "Measurement of temperature coefficient and pressure coefficient of quartz-crystal oscillators," *Rev. Sci. Inst.*, vol. 2, no. 3, pp. 180-183; March, (1931).
62. J. W. Conklin, J. L. Finch, and C. W. Hansell, "New methods of frequency control employing long lines," *Proc. I.R.E.*, vol. 19, no. 11, pp. 1918-1930; November, (1931).

63. B. Decaux, "Visite de quelques laboratoires etrangers a l'occasion de comparaisons internationales de frequence," *L'Onde Electrique*, vol. 10, no. 120, pp. 521-540; December, (1931).

64. J. H. Dellinger, "Service available from the standard frequency transmissions of the Bureau of Standards," *Trans. Amer. Geophysical Union*, 12th annual meeting, p. 27, May 1, (1931).

65. J. B. Dow, "Recent developments in vacuum tube oscillator circuits," *Proc. I.R.E.*, vol. 19, no. 12, pp. 2095-2108; December; (1931).

66. P. P. Eckersley, "On the simultaneous operation of different broadcast stations on the same channel," *Proc. I.R.E.*, vol. 19, no. 2, pp. 175-194; February, (1931).

67. G. D. Gillett, "Some developments in common frequency broadcasting," *Proc. I.R.E.*, vol. 19, no. 8, pp. 1347-1369; August, (1931).

68. F. Guarnaschelli and F. Vecchiacchi, "Direct-reading frequency meter," *Proc. I.R.E.*, vol. 19, no. 4, pp. 659-663; April, (1931).

69. E. Karplus, "Communication with quasi optical waves," *Proc. I.R.E.*, vol. 19, no. 10, pp. 1715-1730; October, (1931).

70. F. B. Llewellyn, "Constant frequency oscillators," *Proc. I.R.E.*, vol. 10, no. 12, pp. 2063-2093; December, (1931).

71. A J. Makower and W. Makower, "New method of measuring frequencies," *Jour. Sci. Inst.*, vol. 8, no. 9, pp. 286-287; September, (1931).

72. C. G. McIlwraith, "Accuracy of the primary frequency standard of the Bureau of Standards," *Trans. Amer. Geophysical Union*, 12th annual meeting, p. 29; May 1, (1931).

73. F. T. McNamara, "Thermionic type frequency meter for use up to 15 kc," *Proc. I.R.E.*, vol. 19, no. 8, pp. 1384-1390; August, (1931).

74. Hans Mogel, "Some methods of measuring the frequency of short waves," *Proc. I.R.E.*, vol. 19, no. 2, pp. 195-213; February, (1931).

75. Aijaz Mohammed and S. R. Kantebet, "Formation of standing waves on Lecher wires," *Jour. P.O.E.E.*, vol. 24, no. 11, pp. 1983-1987; November, (1931).

76. F. E. Nancarrow, "Frequency measurement in the British Post Office," *Jour. P.O.E.E.*, vol. 24, no. 1, pp. 155-159; July, (1931).

77. F. A. Polkinghorn and A. A. Roetken, "Device for the precise measurement of high frequencies," *Proc. I.R.E.*, vol. 19, no. 6, pp. 937-948; June, (1931).

78. Harald Straubel, "Schwingungsform und temperaturkoeffizient von quarzoszillatoren," *Zeits. f. Hochfrequenz.*, vol. 38, no. 1, pp. 14-27; July, (1931).

79. Harald Straubel, "Fundamental crystal control for ultra-high frequencies," *QST*, vol. 16, no. 12, pp. 10-13; April, (1932).

80. J. J. Vormer and C. van Geel, "Frequency measurements of high accuracy," *Experimental Wireless*, vol. 8, no. 93, pp. 298-303; June, (1931).

### 1932

81. J. H. Dellinger and E. L. Hall, "Radio dissemination of the national standard of frequency," Paper delivered at I.R.E. convention in Pittsburgh, April, (1932).

82. V. E. Heaton and E. G. Lapham, "Quartz plate mountings and temperature control for piezo oscillators," *Proc. I.R.E.*, vol. 20, no. 2, pp. 261-271; February, (1932).

83. O. M. Hovgaard, "Application of quartz plates to radio transmitters," *Proc. I.R.E.*, vol. 20, no. 5, pp. 767-782; May, (1932).

84. John M. Ide, "Measurements on magnetostriction vibrators," *Proc. I.R.E.*, vol. 19, no. 7, pp. 1216-1232; July, (1931).

85. Yuziro Kusunose and Shoichi Ishikawa, "Frequency stabilization of radio transmitters," *Proc. I.R.E.*, vol. 20, no. 2, pp. 310-339; February, (1932).

86. E. G. Lapham, "Improved audio-frequency generator," *Proc. I.R.E.*, vol. 20, no. 2, pp. 272-279; February, (1932).

87. W. A. Marrison, "Quartz crystal resonators," *Bell Lab. Rec.*, vol. 10, no. 6, pp. 194-199; February, (1932).

88. H. O. Peterson and A. M. Braaten, "Precision frequency measuring system of R.C.A. Communications, Inc.," *Proc. I.R.E.*, vol. 20, no. 6, p. 941-57; June, (1932).

89. D. E. Replogle, "Recent developments in precision frequency control," *Radio Engineering*, vol. 12, no. 4, p. 29; April, (1932).

90. D. E. Replogle, "A new idea in precision control of crystal oscillators," *Modern Radio*, vol. 1, no. 10, April, (1932).

### MISCELLANEOUS REFERENCES

91. Bureau of Standards, "Radio instruments and measurements," Circular no. 74, March 10, (1924).

92. Bureau of Standards, "Uses of transmission of standard radio frequencies," Letter circular No. 335, July 11, (1932).

93. Bureau of Standards, "Radio publications of the Bureau of Standards," Letter circular no. 40, February 1, (1932).

94. P. Vigoureux, "Quartz Resonators and Oscillators," National Physical Laboratory, His Majesty's Stationery Office, London.

# RADIO FIELD INTENSITY MEASUREMENTS

## I. Long- and Intermediate-Wave Methods

The earliest radio field intensity measurements were made at the long-wave range, this range being at the time the most important in the radio spectrum. Here the radiation consists of an elliptically polarized ground wave with a certain amount of Heaviside layer reflected radiation superposed. The latter makes itself very noticeable at sunrise and sunset periods, and is probably responsible for the difference between day and night transmission in transatlantic signals, but otherwise it produces few of the phenomena characteristic of pure Heaviside layer transmission, such as the rapid, deep, and random fading of short waves. The difficulty of predicting a ground wave attenuation over a curved earth whose surface conditions change markedly over all long ranges and whose ground constants are measurable only for a thin surface skin, has made a theoretical transmission formula unattainable and various empirical formulas are in use. The best known is the first one devised by Austin and Cohen about 1909.

The horizontal field component along the direction of propagation, the same which produces this elliptic polarization of the long wave radio transmission, is, in general, so small that it is negligible and is often entirely forgotten. It is this component which is active in exciting the reception by the Beverage or wave antenna and it makes a loop and an open antenna of the same "effective height," as ordinarily defined, indicate different field intensities for the same radiation. Ordinarily the difference is too small to be noticeable. Maximum wave tilts of the order of three degrees of arc are indicated by wave antenna measurements.<sup>1</sup>

The initial field intensity measurements were made by using a loop receiving antenna and neglecting the ellipticity of the field (results calculated into equivalent vertically polarized field). Several different methods were tried by as many experimenters;<sup>2</sup> the most suitable one was, however, found to be that of introducing into the measuring loop a lumped voltage which had been attenuated from a directly measurable value to an amplitude equal to that of the signal induced voltage.

<sup>1</sup> Austin Bailey, S. W. Dean, and W. T. Wintringham, *Proc. I.R.E.*, vol. 16, no. 12, p. 1645; December, (1928).

<sup>2</sup> See papers by C. R. Englund and H. T. Friis, *A.I.E.E. Trans.*, vol. 46, p. 492; May, (1929); Baumler, *Teleg. u. Fernsprechtechnik*, vol. 17, p. 193, (1928), and K. Sreenivasan, *Wireless Engineer and Experimental Wireless*, vol. 5, no. 4, p. 205; April, (1928), and vol. 5, no. 5, p. 273; May, (1928), for résumés of these methods.

The loop<sup>3</sup> balance to ground must be such that no open antenna effect is noticeable (a sharp loop tune is necessary) and the loop dimensions must be kept down to the point where the lumped e.m.f. is actually equivalent to the line integral of the electric field intensity around the loop. The chief disadvantage of this method is the expense and trouble involved in shielding the local signal generator and attenuator. An advantage is that the type of receiving set is immaterial. Even the variable regeneration of the receiver, so disturbing with the method next to be described, is of no consequence. This controllable local signal generator also makes the best kind of a radio set tester.

This local signal generation-attenuation method was quickly extended to the broadcast range. Here we approach the limit where d-c calibrated attenuator resistance units may be employed, the ordinary wire wound units becoming unsafe at high frequencies.<sup>4</sup> There are difficulties here also connected with the use of inductance and capacity attenuators. All three types have found use, however. (The difficulties referred to are not those of use, but of primary calibration or standardization.) The resistance type is independent of the frequency, a very valuable feature, and has been chiefly used. The mutual inductor has been used to a lesser extent<sup>5</sup> but until recently<sup>6</sup> a successful application of the capacity attenuator has not been reported. Suggestions have also been made that at high frequencies electromagnetic field leakages through graduated shield apertures and certain arrangements of concentric tube transmission lines might be usable for quantitative work. It appears possible to construct quite conventional graphite attenuators for short wave work, although this has not been done yet.

The broadcast wave region is much more affected by Heaviside layer reflections than the long wave region, but due to the necessity for an unvarying signal of strength to override all but the worst local

<sup>3</sup> The only feasible receiving antenna at these wavelengths has been found to be a loop, that is to say, an antenna whose effective height can be calculated from its physical dimensions. An open antenna may be readily calibrated by means of a loop and then used for the actual measurements.

<sup>4</sup> The phase angle of resistors wound of 36 to 40 B.S. gauge wire in non-inductive single-layer windings on cylindrical forms rapidly increases above 2 megacycles. This does not prevent their use in attenuators, however, since these will still be accurate if all the component units have the same phase angle. See "The Use of Thermoelements at High Frequencies," page 206; A. Jensen, *Phys. Rev.*, July, (1925); and Proc. I.R.E., vol. 14, p. 333; June, (1926).

<sup>5</sup> H. H. Beverage and H. O. Peterson, Proc. I.R.E., vol. 11, no. 6, p. 661; December, (1923); G. Anders, *Elek. Nach. Tech.*, vol. 2, no. 12, p. 401; December, (1925); and Proc. I.R.E., vol. 15, no. 4, p. 297; April, (1927).

<sup>6</sup> K. Schlesinger, *Jahr. der draht. Tel. und Tel.*, vol. 36, p. 190, (1930), *Elek. Nach. Tech.*, vol. 7, p. 434, (1930); and *Wireless Eng. and Exp. Wireless*, vol. 8, no. 10, p. 532; October, (1931).

static, the transmission is engineered on a surface wave basis and ranges much exceeding 50 miles are considered unreliable. Night-time Heaviside layer transmission is pronounced and reception is then possible only for nearby or very distant transmitters, since the range where ground wave and Heaviside wave are of about equal amplitude becomes unusable. As before, no account is ordinarily taken of the elliptic polarization of the surface wave. Further, the measurements are still taken on the carrier without consideration of the side band energy.

## II. Short-Wave Methods

The discovery of the abilities of the short waves opened up a region of the radio spectrum until then quite unused. Here the only workable transmission is the long distance one via Heaviside layer refraction or reflection. The ground wave is very rapidly attenuated, dropping out at ranges of 20 to 30 miles.

As indicated earlier, the production of attenuators for frequencies exceeding several megacycles is beset with difficulties and the unmodified local signal generator method of field intensity measurement has, therefore, received little application in this frequency region. A different scheme, developed to avoid this difficulty, has proved quite satisfactory.<sup>7</sup> This scheme puts an attenuator in the double detection set amplifier and, as the intermediate frequency is always below two megacycles, resistance wire wound units can be used. It is true that amplifier impedance matching is not possible and one stage is practically lost ordinarily when a potentiometer is inserted in an amplifier tube plate circuit, but some experiments have been made looking towards a reduction of this loss and it is certain that it can in some measure be avoided. Severe shielding requirements are placed on the amplifier stages so that screen grid tubes are necessary for the higher intermediate frequencies (1 to 2 megacycles). If the shielding is not adequate, regeneration occurs and increases with a diminishing attenuator setting, with the result that the theoretical operation of the measurement is aborted.

The theory of the method is as follows: A signal is received and the amplifier attenuation adjusted to give a workable deflection of the second detector plate meter. A local oscillator is now fed into the loop at exactly signal frequency and adjusted in amplitude (this is not a low level adjustment and the signal can be neglected) until the first detector plate meter, calibrated as a vacuum tube voltmeter, indicates a convenient voltage of say one volt. The amplifier attenuation is now increased until the second detector meter reads the original value. The

<sup>7</sup> H. T. Friis and E. Bruce, Proc. I.R.E., vol. 4, no. 4, p. 507; August, (1926).

difference between these two attenuator readings, in logarithmic units as decibels, gives the attenuation of the signal below one volt, as it appears at the first detector grid. A final attenuator setting to the original second-detector plate-meter deflection with the local signal applied directly to the grid (in parallel across the loop now instead of in series as at first) gives the loop step-up by which the signal is to be further attenuated to reduce the measurement to the ether field input. As the intermediate frequency component of the first detector output alone is filtered out and used the second detector input becomes proportional to the product of the signal carrier by the beating oscillator input over the entire working range.

This method is simple and rapid but it fails if the set has appreciable regeneration. There are also some limitations in regard to the location of the attenuator. If immediately following the first detector, the signal may be reduced, when weak, to the amplitude of the normal set noise (amplifier following the detector in this case) from which it cannot thereafter be freed. If placed too far back in the amplifier there is likelihood of overloading the amplifier stage preceding the attenuator for any first detector input directly measurable. It is to be remembered that both static and signal intensities are ordinarily so low in the short wave band that set noise is a definitely limiting factor in reception.

When the measuring set is required to cover an extreme frequency range the placing of the attenuation network by which measurement is achieved, in the constant frequency amplifier system, is almost a necessity and this requirement puts a premium on this second method for such applications.

For the short wave range the signal is so subject to fading that it is at times difficult to decide what to measure and how to average it out. It has been found advantageous to include an intermediate frequency oscillator so that the adjustment of the local signal frequency can be made by beat note rather than by a fixed resonance maximum setting, in making local and distant signal frequencies alike. Furthermore the radiation is not simple, but always consists of a direct component plus a ground reflected component. To speak of a field as so many microvolts per meter is, therefore, meaningless in general; it is necessary to specify the antenna length, orientation, and method of coupling to the receiver, to obtain any significant data. A good deal of antenna development work has been done without making any effort towards evaluating the electromagnetic field received, the results being expressed in decibels gain over a half wave vertical antenna coupled at the lower end to ground through enough turns of the antiresonant receiver input circuit to match the antenna impedance (about 3000 ohms

normally).<sup>8</sup> When a radiation field consists of two or more components, the necessary measurements to determine these are needlessly extensive, as far as practical receiving requirements are concerned, especially when variations in amplitude and direction of arrival are ever present. It is possible that if the bulk of reception and transmission ultimately takes place via horizontal antenna systems, a return to equivalent horizontal microvolts per meter at a specified height above ground (in wavelength fractions) will take place. At present, short wave transatlantic transmission requires apparatus covering the field intensity range of 0.3 to 100 microvolts per meter. Typical intermediate frequency values are 50 kc for broadcast reception, 200 kc to 300 kc for short wave work and 1.5 megacycles for ultra-short-wave reception. The over-all gain of such a receiver from first detector grid to second detector grid should be about 100 decibels (voltage ratio of 100,000 to 1).

### III. Ultra-Short-Wave Methods

In the ultra-short-wavelength region a return to more stable conditions occurs. Fading is absent entirely and accurate measurements are possible and useful. The experimental setting is, however, radically altered. Reradiation from conductor lengths, operator's body, etc., is very disturbing and it now appears that the receiver antenna must always be kept at a reasonable distance from the receiver, and balanced transmission lines used for transferring the signal energy to the set. The very short wavelength makes open antennas (half-wave elements) experimentally easier to handle than loops and since ground reflection components are always present, a linear radiation probe gives more illuminating information than one with loop characteristics.

So far three methods have been given experimental test.<sup>9</sup>

**A. First Circuit Noise Method.** The thermal noise developed in the first detector input circuit of a double detection set gives a mean effective voltage squared at the second-detector grid of<sup>10</sup>

$$E^2 = \frac{2KT}{\Pi} \int R(\omega) |Y(\omega)|^2 \cdot d\omega \quad (1)$$

where,

$K$  is Boltzmann's constant,

$T$  is the Absolute temperature,

$R(\omega)$  is the real value of the first circuit impedance, between the filament and grid, and

<sup>8</sup> The antenna power output is the same as when used center-tapped but the matching impedance is then much lower. (73.2 ohms for a half-wave antenna.)

<sup>9</sup> This refers to the unpublished work of the Bell Telephone Laboratories. The third method is reported by K. Sohnmann, *Elek. Nach. Tech.*, vol. 8, no. 10, p. 462; October, (1931).

<sup>10</sup> J. B. Johnson, *Phys. Rev.*, vol. 32, p. 97; July, (1928).

$|Y(\omega)|$  is the total receiver voltage step-up from first to second detector grids.

In the practical case, the amplifier resonance characteristic is so much narrower than that of the first detector input circuit that  $R(\omega) = R = \text{constant}$ , and  $E^2 = 4KR T f |Y(\omega)|^2 df = 4KR T A$ .  $A$  is now the area of the squared resonance step-up characteristic of the amplifier.

With a receiving set of sufficient amplification and negligible regeneration, dependable results are probably possible. The value of this method has not as yet been fully determined. The unknown signal is evaluated in terms of this calculable noise voltage and the attenuation difference to give equal second detector outputs.

**B. Modified Short-Wave Method.** The short wave method can be directly applied if we substitute for the step-up (loop "Q" measurement) a "transfer" voltage ratio,

$$E_g/E_a, \quad (2)$$

where,

$E_g$  is the first detector grid voltage, and

$E_a$  is the equivalent voltage induced in the receiving antenna.

With a tuned half-wave antenna separated from a tuned detector grid circuit by a transmission line 6 to 10 meters in length, this transfer voltage ratio is not easy to determine. By operating under circuit matching conditions, where maximum energy transfer takes place, the unknown errors due to the intermediate apparatus are reduced and, in fact, disappear if this intermediate apparatus is sufficiently lossless. The terminal impedances alone then require to be known since

$$\frac{E_g}{E_a} = \frac{1}{2} \sqrt{\frac{R_g}{R_a}}. \quad (3)$$

With the calculable radiation resistance as the greater part of the antenna impedance (equal to the intermediate apparatus input impedance) there remains to measure only the first detector grid input impedance. The radiation resistance of the half-wave antenna is calculated from the Pistolcors-Bechmann formulas<sup>11,12</sup> and is, for an exact half-wave conductor, 73.2 ohms. The calculation is readily carried out for shorter elements. The distributed radiation field along the antenna gives a voltage  $\mathcal{E} = lE$ , which is equivalent to a lumped voltage of

<sup>11</sup> R. Bechmann, Proc. I.R.E., vol. 19, no. 3, p. 461; March, (1931).

<sup>12</sup> R. Bechmann, Proc. I.R.E., vol. 19, no. 8, p. 1471; August, (1931).

$$E_a = \frac{lE \sin \frac{\pi l}{\lambda}}{\frac{\pi l}{\lambda}} \quad (4)$$

at the center of the antenna when the field acts in the same phase all along the conductor. If this is not the case more complicated expressions result.

**C. Modified Long-Wave Method.** Any method of attenuating a local input of exact signal frequency from a directly measurable value to one equal to the signal intensity may be applied and one such, not so far mentioned, is to take advantage of the space attenuation of electromagnetic fields away from a generator. In practice, a small shielded oscillator with a single-turn exposed coil carrying a current meter is used and is normally placed on a tripod well above the ground. The receiving antenna and set then become immaterial, the measurement consisting of the comparison between a local and a distant signal of equal strength. Preferably an attenuator by which the set gain can be varied quantitatively over a reasonable range is included in the set as the portable oscillator need not then be moved back and forth for a comparison setting.

It is necessary to know the distance law accurately and this the Bechmann formula shows to be, for a loop antenna transmitter and half-wave open antenna receiver when the ground reflected field is negligible, a simple inverse distance law. Experiment has checked this also.

The generator employs a loop antenna for several reasons. First, the radiation is of the small value required and the radiation resistance does not enter into the generator performance, while the current distribution is nearly uniform. Second, by 180-degree rotations in various planes, a check on radiation leakage from other current carrying elements in the generator circuits can be obtained. There is always a ground reflected wave, but for a system off the ground at a distance comparable with the spacing of the generator the end-on position of the receiving antenna greatly reduces the component of this wave parallel to the antenna. It has not as yet been determined whether a position, such that the reflected wave strikes the ground at the Brewster minimum angle (one is here only interested in vertically polarized waves), is advantageous.

One apparent disadvantage is the fact that an inverse distance law does not give a very great variation possibility. Thus, if we take  $\lambda/2$

as a minimum distance, a distance of 50 wavelengths will be necessary for a 40 decibel variation (voltage ratio of 100 to 1). At the same time the ground reflection wave may vary markedly and irregularly as regards its signal contribution. Quantitatively variable amplification of the receiver is a great help in this case, and reduces the distance required for spacing the generator. The objection that the method requires considerable clear space is of no consequence since undistorted fields exist only in clear areas. The presence of stray conductors as trees, wire fences, building wiring, etc., so distorts the field that its measurement is useless. In fact, the ultra short wave circuit will be a "clear" or near "optical" one with antennas up and away from local conductors.

All ultra-short wave transmissions consist of the direct component plus one or more reflected components, depending on the topography crossed, and the height of the exposure antenna above ground is quite important. It has been found that by selecting a proper height, horizontally polarized radiation is transmitted as well as or a little better than vertically polarized waves. With fading gone there is some hope of identifying the various components. No surface wave exists, and almost no static. Set noise is the sole limitation to weak signal reception. Either a superregenerative or double detection receiver may be used, but the latter is so far superior to the former in quantitative performance that it is preferable in nearly all cases.

## THE USE OF THERMOELEMENTS AT HIGH FREQUENCIES

The conventional sensitive thermoelement consists of a heating element of chromel, carbon, or other wire of high specific resistance and a thermocouple, usually of copper and constantan, joined to the center of the heater wire by fusing directly to it or to a very small glass bead. The two pairs of terminals are mounted on supports of Dumet wire sealed into a glass stem. The unit is contained in a glass bulb and evacuated. The electromotive force developed at the thermojunction is usually measured by a low resistance millivoltmeter.

The resistance of the heater, to which the electromotive force developed is proportional, increases with temperature and with the frequency of the alternating current used. The former effect is compensated in the direct-current calibration, while the latter is due to skin effect and may to some extent be calculated. The supports for the heater as they pass through the stem have capacitance which shunts the heater and makes the current in the heater less than that in the external circuit.

The errors produced by these effects are of opposite sign, being positive for skin effect and negative for shunting capacitance. The attached table gives the frequencies for which the total error is 0.1 per cent and 1 per cent for each of five thermoelements, on the assumption that the shunting capacitance is 1 micromicrofarad, which is a representative value for an unmounted element. Skin effect is the limiting factor for low resistance, large current heaters and shunting capacitance for high resistance, small current heaters.

Considerable experimental difficulties are encountered in the comparison of two thermoelements.<sup>1</sup> The capacitance of the couple itself and particularly of the direct-current meter to ground shunts part of the heater. This may be minimized by isolating the direct-current meter or by using an insulated junction. In the latter case the effect should be much less than that due to the capacitance of the leads. The ground must be symmetrically placed with reference to the two elements so that the currents delivered to them shall be equal. Commercial thermoelements whose resistances lie between 5 ohms and 100 ohms begin to show considerable errors at a frequency of 5 megacycles.<sup>2</sup>

The best standard is apparently an insulated thermoelement of between 10 ohms and 100 ohms resistance, using a heater 0.5 to 1.0 mil

<sup>1</sup> C. L. Fortescue and L. A. Moxon, "Methods of comparing ammeters at very high frequencies," *Jour. Sci. Inst.*, vol. 8, p. 94-97; March, (1931).

<sup>2</sup> F. M. Colebrook, "Thermo-junctions at high radio frequencies," *Wireless Engineer and Experimental Wireless*, vol. 8, p. 356-361; July, (1931).

TABLE I  
RESULTS OF PRELIMINARY EXPERIMENTS

Heater Material	Diameter of wire in mils	Resistance of heater in ohms	Current in milliamperes	Frequency in Mc. for 0.1 per cent error	Frequency in Mc for 1 per cent error
chromel	12	0.5	275	1	4
"	6	2	100	5	15
"	1	10	25	15	40
"	0.4	100	7	10	53
carbon	0.9	450	4.5	5	30

in diameter, with its leads brought out through separate seals in order to minimize capacitance. This element may be compared with larger current elements either by operating them below capacity and measuring the small induced electromotive force by means of a sensitive potentiometer, or by operating the standard element above its normal limit by admitting air or hydrogen to increase its heat capacity. Similar procedures may be adopted to compare the standard element with elements intended for smaller currents. The limit of the standard element can perhaps be determined by calorimetric measurements.

## SAFETY STANDARDS

### PROVISIONS FOR SAFETY OF OPERATING PERSONNEL IN RELATION TO RADIO TRANSMITTING EQUIPMENT

#### Introduction

**T**HE following Provisions for Safety of Operating Personnel in Relation to Radio Transmitting Equipment are recommended as a safety code for use in all cases where radio transmitting equipment is installed or used, either permanently or experimentally. The recommendations are to be construed as offering supplementary material not ordinarily covered in the existing electrical codes. In all cases, it is recommended that radio equipment shall have safety provisions in accordance with the standard practices prevailing for electrical machinery in addition to the provisions contained herein.

#### I. Antenna Protection

**A. Outdoor Insulation.** Insulators will operate with a minimum electrical safety factor of three (3) at normal rated transmitter output. The mechanical safety factor will be not less than four (4).

**B. Interior Antenna Leads.** Leads are to be of the self-supporting type, preferably of copper tubing, so mounted as to be out of reach, or protected against direct contact. It is desirable that the leads be conspicuously marked or colored. Conductors mounted on insulators and covered with inadequate insulation will be avoided.

**C. Exterior Antenna Leads.** All leads subject to direct contact will be protected by a grille or lattice. If the grille or lattice is of metal, it will be grounded.

**D. Blocking Condensers.** The antenna system should have protection from direct application of high voltages from the power supply, by the insertion of blocking condensers or other means, between the high voltage power source and the antenna.

**E. Static Charges.** Means should be provided at the antenna entrance or in proximity thereto, for protecting the antenna against lightning, or energy pick-up from near-by antennas during periods of shutdown.

**F. Antenna Entrance.** Means should be provided to prevent conduction of rain water directly to the point of entrance.

**G. Safety Strain Insulator.** A safety strain type of insulator should be used in locations where mechanical hazard exists.

**H. Protective Ground Connections.** Ground surface networks should be supplemented with a system of ground rods designed to contact with the permanent moisture level when practicable. Building grounds will firmly contact with the cold water supply and all other grounded piping systems, and with structural steel when available. Ship grounds will contact directly with the hull.

## II. Transmitter Protection

**A. Frame.** The transmitter will be enclosed in a metal frame, or grille or other equivalent means, all parts of which are solidly connected to ground.

**B. Operating Controls.** All external metal handles and controls accessible to the operating personnel are to be solidly grounded.

**C. Switchboard Voltages.** No circuit in excess of 150 volts should have any metal parts exposed to direct contact. A complete dead-front type of switchboard is preferred.

**D. Interlocks.** All access doors should be provided with interlocks which will remove all voltages when any door is opened.

## III. Power Supply Protection

**A. General.** All power equipment and switchboards, except rectifiers and special power equipment, shall have provisions for safety in accordance with the standard practices prevailing for electrical machinery.

**B. Special Equipment.** Special equipment, such as rectifiers, should have provisions for safety the same as specified for transmitters.

**C. Filter and Other Condensers.** Means should be provided for quickly discharging filter and other condensers upon the removal of power.

## MISCELLANEOUS REPORTS

### ELECTROMAGNETIC UNITS AND SYSTEMS

In view of the fact that the question of the standardization of electromagnetic units is likely to come before the Institute of Radio Engineers for official action in the course of a few years, it is important to give thought to the subject in the meantime. The following are the principal systems, the first four of which are in quite general use: electrostatic, electromagnetic, practical, Heaviside-Lorentz, Dellinger-Bennett, Gauss, Giorgi, Karapetoff, Kennelly.

It is not the object, at this time, to recommend any particular system but rather to call attention to certain points that should receive consideration and to stimulate interest in the subject so that when the time comes to make a decision all interests of the Institute will be safeguarded.

Regardless of what system is ultimately standardized it appears that a knowledge of the electrostatic, the electromagnetic, and the practical system will be essential to students, electrical engineers, and physicists because of their use in the vast and important fundamental literature of the past.

In a paper on "Electromagnetic Equations and Systems of Units," *Physics*, April, 1932, Dr. Page presents the following criteria which he thinks should govern the choice of arbitrary constants and determine the selection of sets of units:

"(1) There should be one and only one set of fundamental equations in general use by both physicists and engineers. This simplification would do away with all necessity of converting from the electrostatic to the electromagnetic or Heaviside-Lorentz system or vice-versa, and would abolish at one stroke the endless confusion caused the student in having to memorize three sets of equations.

"(2) There should be two sets of units, one c.g.s. for the physicist and the other a practical set for the engineer. Both sets, however, should employ the same set of fundamental equations, as is the case with the e.m.m. and q.e.s. systems at present. The reasons for this criterion are so obvious as to require no comment.

"(3) The eight internationally recognized practical units (joule, watt, coulomb, ampere, volt, ohm, farad, henry) must be retained in the proposed practical system of units. This requirement is necessitated by the long established use of these units and the fact that electrical instruments are generally calibrated in terms of them.

"(4) The set of equations chosen should exhibit the symmetry ex-

isting between electrical quantities on the one hand and magnetic quantities on the other. The importance of this criterion is sometimes overlooked. To the worker who is using the entire set of electromagnetic equations, however, it is almost vital. No more complicated theory than that involved in the deduction of the wave equation or of the expression for radiation pressure is needed to convince one of the vast superiority of a symmetrical set of equations. From the practical point of view a great simplification is effected as well, for a symmetrical set of equations halves the number of different coefficients appearing in the equations and halves the number of different relations between the practical and the c.g.s. units."

Dr. Page next investigates the means by which these criteria can be satisfied and shows that the Heaviside-Lorentz system is one of the simplest sets of equations exhibiting complete symmetry, in fact, he is a strong advocate of the Heaviside-Lorentz system. Regardless of whether one agrees with all of the conclusions of the author the paper is well worth reading as it includes an interesting analysis of the problem presented from a somewhat different point of view.

Another important paper on "Magnetic Circuit Units"<sup>1</sup> gives a rather complete historical development together with an excellent bibliography. Much other valuable information is included. The discussion of this paper is illuminating as it brings out different points of view.

There is a committee of the American Physical Society actively considering this subject and the matter has received some further consideration by the American Institute of Electrical Engineers during 1931.

<sup>1</sup> A. E. Kennelly, (Abridgment), *Jo. r. A.I.E.E.*, vol. 49, pp. 18-21; January, (1930).



# INDEX

## To 1933 Standards Report

A	
Absolute Efficiency, Electro-Acoustic.....	164
Absorption (6-023).....	10
Acoustic	
Fidelity, Broadcast Receiver...	99
Impedance of a Sound Medium (17-011).....	37
Measurement, Noise.....	104
Radiator (17-104).....	38
Reactance of a Sound Medium (17-013).....	38
Resistance of a Sound Medium (17-012).....	38
Active Transducer (6-006).....	8
Adjustment, Broadcast Receiver..	93
Aerial (11-002).....	16
Alternating Current (abbreviation)	42
Alternator	
Radio-Frequency (2-003).....	4
Transmitter (9-004).....	14
Ammeter	
Hot-Wire, Expansion Type (14-005).....	33
(Symbol).....	49
Thermocouple (14-004).....	33
Ampere (abbreviation).....	42
Amplification	
Current (3-003).....	5
Factor.....	141
(Definition, 13-043).....	23
(Symbol).....	45
Gas (13-320).....	32
Power (3-004).....	5
Voltage (3-002).....	5
Amplifier (3-001).....	5
Class A (13-201).....	28
Class B (13-202).....	28
Class C (13-203).....	28
Vacuum Tube (3-005).....	5
Amplitude Modulation.....	60
Amplitude Relation, Variational	
Sensitivity (13-312).....	31
Anode (13-037).....	22
Antenna.....	64
(Abbreviation).....	42
(Definition, 11-001).....	16
(Symbol).....	49
Additional Tests.....	74
Array.....	69
(Definition, 11-019).....	18
Artificial (11-024).....	18
Breakdown Tests.....	74
Broadcast Receiver Standard..	78
Broadside Array.....	69
Comparison.....	70
Condenser (11-004).....	16
Current Measurement.....	74
Directional (11-005).....	16
Doublet (11-023).....	18
Effective Capacity.....	65
Effective Height.....	67
Transmitting (11-009).....	16
Effective Inductance.....	65
End-On Directional (11-021)...	18
Entrance, Safety.....	208
Exciter.....	69
Frequency Characteristics.....	72
Gain.....	70
At Distance.....	73
Half-Wave.....	69
High-Frequency.....	69
Dummy.....	116
Horizontal Directional Pattern..	73
Impedance Test.....	71
Inductance.....	65
Leads	
Exterior.....	208
Interior.....	208
Load Test.....	74
Loop (11-003).....	16
(Symbol).....	50
Low-Frequency.....	65
Multiple-Tuned (11-006).....	16
Natural Frequency.....	65
Outdoor Insulation.....	208
Power Input.....	66
Power Output.....	67
Protection.....	208
Pseudoreflector.....	69
Radiation	
Efficiency.....	67
Resistance.....	66
Test.....	71
Rating.....	53
Reflector.....	69
(Definition, 11-022).....	18
Resistance.....	66
(Definition, 11-008).....	16
Safety.....	208
Static Capacity.....	65
Testing.....	53
Facilities.....	70
Power.....	70
Tier.....	69
Vertical Directional Pattern...	73
Wave (11-007).....	16
Weather Effects.....	74
A Power Supply (15-006).....	34
Apparatus, Broadcast Receiver	
Testing.....	79

Applied Pressure Due to Sound, Microphone.....	178	Equivalent Noise.....	106
Arc (symbol).....	49	Fidelity.....	77
Arc Converter (2-004).....	4	Harmonic Distortion.....	101
Array, Antenna.....	69	Hum.....	104
Artificial Antenna (11-024).....	18	Distortion.....	104
Aspect Ratio (16-013).....	36	Distortion Measurement.....	105
Atmospherics (6-002).....	10	Measurement.....	105
Attenuation (6-012).....	9	Modulation.....	107
Equalizer (7-013).....	12	Input	
Attenuator		Measurements.....	88
Desired-Signal Generator.....	84	Voltage.....	77
Interfering-Signal Generator.....	83	Interference	
Audibility, Noise.....	106	Crosstalk.....	96
Audio Frequency		Test Input.....	78
(Abbreviation).....	42	Test Output.....	78
(Definition, 1-005).....	1	Interfering-Signal Generator... ..	82
Source, Broadcast Receiver.. ..	80	Local Oscillator Radiation.....	103
Transformer (8-002).....	13	Maximum Undistorted Output .....	78, 101
Autodyne Reception (10-008).....	15	Miscellaneous Noise.....	104
Automatic Regulator (15-002).....	34	Noise.....	103
Automatic Starter.....	34	Audibility.....	106
Automatic Volume Control (15- 004).....	34	Normal Test Output.....	78
Broadcast Receiver.....	101	Operating Conditions.....	92
		Output	
<b>B</b>		Measurements.....	90
Baffle (17-105).....	38	Measuring Circuit.....	81
Balancer (12-012).....	19	Overload.....	100
Band		Performance Graph Sheets.....	108
Communication (1-035).....	4	Radio-Frequency	
Frequency (1-027).....	3	Pick-Up.....	103
Service (1-038).....	4	Source.....	80
Side (1-028).....	3	Random Noise.....	103, 105
Width, Broadcast Receiver... ..	78	Residual Hum.....	107
Band-Pass Filter (7-017).....	12	Selectance.....	78
Banked Winding (8-007).....	13	Selectivity.....	77, 95
Bar (17-010).....	37	Sensitivity.....	77, 94, 102
Battery (symbol).....	49	Test Input.....	77
Beacon, Radio (12-008).....	19	Spurious Response.....	94
Range (12-009).....	19	Test Procedures.....	88
Beat (1-016).....	2	Testing Apparatus.....	79
Beating (1-015).....	2	Tests.....	75
Bias, Grid (13-029).....	22	Transfer Circuit.....	81
Bibliography, Radio-Frequency		Tuning Range.....	94
Measurements.....	192	Two-Signal Interference Test... ..	82
Blocked Impedance (17-002).....	36	Volume Control.....	102
Blocking Condensers, Safety.....	208	Whistle.....	104, 108
B Power Supply (15-007).....	34	Interference.....	97
Breathing, Microphone.....	177	Measurement.....	106
Broadcast Radio Receiver.....	77	Broadcasting, Radio (1-039).....	4
Acoustic		Broadside	
Fidelity.....	99	Array Antenna.....	69
Measurement Noise.....	104	Directional Antenna (11-020)... ..	18
Adjustment.....	93	Burning, Microphone.....	177
Audio-Frequency Source.....	80	By-Pass Condenser (8-009).....	13
Automatic Volume Control... ..	101		
Band Width.....	78	<b>C</b>	
Connecting Generators.....	85	Calibrating High-Frequency Signal Generators.....	117
Crosstalk.....	96	Calibration	
Desired-Signal Generator.....	84	Direction Finder (12-006).....	19
Electrical Fidelity.....	98	Microphone.....	177
Electrical Measurement Noise.. ..	105	Direct.....	179

- Indirect.....184  
 Candle Power (13-406)..... 33  
 Capability, Modulation (9-007)... 14  
 Capacitance  
   Cathode (13-054)..... 24  
     (Symbol)..... 45  
   Direct (7-012)..... 12  
   Grid-Plate.....148  
   Interelectrode.....147  
   Grid (13-055)..... 24  
     (Symbol)..... 45  
   Grid-Cathode (13-058)..... 25  
     (Symbol)..... 45  
   Grid-Heater (symbol)..... 45  
   Grid-Plate..... 25  
     Screen-Grid Tubes.....149  
     (Symbol)..... 45  
   Input (13-060)..... 25  
   Interelectrode.....147  
     (Definition, 13-053)..... 24  
   Output (13-061)..... 25  
   Plate (13-056)..... 25  
     (Symbol)..... 45  
   Plate-Cathode (13-059)..... 25  
     (Symbol)..... 45  
   Plate-Heater (symbol)..... 45  
 Capacitive Coupling (7-010)..... 12  
 Capacity, Antenna..... 65  
 Carbon Contact Pick-Up (17-303)..... 41  
 Carbon Microphone (17-202)..... 40  
 Carrier (1-026)..... 3  
   Current (1-025)..... 3  
   Noise, Measurement..... 62  
   Suppression (1-030)..... 3  
   Wave (1-024)..... 3  
 Cathode (13-018)..... 21  
   Capacitance (13-054)..... 24  
     (Symbol)..... 45  
   Current (13-041)..... 23  
   Heating Time.....128  
   Indirectly Heated (13-019)..... 21  
 Changer, Frequency (15-011)..... 35  
 Channel, Radio (1-034)..... 4  
 Characteristic  
   Current-Wavelength (13-313)... 31  
   Emission (13-011)..... 20  
   Graphs, Vacuum Tubes.....128  
   Grid (13-032)..... 22  
   Grid-Plate (13-047)..... 24  
   Plate (13-052)..... 24  
   Rectification (13-103)..... 26  
   Transfer (13-044)..... 23  
   Transrectification (13-106)..... 26  
 Charger, Trickle (15-005)..... 34  
 Choke Coil (8-006)..... 13  
 Circuit  
   Arrangement, Reflex (10-012) .. 15  
   Oscillatory (7-003)..... 11  
   Radio (1-033)..... 4  
   Resonant (7-002)..... 11  
 Class A Amplifier (13-201)..... 28  
 Class B Amplifier (13-202)..... 28  
 Class C Amplifier (13-203)..... 28  
 Coefficient  
   Coupling (7-007)..... 11  
   Photo-Current (13-319)..... 32  
   Photo-Voltage (13-318)..... 31  
   Thermionic Tube.....134  
 Coil  
   Choke (8-006)..... 13  
   Loading (8-005)..... 13  
 Communication Band (1-035).... 4  
 Comparison Antenna..... 70  
 Comparison of Frequency..... 187  
 Compass, Radio (12-002)..... 19  
 Compensator (12-013)..... 19  
 Compliance of a Mechanical Ele-  
   ment (17-006)..... 37  
 Condenser  
   By-Pass (8-009)..... 13  
   Fixed (symbol)..... 49  
   Shielded (symbol)..... 49  
   Stopping (8-008)..... 13  
   Variable (symbol)..... 49  
 Condenser Antenna (11-004).... 16  
 Condenser Microphone (17-203) .. 40  
 Condenser Pick-Up (17-304)..... 41  
 Condenser Speaker (17-117)..... 39  
 Conductance  
   Electrode (13-045)..... 23  
     Circuit.....134  
     (Symbol)..... 45  
   Grid.....135  
     (Definition, 13-031)..... 22  
     (Symbol)..... 45  
   Phototube (13-314)..... 31  
     (Symbol)..... 48  
   Plate.....136  
     (Definition, 13-050)..... 24  
     (Symbol)..... 45  
   Rectification.....138  
     (Definition, 13-107)..... 27  
     (Symbol)..... 45  
   Variational Phototube (symbol) .. 48  
 Conical Horn (17-110)..... 39  
 Connecting Generators to Receiver 85  
 Constant, Damping (7-005)..... 11  
 Continuous Waves (1-012)..... 2  
   (Abbreviation)..... 42  
   Interrupted (abbreviation)..... 42  
 Control  
   Automatic Volume (15-004).... 34  
   Direct-Frequency.....191  
   Electrode (13-026)..... 21  
   Control Grid (13-034)..... 22  
   Current.....142  
   Plate Transconductance  
     (13-049)..... 24  
   Voltage (symbol)..... 47  
   Converter, Arc (2-004)..... 4  
   Corrected Radio Bearing (12-004) .. 19  
 Counterpoise (11-015)..... 17  
   (Symbol)..... 49  
 Coupling  
   Capacitive (7-010)..... 12  
   Coefficient (7-007)..... 11



- Indirectly Heated Cathode  
(13-019)..... 21
- Inductance, Antenna..... 65
- Induction Speaker (17-115)..... 39
- Inductive Coupling (7-009)..... 12
- Inductor (symbol)..... 49
- Ground Equalizer (11-018)..... 18
- Input
- Admittance, Vacuum Tube  
    (13-065)..... 25
- Antenna Power..... 66
- Capacitance (13-060)..... 25
- Impedance, Vacuum Tube  
    (13-064)..... 25
- Measurements, Broadcast Re-  
    ceiver..... 88
- Voltage, Broadcast Receiver.... 77
- Input-Overload Power, Loud  
  Speaker..... 175
- Insertion Loss (6-011)..... 9
- Insulation, Antenna Outdoor..... 208
- Intensity
- Electric Field (abbreviation)... 42
- Luminous (13-404)..... 33
- Magnetic Field (abbreviation).. 42
- Radio Field (6-018)..... 10
- Radio Noise Field (6-019)..... 10
- Interelectrode
- Capacitance..... 147
- (Definition, 13-053)..... 24
- Direct..... 147
- Interference (6-013)..... 9
- Broadcast Receiver Crosstalk... 96
- Guard Bands (1-037)..... 4
- Test
- Input, Broadcast Receiver... 78
- Output, Broadcast Receiver.. 78
- Two-Signal..... 82
- Interfering-Signal Generator
- Attenuator..... 83
- Broadcast Receiver..... 82
- Frequency
- Calibration..... 82
- Modulation..... 83
- Range..... 82
- Stability..... 82
- Harmonics..... 84
- Hum..... 84
- Modulation Factor..... 83
- Modulation Frequency..... 83
- Output Calibration..... 83
- Output Voltage..... 83
- Shielding..... 83
- Interlocks, Safety..... 209
- Intermediate Frequency (abbrevi-  
  ation)..... 42
- Superheterodyne Reception (10-  
    011)..... 15
- Intermodulation (4-007)..... 6
- Interrupted Continuous Waves  
(1-013)..... 2
- (Abbreviation)..... 42
- Inverse Mutual Conductance (sym-  
  bol)..... 45
- Inverse Transconductance (sym-  
  bol)..... 45
- Ionization Current..... 142, 143
- (Definition, 13-012)..... 20
- J
- Jack (symbol)..... 50
- K
- Key (symbol)..... 50
- Key Clicks..... 56
- Kilocycle (1-003)..... 1
- (Abbreviation)..... 42
- Kilowatt (abbreviation)..... 42
- L
- Lead-In (11-014)..... 17
- Leakage Current..... 142, 145
- Definition, 13-013)..... 21
- Leakage, Phototube..... 162
- Letter Symbols, Phototube..... 28
- Level
- Power (6-001)..... 7
- Transmission (6-002)..... 7
- Light Source, Phototube..... 156
- Line
- Scanning (16-009)..... 35
- Frequency (16-012)..... 36
- Linear Detection (10-005)..... 15
- Linear Rectifier (5-004)..... 7
- Load, Broadcast Receiver Stand-  
  ard Dummy..... 79
- Loading Coil (8-005)..... 13
- Local Oscillator, Radiation..... 103
- Logarithmic Decrement (7-004)... 11
- Loop Antenna (11-003)..... 16
- (Symbol)..... 50
- Loss
- Insertion (6-011)..... 9
- Transmission (6-009)..... 9
- Loud Speaker (17-102)..... 38
- (Symbol)..... 50
- Input-Overload Power..... 175
- Relative Loudness Efficiency... 164
- Response..... 166
- Low Frequency (abbreviation)... 42
- Low-Frequency Antennas..... 65
- Low-Pass Filter (7-015)..... 12
- Lumen (13-407)..... 33
- Luminous Flux (13-402)..... 32
- (Symbol)..... 48
- Luminous Intensity (13-404)..... 33
- Luminous Tungsten Sensitivity  
(13-309)..... 30
- M
- Magnetic
- Armature Speaker (17-116).... 39
- Field Intensity (abbreviation).. 42
- Microphone (17-204)..... 40
- Modulator (4-004)..... 6

Pick-Up (17-302).....	40	Microvolt per Meter (abbrevia- tion).....	43
Speaker (17-112).....	39	Millivolt per Meter (abbreviation)	43
Marking Wave (1-022).....	3	Milliwatt (abbreviation).....	43
Master Oscillator (2-002).....	4	Miscellaneous Noise, Broadcast Receiver.....	104
Maximum Regeneration, High- Frequency Receiver.....	120	Modulated Wave (1-019).....	2
Maximum Undistorted Output		Modulation (4-001).....	5
Broadcast Receiver.....	78, 101	Capability (9-007).....	14
Pentode.....	154	Cross (4-008).....	6
Triode.....	153	Distortion.....	62
Measurement		Double (4-006).....	6
Antenna Gain at Distance.....	73	Desired-Signal Generator.....	84
Broadcast Receiver Output.....	90	Factor (4-009).....	6
Carrier Noise.....	62	Interfering-Signal Generator.....	83
Current in Antenna.....	74	Frequency, Interfering-Signal Generator.....	83
Extremely High Frequencies... ..	190	High-Frequency Signal Gener- ator.....	118
Frequency.....	59	Hum.....	107
Percentage Modulation.....	61	Interfering-Signal Generator Hum.....	84
Radio Field Intensity.....	198	Measurement.....	61
Radio Frequencies.....	185	Negative (16-017).....	36
Transmitter Power.....	54	Percentage (4-010).....	6
Mechanical		Positive (16-016).....	36
Element, Compliance (17-006)..	37	Products.....	57
Impedance of a Mechanical Sys- tem (17-007).....	37	Whistle.....	108
Reactance of a Mechanical Sys- tem (17-009).....	37	Modulator (4-003).....	6
Resistance of a Mechanical Sys- tem (17-008).....	37	Magnetic (4-004).....	6
Megacycle (1-004).....	1	Vacuum Tube (4-005).....	6
(Abbreviation).....	42	Monitoring Radio Receiver (10-002).....	14
Megohm (abbreviation).....	42	Monitors, Radio.....	190
Mercury Vapor Tube (13-003).....	20	Monochromatic Sensitivity (13-306).....	29
Meter-Amperes (11-010).....	17	(Symbol).....	48
Meter, Frequency (14-001).....	33	Motional Impedance (17-004)....	36
Microfarad (abbreviation).....	42	Motor Element (17-103).....	38
Microhenry (abbreviation).....	42	Mouth of a Horn (17-108).....	38
Micromicrofarad (abbreviation)..	43	Moving Coil	
Microphone.....	176	Microphone (17-206).....	40
Breathing.....	177	Speaker (17-114).....	39
Burning.....	177	Moving Conductor	
Calibration.....	177	Microphone (17-205).....	40
Direct.....	179	Speaker (17-113).....	39
Electrostatic Actuator.....	180	Mu-Factor (13-042).....	23
Indirect.....	184	n-Electrodes.....	140
Rayleigh Disk.....	182	(Symbol).....	45
Thermophone.....	179	Multiple-Tuned Antenna (11-006)..	16
Carbon (17-202).....	40	Multiplex Transmission (6-014)...	9
Condenser (17-203).....	40	Multiplier, Frequency (15-013)...	35
(Definition, 17-201).....	40	Mutual Conductance (symbol)....	45
Field Response.....	177		
Generated Electromotive Force..	177		
Magnetic (17-204).....	40		
Moving Coil (17-206).....	40		
Moving Conductor (17-205)....	40		
Packing.....	177		
Pressure Due to Sound.....	178		
Pressure Response.....	176		
Push-Pull (17-207).....	40		
Relative Loudness Efficiency... ..	176		
(Symbol).....	50		
Microvolt (abbreviation).....	43		

## N

Natural Frequency, Antenna.....	65
(Definition, 11-013).....	17
Negative Modulation (16-017)....	36
Noise	
Acoustic Measurement.....	104
Audibility.....	106
Broadcast Receiver, Miscellane-	

ous.....	104
Electrical Measurement.....	105
Random.....	105
Equivalent Side Band Input.....	106
Measurement Carrier.....	62
Tests.....	103
Normal Impedance (17-003).....	36
Normal Test Output	
Broadcast Receiver.....	78
High-Frequency Receiver.....	116
Normal Undistorted Power Output, Pentode.....	155

## O

Observed Radio Bearing (12-003).....	19
Ohm (abbreviation).....	43
Operating Conditions, Broadcast Receiver.....	92
Operating Controls, Safety.....	209
Operation, Duplex (6-015).....	10
Operational Stability, Transmitter.....	59
Optimum Regeneration, High-Frequency Receiver.....	119
Oscillation, High-Frequency Receiver.....	119
Optimum.....	120
Standard.....	120
Oscillations, Parasitic.....	58
Oscillator (2-001).....	4
Master (2-002).....	4
Oscillatory Circuit (7-003).....	11
Output	
Admittance, Vacuum Tube (13-063).....	25
Broadcast Receiver	
Maximum Undistorted.....	101
Undistorted.....	78
Calibration, Interfering-Signal Generator.....	83
Capacitance (13-061).....	25
Impedance, Vacuum Tube (13-062).....	25
Maximum Undistorted	
Pentode.....	154
Triode.....	153
Measurement	
Broadcast Receiver.....	90
High-Frequency Receiver.....	119
Measuring Circuit, Broadcast Receiver.....	81
Normal Test, High-Frequency Receiver.....	116
Normal Undistorted, Pentode.....	155
Voltage	
Desired-Signal Generator.....	84
Interfering-Signal Generator.....	83
Overload Level of a Transducer (6-008).....	9
Overload Test, Broadcast Receiver.....	100

## P

Packing, Microphone.....	177
Parasitic Oscillations.....	58
Passive Transducer (6-005).....	8
Pentode (13-017).....	21
Maximum Undistorted Power Output.....	154
Normal Undistorted Power Output.....	155
(Symbol).....	52
Percentage Modulation.....	60
Definition (4-010).....	6
Measurement.....	61
Per Cent Ripple (5-006).....	7
Performance Graph Sheets.....	108
Performance Indexes, Electro-Acoustic Devices.....	163
Phase Distortion.....	64
Phonograph Pick-Up (17-301).....	40
Phot (13-408).....	33
Photo-Current Coefficient (13-319).....	32
Photometer Box.....	157
Phototube.....	156
Conductance (13-314).....	31
Current-Illumination Characteristic.....	159
Current-Voltage Characteristic.....	158
Current-Wavelength Characteristic.....	159
Definition (13-006).....	20
Gas (13-302).....	29
Amplification Tests.....	161
High Vacuum (13-301).....	29
Leakage.....	162
Light Source.....	156
Primary Emission.....	162
Resistance (13-316).....	31
Sensitivity (13-303).....	29
(Symbol).....	48, 50
Test, Electrical Circuit.....	158
Variational Conductance (13-315).....	31
Variational Resistance (13-317).....	31
Photo-Voltage Coefficient (13-318).....	31
(Symbol).....	48
Pick-Up	
Carbon Contact (17-303).....	41
Condenser (17-304).....	41
Magnetic (17-302).....	40
Phonograph (17-301).....	40
Picture	
Element (16-010).....	35
Transmission (16-002).....	35
Piezo-Electric Plate (symbol).....	50
Plane, Wave Polarization.....	70
Plate (13-038).....	22
Capacitance (13-056).....	25
(Symbol).....	45
Characteristic.....	133
(Definition, 13-052).....	24
Conductance.....	136
(Definition, 13-050).....	24



- Reflector, Antenna..... 69  
 Reflex Circuit Arrangement  
   (10-012)..... 15  
 Regeneration (3-006)..... 5  
   High-Frequency Receiver.....119  
   Maximum.....120  
   Optimum.....119  
   Standard.....120  
 Regulator, Automatic (15-002)... 34  
 Relative Loudness Efficiency  
   Loud Speakers.....164  
   Microphones.....176  
 Relay (15-001)..... 34  
 Residual Hum.....107  
 Resistance (11-011)..... 17  
   Antenna..... 66  
   Electrode (symbol)..... 45  
   Grid (symbol)..... 45  
   Phototube (13-316)..... 31  
   Plate.....136  
     Definition (13-051)..... 34  
     (Symbol)..... 45  
   Rectification (symbol)..... 45  
   Variational Phototube (symbol) 48  
 Resistive Coupling (7-011)..... 12  
 Resistor (symbol)..... 50  
 Resonance (7-001)..... 11  
 Resonant Circuit (7-002)..... 11  
 Response  
   Loud Speaker.....166  
   Microphone Field.....177  
   Test, Broadcast Receiver, Spuri-  
     ous..... 94  
 Revolutions per Minute (abbrevi-  
   ation)..... 43  
 Rheostat (8-001)..... 13  
 Ripple  
   Filter (15-009)..... 34  
   Per Cent (5-006)..... 7  
   Voltage (5-005)..... 7  
 Root-Mean-Square (abbreviation) 43
- S**
- Safety Standards.....208  
 Scanning (16-007)..... 35  
   Line (16-009)..... 35  
   Progressive (16-014)..... 36  
   Rectilinear (16-008)..... 35  
   Staggered (16-015)..... 36  
 Screen Grid (13-033)..... 22  
   Tube (symbol)..... 51  
   Voltage (symbol)..... 47  
 Secondary Emission (13-009)..... 20  
 Sector, Equisignal (12-011)..... 19  
 Selectance, Broadcast Receiver... 78  
 Selectivity  
   Broadcast Receiver.....77, 95  
   High-Frequency Receiver.....122  
   High-Frequency Signal.....122  
   Volume Control Effect.....102  
 Sense Finder (12-007)..... 19  
 Sensitivity  
   Broadcast Receiver.....77, 94  
   Dynamic (13-305)..... 29  
   High-Frequency Receivers.....121  
   Luminous Tungsten (13-309)... 30  
   Maximum Undistorted Output,  
     Broadcast Receiver.....102  
   Monochromatic (13-306)..... 29  
   Phototube (13-303)..... 29  
     (Symbol)..... 48  
   Static (13-304)..... 29  
   Test Input, Broadcast Receiv-  
     ers..... 77  
   Total (13-307)..... 30  
     Luminous (13-308)..... 30  
   Tungsten 2870.....158  
     (Definition, 13-310)..... 30  
   Variational (13-311)..... 30  
   Volume Control Effect.....102  
 Service Band (1-038)..... 4  
 Shielding  
   Desired-Signal Generator..... 85  
   Interfering-Signal Generator... 83  
 Side Band (1-028)..... 3  
 Signal (1-017)..... 2  
 Generator  
   Broadcast Receiver..... 84  
   High-Frequency.....116  
   Modulation.....118  
   Noise Ratio (6-020)..... 10  
   Wave (1-018)..... 2  
 Simple Rectification (13-101).... 26  
 Single Side Band Transmission  
   (1-029)..... 3  
 Sound  
   Microphone Pressure.....178  
   Medium  
     Acoustic Impedance (17-011). 37  
     Acoustic Reactance (17-013).. 38  
     Acoustic Resistance (17-012). 38  
 Space-Charge Grid (13-035)..... 22  
 Spacing Wave (1-023)..... 3  
 Spark  
   Gap (9-003)..... 14  
   (Symbol)..... 51  
   Transmitter (9-002)..... 14  
 Speaker  
   Condenser (17-117)..... 39  
   Induction (17-115)..... 39  
   Loud (17-102)..... 38  
   Magnetic (17-112)..... 39  
     Armature (17-116)..... 39  
   Moving Coil (17-114)..... 39  
   Moving Conductor (17-113).... 39  
   Pneumatic (17-118)..... 39  
 Spurious Radiation..... 54  
   (Definition, 9-006)..... 14  
 Spurious Response, Broadcast Re-  
   ceiver..... 94  
 Stability, Transmitter..... 59  
 Staggered Scanning (16-015).... 36  
 Standard Tests  
   Broadcast Radio Receivers..... 75  
   High-Frequency Receivers.....121  
   Vacuum Tubes.....127



Subharmonics.....	55
Telephone (symbol).....	50
Testing.....	53
Vacuum Tube (9-005).....	14
Transrectification (13-104).....	26
Characteristic.....	156
(Definition, 13-106).....	26
Factor (13-105).....	26
Transrectifier (8-011).....	13
Trickle Charger (15-005).....	34
Triode (13-015).....	21
Maximum Undistorted Power Output.....	153
(Symbol).....	51
Tube	
Gas (13-002).....	20
High Vacuum (13-004).....	20
Mercury Vapor (13-003).....	20
Thermionic (13-005).....	20
Vacuum (13-001).....	20
Standard Tests of Vacuum.....	127
Tuned Transformer (8-004).....	13
Tungsten, 2870 Sensitivity.....	158
(Definition, 13-310).....	30
Tungsten Sensitivity, Phototube (symbol).....	48

## U

Undistorted Output, Broadcast Re- ceiver.....	78
Undistorted Power Output, Tubes.....	152
Unit, Transmission (6-003).....	7

## V

Vacuum Tube (13-001).....	20
Amplifier (3-005).....	5
Characteristic Graphs.....	128
Filament Characteristic.....	128
Harmonic Measurement.....	152
Heater Characteristic.....	128
Input Admittance (13-065).....	25
Input Impedance (13-064).....	25
Modulator (4-005).....	6
Output Admittance (13-063).....	25
Output Impedance (13-062).....	25
Standard Tests.....	127
Transmitter (9-005).....	14
Undistorted Power Output.....	152
Voltmeter (14-006).....	34
Variational Conductance, Photo- tube (13-315).....	31
(Symbol).....	48
Variational Resistance, Phototube (13-317).....	31
(Symbol).....	48
Variational Sensitivity (13-311)...	30

Amplitude Relation (13-312)...	31
Vector Quantities (symbols).....	46
Vertical Directional Pattern, An- tenna.....	73
Visibility (13-403).....	32
Phototube (symbol).....	48
Volt (abbreviation).....	43
Voltage	
Amplification (3-002).....	5
Filament (13-024).....	21
Control-Grid Supply (symbol)..	47
Divider (8-010).....	13
Grid (13-028).....	22
Heater (13-021).....	21
Plate (13-039).....	22
Plate Supply (symbol).....	47
Ripple (5-005).....	7
Screen-Grid Supply (symbol)...	47
Standard Input, Broadcast Re- ceiver.....	77
Voltmeter (symbol).....	52
Vacuum Tube (14-006).....	34
Volume Control	
Broadcast Receiver.....	102
Automatic.....	101
Effect on Fidelity.....	103
Effect on Selectivity.....	102
Effect on Sensitivity.....	102

## W

Watt (abbreviation).....	43
Wave (1-010).....	2
Antenna (11-007).....	16
Carrier (1-024).....	3
Continuous (1-012).....	2
(Abbreviation).....	42
Damped (1-014).....	2
Interrupted Continuous (1-013)...	2
Marking (1-022).....	3
Modulated (1-019).....	2
Polarization Plane.....	70
Signal (1-018).....	2
Spacing (1-023).....	2
Telegraph-Modulated (1-021)...	2
Tone-Modulated (1-020).....	2
Wavelength (1-011).....	2
Weather Effects, Antenna.....	74
Whistle	
Broadcast Receiver.....	104, 108
Interference, Broadcast Receiver	97
Measurement.....	106
Winding, Banked (8-007).....	13
Wire	
Ground (11-017).....	18
Crossed (symbol).....	52
Joined (symbol).....	52



**The Institute of Radio Engineers**

**Manufacturing Standards Applying To  
Broadcast Receivers and Vacuum Tubes**

**From the I.R.E. Year Book**

**for 1932**

**Pages 54 - 71**



Preprints.....(57)	Finances.....(33)
Presented.....(32)	Formation.....IX, 1
Publication Elsewhere.....(32)	Membership.....IX, 2
Publicity for.....(59)	Organization.....(28)
Reprints.....(60)	Papers.....(32)
Resident.....V, 1	Petition.....(26)
Duties.....VI, 1	Secretaries.....(34)
PROCEEDINGS.....(61)	Termination.....IX, 3 (31)
Back Copies for Students.....(39)	Territory.....(30)
Discounts.....(63)	Sponsors.....(4)
Material.....(62)	Waived.....(4)
Subscriptions.....(63)	Standards Committee.....(40) (51)
Publications.....(61)	Student, Abbreviation.....(1)
Publicity.....(66)	Back Copies of PROCEEDINGS.....(39)
Advanco.....(59)	Dues.....IV, 1 (38)
Committee.....(40) (49)	Entrance Fee.....IV, 1
Restatement, Delinquent.....(14)	Mailing Address.....(39)
Publications Obtainable.....(64)	Period of Enrollment.....(37)
Resigned.....(13)	Privileges.....II, 1
Representatives on Other Bodies.....(55)	When Obtained.....(11)
Reprints.....(60)	Requirements.....II, 6
Resignations.....III, 6	Sponsors.....(4) (36)
Secretary.....V, 1	Symbols, Improper Use of.....(3)
Duties.....VI, 5	Transfer, Fee.....IV, 1
Salary.....(21)	Objection to.....(10)
Sections.....IX	Recommended.....(8)
Appropriation.....(33)	Tellers Committee.....(40) (52)
Committee.....(40) (50)	Treasurer.....V, 1
Constitution.....(27)	Duties.....VI, 4
Coöperation.....(29)	Vice President.....V, 1
Debts.....(33)	Duties.....VI, 1
Delegates.....(35)	YEAR BOOK.....(65)

INDEX TO SECTION CONSTITUTION AND BY-LAWS

Roman numerals refer to Articles; arabic numerals, to Sections; and numbers in parentheses, to By-Laws.

Amendments.....IX, 1	Management.....VI
Vote on.....IX, 2	Meetings.....I, 3, VIII, 1
Annual Meeting.....VII, 1	Executive Committee.....VIII, 6
Associates, Privileges of.....II, 2	Notices of.....VI, 4, VIII, 9
By-Laws.....IX, 3	Special.....VII, 3
Filed.....IX, 3	Time of.....VIII, 2
Vote on.....IX, 3	Quorum for.....VIII, 4
Chairman.....V, 1, VI, 2	Membership.....II, 1
Committees.....VI, 5	Privileges.....II, 2
Temporary.....VI, 5	Name.....I, 1
Terms of.....VI, 5	Nomination, Officers.....VII, 1
Dues.....IV, 1	Object.....I, 2
Election, Officers.....VII, 1	Officers.....V, 1
Executive Committee.....VI, 1	Change of.....VII, 3
Meetings.....VIII, 6	Election.....VII, 1, VIII, 5
Quorum.....VIII, 7	Nomination.....VII, 1
Vote.....VIII, 8	Terms of.....V, 2
Expenses, Extraordinary.....IV, 3	Vacated.....VII, 2
Ordinary.....IV, 2	Secretary-Treasurer.....V, 1, VI, 3, VIII, 9
Fellows, Privileges.....II, 2	Students, Privileges.....II, 3
Fiscal Year.....VIII, 3	Territory.....III, 1
Junior Past Chairman.....VI, 1	Treasurer.....V, 1, VI, 3, VIII, 9
Juniors, Privileges.....II, 3	Vice Chairman.....V, 1

## SECTIONAL COMMITTEE ON RADIO AMERICAN STANDARDS ASSOCIATION

THE conception of the American Standards Association was made in 1919 by a group of technical societies, who took the initiative to establish an authoritative channel through which nationally acceptable standards might be promulgated. The organization formed was first known as the American Engineering Standards Committee, and its purpose was to serve as a clearing house through which trade associations, technical societies, or governmental departments might develop national standards. In 1929 the Committee was reorganized to include a broader industrial scope and its name was changed to the American Standards Association.

The ASA is now essentially a federation of forty-five national technical societies, trade associations, and Federal Government departments. Under its procedure, standards on practically any subject may be initiated by any responsible, authoritative group. The organization of the ASA is such as to provide adequate means for the appointment, by the various groups concerned, of broadly representative committees whose function it is to study and formulate standards. Since these committees, known as Sectional Committees, are made up of individuals officially appointed by the organizations concerned with the subject under consideration, there is assurance, when the preponderance of committee opinion is favorable, that the standard recommended by the Sectional Committee has the extensive approval necessary to make it an American Standard.

In December, 1922, the A.E.S.C. received a request from the National Bureau of Standards asking that a Sectional Committee on Radio be formed for the purpose of establishing standards in the field of radio communication. A conference for the discussion of the project was held in January 1923, and upon the recommendation of the representatives attending this conference, joint sponsorship for the Sectional Committee on Radio was assigned to the Institute of Radio Engineers and the American Institute of Electrical Engineers.

In July, 1929, a standard covering dimensions and arrangements of terminals on four-prong vacuum tube bases was submitted to the American Standards Association and approved as an American Tentative Standard.

In October, 1929, a meeting was held to reorganize the work of the Committee and to apportion the work among four technical committees. Dr. Alfred N. Goldsmith was elected chairman, and Dr. C. H.

Sharp, vice chairman of the Committee. The details confronting the Sectional Committee were assigned to the Technical Committee on Transmitters and Parts, under the chairmanship of Haraden Pratt; the Technical Committee on Radio Receivers and Parts, under the chairmanship of V. M. Graham; the Technical Committee on Vacuum Tubes, under the chairmanship of J. C. Warner; and the Technical Committee on Electro-Acoustic Devices, under the chairmanship of Irving Wolff. The division of the work before the Sectional Committee, into four groups corresponding to the four technical committees provided a satisfactory set-up for the establishing of standards on radio matters. During 1930 and the early part of 1931 these four technical committees worked in close coöperation with the similar technical committees of the I.R.E. Committee on Standardization, and during June, 1931, a 44-page pamphlet on "Proposed American Standards on Radio" was forwarded to the members of the Sectional Committee on Radio for ballot vote. The material contained in the "Proposed American Standards on Radio" was based principally on the standards set up by the Institute of Radio Engineers and Radio Manufacturers Association, and contained "Standard Definitions of Terms Used in Radio", "Standard Tests of Broadcast Radio Receivers", "Standard Vacuum Tube Base and Socket Dimensions", and "Manufacturing Standards Applying to Broadcast Receivers".

On November 18, 1931, a meeting of the Sectional Committee was held and the "Standard Vacuum Tube Base and Socket Dimensions" and "Manufacturing Standards Applying to Broadcast Receivers" appearing in the following sixteen pages were unanimously approved by the Committee. Since then this material has been approved by both sponsor bodies and now awaits final approval by the American Standards Association before its adoption as an American Standard.

# STANDARD VACUUM TUBE BASE AND SOCKET DIMENSIONS

SMALL FOUR-PIN BASE

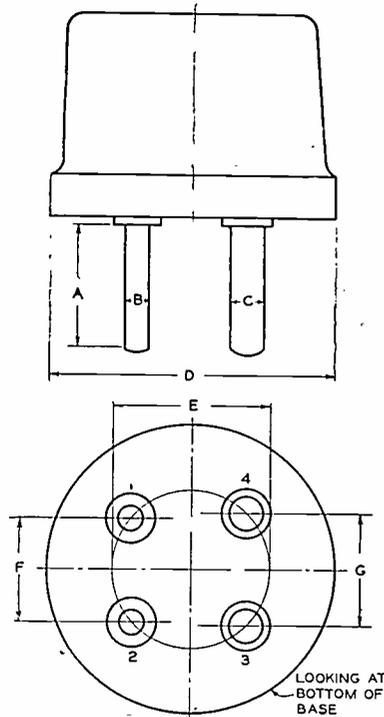

	<i>Nominal</i>	<i>Min.</i>	<i>Center</i>	<i>Max.</i>
A. Length of Pins	$\frac{1}{2}$ in.			
B. Diameter of Small Pins		0.122 in.	0.125 in.	0.128 in.
C. Diameter of Large Pins		0.153 "	0.156 "	0.159 "
D. Diameter of Base	$1\frac{5}{32}$ "			
E. Diameter of Pin Circle			0.640 "	
F. Spacing Between Small Pins			0.437 "	
G. Spacing Between Large Pins			0.468 "	

Pins are rigid, not split.

LARGE FOUR-PIN BASE WITH BAYONET PIN

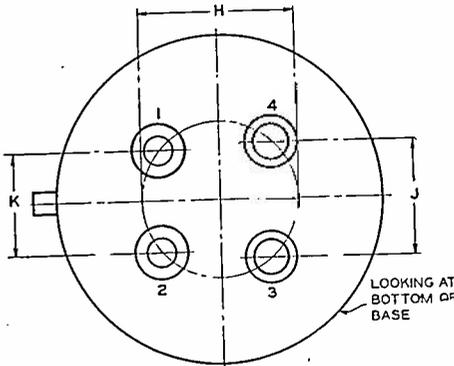
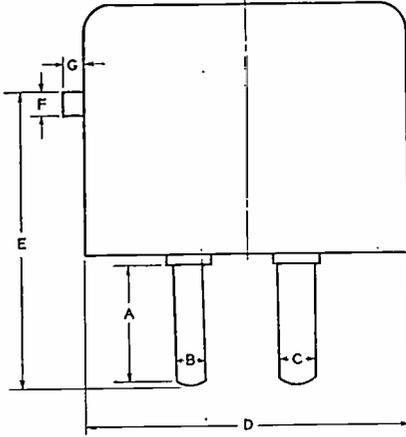

	Nominal	Min.	Center	Max.
A. Length of Pins	$\frac{1}{2}$ in.			
B. Diameter of Small Pins		0.122 in.	0.125 in.	0.128 in.
C. Diameter of Large Pins		0.153 "	0.156 "	0.159 "
D. Diameter of Base				1.377 "
E. Distance from Top of Bayonet Pin to Bottom of Contact Pin	$1\frac{15}{64}$ "			
F. Diameter of Bayonet Pin				0.080 "
G. Length of Bayonet Pin				0.078 "
H. Diameter of Pin Circle			0.640 "	
J. Spacing Between Large Pins			0.468 "	
K. Spacing Between Small Pins			0.437 "	

Pins are rigid, not split.

## LARGE FOUR-PIN BASE, WITHOUT BAYONET PIN

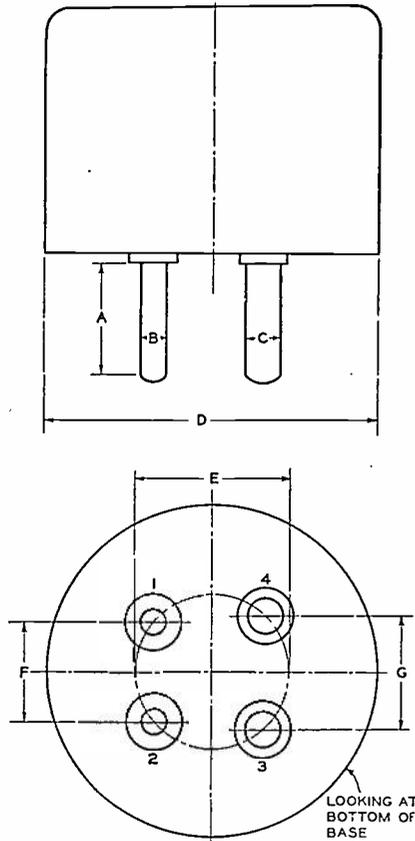

	<i>Nominal</i>	<i>Min.</i>	<i>Center</i>	<i>Max.</i>
A. Length of Pins	$\frac{1}{2}$ in.	0.122 in.	0.125 in.	0.128 in.
B. Diameter of Small Pins		0.153 "	0.156 "	0.159 "
C. Diameter of Large Pins			0.640 "	1.377 "
D. Diameter of Base			0.437 "	
E. Diameter of Pin Circle			0.468 "	
F. Spacing Between Small Pins				
G. Spacing Between Large Pins				

Pins are rigid, not split.

LARGE FIVE-PIN BASE

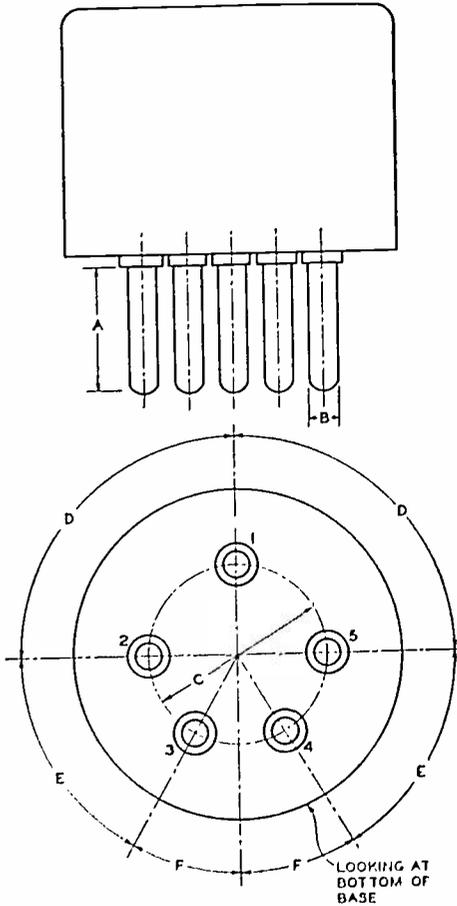

	Nominal	Min:	Center	Max.
A. Length of Pins	1/2 in.			
B. Diameter of Pins		0.122 in.	0.125 in.	0.128 in.
C. Diameter of Pin Circle			0.750 "	

D. Angular Separation of Pins  
1-2 and 3-5

E. Angular Separation of Pins  
2-3 and 4-5.

F. Angular Separation between  
Line and Pins 3 and 4  
Pins are rigid, not split.

90 deg.

60 "

30 "

TERMINAL CAP

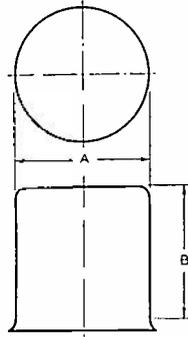

TERMINAL CAP FOR RECEIVING TUBES

	Nominal	Min.	Center	Max.
A. Diameter of Cap		0.346 in.	0.358 in.	0.370 in.
B. Length of Cap	$\frac{3}{8}$ in.			

TERMINAL CAP FOR TRANSMITTING TUBES

	Nominal	Min.	Center	Max.
A. Diameter of Cap		0.550 in.	0.563 in.	0.576 in.
B. Length of Cap	$\frac{1}{2}$ in.			

FOUR-PIN TRANSMITTING TUBE BASE

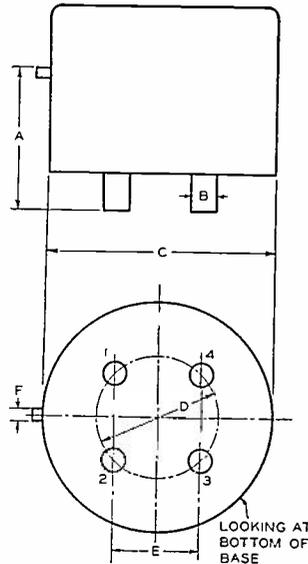

	Nominal	Min.	Center	Max.
A. Distance from Top of Bayonet Pin to Bottom of Contact Pins		1.146 in.	1.165 in.	1.184 in.
B. Diameter of Pins	$\frac{3}{16}$ in.			1.867 "
C. Diameter of Base			0.972 "	
D. Diameter of Pin Circle			0.687 "	
E. Spacing Between Pins			0.078 "	0.082 "
F. Diameter of Bayonet Pin		0.078 "	0.080 "	

Pins are rigid, not split.

LARGE TRANSMITTING TUBE BASE

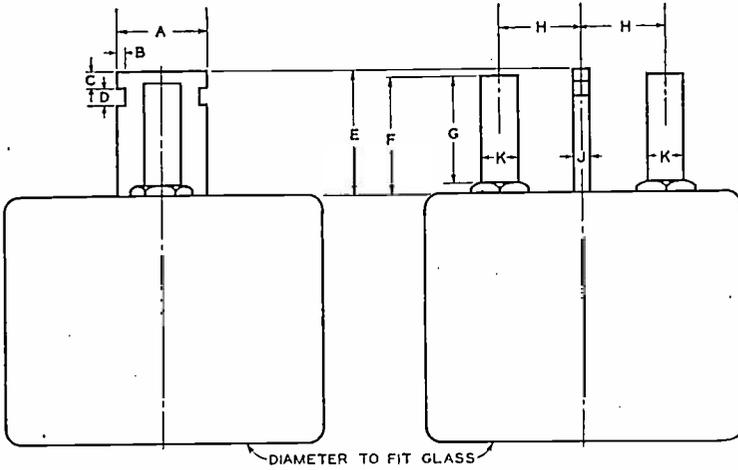

	<i>Nominal</i>
A. Width of Flat Pin	$\frac{3}{8}$ in
B. Depth of Slot	$\frac{1}{16}$ "
C. Distance from End of Slot to End of Flat Pin	$\frac{1}{8}$ "
D. Width of Slot	$\frac{1}{8}$ "
E. Distance from End of Flat Pin to Shell	$1\frac{1}{32}$ "
F. Distance from End of Round Pin to Shell	$\frac{31}{32}$ "
G. Length of Round Pins	$\frac{7}{8}$ "
H. Spacing Between Pins	$1\frac{11}{16}$ "
J. Thickness of Flat Pin	$\frac{1}{8}$ "
K. Diameter of Round Pins	$\frac{5}{16}$ "
Round pins are rigid, not split.	

TERMINAL CAP OF LARGE TRANSMITTING TUBE

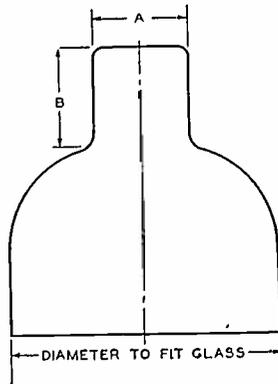

	<i>Nominal</i>
A. Diameter of Contact	$\frac{51}{64}$ in.
B. Length of Contact	$\frac{13}{16}$ "

## FOUR-PIN SOCKET FOR RECEIVING TUBES

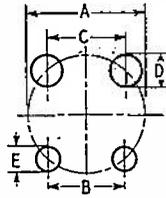

	<i>Min.</i>	<i>Center</i>	<i>Max.</i>
A. Diameter of Pin Circle		0.640 in.	
B. Spacing Between Small Pins	0.435 in.	0.437 "	0.440 in.
C. Spacing Between Large Pins	0.465 "	0.468 "	0.471 "
D. Diameter of Large Pins	0.173 "	0.176 "	0.179 "
E. Diameter of Small Pins	0.142 "	0.145 "	0.148 "

## FIVE-PIN SOCKET FOR RECEIVING TUBES

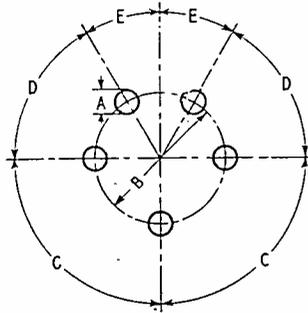

	<i>Min.</i>	<i>Center</i>	<i>Max.</i>
A. Diameter of Pins	0.142 in.	0.145 in.	0.148 in.
B. Diameter of Pin Circle		0.750 "	
C. Angular Separation of Pins 1-2 and 1-5		90 deg.	
D. Angular Separation of Pins 2-3 and 4-5		60 deg.	
E. Angular Separation Between Center Line and Pins 3 and 4		30 deg.	

## STANDARD CONNECTIONS FOR VACUUM TUBE BASES

In directly-heated receiving triodes, it shall be standard to connect the grid to pin 1, the plate to pin 2, and the filament terminals to pins 3 and 4 of the standard four-pin base.

In indirectly-heated receiving triodes, it shall be standard to connect the grid to pin 1, the plate to pin 2, the heater terminals to pins 3 and 4, and the cathode to pin 5 of the standard five-pin base.

In the directly-heated full-wave hot-cathode rectifying tube, it shall be standard to connect the anodes separately to pins 1 (grid) and 2 (plate) and the filament terminals to pins 3 and 4 of the standard four-pin base.

In a directly-heated half-wave hot-cathode rectifying tube, it shall be standard to connect the anode to pin 2 (plate), and the filament terminals to pins 3 and 4 of the standard four-pin base.

In the directly-heated receiving screen-grid tube, it shall be standard to connect the screen grid to pin 1 (grid), the plate to pin 2 (plate), and the filament terminals to pins 3 and 4 of the standard four-pin base. The control grid is to be connected to the cap at the top of the envelope.

In the indirectly-heated receiving screen-grid vacuum tube, it shall be standard to connect the screen grid to pin 1 (grid), the plate to pin 2 (plate), the heater terminals to pins 3 and 4 (heater), and the cathode to pin 5. The control grid is connected to the cap at the top of the envelope.

## MANUFACTURING STANDARDS APPLYING TO BROADCAST RECEIVERS

1. **Battery Operated Radio Receiver.** A radio receiver designed to operate from primary and/or storage batteries shall be known as a battery operated radio receiver.
2. **Socket-Powered Radio Receivers.** A radio receiver of the battery operated type, when connected to a power unit operating from the electric light line, supplying both filament and plate potentials to the tubes of the receiver, shall be known as a socket-powered radio receiver.
3. **Electric Radio Receiver.** A radio receiver operating from the electric light line, with a built-in power unit, shall be known as an electric radio receiver.
4. **A-C Electric Radio Receiver.** An electric radio receiver employing tubes which obtain their operating power from an alternating-current electric light line shall be known as an a-c electric radio receiver.
5. **D-C Electric Radio Receiver.** An electric radio receiver employing tubes which obtain their operating power from a direct-current electric light line shall be known as a d-c electric radio receiver.
6. **Selector (Station Selector.)** The manual adjustment means by which the user of a broadcast receiver is enabled to bring one or more of its circuits into resonance with any desired signal within the range of the receiver. There are three general methods of manual station selection. In these the mechanical means used in any of the three methods may consist of direct connected drives, with or without auxiliary close adjustment means, or may consist of close adjustment means only.  

Note—The use of the word "control" as applying specifically to manual tuning adjustments is not approved.
7. **Multiple Selector.** That method of manual tuning adjustment in which mechanical means are provided for setting independently each of two or more tuned circuits or groups of tuned circuits to resonance at any frequency within the range of the device.
8. **Master Selector.** That method of manual tuning adjustment in which one mechanical means is used to bring all the tuned circuits simultaneously into approximate resonance with any desired fre-

quency within the range of the device, and additional auxiliary means are provided to bring one or more of the tuned circuits into exact resonance.

9. **Single Selector.** That method of manual tuning adjustment in which one and only one mechanical means is provided to the user for bringing all tuned circuits into practical resonance at any desired frequency within the range of the receiver, there being no additional separate means for resonance adjustment and no other controls which appreciably affect the calibration of the single selector.
10. **Direct Selectors.** Direct selectors are those in which the motion ratio between the knob, dial, or other actuating means and the device is unity.
11. **Close Selectors.** Close selectors are those in which the motion ratio between the knob, dial, or other actuating means and the driven device is greater than unity.  
Note—The auxiliary tuning adjustments in master selector arrangements will ordinarily be "close" in their effect and may be so referred to regardless of the actual mechanical motion ratio which they employ.
12. **Volume Control.** The manual adjusting means by which the user of a broadcast receiver is enabled to adjust the sound volume delivered by the sound reproducing device on any signal input, within limits depending on the strength of the signal and the sensitivity of the receiver and the sound reproducing device.
13. **Range Control.** The manual adjusting means by which the user of a broadcast receiver may produce changes in the circuit to obtain two or more degrees of sensitivity. This may also be called "local-distance switch."
14. **On-Off Switch.** The manual means for connecting and disconnecting a source or sources of power which are supplied to the receiver.
15. **On-Off Switches.** When the lever of an "on-off" switch in a radio receiver operates with an up-and-down motion it shall be standard to have the "up" position for "on."

When the lever of an "on-off" switch in a radio receiver operates in a horizontal plane it shall be standard to have the "on" position to the right facing the switch.

When an "on-off" switch of the push-pull type is used in a radio receiver it shall be standard to have the "out" position for "on."

When an "on-off" switch of a radio receiver operates with a rotary motion with a limited angular movement of the knob, it shall be

standard to reach the "on" position with clockwise rotation of the knob and to reach the "off" position with counterclockwise rotation.

When an "on-off" switch of a radio receiver operates with a rotary motion in one direction reaching "on" and "off" positions alternately, it shall be standard to have the knob rotate in a clockwise direction.

16. **Broadcast Receivers—Frequency Range.** The frequency range of standard broadcast receivers shall be the broadcast frequency band from 550 kilocycles (545.1 meters) to 1500 kilocycles (199.9 meters).

17. **Design and Rating of Socket Power Devices and Electric Radio Receivers.** It shall be standard to rate and design socket-power devices and electric radio receivers for operation on voltages from 105 to 125 volts.

When means for adapting a socket power device or electric radio receiver to the line voltage is provided, it shall be standard to design the low range from 105 to 115 volts and the high range from 115 to 125 volts. Normal rating for the low range will be 110 volts and for the high range 120 volts.

18. **Nomenclature—Antenna Parts.** The standard nomenclature to apply to broadcast radio receiving antenna parts shall be as follows:

(a) Antenna wire.

(b) Lead-in wire.

That wire extending from an outdoor antenna to a window lead-in strip, or through a wall insulation directly to the radio set.

(c) Ground wire.

1. Receiver ground wire.

2. Protective ground wire.

The ground wire shall be separately designated as to whether the wire shall run from the receiving set ground binding post to a grounded fixture within the building or whether it run from the receiving set to the outdoor ground, as the conductor may be different.

(d) Insulation.

1. Antenna insulator.

2. Lead-in insulator.

3. Wall insulator.

(e) Ground clamp.

(f) Lead-in connector.

This is the device which is used to fasten or connect the lead-in wire to the antenna wire.

(g) Protective device.

This refers to the lightning arrester, regardless of type.

(h) Supporter of antenna.

This refers to any mast or other rigging to which the antenna wire is attached.

19. **Antenna Installation Instructions.** It shall be standard for manufacturers of receiving sets requiring an outside antenna and for manufactures of outside antenna material sold in unit packages to include in the instruction book or instruction card accompanying the radio receiving set or antenna unit package, reasonably complete instructions for erecting the antenna containing two statements, one cautioning the user that the installation should be made in accordance with these instructions and in accordance with the National Electrical Code and the National Electrical Safety Code, and the other as follows: When erecting the antenna be careful not to allow any wire or rope to come in contact with any electric power or light wires. Such contact is DANGEROUS.

20. **Soldering Tests—Cord Terminals.** The standard test for quality of soldering of cord tips or terminals to radio cords shall be a straight pull of 5 pounds applied to the cord tip or terminal.

21. **Cord Tip—Cylindrical Type.** The standard cylindrical type cord tip for use on the ends of cords connecting to headsets and loud speakers, where concealed binding post connections are employed in the headset or loud speaker, shall have the following dimensions:

<i>Dimension</i>	<i>Minimum in inches</i>	<i>Tolerance in inches</i>	<i>Maximum in inches</i>
A	0.3125 ( $\frac{5}{16}$ )	0.0625 ( $\frac{1}{16}$ )	0.375 ( $\frac{3}{8}$ )
B	0.151	0.010	0.161
C			0.20 (No. 31 D. G.)
D			$\frac{1}{16}$

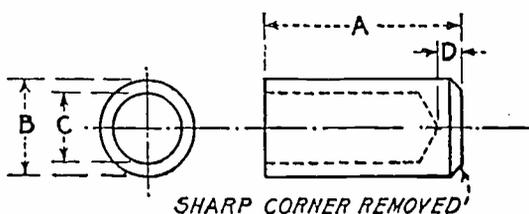

22. **Cord Tip—Pin Type.** The standard cord tip for use on the plug or receiving set end of headset and loud speaker cord conductors shall be of the pin type with important dimensions as listed in the following table:

<i>Dimension</i>	<i>Minimum in inches</i>	<i>Tolerance in inches</i>	<i>Maximum in inches</i>
A	0.9580	0.0620	1.0200
B	0.4900	0.0200	0.5100
C	0.4680	0.0420	0.5100
D	0.1510	0.0100	0.1610
E	0.0800	0.0020	0.0820
F			0.120 (No. 31 D. G.)
G			$\frac{7}{16}$

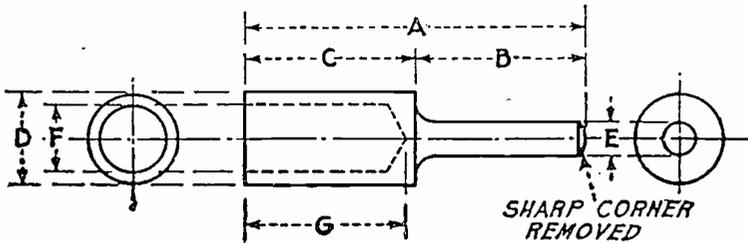

23. **Binding Posts—Drilling Dimensions.** Standard dimensions for the cord tip openings and the fastening screw locations of binding posts to accommodate the standard pin and cylindrical types of cord tip are as follows:

**FOR PIN TYPE CORD TIPS:**

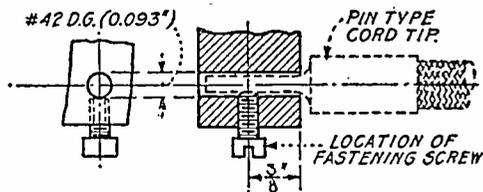

**FOR CYLINDRICAL TYPE CORD TIPS:**

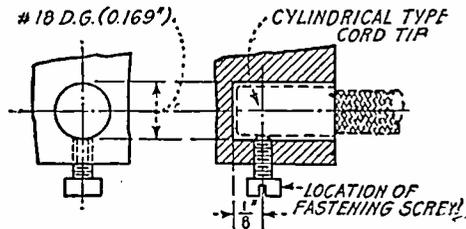

24. **Cable Terminal—Spade Type.** The standard cable terminals for the outer end of battery connecting conductors on radio receiving sets shall have the following dimensions:

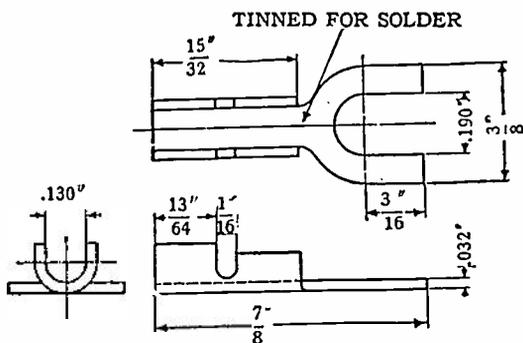

(This terminal is designed for use with binding posts having No. 8-32 or No. 6-32 screws and can be used with spring-type battery connecting clips.)

25. Radio Plugs—Dimensions. The important dimensions of standard radio plugs for use in connection with the standard radio spring jacks are as follows:

<i>Dimension</i>	<i>Minimum in inches</i>	<i>Tolerance in inches</i>	<i>Maximum in inches</i>
A	1.179	0.020	1.199
B			0.959
C			0.863
D	0.248	0.002	0.250
E	0.243	0.002	0.245
F	$\frac{3}{16}$		

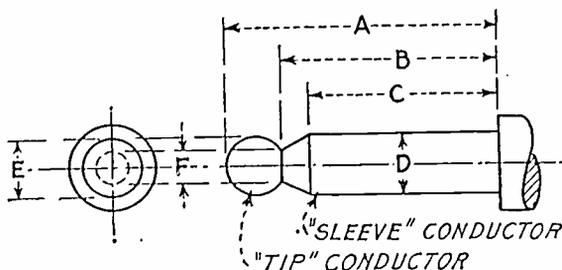

26. Radio Jacks—Dimensions. The important dimensions of standard radio spring jacks for use in connection with the standard radio plugs are as follows:

<i>Dimension</i>	<i>Minimum in inches</i>	<i>Tolerance in inches</i>	<i>Maximum in inches</i>
A	1.000	0.040	1.040
B	0.770	0.020	0.790

C	0.2515	0.0015	0.2530
D	0.020	0.010	0.030
E	0.030	0.010	0.040
F			0.450
G	$\frac{1}{8}$		$\frac{1}{4}$

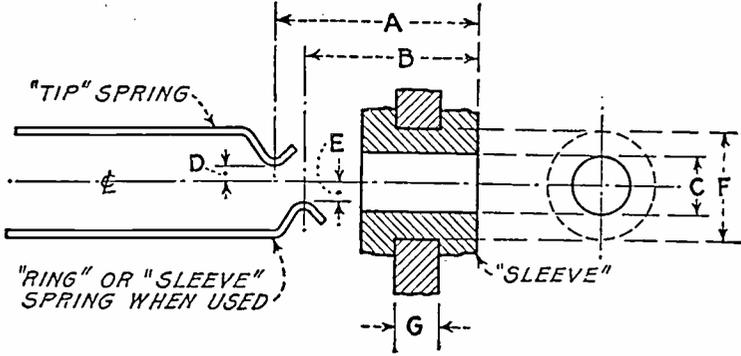

27. Pilot Lamp, Radio Receiver—Base. The standard base for an incandescent lamp to be used for receiver panel illumination shall be the standard miniature screw base, as shown in standard 28 below, with additional important dimensions as follows:

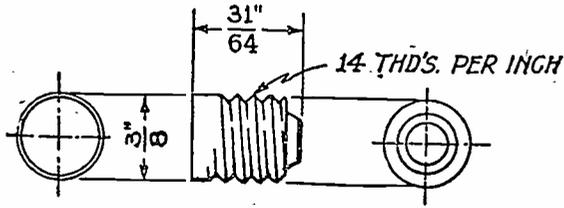

28. Edison-Type Screw Shells, Miniature Size—Standard Form and Dimensions

Diameter Dimensions.

	Lamp Holder Shell	Lamp Base Shell
"Go" gauge, top of thread	0.3775 in.	0.3750 in.
"Not Go" gauge, top of thread	0.3835 in.	0.3700 in.
"Go" gauge, bottom of thread	0.3375 in.	0.3350 in.
"Not Go" gauge, bottom of thread	0.3435 in.	0.3300 in.
Threads per inch	14	14
Depth of thread	0.020 in.	0.020 in.

Form of Thread

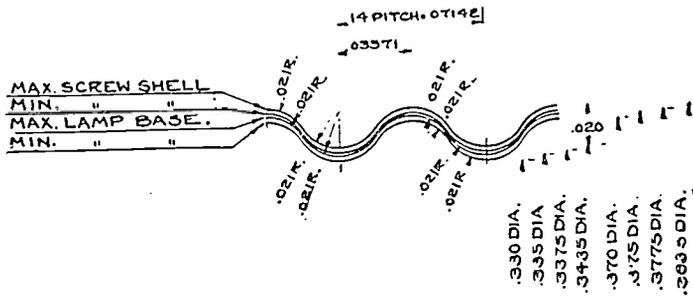

STANDARD FOR MINIATURE SCREW SHELL  
AND LAMP BASE.

29. Pilot or Panel Lamp—Radio Receiver. The standard radio receiver pilot lamp shall have the following dimensions:

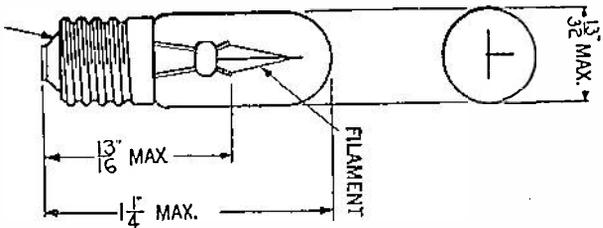

30. Magnetic Pick-up Jack—Connection. When a jack is used for connecting a magnetic pick-up into the input of the audio amplifier of a radio receiving set, it shall be standard to have the sleeve of the jack grounded or connected to the low side of the circuit.



**The Institute of Radio Engineers**

**References Relating to the Measurements  
Characteristics of Radio Receivers  
and Associated Apparatus**

**Related Standards of Other Engineering  
Organizations**

**From the I.R.E. Year Book  
for 1929  
Pages 129-147**

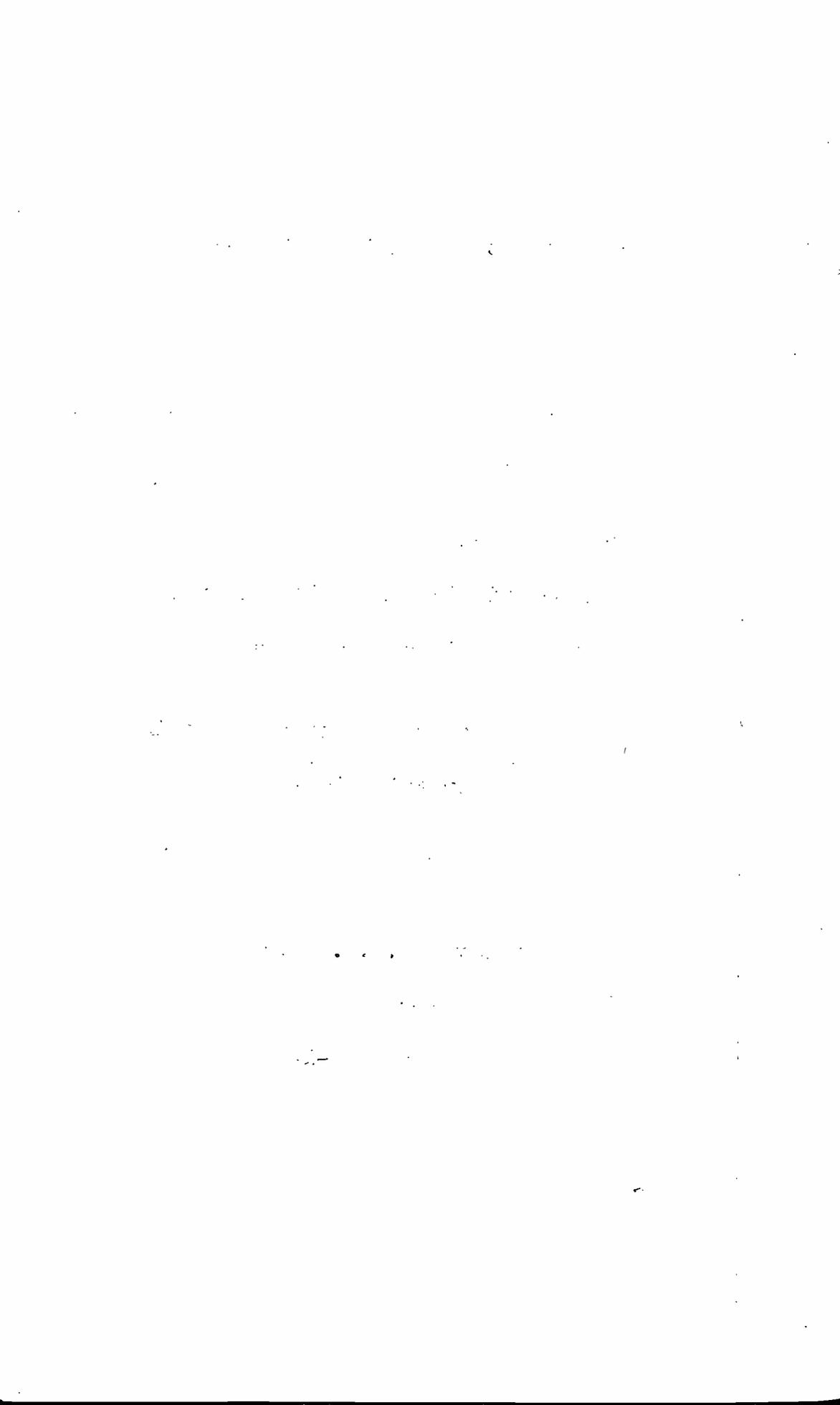

## REFERENCES RELATING TO THE MEASUREMENT OF THE CHARACTERISTICS OF RADIO RECEIVERS AND ASSOCIATED APPARATUS

These references are classified according to the extension of the Dewey Decimal Classification to radio subjects contained in Circular 138 of the U. S. Bureau of Standards.\* An outline of this classification was published in the PROCEEDINGS of the Institute of Radio Engineers, 16, 1423; October, 1928.

Abbreviations for the titles of the publications referred to in these references are as follows:

Amer. Acad. Arts and Sci. <i>Proc.</i>	<i>Proceedings of the American Academy of Arts and Sciences.</i>
A.I.E.E. <i>Jl.</i>	<i>Journal of the American Institute of Electrical Engineers.</i>
A.I.E.E. <i>Trans.</i>	<i>Transactions of the American Institute of Electrical Engineers.</i>
<i>Archiv f. Elek.</i>	<i>Archiv für Elektrotechnik.</i>
<i>Bell Sys. Tech. Jl.</i>	<i>Bell System Technical Journal.</i>
Cir. B. of S.	Circular of the Bureau of Standards.
<i>Elec. Comm.</i>	<i>Electrical Communication.</i>
<i>Electrician</i>	<i>Electrician (London).</i>
<i>Exp. Wls. &amp; Wls. Engr.</i>	<i>Experimental Wireless and Wireless Engi- neer.</i>
Fr. Inst. <i>Jl.</i>	<i>Journal of the Franklin Institute.</i>
G. E. <i>Rev.</i>	<i>General Electric Review.</i>
I.E.E. <i>Jl.</i>	<i>Journal of the Institution of Electrical Engineers.</i>
I.E.E. <i>Jl.</i> (Japan)	<i>Journal of the Institution of Electrical Engineers, Japan.</i>

\* Copies of Circular 138 of the Bureau of Standards can be obtained from the Superintendent of Documents, U. S. Government Printing Office, Washington, D. C. for 10 cents per copy.

LC. B. of S.	Letter Circular of the Bureau of Standards.
<i>Mod. Wls. (Lond.)</i>	<i>Modern Wireless (London).</i>
Natl. Acad. <i>Proc.</i>	<i>Proceedings of the National Academy of Sciences.</i>
<i>Jl. Opt. Soc. Am. &amp; Rev. Sci. Ins.</i>	<i>Journal of the Optical Society of America and Review of Scientific Instruments.</i>
P.O.E.E. <i>Jl.</i>	Post Office Electrical Engineers <i>Journal.</i>
<i>Phys. Rev.</i>	<i>Physical Review.</i>
Phys. Soc. Lond. <i>Proc.</i>	<i>Proceedings of the Physical Society of London.</i>
<i>Phys. Zeits.</i>	<i>Physikalische Zeitschrift.</i>
PROC. I.R.E.	PROCEEDINGS of the Institute of Radio Engineers.
QST	QST
<i>Radio Eng.</i>	<i>Radio Engineering.</i>
<i>Radio Rev.</i>	<i>Radio Review.</i>
Roy. Soc. Lond. <i>Proc.</i>	<i>Proceedings of the Royal Society of London.</i>
Sci. Pa. B. of S.	Scientific paper of the Bureau of Standards.
Tech. Pa. B. of S.	Technologic paper of the Bureau of Standards.
<i>Wls. Age</i>	<i>Wireless Age.</i>
<i>Wls. Wld. &amp; Radio Rev.</i>	<i>Wireless World and Radio Review.</i>

## R100

## RADIO PRINCIPLES

- R100
- (a) Electric oscillations and electric waves, with application to radiotelegraphy. G. W. Pierce. N. Y., McGraw-Hill, 1920.
  - (b) Formulae and tables for the calculation of alternating current problems. Louis Cohen. N. Y., McGraw-Hill, 1913.
  - (c) Handbuch der Experimentalphysik. (Handbook of experimental physics.) Vol. 13, part 2. Physik der

- R100                    Glühenelektroden. Walter Schottky. Leipzig, Akademische Verlagsgesellschaft, 1928.
- (d) Principles of radio communication; 2nd edition. J. H. Morecroft. N. Y., Wiley, 1927.
- R120                    (a) Principles of radio transmission and reception with antenna and coil aerials. J. H. Dellinger. *Sci. Pa.* 354, B. of S. December 11, 1919.

## R130

## ELECTRON TUBES

- R130                    (a) Determination of elementary charge  $e$  from measurements of Shot effects. A. W. Hull and H. Williams. *Phys. Rev.*, 2nd series, vol. 25, no. 2, February 1925, p. 147-173.
- (b) Dynamic method for determining the characteristics of three-electrode vacuum tubes. J. M. Miller. *Proc. I. R. E.*, vol. 6, no. 3, June 1918, p. 141-148.
- (c) Effect of space charge and residual gases on thermionic currents in a high vacuum. Irving Langmuir. *Phys. Rev.*, 2nd series, vol. 2, no. 6, December 1913, p. 450-486.
- (d) Elektronen rohren. (Electron tubes.) H. Barkhausen. Leipzig, S. Hirzel, 1923.
- (e) Elektronenrohren und ihre technischen Anwendungen. (Electrons and their technical applications.) H. G. Moller. Braunschweig, Vieweg, 1922.
- (f) Etude théorique sur l'audion. (Theoretical study of the audion.) M. Latour. *Electrician*, vol. 78, 1916, p. 280-282.
- (g) Thermionic vacuum tube and its applications. H. J. Van der Bijl. N. Y., McGraw-Hill, 1920.
- R130.3                    (a) Notation for electron tube circuits. J. H. Dellinger. *Radio Rev.*, vol. 2, no. 9, September 1921, p. 454-459.
- R137                    (a) Output characteristics of amplifier tubes. J. C. Warner and A. V. Loughren. *Proc. I. R. E.*, vol. 14, no. 6, December 1926, p. 735-757.

## R138

## ELECTRON EMISSION; IONIZATION

- R138                    (a) Effect of electron emission on the temperature of the filament and anode of a thermionic valve. G. Stead.

- R138 I. E. E. *Jl.*, vol. 59, no. 300, April 1921, p. 427-429.  
Discussion, p. 429-432.
- (b) Electron emission from thoriated tungsten filaments, Irving Langmuir. *Phys. Rev.*, 2nd series, vol. 22, no. 4, October 1923, p. 357-398.
- (c) Emission of electricity from hot bodies. O. W. Richardson. Lond., Longmans, Green, 1916.
- (d) Phenomena in oxide-coated filament electron tubes. H. D. Arnold. *Phys. Rev.*, 2nd series, vol. 16, no. 1, July 1920, p. 70-82.
- (e) Pure electron discharge and its applications in radio telegraphy and telephony. Irving Langmuir. *Proc. I. R. E.*, vol. 3, no. 3, September 1915, p. 261-293.
- (f) Short tungsten filament as a source of light and electrons. G. Stead. I. E. E. *Jl.*, vol. 58, no. 287, January 1920, p. 107-117.
- (g) Theory of thermionics. H. A. Wilson. *Phys. Rev.*, 2nd series, vol. 24, no. 1, July 1924, p. 38-48.
- (h) Thermodynamics of electron emission. O. W. Richardson. *Roy. Soc. Lond. Proc.*, series A, vol. 105, no. A732, April 1, 1924, p. 387-405.
- (i) Über den Einfluss von Potentialschwelen auf den Stromubung zwischen einen Gluhdraht und einem Koaxialen Zylinder. (On the effect of potential growth on the emission between filament and a coaxial cylinder.) Walter Schottky. *Phys. Zeits.*, vol. 15, June 15, 1914, p. 624-630.
- (j) Wirkung der Raumladung auf Thermionenstromen im hohen Vakuum. (The space charge effect on thermionic currents in a high vacuum.) Walter Schottky. *Phys. Zeits.*, vol. 15, no. 10, May 15, 1914, p. 526-528.
- R139 (a) Axially controlled magnetron. A. W. Hull. *A. I. E. E. Trans.*, vol. 42, 1923, p. 915-920.
- R141.3 (a) Electric transients. C. E. Magnusson, A. Kalin, and J. R. Tolmie. N. Y., McGraw-Hill, 1922.

## R200

RADIO MEASUREMENTS AND STANDARDIZATION  
(Methods of and apparatus for measurement.)

- R200 (a) Electrical measurement of communication apparatus. W. J. Shackelton and J. G. Ferguson. *Bell Sys. Tech. Jl.*, vol. 7, no. 1, January 1928, p. 70-89.

- R200 (b) Theory and practice of radio frequency measurements. E. B. Moullin. Lond., Griffin, 1926.
- (c) Radio instruments and measurements. Cir. no. 74. B. of S. 2nd edition, March 10, 1924.
- R201 (a) Importance of laboratory measurements in the design of radio receivers. W. A. MacDonald. Proc. I. R. E., vol. 15, no. 2, February 1927, p. 99-111, and discussion, Proc. I. R. E., vol. 15, no. 4, April 1927, p. 329-340.

## R210

## FREQUENCY: WAVELENGTH

- R210 (a) Magnetostriction oscillators. G. W. Pierce. Amer. Acad. Arts and Sci. Proc., vol. 63, no. 1, April 1928, p. 1-47.
- (b) Method of measuring very short radio wavelengths. F. W. Dunmore and F. H. Engel. Proc. I. R. E., vol. 11, no. 5, October 1923, p. 467-478.
- (c) Methods and apparatus for measurement of the frequencies of distant radio transmitting stations. LC. 171, B. of S. November 10, 1926.
- (d) Precision determination of frequency. J. W. Horton and W. A. Marrison. Proc. I. R. E., vol. 16, no. 2, February 1928, p. 137-154.
- (e) Wave meter methods, p. 97-109. Radio instruments and measurements. Cir. 74, B. of S. March 10, 1924.
- R213 (a) Establishment of radio standards of frequency by the use of a harmonic amplifier. C. B. Jolliffe and Grace Hazen. Sci. Pa. 530, B. of S. July 15, 1926.
- R214 (a) Directions for use of the piezo oscillator and auxiliary generator for calibration of a radio frequency meter. LC. 183, B. of S. January 16, 1926.
- (b) Specifications for portable piezo oscillator, Bureau of Standards Type N. LC. 186, B. of S. November 20, 1925.
- (c) Uses and possibilities of piezoelectric oscillators. August Hund. Proc. I. R. E., vol. 14, no. 4, August 1926, p. 447-469.

## R220

## CAPACITY

- R220 (a) Ballistic galvanometer method (of measuring capacity) vol. 2, p. 128-130, Dictionary of applied physics. Richard Glazebrook. Lond., Macmillan, 1922.

- R220
- (b) Bridge method of measuring capacity, vol. 2, p. 130-131, Dictionary of applied physics. Richard Glazebrook. Lond., Macmillan, 1922.
  - (c) Calculation of capacity, p. 235-242. Radio instruments and measurements. Cir. 74, B. of S. March 10, 1924.
  - (d) Capacity measurement method. W. Van B. Roberts. Fr. Inst. *Jl.*, vol. 205, no. 5, May 1928, p. 699-701.
  - (e) Direct capacity measurement. G. A. Campbell. *Bell Sys. Tech. Jl.*, vol. 1, no. 1, July 1922, p. 18-38.
  - (f) Measurement of capacitance in terms of resistance and frequency. J. G. Ferguson and B. W. Bartlett. *Bell Sys. Tech. Jl.*, vol. 7, no. 3, July 1928, p. 420-437.
  - (g) Measurement of capacity, p. 129-131. Radio instruments and measurements. Cir. 74, B. of S. March 10, 1924.

## R230

## INDUCTANCE

- R230
- (a) Bridge methods of measuring inductance, vol. 2, p. 427-429, Dictionary of applied physics. Richard Glazebrook. Lond., Macmillan, 1922.
  - (b) Calculation of inductance, p. 242-243. Radio instruments and measurements. Cir. 74, B. of S. March 10, 1924.
  - (c) Constant impedance method for measuring inductance of choke coils. H. M. Turner. Proc. I. R. E., vol. 16, no. 11, November 1928, p. 1559-1569.
  - (d) Inductance by substitution in resonant circuit, p. 136-139. Radio instruments and measurements. Cir. 74, B. of S. March 10, 1924.
  - (e) Measurement of inductance, chap. VI. "Theory and practice of radio frequency measurements." E. B. Moullin. Lond., Griffen, 1926.
  - (f) Measurement of inductance and capacity of coils, p. 136-139. Radio instruments and measurements. Cir. 74, B. of S. March 10, 1924.
  - (g) Measurement of inductance by the shielded Owen Bridge. J. G. Ferguson. *Bell Sys. Tech. Jl.*, vol. 6, no. 3, July 1927, p. 375-386.

## R240

## RESISTANCE; DECUMENT; PHASE DIFFERENCE; POWER LOSS

- R240 (a) Dielectric and leakage losses, p. 122-128. Radio instruments and measurements. Cir. 74, B. of S. March 10, 1924.
- (b) Measurement of resistance, chap. IV. "Theory and practice of radio frequency measurements." E. B. Moullin. Lond., Griffen, 1926.
- (c) Note on radio frequency measurements. Carl Englund. Proc. I. R. E., vol. 8, no. 4, August 1920, p. 326-333.
- (d) Resistance measurements, p. 175-187. Radio instruments and measurements. Cir. 74, B. of S., March 10, 1924.
- (e) Substitution method for the determination of resistance of inductors and capacitors at radio frequencies. C. T. Burke. A. I. E. E. *Trans.*, vol. 46, 1927, p. 482-487.

## R250

## CURRENT

- R250 (a) Current measurements, vol. 2, p. 643-654, Dictionary of applied physics. Richard Glazebrook. Lond., Macmillan, 1922.
- (b) Method for generating and measuring very weak radio-frequency currents. W. Van B. Roberts. Fr. Inst. *Jl.*, vol. 201, pt. 3, March 1926, p. 301-310.
- (c) New method for the calibration of ammeters at radio frequencies. H. C. Hazel. Proc. I. R. E., vol. 16, no. 1, January 1928, p. 70-74.

## R260

## VOLTAGE

- R260 (a) Current-transformer methods of producing small, known voltages and currents at radio frequencies for calibrating purposes. D. W. Dye. I. E. E. *Jl.*, vol. 63, no. 342, June 1925, p. 597-608.
- (b) Measurement of potential difference and current, chap. II. "Theory and practice of radio frequency measurements." E. B. Moullin. Lond., Griffen, 1926.
- (c) Potentiometer arrangement for measuring micro-voltages at radio frequencies. A. G. Jensen. *Phys. Rev.*, 2nd series, vol. 26, no. 1, July 1925, p. 118-120.

- R261
- (a) Most useful meter. R. F. Shea. *QST*, vol. 11, no. 4, April 1927, p. 47-53.
  - (b) New thermionic instrument. S. C. Hoare. *A. I. E. E. Trans.*, vol. 46, 1927, p. 541-545.
  - (c) Notes on the use of a radio frequency voltmeter. W. N. Goodwin, Jr. *A. I. E. E. Trans.*, vol. 46, 1927, p. 479-481. This discusses a shielded thermionic voltmeter, in "Magnetic behavior of iron in alternating fields of frequencies between 100,000 and 1,500,000 cycles." L. T. Wilson. *Proc. I. R. E.*, vol. 9, no. 1, February 1921, p. 56-80.
  - (d) Thermionic voltmeter. W. B. Medlam and U. A. Oschwald. *Exp. Wls. and Wls. Engr.*, vol. 3, no. 37-38, October-November 1926, p. 589-598, 664-673.

## R270

## SIGNAL INTENSITY

- R270
- (a) Instrument to compare signal strengths. A. Castellain. *Wls. Wld. and Radio Rev.*, vol. 14, no. 7, May 14, 1924, p. 184-188.
  - (b) Measurement of signal strength. A. D. Cowper. *Mod. Wls. (Lond.)*, vol. 1, no. 5 and 7, June and August 1923, p. 330-332, 514-518.
  - (c) Measurement of the electric intensity of received radio signals. J. Hollingworth. *I. E. E. Jl.*, vol. 61, 1923, p. 501-516.
  - (d) Method of measuring radio field intensities and atmospheric disturbances. L. W. Austin and E. B. Judson. *Proc. I. R. E.*, vol. 12, no. 5, October 1924, p. 521-532.
  - (e) Methods for the measurement of radio field strengths. C. R. Englund and H. T. Friis. *A. I. E. E. Trans.*, vol. 46, 1927, p. 492-497.
  - (f) Portable receiving sets for measuring field strengths at broadcasting frequencies. A. G. Jensen. *Proc. I. R. E.*, vol. 14, no. 3, June 1926, p. 333-344.
  - (g) Radio field strength measuring system for frequencies up to forty megacycles. H. T. Friis and E. Bruce. *Proc. I. R. E.*, vol. 14, no. 4, August 1926, p. 507-519.
  - (h) Radio transmission measurements. Ralph Bown, C. R. Englund and H. T. Friis. *Proc. I. R. E.*, vol. 11, No. 2, April 1923, p. 115-152.

- R270 (i) Radio transmission measurements on long wave lengths. H. H. Beverage and H. O. Peterson. *Proc. I. R. E.*, vol. 11, no. 6, December 1923, p. 661-673.
- (j) Resume of modern methods of signal measurement. J. Hollingworth. *Wls. Wld. and Radio Rev.*, vol. 14, no. 17-20, July 23, 30, August 6, 13, 1924, p. 485-487, 518-520, 548-549 and 578-579.
- R275 (a) Telephone transmitter modulation measured at the receiving station. L. B. Turner. *Exp. Wls. and Wls. Engr.*, vol. 4, no. 40, January 1927, p. 3-5.
- (b) Use of the electron tube peak voltmeter for the measurement of modulation. C. B. Jolliffe. *Jl. Opt. Soc. Am. & Rev. Sci. Ins.*, vol. 9, no. 6, December 1924, p. 701-704.
- R281 (a) Methods of measurement of properties of electrical insulating materials. J. H. Dellinger and J. L. Preston. *Sci. Pa.* 471, B. of S., May 2, 1923.

## R300

## RADIO APPARATUS AND EQUIPMENT

(Component parts or apparatus, not complete communication systems.)

## R330

## ELECTRON TUBES

- R330 (a) Thermionic vacuum tube. H. J. Van der Bijl. N. Y., McGraw-Hill, 1920.
- (b) Thermionic vacuum tubes and their applications. R. W. King. *Bell Sys. Tech. Jl.*, vol. 2, no. 4, October 1923, p. 31-100.
- (c) Vacuum-tube production tests. A. F. Van Dyck and F. H. Engel. *Proc. I. R. E.*, vol. 16, no. 11, November 1928, p. 1532-1552.
- R334 (a) Characteristics of shielded-grid pliotrons. A. W. Hull and N. H. Williams. *Phys. Rev.*, 2nd series, vol. 27, no. 4, April 1926, p. 432-438.
- (b) Some characteristics and applications of four-electrode tubes. J. C. Warner. *Proc. I. R. E.*, vol. 16, no. 4, April 1928, p. 424-446.
- (c) Über Hochvakuumverstärker. 3 Teil: Mehrgitterröhren. Walter Schottky. *Archiv. f. Elek.*, vol. 8, no. 9, December 8, 1919, p. 299-328.

## R340

## ELECTRON TUBE APPARATUS

- R341 (a) Vacuum tube rectifier. J. H. Kuhlmann and J. P. Barton. *A. I. E. E. Jl.*, vol. 47, no. 1, January 1928, p. 17-24.
- R342 (a) Load carrying capacity of amplifiers. F. C. Willis and L. E. Melhuish. *Bell Sys. Tech. Jl.*, vol. 5, no. 4, October 1926, p. 573-592.
- (b) Operational characteristics of thermionic amplifiers. Stuart Ballantine. *Proc. I. R. E.*, vol. 7, no. 2, April 1919, p. 129-186.
- (c) Theory and operating characteristics of the thermionic amplifier. H. J. Van der Bijl. *Proc. I. R. E.*, vol. 7, no. 2, April 1919, p. 97-128.
- R342.5 (a) Design of non-distorting power amplifiers. E. W. Kellogg. *A. I. E. E. Jl.*, vol. 44, no. 5, May 1925, p. 490-498.
- R342.6 (a) High frequency amplifiers. H. T. Friis and A. G. Jensen. *Bell Sys. Tech. Jl.*, vol. 3, no. 2, April 1924, p. 181-205.
- (b) Mathematical study of radio frequency amplification. V. G. Smith. *Proc. I. R. E.*, vol. 15, no. 6, June 1927, p. 525-536.
- (c) Measurements of radio frequency amplification. Sylvan Harris. *Proc. I. R. E.*, vol. 15, no. 7, July 1927, p. 641-648.
- R342.7 (a) Measurements on audio-frequency amplifiers. L. M. Hull. *Wls. Age*, vol. 8, no. 9, June 1921, p. 12-16.
- (b) Notes on the testing of audio-frequency amplifiers. E. T. Dickey. *Proc. I. R. E.*, vol. 15, no. 8, August 1927, p. 687-706.
- (c) Testing of audio-frequency transformer-coupled amplifiers. H. Diamond and J. S. Webb. *I. R. E. Proc.*, vol. 15, no. 9, September 1927, p. 767-791.
- R344 (a) Design of a heterodyne type low-frequency generator. H. L. Kirke. *Exp. Wls. & Wls. Engr.*, vol. 4, no. 41, February 1927, p. 67-76.
- (b) Vacuum tubes as power oscillators. D. C. Prince. *Proc. I. R. E.*, vol. 11, no. 3-5, June, August, and October 1923, p. 275-313, 405-435 and 527-550.

## R360

## RECEIVING SETS

- R360
- (a) Notes on radio receiver measurements. T. A. Smith and G. Rodwin. *Proc. I. R. E.*, vol. 15, no. 5, May 1927, p. 387-395.
  - (b) Quantitative determination of radio receiver performance. H. D. Oakley. *A. I. E. E. Jl.*, vol. 46, no. 6, June 1927, p. 568-572.
  - (c) Quantitative methods used in tests of broadcast receiving sets. A. F. Van Dyck and E. T. Dickey. *Proc. I. R. E.*, vol. 16, no. 11, November 1928, p. 1507-1531.
  - (d) Radio receiver testing equipment. K. W. Jarvis. *Proc. I. R. E.*, vol. 17, no. 4, April 1929, p. 664-710.
  - (e) Some methods of testing radio receiving sets. J. L. Preston and L. C. F. Horle. *Tech. Pa.* 256, B. of S. March 26, 1924.

## R376

## TELEPHONE RECEIVERS

- R376
- (a) Electrical vibration instruments. A. E. Kennelly. N. Y., Macmillan, 1923.
  - (b) Theory of magneto-mechanical systems as applied to telephone receivers and similar structures. R. L. Wegel. *A. I. E. E. Jl.*, vol. 40, no. 10, October 1921, p. 791-802.

## R376.3

## LOUD-SPEAKING REPRODUCERS

- R376.3
- (a) Acoustic considerations involved in steady state loud speaker measurements. L. G. Bostwick. *Bell Sys. Tech Jl.*, vol. 8, no. 1, January 1929, p. 135-158.
  - (b) Discussion by E. W. Kellog on paper "Electrical loud speakers." A. Nyman. *A. I. E. E. Jl.*, vol. 42, no. 9, September 1923, p. 921-927; discussed in *A. I. E. E. Jl.*, vol. 42, no. 12, December 1923, p. 1338-1339.
  - (c) Discussion on loud speakers for wireless and other purposes. W. J. Brown. *Phys. Soc. Lond. Proc.*, vol. 36, pts. 2-3, February 14, 1924 and April 15, 1924, p. 218-224 and 211-240.
  - (d) Function and design of horns for loud speakers. C. R. Hanna and J. Slepian. *A. I. E. E. Jl.*, vol. 43, no. 3, March 1924, p. 250-256.

- R376.3
- (e) Loud speaker testing methods. I. Wolff and A. Ringel. Proc. I. R. E., vol. 15, no. 5, May 1927, p. 363-376.
  - (f) Loud speakers of high efficiency and load capacity. C. R. Hanna. Abridgment. A. I. E. E. *Jl.*, vol. 47, no. 4, April 1928, p. 253-257.
  - (g) Notes on the development of a new type of hornless loud speaker. C. W. Rice and E. W. Kellog. A. I. E. E. *Jl.*, vol. 44, no. 9, September 1925, p. 982-991.
  - (h) Sound measurements and loudspeaker characteristics. Irving Wolff. Proc. I. R. E., vol. 16, no. 12, December 1928, p. 1729-1741.
  - (i) *Wireless World*, vol. 22, no. 23, June 6, 1928.

## R380

## PARTS OF CIRCUITS; INSTRUMENTS

- R381
- (a) Electrical condensers. P. B. Coursey. Lond., Pitmans, 1927.
- R384.3
- (a) Reed type frequency meter, vol. 2, p. 25-26, Dictionary of applied physics. Richard Glazebrook. Lond., Macmillan, 1922.
- R385.5
- (a) Carbon transmitter. H. J. Gregory. P. O. E. E. *Jl.*, vol. 13, pt. 2, July 1920, p. 122-136.
  - (b) Marconi-Sykes magnetophone. H. J. Round. *Wls. Wid. & Radio Rev.*, vol. 15, no. 9, November 26, 1924, p. 260-265.

## R386

## FILTERS

- R386
- (a) Design of wave filters and application of the aluminum cell condenser. T. Ishiyama. I. E. E. *Jl.* (Japan), August 1926.
  - (b) Electric filters. F. S. Dellenbaugh, Jr. *QST*, vol. 6, no. 12, vol. 7, no. 1, July-August 1923, p. 15-22, 31, 18-26.
  - (c) Electric wave filters, (an editorial). *QST*, vol. 6, no. 3, October 1922, p. 7-11.
  - (d) Physical theory of the electric wave filter. G. A. Campbell. *Bell Sys. Tech. Jl.*, vol. 1, no. 2, November 1922, p. 1-32.
  - (e) Study of filter systems for transmitter tube plate supply. M. G. Goldberg. *QST*, vol. 6, no. 9, April 1923, p. 14-17.

- R386 (f) Transmission characteristics of electric wave filters. O. J. Zobel. *Bell Sys. Tech. Jl.*, vol. 3, no. 4, October 1924, p. 567-620.
- (g) Mutual inductance in wave filters with an introduction to filter design. K. S. Johnson. *Bell Sys. Tech. Jl.*, vol. 4, January, 1925, p. 52.
- R388 (a) Cathode-ray oscillographs and their uses. E. S. Lee. *G. E. Rev.*, vol. 31, no. 8, August 1928, p. 404-412.
- (b) Low-voltage cathode ray oscillograph. J. B. Johnson. *Bell Sys. Tech. Jl.*, vol. 1, no. 2, November 1922, p. 142-151.
- (c) Oscilloscope; a stabilized cathode-ray oscillograph with linear time-axis. Frederick Bedell and H. J. Reich. *A. I. E. E. Trans.*, vol. 46, May 1927, p. 546-550.

## R800

## NON-RADIO SUBJECTS

(Material of interest but not a part of radio. Classified according to the Dewey system.)

## R800

## (530)

## PHYSICS

- (R800) 530 (a) Dictionary of applied physics. Richard Glazebrook. Lond., Macmillan, 1922.
- 533.85 (a) Ionization manometer. O. E. Buckley. *Natl. Acad. Proc.*, vol. 2, no. 12, December 1916, p. 683-685.
- (b) Studies with the ionization gauge. I. Construction and method of calibration. Saul Dushman and C. G. Found. *Phys. Rev.*, 2nd series, vol. 17, no. 1, January 1921, p. 7-19.

## R800

## (534)

## SOUND

- (R800) 534 (a) Methods of high quality recording and reproducing of music and speech based on telephone research. J. P. Maxfield and H. C. Harrison. *A. I. E. E. Trans.*, vol. 45, 1926, p. 334-348.
- (b) Modern gramophone. *Wls. Wld. & Radio Rev.*, vol. 22, no. 11, March 14, 1928, p. 273-276.

- (R800)534 (c) Movietone. W. I. G. Page. *Wls. Wld. & Radio Rev.*, vol. 21, no. 24, December 14, 1927, p. 789-792.
- (d) Sensibility of the ear to small differences of intensity and frequency. V. O. Knudsen. *Phys. Rev.*, 2nd series, vol. 21, no. 1, January 1923, p. 84-102.
- (e) Theory of vibrating systems and sound. I. B. Crandall. N. Y., Van Nostrand, 1926.
- (f) Useful numerical constants of speech and hearing. Harvey Fletcher. *Bell Sys. Tech. Jl.*, vol. 4, no. 3, July 1925, p. 375-386.
- (R800) 535.3 (a) Alkali metal photoelectric cell. H. E. Ives. *Bell Sys. Tech. Jl.*, vol. 5, no. 2, April 1926, p. 320-335.
- (b) Photoelectric cell. L. R. Koller. *G. E. Rev.*, vol. 31, no. 7, July 1928, p. 373-375.

R800

(537)

## ELECTRICITY

- (R800) 537.1 (a) Conduction of electricity through gases. J. J. Thomson. Cambridge, University Press, 1906.
- 537.7 (a) Alternating current bridge as a harmonic analyser. Irving Wolff. *Jl. Opt. Soc. Am. & Rev. Sci. Ins.*, vol. 15, no. 3, September 1927, p. 163-170.
- (b) Delineation of alternating-current wave forms, vol. 2 p. 33-43. Dictionary of applied physics. Richard Glazebrook. Lond., Macmillan, 1922.

R800

(621.313.7)

## RECTIFIERS

- (R800) 621.313.7 (a) Alternating current rectification and allied problems. L. B. W. Jolley. N. Y., Wiley, 1926.
- (b) New Electronic rectifier. L. O. Grondahl. *A. I. E. E. Jl.*, vol. 46, March 1927, p. 215-222.
- (c) New rectifier. V. Bush and C. G. Smith. *I. R. E. Proc.*, vol. 10, no. 1, February 1922, p. 41-51.
- (d) Sulphide rectifier. H. Shoemaker. *Radio Eng.*, vol. 8, no. 6, June 1928, p. 35-38.
- (e) Theory and performance of rectifiers. H. D. Holler and J. P. Schrodtt. *Tech. Pa.* 265, B. of S. October 9, 1924.

- (R800) 621.313.7 (f) Thin film rectifiers. J. Slepian. Abstract in *Elec. Wld.*, vol. 90, no. 20, November 12, 1927, p. 1003.
- 621.353 (a) Electrical characteristics and testing of dry cells. Cir. 79, B. of S. 2nd ed. January 19, 1923.
- 621.354 (a) Storage batteries. G. W. Vinal. N. Y., Wiley, 1924.
- 621.374.2 (a) Kelvin double bridge, vol. 2, p. 696-698 and 719-723, Dictionary of applied physics. Richard Glazebrook. Lond., Macmillan, 1922.
- (b) Wheatstone bridge, vol. 2, p. 692-696, Dictionary of applied physics. Richard Glazebrook. Lond., Macmillan, 1922.

## R800

(621.385)

## TELEPHONY

- (R800) 621.385 (a) Decibel—the name for the transmission unit. W. H. Martin. *Bell Sys. Tech. Jl.*, vol. 8, no. 1, January 1929, p. 1-2.
- (b) Transmission circuits for telephonic communication. K. S. Johnson. N. Y., Van Nostrand, 1928.
- (c) Transmission unit. R. V. L. Hartley. *Elec. Comm.*, vol. 3, no. 1, July 1924, p. 34-42.
- (d) Transmission unit and telephone transmission reference systems. W. H. Martin. *A. I. E. E. Jl.*, vol. 43, no. 6, June 1924, p. 504-507.
- 621.385.93 (a) Thermophone. E. C. Wentz. *Phys. Rev.*, 2nd series, vol. 19, no. 4, April 1922, p. 333-345.
- 621.385.95 (a) Sensitivity and precision of the electrostatic transmitter for measuring sound intensities. E. C. Wentz. *Phys. Rev.*, 2nd series, vol. 19, no. 5, May 1922, p. 498-503

## LIST OF RELATED STANDARDS OF OTHER ENGINEERING ORGANIZATIONS

### AVAILABLE SECTIONS OF STANDARDS ADOPTED BY THE AMERICAN INSTITUTE OF ELECTRICAL ENGINEERS

Copies may be obtained, at the price indicated, from the Secretary of the American Institute of Electrical Engineers, 33 West 39th Street, New York City. Members of that organization are entitled to a discount of 50 per cent.

- |       |               |   |
|-------|---------------|---|
| No. 1 | (April, 1925) | General principles upon which temperature limits are based in the rating of electrical machinery. Price 20 cents.     |
| 4     | (May, 1928)   | Standards for the measurement of test voltages in dielectric tests. Price 30 cents.                                   |
| 5     | (July, 1925)  | Standards for direct-current generators and motors and direct-current commutator machines in general. Price 40 cents. |
| 7     | (Dec., 1927)  | Standards for alternators, synchronous motors and synchronous machines in general. Price 40 cents.                    |
| 8*    | (Mar., 1925)  | Standards for synchronous converters. Price 40 cents.   |
| 9     | (June, 1927)  | Standards for induction motors and induction machines in general. Price 40 cents.                                     |
| 10    | (July, 1925)  | Standards for direct-current and alternating-current fractional horse-power motors. Price 30 cents.                   |
| 11*   | (July, 1925)  | Standards for railway motors. Price 30 cents.   |
| 13    | (Aug., 1925)  | Standards for transformers, induction regulators and reactors. Price 40 cents.  |
| 14*   | (Mar., 1925)  | Standards for instrument transformers. Price 30 cents.  |
| 15*   | (May, 1928)   | Standards for industrial control apparatus. Price 40 cents.   |
| 16*   | (July, 1925)  | Standards for railway control and mine locomotive control apparatus. Price 40 cents.                                  |
| 17f*  | (Feb., 1928)  | Standards for mathematical symbols. Price 30 cents.   |

\* Approved by American Standards Association as American Standard.

- 17g1 (Oct., 1928) Standards for letter symbols for electrical quantities.  
Price 20 cents.
- 19 (July, 1925) Standards for oil circuit breakers. Price 30 cents.
- 22 (July, 1925) Standards for disconnecting and horn gap switches.  
Price 30 cents.
- 26 (April, 1928) Standards for automatic stations. Price 30 cents.
- 30 (Oct., 1928) Standards for wires and cables. Price 40 cents.
- 33 (Jan., 1927) Standards for electrical measuring instruments. Price  
30 cents.
- 34 (June, 1922) Standards for telegraphy and telephony. Price 30 cents.
- 36\* (Feb., 1928) Standards for storage batteries. Price 20 cents.
- 37\* (July, 1925) Standards for illumination. Price 30 cents.
- 38 (Mar., 1925) Standards for electric arc welding apparatus. Price  
40 cents.
- 39 (Aug., 1926) Standards for electric resistance welding apparatus.  
Price 30 cents.
- 41 (July, 1925) Standard for insulators. Price 30 cents.
- 42\* (Dec., 1923) Standard symbols for electrical equipment of build-  
ings. Price 20 cents.
- 45 (June, 1927) Recommended practise for electrical installations on  
shipboard (marine rules). Price \$1.50.
- 46\* (May, 1927) Standards for hard drawn aluminum conductors.  
Price 20 cents.
- 60\* (Sept., 1928) Specifications for tinned soft or annealed copper wire.
- 61\* (Sept., 1928) Specifications for soft or annealed copper wire. (No.  
60 and 61 published as one pamphlet.) Price 30  
cents.
- 63\* (Sept., 1928) Specifications for 30 per cent rubber insulation for wire  
and cable for general purposes. Price 30 cents.
- 69\* (Sept., 1928) Specifications for cotton covered round copper magnet  
wire.
- 70\* (Sept., 1928) Specifications for silk covered round copper magnet  
wire.
- 71\* (Sept., 1928) Specifications for enameled round copper magnet wire.  
(No. 69, 70, and 71 published as one pamphlet.)  
Price 30 cents.

\* Approved by American Standards Association as American Standard.

ENGINEERING AND INDUSTRIAL STANDARDS OFFICIALLY APPROVED  
BY THE AMERICAN STANDARDS ASSOCIATION

Copies of standards listed below may be obtained at cost from the American Standards Association, formerly the American Engineering Standards Committee, 33 West 39th Street, New York City.

- C 2-1927 National Electrical Safety Code. \$1.00.\*
- C 6-1925 Terminal Markings for Electrical Apparatus. Under rev.
- C 8b 1-1928 Tinned Soft or Annealed Copper Wire for Rubber Insulation, Specifications for (Published also as H 16-1928). Price 30 cents.
- C 8b 2-1928 Soft or Annealed Copper Wire, Specifications for (Published also as H 4-1928). Price 30 cents.
- C 8d 1-1928 30% Rubber Insulation for Wire and Cable for General Purposes, Specifications for. Price 30 cents.
- C 8j 1-1928 Cotton Covered Round Copper Magnet Wire, Specifications for. Price 30 cents.
- C 8j 2-1928 Silk Covered Round Copper Magnet Wire, Specifications for. Price 30 cents.
- C 8j 3-1928 Enameled Round Copper Magnet Wire, Specifications for. Price 30 cents.
- C 10-1924 Electrical Equipment of Buildings, Symbols for. Price 10 cents.
- C 11-1927 Hard Drawn Aluminum Conductors, Properties of. Price 20 cents.
- C 12-1928 Electricity Meters, Code for. Price \$2.00.
- C 13-1926 Tubular Steel Poles for Electric Line Construction, Specifications for. Price 25 cents.
- C 15-1923 600 Volt Direct Current Overhead Trolley Construction, Specifications for. Price 30 cents.
- C 18-1928 Dry Cells and Batteries, Specifications for. Price 5 cents.
- C 19-1928 Industrial Control Apparatus.<sup>s</sup> Price 40 cents.
- C 21-1926 Synchronous Converters.<sup>s</sup> Price 40 cents.
- C 22-1925 Instrument Transformers.<sup>s</sup> Price 40 cents.

\* May be ordered from the Superintendent of Documents, Washington, D. C. (Money Order or Cash.)

<sup>f</sup> French translation available.

<sup>s</sup> Spanish translation available.

- C 25a-1928 Induction Motors and Induction Machines in General, Rating Provisions for (Separate publications deferred). Price 30 cents.
- C 35-1928 Railway Motors. Price 30 cents.
- C 36-1928 Railway Control and Mine Locomotive Control Apparatus. Price 30 cents.
- C 40-1928 Storage Batteries. Price 20 cents.
- H 4-1921 Soft or Annealed Copper Wire, Specifications for (Also published as C 8b 2-1928.<sup>FS</sup> Price 25 cents.
- H 16-1928 Tinned Soft or Annealed Copper Wire for Rubber Insulation, Specifications for (Also published as C 8b 1-1928). Price 25 cents.
- Z 7-1925 Illuminating Engineering Nomenclature and Photometric Standards. Price 15 cents.
- Z 10f-1928 Mathematical Symbols. Price 30 cents.
- H 14-1929 Hard Drawn Copper Wire, Specifications for. In Press.
- Z 10g1-1929 Letter Symbols for Electrical Quantities. In Press.

# INDEX

to Standardization Report for 1928

## General Index

(For Index to Definitions see page 149)

- Abbreviations..... 89
- Amplification Factor..... 99
- Antenna (Real or Artificial)..... 108
- Audio-Frequency Source..... 109
- Bibliography (Measurement of Characteristics of Radio Receivers)..... 129
- Capacitance..... 103
- Capacitance, Grid-Plate..... 103
- Characteristic Curve, Emission... 96
- Characteristic Curve, Mutual... 96
- Characteristic Curves, Filament... 96
- Characteristic, Grid..... 95
- Characteristic, Plate..... 95
- Circuit Elements, Measurement of Properties of..... 127
- Conductance, Grid..... 98
- Conductance, Mutual..... 101
- Conductance, Plate..... 100
- Conventional Undistorted Power Output..... 105
- Current, Ionization..... 102
- Currents, Leakage..... 102
- Decibel..... 81
- Decineper..... 81
- Definitions, Index to..... 149
- Electro-Acoustic Devices, Symbols for..... 86
- Emission Characteristic Curve... 96
- Fidelity..... 107, 109
- Fidelity Test..... 119
- Field Intensity, Normal Radio... 107
- Filament Characteristic Curves... 96
- Frequencies, Standard Test..... 108
- Grid Characteristic..... 95
- Grid Conductance..... 98
- Grid-Plate Capacitance..... 103
- Hum, Tests for..... 123
- Index to Definitions..... 149
- Input Measurements..... 112
- Ionization Current..... 102
- Leakage Currents..... 102
- Letter Symbols—Vacuum-Tube Notation..... 91
- Maximum Undistorted Output... 105
- Measurement of Characteristics of Radio Receivers (bibliography)..... 129
- Measurement of Properties of Radio Circuit Elements..... 127
- Methods of Measuring Vacuum-Tube Characteristics..... 94
- Amplification Factor..... 99
- Capacitance..... 103
- Conventional Undistorted Power Output..... 105
- Emission Characteristic Curve... 96
- Filament Characteristic Curves... 96
- General Precautions..... 94
- General Test Conditions..... 94
- Grid Characteristic..... 95
- Grid Conductance..... 98
- Grid-Plate Capacitance..... 103
- Ionization Current..... 102
- Leakage Currents..... 102
- Maximum Undistorted Power Output..... 105
- Mutual Characteristic Curve... 96
- Mutual Conductance..... 101
- Plate Characteristic..... 95
- Plate Conductance..... 100
- Plate Resistance..... 100
- Undistorted Power Output... 105
- Vacuum-Tube Constants (in general)..... 98
- Mutual Characteristic Curve... 96
- Mutual Conductance..... 101
- Normal Radio Field Intensity... 107
- Normal Test Output..... 107
- Operating Conditions..... 117
- Output Measurements..... 115
- Output Measuring Circuit..... 111
- Output, Normal Test..... 107
- Overloading of Radio Receivers... 121
- Plate Characteristic..... 95
- Plate Conductance..... 100
- Power Output, Conventional Undistorted..... 105
- Power Output, Maximum Undistorted..... 105
- Power Output, Undistorted..... 105
- Radio-Frequency Source..... 110
- Radio Receiver Adjustments... 117
- Radio Receivers, Measurement of Characteristics of (Bibliography)..... 129
- Radio Receivers, Overloading of... 121
- Radio Receivers, Tests of Broadcast..... 106
- Related Standards of Other Organizations, List of..... 144
- Selectivity..... 106, 108

**The Institute of Radio Engineers**

**Related Standards and Definitions**

**From The I.R.E. Year**

**Book for 1930**

**Pages 45 - 105**

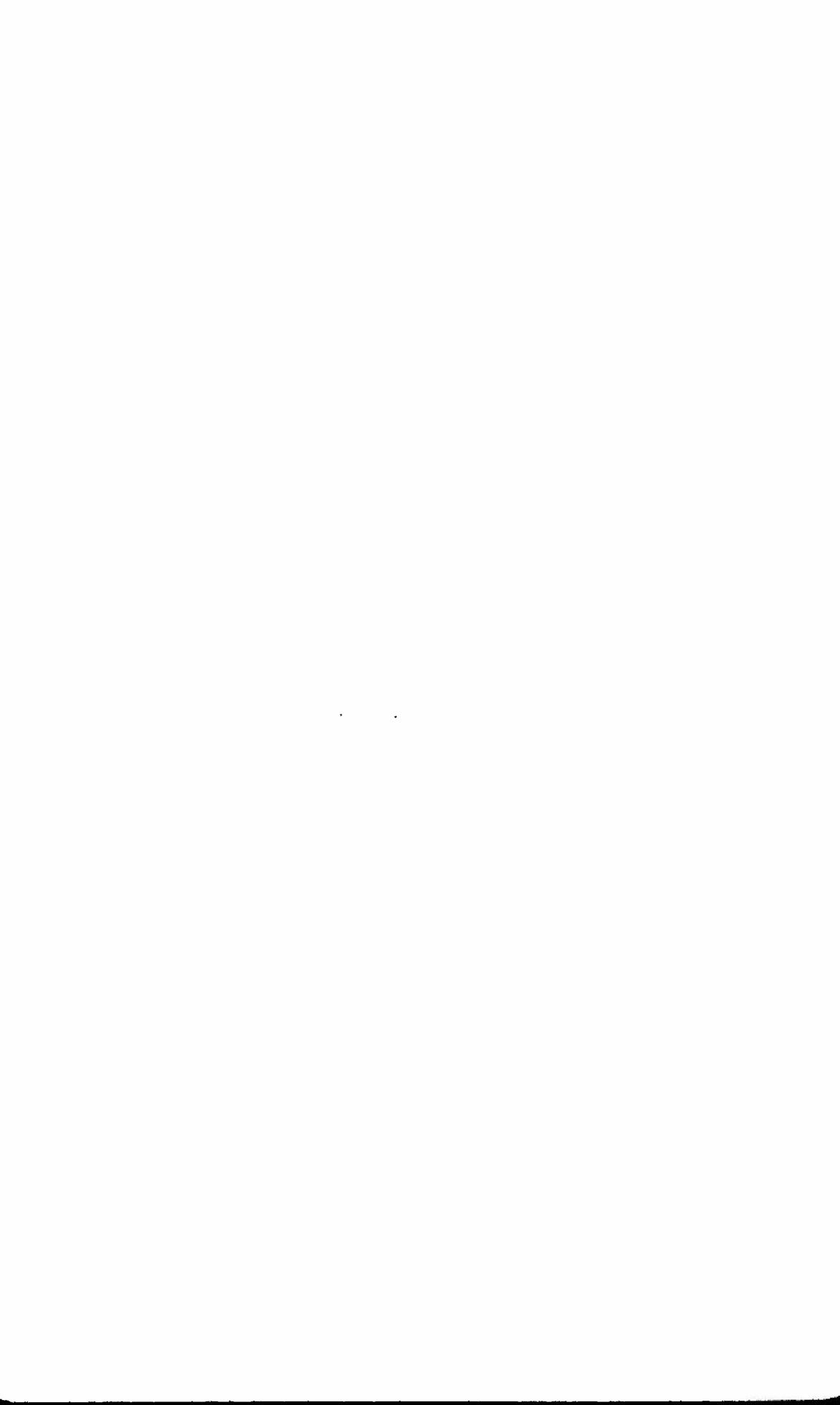

## MATHEMATICAL SYMBOLS\*

(Adopted by the Board of Directors, American Institute of Electrical Engineers, June 23, 1927)

A.S.A. Z 10f 1928

### Arithmetic and Algebra

1.  $= \neq + - \pm \mp < > \leq \geq ( ) [ ] \% \infty \approx$  (for approximately equal to)
2.  $a \times b = a \cdot b = ab$ ;  $a \div b = a/b = \frac{a}{b}$  (Influence extends to next + or -). Thus,  $a - b/c - d$  should not be used for  $(a - b)/(c - d)$ .  
Note that  $\frac{a}{b}$  is difficult to print in running text.
3.  $a/b = c/d$  for proportion. Discourage  $a:b::c:d$ .
4. Notation by powers of 10 for very large or very small numbers is recommended; as  $3.140 \times 10^9$  and  $3.140 \times 10^{-6}$ . The notation  $0.0^5314$  is useful in tables, to indicate that there are five zeros after the decimal point.
5. In writing numbers having a large number of digits, half-spaces may well be used instead of commas to separate groups of digits. In writing decimals, the 0 before the decimal point should not be omitted (except in tables).
6.  $|x|$  = absolute value of  $x$ .  $x! = 1 \cdot 2 \cdot 3 \cdots x$ . Discourage  $\underline{x}$ .
7.  $\sqrt{x} = +\sqrt{x}$ , not  $\pm\sqrt{x}$  ( $x$  being real and positive).  $a^{1/n} = \sqrt[n]{a}$ .  $a^{-n} = 1/a^n$ .  $\exp x = e^x$  is useful when  $x$  is a complicated expression. Note that the bar or vinculum after the  $\sqrt$  is very expensive to print.
8. When  $\log x$  is ambiguous, use  $\log_{10} x$  or  $\log_e x$ . The notation  $\ln x$  may be mentioned as an alternative for  $\log_e x$ .
9.  $P(n, r) = n(n-1)(n-2) \cdots (n-r+1)$   
 $C(n, r) = [n(n-1)(n-2) \cdots (n-r+1)]/[1 \cdot 2 \cdot 3 \cdots r] =$  binomial coefficients.  
A common alternative for  $C(n, r)$  is  $\binom{n}{r}$ ; this, however, is difficult to print in running text.
10.  $a \propto b$  (meaning  $a$  varies directly as  $b$ ).

\* Approved as American Standard by the American Standards Association, January, 1928. Sponsors: American Association for the Advancement of Science, American Institute of Electrical Engineers, American Society of Civil Engineers, The American Society of Mechanical Engineers, and Society for the Promotion of Engineering Education.

## Elementary Geometry

- 11.
- $\angle \triangle \parallel \perp \odot \square \therefore$

## Analytic Geometry

12.  $x, y, z; \xi, \eta, \zeta$ ; rectangular coordinates. Right-handed system preferred.
13.  $\rho, s$ =intrinsic coordinates.  $\rho$ =radius of curvature,  $s$ =length of arc.
14.  $l = \cos \alpha, m = \cos \beta, n = \cos \gamma$ , direction cosines.
15.  $r, \theta$ =polar coordinates.  $\psi$ =angle from radius vector to tangent.
16.  $r, \theta, \phi$ =spherical coordinates.  $\theta$ =co-latitude,  $\phi$ =longitude. (Usage general in mathematical physics; other notations are used in astronomy.)
17.  $r, \theta, z$ =cylindrical coordinates. (Usage diverse.)
18. Conics:  $e$ =eccentricity.  $p$ =semi-latus rectum (usage general in U.S.).
19. Straight line:  $y = mx + b$ .

## Trigonometric and Hyperbolic Functions

20.  $\circ \prime \prime \sin x, \cos x, \tan x, \text{ctn } x, \sec x, \csc x$ .
21.  $\sin^{-1}x$ =the principal value of the angle whose sine is  $x$  (when  $x$  is real). Thus,  $-\pi/2 \leq \sin^{-1}x \leq \pi/2, 0 \leq \cos^{-1}x \leq \pi, -\pi/2 \leq \tan^{-1}x \leq \pi/2$ . (Discourage arc  $\sin x$ ).
22.  $\sin^2 x$  for  $(\sin x)^2$  is an exceptional notation, justified by usage. Similarly for  $\cos^2 x$ , etc.
23.  $\sinh x, \cosh x, \tanh x, \text{ctnh } x, \text{sech } x, \text{csch } x$ .
24.  $\cosh^{-1}x$ =the principal value (when  $x$  is real). (Discourage arc  $\sinh x$ )
25.  $\sinh^2 x$  for  $(\sinh x)^2$  is an exceptional notation, justified by usage. Similarly,  $\cosh^2 x$ , etc.
26. In general  $f^{-1}$  means the inverse of the function  $f$ ; and  $f^2$  denotes iteration of the functional operation. But in exceptional cases,  $f^2$  may denote the square of the function  $f$  (as in  $\sin^2 x$  and  $\sinh^2 x$ ). In general,  $[f(x)]^{-1} = 1/f(x)$ .

## Calculus, etc.

27. If
- $y=f(x)$
- , derivative
- $=y' = f'(x) = \frac{dy}{dx} = D_x y$
- .

$$\text{Second derivative} = y'' = f''(x) = \frac{d(y')}{dx} = D_x^2 y = \frac{d^2 y}{dx^2}. \quad \text{Note: } \frac{d^2 y}{dx^2}$$

cannot be regarded as a fraction, except when  $x$  is the independent variable; in general,  $\frac{d^2}{dx^2} = D_x^2$  is a symbol of operation on  $y$ .

28. If  $u = f(x, y)$ , partial derivative  $= u_x = f_x(x, y) = D_x u = \frac{\partial u}{\partial x}$ .

Similarly,  $u_{xy} = f_{xy}(x, y) = D_y(D_x u) = \frac{\partial^2 u}{\partial y \partial x}$ . Note:  $\frac{\partial^2 u}{\partial y \partial x}$  and  $\frac{\partial u}{\partial x}$  are

not fractions;  $\frac{\partial}{\partial x} = D_x$  and  $\frac{\partial^2}{\partial y \partial x} = D_y D_x$  are symbols of operation.

29.  $\Delta y$  = increment,  $dy$  = differential.  $\delta y$  = variation.  $\sum_{i=a}^b$  = summation.

30.  $\dot{x} = dx/dt = v$ ;  $\ddot{x} = dv/dt$  (used only for differentiation with respect to the time  $t$ , and difficult to print).

31.  $\lim_{x \rightarrow a}(y) = b$ ;  $y \rightarrow b$  as  $x \rightarrow a$ . (Discourage  $\doteq$ .)

32.  $\int_a^b f(x) dx$ .  $F(x) \Big|_a^b = F(b) - F(a)$ .  $\iint f(x, y) dx dy = \int [\int f(x, y) dx] dy$ .

33.  $\pi = 3.1416 \dots$   $e = 2.718 \dots$   $i$  (or  $j$ ) =  $\sqrt{-1}$ .

34. If  $z = x + iy$ , then  $|z|$  = absolute value, or magnitude,  $\angle z$  = angle,  $R(z)$  and  $I(z)$  = real and imaginary parts,  $\bar{z}$  = conjugate of  $z$ . (Where  $\bar{z}$  is difficult to print, use  $\text{conj } z$ .)

### Special Functions

35. Bessel Functions. The notation used in G. N. Watson's Treatise, 1922, as endorsed by E. P. Adams in the Smithsonian Tables, 1922, is recommended.

36. Bernoulli numbers. Of the five or six different notations in use, the notation  $B_1, B_3, B_5, \dots$  has historical priority and many practical advantages, but the notation  $B_1, B_2, B_3, \dots$  is the one most used in recent years. To indicate what usage is being followed, authors will do well to state explicitly the value of the first few numbers, as  $B_1 = 1/6$ ,  $B_2 = 1/30$ ,  $B_3 = 1/42, \dots$

37.  $\gamma = 0.5772 \dots$  (Euler's constant.)

### Vector Analysis<sup>1</sup>

38. Vectors to be indicated in printed matter by letters in bold-face type, and in written manuscript by letters modified by a bar above

<sup>1</sup> NOTE: As to further questions of notation in Vector Analysis (including Tensor Analysis), the desirability of a thorough-going attempt to bring uniformity out of the present diversity of usage is recognized, and the appointment of a special committee to take up this subject has been recommended.

- (or by the doubling of some part of the character). The magnitude of a vector to be indicated in print by the corresponding italic letter, and in manuscript (when necessary) by the use of the absolute value signs,  $| |$ .
39. The scalar product, or dot product,  $= a \cdot b$ , the dot being centered. (Other notations are  $Sab$ , or  $(ab)$  in round parentheses.)
  40. The vector product, or cross product,  $= a \times b$ , the cross being small. (Other notations are  $Vab$ , or  $[ab]$  in square brackets.)
  41.  $i, j, k$  = unit vectors along the axes (right-handed system).

### Abbreviations

42. It is desirable to distinguish between (1) a "symbol," that is, a single letter or a single letter affected with subscripts, etc., which is to be used to represent a numerical value in a formula; and (2) an "abbreviation," which may consist of several letters, but is not intended to be substituted for a numerical quantity in a formula.
43. Abbreviations such as  $\text{ft}/\text{sec}^2$ ,  $\text{ft}\text{-lb}/\text{min}$ , etc., should not be further condensed, lest clearness be sacrificed to brevity.

NOTE: The recommendations concerning terms and symbols in elementary mathematics contained in Chapter 8 of the report on the Re-organization of Mathematics in Secondary Education, made in 1923 by the National Committee on Mathematical Requirements (under the auspices of the Mathematical Association of America and reprinted by Houghton Mifflin Company in 1927), are, with one or two unimportant exceptions, endorsed.

# LETTER SYMBOLS FOR ELECTRICAL QUANTITIES\*

(Adopted by the Board of Directors, American Institute of Electrical Engineers, October 18, 1928)

A.S.A. Z 10g1 1929

Name of Quantity	Symbol	Name of Quantity	Symbol
1. Admittance.....	$Y, y$	23. Frequency.....	$f$
2. Angular frequency.....	$\omega$	24. Impedance.....	$Z, z$
3. Angular velocity.....	$\omega$	25. Inductance.....	$L$
4. Capacitance.....	$C$	26. Magnetic intensity.....	$H$
5. Capacity, electrostatic (see capacitance)	$C$	27. Magnetic flux.....	$\Phi$
6. Conductance.....	$G, g$	28. Magnetic flux density..	$B$
7. Conductivity.....	$\gamma$	29. Magnetomotive force...	$\mathcal{F}$
8. Current.....	$I, i$	30. Mutual inductance.....	$M$
9. Difference of potential, electric (see note 4)...	$E, e$	31. Number of conductors or turns.....	$N$
10. Dielectric constant.....	$K$ or $\epsilon$	32. Permeability.....	$\mu$
11. Dielectric flux.....	$\Psi$	33. Permeance.....	$\mathcal{P}$
12. Dielectric flux density..	$D$	34. Permittance (see capaci- tance)	$\epsilon$
13. Efficiency.....	$\eta$	35. Period.....	$T$
14. Electric potential (see note 4).....	$E, e$	36. Permittivity (see di- electric constant)	$\epsilon$
15. Electrical tension (see voltage)	$E, e$	37. Phase displacement....	$\theta$ or $\phi$
16. Electromotive force....	$E, e$	38. Power.....	$P, p$
17. Electrostatic capacity (see capacitance)	$C$	39. Quantity, electric.....	$Q, q$
18. Electrostatic flux (see dielectric flux)	$\Psi$	40. Quantity of electricity.}	$Q, q$
19. Electrostatic flux density (see dielectric flux density)	$D$	41. Reactance.....	$X, x$
20. Energy.....	$W$	42. Resistance.....	$R, r$
21. Flux density, electro- static (see dielectric flux density)	$D$	43. Resistivity.....	$\rho$
22. Flux density, magnetic (see magnetic flux density)	$B$	44. Reluctance.....	$\mathcal{R}$
		45. Reluctivity.....	$\nu$
		46. Self-inductance.....	$L$
		47. Susceptance.....	$b$
		48. Speed of rotation.....	$n$
		49. Voltage.....	$E, e$
		50. Work.....	$W$

\* Approved as American Standard by the American Standards Association, February 5, 1929. Sponsors: American Association for the Advancement of Science, American Institute of Electrical Engineers, American Society of Civil Engineers, The American Society of Mechanical Engineers, Society for the Promotion of Engineering Education.

## NOTES:

1. Where distinctions between maximum, instantaneous, effective (root-mean-square), and average values are necessary,  $E_m$ ,  $I_m$ ,  $P_m$  are recommended for maximum values;  $e$ ,  $i$ ,  $p$  for instantaneous values,  $E$ ,  $I$  for effective (r. m. s.) values, and  $P$  for average value.

2. In accordance with the practise in other branches of engineering, it is recommended that quantities per unit volume, area, length, etc., be represented as far as practicable by lower-case letters corresponding to the capitals which represent the total quantities.

3. In print, vector or complex quantities should be represented by bold-face letters. In typing, overscoring may be used to indicate bold-face letters, (vectors).

4. Where a distinction between electromotive force and difference of electric potential is desirable, the symbols  $E$   $e$ , and  $V$   $v$ , respectively, may be used.

## Table of Preferred Numbers

Informally approved by the American Standards Association and recommended to industry for a period of trial in practice.

Preferred Numbers are the rounded geometric series with the ratios

$$\sqrt[5]{10} \text{ (5 series)}$$

$$\sqrt[10]{10} \text{ (10 series)}$$

$$\sqrt[20]{10} \text{ (20 series)}$$

$$\sqrt[40]{10} \text{ (40 series)}$$

The exponents thus give the number of terms in one order of magnitude, (that is between 1 and 10, 10 and 100, etc.)

In all length measurements, the numbers apply to the inch as the unit of length. With all other dimensions than lengths, the numbers apply to the unit forming the basis of the standardization.

Preferred Numbers above 10 inches are formed by multiplying the numbers between 1 and 10 in. by 10, 100, etc. Preferred Numbers below .001 in. are formed correspondingly by division of the numbers between .001 in. and .01 in. by 10, 100, etc. Between .001 and .01 in. the 20 series will probably serve as the finest gradation; the 40 series is therefore not given.

So far as possible the numbers of the 5 series are to be used in preference to those of the 10 series, these again in preference to those of the 20 series, and these finally to those of the 40 series. It is permissible to pass over from one series of Preferred Numbers to an adjacent series.

.001 to .01				.01 to .1	
5 Series	10 Series	20 Series	40 Series	5 Series	10 Series
.0010	.0010	.0010		.010	.010
		.0011			
	.0012	.0012			.012
		.0014			
.0016	.0016	.0016		.016	.016
		.0018			
	.0020	.0020			.020
		.0022			
.0025	.0025	.0025		.025	.025
		.0028			
	.0030	.0030			.030
		.0035			
.0040	.0040	.0040		.040	.040
		.0045			
	.0050	.0050			.050
		.0055			
.0060	.0060	.0060		.060	.060
		.0070			
	.0080	.0080			.080
		.0090			
.0100	.0100	.0100		.100	.100

## NOTES:

1. Where distinctions between maximum, instantaneous, effective (root-mean-square), and average values are necessary,  $E_m$ ,  $I_m$ ,  $P_m$  are recommended for maximum values;  $e$ ,  $i$ ,  $p$  for instantaneous values,  $E$ ,  $I$  for effective (r. m. s.) values, and  $P$  for average value.

2. In accordance with the practise in other branches of engineering, it is recommended that quantities per unit volume, area, length, etc., be represented as far as practicable by lower-case letters corresponding to the capitals which represent the total quantities.

3. In print, vector or complex quantities should be represented by bold-face letters. In typing, overscoring may be used to indicate bold-face letters, (vectors).

4. Where a distinction between electromotive force and difference of electric potential is desirable, the symbols  $\mathcal{E}$   $e$ , and  $\mathcal{V}$   $v$ , respectively, may be used.

# Table of Preferred Numbers

A.S.A.  
Z17-1927

Informally approved by the American Standards Association and recommended to industry for a period of trial in practice.

Preferred Numbers are the rounded geometric series with the ratios

$\sqrt[5]{10}$  (5 series)

$\sqrt[10]{10}$  (10 series)

$\sqrt[20]{10}$  (20 series)

$\sqrt[40]{10}$  (40 series)

The exponents thus give the number of terms in one order of magnitude, (that is between 1 and 10, 10 and 100, etc.)

In all length measurements, the numbers apply to the inch as the unit of length. With all other dimensions than lengths, the numbers apply to the unit forming the basis of the standardization.

Preferred Numbers above 10 inches are formed by multiplying the numbers between 1 and 10 in. by 10, 100, etc. Preferred Numbers below .001 in. are formed correspondingly by division of the numbers between .001 in. and .01 in. by 10, 100, etc. Between .001 and .01 in. the 20 series will probably serve as the finest gradation; the 40 series is therefore not given.

So far as possible the numbers of the 5 series are to be used in preference to those of the 10 series, these again in preference to those of the 20 series, and these finally to those of the 40 series. It is permissible to pass over from one series of Preferred Numbers to an adjacent series.

.001 to .01				.01 to .1			.1 to 1.0				1 to 10				Values to 5 Figures	Term No.	
5 Series	10 Series	20 Series	40 Series	5 Series	10 Series	20 Series	5 Series	10 Series	20 Series	40 Series	5 Series	10 Series	20 Series	40 Series			
.0010	.0010	.0010		.010	.010	.010	.10	.10	.10	.10	1	1	1	1	1.05	10592	1
		.0011				.011			.11	.11			1.12	1.12	1.12	11220	2
		.0012			.0125	.0125			.12	.12		1.25	1.25	1.25	1.18	11885	3
		.0014				.014			.125	.125		1.25	1.25	1.25	1.18	12589	4
		.0016			.016	.016			.13	.13			1.4	1.4	1.32	13335	5
		.0018				.018			.14	.14		1.6	1.6	1.4	1.4	14125	6
		.0020			.020	.020			.15	.15		1.6	1.6	1.6	1.5	14962	7
		.0022				.022			.16	.16		1.6	1.6	1.6	1.5	15849	8
		.0025			.025	.025			.16	.16		1.6	1.6	1.6	1.6	16788	9
		.0028				.028			.17	.17					1.7	17783	10
		.0030			.032	.032			.18	.18			1.8	1.8	1.8	18837	11
		.0035				.036			.19	.19		2.0	2.0	2.0	1.9	19953	12
		.0040			.040	.040			.20	.20		2.0	2.0	2.0	2.0	21135	13
		.0045				.045			.21	.21					2.1	22387	14
		.0050			.050	.050			.22	.22			2.25	2.25	2.25	23714	15
		.0055				.056			.24	.24		2.5	2.5	2.5	2.35	25119	16
		.0060			.064	.064			.25	.25		2.5	2.5	2.5	2.5	26608	17
		.0070				.072			.26	.26					2.65	28184	18
		.0080				.080			.28	.28			2.8	2.8	2.8	29854	19
		.0090				.090			.30	.30			3.2	3.2	3.0	31623	20
		.0100			.100	.100			.32	.32		3.2	3.2	3.2	3.2	33497	21
									.34	.34					3.4	35482	22
									.36	.36			3.6	3.6	3.6	37584	23
									.38	.38			4.0	4.0	3.8	39811	24
									.40	.40		4.0	4.0	4.0	4.0	42170	25
									.42	.42					4.25	44668	26
									.45	.45			4.5	4.5	4.5	47315	27
									.48	.48					4.75	50119	28
									.50	.50		5.0	5.0	5.0	5.0	53089	29
									.52	.52					5.3	56234	30
									.56	.56			5.6	5.6	5.6	59566	31
									.60	.60					6.0	63095	32
									.64	.64		6.4	6.4	6.4	6.4	66834	33
									.68	.68					6.8	70795	34
									.72	.72			7.2	7.2	7.2	74990	35
									.75	.75					7.6	79433	36
									.80	.80		8.0	8.0	8.0	8.0	84140	37
									.85	.85					8.5	89125	38
									.90	.90			9.0	9.0	9.0	94405	39
									.95	.95					9.5	100000	40
									1.00	1.00		10.0	10.0	10.0	10.0		

## NOTES:

1. Where distinctions between maximum, instantaneous, effective (root-mean-square), and average values are necessary,  $E_m$ ,  $I_m$ ,  $P_m$  are recommended for maximum values;  $e$ ,  $i$ ,  $p$  for instantaneous values,  $E$ ,  $I$  for effective (r. m. s.) values, and  $P$  for average value.

2. In accordance with the practise in other branches of engineering, it is recommended that quantities per unit volume, area, length, etc., be represented as far as practicable by lower-case letters corresponding to the capitals which represent the total quantities.

3. In print, vector or complex quantities should be represented by bold-face letters. In typing, overscoring may be used to indicate bold-face letters, (vectors).

4. Where a distinction between electromotive force and difference of electric potential is desirable, the symbols  $\mathcal{E}$   $e$ , and  $\mathcal{V}$   $v$ , respectively, may be used.

# Table of Preferred Numbers

A.S.A.  
Z17-1927

Informally approved by the American Standards Association and recommended to industry for a period of trial in practice.

Preferred Numbers are the rounded geometric series with the ratios

$\sqrt[5]{10}$  (5 series)

$\sqrt[10]{10}$  (10 series)

$\sqrt[20]{10}$  (20 series)

$\sqrt[40]{10}$  (40 series)

The exponents thus give the number of terms in one order of magnitude, (that is between 1 and 10, 10 and 100, etc.)

In all length measurements, the numbers apply to the inch as the unit of length. With all other dimensions than lengths, the numbers apply to the unit forming the basis of the standardization.

Preferred Numbers above 10 inches are formed by multiplying the numbers between 1 and 10 in. by 10, 100, etc. Preferred Numbers below .001 in. are formed correspondingly by division of the numbers between .001 in. and .01 in. by 10, 100, etc. Between .001 and .01 in. the 20 series will probably serve as the finest gradation; the 40 series is therefore not given.

So far as possible the numbers of the 5 series are to be used in preference to those of the 10 series, these again in preference to those of the 20 series, and these finally to those of the 40 series. It is permissible to pass over from one series of Preferred Numbers to an adjacent series.

.001 to .01				.01 to .1			.1 to 1.0				1 to 10				Values to 5 Figures	Term No.	
5 Series	10 Series	20 Series	40 Series	5 Series	10 Series	20 Series	5 Series	10 Series	20 Series	40 Series	5 Series	10 Series	20 Series	40 Series			
.0010	.0010	.0010		.010	.010	.010	.10	.10	.10	.10	1	1	1	1	1.05	10592	1
		.0011				.011			.11	.11			1.12	1.12	1.12	11220	2
		.0012			.0125	.0125			.12	.12		1.25	1.25	1.25	1.18	11885	3
		.0014				.014			.125	.125		1.25	1.25	1.25	1.18	12589	4
	.0016	.0016		.016	.016	.016	.16	.16	.13	.13		1.6	1.6	1.6	1.32	13335	5
		.0018				.018			.14	.14		1.6	1.6	1.6	1.4	14125	6
		.0020			.020	.020			.15	.15		1.6	1.6	1.6	1.5	14962	7
		.0022				.022			.16	.16	1.6	1.6	1.6	1.6	1.5	15849	8
	.0025	.0025		.025	.025	.025	.25	.25	.17	.17					1.7	16788	9
		.0028				.028			.18	.18			1.8	1.8	1.8	17783	10
		.0030			.032	.032			.19	.19		2.0	2.0	2.0	1.9	18837	11
		.0035				.036			.20	.20		2.0	2.0	2.0	2.0	19953	12
	.0040	.0040		.040	.040	.040	.40	.40	.21	.21					2.1	21135	13
		.0045				.045			.22	.22			2.25	2.25	2.25	22387	14
		.0050				.050			.24	.24		2.5	2.5	2.5	2.35	23714	15
		.0055				.056			.25	.25	2.5	2.5	2.5	2.5	2.5	25119	16
	.0060	.0060		.064	.064	.064	.64	.64	.26	.26					2.65	26608	17
		.0070				.072			.28	.28			2.8	2.8	2.8	28184	18
		.0080			.080	.080			.30	.30			3.2	3.2	3.0	29854	19
		.0090				.090			.32	.32		3.2	3.2	3.2	3.2	31623	20
		.0100				.100			.34	.34			3.6	3.6	3.4	33497	21
									.36	.36			3.6	3.6	3.6	35482	22
									.38	.38		4.0	4.0	4.0	3.8	37584	23
									.40	.40	4.0	4.0	4.0	4.0	4.0	39811	24
									.42	.42					4.25	42170	25
									.45	.45			4.5	4.5	4.5	44668	26
									.48	.48			4.75	4.75	4.75	47315	27
									.50	.50		5.0	5.0	5.0	5.0	50119	28
									.52	.52			5.0	5.0	5.3	53089	29
									.56	.56			5.6	5.6	5.6	56234	30
									.60	.60			6.0	6.0	6.0	59566	31
									.64	.64	6.4	6.4	6.4	6.4	6.4	63095	32
									.68	.68					6.8	66834	33
									.72	.72			7.2	7.2	7.2	70795	34
									.75	.75			8.0	8.0	7.6	74990	35
									.80	.80		8.0	8.0	8.0	8.0	79433	36
									.85	.85			8.0	8.0	8.5	84140	37
									.90	.90			9.0	9.0	9.0	89125	38
									.95	.95			9.0	9.5	9.5	94405	39
									1.00	1.00	10.0	10.0	10.0	10.0	10.0	100000	40

NOTES

1.  
(root-  
recom  
*E, I f*

2.  
it is r  
be rep  
to the

3.  
bold-f  
face l

4.  
of elec  
may k

# ELECTRICAL MEASURING INSTRUMENTS

(Adopted by the Board of Directors, American Institute of Electrical Engineers, December 10, 1926)  
(Effective April 1, 1927)

A.I.E.E.

No. 33; January, 1927

## SCOPE

The standards in this section apply to the following kinds of indicating electrical instruments for direct current and for alternating current:

- (1). Ammeters
- (2). Voltmeters
- (3). Wattmeters
- (4). Reactive Volt-Ampere Meters
- (5). Frequency Meters
- (6). Power-Factor, Reactive-Factor and Phase-Angle Meters
- (7). Synchrosopes

These standards are not intended to apply to indicating instruments provided with arrangements for curve drawing, contact making, etc. They do not apply to the following kinds of instruments:

- (a) Small instruments of types and sizes which are used where low cost is essential; for example, small polarized-vane ammeters used on automobiles, battery-charging outfits, etc.
- (b) Instruments constructed for very special requirements.

## DEFINITIONS

Definitions given herein apply specifically to the instruments treated in this section. They are included with all other standard definitions in a separate section.

### Instruments and Their Parts

**33-1 Instrument.**—An instrument is a measuring device which measures the present value of the quantity under observation. The term “instrument” is used in two different senses: (a) instrument proper as described below, and (b) to include not only the instrument proper but, in addition, any necessary apparatus, such as shunts, shunt leads, resistors, reactors, condensers, or instrument transformers.

- 33-2 **Mechanism.**—The mechanism is the arrangement for producing and controlling the motion of the pointer. It includes all the essential parts necessary to produce this result, but does not include the base, cover, scale, or any parts, such as series resistors or shunts, whose function is to make the indicated value of the measured quantity agree with the actual value.
- 33-3 **Moving Element.**—The moving element includes the pointer and the parts which move with it.
- 33-4 **Instrument Proper.**—The instrument proper is the mechanism and the scale, built into the case, including all devices (resistors, shunts, etc.) which are built into the case or non-removably attached to it. Examples: An instrument (ammeter) for 500 amperes direct current consists of the instrument proper (which may be thought of as essentially a millivoltmeter) together with a 500-ampere shunt and a pair of shunt leads. Another instrument (wattmeter) consists of the instrument proper (which is essentially a 5-ampere 110-volt wattmeter) together with a current transformer and a potential (voltage) transformer.
- 33-5 **Self-Contained Instrument.**—An instrument is said to be self-contained when all the necessary equipment is built into the case or non-removably attached to it.
- 33-6 **Current Circuit of an Instrument.**—The current circuit of an instrument is that winding of the instrument proper which carries the current to be measured, or a definite fraction of it, or a current dependent upon it.
- 33-7 **Voltage Circuit of an Instrument.**—The voltage circuit of an instrument is that winding of the instrument proper to which is applied the voltage to be measured, or a definite fraction of it, or a voltage dependent upon it.
- 33-8 **Series Resistor.**—A series resistor is a resistor in series with a circuit of an instrument. It usually refers to a resistor forming part of the voltage circuit.
- 33-9 **Multiplier.**—A multiplier is a particular type of series resistor which is used to extend the voltage range of an instrument beyond some particular value for which the instrument is already complete.
- 33-10 **Shunt.**—A shunt is a resistor connected in the circuit to be measured and in parallel with a current circuit of an instrument.

- 33-11 Reactor.**—A reactor is a device used for the purpose of introducing reactance, and usually has a high time-constant.
- 33-12 Shunt Leads.**—Shunt leads are leads which connect the current circuit of an instrument to the shunt.
- 33-13 Crest Voltmeter.**—A crest voltmeter is a voltmeter depending for its indications upon the crest, or maximum value of the voltage of the system to which it is connected. Crest voltmeters should be clearly marked on the instrument proper whether readings are in r. m. s. values or in true crest volts. It is preferred that the marking should be r. m. s. values of the sinusoidal wave having the same crest value.
- 33-14 Synchroscope.**—A synchroscope is a device which indicates synchronism between two machines, and in addition shows whether the incoming machine is fast or slow.
- 33-15 Line-Drop Voltmeter Compensator.**—A line-drop voltmeter compensator is a device used in connection with a voltmeter which causes the latter to indicate the voltage at some distant point of the circuit.

### Scales

- 33-16 Indication Range.**—The indication range is the range within which the electrical quantity (current, voltage, power, etc.) is to be indicated without reference to accuracy.
- 33-17 Measurement Range.**—The measurement range is that part of the indication range within which the requirements for accuracy are to be met.
- 33-18 Scale Length.**—The scale length is the length of the arc described by the end of the pointer in moving from the zero position to the end of the scale.

### Influences of Operating Conditions

- 33-19 Temperature Influence.\***—The temperature influence is defined as the percentage change in the indication which is caused solely by a difference in room temperature of  $\pm 10$  deg. cent. from the reference temperature (20 deg. cent.).

\* If the influences (referred to in 19, 20, and 21) above and below the normal conditions are not equal the greater value should be given.

- 33-20 Frequency Influence.\***—The frequency influence (in other than frequency meters) is defined as the percentage change in the indication which is caused solely by a change of  $\pm 10$  per cent from the rated frequency.
- 33-21 Voltage Influence.\***—The voltage influence (in other than voltmeters and wattmeters) is defined as the percentage change in the indication which is caused solely by a change of  $\pm 10$  per cent from the rated voltage.
- 33-22 External-Field Influence.**—The external-field influence is defined as the percentage change in the indication which is caused solely by an external field of an intensity of 5 gauss produced by a current of the same kind and frequency as that on which the instrument operates, with the most unfavorable phase and position of the external field.
- 33-23 Power-Factor Influence.**—The power-factor influence in wattmeters is defined as the percentage change of the indication which is caused solely by the lowering of the power-factor from unity to 0.50, current lagging, at the rated voltage and frequency.
- 33-24 Position Influence.**—The position influence, in other than gravity-controlled instruments, is defined as the maximum displacement of the pointer which is caused solely by an inclination of 30 deg. in any direction under the most unfavorable conditions as to position. It is to be expressed as a percentage of the scale length.

#### Miscellaneous Definitions

- 33-25 Period of an Instrument.**—The period of an instrument, sometimes called the "periodic time," is the time taken for the pointer to make one complete oscillation (two consecutive swings). A swing is a completed movement in either direction.
- 33-26 Damping.**—This is a term applied to instrument performance to denote the manner in which the pointer settles to its steady indication after a sudden change in the value of the measured quantity. Two general classes of damped motion are distinguished; namely, (a) periodic, in which the pointer oscillates about the final position before coming to rest; (b) aperiodic, in which the pointer comes to rest without overshooting the rest position. The point of change between periodic and aperiodic damping is called critical damping.

\* If the influences (referred to in 19, 20, and 21) above and below the normal conditions are not equal the greater value should be given.

**33-27 Damping Factor.**—Damping factor is the ratio of the angular deviations of the pointer in two successive swings from the position of equilibrium.

**33-28 Responsiveness.**—This term denotes the rapidity with which the pointer of an instrument comes to rest after a change in the value of the measured quantity. It may be measured by the reciprocal of the time in seconds for the pointer to come to rest after a change in the value of the measured quantity.

**33-29 Torque.**—The torque of an instrument is the turning moment produced by the electrical quantity to be measured acting through the mechanism. This is better termed the "deflecting torque," and in instruments having control systems is opposed by the controlling torque, which is the turning moment produced by the mechanism of the instrument tending to return the moving element to a fixed position. Torque is expressed in millimeter-grams. The particular value of the torque for the condition of full scale deflection should be designated "full scale torque" and should be accompanied by a statement of the angle corresponding to this deflection.

In instruments where the controlling torque is proportional to the deflection it is also convenient to state the torque in millimeter-grams per degree deflection computed from the torque at full scale. When the controlling torque is not proportional to the deflection it is desirable to state also the torque at points other than full scale.

**33-30 Restoring Torque.**—The restoring torque is the resultant of the electrical or electrical and mechanical torques tending to restore the moving element to any position of equilibrium when displaced from that position. It should be expressed as the rate of change in resultant turning moment in millimeter-grams per degree at that position.

The principle of restoring torque as here defined applies to any type of instrument and to any method of control such as spring or gravity control, or no mechanical control, as in power factor meters and this term is preferable to the use of the term torque as defined above since it is of universal application which is not the case with torque.

**33-31 Weight.**—The weight of a moving element includes one-half the weight of the springs, if any. It is to be expressed in grams.

**33-32 Error and Correction.**—The error of indication is the difference between the indication and the true value of the quantity being measured. It is the quantity which must be algebraically subtracted from the indication to get the true value. A positive error denotes that the indication of the instrument is greater than the true value.

The correction has the same numerical value as the error of indication, but the opposite sign. It is the quantity which must be algebraically added to the indication to get the true value. If  $T$ ,  $I$ ,  $E$  and  $C$  represent respectively the true value, the indicated value, the error, and the correction, the following equations hold:

$$E = I - T$$

$$C = T - I$$

Example: A voltmeter reads 112 volts when the voltage applied to its terminals is actually 110 volts.

Then,

$$\text{Error} = 112 - 110 = +2 \text{ volts}$$

$$\text{Correction} = 110 - 112 = -2 \text{ volts}$$

**33-33 Accuracy of Indicating Instruments.**—In specifying the accuracy of an indicating instrument the limits of error at any point on the scale shall be expressed as a percentage of the full scale reading.

#### Classification

**33-34** Electrical instruments may be classified as follows:

A. As to Use:

- (a) Portable instruments
- (b) Switchboard instruments

B. As to Principle of Operation

- (a) Electrodynamic (dynamometer)
- (b) Permanent-magnet moving coil\*
- (c) Moving-iron
  - (1) Plunger
  - (2) Vane
  - (3) Repulsion
- (d) Induction

\* Instead of "permanent-magnet moving coil" the following terms were suggested: "d' Arsonval"; "fixed-field."

- (e) Electrothermic
  - (1) Expansion
  - (2) Thermocouple
- (f) Electrostatic

C. As to Kind of Protection:

- (a) Dust-proof
- (b) Moisture-proof
- (c) Rust-resisting
- (d) Water-tight (submersible).

The terms "portable" and "switchboard" are self-defining. A third classification as to use is suggested, namely, "laboratory-standard."

- 33-35 In electrodynamic (dynamometer) instruments one or more coils move within the field produced by a fixed coil or coils.
- 33-36 In permanent-magnet moving-coil instruments a coil moves within the field of a permanent magnet.
- 33-37 In moving-iron instruments one or several pieces of soft iron are caused to move by the magnetic field of a fixed coil or coil system. Various forms of this instrument (plunger, vane, repulsion) are distinguished chiefly by mechanical features of construction.
- 33-38 In induction instruments the torque is produced by fixed coils acting upon moving conducting parts (disks, drums, etc.) in which currents are produced by electromagnetic induction.
- 33-39 Electrothermic instruments depend for their operation on the heating effect of a current. Two distinct types are (a) the expansion type, including the "hot-wire" and "hot-strip" instruments; (b) the thermocouple type, where one or more thermocouples which are heated directly or indirectly by the passage of a current supply a direct current which flows through the coil of a suitable direct-current mechanism, such as one of the permanent-magnet moving-coil type.
- 33-40 Electrostatic instruments depend for their operation on the forces of attraction and repulsion between bodies charged with electricity.
- 33-41 A dust-proof instrument is provided with a case which excludes dust from the mechanism.
- 33-42 A moisture-proof instrument is one in which moisture is excluded from the mechanism, or which is so constructed that moisture will not damage the mechanism.

- 33-43 A rust-resisting instrument is one whose case and parts are made of rust-resisting materials, or are specially finished to resist the corrosive effects of moist air.
- 33-44 A water-tight (submersible) case withstands for one hour complete immersion in a tank containing sufficient water to cover all parts to a depth of at least three feet, without any visible trace of penetration of water into the interior.

#### RATING

- 33-100 Rating of an Instrument.—The rating of an instrument is a designation assigned by the manufacturer to indicate its operating limitations. The full-scale marking of an instrument does not necessarily correspond to its rating.
- 33-101 Rating of the Circuits of an Instrument.—The rating of the circuits of an instrument shall be equal to, or less than, the maximum current or voltage to which they may be continuously subjected without exceeding the permissible temperature rises.

#### HEATING

##### Temperature Limitations

- 33-150 Limiting Temperature Rise of Instrument Windings.—The temperature rises of the windings of instruments shall not exceed the values given in the following table for the class of insulation and the method of temperature determination employed.

TABLE I

Method of Temperature Determination to be Employed	Limit of Observable Temperature Rise in Deg. Cent.		
	Class O Insulation See par. 33-152	Class A Insulation See par. 33-153	Class B Insulation See par. 33-154
Thermometer	35	50	70
Resistance	40	55	75

- 33-151 Limiting Temperature Rise of Shunts.\*—The temperature rise of shunts shall not exceed 80 deg. cent. determined by the Thermometer Method.

\* The temperature rise of a shunt is largely dependent upon the bus bars connected to it and provision should be made to eliminate excessive temperature rise from this source.

Exception: This rule shall not apply to shunts having no soldered joints and made of material which is not permanently changed in resistivity if continuously subjected to a higher temperature.

**33-152 Class O Insulation Defined.**—Class O insulation consists of cotton, silk, paper and similar organic materials when neither impregnated\* nor immersed in oil.

**33-153 Class A Insulation Defined.**—Class A insulation consists of cotton, silk, paper and similar organic materials when impregnated\* or immersed in oil; also enamel as applied to conductors.

**33-154 Class B Insulation Defined.**—Class B insulation consists of inorganic materials such as mica and asbestos in built-up form combined with binding substances. If Class A material is used in small quantities in conjunction for structural purposes only, the combined material may be considered as Class B, provided the electrical and mechanical properties of the insulated winding are not impaired by the application of the temperature permitted for Class B material. (The word "impair" is here used in the sense of causing any change which could disqualify the insulating material for continuous service.)

**33-155 Thermometer Method of Temperature Determination Defined.**—This method consists in the determination of the temperature, by mercury or alcohol thermometers, by resistance thermometers or by thermocouples, any of these instruments being applied to the hottest part of the instrument accessible to mercury or alcohol thermometers.

**33-156 Resistance Method of Temperature Determination Defined.**—This method consists in the determination of temperature by comparison of the resistance of the winding at the temperature to be determined with the resistance at a known temperature.

\* Impregnated Cotton, Paper or Silk—An insulation is considered to be "impregnated" when a suitable substance replaces the air between its fibers, even if this substance does not completely fill the spaces between the insulated conductors. The impregnating substance, in order to be considered suitable, must have good insulating properties; must entirely cover the fibers and render them adherent to each other and to the conductor; must not produce interstices within itself as a consequence of evaporation of the solvent or through any other cause; must not flow during the operation of the machine at full working load or at the temperature limit specified; must not deteriorate under prolonged action of heat.

**33-157 Determination of the Mean Temperature of a Copper Winding by Measurement of its Electrical Resistance when there is known the Resistance at some Reference Temperature.**

Let  $t$  be the reference temperature

$r$  be the resistance at the reference temperature

$R$  be the observed resistance

Then  $T$  (the temperature sought\*)

$$= \frac{R}{r}(234.5 + t) - 234.5$$

#### CHARACTERISTICS

**33-200 Reference Temperature.**—The standard temperature of reference for instrument characteristics shall be 20 deg. cent.

#### Influences of Operating Conditions

In determining the influences of operating conditions (except position influence), ammeters and voltmeters should be tested with rated current or voltage respectively. Wattmeters should be tested with rated voltage and such a current (not exceeding the rated current) as will give a suitable deflection, preferably not less than that corresponding to one-half of the maximum reading. Frequency meters (except in the test for voltage influence) should be tested at rated voltage. Power-factor meters and reactive-factor meters should be tested with rated voltage and rated current at unity power factor.

**33-201 Instrument Calibrations by the Manufacturer and Acceptance Tests by the Purchaser** should be based on the legalized international electrical units.

#### DIELECTRIC TEST

**33-250 Standard Test Voltage.**—The standard test voltage for instruments having a voltage circuit not exceeding 750 volts with or without external resistors shall be twice the rated voltage of the combination, plus 1000 volts. The standard test voltage for in-

\* This formula is derived from the experimentally determined relation between temperature and resistance of copper:

$$\frac{R}{r} = \frac{234.5 + T}{234.5 + t}$$

The temperature rise is the difference between the calculated temperature  $T$  and the temperature of the cooling medium at time of test.

struments without voltage circuits shall be 1000 volts. Test shall be made with alternating current as described in 33-254.

The test between current circuit and voltage circuit (where both exist) of an instrument shall be taken care of under the test prescribed for insulation resistance. (See paragraph 33-300.)

**33-251 Duration of Application of Test Voltage.**—The test voltage shall be applied continuously for a period of 60 seconds.

**33-252 Condition of Instrument to be Tested.**—Dielectric tests shall be made on finished instruments.

**33-253 Points of Application of Test Voltage.**—The test voltage shall be applied between all electrical circuits connected together and other metal parts grounded.

**33-254 Frequency and Wave Shape of Test Voltage.**—The frequency of the test voltage shall be not less than 15 cycles nor more than 65 cycles. A sine wave shape is recommended. The voltage wave shall have a crest value equal to  $\sqrt{2}$  times the specified test voltage.

#### INSULATION RESISTANCE

**33-300 Insulation Resistance.**—The insulation resistance between all the electrical circuits of the instrument connected together and the case shall not be less than 20 megohms. The insulation resistance between the current circuit and the voltage circuit of an instrument (where both exist) shall be not less than 5 megohms. These tests shall be made with 500 volts direct current.

When instruments are specified to have one or more of the circuits internally connected to the case, the necessary exceptions to these requirements are allowed.

#### CONSTRUCTION

**33-350 General.**—The construction of electrical instruments shall be mechanically sound, suitable to their class and purpose and shall be such as to give assurance of permanence in the accuracy of the indications. All materials must be suitable for the purpose for which they are used.

**33-351 Scale and Pointer.**—The preferred value of each scale division should be either 1, 2 or 5 of the units measured or any decimal multiple or submultiple of these numbers. In the case of multiple-range instruments exceptions to this rule may be necessary, but should be avoided where reasonably possible.

The angle subtended by a scale division shall preferably not be less than 0.5 degree in portable instruments, or 1 degree in switch-board instruments. When smaller angles are used the legibility is decreased.

The numbers marked on the scale, except in the lower part of non-uniform scales, shall preferably be by steps of 1, 2 or 5, or a decimal multiple or submultiple of any of these numbers. The figures shall be of such shape as to minimize the risk of different figures being confused with one another and shall be so spaced as to render individual numbers clearly distinguishable from adjacent numbers.

**33-352 External Shunts.**—The main terminals of the shunt shall be so constructed that slight variations in the manner of connecting it in the circuit (such as might occur in an average workmanlike installation) shall not alter the indication of the instrument by more than 0.25 per cent.

The thermal electromotive force produced by continuous operation of the shunt at rated current shall not exceed the value which would cause a change in the reading (at rated current) of 0.25 per cent. The connections to the circuit should be made so that the opportunity for the escape of heat will be the same at both terminals.

**33-353 Marking.**—The instrument shall be distinctly marked with the following particulars in such a way that they will be visible from the front of the case: Name (or symbol) of manufacturer; serial number; designation of the quantity measured; the words "direct-current" or "alternating-current" or their abbreviations; the rated current, voltage or frequency (or the ranges of these quantities) or such of these as apply; the maximum current and voltage, in the case of wattmeters, power-factor meters, and reactive-volt-ampere meters. Of these, only the scale marking itself and the designation of the quantity measured shall be conspicuous.

In the case of alternating-current instruments the following additional items are required: Ratio of the appropriate current transformer expressed thus: 1200:5 or 1200/5; ratio of the appropriate potential (voltage) transformer expressed thus: 6600:110 or 6600/110.

Instruments having separate shunts shall also be marked with the millivolt drop of the shunt with which they are to be used, corresponding to full-scale deflection.

Instruments having separate shunts or series resistors should be marked to indicate this fact.

Separate shunts, if not interchangeable, shall be marked as follows: Name (or symbol) of manufacturer; serial number of the instrument with which it was calibrated; the line current corresponding to full-scale deflection of the instrument; the rated current, if this is less than the preceding, and the millivolt drop at rated current. When the shunts are designed to be used with devices taking sufficient current to be an appreciable proportion of the whole, this fact shall be indicated.

Interchangeable separate shunts shall bear the above markings, except that the serial number may be omitted.

If the rating of an instrument differs from the full-scale marking, the rating shall be marked on the instrument proper.

## TELEPHONY AND TELEGRAPHY

(Adopted by the Board of Directors, American Institute of Electrical Engineers, June 29, 1922)

A. I. E. E.

No. 34; June, 1922

### DEFINITIONS

**34-1 General.**—Many of the following definitions are tentative and not yet fully established. Some of the definitions are specific to telephony, and differ in detail from similar definitions appearing in other sections of the rules.

### Line Circuits

- 34-2 Ground-Return Circuit.**—A ground-return circuit is a circuit consisting of one or more metallic conductors in parallel, with the circuit completed through the earth.
- 34-3 Metallic Circuit.**—A metallic circuit is a circuit of which the earth forms no part.
- 34-4 Two-Wire Circuit.**—A two-wire circuit is a metallic circuit formed by two parallel conductors insulated from each other.
- 34-5 Superposed Circuit.**—A superposed circuit is an additional circuit obtained from a circuit normally required for another service, and in such a manner that the two services can be given simultaneously without mutual interference.
- 34-6 Phantom Circuit.**—A phantom circuit is a superposed circuit, each side of which consists of the two conductors of a two-wire circuit in parallel.
- 34-7 Side Circuit.**—A side circuit is a two-wire circuit forming one side of a phantom circuit.
- 34-8 Non-Phantom Circuit.**—A non-phantomed circuit is a two-wire circuit, which is not arranged for use as the side of a phantom circuit.
- 34-9 Simplex Circuit.**—A simplex circuit is a two-wire telephone circuit, arranged for the superposition of a single ground-return signaling circuit operating over the wires in parallel.
- 34-10 Compositing Circuit.**—A compositing circuit is a two-wire telephone circuit, arranged for the superposition on each of its component metallic conductors, of a single independent ground-return signaling circuit.

- 34-11 **Quadded or Phantomed Cable.**—A quadded or phantomed cable is a cable adapted for the use of phantom circuits.
- 34-12 **Simplex Circuit.**—A simplex circuit in telegraphy is one arranged for operation in one direction at one time.
- 34-13 **Duplex Circuit.**—A duplex circuit in telegraphy is one arranged for simultaneous operation in opposite directions.
- 34-14 **Diplex Circuit.**—A diplex circuit in telegraphy is one arranged for the simultaneous transmission of two messages in the same direction.
- 34-15 **Quadruplex Circuit.**—A quadruplex circuit in telegraphy is one arranged for the simultaneous transmission of two messages in each direction.
- 34-16 **Multiplex Circuit.**—A multiplex circuit in telegraphy is one arranged for the simultaneous transmission of one or more messages in both directions. Both duplex and quadruplex are examples of multiplex whereas diplex is not.
- 34-17 **Linear Electrical Constants.**—The linear electrical constants of a line are the electrical constants per unit length of the line, *e.g.* linear resistance, linear inductance, etc.
- 34-18 **Smooth Line.**—A smooth line is a line whose electric elements are all continuously and uniformly distributed throughout its length.
- 34-19\* **Periodic Line.**—A periodic line is a line consisting of successive similar sections in each of which one or more electric elements are not distributed uniformly. As examples of periodic lines are (1) loaded lines and (2) artificial lines consisting of successive similar sections of lumped constants.
- 34-20 **Equivalent Smooth Line.**—An equivalent smooth line of a periodic line is a smooth line having the same electrical behavior as the periodic line, at a given single frequency, when measured at terminals or at corresponding section junctions.
- 34-21 **Equivalent Periodic Line.**—An equivalent periodic line of a smooth line is a periodic line having the same electrical behavior, for an assumed single frequency, as the smooth line, when measured at terminals or at corresponding section junctions. The terms conjugate smooth line and conjugate periodic line are also sometimes used.

\* (19) The term periodic in this definition refers to the line constants and not to time relations.

- 34-22 **Composite Line.**—A composite line is a line consisting of a plurality of successive sections having different linear electrical constants, as in the case where an underground cable section is joined to an overhead open-wire section.
- 34-23 **Loaded Line.**—A loaded line is one in which the normal reactance of the circuit has been altered for the purpose of increasing its transmission efficiency.
- 34-24 **Series Loaded Line.**—A series loaded line is one in which the normal reactance has been altered by reactance serially applied.
- 34-25 **Shunt Loaded Line.**—A shunt loaded line is one in which the normal reactance of the circuit has been altered by reactance applied in shunt across the circuit.
- 34-26 **Continuous Loading.**—A continuous loading is a series loading in which the added inductance is uniformly distributed along the conductors.
- 34-27\* **Coil Loading.**—A coil loading is one in which the normal inductance is altered by the insertion of lumped inductance in the circuit at intervals.

#### Circuit Constants and Characteristics

- 34-28 **Damping of a Circuit.**—The damping at a given point in a circuit from which the source of energy has been withdrawn, is the progressive diminution in the effective value of electromotive force and current at that point resulting from the withdrawal of electrical energy.
- 34-29\* **Damping Constant.**—The damping constant of a circuit is a measure of the ratio of the dissipative to the reactive component of its admittance or impedance.

\* (27) This lumped inductance may be applied either in series or in shunt.

As commonly understood, coil loading is a series loading, in which the lumped inductance is applied at uniformly spaced recurring intervals.

\* (29) Applied to the admittance of a condenser or other simple circuit having capacity reactance, the damping constant for a harmonic electromotive force of given frequency is the ratio of the conductance  $G$ , of the condenser or simple circuit at that frequency to twice the capacitance,  $C$ , of the condenser at the same frequency,  $(G/2 C)$ .

Applied to the reactance of a coil or other simple circuit having inductive reactance, the damping constant for a harmonic current of a given frequency is the ratio of the resistance,  $R$ , of the coil or circuit at that frequency to twice the inductance,  $L$ , at the same frequency,  $(R/2 L)$ .

**34-30\* Mutual Impedance.**—The mutual impedance for single frequency alternating currents, between a pair of terminals and a second pair of terminals of a network, under any given condition, is the negative ratio of the electromotive force produced between either pair of terminals on open circuit to the current flowing between the other pair of terminals.

**34-31\* Self-Impedance.**—The self-impedance between a pair of terminals of a network, under any given condition, is the ratio of the electromotive force applied across the terminals to the entering current.

**34-32\* Characteristic Impedance.**—The characteristic impedance of a line is the ratio of the applied electromotive force to the resulting steady-state current upon a line of infinite length and uniform structure, or of periodic recurrent structure.

**34-33\* Sending-End Impedance.**—The sending-end impedance of a line is the ratio of the applied electromotive force to the resulting steady-state current at the point where the electromotive force is applied.

**34-34\* Propagation Constant.**—The propagation constant of a uniform line, or section of a line of periodic recurrent structure, is the natural logarithm of the ratio of the steady-state currents at various points separated by unit length in a uniform line of infinite length, or at successive corresponding points in a line of recurrent

\* (30) A receiving-end impedance is an example of a mutual impedance.

Single frequency voltages and currents are here supposed to be represented by complex numbers. Their ratio is therefore a complex number.

\* (31) Single frequency voltages and currents are here supposed to be represented by complex numbers. Their ratio is therefore a complex number.

\* (32) In practise, the terms (1) line impedance, (2) surge impedance, (3) iterative impedance, (4) sending-end impedance, (5) initial sending-end impedance, (6) final sending-end impedance, (7) natural impedance and (8) free impedance, have apparently been more or less indefinitely and indiscriminately used as synonyms with what is here defined as "characteristic impedance."

Single frequency voltages and currents are here supposed to be represented by complex numbers. Their ratio is therefore a complex number.

\* (33) See note under "Characteristic Impedance." In case the line is of infinite length of uniform structure or of periodic recurrent structure, the sending-end impedance and the characteristic impedance are the same.

Single frequency voltages and currents are here supposed to be represented by complex numbers. Their ratio is therefore a complex number.

\* (34) Single frequency voltages and currents are here supposed to be represented by complex numbers. Their ratio is therefore a complex number.

structure of infinite length. The ratio is determined by dividing the value of the current at the point nearer the transmitting end by the value of the current at the point more remote.

- 34-35 Attenuation Constant.**—The attenuation constant for a single frequency is the real part of the propagation constant taken at that frequency.
- 34-36 Wavelength Constant.**—The wavelength constant is the imaginary part of the propagation constant.
- 34-37 Standard Cable.**—A standard cable is an ideal uniform line in terms of which the attenuation of a line or network may be specified. It is characterized by the following constants: Linear resistance, 88 ohms per loop mile (54.7 ohms per loop km.). Linear capacitance between wires 0.054 microfarad per loop mile (0.03355 microfarad per loop km.). Linear inductance and linear leakance, 0.

### Equivalent Circuits

- 34-38\* Equivalent Circuit.**—An equivalent circuit is a simple network of series and shunt impedances, which, at a given frequency, is the approximate electrical equivalent of a complex network.
- 34-39\* "T" Equivalent Circuit.**—A "T" equivalent circuit is a triple-star or "Y" connection of three impedances externally equivalent to a complex network. See Fig. 1 for symbol.

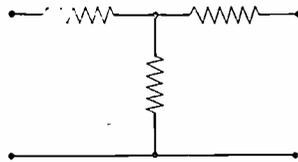

Fig. 1

- 34-40\* "I" Equivalent Circuit.**—An "I" equivalent circuit is a connection of five impedances in the form shown in Fig. 2, which is externally equivalent to a complex network. It differs from the

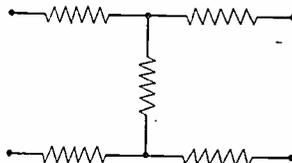

Fig. 2

\* (38 to 40) As ordinarily considered, the simple networks as defined are the electrical equivalents of complex networks only with respect to definite pairs of terminals.

"*T*" equivalent circuit in that the impedances are arranged symmetrically on the two sides of the circuit, which is often desirable in connection with practical problems, as indicating that the circuit is balanced with respect to ground.

34-41\* "*II*" Equivalent Circuit.—A "*II*" equivalent circuit is a delta connection of three impedances externally equivalent to a complex network. It is also called a "*U*" equivalent circuit. See Fig. 3 for symbol.

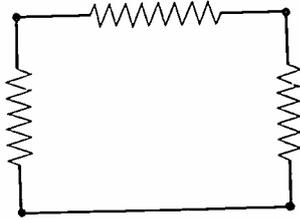

Fig. 3

34-42\* "*O*" Equivalent Circuit.—An "*O*" equivalent circuit is a connection of four impedances in the form shown in Fig. 4, externally equivalent to a complex network. It differs from the *II* equivalent circuit in that the impedances are arranged symmetrically on the

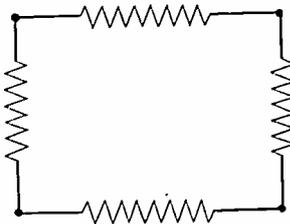

Fig. 4

two sides of the circuit, which is often desirable in connection with practical problems, as indicating that the circuit is balanced with respect to ground.

### Telephony

34-43 Manual Telephone System.—A manual telephone system is one in which the calling party gives his order to an operator who completes the call directly by hand, either with or without the assistance of one or more additional operators.

\* (41 to 42) As ordinarily considered, the simple networks as defined are the electrical equivalents of complex networks only with respect to definite pairs of terminals.

- 34-44 Automatic or Full Mechanical Telephone System.**—An automatic or full mechanical telephone system is one in which the calling party is enabled to complete a call by remote-control switches without the aid of an operator.
- 34-45 Semi-Automatic or Semi-Mechanical Telephone System.**—A semi-automatic or semi-mechanical telephone system is one in which the calling party gives his order to an operator who completes the call through remote-control switches.
- 34-46 Telephone Exchange.**—A telephone exchange consists of one or more central offices with associated plant, by means of which telephone service is rendered in a specified local community.
- 34-47 Telephone Exchange Area or District.**—A telephone exchange area or district is the area or district served by a telephone exchange.
- 34-48 Central Office (British "Exchange").**—A central office is a switching center for inter-connecting lines terminating therein.
- 34-49 Toll Central Office.**—A toll central office is one in which toll and long distance lines terminate.
- 34-50 Local Central Office.**—A local central office is one in which subscriber's lines terminate.
- 34-51 Private Branch Exchange (Generally Abbreviated "P. B. X.").**  
—A private branch exchange is a telephone system generally installed on the premises of a subscriber, including a switchboard and extension sets, and connected to a central office, affording intercommunication between the extension sets and also between these sets and the central office.
- 34-52 Private Exchange.**—A private exchange is one which serves one business organization or individual, and is not connected to a central office.
- 34-53 Private Automatic Exchange.**—A private automatic exchange is an automatic exchange which serves one business organization or individual, and is not connected to a central office.
- 34-54 Subscriber Set (Often Abbreviated to "Subset").** A subscriber set is an assembly of apparatus for sending and receiving telephone calls.
- 34-55 Subscriber Station (Often Abbreviated to "Substation").**—A subscriber station is an installed subscriber set connected to a central office for the purpose of sending and receiving telephone calls.
- 34-56 Pay Station (British "Public Call Office").**—A pay station is a subscriber station available for the use of the public on the pay-

ment of a fee. The fee may be either deposited in a coin box or paid to an attendant.

- 34-57 Toll Station.—A toll station is a pay station located outside of a local service area and affording toll and long distance service only.
- 34-58 Subscriber Line or Subscriber Loop.—A subscriber line or subscriber loop is the wire connection between a subscriber station and the central office.
- 34-59 Subscriber Line Circuit.—A subscriber line circuit is a subscriber line with its associated individual central office apparatus.
- 34-60 Individual Line (British "Direct Line").—An individual line is a subscriber line which connects one subscriber station to a central office, though it may have one or more extension sets.
- 34-61 Party Line.—A party line is a subscriber line which connects two or more subscriber stations to a central office.
- 34-62 Tip Side or Tip Wire, Ring Side or Ring Wire.—The tip side or wire, or the ring side or wire, is that conductor of a circuit which is associated with the corresponding member of a jack.
- 34-63 Negative Side or Negative Wire, Positive Side or Positive Wire.—The negative side or wire, or the positive side or wire, is that conductor of a circuit which is normally connected to the corresponding pole of a battery.
- 34-64 Main Distributing Frame.—A main distributing frame is a structure for terminating the permanent inside and outside wires of a central office and for effecting flexible junctions between them. It generally carries the central office protective devices and functions as a test point between line and office.
- 34-65 Intermediate Distributing Frame.—An intermediate distributing frame is a structure for terminating permanent inside wires of a central office and for effecting flexible junctions between them.
- 34-66 Switchboard.—A switchboard is an assemblage of apparatus in a coordinate structure for switching talking and signaling circuits.
- 34-67 Switchboard Section.—A switchboard section is an element or unit one or more of which constitutes a complete manual switchboard.
- 34-68 Operating Room.—An operating room is a room which contains a manual switchboard and associated apparatus.
- 34-69 Combination Current.—A combination current consists of two or more currents of different characteristics in the same circuit. As ordinarily used the term refers to currents whose characteristics are steadily maintained, as for example, a combination of direct current and an alternating current.

- 34-70 **Manual Ringing.**—Manual ringing is ringing which is affected by and continues with the operation of a key.
- 34-71 **Machine Ringing.**—Machine ringing is intermittent and is caused to act periodically by the apparatus itself.
- 34-72 **Superimposed Ringing Current.**—A superimposed ringing current is a combination current for ringing, consisting of a direct and an alternating current.
- 34-73 **Pulsating Ringing Current.**—A pulsating ringing current is a current for ringing in which the succeeding impulses are separated by intervals approximately equal to those of the impulses themselves.
- 34-74 **Harmonic Selective Signaling.**—Harmonic selective signaling employs devices tuned mechanically or electrically to the frequency of the ringing current, so that each device will not operate when receiving current intended to operate another device.
- 34-75 **Multiple Harmonic Signaling.**—Multiple harmonic signaling employs frequencies which are integral multiples of the lowest frequency.
- 34-76 **Non-Multiple Harmonic Signaling.**—Non-multiple harmonic signaling employs frequencies which are not integral multiples of the lowest frequency.
- 34-77 **“To Call.”**—“To call” is to originate a telephone call.
- 34-78 **“To Dial.”**—“To dial” a number is to use a dial type of calling device in order to control automatic switches.
- 34-79 **“To Set Up.”**—“To set up” a number is to use a key type or multiple lever type of calling device in order to control automatic switches.
- 34-80 **Calling Device.**—A calling device is an apparatus by means of which automatic switches are controlled for the purpose of establishing a connection.
- 34-81 **Calling Party.**—A calling party is a person who originates a telephone call.
- 34-82 **Called Party.**—A called party is the person who answers when a station is called.
- 34-83 **Reverting Call.**—A reverting call is one between two stations on the same subscriber line.

- 34-84 Telephone Traffic.—Telephone traffic is the aggregate volume of communication handled in a given time.
- 34-85 "Busy."—"Busy" is the condition of a line or an apparatus when it is in use.
- 34-86 Free.—Free is the condition of a line or an apparatus when it is not in use. Free is the opposite of busy.
- 34-87 "To Make Busy."—"To make busy" is to cause a line or an apparatus to appear to be busy.
- 34-88 "To Release" or "To Disconnect."—"To release" or "to disconnect" is to terminate a telephone connection by disengaging the apparatus.
- 34-89 "To Clear."—"To clear" is to restore a line or an apparatus to the free condition.
- 34-90 Trunk.—A trunk is the wire connection between switching devices or central offices.
- 34-91 Trunk Circuit.—A trunk circuit is a trunk with its associated individual apparatus.
- 34-92 Trunked Call.—A trunked call is one which employs an inter-office trunk or a trunk between two switchboard positions.
- 34-93 Relay.—A relay is a device by means of which contacts in one circuit are operated by a change in conditions in the same circuit or in one or more associated circuits.
- 34-94 Polar Relay.—A polar relay is a relay which operates in response to a change in the direction of the current in the controlling circuit.
- 34-95 Quick Operating Relay.—A quick operating relay is one which operates its contacts within a specified brief time limit.
- 34-96 Quick Release Relay.—A quick release relay is one which releases its contacts within a specified brief time limit.
- 34-97 Quick Acting Relay.—A quick acting relay is one which has the properties of both a quick operating and a quick release relay.
- 34-98 Slow Operating Relay.—A slow operating relay is one which will not operate until after a specified delay.
- 34-99 Slow Release Relay.—A slow release relay is one which when operated will not release until after a specified delay.
- 34-100 Slow Acting Relay.—A slow acting relay is one which has the properties of both a slow operating and a slow release relay.

- 34-101 **Line Relay.**—A line relay is one whose coil is normally in the line circuit.
- 34-102 **Cut-Off Relay.**—A cut-off relay is one which when operated disconnects from a line apparatus normally connected to it.
- 34-103 **Relay Coil Section.**—A relay coil section is one of two or more windings of a coil on one and the same core. The several sections may be concentric or placed side by side on the core.
- 34-104 **Tension Spring.**—A tension spring is one which functions to exert mechanical pressure but does not carry an electrical current.
- 34-105 **Contact Spring.**—A contact spring is one which takes an electrical part in switching a circuit.
- 34-106 **Main Contact Spring.**—A main contact spring is one which may switch a circuit between two or more other contact springs.
- 34-107 **Armature Spring.**—An armature spring is the first of a group to be moved by the armature. It may or may not be a main contact spring.
- 34-108 **Plunger Spring.**—A plunger spring is the first of a group to be moved by the plunger.
- 34-109 **Impulse Springs.**—Impulse springs are those which act to make or break a circuit for the purpose of sending impulses.
- 34-110 **Make-Before-Break Contact Springs (Abbreviation "M. B. B.")**.—Make-before-break contact springs are those in which the main spring touches the front contact before it breaks away from the back contact. Also called a continuity preserving contact.
- 34-111 **Back Contact Spring.**—A back contact spring is one against which the main contact spring rests when in the normal position.
- 34-112 **Front Contact Spring.**—A front contact spring is one against which the main contact spring rests when in the operated position.
- 34-113 **Automatic Signaling.**—Automatic signaling is effected without the aid of an operator.
- 34-114 **Automatic Switch.**—An automatic switch is a remote control device for controlling talking or signaling circuits.
- 34-115 **Finder Switch.**—A finder switch is a switch connected to one of a smaller number of circuits and which finds automatically a circuit out of a larger number of circuits from whence the signal comes.

- 34-116 **Line Switch.**—A line switch is a switch connected to one of a larger number of circuits from which a signal comes which finds automatically a circuit out of a smaller number of circuits.
- 34-117 **Selector Switch.**—A selector switch is a switch whose duty is to select a particular group of trunks and one trunk of the group selected. In particular cases, one of these functions may be omitted.
- 34-118 **Connector Switch or Final Selector.**—A connector switch or final selector is a switch whose duty is to establish a connection with the called line. It is usually operated by the last digit or digits of the call number.
- 34-119 **Switch Frame.**—A switch frame is a structure for mounting an assembly of switching apparatus which may be integral therewith.
- 34-120 **Section of Switches.**—A section of switches, considered from a trunking standpoint, is a group of adjacent switches whose banks are multiplied together.
- 34-121 **Switchroom.**—A switchroom is a room which contains an assemblage of automatic switches and associated apparatus.
- 34-122 **Bank Wires.**—Bank wires are those wires which multiple adjacent switch banks to each other.
- 34-123 **Bank Cable.**—A bank cable is one which connects a switch bank to a terminal rack.
- 34-124 **Multiple Cable.**—A multiple cable is one which multiples together two or more sections of switch banks by connecting together their terminals.
- 34-125 **Impulse.**—An impulse is any sudden change of brief duration produced in the current of a circuit.
- 34-126 **Make Impulse.**—A make impulse is an impulse due to a temporary flow of current.
- 34-127 **Break Impulse.**—A break impulse is an impulse due to a temporary interruption of current.
- 34-128 **Impulse Frequency.**—The impulse frequency is the number of impulses occurring per second. The reciprocal of this is the impulse period.
- 34-129 **Impulse Period.**—The impulse period is the period of time included between the corresponding points in periodically recording impulses. It thus corresponds to the period of alternating current.

- 34-130 **Impulse Ratio.**—Impulse ratio is the ratio of duration of an impulse to the impulse period.
- 34-131 **Impulse Circuit.**—An impulse circuit is one through which impulses are transmitted.
- 34-132 **Telephone Impulse Repeater.**—A telephone impulse repeater is a device for repeating impulses from one line circuit into another and for performing other duties.
- 34-133 **Supervisory Signal.**—A supervisory signal is a device for attracting attention of an attendant to a duty in connection with switching apparatus or its accessories. This includes cord supervisory lamps on a manual switchboard and the supervisory lamps in an automatic exchange which indicate that a switch has been occupied but has not completed its function.
- 34-134 **Tell-Tale Signal.**—A tell-tale signal is a device for locating the failure of some apparatus; for example, the blowing of a fuse, the continued drawing of heavy current by apparatus intended to receive only momentary current, etc.
- 34-135 **Alarm Signal.**—An alarm signal is a sound producing device for attracting attention to either a supervisory or a tell-tale signal.
- 34-136 **Telephone Repeater.**—A telephone repeater is a device for amplifying a voice current from one line circuit into another line circuit.
- 34-137 **Telephone Receiver.**—A telephone receiver is an electrically operated device designed to produce sound waves or vibrations which correspond to the electromagnetic waves or vibrations actuating it.
- 34-138 **Microphone.**—A contact device designed to have its electrical resistance directly and materially altered by slight differences in mechanical pressure.
- 34-139 **Telephone Transmitter.**—A telephone transmitter is a sound-wave-operated or vibration-operated device designed to produce electromagnetic waves or vibrations which correspond to the sound waves or vibrations actuating it.
- 34-140\* **Coefficient of Coupling of a Transformer.**—The coefficient of coupling of a transformer at a given frequency is the ratio of the mutual impedance between the primary and secondary of the

\* (140) Single frequency voltages and currents are here supposed to be represented by complex numbers. Their ratio is therefore a complex number.

transformer, to the square root of the product of the self-impedances of the primary and of the secondary.

- 34-141 **Repeating Coil.**—A term used in telephone practise meaning the same as transformer, and ordinarily a transformer of unity ratio.
- 34-142\* **Retardation Coil.**—A retardation coil is a reactor (reactance coil) used in a circuit for the purpose of selectively reacting on currents which vary at different rates.
- 34-143 **Manual Switchboard.**—A manual switchboard is one in which the switching operations are performed by hand.
- 34-144 **Multi Office Exchange (British "Multi Exchange System").**—A multi office exchange is one which is composed of more than one office.
- 34-145 **Trunk Hunting.**—Trunk hunting is the operation of an automatic switch in moving its wipers or brushes to an idle set of terminals or contacts in a chosen group of terminals or contacts.
- 34-146 **Wiper.**—A wiper is that portion of the moving member of a selector which engages with a bank contact.
- 34-147 **Bank.**—A bank is an assembly of fixed contacts with which the moving members of a selector engage: Banks are usually multiplied.

### Telegraphy

- 34-148 **Relay.**—A relay is a device by means of which contacts in one circuit are operated by a change in conditions in the same circuit or in one or more associated circuits.
- 34-149 **Polar Relay.**—A polar relay is a relay which operates in response to a change in the direction of the current in the controlling circuit.
- 34-150 **Non-Polar Relay, or Neutral Relay.**—A non-polar relay is a relay which operates in response to a change in the strength of the current in the controlling circuit, irrespective of the direction of the current.
- 34-151 **Neutral Relay.**—See non-polar relay.

\* (142) In telephone and telegraph usage, the terms "impedance coil," "inductance coil," "choke coil" and "reactance coil" are sometimes used in place of the term "retardation coil."

- 34-152 Selector.**—A selector is a device which performs certain functions such as causing an electric lamp to light, or an electric bell to sound, in response to a definite signal or group of successive signals received over a controlling circuit.
- 34-153 Direct-Point Repeater.**—A direct-point repeater is a repeater in which the receiving relay controlled by the signals received over a line repeats these signals into another line or lines without the interposition of any other repeating or transmitting apparatus.
- 34-154 Concentrator.**—A concentrator is a traffic distributing device by means of which a number of telegraph or telephone lines, and connections to operating instruments are brought together at one point to facilitate their interconnection at such times as signals or messages are to be transmitted from one to the other.
- 34-155 Transmitter.**—A transmitter is a device for effecting electrical changes in a controlled circuit. The term transmitter is commonly applied principally to devices which in response to a controlling means effects in a main line telegraph circuit electrical changes necessary to send signals over the line.
- 34-156 Synchronous System.**—A synchronous system of telegraphy is one in which the proper transmission and reception of signals is dependent upon the synchronous operation of similar commutators or other devices located at the sending and receiving stations of a circuit.
- 34-157 Differential Duplex.**—A differential duplex is a duplex system in which at each station one of two portions of the receiving instrument are connected in series with the line wire and the other in series with an artificial line of such electrical characteristics that the effects upon the receiver of currents passing through the main and artificial lines, as a result of outgoing signals, are neutralized.
- 34-158 Bridge Duplex.**—A bridge duplex is a duplex system in which the receiving instruments at each station are connected across two impedances, one in series with the line wire and the other in series with the artificial line in such manner that no electrical change in the receiver circuit is effected by outgoing signals.
- 34-159 Half-Set Repeater.**—A half-set repeater is a repeater used for connecting together a simplex circuit and a duplexed circuit converting them into the equivalent of a single simplex circuit.

- 34-160 Intermediate Current Supply.**—An intermediate current supply is an ungrounded source of current connected in series with a line wire at a station other than a terminal on a ground return telegraph circuit.
- 34-161 Phantoplex Circuit.**—A phantoplex circuit is a superposed circuit operated by alternating current over a simplex, duplex or quadruplex circuit operated from direct-current sources.
- 34-162 Spark Condenser.**—A spark condenser is a condenser, with or without associated non-inductive resistance, connected with a pair of instrument contact points for the purpose of diminishing sparking at these points.
- 34-163 Current Margin.**—In a non-polar simplex system, the difference between the current flowing through a receiving instrument when operated to that flowing when not operated.
- 34-164 Margin Ratio.**—In a non-polar simplex system, the ratio of the current flowing through a receiving instrument when operated to that flowing when not operated.
- 34-165 Percentage Margin.**—In a non-polar simplex, the current margin expressed as a percentage of the current flowing through the relay when operated.
- 34-166 Main Circuit.**—A main circuit is a major electrical circuit of a telegraph system and includes both transmitting and receiving devices.
- 34-167 Local Circuit.**—A local circuit is a circuit, within the limits of the station, usually controlled by a receiving instrument in a main circuit or controlling a transmitter effecting changes in a main line circuit.

## STORAGE BATTERIES\*

(Revised Edition Adopted by the Board of Directors, American Institute of Electrical Engineers,  
February 16, 1928)

A.S.A. C 40 1928

### SCOPE

- 36-1 The standards in this section apply to storage batteries of the lead-acid type and of the nickel-iron alkaline type. They are suitable for large and small batteries in either stationary or portable service.
- 36-2 These standards conform to accepted usage.

### CLASSIFICATION OF STORAGE BATTERIES

- 36-51 Storage batteries are classified as stationary or portable batteries on the basis of construction.
- 36-52 **Stationary Batteries.**—Are those designed for service in a permanent location.
- 36-53 **Portable Batteries.**—Are those designed for convenient transportation during service. Portable batteries may be used for service in a permanent location.

### CONSTRUCTION

- 36-100 **Storage Battery.**—A connected group of two or more electrochemical cells for the generation of electrical energy in which the cells after being discharged may be restored to a charged condition by an electric current flowing in a direction opposite to the flow of current when the battery discharges. Common usage permits this designation to be applied to a single cell used independently.
- 36-101 **Storage Cell.**—The unit of the battery, consisting of positive and negative plates, separators, electrolyte and container, for the generation of electrical energy and capable of being recharged by an electric current.
- 36-102 **Active Materials.**—Materials of plates reacting chemically to produce electrical energy during the discharge. The active materials of storage cells are restored to their original composition, in the charged condition, by oxidation or reduction processes

\* Approved as American Standard by American Standards Association, October 19, 1928. Sponsor: American Institute of Electrical Engineers.

produced by the charging current. In the charged condition the active materials are as follows:

<u>Plate</u>	<u>Lead-acid cells</u>	<u>Nickel-iron alkaline cells</u>
Positive	Lead peroxide	Oxides of nickel
Negative	Sponge lead	Iron

36-103 Grid.—A metallic framework for conducting the electric current and supporting the active material.<sup>1</sup>

36-104 Positive Plate.—The grid and active material from which the current flows to the external circuit when the battery is discharging.

36-105 Negative Plate.—The grid and active material to which the current flows from the external circuit when the battery is discharging.

36-106 Electrolyte.—An aqueous solution of sulphuric acid used in lead cells and of certain hydroxides used in nickel-iron alkaline cells. The concentration of the solutions varies somewhat with the type of cell, its use and condition. The electrolyte of charged cells at 70 deg. fahr. (21 deg. cent.) will ordinarily fall within the following limits of specific gravity.

	<u>Lead-acid cells</u>	<u>Nickel-iron alkaline cells</u>
Maximum.....	1.300	1.230
Minimum.....	1.200	1.160

36-107 Separator.—A device for preventing metallic contact between the plates of opposite polarity within the cell.

36-108 Group.—Assembly of a set of plates of the same polarity for one cell.

36-109 Element.—The positive and negative groups with separators assembled for a cell.

36-110 Couple.—The element of a cell containing two plates, one positive and one negative. This term is also applied to a positive and negative plate connected together as one unit for installation in adjacent cells.

36-111 Jar.—The container for the element and electrolyte of a cell. Specifically a jar for lead-acid cells is usually of hard rubber composition or glass; but for nickel-iron alkaline cells is a nickel plated steel container frequently referred to as a "can."

<sup>1</sup> In certain types of batteries the active material is enclosed in containers which are held in place by the grid.

- 36-112 **Tank.**—A lead container, supported by wood, for the element and electrolyte of a cell. This is restricted to some relatively large types of cells.
- 36-113 **Case.**—A container for several cells. Specifically wood cases are containers for cells in individual jars; rubber or composition cases are provided with compartments for the cells.
- 36-114 **Tray.**—A support or container for one or more cells.
- 36-115 **Terminal Posts.**—The points of the cell or battery to which the external circuit is connected.
- 36-116 **Cell Connector.**—A conductor used for carrying current between adjacent cells.
- 36-117 **Counter Electromotive Force Cells.**—Cells of practically no capacity used to oppose the line voltage. Frequently called "Counter cells."
- 36-118 **End Cells.**—The cells of a battery which may be cut in or out of the circuit for the purpose of adjusting the battery voltage.
- 36-119 **Pilot Cell.**—A selected cell whose temperature, voltage and specific gravity of electrolyte are assumed to indicate the condition of the entire battery.

#### CAPACITY

- 36-150 **Ampere-Hour Capacity.**—The number of ampere-hours which can be delivered by a cell or battery under specified conditions as to temperature, rate of discharge and final voltage.
- 36-151 **Watt-Hour Capacity.**—The number of watt-hours which can be delivered by a cell or battery under specified conditions as to temperature, rate of discharge and final voltage.
- 36-152 **Time-Rate.**—The rate in amperes at which a battery will be fully discharged in a specified time, under specified conditions of temperature and final voltage. Example, the eight-hour rate or the twenty-minute rate.

#### VOLTAGE

- 36-200 **Open-Circuit Voltage.**—The voltage of a cell or battery at its terminals when no current is flowing. For the purpose of measurement, the small current required for the operation of a voltmeter is usually negligible.
- 36-201 **Closed-Circuit Voltage.**—The voltage at the terminals of a cell or battery when current is flowing.

- 36-202 **Average Voltage.**—The average value of the voltage during the period of charge or discharge. It is conveniently obtained from the time integral of the voltage curve.
- 36-203 **Initial Voltage.**—The voltage of a cell or battery at the beginning of a charge or discharge. It is usually taken after the current has been flowing for a sufficient period of time for the rate of change of voltage to become practically constant.
- 36-204 **Final Voltage.**—The prescribed voltage upon reaching which the discharge is considered complete. The final voltage is usually chosen so that the useful capacity of the cell is realized. Final voltages vary with the type of battery, the rate of the discharge, temperature, and the service in which the battery is used.
- 36-205 **Polarity.**—An electrical condition determining the direction in which current tends to flow. By common usage the discharge current is said to flow from the positive or peroxide plate through the external circuit. In a nickel-iron alkaline battery the positive plate is that containing nickel peroxide.
- 36-206. **Polarization.**—The change in voltage at the terminals of a storage cell, when a specified current is flowing, equal to the difference between the actual and the equilibrium (constant open-circuit condition) potentials of the plates, exclusive of the  $IR$  drop.

## CHARGING AND DISCHARGING

- 36-250 **Charge.**—The conversion of electrical energy into chemical energy within the cell or battery. This consists of the restoration of the active materials by passing a uni-directional current through the cell or battery in the opposite direction to that of the discharge. A cell or battery which is said to be "charged" is understood to be fully charged.
- 36-251 **Charging Rate.**—The current expressed in amperes at which a battery is charged.
- 36-252 **Constant-Current Charge.**—A charge in which the current is maintained at constant value. For some types of lead batteries this may involve two rates called the starting and the finishing rates.
- 36-253 **Constant Voltage Charge.**—A charge in which the voltage at the terminals of the battery is held at a constant value. A modified constant voltage system is usually one in which the voltage of the charging circuit is held substantially constant, but a fixed

resistance is inserted in the battery circuit producing a rising voltage characteristic at the battery terminals as the charge progresses. This term is also applied to other methods for producing automatically a similar characteristic.

- 36-254 **Boost Charge.**—A partial charge, usually at a high rate for a short period.
- 36-255 **Equalizing Charge.**—An extended charge given to a battery to insure the complete restoration of the active materials in all the plates of all the cells.
- 36-256 **Trickle Charge.**—A continuous charge at low rate approximately equal to the internal losses and suitable to maintain the battery in a fully charged condition. This term is also applied to very low rates of charge suitable not only for compensating for internal losses but to restore intermittent discharges of small amount delivered from time to time to the load circuit.
- 36-257 **Finishing Rate.**—The rate of charge expressed in amperes to which the charging current for some types of lead batteries is reduced near the end of charge to prevent excessive gassing and temperature rise.
- 36-258 **Discharge.**—The conversion of the chemical energy of the battery into electrical energy.
- 36-259 **Reversal.**—Change in normal polarity of a storage cell.
- 36-260 **Local Action or Self Discharge.**—The internal loss of charge which goes on continuously within a cell regardless of connections to an external circuit.
- 36-261 **Floating.**—A method of operation in which a constant voltage is applied to the battery terminals sufficient to maintain an approximately constant state of charge.
- 36-262 **Specific Gravity of Electrolyte.**—The electrolyte of lead-acid batteries increases in concentration to a fixed maximum value during charge and decreases during discharge. The concentration is usually expressed as the specific gravity of the solution. This variation of specific gravity of the solution affords an approximate indication of the state of charge.

The specific gravity of the electrolyte in nickel-iron alkaline batteries does not change appreciably during charge or discharge and therefore does not indicate the state of charge. The specific gravities, however, are indication of the electrochemical usefulness of the electrolyte.

36-263 Gassing.—The evolution of oxygen or hydrogen, or both.

## EFFICIENCY

36-300 Efficiency.—The ratio of the output of a cell or battery to the input required to restore the initial state of charge under specified conditions of temperature, current rate, and final voltage.

36-301 Ampere-Hour Efficiency.—(Electrochemical Efficiency.)—The ratio of the ampere-hours output to the ampere-hours of the recharge.

36-302 Volt Efficiency.—The ratio of the average voltage during the discharge to the average voltage during the recharge.

36-303 Watt-Hour Efficiency.—(Energy efficiency.)—The ratio of the watt-hours output to the watt-hours of the recharge.

## TEMPERATURE

36-350 Reference Temperature.—The capacity obtained from a storage battery on discharge varies with the temperature of the electrolyte. The following standard reference temperatures are established.

(1) The temperature of electrolyte at beginning of discharge shall be 25 deg. cent. (77 deg. fahr.). No limit is placed on the temperature attained by the electrolyte during discharge.

(2) The ambient temperature on discharge shall be from 5 deg. cent. to 8 deg. cent. lower than the temperature of the electrolyte, on the beginning of discharge. The ambient temperature shall be kept constant throughout the discharge.

36-351 Temperature Coefficient of Voltage.—The change in open-circuit voltage per degree (cent.) change in temperature.<sup>2</sup>

36-352 Temperature Coefficient of Capacity.—The change in delivered capacity expressed as a percentage of the ampere-hour or watt-hour capacity per degree (cent.) change in temperature between specified limits.

36-353 Critical Temperature.—The temperature of the electrolyte at which an abrupt change in capacity occurs.

<sup>2</sup> This is but a few tenths of a millivolt and must not be confused with the effect of temperature on changes in voltages resulting from polarization and *IR* drop when charging or discharging.

## RATING OF BATTERIES

- 36-400 General.**—Batteries are usually rated in terms of the number of ampere-hours which they are capable of delivering when fully charged and under specified conditions as to temperature, rate of discharge and final voltage (See 36-150, 36-204 and 36-250). For different classes of service, different time-rates (See definition of time-rate, 36-152) are frequently used. For comparing the capacities of batteries of different size but of the same general design, it is customary to use the same time-rate, and a comparison based on the different lengths of time they will discharge at the same rate is not recommended as it is misleading.
- 36-401 Misrating.**—A battery which fails to deliver its rated capacity on the third successive measured cycle of charge and discharge under specified current rates, temperature of electrolyte, specific gravity, and final voltage, shall be considered to be improperly rated.

NATIONAL ELECTRICAL CODE  
Regulations of the  
National Board of Fire Underwriters for  
Electrical Wiring and Apparatus  
as recommended by the  
National Fire Protection Association

A.S.A. CI 1930

ARTICLE 37. RADIO EQUIPMENT\*

**3701. General.**

(a) The requirements of this article shall neither apply to equipment installed on shipboard, nor to antennas used for coupling carrier current to line conductors; but shall be deemed to be additional to, or amendatory of, those prescribed in Articles 1 to 19, inclusive, of this code.

(b) Transformers, voltage reducers, keys and other devices employed shall be of types expressly approved for radio reception or transmission.

(c) Methods of wiring from the source of power to and between devices, related to apparatus connected to interior wiring systems, shall be in accordance with the rules covering permanent or portable fixtures, devices and appliances.

It is recommended that the authority enforcing this code be freely consulted as to the specific methods to be followed in any case of doubt relative to installation of antenna and counter-poise conductors and that the National Electrical Safety Code, Part 5, be followed.

**3702. For Receiving Stations Only.**

(a) Antenna and counterpoise conductor sizes shall be not less than No. 14 if of copper or No. 17 if of bronze or copper-clad steel. Antenna and counterpoise conductors outside buildings shall be kept well away from all electric light or power wires of any circuit of more than 600 volts, and from railway, trolley or feeder wires, so as to avoid the possibility of contact between the antenna or counterpoise and such wires under accidental conditions.

\* Approved as American Standard by the American Standards Association, July 19, 1929.

(b) Antenna and counterpoise where placed in proximity to electric light or power wires of less than 600 volts, or signal wires, shall be constructed and installed in a strong and durable manner, and shall be so located and provided with suitable clearances as to prevent accidental contact with such wires by sagging or swinging.

(c) Splices and joints in the antenna span shall be soldered unless made with approved splicing devices.

(d) The preceding paragraphs, (a), (b), and (c), shall not apply to light and power circuits used as receiving antenna, but the devices used to connect the light and power wires to radio receiving sets shall be of approved type.

(e) Lead-in conductors, that is, conductors from antennas to sets, shall be of copper, approved copper-clad steel or other metal which will not corrode excessively, and in no case shall they be smaller than No. 14, except that bronze or copper-clad steel not less than No. 17 may be used.

(f) Lead-in conductors from the antenna to the first building attachment shall conform to the requirements for antennas similarly located. Lead-in conductors from the first building attachment to the building entrance shall, except as specified in the following paragraph, be installed and maintained so that they cannot swing closer to open supply conductors than the following distances:

Supply wires 0 to 600 volts.....	2 feet
Supply wires exceeding 600 volts.....	10 feet

Where all conductors involved are supported so as to insure a permanent separation and the supply wires do not exceed 150 volts to ground, the clearance may be reduced to not less than 4 inches. Lead-in conductors on the outside of buildings shall not come nearer than the clearances specified above to electric light and power wires unless separated therefrom by a continuous and firmly fixed non-conductor which will maintain permanent separation. The non-conductor shall be in addition to any insulating covering on the wire.

(g) Each lead-in conductor shall enter the building through a non-combustible, non-absorptive, insulating bushing slanting upward toward the inside or by means of an approved device designed to give adequate insulation and protection. The lead-in conductor from the building entrance to the set shall have rubber insulation approved for voltages 0-600 (Type R).

(h) Each lead-in conductor shall be provided with an approved protective device (lightning arrester) which will operate at a voltage of 500 volts or less, properly connected and located either inside the building at some point between the entrance and the set which is convenient to a ground, or outside the building as near as practicable to the point of entrance. The protector shall not be placed in the immediate vicinity of easily ignitable stuff, or where exposed to inflammable gases or dust or flyings of combustible materials.

(i) If an antenna grounding switch is employed, it shall in its closed position form a shunt around the protective device. The switch should be placed in the most direct line between the lead-in conductor and the point where the grounding connection is made. Such a switch shall not be used as a substitute for the protective device.

(j) If fuses are used, they shall not be placed in the circuit from the antenna through the protective device to ground.

(k) The protective grounding conductor may be bare and shall be of copper, bronze or approved copper-clad steel. The protective grounding conductor shall be not smaller nor have less conductance per unit of length, than the lead-in conductor, and in no case shall be smaller than No. 14 if of copper nor smaller than No. 17 if of bronze or copper-clad steel. The protective grounding conductor shall be run in as straight a line as possible from the protective device to a good permanent ground. The ground connections shall be made to a cold-water pipe where such pipe is available and is in service and connected to the street mains. An outlet pipe from a water tank fed from a street main or a well may be used, provided such outlet pipe is adequately bonded to the inlet pipe connected to the street water main or well. If water pipes are not available, ground connections may be made to a grounded steel frame of a building or to an artificial ground such as a galvanized iron pipe or a rod driven into permanently damp earth or to a metal plate or other body of metal buried similarly. Gas piping shall not be used for the ground.

(l) The protective grounding conductor shall be guarded where exposed to mechanical injury. An approved ground clamp shall be used where the protective grounding conductor is connected to pipes or piping.

(m) The protective grounding conductor may be run either inside or outside the building. The protective grounding conductor and ground, installed as prescribed in the preceding paragraphs (k) and (l), may be used as the operating ground.

It is recommended that in this case the operating grounding conductor be connected to the ground terminal of the protective device.

If desired, a separate operating grounding connection and ground may be used, this operating grounding conductor being either bare or provided with an insulated covering.

(n) Wires inside buildings shall be securely fastened in a workmanlike manner and shall not come nearer than 2 inches to any electric light or power wire not in conduit unless separated therefrom by some continuous and firmly fixed non-conductor, such as porcelain tubes or approved flexible tubing, making a permanent separation. This non-conductor shall be in addition to any regular insulating covering on the wire.

(o) Storage-battery leads shall consist of conductors having approved rubber insulation. The circuit from a filament, "A," storage battery of more than 20 ampere-hours capacity, NEMA rating, shall be properly protected by a fuse or circuit-breaker rated at not more than 15 amperes. The circuit from a plate, "B," storage battery shall be properly protected by a fuse or circuit-breaker rated at not more than 1 ampere in the negative lead. Fuses or circuit-breakers shall be located not more than 18 inches along the wire from a battery terminal.

### 3703. For Transmitting Stations Only.

(a) Antenna and counterpoise conductors outside buildings shall be kept well away from all electric light or power wires of any circuit of more than 600 volts, and from railway trolley or feeder wires, so as to avoid the possibility of contact between the antenna or counterpoise and such wires under accidental conditions. Antenna and counterpoise conductors where placed in proximity to electric light or power wires of less than 600 volts, or signal wires, shall be constructed and installed in a strong and durable manner, and shall be so located and provided with suitable clearances as to prevent accidental contact with such wires by sagging or swinging.

(b) Antenna conductor sizes shall be not less than given in the following table:

Material	Stations to which power supplied is less than 100 watts and where voltage of power is less than 400 volts	Stations to which power supplied is more than 100 watts or voltage of power is more than 400 volts
Soft copper . . . . .	14	7
Medium-drawn copper . . . . .	14	8
Hard-drawn copper . . . . .	14	10
Bronze or copper-clad steel . . . . .	14	12

(c) Splices and joints in the antenna and counterpoise span shall be soldered unless made with approved splicing devices.

(d) Lead-in conductors shall be of copper, bronze, approved copper-clad steel or other metal which will not corrode excessively and in no case shall be smaller than No. 14.

(e) Antenna and counterpoise conductors and wires leading therefrom to ground switch, where attached to buildings, shall be firmly mounted 5 inches clear of the surface of the building, on non-absorptive insulating supports such as treated pins or brackets, equipped with insulators having not less than 5 inches creepage and air-gap distance to inflammable or conducting material, except that the creepage and air-gap distance for continuous-wave sets of 1000 watts and less input to the transmitter, shall be not less than 3 inches.

(f) In passing the antenna or counterpoise lead-in into the building a tube or bushing of non-absorptive, insulating material, slanting upward toward the inside, shall be used and shall be so insulated as to have a creepage and air-gap distance in the case of continuous-wave sets of 1000 watts and less input to the transmitter, not less than 3 inches, and in all other cases not less than 5 inches. If porcelain or other fragile material is used it shall be protected where exposed to mechanical injury. A drilled window pane may be used in place of a bushing provided creepage and air-gap distances as specified above are maintained.

(g) A double-throw knife switch having a break distance of at least 4 inches and a blade not less than 1/8 inch by 1/2 inch, or a flexible grounding lead and clamp in place of this switch, shall be used to join the antenna lead-in to the grounding conductor. The switch or flexible grounding lead may be located inside or outside the building. The base of the switch shall be of non-absorptive insulating material. The switch or flexible grounding lead shall be so mounted that its current-carrying parts will be at least 3 inches clear of the building wall or other conductors in the case of continuous-wave sets of 1000 watts and less, and in all other cases at least 5 inches. The conductor from grounding switch or flexible grounding lead to ground shall be securely supported. These provisions shall also apply to the connection of the counter poise lead-in to its grounding conductor.

It is recommended that the switch be located in the most direct line between the lead-in conductors and the point where grounding connection is made.

(h) Antenna and counterpoise conductors shall be effectively and permanently grounded at all times when station is not in actual operation and unattended, by a conductor at least as large as the lead-in and in no case smaller than No. 14 copper, bronze or approved copper-clad steel. This protective grounding conductor need not have an insulated covering or be mounted on insulating supports. The protective grounding conductor shall be run in as straight a line as possible to a good permanent ground. The ground connections shall be made to a cold-water pipe where such pipe is available and is in service and connected to the street mains. An outlet pipe from a water tank fed from a street main, or a well may be used, provided such outlet pipe is adequately bonded to the inlet pipe connected to the street water main or well. If water pipes are not available, ground connections may be made to a grounded steel frame of a building or to an artificial ground such as a galvanized iron pipe or a rod driven into permanently damp earth or to a metal plate or other body of metal buried similarly. The protective grounding conductor shall be protected where exposed to mechanical injury. A suitable approved ground clamp shall be used where the protective grounding conductor is connected to pipes or piping. Gas pipes shall not be used for the ground.

It is recommended that the protective grounding conductor be run outside the building.

(i) The operating grounding conductor shall be of copper strip not less than  $\frac{3}{8}$  inch wide by  $\frac{1}{32}$  inch thick, or of copper, bronze, or approved copper-clad steel having a periphery, or girth, of at least  $\frac{3}{4}$  inch, such as a No. 2 wire, and shall be firmly secured in place throughout its length.

(j) The operating grounding conductor shall be connected to a good permanent ground. Preference shall be given to water piping. Other permissible grounds are grounded steel frames of buildings or other grounded metal work in the building, and artificial grounding devices such as driven pipes, rods, plates, cones, etc. Gas piping shall not be used for the ground.

(k) Where the current supply is obtained directly from lighting or power circuits, the conductors whether or not lead-covered shall be installed in approved metal conduit, armored cable or metal raceways.

(l) When necessary to protect the supply system from high-potential surges and kick-backs there shall be installed in the supply

line as near as possible to each radio transformer, rotary spark gap, motor and generator in motor-generator sets and other auxiliary apparatus one of the following:

(1) Two condensers (each of not less than  $1/10$  microfarad capacity and capable of withstanding 600 volt test) in series across the line with mid-point between condensers grounded; across (in parallel with) each of these condensers shall be connected a shunting fixed spark-gap capable of not more than  $1/32$  inch separation.

(2) Two vacuum-tube-type protectors in series across the line with the mid-point grounded.

(3) Lightning arresters, such as the aluminum-cell type.

# NATIONAL ELECTRICAL SAFETY CODE\*

Bureau of Standards

Fourth Edition, December 31, 1926

A.S.A. C2 1927

## SECTION 50. SCOPE

### 500. Scope.

The rules of part 5 apply to radio transmitting and receiving installations, including antennas, counterpoise wires, lead-in conductors, grounding conductors, grounding connections, protective devices, and batteries. The rules do not apply to antennas used for coupling carrier-current equipment to line conductors.

In case the installation is covered by more than one rule, the superior requirement shall apply.

## SECTION 51. CLASSIFICATION OF RADIO STATIONS

### 510. Classification of Radio Stations.

For the purpose of these rules radio stations are classified as follows:

#### A. Receiving stations.

#### B. Transmitting stations.

1. *Low-power*.—Transmitting stations to which the power supplied is less than 100 watts and where the voltage of the power supplied is less than 400 volts.

2. *Medium-power*.—Transmitting stations not classified as low-power or high-power.

3. *High-power*.—Transmitting stations to which the power supplied is greater than 1,000 watts or where the voltage of the power supplied is greater than 2,000 volts.

## SECTION 52. ANTENNA AND COUNTERPOISE INSTALLATION

### 520. Application of Rules.

These rules apply to the following:

A. Outdoor antennas of all classes of receiving and transmitting stations. (There are no requirements for indoor antennas.)

#### B. Counterpoise wires.

\* Approved as American Standard by the American Standards Association, November 15, 1927. The complete handbook can be purchased from the Government Printing Office, Washington, D. C. Price \$1.00.

**521. General Requirements.**

**A. Counterpoise wires.**—Counterpoise wires shall conform to the requirements for antennas similarly located.

**B. Antennas of receiving and low-power transmitting stations.**—Such antennas shall, in general, comply with the requirements for the construction of communication lines for public use in similar situations.

**C. Antennas of medium- and high-power transmitting stations.**—Such antennas shall, in general, comply with the requirements for the construction of supply lines in similar situations.

**522. Locations to be Avoided.**

The following situations should be avoided in erecting antennas and guy wires:

**A.** Attachments to supply or communication poles.

**B.** Crossings over railroad tracks or public highways.

**C.** Crossings over supply or communication conductors.

**D.** Crossings under supply or communication conductors.

**E.** Antenna conflicts with supply or communication conductors.

(See definition of "Antenna conflict.")

**523. Ordinary Construction of Antennas.**

Antennas shall be constructed according to the requirements of rule 523 when they do not cross over railroad tracks, supply conductors, or communication conductors and do not conflict with supply or communication conductors.

**A. Antenna conductors.****1. Material.**

(a) RECEIVING ANTENNAS.

No requirements.

(b) TRANSMITTING ANTENNAS.

Antennas shall be of copper, bronze, copper-covered steel, or other metal which will not corrode excessively under the prevailing conditions.

**2. Size.**—Antenna conductor sizes shall be not less than given in Table I.

**3. Strength.**

(a) ANTENNAS OF RECEIVING AND LOW-POWER TRANSMITTING STATIONS.

No requirements.

(b) ANTENNAS OF MEDIUM- AND HIGH-POWER TRANSMITTING STATIONS.

TABLE I  
ANTENNA CONDUCTOR SIZES—ORDINARY CONSTRUCTION

Material	Receiving antennas		Transmitting antennas			
			Low-power		Medium- and high-power	
	Size A.W.G.	Diameter	Size A.W.G.	Diameter	Size A.W.G.	Diameter
Copper:						
Soft-drawn.....	14	<i>Inch</i> 0.064	14	<i>Inch</i> 0.064	7	<i>Inch</i> 0.144
Medium-drawn.....	14	0.064	14	0.064	8	0.128
Hard-drawn.....	14	0.064	14	0.064	10	0.102
Bronze or copper-covered steel....	17	0.045	14	0.064	12	0.081

The strength of the antenna conductor shall be not less than that of No. 10 A. W. G. (diameter 0.102 inch) hard-drawn copper.

#### B. Antenna insulators.

1. *Antennas of receiving and low-power transmitting stations.*—No requirements.

2. *Antennas of medium- and high-power transmitting stations.*—Insulators shall be of non-combustible material and shall have a creepage distance of not less than 10 inches.

#### C. Antenna supports.

1. *Strength of supports.*—Supports shall be of such initial size as to carry the vertical load and where necessary shall be guyed or braced so as to withstand the transverse and longitudinal loads to which they may be subjected.

2. *Roof supports.*—Antenna supports erected on roofs shall be of rigid construction, and where necessary shall be arranged to distribute the load over the roof. Such supports shall be erected so that they are not dependent in any way on the antenna for stability.

3. *Chimneys.*—The attachment of antennas to chimneys should be avoided.

4. *Grounding metal supports on roofs.*—Metal poles or masts extending more than 10 feet above the supporting building shall be permanently and effectively grounded.

5. *Trees.*—Where a tree is used as an antenna support, sufficient sag (or other means) shall be provided to keep the tension in the antenna safely below the breaking strength when the tree sways in the wind.

#### D. Attaching antennas to supports.

1. *Strength of attachment.*—The means used for attaching the antenna to the support shall be such as to withstand a greater load than that which will break the conductor itself.

2. *Attachment on small poles.*—If the pole is not strong enough to support a person, some arrangement shall be provided to draw up the antenna from the ground.

**E. Minimum clearance above ground.**

1. *Spans 150 feet or less in length.*—Antenna conductors shall have clearances above ground as given in Table II.

TABLE II  
MINIMUM ANTENNA CLEARANCES ABOVE GROUND

Location	Receiving and low-power antennas	Medium- and high-power antennas
	<i>Feet</i>	<i>Feet</i>
Above streets and other traveled roadways.....	18	28
Along road in rural districts.....	15	28
Above roadways to residence garages.....	10	—
Above spaces or ways accessible only to pedestrians.....	10	—

2. *Spans exceeding 150 feet in length.*—For such spans the above clearances shall be increased by 0.1 foot for each 10 feet in excess of 150 feet.

**F. Minimum clearances below supply and communication conductors.**—Antennas shall have the following clearances from conductors under which they cross:

TABLE III  
MINIMUM ANTENNA CLEARANCES BELOW OTHER CONDUCTORS

Crossing under—	Receiving and low-power antennas	Medium- and high-power antennas
	<i>Feet</i>	<i>Feet</i>
Communication conductors.....	2	10
Supply conductors, 0 to 750 volts.....	4	10
Supply conductors exceeding 750 volts.....	6	10

**G. Clearances from combustible material.**—Antennas of medium- and high-power transmitting stations shall be placed so that an air gap of at least 10 inches exists between the antenna and the nearest combustible material.

**524. Special Construction of Antennas.**

Antennas shall be specially constructed according to the following requirements when they cross over railroad tracks, supply conductors, or communication conductors, or are in conflict with supply or communication conductors.

**A. Recommendation against locating antennas in situations where special construction is required.**—It is strongly recommended

that the installation of antennas in these special situations be avoided. If such locations are employed, it must be recognized that special hazards are introduced and that great care is necessary in the construction and maintenance of antennas to avoid contact with supply or communication conductors or to avoid the reduction of clearance over railroad tracks.

**B. Construction of antennas crossing over or conflicting with service loops 0 to 150 volts to ground.**—Antennas constructed in these situations shall conform to the requirements for the ordinary construction of antennas (rule 523) and, in addition, with the requirements set forth below for splices (rule 524, C, 2) and for minimum clearances above communication and supply line conductors (rule 524, C, 4).

**C. Construction of antennas crossing over or conflicting with communication conductors or supply conductors 0 to 750 volts.**

1. *Antenna conductor strength.*—The strength of the antenna conductor shall be not less than that of hard-drawn copper to the following sizes:

Span length	Size of hard-drawn copper	
	Size A.W.G.	Diameter
0 to 150 feet.....	8	<i>Inch</i> 0.128
Exceeding 150 feet.....	6	0.162

2. *Splices.*—Splices in antenna spans shall be made with a suitable twisted-sleeve connector which will provide a strong unsoldered joint.

3. *Antenna supports.*

(a) MATERIAL.

The poles for supporting antennas shall be of steel, concrete, or wood. Wood poles shall be free from observable defects that would decrease their strength or durability.

(b) SIZE.

Wood poles shall have a top diameter of not less than 6 inches.

(c) SETTING.

Poles shall be set to such a depth and in such a manner that any applied load will break the pole before the butt is pulled loose from its setting.

4. *Minimum clearances above communication and supply conductors, 0 to 750 volts.*—Antennas crossing over such conductors shall have the following clearances:

Feet

Antennas of receiving and low-power transmitting stations..... 6  
 Antennas of medium- and high-power transmitting stations..... 10

**D. Antennas crossing over railroads or crossing over or conflicting with supply lines exceeding 750 volts.**

1. *Antennas of receiving and low-power transmitting stations.*—Such antennas shall conform to the requirements for communication lines for public use in similar situations as far as grades of construction and clearances from all other wires and from ground are concerned. (See part 2.)

2. *Antennas of medium- and high-power transmitting stations.*—Such antennas shall conform to the requirements for supply lines in similar situations as far as grades of construction and clearances from all other wires and from ground are concerned. (See part 2.)

**525. Guarding of Antennas.**

Antennas for transmitting stations shall be installed or protected so as to be inaccessible to unauthorized persons.

SECTION 53. LEAD-IN CONDUCTORS

**530. Application of Rules.**

The requirements of this section apply to lead-in conductors of receiving stations and transmitting stations of low and medium power. Lead-in conductors of high-power transmitting stations shall meet such requirements of part 1, "Supply stations," as apply.

**531. Material.**

Lead-in conductors shall be of copper, bronze, copper-covered steel, or other metal which will not corrode excessively under the prevailing conditions.

**532. Size.**

A. *Receiving stations.*—For receiving stations the size of lead-in conductor shall be not less than No. 14 A. W. G. (0.064 inch) if of copper, or less than No. 17 A. W. G. (0.045 inch) if of bronze or copper-covered steel.

B. *Low- and medium-power transmitting stations.*—For such transmitting stations the lead-in conductor shall be not less than No. 14 A. W. G. (0.064 inch).

**533. Installation of Lead-in Conductor.**

A. *From antenna to first building attachment.*—This section of the lead-in wire shall conform to the requirements for antennas similarly located.

**B. From first building attachment to building entrance.**—This section of the lead-in conductor shall be installed and maintained so that it cannot swing closer to open supply conductors than the following distances:

	Feet
Supply lines 0 to 750 volts.....	2
Supply lines exceeding 750 volts.....	10

*Exception.*—The 2-foot clearance may be reduced if the lead-in conductor is separated from supply conductors by a continuous and firmly fixed non-conductor which will maintain permanent separation. This non-conductor shall be in addition to any insulating covering on the wires.

**C. From building entrance to set.**

1. *Receiving stations.*

(a) Lead-in conductors shall be securely fastened in a workman-like manner.

(b) Clearance between lead-in conductor and any supply conductor not in conduit shall not be less than 2 inches.

*Exception.*—This 2-inch clearance does not apply if a firmly fixed non-conductor such as porcelain tube affords a permanent separation. This non-conductor shall be in addition to any insulating covering on the wires.

2. *Low- and medium-power transmitting stations.*

(a) Lead-in conductors shall be securely fastened to suitable insulators.

(b) Clearance between lead-in conductor and any supply wire shall be at least 5 inches.

(c) Lead-in conductors shall be installed and protected to prevent persons from readily coming into accidental contact with them.

SECTION 54. CONSTRUCTION AT BUILDING ENTRANCE

540. **Application of Rules.**

The requirements of this section apply to construction at receiving stations and transmitting stations of low and medium power. Construction at building entrances at high-power transmitting stations shall meet such requirements of part 1, "Supply stations," as apply.

541. **Entrance Bushing.**

Lead-in conductors shall enter the building through a rigid, non-combustible, non-absorptive, insulating tube or bushing, or through a drilled windowpane.

**542. Creepage and Air-Gap Distance.**

The entrance bushing or windowpane mentioned in rule 541 above shall afford the following creepage and air-gap distance from extraneous bodies:

Receiving stations.....	No requirement.
Low- and medium-power transmitting stations using damped waves.....	5 inches.
Low- and medium-power transmitting stations using undamped waves.....	3 inches.

**543. Mechanical Protection of Bushings.**

Entrance bushings of porcelain or other fragile material at transmitting stations shall be protected where exposed to mechanical injury.

**SECTION 55. PROTECTIVE AND OPERATING GROUNDING CONDUCTORS**

**550. Application of Rules.**

The requirements of this section apply to grounding conductors of receiving stations and transmitting stations of low and medium power. Grounding conductors of high-power transmitting stations shall meet such requirements of part 1, "Supply stations," as apply.

**551. General.**

The protective grounding conductor may be used also as the operating grounding conductor.

**552. Material and Size.**

**A. Receiving stations.**

1. *Material.*—No requirements.

2. *Size.*—

(a) OPERATING GROUNDING CONDUCTOR.

No requirements.

(b) PROTECTIVE GROUNDING CONDUCTOR.

This conductor shall not be smaller than the lead-in conductor.

**B. Transmitting stations.**—The operating and grounding conductors shall have strength and conductance per unit length not less than No. 14 A. W. G. (0.064 inch) hard-drawn copper.

**553. Installation of Grounding Conductors.**

**A. Method of running.**

1. Grounding conductors shall be run in as straight a line as possible from the set or the protective device to a good permanent ground.

2. Grounding conductors may be run either inside or outside of the building.

*Recommendation.*—It is recommended that the protective grounding wire for low- and medium-power transmitting stations be run outside of the building.

**B. Mechanical protection.**—Grounding conductors shall be guarded where exposed to mechanical injury.

**C. Insulation.**—Grounding conductors may be of insulated or bare wire and need not be run on insulating supports.

## SECTION 56. GROUND CONNECTIONS

### 560. Application of Rules.

The requirements of this section apply to ground connections for all classes of transmitting stations and to protective ground connections of receiving stations.

### 561. General.

Grounding shall be done in accordance with the following methods. (See section 9 for complete rules for grounding.)

### 562. Gas Pipe Not to be Used.

Gas pipe should not be used for grounding purposes.

### 563. Water-pipe Grounds.

The ground connections shall be made to a cold-water pipe where such pipe is available and is in service and connected to the street mains. An outlet pipe from a water tank fed by a street main or a well may be used, provided such outlet pipe is adequately bonded to the inlet pipe connected to the street water main or well.

### 564. Attachment to Pipes.

Grounding conductors shall be attached to pipes by means of suitable ground clamps. The entire surface of the pipe to be covered by the clamp shall be thoroughly cleaned.

### 565. Driven or Buried Grounds.

If cold-water pipes are not available, ground connections may be made to a galvanized-iron pipe or to a rod driven into permanently damp earth or to a metal plate or other body of metal buried similarly.

### 566. Attachment to Ground Rod or Plate.

The grounding conductor shall be attached to the rod, buried plate, or other body of metal so as to give reliable connection both mechanically and electrically. This connection shall be made so that it

will not fail through corrosion, even when the joint is buried in the earth.

SECTION 57. PROTECTIVE DEVICES

570. Application of Rules.

The requirements of this section apply to protective devices for receiving stations and transmitting stations of low and medium power. Protective devices for high-power transmitting stations shall meet such requirements of part 1, "Supply stations," as apply.

571. Lightning Arrester.

A. Where required.—Each lead-in conductor of a receiving station shall be provided with a lightning arrester, whether or not an antenna grounding switch is used.

B. Operating voltage.—The lightning arrester shall be such as to operate at a potential of 500 volts or less.

C. Location.—The arrester may be located outside the building as near as practicable to the point of entrance, or inside the building between the point of entrance and the receiving set and convenient to a ground. The arrester shall not be placed in the immediate vicinity of easily ignitable material or in a location exposed to dust, inflammable gases, or flyings of combustible materials.

572. Antenna Grounding Switch.

A. Where required.—An antenna grounding switch shall be used at low- and medium-power transmitting stations. An antenna grounding switch is not required at receiving stations, but may be used in addition to the lightning arrester.

B. Type of switch.

1. *Receiving stations.*—The switch should be of the single-pole double-throw type.

2. *Low- and medium-power transmitting stations.*—The switch shall be of the double-throw type and shall meet the following requirements:

- Minimum break distance. . . . . 4 inches.
- Minimum cross-section of switch blade. . . . .  $\frac{1}{8}$  inch  $\times$   $\frac{1}{2}$  inch

Switch base: Non-absorptive insulating material.

C. Location.—The switch may be located either outside or inside the building. The switch should be placed in the most direct line between the lead-in conductor and the point where the grounding connection is made.

**D. Clearance for live switch parts.**—The switch shall be mounted so that its current-carrying parts will clear the building wall or conductors not connected to the switch by the following distances:

Switches for receiving stations: No clearance required.

Switches for low- and medium-power transmitting stations:

Damped-wave sets.....	5 inches.
Undamped-wave sets.....	3 inches.

**E. Method of connection.**

1. *Receiving stations.*—The switch shall be wired so that the antenna lead-in conductor can be disconnected from the set and connected to the grounding conductor. When in the grounding position the switch shall short-circuit the lightning arrester.

2. *Low- and medium-power transmitting stations.*—No requirements.

**F. Operation of switch.**

1. *Receiving stations.*—No requirements.

2. *Low- and medium-power transmitting stations.*—Antenna and counterpoise lead-in conductors of low- and medium-power transmitting stations shall be connected to the grounding conductor whenever the station is not in use.

**573. Protection Against Kick-back.**

**A. Where required.**—Protection should be provided at low- and medium-power transmitting stations where necessary to protect the supply system against high-potential surges and “kick-backs.”

Any of the following methods may be used:

1. Two condensers, usually of 0.1 to 0.5 microfarad capacity and capable of withstanding five times the normal voltage to which they are subjected, placed in series with one another across the supply line with mid-point between condensers grounded. Across (in parallel with) each of these condensers shall be connected a shunting fixed spark gap capable of not more than  $\frac{1}{3\frac{1}{2}}$ -inch separation.

2. Two vacuum-tube-type protectors in series with one another across the line with the mid-point grounded (if the line voltage does not exceed 110 volts).

3. Electrolytic lightning arresters, such as the aluminum-cell type.

**C. Location.**—Apparatus for protection against “kick-back” should be installed across the supply conductors as near as possible to each radio transformer, rotary spark gap, motor, and generator (in motor-generator sets), or other auxiliary apparatus.

## SECTION 58. CONNECTION TO POWER SUPPLY LINES

**580. Connection to Power Supply Lines.**

Devices used in connection with power supply lines and methods of wiring shall be in accordance with the rules covering permanent or portable fixtures, devices, and appliances. (See section 37.)

## SECTION 59. BATTERIES

**590. Application of Rules.**

The requirements of this section apply to batteries for receiving stations and transmitting stations of low and medium power. Battery installations for high-power transmitting stations shall meet such requirements of part 1, "Supply stations," as apply.

**591. Care in Handling.**

Care shall be used in handling batteries in order to avoid contacts with terminals having a high enough difference of potential to cause shock.

**592. Storage Battery.**

**A. Wiring.**—The wiring of storage batteries used with radio receiving equipment shall be subject to the rules covering the wiring of permanent or portable fixtures, devices, and appliances. (See section 37.)

**B. Ventilation.**—Storage batteries shall be located where there is adequate ventilation.

**C. Precautions.**

1. Open flames shall be kept away from storage batteries.
2. Storage batteries should be placed on trays or mats of lead, rubber, or other material which will not be affected by the electrolyte.

**D. Large battery installations.**—Installations of non-portable storage batteries of more than 50-kilowatt-hour capacity at the 8-hour rate of discharge, if used for radio, shall comply with section 13 and rule 353.



**The Institute of Radio Engineers**

**Index to Proceedings 1909-1930**

**Numerical List**

**Authors**

**Subjects**

**Current Publications of Interest to Radio  
Engineers**

**From I.R.E. Year Book  
for 1931  
Pages 206-264**

**Index to Proceedings 1909-1926**

**Subjects**

**From Supplement to Proceedings**

**Vol. 14 No. 11**

**Pages 27 - 32**



Parasitic Oscillations.....103  
 Power Rating.....99  
 Power Rating of Modulated Transmitters.....99  
 Power Rating of Telegraph Transmitters.....99  
 Radiation, Spurious.....100  
 Rating, Power.....99  
 Spurious Radiations.....100  
 Conditions of Measurement of Spurious Radiations.....101  
 Stability, Operational.....105  
 Subharmonics.....101  
 Transmitter, Spark, (3014).....56  
 Transmitter, Vacuum Tube, (3008) 56  
 Transrectification (7104).....69  
 Transrectification Characteristic (7106).....69  
 Transrectification Factor (7105)... 69  
 Trickle Charger (9026).....84  
 Triode (7010).....64  
 Tube, Vacuum.....130  
 Tube Output Resistance.....129  
 Tube Voltmeter, Vacuum.....122  
 Tungsten Sensitivity (7309).....73  
 Tungsten Sensitivity, 2870, (7310) 73  
 Tungsten Sensitivity of Phototubes.....172  
 Tungsten Sensitivity (symbol)... 92  
 Tuned Transformer (9027).....84  
 Tuning (1025).....48  
 Tuning Range Tests.....131

U

Undistorted Power Output.....165  
 Pentode.....168  
 Tetrode.....168  
 Triode.....167  
 Sensitivity at Maximum.....135  
 Unit, Transmission, (1060).....52

V

Vacuum Phototube (7302).....72  
 Vacuum Tube (7001).....63  
 Vacuum Tube Modulator (3019).. 57  
 Vacuum Tube Oscillator.....123  
 Vacuum Tube Output Resistance.129  
 Vacuum Tube Transmitter (3008). 56

Vacuum Tubes.....130  
 Vacuum Tube Voltmeter....122, 182  
 Vacuum Tube Voltmeter (9005).. 81  
 Variational Conductance (symbol). 92  
 Variational Resistance (symbol).. 92  
 Variational Sensitivity (7311).... 74  
 Variational Sensitivity Amplitude Relation (7312).....74  
 Vector Quantities (symbols).....88  
 Visibility (7403).....76  
 Visibility (symbol).....92  
 Volt (abbreviation).....87  
 Voltage Amplification (1034).....50  
 Voltage Divider (9031).....84  
 Voltage, Normal Radio Input (definition).....122  
 Voltage, Ripple (1045).....51  
 Voltage (symbol).....88  
 Voltmeter, Vacuum Tube....122, 182  
 Voltmeter, Vacuum Tube (9005).. 81  
 Voltmeter (symbol).....78  
 Volume Control.....135  
 Volume Control, Automatic (9011) 82  
 Volume Control Tests of Radio Receivers.....135

W

Watt (abbreviation).....87  
 Wave (2001).....53  
 Wave Antenna (5007).....59  
 Wave, Carrier (1016).....48  
 Wave, Continuous, (2003).....53  
 Wave, Damped (2007).....54  
 Wave, Modulated, (3003).....55  
 Wave, Interrupted Continuous (2004).....54  
 Wavelength (2002).....53  
 Wave, Marking, (3004).....55  
 Wavemeter (9001).....81  
 Wave, Signal, (1012).....48  
 Wave, Spacing (3005).....55  
 Wave, Telegraph-Modulated (2006).....54  
 Wave, Tone-Modulated (2005)... 54  
 Weather Conditions, Affecting Antenna.....119  
 Winding, Banked (9015).....82

Z

Zero-Beat Reception (4005).....58

## INDEX TO PROCEEDINGS

These titles are listed in the order in which they were published. The letters and numbers at the left of the titles are keys for use in referring from the Authors Index and the Cross Index. The letters are opposite the titles of papers published in the PROCEEDINGS of The Wireless Institute. The numbers are opposite those published in the PROCEEDINGS of The Institute of Radio Engineers.

	<i>Year</i>	<i>Page</i>
A. The Wireless Institute.....	1909	4
Robert H. Marriott (April Vol. 1 No. 1)		
Discussion.....		11
B. Constitution of the Wireless Institute.....	1909	12
(April Vol. 1 No. 1)		
C. Antennae.....	1909	6
Greenleaf W. Pickard (May Vol. 1 No. 2)		
Discussion.....		22
D. How Business Can Best Be Handled in Case of Distress....	1909	3
Jack R. Binns (June Vol. 1 No. 3)		
Discussion.....		17
E. "Antennae" Discussion.....	1909	16
Frederick W. Midgley (June Vol. 1 No. 3)		
Discussion.....		23
F. The Production of High Frequency Oscillations.....	1909	
Harry Shoemaker (Sept. Vol. 1 No. 4)		
(No copy of this publication has been found)		
G. Proportioning the Transmitter to the Aerial.....	1909	5
Frederick W. Midgley (Oct. Vol. 1 No. 5)		
H. Radio Telephony.....	1909	5
Alfred N. Goldsmith (Nov. Vol. 1 No. 6)		
1. A Discussion on Experimental Tests of the Radiation Law of		
Antennae.....	1913	3
Michael I. Pupin (Jan.)		
Discussion.....		12
(Presented before the Wireless Institute April 6, 1910)		
2. High Tension Insulators for Radio-Communication.....	1913	14
Stanley M. Hills (Jan.)		
Discussion.....		32
(Presented before the Wireless Institute May 4, 1910)		
3. Recent Developments in the Work of The Federal Telegraph		
Co.....	1913	37
Lee DeForest (Jan.)		
Discussion.....		53
4. Radio Operation by Steamship Companies.....	1913	3
Robert H. Marriott (April)		
Discussion.....		8
5. Inaugural Address: Engineering Ethics.....	1913	15
Greenleaf W. Pickard (April)		
6. The Effects of Distributed Capacity of Coils Used in Radio		
Telegraphic Circuits.....	1913	19
Frederick A. Kolster (April)		
Discussion.....		27
7. The Relation Between Effective Resistance and Frequency in		
Radio-Telegraphic Condensers.....	1913	35
Louis W. Austin (April)		
Discussion.....		39

	<i>Year</i>	<i>Page</i>
8. The Seibt Direct Indicating Wave Meter.....	1913	3
Emil J. Simon and Alfred N. Goldsmith (July)		18
Discussion.....		
9. The Sayville Station of the Atlantic Communication Com- pany.....	1913	23
Alfred E. Seelig and Fritz Van Der Woude (July)		35
Discussion.....		39
10. The Daylight Effect in Radio Telegraphy.....	1913	
A. E. Kennelly (July)		52
Discussion.....		
11. The Heterodyne Receiving System and Notes on the Recent Arlington-Salem Tests.....	1913	75
John L. Hogan, Jr. (July)		97
Discussion.....		
See also No. 35—The Theory of Heterodyne Receivers.		
12. The Multitone System.....	1913	5
Hans Rein (Dec.)		28
Discussion.....		
13. Some Recent Radio Sets of the Marconi Wireless Telegraph Company of America.....	1913	43
Roy A. Weagant (Dec.)		61
Discussion.....		15
14. The Audio-Detector and Amplifier.....	1914	
Lee deForest (Jan.)		30
Discussion.....		37
15. Radio Range Variation.....	1914	
Robert H. Marriott (Jan.)		53
Discussion.....		
16. The Influence of Alternating Currents on Certain Melted Metallic Salts.....	1914	59
C. Tissot (Jan.)		63
Discussion.....		69
17. The Goldschmidt System of Radio Telegraphy.....	1914	
Emil E. Mayer (Jan.)		93
Discussion.....		131
18. The Effect of a Parallel Condenser in The Receiving Antenna .....	1914	133
Louis W. Austin (April)		137
Discussion.....		
19. Dielectric Hysteresis at Radio Frequencies.....	1914	157
E. F. W. Alexanderson (April)		165
Discussion.....		
20. Specifications for Steamship Radio Equipment.....	1914	178
Robert H. Marriott (April)		195
Discussion.....		
21. The Radio Operator Problem.....	1914	211
V. Ford Greaves (July)		
Discussion.....		
22. The Operating Characteristics of a Three-Phase 500 Cycle Quenched Spark Transmitter.....	1914	217
Emil J. Simon and Lester L. Israel (July)		235
Discussion.....		237
23. A Method for Determining Logarithmic Decrements.....	1914	
Louis Cohen (July)		241
Discussion.....		253
24. The Hytone Radio Telegraph Transmitter.....	1914	
Melville Eastham (Dec.)		270
Discussion.....		273
25. Radio Traffic.....	1914	
David Sarnoff (Dec.)		288
Discussion.....		

	<i>Year</i>	<i>Page</i>
26. The Resistance of the Spark and its Effect on The Oscillations of Electrical Oscillators.....	1914	307
John Stone Stone (Dec.)		
Discussion.....		325
27. The Naval Radio Service; Its Development, Public Services, and Commercial Work.....	1915	7
Captain W. H. G. Bullard (March)		
Discussion.....		28
28. A Direct-Reading Decremeter and Wave Meter.....	1915	29
Frederick A. Kolster (March)		
29. Radio Frequency Changers.....	1915	55
Alfred N. Goldsmith (March)		
Discussion (New York).....		81
Discussion (Boston).....		88
30. Seasonal Variation in the Strength of Radio-Telegraphic Signals.....	1915	103
Louis W. Austin (June)		
Discussion.....		105
31. Resonance Phenomena in the Low Frequency Circuit of Radio Transmitters.....	1915	107
Henry E. Hallborg (June)		
Discussion.....		125
32. Design and Construction of Guy-Supported Towers for Radio Telegraphy.....	1915	135
Roy A. Weagant (June)		
Discussion.....		154
33. Wooden Lattice Masts.....	1915	161
Cyril F. Elwell (June)		
Discussion.....		171
34. Long Range Reception with Combined Crystal Detector and Audion Amplifier.....	1915	173
Haraden Pratt (June)		
Discussion.....		179
35. The Theory of Heterodyne Receivers.....	1915	185
Benjamin Liebowitz (June)		
Discussion.....		195
36. Radio Communication with Aeroplanes.....	1915	205
Robert A. Fliess (June)		
37. Some Recent Developments in the Audion Receiver.....	1915	215
Edwin H. Armstrong (Sept.)		
Discussion.....		239
See also No. 74—Quantitative Relations in Detector Circuits.		
38. Developments of the Heterodyne Receiver.....	1915	249
John L. Hogan, Jr. (Sept.)		
39. The Pure Electron Discharge, and Its Applications in Radio Telegraphy and Telephony.....	1915	261
Irving Langmuir (Sept.)		
Discussion.....		287
40. A Derivation of the Bjercknes Logarithmic Decrement Formula.....	1915	295
Louis Cohen (Sept.)		
41. The Training of the Radio Operator.....	1915	311
M. E. Packman (Dec.)		
Discussion.....		334
Further Discussion, M. E. Packman (Feb.).....	1916	41
42. Sustained Radio Frequency High Voltage Discharges.....	1915	349
Harris J. Ryan and Roland G. Marz (Dec.)		
Discussion.....		366
43. The Effectiveness of the Ground Antenna in Long Distance Reception.....	1915	371
R. B. Woolverton (Dec.)		
Discussion.....		374

	<i>Year</i>	<i>Page</i>
44. The Design of the Audio Frequency Circuit of Quenched Spark Transmitters..... Julius Weinberger (Dec.)	1915	377
45. The Pupin Theory of Asymmetrical Rotors in Unidirectional Fields (with special reference to the theory of the Goldschmidt alternator)..... Benjamin Liebowitz (Dec.)	1915	385
Discussion.....		406
46. The Use of Multiphase Radio Transmitters..... William C. Woodland (Feb.)	1916	11
47. Capacities..... Fritz Lowenstein (Feb.)	1916	17
Discussion.....		31
48. A Null Method of Measuring Energy Consumption in a Complex Circuit..... Alfred S. Kuhn (Feb.)	1916	33
49. The Darien Radio Station of the U. S. Navy (Panama Canal Zone)..... Lieutenant R. S. Crenshaw (Feb.)	1916	35
50. The Impedances, Angular Velocities, and Frequencies of Oscillating Current Circuits..... A. E. Kennelly (Feb.)	1916	47
Discussion.....		79
51. A Magnetic Amplifier for Radio Telephony..... E. F. W. Alexanderson and S. P. Nixdorff (April)	1916	101
Discussion.....		121
52. Variations in Nocturnal Transmission..... A. Hoyt Taylor and Albert S. Blatterman (April)	1916	131
Discussion.....		149
53. The Theory and Design of Radio Telegraphic Transformers. Fulton Cutting (April)	1916	157
Discussion.....		201
54. Radio in Alaska..... Albert H. Ginman (June)	1916	221
Discussion.....		232
55. An Impulse Excitation Transmitter..... Ellery W. Stone (June)	1916	233
Discussion.....		248
56. Experiments at the U. S. Naval Radio Station, Darien, Canal Zone..... Louis W. Austin (June)	1916	251
Discussion..... See also No. 62—On Telephonic Measurements in a Radio Receiver		259
57. The Mechanism of Radiation and Propagation in Radio Communication..... Fritz Lowenstein (June)	1916	271
Discussion.....		281
58. Amplitude Relations in Coupled Circuits..... E. Leon Chaffee (June)	1916	283
Discussion.....		301
59. Sustained Wave Receiving Data..... Leonard F. Fuller (June)	1916	305
60. Recent Standard Radio Sets..... Harry Shoemaker (Aug.)	1916	313
Discussion.....		337
61. Some Direct Current Sets..... Bowden Washington (Aug.)	1916	341
Discussion.....		356
62. On Telephonic Measurements in a Radio Receiver..... Jonathan Zenneck (Aug.)	1916	363

	<i>Year</i>	<i>Page</i>
63. Arc Oscillations in Coupled Circuits.....	1916	371
Hidetsugu Yagi (Aug.)		
Discussion.....		389
64. Physical Aspects of Radio Telegraphy.....	1916	397
John L. Hogan, Jr. (Oct.)		
65. Arlington Radio Station and Its Activities in the General Scheme of Naval Radio Communication.....	1916	421
Captain William H. G. Bullard (Oct.)		
Discussion.....		447
66. Notes on Radiation from Horizontal Antennas.....	1916	449
Charles A. Culver (Oct.)		
67. A Few Experiments with Ground Antennas.....	1916	455
Leonard F. Fuller (Oct.)		
68. The Effect of the Spark on the Oscillations of an Electric Circuit.....	1916	463
John Stone Stone (Oct.)		
Discussion.....		483
69. On the Determination of the Energy Losses in a Radio Tele- graph Transmitter.....	1916	499
Bowden Washington and P. H. Royster (Dec.)		
70. The Heaviside Layer.....	1916	511
E. W. Marchant (Dec.)		
Discussion.....		521
71. Skin-Effect Resistance Measurements of Conductors at Radio Frequencies up to 100,000 Cycles Per Second.....	1916	523
Arthur E. Kennelly and H. A. Affel (Dec.)		
Discussion.....		575
72. Engineering Precautions in Radio Installations.....	1917	9
Robert H. Marriott (Feb.)		
Discussion.....		23
73. Sustained Wave Transmission Chart.....	1917	25
Tyng M. Libby (Feb.)		
74. Quantitative Relations in Detector Circuits.....	1917	33
Benjamin Liebowitz (Feb.)		
75. Notes on a New Method for the Determination of the Mag- netic Flux Density and Permeability.....	1917	43
August Hund (Feb.)		
76. On the Nature and Elimination of Strays.....	1917	75
Cornelius J. De Groot (April)		
Discussion.....		121
77. Some Additional Experiments on Impulse Excitation.....	1917	133
Ellery W. Stone (April)		
78. A Study of Heterodyne Amplification by the Electron Relay.	1917	145
Edwin H. Armstrong (April)		
Discussion.....		160
79. United States Radio Development.....	1917	179
Robert H. Merriott (June)		
Discussion.....		196
80. On the Use of Constant Potential Generators for Charging Radio Telegraphic Condensers and the New Radio Tele- graphic Installations of the Postal and Telegraph De- partment of France.....	1917	199
Leon Bouthillon (June)		
Discussion by J. F. J. Bethenod (June).....	1918	159
Discussion by Leon Bouthillon (June).....		163
81. The Measurement of Radiotelegraphic Signals with the Os- cillating Audion.....	1917	239
Louis W. Austin (Aug.)		
Discussion.....		247
82. On the Poulsen Arc and its Theory.....	1917	255
P. O. Pedersen (Aug.)		

	<i>Year</i>	<i>Page</i>
Discussion.....		317
See also No. 123—Supplementary Note.		
83. Note on "The Measurement of Radiotelegraphic Signals with with the Oscillating Audion".....	1917	327
Louis W. Austin (Oct.)		
84. The Effect of Commercial Conditions on Spark Transmitter Construction.....	1917	331
Julian Barth (Oct.)		
Discussion.....		348
85. An Automatic Transmitter for Distress Signals.....	1917	353
Chester M. Agner (Oct.)		
86. Harmonic Method of Calibrating a Wave Meter.....	1917	357
E. Leon Chaffee (Oct.)		
Discussion.....		
87. The Coupled Circuit by the Method of Generalized Angular Velocities.....	1917	361 363
V. Bush (Oct.)		
Discussion by John R. Carson (Dec.).....	1917	447
See also No. 97—Additional Notes on the Coupled Circuit by the Method of Generalized Angular Velocities		
88. Some Experiments with Long Electrical Conductors.....	1917	389
John H. Morecroft (Dec.)		
Discussion.....		412
89. Distributed Inductance of Vertical Grounded Antennas....	1917	413
A. Press (Dec.)		
90. Municipal Regulations Covering Radio Stations.....	1917	417
Ellery W. Stone (Dec.)		
91. The Manufacture of Vacuum Detectors.....	1917	427
O. B. Moorehead (Dec.)		
92. On the Phenomena in Resonance Transformers.....	1917	433
Hidetsugu Yagi (Dec.)		
93. The Dynatron, A Vacuum Tube Possessing Negative Re- sistance.....	1918	5
Albert W. Hull (Feb.)		
94. Telephone Receivers and Radio Telegraphy.....	1918	37
H. O. Taylor (Feb.)		
95. Oscillating Audion Circuits.....	1918	63
L. A. Hazeltine (April)		
Discussion by August Hund (Aug.).....	1918	219
96. The Determination of the Audibility Current of a Telephone Receiver with the Aid of the Wheatstone Bridge.....	1918	99
Edward W. Washburn (April)		
Discussion.....		105
97. Additional Notes on "The Coupled Circuit by the Method of Generalized Angular Velocities".....	1918	111
V. Bush (April)		
98. Some Aspects of Radio Telephony in Japan.....	1918	117
Eitaro Yokoyama (June)		
99. A Dynamic Method for Determining the Characteristics of Three-Electrode Vacuum Tubes.....	1918	141
John M. Miller (June)		
100. Edison Storage Batteries for Electron Relays.....	1918	149
Miller Reese Hutchison (June)		
101. Theory of Free and Sustained Oscillations.....	1918	167
H. G. Cordes (June)		
102. Radio Communication with Moving Trains.....	1918	185
Frederick H. Millener (Aug.)		
Discussion.....		217
103. On the interpretation of Early Transmission Experiments by Commandant Tissot and Their Application to the Verification of a Fundamental Formula in Radio Trans- mission.....	1918	221
Leon Bouthillon (Aug.)		

	<i>Year</i>	<i>Page</i>
Discussion.....		225
Discussion by Oscar C. Roos (Oct.).....	1918	285
104. Feasibility of the Low Antenna in Radio Telegraphy.....	1918	237
Edward Bennet (Oct.)		
Discussion.....		266
105. The Amplification Obtainable by the Heterodyne Method of Reception.....	1918	275
G. W. O. Howe (Oct.)		
106. On the Electrical Operation and Mechanical Design of an Impulse Excitation Multi-Spark Group Radio Trans- mitter.....	1918	295
Bowden Washington (Dec.)		
Discussion by Ellery W. Stone and Bowden Washington (Feb.).....	1919	83
Discussion by Samuel Cohen (June).....	1919	327
Discussion by Ellery W. Stone (Oct.).....	1919	541
107. The Vertical Grounded Antenna as a Generalized Bessel's Antenna.....	1918	317
A. Press (Dec.)		
108. On the Possibility of the Tone Production by Rotary and Stationary Spark Gaps.....	1918	323
Hidetsugu Yagi (Dec.)		
109. Resonance Measurements in Radiotelegraphy with the Os- cillating Audion.....	1919	9
Louis W. Austin (Feb.)		
110. A Brief Technical Description of the New San Diego, Pearl Harbor, and Cavite High Power Naval Radio Stations.	1919	11
Leonard F. Fuller (Feb.)		
111. Hysteresis and Eddy Current Losses in Iron at Radio Fre- quencies.....	1919	15
Christian Nusbaum (Feb.)		
112. The Measurement of Radio Frequency Resistance, Phase Difference, and Decrement.....	1919	27
J. H. Dellinger (Feb.)		
113. Note on Losses in Sheet Iron at Radio Frequencies.....	1919	61
Marius Latour (Feb.)		
114. The Natural Frequency of an Electric Circuit Having an Iron Magnetic Circuit.....	1919	73
H. G. Cordes (Feb.)		
115. Theory and Operating Characteristics of the Thermionic Amplifier.....	1919	97
H. J. van der Bijl (April)		
116. The Operational Characteristics of Thermionic Amplifiers..	1919	129
Stuart Ballantine (April)		
Discussion.....		162
117. A Theoretical Study of the Three-Element Vacuum Tube..	1919	187
John R. Carson (April)		
118. Reception Thru Static and Interference.....	1919	207
Roy A. Weagant (June)		
Discussion.....		245
Discussion by Lee de Forest (Oct.).....	1919	543
119. A New Method of Using Contact Detectors in Radio Measurements.....	1919	257
Louis W. Austin (June)		
120. The Possibilities of Concealed Receiving Systems.....	1919	261
A. Hoyt Taylor (June)		
121. On Measurement of Signal Strength.....	1919	267
W. H. Eccles (June)		
Discussion.....		279
122. The Cabot Converter.....	1919	281
Claude F. Cairns (June)		

	<i>Year</i>	<i>Page</i>
123. On the Poulsen Arc and Its Theory (Supplementary Note) . . . . .	1919	293
P. O. Pedersen (June)		
124. Electrical Oscillations in Antennae and Inductance Coils . . . . .	1919	299
John M. Miller (June)		
Discussion by John H. Morecroft (Dec.) . . . . .	1919	265
Discussion by August Hund (Oct.) . . . . .	1920	424
125. Short Wave Reception and Transmission on Ground Wires . . . . .	1919	337
(Subterranean and Submarine)		
A. Hoyt Taylor (Aug.)		
Discussion . . . . .		362
126. Simultaneous Sending and Receiving . . . . .	1919	363
Ernst F. W. Alexanderson (Aug.)		
Discussion . . . . .		379
127. Radio Telegraphy in Competition with Wire Telegraphy in Overland Work . . . . .	1919	391
Robert Boyd Black (Aug.)		
128. A Special Type of Quenched Spark Radio Transmitter . . . . .	1919	409
D. Galen McCaa (Aug.)		
129. On the Multi-Section Quenched Gap . . . . .	1919	417
M. Shuleiken and I. Freiman (Aug.)		
130. A Study of Electrostatically Coupled Circuits . . . . .	1919	427
W. Orland Lytle (Aug.)		
131. The Design of Poulsen Arc Converters for Radio Telegraphy . . . . .	1919	449
Leonard F. Fuller (Oct.)		
132. The Uni-Control Receiver . . . . .	1919	499
Roy E. Thompson (Oct.)		
Discussion . . . . .		515
133. On the Theory of Radiotelegraphic and Radiotelephonic Receiver Circuits . . . . .	1919	517
J. F. J. Bethenod (Oct.)		
134. Determination of the Rate of De-Ionisation of Electric Arc Vapor . . . . .	1919	527
Henry G. Cordes (Oct.)		
135. Long Wave Reception and the Elimination of Strays on Ground Wires (Subterranean and Submarine) . . . . .	1919	559
A. Hoyt Taylor (Dec.)		
136. An Oscillation Source for Radio Receiver Investigations . . . . .	1919	584
Julius Weinberger and Carl Dreher (Dec.)		
137. On the Detecting Efficiency of the Thermionic Detector . . . . .	1919	603
H. J. Van Der Bijl (Dec.)		
Discussion . . . . .		633
138. Harmonic Oscillations in Directly Excited Antennas Used in Radio Telegraphy . . . . .	1919	636
Luigi Lombardi (Dec.)		
139. Re-enforced Harmonics in High Power Arc Transmitters . . . . .	1919	648
Frederick A. Kolster (Dec.)		
140. Naval Aircraft Radio (Part I) . . . . .	1920	3
T. Johnson, Jr. (Feb.)		
Part II . . . . .	1920	87
Discussion . . . . .		135
141. Long Distance Radio Communication in Chile . . . . .	1920	59
E. W. Fielding (Feb.)		
142. The Dependence of the Amplification Constant and Internal Plate Circuit Resistance of a Three-Electrode Vacuum Tube Upon the Structural Dimensions . . . . .	1920	64
John M. Miller (Feb.)		
143. An Experiment on Impulse Excitation . . . . .	1920	75
John H. Morecroft (Feb.)		
144. The Radio Telegraphic Station at Rome (San Paolo) . . . . .	1920	142
B. Micchiardi, G. Pession, and G. Vallauri (April)		
145. Calculation of Antenna Capacity . . . . .	1920	164
Louis W. Austin (April)		

	<i>Year</i>	<i>Page</i>
146. The Use of Ground Wires at Remote Control Stations.....	1920	171
A. Hoyt Taylor and A. Crossley (June)		
Discussion.....		191
Discussion by Ellery W. Stone (Oct.).....	1920	431
147. The Rome Radio Station of the Italian Navy.....	1920	193
Cyril F. Elwell (June)		
148. Simultaneous Transmission and Reception in Radio Telephony.....	1920	199
Noboru Marumo (June)		
149. Radio Frequency Alternators.....	1920	220
Marius Latour (June)		
150. Some Notes on Vacuum Tubes.....	1920	239
John H. Morecroft (June)		
151. Trans-Oceanic Radio Communication.....	1920	263
Ernst F. W. Alexanderson (Aug.)		
152. Measurement of the Electric and Magnetic Fields of Waves Received During Trans-Oceanic Radio Transmissions..	1920	286
Giancarlo Vallauri (Aug.)		
Discussion.....		297
153. Radio Direction Changes and Variations of Audibility.....	1920	299
Carl Kinsley and A. Sobey (Aug.)		
Discussion.....		324
154. Note on Radio Frequency Measurements.....	1920	326
Carl Englund (Aug.)		
155. Note on the Input Impedance of Vacuum Tubes at Radio Frequency.....	1920	334
Julius Weinberger (Aug.)		
Discussion.....		340
156. An Electrical Signaling Method for Guiding Aerial and Marine Craft.....	1920	345
Robert H. Marriott (Oct.)		
157. Static Elimination by Directional Reception.....	1920	358
Greenleaf W. Pickard (Oct.)		
Discussion.....		395
158. Quantitative Experiments with Coil Antennas in Radio Telegraphy.....	1920	416
Louis W. Austin (Oct.)		
Discussion.....		421
159. Electrostatically Coupled Circuits.....	1920	434
Louis Cohen (Oct.)		
160. The Wave Length Relation for a Generalized Bessel's Antenna.....	1920	441
A. Press (Oct.)		
161. Multiplex Radio Telegraphy and Telephony.....	1920	451
Francis M. Ryan, J. R. Tolmie, and Roy O. Bach (Dec.)		
162. A Contribution to the Theory of Magnetic Frequency Changers.....	1920	468
J. Zenneck (Dec.)		
163. Some Characteristics of the Frequency Doubler as Applied to Radio Transmission.....	1920	493
T. Minohara (Dec.)		
164. The Status of the Static Frequency Changer in Radio Engineering Practice.....	1920	509
Frederick C. Ryan (Dec.)		
165. Theory of Antenna Radiation.....	1920	525
A. Press (Dec.)		
166. A New System of Short Wave Amplification.....	1921	3
Edwin H. Armstrong (Feb.)		
Discussion.....		12
167. The Relation Between Atmospheric Disturbances and Wave Length in Radio Reception.....	1921	28
Louis W. Austin (Feb.)		

	<i>Year</i>	<i>Page</i>
		36
168. Discussion.....		
The Reduction of Atmospheric Disturbances in Radio Reception.....	1921	41
Louis W. Austin (Feb.)		
169. The Magnetic Behavior of Iron in Alternating Fields of Frequencies between 100,000 and 1,500,000 Cycles.....	1921	56
Leon T. Wilson (Feb.)		
		78
170. Discussion.....		
Central Stations for Radio Communications.....	1921	83
Ernst F. W. Alexanderson (April)		
171. The Specifications and Characteristics of Moorehead Vacuum Valves.....	1921	95
O. B. Moorehead and F. C. Lange (April)		
172. The Cathode-Ray Oscillograph and its Application in Radio Work.....	1921	130
Lewis M. Hull (April)		
173. Frequencies and Damping Factors of Coupled Circuits.....	1921	150
Louis Cohen (April)		
174. Digest of United States Patents Relating to Radio Telegra- phy and Telephony, Granted January 4, 1921, February 15, 1921.....	1921	164
John B. Brady (April)		
(Similar digests continued in each subsequent issue of the Pro- CEEDINGS to Jan. 1928.)		
175. Recent Progress in Radio Communication in Germany and Austria.....	1921	183
Eugen Nesper (June)		
176. Radio Taste Reception.....	1921	206
Alfred N. Goldsmith and Edward T. Dickey (June)		
		221
Discussion.....		
177. A System for Measuring the Amount of Static.....	1921	225
Austen M. Curtis (June)		
178. On the Poulsen Arc in Coupled Circuits.....	1921	228
P. O. Pedersen (June)		
		242
Discussions.....		
See also Nos. 82 and 123—The Poulsen Arc and its Theory.		
179. The Equivalent Circuit of the Vacuum Tube Modulator....	1921	243
John R. Carson (June)		
180. Vacuum Tube Amplifiers in Parallel.....	1921	250
R. V. L. Hartley (June)		
181. Piloting Vessels by Electrically Energized Cables.....	1921	273
A. Crossley (Aug.)		
		295
Discussion.....		
182. Rapid Determination of Distributed Capacity of Coils.....	1921	300
Ralph R. Batcher (Aug.)		
183. Modulation in Radio Telephony.....	1921	305
R. A. Heising (Aug.)		
184. Naval Radio Tube Transmitters.....	1921	381
T. Johnson, Jr. (Oct.)		
185. Some Improvements in the Poulsen Arc—Part 1.....	1921	434
P. O. Pedersen (Oct.)		
See No. 223—Part II.		
186. The Avalon-Los Angeles Radio Toll Circuit.....	1921	469
Lewis M. Clement, Francis M. Ryan, and De Loss K. Martin (Dec.)		
187. A Visual and Photographic Device for Recording Radio Signals.....	1921	506
Charles A. Hoxie (Dec.)		
188. The Development of Tube Transmitters by the Telefunken Company.....	1922	3
Alexander Meissner (Feb.)		

	<i>Year</i>	<i>Page</i>
189. Improvements in Piloting Cable Receiving Apparatus.....	1922	24
A. Crossley (Feb.)		
Discussion.....		33
190. A New Rectifier.....	1922	41
V. Bush and C. G. Smith (Feb.)		
191. Polyphase Rectification.....	1922	52
Hudson R. Searing and Mark H. Redmond (Feb.)		
192. Notes on the Theory of Modulation.....	1922	57
John R. Carson (Feb.)		
193. The Piezo-Electric Resonator.....	1922	83
W. G. Cady (April)		
194. A Study of the Oscillations Occurring in the Circuits of the Plotron.....	1922	115
James E. Ives and C. N. Hickman (April)		
195. A Simple Method of Calculating Radiation Resistance.....	1922	129
Fulton Cutting (April)		
196. The Monthly Averages of Signal Strength of Nauen in Washington, 1915-1921 and the Monthly Averages of Atmospheric Disturbances in Washington, 1918-1921..	1922	153
Louis W. Austin (June)		
196a. Reception Measurements at Naval Research Laboratory...	1922	158
Louis W. Austin (June)		
197. The Direction and Intensity of Waves from European Stations.....	1922	161
Greenleaf W. Pickard (June)		
198. The Recording of High Speed Signals in Radio Telegraphy..	1922	176
Julius Weinberger (June)		
199. Radio Telegraphy.....	1922	215
Guglielmo Marconi (Aug.)		
Discussion by Stuart Ballantine (Oct.).....	1922	399
200. Receiving Measurements and Atmospheric Disturbances at the Naval Radio Research Laboratory, Bureau of Standards, March and April, 1922.....	1922	239
Louis W. Austin (Aug.)		
201. Some Recent Developments of Regenerative Circuits.....	1922	244
Edwin H. Armstrong (Aug.)		
202. Resistance and Capacity of Coils at Radio Frequencies.....	1922	261
J. H. Morecroft (Aug.)		
Discussion by G. Breit, and J. H. Morecroft.....		287
Further Discussion by A. Press, and G. Breit (Feb.).....	1923	57
203. Receiving Measurements and Atmospheric Disturbances at the United States Naval Radio Research Laboratory, Bureau of Standards, Washington, May and June 1922.	1922	315
Louis W. Austin (Oct.)		
204. The Dynatron Detector—A New Heterodyne Receiver for Continuous and Modulated Waves.....	1922	320
Albert W. Hull, E. F. Hennelly, and F. R. Elder (Oct.)		
205. Applications to Radio of Wire Transmission Engineering...	1922	344
Lloyd Espenschied, (Oct.)		
Discussion.....		369
206. A Method for Testing and Rating Electron Tube Generators	1922	373
L. M. Hull (Oct.)		
207. Mathematical Treatment of Rectification Phenomena.....	1922	393
D. C. Prince (Oct.)		
208. Receiving Measurements and Atmospheric Disturbances at the Naval Radio Research Laboratory, Bureau of Standards, Washington, July and August, 1922.....	1922	421
L. W. Austin (Dec.)		
209. Radio Receiving Equipment.....	1922	426
Frank Conrad (Dec.)		
210. Oscillographic Study of Electron Tube Characteristics.....	1922	440
E. Leon Chaffee (Dec.)		

	Year	Page
211. Photoelectric Electron Tubes.....	1922	451
H. A. Brown and C. T. Knipp (Dec.)		
212. Thermionic Tubes.....	1922	468
Frederick S. McCullough (Dec.)		
213. Receiving Measurements and Atmospheric Disturbances at the United States Naval Radio Research Laboratories, Bureau of Standards, Washington, September and October, 1922.....	1923	3
L. W. Austin (Feb.)		
214. The Oscillation Engineering Design of Submarine Acoustic Signaling Apparatus.....	1923	9
Walter Hahnemann (Feb.)		
215. Note on the Measurements of Radio Signals.....	1923	26
C. R. Englund (Feb.)		
Discussion by L. W. Austin (April).....	1923	153
216. Relations of Carrier and Side-Bands in Radio Transmission. R. V. L. Hartley (Feb.)	1923	34
217. The Work of the International Union of Scientific Radio Tele- graphy.....	1923	75
J. H. Dellinger (April)		
218. Receiving Measurements and Atmospheric Disturbances at the United States Naval Radio Research Laboratory, Bureau of Standards, Washington, November and Decem- ber, 1922.....	1923	83
L. W. Austin (April)		
219. A Combined Kenotron Rectifier and Plotron Receiver Ca- pable of Operation by Alternating Current Power.....	1923	89
Albert W. Hull (April)		
220. A New Non-Interfering Detector.....	1923	97
Harold P. Donle (April)		
221. A High Voltage Mechanical Rectifier.....	1923	111
S. T. Woodhull (April)		
222. Radio Transmission Measurements.....	1923	115
Ralph Bown, Carl R. Englund, and H. T. Friis, (April)		
223. Some Improvements in the Poulsen Arc, Part II.....	1923	155
P. O. Pedersen (April)		
224. Distortion-Free Telephone Receivers.....	1923	163
J. F. J. Bethenod (April)		
225. Receiving Measurements and Atmospheric Disturbances at the United States Naval Radio Research Laboratory, Bureau of Standards, Washington, January and Febru- ary, 1923.....	1923	187
L. W. Austin (June)		
226. Radio Extension of the Telephone System to Ships at Sea..	1923	193
H. W. Nichols and L. Espenschied (June)		
Discussion.....		240
227. Continuous-Wave Transmission on a Wave Length of 100 Meters, Using a Special Type of Antenna.....	1923	243
Francis W. Dunmore (June)		
228. Progress in Radio Engineering in Russia, 1918-1922.....	1923	257
Valerian Bashenoff (June)		
229. Signal-To-Static-Interference Ratio in Radio Telephony....	1923	271
John R. Carson (June)		
230. Vacuum Tubes as Power Oscillators, Part I.....	1923	275
D. C. Prince (June)		
See also No. 237, Part II and No. 242, Part III.		
231. Receiving Measurements and Atmospheric Disturbances at the United States Naval Radio Research Laboratory, Bureau of Standards, Washington, March and April, 1923.....	1923	333
L. W. Austin (Aug.)		

	<i>Year</i>	<i>Page</i>
232. Description of the General Electric Company's Broadcasting Stations at Schenectady, New York.....	1923	339
W. R. G. Baker (Aug.)		
233. Interference.....	1923	375
Robert H. Marriott (Aug.)		
234. On Super Regeneration.....	1923	391
E. O. Hulburt (Aug.)		
235. Loop Uni-Directional Receiving Circuits for the Determination of the Direction of Atmosphere Disturbances.....	1923	395
L. W. Austin (Aug.)		
236. Standards of Capacity Particularly for Radio Frequency Currents.....	1923	399
J. B. Dempster and E. O. Hulburt (Aug.)		
237. Vacuum Tubes as Power Oscillators, Part II.....	1923	405
D. C. Prince (Aug.)		
238. Observations on Lafayette and Nauen Stations in Washington, March 1, 1922, to February 28, 1923.....	1923	459
L. W. Austin (Oct.)		
239. A Method of Measuring Very Short Radio Wave Lengths and Their Use in Frequency Standardization.....	1923	467
Francis W. Dunmore and Francis H. Engel (Oct.)		
Discussion by Eijiro Takagishi and Shigeyoshi Kawazoe (Feb.).....	1925	125
Discussion by S. R. Kantebet and F. W. Dunmore (Oct.)....	1925	647
240. An Improved System of Modulation in Radio Telephony... Charles A. Culver (Oct.)	1923	479
Discussion.....		493
Discussion by R. A. Heising (Feb.).....	1924	83
241. Radio Frequency Tests on Antenna Insulators.....	1923	495
W. W. Brown, (Oct.)		
Discussion.....		523
242. Vacuum Tubes as Power-Oscillators, Part III.....	1923	527
D. C. Prince (Oct.)		
243. The Efficiency of Three-Electrode Tubes Used for the Production of Continuous Waves in Radio Telegraphy, that is, the Conversion of Direct Current Into Alternating Current.....	1923	551
Marius Latour and H. Chireix (Oct.)		
244. Receiving Measurements and Atmospheric Disturbances at the Bureau of Standards, Washington, D. C., May and June, 1923.....	1923	579
L. W. Austin (Dec.)		
245. Recent Developments in High Vacuum Receiving Tubes—Radiotrons, Model UV-199 and Model UV-201-A.....	1923	587
J. C. Warner (Dec.)		
246. Commercial Radio Tube Transmitters.....	1923	601
W. R. G. Baker (Dec.)		
247. Radio Transmission Measurements on Long Wave Lengths.	1923	661
H. H. Beverage and H. O. Peterson (Dec.)		
248. Stationary Waves on Free Wires and Solenoids.....	1923	675
A. Press (Dec.)		
249. Receiving Measurements and Atmospheric Disturbances at the Radio Physical Laboratory, Bureau of Standards, Washington, July and August, 1923.....	1924	3
L. W. Austin (Feb.)		
250. The Radio Equipment of the Steam Yacht "Elettra".....	1924	9
Eric A. Payne (Feb.)		
251. The Development of the Standard Design for Self-Supporting Radio Towers for the United Fruit and Tropical Radio Telegraph Companies.....	1924	29
Albert W. Buel (Feb.)		
Discussion.....		65

	<i>Year</i>	<i>Page</i>
252. Receiving Measurements and Atmospheric Disturbances at the Bureau of Standards, Washington, September and October, 1923.....	1924	113
L. W. Austin (April)		
253. Short Period Variations in Radio Reception.....	1924	119
Greenleaf W. Pickard (April)		
254. New Applications of the Sodian Detector.....	1924	159
Harold P. Donle (April)		
255. The Characteristic Surfaces of the Triode.....	1924	177
J. R. Tolmie (April)		
256. Formulas and Tables for the Calculation and Design of Single-Layer Coils.....	1924	193
Frederick W. Grover (April)		
257. Receiving Measurements and Atmospheric Disturbances at the Bureau of Standards, Washington, November and December, 1923.....	1924	227
L. W. Austin (June)		
258. On Propagation Phenomena and Disturbances of Reception in Radio Telegraphy.....	1924	233
F. Kiebitz (June)		
259. The Cape Cod Marine System of the Radio Corporation of America.....	1924	243
F. H. Kroger (June)		
260. KDKA, The Radio Telephone Broadcasting Station of the Westinghouse Electric and Manufacturing Company, East Pittsburgh, Pennsylvania.....	1924	255
D. G. Little (June)		
Discussion by John H. Morecroft (Feb.).....	1925	123
261. On Optimum Heterodyne Reception.....	1924	277
E. V. Appleton and Mary Taylor (June)		
262. Signal-To-Static Interference Ratio in Radio Telephony....	1924	295
Marius Latour (June)		
263. Regeneration in Coupled Circuits.....	1924	299
E. Leon Chaffee (June)		
Errata (Aug.).....		515
264. Long Distance Radio Receiving Measurements at the Bureau of Standards in 1923.....	1924	389
L. W. Austin (Aug.)		
265. Distribution of Radio Waves From Broadcasting Stations Over City Districts.....	1924	395
Ralph Bown and G. D. Gillett (Aug.)		
266. The Marconi Four-Electrode Tube and Its Circuit .....	1924	411
H. De A. Donisthorpe (Aug.)		
267. The Performance and Theory of Loud Speaker Horns.....	1924	423
Alfred N. Goldsmith and John P. Minton (Aug.)		
268. The Limit of Regeneration.....	1924	479
N. C. Little (Aug.)		
269. On the Calculation of the Inductance and Capacities for a Multi-Range or Other Consecutive Series of Tuned Transmitting or Receiving Circuits, the Total Range and Accuracy Required Being Given.....	1924	485
J. Erskine-Murray (Aug.)		
Discussion by Ralph R. Batcher (Oct.).....	1924	651
270. Method of Measuring Radio Signals Used at the Radio Physical Laboratory, Bureau of Standards, Washington D.C.....	1924	521
L. W. Austin and E. B. Judson (Oct.)		
271. Discovery of a Place Where No Static Could Be Heard in August.....	1924	533
R. H. Marriott (Oct.)		
272. The Super-Heterodyne—Its Origin, Development, and Some		

	<i>Page</i>	<i>Year</i>
Recent Improvements.....	1924	539
Edwin H. Armstrong (Oct.)		
273. Transmitting Equipment for Radio Telephone Broadcasting	1924	553
Edward L. Nelson (Oct.)		
274. An Analysis of Two Triode Circuits.....	1924	579
John H. Morecroft and Axel G. Jensen (Oct.)		
Discussion.....		604
275. Experimental Determination of the Fundamental Dynamic		
Characteristics of a Triode.....	1924	609
Eijiro Takagishi (Oct.)		
276. A High Efficiency Vacuum Tube Oscillating Circuit.....	1924	623
D. C. Prince and F. B. Vogdes (Oct.)		
277. Field Intensity Measurements in Washington on the Radio		
Corporation Stations at New Brunswick and Tucker-		
ton, New Jersey.....	1924	681
L. W. Austin (Dec.)		
278. The High Power Station at Malabar, Java.....	1924	693
Cornelius De Groot (Dec.)		
279. Short-Wave Radio Broadcasting.....	1924	723
Frank Conrad (Dec.)		
Discussion.....		739
280. Broadcast Transmitting Stations of the Radio Corporation		
of America.....	1924	745
Julius Weinberger (Dec.)		
281. An International Comparison of Radio Wave Length Stand-		
ards by Means of Piezo-Electric Resonators.....	1924	805
W. G. Cady (Dec.)		
		<i>Year</i>
		<i>Page</i>
282. Correction Factor for the Parallel Wire System Used in	1924	817
Absolute Radio Frequency Standardization.....		
August Hund (Dec.)		
283. On the Radiation Resistance of a Simple Vertical Antenna		
at Wave Lengths Below the Fundamental.....	1924	823
Stuart Ballantine (Dec.)		
Discussion by Balth. van der Pol and Stuart Ballantine (April)	1925	251
284. On the Optimum Transmitting Wave Length for a Vertical		
Antenna Over Perfect Earth.....	1924	833
Stuart Ballantine (Dec.)		
Discussion by B. van der Pol and S. Ballantine (April).....	1925	251
285. Electrical Constants of Dielectrics for Radio Frequency		
Currents.....	1924	841
R. V. Guthrie, Jr. (Dec.)		
286. A Suggestion for Experiments on Apparent Radio Direction		
Variations.....	1925	3
L. W. Austin, (Feb.)		
287. Recent Investigations on the Propagation of Electromagnetic		
Waves.....	1925	5
M. Bäumlér (Feb.)		
288. The Marconi Marine Radio Direction Finder.....	1925	29
H. De A. Donisthorpe (Feb.)		
289. Recent Developments in Vacuum Tube Transmitters.....	1925	49
B. R. Cummings (Feb.)		
290. A Method of Measuring at Radio Frequencies the Equiva-		
lent Series Resistance of Condensers Intended for Use		
in Radio Receiving Circuits.....	1925	109
Charles N. Weyl and Sylvan Harris (Feb.)		
291. Some Trans-Pacific Radio Field Intensity Measurements...	1925	151
L. W. Austin (April)		
292. The Magnetron Amplifier and Power Oscillator.....	1925	159
Frank R. Elder (April)		
293. Novel Current Supply for Audions.....	1925	189
Charles V. Logwood (April)		

	<i>Year</i>	<i>Page</i>
294. A Method of Measuring Radio Frequency by Means of a Harmonic Generator..... August Hund (April)	1925	207
295. An Electrometer Method for the Measurements of Radio Frequency Resistance..... P. O. Pedersen (April)	1925	215
296. Note on Telephone Receiver Impedance..... E. Z. Stowell (April)	1925	245
297. Long Distance Radio Receiving Measurements in 1924..... L. W. Austin (June)	1925	283
298. Production of Single Side-Band for Trans-Atlantic Radio Telephony..... R. A. Heising (June)	1925	291
299. Power Amplifiers in Trans-Atlantic Radio Telephony..... A. A. Oswald and J. C. Schelleng (June)	1925	313
300. Re-Radiation From Tuned Antenna Systems..... Henry C. Forbes (June)	1925	363
301. A New Phenomenon in Sunset Radio Direction Variations.. L. W. Austin (Aug.)	1925	409
Discussion by R. L. Smith-Rose and R. H. Barfield (Dec.)	1925	781
302. Recent Commercial Developments in Short Wave Transmitters and Receivers..... S. E. Anderson, L. M. Clement, and G. C. De Coutouly (Aug.)	1925	413
303. Design of Telephone Receivers for Loud Speaking Purposes. C. R. Hanna (Aug.)	1925	437
304. Amplification of Weak Currents and Their Applications to Photo-Electric Cells..... G. Ferriè, R. Jouaust, and R. Mesny (Aug.)	1925	461
305. Generation of Polyphase Oscillations by Means of Electron Tubes..... Rene Mesny (Aug.)	1925	471
306. The Shielding of Electric and Magnetic Fields..... John H. Morecroft and Alva Turner (Aug.)	1925	477
307. The "Straight-Line" Frequency Variable Condenser..... Henry C. Forbes (Aug.)	1925	507
308. Calculation of the Mutual Inductances of Co-Axial Cylindrical Coils of Small Radial Depth..... F. B. Vogdes (Aug.)	1925	511
309. The Effect of the Solar Eclipse of January 24, 1925, on Radio Reception..... Greenleaf W. Pickard (Oct.)	1925	539
310. Trans-Oceanic Radio Station—Warsaw, Poland..... William G. Lush, Fred E. Johnston, and J. Leslie Finch (Oct.)	1925	571
311. The Application of the X-L Filament to Power Tubes..... J. C. Warner and O. W. Pike (Oct.)	1925	589
312. Detecting Characteristics of Electron Tubes..... H. M. Freeman (Oct.)	1925	611
313. Life Testing of Tungsten Filament Triodes..... William C. White (Oct.)	1925	685
314. An Investigation of Transmission on the Higher Radio Frequencies..... A. Hoyt Taylor (Dec.)	1925	677
315. A New Directional Receiving System..... H. T. Friis (Dec.)	1925	685
316. An Analysis of Regenerative Amplification..... V. D. Landon and K. W. Jarvis (Dec.)	1925	709
317. Designs and Efficiencies of Large Air Core Inductances..... W. W. Brown and J. E. Love (Dec.)	1925	755
318. An Efficient Tuned Radio Frequency Transformer..... F. H. Drake and G. H. Browning (Dec.)	1925	767

	<i>Page</i>	<i>Year</i>
319. Trans-Atlantic Radio Telephone Transmission . . . . . Lloyd Espenschied, C. N. Anderson, and Austin Bailey (Feb.)	1926	7
320. Some Studies in Radio Broadcast Transmission . . . . . Ralph Bown, De Loss K. Martin, and Ralph K. Potter (Feb.)	1926	57
321. The Present Status of Radio Atmospheric Disturbances . . . . . L. W. Austin (Feb.)	1926	133
322. Transmission and Reception of Photoradiograms . . . . . Richard H. Ranger (April)	1926	161
323. Sleet Removal From Antennas . . . . . J. H. Shannon (April)	1926	181
324. Recent Advances in Marine Radio Communication . . . . . T. M. Stevens (April)	1926	197
325. The Polarization of Radio Waves . . . . . Greenleaf W. Pickard (April) Discussion by E. F. W. Alexanderson (June)	1926	205 391
326. A Method of Calibrating a Low-Frequency Generator with a One-Frequency Source . . . . . Sylvan Harris (April)	1926	213
327. The Shielded Neutrodyne Receiver . . . . . John F. Dreyer, Jr. and Ray H. Manson (April) Discussion by L. A. Hazeltine (June)	1926	217 395
328. New Method Pertaining to The Reduction of Interference in the Reception of Wireless Telegraphy and Telephony H. De Bellescize (April)	1926	249
329. Main Considerations in Antenna Design . . . . . N. Lindenblad and W. W. Brown (June)	1926	291
330. Maintaining a Constant Reading on an Ammeter in the Filament Battery Circuit of a Thermionic Triode . . . . . E. H. W. Banner (June)	1926	325
331. Portable Receiving Sets for Measuring Field Strengths at Broadcasting Frequencies . . . . . Axel G. Jensen (June) Discussion by G. D. Gillett (Oct.)	1926	333 699
332. Sources of "A," "B," and "C" Power for Radio Receivers . . . . . Walter E. Holland (June)	1926	345
333. Direction Determinations of Atmospheric Disturbances on the Isthmus of Panama . . . . . L. W. Austin (June)	1926	373
334. Preliminary Note on Proposed Changes in the Constants of the Austin-Cohen Transmission Formula . . . . . L. W. Austin (June)	1926	377
335. Choice of Power for a Radio Station . . . . . N. N. Tsiklinsky and V. I. Volynkin (June)	1926	381
336. Collegiate Training for the Radio Engineering Field . . . . . C. M. Jansky, Jr. (Aug.) Discussion . . . . .	1926	431 441
337. Uses and Possibilities of Piezo-Electric Oscillators . . . . . August Hund (Aug.)	1926	447
338. Safeguards for the Radio Inventor . . . . . Everett N. Curtis (Aug.)	1926	471
339. KDKA . . . . . D. G. Little and R. L. Davis (Aug.)	1926	479
340. A Radio Field-Strength Measuring System for Frequencies up to Forty Megacycles . . . . . H. T. Friis and E. Bruce (Aug.)	1926	507
341. Relation Between the Height of the Kennelly-Heaviside Layer and High Frequency Radio Transmission Phenomena . . . . . A. Hoyt Taylor (Aug.)	1926	521

	<i>Year</i>	<i>Page</i>
342. Servicing of Broadcast Receivers. . . . .	1926	541
Lee Manley and W. E. Garrity (Aug.)		
343. Reduction of Interference in Broadcast Reception. . . . .	1926	575
Alfred N. Goldsmith (Oct.)		
Discussion by J. C. Van Horn (Jan.) . . . . .	1927	40
344. Combined Electromagnetic and Electrostatic Coupling and Some Uses of the Combination. . . . .	1926	605
Edward H. Loftin and S. Young White (Oct.)		
345. Some Measurements of Short-Wave Transmission. . . . .	1926	613
R. A. Heising, T. C. Schelleng, and G. C. Southworth (Oct.)		
346. Theory of Detection in a High Vacuum Thermionic Tube. .	1926	649
L. P. Smith (Oct.)		
347. Long Distance Radio Receiving Measurements and Atmos- pheric Disturbances at the Bureau of Standards in 1925.	1926	663
L. W. Austin (Oct.)		
Discussion by K. Sreenivasan (Feb.) . . . . .	1927	155
Discussion by Greenleaf W. Pickard (June) . . . . .	1927	539
Discussion by K. Sreenivasan (Dec.) . . . . .	1927	1002
Discussion by B. H. J. Kynaston (March) . . . . .	1928	459
348. Field Distribution and Radiation Resistance of a Straight Vertical Unloaded Antenna Radiating at One of Its Harmonics. . . . .	1926	675
S. A. Levin and C. J. Young (Oct.)		
Discussion by Stuart Ballantine (March) . . . . .	1927	245
Discussion by O. C. Roos (May) . . . . .	1927	439
349. A Method for Maximization in Circuit Calculation. . . . .	1926	689
Walter Van B. Roberts (Oct.)		
Discussion by O. C. Roos (Jan.) . . . . .	1927	57
350. On the Origin of the Super-Heterodyne Method. . . . .	1926	695
Walter Schottky (Oct.)		
351. The Out-put Characteristics of Amplifier Tubes. . . . .	1926	735
J. C. Warner and A. V. Loughren (Dec.)		
Discussion by D. F. Whiting (March) . . . . .	1927	249
Discussion by E. Green (April) . . . . .	1927	319
352. Notes on the Design of Resistance-Capacity Coupled Am- plifiers. . . . .	1926	759
Sylvan Harris (Dec.)		
353. Simultaneous Atmospheric Disturbances in Radio Telegraphy	1926	765
M. Bäumlér (Dec.)		
354. Simplified S.L.F. and S.L.W. Design. . . . .	1926	773
O. C. Roos (Dec.)		
Discussion by Ralph R. Batcher (April) . . . . .	1927	319
Discussion by Paul M. Mueller (April) . . . . .	1927	324
355. Radio Signal Strength Temperature. . . . .	1926	781
L. W. Austin and I. J. Wymore (Dec.)		
356. Preferred Numbers. . . . .	1926	785
L. A. Hazeltine (Dec.)		
357. Piezo-Electric Crystal Controlled Transmitters. . . . .	1927	9
A. Crossley (Jan.)		
358. Simultaneous Production of a Fundamental and a Harmonic in a Tube Generator. . . . .	1927	37
Hoy J. Walls (Jan.)		
359. An Automatic Fading Recorder. . . . .	1927	41
Theodore A. Smith and George Rodwin (Jan.)		
360. Behavior of Alkali Vapor Detector Tubes. . . . .	1927	49
Hugh A. Brown and Chas. T. Knipp (Jan.)		
361. Report Concerning the Observation of the Influence of the Propagation of Radio-Waves of the Sun Eclipse of the 14th of January, 1925, in the Dutch East Indies. . . . .	1927	61
E. C. Holtzappel (Jan.)		
362. The Correlation of Radio Reception with Solar Activity and		

	<i>Year</i>	<i>Page</i>
Terrestrial Magnetism.....	1927	83
Greenleaf W. Pickard (Feb.)		
Discussion by J. H. Dellinger (April).....		326
See also No. 394—Part II.		
363. Importance of Laboratory Measurements in the Design of Radio Receivers.....	1927	99
W. A. MacDonald (Feb.)		
Discussion by H. D. Oakley and Norman Snyder, J. H. Dellinger, Harold A. Wheeler (April).....		329
364. A Theoretical and Experimental Investigation of Detection for Small Signals.....	1927	113
E. L. Chaffee and G. H. Browning (Feb.)		
365. Vacuum-Tube Nomenclature.....	1927	181
E. L. Chaffee (March)		
Discussion by G. R. Metcalfe (March).....		253
Discussion by M. W. Arps (June).....		537
366. Influence on the Amplification of a Common Impedance in the Plate Circuits of Amplifiers.....	1927	195
J. E. Anderson (March)		
367. Some Possibilities and Limitations in Common Frequency Broadcasting.....	1927	213
De Loss K. Martin, Glenn D. Gillett, and Isabel Bemis (March)		
368. The Insulation of a Guyed Mast.....	1927	225
H. P. Miller, Jr. (March)		
369. Piezo-Electric Crystals at Radio Frequencies.....	1927	281
A. Meissner (April)		
370. Quantitative Measurements on Reception in Radio Teleg- raphy.....	1927	297
G. Anders (April)		
371. The Frequency Checking Station at Mare Island.....	1927	313
George T. Royden (April)		
372. Propagation of Short Waves Around the Earth.....	1927	341
E. Quäck (Review of Current Literature by Stuart Ballan- tine—April)		
373. Loud Speaker Testing Methods.....	1927	363
I. Wolff and A. Ringel (May)		
374. High Angle Radiation of Short Electric Waves.....	1927	377
S. Uda (May)		
375. Notes on Radio Receiver Measurements.....	1927	387
Theodore A. Smith and George Rodwin (May)		
376. The Tuned-Grid Tuned-Plate Circuit Using Plate-Grid ca- pacity for Feed-Back. A Derivation of the Conditions for Oscillation.....	1927	397
J. B. Dow (May)		
377. Selectivity of Tuned Radio Receiving Sets.....	1927	401
Kenneth W. Jarvis (May)		
378. Radio Phenomena Recorded by the University of Michigan Greenland Expedition—1926.....	1927	425
P. C. Oscanyan, Jr. (May)		
379. Puncture Damage Through the Glass Wall of a Transmitting Vacuum Tube.....	1927	431
Y. Kusunose (May)		
380. Short-Wave Commercial Long-Distance Communication....	1927	467
H. E. Hallborg, L. A. Briggs, C. W. Hansell (June)		
381. Some Practical Aspects of Short-Wave Operation at High Power.....	1927	501
H. E. Hallborg (June)		
382. Maximization Methods for Functions of a Complex Variable.	1927	519
Walter Van B. Roberts (June)		
383. A Mathematical Study of Radio Frequency Amplification....	1927	525
Victor G. Smith (June)		

	<i>Year</i>	<i>Page</i>
384. Telephone Communication Over Power Lines by High Frequency Currents.....	1927	559
C. A. Boddie (July)		
Discussion by R. D. Duncan, Jr. (Dec.).....		1055
385. Measurements of Radio Frequency Amplification.....	1927	641
Sylvan Harris (July)		
386. A New Frequency Transformer or Frequency Changer.....	1927	669
Issac Koga (Aug.)		
387. Audio Frequency Transformers.....	1927	679
John M. Thomson (Aug.)		
388. Notes on the Testing of Audio Frequency Amplifiers.....	1927	687
Edward T. Dickey (Aug.)		
389. Variations in High-Frequency Ground Wave Ranges.....	1927	707
A. H. Taylor (Aug.)		
390. A Suggestion of a Connection Between Radio Fading and Small Fluctuations in the Earth's Magnetic Field.....	1927	709
G. Breit (Aug.)		
391. Note on Piezoelectric Generators with Small Back Action....	1927	725
August Hund (Aug.)		
392. Standard Frequency Dissemination.....	1927	727
M. S. Strock (Aug.)		
393. Formulas for the Calculation of the Capacity of Antennas....	1927	733
Frederick W. Grover (Aug.)		
394. The Correlation of Radio Reception with Solar Activity and Terrestrial Magnetism.....	1927	749
Greenleaf W. Pickard (Sept.)		
395. The Testing of Audio-Frequency Transformer-Coupled Amplifiers.....	1927	767
H. Diamond and J. S. Webb (Sept.)		
396. Note on Detection by Grid Condenser and Leak.....	1927	793
W. Van B. Roberts (Sept.)		
397. The Torusolenoid.....	1927	797
Ross Gunn (Sept.)		
398. Long-Wave Radio Measurements at the Bureau of Standards in 1926 With Some Comparisons of Solar Activity and Radio Phenomena.....	1927	825
L. W. Austin (Oct.)		
399. Radio Atmospheric Disturbances and Solar Activity.....	1927	837
L. W. Austin (Oct.)		
400. Two Contrasting Examples Wherein Radio Reception was Affected by a Meteorological Condition.....	1927	843
E. H. Kincaid (Oct.)		
401. A Radio Inter-Communicating System for Railroad Train Service.....	1927	869
Henry C. Forbes (Oct.)		
402. On the Values and the Effects of Stray Capacities in Resistance-Coupled Amplifiers.....	1927	895
Manfred von Ardenne and Wolfgang Stoff (Nov.)		
403. Mounting Quartz Oscillator Crystals.....	1927	902
R. C. Hitchcock (Nov.)		
404. The Short Wave Limit of Vacuum Tube Oscillators.....	1927	914
C. R. Englund (Nov.)		
405. Directional Radiation with Horizontal Antennas.....	1927	928
A. Meissner (Nov.)		
406. Making Normal Coordinates Coincide with the Meshes of an Electrical Network.....	1927	935
E. A. Guillemin (Nov.)		
407. Voltage Detection Coefficient.....	1927	946
E. L. Chaffee (Nov.)		
408. Radio Vision.....	1927	958
C. Francis Jenkins (Nov.)		

	<i>Year</i>	<i>Page</i>
409. Atmospherics at Watheroo, Western Australia..... J. E. I. Cairns (Dec.)	1927	985
410. Propagation of Short Waves During a Solar Eclipse..... Edwin J. Alway (Dec.)	1927	998
411. The Relation of Radio Reception to Sunspot Position and Area..... Greenleaf W. Pickard (Dec.)	1927	1004
412. Abbreviated Method of Calculating the Inductance of Irregular Plane Polygons of Round Wire..... V. J. Bashenoff (Dec.)	1927	1013
See also No. 507—Supplementary Note.		
413. Piezo-Electric Resonance and Oscillatory Phenomena with Flexural Vibrations in Quartz Plates..... J. R. Harrison (Dec.)	1927	1040
414. Further Communication on the Propagation of Short Waves. E. Quäck. (Review of Current Literature by Stuart Ballantine—Dec.)	1927	1065
415. Methods of Reducing the Effect of Atmospheric Disturbances Edwin H. Armstrong (Jan.)	1928	15
Discussion by Carl R. Englund (Jan.).....		
		27
416. Automatic Volume Control for Radio Receiving Sets..... Harold A. Wheeler (Jan.)	1928	30
Discussion by G. W. Pickard (Jan.).....		
		35
417. Radio Communication..... G. Marconi (Jan.)	1928	40
418. A New Method for the Calibration of Ammeters at Radio Frequencies..... Herbert C. Hazel (Jan.)	1928	70
419. Experiments and Observations Concerning the Ionized Re- gions of the Atmosphere..... R. A. Heising (Jan.)	1928	75
420. A Precision Method for the Measurement of High Frequen- cies..... Charles B. Aiken (Feb.)	1928	125
421. Precision Determination of Frequency..... J. W. Horton and W. A. Marrison (Feb.)	1928	137
422. A Radio Frequency Oscillator for Receiver Investigations... George Rodwin and Theodore A. Smith (Feb.)	1928	155
423. On the Influence of Solar Activity on Radio Transmission.... L. W. Austin and I. J. Wymore (Feb.)	1928	166
424. Ionization in the Upper Atmosphere..... E. O. Hulburt (Feb.)	1928	174
425. A Theory of the Upper Atmosphere and Meteors..... H. B. Maris (Feb.)	1928	177
426. A Radio Field Strength Survey of Philadelphia..... Knox McIlwain and W. S. Thompson (Feb.)	1928	181
427. On the Theory of Power Amplification..... Manfred von Ardenne (Feb.)	1928	193
428. Condenser Shunt for Measurement of High Frequency Cur- rents of Large Magnitude..... Alexander Nyman (Feb.)	1928	208
429. On the Distortionless Reception of a Modulated Wave and Its Relation to Selectivity..... Frederick K. Vreeland (March)	1928	255
Discussions by Henry Shore and J. R. Nelson (April).....		
		494
Discussion by Lester L. Jones (May).....		
		671
Discussion by V. D. Landon (June).....		
		848
Discussion by R. Raven-Hart (Oct.).....		
		1422
430. Direct Coupled Detector and Amplifiers with Automatic Grid Bias..... Edward H. Loftin and S. Young White (March)	1928	281
Discussion by Henry Shore.....		
		286

	<i>Year</i>	<i>Page</i>
431. On Round-The-World Signals. . . . .	1928	287
E. O. Hulburt (March)		
432. Measurements of the Effective Heights of the Conducting Layer and the Disturbances of August 19, 1927. . . . .	1928	290
O. Dahl and L. A. Gebhardt (March)		
433. Correlation of Long Wave Transatlantic Radio Transmission with Other Factors Affected by Solar Activity. . . . .	1928	297
Clifford N. Anderson (March)		
434. Report of the Chairman of the Commission on Radio Wave Propagation, International Union of Scientific Radio Telegraphy. . . . .	1928	348
L. W. Austin (March)		
435. Notes on the Design of Radio Insulators. . . . .	1928	361
T. Walmsley (March)		
436. The Measurement of Choke Coil Inductance. . . . .	1928	373
C. A. Wright and F. T. Bowditch (March)		
Discussions by W. O. Osbon and C. A. Wright (June). . . . .		844
437. The International Radiotelegraph Conference of Washington, 1927. . . . .	1928	409
W. D. Terrell (April)		
438. Modes of Vibration in Piezo-Electric Crystals. . . . .	1928	416
A. Crossley (April)		
439. Some Characteristics and Applications of Four-Electrode Tubes. . . . .	1928	424
J. C. Warner (April)		
440. The Inverted Vacuum Tube, a Voltage-Reducing Power Amplifier. . . . .	1928	447
Frederick E. Terman (April)		
441. Development of a New Power Amplifier Tube. . . . .	1928	462
C. R. Hanna, L. Sutherlin, and C. B. Upp (April)		
Discussion by J. C. Warner and A. V. Loughren. . . . .		474
442. Measurement of Vacuum-Tube Capacities by a Transformer Balance. . . . .	1928	476
Harold A. Wheeler (April)		
443. A Direct-Capacity Bridge for Vacuum-Tube Measurements. .	1928	482
Lincoln Walsh (April)		
444. A Bridge Method for the Measurement of Inter-Electrode Admittance in Vacuum Tubes. . . . .	1928	487
E. T. Hoch (April)		
445. Broadcast Control Operation. . . . .	1928	498
Carl Dreher (April)		
446. The Lorentz Reciprocity Theorem for Electric Waves. . . . .	1928	513
(Review of Current Literature by Stuart Ballantine— April)		
447. Bibliography on Piezo-Electricity. . . . .	1928	521
W. G. Cady (April)		
448. Studies of High-Frequency Radio Wave Propagation. . . . .	1928	561
A. Hoyt Taylor and L. C. Young (May)		
449. The Status of Frequency Standardization. . . . .	1928	579
J. H. Dellinger (May)		
Discussions by Henry Shore and G. W. Kenrick. . . . .		590
450. Detection by Grid Rectification with the High-Vacuum Triode. . . . .	1928	593
Stuart Ballantine (May)		
451. Recent Developments in Low Power and Broadcasting Trans- mitters. . . . .	1928	614
I. F. Byrnes (May)		
Discussion by F. M. Ryan and I. F. Byrnes (July). . . . .		981
Discussion by Edward L. Nelson (Dec.). . . . .		1776
452. Apparent Night Variations with Crossed-Coil Radio Beacons	1928	652
Haraden Pratt (May)		

	<i>Year</i>	<i>Page</i>
453. Oscillographic Observations on the Direction of Propagation and Fading of Short Waves.....	1928	658
H. T. Friis (May)		
454. An Automatic Recorder for Measuring the Strength of Radio Signals and Atmospheric Disturbances.....	1928	666
E. B. Judson (May)		
455. Use of an Oscillograph for Recording Vacuum-Tube Characteristics.....	1928	674
W. A. Schneider (May)		
456. Beam Transmission of Ultra Short Waves.....	1928	715
Hidetsugu Yagi (June)		
Discussion by J. H. Dellinger.....		
457. The Piezo-Electric Resonator and Its Equivalent Network...	1928	742
K. S. Van Dyke (June)		
458. Some Correlations of Radio Reception with Atmospheric Temperature and Pressure.....	1928	765
G. W. Pickard (June)		
459. Technical Considerations Involved in the Allocation of Short Waves; Frequencies Between 1.5 and 30 megacycles.....	1928	773
Lloyd Espenschied (June)		
460. The Navy's Primary Frequency Standards.....	1928	778
Robert H. Worrall and Raymond B. Owens (June)		
461. A Transmitter Modulating Device for the Study of the Kennelly-Heaviside Layer by the Echo Method.....	1928	794
M. A. Tuve and O. Dahl (June)		
462. A Compensated Electron-Tube Voltmeter.....	1928	799
H. M. Turner (June)		
463. Note on the Effective Heating of Code Transmitters.....	1928	802
Frederick E. Terman (June)		
464. Four-Element Tube Characteristics as Affecting Efficiency...	1928	805
David C. Prince (June)		
465. Detection with the Four-Electrode Tube.....	1928	822
J. R. Nelson (June)		
Discussion by F. B. Llewellyn (Jan.).....		
466. The Screen-Grid Tube.....	1928	840
N. H. Williams (June)		
467. Characteristics of Certain Broadcasting Antennas at the South Schenectady Development Station.....	1928	872
H. M. O'Neill (July)		
468. Development of Radio Aids to Air Navigation.....	1928	890
J. H. Dellinger and Haraden Pratt (July)		
469. Aircraft Radio Installations.....	1928	921
Malcom P. Hanson (July)		
470. The Reduction of Atmospheric Disturbances.....	1928	966
John R. Carson (July)		
471. Thermostat Design for Frequency Standards.....	1928	976
W. A. Marrison (July)		
472. Bibliography on Aircraft Radio.....	1928	985
C. B. Jolliffe and Elizabeth M. Zandonini (July)		
473. A New Type of Standard Frequency Piezo-Electric Oscillator.	1928	1035
Lynde P. Wheeler and Ward E. Bower (Aug.)		
474. The Effect of Regeneration on the Received Signal Strength..	1928	1045
Balth. van der Pol (Aug.)		
475. Characteristics of Output Transformers.....	1928	1053
J. M. Thomson (Aug.)		
476. Cooperation Between the Institute of Radio Engineers and Manufacturers' Associations.....	1928	1065
Alfred N. Goldsmith (Aug.)		
477. Notes on Quartz Plates, and Gap Effect, and Audio-Frequency Generation.....	1928	1072
August Hund (Aug.)		

	<i>Year</i>	<i>Page</i>
478. Notes on Aperiodic Amplification and Application to the Study of Atmospherics . . . . .	1928	1077
August Hund (Aug.)		
479. Effect of the Antenna in Tuning Radio Receivers and Methods of Compensating for it . . . . .	1928	1079
Sylvan Harris (Aug.)		
480. The Cause and Prevention of Hum in Receiving Tubes Employing Alternating Current Direct on the Filament . . . . .	1928	1089
W. J. Kimmell (Aug.)		
481. The International Union of Scientific Radio Telegraphy . . . . .	1928	1107
J. H. Dellinger (Aug.)		
482. The Tuned-Grid, Tuned-Plate, Self-Oscillating Vacuum-Tube Circuit . . . . .	1928	1113
J. Warren Wright (Aug.)		
483. Radiation and Induction . . . . .	1928	1118
R. R. Ramsey and Robert Dreisback (Aug.)		
484. Development of a System of Line Power for Radio . . . . .	1928	1133
George B. Crouse (Aug.)		
485. The Use of Radio Field Intensities as a Means of Rating the Outputs of Radio Transmitters . . . . .	1928	1173
S. W. Edwards and J. E. Brown (Sept.)		
486. Note on Radio-Frequency Transformer Theory . . . . .	1928	1194
H. Diamond and E. Z. Stowell (Sept.)		
487. Radio Beacons for Transpacific Flights . . . . .	1928	1203
Clayton C. Shangraw (Sept.)		
488. Effective Heights of the Kennelly-Heaviside Layer in December, 1927 and January, 1928 . . . . .	1928	1236
G. Breit, M. A. Tuve, and O. Dahl (Sept.)		
489. Considerations Affecting the Licensing of High-Frequency Stations . . . . .	1928	1240
S. C. Hooper (Sept.)		
490. Long-Wave Radio Receiving Measurements at the Bureau of Standards in 1927 . . . . .	1928	1252
L. W. Austin (Sept.)		
491. The Chireix-Mesny Directive Antenna for Short Waves . . . . .	1928	1261
(Review of Current Literature by Stuart Ballantine—Sept.)		
492. Electrical Prospecting . . . . .	1928	1305
J. J. Jakosky (Oct.)		
493. Some Studies of Radio Broadcast Coverage in the Middle West . . . . .	1928	1356
C. M. Jansky, Jr. (Oct.)		
494. A Study of Short-Time Multiple Signals . . . . .	1928	1368
J. B. Hoag and Victor J. Andrew (Oct.)		
495. A New Method for Determining the Efficiency of Vacuum-Tube Circuits . . . . .	1928	1375
A. Crossley and R. M. Page (Oct.)		
496. Some Principles of Grid-Leak Grid-Condenser Detection . . . . .	1928	1384
Frederick E. Terman (Oct.)		
Discussion by W. F. Polydoroff . . . . .	1929	752
497. Simple Inductance Formulas for Radio Coils . . . . .	1928	1398
Harold A. Wheeler (Oct.)		
Discussion by R. R. Batcher and Harold A. Wheeler (March).	1929	580
498. A Gang Capacitor Testing Device . . . . .	1928	1401
Virgil M. Graham (Oct.)		
499. Radiotelegraphic Center at Rome (San Paolo) . . . . .	1928	1404
G. Pession and G. Montefinale (Oct.)		
500. A Decimal Classification of Radio Subjects; An Extension of the Dewey System . . . . .	1928	1423
(Prepared by the Bureau of Standards—Oct.)		
501. Piezo Electric Oscillator Circuits with Four-Electrode Tubes . . . . .	1928	1455
J. R. Harrison (Nov.)		
Discussions by A. Hund, W. G. Cady, and Alfred N. Goldsmith		1467

	<i>Year</i>	<i>Page</i>
502. Note on the Determination of the Ionization in the Upper Atmosphere. . . . .	1928	1471
J. C. Schelleng (Nov.)		
503. Analysis of Broadcasting Station Allocation. . . . .	1928	1477
J. H. Dellinger (Nov.)		
504. The Dependence of the Frequency of Quartz Piezo-Electric Oscillators Upon Circuit Constants. . . . .	1928	1486
Earle M. Terry (Nov.)		
505. Quantitative Methods Used in Tests of Broadcast Receiving Sets. . . . .	1928	1507
A. F. Van Dyck and E. T. Dickey (Nov.)		
506. Vacuum-Tube Production Tests. . . . .	1928	1532
A. F. Van Dyck and F. H. Engel (Nov.)		
507. Supplementary Note to Abbreviated Method for Calculating the Inductance of Irregular Plane Polygons of Round Wire. . . . .	1928	1553
V. Bashenoff (Nov.)		
508. The Constant Impedance Method for Measuring Inductance of Choke Coils. . . . .	1928	1559
H. M. Turner (Nov.)		
509. Fading Curves Along a Meridian. . . . .	1928	1570
Robert C. Colwell (Nov.)		
510. Radio Stations of the World on Frequencies above 1500 Kilocycles. . . . .	1928	1575
Federal Radio Commission (Nov.)		
511. Note on the Effect of Reflection by the Microphone in Sound Measurements. . . . .	1928	1639
Stuart Ballantine (Dec.)		
512. The Receiving System for Long-Wave Transatlantic Radio Telephony. . . . .	1928	1645
Austin Bailey, S. W. Dean, and W. T. Wintringham (Dec.)		
513. Discussions (Jan.) . . . . .	1929	174
513. On the Variation of Generated Frequency of a Triode Oscillator Due to Changes in Filament Current, Grid Voltage, Plate Voltage or External Resistance. . . . .	1928	1706
Keith B. Eller (Dec.)		
514. Sound Measurements and Loud-Speaker Characteristics. . . . .	1928	1729
Irving Wolff (Dec.)		
515. The Design of Transformers for Audio Frequency Amplifiers with Preassigned Characteristics. . . . .	1928	1742
Glenn Koehler (Dec.)		
516. A Bridge Circuit for Measuring the Inductance of Coils while Passing Direct Current. . . . .	1928	1771
V. D. Landon (Dec.)		
517. A Direct Reading Radio-Frequency Meter. . . . .	1929	24
R. C. Hitchcock (Jan.)		
518. On the Determination of the Optimum Radiation Angle for Horizontal Antennas. . . . .	1929	35
A. Meissner and H. Rothe (Jan.)		
519. Magnetostriction Oscillators. . . . .	1929	42
George W. Pierce (Jan.)		
520. The Importance of Radio Telegraphy in Science. . . . .	1929	89
J. Zenneck (Jan.)		
521. An Auxiliary Frequency Control for R. F. Oscillators. . . . .	1929	115
G. F. Lampkin (Jan.)		
522. A Method of Treating Resistance Stabilized Radio-Frequency Amplifying Circuits. . . . .	1929	118
B. L. Snavely and J. S. Webb (Jan.)		
523. The Piezo-Electric Crystal Oscillator. . . . .	1929	127
J. Warren Wright (Jan.)		
524. Fading Curves and Weather Conditions. . . . .	1929	143
R. C. Colwell (Jan.)		

	<i>Year</i>	<i>Page</i>
525. Detection Characteristics of Three-Element Vacuum Tubes.. Frederick Emmons Terman and Thomas M. Googin (Jan.)	1929	149
Discussion by J. C. Warner and F. E. Terman.....	1929	1062
526. Filtering Antennas and Filter-Valve Circuits..... Jozef Plebanski (Jan.)	1929	161
527. Book Review: A Bibliography of Electrical Literature Prepared by Massachusetts Institute of Technology ..... Reviewed by R. R. Batcher (Jan.)	1929	187
528. On the Mechanism of Electron Oscillations in a Triode..... H. E. Hollmann (Feb.)	1929	229
529. A Convenient Method for Referring Secondary Frequency Standards to a Standard Time Interval..... L. M. Hull and J. K. Clapp (Feb.)	1929	252
530. A System for Frequency Measurements Based on a Single Frequency..... E. L. Hall (Feb.)	1929	272
531. Receiving Sets for Aircraft Beacon and Telephony..... Haraden Pratt and Harry Diamond (Feb.)	1929	283
532. An Aircraft Radio Receiver for Use with Rigid Antenna..... F. H. Drake (Feb.)	1929	306
533. Circuit Analysis Applied to the Screen-Grid Tube..... J. R. Nelson (Feb.)	1929	320
534. The Effect of Regeneration on the Received Signal Strength.. Balth. van der Pol (Feb.)	1929	339
535. Reception Experiments in Mount Royal Tunnel..... A. S. Eve, W. A. Steel, G. W. Olive, A. R. McEwan, and J. H. Thompson (Feb.)	1929	347
Discussion by Carl R. Englund and A. S. Eve (May).....	1929	892
536. A Note on the Directional Observations on Grinders in Japan. Eitaro Yokoyama and Tomozo Nakai (Feb.)	1929	377
537. On the Behavior of Networks with "Normalized" Meshes.... E. A. Guillemin and W. Glendinning (Feb.)	1929	380
538. Radio Direction-Finding by Transmission and Reception, (with particular reference to its application to marine navigation)..... R. L. Smith-Rose (March)	1929	425
Discussion by Stuart Ballantine (Aug.).....	1929	1440
Discussion by R. L. Smith-Rose (Oct.).....	1929	1897
539. Some Experiments in Short-Distance Short-Wave Radio Transmission..... J. K. Clapp (March)	1929	479
540. Wireless Telegraphy and Magnetic Storms..... E. O. Hulburt and H. B. Maris (March)	1929	494
541. Recent Developments in Superheterodyne Receivers..... G. L. Beers and W. L. Carlson (March)	1929	501
Discussion by F. K. Vreeland and G. L. Beers (Aug.).....	1929	1454
542. An Extension of the Method of Measuring Inductances and Capacities..... Sylvan Harris (March)	1929	516
Discussion by R. R. Batcher.....	1929	518
543. Apparent Equality of Loudspeaker Output at Various Fre- quencies..... L. G. Hector and H. N. Kozanowski (March)	1929	521
544. Facsimile Picture Transmission..... V. Zworykin (March)	1929	536
Discussion (May).....	1929	895
545. Notes on Grid-Circuit Detection..... J. R. Nelson (March)	1929	551
546. The Radiation Resistance of Beam Antennas..... A. A. Pistolkors (March)	1929	562
547. Frequency Multiplication by Shock Excitation..... E. A. Guillemin and P. T. Rumsey (April)	1929	629

	<i>Year</i>	<i>Page</i>
548. On the Short-Wave Limit of Magnetron Oscillations. . . . . Kinjiro Okabe (April)	1929	652
549. The Use of the Electron Tube Peak Voltmeter for the Meas- urement of Modulation. . . . . C. B. Jolliffe (April)	1929	660
550. Radio Receiver Testing Equipment. . . . . Kenneth W. Jarvis (April)	1929	664
557. Measurements of the Height of the Kennelly-Heaviside Layer G. W. Kenrick and C. K. Jen (April)	1929	711
552. Measurement of the Frequencies of Distant Radio Trans- mitting Stations. . . . . G. Pession and T. Gorio (April)	1929	734
553. Note on Earth Reflection of Ultra Short Radio Waves. . . . . E. H. Lange (April)	1929	745
554. Book Review: <i>Donnees Numeriques de Radioelectricité</i> Edited by R. Mesny; . . . . . Reviewed by W. G. Cady (April)	1929	755
555. Double and Multiple Signals with Short Waves. . . . . E. Quäck and H. Mögel (May)	1929	791
556. Short Range Echoes with Short Waves. . . . . E. Quäck and H. Mögel (May)	1929	824
557. Detection Characteristics of Screen-Grid and Space-Charge- Grid Tubes. . . . . F. E. Terman and Birney Dystart (May)	1929	830
558. A Direct Reading Frequency Bridge for the Audio Range, Based on Hay's Bridge Circuit. . . . . Chester I. Soucy and B. DeF. Bayly (May)	1929	834
559. Voltage Surges in Audio-Frequency Apparatus. . . . . Elmer H. Fisher (May)	1929	841
560. Cold Cathode Rectification. . . . . A. E. Shaw (May)	1929	849
561. Vacuum-Tube Voltmeter Design. . . . . Harry R. Lubeke (May)	1929	864
562. Field Intensity Characteristics of Double Modulation Type of Directive Radio Beacon. . . . . Haraden Pratt (May)	1929	873
563. Logarithmic Scale for Beat-Frequency Oscillator. . . . . E. R. Meissner (May)	1929	879
564. Radio Interference. . . . . James G. Allen (May)	1929	882
565. Book Review: <i>Handbuch der Experimentalphysik</i> Edited by Weinharns. . . . . Reviewed by K. S. Van Dyke (May)	1929	899
566. Reciprocity in Electromagnetic, Mechanical, Acoustical, and Interconnected Systems. . . . . Stuart Ballantine (June)	1929	929
567. Reciprocal Theorems in Radio Communication. . . . . John R. Carson (June)	1929	952
568. The Measurement of Direct Interelectrode Capacitance of Vacuum Tubes. . . . . A. V. Loughren and H. W. Parker (June)	1929	957
569. Photradio Developments. . . . . R. H. Ranger (June)	1929	966
570. Grid Losses in Power Amplifiers. . . . . E. E. Spitzer (June)	1929	985
571. Mathematical Theory of the Four-Electrode Tube. . . . . J. G. Brainerd (June)	1929	1006
572. Design Methods for Soft Magnetic Materials in Radio. . . . . John Minton and I. G. Maloff (June)	1929	1021
573. A New Method of Determining the Height of the Kennelly- Heaviside Layer. . . . . C. B. Mirick and E. R. Hentschel (June)	1929	1034

	<i>Year</i>	<i>Page</i>
574. Some Observations of Short Period Radio Fading.....	1929	1042
T. Parkinson (June)		
575. A High Precision Standard of Frequency.....	1929	1103
W. A. Marrison (July)		
576. Observations on Modes of Vibration and Temperature Coef- ficients of Quartz Crystal Plates.....	1929	1123
F. R. Lack (July)		
577. The Kyle Condenser Loud Speaker.....	1929	1142
V. Ford Greaves, F. W. Kranz, and W. D. Crozier (July)		
578. Detection at High Signal Voltages—Plate Rectification with the High-Vacuum Triode.....	1929	1153
Stuart Ballantine (July)		
579. Transmitting Antennas for Broadcasting.....	1929	1178
A. Meissner (July)		
580. Correlation of Directional Observations of Atmospherics with Weather Phenomena.....	1929	1185
S. W. Dean (July)		
581. Experiments in Recording Radio Signal Intensity.....	1929	1192
L. W. Austin (July)		
582. The Relation of Radio Propagation to Disturbances in Terres- trial Magnetism.....	1929	1206
I. J. Wymore (July)		
583. Some Measurements on the Directional Distribution of Static.....	1929	1214
A. E. Harper (July)		
584. The Routine Measurement of the Operating Frequencies of Broadcast Stations.....	1929	1225
Henry L. Bogardus and Charles T. Manning (July)		
585. East-West and North-South Attenuations of Long Radio Waves on the Pacific.....	1929	1240
Eitaro Yokoyama and Tomozo Nakai (July)		
586. Book Review: Matter, Electricity, Energy.....	1929	1248
Walter Gerlack		
Reviewed by W. G. Cady (July)		
587. The Mutual Impedance Between Adjacent Antennas.....	1929	1277
Carl R. Englund and Arthur B. Crawford (Aug.)		
588. The Propagation of Low Power Short Waves in the 1000- Kilometer Range.....	1929	1296
K. Kruger and H. Plendl (Aug.)		
589. Further Note on the Ionization in the Upper Atmosphere....	1929	1313
J. C. Schelleng (Aug.)		
590. An Electromagnetic Monochord for the Measurement of Audio-Frequencies.....	1929	1316
J. H. Owen Harries (Aug.)		
591. An Empirical Equation for Determining the $d^2i_g/de_g^2$ of De- tectors.....	1929	1322
Sylvan Harris (Aug.)		
592. Engineering Aspects of the Work of the Federal Radio Com- mission.....	1929	1326
J. H. Dellinger (Aug.)		
593. Some Characteristics of Modern Radio Receivers and their Relation to Broadcast Regulation.....	1929	1334
L. M. Hull (Aug.)		
594. (Abstract) The Regulation of Broadcasting Stations as a Sys- tems Problem.....	1929	1342
E. L. Nelson (Aug.)		
595. Some Principles of Broadcast Frequency Allocation.....	1929	1343
L. E. Whittemore (Aug.)		
596. A Study of Heterodyne Interference.....	1929	1354
J. V. L. Hogan (Aug.)		
597. An Outline of the Radio Inspection Service.....	1929	1365
Arthur Batcheller (Aug.)		

	<i>Year</i>	<i>Page</i>
598. The Problems Centering About the Measurement of Field Intensity. . . . . S. W. Edwards and J. E. Brown (Aug.)	1929	1377
599. The Radio Engineer's Responsibility in Coping with Man-Made Interference. . . . . Edgar H. Felix (Aug.)	1929	1385
600. Radio Coordination. . . . . M. D. Hooven (Aug.)	1929	1390
601. United States Radio Broadcasting Development. . . . . R. H. Marriott (Aug.)	1929	1395
602. Studies of Echo Signals. . . . . A. Hoyt Taylor and L. C. Young (Sept.)	1929	1491
603. Group-Velocity and Long Retardations of Radio Echoes. . . . . G. Breit (Aug.)	1929	1508
604. Further Studies of the Kennelly-Heaviside Layer by the Echo Method. . . . . L. R. Hafstad and M. A. Tuve (Aug.)	1929	1513
605. Ionization in the Atmosphere of Mars. . . . . E. O. Hulburt (Sept.)	1929	1523
606. Notes on the Effect of Solar Disturbances on Transatlantic Radio Transmission. . . . . Clifford N. Anderson (Sept.)	1929	1528
607. Image Transmission by Radio Waves. . . . . Alfred N. Goldsmith (Sept.)	1929	1536
608. The Electrical Transmission of Pictures and Images. . . . . J. W. Horton (Sept.)	1929	1540
609. Mechanical Developments of Facsimile Equipment. . . . . R. H. Ranger (Sept.)	1929	1564
610. The Drum Scanner in Radiomovies Receivers. . . . . C. Francis Jenkins (Sept.)	1929	1576
611. The Selection of Standards for Commercial Radio Television Julius Weinberger, Theodore A. Smith, and George Rodwin (Sept.)	1929	1584
612. Naval Communications—Radio Washington. . . . . S. C. Hooper (Sept.)	1929	1595
613. Microphonic Improvements in Vacuum Tubes. . . . . Alan C. Rockwood and Warren R. Ferris (Sept.) Discussion (Oct.)	1929	1621 1899
614. Equivalent Circuits of an Electron Triode and the Equivalent Input and Output Admittances. . . . . E. L. Chaffee (Sept.)	1929	1633
615. An Investigation of the Phenomena of Frequency Multiplication as Used in Tube Transmitters. . . . . R. M. Page (Sept.)	1929	1649
616. Static and Motional Impedance of a Magnetostriction Resonator. . . . . E. H. Lange and J. A. Myers (Oct.)	1929	1687
617. Calculation of Characteristics and the Design of Triodes. . . . . Yuziro Kusunose (Oct.)	1929	1706
618. Wireless Echoes of Long Delay. . . . . P. O. Pedersen (Oct.)	1929	1750
619. An Echo Interference Method for the Study of Radio Wave Paths. . . . . L. R. Hafstad and M. A. Tuve (Oct.)	1929	1786
620. On the Relation between Long-Wave Reception and Certain Terrestrial and Solar Phenomena. . . . . K. Sreenivasan (Oct.)	1929	1793
621. The Significance of Observations of the Phase of Radio Echoes G. Breit (Oct.)	1929	1815
622. Inductance as Affected by the Initial Magnetic State, Air-Gap, and Superposed Currents. . . . . H. M. Turner (Oct.)	1929	1822

	<i>Year</i>	<i>Page</i>
623. Notes on the Detection of Large Signals.....	1929	1834
Sylvan Harris (Oct.)		
624. Single-Wire Transmission Lines for Short-Wave Antennas..	1929	1840
W. L. Everitt and J. F. Byrne (Oct.)		
625. Circuit Tuning by Wave Resonance and Applications to Ra- dio Reception.....	1929	1868
Louis Cohen (Oct.)		
626. Wave Resonance Tuning and Application to Radio Trans- mission.....	1929	1893
William R. Blair and Louis Cohen (Oct.)		
627. Book Review: Radio Encyclopedia.....	1929	1903
Michael Adam (Oct.)		
628. Technical Achievements in Broadcasting and Its Relation to National and International Solidarity Symposium, with papers as follows.....	1929	1939
Introduction.....		
Alfred N. Goldsmith (Nov.)		
Radio Broadcasting Transmitters and Related Transmis- sion Phenomena.....		
Edward L. Nelson (Nov.)		
The National Broadcasting Company, a Technical Or- ganization for Broadcasting.....		
Julius Weinberger (Nov.)		
Speech Input Equipment.....		
D. G. Little (Nov.)		
Wire Line Systems for National Broadcasting.....		
A. B. Clark (Nov.)		
Radio Broadcasting Regulation and Legislation.....		
J. H. Dellinger (Nov.)		
629. Measurement of Frequency.....	1929	2011
S. Jimbo (Nov.)		
630. Further Observations of Radio Transmission and the Heights of the Kennelly-Heaviside Layer.....	1929	2034
G. W. Kenrick and C. K. Jen (Nov.)		
631. The Calculation of the Inductance of Single-Layer Coils and Spirals Wound with Wire of Large Cross Section.....	1929	2053
F. W. Grover (Nov.)		
632. Operating Characteristics in Photoelectric Tubes.....	1929	2064
G. F. Metcalf (Nov.)		
633. The Penetration of Rock by Electromagnetic Waves and Au- dio Frequencies.....	1929	2072
A. S. Eve, D. A. Keys, and F. W. Lee (Nov.)		
634. A Vacuum-Tube Voltage Regulator for Large Power Units..	1929	2075
L. C. Verman and H. J. Reich (Nov.)		
635. Book Review: Vibration Problems in Engineering.....	1929	2082
S. Timoshenko		
Reviewed by S. S. Kirby		
636. Typical Wireless Apparatus Used on British and European Airways.....	1929	2123
J. M. Furnival (Dec.)		
637. Radio for the Air Transport Operator.....	1929	2137
Lester D. Seymour (Dec.)		
638. The Civil Airways and their Radio Facilities.....	1929	2141
H. J. Walls (Dec.)		
639. Applying the Visual Double Modulation Type Radio Range to the Airways.....	1929	2158
H. Diamond (Dec.)		
640. Radio in Aeronautics—Its Technical Status and Organization for Its Application in Germany.....	1929	2185
F. Eisner and H. Fassbender (Dec.)		
641. The Constants of Aircraft Trailing Antennas.....	1929	2230
L. A. Hyland (Dec.)		

	<i>Year</i>	<i>Page</i>
642. On the Daylight Transmission Characteristics of Horizontally and Vertically Polarized Waves from Airplanes.....	1929	2242
F. H. Drake and R. M. Wilmotte (Dec.)		
643. Temperature Rating of Wind-Driven Aircraft Radio Generators.....	1929	2259
C. B. Mirick (Dec.)		
644. Applying the Aural Directive Radio Range to the Airways..	1929	2268
F. G. Kear and W. E. Jackson (Dec.)		
645. Effect of Flight on Hearing.....	1929	2283
C. B. Mirick (Dec.)		
646. Book Review: Radiotechnik.....	1929	2297
F. Kiebitz		
Reviewed by W. G. Cady		
647. Book Review: Elements of Radio Communication.....	1929	2297
J. H. Morecroft		
Reviewed by Edgar H. Felix		
648. Reports of I. R. E. Committee on Broadcasting (Jan.).....	1930	15
649. The Operation of Modulators from a Physical Viewpoint... ..	1930	38
E. Peterson and F. B. Llewellyn (Jan.)		
650. Plate-Voltage Supply for Naval Vacuum-Tube Transmitters.	1930	49
E. C. Raguette (Jan.)		
651. Hot-Cathode Mercury-Vapor Rectifier Tubes.....	1930	67
H. C. Steiner and H. T. Maser (Jan.)		
652. Note on the Stability of Balanced High-Frequency Amplifiers	1930	88
J. R. Nelson (Jan.)		
653. Push-Pull Piezo-Electric Oscillator Circuits.....	1930	95
J. R. Harrison (Jan.)		
654. Long-Wave Radio Receiving Measurements at the Bureau of Standards in 1928.....	1930	101
L. W. Austin (Jan.)		
655. Multiple Signals in Short-Wave Transmission.....		
T. L. Eckersley (Jan.)		
656. A Condenser Bridge for Factory Inspection of Variable Condensers.....	1930	123
R. A. Braden and H. C. Forbes (Jan.)		
657. Hum in All-Electric Radio Receivers.....	1930	137
B. F. Miessner (Jan.)		
658. Some Possibilities of Intelligence Transmission when using a Limited Band of Frequencies.....	1930	167
F. E. Terman (Jan.)		
Discussion by Edgar H. Felix and F. E. Terman (July)		
659. A Thermionic Voltmeter Method for the Harmonic Analysis of Electrical Waves.....	1930	178
Chauncey G. Suits (Jan.)		
660. Book Review: The ABC of Television or Seeing by Radio..	1930	193
Raymond F. Yates		
Reviewed by Edgar H. Felix (Jan.)		
661. Book Review: The Physical Principles of Wireless.....	1930	193
J. A. Ratcliffe		
Reviewed by S. S. Kirby		
662. A New Transformation in Alternating-Current Theory with an Application to the Theory of Audition.....	1930	221
Balth. van der Pol (Feb.)		
663. The Accurate Testing of Audio Amplifiers in Production....	1930	231
Arthur E. Thiessen (Feb.)		
664. A Study of Noise in Vacuum Tubes and Attached Circuits..	1930	243
F. B. Llewellyn (Feb.)		
665. A Study of the Output Power Obtained from Vacuum Tubes of Different Types.....	1930	266
H. A. Pidgeon and J. O. McNally (Feb.)		
666. The Equivalent Generator Theorem.....	1930	294
V. D. Landon (Feb.)		

	<i>Year</i>	<i>Page</i>
667. Filament Supply for Radio Receiver from Rectified 25-Kilo-cycle Current.....	1930	298
Hugh A. Brown and Lloyd P. Morris (Feb.)		
668. Quartz Control for Frequency Stabilization in Short-Wave Receivers.....	1930	307
P. von Handel, K. Kruger, and H. Plendl (Feb.)		
669. A Broadcast Receiver for Use in Automobiles.....	1930	321
Paul O. Farnham (Feb.)		
670. Some Remarks on the Multivibrator.....	1930	327
Yasusi Watanabe (Feb.)		
671. Production Testing of Vacuum Tubes.....	1930	336
K. S. Weaver and W. J. Jones (Feb.)		
672. Cross Modulation in R-F Amplifiers.....	1930	350
Sylvan Harris (Feb.)		
673. Book Review: Report of the Royal Commission on Radio Broadcasting.....	1930	355
Reviewed by C. H. Starr (Feb.)		
674. Standardization in the Radio Vacuum-Tube Field.....	1930	373
W. C. White (March)		
675. Graphs to Prof. Sommerfeld's Attenuation Formula for Radio Waves.....	1930	391
Bruno Rolf (March)		
676. The Radio Plant of R. C. A. Communications, Inc.....	1930	403
H. E. Hallborg (March)		
677. 20-40 Kilowatt High-Frequency Transmitter.....	1930	422
I. F. Byrnes and J. B. Coleman (March)		
678. Power Output Characteristics of the Pentode.....	1930	450
Stuart Ballantine and H. L. Cobb (March)		
679. Report on Experiments with Electric Waves of about 3 Meters: Their Propagation and Use.....	1930	471
Abraham Esau and Walter M. Hahnemann (March)		
680. Method and Apparatus Used at the Bureau of Standards in Testing Piezo Oscillators for Broadcast Stations.....	1930	490
E. L. Hall (March)		
681. A German Common Frequency Broadcast System.....	1930	510
F. Gerth (March)		
682. On a Double Hump Phenomenon of Current Through a Bridge Across Parallel Lines.....	1930	513
Eijiro Takagishi (March)		
683. Weather Forecasting by Signal Radio Intensity: Part 1....	1930	533
R. C. Colwell (March)		
684. A Method of Measuring the Radio-Frequency Resistance of an Oscillatory Circuit.....	1930	537
Hajime Iinuma (March)		
685. The Four-Electrode Vacuum Tube as Beat-Frequency Oscillator.....	1930	544
S. Reid Warren, Jr. (March)		
686. Antenna-Measuring Equipment.....	1930	571
J. K. Clapp (April)		
687. Transmission Characteristics of a Short-Wave Telephone Circuit.....	1930	581
R. K. Potter (April)		
688. Summary of Progress in the Study of Radio Wave Propagation Phenomena.....	1930	649
G. W. Kenrick and G. W. Pickard (April)		
689. Cascaded Direct-Coupled Tube Systems Operated from Alternating Current.....	1930	669
Edward H. Loftin and S. Young White (April)		
690. Note on Day-to-Day Variations in Sensitivity of a Broadcast Receiver.....	1930	683
Ralph P. Glover (April)		

	<i>Year</i>	<i>Page</i>
691. Considerations in Superheterodyne Design..... E. G. Watts, Jr. (April)	1930	690
692. The Piezo-Electric Resonator in High-Frequency Oscillation Circuits—Part I..... Y. Watanabe (April)	1930	695
Parts II, III, and IV (May).....		862
693. Some Experiments on Night Errors for Long Waves..... Isao Tanimura (April)	1930	718
694. New Piezo Oscillations with Quartz Cylinders Cut Along the Optical Axis..... August Hund and R. B. Wright (May)	1930	741
695. The Hague Conference..... S. C. Hooper (May)	1930	762
696. Recommendations of the International Technical Consulting Committee on Radio Communication (May).....	1930	775
697. Development of the Visual-Type Airway Radiobeacon Sys- tem..... J. H. Dellinger, H. Diamond, and F. W. Dunmore (May)	1930	796
698. Engine-Ignition Shielding for Radio Reception in Aircraft.. H. Diamond and F. G. Gardner (May)	1930	840
699. Some Problems in Short-Wave Telephone Transmission.... J. C. Schelleng (June)	1930	913
700. A 12-Course Radio Range for Guiding Aircraft with Tuned- Reed Visual Indication..... H. Diamond and F. G. Kear (June)	1930	939
701. A Tuned-Reed Course Indicator for the Four and Twelve- Course Aircraft Radio Range..... F. W. Dunmore (June)	1930	963
702. Single- and Coupled-Circuit Systems..... E. S. Purington (June)	1930	983
703. The Establishment of the Japanese Radio-Frequency Stand- ard..... Y. Namba (June)	1930	1017
704. The Amplification and Detection of Ultra-Short Electric Waves..... Kinjiro Okabe (June)	1930	1028
705. The Radio Engineer and the Law..... Paul M. Segal (June)	1930	1038
706. Note on Variations in the Amplification Factor of Triodes.. Frederick E. Terman and Albert L. Cook (June)	1930	1044
707. Radiotelegraphy and Radiotelephony on Half-Meter Waves Shintaro Uda (June)	1930	1047
708. The Effect of Rain and Fog on the Propagation of Very Short Radio Waves..... J. A. Stratton (June)	1930	1064
709. Meteorological Influences on Long-Distance, Long-Wave Re- ception..... Eitaro Yokoyama and Tomozo Nakai (June)	1930	1075
710. Book Review: The Radio Manual..... George E. Sterling Reviewed by S. S. Kirby (June)	1930	1084
711. Ultra-Short Waves for Limited Range Communication..... W. J. Brown (July)	1930	1129
712. A Radio-Frequency Potentiometer..... William W. Macalpine (July)	1930	1144
713. Whistling Tones from the Earth..... Heinrich Barkhausen (July)	1930	1155
714. The Calculation of the Service Area of Broadcast Stations.. P. P. Eckersley (July)	1930	1160
715. Frequency Modulation..... Balth. van der Pol (July)	1930	1194

	<i>Year</i>	<i>Page</i>
716. Effect of Cavity Resonance on the Frequency Response Characteristic of the Condenser Microphone.....	1930	1206
Stuart Ballantine (July)		
717. Locating Radio Interference with the Oscillograph.....	1930	1216
J. K. McNeely and P. J. Konkle (July)		
718. The Variation of the Resistance of a Radio Condenser with Capacity and Frequency.....	1930	1226
R. R. Ramsey (July)		
719. Wireless Telegraphy and the Ionization in the Upper Atmosphere.....	1930	1231
E. O. Hulburt (July)		
720. Design of a Portable Temperature-Controlled Piezo Oscillator.....	1930	1239
V. E. Heaton and W. H. Brattain (July)		
721. Electroelastic and Pyro-Electric Phenomena.....	1930	1247
W. G. Cady (July)		
722. Book Review: Transmission Networks and Wave Filters... T. E. Shea Reviewed by K. S. Van Dyke (July)	1930	1266
723. Book Review: The Technique of Amplification Measurements; Instruments and Methods..... Manfred von Ardenne in collaboration with Wolfgang Stoff and Fritz Gabriel Reviewed by H. W. Lamson (July)	1930	1266
724. Properties and Applications of Mycalex to Radio Apparatus. W. W. Brown (Aug.)	1930	1307
725. A Comparison of the Engineering Problems in Broadcasting and Audible Pictures.....	1930	1316
Porter H. Evans (Aug.)		
726. Problems Involved in the Design and Use of Apparatus for Testing Radio Receivers.....	1930	1338
Paul O. Farnham and Alfred W. Barber (Aug.)		
727. Engineering Control of Radio Receiver Production.....	1930	1351
Virgil M. Graham and Benjamin Olney (Aug.)		
728. Dry Electrochemical Condensers.....	1930	1366
P. E. Edelman (Aug.)		
729. War Department Message Center.....	1930	1372
Frank E. Stoner (Aug.)		
730. Fluctuation Noise in Radio Receivers.....	1930	1377
Stuart Ballantine (Aug.)		
731. A Screen-Grid Voltmeter and Its Application as a Resonance Indicator.....	1930	1388
Ronald King (Aug.)		
732. Reflection of Radio Waves from the Surface of the Earth... Lal C. Verman (Aug.)	1930	1396
733. The Coöperation Committee Program.....	1930	1430
A. E. Kennelly (Aug.)		
734. Classification of Radio Subjects: An Extension of the Dewey Decimal System..... Bureau of Standards (Aug.)	1930	1433
735. Book Review: Report of the Radio Research Board for the Period ended 31st March, 1929..... Reviewed by S. S. Kirby (Aug.)	1930	1457
736. Long Wave Radio Receiving Measurements at the Bureau of Standards in 1929.....	1930	1481
L. W. Austin (Sept.)		
737. Low-Frequency Radio Transmission.....	1930	1488
P. A. de Mars, G. W. Kenrick, and G. W. Pickard (Sept.)		
738. Certain Factors Affecting the Gain of Directive Antennas... G. C. Southworth (Sept.)	1930	1502
739. Radio Electric Clock System.....	1930	1537
H. C. Roters and H. L. Paulding (Sept.)		
740. A New Frequency-Stabilized Oscillator System..... Ross Gunn (Sept.)	1930	1560

	<i>Year</i>	<i>Page</i>
741. Interpolation Methods for Use with Harmonic Frequency Standards.....	1930	1575
J. K. Clapp (Sept.)		
742. A Precise and Rapid Method of Measuring Frequencies from Five to Two Hundred Cycles per Second.....	1930	1586
N. P. Case (Sept.)		
743. A Note on the Mathematical Theory of the Multielectrode Tube.....	1930	1593
Peter Caporale (Sept.)		
744. Book Review: Radio Data Charts.....	1930	1603
R. T. Beatty		
Reviewed by S. S. Kirby (Sept.)		
745. Some Developments in Broadcast Transmitters.....	1930	1623
I. J. Kaar and C. J. Burnside (Oct.)		
746. The RCA Photophone System of Sound Recording and Reproduction for Sound Motion Pictures.....	1930	1661
Alfred N. Goldsmith and Max C. Batsel (Oct.)		
747. The Radio Communication Services of the British Post Office	1930	1690
A. G. Lee (Oct.)		
748. The RCA World-Wide Radio Network.....	1930	1732
Arthur A. Isbell (Oct.)		
749. An Electron Tube Wattmeter and Voltmeter and a Phase Shifting Bridge.....	1930	1743
H. M. Turner and F. T. McNamara		
750. On the Magnetron Oscillation of New Type.....	1930	1748
K. Okabe (Oct.)		
751. Variation of the Inductance of Coils due to the Magnetic Shielding Effect of Eddy Currents in the Cores.....	1930	1750
K. L. Scott (Oct.)		
752. Book Review: Principles of Radio.....	1930	1765
Keith Henney		
Reviewed by Carl Dreher		
753. Book Review: A Critical Review of Literature on Amplifiers for Radio Reception (Radio Research Special Report No. 9.).....	1930	1765
Reviewed by S. S. Kirby (Oct.)		
754. Book Review: Radio Telegraphy and Telephony.....	1930	1766
R. L. Duncan and Charles E. Drew		
Reviewed by S. S. Kirby (Oct.)		
755. The Diurnal and Seasonal Performance of High-Frequency Radio Transmission over Various Long Distance Circuits	1930	1797
M. L. Prescott (Nov.)		
756. The van der Pol Four-Electrode Tube Relaxation Oscillation Circuit.....	1930	1921
R. M. Page and W. F. Curtis (Nov.)		
757. An International Comparison of Frequency by Means of a Luminous Quartz Resonator.....	1930	1930
S. Jimbo (Nov.)		
758. Characteristics of Piezo-Electric Quartz Oscillators.....	1930	1935
Issac Koga (Nov.)		
759. Frequency Division.....	1930	1960
J. Groszkowski (Nov.)		
760. Note on the Accuracy of Rolf's Graphs of Sommerfeld's Attenuation Formula.....	1930	1971
W. Howard Wise (Nov.)		
761. Book Review: The Handbook of Chemistry and Physics... ..	1930	1973
Reviewed by S. S. Kirby (Nov.)		
762. Book Review: Alternating-Current Rectification and Allied Problems.....	1930	1973
L. B. W. Jolley		
Reviewed by W. C. White (Nov.)		
763. Solar and Magnetic Activity and Radio Transmission.....	1930	1997

	<i>Year</i>	<i>Page</i>
764. L. W. Austin, E. B. Judson, and I. J. Wymore-Shiel (Dec.) Temperature Control for Frequency Standards.....	1930	2003
765. J. K. Clapp (Dec.) Some Experiences with Short-Wave Wireless Telegraphy... ..	1930	2011
766. N. H. Edes (Dec.) Basis Established by the Federal Radio Commission for the Division of Radio Broadcast Facilities Within the United States (Dec.).....	1930	2032
767. A Study of the High-Frequency Resistance of Single Layer Coils.....	1930	2041
768. A. J. Palermo and F. W. Grover (Dec.) The Development of a Visual Type of Radio Range Trans- mitter Having a Universal Application to the Airways..	1930	2059
769. W. E. Jackson and S. L. Bailey (Dec.) Reduction of Distortion and Cross-Talk in Radio Receivers by Means of Variable-Mu Tetrodes.....	1930	2102
770. Stuart Ballantine and H. A. Snow (Dec.) Summary of Piezo-Electric Crystal Conference Held by U. S. Navy Department, December 3-4, 1929 (Dec.).....	1930	2128
771. Piezo-Electric Terminology.....	1930	2136
772. Walter G. Cady (Dec.) Aviation Communication.....	1930	2143
773. J. Stuart Richardson (Dec.) Some Properties of Grid Leak Power Detection.....	1930	2160
774. Frederick E. Terman and Nathaniel R. Morgan (Dec.) Advances in Transoceanic Cable Technique.....	1930	2176
775. Hobart Mason (Dec.) Book Review: The National Physical Laboratory Collected Researches.....	1930	2192
776. Reviewed by S. S. Kirby (Dec.) Book Review: Radio Operating Questions and Answers....	1930	2192
777. Nilson and Horning Reviewed by S. S. Kirby (Dec.) Book Review: Radio and its Future.....	1930	2192
Martin Codel Reviewed by S. S. Kirby (Dec.)		

## STANDARDS REPORTS

The first report of the Committee on Standardization (1913) will be found in the back of Volume 1. Subsequent revised reports of the 1915, 1922, 1926, and 1928 Committees were published as separate pamphlets. The 1928 report was also included in the 1929 Year Book, Pages 43-153.

## INDEX TO AUTHORS

Numbers refer to the chronological list. Bold-face type indicates papers, light-face type indicates discussions, and italics refer to book reviews.

### A

Adam, M., 627  
 Affel, H. A., 71  
 Agner, C. M., 85  
 Aiken, C. B., 420  
 Alexanderson, E. F. W., 19, 51, 126, 151, 170, 325  
 Allen, J. G., 564  
 Alway, E. J., 410  
 Anders, G., 370  
 Anderson, C. N., 319, 433, 606  
 Anderson, J. E., 366  
 Anderson, S. E., 302  
 Andrew, V. J., 494  
 Appleton, E. V., 261  
 Armstrong, E. H., 37, 78, 166, 201, 272, 415  
 Arps, M. W., 365  
 Austin, L. A., 7, 18, 30, 56, 81, 83, 109, 119, 145, 158, 167, 168, 196, 196a, 200, 203, 208, 213, 215, 218, 225, 231, 235, 238, 244, 249, 252, 257, 264, 270, 277, 286, 291, 297, 301, 321, 333, 334, 347, 355, 398, 399, 423, 434, 490, 581, 654, 736, 763

### B

Bach, R. O., 161  
 Bailey, A., 319, 512, 512  
 Bailey, S. L., 768  
 Baker, W. R. G., 232, 246  
 Ballantine, S., 116, 199, 283, 283, 284, 284, 348, 372, 414, 446, 450, 491, 511, 538, 566, 578, 678, 716, 730, 769  
 Banner, E. H. W., 330  
 Barber, A. W., 726  
 Barfield, R. H., 301  
 Barkhausen, H., 713  
 Barth, J., 84  
 Bashenoff, V., 228, 412, 507  
 Batcheller, A., 597  
 Batcher, R. R., 182, 269, 354, 497, 527, 542  
 Batsel, M. C., 746  
 Bäumlér, M., 287, 353  
 Bayly, B. de F., 558  
 Beatty, R. T., 744  
 Beers, G. L., 541, 541  
 Bemis, I., 367  
 Bennett, E., 104  
 Bethenod, J. F. J., 80, 133, 224  
 Beverage, H. H., 247  
 Binns, J. R., D  
 Black, R. B., 127  
 Blair, W. R., 626  
 Blatterman, A. S., 52

Boddie, C. A., 384  
 Bogardus, H. L., 584  
 Bouthillon, L., 80, 80, 103  
 Bowditch, F. T., 436  
 Bower, W. E., 473  
 Bown, R., 222, 265, 320  
 Braden, R. A., 656  
 Brady, J. B., 174  
 Brainerd, J. G., 571  
 Brattain, W. H., 720  
 Breit, G., 390, 488, 603, 621  
 Briggs, L. A., 380  
 Brown, H. A., 211, 360, 667  
 Brown, J. E., 485, 598  
 Brown, W. J., 711  
 Brown, W. W., 241, 317, 329, 724  
 Browning, G. H., 318, 364  
 Bruce, E., 340  
 Buel, A. W., 251  
 Bullard, W. H. G., 27, 65  
 Bureau of Standards, 500, 734  
 Burnside, C. J., 745  
 Bush, V., 87, 97, 190  
 Byrne, J. F., 624  
 Byrnes, I. F., 451, 451, 677

### C

Cady, W. G., 193, 281, 447, 501, 554, 586, 646, 721, 771  
 Cairns, C. F., 122  
 Cairns, J. E. I., 409  
 Caporale, P., 743  
 Carlson, W. L., 541  
 Carson, J. R., 87, 117, 179, 192, 229, 470, 567  
 Case, N. P., 742  
 Chaffee, E. L., 58, 86, 210, 263, 364, 365, 407, 614  
 Chireix, H., 243  
 Clapp, J. K., 529, 539, 686, 741, 764  
 Clark, A. B., 628  
 Clement, L. M., 186, 302  
 Cobb, H. L., 678  
 Codel, M., 777  
 Cohen, L., 23, 40, 159, 173, 625, 626  
 Cohen, S., 106  
 Coleman, J. B., 677  
 Colwell, R. C., 509, 524, 683  
 Conrad, F., 209, 279  
 Cook, A. L., 706  
 Cordes, H. G., 101, 114, 134  
 Crawford, A. B., 587  
 Crenshaw, R. S., 49  
 Crossley, A., 146, 181, 189, 357, 438, 495  
 Crouse, G. B., 484

Crozier, W. D., 577  
 Culver, C. A., 66, 240  
 Cummings, B. R., 289  
 Curtis, A. M., 177  
 Curtis, E. N., 338  
 Curtis, W. F., 756  
 Cutting, F., 53, 195

## D

Dahl, O., 432, 461, 488  
 Davis, R. L., 339  
 Dean, S. W., 512, 580  
 De Bellescize, H., 328  
 De Coutouly, G. C., 302  
 de Forest, L., 3, 14, 118  
 De Groot, C. J., 76, 278  
 Dellinger, J. H., 112, 217, 362, 363,  
 449, 456, 468, 481, 503, 592, 628, 697  
 de Mars, P. A., 737  
 Dempster, J. B., 236  
 Diamond, H., 395, 486, 531, 639, 697,  
 698, 700  
 Dickey, E. T., 176, 388, 505  
 Donisthorpe, H. De A., 266, 288  
 Donle, H. P., 220, 254  
 Dow, J. B., 376  
 Drake, F. H., 318, 532, 642  
 Dreher, C., 136, 445, 752  
 Dreisback, R., 483  
 Drew, C. E., 754  
 Dreyer, J. F. Jr., 327  
 Duncan, R. D. Jr., 384  
 Duncan, R. L., 754  
 Dunmore, F. W., 227, 239, 239, 697,  
 701  
 Dysart, B., 557

## E

Eastham, M., 24  
 Eccles, W. H., 121  
 Eckersley, P. P., 714  
 Eckersley, T. L., 655  
 Edelman, P. E., 728  
 Edes, N. H., 765  
 Edwards, S. W., 485, 598  
 Eisner, F., 640  
 Elder, F. R., 204, 292  
 Eller, K. B., 513  
 Elwell, C. F., 33, 147  
 Engel, F. H., 239, 506  
 Englund, C. R., 154, 215, 222, 404,  
 415, 535, 587  
 Erskine-Murray, J., 269  
 Esau, A., 679  
 Espenschied, L., 205, 226, 319, 459  
 Evans, P. H., 725  
 Eve, A. S., 535, 535, 633  
 Everitt, W. L., 624

## F

Farnham, P. O., 669, 726  
 Fassbender, H., 640  
 Federal Radio Commission, 510

Felix, E. H., 599, 647, 658, 660  
 Ferrie, G., 304  
 Ferris, W. R., 613  
 Fielding, E. W., 141  
 Finch, J. L., 310  
 Fisher, E. H., 559  
 Fliess, R. A., 36  
 Forbes, H. C., 300, 307, 401, 656  
 Freeman, H. M., 312  
 Freiman, I., 129  
 Friis, H. T., 222, 315, 340, 453  
 Fuller, L. F., 59, 67, 110, 131  
 Furnival, J. M., 636

## G

Gabriel, F., 723  
 Gardner, F. G., 698  
 Garrity, W. E., 342  
 Gebhardt, L. A., 432  
 Gerlack, W., 586  
 Gerth, F., 681  
 Gillett, G. D., 265, 331, 367  
 Ginman, A. H., 54  
 Glendinning, W., 537  
 Glover, R. P., 690  
 Goldsmith, A. N., H, 8, 29, 176, 267,  
 343, 476, 501, 607, 628, 746  
 Googin, T. M., 525  
 Gorio, T., 552  
 Graham, V. M., 498, 727  
 Greaves, V. F., 21, 577  
 Green, E., 351  
 Groszkowski, J., 759  
 Grover, F. W., 256, 393, 631, 767  
 Guillemin, E. A., 406, 537, 547  
 Gunn, R., 397, 740  
 Guthrie, R. V., 285

## H

Hafstad, L. R., 604, 619  
 Hahnemann, W., 214, 679  
 Hall, E. L., 530, 680  
 Hallborg, H. E., 31, 380, 381, 676  
 Hanna, C. R., 303, 441  
 Hansell, C. W., 380  
 Hanson, M. P., 469  
 Harper, A. E., 583  
 Harris, S., 290, 326, 352, 385, 479, 542,  
 591, 623, 672  
 Harrison, J. R., 413, 501, 653  
 Hartley, R. V. L., 180, 216  
 Hazel, H. C., 418  
 Hazeltine, L. A., 95, 327, 356  
 Heaton, V. E., 720  
 Hector, L. G., 543  
 Heising, R. A., 183, 240, 298, 345, 419  
 Hennelly, E. F., 204  
 Henney, K., 752  
 Hentschel, E. R., 573  
 Hickman, C. N., 194  
 Hills, S. M., 2  
 Hitchcock, R. C., 403, 517  
 Hoag, J. B., 494

Hoch, E. T., 444  
 Hogan, J. V. L., 11, 38, 64, 596  
 Holland, W. E., 332  
 Hollmann, H. E., 528  
 Holtzappel, E. C., 361  
 Hooper, S. C., 489, 612, 695  
 Hooven, M. D., 600  
 Hornung, J. L., 776  
 Horton, J. W., 421, 608  
 Howe, G. W. O., 105  
 Hoxie, C. A., 187  
 Hulburt, E. O., 234, 236, 424, 431, 540,  
 605, 719  
 Hull, A. W., 93, 204, 219  
 Hull, L. M., 172, 206, 529, 593  
 Hund, A., 75, 95, 124, 282, 294, 337,  
 391, 477, 478, 501, 694  
 Hutchison, M. R., 100  
 Hyland, L. A., 641

## I

Iinuma, H., 684  
 Isbell, A. A., 748  
 Israel, L. L., 22  
 Ives, J. E., 194

## J

Jackson, W. E., 644, 768  
 Jakosky, J. J., 492  
 Jansky, C. M., 336, 493  
 Jarvis, K. W., 316, 377, 550  
 Jen, C. K., 551, 630  
 Jenkins, C. F., 408, 610  
 Jensen, A. G., 274, 331  
 Jimbo, S., 629, 757  
 Johnson, T., Jr., 140, 184  
 Johnston, F. E., 310  
 Jolley, L. B. W., 762  
 Jolliffe, C. B., 472, 549  
 Jones, W. J., 671  
 Jones, L. L., 429  
 Jouaust, R., 304  
 Judson, E. B., 270, 454, 763

## K

Kaar, I. J., 745  
 Kantebet, S. R., 239  
 Kawazoe, S., 239  
 Kear, F. G., 644, 700  
 Kennelly, A. E., 10, 50, 71, 733  
 Kenrick, G. W., 449, 551, 630, 688, 737  
 Keys, D. A., 633  
 Kiebitz, F., 258, 646  
 Kimmell, W. J., 480  
 Kincaid, E. H., 400  
 King, R., 731  
 Kinsley, C., 153  
 Kirby, S. S., 635, 661, 710, 735, 744,  
 753, 754, 761, 775, 776, 777  
 Knipp, C. T., 211, 360  
 Koehler, G., 515  
 Koga, I., 386, 758  
 Kolster, F. A., 6, 28, 139

Konkle, P. J., 717  
 Kozanowski, H. N., 543  
 Kranz, F. W., 577  
 Kroger, F. H., 259  
 Kruger, K., 588, 668  
 Kuhn, A. S., 48  
 Kusunose, Y., 379, 617  
 Kynaston, B. H. J., 347

## L

Lack, F. R., 576  
 Lampkin, G. F., 521  
 Lamson, H. W., 723  
 Landon, V. D., 316, 429, 516, 666  
 Lange, E. H., 553, 616  
 Lange, F. C., 171  
 Langmuir, I., 39  
 Latour, M., 113, 149, 243, 262  
 Lee, A. G., 747  
 Lee, F. W., 633  
 Levin, S. A., 348  
 Libby, T. M., 73  
 Liebowitz, B., 35, 45, 74  
 Lindenblad, N., 329  
 Little, D. G., 260, 339, 628  
 Little, N. C., 268  
 Llewellyn, F. B., 465, 649, 664  
 Loftin, E. H., 344, 430, 689  
 Logwood, C. V., 293  
 Lombardi, L., 138  
 Loughren, A. V., 351, 441, 568  
 Love, J. E., 317  
 Lowenstein, F., 47, 57  
 Lubcke, H. R., 561  
 Lush, W. G., 310  
 Lytle, W. O., 130

## M

Macalpine, W. W., 712  
 MacDonald, W. A., 363  
 Maloff, I. G., 572  
 Manley, L., 342  
 Manning, C. T., 584  
 Manson, R. H., 327  
 Marchant, E. W., 70  
 Marconi, G., 199, 417  
 Maris, H. B., 425, 540  
 Marriott, R. H., A, 4, 15, 20, 72, 79,  
 156, 233, 271, 601  
 Marrison, W. A., 421, 471, 575  
 Martin, D. K., 186, 320, 367  
 Marumo, N., 148  
 Marx, R. G., 42  
 Maser, H. T., 651  
 Mason, H., 774  
 Mass. Inst. of Technology, 527  
 Mayer, E. E., 17  
 McCaa, D. G., 128  
 McCullough, F. S., 212  
 McEwan, A. R., 535  
 McIlwain, K., 426  
 McNally, J. O., 665  
 McNamara, F. T., 749

McNeely, J. K., 717  
 Meissner, A., 188, 369, 405, 518, 579  
 Meissner, E. R., 563  
 Mesny, R., 304, 305, 554  
 Metcalf, G. F., 632  
 Metcalfe, G. R., 365  
 Micchiordi, B., 144  
 Midgley, F. W., E, G  
 Miessner, B. F., 657  
 Miller, H. P. Jr., 368  
 Miller, J. M., 99, 124, 142  
 Milliner, F. H., 102  
 Minohara, T., 163  
 Minton, J. P., 267, 572  
 Mirick, C. B., 573, 643, 645  
 Mögel, H., 555, 556  
 Montefinale, G., 499  
 Moorehead, O. B., 91, 171  
 Morecroft, J. H., 88, 124, 143, 150,  
 202, 202, 260, 274, 306, 647  
 Morgan, N. R., 773  
 Morris, L. P., 667  
 Mueller P. M., 354  
 Myers, J. A., 616

## N

Nakai, T., 536, 585, 709  
 Namba, Y., 703  
 National Physical Laboratory, 775  
 Nelson, E. L., 273, 451, 594, 628  
 Nelson, J. R., 429, 465, 533, 545, 652  
 Nesper, E., 175  
 Nichols, H. W., 226  
 Nilson, A. R., 776  
 Nixdorff, S. P., 51  
 Nusbaum, C., 111  
 Nyman, A., 428

## O

Oakley, H. D., 363  
 Okabe, K., 548, 704, 750  
 Olive, G. W., 535  
 Olney, B., 727  
 O'Neill, H. M., 467  
 Osbon, W. O., 436  
 Oscanyan, P. C., Jr., 378  
 Oswald, A. A., 299  
 Owen-Harries, J. H. O., 590  
 Owens, R. B., 460

## P

Packman, M. E., 41, 41  
 Page, R. M., 495, 615, 756  
 Palermo, A. J., 767  
 Parker, H. W., 568  
 Parkinson, T., 574  
 Paulding, H. L., 739  
 Payne, E. A., 250  
 Pedersen, P. O., 82, 123, 178, 185, 223,  
 295, 618  
 Pession, G., 144, 499, 552  
 Peterson, J., 649  
 Peterson, H. O., 247

Pickard, G. W., C, 5, 157, 197, 253,  
 309, 325, 347, 362, 394, 411, 416,  
 458, 688, 737  
 Pidgeon, H. A., 665  
 Pierce, G. W., 519  
 Pike, O. W., 311  
 Pistol Kors, A. A., 546  
 Plebanski, J., 526  
 Plendl, H., 588, 668  
 Polydoroff, W. J., 496  
 Potter, R. K., 320, 687  
 Pratt, H., 34, 452, 468, 531, 562  
 Prescott, M. L., 755  
 Press, A., 89, 107, 160, 165, 248  
 Prince, D. C., 207, 230, 237, 242, 276,  
 464  
 Pupin, M. I., 1  
 Purington, E. S., 702

## Q

Quäck, E., 372, 414, 555, 556

## R

Radio Research Board, 735, 753  
 Raguet, E. C., 650  
 Ramsey, R. R., 483, 718  
 Ranger, R. H., 322, 569, 609  
 Ratcliffe, J. A., 661  
 Raven-Hart, R., 429  
 Redmond, M. H., 191  
 Reich, H. J., 634  
 Rein, H., 12  
 Richardson, J. S., 772  
 Ringel, A., 373  
 Roberts, W. van B., 349, 382, 396  
 Rockwood, A. C., 613, 613  
 Rodwin, G., 359, 375, 422, 611  
 Rolf, B., 675  
 Roos, O. C., 103, 348, 349, 354  
 Roters, H. C., 739  
 Rothe, H., 518  
 Royal Comm. on Radio Broadcasting,  
 673  
 Royden, G. T., 371  
 Royster, P. H., 69  
 Rumsey, P. T., 547  
 Ryan, F. C., 164  
 Ryan, F. M., 161, 186, 451  
 Ryan, H. J., 42

## S

Sarnoff, D., 25  
 Schelleng, J. C., 299, 345, 502, 589, 699  
 Schneider, W. A., 455  
 Schottky, W., 350  
 Scott, K. L., 751  
 Searing, H. R., 191  
 Seelig, A. E., 9  
 Segal, P. M., 705  
 Seymour, L. D., 637  
 Shangraw, C. C., 487  
 Shannon, J. H., 323  
 Shaw, A. E., 560

- Shea, T. E., 722  
 Shoemaker, H., F, 60  
 Shore, H., 429, 430, 449  
 Shuleiken, M., 129  
 Simon, E. J., 8, 22  
 Smith, C. G., 190  
 Smith, L. P., 346  
 Smith, T. A., 359, 375, 422, 611  
 Smith, V. G., 383  
 Smith-Rose, R. L., 301, 538, 538  
 Snavelly, B. L., 522  
 Snow, H. A., 769  
 Snyder, N., 363  
 Sobey, A., 153  
 Soucy, C. I., 558  
 Southworth, G. C., 345, 738  
 Spitzer, E. E., 570  
 Sreenivasan, K., 347, 620  
 Starr, C. H., 673  
 Steel, W. A., 535  
 Steiner, H. C., 651  
 Sterling, G. E., 710  
 Stevens, T. M., 324  
 Stoff, W., 402, 723  
 Stone, E. W., 55, 77, 90, 106, 146  
 Stone, J. S., 26, 68  
 Stoner, F. E., 729  
 Stowell, E. Z., 296, 486  
 Stratton, J. A., 708  
 Strock, M. S., 392  
 Suits, C. G., 659  
 Sutherlin, L., 441
- T
- Takagishi, E., 239, 275, 682  
 Tanimura, I., 693  
 Taylor, A. H., 52, 120, 125, 135, 146,  
 314, 341, 389, 448, 602  
 Taylor, H. O., 94  
 Taylor, M., 261  
 Terman, F. E., 440, 463, 496, 525, 525,  
 557, 658, 658, 706, 773  
 Terrell, W. D., 437  
 Terry, E. M., 504  
 Thiessen, A. E., 663  
 Thompson, J. H., 535  
 Thompson, R. E., 132  
 Thompson, W. S., 426  
 Thomson, J. M., 387, 475  
 Timoshenko, S., 635  
 Tissot, C., 16  
 Tolmie, J. R., 161, 255  
 Tsiklinsky, N. N., 335  
 Turner, A., 306  
 Turner, H. M., 462, 508, 622, 749  
 Tuve, M. A., 461, 488, 604, 619
- U
- Uda, S., 374, 707  
 Upp, C. B., 441
- V
- Vallauri, G., 144, 152  
 van der Bijl, H. J., 115, 137
- van der Pol, B., 283, 284, 474, 534,  
 662, 715  
 Van Der Woude, F., 9  
 Van Dyck, A. F., 505, 506  
 Van Dyke, K. S., 457, 565, 722  
 Van Horn, J. C., 343  
 Verman, L. C., 634, 732  
 Vogdes, F. B., 276, 308  
 Volynkin, V. I., 335  
 von Ardenne, M., 402, 427, 723  
 von Handel, P., 668  
 Vreeland, F. K., 429, 541
- W
- Walls, H. J., 358, 638  
 Walmsley, T., 435  
 Walsh, L., 443  
 Warner, J. C., 245, 311, 351, 439, 441,  
 525  
 Warren, S. R., 685  
 Washburn, E. W., 96  
 Washington, B., 61, 69, 106, 106  
 Watanabe, Y., 670, 692  
 Watts, E. G., Jr., 691  
 Weagant, R. A., 13, 32, 118  
 Weaver, K. S., 671  
 Webb, J. S., 395, 522  
 Weinberger, J., 44, 136, 155, 198, 280,  
 611, 628  
 Wein-Harms, 565  
 Weyl, C. N., 290  
 Wheeler, H. A., 363, 416, 442, 497, 497  
 Wheeler, L. P., 473  
 White, S. Y., 344, 430, 689  
 White, W. C., 313, 674, 762  
 Whittmore, L. E., 595  
 Whiting, D. F., 351  
 Williams, N. H., 466  
 Wilmotte, R. M., 642  
 Wilson, L. T., 169  
 Wintringham, W. T., 512, 512  
 Wise, W. H., 760  
 Wolff, I., 373, 514  
 Woodhull, S. T., 221  
 Woodland, W. C., 46  
 Woolverton, R. B., 43  
 Worrall, R. H., 460  
 Wright, C. A., 436, 436  
 Wright, J. W., 482, 523  
 Wright, R. B., 694  
 Wymore, I. J., 355, 423, 582, 763
- Y
- Yagi, H., 63, 92, 108, 456  
 Yates, R. F., 660  
 Yokoyama, E., 98, 536, 585, 709  
 Young, C. J., 348  
 Young, L. C., 448, 602
- Z
- Zandonini, E. M., 472  
 Zenneck, J., 62, 162, 520  
 Zworykin, V., 544, 544

## INDEX TO SUBJECTS

### A

- Absorption: C, 57, 70, 287, 320
  - Selective Atmospheric: 3
- Acoustic Tuning: 9
- Aircraft Radio: 36, 47, 61, 140, 227, 289, 325, 452, 468, 469, 487
- Aviation Communication: 772
- Bibliography: 472
- Civil Airways and their Facilities: 638
- Engine-Ignition Shielding: 698
- Measurement of Antenna Constants: 641
- Receiver for Use with Rigid Antenna: 532
- Receivers for Beacon and Telephony: 531
- Temperature Rating of Wind Driven Generators: 643
- The Aural Radio Range and Airways: 644
- Tuned Reed Indicator for 4- and 12-course Range: 701
- Typical Apparatus used on British and European Airways: 636
- Visual Double Modulation Type Radio Range: 639
- Visual Type Airway Radio Beacon: 697
- Visual Type Transmitter for, Beacon: 768
- 12-Course Range with Visual Indicator: 700
- Allocation:
  - Division of Radio Broadcast Facilities: 766
  - Frequency, Some Principles of Broadcast: 595
- Alternating Current Theory:
  - A new Transformation with Application to Audition: 662
- Amplification:
  - And Detection of Ultra-Short Waves: 704
  - Variation in, Factor: 706
- Amplifier: 39, 51, 74, 115, 116, 179, 180, 245, 289, 304, 316, 318, 327, 331, 340, 342
- Analysis of R. F. Stage: 327
- Aperiodic: 478
- Audio Frequency: 395, 515
- Audion: 16, 34, 37
- Beat Frequency: 166
- Cascade: 9, 37, 39
- Gain Control: 331, 416, 430
- High Mu: 154
- High Vacuum Tube: 39, 51, 351
- Impedance in plate circuit: 366
- Logarithmic: 327
- Magnetic: 51
- Magnetron: 292
- Microphone: 9
- Power: 232, 299, 427, 441
- Push Pull: 276, 339
- Radio Frequency: 51, 93, 327, 331, 344, 383
- Reflexing: 272
- Resistance Coupled: 402
- 150-kw Amplifier, R.F.: 299
- Amplifiers:
  - Cascaded Direct-Coupled: 689
  - Cross Modulation in R.F.: 672
  - Grid Losses: 570
  - Stability of balanced high-frequency: 652
- Amplifying Circuits:
  - Treating Resistance, Stabilized R.F.: 522
- Antenna:
  - Rigid, for Aircraft Receiver: 532
- Antennas: C, E, G, 17, 18, 32, 33, 47, 49, 54, 56, 65, 72, 76, 88, 102, 103, 107, 144, 151, 227, 232, 329, 345
- Antenna-Measuring Equipment: 686
- Balanced: C, 118, 135, 168, 235
- Cage: 329
- Capacity: C, G, 47, 107, 109, 145, 393
- Characteristics of Broadcasting: 467
- Constants: C, G, 124, 160
- Current: 348
- Design: C, 329
- Determination of Radiation Angle: 518
- Directional: 66, 67, 118, 126, 146, 151, 153, 157, 158, 168, 235, 319, 333, 405, 491, 512
- Dummy: 22
- Effective Height: 247, 300, 329
- Factors Affecting Gain of Directive: 738
- Filtering, and Filter Valve Circuits: 526
- Ground: 43, 67, 125, 135, 146
- Hertz: 325
- Inductance Distributed: 89, 107
- Loop: C, E, 120, 153, 158, 168, 235, 325, 331, 343, 412
- Measurement of Aircraft Constants: 641
- Model: 329
- Mutual Impedance between Adjacent: 587
- Operating below Fundamental Wave Length: 283, 348
- Optimum Wave Length for: 284

- Outdoor Tuning Coils: 317  
 Power: 348  
 Radiation Resistance of Beam: 546  
 Re-Radiation from: 300  
 Resistance: 104, 195, 329  
 Shielded: 157  
 Sleet Removal: 323, 329  
 Strain Release: C, 323  
 Submerged: 125, 135, 168  
 Subterranean: 125, 135  
 Transmitting, for Broadcasting: 579  
 Two-Loop Directional: 315  
 Voltage: 348  
 Wave: 319, 512  
 Atmospheric: 56, 76, 196, 200, 203,  
 208, 229, 271, 319, 321, 322  
 Classified: 118, 168  
 Compared to Impulse Oscillograms:  
 143  
 Correlation of Directional Observa-  
 tions with Weather Phenomena:  
 580  
 Daily Variations: 15, 168  
 Dead Spot for: 271  
 Effect on Detector: 37  
 Eliminating Effects of: 76, 118, 135,  
 146, 157, 168, 328, 415, 470  
 Long Wave Measurements at Bu-  
 reau of Standards: 654  
 Reflected: 118  
 Relative to Atmosphere: 400  
 Relative to Lightning: 15, 321  
 Relative to Moon: 15  
 Relative to Mountains: 15, 333  
 Relative to Sun: 15, 399  
 Relative to Temperature: 15  
 Relative to Topography: 271  
 Relative to Vapor Pressure: 15, 271  
 Relative to Wavelength: 167, 321  
 Relative to Wind Velocity: 15  
 Seasonal Variations: 15, 56  
 Simultaneous Records at Distant  
 Points: 258, 353  
 Sources: 15, 76, 157, 235, 271, 321,  
 333  
 Strength: 15, 177, 200, 203, 208,  
 213, 215, 218, 225, 454  
 Vertically Propagated: 118  
 Wave Form: 409  
 Attenuation:  
 Graphs to Formula: 675  
 Note on, Formula: 760  
 Of Long Waves in East-West and  
 North-South Directions on the  
 Pacific: 585  
 Audibility:  
 Measurements: 15, 52, 56, 59, 62,  
 81, 96, 121  
 Meter: 24, 96  
 Audible Pictures:  
 Comparison of Broadcasting, and:  
 725  
 RCA Photophone System: 746  
 Audio:  
 Fidelity: 273, 320, 327  
 Tuning: 37  
 Audio-Frequency Amplifiers:  
 Accurate Testing in Production: 663  
 Audio-Frequency Apparatus:  
 Voltage Surges in: 559  
 Audion: 14, 34, 37, 38, 56  
 Audition:  
 Alternating-Current Theory with  
 Application to: 662  
 Aurora: 157  
 Auxiliary Control for R. F. Oscillators:  
 521  
 Aviation Communication: 772  
  
 B  
 Beacon:  
 Aircraft Receiving Sets for: 531  
 Development of Visual Type: 697  
 Directive Radio Field Intensity  
 Characteristics of Double Modu-  
 lation Type: 562  
 Tuned-Reed Indicator for 4- and 12-  
 Course Range: 701  
 Visual Type Transmitter: 768  
 12-Course Range with Visual Indi-  
 cator: 700  
 Beam Antennas:  
 Radiation Resistance of: 546  
 Beat-Frequency Oscillator:  
 Four Electrode Tube as: 685  
 Logarithmic Scale for: 563  
 Behavior of Networks with Normal-  
 ized Meshes: 537  
 Book Reviews:  
 A Bibliography of Electrical Litera-  
 ture, by Massachusetts Institute  
 of Technology (reviewed by Ralph  
 Batcher): 527  
 Alternating Current Rectification  
 and Allied Problems, by L. B. W.  
 Jolley, (reviewed by W. C. White):  
 762  
 Critical Review of Literature on  
 Amplifiers for Radio Reception,  
 (Radio Research Special Report  
 No. 99), (reviewed by S. S. Kir-  
 by): 753  
 Donnees Numerique de Radio-Elec-  
 tricite, by R. Mesny, (reviewed by  
 W. G. Cady): 554  
 Elements of Radio Communication,  
 by J. H. Morecroft (reviewed by  
 E. H. Felix): 647  
 Handbook of Chemistry and Phys-  
 ics, (reviewed by S. S. Kirby):  
 761  
 Handbuch der Experimentalphysik,  
 edited by Weins-Harms (reviewed  
 by K. S. Van Dyke): 565

- Matter, Electricity, Energy, by Walter Gerlach (reviewed by W. G. Cady): 586
- National Physical Laboratory Collected Researches, (reviewed by S. S. Kirby): 775
- Principles of Radio, by Keith Henney, (reviewed by Carl Dreher): 752
- Radio and Its Future, by Martin Codel, (reviewed by S. S. Kirby): 777
- Radio Data Charts, by R. T. Beatty, (reviewed by S. S. Kirby): 744
- Radio Encyclopedia, by M. Adam: 627
- Radio Operating Questions and Answers, by Nilson and Hornung, (reviewed by S. S. Kirby): 776
- Radiotechnik, by F. Kiebitz, (reviewed by W. G. Cady): 646
- Radio Telegraphy and Telephony, by R. L. Duncan and C. E. Drew, (reviewed by S. S. Kirby): 754
- Report of Radio Research Board for the Period Ended 31st March, 1929, (reviewed by S. S. Kirby): 735
- Report of Royal Commission on Radio Broadcasting, (reviewed by C. H. Starr): 673
- Technique of Amplification Measurements; Instruments and Methods, by Manfred von Ardenne in Collaboration with Wolfgang Stoff and Fritz Gabriel, (reviewed by H. W. Lamson): 723
- The ABC of Television, or Seeing by Radio, by Raymond F. Yates, (reviewed by E. H. Felix): 660
- The Physical Principles of Wireless, by J. A. Ratcliffe, (reviewed by S. S. Kirby): 661
- The Radio Manual, by George E. Sterling, (reviewed by S. S. Kirby): 710
- Transmission Networks and Wave Filters, by T. E. Shea, (reviewed by K. S. Van Dyke): 722
- Vibration Problems in Engineering, by S. Timoshenko, (reviewed by S. S. Kirby): 635
- Bridge:
- Condenser, for Factory Inspection: 656
- Direct Reading Frequency, for Audio Range: 558
- Double Hump Phenomena Through: 682
- Receiver: 126
- R. F.: 71, 75, 154
- Tube Wattmeter, Voltmeter and Phase Shifting: 749
- Broadcast Frequency Allocation: Some Principles of: 595
- Broadcast Stations:
- Regulation of, as a Systems Problem: 594
- Service Area of: 714
- Testing Piezo Oscillators for, at Bureau of Standards: 680
- Broadcasting: 192, 216, 260, 320, 343
- Carrier: 205, 216, 229, 262
- Common Frequency: 367
- Comparison of, and Audible Pictures: 725
- Control System: 445
- Crystal Control: 337
- Developments in Transmitters for: 745
- Effect of Tall Buildings: 265, 320, 331
- Equal Field Strength Contours: 265, 331, 493
- German Common-Frequency Broadcast System: 681
- High Power: 343
- Portable Control Equipment: 232
- Re-Broadcasting: 279
- Reports of I.R.E. Committee on: 648
- Service Ranges: 493
- Short Wave: 279
- Side Bands: 214, 216, 229, 320
- Station: 232, 260, 273, 280, 339, 343
- Synchronization: 367
- Transmitter Developments: 451
- U. S. Radio, Developments in: 601
- Wire Line Pick up for: 280
- Wire Line Systems for National: 628
- Broadcasting Antennas:
- Transmitting: 579
- C
- Cable:
- Advances in Transoceanic Technique: 774
- Calculation of Characteristics and the Design of Triodes: 617
- Calculation of Inductance: Of Single-Layer Coils and Spirals Wound with Wire of Large Cross Section: 631
- Capacitance: Measurement of Direct Interelectrode, of Vacuum Tubes: 568
- Capacity: 47
- Distributed: 31
- Factory Measurement of Variable Condensers: 656
- Method of Measuring: 542
- Standard: 236
- Tube: 95

- Variation of Condenser Resistance with, and Frequency: 718
- Characteristics:
- Detection, of 3-Element Tubes: 525
  - Of Modern Radio Receiver and their Relation to Broadcast Regulation: 593
- Circuit Analysis:
- Applied to Screen Grid Tube: 533
  - Single- and Coupled-Circuit Systems: 702
- Circuit Tuning:
- by Wave Resonance and Applications to Radio Reception: 625
- Circuits:
- Filter Valve, and Filtering Antennas: 526
- Civil Airways:
- And their Radio Facilities: 638
- Classification of Radio Subjects: 734
- Coil:
- Calculation of Inductance of: 631
  - Constants: 124, 202, 397, 436, 507, 508, 516
  - Distributed Capacity of: 6, 182
  - Formula and Tables: 256, 397, 497
  - Insulators: 317
  - Natural Period of: 6
  - No Leakage: 306
- Coils:
- High-Frequency Resistance of: 767
- Cold Cathode Rectification: 560
- Compass: 250, 288
- Condenser:
- Compressed Air: 65
  - Gang Testing Device: 498
  - Geometric Variation: 28, 354
  - High Voltage Air: 289
  - Leakage: 7
  - Losses: 7
  - Resistance: 7, 290
  - Straight Line Frequency: 269, 307, 354
- Condenser Loud Speaker:
- The Kyle: 577
- Condensers:
- Dry Electrochemical: 728
- Conductors:
- Electrolytic: 47
  - Litzendracht: 12, 71
  - R. F. Resistance of: 71
- Constitution: B
- Control:
- Auxiliary Frequency, for R. F. Oscillators: 521
- Convertor:
- AC to DC: 122
- Coöperation Committee Program: 733
- Coördinates:
- Normal: 406
- Coördination:
- Radio: 600
- Cores:
- Eddy Currents in: 751
- Correlation of Directional Observations of Atmospherics with Weather Phenomena: 580
- Coupling: 63, 130, 173, 178, 308, 318, 327, 349
- Capacity: 130, 159, 173, 327
- Combined Capacity and Magnetic: 344
- Direct: 173
- Regeneration in: 263
- Resistance-Capacity: 352
- Theory: 58, 87, 97, 130, 173
- Course Indicator:
- Audio Frequency: 156, 181, 189
- Cross-Talk:
- Reduction of, by Variable-Mu Tetrodes: 769
- Crystal Oscillators: 193, 281, 320, 337, 357, 369, 381, 391, 403, 438, 504
- Flexural Vibrations: 413
- Four-Electrode Tube: 501
- D
- Daylight Transmission Characteristics:
- of Horizontally and Vertically Polarized Waves from Airplanes: 642
- Decimal Classification of Radio Subjects: 500
- Decrement: 22, 23, 40, 68, 101, 112
- Linear: 26, 68
- Decremeter: 28
- Deionization of Mercury Vapor: 134
- Design Methods for Soft Magnetic Materials in Radio: 572
- Design of a Vacuum Tube Voltmeter: 561
- Detection:
- Amplification and, of Ultra-Short Waves: 704
  - High Signal Voltages, Plate Rectification with the High Vacuum Triode: 578
  - Large Signals, Notes on: 623
  - Properties of Grid Leak Power: 773
  - Voltage: 407
- Detection Characteristics:
- of Screen Grid and Space-Charge Grid Tubes: 557
  - of Three-Element Tubes: 525
- Detectors: 79, 430
- Amplifying: 11, 35, 37, 43, 74, 78, 105
- Anti-Coherers: 16
- Audion: H, 14, 34, 37, 43, 49, 79
- Biased Tube: 116, 117, 150, 346
- Cerussite: 13
- Chopper: 105
- Coherers: 79, 102
- Crystal: 79

- Distortion: 346  
 Efficiency of Thermionic: 137  
 Einthoven Galvanometer: 17  
 Electrolytic: H, 11, 56, 79  
 Empirical Equation for Determining the  $d^2i_g/de_o^2$  of: 591  
 Gas Flame: 14  
 Grid Rectification: 346  
 Heterodyne: H, 11, 35, 37, 38, 43, 74  
 Microphonic: 79  
 Sensitivity of: 81, 83  
 Sodium Vapor: 220, 254  
 Steel and Iron: 79  
 Taste: 176  
 Ticker: 3, 11, 17, 49, 79  
 Tone Wheel: 17  
 Tube: 39, 93, 245, 312, 346, 364, 396  
 Valve: 14  
 Development: 4  
   European: 144, 147, 175, 188, 199, 228, 250, 288, 295, 305, 310  
   U. S.: 79  
 Dewey Decimal System: 734  
 Direct Reading Frequency Bridge:  
   For Audio Range: 558  
 Direction: 315, 325  
   Deviations: 140, 197, 199, 286, 325  
   Errors: 288  
   Goniometer: 250  
   Sunset Deviations: 301  
 Direction-Finding:  
   by Transmission and Reception: 538  
 Directional Distribution of Static:  
   Measurements on: 583  
 Directional Observations of Atmospheres:  
   Correlation of, with Weather Phenomena: 580  
 Directional Observations on Static in Japan: 536  
 Directive Radio Beacon:  
   Field Intensity Characteristics of: 562  
 Distortion:  
   Reduction of, by Variable-Mu Tetrodes: 769  
 Double and Multiple Signals:  
   With Short Waves: 555  
 Drum-Scanner in Radiomovies Receivers: 610
- E
- Earth Reflection of Ultra Short Radio Waves: 553  
 East-West and North-South Attenuation of Long Radio Waves on the Pacific: 585  
 Echo Interference Method for Study of Radio Wave Paths: 619  
 Echo Method:  
   Studies of Height of Kennelly-Heaviside Layer by: 604  
 Echo Signals: 655  
   Studies in: 602  
 Echoes:  
   Group Velocity and Long Retardations of: 603  
   Long Delay: 618  
   Short Range, with Short Waves: 556  
   Significance of Observations of Phase of: 621  
 Economics: 84  
 Eddy Currents:  
   Variation Inductance Due to: 751  
 Education: 21, 41, 336  
   Collegiate: 336  
 Effect of Flight on Hearing: 645  
 Electrical Prospecting: 492  
 Electrical Transmission of Pictures and Images: 608  
 Electroelastic and Pyro-Electric Phenomena: 721  
 Electromagnetic Monochord for Measurement of Audio Frequencies: 590  
 Electron Emitting Substances: 39  
 Electron Oscillations in a Triode: 528  
 Electron Theory: 37, 39  
 Electrostatic Telephone Receiver: 35  
 Empirical Equation for Determining the  $d^2i_o/de_o^2$  of Detectors: 591  
 Engineering Aspects of Work of Federal Radio Commission: 592  
 Engineering Control of Radio Receivers in Production: 727  
 Engineering Precautions: 72, 90  
 Equality of Loud Speaker Output at Various Frequencies: 543  
 Equipment for Testing Radio Receivers: 550  
 Equivalent Circuits of an Electron Triode and the Equivalent Input and Output Admittances: 614  
 Ethics, Radio Engineering: 5  
 Experiments in Recording Radio Signal Intensity: 581  
 Experiments in Short-Distance Short-Wave Transmission: 539
- F
- Facsimile Equipment:  
   Mechanical Developments of: 609  
 Facsimile Picture Transmission: 544  
 Fading: 3, 10, 15, 52, 253, 319, 320, 331, 345, 359, 390, 453, 509  
   Some Characteristics of Short Periods: 574  
 Fading Curves and Weather Conditions: 524  
 Federal Radio Commission:  
   Division of Radio Broadcast Facilities: 766  
   Engineering Aspects of Work of: 592  
 Field Intensity:

- Characteristics of Double Modulation Type of Directive Radio Beacon: 562  
 Problems of Measuring: 598  
 Filtering Antennas and Filter Valve Circuits: 526  
 Filters: 224, 293, 320, 339  
 Fire Hazard: 72, 90  
 Four-Electrode Tube:  
 Mathematical Theory of: 571  
 Frequencies:  
 Intelligence Transmission with Limited Band of: 658  
 Routine Measurement of Operating, of Broadcast Stations: 584  
 Frequency: 392  
 Allocation: 459, 489, 503, 510  
 Division: 759  
 High Precision Standard of: 575  
 International Comparison of: 757  
 Measurement: 449, 629  
 Standards: 460  
 Temperature Control for, Standards 764  
 Variation of Condenser Resistance with Capacity and: 718  
 Frequency Bridge:  
 Direction Reading for Audio Range: 558  
 Frequency Changers: 17, 29, 98, 162, 163, 164, 166, 381, 386  
 Frequency Division: 759  
 Frequency Measurements:  
 A System for, Based on a Single Frequency: 530  
 Distant Transmitting Stations: 552  
 Method of, from Five to Two Hundred Cycles: 742  
 Frequency Multiplication:  
 Investigation of, in Tube Transmitters: 615  
 Shock Excitation: 547  
 Frequency Stabilization:  
 Receiver, by Quartz Control: 668  
 Frequency Standards:  
 Establishment of Japanese: 703  
 International Comparison of Frequency by Quartz Resonator: 757  
 Interpolation Methods for use with Harmonic: 741  
 Method of Referring Secondary to Standard Time Interval: 529  
 Temperature Control for: 764  
 Thermostat Design: 471  
 Further Note on Ionization in Upper Atmosphere: 589  
 Further Observations of Radio Transmission and the Heights of the Kennelly-Heaviside Layer: 630  
 Further Studies of the Kennelly-Heaviside Layer by the Echo Method: 604
- G
- General: 64, 79  
 Whistling Tones from the Earth: 713  
 Grid Circuit Detection:  
 Notes on: 545  
 Grid Losses in Power Amplifiers: 570  
 Grinders:  
 Note on Directional Observations in Japan: 536  
 Grounds: C, 49, 54, 66, 102, 104, 144  
 Counterpoise: 9, 104, 329  
 Soil Resistance: 329  
 Group Velocity and Long Retardations of Radio Echoes: 603
- H
- Harmonics: 17, 45, 75, 86, 88, 130, 138, 139, 207, 239, 279, 294, 326, 346, 348, 358  
 Analysis by Thermionic Voltmeter: 659  
 Frequency Division: 759  
 Interpolation Methods for use with, Frequency Standards: 741  
 Transformer of: 276  
 Hearing:  
 Effect of Flight on: 645  
 Height of Kennelly-Heaviside Layer:  
 Measurements of: 551  
 Heterodyne: H, 11, 35, 37, 38, 56, 74, 78, 105, 261  
 Super: 166, 320, 350  
 Heterodyne Interference:  
 A Study of: 596  
 High Precision Standard of Frequency: 575  
 Historical: A, B, C, D, H, 15, 39, 64, 79, 199, 233, 260, 322, 350, 417  
 Homopolar Alternator: 149  
 Horizontal Antennas:  
 Determination of Radiation Angle: 518
- I
- Image Transmission by Radio Waves: 607  
 Images:  
 Electrical Transmission: 608  
 Impedance:  
 Mutual, between Adjacent Antennas: 587  
 Impedances:  
 Static and Motional, of Magnetostriction Resonator: 616  
 Inductance: 622  
 Calculation of: 631  
 Method of Measuring: 542  
 Variation of, Due to Magnetic Shielding: 751  
 Input Equipment:  
 Speech: 628.

- Inspection Service:  
   Outline of: 597  
 Institute Affairs: A, B, 4, 5, 79.  
 Institute of Russian Radio Engineers: 228  
 Insulators: E, 2, 17, 19, 42, 72, 241, 317, 323, 435  
   Antenna: 241, 329  
   Corona Effects: 19, 42  
   Dielectric Constants and Power Factors of: 285  
   Dielectric Hysteresis: 26  
   Properties and Applications of Mycalex: 724  
 Interference: 233  
   Arc Mush: 139, 233  
   Eliminating Causes of: 233  
   Locating with Oscillograph: 717  
   Noise Level: 319  
   Radio: 564  
   Radio Engineer's Responsibility in Coping with Man-Made: 599  
   Re-Radiation: 300  
   Signal to Static Ratio: 229, 262, 328  
   Sources of: 233, 343  
   Station: 343  
   Study of Heterodyne: 596  
 International Union of Scientific Radio Telegraphy (U.R.S.I.): 217, 434, 481  
 Introduction to Symposium on Technical Achievements in Broadcasting: 628  
 Inventing: 338  
 Investigation of Phenomena of Frequency Multiplication as used in Tube Transmitters: 615  
 Ionization:  
   In the Atmosphere of Mars: 605  
   In the Upper Atmosphere: 589  
   Wireless and, in Upper Atmosphere: 719  
 Ionized Upper Air: 10, 70, 341, 419, 424, 425, 502  
 Iron at Radio Frequencies: 51, 75, 111, 113, 114, 169
- K
- Kennelly-Heaviside Layer: 70, 341, 431, 432, 461, 488  
   Heights of: 630  
   Measurements of Height of: 551  
   Method of Determining Height of: 573  
   Studies of, by Echo Method: 604  
   Wireless and Ionization in Upper Atmosphere: 719  
 Kyle Condenser Loud Speaker: 577
- L
- Laws and Regulations: D, 20, 21, 25, 28, 41, 60, 79, 85, 132, 437  
 Legislation:  
   Hague Conference: 695  
   Radio Broadcast: 628  
   Recommendations of C.C.I.R.: 696  
 Legislature:  
   Division of Radio Broadcast Facilities: 766  
   Radio Engineer and Law: 705  
 Light and Power Engineering Applied to Radio: 170  
 Lightning: 72, 76, 90  
 Loading Coils: 110  
 Logarithmic Scale for Beat Frequency Oscillator: 563  
 Loud Speaker: 303, 327  
   Driving Unit: 303  
   Horns: 267  
   Kyle Condenser: 577  
   Measurement of Characteristics: 514  
   Output, Apparent Equality at Various Frequencies: 551  
   Testing: 373  
   Tests: 267  
   Theory: 267
- M
- Magnetic Materials:  
   Design Method for, in Radio: 572  
 Magnetic Shielding:  
   Variation of Inductance Due to: 751  
 Magnetic Storms and Wireless Telegraphy: 540  
 Magnetostriction Oscillators: 519  
 Magnetostriction Resonator:  
   Static and Motional Impedances of: 616  
 Magnetron Oscillations:  
   Of New Type: 750  
   Short-Wave Limit of: 548  
 Man-Made Interference:  
   Radio Engineer's Responsibility in Coping with: 599  
 Masts:  
   Insulation of Guyed: 368  
 Mathematical Theory of the Four Electrode Tube: 571  
 Materials:  
   Properties and Applications of Mycalex: 724  
 Maximization: 382  
 Measurement:  
   Aircraft Antenna Constants: 641  
   Audio Frequencies by Electromagnetic Monochord: 590  
   Direct Interelectrode Capacitance of Vacuum Tubes: 568  
   Field Intensity, Problems of: 598  
   Frequencies of Broadcast Stations: 584  
   Frequency: 629  
   Frequency of Distant Transmitting Stations: 552

- Modulation, Use of Electron Tube Voltmeter for: 549  
 Radio-Frequency Resistance of Oscillatory Circuit: 684  
 Measurements: 422  
   Amplification a-f: 388  
   Amplification r-f: 385  
 Antenna Measuring Equipment: 686  
 Atmospheric Disturbances: 454  
 Current and Condenser Shunt: 428  
 Direction of Propagation: 453  
 Directional Distribution of Static: 583  
 Double Hump Phenomena Through Bridge: 682  
 Fading of Short Waves: 453  
 Field Intensity: 493  
 Field Strength: 152, 197, 215, 222, 226, 247, 253, 270, 277, 291, 319, 331, 340, 343, 345, 359, 370, 426, 454, 485  
 Frequency: 371, 420, 421, 449  
 Height of Kennelly-Heaviside Layer: 551  
 Inductance: 436, 516  
 Interelectrode Admittance: 444  
 Loud Speaker Characteristics: 514  
 Microammeter: 119  
 Noise: 222  
 Null Method: 48  
 Phase Difference: 112  
 Radio Frequency Potentiometer: 712  
 Receiving System: 363, 375, 422  
 Reception: 196a  
 Signals and Atmospheric Strengths at Bureau of Standards: 196, 200, 203, 208, 213, 215, 218, 225, 231, 238, 244, 249, 252, 257, 264, 297, 347, 398, 490, 654, 736  
 Silicon Detector, with Tube Voltmeter: 340  
 System of Frequency, Based on a Single Frequency: 530  
 Tube Capacity: 422, 443  
 Tube Wattmeter, Voltmeter and Phase Shifting Bridge: 749  
 Vacuum Tube Ammeter: 418  
 Variable Condenser Factory Inspection: 656  
 Voltmeter: 169  
 Mechanical Developments of Facsimile Equipment: 609  
 Mechanism of Electron Oscillations in a Triode: 528  
 Meter:  
   Radio Frequency: 517  
 Method of Measuring Inductance and Capacities:  
   Extension of: 542  
 Microphone: H, 51, 232, 280, 511  
 Microphones:  
   Cavity Resonance Effect on Frequency Response of: 716  
   Microphonic Improvements in Vacuum Tubes: 613  
   Modulation: H, 11, 51, 151, 179, 183, 192, 216, 240, 280, 339  
   Condenser Microphone: H, 232  
   Cross, in R.F. Amplifiers: 672  
   Frequency: 715  
   Hydraulic: H  
   Measurement of, with Electron Tube Peak Voltmeter: 549  
   Operation from Physical Viewpoint: 649  
   Oscillograph Indicator: H, 280  
   Pallphotophone: 232  
   Motional Impedance: 94  
   Mount Royal Tunnel:  
     Reception Experiments in: 535  
   Multiple Signals with Short Waves: 555  
   Multiplication of Frequency by Shock Excitation: 547  
   Multivibrator: 670  
     Four-Electrode Tube Relaxation Oscillation Circuit: 756  
   Municipal Regulations: 90  
   Mutual Impedance between Adjacent Antennas: 587
- N
- National Broadcasting Company: 628  
 Naval: 27, 49, 56, 65, 110, 140, 184  
   Power Supply for Transmitters: 650  
 Navigation:  
   Marine, Application of Direction-Finding to: 538  
 Networks:  
   Behavior of, with Normalized Meshes: 537  
 New Method of Determining the Height of the Kennelly-Heaviside Layer: 573  
 Noise:  
   Fluctuation, in Receivers: 730  
   In Tubes and Circuits: 664  
 Nomenclature:  
   Tube: 365  
 Note on Earth Reflection of Ultra-Short Radio Waves: 553  
 Notes on Effect of Solar Disturbances on Transatlantic Radio Transmission: 606  
 Notes on Grid Circuit Detection: 545
- O
- Observations on Modes of Vibration and Temperature Coefficients of Quartz Crystal Plates: 576  
 Observations of Short Period Radio Fading: 574  
 Operating Characteristics in Photoelectric Tubes: 632

- Operating Frequencies of Broadcast Stations:  
 Routine Measurement of: 584
- Operation:  
 Codes: 21, 25, 41, 85  
 Duplex: 126, 144, 148, 186, 226  
 Economics: 84, 127, 216  
 High Speed: 151  
 Multiplex: 161  
 Personnel: 21, 25, 41, 127  
 Traffic: 25, 27, 41, 60, 84, 127, 259, 324  
 Wire vs. Radio: 127
- Oscillations:  
 Local Standard: 136, 193, 270, 331, 340  
 Magnetron, of New Type: 750  
 Magnetron, Short-Wave Limit of: 548  
 Piezo-electric, with Quartz Cylinders: 694  
 Polyphase: 305  
 Spurious: 299  
 Theory of: 1, 101, 124  
 Warbler: 315
- Oscillator:  
 Four-Electrode Tube as Beat Frequency: 685  
 Logarithmic Scale for Beat Frequency: 563  
 Piezo-Electric Crystal: 523  
 Push-Pull Piezo-Electric: 653
- Oscillators:  
 Auxiliary Frequency Control for Radio-Frequency: 521  
 Frequency Stabilized, System: 740  
 Magnetrostriction: 519  
 Multivibrator: 670
- Ocillograms: 26, 37, 61, 82, 111, 130, 143, 194, 201, 204, 210, 280, 320  
 Cathode Ray: 28, 42, 53, 82, 123, 172, 294
- Oscillograph:  
 Locating Radio Interference with: 717
- Outline of the Radio Inspection Service: 597
- Output:  
 Loudspeaker: Apparent Equality at Various Frequencies: 543  
 Power, of Pentode: 678  
 Power, of Vacuum Tubes: 665
- Over Land Stations: 3, 27, 141
- P
- Patents: 174, 338  
 Penetration of Rock by Electromagnetic Waves and Audio Frequencies: 633  
 Photoelectric Tubes:  
 Operating Characteristics in: 632  
 Photradio Developments: 569  
 Pictures:  
 Electrical Transmission of: 608  
 RCA Photophone System: 746  
 Picture Transmission:  
 by Radio Waves: 607  
 Facsimile: 544  
 Piezo-Electric:  
 Resonator in High Frequency Circuits: 692  
 Terminology: 771  
 Piezo-Electric Control:  
 For Short-Wave Receivers: 668  
 Piezo-Electric Crystal:  
 Summary of, Conference: 770  
 Piezo-Electric Crystal Oscillator: 523  
 Characteristics of: 758  
 Push-pull circuits: 653  
 Temperature Control for: 720  
 Testing, for Broadcast Stations at Bureau of Standards: 680  
 Piezo-Electric Oscillations:  
 With Quartz Cylinders: 694  
 Piezo-Electric Plates:  
 International Comparison of Frequency Using: 757  
 Observations on Modes of Vibration and Temperature Coefficients: 576  
 Piezo-Electricity: 369, 391, 413, 438, 457, 473, 477, 504  
 Bibliography: 447  
 Crystal Oscillator Mountings: 403, 477  
 Modes of Vibration of Crystals: 438  
 Resonator and its Network: 457  
 Transmitters, Crystal Controlled: 357  
 Piloting by Induction: 156, 181, 189  
 Plate Rectification with the High Vacuum Tube: 578  
 Power Lines Carrying Radio Frequencies: 148, 188  
 Power Supply:  
 For Filaments from 25-ke Current: 667  
 Preferred Numbers: 356  
 Problems Centering about Measurement of Field Intensity: 598  
 Propagation:  
 Effect of Rain and Fog on, of Very Short Waves: 708  
 Experiments at 3 Meters: 679  
 Low Power Short Waves in the 1000 km Range: 588  
 Meteorological Influence on Long Wave Reception: 709  
 Night Errors for Long Waves: 693  
 Note on Attenuation Formula: 760  
 Performance Long Distance Radio Circuits: 755  
 Reflection from Surface of Earth: 732  
 Relation of, to Disturbances in Terrestrial Magnetism: 582  
 Solar and Magnetic Activity and Radio Transmission: 763

- Summary of Radio Wave: 688  
 Wireless and Ionization in Upper Atmosphere: 719  
 Protective Devices: 72, 90  
 Pyro-Electric Phenomena:  
 Electroelastic and: 721
- . R
- Radiation: 483  
 At an Angle: 284, 374, 405  
 At Frequencies above Fundamental: 283, 348  
 At a Harmonic: 283  
 Resistance: 1, 104, 195, 283, 329  
 Rotary Field: 305  
 Theory of: C, E. 1, 57, 104, 165, 170, 320  
 Radiation Angle:  
 Determination for Horizontal Antennas: 518  
 Radiation Resistance of Beam Antennas: 546  
 Radio Broadcasting Transmitters and Related Transmission Phenomena: 628  
 Radio Coordination: 600  
 Radio Direction-Finding by Transmission and Reception: 538  
 Radio Electric Clock System: 739  
 Radio Engineer's Responsibility in Coping with Man-Made Interference: 599  
 Radio for the Air Transport Operator: 637  
 Radio-Frequency Amplifiers:  
 Cross Modulation in: 672  
 Radio-Frequency Meter:  
 Direct Reading: 517  
 Radio Inspection Service:  
 An Outline of: 597  
 Radio Interference: 564  
 Radio Manufacturers' Association: 476  
 Radio Range:  
 Applying to the Aural Directive Type to the Airways: 644  
 Applying the Visual Double Modulation Type to the Airways: 639  
 Tuned-Reed Indicator for Four- and Twelve-Course: 701  
 Visual Type Radio Beacon: 697  
 Visual Type, Transmitter: 768  
 12-Course, with Visual Indication: 700  
 Radio Receiver Testing Equipment: 550, 656  
 Design and Use of: 726  
 Radio Systems:  
 Communication Services of British Post Office: 747  
 Plant of R.C.A. Communications: 676  
 R.C.A. Radio Network: 874
- Radiotelegraphy:  
 The Importance of, in Science: 520  
 Railroad Trains: 102, 401  
 Range Variation: 15  
 Receivers: 13  
 Aircraft: 531  
 Aircraft, for Use with Rigid Antennas: 532  
 Barrage: 126  
 Broadcast: 209, 327, 343, 363  
 Broadcast, for Automobiles: 669  
 Broadcast, tests of: 505  
 Characteristics of Modern Radio and their Relation to Broadcast Regulation: 593  
 Classified: 343  
 Developments in Superheterodyne: 541  
 Drum Scanner in Radiomovies: 610  
 Effect of Antenna on Tuning: 479  
 Filament Supply from 25-kc Current: 667  
 Fluctuation Noise In: 730  
 Hum in All-electric: 657  
 Multirange: 269  
 Portable: 331  
 Reflexing: 272  
 Selectivity: 327, 343, 377, 429  
 Sensitivity: 327  
 Servicing Broadcast: 342  
 Single Control: 132  
 Theory: 133  
 Variation in Sensitivity of: 690  
 With quartz Control: 668  
 Reception: 362, 370, 375, 394, 400, 416, 429, 505  
 Circuit Tuning and its Applications to: 625  
 Duplex: 9  
 Echo Signals: 448, 461, 494  
 Experiments in Mt. Royal Tunnel: 535  
 Homodyne: 216  
 Long Distance: 34, 372, 512  
 Meteorological Influence Upon Long-Wave: 709  
 Multiple Signals: 372, 414  
 Transatlantic: 38, 512  
 Visual: 187  
 Reciprocal Theorems in Radio Communication: 567  
 Reciprocity in Electromagnetic, Mechanical, Acoustical, and Interconnecting Systems: 566  
 Recording: 198  
 Galvanometer: 253  
 Graphic: 198  
 Pallophotophone: 232  
 Phonographic: 102, 198  
 Photographic: 16, 187, 198, 320, 322  
 Radio Signal Intensity: 581  
 Telephone: 14

- Rectification:  
 Cold Cathode: 560  
 Rectifiers: 29, 38, 190, 191, 207, 221, 289, 293  
 Electrolytic: 332  
 For Plate Supply: 650  
 Hot-Cathode Mercury Vapor Tubes: 651  
 Six-phase: 299  
 Reflection: 3, 5, 10, 52, 57, 70, 287, 320, 341  
 Of Waves from Surface of Earth: 732  
 Refraction: 52, 57, 70, 287, 320, 341  
 Regeneration: 37, 38, 56, 78, 81, 83, 95, 201, 263, 268, 316, 474  
 Effect of, on Signal Strength: 534  
 Super: 234, 272  
 Regeneration Prevention:  
 Neutralizing Feed-Back: 327  
 Shifting Phase of Feed-Back: 344  
 Regulation:  
 Broadcast Stations as a Systems Problem: 594  
 Radio Broadcast: 628  
 Relation between Long-Wave Reception and Certain Terrestrial and Solar Phenomena: 620  
 Relation of Radio Propagation to Disturbances in Terrestrial Magnetism: 582  
 Relaxation Oscillation:  
 Four-Electrode Tube, Circuit: 756  
 Resistance:  
 High Frequency, of Coils: 767  
 Measurement by Calorimeter: 112  
 Measuring Radio-Frequency of Oscillatory Circuit: 684  
 Negative: 93, 204, 337  
 Radiation, of Beam Antennas: 546  
 Skin Effect: 71  
 Spark: 68  
 Stabilized R. F. Amplifying Circuits: 522  
 Variation of Condenser, with Capacity and Frequency: 718  
 Resonance:  
 Cavity, Effect on Microphones: 716  
 Indicated by Oscillating Audion: 109  
 Screen-Grid Voltmeter as Indicator: 731  
 Resonator:  
 Internation Comparison of Frequency with Quartz: 757  
 Rock Penetration by Electromagnetic Waves and Audio Frequencies: 633  
 Routine Measurement of Operating Frequencies of Broadcast Stations: 584
- S
- Safety at Sea: D, 20, 21, 25, 79, 85  
 Distress Calls (NC, CQD, NA, SOS): D  
 "SS Republic" Disaster: D  
 Science:  
 The Importance of Radiotelegraphy in: 520  
 Screen-Grid Tubes:  
 Circuit Analysis Applied to: 533  
 Detection Characteristics of: 557  
 Secondary Frequency Standards:  
 Referring to Standard Time Interval: 529  
 Selection of Standards for Commercial Television: 611  
 Sensitivity:  
 Variation in, of Receivers: 690  
 Shielding: 154, 306, 327, 331, 340  
 Engine-Ignition, for Aircraft: 698  
 Ship Stations: D, 4, 27, 59, 60, 79, 226, 250, 324  
 Auxiliary Power: D, 20  
 Specifications: D, 20  
 Shock Excitation:  
 Frequency Multiplication by: 547  
 Shore Stations: 27, 54, 79, 259, 324, 499  
 Short Period Fading:  
 Some Observations of: 574  
 Short Range Echoes with Short Waves: 556  
 Short-Wave Limit of Magnetron Oscillations: 548  
 Short-Wave Radio Transmission:  
 Experiments in: 539  
 Short Waves: 125, 199, 222, 227, 239, 302, 325, 345, 374, 380, 381, 414, 417, 499  
 Day, Night, and Frequency-Range Diagrams: 345, 381  
 Double and Multiple Signals with: 555  
 Earth Reflection of Ultra: 553  
 Land and Water Effects: 345  
 Propagation of, in 1000-km Range: 588  
 Range Chart: 314, 380  
 Short Range Echoes with: 556  
 Skip Distances: 314, 341, 345  
 Signal Intensity:  
 Experiments in Recording: 581  
 Signal Strength:  
 Effect of Regeneration on: 534  
 Relative to Weather: 683  
 Signals:  
 Double in Short-Wave Transmissions: 655  
 Significance of Observations of the Phase of Radio Echoes: 621  
 Singing Audion: 14  
 Solar Disturbances:

- Effect of, on Transatlantic Radio Transmission: 606  
 Some Principles of Broadcast Frequency Allocation: 595  
 Space Charge: 39  
 Space-Charge-Grid Tubes:  
 Detection Characteristics of: 557  
 Spark Gaps:  
 Tone Production with: 108  
 Speech Input Equipment: 628  
 Standard Frequency: 239, 281, 282, 294, 320, 392, 421, 460, 471  
 Crystal: 193, 281, 337, 369, 421, 460, 473  
 High Precision: 575  
 Standing Waves: 239, 248, 282  
 Tuning Fork: 294, 326, 421  
 Standardization:  
 Vacuum Tube: 674  
 Static:  
 Measurements on Directional Distribution of: 583  
 Note on Directional Observations in Japan: 536  
 Static and Motional Impedances of a Magnetostriction Resonator: 616  
 Stations:  
 Rome (San Paolo) 499  
 Stellar Photometry: 304  
 Storage Batteries: 20, 98, 332  
 Studies of Echo Signals: 602  
 Study of Heterodyne Interference: 596  
 Submarine Signaling, Audio: 214  
 Superheterodyne Receivers:  
 Considerations in Design: 691  
 Developments in: 541  
 Surges:  
 Voltage, in Audio Apparatus: 559
- T
- Technical Achievements in Broadcasting and its Relation to National and International Solidarity: 628  
 Telephone: H, 11, 17, 20, 29, 39, 51, 98, 102, 106, 183, 186  
 Aircraft: 140  
 Carrierless: 262, 298, 299  
 Combination Radio and Wire Line: H, 186  
 Duplex: 126, 148, 186, 226  
 Receivers (Headphone Type): 94, 96, 224, 296  
 Single Side Band: 298, 299  
 Transatlantic: 170, 298, 319, 512  
 Telephone Engineering Applied to Radio: 205  
 Telephony:  
 Frequency Modulation: 715  
 On Half-Meter Waves: 707  
 Operation of Modulator: 649  
 Receiving Sets for Aircraft: 531  
 Short-Wave Transmission: 699  
 Transmission Characteristics of  
 Short-Wave Telephone Circuit: 687  
 Television: 408  
 Selection of Standards for: 611  
 Temperature Coefficients:  
 Quartz Plates: 576  
 Temperature Control:  
 For Piezo Oscillator: 721  
 Temperature Rating of Wind Driven Aircraft Radio Generators: 643  
 Terminology:  
 Piezo-Electric: 771  
 Terrestrial Magnetism:  
 Relation of Radio Propagation to: 582  
 The Penetration of Rock by Electromagnetic Waves and Audio Frequencies: 633  
 Theorem:  
 Equivalent Generator: 666  
 Theory: 406  
 Amplification: 383  
 Circuits: 1, 50  
 Detection by Grid Rectification: 450  
 Maximization: 382  
 Radio Frequency Transformers: 486  
 Reciprocity: 446  
 Time Difference Tests: 16  
 Time Signals: 27  
 Radio Electric Clock System: 739  
 Toroids: 111, 154  
 Towers and Masts: C, E, 17, 32, 33, 49, 54, 56, 65, 72, 76, 147, 151, 232, 251, 323, 329, 339  
 Transatlantic Radio Transmission:  
 Effect of Solar Disturbances on: 606  
 Transformers:  
 Audio Frequency: 387, 395, 515  
 Output: 475  
 Quenched Spark: 44  
 Radio Frequency: 486  
 Resonance: 92, 108  
 Spark Set: G, 53  
 Tuned R. F.: 318, 344, 349  
 Transients: 53  
 Transmission: 320, 414, 434, 453  
 Attenuation: 10, 15, 287  
 Automatic: 9, 85  
 Beam, C, 199, 417, 456  
 Chart: 73, 489  
 Characteristics of Short-Wave Telephone Circuit: 687  
 Effect of Topography: 265, 271, 378  
 Experiences with Short-Wave Telegraphy: 765  
 Experiments in Short Distance Short Wave: 539  
 Facsimile Picture: 544  
 Formula: 72, 73, 103, 152, 287, 319, 334, 347  
 German Common Frequency Broadcast System: 681  
 Graphs to Attenuation Formula: 675

- Ground Waves: 389  
 Images by Radio Waves: 607  
 Intelligence, with Limited Band of  
   Frequencies: 658  
 Long Distance: 3, 9, 15, 34, 49, 65,  
   110, 141, 372, 380, 381, 431  
 Low-Frequency Radio: 737  
 Moon Effect on: 10, 15  
 Multiple Signals in Short-Wave: 655  
 Nocturnal: 52, 452  
 On Half-Meter Waves: 707  
 Picture: 322, 403  
 R. F. over Wires: 14, 148, 188, 205  
 Relative to Atmospherics: 15, 458  
 Relative to Diurnal Effects: 755  
 Relative to Earth's Magnetic Field:  
   253, 362, 390, 394  
 Relative to Fog: 708  
 Relative to General Weather: 52  
 Relative to Magnetic Activity: 763  
 Relative to Meteorological Influ-  
   ence: 709  
 Relative to Seasons: 15, 30, 34, 755  
 Relative to Solar Activity: 319, 362,  
   394, 411, 423, 433, 763  
 Relative to Rain: 708  
 Relative to Temperature: 15, 277,  
   355, 458  
 Relative to Vapor Pressure: 15  
 Relative to Weather: 683  
 Relative to Wind Velocity: 15  
 Round the World Signals: 431, 448  
 Service Area of Broadcast Stations:  
   714  
 Short Wave: 448, 456  
 Skip Distances: 314, 431, 489  
 Solar Eclipse Effect: 309, 361, 410  
 Some Problems in Short-Wave Tele-  
   phone: 699  
 Sun Effect on: 10, 15, 301, 319  
 Sunset and Sunrise Effects: 10, 301,  
   319, 433  
 Theory: 222, 389  
 Transatlantic: 9, 17, 31, 151, 310,  
   319, 433  
 Transpacific: 3, 291  
 Two-Wave: 3  
 Wave Resonance Tuning and Appli-  
   cation to: 626  
 Wire vs. Radio: 127  
 Transmission Characteristics:  
   Waves from Airplanes: 642  
 Transmitters:  
   Arc: H, 3, 17, 29, 42, 49, 59, 61, 63,  
     65, 79, 82, 110, 123, 131, 139, 144,  
     147, 178, 185, 223, 278, 335  
   Auxiliary: D, 79  
   Broadcasting: 451  
   Comparison of: 335  
   Crystal Controlled: 357, 451  
   D. C. Spark: 80  
   Developments in Broadcast: 745  
   Dynamo R. F.: H, 1, 11, 17, 29, 45,  
     51, 71, 79, 106, 149, 151, 170, 335  
   Electrostatic: 29  
   Fog Signal: 289  
   Heating Of: 463  
   High Power: 110, 170, 278  
   High Spark Frequency: 22, 24, 128,  
     147  
   Interrupted Continuous Wave: 246  
   Impulse and Impact: 106  
   Losses in: 69  
   Low Power: 451  
   Induction Coil: 79  
   Master Oscillator: 242  
   Multiphase: 46  
   "Multitone" Spark: 12  
   Multiwave: 350  
   Overlapping Wave-Trains: 22  
   Polyphase: 22  
   Power Supply for: 650  
   Quenched Gap: 9, 13, 22, 24, 26, 31,  
     44, 55, 60, 68, 77, 79, 128, 129  
   Rarefield Gas Discharger: 98  
   Radio Beacon: 452, 487  
   Radio Broadcasting and Related  
     Transmission Phenomena: 628  
   Rating of Output: 485  
   Rotary Gap: 13, 24, 52, 55, 60, 65,  
     80, 98  
   Short Wave: 302, 380  
   Spark: G, 31, 54, 60, 65, 79, 324  
   Spark Resistance: G, 26  
   Synchronous Spark: 46  
   Tube: 37, 39, 184, 188, 237, 246, 289,  
     335, 376  
   Visual Type, for Visual Beacon: 768,  
     20-40-kw High-Frequency: 677  
 Transmitting Antennas for Broadcast-  
   ing: 579  
 Transmitting Stations:  
   Measurement of Frequency of Dis-  
     tant: 552  
 Tube:  
   Theory of Four-Electrode: 571  
   Voltage Regulator, for Large Power  
     Units: 634  
   Voltmeter Design: 561  
 Tubes: 14, 34, 37, 78, 171, 439  
   A Current Source: 100, 219, 293,  
     330, 331, 332, 342, 484  
   Alkali Vapor: 211, 220, 254, 322,  
     360  
   Alternating-Current Filament: 480  
   Alternating-Current Heated Cath-  
     ode: 212  
   Ammeter: 418  
   Amplification Constant Measure-  
     ments: 99, 115, 116  
   B Current Source: 100, 191, 219,  
     293, 332, 342, 484  
   Bias: 117  
   Blocking: 230  
   C Potential Source: 332, 342, 484

- Calculation of Characteristics, and Design of: 617  
 Capacity: 95, 327, 442, 443, 444  
 Characteristics: 95, 99, 115, 116, 117, 137, 150, 171, 194, 206, 210, 230, 245, 255, 274, 275, 311, 351, 455, 464  
 Characteristics Relative to Dimensions: 142, 311  
 Circuit Theory: 482, 513  
 Combined Kenotron and Pliotron: 219  
 Combined Radio and Audio Amplifier and Detector: 266  
 Detection at High Signal Voltage: 578  
 Detection Characteristics of: 525  
 Detection Characteristics of Screen-Grid and Space-Charge Grid: 557  
 Dry Battery: 245  
 Dynatron: 93, 204  
 Efficiency: 243, 276, 495  
 Equivalent Circuits and Equivalent Input and Output Admittances: 614  
 Filament: 91  
 Four-Electrode: 204, 266, 304, 439, 464, 465, 466, 478, 501  
 Gaseous: 188  
 Grid: 91  
 Grid Commutation: 276  
 Grid Condenser, Function of: 346  
 Grid Leak, Function of: 346  
 High Vacuum: 39, 450  
 History: 39  
 Hot-Cathode Mercury-Vapor: 651  
 Input and Output Admittances: 614  
 Input Impedance: 155  
 Internal Impedance: 116  
 Inverted: 440  
 Kenotron: 93  
 Life Testing: 313  
 Manufacture of: 91, 311  
 Mathematical Theory of Multi-electrode: 743  
 Measurement of Direct Interelectrode Capacitance: 568  
 Mechanism of Electron Oscillation in: 528  
 Microphonic Improvement in: 613  
 Modulator: 117, 179  
 Mutual Conductance in: 95, 116, 245  
 Mutual Inductance: 95  
 Noise in, and Circuits: 664  
 Noises: 327  
 Nomenclature: 365  
 Oscillating: 37, 81, 93, 95, 358  
 Oscillations (Gas Action): 95  
 Parasitic Phenomena in Tube Circuits: 230  
 Phase Relations, Grid and Plate: 230, 344, 482  
 Photoelectric: 211, 304, 322, 632  
 Plate: 91  
 Pliodynatron: 93, 204  
 Power: 230, 237, 242, 339  
 Power Amplifier: 441  
 Power Output of Different: 665  
 Power Output of Pentode: 678  
 Production Tests: 506, 671  
 Puncture of Wall: 379  
 Push-Pull: 276  
 Relay: 34, 36, 51  
 Resistance: 95, 99  
 Screen-Grid, Circuit Analysis Applied to: 533  
 Short-Wave Oscillators: 404, 482  
 Standardization of: 674  
 Testing and Rating: 206, 245, 275, 313  
 Theory: 37, 95, 115, 117, 201, 364, 376, 464, 465, 513  
 Theory of Detection: 450, 496  
 Thoriated Tungsten Filament: 311  
 Variable-Mu Tetrodes: 769  
 Variation in Amplifications Factor: 706  
 Voltmeter: 340, 363, 462  
 Water-Cooled: 299  
 Tuning: 18  
 Typical Wireless Apparatus used on British and European Airways: 636
- U
- Ultra Short Radio Waves:  
 Amplification and Detection of: 704  
 Effect of Rain and Fog on: 708  
 Experiments at 3 Meters: 679  
 For Limited Range Communication: 711  
 Note on Earth Reflection of: 553  
 Transmission on Half-Meter Waves: 707  
 Underwriters' Code: 90  
 United States Radio Broadcasting Development: 601  
 Use of Electron Tube Peak Voltmeter for Measuring Modulation: 549
- V
- Vacuum Pumps: 39  
 Vacuum Tube Voltage:  
 Regulator for Large Power Units: 634  
 Vacuum Tube Voltmeter:  
 Design: 561  
 For Harmonic Analysis: 659  
 Vibration and Temperature Coefficients of Quartz Plates: 576  
 Voltage Surges in Audio-Frequency Apparatus: 559  
 Voltmeter:  
 Screen-Grid, as Resonance Indicator: 731

- Thermionic, for Harmonic Analysis:  
659  
Tube Wattmeter, and Phase Shift-  
ing Bridge: 749  
Vacuum Tube, Design: 561
- W
- War Department Message Center: 729  
Wattmeter, R. F.: 24  
Tube, Voltmeter, and Phase Shift-  
ing Bridge: 749  
Wave:  
Ground: E, 52, 57, 341, 389  
Interference: 320  
Polarization: 325  
Square: 207, 276  
Standing: 239, 248, 282  
Trap: 343  
Wave Meter: 28, 193  
Calibrating: 86  
Direct Reading: 8  
For Very Short Waves: 57  
Wave Resonance and Application to  
Reception: 625  
Wave Resonance Tuning and Applica-  
tion to Radio Transmission: 626  
Weather Conditions:  
Fading Curves and: 524  
Wire Line Systems for National Broad-  
casting: 628  
Wired Wireless: 14, 148, 188, 205  
Power Lines Carrying Radio Fre-  
quency: 384  
Wireless Echoes of Long Delay: 618  
Wireless Institute: A, B, C, D, E, F,  
G, H, 1, 2  
Wireless Telegraphy and Magnetic  
Storms: 540

## CURRENT PUBLICATIONS OF INTEREST TO RADIO ENGINEERS

- Acoustical Society of America, Journal of  
George Banta Publishing Co.,  
450 Ahnaip St.,  
Menasha, Wisconsin.
- American Institute of Electrical Engineers, Journal of  
American Institute of Electrical Engineers,  
29 West 39th Street,  
New York, N. Y.
- American Institute of Electrical Engineers, Transactions of  
American Institute of Electrical Engineers,  
29 West 39th Street,  
New York, N. Y.
- Annalen der Physik  
J. A. Booth,  
Solomon-strasse 18 B,  
Leipzig, Germany.
- Archiv für Elektrotechnik  
Julius Springer,  
Berlin, W. 9,  
Germany.
- Bell System Technical Journal,  
American Telephone and Telegraph Company,  
195 Broadway,  
New York, N. Y.
- Bureau of Standards, Circulars of  
Superintendent of Documents,  
Government Printing Office,  
Washington, D. C.
- Bureau of Standards Journal of Research  
Superintendent of Documents,  
Government Printing Office,  
Washington, D. C.
- Bureau of Standards, Letter circulars  
of  
Radio Section,  
U. S. Bureau of Standards,  
Washington, D. C.
- Bureau of Standards, Scientific papers  
of  
Superintendent of Documents,  
Government Printing Office,  
Washington, D. C.
- Bureau of Standards, Technologic papers of  
Superintendent of Documents,  
Government Printing Office,  
Washington, D. C.
- Electrical Communication  
International Standard Electric Corp.,  
67 Broad Street,  
New York, N. Y.
- Electrician  
Electrician,  
Bouverie House,  
154 Fleet Street,  
London, E. C. 4, England.
- Electronics  
McGraw-Hill Publishing Company,  
Inc.,  
10th Avenue at 36th Street,  
New York, N. Y.
- Elektrotechnische Zeitschrift  
Julius Springer,  
Berlin, W. 9,  
Germany.
- Experimental Wireless and the Wireless  
Engineer  
Iliffe and Sons, Ltd.,  
Dorset House,  
Tudor Street,  
London, E. C. 4, England.

## Fernschen

Allgemeine Deutscher Fernsehver-  
eins,  
Potsdam Str., 134 a,  
Berlin, W. 9.

Franklin Institute, Journal of  
Franklin Institute,  
15 South 7th Street,  
Philadelphia, Pennsylvania.

General Electric Review  
General Electric Review,  
Schenectady, N. Y.

Institute of Radio Engineers, Proceed-  
ings of  
Institute of Radio Engineers,  
33 West 39th Street,  
New York, N. Y.

Institution of Electrical Engineers,  
Proceedings of the Wireless Sec-  
tion of  
E. and F. N. Spon, Ltd.,  
57 Haymarket,  
London, S. W. 1, England.

Journal of Wireless Technology  
Institute of Wireless Technology,  
71, Kingsway,  
London, W. C. 2, England.

Journal Telegraphique  
Bureau International de l'Union  
Telegraphique,  
Berne,  
Switzerland.

London, Edinburgh, and Dublin Philo-  
sophical Magazine and Journal of  
Science  
Taylor and Francis,  
Red Lion Court,  
Fleet St.,  
London, E. C. 4.

Modern Wireless  
Amalgamated Press, Ltd.,  
Fleetway House,  
Farringdon Street,  
London, E. C. 4, England.

## L'Onde Electrique

E. Chiron, editor,  
40 Rue de Seine,  
Paris, (4<sup>e</sup>), France.

Optical Society of America, Journal of  
George Banta Publishing Co.,  
450 Ahnaip St.,  
Menasha, Wisconsin.

Physical Review  
American Physical Society,  
450 Ahnaip Street,  
Menasha, Wisconsin.

Physical Society of London, Proceed-  
ings of  
Physical Society,  
1 Lowther Gardens,  
Exhibition Road,  
London, S. W. 7, England.

Physikalische Zeitschrift  
S. Hirscl,  
Leipzig C 1,  
Germany.

Post Office Electrical Engineers Jour-  
nal  
Electrical Review, Ltd.,  
4, Ludgate Hill,  
London E. C. 4, England.

## QST

American Radio Relay League, Inc.,  
38 La Salle Road,  
West Hartford, Connecticut.

## Radio

Pacific Radio Publishing Company,  
428-430 Pacific Building,  
San Francisco, California.

RadioÉlectricité et Q. S. T. Français-  
53, rue Réaumur,  
Paris (2<sup>e</sup>), France.

## Radio Engineering

Bryan Davis Publishing Company,  
Inc.,  
52 Vanderbilt Avenue,  
New York, N. Y.

## Radio News

McKinnon-Fly Publications,  
381 Fourth Ave.,  
New York, N. Y.

## Radio Service Bulletin

Superintendent of Documents,  
Government Printing Office,  
Washington, D. C.

## Reviews of Modern Physics

American Physical Society,  
450-454 Ahnaip Street,  
Menasha, Wisconsin.

Revue des Telephones, Telegraphes et  
T. S. F.

Revue des Telephones, Telegraphes  
et T. S. F.,  
13, Quai Voltaire,  
Paris, France.

## Revue Générale de l'Électricité

Revue Générale de l'Électricité,  
12, Place de Laborde,  
Paris, (VIII<sup>e</sup>), France.

Royal Society of London, Proceedings  
of

Harrison and Sons, Ltd.,  
44-47, St. Martin's Lane,  
London W. C. 2, England.

## Scientific American

Scientific American Publishing Com-  
pany,  
24 West 40th Street,  
New York, N. Y.

## Scientific Instruments, Journal of

Cambridge University Press,  
Fetter Lane,  
London, E. C. 4, England.

## T. S. F. Moderne

T. S. F. Moderne,  
9, Rue Castex,  
Paris (4<sup>e</sup>), France.

## Wireless World and Radio Review

Wireless World and Radio Review,  
Dorset House,  
Tudor Street,  
London, E. C. 4, England.

## CROSS INDEX

As titles do not always indicate all the subjects treated in the paper and in the discussion of that paper this cross index has been prepared. The letters and numbers following these subjects refer to the lettering and numbering in the foregoing Title Index. That is, the subject is treated in the paper or discussion indicated by the key letter or number.

Also the indices in the December numbers of Volumes 2 (1914) to 6 (1918) inclusive, contain very detailed cross indexes to those volumes.

### A

- Acoustic Tuning: 9
- Absorption: C, 60, 73, 310, 349
  - Selective Atmospheric: 3
- Aircraft: 38, 49, 64, 154, 158, 248, 312, 366
- Amplifier: 41, 54, 77, 125, 126, 197, 198, 266, 312, 331, 344, 346, 356, 361, 372, 374
- Analysis of R. F. Stage: 367
- Audion: 15, 36, 39
- Beat Frequency: 183
- Cascade: 9, 39, 41
- Gain Control: 361
- High Mu: 169
- High Vacuum Tube: 41, 54, 384
- Logarithmic: 367
- Magnetic: 54
- Magnetron: 317
- Microphone: 9
- Power: 253, 325
- Push Pull: 298, 371
- 150 K. W. Amplifier, R. F., 325
- Radio Frequency: 54, 97, 356, 361, 367, 376
- Reflexing: 294
- Antennae: C, E, G, 19, 20, 34, 35, 49, 51, 57, 59, 68, 75, 79, 91, 107, 109, 114, 159, 166, 248, 253, 359, 377
- Acroplane: 4, A
- Balanced: C, 128, 148, 185, 256
- Cage: 359
- Capacity: C, G, 49, 114, 116, 160
- Constants: C, G, 134, 153, 174, 177
- Current: 380
- Design: C, 359
- Directional: 69, 70, 128, 137, 161, 166, 168, 172, 173, 185, 256, 348, 363
- Dummy: 24
- Effective Height: 268, 326, 359
- Ground: 45, 70, 136, 148, 161, 175
- Hertz: 354
- Inductance Distributed: 92, 114
- Loop: C, E, 130, 168, 173, 185, 256, 354, 361, 366, 375
- Model: 359
- Operating Below Fundamental Wave Length: 306, 322, 380
- Optimum Wave Length for: 307
- Outdoor Tuning Coils: 345
- Power: 380
- Re-Radiation From: 326
- Resistance: 110, 213, 359
- Select Removal: 352, 359
- Shielded: 172
- Strain Release: C, 352
- Submerged: 136, 148, 185
- Subterranean: 136, 148
- Two Loop Directional: 343
- Voltage: 380
- Wave: 348
- Atmospherics (Static) (See Measurements, audibility): 59, 79, 214, 218, 221, 227, 250, 293, 348, 350, 351
- Classified: 128, 185
- Compared to Impulse Oscillograms: 157
- Daily Variations: 16, 185
- Dead Spot For: 293
- Effect on Detector: 39
- Eliminating Effects of: 79, 128, 147, 148, 161, 172, 185, 357
- Reflected: 147
- Relative To Lightning: 16, 350
- Relative to Moon: 16
- Relative to Mountains: 16, 363
- Relative to Sun: 16
- Relative to Temperature: 16
- Relative to Topography: 293
- Relative to Vapor Pressure: 16, 293
- Relative to Wavelength: 184, 350
- Relative to Wind Velocity: 16
- Seasonal Variations: 16, 59
- Simultaneous Records at Distant Points: 280, 386
- Sources: 16, 79, 172, 256, 293, 350, 363

- Atmospherics (*Continued*)  
 Strength: 16, 195, 218, 221, 227,  
 232, 238, 243, 246  
 Vertically Propagated: 128, 147
- Audio:  
 Fidelity: 295, 349, 356, 367  
 Tuning: 39  
 Audion: 15, 36, 39, 40, 59  
 Audibility:  
 Measurements: 16, 55, 59, 62, 65,  
 84, 100, 131  
 Meter: 26, 100  
 Aurora: 172
- B
- Bridge, R. F.: 74, 78, 169  
 Receiver: 137  
 Broadcasting: 210, 235, 314, 349, 375  
 Carrier: 223, 235, 250, 284  
 Crystal Control: 369  
 Effect of Tall Buildings: 287, 349,  
 383  
 Equal Field Strength Contours:  
 287, 383  
 High Power: 375  
 Portable Control Equipment: 253  
 Re-Broadcasting: 302  
 Short Wave: 302  
 Side Bands: 223, 235, 250, 349  
 Station: 253, 282, 295, 303, 371,  
 375  
 Wire Line Pick-Up For: 303
- C
- Coil:  
 Constants: 134, 153, 174, 220, 236  
 Distributed Capacity of: 6, 200  
 Formula and Tables: 278  
 Insulators: 345  
 Natural Period of: 6  
 No Leakage: 333  
 Compass: 271, 311  
 Condenser:  
 Compressed Air: 68  
 Geometric Variation: 30, 387  
 High Voltage Air: 312  
 Leakage: 7  
 Losses: 7  
 Resistance: 7, 313  
 Straight Line Frequency: 299, 334,  
 387  
 Conductors:  
 Electrolytic: 49  
 Litzendracht: 12, 74  
 R. F. Resistance of: 74  
 Constitution: B, 192  
 Converter, A. C. to D. C.: 132  
 Capacity: 49  
 Distributed: 33  
 Standard: 257  
 Tube: 99  
 Coupling: 66, 141, 190, 196, 335, 346,  
 356, 381  
 Capacity: 141, 176, 190, 356  
 Combined Capacity and Magnetic:  
 376
- Direct: 190  
 Regeneration in: 285  
 Resistance-Capacity: 385  
 Theory: 61, 90, 96, 101, 141, 190  
 Course Indicator, Audio Frequency:  
 171, 199, 207  
 Crystal Oscillators: 211, 304, 349,  
 369  
 Cutting: 36, 9
- D
- Decrement: 24, 25, 42, 71, 106, 119  
 Linear: 28, 71  
 Decremeter: 30  
 Definitions of Terms and Symbols:  
 14  
 De-ionization of Mercury Vapor:  
 145  
 Development: 4  
 European: 159, 162, 193, 206, 217,  
 249, 271, 311, 320, 332, 337  
 U. S.: 82  
 Detectors: 82  
 Amplifying: 11, 37, 39, 45, 77, 81,  
 111  
 Anti-Coherers: 17  
 Audion: H, 15, 36, 39, 45, 51, 82  
 Biased Tube: 126, 127, 165, 378  
 Cerusite: 13  
 Chopper: 111  
 Crystal: 82  
 Coherers: 82, 107  
 Distortion: 378  
 Efficiency of Thermionic: 150  
 Electrolytic: H, 11, 59, 82  
 Einthoven Galvanometer: 19  
 Gas Flame: 15  
 Grid Rectification: 378  
 Heterodyne: H, 11, 37, 39, 40, 45,  
 77  
 Microphonic: 82  
 Steel and Iron: 82  
 Sensitivity of: 84, 86  
 Sodium Vapor: 240, 276  
 Taste: 194  
 Ticker: 3, 11, 19, 51, 82  
 Tone Wheel: 19  
 Tube: 41, 97, 266, 339, 378  
 Valve: 15  
 Direction: 343, 354  
 Deviations: 158, 215, 217, 226,  
 309, 366  
 Errors: 311  
 Goniometer: 271  
 Sunset Deviations: 328, 347
- E
- Economics: 87  
 Education: 23, 43, 52, 368  
 Collegiate: 368  
 Electron Theory: 39, 41  
 Electron Emitting Substances: 41  
 Electrostatic Telephone Receiver: 37

Engineering Precautions: 75, 93  
Ethics, Radio Engineering: 5

## F

Fading: 3, 10, 16, 55, 275, 348, 349,  
361, 377  
Filters: 245, 318, 349, 371  
Fire Hazard: 75, 93  
Frequency Changers: 19, 31, 102,  
179, 180, 181, 183

## G

General Radio in: 67, 82  
Grounds: C, 51, 57, 69, 107, 110, 159  
Counterpoise: 9, 110, 359  
Soil Resistance: 359

## H

Heaviside-Kennelly Layer: 73, 373  
Harmonics: 19, 47, 78, 89, 91, 141,  
151, 152, 225, 260, 302, 319, 322,  
355, 378, 380  
Transformer of: 298  
Heterodyne: H, 11, 37, 39, 40, 59, 77,  
81, 111, 283  
Super: 183, 349, 382  
Historical: A, B, C, D, H, 16, 41, 67,  
82, 217, 254, 314, 351, 382  
Homopolar Alternator: 164

## I

Institute Affairs: A, B, 4, 5, 82, 123,  
192, 327, 358  
Institute of Russian Radio Engineers:  
249  
Insulators: E, 2, 19, 21, 44, 75, 262,  
345, 352  
Antenna: 262, 359  
Corona Effects: 21, 44  
Dielectric Constants and Power  
Factors of: 308  
Dielectric Hysteresis: 28  
Interference: 254  
Arc Mush: 152, 254  
Eliminating Causes of: 254  
Noise Level: 348  
Re-Radiation: 326  
Signal to Static Ratio: 250, 284,  
357  
Sources of: 254, 375  
Station: 375  
Int. Union of Scientific Radio Tele-  
graphy (U. R. S. I.): 237  
Inventing: 370  
Ionized Upper Air: 10, 73, 373  
Iron at Radio Frequencies: 54, 78,  
118, 120, 121, 186

## L

Laws and Regulations: D, 22, 23, 27,  
30, 43, 63, 82, 88, 143  
Light and Power Engineering Applied  
to Radio: 187

Lightning: 75, 79, 93  
Loading Coils: 117  
Loud Speaker: 330, 356  
Driving Unit: 330  
Horns: 289  
Tests: 289  
Theory: 289

## M

Measurements:  
Field Strength (See also Audi-  
bility): 167, 215, 234, 242, 247,  
268, 275, 292, 300, 316, 348, 372,  
375, 377, 383  
Microammeter: 129  
Noise: 242  
Null Method: 50  
Phase Difference: 119  
Resistance by Electrometer:  
Signals and Atmospheric Strengths  
at Bureau of Standards: 214,  
218, 221, 227, 232, 238, 243, 246,  
252, 259, 265, 270, 274, 279, 286,  
323, 379  
Silicon Detector, with Tube Volt-  
meter: 372  
Voltmeter: 186  
Medal of Honor: 123  
Microphone: H, 54, 253, 303  
Modulation: H, 11, 54, 166, 197, 201,  
210, 235, 261, 273, 303, 371  
Condenser Microphone: H, 253  
Hydraulic: H  
Oscillograph Indicator: H, 303  
Pallophotophone: 253  
Motional Impedance: 98  
Municipal Regulations: 93

## N

Naval: 29, 51, 59, 68, 117, 154, 158,  
202

## O

Operation:  
Codes: 23, 27, 43, 52, 88  
Duplex: 137, 159, 163, 204, 247  
Economics: 87, 138, 235  
High Speed: 166  
Multiplex: 178  
Personnel: 23, 27, 43, 138  
Traffic: 27, 29, 43, 63, 87, 138, 281,  
353  
Wire vs. Radio: 138  
Oscillograms: 28, 39, 64, 85, 118, 141,  
157, 212, 219, 222, 229, 303, 349  
Cathode Ray: 28, 44, 56, 85, 133,  
189, 319  
Oscillations:  
Local Standard: 149, 211, 292, 361,  
372  
Polyphase: 332  
Theory of: 1, 106, 134  
Warbler: 343  
Spurious: 325  
Over Land Stations: 3, 29, 155

P

Patents: 191, 370  
 Piloting by Induction: 171, 199, 207  
 Power Lines Carrying Radio Frequencies: 163, 206  
 Preferred Numbers:  
 Prize, Morris Liebman Memorial: 124  
 Protective Devices: 75, 93

R

Railroad Trains: 107  
 Radiation:  
 At An Angle: 307  
 At Frequencies above Fundamental: 306, 322, 380  
 Harmonic, at a 322:  
 Resistance: 1, 110, 213, 306, 359  
 Rotary Field: 332  
 Theory of: C, E, 1, 60, 110, 182, 187, 349  
 Range Variation: 16  
 Receivers: 13  
 Barrage: 137  
 Broadcast: 228, 356, 367, 375  
 Classified: 375  
 Multirange: 291, 299  
 Portable: 361, 383  
 Reflexing: 294  
 Selectivity: 356, 367, 375  
 Sensitivity: 367  
 Servicing Broadcast: 374  
 Single Control: 143  
 Theory: 144  
 Reception:  
 Duplex: 9  
 Long Distance: 36  
 Homodyne: 235  
 Trans-Atlantic: 40  
 Visual: 205  
 Recording: 216  
 Galvanometer: 275  
 Graphic: 216  
 Pallophotophone: 253  
 Phonographic: 107, 216  
 Photographic: 17, 205, 216, 349, 351  
 Telegraphone: 15  
 Rectifiers: 31, 40, 208, 209, 225, 241, 312, 318  
 Electrolytic: 362  
 Six-phase: 325  
 Reflection: 3, 5, 10, 55, 60, 73, 310, 349, 373  
 Refraction: 55, 60, 73, 310, 349, 373  
 Regeneration: 39, 40, 59, 81, 84, 86, 99, 219, 285, 290, 344  
 Super: 255, 294  
 Regeneration, Prevention:  
 Neutralizing Feed back: 356, 367  
 Shifting Phase of Feed back: 376  
 Resistance:  
 Measurement by Calorimeter: 119  
 Negative: 97, 222, 369

Resistance (*Continued*)

Skin Effect: 74  
 Spark: 71  
 Resonance:  
 Indicated by Oscillating Audion: 116

S

Safety at Sea: D, 22, 23, 27, 82, 88  
 Distress Calls. (NC, CQD, NA, SOS): D  
 "SS Republic" disaster: D  
 Salts, Effect of A. C. on:  
 Shielding: 169, 333, 356, 361, 367, 372  
 Ship Stations: D, 4, 29, 62, 63, 82, 247, 271, 353  
 Auxiliary Power: D, 22  
 Specifications: D, 22  
 Shore Stations: 29, 57, 82, 281, 353  
 Short-Circuited Secondary, Effect of: 18  
 Short Waves: 136, 217, 242, 248, 260, 329, 341, 354, 372, 377  
 Day, night, and frequency-range diagrams: 377  
 Land and Water Effects: 377  
 Range Chart: 342  
 Ship Distances: 342, 373, 377  
 Singing Audion: 15  
 Space Charge: 41  
 Spark Gaps (see Transmitters):  
 Tone production with: 115  
 Standard Frequency: 260, 304, 305, 315, 319, 349  
 Crystal: 211, 304, 369  
 Standing Waves: 260, 269, 305, 315, 341  
 Tuning Fork: 319, 355  
 Standards Report: 14  
 Stellar Photometry: 331  
 Storage Batteries: 22, 102, 362  
 Submarine Signaling, Audio: 233  
 Symbols: 14

T

Telephone: II, 11, 19, 22, 31, 41, 54, 102, 107, 135, 201, 204  
 Carrierless: 284, 324, 325  
 Aircraft: 154  
 Combination Radio and Wire Line: H, 204  
 Duplex: 137, 163, 204, 247  
 Receivers (Headphone Type): 98, 100, 245, 321  
 Single Side Band: 324, 325  
 Trans-Atlantic: 187, 324, 348  
 Telephone Engineering Applied to Radio: 223  
 Theory of Circuits: 1, 53  
 Time Difference Tests: 17  
 Time Signals: 29  
 Toroida: 118, 169

Towers and Masts: C, E, 19, 34, 35, 51, 57, 59, 68, 75, 79, 162, 166, 253, 272, 352, 359, 371

Transformers:  
 Quenched Spark: 46  
 Resonance: 95, 115  
 Spark Set: G, 56  
 Tuned R. F.: 346, 376, 381

Transients: 56

Transmission (See also Broadcast-  
 ing): 349  
 Attenuation: 10, 16, 310  
 Automatic: 9, 88  
 Beam: C, 217  
 Chart: 76  
 Effect of Topography: 287, 293  
 Formula: 75, 76, 109, 112, 167, 310, 348, 364, 379  
 Long Distance: 3, 9, 16, 36, 51, 68, 117, 155  
 Moon Effect on: 10, 16  
 Nocturnal: 55  
 Picture: 351  
 R. F. over Wires: 15, 163, 206, 223  
 Relative to Atmospheres: 16  
 Relative to Earth's Magnetic Field: 275  
 Relative to General Weather: 55  
 Relative to Seasons: 16, 32, 36  
 Relative to Temperature: 16, 300, 388  
 Relative to Wind Velocity: 16  
 Relative to Vapor Pressure: 16  
 Skip Distances: 342  
 Solar Disturbances Effect: 348  
 Solar Eclipse Effect: 336  
 Sun Effect on: 10, 16, 328, 348  
 Sunset and Sunrise Effects: 10, 328, 347, 348  
 Theory: 242  
 Trans-Atlantic: 9, 19, 33, 166, 337, 348  
 Trans-Pacific: 3, 316  
 Two Wave: 3  
 Wire vs. Radio: 138

Transmitters:  
 Arc: H, 3, 19, 31, 44, 51, 62, 64, 66, 68, 82, 85, 117, 133, 142, 152, 159, 162, 196, 203, 244, 301, 365  
 Auxiliary: D, 82  
 Comparison of: 365  
 D. C. Spark: 83, 105  
 Dynamo R. F.: H, 1, 11, 19, 31, 47, 54, 74, 82, 113, 164, 166, 187, 365  
 Electrostatic: 31  
 Fog Signal: 312  
 High Power: 117, 187, 301  
 High Spark Frequency: 24, 26, 139, 162  
 Interrupted Continuous Wave: 267  
 Impulse and Impact: 113, 122, 135, 146  
 Losses in: 72

Induction Coil: S2  
 Master Oscillator: 263  
 Multiphase: 48  
 "Multitone" Spark: 12  
 Multiwave: 382  
 Overlapping Wave Trains: 24  
 Polyphase: 24  
 Quenched Gap: 9, 13, 24, 26, 28, 33, 46, 58, 63, 71, 80, 82, 139, 140  
 Rarefield Gas Discharger: 102  
 Rotary Gap: 13, 26, 55, 58, 63, 68, 83, 102, 105  
 Short Wave: 329  
 Spark: G, 33, 57, 63, 68, 82, 353  
 Spark Resistance: G, 28  
 Synchronous Spark: 48  
 Tube: 39, 41, 202, 206, 258, 267, 312, 365

Tubes (See also Audion, Amplifiers, Heterodyne, Detectors, Transmitters, etc.): 15, 36, 39, 81, 188  
 "A" Current Source: 104, 239, 318, 360, 361, 362, 374  
 A. C. Heated Cathode: 231  
 Alkali Vapor: 230, 240, 276, 351  
 Amplification Constant Measurements: 103, 125, 126  
 Audion (see Audion)  
 "B" Current Source: 104, 209, 239, 318, 362, 374  
 Bias: 127  
 Blocking: 251  
 "C" Potential Source: 362, 374  
 Capacity: 99, 108, 356  
 Characteristics: 103, 108, 125, 126, 127, 150, 165, 188, 212, 224, 229, 251, 266, 277, 296, 297, 338, 384  
 Characteristics Relative to Dimensions: 156, 338  
 Combined Kenotron and Plotron: 239  
 Combined Radio and Audio Amplifier and Detector: 288  
 Dry Battery: 266  
 Dynatron: 97, 222  
 Efficiency: 264, 298  
 Filament: 94  
 Four-Electrode: 222, 288, 331  
 Gaseous: 206  
 Grid: 94  
 Grid Commutation: 298  
 Grid Condenser, Function of: 378  
 Grid Leak, Function of: 378  
 High Vacuum: 41  
 History: 41  
 Input Impedance: 170  
 Internal Impedance: 126  
 Kenotron: 97  
 Life Testing: 340  
 Manufacture of: 94, 338  
 Modulator: 127, 197  
 Mutual Conductance in: 99, 108, 126, 266  
 Mutual Inductance: 108

Tubes (*Continued*)

- Noises: 356
- Oscillating: 39, 84, 97, 108
- Oscillations (Gas Action): 99
- Parasitic Phenomena in tube circuits: 251
- Phase Relations, Grid and Plate: 251, 376
- Photoelectric: 230, 331, 351
- Plate: 94
- Pliodynatron: 97, 222
- Power: 251, 258, 263, 371
- Push-Pull: 298
- Relay: 36, 39, 54
- Resistance: 103, 108
- Theory: 39, 99, 125, 127, 219
- Testing and Rating: 224, 266, 297, 340
- Thoriated Tungsten Filament: 338
- Voltmeter: 372
- Water-Cooled: 325
- Tuning: 20

U

- Underwriters' Code: 93

V

- Vacuum Pumps: 41

W

- Wattmeter, R. F.: 26
- Wave:
  - Ground: E, 55, 60, 373
  - Interference: 349
  - Polarization: 354, 366
  - Square: 225, 298
  - Standing: 260, 269, 305, 315
  - Trap: 375
- Wave Meter: 30, 211
  - Calibrating: 89
  - Direct Reading: 8
  - For Very Short Waves: 60
- Wired Wireless: 15, 163, 206, 223
- Wireless Institute: A, B, C, D, E. F. G, H, 1, 2

