

may 1960  
the  
institute  
of  
radio  
engineers

# Proceedings of the IRE

## in this issue

HISTORY OF PARAMETRIC TRANSDUCERS  
TUNNEL DIODE CONVERTER  
NOISE IN ELECTRONIC IMAGING  
PACKAGED TUNABLE MASER  
CADMIUM SULFIDE TRANSISTOR  
GAIN OF A FLOW GRAPH  
CYCLOTRON RESONANCE RF DETECTOR  
ABSORPTION BY ATMOSPHERIC GASES  
INTERACTION IMPEDANCE MEASUREMENTS  
TRANSFORMS FOR LINEAR SYSTEMS  
TRANSFORMS FOR NONLINEAR SYSTEMS  
TRANSACTIONS ABSTRACTS  
ABSTRACTS AND REFERENCES

MOON RADAR ANTENNA:  
PAGE 932





# For Your Special Applications

The bulk of UTC production is on special units designed to specific customers' needs. Illustrated below are some typical units and some unusual units as manufactured for special applications. We would be pleased to advise and quote to your special requirements.

## FILTERS

All types for frequencies from .1 cycle to 400 MC.



400 — telemetering, 3 db at  $\pm 7.5\%$ , 40 db at 230 and 700 —,  $\frac{5}{8}$  x  $1\frac{1}{4}$  x 2"

15 — BP filter, 20 db at 30 —, 45 db at 100 —, phase angle at CF less than 3° from -40 to + 100° C.

LP filter within 1 db to 49 KC, stable to .1 db from 0 to 85° C., 45 db at 55 KC.

LP filter less than .1 db 0 to 2.5 KC, 50 db beyond 3 KC.



## HIGH Q COILS

Toroid, laminated, and cup structures from .1 cycle to 400 MC.

Tuned DO-T servo amplifier transformer, 400 — .5% distortion.

Toroid for printed circuit, Q of 90 at 15 KC.

Dual toroid, Q of 75 at 10 KC, and Q of 120 at 5 KC.

HVC tapped variable inductor for 3 KC oscillator.

## SPECIALTIES

Saturable reactors, reference transformers, magnetic amplifiers, combined units.



RF saturable inductor for sweep from 17 MC to 21 MC.

Voltage reference transformer .05% accuracy.

Multi-control magnetic amplifier for airborne servo.

Input, output, two tuned interstages, peaking network, and BP filter, all in one case.



## PULSE TRANSFORMERS

From miniature blocking oscillator to 10 megawatt.

Wound core unit .01 micro-second rise time.

Pulse current transformer 100 Amp.

Pulse output to magnatron, bifilar filament.

Precise wave shape pulse output, 2500 V. 3 Amps.

## POWER COMPONENTS

Standard and high temperature . . . hermetic, molded, and encapsulated.



Multi-winding 140 VA, 6 KC power transformer  $1\frac{1}{4}$  x  $1\frac{1}{4}$  x 1"

200° C. power transformer, 400 —, 150 VA.

400 — scope transformer, 20 KV output.

60 — current limiting filament transformer, Sec. 25 Mmfd., 30 KV hipot.

# UNITED TRANSFORMER CORPORATION

150 Varick Street, New York 13, N. Y. • EXPORT DIVISION: 13 E. 40th St., New York 16, N. Y.,  
CABLES: "ARLAB" PACIFIC MFG. DIVISION, 4008 W. Jefferson Blvd., Los Angeles, Cal.



**May, 1960**

*published monthly by The Institute of Radio Engineers, Inc.*

# Proceedings of the IRE<sup>®</sup>

*contents*

	<b>Poles and Zeros</b> .....	845
	<b>Ferdinand Hamburger, Jr., Editor, 1960</b> .....	846
	<b>Scanning the Issue</b> .....	847
<b>PAPERS</b>	Some Notes on the History of Parametric Transducers, <i>W. W. Mumford</i> .....	848
	Low-Noise Tunnel-Diode Down Converter Having Conversion Gain, <i>K. K. N. Chang, G. H. Heilmicler, and H. J. Prager</i> .....	854
	Noise Limitations to Resolving Power in Electronic Imaging, <i>J. W. Coltman and A. E. Anderson</i> .....	858
	Packaged Tunable L-Band Maser System, <i>F. R. Arans and S. Okwit</i> .....	866
	Cadmium Sulfide Field Effect Phototransistor, <i>R. R. Bockemuhl</i> .....	875
	The Optimum Formula for the Gain of a Flow Graph or a Simple Derivation of Coates' Formula, <i>C. A. Desoer</i> .....	883
	A Broad-Band Cyclotron Resonance RF Detector Tube, <i>Franklin M. Turner</i> .....	890
	Anomalies in the Absorption of Radio Waves by Atmospheric Gases, <i>A. W. Straiton and C. W. Tolbert</i> .....	898
	Interaction Impedance Measurements by Propagation Constant Perturbation, <i>P. R. Melsaac and C. C. Wang</i> .....	904
	Taylor-Cauchy Transforms for Analysis of a Class of Nonlinear Systems, <i>Y. H. Ku, A. A. Wolf, and J. H. Dielz</i> .....	912
	Laurent-Cauchy Transforms for Analysis of Linear Systems Described by Differential-Difference and Sum Equations, <i>Y. H. Ku and A. A. Wolf</i> .....	923
	Correction to "A Unified Analysis of Range Performance of CW, Pulse and Pulse Doppler Radar," <i>J. J. Busgang, P. Nesbeda, and H. Safran</i> .....	931
<b>CORRESPONDENCE</b>	Radio Frequency Scattering from the Surface of the Moon, <i>R. L. Leadabrand, R. B. Dyce, A. Fredriksen, R. I. Presnell, and J. C. Schlobohm</i> .....	932
	Measurements of Lunar Reflectivity Using the Millstone Radar, <i>Gordon H. Pettengill</i> .....	933
	Lunar Echoes Received on Spaced Receivers at 106.1 mc, <i>R. B. Dyce and R. A. Hill</i> .....	934
	Noise Figure of Tunnel Diode Mixer, <i>D. J. Breitzer</i> .....	935
	Effect of External Base and Emitter Resistors on Noise Figure, <i>J. W. Halligan</i> .....	936
	A Ferromagnetic Amplifier Using Longitudinal Pumping, <i>R. T. Denton</i> .....	937
	Parametric Phase Distortionless L-Band Limiter, <i>A. D. Sutherland and D. E. Countiss</i> .....	938
	The Diode-Loaded Helix as a Microwave Amplifier, <i>G. Conrad, K. K. N. Chang, and R. Hughes</i> .....	939
	A High Field Effect Two-Terminal Oscillator, <i>R. W. Lade and T. R. Schlax</i> .....	940
	Generating a Rotating Polarization, <i>P. J. Allen</i> .....	941
	A "Z-Transform-Describing-Function" for On-Off Type Sampled-Data Systems, <i>B. C. Kuo</i> .....	941
	A Note on the Steady-State Response of Linear Time-Invariant Systems to General Periodic Input, <i>Eliahu I. Jury</i> .....	942
	WWV and WWVH Standard Frequency and Time Transmissions, <i>National Bureau of Standards</i> .....	944
	Electronically-Variable Phase Shifters Utilizing Variable Capacitance Diodes, <i>R. H. Hardin, E. J. Dozency, and J. Munushian</i> .....	944
	Gallium Arsenide Microwave Diode at X Band, <i>M. Herndon and A. C. Macpherson</i> .....	945
	A Wide-Band Phase Shifter, <i>A. A. Ahmed</i> .....	945
	Bandwidth of Lower Sideband Parametric Up-Converters and Parametric Amplifiers, <i>S. T. Fisher</i> .....	946
	Noise Measurements on an M-Type Backward-Wave Amplifier, <i>J. R. Anderson</i> .....	946
	On the Start Oscillation of the O-Type Backward Wave Oscillator, <i>C. L. Tang</i> .....	947
	Negative Resistance in Transistors Based on Transit-Time and Avalanche Effects, <i>H. N. Stutz and R. A. Pucel</i> .....	948
	Charge Analysis of Transistor Operation, <i>A. N. Baker</i> .....	949
	Determination of the Orbit of an Artificial Satellite, <i>P. L. Besag and J. T. Anderson</i> .....	950
	Radiation Damage and Transistor Life in Satellites, <i>J. M. Denney and D. Pomeroy</i> .....	950

**COVER**

The advent of more powerful and sensitive radars has led to novel proposals for studying the surface of the moon by radar, as reported in the Correspondence section of this issue. Shown on the cover is a 142-foot steerable parabolic antenna, the second largest in the world, located in Frasersburgh, Scotland. Built and operated by Stanford Research Institute under contract with the Rome Air Development Center, this antenna was used in the moon radar experiments reported on page 932.

published monthly by The Institute of Radio Engineers, Inc.

# Proceedings of the IRE®

continued

Increasing the Dynamic Tracking Range of Phase-Locked Loop, <i>C. S. Weaver</i> .....	952
Combined AM and PM for a One-Sided Spectrum, <i>A. H. Taylor</i> .....	953
On the Large-Signal Aspect of the Broadband Multicavity Klystron Problem—Theory and Experiment, <i>S. F. Yadarvalli</i> .....	953
High Q Inductance Simulation, <i>John E. Fulenwider</i> .....	954
HF Noise Radiators in Ground Flashes of Tropical Lightning, <i>S. F. Chandrashekhar, Iiya</i> ..	955
Experimental Proof of Focusing at the Skip Distance by Backscatter Records, <i>K. Bibl</i> .....	956

## REVIEWS

Books:	
“Probability and Statistics,” by Ulf Grenander, Ed., <i>Reviewed by H. P. Edmundson</i> ....	961
“Materials and Techniques for Electron Tubes,” by Walter H. Kohl, <i>Reviewed by A. P. Haase</i> .....	961
“Mathematics for Communication Engineers,” by S. J. Cotton, <i>Reviewed by George B. Hoadley</i> .....	961
“Telemetry Systems,” by Perry A. Borden and W. J. Mayo-Wells, <i>Reviewed by Elliot L. Gruenberg</i> .....	962
“Modern Network Analysis,” by F. M. Reza and Samuel Seely, <i>Reviewed by M. J. DiToro</i> .....	962
“Introduction to Matrix Analysis,” by Richard Bellman, <i>Reviewed by Dr. R. E. Kalman</i> .....	962
“The Theory of Optimum Noise Immunity,” by V. A. Kotelnikov (translated from the Russian by R. A. Silverman), <i>Reviewed by Norman Abramson</i> .....	963
“The Electric Arc,” by J. M. Somerville, <i>Reviewed by J. D. Cobine</i> .....	963
“Sound in the Theatre,” by Harold Burris-Meyer and Vincent Mallory, <i>Reviewed by Daniel W. Martin</i> .....	963
“The Physics of Television,” by Donald G. Fink and David M. Lutyens, <i>Reviewed by Knox McIlwain</i> .....	964
“Class D Citizens Radio,” by Leo G. Sands, <i>Reviewed by Keith Henney</i> .....	964
“Millimicrosecond Pulse Techniques,” by I. A. D. Lewis and F. H. Wells, <i>Reviewed by Anthony B. Giordano</i> .....	964
Scanning the TRANSACTIONS .....	965

## ABSTRACTS

Abstracts of IRE TRANSACTIONS .....	966
Abstracts and References .....	973
Translations of Russian Technical Literature .....	988

## IRE NEWS AND NOTES

Current IRE Statistics .....	16A
Calendar of Coming Events .....	16A
Miscellaneous IRE Publications Available .....	22A
Programs:	
1960 IRE 7th Region Conference .....	26A
4th National Convention on Military Electronics .....	28A
Professional Groups, Sections and Subsections .....	36A

## DEPARTMENTS

Contributors .....	958
IRE People .....	46A
Industrial Engineering Notes .....	88A
Meetings with Exhibits .....	8A
Membership .....	157A
News—New Products .....	42A
Positions Open .....	134A
Positions Wanted by Armed Forces Veterans .....	152A
Professional Group Meetings .....	178A
Section Meetings .....	112A
Advertising Index .....	213A

## BOARD OF DIRECTORS, 1960

\*R. L. McFarlan, *President*  
 J. A. Ratcliffe, *Vice-President*  
 \*J. N. Dyer, *Vice-President*  
 \*W. R. G. Baker, *Treasurer*  
 \*Haraden Pratt, *Secretary*  
 \*F. Hamburger, Jr., *Editor*  
 \*D. G. Fink  
*Senior Past President*  
 \*Ernst Weber  
*Junior Past President*

1960

A. P. H. Barclay (R8)  
 \*L. V. Berkner  
 G. S. Brown  
 W. H. Doherty  
 A. N. Goldsmith

P. E. Haggerty  
 C. E. Harp (R6)  
 H. F. Olson (R2)  
 A. H. Waynick (R4)

1960-1961

C. W. Carnahan (R7)  
 B. J. Dasher (R3)  
 C. F. Horne  
 R. E. Moe (R5)  
 B. M. Oliver  
 J. B. Russell, Jr. (R1)

1960-1962

W. G. Shepherd  
 G. Sinclair

\*Executive Committee Members

## EXECUTIVE SECRETARY

George W. Bailey  
 John B. Buckley, *Chief Accountant*  
 Laurence G. Cumming, *Technical Secretary*  
 Emily Sirjane, *Office Manager*

## ADVERTISING DEPARTMENT

William C. Copp, *Advertising Manager*  
 Lillian Petranek, *Assistant Advertising Manager*

## EDITORIAL DEPARTMENT

Alfred N. Goldsmith, *Editor Emeritus*  
 F. Hamburger, Jr., *Editor*  
 E. K. Gannett, *Managing Editor*  
 Helene Frischauer, *Associate Editor*

## EDITORIAL BOARD

F. Hamburger, Jr., *Chairman*  
 A. H. Waynick, *Vice-Chairman*  
 E. K. Gannett  
 T. A. Hunter  
 J. D. Ryder  
 G. K. Teal  
 Kiyoo Tomiyasu



PROCEEDINGS OF THE IRE, published monthly by The Institute of Radio Engineers, Inc. at 1 East 79 Street, New York 21, N. Y. Manuscripts should be submitted in triplicate to the Editorial Department. Responsibility for contents of papers published rests upon the authors, and not the IRE or its members. All republication rights, including translations, are reserved by the IRE and granted only on request. Abstracting is permitted with mention of source.

Thirty days advance notice is required for change of address. Price per copy: members of the Institute of Radio Engineers, one additional copy \$1.25; non-members \$2.25. Yearly subscription price: to members \$9.00, one additional subscription \$13.50; to non-members in United States, Canada, and U. S. Possessions \$18.00; to non-members in foreign countries \$19.00. Second-class postage paid at Menasha, Wisconsin under the act of March 3, 1879. Acceptance for mailing at a special rate of postage is provided for in the act of February 28, 1925, embodied in Paragraph 4, Section 412, P. L. and R., authorized October 26, 1927. Printed in U.S.A. Copyright © 1960 by the Institute of Radio Engineers, Inc.



## MOST RELIABLE "WRAP-AND-ENDFILL" FILM CAPACITORS—

*Reliability in a "wrap-and-endfill" at last! . . . Sprague Yellow-Jacket Filmite "E" Capacitors. The design of these small, lightweight film capacitors is based on the most extensive life test data for polyester film dielectrics available at the present time. These capacitors will withstand a 250 hour accelerated life test of 150% of the 85 C rated voltage impressed or the equivalent derated 125 C voltage. Not more than 1 failure is permitted in 25 samples tested.*

The "extended-foil" capacitor sections are fully protected against moisture by an outer wrap of yellow polyester-film tape. Only ultra-thin, specially selected foil and polyester film are used. The end seals are of a plastic resin which has been formulated to bond with the film wrap and the tinned leads so as to provide a secure seal.

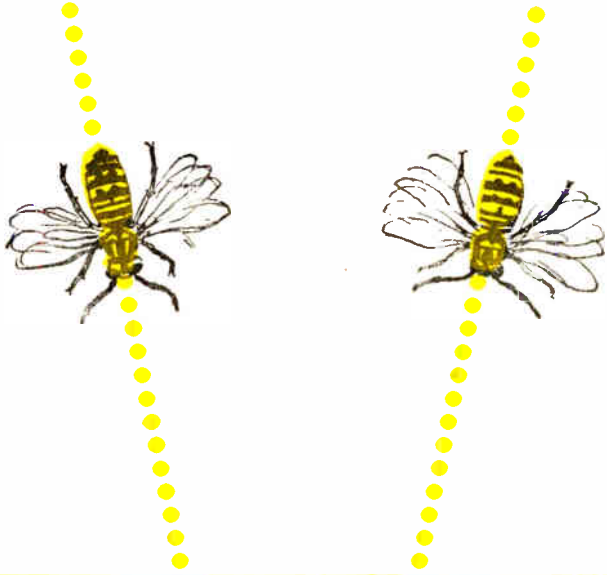

TYPE 158P

## YELLOW-JACKET<sup>®</sup> CAPACITORS

for military  
and industrial  
electronics



Because of their outstanding resistance to humidity, vibration, and shock, Type 158P Yellow-Jacket Capacitors are ideal for many military, computer, industrial control, and similar applications. They are particularly well-suited for potting or encapsulating in electronic sub-assemblies, filters, etc.

*For complete engineering data on Military-Grade Yellow-Jacket Film Capacitors (Type 158P) write for Engineering Bulletin 2301. Data on Sprague's Commercial and Entertainment Grade Yellow-Jacket Capacitors (Types 148P and 149P) is given in Bulletin 2063A. Both bulletins are available from Technical Literature Section, Sprague Electric Company, 235 Marshall Street, North Adams, Massachusetts.*

### SPRAGUE COMPONENTS:

CAPACITORS • RESISTORS • MAGNETIC COMPONENTS • TRANSISTORS • INTERFERENCE FILTERS • PULSE NETWORKS  
HIGH TEMPERATURE MAGNET WIRE • CERAMIC-BASE PRINTED NETWORKS • PACKAGED COMPONENT ASSEMBLIES





In this article, Robert L. Slevin of our Department of Applied Electronics discusses a branch type directional filter and some surprising results of a study program.

## Directional Filters

The problem of "peeling off" the frequency components of an input signal as shown in Figure 1 is inherent in many countermeasures systems. While other types of filters have been used in the past, a rather unconventional filter appeared to offer several advantages. This filter (Figure 2) is a branch-type directional filter and its performance has recently been studied at AIL. The study program revealed the surprising result that many of the advantages of directional filters can be obtained if *one and only one* resonator is included in each branch.

The directional filter is a four-port network whose ideal responses are:

- Port 1—Unity SWR
- Port 1 to Port 2—Band-Pass Response
- Port 1 to Port 3—Infinite Isolation
- Port 1 to Port 4—Band-Reject Response

A network with the above performance is well-suited for multiplexing systems as can be seen from the block diagram shown in Figure 1. Signals at the resonant frequency of each directional filter will appear at the correct ports without any branching loss and the effect of one directional filter upon the other is negligible. This is not true with conventional branching filters.

The symmetry of the branch line directional filter is utilized to simplify the analysis of the four-port network by reducing it to an equivalent two-port. The overall network can be described as the product of three ABCD matrices. One of these matrices is for the filter network in each branch of the directional filter and the other two matrices are for lengths of transmission line corresponding to the spacing of the branches along the main transmission lines. In order to obtain theoretically the response stated above for each of the directional filter ports, certain conditions must be imposed on each of the matrices. High directivity (isolation of Port 3 from Port 1) is obtained when each branch of the directional filter is identical and the spacing of the branches is  $(2n + 1) \lambda/4$  on one manifold and

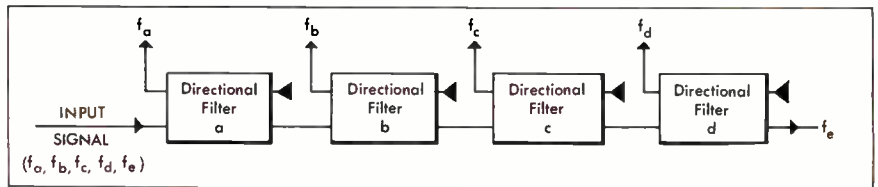

Figure 1. Directional Filter Multiplexer

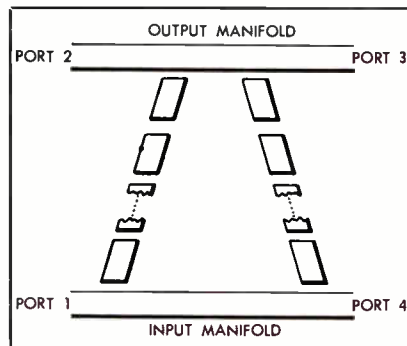

Figure 2. Branch Line Directional Filter

$(2n + 3) \lambda/4$  on the other manifold. To obtain the desired response at Ports 1, 2 and 4, conditions are imposed on the filter network which cannot be satisfied when each branch contains multiresonator filters. The filter network, in order to satisfy all conditions, must have identical driving point and transfer functions. This requirement can only be fulfilled when each branch of the directional filter contains one resonator. This result is significant because in the past it had been felt that as greater selectivity was required, more resonators would be used in each branch of the directional filter.

After having proved that ideal directional filter characteristics were not theoretically obtainable with multiresonator branches, the study continued until a suitable compromise in the response at each of the ports, was found, for the multiresonator case. The discrepancies between desired and obtainable directional filter performance differ depending upon the number of resonant elements in each

branch. With an even number of dissipationless resonators in each branch, the power at resonance divides between Ports 2 and 4 and finite SWR exists at Port 1. With an odd number of resonant elements in each branch, the desired directional filter performance is obtained at resonance: that is, all power out Port 2. Except for the one resonator case, however, all directional filters with an odd number of resonators in each branch exhibit high SWR's at points in the passband.

The effect of dissipation on the directional filters performance is to mask some of the undesired characteristics and to magnify others. The passband SWR's are diminished in the presence of loss and the power out Port 4, which should be zero at resonance, becomes significant when dissipation is present.

The conclusions drawn from the directional filter study program were: (1) the ideal directional filter response listed above is theoretically obtainable when each branch consists of only one resonator and (2) when the selectivity of multiresonator filters is required, proper selection of filter decrements and coefficients of coupling will result in a directional filter response that is adequate for many purposes. The theoretical conclusions of the branch line directional filter program were verified experimentally by AIL.

*A complete bound set of our fourth series of articles is available on request. Write to Harold Hechtman at AIL for your set.*

*Airborne Instruments Laboratory*  
A DIVISION OF CUTLER-HAMMER, INC.

DEER PARK, LONG ISLAND, N. Y.  
Phone MYrtle 2-6100





# BLUE JACKET®

VITREOUS ENAMEL-PROTECTED,  
POWER WIREWOUND RESISTORS.

Send for Bulletins: 7410-A (Axial Lead), 7400-A (Tab Type)



# KOOLOHM®

CERAMIC INSULATED-SHELL,  
POWER WIREWOUND RESISTORS.

Send for Engineering Bulletin: 7300-A



# PERMASEAL®

CAST EPOXY HOUSING,  
PRECISION WIREWOUND RESISTORS.

Send for Engineering Bulletin: 7500

# SPRAGUE RESISTORS



# FILMISTOR®

PRECISION CARBON FILM RESISTORS.

Send for Bulletins: 7000 (Molded shell), 7010-B (Ceramic shell)



# MEG-O-MAX®

GLASS-JACKETED HIGH VOLTAGE,  
HIGH POWER RESISTORS.

Send for Engineering Bulletin: 7200-A



# SPIRAMEG®

HIGH-RESISTANCE SPIRAL ELEMENT  
RESISTORS.

Send for Engineering Bulletin: 7100

SPRAGUE ELECTRIC COMPANY 235 Marshall Street North Adams, Mass.

SPRAGUE COMPONENTS: RESISTORS • CAPACITORS • MAGNETIC COMPONENTS • TRANSISTORS  
INTERFERENCE FILTERS • PULSE NETWORKS • HIGH TEMPERATURE MAGNET WIRE • PRINTED CIRCUITS

HAROLD S. BLACK, LAMME MEDALIST



## A MAN WINS A MEDAL...AND STRENGTHENS A PHILOSOPHY

The search for the “hitherto unattainable” sometimes ends in strange places.

For years Bell Laboratories engineer Harold S. Black pondered a problem: how to rid amplifiers of the distortion which unhappily accumulated as signal-transmission paths were made longer and amplifiers were added. There had been many approaches but all had failed to provide a practical answer.

Then one day in 1927 the answer came—not in a research laboratory, but as he traveled to work on the Lackawanna Ferry. On a newspaper, Mr. Black jotted down those first exciting calculations.

Years later, his *negative feedback principle* had revolutionized the art of signal amplification. It is a principal reason why telephone and TV networks can now blanket the country, the transoceanic cable is a reality, and military radar and missile-control systems are models of precision.

For this pioneer achievement, and for numerous other contributions to communications since then (some

60 U. S. patents are already credited to him), Mr. Black received the 1957 Lamme Medal from the American Institute of Electrical Engineers. He demonstrated that the seemingly “unattainable” often *can* be achieved, and thus strengthened a philosophy that is shared by all true researchers.

He is one of many Bell Telephone Laboratories scientists and engineers who have felt the challenge of telephony and have risen to it, ranging deeply into science and technology. Numerous medals and awards have thus been won. Two of these have been Nobel Prizes, a distinction without equal in any other industrial concern.

Much remains to be done. To create the communication systems of the future, we must probe deeper still for new knowledge of Nature’s laws. We must continue to develop new techniques in switching, transmission and instrumentation for every kind of information-bearing signal. As never before, communications offer an inspiring challenge to creative men.

**BELL TELEPHONE LABORATORIES**

WORLD CENTER OF COMMUNICATIONS RESEARCH AND DEVELOPMENT





To assure a new order  
of reliability

# MICRO-MODULE EQUIPMENT

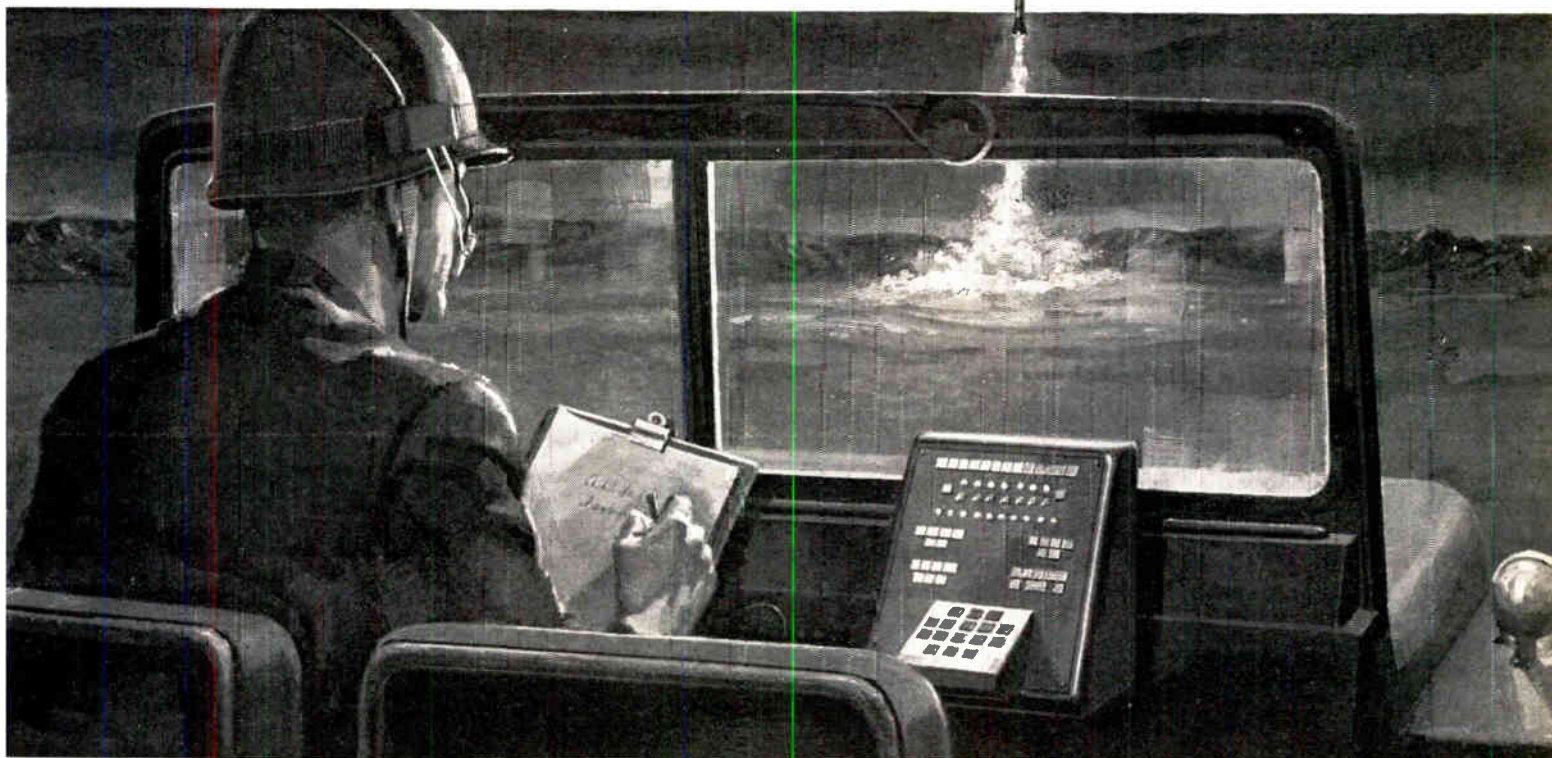

The micro-module is a new dimension in military electronics. It offers answers to the urgent and growing need for equipment which is smaller, lighter, more reliable and easier to maintain. Large scale automatic assembly will bring down the high cost of complex, military electronic equipment. Looking into the immediate future, we see a tactical digital computer occupying a space of less than two cubic feet. It will be capable of translating range, wind

velocity, target position, barometric pressure, and other data into information for surface to surface missile firings. The soldier-technician monitoring the exchange of computer data will have modularized communications with the other elements of his tactical organization. RCA is the leader contractor of this important United States Army Signal Corps program and is working in close harmony with the electronic components industry.



Tmk(s)®

**RADIO CORPORATION of AMERICA**

DEFENSE ELECTRONIC PRODUCTS

CAMDEN, NEW JERSEY

# FIRST 2-Way Crystal Filter Radio to

## Guarantee Lifetime Receiver Selectivity

### Uses HERMES CRYSTAL FILTERS

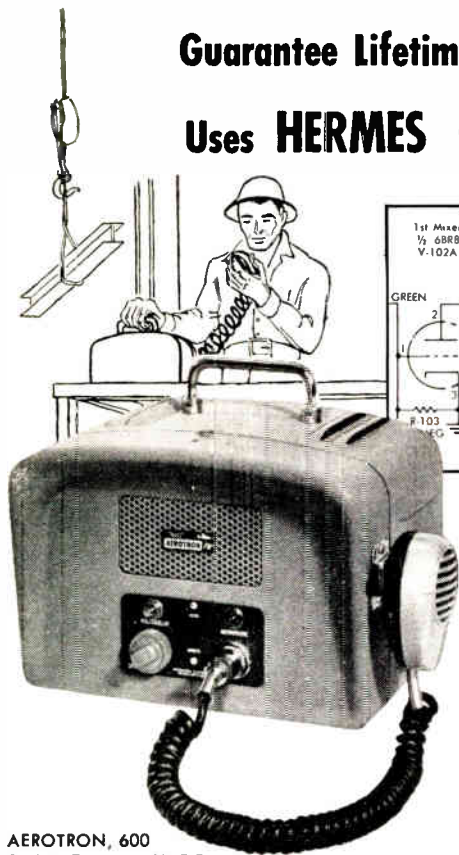

AEROTRON, 600 Series, Two-way VHF-FM Radio Communications Equipment

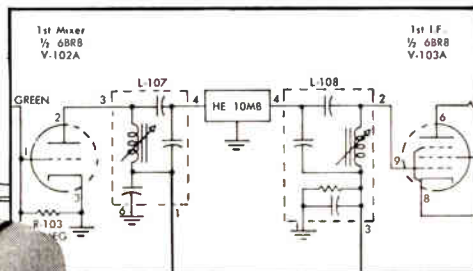

A portion of schematic diagram for AEROTRON 600 Series Receiver showing Hermes 10.7 Mc Crystal Filter at First Mixer.



Hermes Crystal Filter, Model 10 MB, measures 2 3/8" long x 1" wide x 1 1/32" high.

The AEROTRON, Model 600 Series, is the first commercially available two-way VHF-FM Mobile Radio Equipment to use a high frequency crystal filter to guarantee Receiver selectivity for the life of the equipment. This equipment is designed by Aeronautical Electronics, Inc. of Raleigh, North Carolina, for the new "split channel" frequency allocations where exceptional frequency stability and selectivity are imperative. The use of a Hermes Crystal Filter at the highest intermediate frequency eliminates any desensitization from very strong, adjacent channel stations and offers a very flat response throughout the bandpass of the filter.

Hermes crystal filters were selected because of their superior performance, small size, and immediate availability. Close cooperation between the engineering departments of the two companies contributed to the rapid development of this new Mobile Radio Equipment. Receiver characteristics include: *Frequency Stability*:  $\pm 0.0005\%$  over  $-40$  to  $+75^\circ\text{C}$ ; *Sensitivity*: 0.6 microvolt or less for 20 db quieting; *Selectivity*:  $\pm 7.5$  kc at 6 db down; *Modulation Acceptance*:  $\pm 1/2$  db throughout bandpass range of  $\pm 6$  kc.

Whether your selectivity problems are in transmission or reception, AM or FM, mobile or fixed equipment, you can call on Hermes engineering specialists to assist you in the design of your circuitry and in the selection of filter characteristics best suited to your needs. Write for *Crystal Filter Bulletin*.

A limited number of opportunities are available to experienced circuit designers. Send résumé to Dr. D. I. Kosowsky.

# Hermes



ELECTRONICS CO.

75 CAMBRIDGE PARKWAY, CAMBRIDGE 42, MASSACHUSETTS  
DEPT. B



## Meetings with Exhibits

● As a service both to Members and the Industry, we will endeavor to record in this column each month those meetings of IRE, its sections and professional groups which include exhibits.

Δ

May 23-25, 1960

**1960 National Telemetering Conference**, Miramar Hotel, Santa Monica, Calif.

*Exhibits*: Mr. William Van Dyke, Douglas Aircraft Co., Inc., El Segundo, Calif.

May 24-26, 1960

**Seventh Regional Technical Conference & Trade Show**, Olympic Hotel, Seattle, Wash.

*Exhibits*: Mr. Rush Drake, 1806 Bush Place, Seattle 44, Wash.

May 24-26, 1960

**Armed Forces Communications & Electronics Association Convention and Exhibit**, Sheraton-Park Hotel, Washington, D.C.

*Exhibits*: Mr. William C. Copp, 72 West 45th St., New York 36, N.Y.

June 20-21, 1960

**Chicago Spring Conference on Broadcast and Television Receivers**, Graemere Hotel, Chicago, Ill.

*Exhibits*: Mr. Stanley Hopper, Zenith Radio Corp., 6001 W. Dickens Ave., Chicago 39, Ill.

June 27-29, 1960

**National Convention on Military Electronics**, Sheraton-Park Hotel, Washington, D.C.

*Exhibits*: Mr. L. David Whitelock, Bu-Ships, Electronics Div., Dept. of Navy, Washington, D.C.

August 1-3, 1960

**Fourth Global Communications Symposium**, Hotel Statler, Washington, D.C.

*Exhibits*: Mr. Robert O. Brady, Office of the Chief Signal Officer, U. S. Army Signal Corps, Washington, D.C.

August 23-26, 1960

**WESCON, Western Electronic Show and Convention**, Ambassador Hotel & Memorial Sports Arena, Los Angeles, Calif.

*Exhibits*: Mr. Don Larson, WESCON, 1435 LaCienega Blvd., Los Angeles, Calif.

September 19-21, 1960

**National Symposium on Space Electronics & Telemetry**, Shoreham Hotel, Washington, D.C.

*Exhibits*: Mr. Leon King, Jansky and Bailey, 1339 Wisconsin Ave., N.W., Washington, D.C.

October 3-5, 1960

**Sixth National Communications Symposium**, Hotel Utica & Utica Municipal Auditorium, Utica, N.Y.

*Exhibits*: Mr. R. E. Bischoff, 19 Westminster Road, Utica, N.Y.

(Continued on page 10A)



# A Complete, Automatic Noise Figure Test Set

**NEW!**

## **KAY** *Auto-Node\**

**AUTOMATIC  
NOISE FIGURE TESTS  
AND GAIN OR LOSS  
MEASUREMENTS  
AT UHF, VHF AND  
MICROWAVE FREQUENCIES**



Cat. Number 790

- Optimum Noise Figure Adjustments
- Precision Noise Figure Read Out
- Noise Figure Measurements using other type External Noise Generators
- Precision Measurements of Gain or Loss in components and systems at Microwave, UHF and VHF Frequencies
- No Errors Associated with Temperature-Limited-Diodes, Meter Readings, Transit Time

### SPECIFICATIONS

as an automatic noise-figure measuring set:

Useful Frequency Range of Noise Generator: 2-2000 mc.

Maximum VSWR Variation during test: 2 parts per 1000.

Noise Figure Accuracy Including Read Out Error:

$\pm 0.1 \text{ db} \pm \frac{\text{Noise Figure}}{20}$  (db) (depends mainly on noise figure calibration of post amplifier).

Nominal Output Impedance of Noise Generator: 50 ohms (N-type connector).

Noise Figure Range: 0-18 db.

Input Center Frequency: 30, 60 or 70 megacycles (others available on special request).

Input Impedance: 70 ohms nominal.

Maximum Noise Figure of Measuring System: 3.5 db (matched) 2 db (mismatched).

Accuracy of System when making other type measurements including Microwave, UHF, and VHF Gain or Loss:  $\pm 0.2$  db.

Power Requirements: 117V, 60 cps.

Dimensions:  $9\frac{3}{4}'' \times 19\frac{1}{2}'' \times 13''$

Weight: 55 lbs. (approx.)

Price: \$1,995.00, f.o.b. factory.

Kay Auto-Node is a complete, highly flexible, Automatic Noise Figure Test Set designed to obtain simplified, noise figure meter displays for making optimum noise figure adjustments and provide precision noise figure read-out, noise figure measurements using other type external noise generators as well as precision measurements of Gain or Loss in components and systems at microwave, UHF and VHF frequencies.

Kay Auto-Node Automatic Noise Figure Test Set features a small, probe size, temperature modulated resistor as a noise generator having the following additional characteristics.

- Sine wave temperature-modulation at a 10 cps rate with temperature excursions between 300° and 400° K
- Extremely small VSWR variations during modulation (less than 2 parts in 1000)
- Useful frequency range of noise generator from 2 to 2000 mc.

KAY Auto-Node's high-gain, low-noise post amplifier has excellent noise figure stability, better than 3.5 db (matched) and the gain is sufficient to raise the input noise to a value of 10 volts after final detection. The bandwidth is 2 megacycles and the unit is supplied with one of three center frequencies—30, 60 or 70 mc.

Kay Auto-Node's precision step attenuator and expanded output meter allows for measurements to within 0.2 db accuracy when making Gain or Loss measurements. Bridge detection and selective AGC, allows noise figure up to 18 db to be made with small temperature modulation in the noise source.

### OTHER KAY NOISE GENERATORS

Instrument & Cat. No.	Frequency Range (mc)	Noise Figure Range (db)	Output Impedance (ohms)	Price f.o.b. factory
Mega-Node <sup>®</sup> 240-B	5-220	0-16 at 50 ohms 0-23.8 at 300 ohms	unbal. 50, 75, 150, 300, ∞ bal. 100, 150, 300, 600, ∞	\$365.00
Mega-Node 403-A	3-500	0-19	unbalanced 50	\$365.00
Mega-Node 3000	1-3000	0-20	unbalanced 50	\$790.00
Radio-Node <sup>®</sup> 600-A	5-400	0-23.8 depending on impedance	unbalanced as specified	\$1495.00
	10-3000	0-20	unbal. nom. 50	\$1965.00
	1120-26,500	15.78 or 15.8	waveguide	†
Microwave Mega-Nodes <sup>®</sup>	1120-26,500	15.28 or 15.8	waveguide	\$175.00 to \$595.00
Therma-Node	2-1000	±0.1	unbalanced 50	\$495.00

† Price varies with Microwave Mega-Node, used as accessory.

\* Ideally suited for noise figure measurement in radar communication.

\*Pat. Pending

Write for  
New Kay Catalog

## **KAY ELECTRIC COMPANY**

Dept. I-5, 14 Maple Avenue, Pine Brook, New Jersey

Capital 6-4000



## Meetings with Exhibits



(Continued from page 8-A)

October 10-12, 1960

**National Electronics Conference**, Hotel Sherman, Chicago, Ill.

*Exhibits:* National Electronics Conference, Inc., 228 North La Salle St., Chicago 1, Ill.

October 24-26, 1960

**East Coast Aeronautical & Navigational Electronics Conference**, Lord Baltimore Hotel & 7th Regiment Armory, Baltimore, Md.

*Exhibits:* Mr. R. L. Pigeon, Westinghouse Electric Corp., Air Arm Div., P.O. Box 746, Baltimore, Md.

October 26-28, 1960

**Fifth Annual Conference on Non-Linear Magnetics and Magnetic Amplifiers**, Bellevue-Stratford Hotel, Philadelphia, Pa.

*Exhibits:* J. L. Whitlock Associates, 6044 Ninth St., North, Arlington 5, Va.

Oct. 31-Nov. 2, 1960

**13th Annual Conference on Electrical Techniques in Medicine & Biology**, Sheraton-Park Hotel, Washington, D.C.

*Exhibits:* Mr. Lewis Winner, 152 West 42nd St., New York 36, N.Y.

November 15-16, 1960

**Mid-America Electronics Convention (MAECON)**, Hotel Muehlebach, Kansas City, Mo.

*Exhibits:* Mr. Gustav Vasen, H. A. Roes Co., 2106 Cherry, Kansas City 8, Mo.

November 15-17, 1960

**Northeast Electronics Research & Engineering Meeting (NEREM)**, Boston Commonwealth Armory, Boston, Mass.

*Exhibits:* Miss Shirley Whitcher, IRE Boston Office, 73 Tremont St., Boston, Mass.

December 1-2, 1960

**PGVC Annual Meeting**, Sheraton Hotel, Philadelphia, Pa.

*Exhibits:* Mr. E. B. Dunn, Atlantic Refining Co., 260 S. Broad St., Philadelphia 1, Pa.

December 11-14, 1960

**Eastern Joint Computer Conference**, Hotel New Yorker, New York, N.Y.

*Exhibits:* J. L. Whitlock Associates, 6044 Ninth St., North, Arlington 5, Va.

▲

Note on Professional Group Meetings: Some of the Professional Groups conduct meetings at which there are exhibits. Working committeemen on these groups are asked to send advance data to this column for publicity information. You may address these notices to the Advertising Department and of course listings are free to IRE Professional Groups.

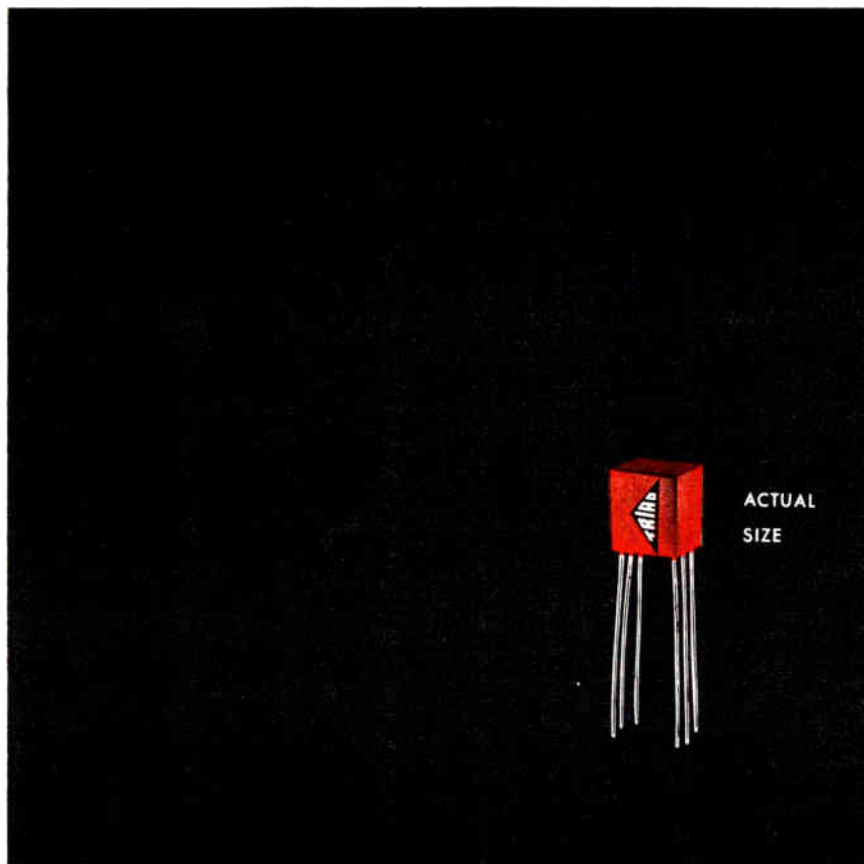

## you can put 34,560 of these transformers in 1 cubic ft.!

We call these transformers "Red Specs." You probably wouldn't want to put 34,560 of them in a cubic foot, but you could if you had to. Actual dimensions are .310" x .390" base and .440" high. Volume is .05 cu. in.

Designed for use with transistors, they are adaptable to printed circuit mounting or chassis wiring. Their wide frequency range, low distortion, and high efficiency add up to amazing performance in units of this size. Complete performance information is available if you will ask for the "Red Spec" pamphlet. Write today. Meanwhile, we list below a few of the thirty-six items available.

TYPE NO.	TYPE	PRIMARY	SECONDARY
SP-4	Input	200000 c.t.	1000 c.t.
SP-5	Input	500000 c.t.	1000 c.t.
SP-7	Input	200000	1000
SP-11	Interstage	20000/30000	800/1200
SP-13	Interstage	20000/30000 c.t.	800/1200 c.t.
SP-15	Interstage	10000/12000 c.t.	1500/1800 c.t.



**TRIAD TRANSFORMER CORPORATION**

A DIVISION OF LITTON INDUSTRIES

4055 Redwood Avenue, Venice, California • 305 No. Briant Street, Huntington, Indiana

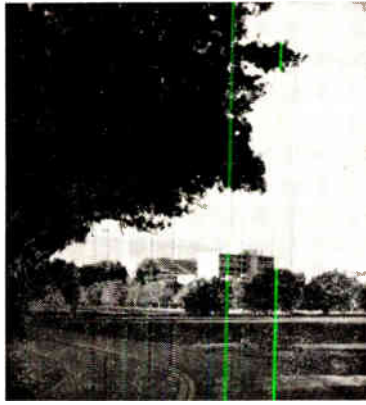

## At The Ramo-Wooldridge Laboratories... integrated programs of research & development of electronic systems and components.

The new Ramo-Wooldridge Laboratories in Canoga Park provide an environment for creative work in an academic setting. Here, scientists and engineers seek solutions to the technological problems of today. The Ramo-Wooldridge research and development philosophy places major emphasis on the imaginative contributions of the members of the technical staff. ■ There are outstanding opportunities for scientists and engineers. Write Dr. Richard C. Potter, Head, Technical Staff Development, Department 22-E.



**THE RAMO-WOOLDRIDGE LABORATORIES**

8433 FALLBROOK AVENUE, CANOGA PARK, CALIFORNIA

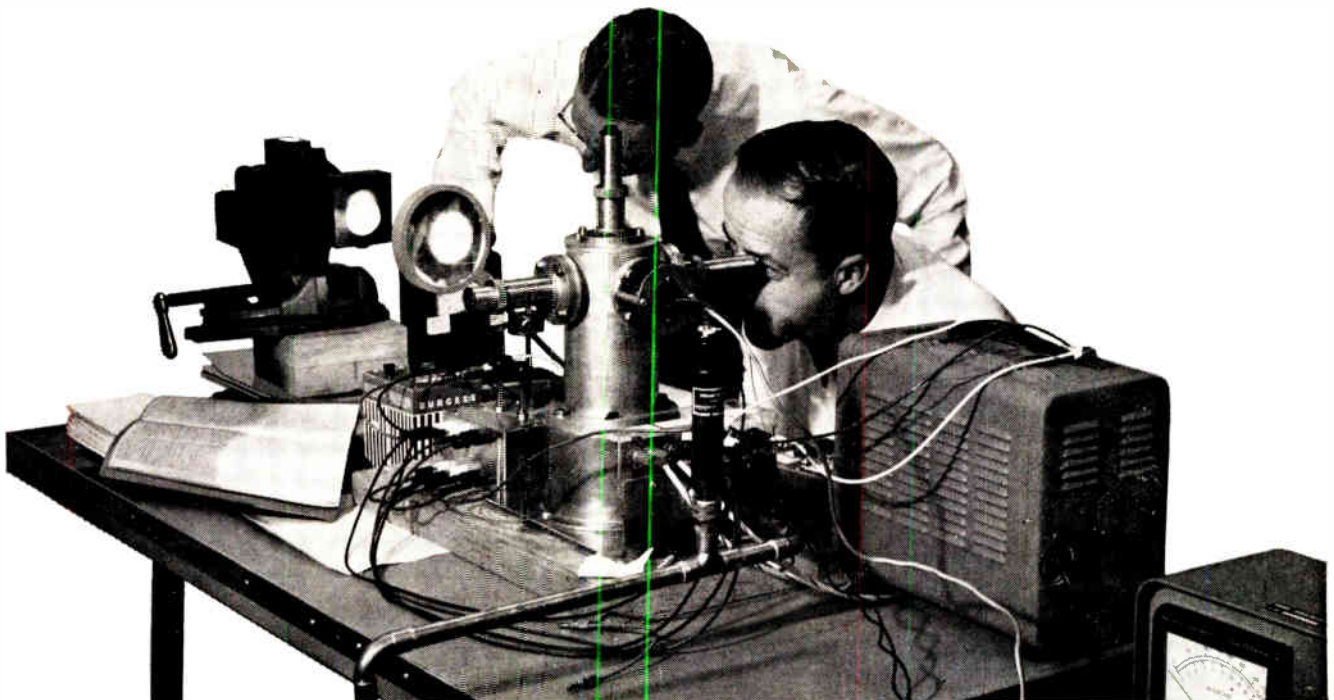

An electron device permits scientists to study the behavior of charged dust particles held in suspension.



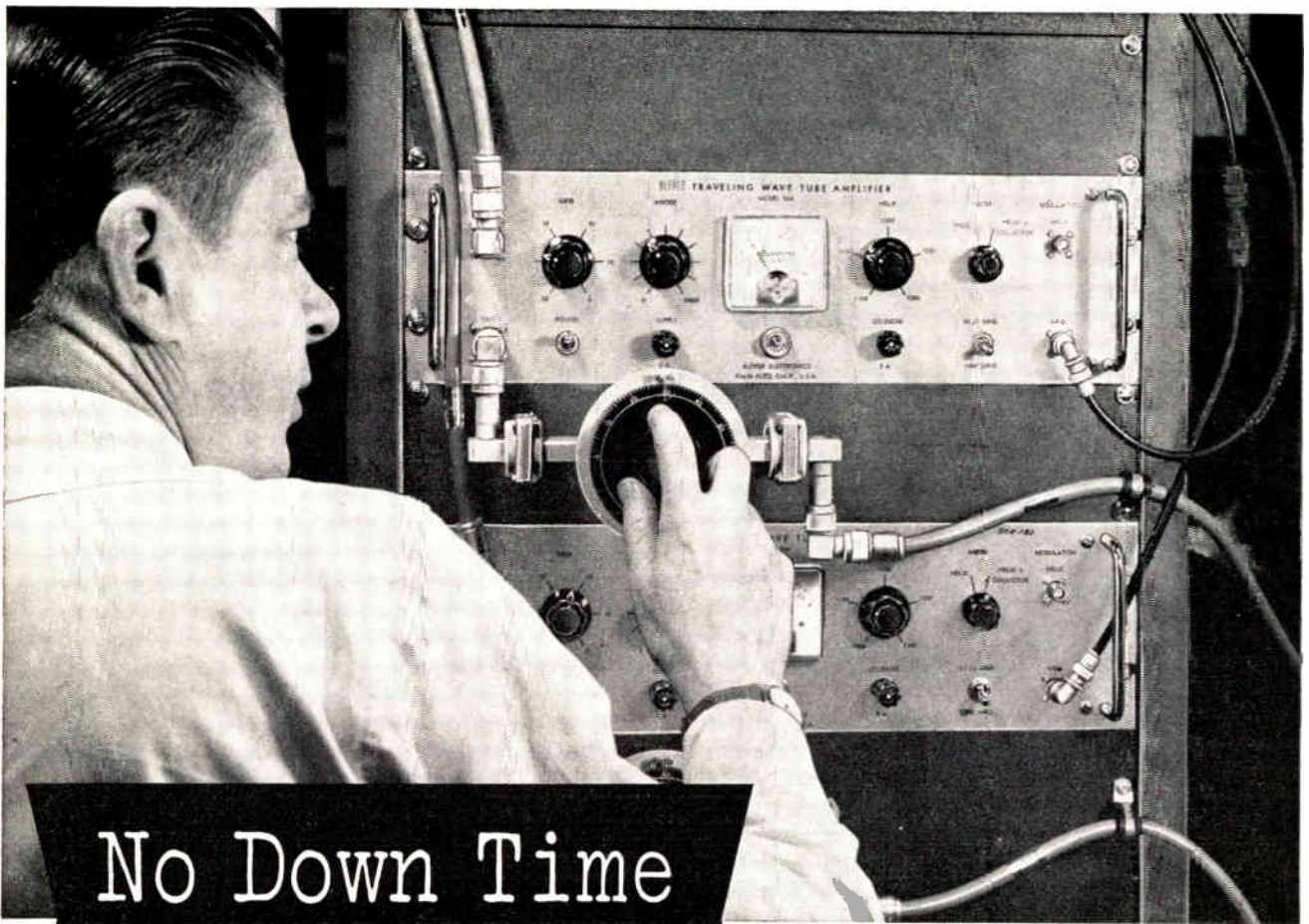

No Down Time  
Is Normal...

Alfred Electronics Model 504 Microwave Amplifiers,  
in use at Hughes Aircraft Co., Culver City, California

**with ALFRED Microwave Amplifiers**

These Alfred TWT microwave amplifiers have seen continuous service at Hughes for over 9 months. There has been practically no down time even for replacement of TWT tubes. Used in the RF portion of a missile testing system, the Alfred units provide high gain, wide band, flat response and low spurious modulation from 8 to

12.4 kmc. Hughes engineers praise the functional layout of the Model 504, its simple operation and reliable performance.

In short, Hughes finds the Alfred 504 Microwave Amplifiers good, sound, straightforward reliable instruments. We think you will too.

**KEY SPECIFICATIONS—ALFRED MICROWAVE AMPLIFIERS**

	Model	Frequency Range kmc	Gain db (min)	Power Out-put (min)	Price
<b>General Purpose Amplifiers for AM, Pulse and Phase Modulation</b>	505	1 to 2	30 db	10 mw	\$1,550
	501	2 to 4			\$1,390
	503	4 to 8			\$1,490
	504	8 to 12.4			\$1,490
	549	10.5 to 16			\$3,550
<b>Medium Power Amplifiers</b>	5-6752	1 to 2	30 db	1 w	\$2,290
	512	2 to 4	30 db	1 w Pulsed	\$1,850
			20 db	100 mw CW	
	502	2 to 4	30 db	1 w	\$1,390
	5-6868	2 to 4	30 db	10 w	\$2,850
	506	{ 4 to 8 }	27 db	{ .5 w }	\$2,290
		{ 4.5 to 7.5 }		{ 1 w }	
	5-542	4 to 8	25 db	1 w	\$3,190
	510	8 to 12.4	20 db	100 mw	\$2,150
	509	8.2 to 11	27 db	.5 w	\$3,150
5-6996	8 to 9.6	30 db	10 w	\$3,590	
<b>High Power Amplifiers</b>	5-6826	2 to 4	30 db	1 kw pk	\$4,850

Amplifiers with low and medium noise figures are available either as packaged units or unitized for remote operation of TW tube and solenoid. Standard units provide coverage from .5 to 12.4 kmc with noise figures from 7 db up.

**MANY MODELS TO CHOOSE FROM**

The 504 is just one model from the industry's most complete line of microwave amplifiers. For technical details and a demonstration arranged at your convenience, contact your nearby Alfred representative or write direct. Please address...

**ALFRED ELECTRONICS**

897 COMMERCIAL STREET  
PALO ALTO, CALIFORNIA

DEPT. 86

# keep an accurate graphic record

OF RESEARCH, DESIGN,  
TEST DATA

## two channels

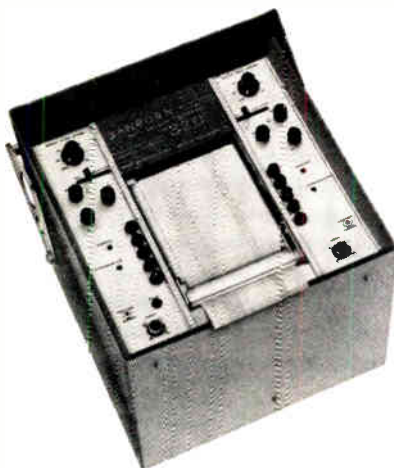

### For General Purpose DC Recording — Model 320

For recording *two variables* simultaneously, the Model 320 provides a versatile, transistorized amplifier for each input signal. The rugged 2-channel recorder assembly has heated stylus recording on two 50 mm wide rectangular coordinate channels, 4 pushbutton chart speeds, and 6 inches of visible chart. The Recorder can be placed vertically, horizontally or at a 20° angle.

#### MODEL 320 SPECIFICATIONS

Sensitivity: 0.5, 1, 2, 5, 10, 20 mv/mm and v/cm  
Frequency Response: 3 db down at 125 cps, 10 mm peak-to-peak  
Common Mode Voltage:  $\pm 500$  volts max.  
Common Mode Rejection: 140 db min. DC  
Calibration: 10 mv internal  $\pm 1\%$   
Output Connectors for each channel except external monitoring 'scope or meter  
Price: \$1495

## NEW SANBORN PORTABLE DIRECT WRITING RECORDERS FOR IN-PLANT, LABORATORY OR FIELD RECORDING

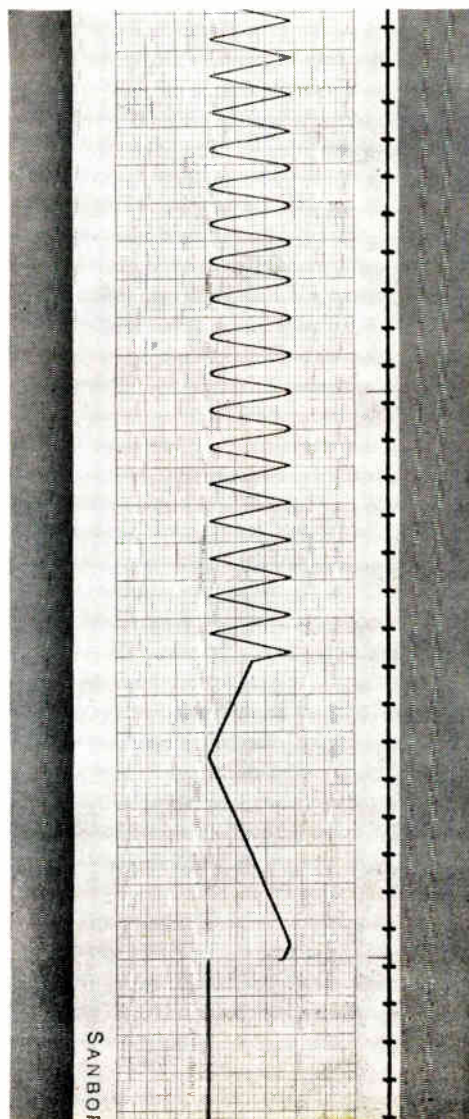

## single channel

Two models of this 21 lb. brief case size recorder are available — Model 301 for AC strain gage recording, Model 299 for general purpose DC recording. Both provide immediately visible, inkless traces by heated stylus on 40 division rectangular coordinate charts . . . frequency response to 100 cps . . . 5 and 50 mm/sec chart speeds . . . approx. 4 inches of record visible in top panel window.

#### MODEL 299 SPECIFICATIONS

Combines the dependability of transistors with the high input impedance of vacuum tubes for reliable broad-band DC recording.  
Sensitivity: 10, 20, 50, 100, 200, 500 mv/div and 1, 2, 5 and 10 v/div  
Input Resistance: 5 megohms balanced each side to ground  
Common Mode Voltage:  $\pm 2.5$  volts max. at 10 mv/div sensitivity increasing to  $\pm 500$  volts max. at other sensitivities  
Common Mode Rejection: 50:1 most sensitive range  
Calibration: 0.2 volt internal  $\pm 1\%$   
Output Connector: for external monitoring 'scope or meter  
Price: Model 299 (with zero suppression) \$700  
Model 299A (without zero suppression) \$650

#### MODEL 301 SPECIFICATIONS

The amplifier section of the Model 301 is an all-transistorized carrier type with phase sensitive demodulator. The power supply and internal oscillator circuits are also transistorized.  
Sensitivity: 10 uv rms/div (from transducer)  
Attenuator Ratios: 2, 5, 10, 20, 50, 100, 200  
Carrier Frequency: 2400 cps internal  
Transducer Impedance: 100 ohms min.  
Calibration: 40 uv/volt of excitation  
Output Connector: for external monitoring 'scope or meter  
Price: \$750

All prices are F. O. B. Waltham, Mass., within continental U. S. A. and are subject to change without notice.

Contact your Sanborn Sales-Engineering representative for complete information, or write the main office in Waltham. Sales-Engineering representatives are located in principal cities throughout the United States, Canada and foreign countries.

# SANBORN COMPANY

INDUSTRIAL DIVISION

175 Wyman Street, Waltham 54, Mass.



# 1960 INTERNATIONAL IRE CONVENTION

Record 69,760 Attendance



Engineers at the opening of the IRE Convention in the Coliseum gather around the Pioneer V auxiliary control station which was designed, assembled and operated by Space Technology Laboratories, Inc. Contact was made with Pioneer V a few moments after this picture was taken.



Dr. George Mueller, Vice President of Space Technology Labs., Inc., about to initiate a command signal from the control station in the lobby of the Coliseum. The command was sent by transatlantic cable to the Jodrell Bank radio telescope in England, which relayed the command to Pioneer V, which at the moment was 1,448,000 miles from the earth. Pioneer V's response came back to the Coliseum by the same route. At the left is a full-scale model of Pioneer V.



One of the highlights of the technical program was a seminar on the 1959 International Radio Conference in Geneva. Participants were (left to right) Rosel H. Hyde, FCC Commissioner; Francis C. de Wolf, Chief, Telecommunications Division, Department of State; T. A. M. Craven, FCC Commissioner; Arther L. Lebel, Assistant Chief, Telecommunications Division, Department of State; and Edward W. Allen, Jr., Chief Engineer, FCC.



Retiring IRE President, Ernst Weber, hands the gavel of office to the incoming IRE President, R. L. McFarlan at the Annual Meeting held in the Grand Ballroom of the Waldorf-Astoria Hotel.



IRE Officers present at the Convention (seated, left to right): G. W. Bailey, Executive Secretary; Ferdinand Hamburger, Jr., Editor; John N. Dyer, Vice President; and L. V. Berkner, Director and Speaker at the Annual Meeting. Standing, left to right, are Ernst Weber, Junior Past President; R. L. McFarlan, President; and Haraden Pratt, Secretary.





A view of some of the exhibits at the Coliseum, topped by the theme of the Radio Engineering Show, "Where Tomorrow is Today." There were 856 exhibitors at the Show, with 25,000 items on display.



The speaker's table at the Annual IRE Banquet, held in the Grand Ballroom of the Waldorf-Astoria Hotel.



Eric Walker, President of Pennsylvania State University, spokesman for the new Fellows; H. I. Romnes, President of Western Electric, principal speaker; and B. M. Oliver, Vice President, Hewlett-Packard Co., toastmaster, at the Annual Banquet.



(Left) IRE President R. L. McFarlan presents the Founder's Award to Haraden Pratt, left, and the Medal of Honor to Harry Nyquist, right, at the Annual Banquet.

(Right) President McFarlan presents the Morris Liebmann Memorial Prize to J. A. Rajchman, the Browder J. Thompson Memorial Prize to J. W. Gewartowski, and the Harry Diamond Memorial Award to K. V. Norton.



## CURRENT IRE STATISTICS

(As of March, 31, 1960)

Membership—80,274  
 Sections\*—105  
 Subsections\*—27  
 Professional Groups\*—28  
 Professional Group Chapters—263  
 Student Branches†—187

\* See this issue for a list.  
 † See October, 1959 issue for a list.

## Calendar of Coming Events and Authors' Deadlines\*

1960

- Natl. Aeronautical Electronics Conf., Dayton-Biltmore and Miami Hotels, Dayton, Ohio, May 1-3.
- URSI-IRE Spring Mtg., Sheraton Park Hotel and NBS, Washington, D. C., May 2-5.
- Western Joint Computer Conf., San Francisco, Calif., May 2-6.
- Symp. on Graduate Programs in Bio-Medical Engrg., Univ. of Vermont, Burlington, May 5-6.
- PGMTT Natl. Symp., San Diego, Calif., May 9-11.
- Electronic Components Conf., Hotel Washington, Washington, D. C., May 10-12.
- Natl. Telemetering Conf., Miramar Hotel, Santa Monica, Calif., May 23-25.
- 7th Reg. Tech. Conf. & Trade Show, Olympic Hotel, Seattle, Wash., May 24-26.
- 6th Radar Symp., Ann Arbor, Mich., June 1-3.
- Inst. on Recent Advances in Solid State Devices, Marquette Univ., Milwaukee, Wis., June 1-2.
- 10th Ann. Conv. of Soc. of Women Engrs., Benjamin Franklin Hotel, Seattle, Wash., June 9-11.
- Radio Frequency Interference Symp., Shoreham Hotel, Washington, D.C., June 13-14.
- Chicago Spring Conf. on Broadcast and Television Receivers, Graemere Hotel, Chicago, Ill., June 20-21.
- Conf. on Standards and Electronic Measurements, NBS Boulder Labs., Boulder, Colo., June 22-24.
- Workshop on Solid State Electronics, Purdue Univ., Lafayette, Ind., June 23-24.
- Natl. Conv. on Mil. Elec., Sheraton Park Hotel, Washington, D. C., June 27-29.
- Cong. Intl. Federation of Automatic Control, Moscow, USSR, June 25-July 9.
- Int'l Conf. on Electrical Engrg. Education, Sagamore Conf. Center, Syracuse Univ., Syracuse, N. Y., Jul.
- 7th Ann. Symp. on Computers and Data Processing, Stanley Hotel, Estes Park, Colo., July 28-29.

\* DL = Deadline for submitting abstracts.

(Continued on page 18A)

## BENELUX SECTION TO CONDUCT DATA TRANSMISSION SYMPOSIUM

The Benelux Section of the IRE has announced an International Symposium on Data Transmission, to be held at Delft, Netherlands, on September 19 and 20, 1960. The symposium will be concerned with the problems of transmitting and receiving information in digital form. Particular emphasis will be placed on the behavior of practical communication networks—including existing telephone systems, existing and planned military systems, and schemes of the future, such as those that use satellites. Appropriate topics include the choice of modulation, the application of coding, the demands of channel users, the design of new systems and the improvement of old, the behavior of links and networks under test, and the selection of models for further study. The aim will be to reduce the gap now existing between theory and practice.

The symposium will be conducted in English. Papers already promised indicate good representation of the work being carried on in the USA, as well as that conducted in Europe. The Symposium Committee consists of H. C. A. van Duuren, Chairman, B. B. Barrow, H. Rinia, and F. L. Stumpers. All correspondence regarding the symposium should be addressed to B. B. Barrow, Secretary, The Benelux Section of the IRE, Postbus 174, Den Haag, Nederland.

## FIRST ARMY MARS NET PRESENTS MAY SPEAKERS

With the presentation of its May Speaker Schedule, the First U. S. Army MARS SSB Technical Net will recess its weekly series of technical talks and forum until September of this year. The Net meets on 4030 kc each Wednesday at 9:00 P.M. EDT. The schedule for May includes:

- May 4 "Antenna Panel," W. Offutt, Engineering Manager; L. De Size, Group Leader and B. Woodward, Engineer—Airborne Instrument Labs, Inc., Melville, L. I., N. Y.
- May 11 "Frequency Control," Dr. G. Winkler, Scientist USARDL, Fort Monmouth, N. J.

- May 18 "Communication Electronic Needs of the Future," Dr. J. V. Harrington, Division Head, and Dr. B. Lax, M.I.T. Lincoln Lab., Lexington, Mass.
- May 25 "Fundamentals of Oscillator Operation," R. W. Gunderson, Editor, Braille Technical Press, New York, N. Y.

## NBS HEAD HONORED BY CIVIL SERVICE LEAGUE

Allen V. Astin (SM'50-F'54), Director of the National Bureau of Standards, has been selected by the National Civil Service League as one of the top ten career employees in the Federal civil service for 1960. The Award was presented to Dr. Astin at a dinner in Washington, D. C., on March 15.

The League, a non-partisan citizens' organization for better government through better personnel, this year will give its sixth series of Career Service Awards to ten Federal employees chosen for competence, character and achievement.

Dr. Astin has been in government 27 years. A native of Salt Lake City, Utah, with degrees from the University of Utah, New York University, Lehigh and George Washington, he now lives in Bethesda, Md.

Joining the Bureau of Standards in 1932, he was active for eight years in research in the Heat and Power and Electricity Divisions, and during the next eight became successively Chief of the Optical Fuze Section and the Ordnance Development Division. He was promoted to Director of the Bureau in 1952.

Among his scientific contributions are the discovery and development of improved methods of measuring dielectric constants and power factors of dielectric materials; pioneering work in developing radio telemetering techniques and instruments, especially applied to meteorological and cosmic ray problems; and contributions to the development and evaluation of proximity fuzes. His record of publications begins in 1929 and has continued productively. He has served on many committees and boards, such as the Defense Science Board, International Committee of Weights and Measures, and National Advisory Committee for Aero-

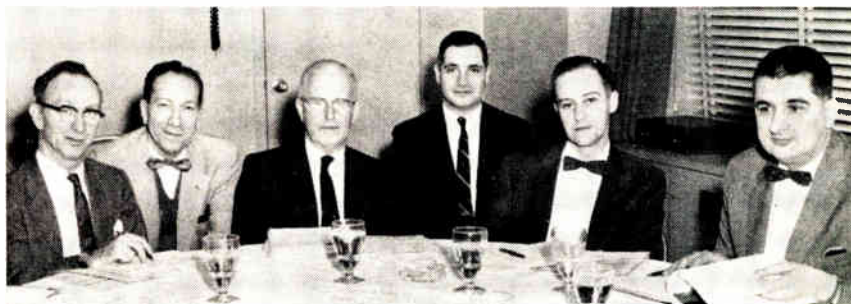

At a recent meeting of the national committee of the 13th Annual Conference on Electrical Techniques in Medicine and Biology, in the Sheraton Hotel, Philadelphia, Pa., where plans for the forthcoming Washington, D. C., conference (October 31, November 1-2) were made, left to right: A. L. Henley, secretary; Lewis Winner, public relations-exhibits; L. E. Flory, editorial board; A. Shapero, treasurer; G. N. Webb, program chairman and R. L. Bowman, conference chairman.



# For unmatched reliability . . . **BOMAC BEACON MAGNETRONS**

**Life** — up to 500 hours guaranteed — over 3000 hours reported  
**Frequency stability** — less than 2 Mc drift per 100 hours (C band)  
**Power stability** — drop of less than 1 db for constant voltage input  
**Duty cycle stability** — less than 3 Mc frequency shift for a change in duty cycle of 0.00005 to 0.002 (C band)  
**Vibration** — less than 2.5 Mc frequency shift from 55 to 2000 cps  
**Shock** — withstands 100 g's of 6 millisecond duration  
**Lightweight** — 7 to 10 oz.  
**Miniaturized**  
**Tunable over a broad band**



Band	Tube Type	Fixed Freq. or Tunable	Frequency Range Mc	Min. Peak Power Watts	Output Mates With
C	BL-212	Tunable	5400-5900	100	UG699/U
C	BL-243	Tunable	5400-5900	200	UG699/U
C	BL-242	Tunable	5400-5900	400	N
C	BLM-022	Tunable	5400-5900	500	TNC
C	BLM-026	Tunable	5400-4900	500	TNC
C	BLM-020	Tunable	5400-5900	700	TNC
C	BL-245	Tunable	5400-5900	900	TNC
C	BL-250	Tunable	5400-5900	150	TNC
X	BLM-003	Tunable	9000-9500	150	TNC
X	BLM-014	Tunable	8500-9000	150	TNC
X	BLM-012	Tunable	8900-9400	1000	TNC
X	BLM-021	Tunable	8900-9400	1000	UG40A/U
X	BLM-024	Tunable	9300-9500	150	TNC

New short form catalog available. Send for your copy today.



**BOMAC laboratories, Inc.**

SALEM ROAD - SEVERLY, MASSACHUSETTS

Offices in major cities — A subsidiary of Varian Associates.

Leaders in the design, development and manufacture of TR, ATR, Pre-TR tubes; shutters; reference cavities; crystal protectors; silicon diodes; magnetrons; klystrons; duplexers; pressurizing windows; noise source tubes; high frequency triode oscillators; surge protectors.



## Calendar of Coming Events and Authors' Deadlines\*

(Continued from page 16A)

- 4th Global Communications Symp., Hotel Statler, Washington, D. C., Aug. 1-3.
- AIEE Pacific Gen. Mtg., El Cortez Hotel, San Diego, Calif., Aug. 9-12.
- WESCON, Los Angeles Mem. Sports Arena, Los Angeles, Calif., Aug. 23-26.
- URSI 13th Gen. Assembly, Univ. of London, London, Eng., Sept. 5-15.
- Joint Automatic Control Conf., M.I.T., Cambridge, Mass., Sept. 7-9.
- Conf. on Communications, Roosevelt Hotel, Cedar Rapids, Iowa, Sept. 9-10.
- 4th Ann. Joint Mil. Ind. Electronic Test Equip. Symp., Chicago, Ill., Sept. 14-15.
- Space Electronics and Telemetry Conv. and Symp., Shoreham Hotel, Washington, D.C., Sept. 19-22.
- Industrial Elec. Symp., Manger Hotel, Cleveland, Ohio, Sept. 21-22.
- Sixth Natl. Communications Symp., Hotel Utica and Utica Municipal Aud., Utica, N. Y., Oct. 3-5. (DL\*: June 1, B. H. Baldrige, 25 Bolton Rd., New Hartford, N. Y.)
- PGNF 7th Ann. Mtg., Gatlinburg, Tenn., Oct. 3-5.
- Natl. Elec. Conf., Hotel Sherman, Chicago, Ill., Oct. 10-12. (DL\*: May 1960 Prof. T. F. Jones, Jr., School of E.E., Purdue Univ., Lafayette, Ind.)
- Engrg. Writing and speech Symp., Bismark Hotel, Chicago, Ill., Oct. 13-14.
- Symp. on Space Navigation, Deshler-Hilton Hotel, Columbus, Ohio, Oct. 19-21, (DL\*: July 15, J. D. Kraus, Ohio State Univ. Radio Observatory, Columbus.)
- East Coast Conf. on ANE, Lord Baltimore Hotel, Baltimore, Md., Oct. 24-26. (DL\*: June 6, S. Hershfield, The Martin Co., Baltimore, Md.)
- 5th Ann. Conf. on Nonlinear Magnetics and Magnetic Amplifiers, Bellevue-Stratford Hotel, Philadelphia, Pa.
- Electron Devices Mtg., Hotel Shoreham, Washington, D. C., Oct. 27-29.
- 13th Ann. Conf. on Elec. Tech. in Med. and Bio., Sheraton Park Hotel, Washington, D. C., Oct. 31, Nov. 1-2.
- Radio Fall Mtg., Hotel Syracuse, Syracuse, N. Y., Oct. 31, Nov. 1-2.
- 6th Ann. Conf. on Magnetism and Magnetic Materials, New Yorker Hotel, N. Y., N. Y., Nov. 14-17.
- Mid-Amer. Elec. Conv., Hotel Muehlebach, Kansas City, Mo., Nov. 15-16. (DL\*: June 15, J. Austin, Bendix Aviation Corp., 95 and Troost, Kansas City, Mo.)
- PGPT Ann. Conf., Boston, Mass., Nov. 15-16. (DL\*: June 1, C. W. Watt, Raytheon Co., Waltham, Mass.)
- 1960 NEREM (Northeast Electronics Res. & Engrg. Mtg.), Boston, Mass., Nov. 15-17.
- PGVC Ann. Mtg., Sheraton Hotel, Philadelphia, Pa., Dec. 1-2, (DL\*: July 15, W. G. Chaney, American Telephone and Telegraph Co., 195 Broadway, N. Y. 7, N. Y.)
- Eastern Joint Computer Conf., New Yorker Hotel, New York, N.Y., Dec.

\* DL = Deadline for submitting abstract.

navitics. He has had a leading role in government science programs and the direction of national and international science activities. His awards include the Presidential Certificate of Merit and His Majesty's Medal for Service in the Cause of Freedom.

## NATIONAL SCIENCE FOUNDATION ESTABLISHES ADVISORY PANEL

A temporary Advisory Panel on Radio Telescopes has been appointed by the National Science Foundation. The purpose of the Panel is to 1) study the present and predictable needs of radio astronomers with regard to improved instrumentation; 2) study existing and proposed instruments with regard to their capabilities and limitations and 3) advise the Foundation with regard to the desirability and feasibility of more powerful instruments. The members of the Panel are Dr. J. R. Pierce, Bell Telephone Laboratories, Chairman; Dr. R. N. Bracewell, Stanford University; Dr. P. E. Chenea, Purdue University; Dr. L. J. Chu, Massachusetts Institute of Technology; Dr. R. M. Emberson, Assoc. Universities, Inc.; Dr. W. E. Gordon, Cornell University; Dr. D. S. Heeschen, National Radio Ast. Obs.; Dr. R. Minkowski, Mt. Wilson and Palomar Obs.; Dr. G. W. Swenson, Jr., University of Illinois; J. H. Trexler, Naval Research Lab. Scientists and engineers wishing to bring their ideas to the attention of the panel are encouraged to communicate them (to the panel members or directly) to the Astronomy Program, National Science Foundation.

## CORNELL UNIVERSITY TO HOLD JUNE SEMINARS

The annual Industrial Engineering Seminars are being presented for the seventh successive year at Cornell University during June 14-17, 1960. Seminars will be conducted in seven major areas. Of these, those of interest to radio and electronics engineers will be the seminars in Engineering Administration, Systems Simulation Using Digital Computers, Statistical Decision-Making: Theory and Applications, and in Statistical

Reliability Analysis: Theory and Applications.

The seminar series on Engineering Administration has been planned for persons responsible for the administration of engineering and applied research activities. Topics to be discussed include a) communication problems in the technical organization, b) manpower planning and the growing shortage of engineers, c) the development of engineers as supervisors, d) creativity through group effort, e) directing engineering programs, f) engineering program planning, g) the management of technical services, and h) cost control of engineering projects.

The seminar group on Statistical Reliability Analysis: Theory and Application will provide a current survey of statistical theory and techniques on reliability analysis that are being developed to meet the growing demands for improved materials and component reliability. It is intended for those engineers and manufacturing executives whose responsibilities include predicting and implementing the economic balance of product quality against cost through environmental destruction tests, marginal checking and failure analysis. Among the topics to be discussed will be: a) statistical aspects of experimentation, b) statistical theory of reliability based on failure models such as the exponential, Weibull, gamma and extreme-value, c) techniques of analyzing failure data, d) the improvement of reliability through redundancy and maintenance, e) the design of life-testing experiments, f) selection and ranking problems, and g) unsolved problems in reliability.

The use of simulated experimentation in the analysis and design of complex systems is one of the most promising of the applications of high-speed digital computers. The series of seminar sessions on Systems Simulation Using Digital Computers will explore this expanding field and consider problems in constructing the program, in using a simulator and in analyzing results. The topics for discussion will include a) the experimental investigation of complex systems, b) equipment requirements for digital simulation, c) the logical representation of an operating system, d) the construction of a computer program to simulate a simple system, e) problems in the design of a simulation experiment, f) experimental determination of



In preparation for the 1960 IRE 7th Regional Conference, Dr. D. K. Reynolds, Technical Program Chairman (far right) explains to other IRE committee chairmen the three major fields which the conference attendants will study. The conference, to be held in Seattle on May 24-26, will feature studies of control systems, solid state electronics, and electromagnetics. The other IRE conference chairmen include (left to right) W. T. Harrold, Public Relations Chairman; Rush Drake, Electronics Exhibit Chairman; Dr. Frank S. Holman, Chairman; L. C. Perkins, Chairman of the Seattle Section; and Frank A. Little, Treasurer.

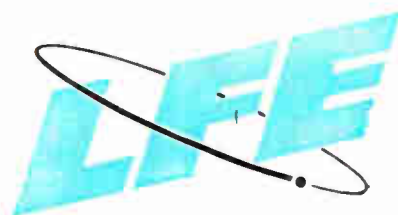

***is experienced  
... in Radar  
Surveillance Systems***

The eye was man's first instrument of surveillance. Its most unique characteristic is the ability to distinguish moving objects.

LFE, a pioneer in motion detection by radar means, is prime contractor for a new Ground Control Approach System for tactical air traffic control. Now in production, it exemplifies the latest in lightweight, portable GCA equipment.

This is an illustration of LFE's interest in radar techniques with continued emphasis on motion detection. Such techniques are having an evolutionary influence on military and industrial systems.

Further details about LFE Radar Surveillance Systems may be had by writing the Vice President of Marketing. Ask for Technical Data Digest No. 6025.



**LABORATORY FOR ELECTRONICS, INC., Boston 15, Massachusetts**

SYSTEMS, EQUIPMENT & COMPONENTS FOR  
AIRBORNE NAVIGATION • RADAR and SURVEILLANCE • ELECTRONIC DATA PROCESSING • AUTOMATIC CONTROLS • GROUND SUPPORT





Dr. Edgar A. Sack, Jr. (center), who received recognition by Eta Kappa Nu as the out-standing young electrical engineer of 1959, receives congratulations from IRE's President, Albrecht Naeter (left) and Dr. Erast Weber, president of Brooklyn Polytechnic Institute, who delivered the major address of the evening.

optimum operating conditions, g) production control simulation and the comparison of decision rules, and h) manufacturing systems simulation.

The seminar on Statistical Decision-Making is designed for individuals who are engaged in research, experimentation, production, inspection, or acceptance sampling where attention is centered on problems of selecting or ranking processes, methods, or categories according to various criteria of "goodness." It will consist of integrated sessions in which new statistical procedures will be proposed for coping with such multi-decision problems. Among the topics to be discussed will be a) some statistical aspects of experimentation, b) multiple comparison procedures: why and how they are used, c) three-decision problems, d) selection and ranking problems (Bechhofer-Sobel approach), e) selection and ranking problems (Sonnerville approach), f) selection and ranking problems (Gupta-Sobel approach), and g) implications of the approaches, directions of research, and new applications.

These seminars are sponsored by the Department of Industrial and Engineering Administration of the Sibley School of Mechanical Engineering, College of Engineering at Cornell. For further information address inquiries to: J. W. Gavett, Seminars Coordinator, Upson Hall, Cornell University, Ithaca, N. Y.

#### PGPT CALLS FOR PAPERS

The 4th Annual Conference of the PGPT will be held in Boston, Mass., on November 15-16, in conjunction with the 1960 Northeast Electronics Research and Engineering Meeting (NEREM). Papers for two sessions, to be grouped under the general headings of "Design Techniques That Insure a Better Product," and "Materials and the Product Today," are being solicited. Reports on new and original work in these fields are especially desired. Prospective authors should submit, before June 1, 1960, summaries of their papers, in triplicate, to C. W. Wart, Program Chairman, 4th Annual Conference

PGPT, c/o Raytheon Company, Waltham 54, Mass.

#### MARQUETTE UNIVERSITY TO SPONSOR INSTITUTE

An Institute sponsored by the Department of Electrical Engineering of Marquette University will be held on June 1 and 2, 1960. The title of the Institute is "Recent Advances in Solid State Devices." The program emphasizes High-Power Controlled Rectifiers, Application of the Silicon Controlled Rectifier, Parametric Amplification, Tunnel Diode and Applications, Direct Energy Conversion—Thermoelectric Devices, Direct Energy Conversion, Solid State Maser Amplifiers, Avalanche Devices and Solid State "Grown" Circuits. Persons highly specialized in their fields will present the program.

For further information write to Stanley Krupnik, Jr., Assistant Chairman of Electrical Engineering, Marquette University, Milwaukee 3, Wis.

#### PGRFI WILL CONDUCT 2ND ANNUAL SYMPOSIUM

The Professional Group on Radio Frequency Interference (PGRFI) will hold its 2nd Annual Symposium in Washington, D. C. at the Shoreham Hotel on June 13 and 14, 1960.

The program will include morning and afternoon sessions on both Monday, June 13 and Tuesday, June 14. The morning session on June 13 will deal with RFI prediction with various computer models, the afternoon program with measurement methods and system characteristics. A total of 10 papers will be presented. The second day will feature a round table discussion in the morning covering the present status of RFI and compatibility standards. In the afternoon, there will be a field trip to the NOL and FCC Laboratories. The ladies' program will include a daily hospitality room, a

fashion show, an embassy tea, and a sight-seeing tour.

Advance registration is recommended; for further information please contact: E. F. Mischler, Chairman, Public Relations Committee, National Engineering Service, 1108 16th Street, N.W., Washington 6, D.C.

#### SUMMER WORKSHOP ANNOUNCED

A day and a half tutorial program on solid-state electronics is to be presented at Purdue University on June 23 and 24, 1960 under the joint sponsorship of the IRE Professional Group on Education and the Electrical Engineering Division of ASEE. The program for the event was announced by Dr. John G. Truxal and Dr. J. H. Mulligan, Jr., respective Chairmen of the two organizations. Dr. Warren B. Boast, Iowa State University, is Chairman of the Program Committee for the Workshop. Other members are Dr. R. H. Mattson, Iowa State University; Dr. J. L. Moll, Stanford University; Dr. R. L. Pritchard, Texas Instruments, Inc., and Mr. G. R. Madland, Motorola Semiconductor Products Division.

Designed primarily for electrical engineering educators, but open to all interested parties, the Workshop will include nine papers arranged in three sessions as follows:

Thursday afternoon, June 23

"Characteristics of Electrons in Solids," Dr. J. M. Shive, Bell Telephone Lab., Inc.

"Semiconductors," Dr. R. H. Mattson, Iowa State University.

"Electrical Properties of Semiconductor Materials," Dr. W. G. Dow, University of Michigan.

Friday morning, June 24

"Diodes," Dr. M. O. Thurston, Ohio State University.

"Transistors," Dr. J. M. Early, Bell Telephone Lab., Inc.

Friday afternoon, June 24

"Energy Conversion Devices," Dr. S. J. Angello, Westinghouse Electric Corp.

"Low Temperature Devices," Dr. A. L. McWhorter, Lincoln Labs., M.I.T.

"Other Solid State Devices," Dr. J. L. Moll, Stanford University.

Further details regarding program information may be obtained from Dr. Warren B. Boast, Iowa State University, Ames, Iowa; information regarding living accommodations for the meeting may be obtained from Dr. Thomas F. Jones, Purdue University, Lafayette, Ind.

The Workshop on Solid-State Electronics is but one of the events of the Electrical Engineering Division scheduled for the ASEE Annual Meeting at Purdue University. On Monday, June 20 there will be a session on "Learning Machines" under the chairmanship of Professor A. V. Eastman of the University of Washington. The following papers will be presented:

"The Automization of Socrates," Dr. D. Cook, Purdue University.

"Design Techniques of Automatic Teaching Machines," Dr. H. A. Baldwin, University of Arizona.

"Teaching Elementary Stress Analysis



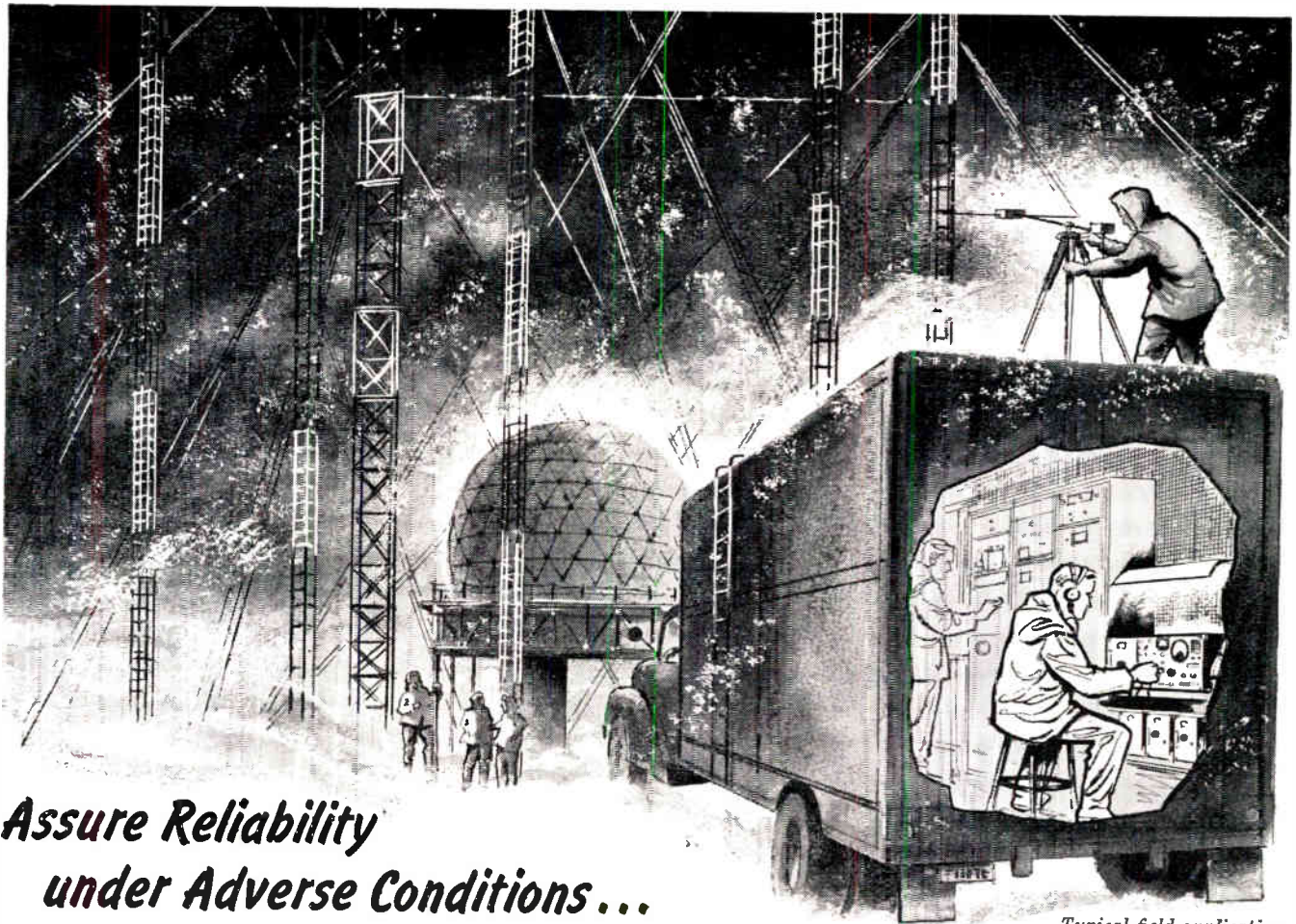

**Assure Reliability  
under Adverse Conditions...**  
in the Field and in your Plant

*Typical field application  
of NF-105 in mobile  
Radio Interference Laboratory*

## **SPECIFY EMPIRE'S COMPACT AND RUGGED NOISE and FIELD INTENSITY METER MODEL NF-105**

- Measures 150 kilocycles to 1000 megacycles accurately and quickly with only one instrument.
- For measurements in accordance with Specifications: MIL-I-6181B, Class 1; MIL-S-10379A; MIL-I-11683B; MIL-I-11748B; MIL-I-12348A; MIL-I-13237; MIL-I-16910A; MIL-I-26600 (USAF), Category A; F.C.C. Specifications.
- Direct substitution measurements by means of broad-band impulse calibrator, without charts, assure repeatability.
- Economical...avoids duplication.
- True peak indication by direct meter reading or aural slideback.
- Four interchangeable plug-in tuning units, for extreme flexibility.
- Safeguards personnel...ALL antennas can be remotely located from the instrument without affecting performance.
- Self-calibrating, for reliability and speed of operation.
- Compact, built-in regulated "A" and "B" power supply, for stability.
- Minimum of maintenance required, proven by years of field experience.

### **DELIVERY FROM STOCK**

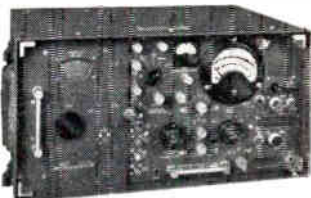

The unique design of Model NF-105, with 4 plug-in tuning units, avoids costly repetition of circuitry and components common to all frequency ranges, at savings in size, weight and cost. Simple to operate, this instrument permits fast and accurate measurements of both broadband or CW signals. *Send for our Catalog N-611.* Plan to attend our next seminar on interference instrumentation, details upon request.



**EMPIRE DEVICES PRODUCTS CORP.**  
AMSTERDAM, NEW YORK VICTOR 2-8400

MANUFACTURERS OF:  
FIELD INTENSITY METERS • DISTORTION ANALYZERS • IMPULSE GENERATORS • COAXIAL ATTENUATORS • CRYSTAL MIXERS

## MISCELLANEOUS IRE PUBLICATIONS AVAILABLE

The following issues of miscellaneous publications are available from the Institute of Radio Engineers, Inc., 1 East 79th Street, New York 21, New York, at the prices indicated below:

Meetings	Publications	Price per Copy
Aeronautical and Navigational Electronics Conference	<i>Proceedings of the 5th Annual East Coast ANE Conference</i> , held October 27-28, 1958 in Baltimore, Md.	\$5.00*
Electronic Components Symposium	<i>Proceedings of the 1957 Electronic Components Symposium</i> , held May 1-3, 1957 in Chicago, Ill.	5.00
Electronic Computer Conferences	<i>Proceedings of the Joint AIEE IRE ACM Eastern Conference</i> , held December 10-12, 1951 in Philadelphia, Pa.	3.50
	<i>Proceedings of the Joint AIEE IRE ACM Eastern Conference</i> , held December 8-10, 1954 in Philadelphia, Pa.	3.00
	<i>Proceedings of the Joint AIEE IRE ACM Eastern Conference</i> , held November 7-9, 1955 in Boston, Mass.	3.00
	<i>Proceedings of the Joint AIEE IRE ACM Eastern Conference</i> , held December 10-12, 1956 in New York, N. Y.	3.00
	<i>Proceedings of the Joint AIEE IRE ACM Eastern Conference</i> , held December 9-13, 1957 in Washington, D. C.	3.00
	<i>Proceedings of the Joint AIEE IRE ACM Eastern Conference</i> , held December 3-5, 1958 in Philadelphia, Pa.	3.00
	<i>Proceedings of the Joint AIEE IRE ACM Eastern Conference</i> , held December 1-3, 1959 in Boston, Mass.	3.00
	<i>Proceedings of the Joint AIEE IRE ACM Western Conference</i> , held March 1-3, 1955 in Los Angeles, Calif.	3.00
	<i>Proceedings of the Joint AIEE IRE ACM Western Conference</i> , held February 7-9, 1956 in San Francisco, Calif.	3.00
	<i>Proceedings of the Joint AIEE IRE ACM Western Conference</i> , held May 6-8, 1958 in Los Angeles, Calif.	4.00
Magnetic Amplifiers Conference	<i>Proceedings of the Conference on Magnetic Amplifiers</i> , held April 5-6, 1956 in Syracuse, N. Y.	4.00
	<i>Bibliography on Medical Electronics</i> , June 1958	2.50
Bio-Medical Electronics Bibliographies	<i>Bibliography on Medical Electronics</i> , June 1959 (Supplement #1)	2.50
	<i>Proceedings of the 1st National Convention</i> , held June 17-19, 1957 in Washington, D. C.	5.00†
Military Electronics	<i>Proceedings of the 2nd National Convention</i> , held June 16-18, 1958 in Washington, D. C.	5.00†
	<i>Proceedings of the 3rd National Convention</i> , held June 29-July 1, 1959 in Washington, D. C.	4.00
	<i>Proceedings of the 4th National Symposium</i> , held January 6-8, 1958 in Washington, D. C.	5.00
Reliability and Quality Control in Electronics Symposia	<i>Proceedings of the 5th National Symposium</i> , held January 12-14, 1959 in Philadelphia, Pa.	5.00
	<i>Proceedings of the 6th National Symposium</i> , held January 11-13, 1960 in Washington, D. C.	5.00
	<i>Proceedings of the 1953 National Conference</i> , held May 20-22, 1953 in Chicago, Ill.	2.00
Telemetry Conference and Symposia	<i>Proceedings of the 1958 National Symposium</i> , held September 22-24, 1958 in Miami Beach, Fla.	5.00
	<i>Proceedings of the 1959 National Symposium</i> , held September 28-30, 1959 in San Francisco, Calif.	5.00

\* IRE Member Rate \$3.50.  
† IRE Member Rate \$3.00.

by Machine," Dr. A. F. Johnson and Dr. D. J. Mayhew, University of Utah.

"MARI—A Simple Electrical Teaching Device," Dr. M. Crosby and Dr. O. Lancaster, Pennsylvania State University.

On Monday evening at 8:00 P.M. there will be a panel discussion on the theme "The Role of the Electrical Engineering Division in the Next Decade." Participants will be Dr. Warren B. Boast, Head, Electrical Engineering Department, Iowa State University; Dr. Richard K. Moore, Head, Electrical Engineering Department, University of New Mexico; and Dr. James H. Mulligan, Jr., Head, Electrical Engineering Department, New York University.

On Tuesday, June 21 at 2:00 P.M. there will be a session devoted to Probability and Statistics in Electrical Engineering under the direction of Dr. J. Stuart Johnson, Dean of Engineering, Wayne State University. The four papers scheduled for this meeting are:

"Mathematics Approach to Probability and Statistics Instruction for Electrical Engineers," Dr. J. G. Brainerd, University of Pennsylvania.

"Electrical Engineering Approach to Probability and Statistics Instruction for Electrical Engineers," Dr. R. J. Schwarz, Columbia University.

"Random Process Studies and Information Theory," Dr. V. C. Rideout and Dr. A. Burr, University of Wisconsin.

"Reliability of Electronic Equipment," Dr. C. A. Krohn, Motorola, Inc.

### PHOTOGRAPHY SEMINAR TO BE HELD AT M.I.T.

The scientific and engineering uses of high-speed photographic measurement techniques will be the subject of a one week seminar at the Massachusetts Institute of Technology, starting Monday, August 15, 1960. The meetings will center at the Stroboscopic Light Laboratory where the theory and application of numerous methods will be discussed and studied.

It is planned that mornings will be devoted to theory and demonstrations and the afternoons to laboratory practice and experience.

Subjects to be covered include pulsed stroboscopic lighting, optical high-speed cameras, Kerr cells, Faraday shutters, image converters, and so forth. Specialists in high-speed photography have been invited to cover their subjects at the seminar, and there will be practical laboratory demonstrations of many types of high-speed photography equipment.

The high-speed motion picture and still cameras give space-time resolution for complicated mechanical motions. In some ways one can think of high-speed cameras as instruments for the mechanical engineer that correspond to the cathode-ray oscillograph for the electrical. One of the objects of the seminar is to give those who attend a real working knowledge of the various devices.

The program is under the direction of Professor Harold E. Edgerton of the Department of Electrical Engineering at M.I.T. For further information inquire from the Office of the Summer Session, Room, 7-103, M.I.T., Cambridge 39, Mass.



AVAILABLE NOW FROM TI

# 100:1 miniaturization with **SOLID CIRCUIT\*** semiconductor networks

Now — 3 years ahead of industry's expectations — **Solid Circuit** semiconductor networks from Texas Instruments for many of your high-reliability miniaturized systems!

*Solid Circuit* networks are a major departure from conventional components because they integrate resistor, capacitor, diode, and transistor functions into a single high-purity semiconductor wafer. Protection and packaging of discrete elements is eliminated, and contacts between dissimilar materials are minimized, reducing element interconnections as much as 80%. Fabrication steps have been reduced to one-tenth those required for the same circuit function using conventional components.

Only a few process steps and time-proved TI mesa production techniques permit a high degree of process control in *Solid Circuit* network fabrication. The result of these facts: *reliability is built into each Solid Circuit* network.

If you need to reduce equipment size and weight—or to design a more complex system in the same size—investigate *Solid Circuit* networks for your missile, satellite, space vehicle, and other microelectronic programs. TI engineers are ready to custom design this concept to your requirements. Contact your nearest TI Sales Engineer today. The TI Type 502 *Solid Circuit* network is immediately available for your evaluation.

## SEMICONDUCTOR NETWORK CONCEPT

The concept of a semiconductor network is the relation of conductance paths in a semiconductor to the classical circuit elements, establishing an orderly design approach based on circuit knowledge. In this manner, semiconductor networks may be designed to perform the functions of a wide variety of existing circuits. Through the proper selection and shaping of semiconductor conductance paths, it is possible to realize such electronic functions as amplification, pulse formation, switching, attenuation, and rectification.

An assembly of 13 **Solid Circuit** networks, actual size, performs a full serial adder function, replacing 85 conventional components with a 100:1 size reduction. Weight: 1.5 gm. Volume: 0.02 cubic inch.



\*Trademark of TEXAS INSTRUMENTS INCORPORATED

TI Type 502 silicon **Solid Circuit** network is intended for binary counter, flip-flop, or shift register applications. The dimensions of the glass-to-metal hermetic-sealed package are 0.250 x 0.120 x 0.030 inch.

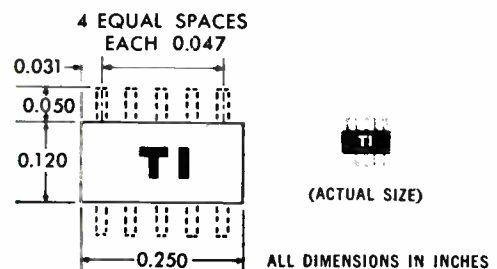
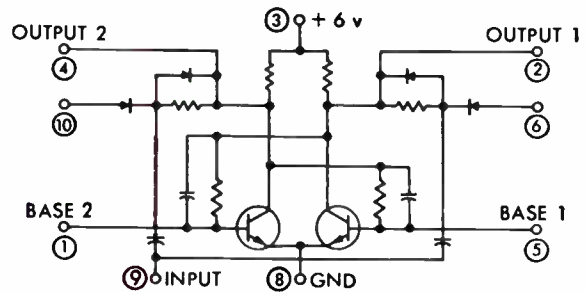

TEXAS  INSTRUMENTS  
INCORPORATED

SEMICONDUCTOR COMPONENTS DIVISION

POST OFFICE BOX 312 · DALLAS, TEXAS

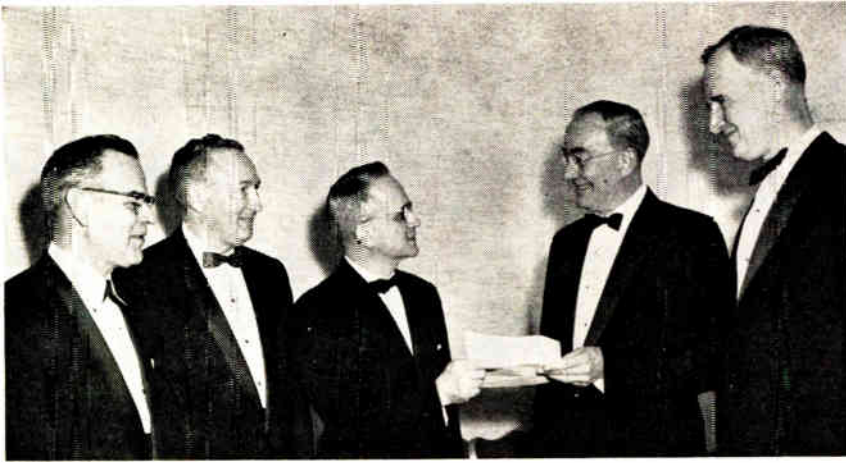

Three members of the Washington, D. C., Section received Patron Awards for "distinguished service" to the Section at the Annual Banquet on February 13, 1960. *Left to right:* Stuart L. Bailey, President, Jansky and Bailey; Leland D. Whitlock, Head Engineer, Communications Branch, Bureau of Ships, Navy Department; John Durkovic, Chairman, Washington Section; Francis H. Engel, Assistant to the Vice President, RCA Defense Electronics; and Dr. Ronald L. MacFarlan, IRE President, 1960.

## RECORD ATTENDANCE AT 1960 SOLID-STATE CIRCUITS CONFERENCE

Over 3000 attended the recent 1960 International Solid-State Circuits Conference which was held on the campus of the University of Pennsylvania and at the Sheraton Hotel in Philadelphia, Pa.

Among those in attendance were scores of solid-state specialists from abroad—Japan, Italy, France, Sweden, Hungary, Switzerland, England and the Netherlands.

Honored guests included Leo Esaki of tunnel-diode fame; M. J. O. Strutt, chairman, Electrical Engineering Department, Swiss Federal Institute of Technology, and C. Guy Suits, Vice President and Director of Research, General Electric Company, the latter delivering invited addresses at the formal opening of the meeting.

A tribute was paid to the late Dudley Buck during an afternoon memorial session.

A complete conference report—100-page-letterpress-book with over 300 illustrations—covering the 43 papers presented, was distributed to all registrants. Post-conference copies of this text, officially known as the Digest of Technical Papers, are available from Henry G. Sparks, Moore School of Electrical Engineering, University of Pennsylvania, Philadelphia 4, Pa., at \$5.00 per copy. Remittance to be made out to "Solid-State Circuits Conference."

## PURDUE UNIVERSITY TO HOST ANNUAL CONVENTION ON ENGINEERING EDUCATION

The fact that engineering education is currently in a state of change is reflected in the program which the American Society for Engineering Education has planned for its 68th annual convention at Purdue University June 20 through 24, 1960.

This largest and most significant meeting of the year, between educators and the engineers and employers of engineers in industry,

will begin with an address by President Frederick L. Hoyde of Purdue on his philosophy of the total education of the engineer. Some 45 general sessions and special conferences will follow during the week, in addition to numerous luncheons, dinners, and entertainment features.

Sessions will be held on "Methods of Teaching Electrical Engineering," "The Impact of Digital Computers on Engineering Education," and the EE and IRE Divisions will hold an extended workshop on "Solid State Electronics."

Of special note will be a general session by the Relations With Industry Division on Wednesday, June 22, on "Long Range Education and Development of the Engineer." Addresses will be given by Dr. Carl W. Borgmann, of the Ford Foundation; P. E. Haggerty, president of the Texas Instrument Company; Will Mitchell, Jr., associate research director of Allis Chalmers; and E. C. Koerper, consulting engineer.

A joint session by the Aeronautical Engineering, Mathematics and Physics Divisions will have as its theme "The Impact of New Technologies."

The currently live topic of high school preparation for college will be the subject of a major session to be presided over by Dr. A. R. Spalding, head of the Purdue department of freshman engineering, which receives some 2000 freshmen from secondary schools each year.

The Mechanics Division will feature a critical examination of "Substance and Objectives of Typical Curricula in Engineering Mechanics, Engineering Science, and Engineering Physics" by a panel consisting of Dr. Fred Lindvall, chairman of engineering at California Institute of Technology; Dr. Paul Chenea, head of the School of Mechanical Engineering at Purdue; Dr. J. H. Meier of General Electric; and Dr. Charles E. Taylor, of the University of Illinois.

Other major topics include "An Evaluation of Cooperative Education," "A National Survey of Technical Institute Education," and "The Future of Industrial Engineering."

For reservations and a complete program, address Prof. Mark Roberts, Engineering Administration, Purdue University, Lafayette, Ind.

## TELEMETERING CONFERENCE PROGRAM COMPLETED

The 1960 National Telemetry Conference will be held May 23-25, 1960 at the new Miramar Hotel in Santa Monica, Calif. The theme of this year's conference is "Telemetry—Tool for Industry and Defense." Sponsoring societies are the Instrument Society of America (ISA) which is the 1960 host, the American Rocket Society (ARS), the American Institute of Electrical Engineers (AIEE), the Institute of Aeronautical Sciences (IAS), and the Institute of Radio Engineers (IRE).

Seventy-one technical papers have been selected, and will be presented in panel form in 16 separate sessions running 3 sessions concurrently. In addition, two workshop sessions are scheduled. Session topics are:

### Monday Morning, May 23

- "Industrial Data Transmission Systems"
- "Bio-Medical Measurements"
- "Space Data Acquisition Systems"

### Monday Afternoon

- "General RF Components and Techniques"
- Missiles and Aircraft Telemetry Workshop—
- "R&D Needed in the 60's"
- "Data Processing and Presentation"—I

### Tuesday Morning, May 24

- "PCM Progress"
- "General—Transducers"
- "Ground Stations—New Components and Techniques"

### Tuesday Afternoon

- "Industrial Supervisory Control"
- "Missiles and Aircraft—Flight Data Systems"
- "Telemetry Techniques"—I

### Wednesday Morning, May 25

- "Data Processing and Presentation"—II
- "Missiles and Aircraft—Environment Measurement"
- "General Transistorization Progress"

### Wednesday Afternoon

- Industrial Telemetry Workshop—"What We Really Need Is . . ."
- "Telemetry Techniques"—II
- "Reliability in Telemetry"

The latest in telemetry equipment and techniques will be displayed by leading manufacturers for both commercial industry and the military. Over 66 exhibit booth spaces have been provided in a layout in two large halls which are near to the technical sessions. In addition to the banquet and cocktail party, several interesting tours are planned for both conferees and wives.

Additional information may be obtained by contacting the Conference Chairman, Hugh Pruss, 8345 Hayvenhurst Ave., Sepulveda, Calif.

## NEREM CALLS FOR PAPERS

Technical papers describing significant original contributions—focused on research



**USE  
THIS  
NEW**



**185A 500 MC oscilloscope**

**now for these important measurements:**

- Analyze millimicrosecond pulses
- Measure transistor response time
- Make fractional millimicrosecond time comparisons
- Measure diode switching time
- Determine pulse jitter
- Make permanent X-Y plots
- Measure memory-unit switching
- Measure uhf voltage amplitude

- Ⓢ 185A Sampling Oscilloscope with
- Ⓢ 187A Dual Trace Amplifier

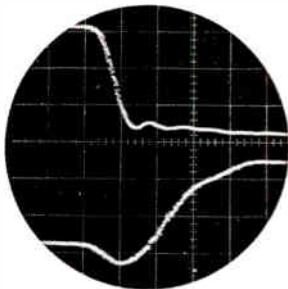
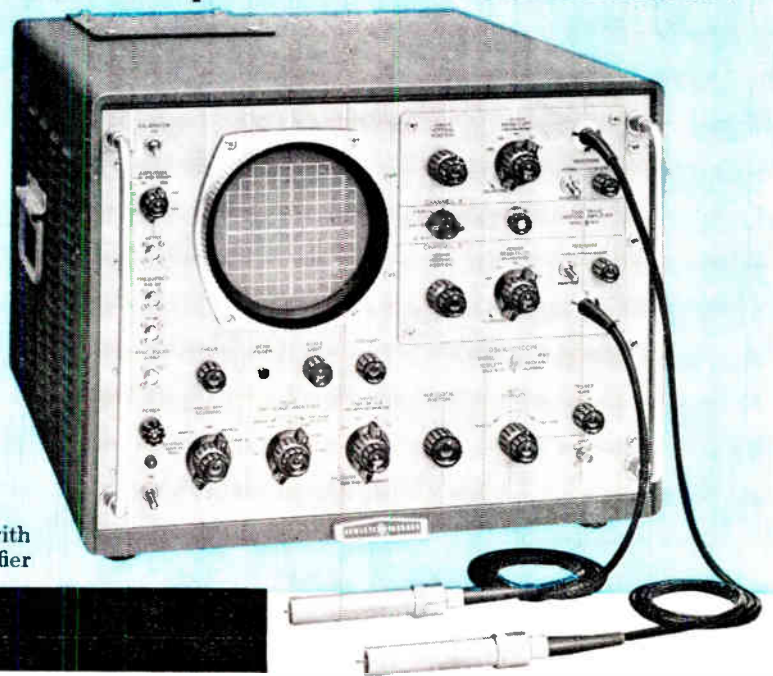

Bright, clear dual pulse presentation on *hp*-185A's big 5" scope face. Top trace shows pulse from mercury pulser applied to 2N1385 mesa transistor. Bottom trace shows responding turn-on of transistor. Dip in bottom trace at start of turn-on results from capacitance. Scope sweep speed is 1  $\mu\text{sec/cm}$ .

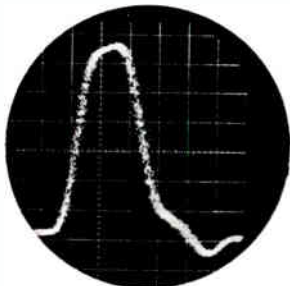

Brilliant, steady trace of a 2 millimicrosecond pulse on the 185A 5AQP cathode ray tube face.

**IMPORTANT FEATURES:** Less than 0.7  $\mu\text{sec}$  rise time. 500 MC pass band; bright steady traces even at rep rates down to 50 cps. Sensitivity 10 mv/cm to 200 mv/cm; vernier increases sensitivity to 3 mv/cm. Sweep times 10  $\mu\text{sec/cm}$  to 100  $\mu\text{sec/cm}$  with expander to 0.1  $\mu\text{sec}$ . Front panel delayed sync pulse for triggering circuits under test. Dual channel input. 10 cm vertical display. High sensitivity, wide dynamic range. 100,000 ohm probe minimizes circuit disturbance. X-Y recorder output. Time-amplitude calibrators, beam finder, panel similar to conventional scopes. Built-in time and amplitude calibrators.

**FOR COMPLETE DETAILS** of this totally new, easy-to-use instrument, call your Ⓢ representative or write direct.

Ⓢ 185A 500 MC Oscilloscope, \$2,000.00

Ⓢ 187A Dual Trace (plug-in) Amplifier, \$1,000.00

*Data subject to change without notice. Prices f.o.b. factory*

**HEWLETT-PACKARD COMPANY**

1026D Page Mill Road, Palo Alto, California, U.S.A.

Cable "HEWPACK" Davenport 6-7000

**HEWLETT-PACKARD S. A.**

Rue du Vieux Billard No. 1, Geneva, Switzerland

Cable "HEWPACKSA" Tel. No. (022) 26. 43. 36

over 300 fast, accurate measuring instruments

and development—are invited for presentation at the 1960 Northeast Electronics Research and Engineering Meeting (NEREM) which will be held on November 15, 16, 17, 1960, in the Commonwealth Army and the Sheraton-Plaza Hotel, Boston, Mass.

This year's meeting will project a marked departure in technical program format, scope and size, as well as type and number of exhibits. The program will feature many invited state-of-the-art tutorial sessions, with related evening informal discussion periods.

All registrants will receive, free-of-additional charge, a copy of the NEREM Record, a printed 200-page conference report with 600-1000 word digests (supported by drawings and photographs) of every paper presented at the meeting. Illustrated profiles of every NEREM speaker will also be included in the Record.

A suggestive, but not inclusive, list of subject areas for NEREM 1960 is: Antennas; Circuit Theory; Components, Production Techniques and Reliability; Electronic Computers; Engineering Management; Feedback Control Systems; Information Theory and Processing; Biomedical Electronics; Microwave Devices—Theory and Techniques—Involving Ferrites, Masers, Parametric Amplifiers and Ionized Media; Military Electronics Including Inertial, Infrared and Data-Handling Systems; Semiconductor Devices and Circuits Including Micro-Circuitry and Photo Electronic Applications.

To permit the development of well-integrated technical sessions, speakers are requested to furnish either complete papers or 400-500 word abstracts, in triplicate, plus 50-word summaries for advance program mailings.

All material should be mailed on or before July 15, 1960 to the 1960 NEREM Program Chairman, J. H. Mulligan, Jr., Dept. of Electrical Engineering, New York University, New York 53, N. Y. Authors will be notified of paper acceptance or rejection by August 15, 1960.



1922 receiver demonstrated at IRE Section Annual Banquet—The operation of the "Azzola Sr. Receiver," a Westinghouse Product, is demonstrated by Captain W. F. Kirlin, Chairman of the Northwest Florida Section of the IRE, to Dr. R. L. McFarlan, International President of the IRE, and General R. H. Warren, Vice Commander, APGC. Ralph Cor. (left) Section Vice-Chairman, and Harold Huinagle (right), Section Secretary-Treasurer, look on.

#### MAY SCHEDULE PLANNED BY AIR FORCE MARS

The following is the schedule of the Air Force MARS Eastern Technical Net (3295 kc, 7540 kc, and 15,715 kc, on Sundays from 2 to 4 P.M. EST):

- May 1 "Quality Control Techniques," A. Stein, Statistical Engineer, Riverside Plastics Corp.
- May 8 "Medical Electronics in Gastro-Intestinal Research," Dr. J. T. Farrar, Chief, Gastro-Neurology Section of the Veterans' Hospital of

New York and R. Bostrom, Research Engineer, Airborne Instruments Lab.

- May 15 "The Evolution of Modern Radar," Dr. N. J. Nilsson, Chief, Directorate of Control and Guidance, Advanced Developments Lab., Rome Air Development Center, USAF.
- May 22 "Air Crew Escape Systems," Discussion by engineers from Frankford Arsenal, USAF.
- May 29 "Materials," Discussion by engineers from Frankford Arsenal, USAF.

## 1960 IRE 7th Region Conference

OLYMPIC HOTEL, SEATTLE WASH., MAY 24-26, 1960

The cocktail party, to be held May 24 in the Olympic Hotel, Seattle, Wash., is the traditional opening of the IRE 7th Regional Conference. The All-Industry Luncheon will also be held on May 24, in the Spanish Ballroom of the Olympic Hotel.

On May 25 a field trip will be conducted to the Transport Division of the Boeing Airplane Company, Renton, Wash. This will provide views of the following: the factory, flight line (radar test), electronic shops (radar checkout), electronic mock-up landing simulator, computer—IBM 704 (evaluation of flight situations), and airplane mock-up, both present and future.

Women's activities, under the direction of Mrs. Frank S. Holman, will include a reception and several cruises and excursions to interesting sites in the area.

#### Session 1—Opening General Session

Tuesday Morning, May 24

Chairman: O. G. Villard, Jr., Stanford Univ., Stanford, Calif.

Speakers: F. S. Holman, Chairman, 7th Region Conference, Boeing Airplane Co., Seattle, Wash.; R. L. McFarlan, President, IRE; R. N. Clark, Univ. of Washington, Seattle; O. G. Villard, Jr., Stanford Univ., Stanford, Calif.

#### Session 2

##### Control Systems I—Performance Criteria

Tuesday Afternoon

Chairman: G. F. Franklin, Stanford Univ., Stanford, Calif.

Co-Chairman: F. C. Fickeisen, Boeing Airplane Co., Seattle, Wash.

"Optimum Performance Criteria with a

Minimum Lead System," G. S. Axelby, Westinghouse Corp., Baltimore, Md.

"Consideration in the Design of Feedback Control Systems with Optimum Performance," R. L. Cosgriff and E. J. Hagin, Ohio State Univ., Columbus.

"Optimum Control System with Minimum Spectral Bandwidth," J. C. Hung, New York Univ., New York, N. Y.

"Performance Measures—Past, Present, and Future," W. C. Schultz, Cornell Aero Lab., Buffalo, N. Y., and V. C. Rideout, Univ. of Wisconsin, Madison.

#### Session 3

##### Solid State Electronics I—Semiconductors

"Negative Resistance Processes in Semiconductors," R. E. Burgess, University of



# PRD's brand new Broadband Attenuators

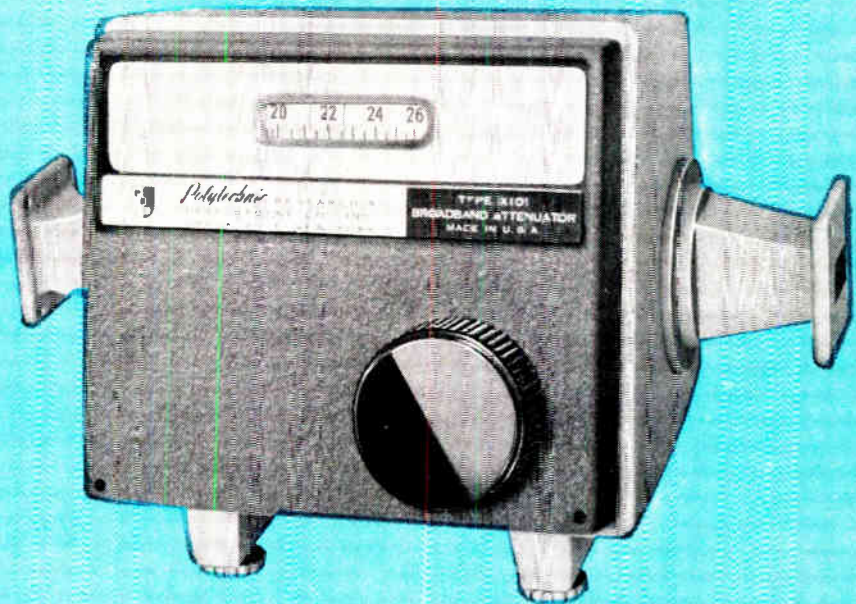

## FEATURES:

- Short insertion length
- Full 60 db attenuation range
- *Minimum* insertion loss
- Compact Tape readout
- Precision accuracy

Once again, to meet the present and future needs of microwave engineers, PRD has produced a completely new concept in test equipment. Here is a *rotary vane attenuator* in a radically modern package: small, light, rugged ...and *precise*—to fill all your needs from 3.95 to 40 kmc. The 101 series of Broadband Attenuators features a precise, compact, low-backlash drive and easy-to-read tape readout. Levelling screws quickly adjust to match transmission line heights. A simple adapter is available for panel mounting.

## SPECIFICATIONS:

VSWR: 1.15 maximum

Attenuation Range: 60 db

Accuracy:  $\pm 0.1$  db or  $\pm 2\%$ , whichever is greater, from 0 to 50 db;  $\pm 3\%$  from 50 to 60 db.

The table below indicates maximum insertion loss and dimensions.

Type No.	Freq. Range	Max. Insertion Loss	Insertion Length	Height	Depth
G 101	3.95 — 5.85	0.5 db	18 $\frac{7}{8}$	6 $\frac{5}{16}$	7 $\frac{3}{16}$
C 101	5.3 — 8.2	0.5 db	14 $\frac{1}{16}$	6 $\frac{3}{16}$	7 $\frac{3}{16}$
H 101	7.05 — 10.0	0.5 db	11 $\frac{1}{8}$	6 $\frac{3}{16}$	7 $\frac{3}{16}$
X 101	8.2 — 12.4	0.5 db	9	6 $\frac{1}{8}$	6 $\frac{1}{4}$
U 101	12.4 — 18.0	0.7 db	7 $\frac{1}{16}$	5 $\frac{1}{4}$	6 $\frac{1}{4}$
K 101	18.0 — 26.5	0.7 db	7 $\frac{3}{16}$	5 $\frac{1}{8}$	6 $\frac{1}{4}$
A 101	26.5 — 40.0	1.0 db	6 $\frac{3}{16}$	5 $\frac{1}{8}$	6 $\frac{1}{4}$

data subject to change without notice

To find out more about the new PRD 101 Series of Broadband Attenuators contact your local PRD representative, or phone, write, or wire:



**PRD ELECTRONICS INC.**  
A Subsidiary of Harris-Intertype Corporation

Formerly Polytechnic Research & Development Co., Inc.  
Factory and General Office: 202 Tillary Street, Brooklyn 1, New York, U1ster 2-6800  
Western Sales Office: 2639 So. La Cienega Blvd., Los Angeles 34, Calif., UPTon 0-1940

British Columbia, Vancouver, Canada.

"Recent Progress in the Development of High Frequency Transistors," *G. N. Hanson, Bell Telephone Labs., Allentown, Pa.*

"Some Aspects of Semiconductor Noise," *A. Van Der Ziel, Univ. of Minnesota, Minneapolis.*

"Maser Operation at Infrared and Optical Frequencies," *L. C. Levitt, Hughes Research Labs., Culver City, Calif.*

#### Session 4

##### Control Systems II—Optimal Design Techniques

Wednesday Morning, May 25

Chairman: *A. H. Koschmann, Univ. of New Mexico, Albuquerque.*

Co-Chairman: *R. M. Hubbard, Boeing Airplane Co., Seattle, Wash.*

"Performance Criteria in Adaptive Control," *C. W. Sarture and J. A. Aseltine, Space Technology Labs., Los Angeles, Calif.*

"Limit Cycle Efficiency of On-Off Reaction Control Systems," *G. W. Freeman, Boeing Airplane Co., Seattle, Wash.*

"Design Aspects of Attitude Control Systems," *M. F. Marx, General Electric Co., Schenectady, N. Y.*

"A Simulator Study of a Two-Parameter Adaptive System," *V. C. Rideout and R. J. McGrath, Univ. of Wisconsin, Madison.*

#### Session 5

##### Solid State Electronics II—Solid State Energy Conversion

#### Session 6

##### Electromagnetics I—Radio Astronomy

"Radio Emission from the Sun at Decametric Wavelengths," *J. W. Warwick, High Altitude Observatory Univ. of Colorado, Boulder.*

*B. S. Yaplee, Radio Astronomy Br., U. S. Naval Research Lab., Washington, D. C.*

*D. D. Cudaback, Electrical Engineering Dept. Stanford Univ., Stanford, Calif.*

*A. E. Lilley, Harvard College Observatory, Cambridge, Mass.*

#### Session 7

##### Control Systems III—Nonlinear and Sampled Data Systems

Wednesday Afternoon

Chairman: *R. E. Hanna, Douglas Aircraft Co., Santa Monica, Calif.*

Co-Chairman: *E. Noges, Univ. of Washington, Seattle.*

"Nonlinear Effects in Servo Control Systems," *R. B. Higley, Autonetics, Downey, Calif.*

"Control of Higher Order Systems Based on Time Optional Regulations," *F. B. Smith, Minneapolis Honeywell, Minneapolis, Minn.*

"An Error Minimization Technique for Sampled-Data Systems," *A. F. Engelbrecht and C. W. Steeg, Jr., Radio Corporation of America, Burlington, Mass.*

#### Session 8

##### Electromagnetics II—Very Large Aperture Antennas

"Radar Astronomy: A New Technique for the Study of the Solar System," *R. L. Lendabrand and R. B. Dyce, Stanford Research Inst., Menlo Park, Calif.*

"The Design and Operation of a Two-Mile Aperture Antenna," *W. C. Erickson, Convair Scientific Research Lab., San Diego, Calif.*

"Environmental Antenna Patterns," *J. F. Carpenter, Dalmo Victor Co., Division of Textron, Inc., Belmont, Calif.*

"The Ohio State 360 Foot Radio Telescope," *R. T. Nash, Radio Observatory, Dept. of Electrical Engineering, Ohio State Univ., Columbus.*

#### Session 9

##### Student Prize Paper Contest—IRE 7th Region Finals

Wednesday Evening

Chairman: *F. D. Robbins, Univ. of Washington, Seattle.*

#### Session 10

##### Engineering Management Symposium—Technical Management of Large Systems

#### Session 11

##### Control Systems IV—Biological Control Systems

Thursday Morning, May 26

"The Design of Man-Machine Systems by Means of Quantitative Analysis Tech-

niques of Human Factors Engineering," *O. H. Lindquist, Minneapolis-Honeywell, Minneapolis, Minn.*

"Control Systems Characteristics of the Respiratory System," *A. C. Young, Univ. of Washington, Seattle.*

"Relaxation and Transit Time Oscillations in the Heart," *J. W. Woodbury, Univ. of Washington, Seattle.*

#### Session 12

##### Electromagnetics III—Arctic Ionospheric Phenomena

"Distribution of Auroral Radar Disturbances in Alaska During the IGY," *R. S. Leonard, Geophysical Inst., College, Alaska.*

"Sweep-Frequency Backscatter Studies in the Auroral Zone," *H. F. Bates, Geophysical Inst., College, Alaska.*

"High Frequency Studies of the Arctic Ionosphere," *L. O'Brien and R. D. Hunsucker, Geophysical Inst., College, Alaska.*

"A High Latitude Study of Spread F Echoes," *Z. A. Ansari and L. O'Brien, Geophysical Inst., College, Alaska.*

#### Session 13

##### Solid State Electronics III—Magnetics and Dielectrics

Thursday Afternoon

"Ferroelectric Power Converters," *S. R. Hoh, IT and T Co., Nutley, N. J.*

"New Magnetic Devices for Digital Computers," *D. H. Looney, Bell Telephone Labs., Murray Hill, N. J.*

*L. Rimai, Raytheon Co., Waltham, Mass*

#### Session 14

##### Electromagnetics IV—Terrestrial Electromagnetic Effects

"Terrestrial Propagation of VLF Radio Waves," *J. R. Wait, National Bureau of Standards, Boulder, Colo.*

"Whistlers and Related Phenomena," *R. A. Helliwell, Radioscience Lab., Stanford Univ., Stanford, Calif.*

"Effects of Terrestrial Electromagnetic Disturbances on Wireline Communications," *R. Sanders, Hughes Aircraft Co., Culver City, Calif.*

"Fading of Radio Waves Vertically Incident Upon the Ionosphere," *D. H. Schrader and H. M. Swarm, Dept. of Electrical Engineering, Univ. of Washington, Seattle.*

## Fourth National Convention on Military Electronics

SHERATON PARK HOTEL, WASHINGTON, D.C., JUNE 27-29, 1960

A panel discussion on military research and development will highlight the opening session of the 4th National Convention on Military Electronics (MIL-E-CON 1960) which will be held again this year in Washington, D.C. on June 27-29. This annual meeting is sponsored by the Professional Group on Military Electronics.

Dr. Jerrold R. Zacharias, Professor of Physics at the Massachusetts Institute of Technology, will moderate the discussion by officers from the three military services, in-

cluding Vice Admiral John T. Hayward, USN, Deputy Chief of Naval Operations (Development) and Major General Leighton I. Davis, USAF, Assistant Deputy Chief of Staff, Development, U.S. Air Force.

The technical program includes 25 sessions, 20 of which will be unclassified. The Air Force Research and Development Command will sponsor five classified sessions at MIL-E-CON 1960; security clearance is required for attendance at these classified meetings. Printed copies of the 1960 *Con-*

*ference Proceedings*, containing the unclassified papers, will be distributed free of charge to each registrant.

Exhibits of the latest in military components and equipment will fill the exhibit areas of the Sheraton-Park Hotel. The exhibits will run concurrently with the technical sessions.

On the social side, there will be a Keynote Luncheon on Monday, June 27, a buffet and entertainment Monday evening, a Ladies' Breakfast on Tuesday, and the Au-



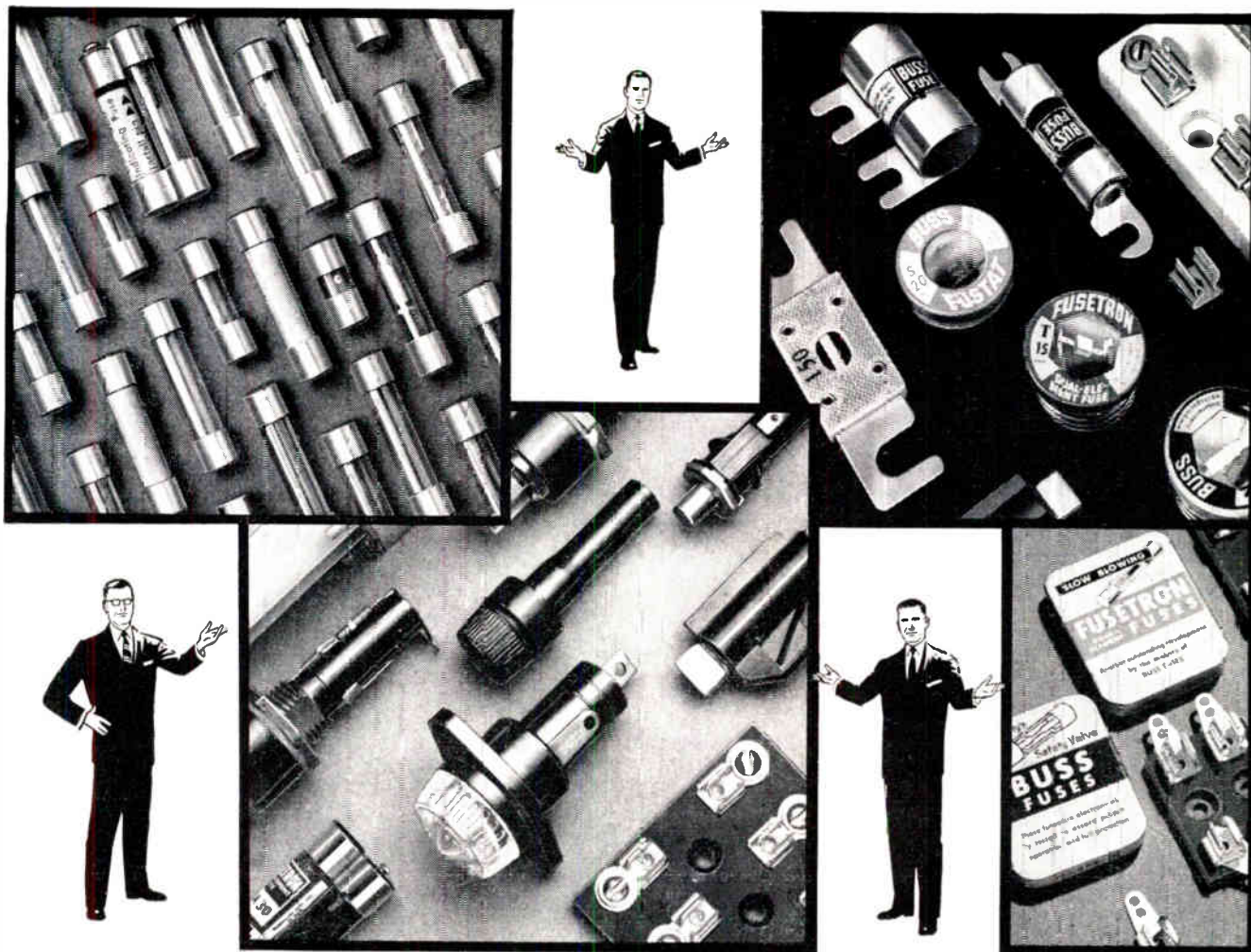

# Here are the plain facts!

*... why it pays to specify and use dependable  
BUSS FUSES*

**IT'S A FACT!** By specifying BUSS fuses, you obtain the finest electrical protection possible — and you help safeguard the reputation of your product for quality and reliability.

**IT'S A FACT!** BUSS fuses have provided dependable electrical protection under all service conditions for over 45 years—in the home, in industry and on the farm.

**IT'S A FACT!** To make sure BUSS fuses will give your equipment maximum protection, every one made is tested in a sensitive electronic device. Any fuse not correctly calibrated, properly constructed and right in all physical dimensions is automatically rejected.

**IT'S A FACT!** Whatever your fuse requirements, there's a dependable BUSS or FUSETRON fuse to satisfy them. Sizes from 1/500 ampere up and there's a companion line of fuse clips, blocks and fuseholders.

**IT'S A FACT!** The BUSS fuse engineering staff will work with you to help you find or develop the best-suited to your needs. This places the world's largest fuse research laboratory and its personnel at your command to save you engineering time.

*For more information on BUSS and FUSETRON Small Dimension fuses and fuseholders, write today for Bulletin SFB.*

BUSSMANN MFG. DIVISION, McGraw-Edison Co. University at Jefferson, St. Louis 7, Mo.

560

*BUSS fuses are made to protect - not to blow, needlessly.*

*BUSS makes a complete line of fuses for home, farm, commercial, electronic, electrical, automotive and industrial use.*



meal Banquet Tuesday evening, featuring a prominent guest speaker and the presentation of the Barry M. Carlton Award. The Washington Chapter of PGMIL will be the host at the Keynote Luncheon, with Major General Earle F. Cook, USA, Deputy Chief Signal Officer, as the speaker. Dr. Edward G. Witting, Deputy Director of Research and Development, Office of the Secretary of the Army, and chairman of the Washington Chapter, PGMIL will be the master of ceremonies at this luncheon. A meeting of the Administrative Committee of PGMIL is scheduled for Tuesday morning.

Advance registration fees, which include the *Conference Proceedings*, are \$2 for IRE members, \$3 for nonmembers, and \$1 for students. Deadline for advance registration is June 1. At-the-door registration fees will be \$4 for IRE members, \$5 for nonmembers, and \$1 for students. Tickets for the luncheon are \$3.50; for the Ladies' Day Breakfast, \$2; for the buffet \$5; and for the banquet, \$10. Tables seating eight may be reserved for the banquet at \$80 each. Mr. Jack Carter, Jansky & Bailey, Inc., 3269 M Street, N. W., Washington 7, D.C., is chairman of the Registration Committee.

Robert H. Cranshaw, Manager, Advanced Space Products, General Electric Company, Utica, New York, is President of MIL-E-CON 1960. Dr. Craig M. Crenshaw, Chief Scientist, Office of the Chief Signal Officer, Department of Defense (Army), is Chairman of the Technical Program Committee.

### Monday Afternoon, June 27

#### Session 1.1—Reconnaissance and Ranging I (Confidential)

Sponsor: Air Research and Development Command.

Moderator: *To be announced.*

"Experimental Evaluation of a Diversity Radar," P. W. Crist, *Airborne Instruments Lab., Melville, N. Y.*

"Radar Density Related to Tactical Troop Concentrations," R. T. Stefanik, G. C. Arrossmith, and G. A. Pitsenbarger, *Sylvania Electronic Defense Lab., Mountain View, Calif.*

"Instrumentation System for Three-Dimensional Tracking of Underwater Missiles," C. S. Soliozy and J. M. Formwalt, *U. S. Naval Underwater Ordnance Station, Newport, R.I.*

"ITT Secure Ranging and Communication System," A. E. Nashman, *ITT Labs., Nutley, N. J.*

"Identification and Evaluation of Magnetic Field Sources Associated with Magnetic-Anomaly Detector Equipped Aircraft," P. Leliak, *The Martin Co., Baltimore, Md.*

"Inertialess Scanning and Tracking Radar (INSTAR)," J. R. Karp, *The W. L. Maxson Corp., New York, N. Y.*

#### Session 1.2—Satellite Electronics

Moderator: *To be announced.*

"A Satellite Microwave Telemetry Oscillator Using Traveling-Wave Tube Techniques," L. A. Roberts, *Watkins-Johnson Co., Palo Alto, Calif.*

"Application of Microminiaturization Concepts to Space Guidance Computers," E. Keonjiam, *American Bosch Arma Corp., Hempstead, N. Y.*

"Criteria for the Optimum Design of Active Satellite Communication Systems,"

A. R. Giddis, *Philco Western Development Lab., Palo Alto, Calif.*

"Satellite Ionosounder," S. Horowitz, *AF Cambridge Research Center, Bedford, Mass., and L. Humphrey, General Electric Co., Ithaca, N. Y.*

"Satellite Reliability Achieved Through Comprehensive Environmental and Functional Testing," J. A. Chambers, *U. S. Army Ordnance Missile Command, Redstone Arsenal, Ala.*

"A Compact UHF Diplexer for Applications Involving Rockets or Satellites," S. E. Parker, *Hughes Aircraft Co., Culver City, Calif.*

#### Session 1.3—Microwave Devices and Techniques

Moderator: G. R. Kilgore, *Westinghouse Electric Corp., Baltimore, Md.*

"Status of Ultra-Low-Noise Traveling-Wave Tubes and Beam-Type Parametric Amplifiers," K. Kotzebue, B. P. Israelsen and G. E. St. John, *Watkins-Johnson Co., Palo Alto, Calif.*

"New Microwave Devices with Bulk Semiconductors," H. Jacobs, F. A. Brand, M. Benanti, J. Meindl, and R. Benjamin.

"Phase Stable Limiting Amplifiers Using Beam Deflection Tubes," E. R. W'ingrove, Jr., *General Electric Co., Syracuse, N. Y.*

"Applications of Traveling Wave Tubes to Microwave Circuits," G. E. Austin, *Sylvania Electronic Defense Lab., Mountain View, Calif.*

"Recent Electronic Scanning Developments," J. P. Shelton and K. S. Kelleher, *Aero Geo Astro Corp., Alexandria, Va.*

"Practical Stripline Component Design," T. T. Norwood, *Hughes Aircraft Co., Culver City, Calif.*

#### Session 1.4—Instrumentation

Moderator: *To be announced.*

"The Pulsed Light Theodolite," L. A. Jay, *U. S. Army Electronic Proving Ground, Fort Huachuca, Ariz.*

"Multiple High-PRF Ranging," D. H. Mooney and W. A. Skillman, *Westinghouse Electric Corp., Baltimore, Md.*

"Recent Achievements in Missile-Borne Magnetic Tape Recorders," M. M. Siera, *Lockheed Aircraft Corp., Palo Alto, Calif.*

"Hit Indicator Techniques for Direct Fire Weapons," H. Chaskin, *U. S. Naval Training Device Center, Port Washington, N. Y.*

"Effects of Atmospheric Pollutants on Electronic Equipment," H. C. McKee, *Southwest Research Inst., San Antonio, Texas.*

"A Delay-Line Synthesized Filter Bank with Electronically Adjustable Impulsive Response," H. J. Bickel and E. Brookner, *Federal Scientific Corp., New York, N. Y.*

#### Session 1.5—Noise Effects on Precision and Data

Moderator: *To be announced.*

"0.1% Accuracy Variable Speed Control System," M. Hartman, *Fairchild Camera and Instrument Corp., Syosset, L. I., N. Y.*

"Pulse Operation of DC Servo Motors for Lower Thresholds," D. J. Salonimer and W. E. Yoakum, *Guided Missile Agency, Redstone Arsenal, Ala.*

"A Mathematical Analysis of Transients Caused by AGC Reset in Line Switching Amplifier as Used in AN/MSQ-18 (Missile

Monitor) Equipment," *1st. Lt. R. A. Perry and SP-4 J. M. Dugan, U. S. Army Air Defense Board, Fort Bliss, Texas.*

"An Analogue Computer for Separating Evoked Physiological Potentials from Background Noise," W. Korpf, R. Robinson and J. C. Armington, *Walter Reed Army Inst. of Res., Washington, D. C.*

"Precision Frequency Measurement of Noisy Doppler Signals," W. A. Dean, *Balistic Measurements Lab., Aberdeen Proving Ground, Md.*

"Output Signal-to-Noise Characteristics of Correlators," B. R. Mayo and D. K. Cheng, *General Electric Co., Syracuse, N. Y.*

### Tuesday Morning, June 28

#### Session 2.1—Communications and Data Handling (Confidential)

Sponsor: Air Research and Development Command.

Moderator: F. Brady, *Research and Development Div., Office of The Chief Signal Officer, Dept. of the Army, Washington, D. C.*

"Engineering Analysis of Qualitative Data to Provide a Missile System for Simulation and Vulnerability Studies," N. Johnson, *Sylvania Electronic Defense Lab., Mountain View, Calif.*

"Spasur Automatic Digital Data Assembly System, Part I—The Digital Data Transmission Problem, Part II—Description of the Digital System," W. B. Poland, Jr., *U. S. Naval Research Lab. and M. S. Maxwell, and J. Pinker, U. S. Naval Weapons Lab., Dahlgren, Va.*

"Simulation by Interpretation," F. W. Sinn, Jr. and J. J. Wolf, *Burroughs Corp., New York, N. Y.*

"A Transistorized Digital Range Unit," R. M. Lucas, *Bell Telephone Labs., Inc., Whippany, N. J.*

"Pacific Missile Range Communications," S. H. Vogt, *Dept. of the Navy, Washington, D. C.*

"Evaluation of Video and IF MTI Cancellation Techniques," E. C. Nordell, *General Electric Co., Deshitt, N. Y.*

#### Session 2.2—Communications I

Moderator: *To be announced.*

"Military Applications for Speech Compression Techniques," A. J. Strassman, *Hughes Aircraft Co., Los Angeles, Calif.*

"Instrumentation Used for Ionosphere Electron Density Measurements," W. J. Cruickshank, *Ballistic Research Lab., Aberdeen Proving Ground, Md.*

"Electron Density Measurements in Hypersonic Projectile Trails," R. S. Hebbert, *U. S. Naval Ordnance Lab., White Oak, Silver Spring, Md.*

"Topology Engineering of Communication Networks," Dr. K. Ikrath and C. C. Comstock, *Hqs. U. S. Army Signal Res. and Dev. Lab., Fort Monmouth, N. J.*

"Frequency Selection," H. R. Smith, *Sierra Vista, Ariz.*

"The Economic Design of Radio Communication Systems by Matching the Message Urgency to the Fading Conditions," L. P. Yeh, *Page Communications Engineers, Inc., Washington, D. C.*

#### Session 2.3—Reliability

Moderator: *To be announced.*

"Serviceability: Complement to Reliability," R. H. Wilcox and Cdr. V. R. Wanner, *Office of Naval Res., Washington, D. C.*



It could  
happen...

with

**El-Menco**  
CAPACITORS!

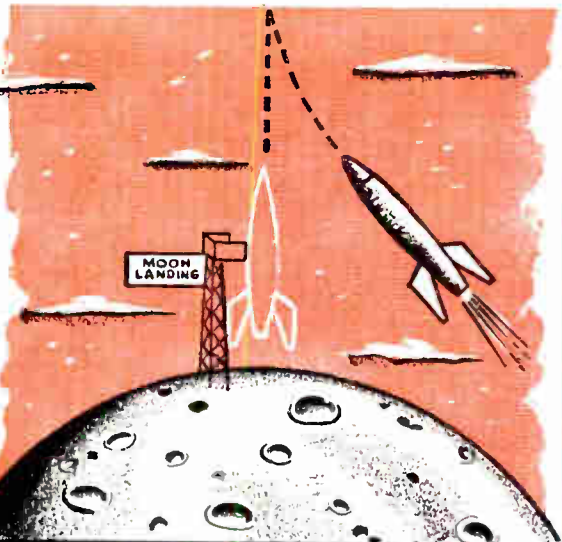

**NEW**

*Mylar-Paper Dipped*

**CAPACITORS**

**TYPE  
MPD**

**INSURE FAILURE-PROOF PERFORMANCE!**

Only 1 Failure in 7,168,000 Unit-Hours for 0.1 MFD Capacitors\*

**Setting a new standard of reliability!**

\*Life tests have proved that El-Menco Mylar-Paper Dipped Capacitors — tested at 100°C with rated voltage applied — have yielded a failure rate of only 1 per 716,800 unit-hours for 1 MFD. Since the number of unit-hours of these capacitors is inversely proportional to the capacitance, 0.1 MFD El-Menco Mylar-Paper Dipped Capacitors will yield **ONLY 1 FAILURE IN 7,168,000 UNIT-HOURS.**

**SPECIFICATIONS**

- **TOLERANCES:** ±10% and ±20%. Closer tolerances available on request.
- **INSULATION:** Durez phenolic resin impregnated.
- **LEADS:** No. 20 B & S (.032") annealed copper-weld crimped leads for printed circuit application.
- **DIELECTRIC STRENGTH:** 2 or 2½ times rated voltage, depending upon working voltage.
- **INSULATION RESISTANCE AT 25°C:**  
For .05MFD or less, 100,000 megohms minimum.  
Greater than .05 MFD, 5000 megohm-microfarads.
- **INSULATION RESISTANCE AT 100°C:**  
For .05MFD or less, 1400 megohms minimum.  
Greater than .05MFD, 70 megohm-microfarads.
- **POWER FACTOR AT 25°C:**  
1.0% maximum at 1 KC.

**SUPERIOR FEATURES!**

● Five case sizes in working voltages and ranges:

200 WVDC —	.018 to .5 MFD
400 WVDC —	.0082 to .33 MFD
600 WVDC —	.0018 to .25 MFD
1000 WVDC —	.001 to .1 MFD
1600 WVDC —	.001 to .05 MFD

Write for Technical Brochure Giving Complete Information on the El-Menco Tubular Dur-Paper Line.

THESE CAPACITORS WILL EXCEED ALL THE ELECTRICAL REQUIREMENTS OF E.I.A. SPECIFICATION RS-164 AND MILITARY SPECIFICATIONS #MIL-C-91A AND MIL-C-25A.

FOR FAILURE-PROOF PERFORMANCE... COUNT ON EL-MENCO MYLAR-PAPER DIPPED CAPACITORS... FROM MISSILE GUIDANCE SYSTEMS TO DATA PROCESSING EQUIPMENT!

\*Registered Trade Mark of DuPont Co.

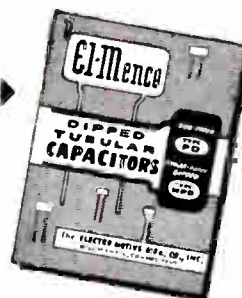

**THE ELECTRO MOTIVE MFG. CO., INC.**  
WILLIMANTIC CONNECTICUT

Manufacturers of El-Menco Capacitors

- molded mica ● dipped mica ● mica trimmer ● dipped paper
- tubular paper ● ceramic ● silvered mica films ● ceramic discs

Arco Electronics, Inc., 64 White St., New York 13, N. Y.  
Exclusive Supplier To Jobbers and Distributors in the U.S. and Canada

"Reliability Anatomy for System Design Engineers," E. S. Winlund, *General Electric Co., Phoenix, Ariz.*

"A Complete Reliability Analysis of a One-Unit System," R. E. Barlow and L. C. Hunter, *Sylvania Electronic Defense Lab., Mountain View, Calif.*

"Statistical Pitfalls for the Reliability Engineer," G. H. Beckhart, *Radio Corp. of America, Moorestown, N. J.*

"The Use of IBM Cards to Predict, Control, and Measure Reliability of a Missile Electronics Unit," G. F. Dolan, *Hughes Aircraft Co., Culver City, Calif.*

"System Improvement Through Failure Effect and a Reliability Model," G. E. Unruh, *Paramount Electronics, Inc., Hicksville, N. Y.*

#### Session 2.4—Antennas

Moderator: Dr. W. J. Otting, Jr., *Director of Physical Sciences, Air Force Office of Scientific Res., Washington, D. C.*

"Ferromagnetic Antennas," R. New, *American Electronic Labs., Inc., Lansdale, Pa.*

"Effect of Antenna Phase Pattern on Doppler System Operation," H. S. Rothman and W. E. Scharfman, *Stanford Research Inst., Menlo Park, Calif.*

"A Generalized Analysis of Electronic Antenna Beam Steering," P. D. Kennedy, *Lockheed Aircraft Corp., Sunnyvale, Calif.*

"The Effect of Field Wire Stability on the Maximum Length of Loop," N. W. Feldman and G. P. Tripp, *Hqs. U. S. Army Signal Research and Development Lab., Fort Monmouth, N. Y.*

"The Shroud Antenna for High Speed Missiles," V. W. Richard, *Ballistic Research Lab., Aberdeen Proving Ground, Md.*

"Ring Arrays," W. D. Nelson, *General Electric Co., East Dewitt, N. Y.*

#### Session 2.5—Ranging, Tracking and Reconnaissance

Moderator: Dr. J. A. Boyd, *Director, Willow Run Labs., University of Michigan, Ann Arbor, Mich.*

"A Continuous Wave Range System," F. C. Lanza, *Philco Corp., Palo Alto, Calif.*

"An Experimental Study of Monopulse Technique for Ground Clutter Discrimination," S. Y. Chang and V. Stabilito, *U. S. Army Ordnance, Frankford Arsenal, Philadelphia, Pa.*

"Tracking Research at the Naval Training Device Center," G. Micheli, *U. S. Naval Training Device Center, Port Washington, N. Y.*

"On the Tracking and Geodetic Potentialities of a Doppler Rate Measuring System," D. C. Brown, *RCA Service Co., Patrick Air Force Base, Fla.*

"Instrumentation Error Analysis of the AMR Missile Tracking System," B. U. Glass, *RCA Service Co., Patrick Air Force Base, Fla.*

"Statistical Method of Calculating Measurement Errors in Ranging and Tracking Checkout Systems" L. G. Larson, *Philco Corp., Palo Alto, Calif.*

#### Tuesday Afternoon

##### Session 3.1—Guidance and Space Technology (Confidential)

Sponsor: Air Research and Development Command.

Moderator: *To be announced.*

"Integrated Design of Antennas for Ballistic Missiles and Space Vehicles," D. A. Alsberg, *Bell Telephone Lab., Inc., Whippany, N. J. and H. W. Redlien, Wheeler Lab., Great Neck, L. I., N. Y.*

"The Space Surveillance System," Dr. C. E. Cleeton, *U. S. Naval Research Lab., Washington, D. C.*

"Orbit Determination for Passive Satellite Detection," R. B. Patton, Jr., *Ballistic Research Lab., Aberdeen Proving Ground, Md.*

"Evaluation of Reliability Prediction Techniques of the Electronics System of the Falcon Missile," F. A. Barta, *Hughes Aircraft Co., Culver City, Calif.*

"Reflections from Meteor Trails Meteorite Experiment," D. Lynch and C. A. Bartholomew, *U. S. Naval Research Lab., Washington, D. C.*

"A Proposed 24-Hour Communications Satellite System," J. Y. Michaels, G. N. Krassner and J. E. Bartow, *U. S. Army Signal Res. and Dev. Lab., Fort Monmouth, N. J.*

##### Session 3.2—Data Handling II

Moderator: *To be announced.*

"Research and Development of New Computer Programming Techniques Required for Mechanization of Machine Learning," Dr. R. E. Smith, *Control Data Corp., Minneapolis, Minn.*

"Pattern Recognition," J. W. Bronillette and C. W. Johnson, *General Electric Co., Syracuse, N. Y.*

"New Techniques in Residual Arithmetic," M. R. Levine and J. Marx, *American Bosch Arma Corp., Hempstead, N. Y.*

"A Note on the Applicability of Error-Correcting Codes," J. E. Palmer, *Radio Corp. of America, Camden, N. J.*

"A Real Time Telemetry Data Transmission System," H. E. Rennacker, *Collins Radio Co., Burbank, Calif.*

"Computer Controlled Automatic Diagnostic and Checkout System for Field Use," R. J. Brachman, *Frankford Arsenal, Philadelphia, Pa.*

##### Session 3.3—Special Electrical Components

Moderator: *To be announced.*

"Some Aspects of Tunnel Diode Applications," T. O. Krueger, *U. S. Army Signal Res. and Dev. Lab., Fort Monmouth, N. J.*

"The 'Rayistor' an Electrical Transformer Using Optical Coupling," J. C. Davis, Jr., *Raytheon Co., Bedford, Mass.*

"Thin Film Components Based on Tantalum," R. W. Berry and N. Schwartz, *Bell Telephone Lab., Inc., Murray Hill, N. J.*

"Non Steady-State Thermoelectric Generators," S. R. Hawkins, *Lockheed Aircraft Corp., Sunnyvale, Calif.*

"New Developments in the Field of Military Quartz Crystals," G. K. Guttwain, *U. S. Army Signal Res. and Dev. Lab., Fort Monmouth, N. J.*

##### Session 3.4—Radar

Moderator: *To be announced.*

"Precision Recording of Radar Operation," C. M. Redman, *Hq, White Sands Missile Range, N. M.*

"System Evaluation of Low Noise Radar Sensitivity," S. Charlton and G. Ver Wys, *Radio Corp. of America, Moorestown, N. J.*

"The Implementation of the Integrated Mapping System," J. Boyajean, *Fairchild Camera and Instrument Corp., Syosset, L. I., N. Y.*

"A Flush-Mounted VHF Telemetry Antenna with Hemispherical Coverage," R. C. Payne and P. Painter, Jr., *Dynatronics, Inc., Orlando, Fla.*

"The Limitations of Angular Radar Resolution," Dr. E. Eichler, *U. S. Army Ordnance, Frankford Arsenal, Philadelphia, Pa.*

"Internal Ballistic Measuring System," L. Adelson, *Picalinny Arsenal, Dover, N. J.*

#### Session 3.5—Simulation General

Moderator: Dr. R. A. Weiss, *Scientific Director, Army Research Office, Washington, D. C.*

"Space Simulation with High Gas Release Rates," W. W. Balwanz and J. M. Singer, *Naval Res. Lab., Washington, D. C.*

"Tank vs Tank Synthetic Gunnery Trainer," I. Friedland, *U. S. Naval Training Device Center, Port Washington, N. Y.*

"Radar Simulation," C. Colbert, *Westgate Lab., Inc., Yellow Springs, Ohio.*

"Mathematical Models of Multiple-Gimbal Systems," Dr. A. Rosenfeld, *Budd Lewyt Electronics, Inc., Long Island City, N. Y.*

"Optimization of Test Systems," J. C. O'Brien, *Cooper Development Corp., Monrovia, Calif.*

"Optimum Search Routines for Automatic Fault Location," S. I. Firstman, *The Rand Corp., Santa Monica, Calif., and B. Gluss, Armour Research Foundation of Illinois, Chicago.*

#### Wednesday Morning, June 29

##### Session 4.1—Electronic Generation, Switching and Radiation (Confidential)

Sponsor: Air Research and Development Command.

Moderator: R. I. Cole, *Manager, Military Projects Planning, Melpar, Inc., Falls Church, Va.*

"A Very High Gain Experimental Millimeter Foster Scanner," C. A. Hacking, *I-T-E Circuit Breaker Company, Philadelphia, Pa.*

"A Special Purpose Microwave Switch for Anti-jam Operation of Conical Scanning Radars," S. D. Schreyer and G. Klein, *Westinghouse Electric Corp., Baltimore, Md.*

"A Periodically-Focused 10 KW Microwave Traveling-Wave Amplifier," O. T. Purl and K. W. Slocum, *Watkins-Johnson Co., Palo Alto, Calif.*

"Electromagnetic Radiation in Sea Water," E. J. Illiardi, *U. S. Naval Underwater Ordnance Station, Newport, R. I.*

"Self-Focusing Technique for Large Arrays," P. W. Howells, *General Electric Co., Dewitt, N. Y.*

"A Radar Technique Using an Electro-Optical Two-Dimensional Filter, Part I—Principles of Operation, Part II—An Experimental Model Employing a Delay-Line Light Modulator," L. Lambert, *Moses Arm, and Isaac Weissman, Columbia Univ., New York, N. Y.*

##### Session 4.2—Communications II

Moderator: *To be announced.*

"Operational Testing of a Long Range Rocket Communication System," B. J. Huffman, *Hughes Aircraft Corp., Culver City, Calif., and W. F. O'Neil, C & N Lab. WADD, Wright-Patterson AFB, Ohio.*

"A Long Range Rocket Communication System," W. L. Exner and E. R. Gaul, *Hughes Aircraft Co., Los Angeles, Calif.*



# Electron Tube News ...from SYLVANIA



*Cool operation sparks  
home-radio sales  
when you design around*

## SYLVANIA 100-mA ALL-AMERICAN FIVE

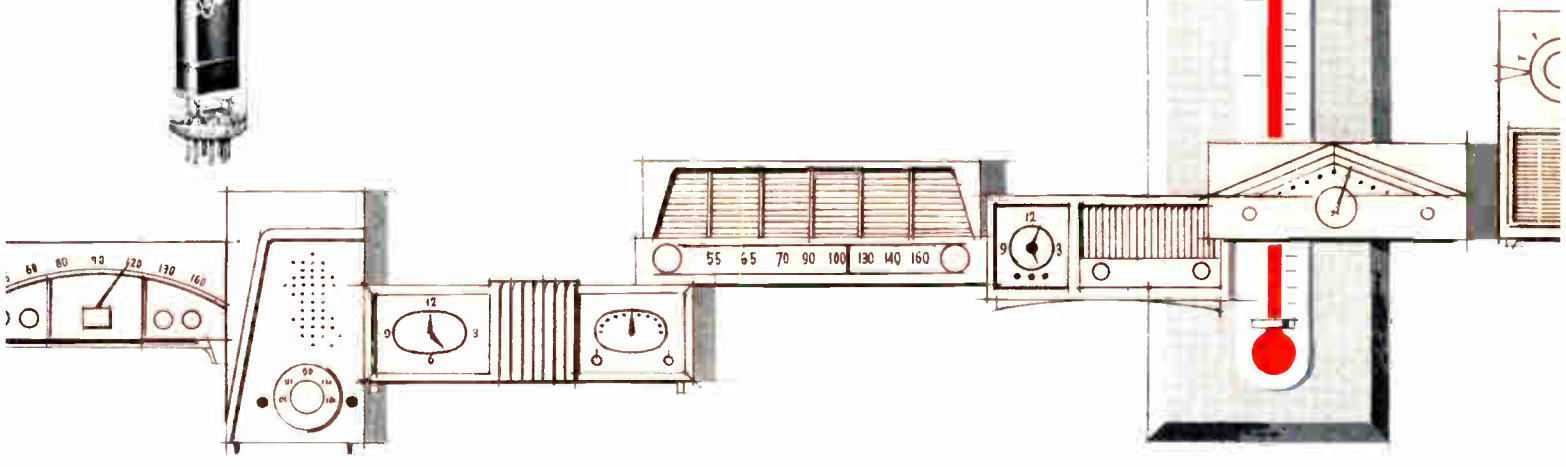

**Originated by Sylvania**—the 100-mA All-American Five requires  $\frac{1}{8}$  less heater power, opens new design possibilities and offers significant merchandising opportunities. Now, tube layout is comparatively unrestricted, cabinet styling is more flexible. Cost reductions in cabi-

netry, circuitry and components are within easy grasp. Tube reliability is enhanced. Printed circuit techniques can be used advantageously. Here, then, are important advances in home radio design—made possible by the Sylvania 100-mA All-American Five.

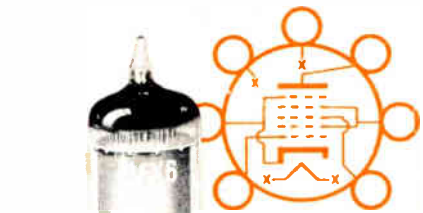

**Named to the All-American Five are:** 18FW6, semi-remote cut-off pentode; 18FX6, pentagrid converter; 18FY6 high mu triode-double diode; 32ET5, beam power pentode; and the 36AM3, half-wave rectifier—a tube complement with proven field experience.

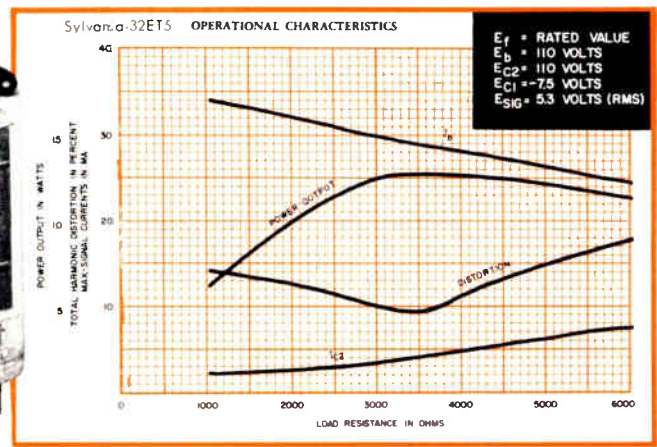
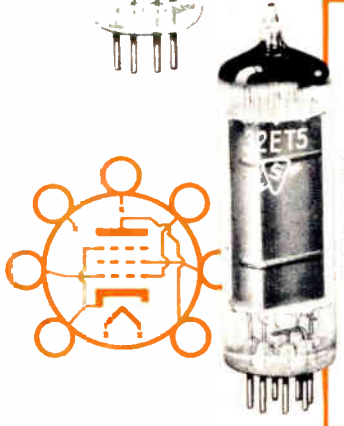

**Lower ambient temperatures** increase design flexibility and offer substantial economies. Radio cabinets utilizing this carefully mated complement show temperature reductions of 20-25%. The area of the power output tube shows an even greater temperature decrease—as much as 30%. As a result, less expensive plastics can be used. Vertical chassis can be designed without special heat shielding. Placement of the power output tube is no longer critical because of heat-wide, outside “berths” are unnecessary—designs can be compact.

Printed circuit boards may be used without deterioration in set life and performance caused by high ambient temperatures.

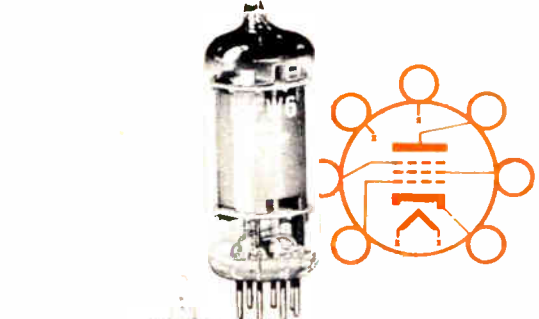

**Tube reliability is increased.** Sylvania heater design of the 100-mA line provides for more balanced distribution of the heater voltages in the heater string. Surge voltages across individual tubes are minimized.

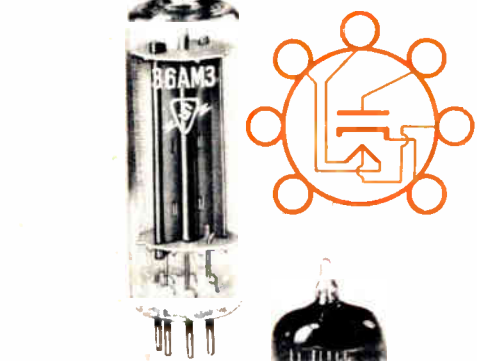

**Sylvania 100-mA All-American Five** can be used in existing 150-mA designs with a minimum of redesign time. The 100-mA tube complement presents many advantages that can be directly translated into consumer benefits and increased home radio sales.

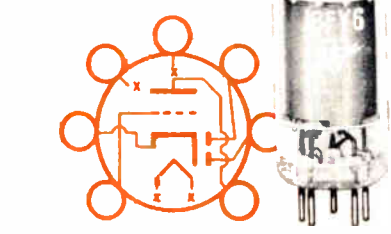

**New developments in the 100-mA line.** Sylvania is developing further tube complements that will incorporate the inherent advantages of a cooler-operating 100-mA line. These include a four tube line for home radio sets, a complement for FM radio receivers, and two new types that hold exciting possibilities for quantity-produced Hi-Fi.

Your local Sylvania Sales Engineer will gladly give you the whole story on the Sylvania 100-mA line. Call him or write Electronic Tubes Division, Sylvania Electric Products Inc., Dept. 195, 1740 Broadway, New York 19, New York.

# SYLVANIA

Subsidiary of **GENERAL TELEPHONE & ELECTRONICS**

World Radio History





"Impact of the Recent International Radio Conference, Geneva, on USAF Communications-Electronics Programs," *C. W. Loeber, Dept. of Air Force, Washington, D. C.*

"Communication by Re-radiation from Chaff," *B. V. Blom, Benson, Ariz.*

"Use of Faraday Rotations in Prediction of Ionospheric Disturbances," *H. S. Marsh, Watkins Johnson Co., Palo Alto, Calif.*

"Digital Battlefield Communications," *W. C. Slagle, Stromberg-Carlson, San Diego, Calif.*

#### Session 4.3—Reliability II

Moderator: *W. S. Marks, Jr.*

"Participation in the Fleet Ballistic Missile Weapon System Component Reliability and in the Interservice Data Exchange Programs," *S. I. Pollock, U. S. Naval Ordnance Laboratory, Corona, Calif.*

"Application of an Environmental Probe Test Technique for Improving the Reliability of a Guided Missile Fuze," *B. W. Teres, Diamond Ordnance Fuze Lab., Dept. of the Army, Washington, D. C.*

"Reliability of a Parallel System Considering Load Redistribution," *C. H. Tsao and H. L. Love, Hughes Aircraft Corp., Culver City, Calif.*

"Understanding and Improving System Reliability and Maintainability, Using Information in Engineering/Environmental Malfunction Data Samples," *G. H. Allen, Raytheon Co., Maynard, Mass.*

"The Reliability of Hermetically Sealed Equipment," *W. B. Rossmagel, Kearfoot Div. of General Precision, Little Falls, N. J.*

#### Session 4.4—Systems Ancillary to Missiles

Moderator: *To be announced.*

"Equipment Design Trends in Missile Scoring Devices," *W. Ficklin, A. H. Maciszewski, J. J. Pagan and K. Ringer, A. R. F. Products, Inc., River Forest, Ill.*

"System Integration Factors in V/Stol Launched Air-to-Surface Missile," *I. H. Rubaii, International Business Machines Corp., Owego, N. Y.*

"Electric Firing of Fully Combustible Ammunition," *F. J. Dashnow, Waterliet Arsenal, Waterliet, N. Y.*

"Airborne Instrumentation Systems Utilized in First and Second Generation Ballistic Re-entry Vehicles," *L. E. Foster, General Electric Co., Philadelphia, Pa.*

"Flight Measurements on the JUPITER R&D Missile," *C. T. N. Paludan, Huntsville, Ala.*

#### Session 4.5—Simulation—Electronic

Moderator: *To be announced.*

"Electromagnetic Environment Simulation for System Trainers," *F. P. Cullen, W. Helf, and J. K. Scully, The Marquardt Corp., Pomona, Calif.*

"The Development of a Dynamic Target and Countermeasures Simulator," *R. L. Norton, U. S. Army Signal Missile Support Agency, White Sands Missile Range, N. M.*

"All Electronic Visual Flight Simulator," *P. L. Fox, Aerojet-General Corp., Azusa, Calif.*

"Celestial Navigation Trainer," *G. Jaquiss, U. S. Naval Training Device Center, Port Washington, N. Y.*

"ASW Submarine Target, Device 21B12, Type 1," *R. H. Dickman, U. S. Naval Training Device Center, Port Washington, N. Y.*

"Tank Turret Trainer, Device 3T1," *T. Mongello, U. S. Naval Training Device Center, Port Washington, N. Y.*

#### Wednesday Afternoon

#### Session 5.1—Instrumentation IV —(Confidential)

Sponsor: Air Research and Development Command.

Moderator: *D. J. McLaughlin, U. S. Naval Res. Lab., Washington, D. C.*

"Transmission of Electromagnetic Waves Through An Ionized Medium in the Presence of a Strong Magnetic Field," *T. P. Harley, Boeing Airplane Co., Seattle, Wash.*

"The Exploitation of Millimeter Waves for Military Applications," *H. N. Tate, Hq. U. S. Army Signal Res. and Dev. Lab., Fort Monmouth, N. J.*

"A Millimeter Wave Radar System," *J. M. DeBell, Jr., Allen B. DuMont Lab., Inc., Clifton, N. J.*

"Increased Jamming and Reconnaissance Effectivity Through Polarization Diversity," *E. F. Henry, Melpar, Inc., Falls Church, Va.*

"Countermeasures Techniques for Use Against Frequency-Jump Radars," *G. E. Austin, Sylvania Electronic Defense Lab., Mountain View, Calif.*

#### Session 5.2—Space Technology

Moderator: *Dr. H. K. Ziegler, Chief Scientist, U. S. Army Signal Res. and Dev. Lab., Fort Monmouth, N. J.*

"Maintenance, Repair and Assembly in Space by Remote Means," *J. W. Clark, Hughes Aircraft Co., Culver City, Calif.*

"The Able-4 Thor Deep Space Probe," *P. F. Glaser, Space Technology Labs., Inc., Los Angeles, Calif.*

"Communication in Space by Deflected Sunlight," *K. W. Otten, Wright Air Development Div., Wright-Patterson AFB, Ohio.*

"Optimum Capacitor Charging Efficiency for Space Systems," *Dr. P. M. Mostow, Dr. J. L. Neuringer and D. S. Rigney, Republic Aviation Corp., Farmingdale, N. Y.*

"Application of Inertial Techniques to Interplanetary Navigation," *M. J. Minneman, Republic Aviation Corp., Farmingdale, N. Y.*

#### Session 5.3—Camera Display Devices

Moderator: *To be announced.*

"High Performance Camera Tube Program," *S. Gray, RCA Labs., Princeton, N. J.*

"High Speed Direct Electronic Printing Cathode Ray Tube," *N. Fyler, D. Cone, R. Dorr, J. Wurtz, Litton Industries, San Carlos, Calif.*

"Extending the Dynamic Range of Camera Tubes Employing Return Beam Modulation," *A. D. Cope and H. Borkan, Radio Corp. of America, Princeton, N. J.*

"Image Orthicon Tubes as Image Intensifiers," *N. Swanson, U. S. Army Engineer Res. and Dev. Lab., Fort Belvoir, Va.*

"Three-Dimensional Direct-View Display Tube," *R. D. Ketchpel, Huges Aircraft Co., Culver City, Calif.*

#### Session 5.4—Vulnerability, Guidance and Control

Moderator: *W. S. Hinman, Jr., Technical Director, Diamond Ordnance Fuze Lab., Ordnance Corps, U. S. Army, Washington, D. C.*

"Loran-C Navigation System," *W. Dickinson, Jansky and Bailey, Inc., Washington, D. C.*

"Abstract of MATTS System (Multiple Airborne Target Trajectory System)," *W. J. Zable, Cubic Corp., San Diego, Calif.*

"A New Gyro for Autopilot Use," *S. Dardarian, General Precisions, Inc., Little Falls, N. J.*

"Lightweight Inertial Systems," *R. E. Marcille, Litton Industries, Beverly Hills, Calif.*

"Inertial Accelerometers—Their Nature, Character and Limitations," *M. Mancrer, General Precision, Inc., Little Falls, N. J.*

"Jamming Effectiveness Instrumentation," *Capt. C. H. Redwin and C. H. Meyer, III, Rome Air Dev. Center, Griffiss AFB, N. Y.*

#### Session 5.5—Data Handling

Moderator: *To be announced.*

"High Speed Auto-Data System for Blast Studies," *R. D. Jones and J. D. Smith, Sandia Corp., Sandia Base, Albuquerque, N. M.*

"Data Acquisition for a Research and Development Test Stand," *T. Wong and R. L. Thomason, U. S. Naval Ordnance Test Station, China Lake, Calif.*

"The Handling of UDOP Data," *D. H. Parks, Radio Corp. of America, Patrick AFB, Fla.*

"Description of Automatic Data Reduction Facility Combining Maximum Versatility and Speed," *W. R. Schumacher, U. S. Navy Underwater Sound Lab., New London, Conn., and H. M. Wilkinson, Epsco, Inc., Cambridge, Mass.*

"The Digitron—A High Speed Data Display System," *P. J. Meredith, D. J. Griffin, and F. A. Paulus, The Marquardt Corp., Pomona, Calif.*

# Professional Groups\*

- Aeronautical & Navigational Electronics (G-11)**—L. M. Sherer, RTCA, Bldg. T-5, 16 and Constitution Ave., N.W., Washington 25, D. C.; H. R. Mimmo, Harvard Univ., Cambridge, Mass.
- Antennas & Propagation (G-3)**—A. Dorne, Dorne and Margolin, Westbury, L. I., N. Y.; S. A. Bowhill, Pennsylvania State Univ., University Park, Pa.
- Audio (G-1)**—H. S. Knowles, Knowles Electronics, 9400 Belmont Ave., Franklin Park, Ill.; Prof. A. B. Bereskin, E.E. Dept., Univ. of Cincinnati, Cincinnati 21, Ohio; M. Camras, Armour Res. Found. Tech. Ctr., Chicago 16, Ill.
- Automatic Control (G-23)**—J. E. Ward, Servomechanisms Lab., M.I.T., Cambridge 39, Mass.; G. S. Axelby, Westinghouse Air Arm Div., Friendship Airport, Baltimore 3, Md.
- Broadcast & Television Receivers (G-8)**—R. R. Thalner, Sylvania Home Electronics, 700 Ellicott St., Batavia, N. Y.; C. W. Sall, RCA, Bldg. 13-4, Camden, N. J.
- Broadcasting (G-2)**—G. E. Hagerty, Westinghouse Elec. Corp., 122 E. 42 St., Suite 2100, N. Y. 17, N. Y.; W. L. Hughes, E.E. Dept., Iowa State College, Ames, Iowa.
- Circuit Theory (G-4)**—S. Darlington, Bell Telephone Labs., Murray Hill, N. J.; W. Bennett, Bell Telephone Labs., Murray Hill, N. J.
- Communications Systems (G-19)**—J. E. Schlaikjer, IT&T Co., 67 Broad St., N. Y. 4, N. Y.; M. R. Donaldson, Electronic Comm. Inc., St. Petersburg, Fla.
- Component Parts (G-21)**—J. J. Drvostep, Sperry Gyroscope Co., Mail Station 1A 36, Great Neck, L. I., N. Y.; G. Shapiro, Engineering Electronics Sec., Div. 1.6, NBS, Connecticut Ave. and Van Ness St., Washington, D. C.
- Education (G-25)**—J. G. Truxal, Head, Dept. of E.E., Polytechnic Inst. of Brooklyn, Brooklyn, N. Y.; W. R. LePage, Dept. of E.E., Syracuse Univ., Syracuse, N. Y.
- Electron Devices (G-15)**—W. M. Webster, Semi-Conductor Div., RCA, Somerville, N. J.; E. L. Steele, Hughes Prods., Inc., International Airport Station, Los Angeles 45, Calif.
- Electronic Computers (G-16)**—A. A. Cohen, Remington Rand Univac, St. Paul 16, Minn.; R. O. Endres, Rese Engrg. Co., Philadelphia, Pa.; H. E. Tompkins, Moore School of E.E., Univ. of Pennsylvania, Philadelphia.
- Engineering Management (G-14)**—H. M. O'Bryan, Sylvania Elec. Prods., 730 3rd Ave., N. Y. 17, N. Y.; A. H. Rubenstein, Northwestern Univ., Evanston, Ill.
- Engineering Writing and Speech (G-16)**—T. T. Patterson, Jr., RCA, Bldg. 13-2, Camden, N. J.; H. B. Michaelson, IBM Res. Center, Box 218, Yorktown Heights, N. Y.
- Human Factors in Electronics (G-28)**—C. M. Jansky, Royal McBee Corp., Portchester, N. Y.; J. I. Elkind, Bolt, Beranek and Newman, Cambridge, Mass.
- Industrial Electronics (G-13)**—J. E. Eiselein, RCA Victor Div., Camden, N. J.; R. W. Bull, Armour Res. Found., Chicago, Ill.
- Information Theory (G-12)**—P. Elias, M.I.T., Rm. 26-347, Cambridge 39, Mass.; A. Kohlenberg, Melpar Inc., 43 Leon St., Boston 15, Mass.
- Instrumentation (G-9)**—C. W. Little, C-Stellator Assoc., Box 451, Princeton, N. J.; G. B. Hoadley, Dept. of E.E., North Carolina State College, Raleigh, N. C.
- Medical Electronics (G-18)**—W. E. Tolles, Airborne Instruments Lab., 160 Old Country Rd., Mineola, L. I., N. Y.; L. B. Lusted, Univ. of Rochester Medical School, Strong Memorial Hosp., Rochester 20, N. Y.
- Microwave Theory and Techniques (G-17)**—A. A. Oliner, Microwave Res. Inst., 55 Johnson St., Brooklyn 1, N. Y.; D. D. King, Electronic Comm., Inc., 1830 York Rd., Timonium, Md.
- Military Electronics (G-24)**—H. Randall, 1208 Seaton Lane, Falls Church, Va.; D. R. Rhodes, Radiation Lab., Instrument Div., Orlando, Fla.
- Nuclear Science (G-5)**—A. B. Van Rennes, United Res. Inc., Tech. Div., 128 Alewife Brook Pkwy., Cambridge, Mass.; R. F. Shea, Dig Power Plant Engrg., Knolls Atomic Power Lab., General Electric Co., Schenectady, N. Y.
- Production Techniques (G-22)**—L. M. Ewing, General Electric Co., HMEED CSP-3, Syracuse 1, N. Y.; A. R. Gray, Rte. #1, Box 940, Orlando Vineland Rd., Wintergarden, Fla.
- Radio Frequency Interference (G-27)**—J. P. McNaul, U. S. Signal Corps., Hdqrs. Ft. Monmouth, N. J.; P. O. Schreiber, Technical Wire Prods., Springfield, N. J.
- Reliability and Quality Control (G-7)**—P. K. McElroy, General Radio Co., 22 Baker Ave., West Concord, Mass.; E. J. Breiding, IBM Corp., Kingston, N. Y.
- Space Electronics and Telemetry (G-10)**—C. H. Hoepfner, Radiation, Inc., Melbourne, Fla.
- Ultrasonics Engineering (G-20)**—W. Roth, Roth Lab., 1240 Main St., Hartford 3, Conn.; O. Mattiat, Aerophysics Dev. Corp., P.O. Box 689, Santa Barbara, Calif.
- Vehicular Communications (G-6)**—A. A. MacDonald, Motorola, Inc., 4545 Augusta Blvd., Chicago 51, Ill.; R. P. Gifford, General Electric Co., Syracuse, N. Y.

\* Names listed are Group Chairmen and Transactions Editors.

# Sections\*

- Akron (4)**—C. D. Morrill, 2248 16th St., Cuyahoga Falls, Ohio; C. M. Kelly, 2915 Silver Lake Circle, Cuyahoga Falls, Ohio.
- Alamogordo-Holloman (7)**—M. W. Jones, 2302 Willow Dr., Alamogordo, N. Mex.; A. F. La Pierre, 1500 Roosevelt Ave., Alamogordo, N. Mex.
- Albuquerque-Los Alamos (7)**—R. C. Spence, 3020 W. Sandia Dr., Sandia Base, Albuquerque, N. Mex.; E. C. Davis, Neely Enterprises, 107 Washington St. S. E., Albuquerque, N. Mex.
- Anchorage (7)**—R. O. Voight, HQ Alaskan Command, APO 942, Seattle, Wash.; J. T. Little, Star Route B, Box 3453, Spearhead, Alaska.
- Atlanta (3)**—W. L. Fattig, 1643 N. Gatewood Rd., Atlanta 6, Ga.; R. L. Ellis, Jr., 77 Karland Dr., N.W., Atlanta, Ga.
- Baltimore (3)**—B. Wolfe, 6112 Talles Rd., Baltimore 7, Md.; J. T. Wilner, 2610 No. Charles St., Sta. WBAL, Baltimore 18, Md.
- Bay of Quinte (8)**—H. L. Blacker, Northern Electric Co., Ltd., 250 Sidney St., Belleville, Ont., Canada; G. M. Turney, R.R. 2, Carrying Place, Ont., Canada.
- Beaumont-Port Arthur (6)**—A. L. Musick, Jr., 585 Sunbury Dr., Beaumont, Tex.; C. J. Hamilton, Jr., Route 2, Box 414, Port Arthur, Tex.
- Benelux**—Herre Rinia, Parklaan 24, Eindhoven, Netherlands; B. B. Barrow, S.A.D.T.C., Box 174, The Hague, Netherlands.
- Binghamton (1)**—B. H. Rudwick, 622 Lacey Dr., Johnson City, N. Y.; F. W. Schaaf, R.D. 1, Apalachin, N. Y.
- Boston (1)**—F. K. Willenbrock, Gordon McKay Lab., Harvard Univ., Cambridge 38, Mass.; F. M. Dukat, 205 Bacon St., Waltham 54, Mass.
- Buenos Aires**—Lirio A. Pereyra, 5 de Julio 369, Vincente Lopez, Argentina; D. W. Gamba, 1337 Charcas, Buenos Aires, Argentina.
- Buffalo-Niagara (1)**—J. P. Welsh, 544 Lisbon Ave., Buffalo 15, N. Y.; D. P. Sante, 30 Greenbriar Rd., Williamsville 21, N. Y.
- Cedar Rapids (5)**—D. M. Hodgins, Jr., 3206 Vine Ave., S.E. Cedar Rapids, Iowa; G. M. Marnier, R 3, Marion, Iowa.
- Central Florida (3)**—W. S. Hines, 1320 Indian River Dr., Eau Gallie, Fla.; M. Gould, 8 Azalea Dr., Cocoa Beach, Fla.
- Central Pennsylvania (4)**—C. R. Ammerman, 125 Grandview Rd., State College, Pa.; W. J. Ross, 105 Elec. Engrg. Dept., University Park, Pa.
- Chicago (5)**—R. E. Bard, General Radio Co., 6605 W. North Ave., Oak Park, Ill.; W. B. McClelland, 7036 N. Tahoma, Chicago 46, Ill.
- China Lake (7)**—R. T. Merriam, 1501-B Smith Rd., China Lake, Calif.; L. D. Bryant, Box 333, Naval Ord. Test Sta., China Lake, Calif.

\* Numerals in parentheses following sections designate region number. First name designates Chairman, second name Secretary.



# CLAREED<sup>®</sup>

**FITS  
INTO  
YOUR  
DESIGN!**

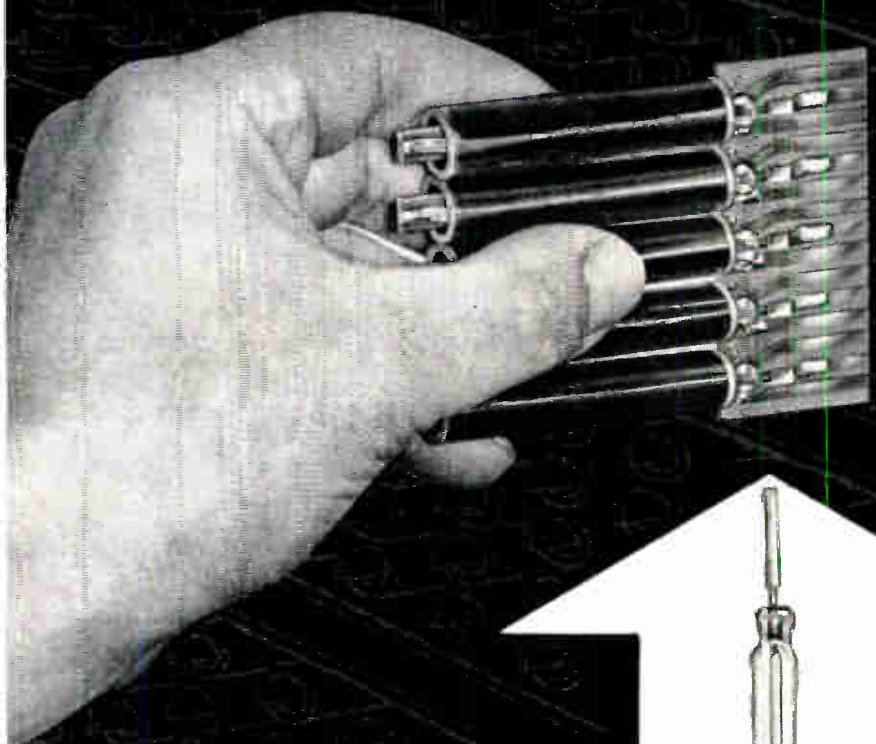

## PACKAGED TO MEET YOUR REQUIREMENTS

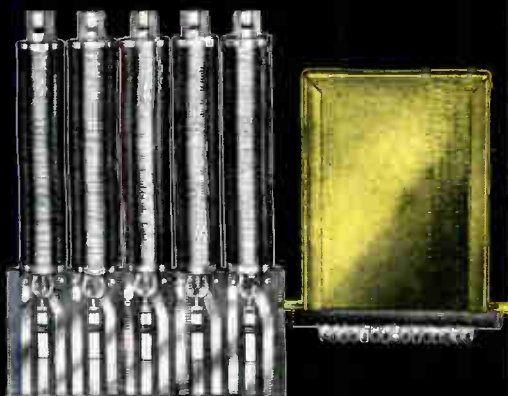

Here five relays, each containing two switches, are mounted on a printed circuit board. This assembly may be inserted directly into your equipment or enclosed in a flat pack container.

These six switches are clustered to form the core of a single electromagnetic coil, and encased in a cylindrical steel container.



## ACTUAL SIZE

Basic element of CLAREED relays is this switch capsule. A pair of magnetically operated contacts is hermetically sealed in an atmosphere of inert gas. The capsule combines extreme simplicity with high reliability and long life. It has excellent low-level characteristics.

CLAREED Sealed Contact Reed relays put you . . . the designer . . . in the driver's seat. They are simple in design, flexible in assembly. They are packaged and mounted to comply with *your* mechanical design configuration . . . even on your own circuit board. CLAREED relays are ideal components for transistor-drive applications, computers, data-processing and other high speed equipment.

Contacts are hermetically sealed in inert gas. Tens of millions of operations are assured since contact contamination is completely precluded. Hundreds of millions of operations are possible when operated up to  $\frac{1}{2}$  rated load.

If you use relays, it will pay you to know all about CLAREED . . . an entirely new concept in relay design. Address C. P. Clare & Co., 3101 Pratt Blvd., Chicago 45, Illinois. In Canada: C. P. Clare Canada Limited, Box 134, Downsview, Ontario. Cable Address: CLARELAY. Send for Bulletin CPC-5.

# CLARE

*When only the best is good enough*

- Cincinnati (4)**—H. E. Hancock, Box 52, R.R.4, Branch Hill, Loveland, Ohio; J. P. Meehan, American Tel. & Tel. Co., 138 E. Court St., Cincinnati 2, Ohio.
- Cleveland (4)**—R. A. Dambach, 3881 W. 162, Cleveland 11, Ohio; R. J. Plaisted, Westinghouse Broadcasting, 6600 Broadview Rd., Parma, Cleveland 34, Ohio.
- Colombia**—T. J. Meek, Apartado Aereo 78-15, Bogota, Colombia; F. S. Garbrecht, Apartado Nal. 2773, Bogota, Colombia.
- Columbus (4)**—D. F. Yaw, 2356 Farleigh Rd., Columbus 21, Ohio; F. A. Wolf, 354 Chatham Rd., Columbus 14, Ohio.
- Connecticut (1)**—A. R. Perrins, 951 Sperry Rd., Cheshire, Conn.; Ivan Flores, S. Huckleberry Dr., Norwalk, Conn.
- Dallas (6)**—T. B. Moseley, 6114 Northwood Rd., Dallas 25, Tex.; Tom Prickett, Jr., 805 Clearwater Dr., Richardson, Tex.
- Dayton (4)**—D. G. Clute, 4424 Appleton Pl., Kettering 40, Ohio; R. J. Framme, 316 Claranna, Dayton 9, Ohio.
- Denver (6)**—W. G. Worcester, 748 10th St., Boulder, Colo.; H. S. Johnson, 1241 Monaco Pkwy., Denver 20, Colo.
- Detroit (4)**—L. J. Giacoletto, Ford Motor Co., Scientific Lab., Box 2053, Dearborn, Mich.; H. W. Hale, Dept. of Elec. Engrg., Wayne State University, Detroit 2, Mich.
- Egypt**—H. M. Mahmoud, Faculty of Engrg., Fouad I University, Giza, Cairo, Egypt; El Garhi I. El Kashlan, Egyptian Broadcasting, 4, Shari Sherifein, Cairo, Egypt.
- Elmira-Corning (1)**—D. F. Aldrich, 1030 Hoffman St., Elmira, N. Y.; T. G. Keeton, 611 McDowell Pl., Elmira, N. Y.
- El Paso (6)**—W. A. Toland, 912 Brazil St., El Paso, Tex.; W. H. DeBusk, 3017 Daisy, El Paso, Tex.
- Emporium (4)**—H. V. Kalmier, Jr., 150 Elmwood Ctr., Emporium, Pa.; W. H. Herbert, Sylvania Elec. Prods., Inc., Emporium, Pa.
- Erie (1)**—P. E. Sterner, 322 Forest Dr., Erie, Pa.; Secretary to be advised.
- Evansville-Owensboro (5)**—L. E. Roberts, Jr., 2516 Iroquois Dr., Owensboro, Ky.; K. G. Miles, 2105 E. Gum St., Evansville 14, Ind.
- Florida West Coast (3)**—R. Murphy, 12112 N. Edison Ave., Tampa 4, Fla.; L. Swern, Sperry Microwave Electronics Co., Box 1828, Clearwater, Fla.
- Fort Huachuca (7)**—J. C. Domingue, 62506 Barnes St., Fort Huachuca, Ariz.; A. S. Montasser, 368 Wolfe St., Sierra Vista, Ariz.
- Fort Wayne (5)**—T. Major, 5355 Meadowbrook Dr., Fort Wayne, Ind.; C. F. Mason, 1519½ Crescent Ave., Fort Wayne, Ind.
- Fort Worth (6)**—G. H. Robertson, 5749 Tracyne Drive, Fort Worth 14, Tex.; W. D. Raymond, 2015 Valley Lane, Arlington, Tex.
- Gainesville (3)**—C. V. Shaffer, 113 N.W. 25 St., Gainesville, Fla.; J. H. Neidert, 1811 N.W. 11 Rd., Gainesville, Fla.
- Hamilton (8)**—C. J. Smith, 43 Gilbert Ave., Ancaster, Ont., Canada; F. H. Edwards, United-Carr Fastener Co. of Canada Ltd., 231 Gage Ave., N., Hamilton, Ont., Canada.
- Hawaii (7)**—M. S. Vittum, 218 Kuuhoa Pl., Kailua, Hawaii; G. Piety, 2030 Home Rule St., Honolulu 17, Hawaii.
- Houston (6)**—R. J. Loofbourrow, The Texas Co., Box 425, Bellaire 101, Tex.; W. P. Schneider, 8417 Bluegate, Houston, Tex.
- Huntsville (3)**—H. H. Hosenhien, 515 Madison St., Huntsville, Ala.; W. H. Cook, Jr., 2702 Evergreen St., S.E., Huntsville, Ala.
- India**—Officers to be elected.
- Indianapolis (5)**—G. R. Fraser, U. S. Naval Avionics Facility, 21 St. & Arlington Ave., Indianapolis 18, Ind.; C. E. David, 6110 E. 21 St., Indianapolis 18, Ind.
- Israel**—Israel Cederbaum, 117-13, Ramot Remez, Haifa, Israel; Ephraim Weissberg, 4 Shalom Aleihem St., Haifa, Nave Shaanan, Israel.
- Italy**—Algeri Marino, Via Guido d'Arezzo 14, Rome, Italy; Giuseppe P. Tarchini, Laboratorio Ricerche Elettr., Via Del Parlamento N. 33, Borgolombardo, Milan, Italy.
- Ithaca (1)**—C. E. Ingalls, 106 Sheldon Rd., Ithaca, N. Y.; N. H. Bryaut, School of Elec. Engrg., Cornell University, Ithaca, N. Y.
- Kansas City (6)**—N. E. Vilander, 2509 W. 83rd St., Kansas City 15, Mo.; F. A. Spies, Bendix Aviation Corp., Box 1159, Kansas City 41, Mo.
- Little Rock (6)**—V. L. Dillaplain, 203 S. Pine St., Little Rock Ark.; R. V. Anders, 1814 Wolfe St., Little Rock, Ark.
- London (8)**—J. A. Fulford, Physics Dept., Univ. of Western Ontario, London, Ont., Canada; D. Moore, R.R. 3, Dorchester, Ont., Canada.
- Long Island (2)**—J. G. Stephenson, Airborne Instruments Lab., Walt Whitman Rd., Melville, N. Y.; J. Sinnott, 65 Jester Lane, Levittown, N. Y.
- Los Angeles (7)**—B. Dempster, Electronic Engrg. Co. of California, 1601 E. Chestnut Ave., Santa Ana, Calif.; J. Lewi, Packard-Bell, 12333 W. Olympic, Los Angeles 64, Calif.
- Louisville (5)**—W. J. Ryan, 4215 Northwestern Pkwy., Louisville 12, Ky.; H. T. Smith, 2511 Saratoga Dr., Louisville, Ky.
- Lubbock (6)**—J. J. Criswell, 511 50 St., Lubbock, Tex.; J. P. Craig, Route 7, Lubbock, Tex.
- Miami (3)**—J. W. Keller, Jr., Miami Shipbuilding Corp., 615 S. W. Second Ave., Miami 36, Fla.; F. R. Macklin, 325 Malaga Ave., Coral Gables, Fla.
- Milwaukee (5)**—F. J. Lofy, 2258 S. 56 St., West Allis 19, Wis.; J. D. Horgan, 1530 N. Longwood Ave., Elm Grove, Wis.
- Montreal (8)**—R. B. Lumsden, 1680 Lepine St., St. Laurent 9, P.Q., Canada; H. H. Schwartz, 5212 King Edward Ave., Montreal 29, P.Q., Canada.
- Newfoundland (8)**—M. D. MacGray, Canadian Marconi Co., 3 Prescott St., St. John's, Newf., Canada; F. A. Mulloy, 55 Calver Ave., St. John's, Newf., Canada.
- New Orleans (6)**—J. C. Spencer, 1524 Shirley Dr., New Orleans 14, La. (Chairman and Acting Secretary).
- New York (2)**—Joseph Reed, 52 Hillcrest Ave., New Rochelle, N. Y.; Herbert W. Pollack, 300 Lennox Road, Brooklyn, N. Y.
- North Carolina (3)**—W. G. McAvoy, 500 Magnolia St., Winston-Salem, N. C.; W. E. Langford, 3260 Nottingham Rd., Winston-Salem, N. C.
- Northern Alberta (8)**—Roy Usher, St. Albert, Alta., Canada; W. L. Storms, 12907 134 Ave., Edmonton, Alta., Canada.
- Northern New Jersey (2)**—G. D. Hulst, 73 Mt. Prospect Ave., Verona, N. J.; J. G. Kreer, Jr., 114 Mountain Ave., Bloomfield, N. J.
- Northwest Florida (3)**—W. F. Kirlin, 312 May Circle, Bens Lake Area, Eglin AFB, Fla.; H. H. Hufnagle, 1 Katherine Ave., Fort Walton Beach, Fla.
- Oklahoma City (6)**—T. K. McDonald, 205 W. Coe Dr., Midwest City, Okla.; Elmo Black, 1701 N. W., 35 St., Oklahoma City 18, Okla.
- Omaha-Lincoln (5)**—R. H. Ralls, 5835 William St., Omaha 6, Neb.; R. A. Stratbucker, University of Nebraska, College of Medicine, 42 & Dewey Ave., Omaha, Neb.
- Orlando (3)**—A. E. Linden, 3001 Nancy Court, Orlando, Fla.; J. R. Matzinger, 1825 Whitehall Dr., Winter Park, Fla.
- Ottawa (8)**—F. V. Cairns, Radio Div., National Res. Council, Ottawa, Ont., Canada; M. Yurko, 1295 Wesmar Drive, Ottawa, Ont., Canada.
- Philadelphia (3)**—W. A. Howard, National Broadcasting Co., 1619 Walnut St., Philadelphia 3, Pa.; H. J. Woll, 123 Third Ave., Haddon Heights, N. J.
- Phoenix (7)**—E. S. Shepard, Sr., 5716 N. 19th St., Phoenix, Ariz.; H. R. Hyder, III, 2523 N. 57th St., Phoenix, Ariz.
- Pittsburgh (4)**—A. E. Anderson, Westinghouse Res. Labs., Physics Proj. Labs., Beulah Rd., Churchill Borough, Pittsburgh 30, Pa.; W. P. Caywood, Jr., Box 179, RD 2, Murrysville, Pa.
- Portland (7)**—J. C. Riley, 2039 S.E. Yamhill St., Portland 14, Ore.; L. C. Hedrick, 35 S.W. 88 Ave., Portland 25, Ore.
- Princeton (2)**—Sylvan Fich, College of Engineering, Rutgers Univ., New Brunswick, N. J.; R. D. Lohman, RCA, Somerville, N. J.
- Quebec (8)**—Paul Du Berger, 1267 Villars Ave., Sillery, P.Q., Canada; Theodore Wildi, 1365 De Longueuil, Quebec City, P.Q., Canada.
- Regina (8)**—L. E. McBride, 3211 Regina Ave., Regina, Sask., Canada; J. M. McNeil, 3147 Retallack St., Regina, Sask., Canada.
- Rio de Janeiro**—H. Bonapace, Rua Nascimento Silva 572, Ipanema, Rio de Janeiro, Brazil; Z. Fuzesi, Caixa Postal 2668, Rio de Janeiro, Brazil.
- Rochester (1)**—F. A. Mitchell, Stromberg-Carlson Co., 1400 N. Goodman St., Rochester 9, N. Y.; J. L. Wheeler, 535 Rondo Lane, Webster, N. Y.
- Rome-Utica (1)**—W. J. Kuehl, 5 Hoffman Road, New Hartford, N. Y.; R. A. Zachary, Jr., 11 Arbor Drive, New Hartford, N. Y.
- Sacramento (7)**—Xelis W. Godfrey, 3220 Fulton Ave., Sacramento 21, Calif.; A. O. Rohde, 3160 Adams Road, Sacramento 25, Calif.
- St. Louis (6)**—R. L. Frazier, 9707 Willow Creek Lane, Rock Hill 19, Mo.; R. D. Hill, Jr., 363 Gray Ave., Webster Groves 19, Mo.
- Salt Lake City (7)**—R. W. Haegele, c/o Eitel-McCullough Inc., 1678 S. Pioneer Rd., Salt Lake City, Utah; A. W. Vodak, Sperry Utah Engrg. Labs., 322 N. 21 W. Street, Salt Lake City, Utah.
- San Antonio-Austin (6)**—A. F. Hasbrook, Rt. 11, Box 207, San Antonio, Tex.; F. X. Bostick, Jr., 5002 Beverly Hills Dr., Austin 3, Tex.
- San Diego (7)**—R. E. Honer, 5462 Mary



5/8 actual size

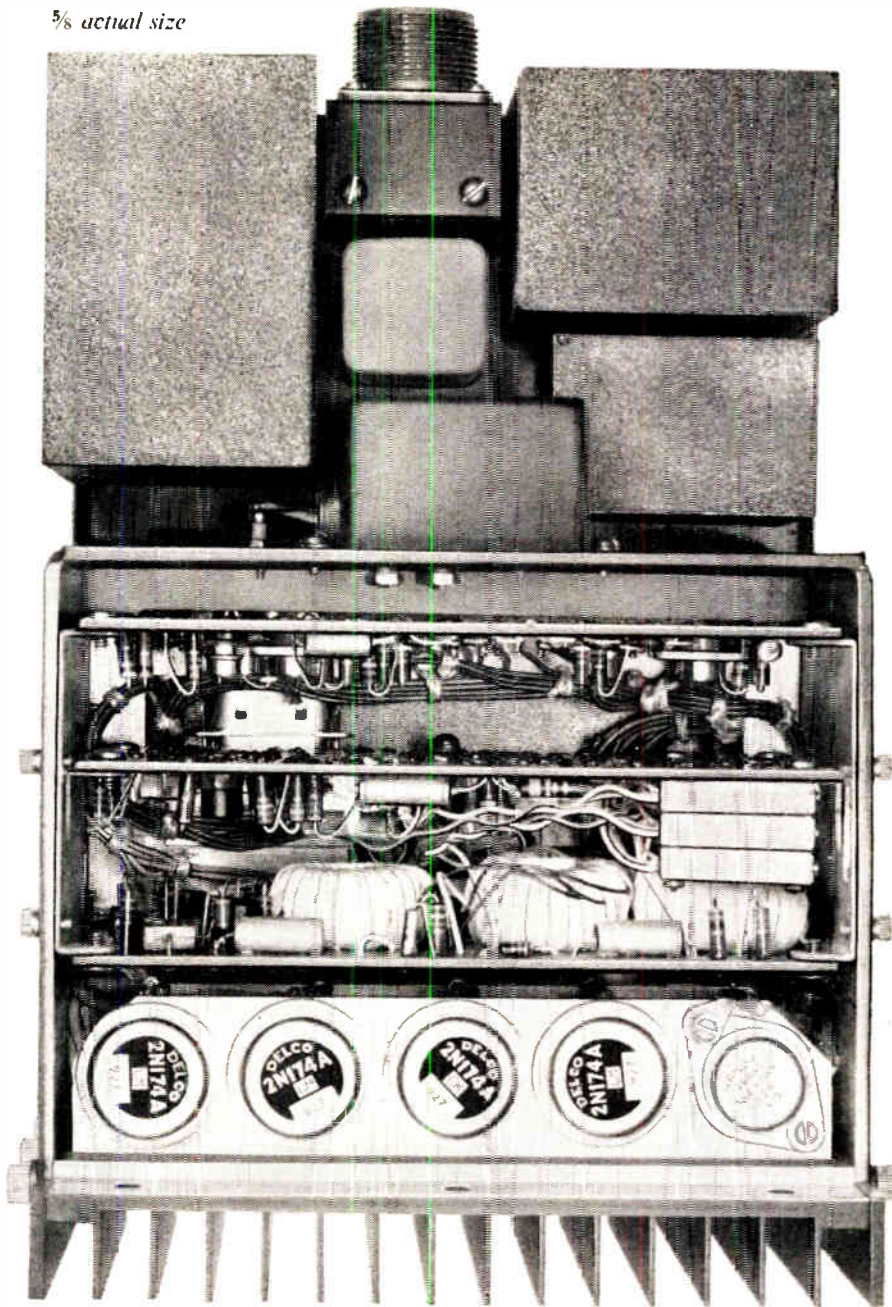

# FROM DELCO RADIO NEW IDEAS FOR DEFENSE

## HIGH CAPACITY STATIC INVERTERS WITH NO MOVING PARTS

Delco Radio's high capacity Static Inverters and Converters fill a critical need in missile guidance and control—offering extremely reliable, very highly regulated power of precise frequency. The Static Inverters use direct crystal-frequency control and digital logic circuits to produce accurate, single or polyphase power output. They have no moving parts. There is nothing that can get out of adjustment. Electrical characteristics are: High Capacity—150 to 4,000 volt-amperes. High Efficiency—65 to 90% depending on power and control (precision and regulation) required. Accurate Phase Angle Control—to 0.5 degree. Precise Frequency Control—up to 6 parts per million maximum variation under all load and environmental conditions. Voltage Amplitude Control—to  $\pm 1\%$  no load to full load. Low Distortion—typically 2% total harmonic distortion. Delco Radio has developed and produced power supplies for missiles such as the Air Force's Ballistic Intermediate Range Thor, Intercontinental Titan, and the pilotless aircraft Mace. For further information on military electronics, write to our Sales Department. *Physicists and electronics engineers: Join Delco Radio's search for new and better products through Solid State Physics.*

PIONEERING PRECISION PRODUCTS THROUGH SOLID STATE PHYSICS

**DELCO  
RADIO**

Division of General Motors • Kokomo, Indiana

- Lane Dr., San Diego, Calif.; E. W. Carlson, 2260 Clove St., San Diego 6, Calif.
- San Francisco (7)**—V. B. Corey, 385 Gravatt Dr., Berkeley 5, Calif.; S. F. Kaisel, Microwave Electronics Corp., 4061 Transport St., Palo Alto, Calif.
- Schenectady (1)**—T. R. Hoffman, 1471 Regent St., Schenectady 9, N. Y.; P. N. Hess, 1561 Clifton Park Rd., Schenectady 9, N. Y.
- Seattle (7)**—L. C. Perkins, Box 307, Des Moines, Wash.; H. H. Judson, Jr., 2006 14 Ave., N., Seattle 2, Wash.
- Shreveport (6)**—L. Hurley, 2736 Rosemont, Shreveport, La.; E. J. Culling, 3252 Sarah St., Bossier City, La.
- South Bend-Mishawaka (5)**—P. G. Cox, R.R.2, 10251 Harrison Rd., Osceola, Ind.; El L. Crosby, Jr., 400 S. Beiger St., Mishawaka, Ind.
- South Carolina (3)**—W. R. Boehm, Charleston Naval Shipyards, U. S. Naval Base, Code 210, Charleston, S. C.; H. L. Hunter, 49 Fort Dr., Rte. 6, N. Charleston, S. C.
- Southern Alberta (8)**—R. W. H. Lamb, Radio Sta. CFCN, 12th Ave. & 6th St. E., Calgary, Alta., Canada; J. D. Moore, Dept. of Transport, 404 Public Bldg., Calgary, Alta., Canada.
- Syracuse (1)**—Donald E. Maxwell, 117 Buffington Rd., Syracuse 10, N. Y.; R. E. Gildersleeve, 110 S. Burdick St., Fayetteville, N. Y.
- Tokyo**—I. Koga, 254 8-Chome, Kami-Meguro, Tokyo, Japan; F. Minozuma, 16 Ohara-Machi, Meguro-Ku, Tokyo, Japan.
- Toledo (4)**—K. P. Herrick, 2516 Fulton St., Toledo 10, Ohio; R. B. Williams, Jr., 5945 Summit St., Sylvania, Ohio.
- Toronto (8)**—R. J. A. Turner, 66 Gage Ave., Scarborough, Ont., Canada; G. T. Quigley, Philips Industries Ltd., Vanderhoof Ave., Leaside, Toronto 17, Ont., Canada.
- Tucson (7)**—A. M. Creighton, Jr., RCA Surface Comm. Systems, 2720 E. Broadway, Tucson, Ariz.; Ernest L. Morrison, Jr., 4557 E. Eastland St., Tucson, Ariz.
- Tulsa (6)**—Robert Broding, 2820 E. 39th, Tulsa, Okla.; P. M. Ferguson, 1133 N. Lewis, Tulsa, 10, Okla.
- Twin Cities (5)**—S. W. Schulz, 3132 Fourth St., S.E., Minneapolis 14, Minn.; H. D. Shekels, 1942 Beechwood, St. Paul 16, Minn.
- Vancouver (8)**—T. G. Lynch, 739 Edgewood Rd., North Vancouver, B. C., Canada; H. A. Hoyles, 1846 Beaulynn Pl., Westllyn Park, North Vancouver, B. C., Canada.
- Virginia (3)**—Orville R. Harris, 908 Rosser Lane, Charlottesville, Va.; Warren L. Braum, 901 "C" St., Harrisonburg, Va.
- Washington (3)**—J. E. Durkovic, 10316 Colesville Rd., Silver Spring, Md.; Ben S. Melton, 3921 Mayfair Lane, Alexandria, Va.
- Western Massachusetts (1)**—A. K. Hooks, Sprague Electric Co., Union St., North Adams, Mass.; J. J. Allen, 29 Sunnyside Dr., Dalton, Mass.
- Western Michigan (4)**—F. E. Castenholz, Police Headquarters, Jefferson & Walton Sta., Muskegon, Mich.; J. F. Giardina, 1528 Ball, N.E., R. 4, Grand Rapids 5, Mich.
- Wichita (6)**—J. W. D. Brown, 808 Gouverneur Road, Wichita, Kans.; R. F. Knowlton, 1200 North Derby, Derby, Kans.
- Williamsport (4)**—N. C. Peterson, Sylvania Electric Products Inc., Special Tube Operations, 1891 E. Third St., Williamsport, Pa.; W. H. Watson, Sylvania Electric Products Inc., Special Tube Operations, 1891 E. Third St., Williamsport Pa.
- Winnipeg (8)**—R. A. Johnson, Dept. of Electrical Engrg., The Univ. of Manitoba, Winnipeg, Man., Canada; H. T. Body, Siemens Bros. "Canada" Ltd., 419 Notre Dame Ave., Winnipeg 2, Man., Canada.

## Subsections

- Buenaventura (7)**—J. E. Bossoletti, 2004 South "K" St., Oxnard, Calif.; R. L. O'Bryan, 757 Devonshire Dr., Oxnard, Calif.
- Burlington (5)**—P. D. Keser, Box 123, Burlington, Iowa; Cleo D. Cherryholmes, 2072 Highland, Burlington, Iowa.
- East Bay (7)**—D. O. Pederson, Elec. Engrg. Dept., University of Calif., Berkeley 4, Calif.; Eugene A. Aas, 2684 Kennedy St., Livermore, Calif.
- Eastern North Carolina (3)**—W. J. Barclay, Dept. of Elec. Engrg., North Carolina State College, Raleigh, N. C.; W. J. Speed, 2718 E. Rothgeb Dr., Raleigh, N. C.
- Fairfield County (1)**—J. M. Hollywood, Fairfield House, 50 Lafayette Pl., Greenwich, Conn.; R. Townsend, 60 Du Bois St., Darien, Conn.
- Kitchener-Waterloo (8)**—George J. Dufault, 44 Ellis Crescent, North, Waterloo, Ont., Canada; C. L. Barsony, 169 Chapel St., Apt. 4, Kitchener, Ont., Canada.
- Lancaster (3)**—F. S. Veith, 366 Arbor Rd., Lancaster, Pa.; J. Evans, 2109 Lyndell Dr., Lancaster, Pa.
- Las Cruces-White Sands Proving Ground (6)**—H. Coleman, Box 1238, Las Cruces, N. Mex.; Secretary to be advised.
- Lehigh Valley (3)**—Leslie G. McCracken, Jr., 1782 W. Union Blvd., Bethlehem, Pa.; Joseph H. Volk, 411 Grant St., Easton, Pa.
- Memphis (3)**—Joseph J. Freymuth, 3205 Guernsey Ave., Memphis 12, Tenn.; Brother I. John Haas, Christian Brothers College, Memphis 4, Tenn.
- Merrimack Valley (1)**—P. N. Hambleton, 382 Main St., Amesbury, Mass.; D. D. Sagaser, Bell Telephone Labs., 1600 Osgood St., North Andover, Mass.
- Mid-Hudson (2)**—R. R. Blessing, IBM Corp., Box 390, Dept. 569, Poughkeepsie, N. Y.; R. J. Domenico, IBM Research Lab., Poughkeepsie, N. Y.
- Monmouth (2)**—C. A. Borgeson, 82 Garden Road, Little Silver, N. J.; Paul E. Griffith, 557 Cedar Ave., West Long Branch, N. J.
- Nashville (3)**—Paul E. Dicker, Dept. of Elec. Engrg., Vanderbilt University, Nashville, 5 Tenn.; R. L. Hucaby, 945 Caldwell Lane, Nashville, 4, Tenn.
- New Hampshire (1)**—W. J. Uhrich, 107 Tolles St., Nashua, N. H.; F. L. Striffler, Ponemah Hill Rd., R.F.D. 2, Milford, N. H.
- Northern Vermont (1)**—L. M. Bundy, R.F.D. 1, Shelburne, Vt.; D. M. Wheatley, 14 Patrick St., South Burlington, Vt.
- Orange Belt (7)**—G. D. Morehouse, 3703 San Simeon Way, Riverside, Calif.; W. G. Collins, 958 Dudley, Pomona, Calif.
- Panama City (3)**—C. E. Miller, Jr., 603 Bunkers Cove Rd., Panama City, Fla.; Robert C. Lowry, 2342 Pretty Bayou Dr., Panama City, Fla.
- Pasadena (7)**—H. L. Richter, Jr., 4800 Oak Grove Dr., Pasadena, Calif.; Bertin N. Posthill, 56 Suffolk Ave., Sierra Madre, Calif.
- Reading (3)**—F. L. Rose, 42 Arlington St., Reading, Pa.; Harold S. Hauck, 216 Jameson Pl., Reading, Pa.
- Richland (7)**—C. A. Ratcliffe, 1601 N. Harrison St., Kennewick, Wash.; P. Richard Kelly, 220 Delafield, Richland, Wash.
- San Fernando (7)**—R. A. Lamm, 15573 Briarwood Dr., Sherman Oaks, Calif.; Jack D. Wills, 6606 Lindley Ave., Reseda, Calif.
- Santa Ana (7)**—T. W. Jarmie, 12345 Cinnabar Rd., Santa Ana, Calif.; R. F. Geiger, Aeronutronic, A Div. of Ford Motor Co., Ford Rd., Newport Beach, Calif.
- Santa Barbara (7)**—C. P. Hedges, 316 Coleman Ave., Santa Barbara, Calif.; J. A. Moseley, 4532 Via Huerto, Santa Barbara, Calif.
- South Western Ontario (8)**—W. A. Ruse, Bell Telephone Co., 1149 Goyeau St., Windsor, Ont., Canada; G. L. Virtue, 959 Rankin Blvd. Windsor, Ont., Canada.
- Westchester County (2)**—M. J. Lichtenstein, 52 Sprain Valley Rd., Scarsdale, N. Y.; Martin Ziserman, 121 Westmoreland Ave., White Plains, N. Y.
- Western North Carolina (3)**—L. L. Caudle, Jr., Box 2536, 1925 N. Tryon St., Charlotte, N. C.; John I. Barron, Southern Bell T. & T. Co., Box 240, Charlotte, N. C.



# Convert

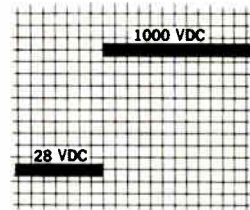

# Invert



# Change



## **Daven solves your solid-state power supply problems!**

Take advantage of Daven's experience in designing extremely compact, light-weight, high temperature units, which can withstand the most severe altitude, shock, and vibration environments. Let us engineer solid-state supplies for your missile-borne, airborne, shipborne, underwater or ground support equipment.

### **Converters**

- DC input voltage from 6 volts to 230 volts
- DC output voltage from 1 volt to 15 kilovolts
- DC output current from microamperes to 100 amps
- Dynamic regulation, ripple, stability as required

### **Inverters**

- DC input voltage from 6 volts to 230 volts
- AC output from 20 VA to 2500 VA
- 60-400-800-1600-2000 cycles per second
- One, two or three phase, any voltage level
- Voltage and frequency regulation 0.1% to 10% as required
- Output waveform — sine or square wave

### **Frequency Changers**

- 20 VA to 2500 VA
- Change to or from any of these frequencies: 60-400-800-1600-2000 cycles per second
- Voltage and frequency regulation 0.1% to 10% as required

Write for complete information, including your application and requirement data.



THE **DAVEN** CO.



LIVINGSTON, NEW JERSEY

TODAY, MORE THAN EVER, THE DAVEN © STANDS FOR DEPENDABILITY



# NEWS New Products

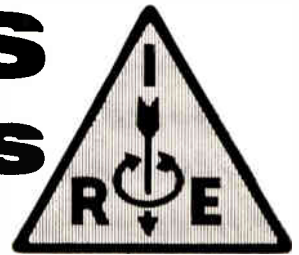

## New Cathode Ray Tubes

Three years of research & development in the laboratories of **Thomas Electronics Inc.**, Passaic, N. J., have resulted in a new technique in the manufacture of industrial-military cathode ray tubes used in instrument and radar applications. The development, involving new processes, techniques and materials, permits the aluminizing of cathode ray tubes operating with anode potentials of as low as 2 kilovolts. Previously tubes were aluminized only at high voltages greater than 5 to 6 kilovolts.

Aluminized cathode ray tubes offer many advantages, one of which is a substantial increase in the screen brightness. Brightness can now be augmented by as much as 90% in low voltage cathode ray tubes, resulting in an increase in the writing rate, which is especially desirable in photographic and visual applications. Alternatively, the increase in brightness permits a reduction in the beam current for the average display which results in a consequent reduction in line width and better overall resolution.

When the faceplate of an ordinary cathode ray tube is touched with the hand, the effect may be an impairment of the resolution of the display, or the display may shift its position. These adverse effects are eliminated with an aluminized screen, since its overall screen potential is made uniform by the conductivity of the aluminum layer.

Another advantage is the elimination of cathode glow and the back reflection of light from the walls of an aluminized cathode ray tube resulting in a marked improvement in contrast for photographic and visual applications. Other improvements include the reduction or elimination of ion burns for magnetic deflection types and significantly longer overall tube life and reliability.

The aluminizing development can be incorporated into the manufacture of all existing JEDEC cathode ray tubes operating in the range between 2 to 8 kilovolts. Prototypes of the 5ADP- and 5AQP-types will be made available shortly.

The first user of one of the low-voltage aluminized tubes is Analab Instrument Corp. which has worked jointly with Thomas in setting the specifications and has been evaluating performance of prototypes for oscilloscope applications.

In addition to oscilloscope applications, the tubes are suited for radar displays and any other display systems requiring the ultimate in light output and screen stability.

These manufacturers have invited PROCEEDINGS readers to write for literature and further technical information. Please mention your IRE affiliation.

## Pulse Transformers And Reactors

Custom engineered pulse transformers and their associated charging reactors are now available from **Manson Laboratories**, P. O. Box 1214, Stamford, Conn. Pulsed viewing transformers, mono and bifilar types, and transformers for magnetron and klystron applications can be produced in quantity for circuits rated up to 250 kv. Illustrated in photo are two examples of this custom engineering: On the left a bifilar pulse transformer with recessed bellows providing a wide temperature tolerance, 30 kv rated output, step up ratio 1:5, the Bifilar Secondary supplies a magnetron with 3 amperes heater current. On the right; a charging reactor (4.5 henry), high "Q," linear over a wide dc current range, insulated for operation at 10 kv dc supply voltage. All components will meet applicable MIL specs when required.

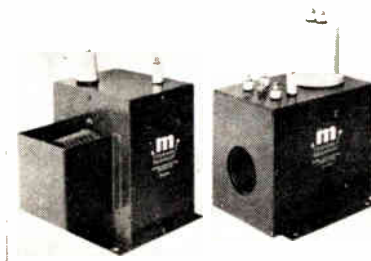

Inquiries regarding special applications and specifications are invited. Brochure #XFR260 and data application forms are available upon request.

## CGS Laboratories Now Trak Electronics

Elton T. Barrett, president, **CGS Laboratories, Inc.**, Wilton, Conn., announces that henceforth the company will carry on operations under the name of **Trak Electronics Co.** The corporate name remains unchanged for the present, and the business will be conducted under the name Trak Electronics Co., Division of CGS Laboratories, Inc.

In announcing the change, Mr. Barrett said: "The principal reasons for the change are the adoption of a name by another company similar to our corporate name, a desire to avoid the limitations implied by the word 'Laboratories,' and to facilitate promotion to the trade mark 'TRAK,' which already has acceptance in the trade."

## Radar Beacon

**Telerad Manufacturing Corp.**, 1440 Broadway, New York 18, N. Y., announces a new, compact radar beacon MODEL SRT-3081. The outstanding features of this beacon are:

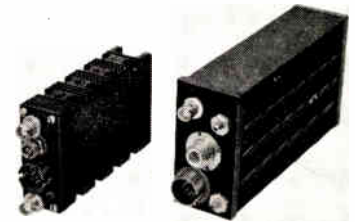

Environmental conditions—Temperature:  $-54^{\circ}\text{C}$  to  $+125^{\circ}\text{C}$ . Vibration: 10 to 100 cps at 25 G. Acceleration: 50 G. Altitude: 60,000 ft. Shock: 15 G.

Receiver—Frequency range: 2750-2950 mc. Bandwidth: 6-12 mc at 3 db points 35 mc maximum at 40 db down.

Triggering sensitivity:  $-41$  db (min.). Interrogation: Single or double pulse. Frequency stability:  $\pm 2$  mc. Size  $11'' \times 2\frac{1}{2}'' \times 5\frac{3}{4}''$ .

Transmitter—Frequency range: 2750-2950 mc. Frequency stability:  $\pm 2$  mc. Pulse power: 100 watts peak (min.) Pulse repetition rate: 2000 pp. Pulse width:  $0.65 \pm 0.05$  microsecond. Delay: 1.5 microseconds. Range jitter: 0.1 microsecond. Size:  $2'' \times 3\frac{1}{2}'' \times 7\frac{1}{8}''$ . Weight: 3.45 lbs. Power supplies available on special order.

For more detailed information on this beacon and other Telerad products that embrace the L, S, C, X and K bands, write to the firm.

## Connector Catalog

**Automatic Metal Products Corp.**, 323 Berry St., Brooklyn 11, N. Y., has published a radio frequency connector guide and technical manual.

Over two years of extensive research, development and preparation has gone into the production of this coaxial connector volume.

In addition to the connector illustrations, diagrams, and numerical designations, this volume will contain technical information on the use of connectors, a comprehensive section devoted to coaxial cables, and complete cable assembly instructions for all connectors listed. An additional section devoted to Automatic's coaxial relays and switches is also included.

Further information may be obtained by writing to the firm.

(Continued on page 192A)



# Creative Microwave Technology

Published by MICROWAVE AND POWER TUBE DIVISION, RAYTHEON COMPANY, WALTHAM 54, MASS., Vol. 1, No. 9

## NEW RAYTHEON MAGNETRONS FOR A WIDE RANGE OF APPLICATIONS

Designed for C-band systems requiring tunability, the RK-7156 magnetron has a minimum peak power output rating of 250 kilowatts over a frequency range of 5,450 to 5,825 megacycles. Applications include a flight-tested, revolutionary airborne weather radar system. The RK-7156 is in quantity production.

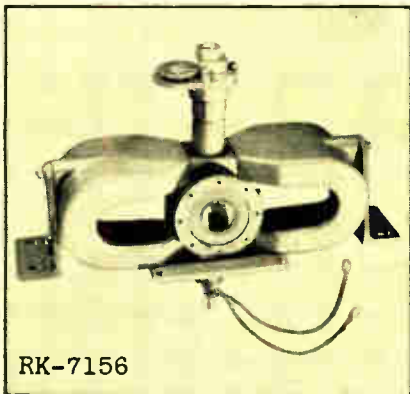

RK-7156

\* \* \*

X-band magnetron for airborne search radar provides one megawatt minimum peak power and 875 watts average

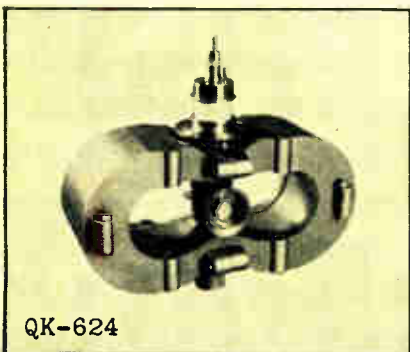

QK-624

power within a frequency range of 9,340 to 9,440 Mc. Designated QK-624, this pulsed-type tube is liquid cooled and should give at least 1,000 hours of reliable service.

\* \* \*

For ground-based and airborne radar systems, the RK-7529 magnetron provides a 2.0 microsecond pulse of 3.5 megawatts minimum peak power over 2,700 to 2,850 Mc. This liquid-cooled tube is interchangeable with other fixed-frequency S-band tubes operating at similar power levels.



RK-7529

\* \* \*

A one kilowatt beacon magnetron, the RK-7578 weighs only 14 ozs., yet will withstand vibrations of 15 G's at 20 to 2,000 cycles and shock up to 100 G's. It is

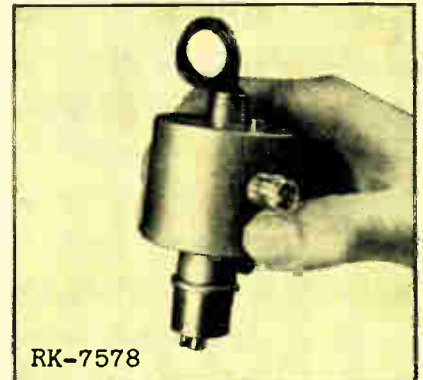

RK-7578

mechanically tunable and covers the 5,400 to 5,900 Mc range.

\* \* \*

Developed to withstand extreme environmental conditions, the RK-7449 magnetron is a lightweight, compact tube with a minimum peak power output of 45 kilowatts at the operating frequency of 24 kmc. The RK-7449 is required to withstand re-



RK-7449

peated shocks of 50G. Stable operation is guaranteed at vibration frequencies up to 2,000 c.p.s. with 30G applied.

A Leader in Creative Microwave Technology



*For the highest  
standard of  
Accuracy  
and Reliability*

# MARCONI INSTRUMENTS

## for Precise Measurement



### LOW CAPACITANCE BRIDGE Model 1342

- \* Capacitance range: 0.002  $\mu\text{F}$  to 1,111  $\mu\text{F}$ ,  $\pm 0.2\%$  accuracy.
- \* Shunt-resistance range: 1 to 1,000 M $\Omega$ .
- \* Suitable for in-situ measurements.
- \* Decade switching and readout.
- \* Independent indication of resistive component.

Capacitances down to 0.002  $\mu\text{F}$  can be measured with speed and precision by means of this three-terminal transformer ratio-arm bridge. Its exceptional discrimination and stability make it suitable for such applications as the measurement of the temperature coefficient of capacitors or changes in tube interelectrode capacitance. The bridge measures the capacitance between any two terminals of a 3-terminal network and is virtually unaffected by the impedance between either of these terminals and the third point. Connection to the component under test can be made via long leads without affecting measurement accuracy. Remote or wired-in components can be measured in-situ without the need to disconnect associated circuits.

### 20-MC SWEEP GENERATOR Model 1099

Can be used in conjunction with any oscilloscope for direct display of video response characteristics up to 20 MC. Frequency is indicated by crystal-controlled marker pips, and a special circuit provides for differential amplitude measurements, enabling relative response to be determined with a discrimination better than 0.01 dB. Frequency Swept Output: Frequency Range: Lower limit 100 kc. Upper limit 20 MC. Output level: Continuously variable from 0.3 to 3 volts. Output Impedance: 75 $\Omega$ . Time Base: Repetition Rate: 50 to 60 cps. Output for c.r.o. X deflection: 250 volts. Frequency Markers: At 1 MC intervals; every fifth pip distinctive and crystal controlled.

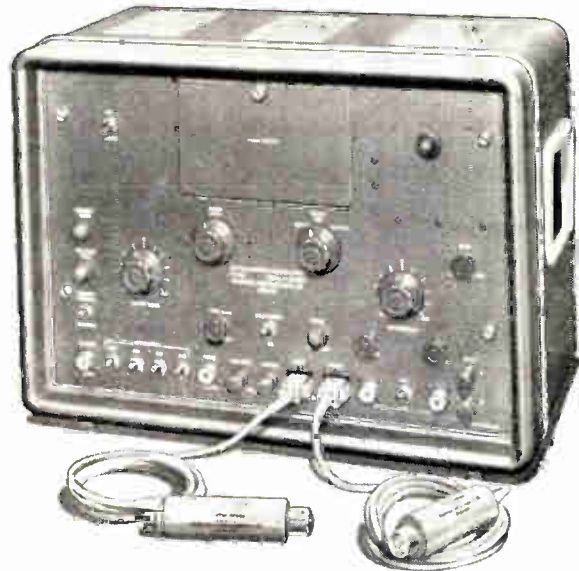

*Available  
Now*

### SHORT-FORM CATALOG OF MARCONI INSTRUMENTS

Keeps you up to date. Facilitates the rapid identification of the Marconi instrument most suitable for a prescribed purpose. More detailed information freely available.



**Marconi Instruments wide range of test equipment covers VLF to EHF. The latest short-form Catalog is now freely available.**

*Designers and Manufacturers of*

AM & FM SIGNAL GENERATORS  
 AUDIO & VIDEO OSCILLATORS  
 FREQUENCY METERS · VOLTMETERS  
 POWER METERS · DISTORTION METERS  
 FIELD STRENGTH METERS  
 TRANSMISSION MONITORS  
 DEVIATION METERS · OSCILLOSCOPES  
 SPECTRUM & RESPONSE ANALYZERS  
 Q METERS & BRIDGES

**Model 1064A/2 for MOBILE RADIO**

This FM Signal Generator provides RF outputs of 30 to 50, 118 to 185, and 450 to 470 MC, with FM at one fixed deviation and 0-15 kc variable; IF crystal outputs at five spot frequencies, (xtals not supplied) and also an AF output. High frequency stability, quick warm up and accurate FM have been obtained by use of modern semi-conductor components. FM is produced by a varactor and the power supply is transistor stabilized with zener diode reference.



**Q METER  
 Model 1245**

Here for the first time is a single Q Meter covering the range AF to VHF.

**Frequency Range:** 1 kc to 300 MC. Measures Q: 5 to 1,000; accuracy 5% at 100 MC.  
**Q Multiplier:** x0.9 to x2.  
**Delta Q:** 25-0-25. Test Circuits: separate LF and HF test circuits have ranges of 1 kc to 50 MC and 20 to 300 MC. **Capacitance Range:** 7.5 to 110  $\mu$ F with 1-0-1  $\mu$ F incremental, for either test circuit; 20 to 500  $\mu$ F for LF test circuit. **Shunt Loss:** 12 M $\Omega$  at 1 MC, 0.3 M $\Omega$  at 100 MC. **External Oscillators:** Model 1247, 20 to 300 MC. Model 1246, 40 kc to 50 MC. Model 1101, 20 cps to 200 kc.

**MARCONI INSTRUMENTS**

**111 CEDAR LANE · ENGLEWOOD · NEW JERSEY**

*Telephone: LOwell 7-0607*

CANADA: CANADIAN MARCONI CO · MARCONI BUILDING · 2442 TRENTON AVE · MONTREAL 16  
 MARCONI INSTRUMENTS LTD · ST. ALBANS · HERTS · ENGLAND

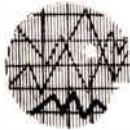

# IRE People



**VANE  
AXIAL  
FAN**  
MODEL  
E-2543-200

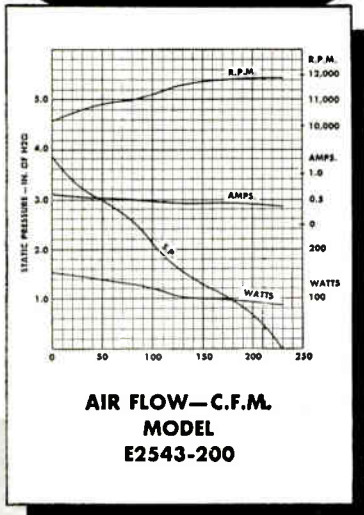

**SPECIFICATIONS:**  
 200V 400 cps 3 phase  
 200 CFM at 3/4" S.P.  
 Weight: 3 lb. 8 oz.  
 Ambient: 85°C  
 Life: 5000 hrs.  
 Environmental MIL-E-5422D  
 Material MIL-E-5400B  
 Class F Insulation

*Our Field Engineers will gladly assist you in your cooling problems*

Air-Marine motors and cooling units have been designed and tested to meet the specifications of both the military and industry.

**air • marine motors, inc.**

369 Bayview Ave.  
Amityville  
L.I., N.Y.



2221 Barry Ave.  
Los Angeles  
California

in Canada AAE Limited, Weston, Ontario  
WRITE TODAY FOR OUR NEW CATALOG

Wayne D. Brodd (A'54), has been promoted to the position of advisory engineer in the IBM 7070 Engineering Department of the IBM Product Development Laboratory at Poughkeepsie, N. Y., where he is engaged in the New Product Engineering effort on the 7070 Unit Record Equipment, and system coordination with Endicott and Rochester Engineering groups.

He joined IBM in 1950 as a customer engineer trainee at Evanston, Ill. He was transferred to Poughkeepsie in 1953 as a technical engineer on the 702 input/output development and advanced to associate engineer in 1955 where he became engaged in work on the 774 Tape Data Selector. He attained the status of staff engineer in 1958, his position until his recent advancement.

Mr. Brodd is a graduate of the University of Illinois, Urbana, in 1950 with the B.S.E.E. degree.



Donald W. Burns (A'56), has been advanced to the position of technical assistant to Arthur J. Hatch, vice president and general manager of Stromberg-Carlson's Commercial Products Division, according to an announcement issued by Mr. Hatch. Stromberg-Carlson is a division of General Dynamics Corporation.



D. A. BURNS

In this new position Mr. Burns will be responsible for development and coordination of a variety of technical programs. Prior to this appointment he was chief engineer in the Commercial Products Division.

He has been with Stromberg-Carlson since 1954, when he joined the firm as a staff engineer to the manager of quality control in the Radio and Television Division. Subsequently he served as an engineer in the Research Division, as a senior design engineer in the Special Products Division, and as chief engineer of the Commercial Products Group in the Special Products Division. Earlier he had been a design development engineer with Sylvania Electric Products Corporation in Buffalo.

Mr. Burns attended the University of Buffalo and received the B.A. degree in mathematics from the University of Rochester. He is a member of the Rochester Society for Quality Control, and is chairman of the Committee on Sound Apparatus of the Electronic Industries Association.



Roy J. Sandstrom, Bendix Systems Division, General Manager, has announced the appointment of James A. Burns (A'54) as Director of Long Range Planning for the Bendix Systems Division. He will fill the position vacated by L. B. Young who recently became Assistant General Manager of the Division. Mr. Burns was formerly Head of Technical Planning under Mr. Young.

As the new Director of Long Range Planning, he will direct the Technical Planning and Marketing activities of the division and will coordinate customer requirements into the preliminary design studies as well as preparation and presentation of proposals. He will also integrate the capabilities of other Bendix Divisions and potential subcontractors into major systems investigation.

He received the B.S. degree in electrical engineering from the University of Michigan, Ann Arbor, in 1952, majoring in electronics. After graduation, he joined the Willow Run Laboratories of the University of Michigan Engineering Research Institute where he participated in the fields of analog computation, weapons systems design and analysis, air defense system design, communication equipment design and test, and battle area surveillance system and equipment design and analysis. During this period, he was Project Engineer on systems design for low-altitude defense and other weapons systems work.

In the field of battle area surveillance, he served from 1953 to 1957 in various capacities on Project Michigan, a triservice program to improve the intelligence gathering capabilities of the service. He was engaged primarily in radar system design and analysis, particularly in the field of MTI and the processing and display of radar data. He performed a survey of all existing or development radar equipment to establish its application to battle area surveillance. In addition, he performed detailed evaluation and test of several specific radar systems, particularly those employing MTI.

In addition to his work in radar, he also participated in the establishment of requirements for battle area surveillance systems, including evaluation and test, using television, microwaves, infrared, acoustics, and optical devices as well as navigational subsystems of both the ground-based and self-contained types. In this connection, he performed system design involving sensory devices, data processing and display techniques, and communications. He also participated in the test of battle area surveillance and intelligence processing equipment in large-scale Army maneuvers. He was a consultant to the Bendix Systems Division on air defense and air traffic control problems in 1956, and joined Bendix in January, 1957.

*(Continued on page 50A)*



## SPACE AGE TV— WITH EIMAC CERAMIC TUBES

Lockheed's new miniature TV transmitter and camera have special significance for a space-curious world. They may one day help unravel some of the mysteries of the unknown as they soar through the outer reaches of space in a sophisticated satellite.

At the heart of the tiny transmitter is an Eimac ceramic tetrode, the 4CX300A. Eimac ceramic tubes can take tough assignments like this in their stride, with performance "extras" that mean outstanding reliability.

Eimac advanced ceramic design makes possible a compact tube capable of maintaining exceptional stability. Even under conditions of severe shock, vibration and accelerations up to 20g at frequencies from 20 to 2000 cycles per second no tube damage will result. Rugged, reliable power in a small package.

EITEL-McCULLOUGH, INC. • San Carlos, California



Today, over 40 ceramic tube types pioneered by Eimac engineering and research are available for use under adverse conditions. Whenever you have an application that requires compact tubes that *can take it*, investigate the many advantages of Eimac advanced ceramic-metal construction.

# FULL LINE OF HIGHEST BETA GER

## New TI high-efficiency emitter gives you high beta germanium power transistors!



Now minimum and maximum betas are guaranteed from 20 to 60 at the maximum current rating

of  $I_C = 25$  amps in new TI 2N514 series transistors. New high efficiency emitter makes possible greatly improved specifications for TI 2N456, 2N511, 2N512, 2N513, 2N514, and 2N1021 series alloy-junction germanium power transistors.

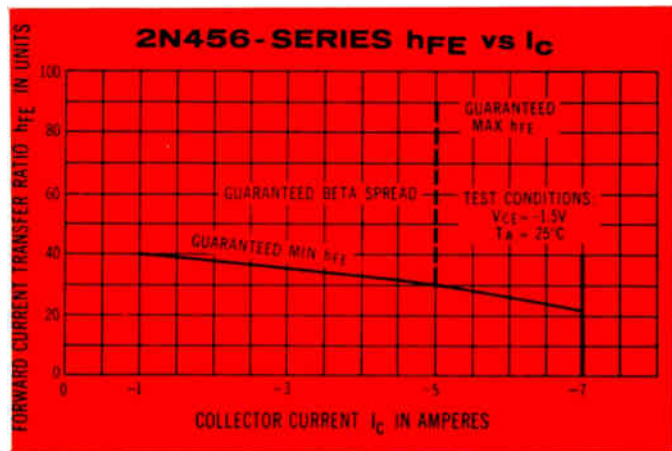

### TI gives you design leadership in quality germanium power transistors

#### INCREASED BETA THROUGH HIGH-EFFICIENCY EMITTER

Emitter efficiency can be improved by increasing the ratio of resistivities between the emitter and base region. For example, when a 10 ohm-centimeter resistivity germanium wafer is used as the base material, it is advantageous to have less than a .01 ohm-centimeter resistivity emitter regrowth region. Since initial doping of the germanium crystal establishes base resistivity, the ratio can be changed only by varying the emitter material. TI utilizes an emitter material that results in a lower emitter resistivity and an increased emitter efficiency, plus providing the higher beta at high currents.

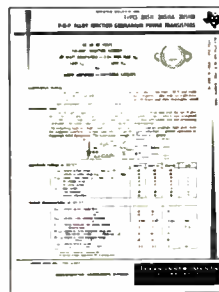

Optimum reliability for all TI germanium power transistors is assured by . . . 100% testing . . . 100% temperature cycling . . . 100% hermetic seal testing . . . continuous and intensive quality assurance program. Write on your company letterhead for germanium power transistor specifications.

#### GERMANIUM

**POWER/SWITCHING/DEFLECTION CIRCUIT**

**TRANSISTORS**

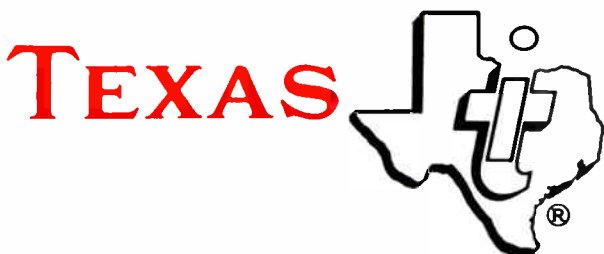

**INSTRUMENTS**  
INCORPORATED  
SEMICONDUCTOR-COMPONENTS DIVISION  
13500 N. CENTRAL EXPRESSWAY  
POST OFFICE BOX 312 • DALLAS, TEXAS



# MANIUM POWER TRANSISTORS

New high current 2N1046-A-B give you high frequency/dissipation/voltage with high beta!



New TI 2N1046B germanium power transistors give you 10 amp  $I_C$  with

typical 18 mc  $f_T^*$  . . . 130 volt  $BV_{CBO}$  . . . guaranteed beta of 10 at 10 amp  $I_C$  . . . 30 watt dissipation . . . high frequency/high current operating characteristics. The 2N1046 series alloy-diffused P-N-P transistors provides maximum reliability for your core driving, hi-fi amplification, and other high frequency power applications.

$f_T^*$  Frequency at which common emitter current gain of the device is unity.

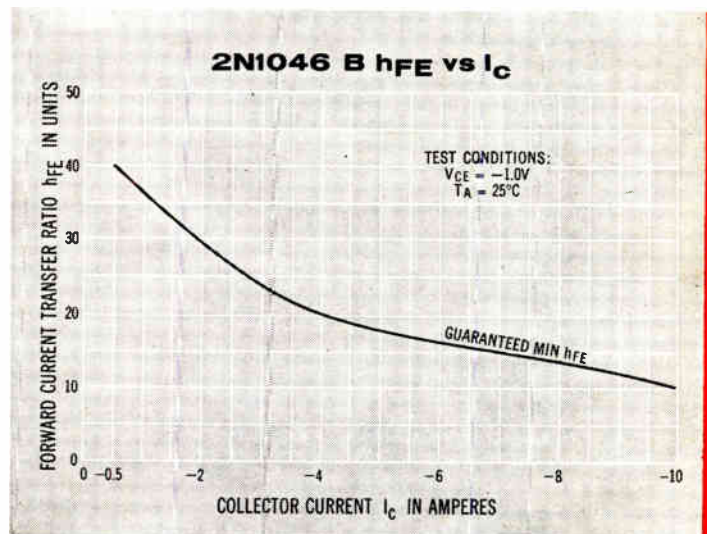

Call on your nearest TI distributor or sales office for immediate delivery of TI germanium power transistors including the 1-amp 2N1038 series and the 3-amp 2N1042 series power transistors.

## TI GERMANIUM POWER TRANSISTOR CHARACTERISTICS AT 25°C

Type	Dissipation at 25°C watts	Collector to Base Voltage-v max	Collector to Emitter Voltage min $BV_{CEO}$	Emitter to Base Voltage-v min $BV_{EBO}$	Collector Current Amps max	$h_{FE}$ @ $I_C$		Collector Reverse Current $I_{CO}$ max		Typ $R_{CS}$ @ $I_C$ ohms	Internal Cutoff Frequency avg $f_T$
						min	max	ma	v		
2N456A	50	-40	-20	-20	-7	30 @ 5a	90	-0.5	-20	0.040 @ 5a	430 kc
2N457A	50	-60	-30	-20	-7	30 @ 5a	90	-0.5	-30	0.040 @ 5a	430 kc
2N458A	50	-80	-40	-20	-7	30 @ 5a	90	-0.5	-40	0.040 @ 5a	430 kc
2N1021	50	-100	-50	-20	-7	30 @ 5a	90	-0.5	-50	0.040 @ 5a	430 kc
2N1022	50	-120	-50	-20	-7	30 @ 5a	90	-0.5	-60	0.040 @ 5a	430 kc
2N511	80	-40	-20	-30	-25	20 @ 10a	60	-2	-20	0.025 @ 10a	260 kc
2N511A	80	-60	-30	-30	-25	20 @ 10a	60	-2	-30	0.025 @ 10a	260 kc
2N511B	80	-80	-40	-30	-25	20 @ 10a	60	-2	-40	0.025 @ 10a	260 kc
2N512	80	-40	-20	-30	-25	20 @ 15a	60	-2	-20	0.033 @ 15a	280 kc
2N512A	80	-60	-30	-30	-25	20 @ 15a	60	-2	-30	0.033 @ 15a	280 kc
2N512B	80	-80	-40	-30	-25	20 @ 15a	60	-2	-40	0.033 @ 15a	280 kc
2N513	80	-40	-20	-30	-25	20 @ 20a	60	-2	-20	0.038 @ 20a	300 kc
2N513A	80	-60	-30	-30	-25	20 @ 20a	60	-2	-30	0.038 @ 20a	300 kc
2N513B	80	-80	-40	-30	-25	20 @ 20a	60	-2	-40	0.038 @ 20a	300 kc
2N514	80	-40	-20	-30	-25	20 @ 25a	60	-2	-20	0.040 @ 25a	350 kc
2N514A	80	-60	-30	-30	-25	20 @ 25a	60	-2	-30	0.040 @ 25a	350 kc
2N514B	80	-80	-40	-30	-25	20 @ 25a	60	-2	-40	0.040 @ 25a	350 kc
2N1038	20	-40	-30	-20	-3	20 @ 1a	60	-125 $\mu$ a	-20	0.150 @ 1a	8.0 kc $f_{ae}$ min
2N1039	20	-60	-40	-20	-3	20 @ 1a	60	-125 $\mu$ a	-30	0.150 @ 1a	8.0 kc $f_{ae}$ min
2N1040	20	-80	-50	-20	-3	20 @ 1a	60	-125 $\mu$ a	-40	0.150 @ 1a	8.0 kc $f_{ae}$ min
2N1041	20	-100	-60	-20	-3	20 @ 1a	60	-125 $\mu$ a	-50	0.150 @ 1a	8.0 kc $f_{ae}$ min
2N1042	20	-40	-30	-20	-3	20 @ 3a	60	-125 $\mu$ a	-20	0.167 @ 3a	8.0 kc $f_{ae}$ min
2N1043	20	-60	-40	-20	-3	20 @ 3a	60	-125 $\mu$ a	-30	0.167 @ 3a	8.0 kc $f_{ae}$ min
2N1044	20	-80	-50	-20	-3	20 @ 3a	60	-125 $\mu$ a	-40	0.167 @ 3a	8.0 kc $f_{ae}$ min
2N1045	20	-100	-60	-20	-3	20 @ 3a	60	-125 $\mu$ a	-50	0.167 @ 3a	8.0 kc $f_{ae}$ min
2N1046	30	-100	-50	-1.5	-10	40 @ 0.5a	60	-125 $\mu$ a	-50	0.167 @ 3a	8.0 kc $f_{ae}$ min
2N1046A	30	-140	-50	-1.5	-10	20 @ 4a	60	-1	-40	0.500 @ 1a	15 mc min
2N1046B	30	-140	-50	-1.5	-10	40 @ 4a	60	-1	-40	0.125 @ 4a	15 mc min
						10 @ 10a	60	-1	-40	0.050 @ 10a	15 mc min

# NOT NEW, but...



...proved by millions in use over several years! IERC TR type Heat-dissipating Electron Tube Shields are still the only effective heat-dissipating tube shield designed for retrofitting equipment having JAN bases.

Present TR's are unchanged from the original version introduced — and over the years, nothing has equalled their cooling and retention qualities. The greatly extended tube life and reliability provided by IERC TR's is acknowledged by the entire industry.

IERC's TR's have been right for the job — right from the start. For immediate, increased tube life and reliability — retrofit now with IERC TR Shields.



Free IERC Tube Shield Guide, listing TR Shields, is available by writing Dept. TR for your copy.

**International Electronic Research Corporation**  
145 West Magnolia Boulevard, Burbank, California



**IRE People**



(Continued from page 46A)

Mr. Burns is a member of Tau Beta Pi, Eta Kappa Nu, Sigma Xi and Phi Kappa Phi. He has authored several classified publications and technical articles in the electronics field.



**Jack G. Anderson** (A'56) has been appointed vice president for government relations at Stromberg-Carlson, Vice President and General Manager Allan R. Shilts has announced. Stromberg-Carlson is a division of General Dynamics Corporation.



J. G. ANDERSON

Mr. Anderson comes to Stromberg-Carlson from Hoffman Electronics Corporation of Los Angeles, where

he was vice president for marketing. He had been with Hoffman since 1954, first as manager of Air Force operations and later as director of military marketing.

From 1942 to 1954 he served with the U. S. Air Force in many assignments throughout the United States, Europe, Africa and the Pacific. He was a major when discharged.

Mr. Anderson attended the University of Louisville and received the B.S. degree from the USAF Institute of Technology in Dayton, Ohio.

He is a past president of the Dayton Wright Chapter of the Armed Forces Communications and Electronics Association and is a member of many other organizations, including the American Rocket Society, Institute of Aeronautical Sciences, Air Force Association, Air Traffic Control Association, American Ordnance Association, Association of the U. S. Army, and the Navy League.



**Ralph J. Bahnsen** (S'54-A'55-M'59), has been promoted to the position of advisory engineer in the Systems Engineering Department of Advanced Computational Systems at the IBM Product Development Laboratory in Poughkeepsie, N. Y. He is in charge of analysis work on an advanced Data Processing System.

He joined the company in June, 1954 as a technical engineer working on the 702 Computer. He was transferred to Kingston in 1955 and returned to Poughkeepsie in 1956, attaining the status of associate engineer. He was engaged in the 738 memory and logical design of an advanced data processing system. He became a staff engineer in 1958, his position until his recent promotion.

Mr. Bahnsen attended Queens College and received the B.E.E. degree from the College of the City of New York in 1954.



**Dr. Nicholas A. Begovich** (S'41-A'48-M'58), has been appointed assistant man-

(Continued on page 54A)



*Reliability in volume...*

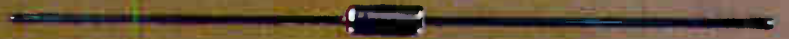

**CLEVITE**  
TRANSISTOR  
WALTHAM, MASSACHUSETTS



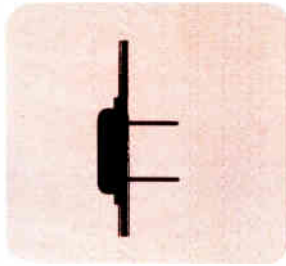

**NEW!**

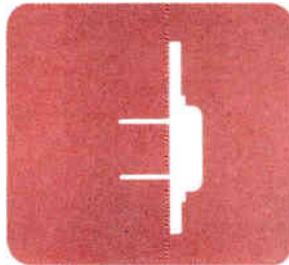
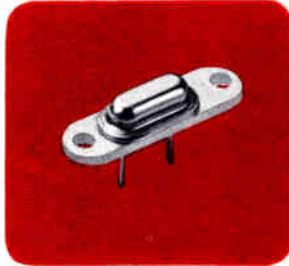

## ADVANCED DESIGN POWER TRANSISTORS FROM CLEVITE

Three new lines of germanium power transistors by Clevite feature new advances in controlled gain spread, fully specified collector-to-emitter voltage characteristics and low current leakage — even at maximum voltages and high temperatures.

*The new 8 ampere switching series* can be used to replace the older, more costly ring-emitter types in 3 to 8 ampere service.

*The new 25 ampere switching type* offers exceptionally low saturation voltage and is available with either pin terminals or solder lugs.

*The new Spacesaver design* not only affords important savings in space and weight, but its significantly improved frequency response means higher audio fidelity, faster switching and better performance in regulated

power supply applications. Its low base resistance gives lower input impedance for equal power gain and lower saturation resistance, resulting in lower "switched-on" voltage drop. Lower cut off current results in better temperature stability in direct coupled circuits and a higher "switched-off" impedance.

### CLEVITE NOW OFFERS THESE COMPLETE LINES

#### Switching Types

5 ampere  
8 ampere  
15 ampere  
25 ampere

#### Amplifier Types

2 watt  
4 watt  
2 watt Spacesaver

#### 3 ampere Spacesaver

All Clevite germanium power transistors are designed for low thermal resistance, low base input voltage, low saturation voltage and superior current gain.

*For latest data and prices or application assistance, write for Bulletin 60 . . .*



*Reliability in volume . . .*

# CLEVITE TRANSISTOR

254 Crescent Street Waltham 54, Mass. Tel: TWinbrook 4-9330





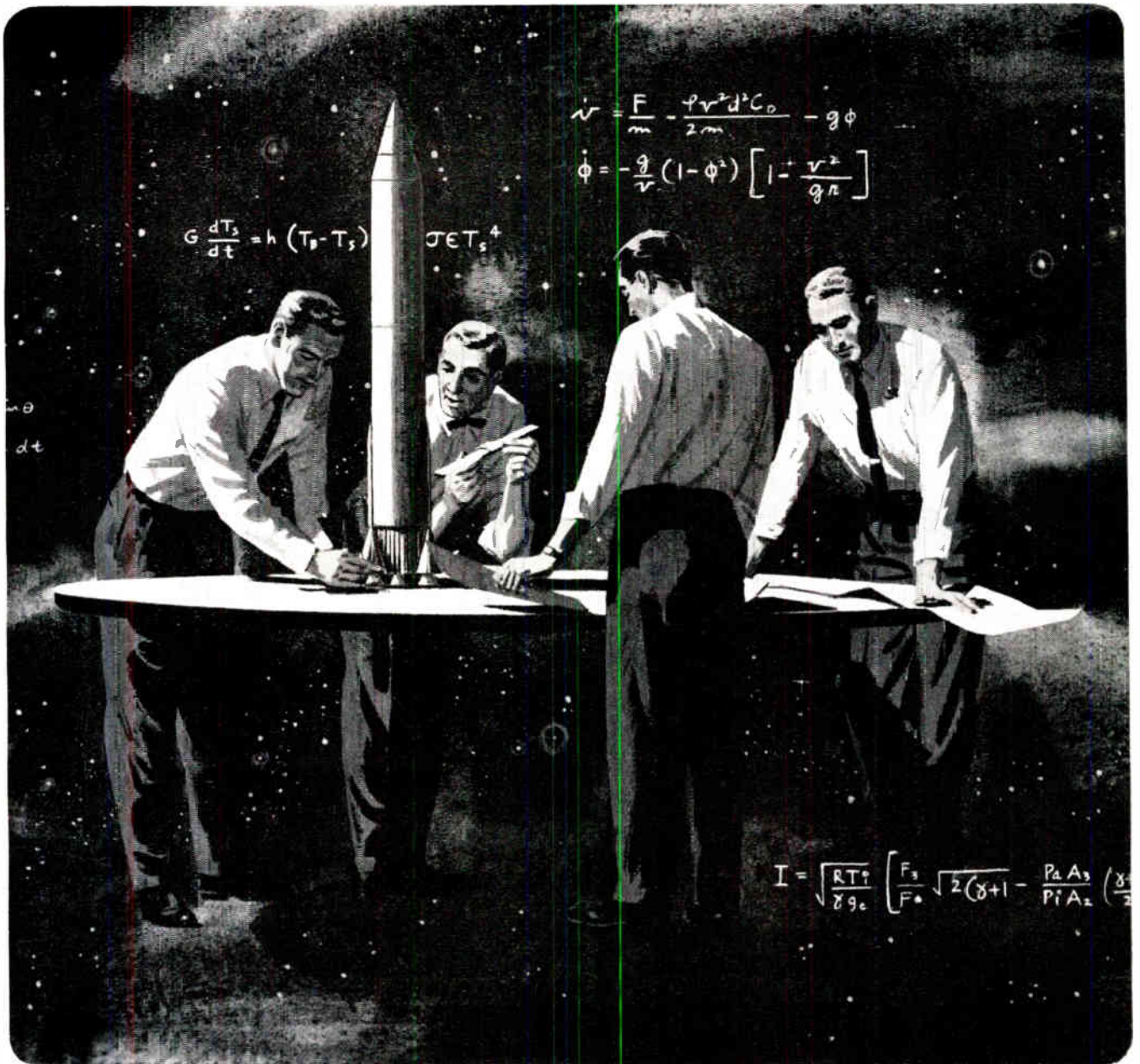

## ENGINEERING TEAMWORK IN SPACE EXPLORATION

Engineers and scientists interested in a wide range of activities will appreciate the advanced nature of research and development projects under way at JPL. These projects include research, basic and applied, in Electronics, Solid State Physics, Propulsion, Aerodynamics, Structures and Materials and the design, development and analysis of space probes and satellites. Individually responsible engineers and scientists work together as a thoroughly integrated

team in accomplishing the complete objective.

Programs involve guidance, telemetering, data recording and reduction, instrumentation, structures, propulsion, materials, solid state physics, components, heat transfer problems and systems analysis and are constantly influenced by continuing JPL space exploration research providing individuals with challenging assignments in almost every phase of engineering and

science. Staff progress in diverse fields of activity is constantly being made.

Pioneering in basic research, applied research and development engineering in space exploration proves to be a stimulating attraction for engineers and scientists with innate curiosity and intense interest in the future of space exploration.

More men of this type are needed — if you believe you are qualified for the JPL team, send in your resume today.



### CALIFORNIA INSTITUTE OF TECHNOLOGY JET PROPULSION LABORATORY

A Research Facility operated for the National Aeronautics and Space Administration  
PASADENA, CALIFORNIA

Employment opportunities for Engineers and Scientists interested in basic and applied research in these fields:

COMMUNICATIONS • MICROWAVE • SERVOMECHANISMS • COMPUTERS • LIQUID AND SOLID PROPULSION  
• STRUCTURES • CHEMISTRY • INSTRUMENTATION • MATHEMATICS • AND SOLID STATE PHYSICS •

Send professional resume, with full qualifications and experience, for our immediate consideration.

# McCoy

G-20 & G-21 MINIATURE

## ALL-GLASS

HC-18/U TYPE

# CRYSTAL UNITS

Possess all of the quality and dependability for which the McCoy line of metal encased crystal units is famous.

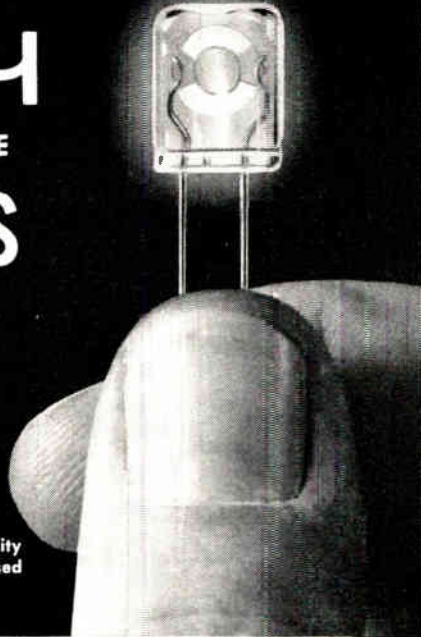

### Check these advantages:

- ✓ Excellent Long-Term Stability
- ✓ Minimum Aging
- ✓ Choice of Leads — Pins or Flexible Wire
- ✓ Maximum Resistance to Shock and Vibration  
30 vector G's from 20 to 2000 cps — vibration  
100 G's — shock
- ✓ True Hermetic Seal  
Altitude is no problem
- ✓ Meets new CR-73/U and CR-74/U Specs
- ✓ Wide Range of Frequencies Available  
5000 KC to 200,000 KC
- ✓ Extremely Small Size

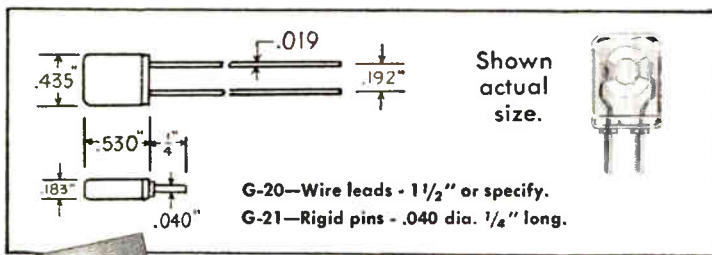

Write today for our free illustrated catalog which includes complete listing of military specifications. For specific needs, write, wire or phone us. Our research section is anxious to assist you.

# McCoy

**ELECTRONICS CO.**

Dept. P-5

MT. HOLLY SPRINGS, PA.

Phone HUter 6-3411



**IRE People**



(Continued from page 50A)

ager of Hughes Aircraft Company's Ground Systems Group, C. Harper Brubaker, vice-president and Group manager, has announced.



N. A. BEGOVICH

Dr. Begovich, formerly director of engineering at the Hughes plant, also will serve as director of product line operations.

He developed the principle of radar frequency scanning which, as incorporated in Hughes' "Frescanar," provides pinpoint three-dimensional information (range, bearing and altitude) using only one antenna, one transmitter and one receiver. Frescanar is the "eyes" of Missile Monitor, an advanced mobile air defense developed by Hughes for the U. S. Army.

Joining Hughes as a research physicist in 1948, he has also served as a consultant to the weapons system evaluation group for the Department of Defense, as a research engineer for the War Metallurgy Committee and the War Production Board, and as an instructor in electrical engineering at California Institute of Technology.

(Continued on page 56A)



## STANDING WAVE DETECTORS

—exceptionally accurate

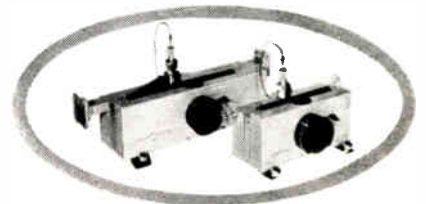

You get the accuracy that results from perfect parallelism between slot and waveguide axis... between probe travel and waveguide axis. Only 30 seconds needed to equip a D-B slotted line to measure adjacent frequency bands. Range: 5.8 KMC to 140 KMC—covered by a *minimum* of units, to stretch your budget. Literature on request.



**DE MORNAY—BONARDI**  
780 SOUTH ARROYO PARKWAY • PASADENA, CALIF.



Distributed constant delay lines • Lumped constant delay lines • Variable delay networks • Continuously variable delay lines • Pushbutton decade delay lines • Shift registers •

# ESC EXTRA

Pulse transformers • Medium and low-power transformers • Filters of all types • Pulse-forming networks • Miniature plug-in encapsulated circuit assemblies

# ESC DEVELOPS DELAY LINE WITH 170 to 1 DELAY TIME / RISE TIME RATIO

## Model 61-34 Perfected For Specialized Communications Application

PALISADES PARK, N. J.—An entirely new Lumped-Constant Delay Line, with a proven 170 to 1 delay time/rise time ratio, has been announced by the ESC Corporation, Palisades Park, N. J. The new delay line, known as Model 61-34, was specifically designed for a specialized communications application calling for the exceptionally high delay time/rise time ratio.

ESC, the world's leading manufacturer of custom built and stock delay lines, is already widely recognized in the electronics industry for its exceptional engineering advances. In October, 1958, ESC broke through an existing design barrier and produced a delay line with a 145 to 1 delay time/rise time ratio. It had been thought, prior to the announcement of the Model 61-34, that ESC had reached the ultimate in this type of delay line.

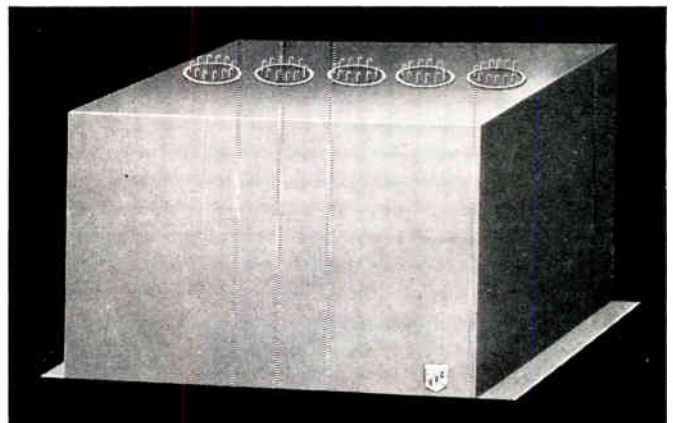

### SPECIFICATIONS OF NEW DELAY LINE MODEL 61-34

Delay time/rise time ratio: 170/1  
Delay: 200 usec.  
Rise time: 1.16 usec.  
Attenuation: less than 2 db  
Frequency response: 3 db = 325 KC  
50 taps with an accuracy of  $\pm 0.2$  usec. at each tap.

Complete technical data on the new unit can be obtained by writing to  
**ESC Corporation, 534 Bergen Boulevard, Palisades Park, New Jersey.**

# PROVEN RELIABILITY— SOLID-STATE POWER INVERTERS

over 260,000 logged hours— voltage-regulated,  
frequency-controlled, for missile, telemeter, ground-  
support, 135°C all-silicon units available now—

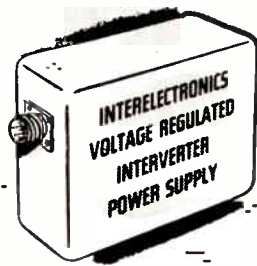

Interelectronics all-silicon thyatron-like gating elements and cubic-grain toroidal magnetic components convert DC to any desired number of AC or DC outputs from 1 to 10,000 watts.

Ultra-reliable in operation (over 260,000 logged hours), no moving parts, unharmed by shorting output or reversing input polarity. Wide input range (18 to 32 volts DC), high conversion efficiency (to 92%), including voltage regulation by Interelectronics patented reflex high-efficiency magnetic amplifier circuitry.

Light weight (to 6 watts/oz.), compact (to 8 watts/cu. in.), low ripple (to 0.01 mv. p-p), excellent voltage regulation (to 0.1%), precise frequency control (to 0.2% with Interelectronics extreme environment magnetostrictive standards or to 0.0001% with fork or piezoelectric standards).

Complies with MIL specs. for shock (100G 11 mlsec.), acceleration (100G 15 min.), vibration (100G 5 to 5,000 cps.), temperature (to 150 degrees C), RF noise (1-26600).

AC single and polyphase units supply sine waveform output (to 2% harmonics), will deliver up to ten times rated line current into a short circuit or actuate MIL type magnetic circuit breakers or fuses, will start gyros and motors with starting current surges up to ten times normal operating line current.

Now in use in major missiles, powering telemeter transmitters, radar beacons, electronic equipment. Single and polyphase units now power airborne and marine missile gyros, synchros, servos, magnetic amplifiers.

Interelectronics—first and most experienced in the solid-state power supply field produces its own all-silicon solid-state gating elements, all high flux density magnetic components, high temperature ultra-reliable film capacitors and components, has complete facilities and know how—has designed and delivered more working KVA than any other firm!

For complete engineering data, write Interelectronics today, or call LUDlow 4-6200 in New York.

## INTERELECTRONICS CORPORATION

2432 Grand Concourse, New York 58, N. Y.

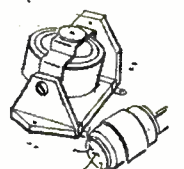
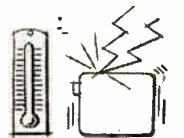

### SEAL PROBLEMS?

### A CASE IN POINT

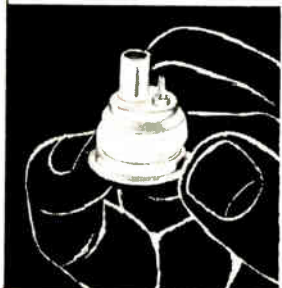

#### PROBLEM:

GENERAL ELECTRIC required development of a rugged compact high current thermic seal CONTROLLED RECTIFIER housing constructed of materials and processes to withstand temperatures above soft solder range—design involves 5 seals to dissimilar materials.

#### SOLUTION:

Mechanical requirement dictated use of 3 metals; alloy #52, OFHC and Gr "A" Ni. Braze material selected is above 1435°F, so that subsequent welding, or brazing, can be done without detrimental effect. Tapered seal eliminates costly ground ceramics.

#### CERAMIC TO METAL ASSEMBLIES BY MITRONICS ARE:

- More precise • More compact • More economical • More durable

Why struggle with metallizing problems when Mitronics' complete engineering facilities are at your disposal.

METALLIZING SPECIALISTS

Write, phone or wire for technical assistance, information

**mitronics inc.**

1292 Central Ave., Hillside, N. J. WAverly 6-2250



IRE People



(Continued from page 54A)

Dr. Begovich received the B.S., M.S. and Ph.D. degrees from Caltech. He has published papers on high frequency vacuum tube theory, electro-magnetic radiation problems and radar detection theory.

Carl W. Burrows, Jr., (M'59), has been appointed director of headquarters sales at Stromberg-Carlson Division of General Dynamics Corporation, according to an announcement by Alan R. Shilts, vice president and general manager of the division.



Mr. Burrows comes to Stromberg-Carlson from Hoffman Electronics Corporation where he was associated with the military products division as director of headquarters sales. Prior to this he was with the Bendix-Pacific Division of Bendix Aviation Corporation.

From 1943 to 1955 he was on active duty with the Navy. For two and a half years during this time he served as an instructor at the U. S. Naval Postgraduate School, Monterey, Calif. in communications and anti-submarine warfare. He resigned from the Navy in 1955 as a lieutenant commander.

He attended Pasadena City College and was graduated from the U. S. Naval Academy at Annapolis, Md., in 1943. He is also a graduate of the communications course at the U. S. Naval Postgraduate School, Annapolis.

He is a member of the Institute of Aeronautical Sciences and the American Rocket Society.

Solomon Charp (A'43-M'44-SM'50), has been appointed Manager of Navigation and Control Electronic Equipment for General Electric's Missile and Space Vehicle Department, Philadelphia, Pa.

He is responsible for three basic functions: investigation of complete navigation and control electronic systems; design and development of control components such as sensors and computers; and the design of electronic circuitry.

He joined the company in July, 1959, as a Consultant in radiation and data comparison and electronic systems. For eleven years previous to that he was a member of the research staff of The Franklin Institute.

A native of Jersey City, N. J., he attended public schools in Philadelphia. He graduated from the University of Pennsylvania, Philadelphia, in 1940 with the B.S. degree in Electrical Engineering and received the M.S. degree from that university in 1941.

He was an instructor and research associate at the University of Pennsylvania for seven years previous to joining

(Continued on page 58A)



# PHILCO MAT\* TRANSISTORS

## are UNIVERSALLY APPLICABLE

### To All Logic Circuits Up To 5mc

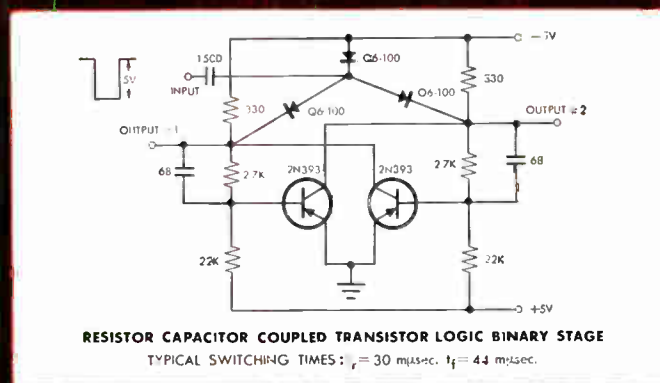
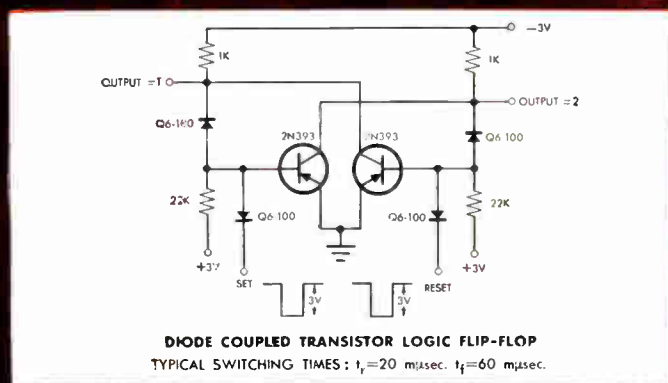
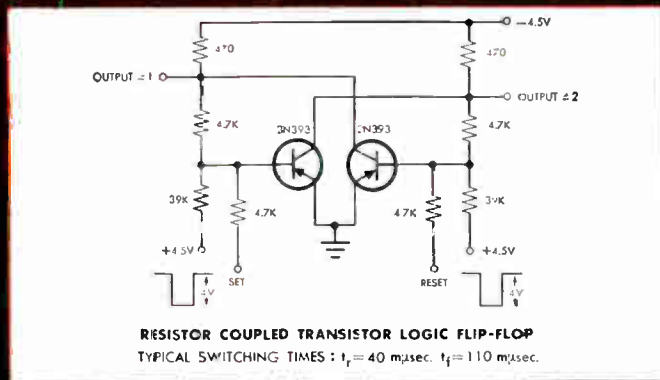
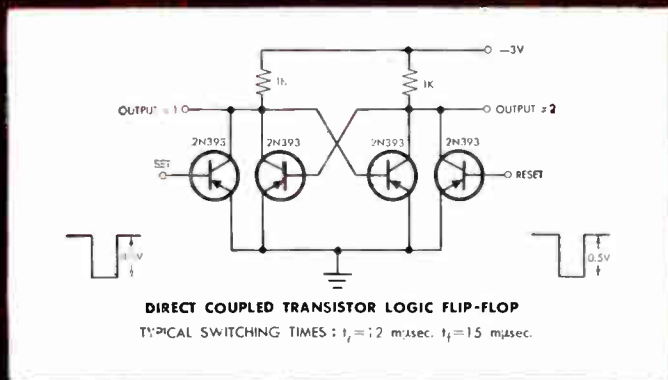

## high frequency performance...at medium frequency prices



The Philco 2N393 Micro Alloy Transistor (MAT) has proved its complete reliability in millions of operating hours in every type of computer logic circuit up to 5 mc. It combines all the advantages of high frequency performance with low price. The 2N393 is easily designed into any logic circuit and offers the designer these important advantages:

- High beta
- Low saturation voltage
- High speed
- High  $V_{BE}$  rating
- Low  $I_{CO}$
- Low hole storage time

When you can buy so much for so little . . . don't settle for less in *your* equipment.

The 2N393 is also available in a military version . . . Mil 5-19500/77A (Sig.C.)

Other Philco MATs to Meet Your Special Requirements:

- 2N1122 . . . with 11 volt rating
- 2N1122A . . . with 14 volt rating
- 2N1427 . . . with additional parameter control

For data sheets, write Department IR 560.

\*Reg. U.S. Pat. Off.

Immediately available in quantities 1000 from your local Philco Industrial Semiconductor Distributor.

# PHILCO



Famous for Quality the World Over

LANSDALE DIVISION • LANSDALE, PENNSYLVANIA



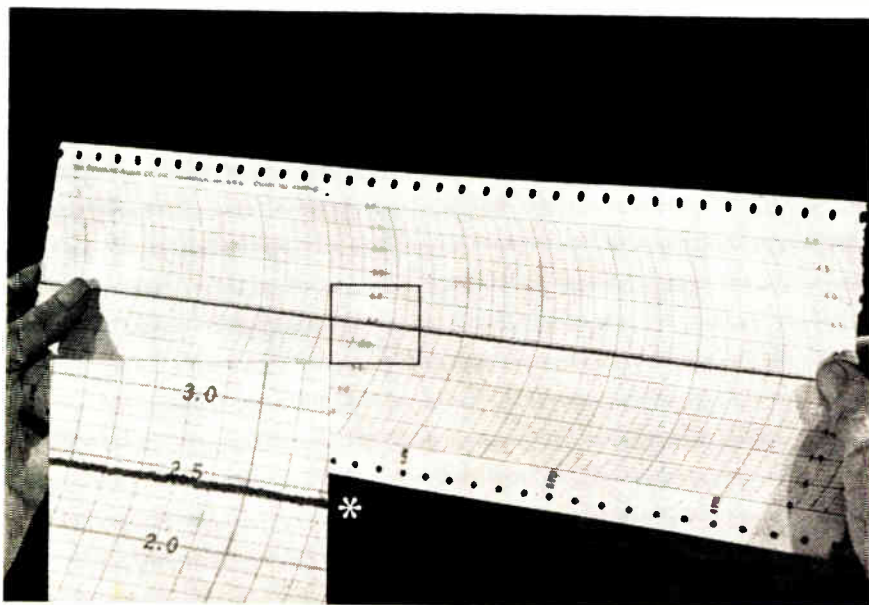

Measure fractions of a microvolt... approaching the Johnson noise limit... with Beckman DC Breaker Amplifiers. These high gain, low drift amplifiers are insensitive to vibrations, provide fast response and feed outputs directly to standard recorders. This means you can measure dc and low frequency ac voltages which were impossible or too tedious with devices like suspension galvanometers. A few applications include use with ultra-precision bridge circuits for measurement of differential thermocouples, nerve voltages, and other extremely low voltages. For detailed specifications write for Data File 9-5-11.

**Beckman**  
Scientific and Process Instruments Division  
Beckman Instruments, Inc.  
2500 Fullerton Road, Fullerton, California

\*Note low noise level...less than .003 microvolt



# new GEN-PRO®

## AIRCRAFT TYPE TERMINAL BOARDS

New series of Molded Terminal Boards available in three basic types—AN, NAS and MS. Special compoundings, backing strips and hardware on request.

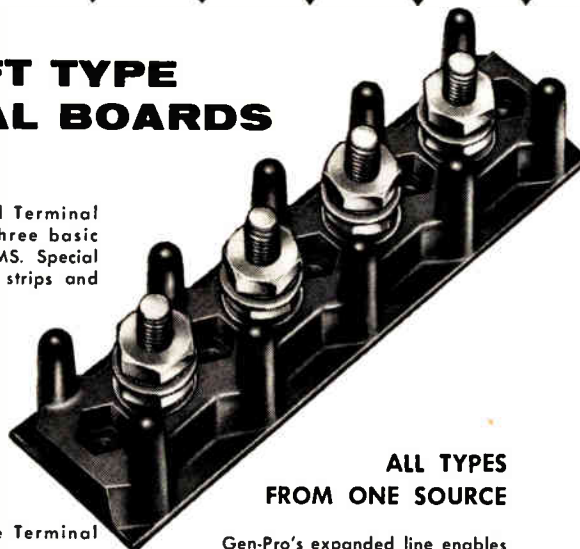

ALL TYPES  
FROM ONE SOURCE

Gen-Pro Aircraft Type Terminal Boards — soon available through distributors. Sales and service reps in key U. S. cities. Fast delivery.

WRITE NOW FOR FURTHER DETAILS

Gen-Pro's expanded line enables you to order all types of Terminal Boards from a single source; standard military, commercial, and others for special applications.

**GENERAL PRODUCTS CORPORATION**  
Over 25 Years of Quality Molding  
UNION SPRINGS, NEW YORK TWX No. 169



**IRE People**



(Continued from page 56A)

The Franklin Institute in 1948.

He has conducted research in naval anti-aircraft fire control systems, electro-mechanics, statistical-type analogue computers, radar reflections, and radar guidance systems.

Mr. Chapp is a member of Tau Beta Pi, Pi Mu Epsilon, Sigma Xi, the Research Society of America, and the AIEE. He is a member of the Executive Board of the Philadelphia Section of the AIEE and serves as Treasurer, 1960 International Solid State Circuits Conference.

**L. Berkley Davis** (SM'53), has been elected a vice-president of the General Electric Company. He is general manager of the company's electronic components division which is made up principally of the Receiving Tube Department (Owensboro, Ky., also site of division headquarters); the Cathode Ray Tube Department (Syracuse, N. Y.); the Power Tube Department (Schenectady, N. Y.); and the Semiconductor Products Department (Syracuse, N. Y.)



L. B. DAVIS

He was born in Lewisport, Ky., October 27, 1911, and graduated from high school there. He attended the Engineering College of the University of Kentucky at Lexington, a member of the class of 1934.

After starting work in 1934 as an engineer with the former Ken-Rad Tube and Lamp Corporation in Owensboro, Ky., subsequent advancements placed him in charge of tube production engineering and brought him the position of chief engineer for the Ken-Rad Transmitting Tube Corporation. During World War II he became plant manager of the Owensboro Transmitting Tube operation. General Electric acquired the Ken-Rad tube facilities on January 2, 1945, and near the end of that year Mr. Davis was made manager of the Owensboro operations.

In December, 1949 he was appointed general manager of General Electric Receiving Tube operations, with headquarters in Owensboro. He became general manager of the newly-created Electronic Components Division of the General Electric Company in June, 1956, and retains this position with his appointment as a vice-president of the company.

**Warren C. Foin** (S'53-A'54), has been promoted to the position of development engineer in the 7080 Engineering Department of Advanced Data Systems Development at the IBM Product Development Laboratory in Poughkeepsie, N. Y. He is now project manager, responsible for the design of the IBM 7080 Data Processing System.

(Continued on page 60A)





## SUBMINIATURE **DISCAPS**

# DESIGNED FOR COMPACT PRODUCTS



### SPECIFICATIONS

- POWER FACTOR: 1.5% Max. @ 1 KC (initial)
- WORKING VOLTAGE: 500 V.D.C.
- TEST VOLTAGE (FLASH): 1000 V.D.C.
- LEADS: No. 22 tinned copper (.026 dia.)
- INSULATION: Durez phenolic (1/8" max. on leads)—vacuum waxed
- STAMPING: RMC—Capacity—Z5U
- INITIAL LEAKAGE RESISTANCE: Guaranteed higher than 7500 megohms
- AFTER HUMIDITY LEAKAGE RESISTANCE: Guaranteed higher than 1000 megohms

RMC Type SM DISCAPS are designed for applications in compact radios, testing products, communication equipment and other products where space is of prime importance. These DISCAPS are rated at a working voltage of 500 volts and exhibit a minimum capacity change between +10° and +85° C. Type SM DISCAPS can be specified with the complete assurance of quality and reliability that is inherent in all RMC DISCAPS.

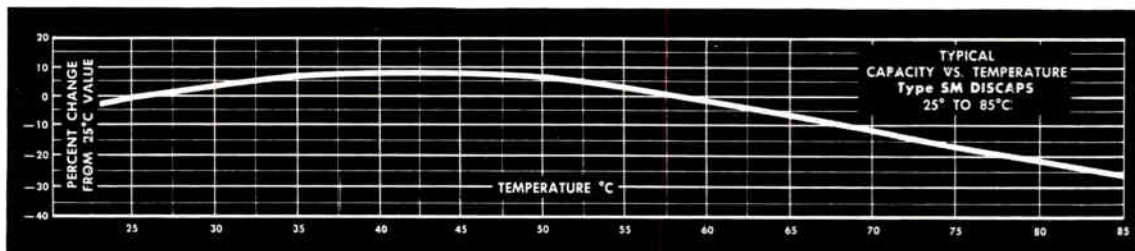

DISCAP CERAMIC CAPACITORS



**RADIO MATERIALS COMPANY**  
 A DIVISION OF P. R. MALLORY & CO., INC.  
 GENERAL OFFICE: 3325 N. California Ave., Chicago 18, Ill.  
 Two RMC Plants Devoted Exclusively to Ceramic Copocitors  
**FACTORIES AT CHICAGO, ILL. AND ATTICA, IND.**

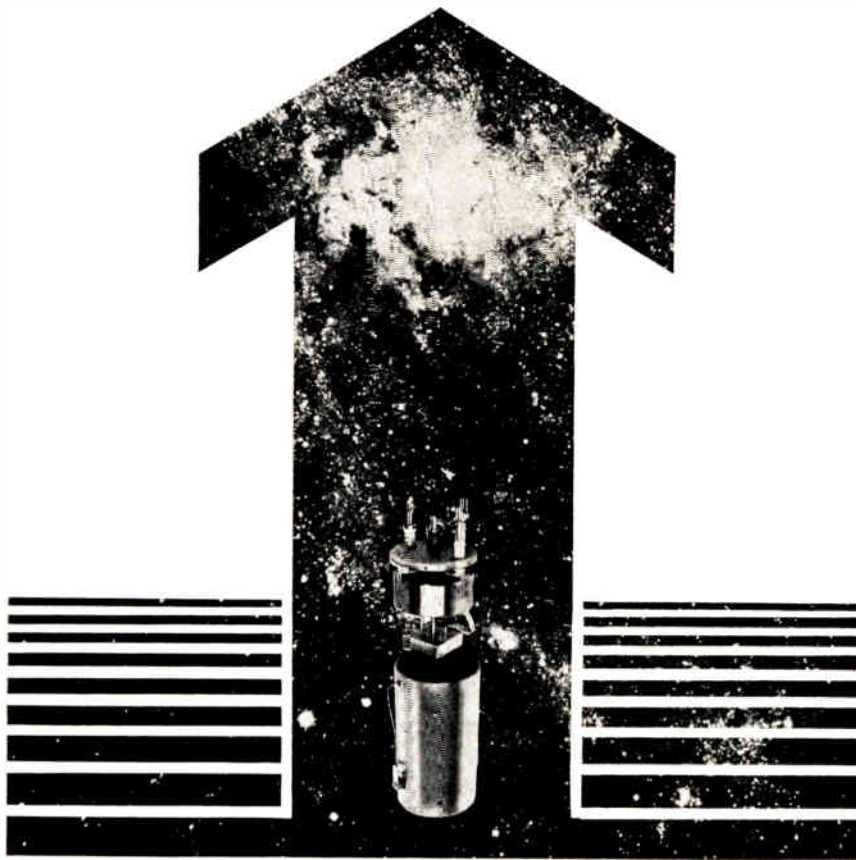

“... Where there is no air  
to resist their motions,  
all bodies will move with the greatest freedom.”

SIR ISAAC NEWTON *Principles of Natural Philosophy*

Today, almost three hundred years after Newton's *Principia* appeared, man is about to satisfy his centuries-old curiosity concerning space “where there is no air.” First instruments went. Soon man himself will go.

Prior to man's undertaking sustained space voyages propulsion systems with efficiencies far exceeding those presently available must be developed.

The scientists and engineers at Electro-Optical Systems are in the advanced stages of research and development on what may well be a forerunner of practical space propulsion systems — the ion engine.

Other advanced research and development programs in areas vital to technological progress in space, military weaponry and industry include:

- Energy Conversion Research and Advanced Power Systems
- Heat Rejection in Space
- Molecular Electronics
- Optical Tracking and Guidance
- Space Communications Systems
- Exploding Wire Research

*EOS has professional opportunities for Physicists, Mathematicians and Engineers.*

**E**  
ELECTRO-OPTICAL SYSTEMS, INC. 125 NORTH VINEDO AVE.  
**S** PASADENA, CALIFORNIA

(Continued from page 58A)

Mr. Foin joined IBM in December, 1950 as a customer engineer and became a technical engineer on the IBM 770 in 1954. He has subsequently held positions as associate engineer and project engineer, his position until his recent advancement. Prior to his affiliation with the Company, Mr. Foin was associated with the Chance Vought Division of United Aircraft.

Mr. Foin received B.S.M.E. degrees from the Universities of New Hampshire and Illinois in 1945 and 1947 respectively, and the M.S.M.E. degree from Columbia University, New York, N. Y., in 1950. He is a member of Pi Tau Sigma.



**Steve J. Gadler** (SM'59), Col. USAF (Ret.), has been elected a Vice President of Hitchcock & Estabrook, Inc., Consulting Engineers and Architects. Mr. Gadler, who is director of the firm's newly established Electronic Division, is a graduate of the University of Minnesota in Electrical Engineering, is a registered professional engineer, and is considered an authority in Electronic Communications Systems Engineering.

He was decorated with the Legion of Merit for his outstanding contributions in the Communications Electronic field while he was Director of Electronics for

(Continued on page 61A)

send for this

**FREE** 

**EICO Electronics Catalog**

*you save 50% on Top-Quality Test Instruments*  
**HI-FI • Ham Gear**  
**KITS AND WIRED**  
for professional and home use

<b>TEST INSTRUMENTS</b>	<b>HI-FI</b>
battery eliminators	stereo and monaural
battery testers	tuners
bridges	preamplifiers
decade boxes	power amplifiers
electronic switch	integrated amplifiers
flyback tester	speaker systems
oscilloscopes	
probes	<b>HAM GEAR</b>
signal and sweep generators	cw transmitter
tube testers	modulator-driver
transistor tester	grid dip meter
vacuum tube	
voltmeters	<b>OVER 2 MILLION</b>
volt-ohm-milliammeters	EICO instruments in use throughout the world.

**LIFETIME** service and calibration guarantee.  
**IN STOCK** at your neighborhood EICO dealer.  
Send now for **FREE** catalog IRE-5

**EICO** 33-00 N. Blvd., L. I. C. 1, N. Y.  
praised by the experts  
as **BEST BUYS IN ELECTRONICS**

ELECTRONIC INSTR. CO., INC.



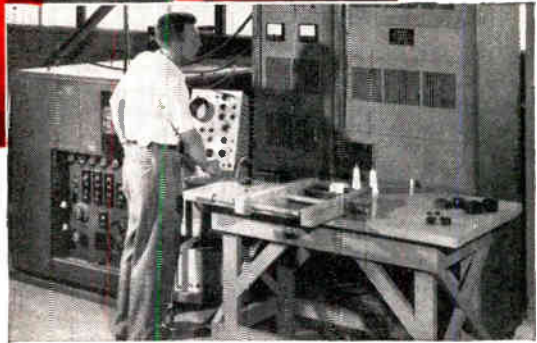
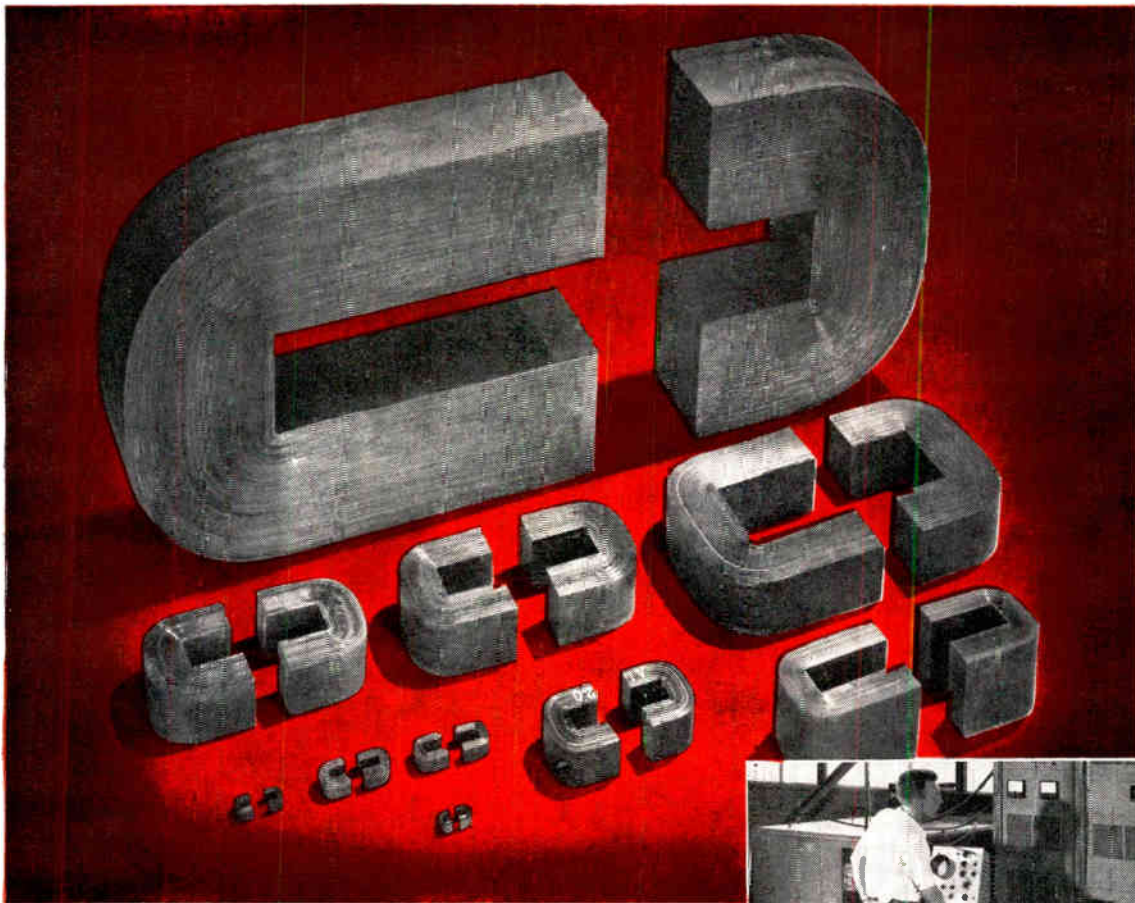

7372 C

*Arnold Pulse Transformer  
Cores are individually tested  
under actual pulse conditions*

Here's  
technical data on  
**ARNOLD  
SILETRON  
CORES**

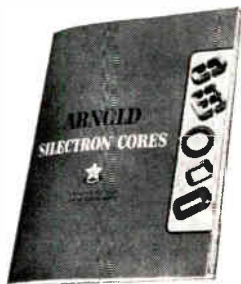

*Bulletin SC-107 A*  
... this newly-reprinted 52-page bulletin contains design information on Arnold Tape Cores wound from Siletron (grain-oriented silicon steel). It includes data on cut C and E cores, and uncut toroids and rectangular shapes. Sizes range from a fraction of an ounce to more than a hundred pounds, in standard tape thicknesses of 1, 2, 4 and 12 mils.

Cores are listed in the order of their power-handling capacity, to permit easier selection to fit your requirements, and curves showing the effect of impregnation on core material properties are included. A valuable addition to your engineering files—write for your copy today.

ADDRESS DEPT. P-5

The inset photograph above illustrates a special Arnold advantage: a 10-megawatt pulse-testing installation which enables us to test-prove pulse cores to an extent unequalled elsewhere in the industry.

For example, Arnold 1 mil Siletron "C" cores—supplied with a guaranteed minimum pulse permeability of 300—are tested at 0.25 microseconds, 1000 pulses per second, at a peak flux density of 2500 gauss. The 2 mil cores, with a guaranteed minimum pulse permeability of 600, receive standard tests at 2 microseconds, 400 pulses per second, at a peak flux

density of 10,000 gauss.

The test equipment has a variable range which may enable us to make special tests duplicating the actual operating conditions of the transformer. The pulser permits tests at .05, .25, 2.0 and 10.0 microsecond pulse duration, at repetition rates varying anywhere from 50 to 1000 pulses per second.

This is just another of Arnold's facilities for better service on magnetic materials of all description. ● Let us supply your requirements. *The Arnold Engineering Company, Main Office & Plant, Marengo, Ill.*



BRANCH OFFICES and REPRESENTATIVES in PRINCIPAL CITIES  
Find them FAST in the YELLOW PAGES

# When it comes to SEMICONDUCTORS

For the most **complete** line of solid state devices...

- Westinghouse has perfected the widest selection of rectifiers, transistors, and special semiconductor devices available in the industry. In Silicon power rectifiers, Westinghouse is the acknowledged leader in the field.

For the most **dependable** semiconductor devices...

- Every Westinghouse semiconductor device has been carefully designed, manufactured, and thoroughly tested to assure long life, high reliability, and excellent stability.

For **true voltage ratings** in silicon power transistors...

- Only Westinghouse 2N1015 and 2N1016 silicon power transistors offer *true* voltage ratings, guaranteed by 100% power testing—means they may be operated continuously at the  $V_{CE}$  listed provided the power dissipation of the transistor is not exceeded. Other conventional power transistors derate the  $V_{CE}$  voltage under comparable conditions.

For **new and unusual ideas** in semiconductors...

- Westinghouse is constantly pioneering in exciting new semiconductor devices. Among the latest: a new 50 ampere "TRINISTOR"\* controlled rectifier; new thermoelectric cooling devices; an extremely rapid and sensitive infrared detector.

For **quality, reliability, performance, and availability**...



- Come to *Westinghouse!* For more information call your Westinghouse representative, or write directly to Westinghouse Electric Corp., Semiconductor Department, Youngwood, Pa.

**YOU CAN BE SURE...IF IT'S** **Westinghouse**

\*Westinghouse Trademark

Westinghouse Semiconductor Department, Youngwood, Pa.



SILICON RECTIFIERS		P. R. V.	Max. DC Current at T°C Resistive Load	Max. One Cycle 60 C.P.S. Surge Full Load	Max. Rev. Peak Current @ Max. Temp. & P.I.V.
LOW POWER RECT.		1N1217 SERIES	50-1000 V.	500 MA @ 110°C. AMB.	15 AMPS.
		1N1227 SERIES	50-1000 V.	1.6 A @ 140°C. CASE	15 AMPS.
MEDIUM POWER RECT.		1N1341 SERIES	50-600 V.	6 A @ 150°C. CASE	160 AMPS.
		1N1199 SERIES	50-600 V.	12 A @ 150°C. CASE	200 AMPS.
		1N1191 SERIES	50-600 V.	18 A @ 140°C. CASE	220 AMPS.
		1N1183 SERIES	50-600 V.	35 A @ 140°C. CASE	220 AMPS.
HIGH POWER RECT.		1N1396 SERIES	50-500 V.	70 A @ 150°C. CASE	1200 AMPS.
		1N1660 SERIES	50-500 V.	160 A @ 125°C. CASE	2000 AMPS.
		1N1670 SERIES	50-500 V.	240 A @ 125°C. CASE	3000 AMPS.
		439 SERIES	50-600 V.	240 A @ 125°C. CASE	3000 AMPS.

GERMANIUM TRANSISTORS		Class	Typical Operation			Maximum Ratings			
			I <sub>CSO</sub> μA	h <sub>FE</sub>	f mc/s	V <sub>CE</sub> V	I <sub>C</sub> ma	P <sub>C</sub> mw	T <sub>J</sub> °C
	2N59	AUDIO-PNP	10	100	1.2	20	200	180	85
	2N60	AUDIO-PNP	10	70	1.1	20	200	180	85
	2N403	AUDIO-PNP	10	33	0.85	20	200	180	85
	2N614	IF -PNP	3	5	3	20	150	125	85
	2N616	IF -PNP	3	20	9	20	150	125	85
	2N617	IF -PNP	3	14	7	20	150	125	85

SILICON POWER TRANSISTORS		Type	h <sub>ie</sub> or h <sub>FE</sub>	f <sub>αmc</sub>	V <sub>CEX</sub> Volts	I <sub>C</sub> Amps	T <sub>J</sub> °C
2N1015 SERIES—2 AMP.		NPN	10 (V <sub>CE</sub> =4 V I <sub>C</sub> =2 A)	ALPHA CUTOFF .300	30-200	7.5a	150
2N1016 SERIES—5 AMP.		NPN	10 (V <sub>CE</sub> =4 V I <sub>C</sub> =5 A)	ALPHA CUTOFF .300	30-200	7.5a	150

50 AMPERE SILICON "TRINISTOR" CONTROLLED RECTIFIER	Breakover Voltage @ 125°C T <sub>J</sub>	Reverse Blocking Voltage @ 125°C T <sub>J</sub>	Turn-on Time	Turn-off Time
	TYPICAL			
	50-200 VOLTS	50-200 VOLTS	1.0 μ SEC.	15-20 μ SEC.

**RECTIFIER ASSEMBLIES**

Standard rectifier assemblies are available in all types of circuit configurations, and are designed for either forced air or natural convection cooling with a wide range of ratings. Nickel-plated copper plates and other materials used in these assemblies have been chosen to insure satisfactory performance in corrosive atmospheres and high ambient temperatures.

**THERMOELECTRIC COOLING DEVICES**

Two types are available in commercial quantities: WX814 (2.5 oz.) and WX816 (3.0 oz.). Both types measure about an inch and a half square and will find immediate application in cooling germanium transistors, infrared detectors, optical systems, mechanical and electric instruments, laboratory and portable medical equipment, and related fields where spot cooling below ambient is necessary.

INFRARED DETECTORS	Type	Noise Equivalent Power (NEP) Watts	Wave-length Response, Microns	Time Constant, μ SEC.
		812	TYPICAL LIMIT 5x10 <sup>-11</sup> 10 <sup>-10</sup> MAX.	1-12

The types listed are just a small sampling of the complete line which can be supplied in volume quantities for prompt deliveries.

Now Available for the First Time...

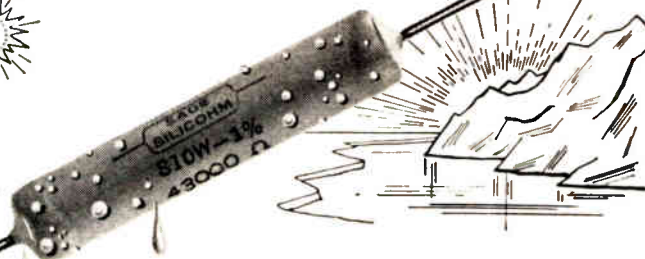

## SAGE RESISTORS

with The Amazing New Moisture-Resistant  
"IMPERVOHM" silicone coating

**WHAT IS "IMPERVOHM"?** . . . It is a new non-porous silicone encapsulant representing a significant moisture seal "break through," which has been developed exclusively for SAGE Characteristic "G" and "V" Power Resistors.

**WHAT ARE ITS ADVANTAGES?** . . . Because of its unusual characteristics attributed to optimum balance of resin and precise filler particles, this new coating requires no compromise in offering:

- Improved heat endurance (-65°C to +350°C).
- Superior resistance stability (0.1%) after severe moisture cycling.
- Availability of all type "S" Resistors as reliable body insulated styles (1000 Volts rms min.).
- New ruggedness in ultrasonic solvent wash not previously available. These features signify an insulating achievement unmatched in the power resistor field.

### WHERE DO SAGE "IMPERVOHM"-SEALED RESISTORS EXCEL?

Component and Circuit Design Engineers will be wise to specify SAGE in all applications demanding critical sensitiveness to moisture and temperature extremes. They will also take advantage of the insulation ruggedness these Resistors offer for printed circuit assembly as well as for metal chassis contact mounting. Of special significance in all cases is long life environment protection.

**YOU PAY NO PREMIUM FOR "IMPERVOHM" PROTECTION** . . . This remarkable coating is now "Standard" on SAGE Resistors—conventionally wound types "S" and "CS" and non-inductively wound types "NS" and "NCS."

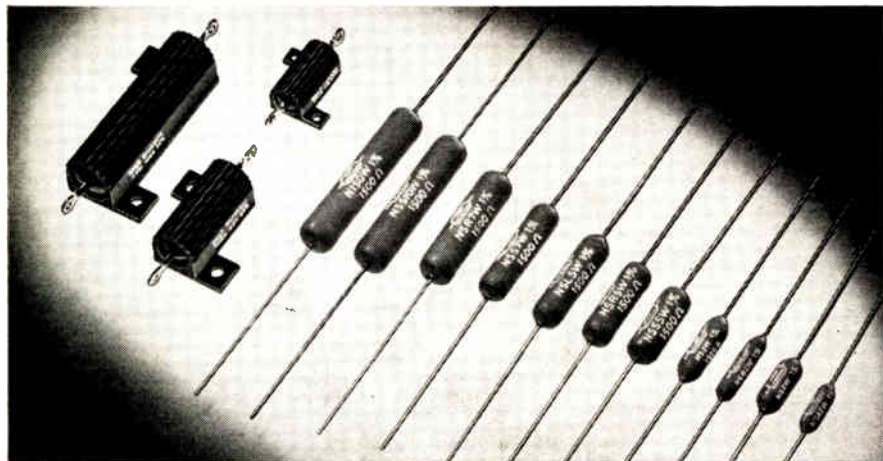

Write for samples and engineering data

# SAGE

## ELECTRONICS CORPORATION

COUNTRY CLUB ROAD • EAST ROCHESTER, N. Y.



IRE People



(Continued from page 66:1)

the Air Defense Command Headquarters at Colorado Springs, Colo.

He is the author of many articles on technical matters and has several electronic developments to his credit. Mr. Gadler is a member of the American Institute of Electrical Engineers the Minnesota Society of Professional Engineers, the National Society of Professional Engineers, the North St. Anthony Park Business Men's Association and a Senior member of the Institute of Radio Engineers. He has been officially commended by the Norwegian and Japanese Governments for his work in Electronics.



Dr. Albert C. Hall (A'39-SM'46-F'58), director of research and engineering for The Martin Company, has been named the company's vice president of engineering. George M. Bunker, chairman of the board, has announced.



A. C. HALL

Dr. Hall was elected by the missile, electronic and nuclear firm's board of directors at its regular monthly meeting last Friday. He will make his

(Continued on page 66:1)

**DEPENDABLE  
FREQUENCY  
CONTROL**



WITH  
**BASSETT**  
CONTROL  
CRYSTALS  
for

- CITIZENS BAND USE
- AMATEUR and CAP
- AIRLINE and AVIATION
- TAXICAB and POLICE
- MARINE RADIOPHONE
- MILITARY and MISSILE USE

plus all other requirements where precise and dependable frequency control insure successful, economical operation.

Available for immediate delivery in any type, any frequency, any quantity

Backed by Over 20 Years Experience

Complete information and prices on request  
Engineering assistance available

**REX BASSETT, Inc.**

Subsidiary of Savoy Industries, Inc.  
BASSETT BLDG. • FORT LAUDERDALE, FLA  
P. O. Box 7127 Phone LOgan 6-8416



*NEW from RHEEM!*

# MILLI- MICRO- SECOND SWITCHING DIODES

15 advanced types including IN903  
through IN908: IN251 • IN914 • IN916

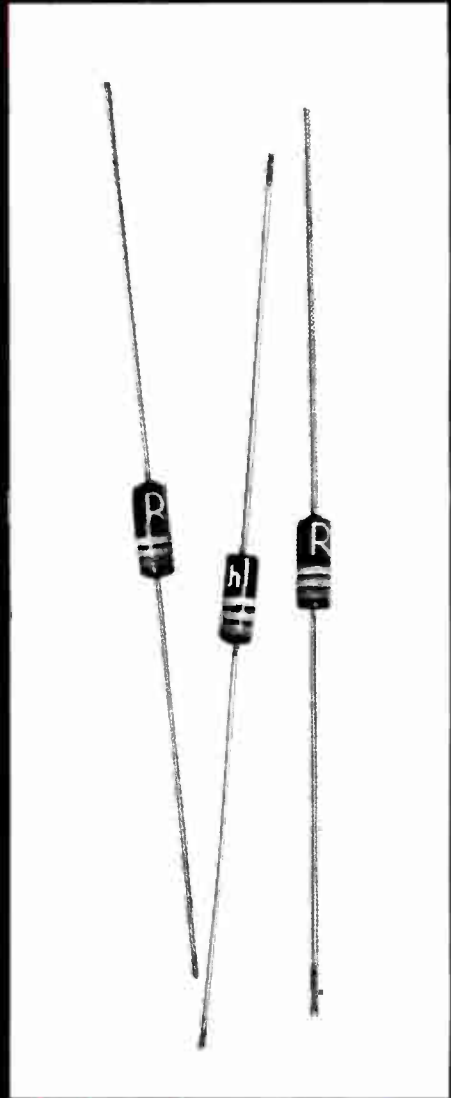

*These new Millimicrosecond Diodes feature:*

**RECOVERY TIME**

*.004  $\mu$ sec.*

**VERY LOW CAPACITANCE**

*1  $\mu$ f @ -6 volts*

RHEEM OFFERS THE INDUSTRY'S  
BROADEST LINE OF SILICON DIODES



## **RHEEM SEMICONDUCTOR CORPORATION**

*A SUBSIDIARY OF RHEEM MANUFACTURING COMPANY*

Dept. E-1, P.O. Box 1327, Mountain View, California, Phone Y0rkshire B-9211. Regional Sales Offices: LOS ANGELES, 5150 Wilshire Blvd. • SAN FRANCISCO, 327 Moffett Blvd., Mountain View, Calif. • MINNEAPOLIS, 6519 Nicollet Ave. • DETROIT, 18450 Livernois Ave. • CHICAGO, 1919 N. Harlem Ave. • ENGLEWOOD, N. J., 610 East Palisade Ave. Distributors: NEW JERSEY, Eastern Radio Corp., 312 Clifton Ave., Clifton, New Jersey, Phone, GRegory 1-6600 • CHICAGO, Allied Radio Corp., 100 Northwestern Ave., Chicago, Illinois, Phone, HAymarket 1-6800 • PHILADELPHIA, Almo Radio Co., 412-16 N. 6th St., Philadelphia, Penn., Phone, WA 2-5918 • SAN FRANCISCO, Avnet Electronics Corp. of Northern Calif., 1262 N. Lawrence Station Rd., Sunnyvale, Calif., Phone, REgent 6-0300 • LOS ANGELES, Avnet Corp., 5877 Rodeo Rd., Los Angeles, Calif., Phone, UPTon 0-6141 or VERmont 7-7111 • Westates Electronics Corp., 11331 Playa St., Culver City, Calif., Phone, EXmont 1-6201 or UPTon 0-4544.

# AIRPAX

"500 SERIES"  
MINIATURE

CIRCUIT  
BREAKER

ACTUAL SIZE



POSITIVE PROTECTION

Available in series, shunt and relay types, Airpax Miniature Magnetic Circuit Breakers are stocked in DC, 60 and 400 CPS models. Current ratings are from 0.05 to 10 amperes. Trip action can be instantaneous or delayed depending on the circuit requirement. These Circuit Breakers are also available in 2 and 3 gang assemblies, in any combination, for interlock-circuit protection.

Ask for Bulletins B-07 and B-16



CAMBRIDGE DIVISION

CAMBRIDGE, MARYLAND



IRE People



(Continued from page 64A)

headquarters in Denver, Colo.

Since joining Martin in 1958, his major effort has been with the TITAN program. Martin is prime contractor for airframe design, fabrication and testing of the weapon system.

A leading guidance and control systems scientist, he was general manager of the Bendix Aviation Corporation's Research Laboratories Division, Detroit, before he came to Martin as research director. He became engineering director for the TITAN in January, 1959.

The new vice president founded the Dynamic Analysis and Control Laboratory at the Massachusetts Institute of Technology, where he was a faculty member for 13 years.

A native of Port Arthur, Texas, where he was born on June 27, 1914, Dr. Hall earned the B.S. degree in electrical engineering from Texas A. & M. in 1936. He received the M.S. degree in 1938 and the D.Sc. degree in 1943, both from M.I.T.

He joined the M.I.T. faculty in 1937 as associate professor of electrical engineering. He founded and became the first director of the Dynamic Analysis and Control Laboratory in 1946.

While at M.I.T., he helped to develop missile control design techniques and directed the control system design effort for the World War II B.A.T., the first successful Navy air-to-surface guided missile.

As laboratory director, he supervised the development of the first missile simulator. He also was a Martin consultant for the Navy VIKING high altitude research rocket.

He left M.I.T. in 1950 to become associate director of the Bendix Research Laboratories Division. He was named division technical director in 1952 and general manager two years later. At Bendix, he directed research and development of electronic and hydraulic controls, including guidance and control systems for several guided missiles and automatic machine tool controls.

He was a member of the first Automation Exchange group sent to Russia in 1955 under the auspices of the American Society of Mechanical Engineers.

Dr. Hall holds the Naval Ordnance Development Award and the Eta Kappa Nu Outstanding Young Electrical Engineer Award. He is a member of Tau Beta Pi, Sigma Xi and several engineering societies.



Cecil S. Bidlack (A'35-V.A'39-SM'55), of Smith Electronics, Inc. and formerly of the National Association of Educational Broadcasters has joined the firm of Carl E. Smith Consulting Radio Engineers, Brecksville, Ohio. He will be responsible for consulting work in Television and FM broadcast.

His last assignment was with the sister firm of Smith Electronics, Inc., where as

(Continued on page 68A)





Other type numbers in the RHEEM Mesa line:  
2N497, 2N498, 2N696, 2N697, 2N656, 2N657,  
2N699, 2N1252, 2N1253, 2N1420

*another RHEEM FIRST!*

# NEW SILICON MESA 1/2 AMP. FAST SWITCHING TRANSISTORS

RT5001 RT5002 RT5003 RT5004

SPECIFY RHEEM FOR RELIABILITY



*RHEEM'S new High Current Switching transistors feature:*

**LOW SATURATION VOLTAGE**

*1.5 volts @ 500 mA*

**HIGH COLLECTOR CURRENT**

*1 amp*

**CORE SWITCHING**

*0.1 μsec.*

**RHEEM SEMICONDUCTOR CORPORATION**

*A SUBSIDIARY OF RHEEM MANUFACTURING COMPANY*

Dept. E4, P.O. Box 1327, Mountain View, California, Phone YOrkshire 8-9211. Regional Sales Offices: LOS ANGELES, 5150 Wilshire Blvd. • SAN FRANCISCO, 327 Moffett Blvd., Mountain View, Calif. • MINNEAPOLIS, 6519 Nicollet Ave. • DETROIT, 18450 Livernois Ave. • CHICAGO, 1919 N. Harlem Ave. • ENGLEWOOD, N. J., 610 East Palisade Ave. Distributors: NEW JERSEY, Eastern Radio Corp., 312 Clifton Ave., Clifton, New Jersey, Phone, GRegory 1-6600 • CHICAGO, Allard Radio Corp., 100 Northwestern Ave., Chicago, Illinois, Phone, HAYmarket 1-6800 • PHILADELPHIA, Almo Radio Co., 412-16 N. 6th St., Philadelphia, Penn., Phone, WA 2-5918 • SAN FRANCISCO, Avnet Electronics Corp. of Northern Calif., 1262 N. Lawrence Station Rd., Sunnyvale, Calif., Phone, REgent 6-0300 • LOS ANGELES, Avnet Corp., 5877 Rodeo Rd., Los Angeles, Calif., Phone, UFTon 0-6141 or VERmont 7-7111 • Westates Electronics Corp., 11334 Playa St., Culver City, Calif., Phone, EXmont 1-6201 or UPTon 0-4544.

"SPOOLY"  
SAYS...



# Super-Temp for Fastest Delivery of HIGH TEMPERATURE MAGNET WIRE

You get the finest . . . fastest from Super-Temp. Magnet wire insulated with Teflon\*, silicone or Isonel films. Ranges to +260°C. Mica films with ranges to +350°C. Complete quality control.

ALSO: Airframe Wire, Hook-up Wire, Tapes  
Coaxial Cables, Miniature & Jumbo Cables  
Teflon or Silicone Rubber Insulations

\*DUPONT'S TFE RESIN



## Save Time WITH Super-Temp

American Super-Temperature Wires, Inc.

10 West Canal Street, Winooski, Vermont • UNiversity 2-9636  
General Sales Office: 195 Nassau St., Princeton, N. J. • WAlnut 4-4450  
A Subsidiary of Haveg Industries, Inc.

• Free! Send for 1960  
• Catalog. 88 pages of  
• valuable data.

M  
P  
E

# TWT AMPLIFIERS . . . .

*cover the entire frequency band from  
0.5 to 16.0 KMC*

The use of permanent magnet focused tubes in Menlo Park Engineering's microwave amplifiers represents a significant improvement over units using solenoid focused tubes . . . and results in three important advantages:

- Lighter weight
- More Compact
- Less power consumption



TA-29

Frequency	Model No.
0.5- 1.0 KMC	TA-36
1.0- 2.0 KMC	TA-31
2.0- 4.0 KMC	TA-29
4.0- 8.0 KMC	TA-28
8.2-11.0 KMC	TA-20
10.0-16.0 KMC	TA-49

PLEASE WRITE FOR  
COMPLETE  
SPECIFICATIONS

## MENLO PARK ENGINEERING

711 Hamilton Avenue Menlo Park, Calif. Davenport 6-9080

M  
P  
E



IRE People



(Continued from page 66A)

Supervisor of Systems Engineering he was charged with the design of audio and control circuitry for the Consolidated East Coast Facilities sites of the Voice of America at Greenville, North Carolina. With the NAEB at Urbana, Illinois, Mr. Bidlack served as engineering advisor to the executive director of the association.

Mr. Bidlack's affiliations include the Society of Motion Picture and Television Engineers, the American Institute of Electrical Engineers and the Audio Engineering Society. He is a registered Professional Engineer in the State of Ohio and holds radiotelephone first-class and amateur radio class "A" licenses.



Donald C. Bright (SM'49), formerly a division sales manager with Radio Corporation of America, has been appointed general manager of the new Industrial Electronics Division of Hoffman Electronics Corp.



D. C. BRIGHT

Before joining Hoffman, he was with RCA nine years and most recently was manager of government contracts and sales for its West Coast missile and surface radar division in Los Angeles.

Mr. Bright's earlier experience included assignments as chief engineer of Liberty Manufacturing Co., Youngstown, Ohio; chief of the radio control section for the U. S. Air Force, Wright Field, Dayton, Ohio; and sales engineer with Westinghouse.



Earl H. Flath, Jr., (A'44-M'54), has joined Temco Electronics division of Temco Aircraft Corporation as a senior scientist to plan developments in the fields of radiation, antennas and microwave systems.



E. H. FLATH, JR.

He was graduated from Southern Methodist University with honors in 1943 and received the M.S. Degree from the University of Cincinnati. He also studied at the University of Maryland.

He served as an electronic scientist with the Naval Research Laboratory and as senior aerophysics engineer with Convair prior to joining Chance Vought in 1952. With the latter company, he served in various supervisory positions in the fields of antenna development and electronics systems design, and finally as engi-

(Continued on page 72A)





**LOW POWER.** Consider the high efficiency Raytheon 1N536 series.



**MEDIUM POWER.** Lock into the Raytheon 1N2512 and the new 1N2512 series.



**HIGH POWER.** Note the all new Raytheon 1N248A, 1N1191A and 1N1195 series.

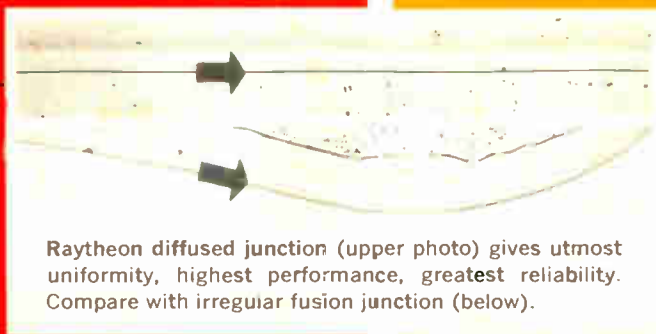

Raytheon diffused junction (upper photo) gives utmost uniformity, highest performance, greatest reliability. Compare with irregular fusion junction (below).

*For reliable power . . .*

## Depend on diffused junction rectifiers!

Here are reliable Raytheon diffused junction silicon rectifiers spanning the complete semiconductor power spectrum!

Raytheon manufacturing success in diffused junction rectifiers has long provided fast recovery, low forward voltage drop and extreme uniformity of device characteristics. Outstanding mechanical design and production under stringent quality control result in rectifiers with excellent ratings and characteristics. Utmost reliability is assured by constant life and environmental testing beyond the most stringent requirements of Mil 19500B, over the guaranteed temperature range of  $-65^{\circ}\text{C}.$  to  $+165^{\circ}\text{C}.$

Of special interest in low current applications of the 1N536 series are the excellent reverse recovery, fast start

and fast rise of Raytheon diffused junction rectifiers.

In the four amp range, the Raytheon 1N2512 series features low reverse current and is available in three package styles: with insulated stud, stud connected to anode, or stud connected to cathode.

In the higher current range, the new Raytheon diffused junction silicon rectifiers offer ratings up to 22 amps (at  $150^{\circ}\text{C}.$ )—plus the important advantages of low forward voltage drop and high efficiency, for exceptional regulation in power applications.

Further information on all these reliable Raytheon rectifiers is given on the following page. Semiconductor Division, Raytheon Company, 215 First Avenue, Needham Heights 94, Massachusetts.



# RAYTHEON SEMICONDUCTORS

# Raytheon diffused junction silicon rectifiers

**LOW CURRENT SERIES.** The fast reverse recovery, low current Raytheon rectifiers. Feature both fast start and fast rise. Temperature range  $-65^{\circ}\text{C. to }+165^{\circ}\text{C.}$

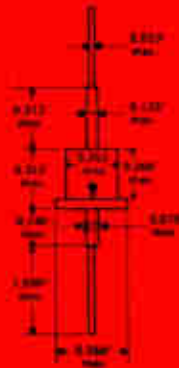

Type	P. I. V.	Avg. Rectified Current		Reverse Current (Max.) ( $\mu\text{A}$ at rated P. I. V.)	
		25°C	150°C	25°C	150°C
		mA	mA		
1N536	50	750	250	2	400
1N537	100	750	250	2	400
1N538	200	750	250	2	300
1N539	300	750	250	2	300
1N540	400	750	250	2	300
1N1095	500	750	250	2	300
1N547	600	750	250	2	300

**MEDIUM CURRENT SERIES.** Workhorse of the Raytheon rectifier line. High efficiency and stability. Insulated or non-insulated stud, standard or reverse polarity. Temperature range  $-65^{\circ}\text{C. to }+165^{\circ}\text{C.}$

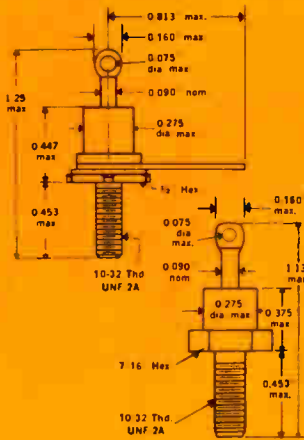

Cathode to Stud	Anode to Stud	INSULATED Stud	P. I. V. Volts	Ave. Rectified Current		Reverse Current (max.) $\mu\text{A}$ at rated P. I. V.	
				30°C amps.	150°C amps.	25°C	150°C
1N2512	1N2512R	1N2518	100	4.0	1.0	2.0	250
1N2513	1N2513R	1N2519	200	4.0	1.0	2.0	250
1N2514	1N2514R	1N2520	300	4.0	1.0	2.0	300
1N2515	1N2515R	1N2521	400	4.0	1.0	2.0	300
1N2516	1N2516R	1N2522	500	4.0	1.0	2.0	350
1N2517	1N2517R	1N2523	600	4.0	1.0	2.0	400
1N253			95		1.0*		100*
1N254			190		0.4*		100*
1N255			380		0.4*		150*
1N256			570		0.2*		150*

\*At 135°C.

**HIGH CURRENT SERIES.** The heavy current family of reliable Raytheon rectifiers. Features low forward voltage drop, high efficiency, exceptional regulation. Temperature range  $-65^{\circ}\text{C. to }+175^{\circ}\text{C.}$

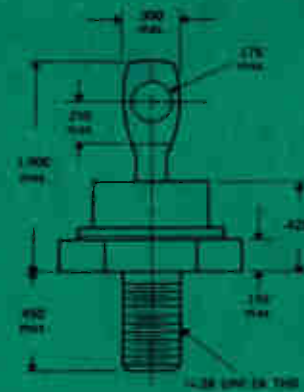

Type	P. I. V.	Ave. Rectified Current, Amps @ 150°C	Reverse Current (Max.) at Rated P. I. V., mA @ 150°C
1N248A	50	20	5
1N249A	100	20	5
1N250A	200	20	5
1N1191A	50	22	5
1N1192A	100	22	5
1N1193A	150	22	5
1N1194A	200	22	5
1N1195	300	18	10
1N1196	400	18	10
1N1197	500	18	10
1N1198	600	18	10

J-6949

Your local authorized Raytheon Distributors carry in-stock inventories for immediate delivery.



**SEMICONDUCTOR DIVISION RAYTHEON COMPANY**

SILICON AND GERMANIUM DIODES AND TRANSISTORS • SILICON RECTIFIERS • CIRCUIT-PAKS

ENGLEWOOD CLIFFS, N. J., LOwell 7-4911 (Manhattan Phone, Wisconsin 7-6400) • BOSTON, MASS., Hillcrest 4-6700 • CHICAGO, ILL., National 5-4000 • LOS ANGELES, CAL., NOrmandy 5-4221 • ORLANDO, FLA., GArden 3-0518 • SYRACUSE, N. Y., GRAnite 2-7751 • BALTIMORE, MD., Southfield 1-0450 • CLEVELAND, O., Winton 1-7716 • SAN FRANCISCO, CAL., FlReside 1-7711 • CANADA: Waterloo, Ont., SHerwood 5-6831 • GOVERNMENT RELATIONS: Washington, D. C., METropolitan 8-5205



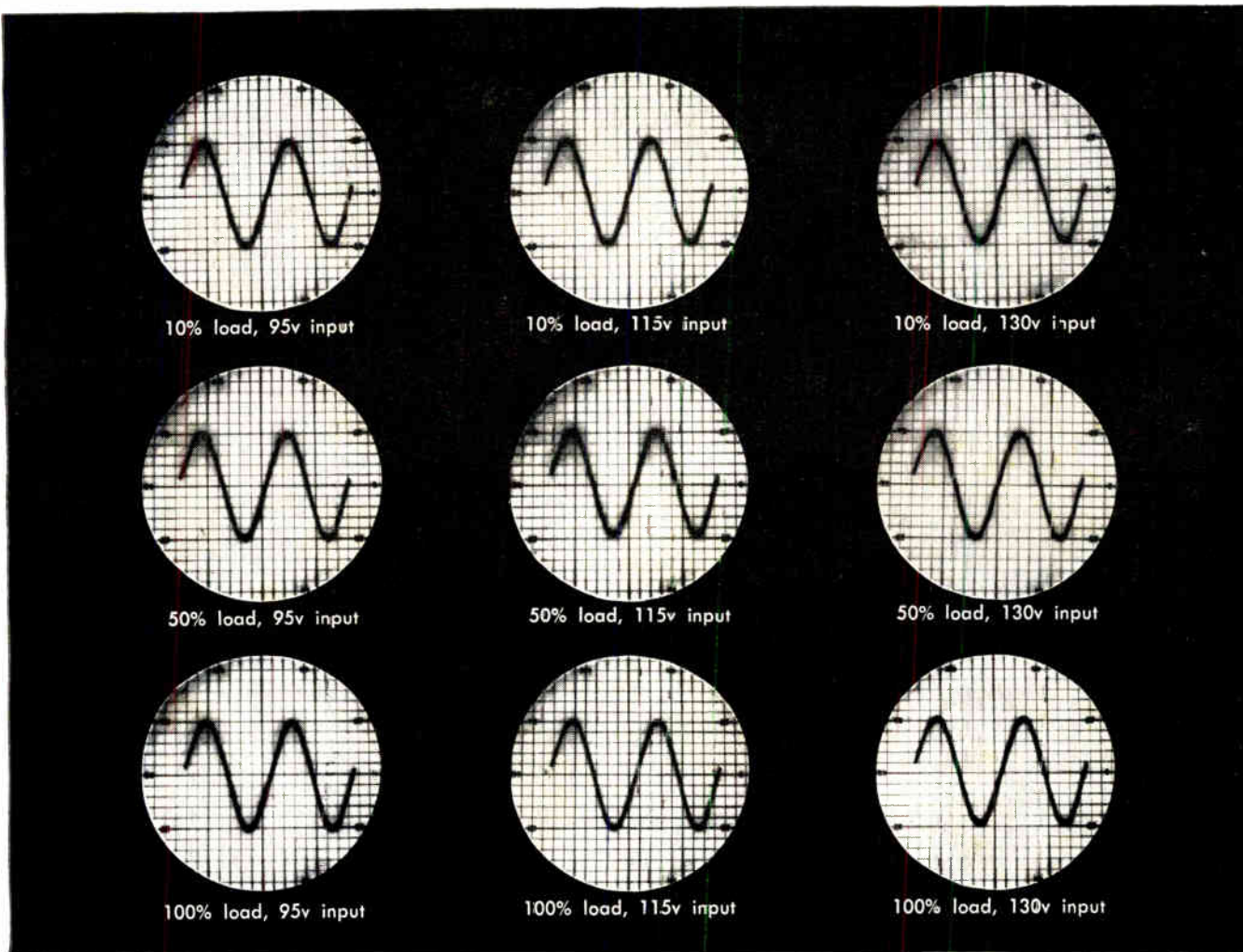

Output wave shapes under varying input and load conditions. Sola Catalog No. 23-13-150 used in this test.

## Sola's moderate-cost static-magnetic voltage regulator has sine-wave output



Sola now offers sinusoidal output in every standard-type regulator *with no price premium*. This development — a result of major design and production innovations — greatly widens the field of use for static-magnetic voltage regulation. The new standard sinusoidal design is now ideal for use with electrical and electronic equipment requiring a regulated input voltage with commercial sine wave shape — especially where harmonic-free supply had previously been too costly. The sinusoidal output also contributes to ease of selection and ordering, since this Sola stabilizer is virtually universal in application.

The Sola Standard Sinusoidal Constant Voltage Transformer provides output with less than 3% rms harmonic content. It automatically and continuously regulates output voltage within  $\pm 1\%$  for line voltage variations of  $\pm 15\%$ . Average response time is 1.5 cycles or less. The new line includes nine stock output ratings from 60va to 7500va.

Besides the improved electrical characteristics, these units are substantially smaller and lighter than previous models. Size and weight reductions were accomplished without any loss of performance or dependability.

With the Sola Standard Sinusoidal Constant Voltage

Transformer you also get all the proved benefits of a static-magnetic regulator. It is simple and rugged. There are no tubes . . . no moving parts . . . no replaceable parts. Maintenance and manual adjustment are not necessary.

Its current-limiting characteristic protects against shorts on the load circuit. It is available in step-up and step-down ratios, allowing substitution for conventional, non-regulating transformers. These units can be used in any electronic or electrical application requiring a regulated sinusoidal power source where the peak power demand does not exceed the capacity of the constant voltage transformer. Circuit design formulae based on sinusoidal wave shape are directly applicable. Custom units to specific requirements are available in production quantities.

**SOLA**  
SOLA ELECTRIC CO.

Write for Bulletin CVS

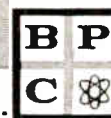

A Division of  
Basic Products  
Corporation

4633 West 16th Street Chicago 50, Illinois

BUILD ON . . .

# Eastern

## CLIMATE CONTROL EXPERIENCE:

# PRESSURIZATION and DEHYDRATION

Look to Eastern Industries for the advanced pressurization/dehydration packs required by the avionic and ground support systems of tomorrow. Whenever a precisely controlled flow of dehydrated air is required, Eastern design and production experience team up to create compact, lightweight, reliable subsystems. Characteristics and performance range of existing units:

Characteristics and performance range of existing units:

capacities: up to 1.5 FT<sup>3</sup>/Min. free air  
operating temperatures: from -67°F to +150°F, 100% R.H.

operating altitudes: from 10,000 ft. to 50,000 ft.

weights: from 8 lbs. to 115 lbs. complete

Smaller packs feature replaceable chemical dehydrator elements—the larger subsystems are available with automatic reactivating dehydrators.

Let us quote on your next pressurization/dehydration requirement. In the meantime, write for full information on the entire line of Eastern aviation products. Send for Bulletin 360.

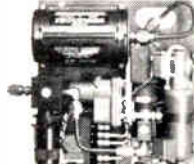
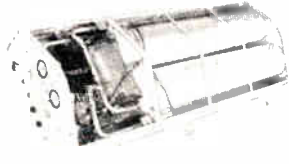

a wide range of units for specialized air control

**EASTERN  
INDUSTRIES  
INCORPORATED**  
100 SKIFF STREET  
HAMDEN 14, CONN.



**IRE People**



*(Continued from page 68A)*

neering branch manager in charge of electromagnetic products.

Mr. Flath holds memberships in several professional societies, including the American Institute of Electrical Engineers, Texas Society of Professional Engineers, Sigma Tau and Eta Kappa Nu.



**R. Karl Honaman** (A'23-SM'44), Director of Publication at Bell Telephone Laboratories, retired on March 1 after more than 40 years of Bell System service.

Since 1945 he had directed all public relations activities of Bell Laboratories, including press relations, employee information, advertising, technical and personnel magazines, technical libraries, and community relations.



**R. K. HONAMAN**

A native of Lancaster, Pa., he received the B.S. and M.S. degrees from Franklin and Marshall College in 1916 and 1917, respectively.

*(Continued on page 70A)*



## Owen Type 210 A TRANSISTOR TEST SET

Self-contained for measurement of "H" parameters, beta, and I<sub>cb0</sub> of all small transistors. A standard of the industry. \$550. Other sets for power transistors, portable use, etc.

**Owen**  
LABORATORIES INC  
35 BEACON PL. • PASADENA, CALIF.



# TUNG-SOL/CHATHAM 6080 FAMILY

*All fit the same socket . . .*

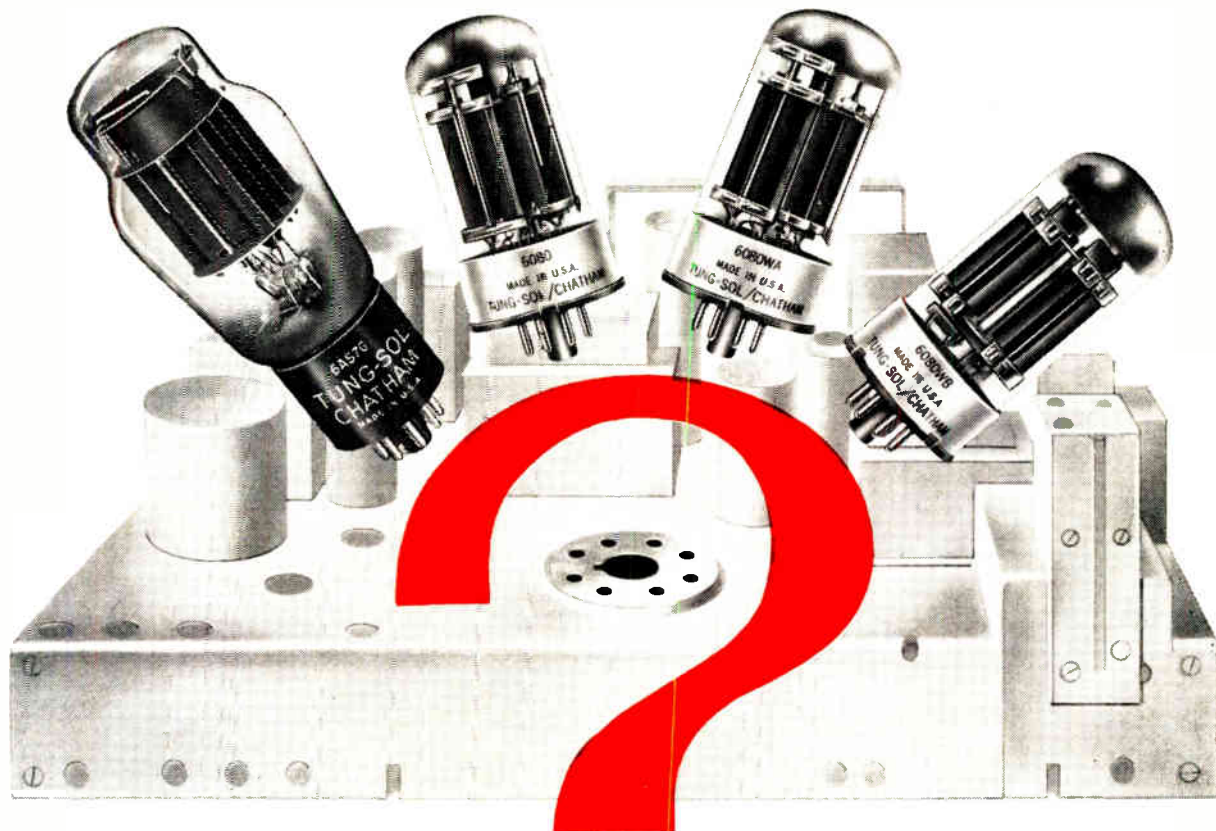

## But which fits your application

Like most circuit designers, you're probably often confronted with a wide choice of tubes which meet the *electrical requirements* specified by your design. But depending on other factors, such as the kind of environment in which the tubes are expected to operate, your choice may be limited.

Consider the Tung-Sol/Chatham 6080 tube family, for example. The 6080, the 6080WA, the 6080WB and the prototype 6AS7G all fit the same socket. The electrical ratings of these series regulator tubes are the same. Would you know which to specify for your power supply? The differences are vital. Knowing them can make all the difference in the ultimate reliability of your design.

If economy in original component cost is paramount and size not a factor, then the 6AS7G may be your choice. If size is a factor, the smaller 6080 would be used. The 6080WA is the right tube if more closely controlled characteristics are important, if environmental conditions are severe, and if greater assurance of long life is needed. Where the tube is expected to operate under high ambient temperatures and

severe vibration, and if many tubes are to be operated in parallel, then the 6080WB is best.

Of this you can be sure: Tung-Sol will recommend the "best" tube for your particular requirements. Once you have specified a Tung-Sol tube for your application, you'll be gratified by the superior performance and the highest operational reliability all Tung-Sol components provide. Every Tung-Sol tube is the product of the highest manufacturing standards and unexcelled quality control.

Full technical details on the Tung-Sol/Chatham 6080 family are also available to you on request.

And if you would like prompt and able assistance in selecting the correct tube for your application, get in touch with Tung-Sol tube experts. They'll be glad to study your design and recommend the tubes best for you. Tung-Sol Electric Inc., Newark 4, N. J. TWX: NK193

Technical assistance is available through the following sales offices: Atlanta, Ga.; Columbus, Ohio; Culver City, Calif.; Dallas, Texas; Denver, Colo.; Detroit, Mich.; Irvington, N. J.; Melrose Park, Ill.; Newark, N. J.; Philadelphia, Pa.; Seattle, Wash. Canada: Toronto, Ontario.

 **TUNG-SOL<sup>®</sup>**

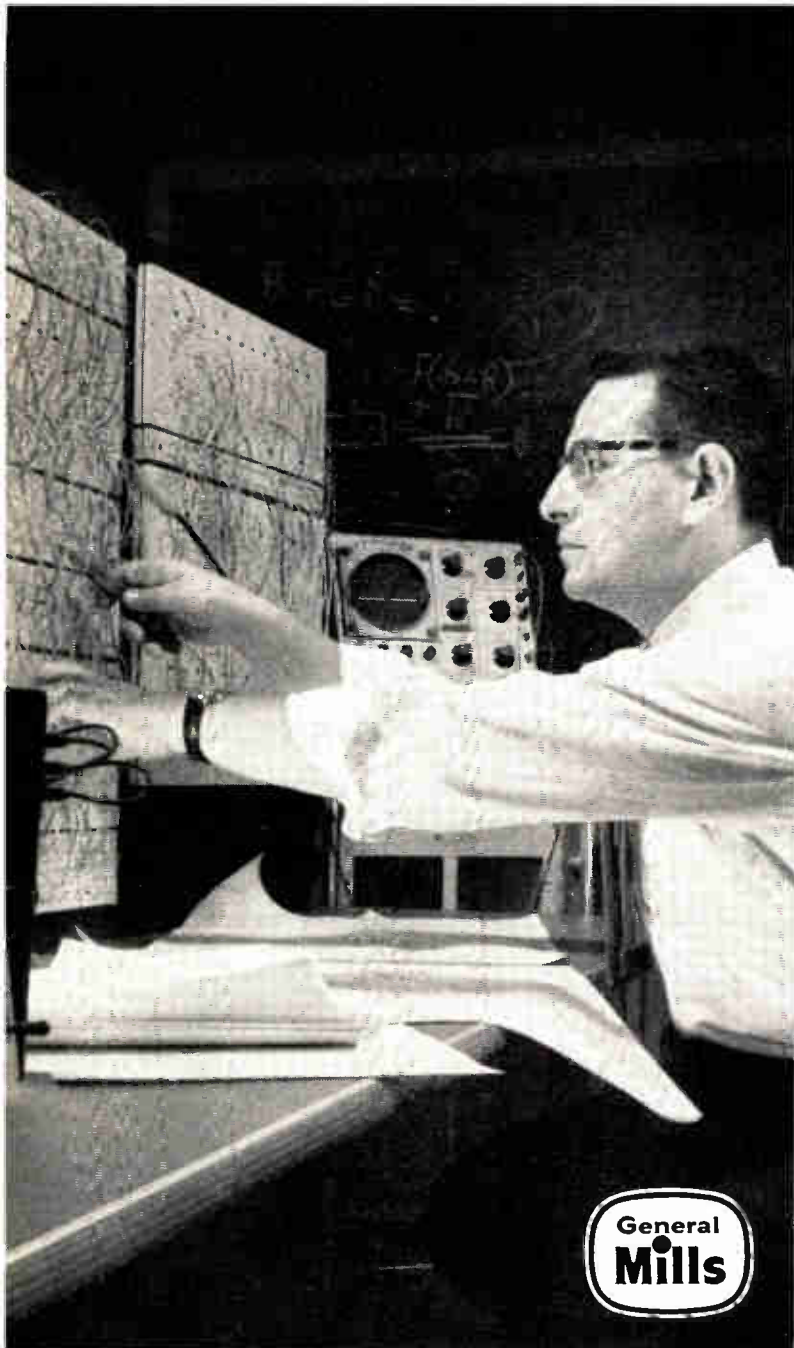

Here is Francis Alterman, Manager of General Mills Digital Computer Laboratory, checking one of our newest computers which he helped design. General Mills computers, both analog and digital, are being used in missile



guidance, bombing and navigation systems, automatic surveying and in industrial control. In future space travel, computers will help control navigational systems of space vehicles and will process data gathered in outer space.

## General Mills engineers work today

General Mills has been producing computers for nearly 20 years. Exciting new concepts in high speed magnetic tape units, ultra-high precision analog to digital converters and optical keyboards are examples of continuous developments in our over-all computer program. We work to improve reliability, increase speed, cut cost.

Our research activities cover broad areas in physics, chemistry, mechanics, electronics

and mathematics. Some of the studies representative of these activities are: ions in vacuum, deuterium sputtering, dust erosion, magnetic materials, stress measurements, surface friction and phenomena, trajectory data and infrared surveillance.

In our engineering department, current projects include: specialized inflatable vehicles and structures, airborne early warning systems, micro wave radar test equipment,



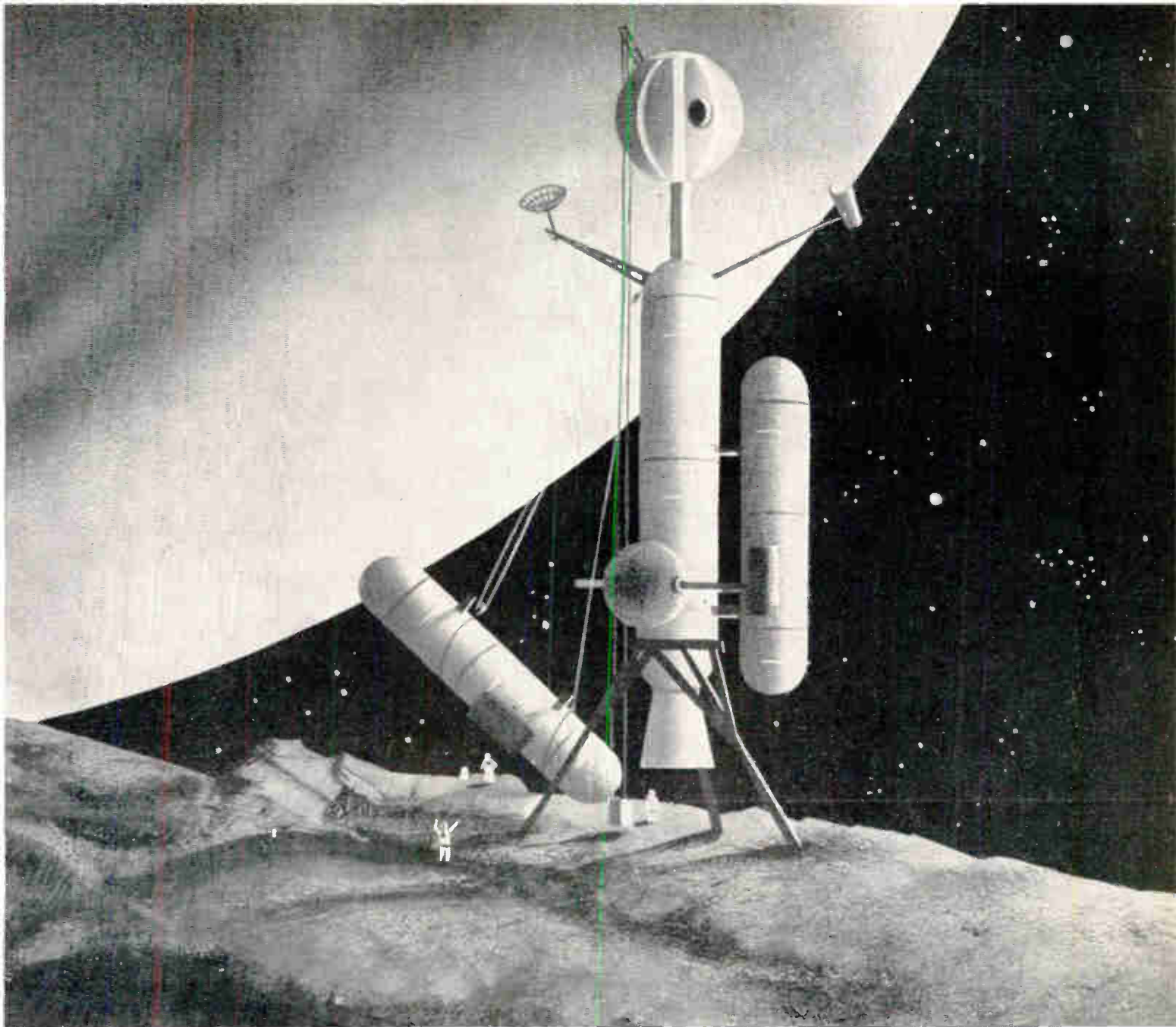

Mars seen from one of its moons . . . illustration from book written for General Mills by Willy Ley.

## to help you explore space tomorrow

antennas and pedestals, infrared and optics, inertial guidance and navigation, digital computers—and many other activities.

Our entire manufacturing department is geared to produce systems, sub-systems and assemblies to the most stringent military

requirements. Our people have a wealth of experience in complex military projects.

Write for free booklets: (1) Complete research, engineering and manufacturing capabilities of the Mechanical Division (2) New booklet on General Mills computers.

### **MECHANICAL DIVISION**

1620 Central Avenue, Minneapolis 13, Minnesota

*To wider worlds—through Intensive Research • Creative Engineering • Precision Manufacturing*





(Continued from page 72A)

He began his telephone career in 1919 with the Development and Research Department of the American Telephone and Telegraph Company in New York. For the next 20 years his work dealt principally with the protection of telephone circuits, and a number of patents were granted to him for inventions in this field. As Assistant Protection Development Engineer, he transferred with his group to Bell Laboratories in 1934.

At the beginning of World War II, and at the request of the Army and Navy, Bell Laboratories instituted its School for War Training to instruct military personnel in radar and related developments. Mr. Honaman organized the school and served as its director until 1945. More than 4,000 officers and men were trained during this period and extensive text material was prepared for the program. At the end of the war, the school had a faculty of almost 100 members.

After the war, he was appointed Director of Publication, with responsibility for all publication and public relations programs of Bell Laboratories.

From October, 1954 to January, 1956, he was on leave from Bell Laboratories to serve with the Federal Government. During the first part of this period he was Consultant to the Secretary of Commerce, and organized and served as Director of the

(Continued on page 80A)

# Aircraft missiles, too, use PERIODIC PERMANENT MAGNET AMPLIFIERS

Impressive savings in weight, space, and power have been effected by Huggins in a series of TWT's which substitute periodic permanent magnets for focussing solenoids. This adds greatly to aircraft and missile applications for TWT's.

Huggins produces the industry's most complete line of PM focussed amplifiers

Frequency	10 Milliwatts	1 Watt	Pulsed
250-500 mcs	HA- 51		
.5- 1 kmc	HA- 36		
1- 2 kmc	HA- 31		
2- 4 kmc	HA- 29	HA- 30	PA- 6
4- 8 kmc	HA- 28	HA- 35	PA- 8
8-11 kmc	HA- 20	HA- 21	PA- 9
10-16 kmc	HA- 49		

Send for a copy of our "Engineering News" containing environmental information on this line. Catalogues and price lists are also available.

## HUGGINS LABORATORIES, INC.



999 East Arques Avenue • Sunnyvale, California

REgent 6-9330

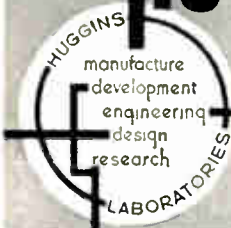

**G. E. WARNER  
MANAGER**

Engrave them all yourself  
with  
**Engravograph**

It's tracer-guided  
for unskilled  
labor.

Visit Booth 92  
I.R.E.—I.S.A.  
Tech. Exhibit

Write for catalog YM-1

**new hermes**  
ENGRAVING MACHINE CORP.  
154 WEST 14TH ST., NEW YORK 11, N. Y.



**ONE INTEGRATED SOURCE**

**for Ceramic-to-Metal Seals**



Standard types of Alite high voltage bushings are available in various sizes and configurations.

### INSIDE LOOK AT ALITE—

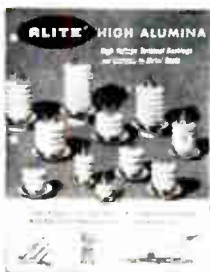

Fact-packed, illustrated Bulletin A-40 gives vital technical data and product information. Write today.

In *all* phases of planning for ceramic-to-metal seals—from design to finished assembly—you can rely on ALITE for the know-how and “do-how” required to produce highest quality ceramic-metal components for critical applications.

High alumina Alite is the ideal material for making rugged, high performance hermetic seals and bushings. It has superior mechanical strength, high temperature and thermal shock resistance, plus reliable electrical characteristics. Our complete high temperature metalizing and bonding facilities assure delivery of the finest seals available—mass-spectrometer tested for vacuum-tightness.

Please contact us for valuable performance data and information regarding ceramic-to-metal applications . . . no obligation.

ALITE DIVISION

**U. S. STONEWARE**

Orrville, Ohio

New York Office  
60 East 42nd St.

12F-1



# NEWS

Another Example of ROHDE & SCHWARZ Contribution to Precise Measurement.

## Standard Time Systems

### Type CAA

- Combine high precision crystal clocks with carefully designed auxiliary units for time measurement and distribution.
- Are the most versatile and practical equipment for use in observatories, standard time institutes, hydrographic observatories, geodetic institutes, and all operations where precise time measurements are needed.
- Can be supplied in several models differing in size and facilities.
- 21 years experience in crystal chronometry.
- Write for detailed 8 page brochure CAA.

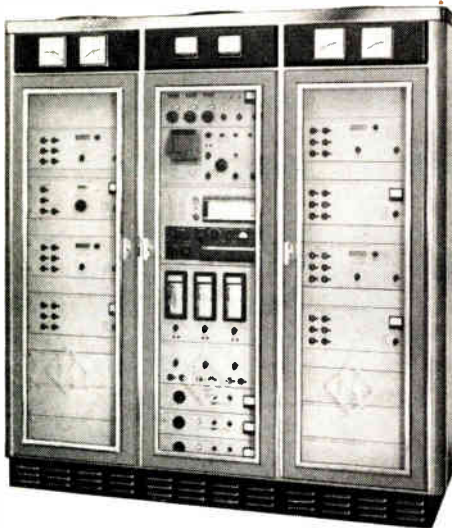
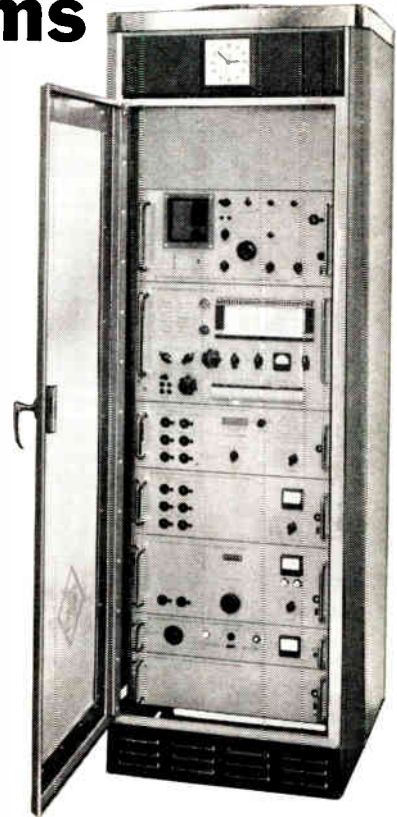

#### Write for New Catalog

36-page catalog describes complete line of Rohde & Schwarz precision electronic measuring and testing equipment.

Write for your free copy of Catalog-MT.

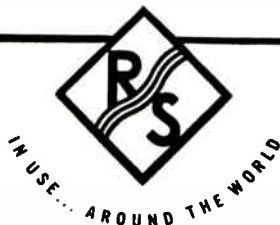

## ROHDE & SCHWARZ

111 Lexington Ave., Passaic, New Jersey

Telephone: PRescott 3-8010

Cable Address: ROHDESCHWARZUSA



**GUDELACE**  
is engineered  
for  
problem-free  
lacing

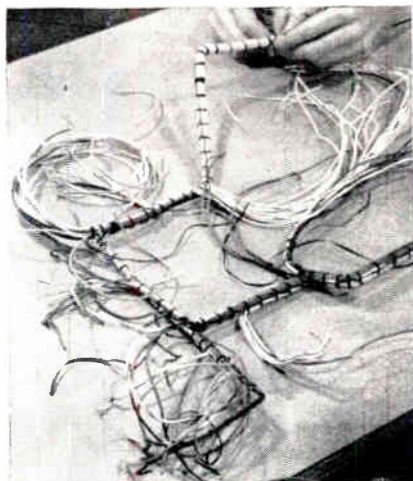

It's no accident that Gudelace is the best lacing tape you can buy. Excellence is *engineered* into Gudelace. A sturdy nylon mesh is meticulously combined with the optimum amount of special microcrystalline wax. Careful selection of raw materials and superior methods of combining them give Gudelace outstanding strength, toughness, and stability. Gudelace is the original *flat* lacing tape which distributes stress evenly over a wide area. It is engineered to stay flat; it will not stretch out of shape when pulled. Gudelace's nonskid surface prevents slipping, eliminating the too-tight pull that causes strangulation and cold flow. Durability and dependability make Gudelace your most economic buy—with no cut insulation, fingers, or feelings.

Write for Data Book with specifications on Gudelace and Gudebrod's complete line of braided lacing tapes and dial cords—Temp-Lace, Stur-D-Lace, and Gude-Glass.

**GUDEBROD**  
BROS. SILK CO., INC.

Electronic Division  
225 West 34th Street, New York 1, N.Y.

Executive Offices  
12 South 12th Street, Philadelphia 7, Pa.

**BALLANTINE'S MODEL 305A VOLTMETER**

measures peak, or peak to peak

**PULSES**

as short as **0.5  $\mu$ s**

**AT PULSE RATES AS LOW AS 5 pps  
... VOLTAGES OF 1 mv TO 1000 v**

*Also measures*

### Complex Waveforms

having fundamental of  
5 cps to 500 kc with  
harmonics to 2 mc.

### Accuracy

is 2% to 5% OF  
**INDICATED**  
VOLTAGE, depending  
upon waveform and  
frequency.

### Scale

is the usual Ballantine  
log-voltage and linear db,  
individually hand-  
calibrated for optimum  
precision.

### Input Impedance

is 2 meg, shunted by  
10 pf to 25 pf.

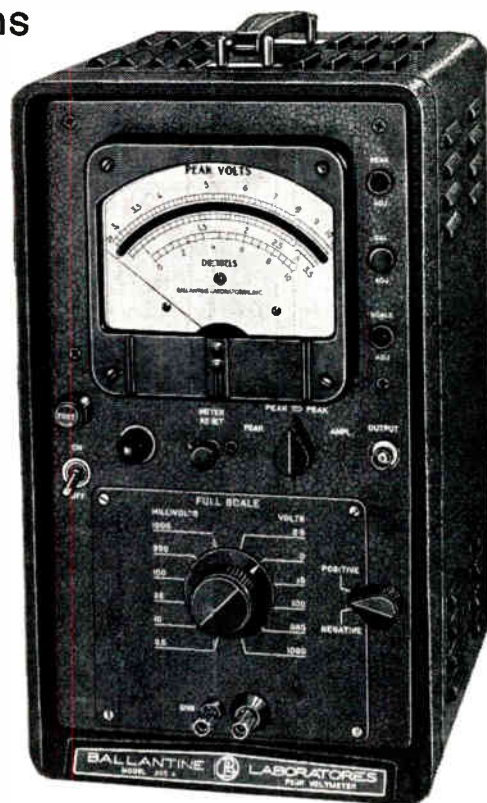

Price: \$395.

THIS "A" MODEL is the result of improvements and new features AFTER 11 YEARS OF MANUFACTURING THE VERY SUCCESSFUL MODEL 305

Write for brochure giving many more details



— Since 1932 —  
**BALLANTINE LABORATORIES INC.**

Boonton, New Jersey

CHECK WITH BALLANTINE FIRST FOR LABORATORY AC VACUUM TUBE VOLTMETERS, REGARDLESS OF YOUR REQUIREMENTS FOR AMPLITUDE, FREQUENCY, OR WAVEFORM. WE HAVE A LARGE LINE, WITH ADDITIONS EACH YEAR ALSO AC/DC AND DC/AC INVERTERS, CALIBRATORS, CALIBRATED WIDE BAND AF AMPLIFIER, DIRECT-READING CAPACITANCE METER, OTHER ACCESSORIES.

# TELREX LABORATORIES

Designers and Manufacturers of

## COMMUNICATION ARRAYS FOR THE ARMED FORCES and Commercial Service

"TRI-BAND"  
MODEL  
XCYST  
111420

Rotatable  
52 ohm  
Single-  
Transmission-  
Line Array

Power rating—  
1.5 Kw., 100% A.M.

(Higher ratings  
available)

### Specifications:

Gain 11Mc.—8.0 db, F/B 24 db, E-Plane B-W 1/2 Power—66°  
Gain 14Mc.—8.4 db, F/B 24 db, E-Plane B-W 1/2 Power—60°  
Gain 20Mc.—8.6 db, F/B 24 db, E-Plane B-W 1/2 Power—56°  
Wind surface—13.36 sq. ft. Load at 100 mph.—423 lbs.  
Turning radius—23 ft. Container size—12"x12"x14"  
Antenna weight—160 lbs. Shipping weight 200 lbs.  
Antenna rated design with 1/2" radial ice—110 mph.

Calibrated for easy assembly to specifications and center frequency of your choice. Custom Quality construction throughout. Suggested rotator for above—Telrex Model 500-RIS.

Also available: Over 172 off-the-shelf fixed or rotatable high-performance arrays. 7Mc. to 600Mc. Mono, Duo, Tri and Multi-band individually fed or single line feed, and medium to extra heavy duty rotator-indicator control systems, rotated masts, and towers.

● Telrex is equipped to design and supply to our specifications or yours, Broad-band or single frequency, fixed or rotary arrays for communications, FM, TV, scatter-propagation, etc.

● Consultants and suppliers to communication firms, universities, propagation laboratories and the Armed Forces.

For information or to order, phone  
PRospect 5-7252  
or write  
Department 5C.

ANTENNAS

SINCE  
1921

Communication and TV Antennas  
**telrex** LABORATORIES

ASBURY PARK 25, NEW JERSEY, U.S.A.

quick-disconnect  
or permanently connected

## MODULOK\* terminal block

with snap-in, spring-loaded contacts

True versatility in a terminal block. 30 modules (2 or 4 tier) per foot. Twist of a screwdriver transforms quick-disconnect contacts to permanent connections.

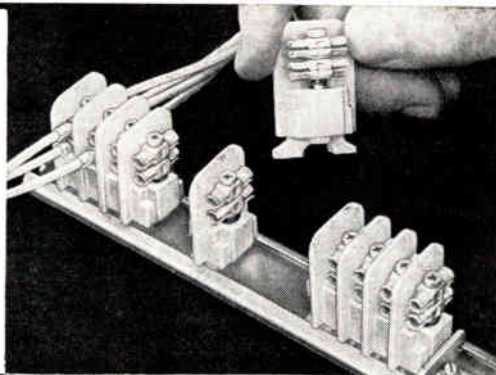

\*trade mark

For complete information, write: OMATON DIVISION, BURNDY—Norwalk, Connect.

59-2

**BURNDY**

**HLAB**

## Model 802B Twin Transistorized Supply

EACH OUTPUT:

0-36 VOLTS

0-1.5 AMPERES

PRICE: \$580.00

LINE REGULATION: Less than 5.0 millivolts  
LOAD REGULATION: Less than 5.0 millivolts  
RIPPLE AND NOISE: Less than 200  $\mu$ v rms  
SERIES CONNECTED: 0-72 volts, 0-1.5 amperes

OUTPUT CONTINUOUSLY VARIABLE  
REMOTE ERROR SENSING  
AUTOMATIC OVERLOAD PROTECTION  
CONVECTION COOLING: No moving parts

**HARRISON LABORATORIES, INC.**  
45 INDUSTRIAL ROAD • BERKELEY HEIGHTS, NEW JERSEY • CR 3-9123



IRE People



(Continued from page 76A)

Office of Strategic Information. From April to December, 1955, he was Deputy Assistant Secretary of Defense, having responsibility for the public affairs activities of the Defense Department.

He was awarded the 1956 Alumni Citation of Franklin and Marshall College for "outstanding contributions to the greater community." In 1958 he received the Centennial Medal of Seton Hall University.

He is Chairman of the Committee for Engineering Information Services, an Engineers Joint Council sub-committee for cooperation with the National Science Foundation.

He is a Fellow of the American Association for the Advancement of Science and of the American Institute of Electrical Engineers. He is a past president of the New York Electrical Society. He is also a member of the American Management Association, The Society for the Advancement of Management, Public Relations Society of America, Public Relations Society of New York, The Commerce and Industry Association of New York, The New Jersey State Chamber of Commerce, The American Ordnance Association and the Armed Forces Communications and Electronics Association.

He is a director of the Rand Development Corporation, Cleveland, Ohio, of Floating Floors, Inc., New York, N.Y., and of the New Jersey Council on Economic Education.

Mr. Honaman was a member of a delegation which visited Moscow in 1958 to discuss trade relations with the Soviet Union. In 1959 he visited a number of countries of Western Europe, where he discussed industrial and technological problems.



Ark Engineering Company, established in July 1952 as a sole proprietorship under the direction of Albert R. Kall (A'49-M'55), announces its incorporation as of January 1, 1960 under the name of Ark Electronics Corporation. The main activities of the company, as before, are consulting engineering specializing in the field of radio interference studies and tests, interference-susceptibility studies of complex weapons and communications systems, custom filter development and production, and custom electromagnetic shielding design. The personnel and policies of the company remain the same. Mr. Kall has been elected president; other executive positions will be announced at a later date.



A. R. KALL

E. H. Lockhart (A'53-M'56) has been elected Vice-President of R. O. Roberts



(Continued on page 85A)



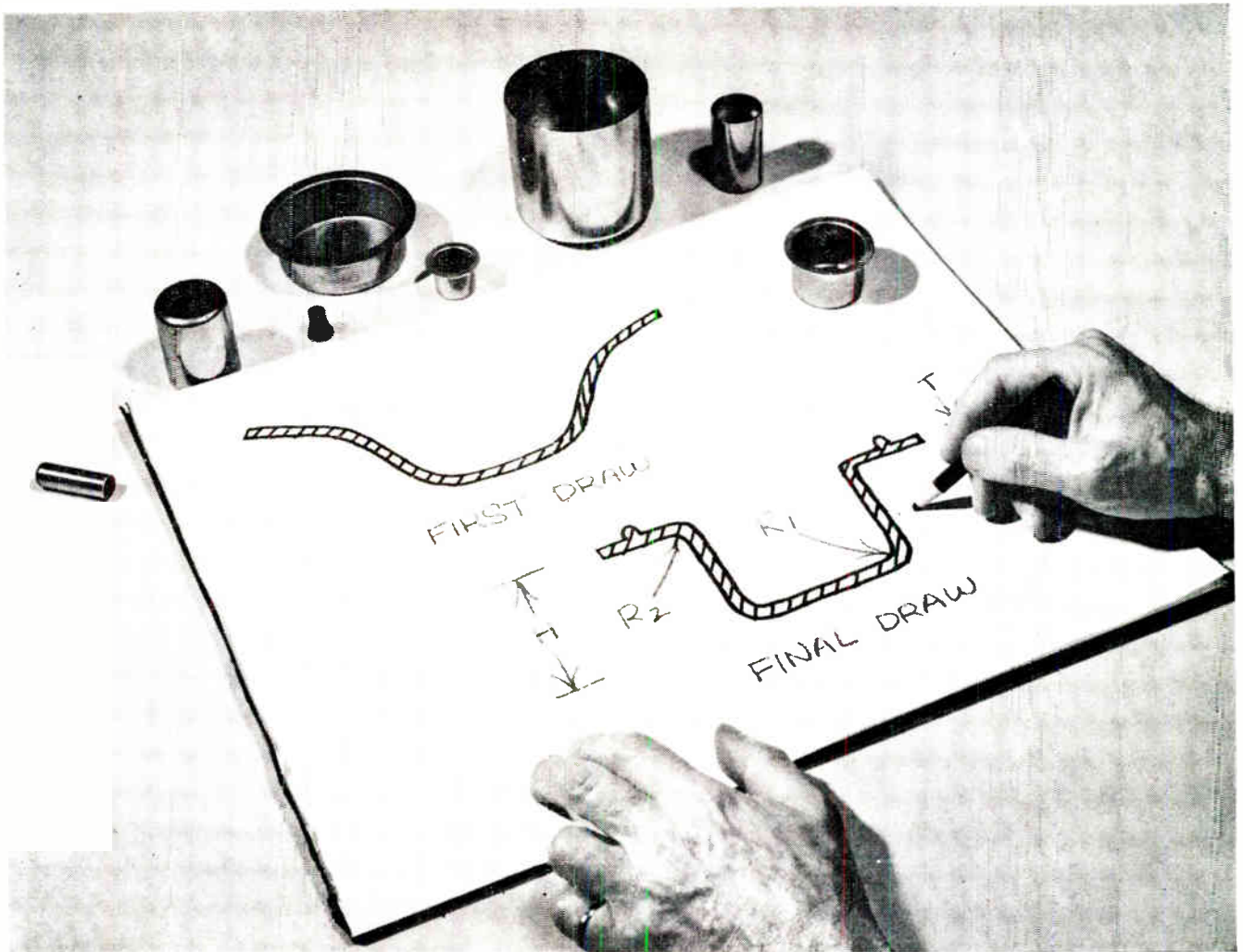

Engineering hints from Carborundum

## Correct techniques simplify production of KOVAR® Alloy drawn shapes

KOVAR is an iron-nickel-cobalt alloy with thermal expansion characteristics essentially matching those of several hard glasses. It is the ideal material for making high-quality drawn shapes required for vacuum- or pressure-tight glass-to-metal seals in equipment such as electron tubes and semi-conductors.

KOVAR has deep drawing qualities similar to cold-rolled steel. Satisfactory results are assured by observing a few simple precautions:

1. On the initial draw, punch radius should be a minimum of four times the material thickness. Reduce successively on re-draws
2. Inside radii at the corners on the final draw should be not less than the thickness of the metal.
3. Sharper radii, if absolutely essential, should be produced by a subsequent coining operation.
4. Hold-down pressures in drawing should be kept to a minimum to insure metal flow from the outside rather than stretching.

*For permanent vacuum and pressure-tight sealing... count on*

# CARBORUNDUM®

Obviously, to prolong tool life and simplify production, maximum permissible tolerances should be allowed. More detailed information on deep drawing of KOVAR alloy is supplied in Technical Data Bulletin 100 EB11.

Carborundum maintains large stocks of KOVAR alloy in a wide variety of sizes and forms. This alloy can be welded, brazed, soldered and plated with other metals. It can be either oxide bonded to hard glass or brazed to metallized-ceramic insulators. Technical service is available to help you solve processing and application problems. Contact The Carborundum Company, Refractories Division, Dept. P-50, Latrobe Plant, Latrobe, Pa.

### FIND OUT ABOUT KOVAR -- WHERE IT IS USED AND WHY

Bulletin 5134 gives data on composition, fabrication techniques and applications. Send for your free copy today.



## Catching Up with a Slippery Equation

What goes on when two moving surfaces are separated by a film of oil?

Simple question? Maybe, but engineers and mathematicians have been trying to answer this classic question of lubrication ever since Osborne Reynolds neatly stated the problem in equation form back in 1886.

Unfortunately, analytical methods for solving Professor Reynolds' partial differential equation worked only for unrealistic oil bearings, bearings with widths approaching zero or infinity. And approximate methods were crude, requiring a complete recalculation for each slight change in the bearing.

Recently, mathematicians at the General Motors Research Laboratories came up with the most versatile and efficient method of solution yet made. Their analytical method for solving the two-dimensional Reynolds' equation applies to all finite journal bearings — as well as other hydrodynamic bearings — with *no* assumptions or approximations about boundary locations. The new method uses a long-neglected energy theorem recorded by Sir Horace Lamb instead of the force relationship tried by Reynolds and others.

Besides being a valuable contribution to the theory of lubrication, this work has its practical side: namely, accurate, serviceable design curves for engineers. At GM Research, we believe delving into both the theoretical and applied sides of a problem is important to progress. It is a way of research that helps General Motors fulfill its pledge of "more and better things for more people."

**General Motors Research Laboratories**  
Warren, Michigan

Hydrodynamic analyses have led to specific answers about bearing operation. Shown here are the oil pressure distribution (main illustration) and load-carrying capacity for a non-rotating journal with a reciprocating load.

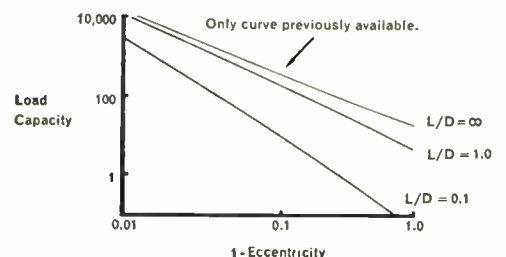





EXTRA QUALITY AT NO EXTRA COST WITH BENDIX TRANSISTORS

# Bendix Bulletin



Up-to-the-minute news about transistors

## NEW DRIVER TRANSISTORS SWEEPING THE FIELD

Extra-versatile Bendix units beat high costs, design limitations over wide front

Called the "workhorse of the transistor industry," the new Bendix\* Driver Transistor series is winning the nod from more and more engineers daily. These men find it the answer to audio frequency and switching applications requiring extra performance without extra cost.

Here is a special device for use where reliability, versatility, and low cost are primary requirements. The Bendix units combine higher voltage rating and high current gain with more linear current gain characteristics for low distortion and more efficient switching.

They're now in high production for rapid delivery in JEDEC TO-9 packages.

NEW BENDIX SEMICONDUCTOR CATALOG on our complete line of power transistors, power rectifiers, and driver transistors available on request. Write SEMICONDUCTOR PRODUCTS, BENDIX AVIATION CORPORATION, LONG BRANCH, N. J. For information about employment opportunities write personnel manager.

\*TRADEMARK

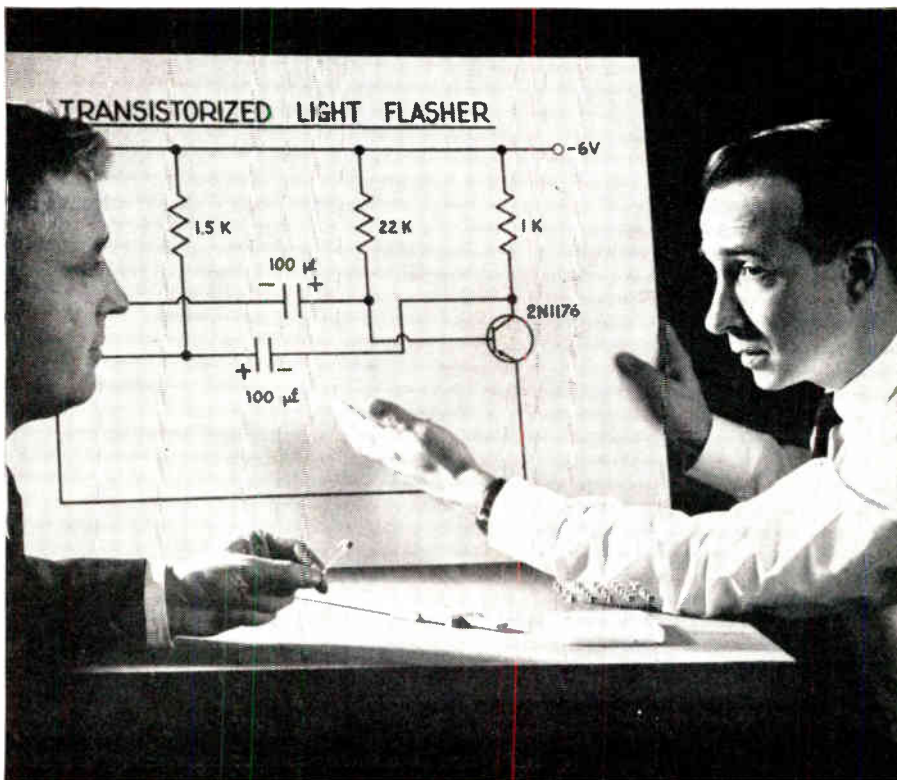

ENGINEERS KNOW the new Bendix Driver Transistor line-up meets on unusually wide range of circuitry applications. Bendix Applications Engineering Department suggestions on circuitry problems are helpful, too.

### APPLICATION, PERFORMANCE DATA INDICATE BROAD USAGE

TYPE NUMBERS	MAXIMUM RATINGS					TYPICAL OPERATION		
	V <sub>ce</sub>	I <sub>c</sub>	P <sub>c</sub>	T <sub>j</sub>	T storage	h <sub>fe</sub>	f <sub>cb</sub>	V <sub>ce</sub> (Sat)
	Vdc	mAdc	mW	°C	°C	I <sub>c</sub> = 10 mAdc	I <sub>c</sub> = 100 mAdc I <sub>b</sub> = 10 mAdc	
2N1008	-20	300	400	85	-65 to +85	90	1.2 mrc	0.15 Vdc
2N1008A	-40	300	400	85	-65 to +85	90	1.2 mc	0.15 Vdc
2N1008B	-60	300	400	85	-65 to +85	90	1.2 mc	0.15 Vdc
2N1176	-15	300	300	85	-65 to +85	65	1.2 mc	0.15 Vdc
2N1176A	-40	300	300	85	-65 to +85	65	1.2 mc	0.15 Vdc
2N1176B	-60	300	300	85	-65 to +85	65	1.2 mc	0.15 Vdc

Ideal for such applications as:

**TRANSISTOR DRIVER • AUDIO AMPLIFIER (CLASS A OR B)  
POWER SUPPLY • SERVO CONTROL • AUDIO OSCILLATOR  
MOTOR CONTROL • RELAY DRIVER • POWER SWITCH**

SEMICONDUCTOR PRODUCTS  
Red Bank Division  
LONG BRANCH, N. J.



West Coast Sales Office:  
117 E. Providencia Avenue, Burbank, California

Midwest Sales Office:  
2N565 York Road, Elmhurst, Illinois

New England Sales Office:  
4 Lloyd Road, Tewksbury, Massachusetts

Export Sales Office: Bendix International Division,  
205 E. 42nd Street, New York 17, New York

Canadian Affiliate: Computing Devices of Canada, Ltd.,  
P. O. Box 508, Ottawa 4, Ontario, Canada

Simplified block diagram of Model CF-1. Amplitude and phase input functions are plotted on graph paper for presentation. Integration is observed on a dc oscilloscope. Absolute magnitude is recorded on any S-A Series 121 or APR 20 Antenna Pattern Recorder with a logarithmic response.

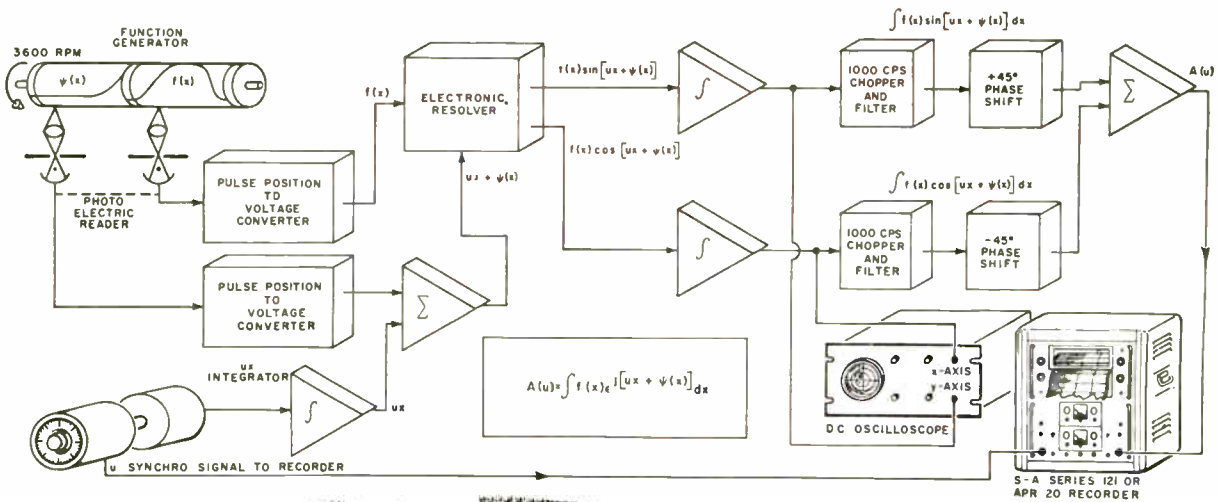

To solve

$$A(u) = \int_{-1}^1 f(x) e^{j[ux + \psi(x)]} dx$$

investigate the new

**S A** **FOURIER INTEGRAL COMPUTER**

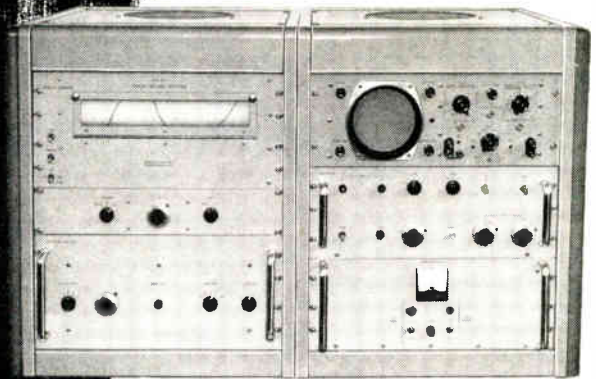

Model CF-1

A sophisticated solution to the vexing problem of solving bounded Fourier integrals quickly and accurately, Scientific-Atlanta designed the Model CF-1 especially for the antenna design engineer.

The computer has broad general application including determination of the far fields of aperture antennas from the distribution of the field in the aperture, the far fields of arrays from the magnitude and phase of the currents in the elements, the frequency spectra of voltage pulses, and other physical problems involving Fourier transforms and their inverse transforms over finite limits.

**PRICES**

**Model CF-1**  
**Fourier Integral**  
**Computer . . . \$9,000**

**Model APR 22**  
**Antenna Pattern**  
**Recorder (logarithmic**  
**response) . . . \$4,300**

Consult your nearby S-A engineering representative for more information. Or you may write directly to the factory for complete specifications. Address Dept. 86.



**SCIENTIFIC-ATLANTA, INC.**

2162 PIEDMONT ROAD, N.E. • ATLANTA 9, GEORGIA

Tel. TRinity 5-7291





(Continued from page 80A)

Company, Inc., Santa Fe Springs, Calif.

A veteran of over 20 years with the electronics industry, he most recently was vice-president of Radiotronics Incorporated, Van Nuys, Calif. He has also had engineering and management experience with Hughes Aircraft Company, Stanford University



E. H. LOCKHART

Microwave Laboratory, Los Alamos Scientific Laboratory, University of California Radiation Laboratory, and General Electric Company.

He has been active in the Western Electronic Manufacturer's Association for many years, serving on the Membership Committee in 1955, Greeters Committee Chairman 1956, Program Chairman 1957, and as a Director in 1958 and 1959.

Mr. Lockhart served as Registration Chairman for the 1958 Wescon, and is Vice-Chairman of the All Industry Luncheon Committee for the 1960 Wescon. His affiliations include the Aircraft Electrical Society and AFCEA.

(Continued on page 198A)

# ROBOTEC®

IN

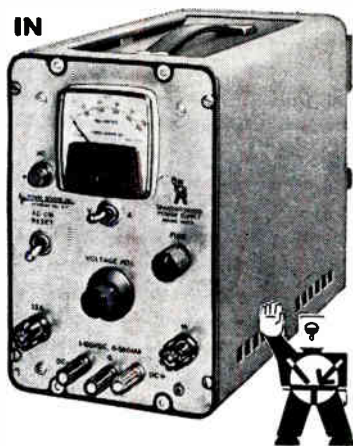

## SEMICONDUCTORIZED VOLTAGE REGULATED POWER SUPPLIES

... electronically cuts off output in less than 30 microseconds with overload or short circuit. Permits safe continuous operation into dead short. Models up to 100 volts and 10 amperes. Write for literature RI.

**Power Designs inc.**

1700 SHAMES DRIVE  
WESTBURY, NEW YORK  
EDgewood 3-6200

# Wide-Range Self-Contained Precision Inductance Bridge

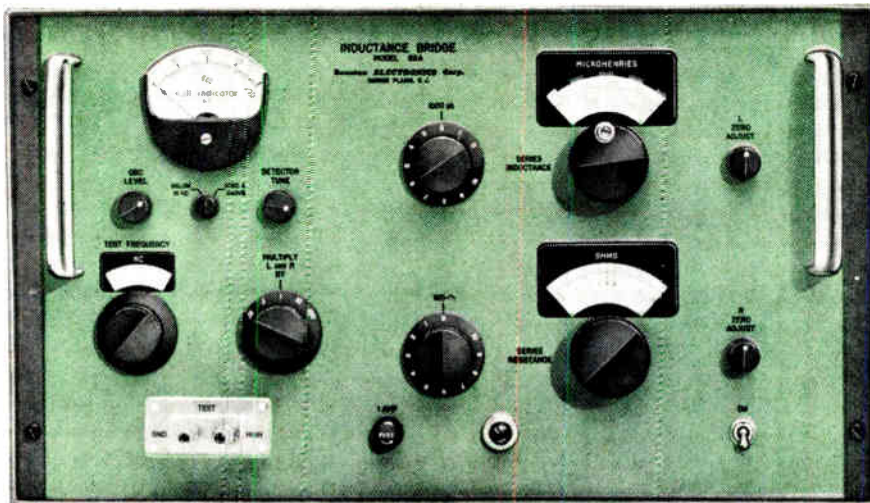

MODEL 63A

PRICE \$1500

- Inductance Range: .002 Microhenry to 1.1 Henries.
- Series Resistance Range: .002 Ohm to 110K Ohms.
- Built-in 1 to 100 KC Oscillator - Detector.
- No False or Sliding Nulls.

ALSO MANUFACTURERS OF THESE FINE INSTRUMENTS



DC Millivoltmeter

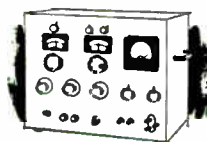

Capacitance Bridge



RF Distortion Meter



UHF Grid Dip Meter

## Boonton ELECTRONICS Corp.

Morris Plains, New Jersey • Phone: JEfferson 9-4210



A pulse transformer. Wire wound in careful coils. Metals, magnetic materials and dielectrics combined in careful ratios, spacings and dimensions. The result: a device with precise parameters—pulse shape, rise fall times, ripple, backswing, overshoot, life. What sets this one apart? A unique thing—Carad capability. Capability gained in designing and building hundreds of special pulse transformer types to exact specifications. Weights from ounces to hundreds of pounds. Ratings from 10 volts to 500 kv. None of these extremes are considered limits at Carad. For pulse transformers of any type you will find it worth your while to investigate Carad capability.

**CARAD CORPORATION** 2850 Bay Road • Redwood City • California

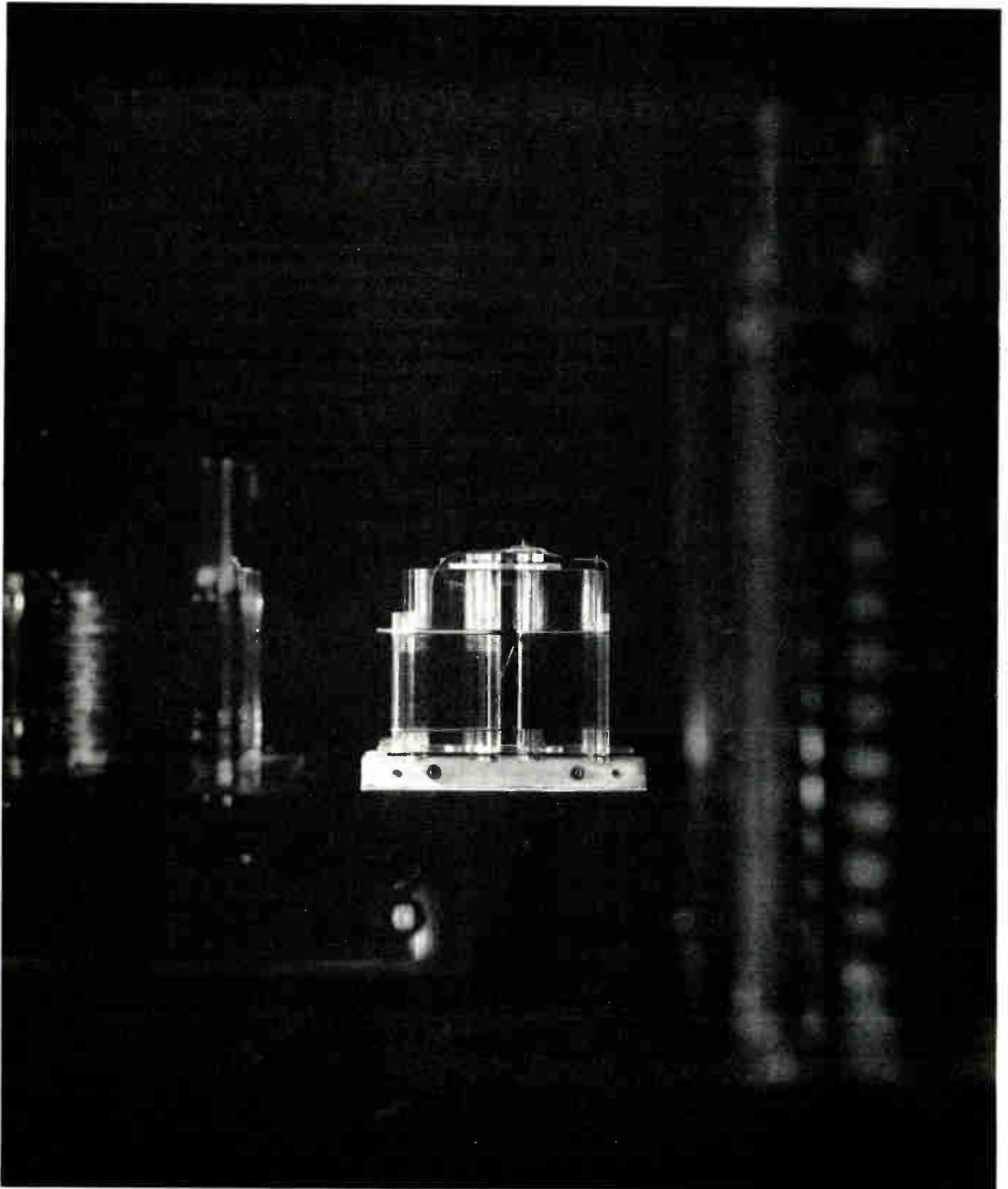



FROM **Transitron**...INDUSTRY'S BROADEST LINE OF

# MICRO-DIODES

**MICRO-MINIATURIZATION POSSIBLE NOW!**

**YES — FASTEST DIFFUSED SILICON MICRO-DIODES AVAILABLE.** They combine advanced diffusion techniques with extremely small size, to provide milli-micro-second switching speeds, excellent static, forward and inverse characteristics.

**YES — ONLY SERIES OF HIGH QUALITY MICRO-REGULATORS.** Series of 8 diffused-silicon micro-regulators provides stable voltage regulation and reference sources previously found only in considerably larger devices. Excellent dynamic resistance characteristics.

**YES — BASIC FAMILY OF MULTI-PURPOSE MICRO-DIODES.** Series of 3 high quality diffused-silicon micro-diodes provides voltage ratings up to 200 volts, current rating up to 50 milliamperes. May be considered for switching applications. Exceptional static, forward and inverse characteristics.

**YES — EVEN A MICRO-STABISTOR.**

This diffused-silicon stabistor is the micro-counterpart of Transitron's universally-known SG-22.

All of these new micro-diodes are **COMPLETELY COMPATIBLE** with present circuitry . . . provide the same excellent performance as larger Transitron diodes in 1/10th the space! Here is your chance to micro-miniaturize circuits **TODAY!**

#### VERY FAST SWITCHING MICRO-DIODE

TYPE	PIV	$E_f$ @ 5 MA	RECOVERY TIME
TMD-50	50V	0.75V	4 $\mu$ sec

#### FAST SWITCHING MICRO-DIODE

TYPE	PIV	$E_f$ @ 20 MA	RECOVERY TIME
TMD-24	50V	0.85V	0.3 $\mu$ sec
TMD-25	100V	0.85V	0.3 $\mu$ sec
TMD-27	200V	0.85V	0.3 $\mu$ sec

#### SILICON MICRO-REGULATOR

TYPE	VOLTAGE @ 1 MA	POWER RATING @ 25°C
TMD-01	5.1V	100 MW
TMD-03	6.2V	100 MW
TMD-07	9.1V	100 MW

#### HIGH CONDUCTANCE MICRO-DIODE

TYPE	PIV	$E_f$ @ 100 MA	POWER RATING @ 25°C
TMD-41	50V	1.0V	100 MW
TMD-42	100V	1.0V	100 MW
TMD-45	200V	1.0V	100 MW

#### SILICON MICRO-STABISTOR

TYPE	$E_f$ @ 1 MA	DYNAMIC RESISTANCE
TMD-40	0.55V	60 OHMS

For further information,  
write for Bulletins:

PB-71A (High Conductance), PB-71B (Fast Switching),  
PB-71C (Very Fast Switching), PB-71D (Stabistor),  
PB-71E (Regulators); AN 1358A Application Notes.

See Transitron at the AFCEA Show, Booths 157-158

# Transitron

electronic corporation • wakefield, massachusetts

"Leadership in Semiconductors"

SEE YOUR LOCAL AUTHORIZED TRANSITRON DISTRIBUTOR FOR QUANTITIES FROM 1-999.





**YOU** want to  
make 0.1% strain,  
temperature, and  
other measurements  
...rescue microvolt  
signals from  
volts of noise...



Consider a KINTEL  
Differential DC Amplifier

The KINTEL 114A virtually eliminates ground loop problems... amplifies microvolt level signals in the presence of volts of common-mode noise. Input is isolated from output and both are completely isolated from chassis ground. Common-mode rejection is 180 db for DC, 130 db for 60 cps with up to 1000 ohms input unbalance. Equivalent input drift  $< 3 \mu\text{V}$ , input resistance 5 megohms, output capability 10 volts at 10 ma, gain 10 to 1000, bandwidth 100 cps, gain stability 0.1%. There's no better way to measure strain, temperature and other phenomena to very high accuracies. Price: 114A \$875, single amplifier cabinet \$125, six amplifier module \$295.

Representatives in all major cities



5725 Kearny Villa Road, San Diego 11, California  
Phone: BRowing 7-6700

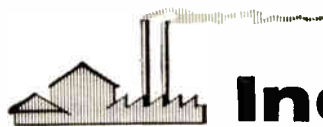

# Industrial Engineering Notes\*



## AIR TRAFFIC CONTROL

The Federal Aviation Agency hopes to have air traffic control on a semi-automatic basis by 1963 and fully automatic "as soon as possible thereafter," FAA Administrator E. R. Quesada said. Speaking at a meeting of the National Society of Professional Engineers, Mr. Quesada said a 400-engineer staff is working on R&D connected with modernization of the airways and that one of the most pressing projects is the automation of the air traffic control system. Automation has, he said, "terrifically far-reaching implications. The key to the project is the development of an air traffic control Data Processing Central that will remove many of the controller's bookkeeping chores and give him more time to analyze traffic situations and make control decisions." The Central's "most spectacular" function will be in probing, detecting, and predicting conflicts, he continued. It will warn of any unsafe situation and automatically suggest corrective alternatives. Present plans call for the Central to be controlling the New York, N. Y., area's air traffic in 1963, with systems to follow at Cleveland, Washington, Chicago, Los Angeles, and Oakland. Other plans for airway modernization call for increased installations of radar and other electronic equipment; improving the communications systems and the aeronautical weather service; and developing new control procedures, the administrator said.

## ENGINEERING

Standards on resistors and capacitors have just been published by the American Standards Association. Publication 115 applies to fixed resistors of types other than wire-wound, with a rate dissipation not exceeding 2 watts and a rated resistance value between 10 ohms and 10 megohms, suitable for use in circuits where high stability properties are essential. Publication 116 applies to fixed capacitors with a dielectric of mica with the electrodes directly deposited on the mica sheets and intended for use in telecommunication receiving equipment and for similar applications in other electronic equipment. Copies of these publications are available from ASA Headquarters 70 E. 45th St. New York, N. Y., \$3.20 per copy. . . . A two-part report of Air Force-sponsored research into magnetic amplifier circuits has been published for sale to industry through the Office of Technical Services, U. S. Department of Commerce, Washington 25, D. C.

\* The data on which these NOTES are based were selected by permission from *Weekly Report* issues of February 23 and March 7, 1960, published by the Electronic Industries Association, whose helpfulness is gratefully acknowledged.

## MILITARY ELECTRONICS

The Army has shown members of the press a device which can, it was claimed, perform many of the functions of electronic devices—without electricity or moving parts. The device is a "pure fluid amplifier." The unit demonstrated by its inventors, scientists of the Army's Diamond Ordnance Fuze Laboratory in Washington, resembled a block somewhat larger than a pack of playing cards. It was airtight, except for tiny apertures, and contained passageways. Attached to a source of pressurized gas or liquid, the device can amplify, digitalize, remember, feedback, and compute, the scientists said. The new device "makes possible a whole new class of amplifiers, computers, logic circuits and control systems, and will bring automation and control more into industrial and personal life," its developers said. The "revolutionary" system will not replace the electronics industry, they declared, but in some specialized applications it "will do things better and more reliably than electronic systems." "Pure fluid amplifying and computing elements will take a place in hydraulic and pneumatic systems similar to the position that the vacuum tube and transistor occupy in the field of electricity," the scientists said. The amplifier works by injection into the internal passageways of one strong stream of gas or liquid and a second, weaker stream which displaces or redirects the main flow. The idea for the system is an old one—"an overlooked one," its developers said. Fluids in motion have been used in many applications, such as hydraulic systems, windshield wipers and autopilots. But those systems have moving parts. The advantage of the pure pneumatic device is that it has none. Thus, the inventors claimed, it is trouble-free to an astonishing degree, easy to make and maintain, and as rugged as its few component materials are. It can operate, for example, in white heat. The inventors said a unit could be produced for 2/10ths of a cent which would do the work of a vacuum tube costing 50 cents. A unit the size of a pea with an aperture 5/1000ths of an inch in diameter was displayed. It was said that the size of the device could be adjusted to fit almost any applications "up into the horsepower range." The prime advantage is the speed of the device. "They will never compete with electronic systems for very high speed applications," the scientists said. The pure fluid amplifier will be described in an engineering handbook now being prepared by the Army and in a series of technical papers to appear in trade magazines. A full technical report will be issued later.

(Continued on page 92-A)



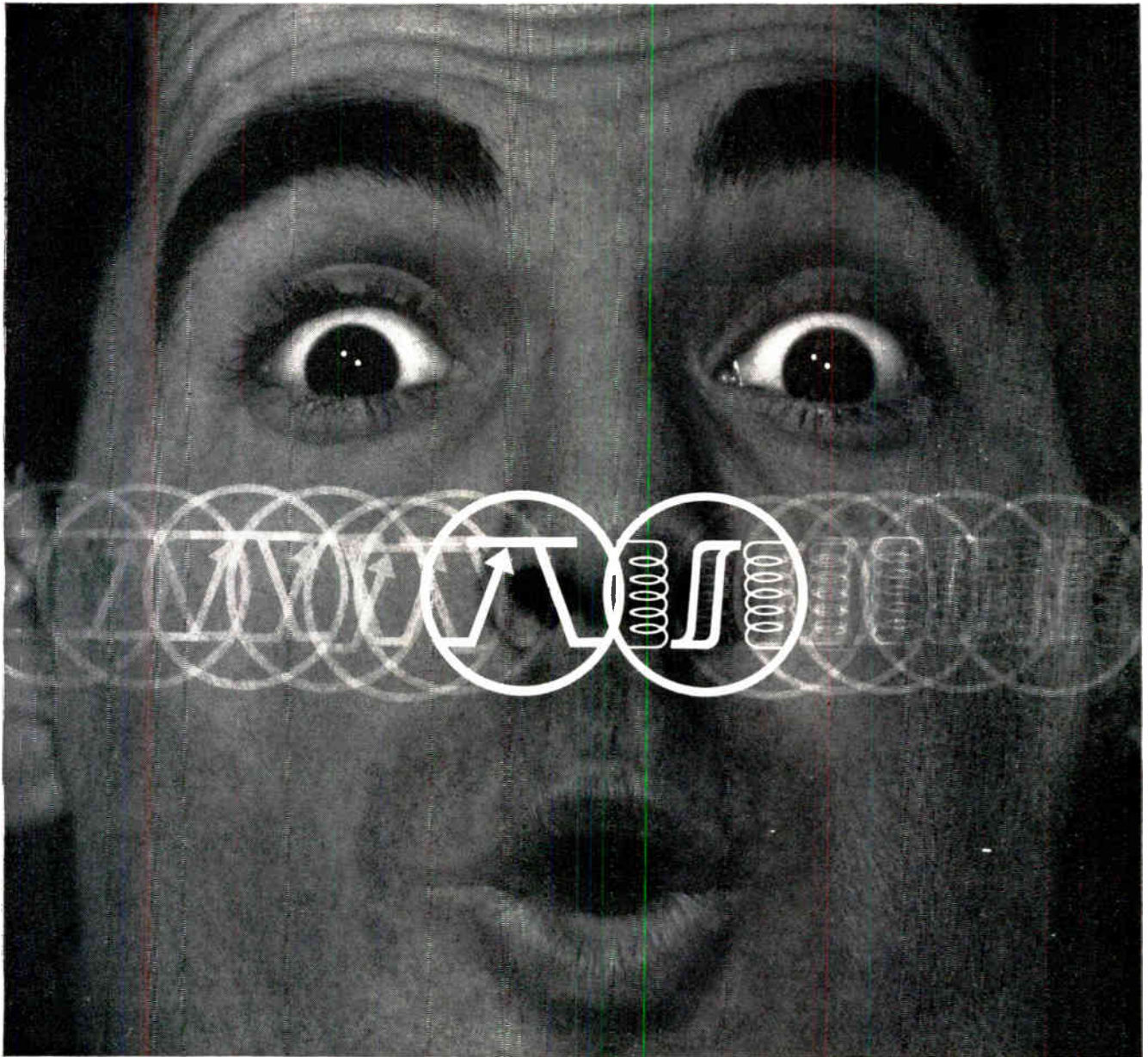

## ***Open your eyes to new amplifier designs!***

See how to combine tape wound cores and transistors for more versatile, lower-cost, smaller amplifiers

Tie tape wound cores and transistors into a magnetic-transistor amplifier, and open your eyes to new design opportunities.

To start with, these are static control elements—no moving parts, nothing to wear or burn out. Next thing you find is that you reduce components' size—your amplifier is smaller and costs less. That's because between them the core and the transistor perform just about every circuit function . . . and then some.

For instance? The core has multiple isolated windings. Thus you can feed many inputs to control the amplifier. The core also has a square hysteresis loop, and thus acts as a low loss transformer. That means you save power. In addition, the core can store and remember signals—so time delay becomes simple.

There's no need for temperature stabilization, either. The transistor acts only as a low loss, fast, static switch—and in this function it has no peer.

How do you want to use this superb combination? As a switching amplifier—or a linear one? In an oscillator? A power converter (d-c to d-c or d-c to a-c)? You'll have ideas of your own—and if they involve tape wound cores, why not write us? Ours are Performance-Guaranteed. *Magnetics Inc., Dept. P-81, Butler, Pennsylvania.*

***MAGNETICS inc.***  
®



## NEW BORG MICRODIALS ADD RICHNESS AND STYLE TO CONTROL PANELS AND INSTRUMENTS

Now from Borg, originator of famous Microdials, comes a fresh, new concept in turn-counting dial appearance . . . Series 1360 Microdials. These new Borg Microdials were specially developed to add style and color to electronic control panels and equipment. Available in five smart models of red, gray and black color variations. Colors are inlays of colored plastic . . . will never wear, scale or rub off. Quality

mechanical features such as smoothness of action . . . absence of noise . . . fewer ambiguities in reading and setting assure accurate, reliable performance. Contoured brake arms lock settings in place, but do not interfere with reading and setting. Catalog data sheet BED-A137 gives complete color combinations and specifications. See your Borg technical representative or distributor, or let us put him in touch with you,



### **BORG EQUIPMENT DIVISION**

Amphenol-Borg Electronics Corporation  
Janesville, Wisconsin

Micropot Potentiometers

• Turns-Counting Microdials

• Sub-Fractional Horsepower Motors

• Frequency and Time Standards



# OHMITE RESISTORS



**THE EXACT RESISTOR YOU NEED—WHEN YOU NEED IT—FOR EVERY INDUSTRIAL AND MILITARY REQUIREMENT**

Fixed . . . adjustable . . . tapped . . . noninductive . . . precision metal film and encapsulated wire-wound . . . thin type . . . high-current—practically any resistor you need, you can find in the Ohmite line.

**W**ORLD'S LARGEST STOCK FOR IMMEDIATE DELIVERY—Chances are Ohmite's huge stock of several million resistors in more than 2000 sizes and types contains a unit that fits your requirements. Many types are also available through Electronic Parts Distributors located across the Nation.

**Y**OUR CUSTOMERS KNOW THE VALUE OF OHMITE QUALITY—When a purchaser sees Ohmite resistors in a piece of equipment, he knows that equipment is designed and built for dependability.

**O**HMITE ENGINEERING ASSISTANCE ASSURES THE RIGHT UNIT—Selecting the right resistor for the job is sometimes a tough problem. Why not call on Ohmite application engineers to help out. Take advantage of their specialized skills and background.

*Write on Company Letterhead for Catalog and Engineering Manual 58*

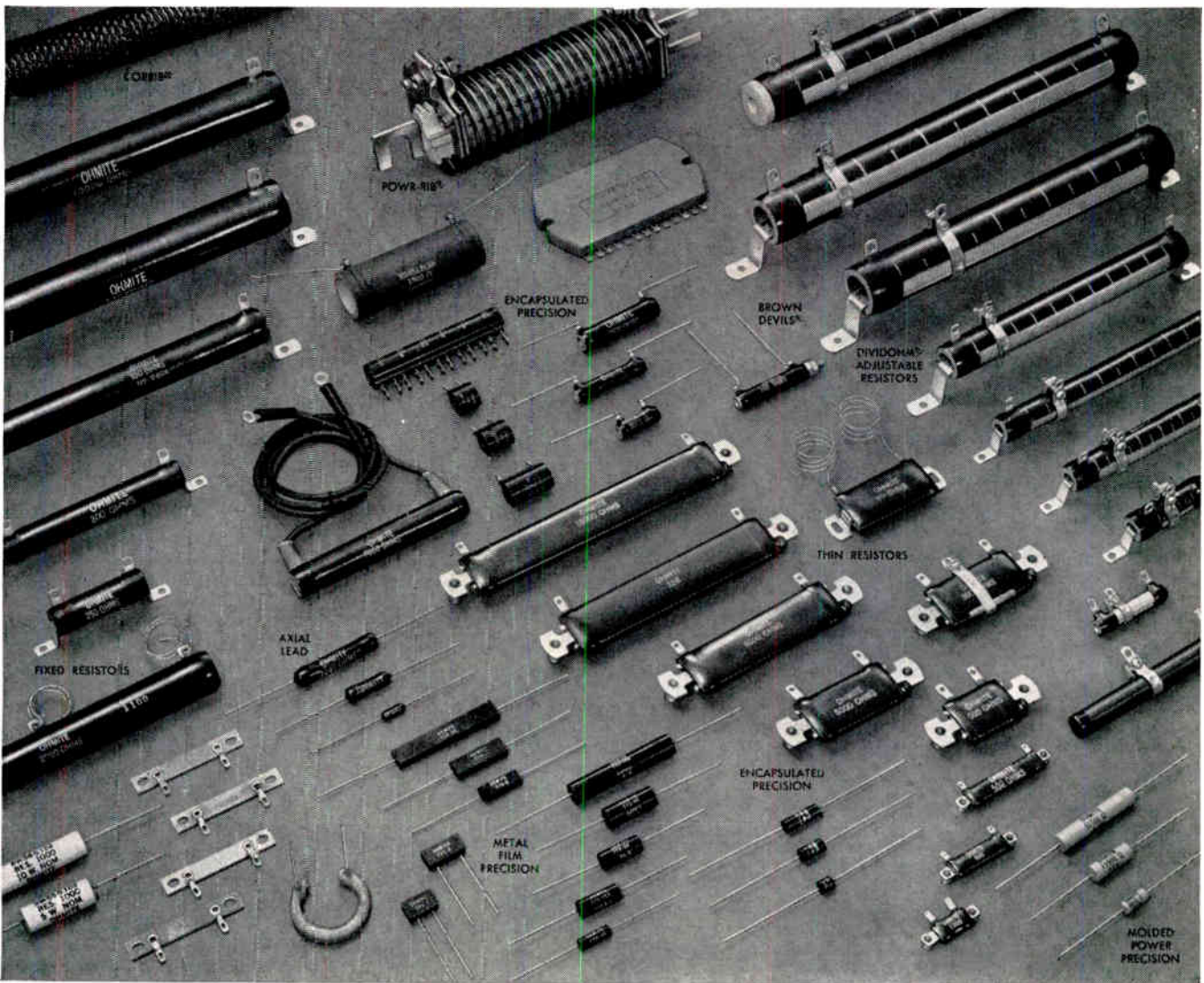

# OHMITE

**OHMITE MANUFACTURING COMPANY  
3617 Howard Street, Skokie, Illinois**

## Quality Components

**RHEOSTATS • RESISTORS • TAP SWITCHES  
RELAYS • R.F. CHOKES • TANTALUM CAPACITORS  
VARIABLE TRANSFORMERS • GERMANIUM DIODES**



# TOROIDS PUZZLING YOU?

NETWORKS  
MAG AMPS  
DELAY LINES  
SATURABLE  
REACTORS



Advanced engineering, complete industry liaison and exclusive specialization in toroidal components are all part of a continuing program at C-A-C. Our unique equipment—designed and built by C-A-C—enables us to produce quality toroids of all types in high volume for fast delivery.

Always Specify C-A-C Toroids



**COMMUNICATION  
ACCESSORIES  
COMPANY**

Lee's Summit, Missouri

309

# 50% SAVINGS

with

## BEAD CHAIN® Multi-Swage Parts

**CONTACT PINS**

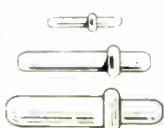

**TERMINALS**



**JACKS**



**FRICTION CONTACTS**

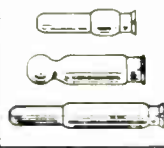

also **PRINTED CIRCUIT  
MINIATURE PARTS**

Contact pins, terminals, jacks or any small tubular parts. Maximum 1/4" diameter x 1 1/4" length.

Send sketch for quotations.

**BEAD CHAIN DRIVES**

Low-speed positive drives or motion transfer ... at far less cost!

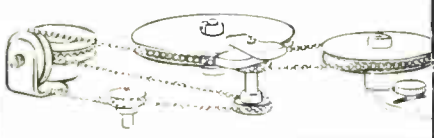

Send for Multi-Swage or Bead Chain Drive Catalogs

**THE BEAD CHAIN MFG. CO.**

**MINIATURE PINS**

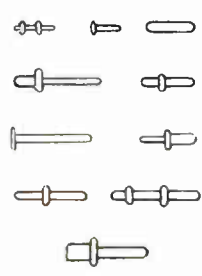

**QUALIFIED BEAD CHAIN**

- No. 3—3/32" Dia.
- No. 6—1/8" Dia.
- No. 10—3/16" Dia.
- No. 13—1/4" Dia.

**Industrial Engineering Notes**

(Continued from page 88A)

**EIA PROPOSAL**

EIA has submitted to the Labor Department its proposed definition of the Electronic Equipment Industry and urged that it be used in the upcoming survey preliminary to a Walsh-Healey wage determination for the industry. The EIA proposal defines the industry in terms of classes of products it manufactures, and limits the categories to those that are specifically electronic. It is intended to replace a more general definition proposed earlier by the Labor Department which identifies the industry as devoted to "... the manufacture of electrical apparatus and sub-assemblies thereof involving the use of electronic tubes and/or solid state semiconductor devices." In a statement accompanying its definition, EIA pointed out that the proposal would eliminate the possibility of including products of other electronic industries already covered by Walsh-Healey wage determinations, such as the electronic components and the tube and semiconductor industries. The definition proposed by EIA is "The manufacture of electronic equipment for the purpose of this survey, is defined as that industry which manufactures any of the following classes of

(Continued on page 108A)





An achievement in  
defense electronics

NEW THERMOPLASTIC RECORDING DISPLAY ACHIEVES

## Detection to Projection in Less than a Second

Large-screen display of radar signals can be recorded and projected in less than a second. This advanced technique in information display is an example of one application of the new thermoplastic recording system developed by General Electric.

The grainless, thermoplastic film eliminates processing delays and permits, with higher resolution, much greater enlargement than is practical with high-speed photographic film. Target delineation is also significantly improved by optical filtering used to increase the signal-to-noise ratio.

Now undergoing final development in General Electric's Electronics Laboratory, the "thermoplastic display" is expected to find maximum application in the high-speed radar systems of the future.

176-03

*Progress Is Our Most Important Product*

**GENERAL  ELECTRIC**

DEFENSE ELECTRONICS DIVISION  
HEAVY MILITARY ELECTRONICS DEPARTMENT  
SYRACUSE, NEW YORK

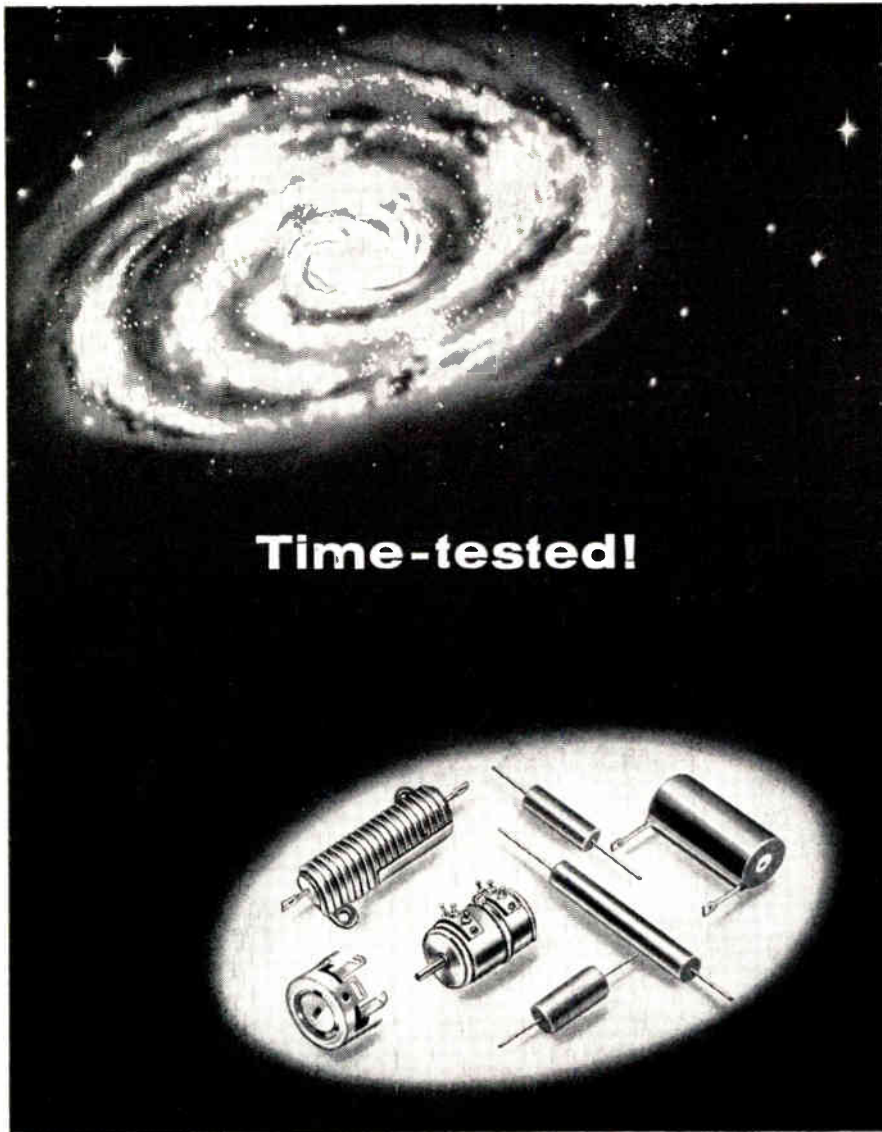

**Time-tested!**

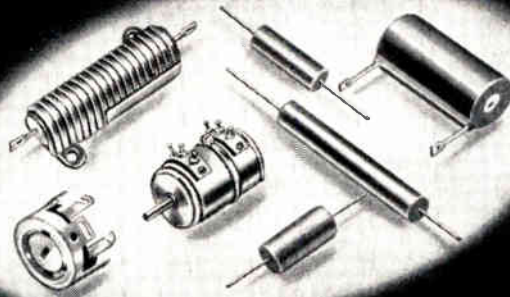

— the time-tested standard of the resistor industry

# Evanohm\*

## RESISTANCE ALLOY

— for resistors and precision instruments

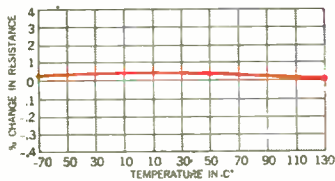

Percent change in resistance of an ideal sample of Evanohm. Normal production material (.002" and finer) is supplied within the range  $\pm 10$  ppm ( $-65$  to  $25$  C and  $25$  to  $125$  C, referred to  $25^\circ$  C.)

Wherever exceptional stability over a wide temperature range is essential, EVANOHM is the accepted standard of performance. This high-reliability resistance alloy provides high specific resistance, low temperature coefficient, low thermal EMF to copper. EVANOHM is especially recommended for use in resistors, aircraft instruments, for guided missiles, rockets and other precision equipment. Available in bare wire, enamel, formvar, polyurethane, silk, cotton, nylon and glass insulation. Write for complete electrical and mechanical data and recommendations on your specific application.

\*Patents 2,293,878-2,638,425 — Tradename Registered

**WILBUR B. DRIVER CO.**  
Main Office: NEWARK, N. J. — Tel. HUmboldt 2-5550



Branch Offices and Warehouses in Principal Cities. Manufacturing Plants: 1875 McCarter H'way, Newark 4, N. J.; 2734 Industrial Way, Santa Maria, Calif. Canadian Wilbur B. Driver Co., Ltd., Rexdale (Toronto). Subsidiary: Western Gold and Platinum Co., 525 Harbor Blvd., Belmont, Calif.

# HIGH PACKAGE DENSITY!

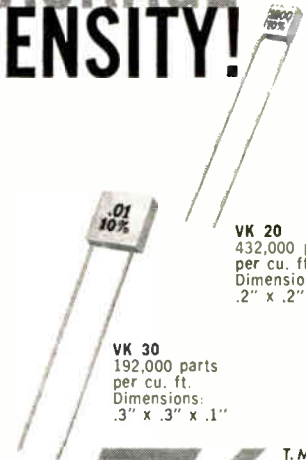

**VK 20**  
432,000 parts per cu. ft.  
Dimensions: .2" x .2" x .1"

**VK 30**  
192,000 parts per cu. ft.  
Dimensions: .3" x .3" x .1"

T.M.

## micro-miniature CERAMIC CAPACITORS

- Decimal dimensioned case
- Max. volumetric efficiency
- Contiguous flush-mount
- 47-10,000 mmf
- 200 vdc without derating
- $-55^\circ$  C to  $150^\circ$  C operation

"VK" capacitors are designed with square precision molded cases in only two sizes and a single standard 0.2" lead spacing for all values. Continuous life and environmental testing, plus 100% tests for Dissipation Factor, Insulation Resistance, and Capacitance guarantee that each "VK" capacitor in your circuit will perform as predicted.

**ALSO UNCASED FOR COMPLETE ASSEMBLY ENCAPSULATION**



Same electrical characteristics as standard "VK" series. Each unit coated with a resilient protective compound. Dimensions: 47-100 mmf, .100" square; 120-270 mmf, .130" square; 330-1000 mmf, .150" square; 1200-3300 mmf, .250" square; 3900-10,000 mmf, .265" square.





# SIDE BY SIDE

WITH ANY INSTRUMENTATION...



## CUBIC Digital systems speak for themselves

An uncluttered, human-engineered front panel and internal engineering and construction demonstrate to the eye that Cubic's is the *superior* digital instrument. Proof of this superiority is in the *operation* . . . and side by side in independent evaluations of many instruments, Cubic again and again provides the instrumentation that is *specified*.

Any phenomenon of science which can be converted to a usable DC Voltage can be measured with the Cubic 4 or 5-digit Voltmeter (Models V-41, V-51) powered by the Model C-1 Control Unit. Addition of an AC Converter (Model AC-1, manual ranging; Model AC-2, automatic ranging) or a Model PA-1 Preamplifier extends the systems capabilities to the measurements of AC voltages or lower level DC voltages.

Precise resistance measurement is possible with the 0-41 and 0-51 4 and 5-digit Ohmmeters, powered by the C-1 or C-2 Control Unit.

Multiple input channels may be sampled rapidly and accurately with the Model MS-2, a single unit for scanning up to 100 points, or the MS-1, AS-1 Master-Auxiliary combination for scanning up to 1000 points with multiples of one, two, four or five-wire inputs.

Voltage ratio measurements are made with the R-41 and R-51 4 and 5-digit models operating only as Ratiometers or with the VR-41 and VR-51 models, which operate both as Ratiometers and Voltmeters. Measurements can be permanently recorded with the addition of a PC-Series Printer Control Unit, providing input for any quality printer on the market.

**AND NEW FROM CUBIC . . .** the Talking Meter, instrumentation that really *does* speak for itself, instrumentation that provides a new dimension in "readout," measurements or other parameters reported to the ear by a clear human voice.



Years-ahead engineering, factory production techniques inspired by pride in the end result, careful quality control and reliability testing . . . all these factors make Cubic's the truly fine instrumentation . . . Digital Systems that speak for themselves.



**CUBIC CORPORATION**  
INDUSTRIAL DIVISION

5575 Kearny Villa Road, San Diego 11, California

Electronic Engineering With a Dimension for the Future

MORE THAN "HARDWARE," CUBIC  
OFFERS FINE PRECISION INSTRUMENTATION AT MODERATE PRICES.

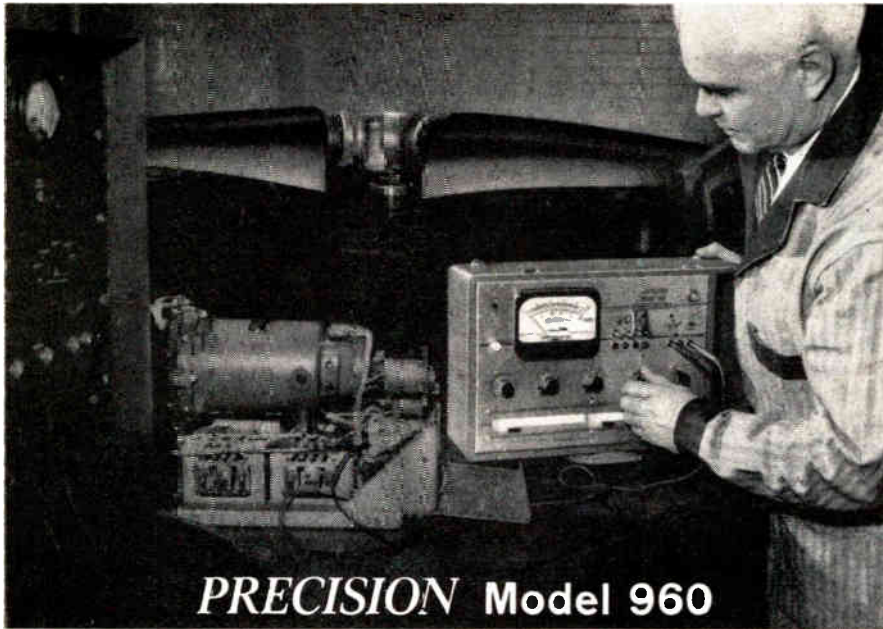

## PRECISION Model 960

transistor and crystal diode tester...

### AND WHY IT WAS CHOSEN BY CURTISS-WRIGHT...

#### THE PROBLEM:

Curtiss-Wright needed an accurate and reliable transistor tester, for field testing and maintenance of their transistorized Propeller Synchronizer and its associated equipment.

#### THE SOLUTION:

After evaluating available test instruments, the PRECISION Model 960<sup>®</sup> was chosen on the basis of its design suitability, reliability and low unit cost.



leading semiconductor manufacturers • self-contained AC power supply eliminates the necessity for batteries • \$99.95



Perhaps you, too, have a production-line or servicing problem that can be solved by the PRECISION Model 960...

If so, you will be interested to learn that the Model 960, and all other PRECISION test instruments, are available to you now for a free trial... in your plant... under actual operating conditions... without obligation.

For complete information... plus a copy of the comprehensive, new PRECISION test instrument catalog, write on your company letterhead to:

**PRECISION Apparatus Co., Inc.**  
70-31 84th Street, Glendale 27, Long Island, N. Y.  
Export: 458 Broadway, New York 13, New York  
Canada: Atlas Radio Corp., Ltd., 50 Wingold Ave., Toronto 19

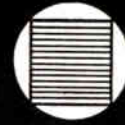

Raster



PP

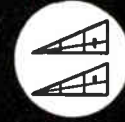

GCA Display



Elevation Scope



Character Display

## A YOKE FOR ANY SCAN to your Specifications



Composite Display:  
Horizon-Altitude-Airport



Off Centered  
Sector Scan



Precision  
Linear Sweeps



Loran



O Scope



DF Scope

**COMPLETE LINE** of deflection yokes for every military and special purpose—in production quantities or custom designed to your exact requirement.

For engineering assistance with your display problems, call on your nearest

**SYNTRONIC YOKE SPECIALIST** today:

**New York Area:** Jules J. Bressler Co.  
Phone: N.Y., OXford 5-0255; N.J., UNion 4-9577

**Philadelphia Area:** Massey Associates  
Phone: MOhawk 4-4200

**Washington-Baltimore Area:** Massey Associates  
Phone: GRanite 4-2071

**Indianapolis:** Joe Murphy  
Phone: VICTor 6-0359

**Los Angeles:** Ash M. Wood Co.  
Phone: CUMberland 3-1201

**syntronic**  
**INSTRUMENTS, INC.**

100 Industrial Road, Addison, Illinois  
Phone: KINGSwood 3-6444





WHAT  
HAS  
THE  
**7182**  
S BAND MAGNETRON  
IN  
COMMON  
WITH  
THIS  
CAT?

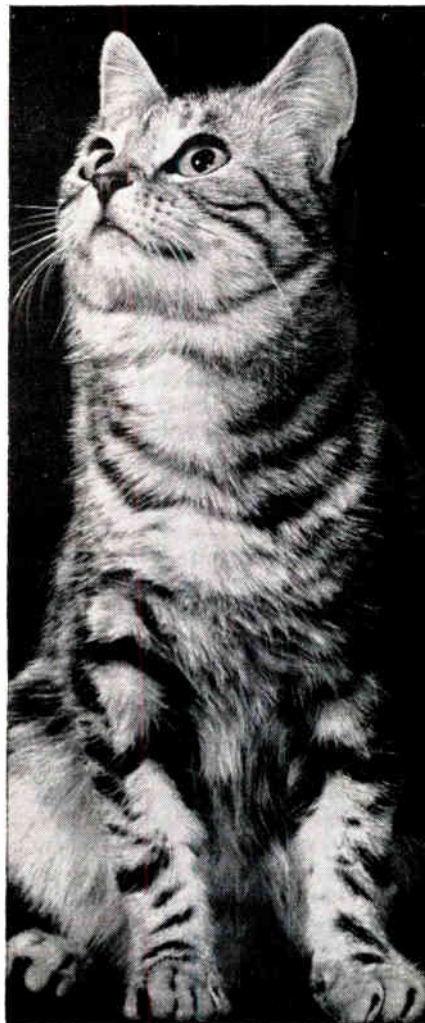
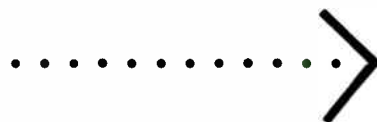

A good question! According to legend, a cat has nine lives – something that has yet to be proved. The 7182, on the other hand, has a *proved* life 8 to 10 times greater than any similar S-Band magnetron.

The 7182 retains its remarkable stability and reliability during a life of 10,000 hours, and is one of a series of magnetrons now in production providing peak powers of 5 MW. These magnetrons operate at voltages and current densities usually associated with magnetrons rated at a fraction of the power output.

A parallel development in L-Band ensures that attainments in this field equal the phenomenal successes already achieved with S-Band magnetrons.

**'ENGLISH ELECTRIC'**  
Agents throughout the World

**ENGLISH ELECTRIC VALVE CO. LTD.**



CHELMSFORD, ENGLAND  
Telephone: Chelmsford 3491

**BASIC BUILDING BLOCKS FROM KEARFOTT**



**20 SECOND SYNCHRO**

This synchro, just one of a broad line offered by Kearfott, provides the extreme accuracy required in today's data transmission systems. Kearfott synchro resolvers enable system designers to achieve unusual accuracy without the need for 2-speed servos and elaborate electronics. By proper impedance, matches up to 64 resolver control transformers can also operate from one resolver transmitter.

**TYPICAL CHARACTERISTICS SIZE 25**

	Transmitter	Control Transformer
Type Resolver	25161-001	25151-003
Part Number		
Excit. Volts (Max.)	115	90
Frequency (cps)	400	400
Primary Imped.	400/80°	8500/80°
Secondary Imped.	260/80°	14000/80°
Transform. Ratio	.7826	1.278
Max. Error fr. E.Z.	20 seconds	20 seconds
Primary	Rotor	Stator

Write for complete data.

**BASIC BUILDING BLOCKS FROM KEARFOTT**

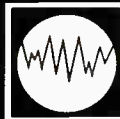

**PRECISE ANGLE INDICATOR**

Consisting of an angle position indicator, motor and servo amplifier, this small, versatile, rack panel mounted unit provides angular position indications for laboratory, production and field use. Input signals proportional to unknown angular position of synchro device being measured are resolved as an error voltage, which is amplified and used to drive an internal servo loop to null. Counter mechanism then provides direct visual readout of angular position.

**TYPICAL CHARACTERISTICS**

Input Signal:  $S_1$ ,  $S_2$ , and  $S_3$  of external synchro transmitter.  
 Repeatability: Within 0.6 minute in either a clockwise or counterclockwise direction for any angular position.  
 Readability: 0.5 minute through full range from zero to 360°  
 Rotation is continuous.  
 Accuracy:  $\pm 6$  minutes in the standard unit. Other accuracies available on request.  
 Sensitivity: 0.5 minutes maximum.  
 Slewing Speed: Phase sensitive, 180° in 7 seconds.  
 Input Voltages: 115 volts, single phase, 400 cycles, 23 VA max.  
 Size: Standard Rack Mounting—1 3/4" x 9 1/2" x 8 1/2"  
 Write for complete data.

**BASIC BUILDING BLOCKS FROM KEARFOTT**



**FLOATED RATE INTEGRATING GYROS**

Specifically designed for missile applications, these Kearfott miniature gyros operate efficiently at unlimited altitudes. Their outstanding accuracy and performance make them superior to any comparably-sized units on the market. Hermetically sealed within a thermal jacket, these gyros are ruggedly designed and completely adaptable to production methods. Performance characteristics that are even more precise can be provided within the same dimensions.

**TYPICAL CHARACTERISTICS**

Mass Unbalance:  
 Along Input Axis: 1.0°/hr maximum untrimmed  
 Standard Deviation (short term):  
 Azimuth Position: 0.05°/hr  
 Vertical Position: 0.03°/hr  
 Drift Rate Due to Anisotropy:  
 Steady Acceleration:  
 .015°/hr./g<sup>2</sup> maximum  
 Vibratory Acceleration:  
 .008°/hr./g<sup>2</sup> maximum  
 Damping:  
 Ratio of input angle to output angle is 0.2  
 Characteristic Time:  
 .0035 seconds or less  
 Weight: 0.7 lbs.  
 Warm-Up Time:  
 10 minutes from -60°F  
 Life: 1000 hours minimum  
 Write for complete data.

Tachometers



Servo Valve



Ferrites



**KEARFOTT DIVISION**

**GENERAL PRECISION INC.**  
 LITTLE FALLS, NEW JERSEY

Midwest Office: 23 W. Calendar Ave., La Grange, Ill.  
 South Central Office: 6211 Denton Drive, Dallas, Texas  
 West Coast Office: 253 N. Vinedo Avenue, Pasadena, Calif.

**Engineers:** Kearfott offers challenging opportunities in advanced component and system development.



# NEW DELCO 50-AMP. TRANSISTORS

HIGHER CURRENT THAN EVER BEFORE FOR MILITARY AND COMMERCIAL USE

	2N1518	2N1519	2N1520	2N1521	2N1522	2N1523
Maximum Collector Current (Amps.)	25	25	35	35	50	50
Maximum Collector to Base Volts, Emitter Open, Max $I_{CO}$ 4ma	50	80	50	80	50	80
Minimum Open Base Volts (1-Amp. Sweep Method)	40	60	40	60	40	60
Maximum Saturation Volts at Maximum Collector Current	0.7	0.7	0.6	0.6	0.5	0.5
Gain at $I_C$ at 15 Amps.	15-40	15-40	17-35	17-35	22-45	22-45
Minimum Gain at Maximum Collector Current	12	12	12	12	12	12
Thermal Resistance Junction to Mounting Base ( $^{\circ}C/Watt$ )	0.8	0.8	0.8	0.8	0.8	0.8

Characteristics at 25°C Maximum Junction Temperature 95°C

A new family of high current transistors featuring the 50-ampere 2N1522 and 2N1523. Two 25- and two 35-ampere types round out the line. All thoroughly tested and completely reliable. Available in production quantities. Call or write your nearest Delco Radio sales office for full product information and applications assistance.

**DELCO**  
DEPENDABILITY  
**RADIO**

Division of General Motors  
Kokomo, Indiana

Newark, New Jersey  
1180 Raymond Boulevard  
Tel: Mitchell 2-6165

Chicago, Illinois  
5750 West 51st Street  
Tel: Portsmouth 7-3500

Santa Monica, California  
726 Santa Monica Boulevard  
Tel: Exbrook 3-1465

Detroit, Michigan  
57 Harper Avenue  
Tel: TRinity 3-6560

**marion**  
 advancement  
 in instrument  
 design

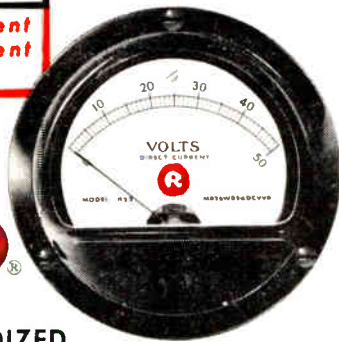

**SEALED  
 RUGGEDIZED  
 PANEL METERS**

HERMETICALLY SEALED . . . GLASS-TO-METAL

MIL 2½" (MR26) and MIL 3½" (MR36) sizes. Also 1½" Ruggedized and 4½" Sealed Models. va, ma, amp, mv, volt, kv, ac rectifier types for voltage, decibel and VU measurement. Standard ranges. Bulletin on request. Marion Instrument Division, Minneapolis-Honeywell Regulator Co., Manchester, N. H., U.S.A. In Canada, Honeywell Controls Limited, Toronto 17, Ontario.

**Honeywell**

PIONEERING THE FUTURE  *First in Control*  
 SINCE 1885

# SYNTRON

## POWER RECTIFIERS

Silicon and Selenium  
*Reliable Performance*

### SYNTRON RECTIFIER DIVISION

SUBSIDIARY OF LINK-BELT COMPANY

242 Lexington Ave.

Homer City, Penna.

# CAPITOL RADIO ENGINEERING INSTITUTE

Advanced Home Study and Residence Courses  
 in Electronics, Automation and  
 Industrial Electronics Engineering Technology

Pioneer in Electronics Engineering Instruction  
 Since 1927

*ECPD Accredited  
 Technical Institute  
 Curricula*

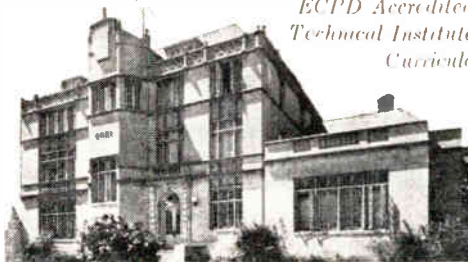

Request your free Home Study or  
 Resident School Catalog by writing to: Dept. 26056

3224 16th St., N. W. Washington 10, D. C.

Approved for Veteran Training

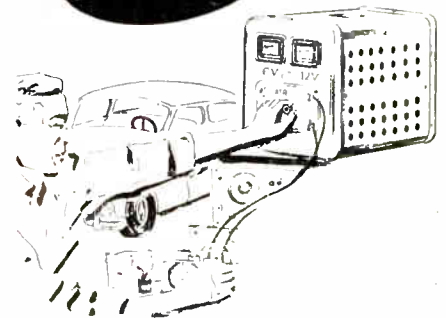

## "A" BATTERY ELIMINATORS

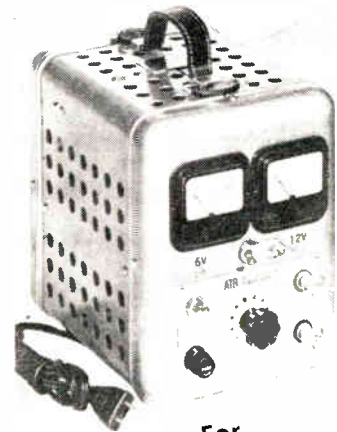

For  
**Demonstrating and  
 Testing Auto Radios**  
 TRANSISTOR OR VIBRATOR OPERATED  
 6 Volt or 12 Volt!

New Models . . . Designed for testing D.C.  
 Electrical Apparatus on Regular A.C. Lines.  
 Equipped with Full-Wave Dry Disc Type  
 Rectifier, Assuring Noiseless, Interference-  
 Free Operation and Extreme Long  
 Life and Reliability.

TYPE	INPUT A.C. Volts 60 Cycles	D.C. OUTPUT		SHIP. WT.	USER PRICE
		VOLTS	AMPERES Cont. Int.		
610C-ELIF	110	6	10 20	22	\$49.95
		12	6 12		
620C-ELIT	110	6	20 40	33	\$66.95
		12	10 20		

### SEE YOUR JOBBER OR WRITE FACTORY

✓ NEW MODELS ✓ NEW DESIGNS ✓ NEW LITERATURE  
 • "A" Battery Eliminators • DC-AC Inverters • Auto Radio Vibrators



**AMERICAN TELEVISION & RADIO CO.**  
*Quality Products Since 1931*  
 SAINT PAUL 1, MINNESOTA, U. S. A.





## TOP LEVEL MEETING IN NATION'S CAPITAL

Washington, D.C., April 4 (AFCEA). The Armed Forces Communications and Electronics Association will hold its 14th National Convention and Exhibit in the nation's capital on May 24-26.

Because the Convention is a *common ground* meeting place, it affords you the perfect opportunity to get to know the most important members of the

## This bulletin is news for you if you're looking for big military contracts

The annual AFCEA National Convention and Exhibit really is a top level meeting, where you join the upper sales echelons as your own ambassador, and introduce your products in the most strategic of all areas.

Here you mingle with the cream of the electronics and communications industry, and the top representatives of the Armed Forces and government. Your firm and its products will be on display for a large, exclusive audience of market V.I.P.'s - all of whom are prospective customers.

Because the Convention is a *common ground* meeting place, it affords you the perfect opportunity to get to know the most important members of the Armed Services and your industry.

You meet with military purchasers and manufacturing colleagues; personal contact with those in the know keeps you up to date on the latest needs and projects of the military, as well as current industry research and developments.

The Exhibit is a must for manufacturers who want to sell in the most profitable of all markets. It serves as a big, bright showcase which attracts buyers from all over the country, and you as an exhibitor identify yourself in the most practical way as being a supplier in *the* market. Remember, almost all of the viewers of your display are prospective purchasers. A good, working display makes the contacts for you, and can mean on-the-spot sales!

The AFCEA Convention and Exhibit are both held in Washington's Sheraton-Park Hotel, where for three days you are kept busy and stimulated by:

*Panel discussions* which feature carefully-prepared *professional papers* on timely military-electronics subjects, presented by well-known engineers and scientists.

Interesting *speeches* on significant themes, given by famous military and industry personalities.

A tour, conducted by the U.S. Army, through a large military installation.

*Banquets, receptions and luncheons* which provide still more occasions for profitable contacts.

And, of course, the 94 displays set up in the exhibition hall of the famous hotel.

"Communications and Electronics—the arm of control, the voice of command." is the theme of AFCEA's 1960 Convention and Exhibit. The Exhibit will reflect the amazing progress this young industry is making; wouldn't you like to show what your own firm has accomplished?

As a service to each exhibitor advertising in *SIGNAL*, the official publication of the AFCEA, a free ad in the exhibit listings of both *SIGNAL* and the official program is offered. Such wide advertising coverage gives added sales impact. The May issue of *SIGNAL* gives full coverage to the AFCEA Convention and Exhibit. In itself an "Exhibit in Print," this issue will be out in advance of the big event, spotlighting your products and serving to direct visitors to your display at the Exhibit. The issue will be indispensable as a guide to this year's Convention and Exhibit, since it will contain a complete list of exhibitors and the products to be displayed, as well as advance data about all technical papers, meetings, and other special activities.

For a complete and effective, year-round sales program that will make you a front-rank competitor in this \$4 billion market, inquire about AFCEA's profitable package plan.

EPA

# SIGNAL

OFFICIAL JOURNAL OF AFCEA

**Wm. C. Copp & Associates**

72 West 45th Street, New York 36, N. Y.

Murray Hill 2-6606

BOSTON • CHICAGO

MINNEAPOLIS • LOS ANGELES • SAN FRANCISCO



# Now Check these Proofs of Reliability...

## 12,000-hour life tests...

## long term in-circuit performance...

# RCA-2N404

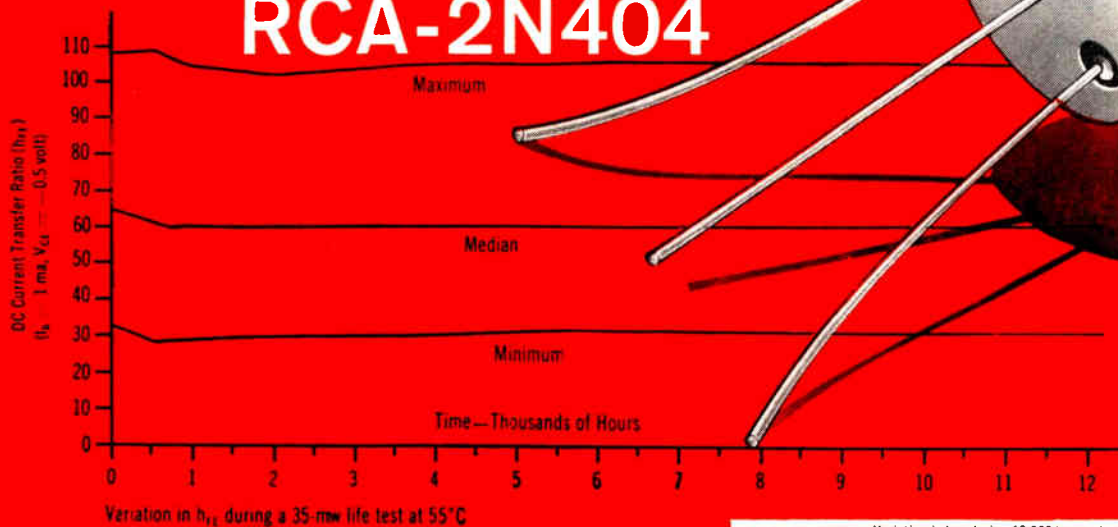

The transistor that helped build an industry ...designed, built and introduced by RCA... chosen by top manufacturers for the finest computers...the RCA-2N404 has set new standards of reliability for transistorized computers

Outstanding new achievements of operating reliability, long life, and stability are being made by the RCA-2N404 germanium p-n-p medium-speed switching transistor. Stringent long-term life tests and dynamic in-circuit performance checks, both at maximum ratings, provide additional proof of the bedrock reliability of the RCA-2N404.

Here are the results:

(1) Representative samples of the RCA-2N404 computer transistor have now passed 12,000 hours of operating life at *maximum* ratings. The curves at the right show the remarkable stability of transistor parameters over this exceptional time period.

(2) Samples from every lot of RCA-2N404 transistors are tested at *maximum* ratings for 1,000 hours. During 1959, almost 6,000,000 transistor test-hours at 85°C junction temperature were logged.

Why not call your RCA Field Representative today for the full story on the RCA-2N404 and the RCA-2N404 designed to meet military specification MIL-T-19500 20 USAF. For technical information write RCA Commercial Engineering, Section E-35-NN, Somerville, N.J.

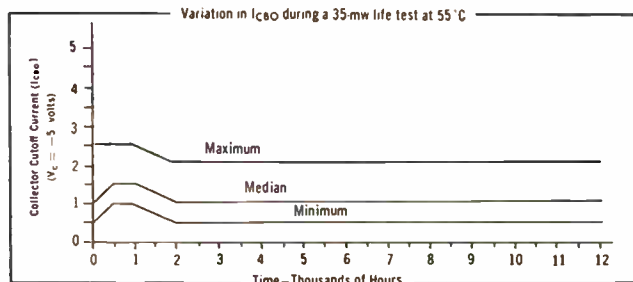
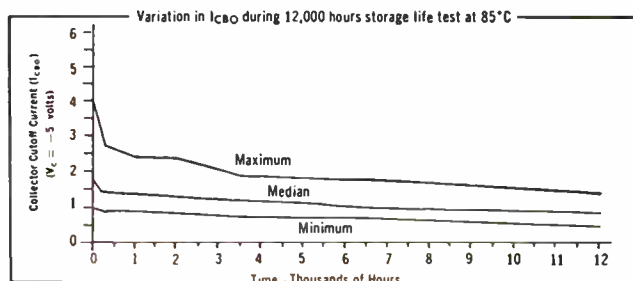
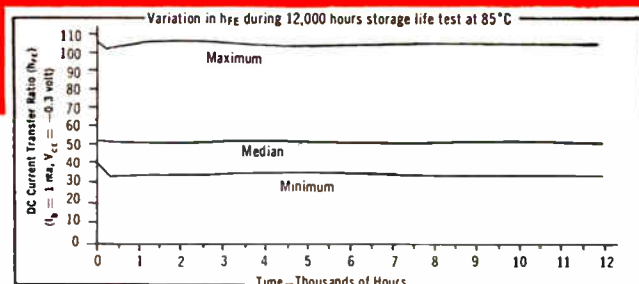

## RADIO CORPORATION OF AMERICA

SEMICONDUCTOR AND MATERIALS DIVISION

SOMERVILLE, N. J.

ANOTHER WAY RCA SERVES YOU THROUGH ELECTRONICS

East: 744 Broad St., Newark, N. J., HUmboldt 5-3900 • Northeast: 64 "A" St., Needham Heights 94, Mass., HILLcrest 4-7200 • East Central: 714 New Center Bldg., Detroit 2, Mich., TRinity 5-5600 • Central: Suite 1154, Merchandise Mart Plaza, Chicago, Ill., WHItehall 4-2900 • West: 6355 East Washington Blvd., Los Angeles, Calif., RAymond 3-8361 • Southwest: 7905 Empire Freeway, Dallas 7, Texas, FLEetwood 7-8167 • Gov't: 224 N. WILkinson Street, Dayton, Ohio, BALdwin 6-2366; 1625 "K" Street, N.W., Washington, D.C., DIstrict 7-1260

AVAILABLE THROUGH YOUR RCA DISTRIBUTOR

World Radio History



## Proceedings of the IRE



## Poles and Zeros

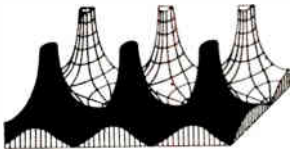

**Section Publications.** The issuance, in March, 1960, of a new edition of the "Manual for IRE Section Publications" re-

calls again the local Section phase of IRE: "information processing." Poles and Zeros tossed a bouquet (Roses to Ye Editors) to the Section publications in April, 1959. It can now report a little over a year later, not only that old standbys are flourishing but also that two new infants are born. The new additions are the "Denshi Tokyo" and "The Benelux Bridge" of the Tokyo and Benelux Sections, respectively. We wish the newcomers well and trust that they will take their rightful place in the sun. Sections that contemplate a publication venture should acquire a copy of the Sections Publication Manual; it is filled with pertinent and helpful information.

**Feedback.** The Editor of any publication receives mail from readers containing both constructive criticism, and destructive diatribe. Fortunately, the distribution of mail (to this Editor, so far) is weighted on the constructive side. Every letter has received, or is receiving, attention from the Editorial Board. Occasionally, the sequence of correspondence is in itself helpful. On two successive days letters were recently received. The first letter suggested that all issues of the PROCEEDINGS should be "Special Issues" and contain only material of general interest (twelve per year—what would we call them?). The same correspondent suggested that specific interest material be published in the TRANSACTIONS. The second letter deplored the use and existence of the TRANSACTIONS and, the writer felt, all material should be published in the PROCEEDINGS. Perhaps the present plan is the compromise which meets the need of most people!

Another correspondent struck a most responsive chord. He made an impassioned plea for the use of a consistent set of dimensional units for all PROCEEDINGS papers. A glance through several issues of the PROCEEDINGS validates his protest. As engineering writers we are certainly careless about dimensionality. In a given paper, on occasion, the same author mixes the English and the metric systems. This carelessness does not contribute either to smooth reading or to ease of continuity of interpretation. Without entering into the larger question of the ultimate adoption of the metric system in the United States (see, for example, page 584 of the April, 1959 issue of the PROCEEDINGS), it does seem that at least for scientific and technical articles, uniformity would be advantageous. Since the MKS system has been officially adopted, and all college and university text books have accepted the system, why not use it consistently in all engineering writing?

Another letter to the Editor has pointed out certain in-

consistencies, to be deplored, in the use of abbreviations. What excuse is there, queries this communicator, for the small case "m," as an example, in "mc" as an abbreviation for megacycle and in "ms" as an abbreviation for millisecond? This complaint recalls the interesting article by Arnold P. G. Peterson, in the TRANSACTIONS ON ENGINEERING WRITING AND SPEECH, for December, 1959, in which he suggests a rational system for naming the prefixes for both positive and negative powers of ten, and he associates with each a suggested symbol. These suggestions avoid the difficulty quoted above by using capital letters as symbols, for positive values of the exponent of ten, and lower case letter symbols for the negative exponent.

These rambling comments, engendered by recent correspondence, emphasize the necessity for such a Professional Group as that on Engineering Writing and Speech; it behooves all IRE authors to make use of the opportunities this Professional Group offers for the improvement of their literary efforts. The Editorial Board is presently considering the revision and subsequent reissuance of the IRE document titled "Information for Authors." This brief document might well be supplemented ultimately by a more complete "style manual" produced in cooperation with the PGEWS.

**Aftermath.** Poles and Zeros in March took notice of the 1960 International Convention and Radio Engineering Show. In those comments attention was called to the Panel Session "Electronics—Out of This World" and now that the convention is history one reflects that much of it was "out of this world." To this observer a small sample of such reflections might be listed thus: opening ceremonies at the Coliseum contacted Pioneer V, already 1,449,000 miles from earth and going away at the rate of 6,000 miles an hour; components so minute that their containers must be labeled "This Box Is Not Empty;" solar powered electric automobile (1912 model), which prior to the convention operated in Central Park; the announcement of a search for intelligence coming from outer space at distances so great that the initiators may have been extinct for milleniums; passive satellite balloons ten stories high; eyes and brains too tired to take in more; possible clues to the diagnosis of muscular disease based on new ability to measure extremely weak high frequency electrical signals; miracles of microminiaturization—a one hundred tube digital computer the size of a cigarette box; the implantation of electronic equipment in the human body for periods up to five years; the use of electronic devices for prenatal diagnosis; etc., etc.; the largest attendance of all time totaling 69,760, exceeding 1959 by 15 per cent.—F. H. Jr.

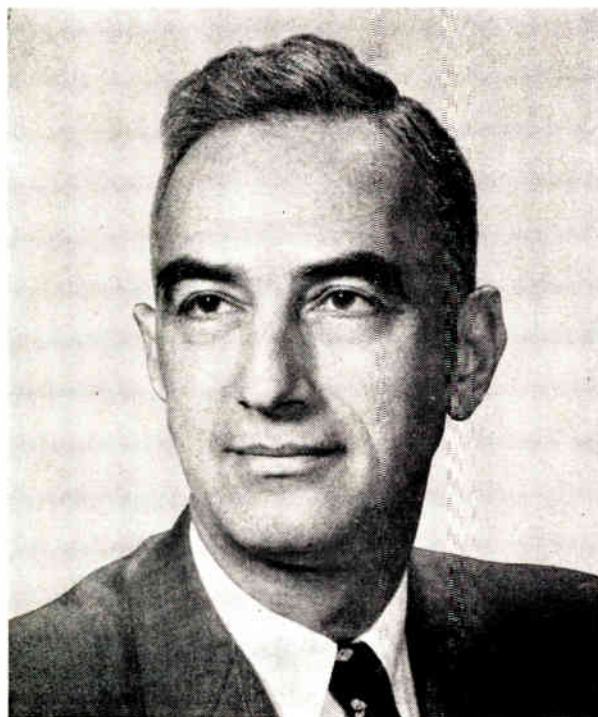

## Ferdinand Hamburger, Jr.

*Editor, 1960*

Ferdinand Hamburger, Jr. (A'32-M'39-SM'43-F'53) was born in Baltimore, Md., on July 5, 1904. He received the degrees of Bachelor of Engineering in 1924, and Doctor of Engineering in 1931, from The Johns Hopkins University, Baltimore, Md. He was a Charles A. Coffin Fellow in 1930-1931.

During the period between the undergraduate and graduate degrees he participated in a program of dielectric research at The Johns Hopkins University. In 1931 he was appointed instructor in electrical engineering, in 1947 professor of electrical engineering, and in 1954 chairman of the Department of Electrical Engineering, and in addition, in 1958 Director of the Radiation Laboratory of The Johns Hopkins University. He served as chief test engineer for Bendix Radio Division from 1942 to 1945, while on partial leave of absence from the University. He has acted as consultant for the Research and Standard Section, Bureau of Ships, Navy Department; U. S. District Court; RCA, and

others. He has served as Research Contract Director of a number of research investigations supported by the Department of Defense at The Johns Hopkins University.

Dr. Hamburger was IRE Regional Director of the Central Atlantic Region in 1950-1951, and a Director-at-Large in 1959. He has served on the Nominations, Appointments, Policy Advisory, and Education Committees. He has been a member of the Editorial Board since 1956 and was Vice Chairman in 1958-1959. He was IRE representative at The Johns Hopkins University from 1941 to 1955. He was largely responsible for the formation of the Baltimore Section of the IRE in 1939 and its reorganization in 1944; he served as its Chairman in 1940-1941.

He is a Fellow of the American Institute of Electrical Engineers and is presently serving as Vice Chairman of its Instrumentation Division. He is a member of Sigma Xi, Tau Beta Pi, and Eta Kappa Nu, and is a registered Professional Engineer in the State of Maryland.



## Scanning the Issue

**Some Notes on the History of Parametric Transducers** (Munford, p. 848)—One would be hard put to name a subject which has caused more excitement in recent years than the parametric amplifier. What started as a small flurry of article writing a few years ago has since grown to near blizzard proportions. Well over 100 papers have been written on this subject in the last two years alone. Yet the parametric principle has been with us for many decades. Zenneck and Alexanderson described magnetic frequency doublers and magnetic amplifiers to IRE audiences 44 years ago. Indeed, this subject can be traced as far back as 1831 to Faraday's observations of the double period oscillation of surface waves of liquids. The history of the development of parametric principles and devices, from 1831 to the present, is briefly summarized in this excellent review of the subject. The chronology presented here, supported by 200 selected references, is little known and will do much to help readers orient in their minds the recent rash of new amplifiers having a common underlying principle.

**Low-Noise Tunnel-Diode Down Converter Having Conversion Gain** (Chang, *et al.*, p. 854)—A new and important use has been found for a device which is currently one of the most talked about components in the electronics field. As reported last July in the PROCEEDINGS, the tunnel, or Esaki, diode is a semiconductor device with negative resistance characteristics which give it exceptional high-frequency low-noise amplification capabilities. It is now shown that the nonlinearity of this negative resistance characteristic can be used for low-noise high-gain frequency conversion—from a high frequency to a lower frequency. This down-conversion capability is most significant. Although good up-converters have been developed recently, there is at present no mixer device capable of down-conversion that does not exhibit either a conversion loss or a poor noise factor. Thus the tunnel diode becomes the first device which can convert UHF or microwave signals to a lower frequency with low noise and conversion gain.

**Noise Limitations to Resolving Power in Electronic Imaging** (Coltman and Anderson, p. 858)—In recent years an increasingly large segment of the electronics profession has become concerned with the recognition of patterns on television and other cathode-ray-tube displays in the presence of noise. The study presented here of the limiting effects of noise on image resolution will be of fundamental interest to this group of readers. The authors show that the resolution limit can be accurately predicted in quantitative terms from a knowledge of noise power per unit bandwidth and the sine wave response of the system.

**Packaged Tunable L-Band Maser System** (Arams and Okwit, p. 866)—A maser normally requires cumbersome and highly precise supplementary equipment which limits its use to laboratory and a few other special types of installations. This paper describes a tunable maser system that has been packaged into a sufficiently compact form to make it suitable for field operational use without detriment to its low-noise performance. This "reduction to practice" of one of the important new developments in electronics will be of wide interest, especially to radio astronomers because its frequency range makes it suitable for studying the Doppler shift of the 21-centimeter hydrogen line in receding galaxies.

**Cadmium Sulfide Field Effect Phototransistor** (Bockemuehl, p. 875)—Cadmium sulfide has previously achieved fame as a photoconductive material. The author has now extended its utility by fabricating a cadmium sulfide transistor and obtaining useful power gain from it. This represents the first time that field effect amplification has been reported for

any material in which virtually all the carriers are generated photoelectrically. Although CdS will never compete with germanium for general transistor applications, this work opens the door to many novel photocircuit functions which are not practicable with conventional circuit elements.

**The Optimum Formula for the Gain of a Flow Graph, or a Single Derivation of Coates' Formula** (Desoer, p. 883)—During the seven years since the first paper on the subject appeared in the PROCEEDINGS, signal flow graphs have become a popular and useful tool for analyzing a wide variety of engineering problems. This paper provides an important refinement of this tool—a new and simpler derivation of the gain formula for flow graphs. It has the added blessings of being a self-contained discussion of the subject and, in the author's words, being so simple "that even seniors can grasp it."

**A Broad-Band Cyclotron Resonance RF Detector Tube** (Turner, p. 890)—A novel method of detecting RF signals has been developed which utilizes the spiral motion of electrons as a tunable system which will become resonant when the frequency of spiraling is the same as that of an incoming signal. The tube is in essence a complete TRF receiver (less video amplifier) within one vacuum envelope. Its rapidly variable tuning and wide bandwidth (10 to 1) will make this development of considerable interest to engineers concerned with microwave systems for search, analysis and reception of signals over wide frequency ranges.

**Anomalies in the Absorption of Radio Waves by Atmospheric Gases** (Straiton and Tolbert, p. 898)—This paper will be of great interest to anyone concerned with propagation above 10,000 megacycles. The authors have gathered the results of recent propagation measurements in the millimeter range to shed new light on losses due to atmospheric absorption. They find that the measured losses in this relatively new part of the spectrum do not entirely agree with the losses predicted by classical theory developed over a decade ago, especially with respect to losses due to water vapor.

**Interaction Impedance Measurements by Propagation Constant Perturbation** (McIsaac and Wang, p. 904)—This paper is concerned with a technique for measuring the interaction impedance characteristics of microwave circuits by determining the change produced in the propagation constant when a rod is inserted in a waveguide. The technique is broadly applicable to various types of microwave structures, such as slow wave structures for traveling-wave tubes, and the results developed here will no doubt be regarded as a primary reference on the subject.

**Taylor-Cauchy Transforms for Analysis of a Class of Nonlinear Systems** (Ku, Wolf and Dietz, p. 912)—Since this paper is a companion to the paper that follows, the discussion of both papers have been combined below.

**Laurent-Cauchy Transforms for Analysis of Linear Systems Described by Differential-Difference and Sum Equations** (Ku and Wolf, p. 923)—This and the companion paper that precedes it describe a novel type of transform for solving problems described by linear and nonlinear differential and difference equations. The first paper, on Taylor-Cauchy transforms, deals with continuous nonlinear processes, while the second paper, on Laurent-Cauchy transforms, deals with discrete processes. They provide engineers with another tool of considerable usefulness in the analysis of a variety of physical systems.

**Scanning the Transactions** appears on page 965.

# Some Notes on the History of Parametric Transducers\*

W. W. MUMFORD†, FELLOW, IRE

**Summary**—This paper summarizes briefly the chronology of the development of parametric transducers. The early works of Michael Faraday (1831), F. Melde (1859), and Lord Rayleigh (1883) are cited as mechanical examples and the pioneering work of L. Kühn, J. Zenneck, E. F. W. Alexanderson and R. V. L. Hartley are cited as electrical examples. A very brief résumé of selected contributions follows, dating from the work on H. Q. North's diodes in 1945 to the present flurry of excitement beginning in 1954, created by the development of the Signal Corps-Bell Laboratories Task 8 varactor diodes. A list of 200 selected references is included.

THE recent interest in amplifiers which derive their gain from variable reactance circuit elements stems chiefly from the development of low-loss variable-capacitance diodes. There are two reasons for this interest. One reason is the fact that such amplifiers have low noise and the other is that the diodes are expected to have extremely long life. Either one of these properties is adequate justification for the excitement currently rampant throughout the world concerning the exploitation of this "new" type of amplifier, but, with two good reasons readily apparent, this excitement is doubled.

Mystery seemed to invade the thoughts of people when the scientists announced this new type of amplifier which was called a variety of names, such as: "Parametric Amplifier," "Reactance Amplifier" and "MAVAR" (Modulator Amplifier by Variable Reactance).<sup>1</sup> Some of this mystery could have been avoided had the modern men known or mentioned that the principle underlying the mechanism whereby electrical amplification was effected was an old principle. This principle may be broadly stated thus: *The energy of an oscillating system may be increased by supplying energy at a frequency which differs from the fundamental frequency of the oscillator.* One mechanical illustration of this principle is the simple pendulum. The child in the swing learns that he can "pump up" the amplitude of the oscillation of the swing by lowering his center of gravity on the down swing and raising it on the up swing. He thus "pumps" at twice the frequency of the swing. Who knows when this was invented? Could it have been in prehistoric times by a monkey swinging by his tail from the branch of a tree?

Faraday, Melde and Lord Rayleigh have published observations and calculations concerning this principle. Quoting Lord Rayleigh, "Faraday, . . . with great ingenuity and success (upon examining) . . . the crispations upon the surface of water which oscillates vertically, arrived at the conclusion experimentally that

there were two complete vibrations of the support for each complete vibration of the liquid. Crispations (may be) observed upon the surface of liquid in a large wine glass or finger glass which is caused to vibrate in the usual manner by carrying the moistened finger round the circumference. All that is essential to the production of crispations is that the body of liquid with a free surface be constrained to execute a vertical vibration. Faraday's assertion that the waves have a period double that of the support has been disputed, but it may be verified in various ways." Faraday's work was published in 1831 and Lord Rayleigh verified his conclusions sixty years later, also with considerable ingenuity. The double period oscillation of the water is not readily proven by casual observation.

The following example of the principle, reported by Melde in 1859, is, however, readily observed and understood. Quoting again from Lord Rayleigh, "Perhaps the best known example is that form of Melde's experiment in which a fine string is maintained in transverse vibration by connecting one of its extremities with a vibrating prong of a massive tuning fork, *the direction of motion of the point of attachment being parallel to the length of the string.* Under these circumstances . . . the string may settle down into a permanent and vigorous vibration, whose period is the *double* of that of the fork." Lord Rayleigh analyzed and experimented with this and other similar mechanical phenomena in 1887. This led to analogous experiments with electrical circuits.

The electrical principle is readily understood by the following simple explanation. Suppose that we have a capacitor formed by two metal plates separated by air. Assume that a charge exists on the capacitor. The plates will be attracted to each other because of the equal and opposite charges so that to separate the plates requires work. Upon separating the plates, say to twice the original distance, the capacitance will be reduced to half its original value and, hence, the voltage must be twice the original value, since the charge upon the plates remains the same. The electrostatic energy, however, has been doubled, since it is proportional to the square of the voltage and directly proportional to the capacitance. The energy required to separate the plates now appears as electrostatic energy in the capacitor.

Now suppose that the capacitor is combined with an inductor to form an oscillating circuit. The voltage on the capacitor will reach a maximum value twice each cycle. Now if, on each half cycle, the capacitance is decreased when the voltage is maximum and increased when the voltage is zero, net energy will be imparted to the oscillations since no electrical energy is used to restore the capacitor to its original value when the voltage is zero.

\* Original manuscript received by the IRE, November 17, 1959; revised manuscript received, February 1, 1960.

† Bell Telephone Labs., Whippany, N. J.

<sup>1</sup> These three names are considered herein to be synonymous and to apply to any device which derives its gain from the pumping of a variable reactance.



Similarly, it is apparent that energy could be imparted to the circuit had the *inductance* been varied in the appropriate phase. This electrical principle was expanded to include frequencies other than the two-to-one ratio and the resulting device was used successfully in radio telephone communication between Berlin and Vienna prior to World War I. This was described by L. Kühn in 1915. Prof. J. Zenneck, E. F. W. Alexanderson and R. V. L. Hartley pioneered with theoretical and experimental contributions within the next few years. Alexanderson called these devices "Magnetic Amplifiers," a name which remains with us today. The objective then was to modulate a continuous wave arc transmitter by means of a nonlinear inductance or saturable reactance. Here the voice currents constituted the signal, and the carrier was the pump. The resulting sidebands were radiated, together with the pump (or its harmonic in some cases).

I quote the following from a paper delivered by E. F. W. Alexanderson at an IRE meeting in New York City on February 2, 1916:

The name "Magnetic Amplifier" has been given to a device for controlling the flow of radio frequency currents because this name seems to describe its function when it is used for radio telephony better than would any other. As the same device can be used for a variety of other purposes, the above name may in some cases not seem too appropriate. However, the essential part of the theory that will be given refers to the amount of amplification which is possible of attainment and the methods of securing a higher ratio of amplification than would be given by the device in its simplest form. . . .

The ratio of amplification is proportional to the ratio between the frequency of the radio current and that of the controlling current.

(This conclusion was verified by R. V. L. Hartley and subsequently by Manley and Rowe.)

Alexanderson, in the discussion, also suggested amplification of incoming signals by cascaded stages of up-conversion, rectification and up-conversion, etc. The name of Alexanderson's device withstood the rigors of time. Currently, however, we recognize its radio frequency version as a type of parametric amplifier, reactance amplifier, or MAVAR.

In Alexanderson's magnetic amplifier, the chief interest resided in the mode of operation in which the input signal was in the voice frequency band and the useful output power was taken in some radio frequency band. Thus it was a modulator or up-converter.

Alexanderson presented curves to show that negative resistance effects could exist. Quoting again from his 1916 paper: Under some conditions "instability and generation of self-excited oscillations" can exist. "This is a condition that must be avoided for telephone control; whereas it may have useful applications for other purposes." (One useful application, pointed out by Eugene Peterson in 1930, was the negative resistance straight-through amplifier, in which the negative resistance effect was enhanced by the suppression of frequencies higher than the pumping frequency.)

Louis Cohen, in a communicated discussion of the paper, said:

It appears to me that the fundamental principle . . . will find its application to other problems in connection with radio frequency circuits. One that suggests itself immediately is the amplification of incoming signals.

Alfred N. Goldsmith pointed out the advantages of Alexanderson's magnetic amplifier over the direct-current-controlled frequency doubler employed by Kühn.

Lee De Forest commented that the magnetic amplifier was far more practical as a high-power modulator than the ensemble of over 500 audion amplifiers used to obtain 11 kw at Arlington by the Western Electric Company. "No one can say, however, that the situation will not be altered very materially in one, two or three years after we learn how to build oscillations for large power outputs, say 5 or 10 kw each. That will create a very different situation."

Thus, there appears to be very old prior art on MAVAR, both as modulator and amplifier. However, the interest in magnetic amplifiers as radio frequency modulators subsided quickly with the advent of the high-power vacuum tube modulators. The "different situation" predicted by Lee De Forest in February, 1916, did, indeed, come to pass.

In the 1920's and '30's, interest developed in subharmonic oscillations in electrical circuits containing a variable reactance. These "parametric" oscillations could exist at any one of  $f/n$  frequencies, where  $n$  is the subharmonic fraction of the fundamental frequency. In 1954 Von Neumann and Goto independently recognized that a phase ambiguity existed in the subharmonic oscillations and that this ambiguity could be utilized in logic circuits. Goto calls this device a "parametron."

About thirty years after the pioneering work of Kühn, Zenneck, Alexanderson, and Hartley on inductive reactance modulators, interest developed in capacitance reactance modulators at microwave frequencies. The failure of reciprocity in some crystal converters observed in the middle 1940's by L. Apker of General Electric Co., Schenectady, N. Y., and R. N. Smith of Purdue University, Lafayette, Inc., and the peculiar behavior of welded contact germanium diodes made by H. Q. North of General Electric Co., Schenectady, N. Y., was interpreted to mean that the contact capacity varied with bias. H. C. Torrey of the Massachusetts Institute of Technology Radiation Laboratory, Cambridge, Mass., gave a thorough discussion of the theory of nonlinear capacity converters.

M. C. Waltz and R. V. Pound at the MIT Radiation Laboratory observed negative IF conductance when units like North's were used. Pound gave many interesting details about measured power and gain and also measured negative IF conductance. He obtained a 10-db gain and reasoned that such a receiver should have a better noise figure than that of a conventional converter which has conversion loss. He was unable, however, to achieve this.

In 1948, A. van der Ziel and, in 1949, V. D. Landon also derived the MAVAR gain relationships; the former also pointed out the low-noise figure possibilities.

In 1952, C. F. Edwards observed nonreciprocal behavior in converters when he used R. S. Ohl's bombarded silicon diodes which exhibited variable capacitance as well as variable resistance characteristics. This observation again triggered a sequence reminiscent of the North diode sequence of the 1940's in which Apker, Smith, Pound, and Waltz reported the experimental results and Torrey, van der Ziel, and Landon derived the theory. Corresponding names for the early 1950 sequence are Ohl, Edwards, Manley, and Rowe.

However, in neither of these sequences was a very low-loss variable capacitance diode available and hence the gain was limited and the noise figure was not especially good.

In 1954, the United States Signal Corps sponsored a project at Bell Telephone Laboratories, Murray Hill, N. J., to develop semiconductor devices. In the second interim report of this now famous "Task 8," A. E. Bakanowski published his derivation of the nonlinear capacitor as a mixer. The work of Bakanowski, Crauna and Uhlir led to the discovery of a technique for making low-loss units.

The technique of making low-loss silicon diode varactors or varicaps advanced rapidly and interest in these new units began to expand.

In the meantime, H. Suhl discovered that variable reactance in the microwave range was obtained in ferrite materials when properly excited by a pumping frequency. He proposed using this effect to obtain parametric amplification and discussed suitable materials in the paper published in 1957. M. T. Weiss verified Suhl's proposal experimentally.

M. E. Hines and H. E. Elder succeeded in demonstrating gain and oscillations in a reactance amplifier which used silicon varactors and suggested several microwave circuits for up-converters and negative resistance amplifiers. Their work stimulated activity in microwave applications of "varactor" diodes.<sup>2</sup>

In 1957, Heffner and Wade considered theoretically the noise, gain and bandwidth of parametric amplifiers.

Early in 1958, the low-noise properties predicted by theory were verified experimentally at the Bell Telephone Laboratories at 6000 mc by Uenohara and at 380 mc by Engelbrecht. Salzberg at Airborne Instruments Laboratory, Mineola, N. Y., and Heffner and Kotzebue at Stanford University, Stanford, Calif., also achieved low-noise performance working at 1 mc and 1200 mc, respectively.

Miyakawa in Japan, Cullen in England and Tien and Suhl in America considered the amplification and frequency conversion in propagating circuits in which the variable reactors were distributed along a transmission line while Bloom, Chang and Wittke of RCA Laboratories, Princeton, N. J., took up the theory of parametric amplification and discussed the new approaches to am-

plification of microwaves. Bloom and Chang also discussed the case of low frequency pumping.

R. S. Engelbrecht at Bell Telephone Laboratories designed a traveling wave UHF parametric amplifier using varactor diodes and achieved over 200-mc bandwidth at UHF with 8 to 10 gain. Measurements indicated an "astronomy" noise figure of one db, corresponding to a "radar" noise figure of about 3.5 db. (This compares favorably with the best commercially available vacuum tube, whose noise figure is about 5 db.)

In the meantime, Adler of Zenith, Chicago, Ill. (in June, 1957), suggested a novel principle of signal amplification using a pumped electron beam, and Bridges (in February, 1958) suggested and constructed a parametric amplifier using the variable reactance of a floating drift tube klystron. Louisell and Quate discussed the capabilities of this type of amplifier, and Adler demonstrated that the conclusions concerning the low-noise capabilities were indeed correct. He achieved a noise figure capability of 1.4 db, of which 0.4 db represented the loss in the input coupler.

The development of the vacuum tube in Alexander's time curtailed the interest in radio frequency parametric transducers. Thirty or so years later, the invention of the transistor then diminished the interest in vacuum tubes. But the interest in radio frequency parametric transducers was resurrected by the development of the low-noise variable capacitance diode, and this resurrection, in turn, has stimulated the interest in vacuum tubes as parametric transducers.

What is the next cycle in this see-saw pattern?

#### LIST OF SELECTED REFERENCES ON PARAMETRIC AMPLIFIERS (TO JULY, 1959)

1. M. Faraday, "On a peculiar class of acoustical figures; and on certain forms assumed by a group of particles upon vibrating elastic surfaces," *Phil. Trans. Roy. Soc., London*, vol. 121, pp. 299-318; May, 1831.
2. F. Melde, "Über erregung stehender Wellen eines fadenförmigen Körpers," *Ann. der Physik u. Chemie*, Ser. 2, vol. 109, pp. 193-215; month, 1859.
3. J. W. Strutt, Lord Rayleigh, "On the crispations of fluid resting upon a vibrating support," *Phil. Mag.*, vol. 16, pp. 50-53; July, 1883.
4. J. W. Strutt, Lord Rayleigh, "On the maintenance of vibrations by forces of double frequency, and on the propagation of waves through a medium endowed with a periodic structure," *Phil. Mag.*, ser. 5, vol. 24, issue 147, pp. 145-159; August, 1887.
5. J. W. Strutt, Lord Rayleigh, "Theory of Sound," Macmillan and Co., Ltd., London, England, 2nd edition, vol. I, 1894; vol. II, 1896.
6. R. Goldschmidt, "Reduction of hysteresis losses by high-frequency currents," *Elektrotech. Z.*, vol. 31, pp. 218-221; March, 1910.
7. L. Kühn, "Über ein neues radiotelephonische system," *Jahr. für dracht. Teleg. und Telephone*, vol. 9, pp. 502-534; June, 1915.
8. J. Zenneck, "A contribution to the theory of magnetic frequency doublers," presented at IRE meeting, New York, N. Y.; September, 1915.
9. E. F. W. Alexanderson, "A magnetic amplifier for radio telephony," *PROC. IRE*, vol. 4, pp. 101-149; April, 1916.
10. E. F. W. Alexanderson, U. S. Patent #1,206,643.
11. R. V. L. Hartley, U. S. Patent #1,287,982.
12. B. van der Pol, "On relaxation-oscillations," *Phil. Mag.*, ser. 7, vol. 2, pp. 987-992; November, 1926.
13. E. Peterson, "Atomic physics and circuit theory," *Bell Labs. Record*, vol. 7, pp. 231-233; February, 1929.

<sup>2</sup> It should be pointed out that, unknown to Hines and Elder, Kita and Fujii in Japan had been successful in demonstrating gain and oscillations at microwave frequencies independently while working with variable capacitance diodes in 1954.



14. R. V. L. Hartley, "A wave mechanism of quantum phenomena," *Phys. Rev.*, vol. 33, p. 289; February, 1929. (Abstract.)
15. E. Peterson, "Magnetic wave amplifying repeater," U. S. Patent #1,884,844. Filed March 30, 1929, issued October 25, 1932.
16. E. Peterson, "Magnetic Amplifier," U. S. Patent #1,884,845. Filed September 13, 1930, issued October 25, 1932.
17. W. R. Bennett, "New results in the calculation of modulation products," *Bell Syst. Tech. J.*, vol. 12, pp. 228-243; April, 1933.
18. B. van der Pol, "Nonlinear theory of electric oscillations," *Proc. IRE.*, vol. 22, pp. 1051-1086; September, 1934.
19. W. R. Bennett and R. M. Kalb, "Ferromagnetic distortion of a two-frequency wave," *Bell Syst. Tech. J.*, vol. 14, pp. 322-359; April, 1935.
20. L. Mandelstam, N. Papalexii, A. Andronov, S. Chaikin, and A. Witt, "Exposé des recherches récentes sur les oscillations non linéaires," *Tech. Phys. U.S.S.R.*, vol. 2, pp. 134; 1935.
21. G. Gorélik, "Phénomènes de résonance dans les systèmes linéaires a paramètres périodiques," *Tech. Phys. U.S.S.R.*, vol. 2, no. 2-3, pp. 135-180; 1935.
22. R. V. L. Hartley, "Oscillations in systems with non-linear reactance," *Bell Syst. Tech. J.*, vol. 15, pp. 424-440; July, 1936.
23. W. L. Barrow, D. B. Smith, and F. W. Baumann, "A further study of oscillatory circuits having periodically varying parameters," *J. Franklin Inst.*, vol. 221, pt. I, pp. 403-416; pt. II, pp. 509-529; March, 1936.
24. L. W. Hussey and L. R. Wrathall, "Oscillations in an electromagnetic system," *Bell Syst. Tech. J.*, vol. 15, pp. 441-445; July, 1936.
25. R. N. Smith, "The Theory of Mixers in Terms of Measurable Mixer Constants," NDRC Rept. No. 14-259, Purdue University, Lafayette, Ind.; March 24, 1944.
26. L. Apker, "Note on Reciprocity Failure in Crystal Mixers," NDRC Rept. No. 15-931-16, Contract OEMSR-931, General Electric Co.; March 9, 1945.
27. L. Apker, E. Taft, and J. Dickey, "Theory of a Double Mixer for Spectrum Analyzer Applications," NDRC Rept. No. 931-17, 15-931-16, General Electric Co.; April 2, 1945.
28. H. C. Torrey, "Theory of the Negative IF Conductance of North's Welded Contact Germanium Rectifiers," RL Rept. No. 55, Mass. Inst. Tech., Cambridge, Mass.; May 22, 1945.
29. N. Minorski, "On parametric excitation," *J. Franklin Inst.*, vol. 240, pp. 25-46; July, 1945.
30. L. C. Peterson and F. B. Llewellyn, "The performance and measurements of mixers in terms of linear network theory," *Proc. IRE.*, vol. 33, pp. 458-476; July, 1945.
31. H. Q. North, "Properties of welded contact germanium rectifiers," *J. Appl. Phys.*, vol. 19, pp. 912-923; November, 1946.
32. J. M. Manley and E. Peterson, "Negative resistance effects in saturable reactor circuits," *Trans. AIEE.*, vol. 65, pp. 870-881; December, 1946.
33. N. W. McLachlan, "Theory and Applications of Mathieu Functions," Oxford University Press, New York, N. Y., pp. 69-70, 274-275; 1947.
34. F. Rockett, "The electron art," *Electronics*, vol. 21, pp. 136-195; January, 1948.
35. H. C. Torrey and C. A. Whitmer, "Crystal Rectifiers," M.I.T. Rad. Lab. Ser., McGraw-Hill Book Co., Inc., New York, N. Y., vol. 15; 1948.
36. M. C. Waltz, "Negative i-f conduction," in "Crystal Rectifiers," H. C. Torrey and C. A. Whitmer, M.I.T. Rad. Lab. Ser., McGraw-Hill Book Co., Inc., New York, N. Y., vol. 15, p. 401; 1948.
37. R. V. Pound, "Microwave Mixers," M.I.T. Rad. Lab. Ser., McGraw-Hill Book Co., Inc., New York, N. Y., vol. 16; 1948.
38. A. van der Ziel, "On the mixing properties of nonlinear condensers," *J. Appl. Phys.*, vol. 19, pp. 999-1006; November, 1948.
39. C. L. Cuccia, "The electron coupler," *RCA Rev.*, vol. 10, pp. 270-33; June, 1949.
40. V. D. Landon, "The use of ferrite cored coils as converters, amplifiers and oscillators," *RCA Rev.*, vol. 10, pp. 387-396; September, 1949.
41. W. R. Bennett, "A general review of linear varying parameter and non-linear circuit analysis," *Proc. IRE.*, vol. 38, pp. 259-263; March, 1950.
42. J. M. Manley, "Some general properties of magnetic amplifiers," *Proc. IRE.*, vol. 39, pp. 242-251; March, 1951.
43. H. S. Tsien, "Engineering Cybernetics," McGraw-Hill Book Co., Inc., New York, N. Y.; 1954.
44. J. von Neumann, "Non-linear capacitance or inductance switching, amplifying and memory organs," U. S. Patent #2,815,488. Filed April 28, 1954, issued December, 1957.
45. D. Leenov, Bell Telephone Labs., Murray Hill, N. J., Interim Repts. on Task 8, Signal Corps Contract No. DA-36-039-s65589; 1954 to present.
46. S. Kita and T. Fujii, "Microwave amplification by use of crystal diode," ECL Internal Rept.; February, 1954. Annual Convention, Inst. of Elec. Commun. Engrs., Japan; October, 1954.
47. W. P. Mason and R. F. Wick, "Ferroelectrics and the dielectric amplifier," *Proc. IRE.*, vol. 42, pp. 1606-1620; November, 1954.
48. E. Goto, "New parametron circuit element using non-linear reactance," *Kokusai, Den. Den. Kenkyu Shiryo*; November, 1954.
49. A. E. Bakanowski, "The non-linear capacitor as a mixer," 2nd Interim Rept. on Task 8, Crystal Rectifiers, Signal Corps Project 2-7-323A; December 31, 1954.
50. R. J. Duffin, "Impossible behaviour of non-linear networks," *J. Appl. Phys.*, vol. 26, pp. 602-605; April, 1955.
51. E. Goto, "On the application of parametrically excited non-linear resonators," *J. Elec. Commun. Engrs., Japan*, vol. 38, pp. 770-775; October, 1955.
52. S. Oshima, Enomoto and Watanabe, "Oscillation theory of parametron and method of measuring non-linear elements," *Kokusai, Den. Den. Kenkyu Shiryo*; November, 1955.
53. A. van der Ziel, "Theory of shot noise in junction diodes and junction transistors," *Proc. IRE.*, vol. 43, pp. 1639-1646; November, 1955.
54. S. Oshima, "Introduction to parametron," *Denshi Kogyo*, vol. 4, p. 4; December, 1955.
55. S. Oshima, "General remarks on a parametron circuit," *Denshi Kogyo*, Special issue.
56. H. Yamada, "A parametron circuit examined from the point of mathematical logic," *Denshi Kogyo*, Special issue.
57. A. C. Macpherson, "An analysis of diode mixer consisting of non-linear capacitance and conductance and ohmic spreading resistance," NRL Rept. 4667; February 13, 1956.
58. L. J. Giacoletto and J. O'Connell, "A variable capacitance germanium diode for U.H.F.," *RCA Rev.*, March, 1956, also "Transistors I," RCA Lab., Princeton, N. J.; pp. 221-238.
59. F. Dill and L. Depian, "Semiconductor capacitance amplifier," 1956 IRE CONVENTION RECORD, pt. 3, pp. 172-174.
60. A. Uhlir, Jr., "High-frequency shot noise in p-n junctions," *Proc. IRE.*, vol. 44, 557-558; April, 1956.
61. M. Vadrjal, "Resonant dielectric amplifier," *Alta Frequenza*, vol. 25, pp. 211-232; June-August, 1956.
62. A. Uhlir, "Frequency conversion and computation with p-n junction devices," Sixth Interim Tech. Rept. on Task 8, Crystal Rectifiers, Signal Corps Contract No. DA-36-039sc-5589, ch. 1; June 15, 1956.
63. W. H. Higa, "Theory of non-linear coupling in a novel ferroelectric device," *J. Appl. Phys.*, vol. 27, pp. 775-777; July, 1956.
64. A. Uhlir, Jr., "Possible uses of non-linear capacitor diodes," Bell Telephone Labs., Eighth Interim Rept. on Task 8, Signal Corps Contract No. DA-36-039-565589; July 15, 1956.
65. J. M. Manley and H. E. Rowe, "Some general properties of non-linear elements—Part I. General energy relations," *Proc. IRE.*, vol. 44, pp. 904-913; July, 1956.
66. J. E. Pippin, "Frequency doubling and mixing in ferrites," *Proc. IRE.*, vol. 44, pp. 1054-1055; August, 1956.
67. A. Uhlir, Jr., "Two-terminal p-n junction devices for frequency conversion and computation," *Proc. IRE.*, vol. 44, pp. 1183-1192; September, 1956.
68. A. E. Bakanowski, "Small signal admittance measurements for a retarding field diode," Ninth Interim Tech. Rept. on Task 8, Crystal Rectifiers, Signal Corps Contract DA 36-039sc-5589, ch. 2; October 15, 1956.
69. H. Suhl, "The theory of ferromagnetic resonance at high signal powers," *J. Phys. Chem. Solids*, vol. 1, pp. 209-227; September /October, 1956.
70. H. Suhl, "The nonlinear behavior of ferrites at high microwave frequencies," *Proc. IRE.*, vol. 44, pp. 1270-1284; October, 1956.
71. H. Takahashi, "The Parametron," *Tsugakkai Shi*, vol. 39, p. 56; 1956.
72. C. F. Edwards, "Frequency conversion by means of a non-linear admittance," *Bell Syst. Tech. J.*, vol. 35, pp. 1403-1416; November, 1956.
73. A. C. Macpherson, "An analysis of the diode mixer consisting of nonlinear capacitance and conductance and ohmic spreading resistance," IRE TRANS. ON MICROWAVE THEORY AND TECHNIQUES, vol. MTT-5, pp. 43-51; January, 1957.
74. *Proc. Symp. on the Role of Solid State Phenomena in Electric Circuits*, J. Fox, Ed., Polytechnic Institute of Brooklyn, Brooklyn, N. Y.; 1957.
75. H. Suhl, "A proposal for a ferromagnetic amplifier in the microwave range," *Phys. Rev.*, vol. 106, pp. 384-385; April 15, 1957.
76. C. H. Page, "Frequency conversion with nonlinear resistance," *J. Res. NBS.*, vol. 58, pp. 227-236; May, 1957.
77. J. L. Melchor, W. P. Ayres, and P. H. Vartanian, "Microwave frequency doubling from 9 to 18 kmc in ferrites," *Proc. IRE.*, vol. 45, pp. 643-646; May, 1957.
78. J. J. Schäffer, "Theory of electrical networks with non-linear elements," *Arch. Elektrotech.*, vol. 43, pp. 151-168; May 20, 1957.
79. M. E. Hines, "Amplification with non-linear reactance modulators," presented at Electron Tube Res. Conf., University of California, Berkeley; June, 1957.

80. S. Duinker, "General properties of frequency converting networks," Dissertation, Tech. Univ. of Delft, The Netherlands; June, 1957.
81. R. Adler, "A new principle of signal amplification," presented at Electron Tube Res. Conf., University of California, Berkeley; June, 1957.
82. F. Paschke, "On non-linear behavior of electron-beam devices," *RCA Rev.*, vol. 18, pp. 221-242; June, 1957.
83. M. T. Weiss, "Solid state microwave amplifier and oscillator using ferrites," *Phys. Rev.*, vol. 107, p. 317; July 1, 1957.
84. R. W. DeGrasse and G. Wade, "Microwave mixing and frequency dividing," *Proc. IRE*, vol. 45, pp. 1013-1015; July, 1957.
85. A. E. Bakanowski, N. G. Crama, and A. Uhlir, Jr., "Diffused germanium and silicon non-linear capacitor diodes," presented at the IRE-AIEE Semiconductor Device Res. Conf., Boulder, Colo.; July, 1957.
86. M. T. Weiss, "Quantum derivation of energy relations analogous to those for nonlinear reactances," *Proc. IRE*, vol. 45, pp. 1012-1013; July, 1957.
87. L. J. Giacometto, "Junction capacitance and related characteristics using graded impurity semiconductors," *IRE TRANS. ON ELECTRON DEVICES*, vol. ED-4, pp. 207-214; July, 1957.
88. "New ferrite microwave amplifier," *Bell Labs. Record*, vol. 35, pp. 316-317; August, 1957.
89. A. Uhlir, Jr. and N. Bronstein, "Semiconductor diodes yield converter gain," *Bell Labs. Record*, vol. 35, p. 412; October, 1957.
90. B. Salzberg, "Masers and reactance amplifiers, basic power relations," *Proc. IRE*, vol. 45, pp. 1544-1545; November, 1957. Simple derivation of Manley Rowe relations.
91. H. Suhl, "Theory of the ferromagnetic amplifier," *J. Appl. Phys.*, vol. 28, pp. 1225-1236; November, 1957.
92. Y. Miyakawa, "Amplification and frequency conversion in propagation circuits," *Inst. Elec. Commun. Engrs., Japan, National Convention Record*, p. 8; November, 1957. (In Japanese.)
93. S. Bloom and K. K. N. Chang, "Theory of parametric amplification using nonlinear reactances," *RCA Rev.*, vol. 18, pp. 578-593; December, 1957.
94. J. P. Wittke, "New approaches to the amplification of microwaves," *RCA Rev.*, vol. 18, pp. 441-457; December, 1957.
95. E. O. Keizer, "A carrier-energized bistable circuit using variable capacitance diodes," *RCA Rev.*, pp. 475-485; December, 1957.
96. B. Lax, "Status of microwave applications of ferrites and semiconductors," *IRE TRANS. ON MICROWAVE THEORY AND TECHNIQUES*, vol. MTT-6, pp. 5-18; January, 1958.
97. "Varicap," *Radio Electronics*, vol. 29, p. 45; January, 1958.
98. L. Esaki, "New phenomenon in narrow germanium  $p-n$  junctions," *Phys. Rev.*, vol. 109, pp. 603-604; January 15, 1958.
99. S. Duinker, "General properties of frequency converting networks," *Phillips Res. Repts.*, vol. 13, pp. 37-78, February, 1958; pp. 101-148, April, 1958.
100. A. L. Cullen, "A travelling-wave parametric amplifier," *Nature*, vol. 181, p. 332; February 1, 1958.
101. T. J. Bridges, "An electron beam parametric amplifier," *Proc. IRE*, vol. 46, p. 494-495; February, 1958.
102. H. Krömer, "Proposed negative mass microwave amplifier," *Phys. Rev.*, vol. 109, p. 1856; March 1, 1958.
103. H. Suhl, "Origin and use of instabilities in ferromagnetic resonance," *J. Appl. Phys.*, vol. 29, pp. 416-421; March, 1958.
104. K. W. H. Stevens, "Amplification using a processing magnetic moment," *J. Electronics Control*, vol. 4, pp. 280-284; March, 1958.
105. C. L. Hogan, R. L. Jepsen, and P. H. Vartanian, "New type of ferromagnetic amplifier," *J. Appl. Phys.*, vol. 29, pp. 422-423; March, 1958.
106. S. Bloom and K. K. N. Chang, "Parametric amplification using low frequency pumping," *J. Appl. Phys.*, vol. 29, p. 594; March, 1958.
107. P. K. Tien and H. Suhl, "A traveling wave ferromagnetic amplifier," *Proc. IRE*, vol. 46, pp. 700-706; April, 1958.
108. W. H. Louisell and C. F. Quate, "Parametric amplification of space charge waves," *Proc. IRE*, vol. 46, pp. 707-716; April, 1958.
109. H. Heffner and G. Wade, "Noise, gain and bandwidth characteristics of the variable parameter amplifiers," presented at IRE PGED meeting, Washington, D. C.; October 31 to November 1, 1957. (Abstract, *IRE TRANS. ON ELECTRON DEVICES*, vol. ED-5, p. 112; April, 1958.)
110. H. E. Rowe, "Some general properties of nonlinear elements, II. Small signal theory," *Proc. IRE*, vol. 46, pp. 850-860; May, 1958.
111. H. Suhl, "Quantum analog of the ferromagnetic microwave amplifier," *J. Phys. Chem. Solids*, vol. 4, no. 4, pp. 278-282; 1958.
112. R. P. Turner, "Using the varicap," *Radio Electronics*, vol. 29, pp. 57-59; May, 1958.
113. G. G. Straube, "A voltage variable capacitor" (2 parts), *Electronic Inds.*, pp. 69-73, May, 1958; pp. 77-80, July, 1958.
114. R. S. Engelbrecht, "A low-noise non-linear reactance traveling wave amplifier," presented at Solid-State Devices Res. Conf., Columbus, Ohio; June 18, 1958.
115. G. G. Herrmann, M. Uenohara, and A. Uhlir, Jr., "Noise figure measurements on two types of variable reactance amplifiers using semiconductor diodes," *Proc. IRE*, vol. 46, pp. 1301-1303; June, 1958.
116. A. Uhlir, Jr., "The potential of semiconductor diodes in high-frequency communication," *Proc. IRE*, vol. 46, pp. 1099-1115; June, 1958.
117. B. Salzberg and E. W. Sard, "A low-noise wide-band reactance amplifier," *Proc. IRE*, vol. 46, p. 1303; June, 1958.
118. S. Kita, "A harmonic generator by use of the nonlinear capacitance of germanium diode," *Proc. IRE*, vol. 46, p. 1307; June, 1958.
119. R. Adler, "Parametric amplification of fast electron waves," *Proc. IRE*, vol. 46, pp. 1300-1301; June, 1958.
120. H. Heffner and K. Kotzebue, "Experimental characteristics of a microwave parametric amplifier using a semiconductor diode," *Proc. IRE*, vol. 46, p. 1301; June, 1958.
121. P. K. Tien, "Parametric Amplification and Frequency Mixing in Propagating Circuits," Sixteenth Annual Conf. on ET Res., Université Laval, Quebec, Canada, June 26, 1958.
122. C. B. Crumly, P. M. Fitzgerald, and G. Wade, "Multi-Tank Microwave Parametric Converters and Amplifiers," Sixteenth Annual Conf. on ET Res., Université Laval, Quebec, Canada, June 26, 1958.
123. A. Ashkin, "Parametric Amplification on Space Charge Waves," Sixteenth Annual Conf. on ET Res., Université Laval, Quebec, Canada; June 26, 1958.
124. K. K. N. Chang and S. Bloom, "Parametric amplifier using lower frequency pumping," *Proc. IRE*, vol. 46, pp. 1383-1386; July, 1958.
125. N. Minorsky, "On parametric excitation," *Compt. rend. Acad. Sci., Paris*, vol. 247, pp. 406-408; July 28, 1958.
126. "Low-noise amplifier for high frequencies uses new semiconductor diodes," *Bell Labs. Record*, vol. 36, pp. 250-251; July, 1958.
127. L. D. Buchmiller and G. Wade, "Pumping to extend traveling-wave-tube frequency range," *Proc. IRE*, vol. 46, pp. 1420-1421; July, 1958.
128. D. Leenov, "Gain and noise figure of a variable capacitance up converter," *Bell Syst. Tech. J.*, vol. 37, pp. 989-1008; July, 1958.
129. R. E. Beam, "Report on advances in microwave theory and techniques," *IRE TRANS. ON MICROWAVE THEORY AND TECHNIQUES*, vol. MTT-6, pp. 251-263; July, 1958.
130. A. Uhlir, Jr., "Shot noise in  $p-n$  junction frequency converters," *Bell Syst. Tech. J.*, vol. 37, pp. 951-987; July, 1958.
131. K. M. Poole and P. K. Tien, "A ferromagnetic resonance frequency converter," *Proc. IRE*, vol. 46, pp. 1387-1396; July, 1958.
132. A. D. Berk, L. Kleinman, and C. E. Nelson, "Modified semi-static ferrite amplifier," 1958 WESCON CONVENTION RECORD, pt. 3, pp. 9-13.
133. L. B. Valdes, "Circuit conditions for parametric amplification," *J. Electronics Control*, vol. 5, pp. 129-141; August, 1958.
134. H. Heffner and G. Wade, "Minimum noise figure of a parametric amplifier," *J. Appl. Phys.*, vol. 29, p. 1262; August, 1958.
135. A. Ashkin, T. J. Bridges, W. H. Louisell, and C. F. Quate, "Parametric electron beam amplifiers," 1958 WESCON CONVENTION RECORD, pt. 3, pp. 13-17.
136. H. Heffner, "Masers and parametric amplifiers," 1958 WESCON CONVENTION RECORD, pt. 3, pp. 3-9.
137. K. K. N. Chang and S. Bloom, "A parametric amplifier using low frequency pumping," 1958 WESCON CONVENTION RECORD, pt. 3, pp. 23-27.
138. M. E. McMahon and G. F. Straube, "Voltage sensitive semiconductor capacitors," 1958 WESCON CONVENTION RECORD, pt. 3, pp. 72-82.
139. R. S. Engelbrecht, "A low noise nonlinear reactance traveling wave amplifier," *Proc. IRE*, vol. 46, p. 1655; September, 1958.
140. P. K. Tien, "Parametric amplification and frequency mixing in propagating circuits," *J. Appl. Phys.*, vol. 29, pp. 1347-1357; September, 1958.
141. H. Heffner and G. Wade, "Gain, bandwidth and noise characteristics of the variable parameter amplifier," *J. Appl. Phys.*, vol. 29, pp. 1321-1331; September, 1958.
142. S. Weber, "The Maver: A low noise microwave amplifier," *Electronics*, vol. 31, pp. 65-71; September 26, 1958.
143. W. L. Whirry and F. B. Wang, "Phase dependence of a ferromagnetic amplifier," *Proc. IRE*, vol. 46, pp. 1657-1658; September, 1958.
144. R. Gardner, J. C. Greene, P. P. Lombardo, and E. W. Sard,



- "Application of semiconductor diodes to microwave low-noise amplifiers and harmonic generators," 1) Rept. 4589-M-1 Cont. AF30(602)-1854, September, 1958 (RADC, Rome); 2) Rept. 5872-1-1 Cont. 36-039-sd-78161 DA Project 3-99-15-106, October 15, 1958 (U. S. Army Signal Engrg. Lab.).
145. H. Suhl, "The ferromagnetic microwave amplifier," *Physics Today*, vol. 11, pp. 28-30; September, 1958.
  146. S. Muroga, "Elementary principles of Parametron and its application to digital computers," *Otomation*, vol. 4, pp. 31-34; September/October, 1958.
  147. S. Saito, "A new method of measuring the noise parameters of an electron beam," IRE TRANS. ON ELECTRON DEVICES, vol. ED-5, pp. 264-275; October, 1958.
  148. R. Adler, G. Hrbek, and G. Wade, "A low-noise electron beam parametric amplifier," PROC. IRE, vol. 46, pp. 1756-1757; October, 1958.
  149. H. A. Haus, "The kinetic power theorem for parametric, longitudinal electron-beam amplifiers," IRE TRANS. ON ELECTRON DEVICES, vol. ED-5, pp. 225-232; October, 1958.
  150. S. Saito, "Parametric amplification of space charge waves on a thin electron beam," *J. Inst. Elec. Engrs. Japan*, vol. 41, pp. 1113-1120; November, 1958.
  151. Microwave Parametric Device Lecture Series, IRE PGED and PGMFTT, San Francisco, Calif.; October 15, 22, 29, and November 5, 12, 19, 1958.
  152. B. Salzberg, "General characteristics of nonlinear energy storage elements," presented at Microwave Parametric Device Lecture Series, IRE PGED and PGMFTT, San Francisco, Calif.; October 15, 1958. Résumé by B. Fank in *Grid*, vol. 5, pp. 16-18; November, 1958.
  153. K. Kotzebue, "Large signal properties of parametric amplifiers," presented at Microwave Parametric Device Lecture Series, IRE PGED and PGMFTT, San Francisco, Calif.; October 29, 1958. Résumé by B. Fank, *Grid*, vol. 5, pp. 18-20; November, 1958.
  154. H. Helfner, "Back-biased diode parametric amplifiers," presented at Microwave Parametric Device Lecture Series, IRE PGED and PGMFTT, San Francisco, Calif.; October 22, 1958. Résumé by K. Hunton, *Grid*, vol. 5, p. 18; November, 1958.
  155. J. Gibbons, "The characteristics of back-biased diodes," presented at Microwave Parametric Device Lecture Series, IRE PGED and PGMFTT, San Francisco, Calif.; November 5, 1958. Résumé by K. Hunton, *Grid*, vol. 5, pp. 16-18; December, 1958.
  156. P. H. Vartanian, "Ferromagnetic parametric amplifiers," presented at Microwave Parametric Device Lecture Series, IRE PGED and PGMFTT, San Francisco, Calif.; November 12, 1958. Résumé by B. Fank, *Grid*, vol. 5, pp. 18-24; December, 1958.
  157. R. Adler, "Beam type parametric amplifiers," presented at Microwave Parametric Device Lecture Series, IRE PGED and PGMFTT, San Francisco, Calif.; November 19, 1958. Résumé by B. Fank, *Grid*, vol. 5, pp. 24-26; December, 1958.
  158. Electrons at Work, "Parametric amplifier increases scatter range," *Electronics*, vol. 31, p. 96; November 7, 1958.
  159. F. S. Harris, "The parametric amplifier," *CQ*, vol. 14, p. 74, *et seq.*; November, 1958.
  160. R. Bateman and W. F. Bain, "New thresholds in VHF and UHF reception, the world below KTB," *QST*, vol. 42, p. 30, *et seq.*; December, 1958.
  161. R. H. Pantell, "General power relationships for positive and negative nonlinear resistive elements," PROC. IRE, vol. 46, pp. 1910-1913; December, 1958.
  162. A. Ashkin, "Parametric amplification of space-charge waves," *J. Appl. Phys.*, vol. 29, pp. 1646-1651; December, 1958.
  163. W. E. Danielson, "Low noise in solid state parametric amplifiers at microwave frequencies," *J. Appl. Phys.*, vol. 30, pp. 8-16; January, 1959.
  164. W. G. Matthei, "Recent advances in solid state receivers," *Microwave J.*, vol. 2, pp. 19-24; January, 1959.
  165. B. Lax, "Microwaves and the solid state," *Microwave J.*, vol. 2, p. 5; January, 1959.
  166. F. A. Brand, W. G. Matthei, and T. Saad, "A low-noise semiconductor diode microwave amplifier," PROC. IRE, vol. 47, pp. 42-44; January, 1959.
  167. B. Oguchi, S. Kita, N. Inage, and T. Okajima, "Microwave parametric amplifier by means of germanium diode," PROC. IRE, vol. 47, pp. 77-78; January, 1959.
  168. H. Helfner, "Solid-state microwave amplifier," IRE TRANS. ON MICROWAVE THEORY AND TECHNIQUES, vol. MTT-7, pp. 83-91; January, 1959.
  169. R. S. Engelbrecht and W. W. Mumford, "Some data on the performance of MAVARS," presented at the IRE PGMFTT meeting, San Francisco, Calif.; January 20, 1959.
  170. G. Wade and R. Adler, "A new method for pumping a fast space-charge wave," PROC. IRE, vol. 47, pp. 79-80; January, 1959.
  171. K. K. N. Chang, "Four terminal parametric amplifiers," PROC. IRE, vol. 47, pp. 81-82; January, 1959.
  172. R. Bateman and W. F. Bain, "New thresholds in VHF and UHF reception devices and diodes," *QST*, vol. 43, p. 11, *et seq.*; January, 1959.
  173. K. Kurokawa and J. Hamasaki, "Theoretical analysis of periodic structures for parametric amplifiers," Rept. of Microwave Transmission Res. Committee of Japan, January, 1959. (In Japanese.) See "Mode theory of lossless periodically distributed parametric amplifiers," IRE TRANS. ON MICROWAVE THEORY AND TECHNIQUE, vol. MTT-7, pp. 360-365; July, 1959.
  174. A. Uhlir, Jr., "Amplification by non-linear reactance," Digest of Technical Papers, 1959 Solid-State Circuits Conf., Philadelphia, Pa.; February 12, 1959.
  175. P. P. Lombardo, "Low-noise 400 mc reactance amplifier," Digest of Technical Papers, 1959 Solid-State Circuits Conf., Philadelphia, Pa.; February 12, 1959.
  176. R. S. Engelbrecht, "Non-linear-reactance (Parametric) traveling wave amplifiers for U.H.F.," Digest of Technical Papers, 1959 Solid-State Circuits Conf., Philadelphia, Pa.; February 12, 1959.
  177. K. L. Kotzebue, "Large-signal characteristics of three-frequency cavity parametric amplifiers," Digest of Papers, 1959 Solid-State Circuits Conf., Philadelphia, Pa.; February 12, 1959.
  178. Hsu Hsiung, "Multiple frequency parametric devices," Digest of Technical Papers, 1959 Solid-State Circuits Conf., Philadelphia, Pa.; February 12, 1959.
  179. R. Bateman and W. F. Bain, "New thresholds in VHF and UHF reception—circuit theory and diode details," *QST*, vol. 43, pp. 28-35; February, 1959.
  180. F. Shumann, "The variable reactance amplifier," *Radio Electronics*, vol. 30, pp. 78-82; February, 1959.
  181. L. B. Valdes, "Proposed microwave mixer diode of improved conversion efficiency," *J. Appl. Phys.*, vol. 30, pp. 436-440; March, 1959.
  182. H. Krömer, "The physical principles of a negative-mass amplifier," PROC. IRE, vol. 47, pp. 397-406; March, 1959.
  183. L. S. Nergaard, "Nonlinear capacitance amplifiers," *RCA Rev.*, vol. 20, pp. 3-17; March, 1959.
  184. J. Sie and S. Weisbaum, "Noise figure of receiving systems using parametric amplifiers," 1959 IRE NATIONAL CONVENTION RECORD, pt. 3, pp. 141-158.
  185. T. B. Warren, "Low noise parametric amplifiers and converters," 1959 IRE NATIONAL CONVENTION RECORD, pt. 3, pp. 158-159.
  186. R. Bateman and W. F. Bain, "New thresholds in VHF and UHF reception, practical results," *QST*, vol. 43, pp. 35-39; March, 1959.
  187. H. Helfner, "Masers and parametric amplifiers," *Microwave J.*, vol. 2, pp. 33-38; March, 1959.
  188. R. L. Wightton, "A new concept in computing," PROC. IRE, vol. 47, pp. 516-523; April, 1959.
  189. E. D. Reed, "The variable-capacitance parametric amplifier," IRE TRANS. ON ELECTRONIC DEVICES, vol. ED-6, pp. 216-225; April, 1959.
  190. E. W. Sard, "Analysis of a negative conductance amplifier operated with a non-ideal circulator," IRE TRANS. ON MICROWAVE THEORY AND TECHNIQUES, vol. MTT-7, pp. 288-294; April, 1959.
  191. F. A. Olson, C. P. Wang, and G. Wade, "Parametric devices tested for distortionless limiting," PROC. IRE, vol. 47, pp. 587-588; April, 1959.
  192. R. D. Haun, Jr. and T. A. Osial, "Gain measurements on a pulsed ferromagnetic amplifier," PROC. IRE, vol. 47, pp. 586-587; April, 1959.
  193. R. C. Kuechli and R. D. Weglein, "Low-noise parametric amplifiers," PROC. IRE, vol. 47, pp. 584-585; April, 1959.
  194. L. U. Kibler, "Directional bridge parametric amplifier," PROC. IRE, vol. 47, pp. 583-584; April, 1959.
  195. P. P. Lombardo and E. W. Sard, "Low frequency prototype traveling-wave reactance amplifier," PROC. IRE, vol. 47, pp. 995-996; May, 1959.
  196. J. J. Younger, A. G. Little, H. Helfner, and G. Wade, "Parametric amplifiers as superregenerative detectors," PROC. IRE, vol. 47, pp. 1271-1272; July, 1959.
  197. H. S. Sommers, Jr., "Tunnel diodes as high-frequency devices," PROC. IRE, vol. 47, pp. 1201-1206; July, 1959.
  198. G. M. Roe and M. R. Boyce, "Parametric energy conversion in distributed systems," PROC. IRE, vol. 47, pp. 1213-1218; July, 1959.
  199. B. B. Bossard, "Superregenerative reactance amplifier," PROC. IRE, vol. 47, pp. 1269-1271; July, 1959.
  200. K. K. N. Chang, "Low-noise tunnel diode amplifier," PROC. IRE, vol. 47, pp. 1268-1269; July, 1959.

# Low-Noise Tunnel-Diode Down Converter Having Conversion Gain\*

K. K. N. CHANG†, G. H. HEILMEIER†, STUDENT MEMBER, IRE, AND H. J. PRAGER†

**Summary**—This paper describes the use of the new tunnel diode in a down converter. An experimental UHF circuit converting from a signal frequency of 210 mc to an intermediate frequency of 30 mc is used to illustrate the feasibility of this new converter. Conversion power gain of 22 db with less than 3 db noise has been achieved with gallium arsenide diodes. The circuit analysis proceeds from the basic nonlinear resistance of the tunnel diode I-V characteristic. Equations are developed for conversion gain, bandwidth and noise figure. From these equations, criteria are derived for the choice of diode characteristics and circuit parameters to obtain optimum performance.

## INTRODUCTION

THE low-noise, high-gain, conversion of a high-frequency signal to a lower-frequency signal has not been possible with previous mixer devices. Ordinary crystal mixers, which make use of the nonlinearity of their positive resistance, exhibit a conversion loss and a poor noise factor. The recently introduced parametric converters, which operate on a nonlinear capacitance or inductance basis, have achieved good noise factors with *up-conversion* gain. The parametric *down converters*, however, have poor noise factors. For such down converters, it is found that the excess noise factor (*i.e.*, the noise factor minus unity) varies roughly as the ratio of the input frequency to the output frequency. Thus, for a ten-to-one frequency down-conversion, the noise factor is around 10 db. Because of this frequency dependence, it is almost impossible to convert a microwave frequency into a low intermediate frequency with a reasonable noise factor by parametric converters.

The purpose of this paper is to report on a down converter using a tunnel diode (Esaki diode<sup>1,2</sup>) as the nonlinear resistance element. The fact that the negative resistance characteristic of a tunnel diode can be utilized to achieve low-noise amplification has already been demonstrated.<sup>3</sup> It is now shown that the nonlinearity of this negative resistance characteristic can be used for frequency conversion. Since the nonlinearity of a resistance, *not* a reactance, is utilized for frequency conversion, the noise factor is independent of the ratio of the input frequency to the output frequency. Thus, by using a tunnel diode, a low-noise down converter with conversion gain has been achieved.

\* Original manuscript received by the IRE, December 14, 1959; revised manuscript received, February 16, 1960. This research was sponsored in part by the Electronic Res. Directorate, AF Cambridge Res. Center, under Contract AF 19-(604)-4980.

† RCA Laboratories, Princeton, N. J.

<sup>1</sup> L. Esaki, "New phenomenon in narrow Ge *p-n* junctions," *Phys. Rev.*, vol. 109, p. 603 (1.); 1958.

<sup>2</sup> H. S. Sommers, Jr., "Tunnel diodes as high-frequency devices," *Proc. IRE*, vol. 47, pp. 1201-1206; July, 1959.

<sup>3</sup> K. K. N. Chang, "Low-noise tunnel diode amplifier," *Proc. IRE*, vol. 47, pp. 1268-1269; July, 1959.

## ANALYSIS

The converter circuit to be analyzed is shown in Fig. 1, which also establishes the notation to be used in the following analysis. The three tank circuits which resonate at  $\omega_1$ , the input signal frequency;  $\omega_2$ , the difference frequency; and  $\omega_3 = \omega_1 + \omega_2$ , the local oscillator frequency, are coupled together by the tunnel diode.

The analysis proceeds in a manner entirely similar to that for the small signal nonlinear reactance case.<sup>4</sup> The I-V characteristic of the tunnel diode (Fig. 2) at the operating point *P* can be represented by a quadratic relation:

$$I = G_0 V - \mathcal{G} V^2. \quad (1)$$

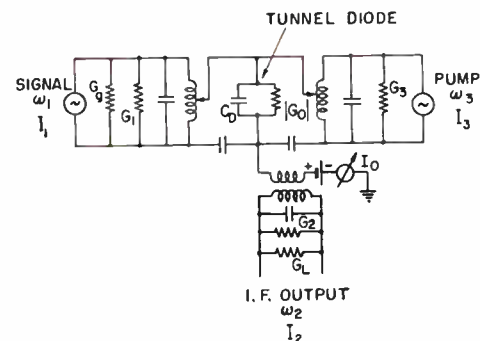

Fig. 1—Schematic diagram of converter circuit.

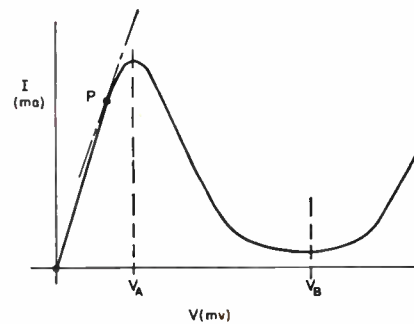

Fig. 2—Tunnel-diode I-V characteristic.

An operating point in the positive resistance region is chosen for reasons to be discussed later. The currents at the three frequencies are:

$$\begin{aligned} I_1 &= V_1(\bar{G}_1 + j\bar{B}_1) - \mathcal{G} V_2^* V_3 \\ I_2 &= V_2(\bar{G}_2 + j\bar{B}_2) - \mathcal{G} V_1^* V_3 \\ I_3 &= V_3(\bar{G}_3) - \mathcal{G} V_1 V_2 \end{aligned} \quad (2)$$

<sup>4</sup> S. Bloom and K. K. N. Chang, "Theory of parametric amplification using nonlinear reactances," *RCA Rev.*, vol. 18, pp. 578-593; December, 1957.



where

$$\begin{aligned} \bar{G}_1 &= G_1 + G_\theta + G_0 \\ \bar{G}_2 &= G_2 + G_L + G_0 \\ \bar{G}_3 &= G_3 + G_0 \\ \bar{B}_1 &= \omega_1 C_1 \left( \frac{\omega}{\omega_1} - \frac{\omega_1}{\omega} \right) \\ \bar{B}_2 &= \omega_2 C_2 \left( \frac{\omega_3 - \omega}{\omega_2} - \frac{\omega_2}{\omega_3 - \omega} \right). \end{aligned} \quad (3)$$

The small signal analysis neglects the effect of the non-linear interaction on the local oscillator current. Hence,  $\mathcal{G}V_1V_2$  is neglected in the third equation of (2).

In (3),  $G_1$ ,  $G_2$  and  $G_3$  are the loss conductances of the respective circuits. These loss conductances consist of the circuit and the tunnel diode ohmic losses. The capacitances,  $C_1$  and  $C_2$ , similarly consist of the circuit and tunnel diode capacitance,  $C_D$ .

### A. Conversion Power Gain

The conversion power ratio under matched conditions is defined as

$$g_c = \frac{V_2^2 G_L}{I_1^2} \cdot \frac{1}{4G_\theta} \quad (4)$$

Solving (2), one obtains

$$g_c = \frac{4\mathcal{G}^2 V_3^2 G_\theta G_L}{[\bar{G}_1 \bar{G}_2 - \mathcal{G}^2 V_3^2]^2} \quad (5)$$

Eq. (5) is a general expression for the conversion power ratio. When  $G_\theta$  is positive, the ratio can be either greater or less than unity, depending on the I-V characteristic of the nonlinear conductance. In order to obtain a conversion gain (i.e.,  $\sqrt{g_c} > 1$ ) with a positive  $G_\theta$ , it follows from (5) that

$$\sqrt{g_c} = \frac{2 \frac{\mathcal{G}V_3}{G_\theta}}{\frac{1}{\sqrt{G_\theta G_L}} \left\{ \frac{(G_\theta + G_1)(G_L + G_2)}{G_0} + G_1 + G_2 + G_0 \left( 1 - \frac{\mathcal{G}^2 V_3^2}{G_0^2} \right) \right\} + \sqrt{\frac{G_L}{G_\theta}} + \sqrt{\frac{G_\theta}{G_L}}} > 1. \quad (6)$$

Since

$$\sqrt{\frac{G_L}{G_\theta}} + \sqrt{\frac{G_\theta}{G_L}} > 2 \quad (7)$$

when  $G_\theta$  is positive, (6) is satisfied if

$$\frac{\mathcal{G}V_3}{G_0} > 1. \quad (8)$$

Eq. (8) is the necessary condition for gain. This equation shows, together with (1), that the I-V characteristic whose origin is at the operating point (such as  $P$

in Fig. 2) must exhibit a maximum value, and that the local oscillator voltage  $V_3$  must be sufficiently large so that it swings the current below the value of the current at the operating point. In the case of an ordinary crystal detector, the I-V characteristic exhibits no such maximum and (1) and (8) can never be satisfied simultaneously. It is important to note that (8) can be satisfied when the operating point is chosen in the region where  $V < V_A$  and where  $G_\theta$  is positive.

For the region  $V > V_B$ , (8) still applies. In this region, however, the diode current is due to minority carriers and so it is probably not suitable for high frequency conversion.

For the region  $V_A < V < V_B$ , the  $G_\theta$  is negative and stable biasing becomes critical. It is difficult to find a stable operating point without having the device break into spurious oscillations, because of the large voltage swing of the local oscillator.

In order to normalize the conversion power ratio (5), let:

$$\lambda = \frac{\mathcal{G}^2 V_3^2}{\bar{G}_1 \bar{G}_2} \quad (9)$$

$$Q_\theta = \frac{\omega_1 C_1}{G_\theta} \quad (10)$$

$$Q_L = \frac{\omega_2 C_2}{G_L} \quad (11)$$

$$\bar{Q}_1 = \frac{\omega_1 C_1}{\bar{G}_1} \quad (12)$$

$$\bar{Q}_2 = \frac{\omega_2 C_2}{\bar{G}_2} \quad (13)$$

$$\bar{g}_c = \left( \frac{Q_\theta}{\bar{Q}_1} \frac{Q_L}{\bar{Q}_2} \right) g_c. \quad (14)$$

Eq. (5) then becomes

$$\bar{g}_c = \frac{4\lambda}{(1 - \lambda)^2} \quad (15)$$

### B. Bandwidth

Assuming that the half-power frequencies are near the resonant frequency, the following approximation can be made:

$$\bar{B}_1 = \omega_1 C_1 \left( \frac{\omega}{\omega_1} - \frac{\omega_1}{\omega} \right) \doteq 2(\omega - \omega_1) C_1 \quad (16)$$

$$\bar{B}_2 = \omega_2 C_2 \left( \frac{\omega_3 - \omega}{\omega_2} - \frac{\omega_2}{\omega_3 - \omega} \right) \doteq 2(\omega_1 - \omega)C_2. \quad (17)$$

By defining the relative bandwidth as  $B_1 = \Delta f_1/f_1$  and defining

$$S_1 = 2\bar{Q}_1 B_1 \quad (18)$$

and

$$c = \frac{\bar{Q}_2 \omega_1}{\bar{Q}_1 \omega_2}, \quad (19)$$

one obtains

$$S_1^2 = \frac{[2c(1 - \lambda) - (1 + c)^2] + \sqrt{[2c(1 - \lambda) - (1 + c)^2]^2 + 4c^2(1 - \lambda)^2}}{2c^2}. \quad (20)$$

Eq. (2) can then be written as:

$$\begin{aligned} |g_1|^2 &= |V_1 \bar{G}_1 - g V_2^* V_3|^2 \\ |g_2|^2 &= |V_2 \bar{G}_2 - g V_1^* V_3|^2 \\ |I_3|^2 &= |V_3 \bar{G}_3 - g V_1 V_2|^2. \end{aligned} \quad (24)$$

From the definition for the noise figure, one obtains

$$F = \frac{P_{in}}{P_{out}} \frac{N_{out}}{N_{in}} = \frac{1}{g_c} N_{out} \frac{1}{kT_0 \Delta f} = \frac{|V_2|^2 G_L}{g_c kT_0 \Delta f}. \quad (25)$$

After solving (24) for  $|V_2|^2$  and substituting, (25) becomes

$$F = 1 + \frac{T}{T_0} \left[ \frac{G_e}{G_\theta} + \frac{G_1}{G_\theta} + \frac{(G_L + G_2 + G_e) \bar{G}_1}{G_\theta \bar{G}_2} \frac{1}{1 - \frac{2(\sqrt{1 + \bar{g}_c} - 1)}{\bar{g}_c}} \right]. \quad (26)$$

For the case of high gain, *i.e.*,  $\lambda \doteq 1$ , (20) becomes

$$S_1 \doteq \frac{1 - \lambda}{1 + c} \doteq \frac{1}{1 + c} \frac{2[\sqrt{1 + \bar{g}_c} - 1]}{\bar{g}_c} \quad (21)$$

and the voltage gain-bandwidth product is

$$\sqrt{\bar{g}_c} B_1 \doteq \frac{1}{1 + c} \frac{1}{\bar{Q}_1}. \quad (22)$$

*C. Noise Figure*

The noise figure can be found by considering the currents in (2) to be due to the thermal noise sources of the circuits:

$$\begin{aligned} |g_1|^2 &= 4k\Delta f(G_\theta T_0 + G_1 T + G_e T) \\ |g_2|^2 &= 4k\Delta f(G_L T + G_2 T + G_e T) \end{aligned} \quad (23)$$

where

- $k$  = Boltzmann's constant,
- $T_0$  = reference temperature (290°K),
- $T$  = ambient temperature,
- $G_e$  = equivalent shot noise conductance of the tunnel diode,
- $G_e = eI_0/2kT$ ,  $I_0$  = dc current of the tunnel diode, and
- $|g|$  = equivalent noise currents.

EXPERIMENTAL RESULTS

An experimental circuit based on Fig. 1 and using coaxial lines has been built. The operating frequencies were  $f_1=210$  mc,  $f_2=30$  mc, and  $f_3=240$  mc. Representative results are shown in Table I, and compared with computed values.

Figs. 3 and 4 show typical curves of the I-V characteristic of the germanium and gallium arsenide tunnel diodes that were used in the experiments in Table I. The germanium diode had a peak current of 35 ma at 62 mv; its operating point was chosen at 18 ma and 29 mv yielding a positive  $G_0=0.42$  mho. The gallium arsenide diode had a peak current of 23.6 ma at 100 mv; the operating point was at 20 ma and 60 mv with a positive  $G_0=0.20$  mho.

To complete the calculations according to (15), (22), and (26), it is necessary to know the values of certain circuit parameters. For the case of the experimental circuit of Fig. 1, the following values were measured. The values of  $\lambda$  were chosen to give agreement with measured gain ratios.

Germanium Diodes:  $\lambda=0.43$   $c=0.1$   $\bar{Q}_1=100$   $G_\theta = G_L = 4$  mhos  $G_1 \doteq G_2 \doteq 0$   $G_e \doteq 20I_0 \doteq 0.36$  mho:  $G_0=0.42$  mho.

Gallium Arsenide:  $\lambda=0.88$   $c=0.1$   $\bar{Q}_1=100$   $G_\theta = G_L = 4$  mhos  $G_1 \doteq G_2 \doteq 0$   $G_e = 0.40$  mho  $G_0 = 0.21$  mhos.



TABLE I

Diode	Power Gain		Bandwidth		Noise Figure		Sensitivity
	Measured	Computed	Measured	Computed	Measured	Computed	Measured
Germanium	6.0 db	6.0 db	0.9 mc	0.6 mc	5.2 db	4.4 db	1.5 $\mu$ v
Gallium arsenide*	22.7 db	22.7 db	0.15 mc	0.26 mc	2.8 db	3.8 db	0.25 $\mu$ v

\* The gallium-arsenide diode is an experimental sample developed by A. Wheeler of the Advanced Development Group of RCA Semiconductor Division, Somerville, N. J.

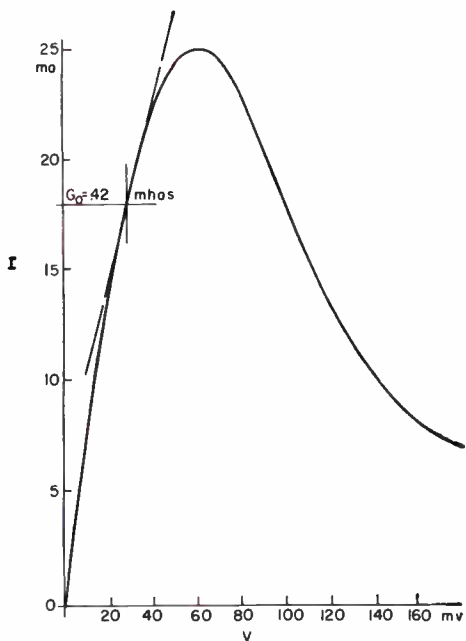

Fig. 3—Germanium tunnel diode.

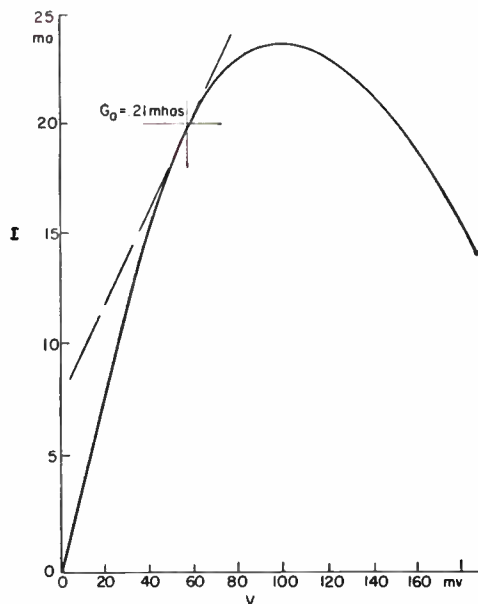

Fig. 4—Gallium arsenide tunnel diode.

DISCUSSION

It is noted from Figs. 3 and 4 that the operating points for the diodes were chosen at a region where the slope of the I-V characteristic is positive. These operating points were established by the initial dc current from the bias supply and the rectified RF current of the local oscillator.

Conversion gain will result for positive  $G_0$  when the requirements of (1) and (8) are met simultaneously (see Fig. 5).  $G_3$  will be larger than  $G_0$  when the RF voltage swing of the local oscillator is large enough to drive across the peak of the I-V curve and into the negative slope region until the instantaneous values of the current are smaller than the dc current at the operating point.

However, any appreciable voltage swing into the negative slope portion will make the system unstable, particularly when the negative slope is very steep. For this reason, it is more difficult to obtain high gain with germanium diodes, where the negative slope is much steeper, than for gallium arsenide. Had it not been for this stability problem, the germanium diodes would have yielded the same low-noise figure as the gallium arsenide diodes.

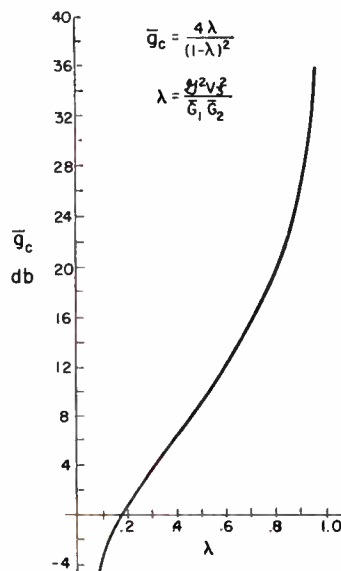

Fig. 5—"Normalized" conversion power ratio.

Further consideration of (22) and (26) will show the theoretical approach to optimum bandwidth and noise figure (Figs. 6 and 7). For improved bandwidth, the parameter  $c$  should be made small and the circuit's  $Q$  values should also be made small. Since  $\bar{Q}_1 = \omega_1 C_1 / \bar{G}_1$ , this immediately suggests that the circuit capacitances and

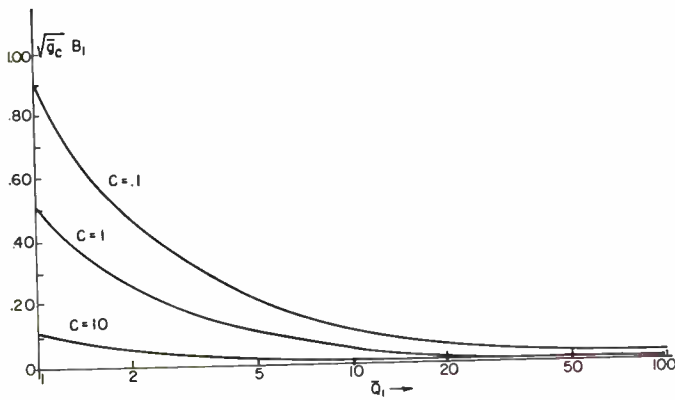

Fig. 6—Gain times bandwidth vs circuit  $Q$  for various

$$C = \frac{Q_2 \omega_1}{Q_1 \omega_2}$$

especially the diode capacitance  $C_D$  should be made as small as possible. For a similar reason,  $G_\theta$  should be made larger than  $G_r$  to yield a low-noise figure.

The possibility of obtaining conversion using a lower pump frequency is to be noted. In this case, the non-linearity of the diode characteristic could be used to produce the desired harmonic of the lower pump frequency for mixing. It is also noted that the possibility of making the diode-pump circuit self-oscillatory exists. Thus, direct down conversion can be obtained without a separate local oscillator.

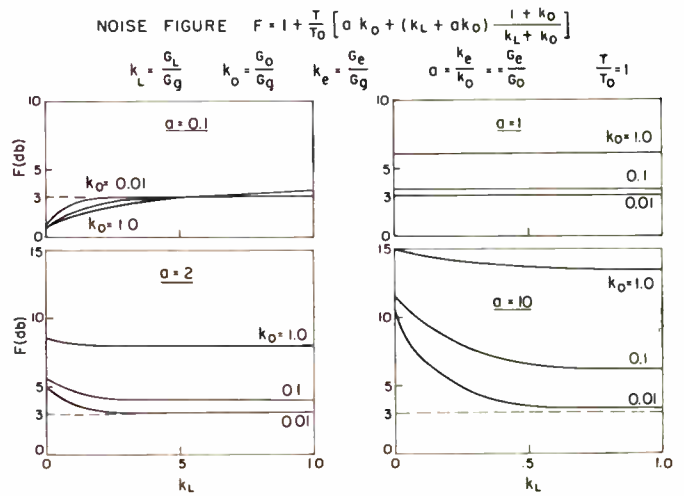

Fig. 7—Noise factor as a function of diode and circuit conductances.

CONCLUSIONS

The present experiments have demonstrated that the tunnel diode can be utilized as a *low-noise, high-gain down converter* in the UHF range. It seems feasible to extend the operating frequencies into the microwave region. The diodes for such applications should be designed with as low a capacitance as possible. The associated circuits, and especially the input circuit, should have high conductance and low  $Q$ 's in order to realize optimum bandwidth and noise figures.

# Noise Limitations to Resolving Power in Electronic Imaging\*

J. W. COLTMAN† AND A. E. ANDERSON†

**Summary**—A theoretical derivation, verified by experiment, shows that the maximum visible line number of a displayed bar pattern is directly proportional to the signal-to-white-noise ratio. The constant of proportionality and the effect of finite screen boundaries have been experimentally determined. It is found both theoretically and experimentally that the masking effect of white noise depends only on the noise power per unit bandwidth, and is independent of the upper frequency limit of the noise spectrum, provided that this exceeds the frequency limit set by the eye.

These results can be used together with the aperture response of any imaging system to predict in quantitative terms the resolution limit as a function of the signal and noise levels. As an example, the theorems postulated are used together with the measured amplitude response function of the 5820-image orthicon to obtain a universal resolution vs signal-to-noise ratio curve for beam-noise-limited tubes of the image orthicon type. The predicted performance is in

good agreement with experimental results. A similar set of curves for quantum-noise-limited image tubes is also given. The effects of object contrast variation, signal integration in time, and the presence of spurious background are presented.

I. INTRODUCTION

IN recent years, there has been a widening interest in electronic imaging devices whose capabilities, with respect to sensitivity or spectral response, lie beyond that of the unaided eye. Television techniques, which permit arbitrarily high brightness amplification and contrast intensification, essentially remove most limitations of the human eye, so that performance is limited only by two system characteristics, the fidelity with which the image is reproduced, and the noise introduced into the information-bearing channel.

This paper deals quantitatively with the manner in

\* Original manuscript received by the IRE, November 17, 1959.  
 † Westinghouse Res. Labs., Pittsburgh, Pa.



which system noise interferes with image resolution. In the first section, there are derived, from pure scaling arguments, some completely general relationships between visual image detectability and noise intensity. These relationships are then particularized to the case of television presentation, and some experimental data in verification of the theory are presented. In the second section, it is shown how deterioration of the signal for fine patterns, together with the previously established demands on signal-to-noise ratio, combine to set a quantitative limit on resolving power.

## II. NOISE CONSIDERATIONS

### A. Signal-to-Noise Ratio Required for Detection of an Image

The ability of the eye to distinguish a pattern in a noisy signal has been previously investigated<sup>1,2</sup> for cases in which the noise was assumed to result from the quantum nature of the signal itself. The formulation is ordinarily in terms of pattern contrast and population of events (light or X-ray quanta) giving rise to the noise. In the case being treated here, and indeed in essentially all cases of television presentation, one deals with a different situation, where there is an additive noise independent of the signal strength, and the final image contrast, brightness, and magnification can be adjusted at will by the observer. This paper establishes image detection limits which are independent of these last named quantities. Limiting resolutions are expressed solely by the signal-to-noise ratio as measured at some critical point in the system.

It is possible to derive certain relationships between image detail and signal-to-noise ratio required without recourse to any experiment. The argument which follows is not restricted to television-type displays, but, subject to the postulates given, applies to any display whatever.

This thought experiment is best conducted by first postulating a viewing screen, infinite in extent, producing light at an average brightness  $B$ , which fluctuates in time and space. Let the nature of this fluctuation correspond to "white" noise, that is, the light flux  $L$  per steradian from any area  $A$  has an average value  $AB$  and is distributed in a Gaussian fashion with a standard deviation  $\Delta L = m\sqrt{AB}$ . (This kind of "noisy" illumination is typified, for example, by an area emitting light in the form of uniform flashes, randomly distributed in time and space.) No particular value of  $m$  need be assumed, *i.e.*, it is permissible to subtract a constant value  $B_0$  from the average brightness or to change the gain of the system, provided that the occurrence (mathematically speaking) of a negative value of light flux is a very rare event in any area of practical interest.

A viewer stands before this screen, and an operator superimposes on the noisy background described above a signal image of specified form and size. The operator then slowly reduces the signal strength until the image is no longer visible to the observer. During this process, the observer is free to change his viewing distance, add or subtract a constant brightness  $B_0$  (subject to the condition mentioned above) and change the "gain" of the system, which operates on both the signal and noise alike. These are the operations known as "contrast enhancement" in a television system. Eventually, a value of signal will be reached which no longer permits the image to be distinguished in the noise, in spite of optimum adjustments on the part of the viewer. This is the threshold signal for the particular image and noise chosen, which we call Condition I.

Now three changes are made. The operator makes the image larger by a factor  $g$ , while the signal strength is left constant. He also increases the strength of the noise  $m\sqrt{AB}$  by a factor  $g$ , to  $gm\sqrt{AB}$ . The viewer meanwhile is asked to increase his viewing distance by the same factor,  $g$ , and to leave all other parameters fixed. This is Condition II.

It is evident that the signal image is unchanged as far as the viewer is concerned; the increased viewing distance exactly compensates for the increase in pattern size, while the average apparent brightnesses, being independent of viewing distance, are fixed. What about the apparent fluctuation? This is unchanged also. In Condition I, an area  $A$  on the screen is projected to some area  $A'$  on the observer's retina. Under Condition II, this same element  $A'$  encompasses an area  $g^2A$  on the screen, because of the increased viewing distance. The operator has also changed the strength of the noise by a factor  $g$ , so that the standard deviation in the light flux per steradian corresponding to the area  $A'$  is now  $gm\sqrt{g^2AB} = g^2m\sqrt{AB}$ . The solid angle subtended by the observer's pupil is, however, less by a factor  $g^2$ , so we find that the fluctuation in brightness for any area  $A'$  on the observer's retina is exactly as in Condition I.

Thus, the visual effect received by the observer in Condition II is identical in all respects to that of Condition I. Since Condition I was an optimum as far as viewing distance, gain, and background brightness were concerned, then Condition II must also be an optimum, and represents again a threshold. Referring back to the changes made by the operator at the screen, we infer: *The strength of white noise required to mask an image signal is directly proportional to the linear size of the image.*

Because it is assumed that the viewer can change at will the gain, background brightness, and viewing distance, it is apparent that only the signal-to-noise ratio is important in determining the threshold. We may thus restate the results: *The signal-to-white-noise ratio required for detection of an image is inversely proportional to the linear dimension of the image.*

A corollary of the above may also be inferred from the

<sup>1</sup> A. Rose, "Sensitivity of the human eye on an absolute scale," *J. Opt. Soc. Amer.*, vol. 38, pp. 196-208; February, 1948.

<sup>2</sup> J. W. Coltman, "Scintillation limitations to resolving power," *J. Opt. Soc. Amer.*, vol. 44, pp. 234-237; March, 1954.

same argument: *The optimum viewing distance for detection of an image in white noise is directly proportional to the image size.*

### B. Signals and Noise in Television Displays

In deriving the theorems of Section II-A, noise was specified only by the constant  $m$  in the expression  $m\sqrt{AB}$  and the image size by a linear dimension. In the television case, it is more convenient to measure the signal and noise in the electrical channel prior to conversion to a pattern, and to use for a standard of length the width of the frame of the picture. For convenience in the derivations which follow, it is assumed that the light produced on the kinescope face is directly proportional to the impressed signal. While this is not the case in practice, the threshold signals with which we deal are small, and since the "gamma" of the kinescope acts on signal and noise alike, the effect of the kinescope non-linearity is equivalent, in the first order, to a simple change in system gain.

Assume a television image of a vertical sine wave bar pattern, having enough lines showing in the picture so that the effect of the finite frame size may be ignored. The theorem proposed states that the threshold signal-to-noise ratio is inversely proportional to the linear dimension of the image, or proportional to the number of lines  $N$  per cm.

$$N_{\text{threshold}} = \text{const} \left( \frac{\text{screen signal}}{\text{screen noise}} \right) \text{lines/cm.} \quad (1)$$

In (1) the screen noise is measured by the brightness fluctuation on some small area of the screen. It remains to relate this fluctuation to the noise impressed on the scanning beam.

Let the scanning beam current be  $i_0$  and let it fluctuate with a noise of rms value  $i_n$ , measured over the bandwidth  $\Delta f$ . Consider an area  $A$  on the picture, small compared to the frame size but large enough to contain several resolution elements. In a time  $t$  larger than several frame times, there will be deposited in this area a total charge  $q = (A/A_0)i_0t$ , where  $A_0$  is the frame area, or, more accurately, an extended frame area which takes account of the blanking and return times of the scans. This value of  $q$  will vary due to the fluctuation in  $i$ , but the fractional variation will be much smaller than that of  $i$ , because there are many samples of the beam current going to make up  $q$ . In measuring the noise current over a bandwidth  $\Delta f$ , we have effectively sampled the beam current by collecting charge over short times  $1/2\Delta f$  in duration. In measuring  $q$ , however, the beam spends a time  $(A/A_0)t$  in the area  $A$ , so that  $q$  contains  $(A/A_0)2\Delta ft$  independent samples of the beam current. The fractional variation in  $q$  compared to that in the beam is reduced by the square root of this number. Thus

$$dq/q = (2\Delta ft A/A_0)^{-1/2} i_n/i_0. \quad (2)$$

The screen signal is related to  $q$  by a modulation factor which is the same as that for the beam current. Therefore

$$\frac{\text{screen signal}}{\text{screen noise}} = (2\Delta ft A/A_0)^{1/2} \left( \frac{\text{signal}}{\text{noise}} \right), \quad (3)$$

where both the signal and noise in the right-hand member are measured as currents or voltages in the electrical channel. It should be emphasized here that  $\Delta f$  is not necessarily the bandwidth of the system, but represents merely the frequency interval over which the noise was measured. It will be recognized that for white noise, the noise is directly proportional to  $\sqrt{\Delta f}$ , so that  $\sqrt{\Delta f}/\text{noise}$  is a constant independent of the bandwidth chosen, and is a measure of the spectrum level of the noise.

Combining (1) and (3),

$$N_{\text{lines/cm}} = \text{const} (2\Delta ft A/A_0)^{1/2} \left( \frac{\text{signal}}{\text{noise}} \right). \quad (4)$$

If the width of the displayed picture is  $W$  cm, the number of lines per picture is  $NW$ , and if  $A_0$  is replaced by  $HW/e_v e_h$ , where  $H$  is the height and  $e_v$  and  $e_h$  are the sweep efficiencies, then (4) can be written as

$$N_{\text{lines/picture}} = k \left( \frac{A e_h e_v \Delta f}{R} \right)^{1/2} \frac{\text{signal}}{\text{noise}}, \quad (5)$$

where  $R$  is the aspect (height to width) ratio. Note that only this factor and the sweep efficiencies enter; the expression is independent of the number of scanning lines or the frame rate of the system.

It will be noted that in the derivation of (2) it was required that the minimum sample area  $A$  extend far enough to encompass several independent samples of  $i_n$ ; i.e., in terms of the television scan it must be several times wider than the resolution element set by the bandwidth. If the pattern detail is sufficiently large so that the eye can integrate over such an elemental area without decreasing the pattern contrast, then (5) can be expected to hold.

Now, if the noise in question arises, as is usually the case, from a white noise source located prior to the bandwidth-limiting circuits of the system, the noise current is itself proportional to  $\sqrt{\Delta f}$ . Eq. (5) in this case implies that *the threshold value for signal recognition is independent of the system bandwidth.*

The requirement on the sample area  $A$  noted above, and the use of an integrating time  $t$  larger than the frame time, is essentially equivalent to assuming that the eye, and not the system, sets the bandwidth. Since it is probable that the eye does not curtail the bandwidth sharply, pattern detectability may decrease somewhat as the bandwidth is gradually increased over the minimum required. Eventually, however, pattern detectability will become constant and independent of further increases in bandwidth.

The fact that the spectrum level of white noise re-



quired just to perceive the noise itself is independent of the noise bandwidth, is discussed by Mertz.<sup>3</sup> In that work, he finds a square "sampling area" for the eye of about 5 minutes of arc in linear dimension; this is consistent with the optimum viewing distance indicated in Fig. 3.

### C. Experimental Determination of the Visibility Thresholds for a Bar Pattern

To test the relationships derived in the previous section, an experimental investigation of the visibility of sine wave bar patterns was carried out using a television monitor displaying accurately-measured sine wave signals and white noise. It should be noted that television kinescopes do not, in general, respond linearly (in light flux) to the voltage applied to the grid, so that we depart in this respect from the conditions postulated in the theory. For small signals and noise, this lack of linearity is of no consequence, as it merely introduces an extra gain in the system. For large signals, the noise will no longer be Gaussian. The extent of the departure from theory is left for experimental determination.

A block diagram of the equipment is shown in Fig. 1.

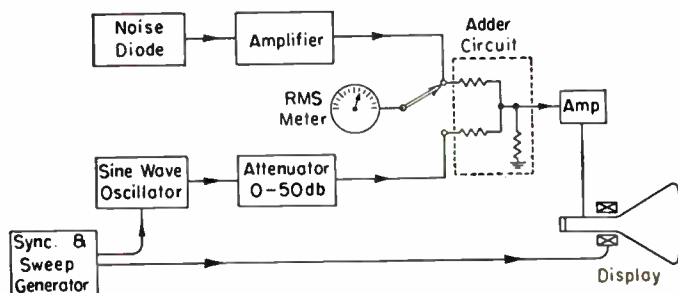

Fig. 1—Arrangement for displaying measured signals and noise. The synchronized sine wave oscillator produced a vertical sine wave bar pattern of variable intensity on the display, while a fixed measured white noise was superimposed.

The noise source was a temperature-limited thermionic diode, operating into a high-gain video amplifier. The amplifier characteristic was such as to give a noise power uniformly distributed within  $\pm 1$  db from a few kilocycles to about 4.5 mc, with a rapid drop-off to a few per cent at 5.5 mc. The total curve could be approximated by a rectangular distribution extending to 5.0 mc. A coherent sine wave oscillator generated a sinusoidal bar pattern variable over the entire frequency band. An rms milliammeter with response flat to 8 mc was used to measure either the noise or the signal, which were then mixed and fed to the display kinescope. An attenuator was provided in the oscillator circuit to reduce the signal to any desired value. Brightness and contrast could be controlled on the monitor after the signals were measured and mixed.

<sup>3</sup> P. Mertz, "Perception of television random noise," *J. Soc. Motion Picture and Television Engrs.*, vol. 54, pp. 8-34; January, 1950.

The experimental procedure was to seat the subject before the television screen at a chosen distance, select a bar pattern of the desired number of lines (the number of line pairs per picture was taken as the number of cycles of the oscillator between blanking pulses, not all of which were visible on the screen because of masking) and set the noise and signal power equal by means of the noise meter. Correction was made for blanking periods, so the signal-to-noise ratios quoted represent those during the active period. The signal attenuator was then set to a value near the threshold of pattern visibility. The subject was asked whether or not he could discern the presence of the pattern, and after a "yes" or "no" response, the attenuator was reset to a neighboring value. At each condition, some 18 to 24 responses were requested, the attenuator being varied at random among three or four settings separated by 2 db. The setting (or interpolated setting value) at which the observer responded "yes" 50 per cent of the time was taken as the threshold of visibility. In almost all cases, a clean dividing line could be made, a typical situation being that in which six out of six responses were "yes" at 20 db, three out of six were "yes" at 22 db, and all were "no" at 24 db. Signal-to-noise ratios used in this paper are based on current rather than power, so that a 2-db step represents a 26 per cent change in signal current.

While an unequivocal result could usually be obtained in a single test, it was evident that an individual's threshold for a given set of conditions was not constant, but could vary by 50 per cent or more with time. Variations among individuals were also apparent. The amount of data taken was limited, and conditions of surround brightness, time interval between tests, etc., were not carefully controlled, so that the data presented here do not constitute a definitive study of this particular visual parameter. They suffice, however, to demonstrate the relationships derived above, to provide a numerical value of the constant  $k$  in (5), and to outline the area of validity of the theoretical treatment.

### D. Experimental Results

Since the theory presupposes an optimum viewing angle for a given pattern, an attempt was made to establish this angle. With a fixed pattern, a single subject was tested at viewing distances ranging from  $\frac{1}{4}$  to 7 meters. Several repeats at two meters were taken to check for uncontrolled shift of the threshold. Evidence of a considerable shift is given in Fig. 2, where threshold attenuator settings are plotted, not against distance, but against order number of the trials. The circled points are all for two meters. The points are labeled with the distance. In an attempt to extract some information, it was assumed that the threshold shift was gradual, and could be represented by the dotted line through the two-meter points. Deviations from this line by the other points were taken as representing a distance effect.

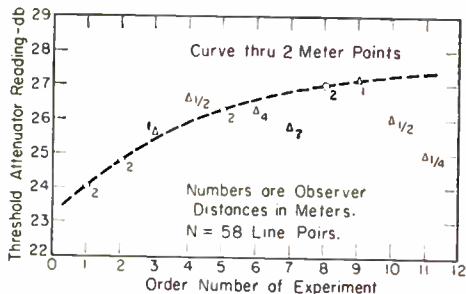

Fig. 2—Threshold readings taken at various distances as labeled on the points. Drift of the threshold is evident from the curve through the 2-meter points. All readings are with  $N=58$ .

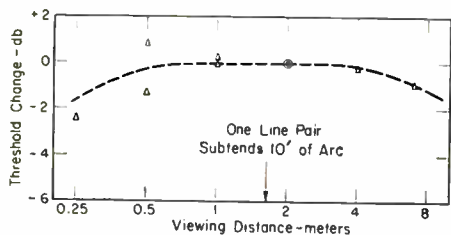

Fig. 3—Relative threshold as a function of viewing distance. Data are taken as the departure of points from the curve of Fig. 2. The extreme broadness of the optimum is evident.

The results are plotted in Fig. 3. There is some suggestion of an optimum near 1.5 meters, where one line pair subtends about 10 minutes of arc, but the most striking result is the broadness of the distribution. The effect of changing distance over a range of 30:1 is hardly outside the experimental error in determining the threshold. Thus, in succeeding tests, the subject assumed viewing distances roughly proportional to the pattern line width, but no attempt was made to control this factor rigidly.

The results of a series of runs using varying numbers of line pairs (cycles) per picture are given in Fig. 4. The solid line drawn with a 45-degree slope demonstrates the expected proportionality between line number and signal-to-noise ratio. It is of great interest to note the extremely small signal-to-noise ratios required, clearly showing the great extent to which integration takes place in the eye. From the position of this line and the 5.0-mc bandwidth used, we can evaluate the constant in (5) and write:

$$N_{\text{threshold}} = 615 \sqrt{\Delta f} \cdot (\text{signal/noise}), \quad (6)$$

where  $\Delta f$  is measured in megacycles, and  $N$  is line pairs per picture width.

The earlier work on scintillation limited square wave bar patterns by Coltman<sup>2</sup> can be reformulated in terms of signal-to-noise ratio by calculating the noise power which the scintillations would generate in a circuit of bandwidth  $\Delta f$ , and taking account of blanking times and picture aspect ratio. When this is done, we arrive at the expression:  $N = 640 \sqrt{\Delta f} \cdot (\text{signal/noise})$ , which is in good agreement with (6). The constant in both cases is independent of the number of scanning lines and frame times, but will depend on the aspect (height to width)

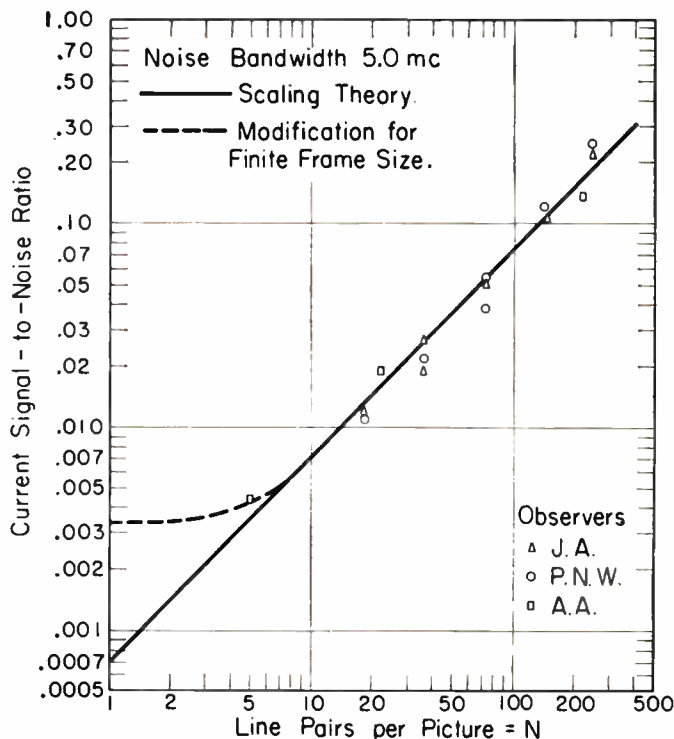

Fig. 4—Threshold signal-to-noise ratio as a function of number of cycles of the sine wave bar pattern displayed. The linear relationship extends over two decades, and departure is observed only for very small line numbers.

ratio and the fraction of the time spent in blanking, in the manner expressed by (5).

It is clear that while the scaling argument predicts a straight-line relationship over all values, the finite size of the screen will introduce departures for large line spacing. In order to determine the shape of the curve for very low numbers of line pairs per picture, a separate experiment was run. Here, the displayed picture was left fixed, and a series of cardboard aperture masks were employed to vary the number of lines seen by the observer.

The results, plotted in Fig. 5, show that the observer probably uses no more than seven line pairs in making an identification. As the number which he is permitted to see is decreased, the signal required rises rapidly, being greater by a factor of four when only one line pair is presented. The curve of Fig. 5 was used to draw the dotted lower portion of the curve of Fig. 4 by applying to the extension of the straight line the measured increase in signal required. A lower limit to the threshold signal-to-noise ratio for the largest complete sine wave pattern which can be shown is thus found to be about 1/300, where the noise is measured over 5 mc.

A fourth experiment was made to demonstrate the effect of bandwidth. A capacitor was arranged to be switched across the input circuit so as to reduce the bandwidth from 5 mc to about 600 kc. The total integrated noise power was thereby reduced by a factor of 7.6, and the rms noise current by a factor of 2.8. An 11-line pattern, whose frequency was so low as to be essentially unaffected by the bandwidth change, was dis-



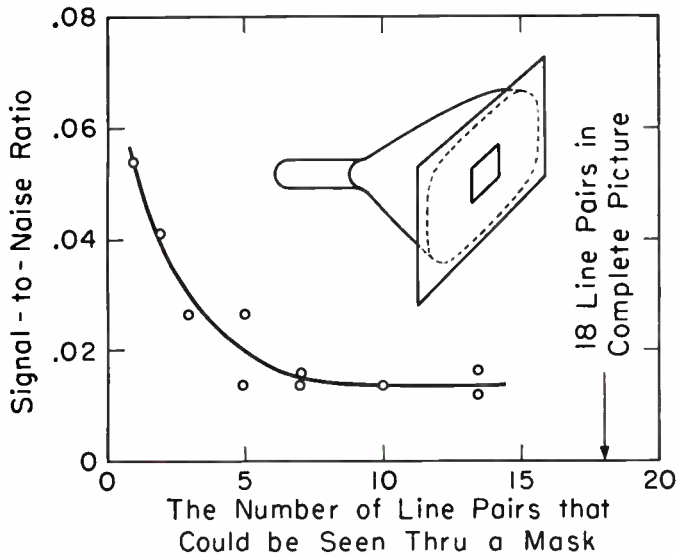

Fig. 5—Effect of frame limitation on signal-to-noise ratio required. These data were used to extend the curve of Fig. 4 to low line numbers.

played. Threshold measurements were taken while the capacitor was switched in and out at random intervals. It was found that the observer required 25 per cent less signal when the narrow bandwidth was used. While the shift was not zero, it was small compared to the large factor in noise current. This indicates that the over-all bandwidth was being set primarily by the eye, though it was still being affected somewhat by the system. A more carefully arranged experiment with sharp cutoff filters and optimum viewing distance for the observer would delineate more clearly the manner in which the eye can ignore high frequencies when looking for a low-frequency pattern.

### III. ESTABLISHING THE RESOLUTION LIMIT

The theoretical and experimental information presented in Section II establishes the signal-to-noise ratio required to perceive a given line number. In many types of imaging systems, it is possible to determine by calculation what signal-to-noise ratio will be obtained, and this is also a function of line number. With these two pieces of information, one can determine quantitatively the resolution limit—the line number which can no longer be perceived by the eye—as a function of the input conditions and system parameters. A few cases which represent basic situations are discussed below.

#### A. Noise Independent of Signal

The signal current in the information channel will, of course, be a function of many system parameters. In particular, as a result of finite scanning apertures, electron-optical aberrations, etc., the signal response will diminish for fine patterns. It is convenient to describe this effect by the sine wave response function,<sup>4</sup> which

<sup>4</sup> J. W. Coltman, "The specification of imaging properties by response to a sine wave input," *J. Opt. Soc. Amer.*, vol. 44, pp. 468-471; June, 1954.

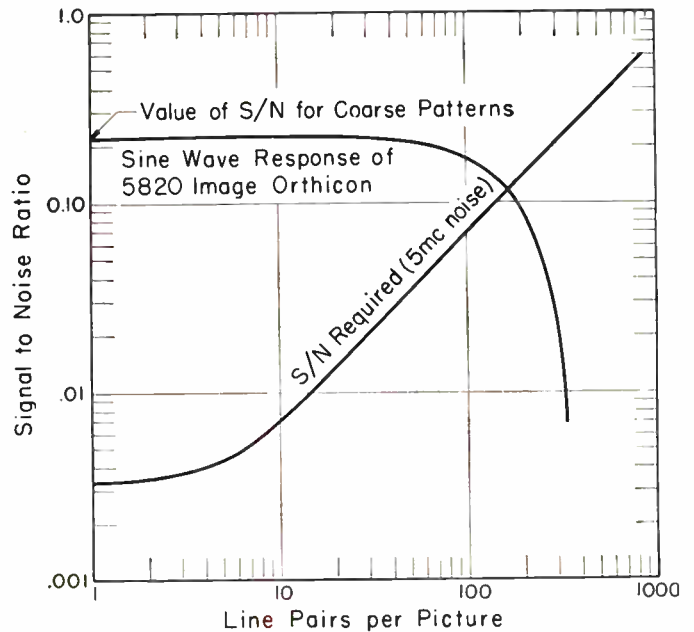

Fig. 6—Limiting resolution established by the intersection of curves representing available and required signal-to-noise ratio.

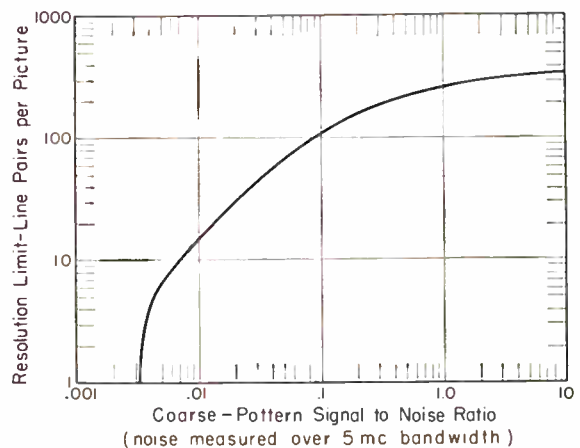

Fig. 7—Calculated resolution limit for a typical image orthicon as a function of the signal-to-noise ratio for large patterns.

gives the relative signal strength as a function of the space frequency of a sine wave test pattern. Such a response curve for a typical image orthicon is plotted as the upper curve in Fig. 6. The intercept at a signal-to-noise ratio of 0.22 is arbitrarily chosen for an example. The value is maintained essentially unchanged for low line numbers, and is called here the coarse-pattern signal-to-noise ratio. At higher line numbers the signal (and therefore the signal-to-noise ratio) diminishes as shown. Also plotted in Fig. 6 is the previously derived curve of Fig. 4 which establishes for each line number the threshold of signal-to-noise ratio. The abscissa of the intersection of the two curves gives the resolution limit corresponding to the coarse-pattern signal-to-noise ratio chosen.

By making a series of such choices, the curve of Fig. 7 is derived, which gives the resolution limit as a function of the coarse-pattern signal-to-noise ratio. The curve approximates over a decade a direct proportion

between signal-to-noise ratio and resolution limit; it drops rapidly at the lower end due to the inability of the finite picture to display enough lines, while at the upper end it flattens out as the effects of finite focal spots reduce the available signal.

It should be noted that these curves assume an electrical channel of flat response and wide bandwidth. The 5-mc band over which the noise is measured is used only to establish a numerical value for the signal-to-noise ratio. Both noise (assumed white) and signal may extend well beyond this limit.

For an image orthicon operated at low light levels, the noise is essentially fixed, so that the signal-to-noise scale can be replaced by a properly established scale of scene illumination. The conversion factor will be a function of the photo-surface response, the optics used, and the object contrast, but the shape of the curve will remain fixed. Experimental confirmation is afforded by some data taken by Hannam<sup>5</sup> on two image orthicons employing different target materials, giving the observed resolution as a function of illumination. These data have been plotted in Fig. 8 with the illumination scale shifted for each tube to obtain the best fit to the theoretical curve. Considering the semi-subjective nature of such measurements, the agreement is satisfactory.

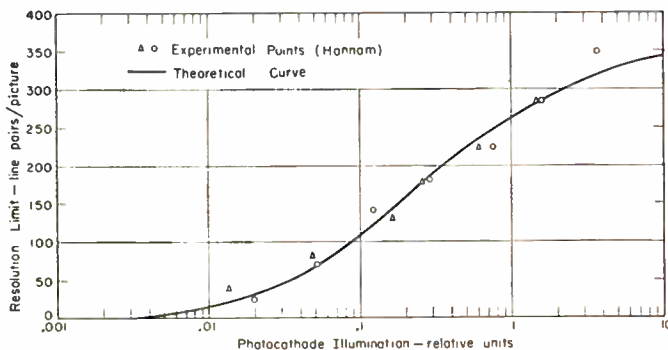

Fig. 8—Comparison of experimental and calculated resolution for two image orthicons.

### B. Noise a Function of Signal

Optical imaging systems will finally be limited in detectivity by the quantum noise inherent in the light itself. The relationship between highlight illumination and resolution limit will no longer have the form of Fig. 7, since the noise is a function of the signal strength. The case of a signal pattern of 100 per cent contrast and a pickup system where no noise is introduced other than that associated with the quantum nature of the light represents the ultimate in detectivity. The coarse-pattern signal-to-noise ratio now becomes proportional to the square root of the signal itself. Rather than working in terms of a signal-to-noise ratio which remains to be measured on the particular equipment at hand, the results can be generalized by employing as an independent variable the number of quanta registered per

unit time. This number will be directly proportional to the illumination on the scene, the constant of proportionality being determined by the effective size of the optical aperture and the dimensions and quantum efficiency of the receiving photosurface.

Let  $n$  be the number of photoelectrons ejected per second from the entire photosurface when it is uniformly illuminated at the level corresponding to the highlight scene brightness. If a sine wave pattern of 100 per cent contrast is then used as a test object, the peak-to-peak signal current during the scan is  $ne/c_h e_r$  where  $e$  is the electronic charge and  $c_h$  and  $e_r$  the horizontal and vertical scan efficiencies. The corresponding rms signal current is  $ne/\sqrt{8}e_h e_r$ . The average current  $\bar{i}$ , which is just half of the peak current, gives rise to an rms noise current equal to  $\sqrt{2e\bar{i}\Delta f}$ . The signal-to-noise ratio during the active portion of the scan is then:

$$\text{SNR} = \sqrt{n/8e_h e_r \Delta f}. \quad (7)$$

In order to use the curves of Fig. 6 and Fig. 7, the values of  $\Delta f = 5 \times 10^6$  and  $e_h e_r = 0.79$  corresponding to the test conditions are substituted, to yield

$$\text{SNR} = 1.80 \times 10^{-4} \sqrt{n}. \quad (8)$$

The validity of this procedure may be questioned for values of  $n$  such that less than one impulse is received in a half-cycle of the upper frequency of 5 mc. It is necessary again to point out that the 5-mc bandwidth assumed for the calculation of Figs. 6 and 7 is an arbitrary means of specifying the noise power per unit bandwidth of a white noise spectrum. Because the eye integrates in time and space, (7) is a valid transformation factor for relatively small values of  $n$ , even though it does not predict the result which would be obtained by measurement in the electrical channel with a wide-band noise meter. The correctness of this argument is borne out by the visual experiments by Coltman,<sup>2</sup> which show that the relationship (6) is followed for values of  $n$  at least as low as 1000 per second.

Using (8) and the curve of Fig. 7, it is possible to calculate the performance of a hypothetical imaging system whose optical fidelity is the same as that of the image orthicon, but which has no noise other than the inherent shot effect of the initial photoelectric surface. The relation between the resolution limit and the photoelectron emission rate for this case is shown as curve 1 of Fig. 9. It is extremely broad and extends to the remarkably low limit of about 400 flashes per second.

In practice, complete freedom from extraneous noise is an ideal rarely to be expected. For example, at room temperature, thermionic emission from the photoelectric surface will contribute a fixed electron emission rate which should be included in  $\bar{i}$  in calculating the signal-to-noise ratio. If  $n_0$  is the fixed emission rate which must be added to the rate  $n/2$  due to the signal, we obtain as a modification of (8) the expression

$$\text{SNR} = 1.8 \times 10^{-4} \frac{n}{\sqrt{n + 2n_0}}. \quad (9)$$

<sup>5</sup> H. J. Hannam, "Development of New Thin Film Targets for the Image Orthicon," U. S. ERDL, Fort Belvoir, Va., Third Quarterly Rept., Contract DA-44-009 ENG-3652.



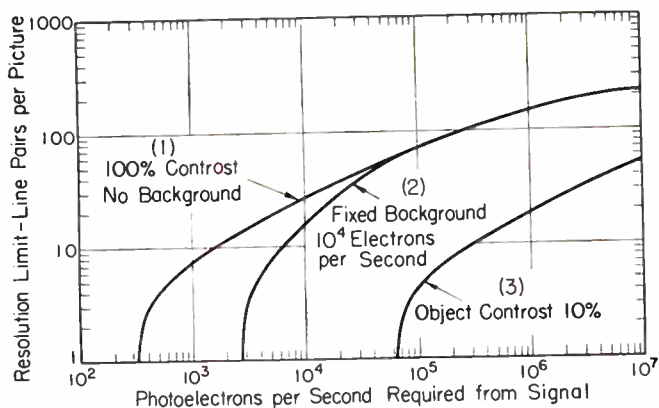

Fig. 9—Calculated resolution limits for cases where noise originates solely in the photocathode of an image orthicon type tube.

The effect of a fixed background emission of 10<sup>4</sup> electrons per second is illustrated by curve 2 of Fig. 9.

C. Effect of Contrast Reduction

While a 100 per cent contrast test pattern makes a convenient test object for specifying system performance, the scenes to be viewed in practice may often have relatively low contrast values. Contrast is defined here in terms of the highlight brightness, *i.e.*, for a sinusoidal test pattern, as follows:

$$C = (B_{max} - B_{min})/B_{max}$$

In the case where the noise is independent of the signal, loss of contrast simply means a corresponding loss of signal, so that the curve of Fig. 7 retains its shape while the scale of illumination is appropriately altered. Thus, in going from a 100 per cent to a 10 per cent contrast test pattern, the illumination must be increased by a factor of 10 to achieve the same resolution.

When the noise is due purely to the shot effect in the photosurface, a loss of contrast is attended by a similar loss of signal, but an increase of illumination to counteract this loss will also increase the noise. By a procedure similar to that used in the derivations of (7) and (9), a general expression is obtained which takes account both of fixed noise *n*<sub>0</sub> and contrast *C*, both referred to the maximum emission rate *n* due to the light alone, as follows:

$$SNR = 1.8 \times 10^{-4} \frac{nC}{\sqrt{n(2 - C) + 2n_0}} \quad (10)$$

Curve 3 of Fig. 9 shows the relatively drastic effect of contrast reduction in the case of quantum noise only. A reduction of contrast from 100 per cent to 10 per cent now requires for compensation not ten times the illumination but 190 times. It will be appreciated, however, that the quantum noise is always present, and that the fixed noise case represents merely the situation where the additive noise is so large that it swamps out the quantum noise. When *n*<sub>0</sub> ≫ *n*, (10) reduces to the case where the signal-to-noise ratio is directly proportional to the illumination and the contrast.

D. Effect of Integration in Time

The integration time of the eye is generally accepted to be approximately 0.2 second, a value which can be determined by comparing still photographs taken with various exposure times with impressions received of live pictures of noisy material. While this was not done quantitatively in the above work, some remarks on the expected effect of time integration may be appropriate. In a conventional television pickup system, light is collected for a time *τ* (1/30 second) before the information is scanned off and presented. If this time is lengthened to *T* the signal may be enhanced (in a properly operating storage medium) by a factor *T*/*τ*. If the noise arises solely in the subsequent system, it need not be presented to the eye during storage, and the visual signal-to-noise ratio is improved by a similar factor.

In the case of noise arising solely from the photoelectric shot noise, the situation is quite different. As long as the frame time is short compared to the integration time of the eye (0.2 second) the visual signal-to-noise ratio will be independent of the frame time or the duration of the individual flashes. Integration by storage means or by a long persistence phosphor will be effective only if it extends the integration time beyond that of the eye. The exact effect of added integration can be calculated only through a convolution of the decay characteristic of the eye with that of the storage system employed. However, a rule-of-thumb frequently employed in convolution processes indicates that the effective total integration time will approximate the square root of the sum of the squares of the two individual times. Thus the illumination required to achieve a given resolution will vary as

$$[(T/0.2)^2 + 1]^{-1/2}$$

where *T* is the system integration time in seconds. For values of *T* much less than 0.2 second, the illumination required is independent of *T*; for large values it is inversely proportional to *T*, so that the product of the illumination and the time, *i.e.*, the exposure, is constant.

CONCLUSIONS

For imaging systems whose output is viewed by the eye, and which are limited by white noise, the resolution limit can be predicted from a knowledge of two parameters, the noise power per unit bandwidth, and the sine wave response of the system. Because the demands on signal-to-noise ratio increase linearly with the line number, and the sine wave response usually falls off with at least the square of the line number, the resolution limit varies only slowly with signal input. The range of object illumination over which the resolution is appreciably varying may extend over several decades. In specifying the performance of systems designed to operate in the noise-limited region, it is thus highly desirable to give the entire resolution vs illumination curve, since neither the large-object detection limit nor the resolving power in the absence of noise (the two most frequently used characteristics) is a well-defined quantity.

# Packaged Tunable L-Band Maser System\*

F. R. ARAMS†, SENIOR MEMBER, IRE, AND S. OKWIT‡, ASSOCIATE MEMBER, IRE

**Summary**—A low-noise tunable L-band maser system is described. The maser uses a pink ruby crystal oriented at 90° and is tunable from 850 to 2000 mc. The voltage-gain bandwidth product is as high as 37.5 mc at a liquid helium bath temperature of 1.5°K. An L-band circulator has been developed for use with the maser. It has an insertion loss of 0.3 db, operates over a 200-mc frequency range at L-band, and determines the usable tuning range of the circulator-maser system. The maser and circulator have been packaged into an operational unit that includes all auxiliary components, and has a system noise factor of 0.5 db (35°K). Electrical and mechanical features of the system are described and performance data are given.

## I. INTRODUCTION

THE low-noise characteristic of the three-level solid-state maser amplifier has stimulated the interest of workers in a number of fields where the ultimate in receiver sensitivity is required. Radio astronomers, for example, are particularly interested in using a maser as a preamplifier for a 21-cm interstellar hydrogen-line receiver. Because of the Doppler shift in the frequency of the hydrogen line in receding galaxies, an L-band maser amplifier, which covers 1420 mc and tunes down in frequency, is of great practical interest. A packaged tunable maser system is described that tunes over a 200-mc frequency range at L-band.

Fixed-frequency L-band masers have been operated using chromium-doped potassium cobaltcyanide.<sup>1,2</sup> Furthermore, gadolinium-doped hydrated lanthanum ethyl sulfate with cerium impurity<sup>3</sup> and chromium-doped aluminum oxide (ruby) had given satisfactory operation at higher microwave frequencies.<sup>4-7</sup> Ruby was chosen for our maser, because of its excellent physical, mechanical, and chemical characteristics, even though it had not previously to our knowledge been used as a

material for L-band maser operation. Its characteristics include favorable "zero-field" splitting of the energy levels, good crystal line width, favorable relaxation times, low dielectric loss, machinability to accurate dimensions, resistance to cracking upon repeated temperature cycling, chemical inertness, and availability.

It was found<sup>8</sup> that L-band maser operation using ruby could be achieved, and satisfactory gain-bandwidth products obtained. In our design we placed emphasis on the feature of tunability. A tuning range from 850 to 2000 mc was obtained. Since a low-loss four-port L-band circulator was not available, such a unit, having a 200-mc frequency range for use with the maser, was developed.<sup>9</sup>

The maser and circulator were then packaged with the necessary auxiliary equipment to form a complete low-noise L-band preamplifier having a system noise factor of 0.5 db (35°K).

## II. SYSTEM DESCRIPTION

A schematic diagram of the maser system is shown in Fig. 1. The signal received by the antenna is directed by the four-port circulator into the single-port cavity maser; the amplified signal leaves the maser by the same

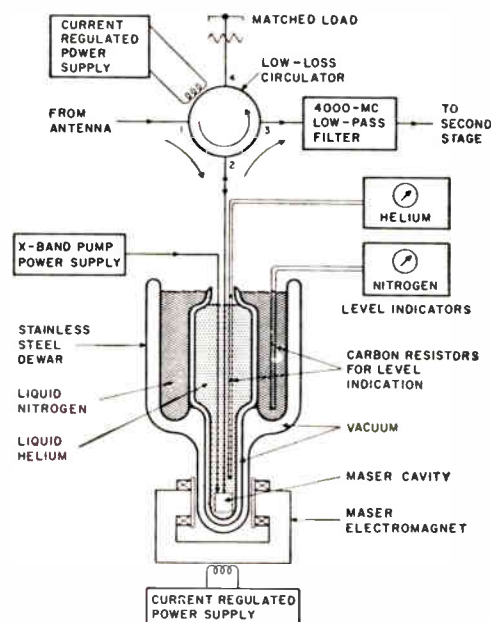

Fig. 1—Schematic diagram of maser system.

\* Original manuscript received by the IRE, August 19, 1959; revised manuscript received, December 21, 1959. This work was supported by the U. S. Department of Defense, and was presented at the 1959 PGMTT Symposium, Harvard University, Cambridge, Mass.; June 2, 1959.

† Airborne Instruments Lab., Cutler-Hammer, Inc., Melville, L. I., N. Y.

<sup>1</sup> J. O. Artman, N. Bloembergen, and S. Shapiro, "Operation of a three-level solid-state maser at 21 cm," *Phys. Rev.*, vol. 109, pp. 1392-1393; February 15, 1958.

<sup>2</sup> S. Autler and N. McAvoy, "21-centimeter solid-state maser," *Phys. Rev.*, vol. 110, pp. 280-281; April, 1958.

<sup>3</sup> H. E. D. Scovil, G. Feher, and H. Seidel, "Operation of a solid-state maser," *Phys. Rev.*, vol. 105, pp. 762-763; January 1, 1957.

<sup>4</sup> G. Makhov, C. Kikuchi, J. Lambe, and R. W. Terhune, "Maser action in ruby," *Phys. Rev.*, vol. 109, pp. 1399-1400; February 15, 1958.

<sup>5</sup> R. W. DeGrasse, E. O. Schulz-DuBois, and H. E. D. Scovil, "Three-level solid-state traveling wave maser," *Bell Sys. Tech. J.*, vol. 38, pp. 305-334; March, 1959.

<sup>6</sup> T. H. Maiman, "Solid-state masers—design and performance," *Proc. NSI-ARDC Conf. on Molecular Electronics*, Washington, D. C.; November 13, 1958.

<sup>7</sup> J. A. Giordmaine, L. E. Alsop, C. H. Mayer, and C. H. Townes, "A maser amplifier for radio astronomy at X-band," *Proc. IRE*, vol. 47, pp. 1062-1069; June, 1959.

<sup>8</sup> F. R. Arams, S. Okwit, and A. Penzias, "Maser action in ruby at 21 cm," *Bull. Amer. Phys. Soc.*, ser. II, vol. 4, p. 21; January 28, 1959.

<sup>9</sup> F. R. Arams, G. Krayner, and S. Okwit, "Low-loss S- and L-band circulators," 1959 IRE NATIONAL CONVENTION RECORD, pt. 3, pp. 126-133.



port and is directed by the circulator to the second stage. A low-pass filter having a cutoff frequency of 4000 mc is placed at the output of the maser system to prevent feed-through of pump power into the receiver. At this location, the filter will not adversely affect system noise factor.

A matched load is connected to the fourth port of the circulator. This load can be refrigerated if it is necessary to reduce its noise contribution caused by antenna mismatch (which reflects load noise into the maser).

The maser cavity (which is described more fully in Section III) is located near the bottom of a 2-inch inner diameter stainless-steel double Dewar flask. The inner portion of the Dewar flask is filled with  $2\frac{1}{4}$  liters of liquid helium, which is allowed to enter the maser cavity. One charge of liquid helium yields approximately 16 hours of operation. The outer jacket of the Dewar flask is filled with liquid nitrogen to reduce liquid helium evaporation. The Dewar flask is constricted at the bottom to a  $2\frac{1}{4}$ -inch outer diameter to keep the dimensions of the maser electromagnet to a minimum. The maser electromagnet employs a 5-inch diameter pole-face and provides a magnetic field that is homogeneous within  $\pm 5$  gauss out of 2000 gauss over the volume occupied by the ruby crystal.

Liquid level indicators are provided for the refrigerants. These use three carbon resistors connected in parallel and located at various heights in the Dewar flask. Liquid levels are displayed on two ammeters. A relay-actuated warning light indicates when a new charge of liquid helium is required.

The X-band pump power circuitry (shown in Fig. 2) consists of 1) a Varian X-13, 100-mw, klystron with a dial mounted on its tuning shaft that is directly calibrated in frequency, 2) an isolator that helps to stabilize the klystron by protecting it from load variations, 3) a variable attenuator that allows for pump power level adjustment, and 4) a 20-db bidirectional coupler to sample the pump output that is detected and displayed on a microammeter (this monitors the pump power level). The power reflected from the maser cavity is also sampled by the bidirectional coupler, detected, and fed to an oscilloscope to permit observation of the maser cavity resonance. For this purpose, the klystron is frequency-modulated using sawtooth modulation from the klystron power supply. A reaction frequency meter is included to permit accurate determination of pump frequency.

### III. TUNABLE MASER CAVITY DESIGN

For maser operation, it is desirable that the cavity containing the paramagnetic material (ruby) be resonant at both the signal and pump frequencies. Furthermore, it is desirable that 1) these two cavity resonances be independently tunable, 2) the tuning be accomplished from the top of the Dewar flask while the cavity is in the liquid helium, and 3) the cavity coupling at the

signal frequency be adjustable so that gain and bandwidth can be varied during operation.

The cavity design used, which meets all of these requirements, is shown in Fig. 3. This structure has the additional feature of simple mechanical design for making the required tuning and coupling adjustments.

The signal-frequency mode consists of a quarter-wavelength TEM-mode resonator.<sup>1</sup> This resonator is a thin-rod center conductor between parallel ground planes provided by the broad walls of a small X-band waveguide. This type of structure has the advantages that 1) resonant wavelength is proportional to rod length, 2) cavity coupling remains reasonably constant with frequency, and 3) the RF magnetic field distribution over the paramagnetic material remains essentially unchanged while the cavity is tuned. Because the TEM mode is dominant, the problem of spurious responses is minimized. A tuning range of more than one octave is obtained simply by varying the length of the center-conductor rod. The rod length is reduced by a factor of about three because of the high dielectric constant of the ruby. This is desirable at L-band to keep physical dimensions small. The unloaded Q of this structure is 550 at room temperature and increases to 1100 at 4.2°K.

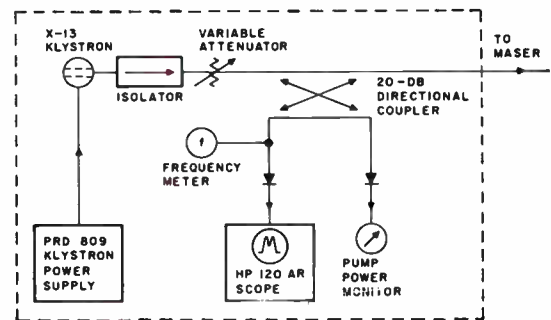

Fig. 2—Schematic diagram of X-band pump power supply.

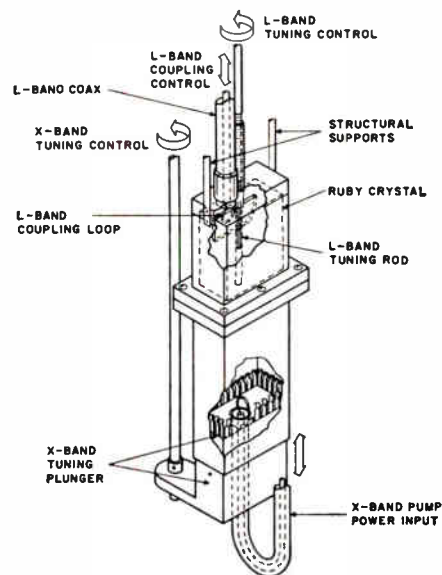

Fig. 3—Tunable maser cavity structure.

The waveguide region not occupied by the rod is beyond cutoff for the signal frequency. Therefore, a contacting plunger located in this region can serve as the tuning element for the  $X$ -band pump resonance (which operates in a  $TE_{107}$  mode) without affecting the  $L$ -band resonance (Fig. 3). The  $X$ -band pump power is loop-coupled into the cavity, through the backplate of the  $X$ -band tuning plunger, by means of a coaxial line having a bead-supported center conductor. Such a line has an  $X$ -band dissipative loss of only a few tenths of a db, has a much smaller cross section compared with waveguide, and the coupling remains reasonably constant over a broad tuning range. The  $X$ -band cavity is conveniently tuned from the top by a tuning rod directly connected to the tuning plunger. All low-temperature moving joints (except where electrical contact is required) consist of metal-to-teflon bushings.

Two factors were considered in choosing the 0.086-inch diameter of the  $L$ -band tuning rod: 1) the diameter should be as small as possible to minimize its effect on the  $X$ -band resonant frequency, and 2) the diameter dimension should yield a high unloaded  $Q$  at the  $L$ -band signal frequency. Measurements showed that the  $X$ -band resonance goes through a cyclical variation of only  $\pm 3$  mc when the  $L$ -band resonance is tuned. The  $X$ -band tuning plunger is, as previously stated, in a region beyond cutoff for the  $L$ -band mode. Thus, the two resonances are independently tunable.

The coupling to the  $L$ -band mode is accomplished by means of a loop that penetrates into a thin slot in the ruby. The loop is oriented in a plane parallel to the broad waveguide dimension to minimize coupling to the  $X$ -band pump resonance. The coupling is variable from the top of the Dewar flask by means of a micrometer head that moves the  $L$ -band coaxial line in the vertical direction. This varies the penetration of the coupling loop into the maser cavity. Two other micrometer heads located at the top of the Dewar flask are used to tune the  $L$ - and  $X$ -band cavity resonances. The cavity assembly and the superstructure are shown in Figs. 4 and 5, respectively.

#### IV. MASER PERFORMANCE

The relationship between the pump and signal resonant frequencies of the cavity and the external magnetic field required for maser operation are determined by the inherent quantum-mechanical properties of the paramagnetic crystal. These quantum-mechanical properties (energy levels, RF transition probabilities, and relaxation times) are strongly dependent upon the external magnetic field  $H$  and the angular orientation  $\theta$  between the external magnetic field and the crystal  $C$ -axis.

Best  $L$ -band maser performance was obtained for an angular orientation  $\theta$  of  $90^\circ$  at high magnetic fields ( $H \approx 2000$  gauss). The energy level diagram for ruby

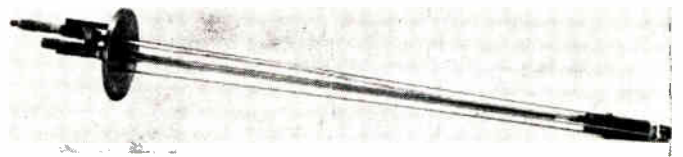

Fig. 4—Maser cavity assembly.

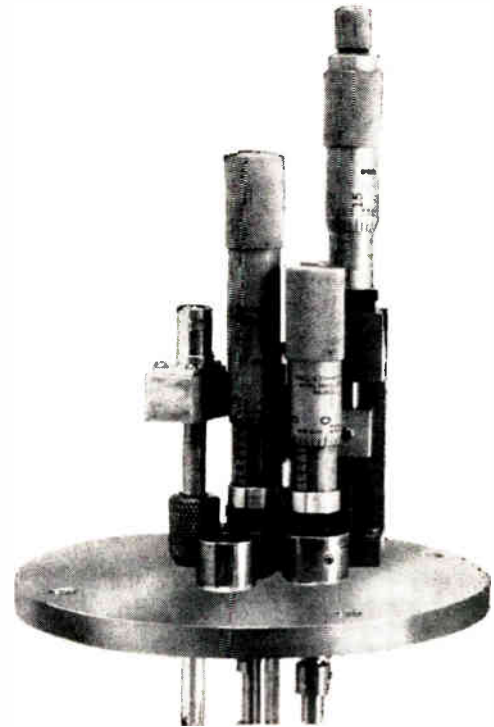

Fig. 5—Cavity superstructure.

when  $\theta$  is equal to  $90^\circ$  is shown in Fig. 6. It shows four (low-lying) energy levels, since  $Cr^{+++}$  in  $Al_2O_3$  has a spin  $S = 3/2$ . The  $L$ -band signal transition and  $X$ -band pump transition that were used are between levels 1 and 2, and levels 1 and 3, respectively. The high-field  $90^\circ$  operating point is attractive on theoretical grounds because the calculated signal and pump transition probabilities are high.<sup>10,11</sup> At this operating point, the signal transition probability is maximum when the microwave signal magnetic field is nearly perpendicular to the external magnetic field and parallel to the ruby  $C$ -axis. This condition is realized to a fair degree in our design, since the ruby crystal that we utilized had its  $C$ -axis oriented in a plane parallel to the broad face of the  $X$ -band waveguide, and at  $60^\circ$  to the  $L$ -band tuning rod (see Fig. 3), and the signal magnetic field is elliptically shaped for slabline TEM mode employed.

<sup>10</sup> W. S. Chang and A. E. Siegman, "Characteristics of Ruby for Maser Applications," Electron Devices Laboratory, Stanford University, Stanford, Calif., Tech. Rept. 156-2, Figs. 14 and 15; September 30, 1958. Also, J. Weber, "Masers," *Rev. Mod. Phys.*, vol. 31, pp. 681-710; July, 1959.

<sup>11</sup> E. O. Schulz-DuBois, H. E. D. Scovil, and R. W. DeGrasse, "Use of active material in three-level solid-state masers," *Bell Sys. Tech. J.*, vol. 38, pp. 335-352; March, 1959.



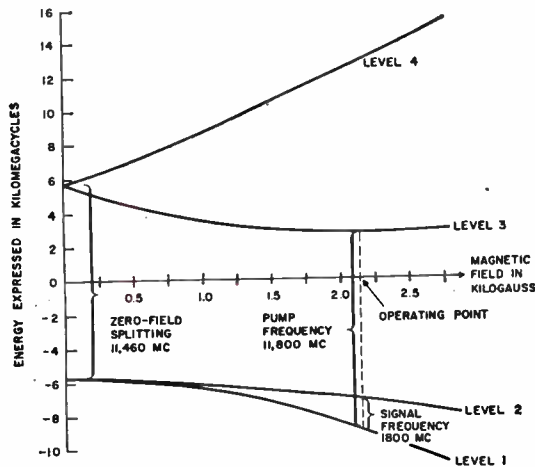

Fig. 6—Energy levels utilized for L-band maser.

Measurements of the voltage-gain bandwidth product at high magnetic fields were made at liquid helium bath temperatures of 4.2°K and 1.5°K. The results of these measurements are listed in Table I.

Table I shows that a voltage-gain bandwidth product of 37.5 mc was measured at 1750 mc for a temperature of 1.5°K. Thus, for a half-power bandwidth of 3.75 mc, a gain of 20 db will be obtained. Furthermore, operation was also obtained at an operating temperature of 4.2°K, where a voltage-gain bandwidth product as high as 20 mc was measured.

The gain-bandwidth products measured were used to calculate the effective magnetic Q. For such calculations, Fig. 7 and (3) (Appendix 1) can be used, under the condition that the cavity unloaded Q is much greater than the external Q. The effective magnetic Q calculated at 1200 mc (Table I) is 140 and 210 for operation at 1.5°K and 4.2°K, respectively. The magnetic Q is approximately constant over the L-band region. There is a deterioration in magnetic Q at the low-frequency end that is probably due to cross-relaxation effects.<sup>12</sup> The pump power that was required varied between 5 and 150 mw for the various measurements.

A four-level experiment was also performed for  $\theta$  equal to 90° at high magnetic fields. Here, pumping was done between levels 1 and 4, with the signal transition again between levels 1 and 2. Maser operation at a liquid helium bath temperature of 4.2° K was readily obtained at frequencies from 850 to 1750 mc (Table II). However, the measured voltage-gain bandwidth product did not show the expected improvement of greater than 100 per cent (assuming equal relaxation times between all levels) over the three-level arrangement. This may have been due in part to the limited pumping power available from the 20-kmc klystron that was used. Of the 50 mw

TABLE I  
SUMMARY OF L-BAND MASER PERFORMANCE (THREE-LEVEL OPERATION)

Liquid Helium Bath Temperature (°K)	Signal Frequency (mc)	Voltage-Gain Bandwidth Product Measured (mc)	Voltage-Gain Bandwidth Product Determined from External Q Measurement (mc)	Pump Frequency (mc)	Magnetic Field (gauss)
4.2	2000	*	*	12,150	2260
4.2	1815	20	22	11,860	2150
4.2	1200	11	13	10,950	1740
4.2	1010	9	12	10,700	1650
4.2	850	*	*	10,460	1510
1.5	1750	37.5	37.5	11,795	2100
1.5	1200	19	20	10,845	1740

\* Not measured.

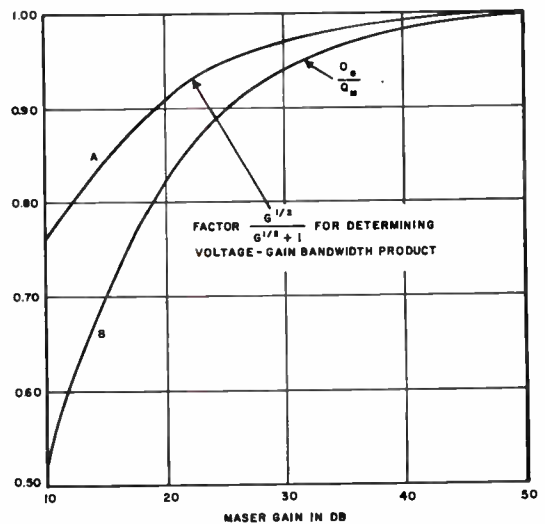

Fig. 7—Relationship of external Q to gain-bandwidth product and magnetic Q for cavity maser [when the cavity unloaded  $Q(Q_u)$  is much greater than the external  $Q(Q_e)$ ]. Curve A: Correction factor, due to finite gain, on gain-bandwidth product determined from external-Q measurement. Curve B: Relationship of external Q to magnetic Q as a function of gain.

TABLE II  
SUMMARY OF L-BAND MASER PERFORMANCE (FOUR-LEVEL OPERATION)

Liquid Helium Bath Temperature (°K)	Signal Frequency (mc)	Voltage-Gain Bandwidth Product Measured (mc)	Pump Frequency (mc)
4.2	1750	13	21,750
4.2	1005	6	19,180
4.2	855	5	18,420

available from a Raytheon QK306 klystron, only an estimated 10 mw reached the maser cavity. This power level was insufficient to saturate the 20-kmc pump transition, which has a low calculated transition probability.<sup>10</sup>

<sup>12</sup> N. Bloembergen, S. Shapiro, P. S. Pershan, and J. O. Artman, "Cross-relaxation in spin systems," *Phys. Rev.*, vol. 114, pp. 445-459; April 15, 1959.

For convenient reference, we have plotted the energy levels in ruby in a manner that is particularly suitable for three-level tunable maser operation [Fig. 8(a) and 8(b)]. By plotting pump frequency as a function of magnetic field, with angular orientation  $\theta$  and signal frequency as parameters, the variation in pump frequency and magnetic field for a given signal tuning range are readily determined. The region of operation used in our maser is indicated by a heavy line in Fig. 8(b).

This form of plotting the energy levels brings out an interesting and useful point, namely, that the ruby crystal can be readily oriented to  $90^\circ$  by varying the crystal orientation until the dc magnetic field required for resonance absorption is maximized. As Fig. 8(b) shows, this alignment technique can be applied to either the pump or signal transition.

### V. LOW-LOSS CIRCULATOR

This is a four-port circulator having an insertion loss near 0.3 db and isolations greater than 23 db over a 200-mc frequency range.<sup>9</sup> Fig. 9 shows the circulator. Electrically, it consists of dual  $90^\circ$  non-reciprocal phase-shift sections connected to two hybrids.<sup>13</sup> Our unit used strip-transmission-line hybrids with transitions to a MgMnAl-ferrite-loaded L-band waveguide, which was reduced in height to one inch to keep the electromagnet dimensions at a minimum and to reduce the ferrite material requirements.

The strip-transmission-line hybrids are shown in detail in Fig. 10, with the top ground plane removed. The ring hybrid is equivalent in its operation to the waveguide folded tee, and the other hybrid is equivalent to the waveguide short-slot hybrid. The use of the strip-transmission-line hybrids results in reasonable physical size.

### VI. PACKAGE DESCRIPTION AND PERFORMANCE

#### A. Description of Package

The over-all maser system is housed in two standard relay cabinets (Fig. 11). The smaller cabinet contains the maser cavity structure, stainless-steel Dewar flask, and maser magnet. The larger cabinet contains the associated auxiliary equipment, including (from top to bottom in Fig. 11):

- 1) oscilloscope to view either the pump or signal frequency cavity resonance and to observe and optimize maser action;
- 2) current-regulated power supplies to drive circulator and maser electromagnets;

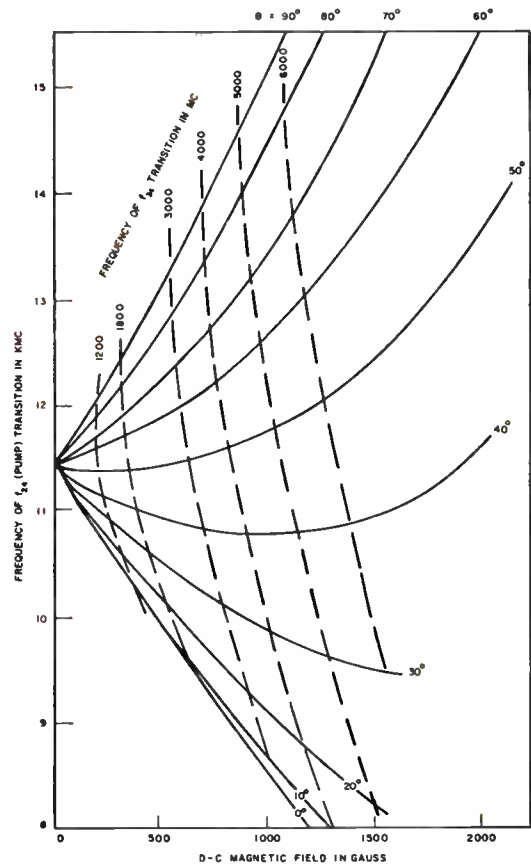

(a)

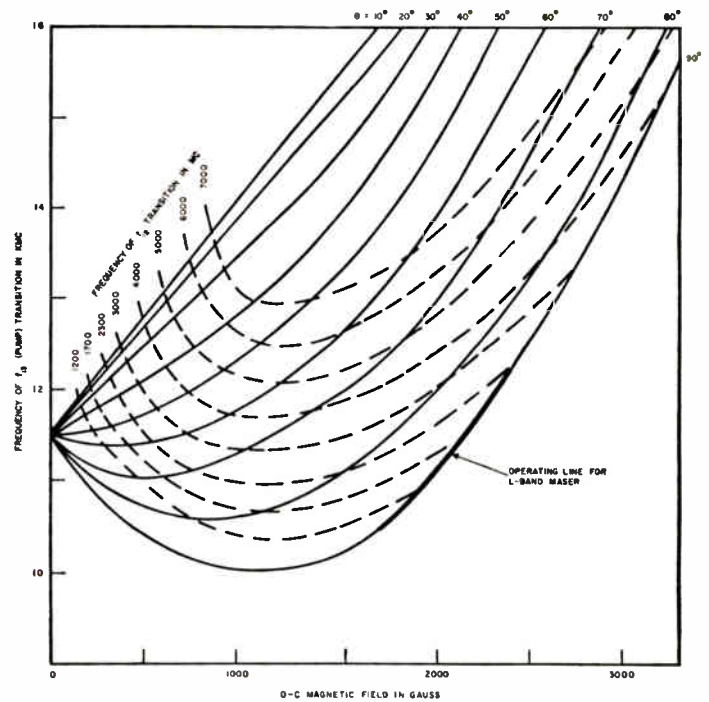

(b)

<sup>13</sup> C. L. Hogan, "Elements of non-reciprocal microwave devices," Proc. IRE, vol. 44, pp. 1345-1368; October, 1956.

Fig. 8—Frequency relationships for three-level ruby maser as a function of magnetic field and angular orientation. (a) Upper three energy levels. (b) Lower three energy levels.

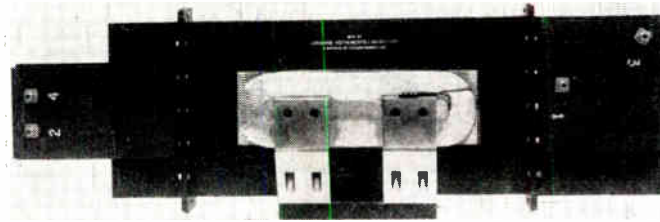
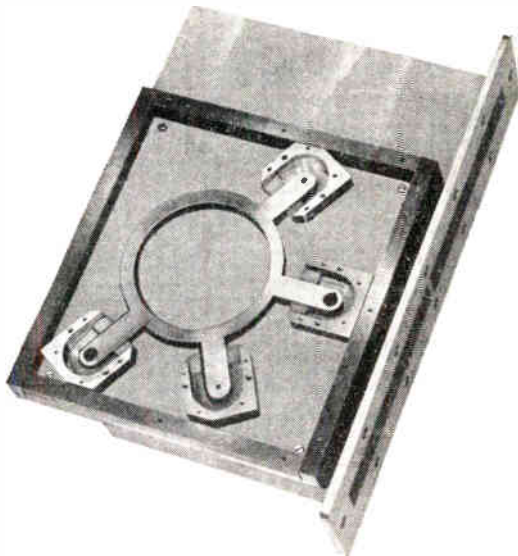
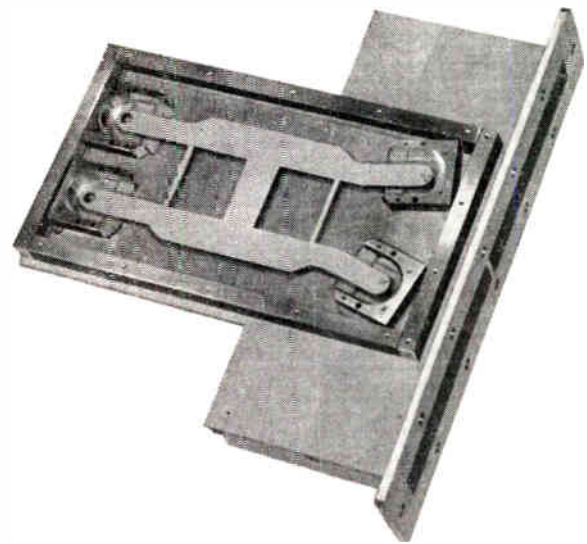

Fig. 9—Low-loss L-band circulator.



(a)



(b)

Fig. 10—Strip transmission line hybrids used in L-band circulator. (a) 180° 3-dB hybrid. (b) 90° 3-dB hybrid.

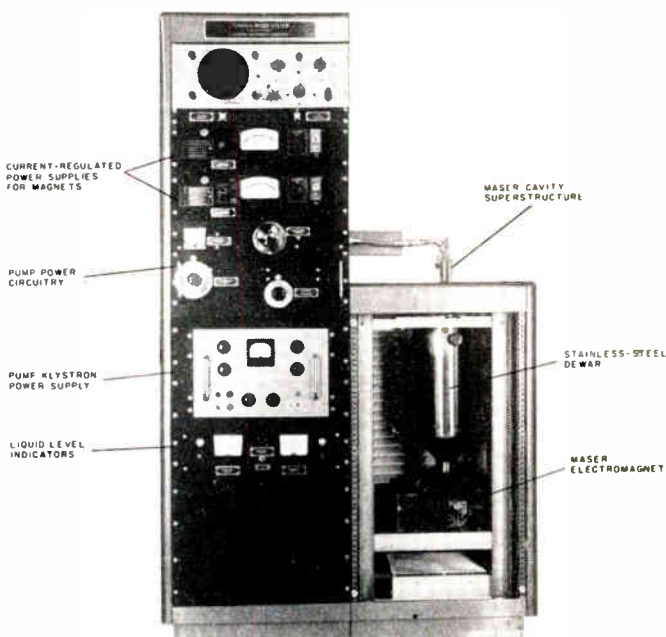

Fig. 11—Packaged maser system.

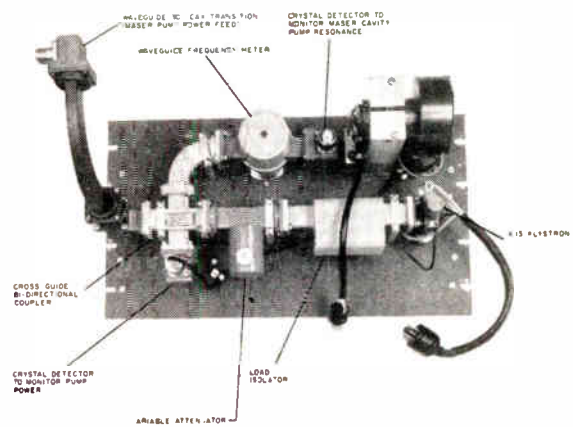

Fig. 12—Pump power circuitry.

- 3) pump power circuitry, including klystron, isolator, variable attenuator, frequency meter, bidirectional coupler, and detectors (shown in detail in Fig. 12);
- 4) klystron power supply; and
- 5) liquid level indicators for the refrigerants.



The circulator (which cannot be seen in Fig. 11) is located in the rear of the larger cabinet and is connected to the maser by a low-loss strip transmission line having  $1\frac{1}{2}$ -inch ground-plane spacing. The input to the maser system consists of  $1\frac{5}{8}$ -inch coaxial line.

### B. General Performance

The maser is easily tuned to any operating frequency over the 200-mc range by adjusting the dc magnetic field, the pump frequency, and the two cavity resonances. All the adjustments necessary for tuning the maser to a specific operating frequency have been calibrated. The signal-frequency cavity-resonance adjustment can be set to any specified frequency within  $\pm 2$  mc with the calibrated micrometer head. One of the required adjustments, the dc magnetic field, is critical and requires fine tuning. The other two adjustments (pump cavity resonance and pump frequency) are not critical; maser operation can be obtained with the pump cavity resonance and pump frequency detuned as much as 75 mc.

The angular orientation  $\theta$  of the ruby-loaded maser cavity with respect to the dc magnetic field is not critical. Maser operation has been obtained, without serious degradation in gain-bandwidth product, at angular deviations of several degrees from  $90^\circ$  throughout the tuning range. Consequently, controls for fine-tuning the alignment of the maser cavity were deemed unnecessary. A mechanical feature ensures that the maser cavity structure is correctly oriented when it is inserted into the system.

### C. System Noise Temperature

Noise-temperature measurements were made on the maser system using the technique described in Appendix I. The noise generators used for the measurement consisted of two matched loads—one at room temperature and one at liquid nitrogen temperature (Appendix II). A series of measurements, made with the maser operating at high gains, yielded a noise factor of  $0.5 \pm 0.1$  db, which is equivalent to a noise temperature of  $35^\circ\text{K}$ .

The main contributing noise sources are:

- 1) The dissipative losses of the circulator and input coaxial feed lines; these give a noise temperature of approximately  $28^\circ\text{K}$  (0.4 db).
- 2) The second-stage amplifier and other components at the output of the maser having an over-all noise factor of 7.2 db ( $1230^\circ\text{K}$ ). The amplifier consists of a balanced mixer utilizing 1N21EMR crystals and a 30-mc IF amplifier. Its measured noise factor was 6.6 db. With a net maser system gain of 23 db, this contribution is  $6.15^\circ\text{K}$ .
- 3) The maser signal frequency spin temperature, which is calculated to be  $1.5^\circ\text{K}$ , for a bath temperature of  $4.2^\circ\text{K}$ , assuming equal idler and signal spin-lattice relaxation times.

Thus, good correlation is obtained between the calculated and measured noise temperatures.

### D. Maser Saturation Characteristics

A saturation curve that was measured on the maser system is shown in Fig. 13. As can be seen, the gain drops 3 db at a power output of  $-35$  dbm. This yields a dynamic range of 68 db for a post-receiver bandwidth of 1 mc.

Susceptibility of the maser to nearby CW signals is shown in Fig. 14. The power level of the interfering signal, at which the maser gain drops 3 db at its center frequency, is plotted as a function of the frequency of the interfering signal. The shape of the measured response can be closely determined from the frequency response of the active maser cavity. The measurement was made with a three-cavity filter between the maser and the second stage receiver to ensure that the interference effect measured was primarily due to the maser proper. The filter had a 3-db bandwidth of 15 mc and an insertion loss of 25 db at 15 mc from center frequency.

It is essential that the input level of interfering signals be kept below the microwatt range (Figs. 13 and 14). To insure this, it is desirable to use a preselector cavity and/or passive ferrite limiter that has its limiting

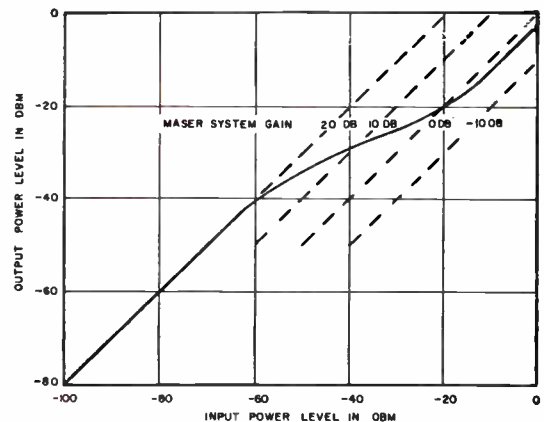

Fig. 13—Maser saturation characteristic due to main signal.

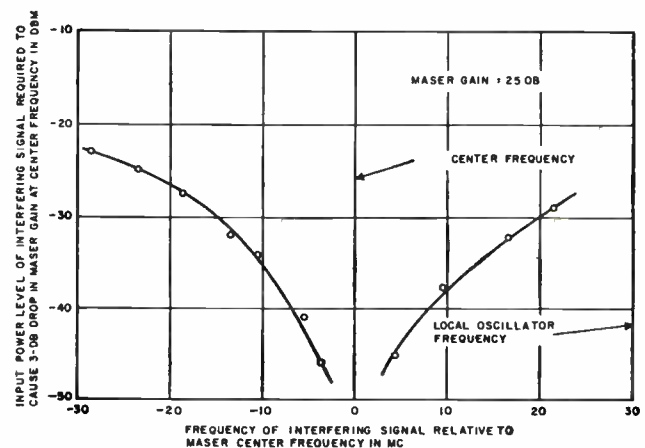

Fig. 14—Maser saturation characteristic due to nearby signals.

threshold at microwatt power levels.<sup>14</sup> These can be placed in the low temperature bath to minimize their noise contribution. The relatively low saturation power level (and relatively long recovery time) of the ruby maser is a result of the relatively long spin-lattice relaxation time of the idler transition, which (for  $\theta$  equal to  $90^\circ$ ) is in the tens of milliseconds at  $4.2^\circ\text{K}$ . Future masers will show marked improvements in saturation level and recovery time by using new materials or "impurity-doped" ruby to reduce the idler relaxation time.

To prevent maser saturation effects due to the local oscillator in the second-stage receiver, a balanced mixer should be used. A balanced mixer provides a local-oscillator isolation of 30 db, which, in combination with the circulator isolation and maser cavity selectivity, is more than sufficient to prevent maser saturation effects due to local-oscillator power leakage.

### E. Gain Stability

The results of a number of stability measurements at a helium bath temperature of  $4.2^\circ\text{K}$  and a maser gain of 22 db yielded a long-term peak-to-peak drift of  $\pm 0.55$  db, and a short-term peak-to-peak stability of  $\pm 0.1$  to  $\pm 0.2$  db over a period of several hours. These figures represent the fluctuations of a complete receiver with the maser front end fed by a standard signal generator. Hence, a portion of the output variation must be ascribed to parts of the measurement setup rather than the maser.

Turbulence in the liquid helium appears to be responsible for some of the short-term gain variations observed in the maser. This effect is reduced by the use of poly-foam loading of the microwave structure. The fluctuations are also significantly reduced by reducing the helium bath temperature below the  $\lambda$ -point ( $2.2^\circ\text{K}$ ), where the liquid helium becomes a superfluid.

The parameter having the greatest detrimental effect on long-term gain stability was found to be the maser magnetic field, which is controlled by a current-regulated power supply. This is evident when it is noted that the regulation must be substantially better than the magnetic line width of the ruby, which is about 1 per cent of the external magnetic field that was used. The electromagnet is designed to permit maser operation over the entire 850 to 2000 mc tuning range of the cavity. Improved stability can be obtained by using a permanent magnet employing an adjustable mechanical shunt or bucking coils for tuning, since a variation in magnetic field of about 6 per cent is needed to cover the 200 mc tuning range of the maser system.

## VII. CONCLUSION

It can be concluded that a cavity maser can be satisfactorily operated over frequency bands greater than

one octave. In packaging such a maser together with a circulator for field operational use, the usual 12-inch diameter laboratory magnet and other highly precise supplementary equipment have been eliminated without detrimental effect on gain-bandwidth product, noise figure, and other system parameters. The resulting equipment is reasonably compact and easily operated by semi-skilled personnel.

## APPENDIX I

### TECHNIQUES FOR MEASURING MASER GAIN-BANDWIDTH PRODUCT

The voltage-gain-bandwidth product was determined by two methods. In the first method, gain and half-power bandwidth were measured directly, using the setup shown in Fig. 15. Maser gain is measured by noting the increase in generator output required to maintain a constant output meter reading when the maser is disconnected from the circuit and replaced by a short-circuit at point A of Fig. 15.

In the second method, the external  $Q$  of the maser cavity was measured with the pump power and magnetic field turned off. The voltage-gain bandwidth product  $G^{1/2}B$  can then be calculated since, for the condition of high gain ( $G^{1/2} \gg 1$ ), it is approximately

$$G^{1/2}B \approx \frac{2f}{Q_e} \quad (1)$$

where  $f$  is the signal frequency and  $Q_e$  is the external  $Q$ . The more exact expression<sup>15</sup> for  $Q_e \gg Q_c$  is

$$G^{1/2}B = \frac{2f}{Q_e} \left[ \frac{G^{1/2}}{G^{1/2} + 1} \right] \quad (2)$$

The bracketed term in (2) is the correction factor on the approximation. It is plotted in Fig. 7, and is seen to be less than 10 per cent for gains greater than 20 db.

For comparison with theoretical computations of maser performance, it is desirable to determine  $Q_m$ , the magnetic  $Q$ , which is a measure of the negative resistance introduced by the paramagnetic maser material.

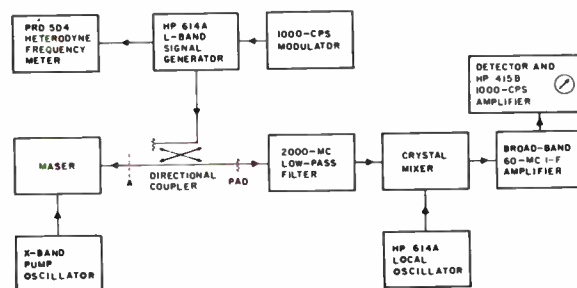

Fig. 15—Measurement setup for maser gain and bandwidth.

<sup>14</sup> R. W. DeGrasse, "Low-loss gyromagnetic coupling through single crystal garnets," *J. Appl. Phys.*, vol. 30, suppl. 4, pp. 155.S-156.S; April, 1959.

<sup>15</sup> J. O. Artman, "The Solid-State Maser," *Proc. Symp. on Role of Solid-State Phenomena in Electric Circuits*, Polytechnic Inst. of Brooklyn, Brooklyn, N. Y., sec. 3, p. 77; April, 1957.

The magnetic  $Q$  is related to  $Q_e$  by the expression

$$\frac{Q_e}{Q_m} = \frac{G^{1/2} - 1}{G^{1/2} + 1}, \quad (3)$$

and is plotted in Fig. 7. Obviously,  $Q_e \approx Q_m$  for high gains. The correction factor is less than 20 per cent for gains greater than 20 db.

APPENDIX II

MEASUREMENT OF SYSTEM NOISE TEMPERATURE

Of the several methods used for the measurement of noise temperature,<sup>16</sup> the  $Y$ -factor method appeared to be most satisfactory for low noise temperatures. In this method, the output noise power of the receiver, when the input source resistance is at a high temperature  $T_2$ , is compared with the output noise power of the receiver when the input source resistance is at a lower temperature  $T_1$ . The ratio of these two noise powers is called the  $Y$ -factor, which is related to the noise temperature,  $T_e$ , by the expression

$$T_e = \frac{T_2 - T_1}{Y - 1} - T_1. \quad (4)$$

The accuracy with which  $T_e$  can be determined depends upon how accurately  $T_1$ ,  $T_2$ , and  $Y$  are known.

Fig. 16 shows the experimental arrangement used for the noise measurement. The available noise power from the two loads (one maintained at a liquid nitrogen temperature of 77.3°K, and the other at room temperature) is alternately coupled to port 1 of the circulator through a coaxial switch. These noise powers are directed by the circulator into the maser (port 2) and from the maser into a second-stage amplifier consisting of a mixer and an AIL Type 130 Test Receiver. The  $Y$ -factor is then accurately determined by using a precision calibrated attenuator that is part of the AIL Type 130 Test Receiver.

It is estimated that the absolute temperature of the two loads can be determined to within  $\pm 1^\circ\text{K}$  and that the  $Y$ -factor can be measured to within  $\pm 0.5$  per cent.

<sup>16</sup> M. Wind, "Handbook of Electronic Measurements," Microwave Res. Inst., Polytechnic Inst. of Brooklyn, Brooklyn, N. Y., ch. 13; 1954-1955.

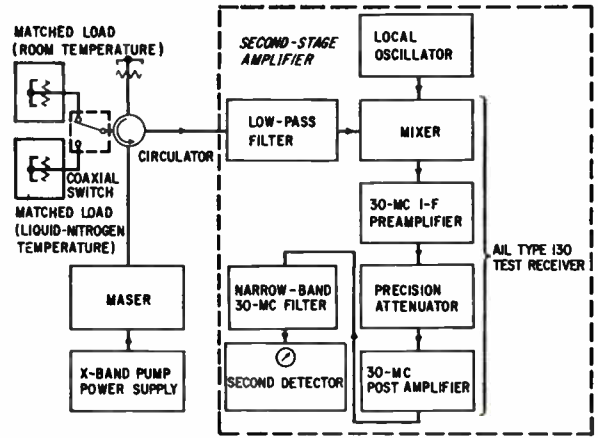

Fig. 16—Measurement setup for maser system noise temperature.

Application of these errors to a variational form of (4) yields a calculated over-all measurement accuracy of better than  $\pm 3^\circ\text{K}$ .

In measuring low noise temperatures, the following precautions were taken.

- 1) The two noise generators (ambient temperature load and the liquid nitrogen load) were well matched.
- 2) Linearity measurements of the second-stage amplifier were made over a 40-db range. The linearity was found to be within  $\pm 0.05$  db. In addition, the bandwidth of the second stage was made narrower than that of the first stage, to eliminate bandwidth corrections from the noise-factor measurement.
- 3) The over-all receiving system was tested for spurious responses. Since broad-band noise sources were used, all spurious responses must be known to reduce the measurement data accurately. All spurious responses were found to be negligible.

ACKNOWLEDGMENT

The advice and aid of C. H. Townes and A. Penzias of Columbia University during the early phases of the project are gratefully acknowledged. The authors also wish to express their gratitude to their co-workers, J. G. Smith and M. Grace, who helped with the packaging and with the measurements.



# Cadmium Sulfide Field Effect Phototransistor\*

R. R. BOCKEMUEHL†

**Summary**—The experimental evaluation of cadmium sulfide field effect transistors indicates that, although the material does not compete with germanium for general transistor application, useful power gain was achieved and certain advantages exist for CdS in phototransistor applications. Many unique circuit functions can be performed by the device. The active electronic properties vary greatly with the intensity and wavelength of incident light, and with photoconductivity quenching infrared radiation. Voltage gains greater than 500, mutual transconductances up to 20  $\mu$ mho and input resistances near 100 megohms have been observed. Electron-hole pairs are generated photoelectrically in the highly pure, single crystal CdS. The holes are virtually immobile and form a space charge when an applied electric field removes the mobile electrons from a region. Modulation of the space charge boundary by application of a potential to one terminal of the device produces modulation of the conductance between two other terminals and signal amplification results. Attempts to correlate the illumination sensitivity of the terminal characteristics with theoretical field effect parameters indicates the carrier distribution in the crystal is complex and varies with illumination wavelength and quenching intensity.

## INTRODUCTION

THE group II-VI compound semiconductors have potential advantages as specialized electronic components with transistor configurations. For example, the utility of photoconductive materials may be extended when fabricated as a transistor. Furthermore, transistor configurations facilitate observation of additional material properties and mechanisms which may extend theoretical understanding of semiconductors. The group II-VI compounds are not expected to compete with elemental or group III-V compounds as general-purpose transistor materials, inasmuch as those studied possess a prohibitively low carrier mobility, or low band gap, or high "intrinsic" carrier concentration.<sup>1</sup> The study of group II-VI transistors is important, however, on the basis of improvement of understanding and utilization of specialized properties, particularly photoelectric properties.

Cadmium sulfide was selected for transistor experimentation because its properties are probably the best known of the II-VI compounds and because it is available in sufficiently pure, single-crystal form.<sup>2</sup> The relatively low mobility of CdS ( $\approx 200$ ) requires an excessively thin base layer in a junction transistor configuration. However, the unipolar field effect transistor con-

figuration permits practical device dimensions even though mobility is relatively low.

The field effect transistor was first given detailed consideration by Shockley.<sup>3</sup> Modulation of the conductance of a unipolar semiconductor slab is achieved by applying an electric field, perpendicular to the current flow, creating a space charge region which effectively reduces the conducting cross section of the slab. In practice, the transverse field is applied through an intimate, but non-carrier-injecting contact such as a *p-n* junction. Application of the transverse field through an insulating medium does not produce an appreciable space charge in the semiconductor slab because of trapped charges which develop on the slab surface.<sup>3</sup>

Experimental field effect transistors have been fabricated from Ge<sup>4</sup> and Si,<sup>5</sup> and the effect has been observed in InP and GaAs.<sup>6</sup> However, no previous observation of field effect amplification has been reported for any group II-VI compound, nor for any material in which virtually all of the carriers are generated photoelectrically.

## FABRICATION

The experimental field effect phototransistors were cut from thin single-crystal plates with a special air-abrasive cutting machine to dimensions of 3 mm  $\times$  3 mm square. Thickness was not modified and ranged from 0.15 to 0.5 mm in various units. The thin CdS crystal plates were grown by the vaporization-crystallization method by Boyd and Sihvonen.<sup>2</sup> The placement of the contacts is illustrated in Fig. 1. The contact nomenclature is consistent with that proposed by Shockley.<sup>3</sup> The gate contact is vacuum deposited copper, a few hundredths of a micron thick. The necessary rectifying characteristic is obtained by heating at 400°C for ten minutes in room air. The gate contact is transparent and back resistance is greater than 10<sup>7</sup> ohms. The formation of the rectifying junction is similar to that described by Reynolds, *et al.*;<sup>7</sup> however, the presence of air was found to be necessary during the heating process.

<sup>3</sup> W. Shockley, "A unipolar 'field effect' transistor," *PROC. IRE*, vol. 40, pp. 1365-1376; November, 1952.

<sup>4</sup> G. C. Dacey and I. M. Ross, "Unipolar field effect transistor," *PROC. IRE*, vol. 41, pp. 970-979; August, 1953.

<sup>5</sup> G. L. Pearson, "High impedance field effect silicon transistors," *Phys. Rev.* vol. 90, p. 336; April, 1953.

<sup>6</sup> A. Herzog, R. R. Haberecht, and A. E. Middleton, "Preparation and properties of aluminum antimonide," *J. Electrochem. Soc.*, vol. 105, p. 535; September, 1958.

<sup>7</sup> D. C. Reynolds, L. C. Greene, and L. L. Antes, "Properties of a cadmium sulfide photo-rectifier," *J. Chem. Phys.*, vol. 25, pp. 1177-1179; December, 1956.

\* Original manuscript received by the IRE, October 22, 1959.

† Res. Labs., General Motors Corp., Warren, Mich.

<sup>1</sup> D. A. Jenny, "The status of transistor research in compound semiconductors," *PROC. IRE*, vol. 46, pp. 959-968; June, 1958.

<sup>2</sup> D. R. Boyd and Y. T. Sihvonen, "Vaporization-crystallization method for growing CdS single crystals," *J. Appl. Phys.*, vol. 30, pp. 176-179; February, 1959.

The ohmic source and drain contacts were prepared by electroplating indium from an indium fluoroborate solution after the gate contact heat treatment. All surfaces were cleaned and etched in HCl before contact application. Leads were connected to contacts with silver conducting paint. The units were mounted first on special printed circuit boards, and later in standard transistor headers with transparent cover as shown in Fig. 2.

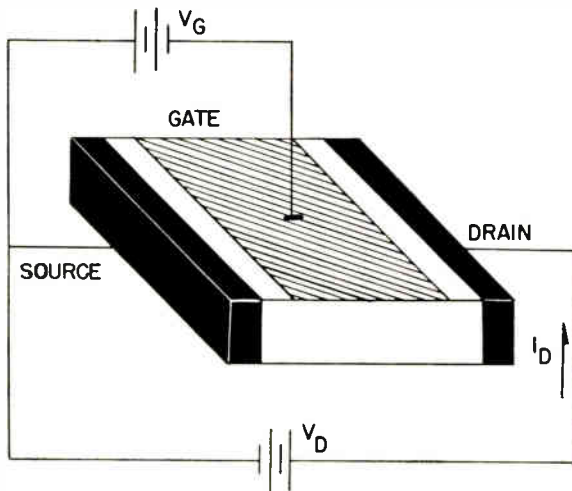

Fig. 1—Field effect phototransistor terminal relationship and common source connection. Source and drain are ohmic; gate is diodic and semitransparent.

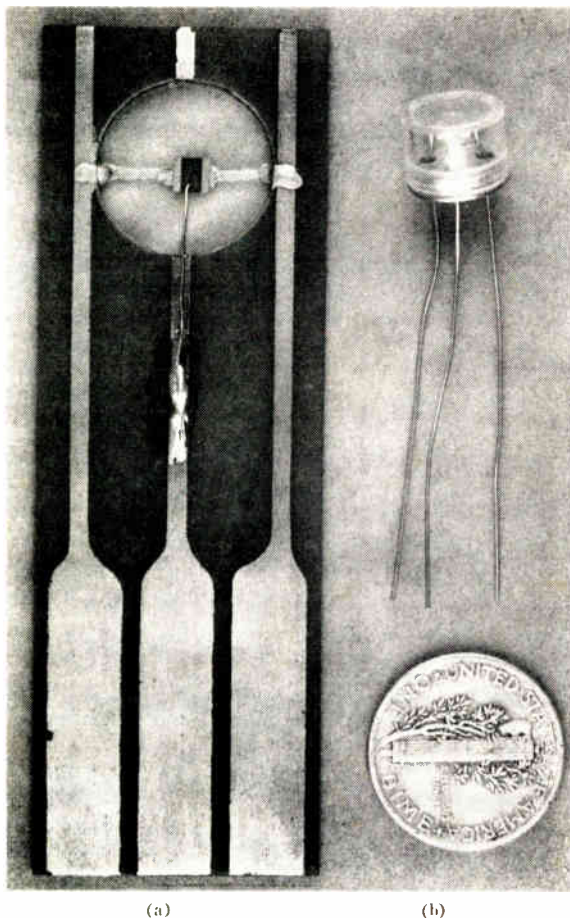

Fig. 2—Cadmium sulfide field effect phototransistors. (a) Mounted for detailed evaluation. (b) Mounted in transparent transistor header.

## TERMINAL CHARACTERISTICS

The penetration of the space charge layer into the semiconductor slab, and the resulting decrease in the slab conductance is determined by the magnitude of the reverse bias voltage across the gate junction. Considering the grounded source terminal configuration, Fig. 1, the gate bias voltage is the difference between the potential applied to the gate terminal and the potential in the semiconductor slab. The latter is a function of the drain terminal potential. Thus, the slab conductance is a function of both gate and drain potentials.

The drain terminal voltage-current characteristic at various values of gate voltage (common source) is shown in Fig. 3. A "constant" current region of operation exists when the gate-to-drain potential difference is sufficient to cause the thickness of the space charge layer to approach that of the slab. This bias voltage is designated "pinch-off" voltage  $V_p$ . An increase in drain voltage above the  $V_p$  value alters the space charge distribution in such a manner to keep the pinch-off current essentially constant. The gate potential determines the value of the pinch-off current; thus an active gate-to-drain mutual transconductance  $G_m$  exists. The mutual transconductance, together with the high dynamic output impedance of the device, permits a large voltage gain to be realized. Furthermore, the high gate terminal impedance of the device permits useful current and power gains to be realized.

The terminal characteristics of the field effect phototransistor are dependent on the carrier density within the slab, which is determined by the intensity and wavelength of the incident light excitation. Therefore, these characteristics vary greatly with illumination parameters.

Typical characteristics of a unit when illuminated with an incandescent lamp at an intensity of the order of 200 foot-candles are as follows:

- Pinch-off current ( $V_g = 0$ ): 200  $\mu a$ ,
- Pinch-off voltage: 30 volts,
- Mutual transconductance: 20  $\mu mho$ ,
- Short circuit current gain: 400,
- Open circuit voltage gain: up to 1000,
- Output impedance (resistive): up to 50 megohms,
- Input impedance: 20 to 100 megohms depending on load resistance.

A finite gate-to-drain resistance exists which produces feedback resulting in the dependence of input impedance on load resistance and of output impedance on source resistance.

Several experimental phototransistors were operated in a temperature range from  $-50^\circ F$  to  $150^\circ F$  with a negligible change in terminal characteristics when illuminated with an incandescent lamp. However, a considerable temperature dependence was observed when illuminated with monochromatic wavelengths greater than 5300 angstroms.

Frequency response varies greatly with operating conditions but extends from dc throughout the audio range.

High-frequency attenuation results from the junction capacity of the gate and from stray capacities in the drain circuit in conjunction with the high dynamic drain impedance.

PHOTOELECTRIC CHARACTERISTICS

The pinch-off current of the cadmium sulfide field effect phototransistor is much more sensitive to illumination intensity and wavelength than are the other electrical parameters of the device. The photoconductivity of cadmium sulfide exhibits a sharp peak between 5100 and 5200 Å.<sup>8</sup> The wavelength dependence of pinch-off current of the transistor, and the photocurrent when connected as a two-terminal photoconductor is shown in Fig. 4. Under certain operating conditions, the pinch-off current has been observed to be proportional to the square of the illumination intensity. Sensitivities of the

<sup>8</sup> M. Balkanski and R. D. Waldron, "Internal photoeffect and exciton diffusion in cadmium and zinc sulfides," *Phys. Rev.*, vol. 112, pp. 123-125; October 1, 1958.

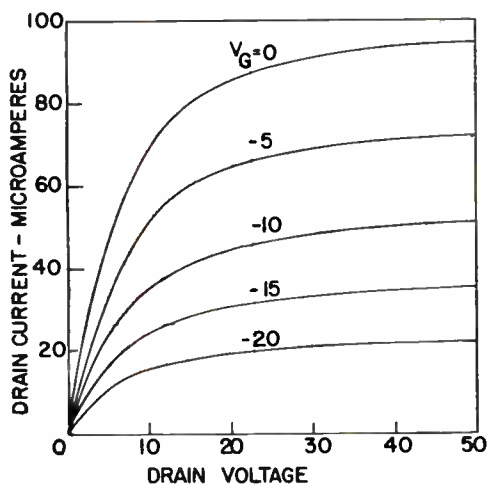

Fig. 3—Typical drain terminal characteristic with common source connection and 200 foot-candle illumination.

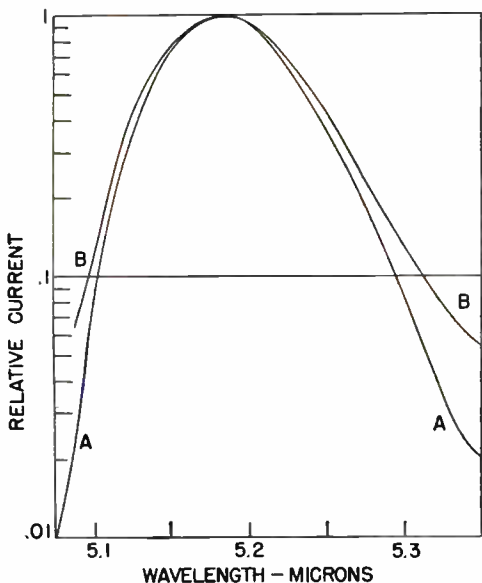

Fig. 4—Pinch-off current (A), and two-terminal photocurrent (B), as a function of incident wavelength.

order of  $10^{-8}$  amperes per foot-candle squared have been observed with incandescent illumination.

The pinch-off current is also very sensitive to infrared quenching wavelengths.<sup>9</sup> Certain discrete wavelengths in the 1-micron region, when applied in combination with excitation wavelengths, cause a reduction in the conductivity of cadmium sulfide and produce other effects which sharply reduce the pinch-off current. This wavelength dependence of the pinch-off current and two-terminal photocurrent is shown in Fig. 5. Pinch-off current sensitivities of the order of  $1 \mu a/\mu w/cm^2$  have been observed. The variation of pinch-off current and two-terminal photocurrent with infrared quenching intensity is shown in Fig. 6. The pinch-off current is many times more sensitive to infrared quenching intensity than is the two-terminal photocurrent.

<sup>9</sup> R. H. Bube, "Infrared quenching and unified description of photoconductivity phenomena in cadmium sulfide and selenide," *Phys. Rev.*, vol. 99, pp. 1105-1116; August, 1955.

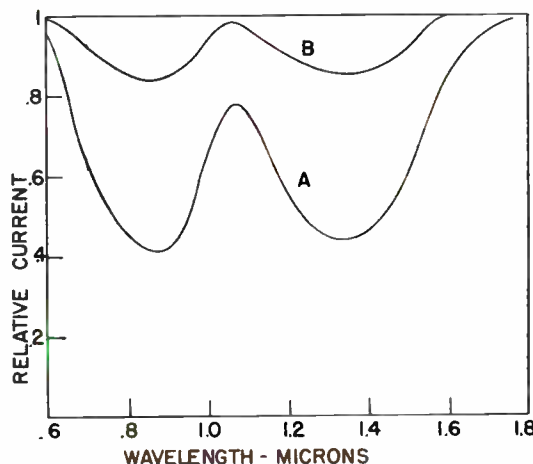

Fig. 5—Infrared quenching vs wavelength with constant excitation illumination from tungsten source; A) pinch-off current, B) two-terminal photocurrent.

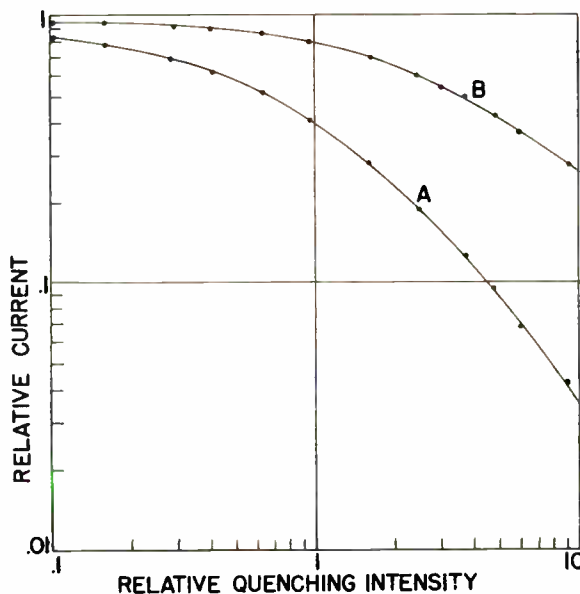

Fig. 6—Infrared quenching vs quenching intensity, A) pinch-off current, B) two-terminal photocurrent. Quenching source: 1200°K black body; excitation source: 2850°K tungsten source with quenching wavelengths filtered out.



## FIELD EFFECT PARAMETERS

Field effect theory in a photoconductor differs in detail from that in a doped semiconductor, although generalizations common to both cases can be derived. The parameters used in deriving theoretical relationships are common to both cases but some which are constant in doped semiconductors are variables when photoconductors are considered.

The electrical characteristics of a field effect transistor are dependent on the physical dimensions and the bulk properties of the semiconductor slab. The important dependent and independent parameters are summarized:

- $V_p$  = pinch-off potential, volts,
- $I_p$  = pinch-off current, amperes,
- $a$  = thickness, cm,
- $c$  = width, cm,
- $L$  = length, cm,
- $\rho$  = charge density, coulombs/cm<sup>3</sup>,
- $k$  = dielectric constant, farads/cm,
- $\mu$  = carrier mobility, cm<sup>2</sup>/volt-second.

The following relationships are based on the gradual approximation defined by Shockley.<sup>3</sup> The potential within the semiconductor slab  $V(y)$ , the field  $E_y$  and the charge density  $\rho(y)$  are related by Poisson's equation:

$$-d^2V(y)/dy^2 = dE_y/dy = \rho(y)/k, \quad (1)$$

where  $(y)$  is the distance from the gate surface. The induced charge is contained in the space charge layer and an increase in junction bias voltage increases the total space charge by extending the boundary of the space charge layer. The relationship between bias voltage and space charge layer thickness is dependent on the manner in which the space charge is distributed in the material. However, considering a general charge density distribution, the pinch-off potential can be derived from (1) in the following form:

$$V_p = (\rho_0 a^2 / 2k) [D_v], \quad (2)$$

where  $[D_v]$  is a function of the charge distribution, and  $\rho_0$  is the charge density at  $y=0$ .

Inasmuch as a potential gradient exists in the direction of current flow ( $x$ ), the potential in the conducting channel and the resulting space charge boundary are both functions of ( $x$ ), the distance from the source contact. Therefore the current density in the conducting channel is a function of ( $x$ ). Furthermore, if free carrier distribution in the conducting channel is a function of ( $y$ ), the conductivity  $\sigma(y)$  and the current density  $J$  will be a function of ( $y$ ):

$$J(x, y) = E_x \sigma(y). \quad (3)$$

Integration of (3) over suitable limits yields pinch-off current,

$$I_p = (a^3 c \mu \rho_0^2 / 6kL) [D_1], \quad (4)$$

when the gate-to-source voltage equals zero.

The bulk conductance of the semiconductor slab with no space charge layer is

$$G_0 = (c/L) \int_0^a \sigma(y) dy = (\rho_0 a c \mu / L) [D_0], \quad (5)$$

where  $[D_0]$  is another function of carrier distribution.

The mutual transconductance  $G_m$  of a field effect transistor with zero bias between gate and source terminals is theoretically equal to the bulk conductance  $G_0$  of the slab.

The portions of (2), (4), (5) which are in parentheses are independent of the charge distribution. The bracketed portions are dependent on charge distribution and are always dimensionless. The distribution functions will generally include the thickness parameter ( $a$ ). The distribution functions for an exponential charge distribution are derived in the Appendix.

## FIELD EFFECT IN A PHOTOCONDUCTOR

The principal differences encountered in consideration of field effects in a photoconductor and in a doped semiconductor result from the differences in the mechanisms which determine the space charge distribution and the carrier distribution in the material. In the analyses made by Shockley<sup>3</sup> and by Warner, *et al.*,<sup>10</sup> semiconductor materials such as Ge and Si were sufficiently activated with donors or acceptors to permit minority carriers to be neglected. The application of an electric field which removes the majority carriers from a region creates a space charge in that region with polarity opposite to that of the removed carriers. The distribution of the charge density in the space charge region is equal to the difference between donor and acceptor density in that region. Furthermore, the distribution of the carrier density in the conducting channel is equal to that of this activation density in the channel.

In an insulating photoconductor, however, electron-hole pairs are generated photoelectrically. In CdS and other  $n$ -type photoconductors, free holes produced by pair excitation are captured quickly by imperfection centers.<sup>11</sup> The resulting free hole mobility and lifetime have extremely low values; the holes can be assumed to be immobile in a first-order approximation. Application of an electric field to illuminated CdS, which removes the free electrons from a region, creates a positive space charge in that region in the form of trapped holes.

<sup>10</sup> R. M. Warner, W. H. Jackson, E. I. Doucette, and H. A. Stone, "A semiconductor current limiter," *Proc. IRE*, vol. 47, pp. 44-56; January, 1959.

<sup>11</sup> R. H. Bube, "Photoconductivity of the sulfide, selenide, and telluride of zinc or cadmium," *Proc. IRE*, vol. 12, pp. 1836-1850; December, 1955.

Inasmuch as the space charge and carrier distribution in a doped semiconductor correspond directly to the activation distribution, these values can be evaluated and applied to field effect equations. Furthermore, the distribution functions do not have first-order dependence on external parameters. In a photoconductor, however, the space charge and carrier distribution is an interdependent function of illumination intensity and wavelength, crystal inhomogeneities and electric field. The distribution functions are not only difficult to predict but also vary greatly with external parameters.

The carrier density in a photoconductor is equal to the rate at which the free carriers are generated per unit volume (excitation density) times the mean carrier lifetime in the conduction band before recombining with a hole. The carrier density distribution within the photoconductor slab is dependent on the distribution of the excitation density and on the manner in which the carriers may diffuse or drift from their generation sites. The excitation density at a particular point is proportional to the rate at which light is absorbed at that point. The light intensity distribution is a function of the incident light intensity  $J_0$  and the absorption coefficient  $\alpha$  and is related by Lambert's law:

$$J(y) = J_0 \exp(-\alpha y), \quad (6)$$

where  $(y)$  is the distance from the illuminated surface. The excitation density  $f(y)$  is proportional to the rate of absorption:

$$f(y) = -dJ(y)dy = J_0\alpha \exp(-\alpha y). \quad (7)$$

The absorption coefficient  $\alpha$  is a function of wavelength<sup>8</sup> and may vary over a range from 10 to 10<sup>4</sup> cm<sup>-1</sup>. Thus illumination wavelength is important in determining the excitation density distribution.

Because of their very short lifetime as a carrier and low mobility, the generated holes do not drift an appreciable distance from their point of generation. The drift may not be entirely negligible at illumination wavelengths which yield a very high absorption coefficient, inasmuch as all of the carriers may be generated in an extremely narrow region near the surface. In addition, exciton diffusion lengths in CdS have been reported to be of the order of one cm and exciton production has been found to exceed pair production at certain wavelengths.<sup>8</sup> Excitons may diffuse into unilluminated regions of the crystal and dissociate into electron-hole pairs, thereby influencing charge distribution.

Carrier lifetime is probably nonuniform throughout the crystal, especially in the presence of infrared quenching radiation. Near-infrared radiation in the 0.89- and 1.35-micron regions cause a reduction of the photoconductivity of CdS, as shown in Fig. 5, by effectively reducing the carrier lifetime. A mechanism has been proposed whereby the infrared shifts the population density of certain recombination centers with a re-

sulting increase in recombination rate.<sup>9</sup> The quenching effect is a function of the ratio of quenching intensity to excitation intensity.<sup>9</sup> Most excitation radiation is absorbed in relatively short distances in the crystal, while the absorption of the infrared quenching radiation is very slight. Thus, the ratio of quenching to excitation wavelengths increases with distance ( $y$ ) from the illuminated surface, and the free carrier lifetime may be expected to decrease with ( $y$ ), with a corresponding decrease in free electron and trapped hole density. The influence of quenching radiation on the charge distribution may be great and would account for the significantly greater effect of infrared on the pinch-off current than on the two-terminal photocurrent as shown in Figs. 5 and 6. The two-terminal photocurrent is proportional to the bulk conductance of the semiconductor slab. The bulk conductance (5) is proportional to the area under the charge distribution curve, independent of its shape, while the pinch-off voltage and current are extremely sensitive to the distribution characteristic.

All of the factors discussed so far affect the charge distribution in a perfectly homogeneous semiconductor slab. Additional factors exist in a practical device. For example, the carrier lifetime, mobility and infrared effects may be significantly different at the crystal surface than in the interior of the slab, effecting a charge distribution discontinuity near the surface. Furthermore, inasmuch as the gate is formed by heating a copper contact, the copper is diffused a small but finite distance into the crystal. The excitation density, carrier lifetime, mobility, infrared effects and the resulting charge distribution will be different in this "doped" region than in the bulk of the slab.

#### EXPERIMENTAL CORRELATION

Qualitative correlation of the experimental results with theoretical relationships is possible if an assumption of the charge distribution is made. Quantitative correlation is not possible because of incomplete knowledge relating the many factors which influence the charge distribution. Because of the exponential decrease of light intensity within the crystal, a simple first assumption is that the charge distribution decreases exponentially with distance from the illuminated surface. Then, if the gate surface is illuminated,

$$\rho(y) = \rho_0 \exp(-my), \quad (8)$$

where  $m$  is a factor which represents the combined effects of all the mechanisms producing the exponential reduction. With this distribution, the distribution functions in (2), (4), (5) are, as derived in the Appendix,

$$[D_v]_G = (2/m^2a^2)(e^{-ma} + ma e^{-ma} - 1), \quad (9)$$

$$[D_I]_G = (3/2m^3a^3)[(2ma + 3)e^{-2ma} - 4e^{-ma} + 1], \quad (10)$$

$$[D_o] = (1/ma)(1 - e^{-ma}). \quad (11)$$

If the surface opposite the gate junction is illuminated, the charge distribution is reversed:

$$\rho(y) = \rho_0 \exp m(y - a), \quad (12)$$

$$[D_r]_0 = (2/m^2 a^2)(ma + e^{-ma} - 1), \quad (13)$$

$$[D_I]_0 = (3/2m^3 a^3)[(2ma - 3) + 4e^{-ma} - e^{-2ma}]. \quad (14)$$

Inasmuch as the bulk conductance is proportional to the area under the  $\rho(y)$  curve,  $[D_y]$  is not dependent on which surface is illuminated.

The ratio of the pinch-off current with opposite surface illuminated to that with the gate surface illuminated is equal to the ratio of the corresponding distribution functions:

$$(I_p)_0/(I_p)_G = [D_I]_0/[D_I]_G. \quad (15)$$

Pinch-off current ratios were obtained experimentally at several illumination wavelengths and quenching intensities. When the illumination was changed from the gate side to the opposite side, the illumination intensity was adjusted to yield a common value of bulk conductance. This partially compensates for the reduction of intensity by the semitransparent copper gate. Pinch-off current ratios in the range from 1 to 4 were observed, indicating a variation in the value of  $(ma)$  from 0 to 3.1. Thus, a qualitative variation of the charge distribution with both illumination wavelength and quenching intensity is indicated.

The measured value of pinch-off current ratio is subject to error inasmuch as the semitransparent gate reduces the effective incident illumination on only that portion of the surface beneath the gate. When illuminated from the gate side, the relative intensity is greater on the end portions than beneath the gate. However, when illuminated from the opposite side, the incident intensity is uniform over the entire surface. Inasmuch as the portions of the slab outside of the gate region act as degenerative feedback resistances,<sup>4</sup> the resulting feedback ratio will also change with direction of illumination. For this reason, the measured values of the pinch-off current ratios will be slightly lower than the ratios of their distribution functions.

The distribution functions  $[D_I]_G$  and  $[D_y]$  from (10) and (12), are plotted as a function of  $(ma)$  in Fig. 7. The experimentally obtained relationship between pinch-off current and two-terminal photocurrent as a function of infrared quenching intensity, Fig. 6, is qualitatively similar to the theoretical curves, Fig. 7. The similarity between the experimental and theoretical curves indicates that the assumed exponential distribution may not differ greatly from the actual distribution and that the exponent  $(m)$  increases with infrared quenching intensity.

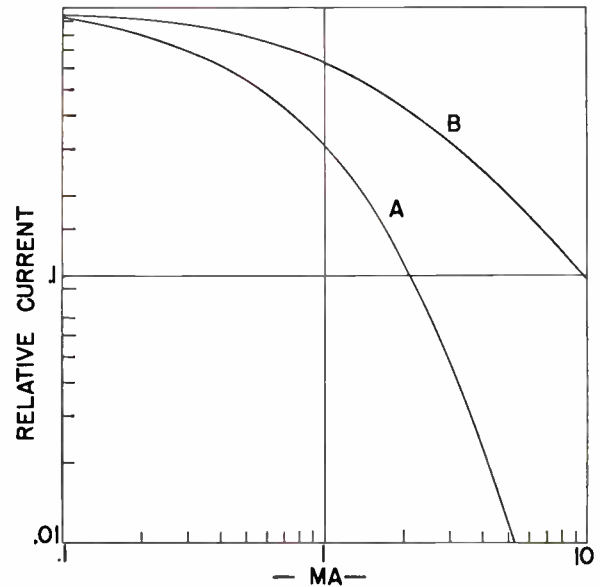

Fig. 7—Theoretical relationship between distribution function and the exponent  $(ma)$  with exponential charge distribution, for A) pinch-off current with gate side illuminated, B) two-terminal photocurrent.

#### PRACTICAL APPLICATIONS

The unique characteristics of field effect phototransistors allow them to perform new and combined circuit functions which are not practicable with conventional circuit elements. Furthermore, they are solid state devices having the small size, high efficiency and ruggedness common to semiconductor components.

Direct connection of the gate-to-drain terminals yields a two-terminal current limiter similar to that described by Warner, *et al.*,<sup>10</sup> but whose limiting current is a function of light intensity. Because of its high ratio of dynamic-to-dc impedance, the device can be applied to conventional two-terminal photoconductor circuits (*i.e.*, bridges and dividers) and produce a considerably greater output voltage change for a given supply voltage than would a simple two-terminal photoconductor. Furthermore, the dependence of pinch-off current on the square of the light intensity has particular advantage in detecting small changes in relatively large light levels.

When connected in a conventional photocell circuit, application of suitable signals to the gate will perform switching and modulating functions. A reference voltage can be applied to the gate terminal which will determine the light intensity required to produce a particular output current for use in illumination control systems. Furthermore, suitable feedback networks between the gate and drain terminals can be used for frequency or temperature compensation, or for arbitrary shaping of the device characteristics.

Inasmuch as the field effect phototransistor has useful power gain, it can be used as an oscillator or as a signal amplifier. Phase shift oscillators employing one pho-



totransistor have been constructed whose amplitude is a function of light intensity or which will oscillate only within a narrow range of incident light intensity. Signal amplifiers have been made which have light dependent gain, and which can be gated on or off with light intensity. Neon lamp relaxation oscillators using the cadmium sulfide transistor in place of the conventional resistor produce a very linear, constant amplitude sawtooth signal whose repetition rate can be varied with gate voltage and light intensity.

Unusual circuit functions can be performed by the device when signal information is contained in both the light modulation and gate voltage. For example, if the device is connected as a marginal oscillator, a discrete output occurs when the incident light intensity is modulated at the oscillator frequency. Furthermore, if the light modulation frequency is the same as that of the gate signal, synchronous phase discrimination results. Other specialized circuit functions can be performed by circuits which include two or more field effect phototransistors or by combining with other active circuit elements. The combination of this amplifying photoconductive device with electroluminescent devices may extend the utility of photoelectric circuits.<sup>12</sup>

#### PRACTICAL LIMITATIONS

The CdS field effect transistor does not compete with conventional junction transistors or vacuum tubes for general amplification applications. The major difficulties encountered in design of practical circuits using the device result from the relatively low mutual transconductance and high output impedance.

The mutual transconductance with zero gate voltage is approximately equal to the bulk conductance of the semiconductor slab, (5), and is a function of the carrier charge density, mobility and slab dimensions. Carrier density is the only parameter sufficiently flexible to permit a significant increase in transconductance. Increasing carrier density by a factor of 10 will increase  $G_m$  by that factor but will also increase pinch-off voltage by 10, pinch-off current by 100 and quiescent power dissipation by 1000. This results in impractical values for pinch-off current and voltage, and the power dissipation and electric field in the semiconductor slab may reach destructive limits of the material. Thus,  $G_m$  is limited to values of the order of  $10 \mu\text{mho}$  in a CdS field effect transistor.

Both the output and input resistances of the CdS transistor are higher than are normally encountered with junction transistors and vacuum tubes. Efficient coupling to other active circuit elements is difficult and its advantageous use as an amplifying element is limited to low-frequency applications requiring high impedance

levels (*i.e.*, photomultiplier or ion chamber signal amplification).

Improvement of the practical amplification characteristics can be achieved by increasing the carrier mobility of the slab material. This requires selection of a different material and would ultimately lead to an elemental or a group III-V compound semiconductor. However, CdS is very likely the best material for phototransistor application.

#### APPENDIX

A more general mathematical formulation is required to derive field effect equations for exponential charge distribution than is necessary for uniform<sup>3</sup> or linear graded<sup>10</sup> distributions. If the charge distribution is known, a relationship  $V_g = f(h)$  can be derived from the gate potential as a function of the thickness of the space charge layer. Subsequent operations are simplified if the relation  $h = g(V_g)$  can be found. This can be done for the uniform or linear graded case but is not possible for the exponential charge distribution case.

With exponential charge distribution of the form,

$$\rho(y) = \rho_0 \exp(-my), \quad (16)$$

the field in the  $y$  direction is assumed to be zero in the conducting channel ( $h \leq y \leq a$ ) using Shockley's gradual approximation.<sup>3</sup>

$$\begin{aligned} E_y &= (I/K) \int \rho(y) dy = 0 \quad \text{at} \quad y = h \\ &= -(\rho_0/mk)(e^{-my} - e^{-mh}). \end{aligned} \quad (17)$$

The maximum field  $E_p$  required to pinch-off the conducting channel ( $h = a$ ) exists at  $y = 0$ :

$$E_p = (-\rho_0/mk)(1 - e^{-ma}). \quad (18)$$

The potential in the space charge region  $V(y)$  is equal to the gate voltage  $V_g$  at  $y = 0$ :

$$\begin{aligned} V(y) &= - \int E_y dy = V_g \quad \text{at} \quad y = 0 \\ &= (\rho_0/m^2K)(1 - e^{my} - mye^{-mh}) + V_g. \end{aligned} \quad (19)$$

With finite channel current, the potential in the conducting channel is a function of  $x$ , the distance from the source. The potential  $V(x)$  cannot be derived directly for the exponential case but can be solved for  $V(h)$  where  $h$  is a function of  $x$ :

$$\begin{aligned} V(h) &= V(y) \quad \text{at} \quad y = h \\ &= (\rho_0/m^2K)(1 - e^{-mh} - mhe^{-mh}) + V_g. \end{aligned} \quad (20)$$

With a gate-to-source potential  $V_g$ , a finite space charge layer thickness  $II_s$  will exist at  $x = 0$ . Furthermore,  $V(h) = 0$  at  $x = 0$ , so from (20),

$$V_g = (\rho_0/m^2K)(e^{-mII_s} + mII_s e^{-mII_s} - 1). \quad (21)$$

<sup>12</sup> S. K. Ghandhi, "Photoelectronic circuit applications," Proc. IRE, vol. 47, pp. 4-11; January, 1959.

The space charge layer thickness  $II_D$  at the drain end of the channel ( $x=L$ ) is related to the gate voltage and the drain voltage  $V_D$ :

$$V_g - V_D = (-\rho_0/m^2K)(1 - e^{-mH_D} - mII_De^{-mH_D}). \quad (22)$$

The potential  $V_p$  required to pinch off the conducting channel is equal to  $V_g - V_D$  at  $II_D=a$ :

$$V_p = (\rho_0/m^2K)(1 - e^{-ma} - mac^{-ma}). \quad (23)$$

The current in the conducting channel is constant at all values of  $x$ . The charge density represented by the free electrons in the conducting channel is assumed to be equal to  $-\rho(y)$  in that region. The immobile holes generated in that region do not contribute to the channel conductivity. Additional free electrons forced into the conducting channel by the transverse field are rapidly distributed throughout the conducting system of the circuit and do not contribute significantly to the steady state channel current. Although the channel current is not a function of  $x$ , the current density  $J$  in the channel is a function of both  $x$  and  $y$  because of its dependence on  $h(x)$  and  $\rho(y)$ :

$$J(x, y) = -E_x\mu\rho(y). \quad (24)$$

The channel current is obtained by integrating (24) and inserting the slab width  $c$  and the relationship  $E_x = -dV(x)/dx$ :

$$\begin{aligned} I &= c\mu(dV/dx) \int_h^a \rho(y)dy \\ &= (c\mu\rho_0/m)(e^{-mh} - e^{-ma})(dV/dx). \end{aligned} \quad (25)$$

Then, by substituting  $dV(x)/dx = (dV/dh)(dh/dx)$  where  $(dV/dh) = (\rho_0k/h) \exp(-mh)$  from (20),

$$I \int_0^L dx = \frac{c\mu\rho_0^2}{mK} \int_{H^a}^{H_D} (he^{-2mh} - he^{-m(a+h)})dh. \quad (26)$$

At pinch-off,  $II_D=a$  and with zero gate voltage,  $II_S=0$ . The current  $I_p$  existing with these conditions is

$$I_p = (c\mu\rho_0^2/4m^2KL)[(2ma+3)e^{-2ma} - 4e^{-ma} + 1]. \quad (27)$$

The mutual transconductance from gate to drain is

$$\begin{aligned} G_m &= (\partial I / \partial V_g) = (\partial I / \partial II_S)(\partial V_g / \partial II_S)^{-1} \\ &\quad + (\partial I / \partial II_D)(\partial V_g / \partial II_D)^{-1}. \end{aligned} \quad (28)$$

The partial derivatives are obtained from (21), (22), (26):

$$G_m = (c\mu\rho_0/mL)(e^{-mH_S} - e^{-mH_D}). \quad (29)$$

The bulk conductance of the slab is

$$G_0 = (\mu c/L) \int_0^a \rho(y)dy = (c\mu\rho_0/mL)(1 - e^{-ma}). \quad (30)$$

Note that with zero gate voltage, ( $II_S=0$ ), and with  $V_D = V_p$ , ( $II_D=a$ ), then  $G_m = G_0$ .

#### ACKNOWLEDGMENT

The cadmium sulfide field effect transistor program was initiated and coordinated by E. F. Weller. Additional appreciation is extended to Y. T. Sihvonen who supplied the CdS crystals and prepared the contacts on the first successful units, to J. W. Bergstrom and F. D. Bosco who further developed fabrication techniques, and to A. J. Gioia who assisted in parameter evaluation.

# The Optimum Formula for the Gain of a Flow Graph or a Simple Derivation of Coates' Formula\*

C. A. DESOER†, SENIOR MEMBER, IRE

**Summary**—Starting from the definition of a determinant and using a few of its elementary properties, this paper gives an independent derivation of the optimum formula for the gain of a flow graph. Thus, a simpler path is shown to Coates' important result. This paper is self-contained, so that no previous knowledge of flow graphs is required. For motivation, the reader is referred to some well known papers and books.

## I. INTRODUCTION

MASON'S signal flow graphs<sup>1,2</sup> constitute a very useful tool for analysis of engineering problems, linear problems especially. The reason for their popularity and usefulness is that they display in a very intuitive manner the causal relationships between the several variables of the system under study. Many people have successfully used flow graph ideas in various fields.<sup>1-9</sup> Therefore, the publication of Mason's second paper<sup>2</sup> giving a systematic method for writing down almost by inspection the gain of a linear system was an important addition to the flow graph literature. Presently the state has been reached where a great many engineering schools include signal flow graphs in one of their senior courses.<sup>5</sup>

More recently, C. L. Coates<sup>3</sup> has shown that Mason's general gain formula is not the simplest expansion and has given a rigorous and lucid derivation of a new gain formula that is optimum in the sense that, *in general*, 1) no cancellations can occur between common factors of the numerator and denominator, and, 2) no cancellation can occur among the terms of the algebraic sums of the numerator and of the denominator.

\* Original manuscript received by the IRE, August 10, 1959; revised manuscript received, December 7, 1959. This research was supported by the U. S. Air Force, through the Air Force Office of Scientific Research, Air Research and Development Command.

† Dept. of Elec. Engrg., University of California, Berkeley, Calif.

<sup>1</sup> S. J. Mason, "Feedback theory—some properties of signal flow graphs," *PROC. IRE*, vol. 41, pp. 1144-1156; September, 1953.

<sup>2</sup> S. J. Mason, "Feedback theory—further properties of signal flow graphs," *PROC. IRE*, vol. 44, pp. 920-926; July, 1956.

<sup>3</sup> C. L. Coates, "Flow Graph Solutions of Linear Algebraic Equations," G. E. Research Lab., Schenectady, N. Y., Rept. No. 58-RL-1997; October, 1958. Also *IRE TRANS. ON CIRCUIT THEORY*, vol. CT-6, pp. 170-187; June, 1959.

<sup>4</sup> F. E. Hohn, "Elementary Matrix Algebra," The MacMillan Co., New York, N. Y.; 1958.

<sup>5</sup> David K. Cheng, "Analysis of Linear Systems," Addison Wesley Publ. Co., Reading, Mass.; 1959.

<sup>6</sup> O. Wing, "Ladder network analysis by signal flow graph. Application to analog computer programming," *IRE TRANS. ON CIRCUIT THEORY*, vol. CT-3, pp. 289-294; December, 1956.

<sup>7</sup> W. H. Huggins, "Signal flow graphs and random signals," *PROC. IRE*, vol. 45, pp. 74-86; January, 1957.

<sup>8</sup> L. A. Zadeh, "Signal flow graphs and random signals," *PROC. IRE*, vol. 45, pp. 1413-1414; October, 1957.

<sup>9</sup> O. Wing, "Cascade directional filter," *IRE TRANS. ON MICROWAVE THEORY AND TECHNIQUE*, vol. MTT-7, pp. 197-201; April, 1959.

The purpose of this paper is to present an independent derivation of Coates' formula. The author's hope is that this derivation is so simple that even seniors can grasp it!<sup>10</sup> The only required background is the definition of a determinant. For the reader's convenience, this definition and the properties of determinants used in the derivation are listed in the Appendix.

For further background, motivation and examples, the reader is referred to the literature.<sup>1-3,5</sup> The present paper is self-contained in that it can be read independently of Mason's and Coates' papers.<sup>1-3</sup>

A word about the organization of the paper: There is a difference between Mason's and Coates' procedure for drawing the flow graph of a linear system. The difference, however, is very slight. The first five sections constitute an independent derivation of Coates' formula; they use exclusively Coates' procedure for associating a flow graph to a system of equations. Section VII discusses the difference between Mason's signal-flow graphs and Coates' flow graphs; it shows how, given one of them, the other may easily be obtained.

## II. THE SET OF EQUATIONS AND ITS ASSOCIATED FLOW GRAPH

Our purpose is to solve by topological methods the set of linear algebraic equations

$$\sum_{j=1}^n a_{kj}x_j - b_k = 0 \quad (k = 1, 2, \dots, n). \quad (1)$$

To this set of equations we shall associate a *flow graph* which is defined as follows:

**Definition 1**—A *flow graph* is a set of weighted oriented branches which connect at nodes. That is, each branch has a positive direction and a weight, the branch gain.

The flow graph associated with (1) has  $n$  nodes and one source node. The case  $n = 2$  is illustrated in Fig. 1. The process of associating a flow graph to a set of equations is as follows:

- 1) To the source node is associated an input variable that is taken to be unity.
- 2) To each of the other nodes is associated one of the variables  $x_1, x_2, \dots, x_n$  of the set.

<sup>10</sup> Some school will insist that the word "seniors" be replaced by "sophomores." More power to them!



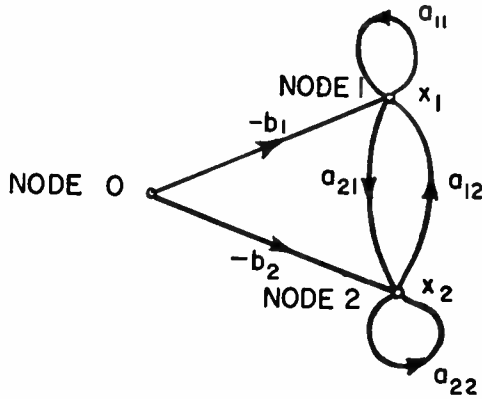

Fig. 1—Flow graph for the case of 2 equations with 2 unknowns.

- 3) Each node is labelled by one of the integers from 1 to  $n$  such that the node labelled  $k$  is associated with  $x_k$ . The source node is labelled 0.
- 4) If  $a_{jk} \neq 0$ , there is a branch directed from node  $k$  to node  $j$  with gain  $a_{jk}$ .
- 5) If  $b_k \neq 0$ , there is a branch connecting the source node 0 to node  $k$ . This branch is directed from 0 to  $k$  and its branch gain is  $-b_k$ .

This process describes how one goes from the equations to the graph. The reverse process, to obtain the equations from the graph, is very simple.

Consider Fig. 1 and concentrate on node 1. In order to write the equation associated with node 1, first consider all the branches coming into node 1; they are  $a_{11}$ ,  $a_{12}$  and  $-b_1$ . The equation is obtained by equating to zero the sum of the products of their branch gains times the variables these branches originate from, viz:

$$a_{11}x_1 + a_{12}x_2 - b_1 \cdot 1 = 0.$$

Physically, we may think of these nodes as high gain operational amplifiers whose feedback loop is open. Because, in that case, if the output voltage is in the linear range of the amplifier, the sum of the currents into the input node must be very nearly zero.

At this stage an important point should be brought up. It is clear that to every set of equations such as (1) corresponds a flow graph and conversely. If, however, the order in which the equations appear in (1) is changed, the corresponding flow graph changes in a non-trivial manner. For example, to the set of equations

$$\begin{cases} \alpha x_2 + \beta x_3 = 0 \\ \gamma x_1 + \delta x_3 = b_1 \\ \epsilon x_1 + \eta x_2 = b_2 \end{cases}$$

corresponds the flow graph of Fig. 2.

Rearranging them as follows, we get a new set of equations

$$\begin{cases} \gamma x_1 + \delta x_3 = b_1 \\ \epsilon x_1 + \eta x_2 = b_2 \\ \alpha x_2 + \beta x_3 = 0 \end{cases}$$

and the flow graph of Fig. 3.

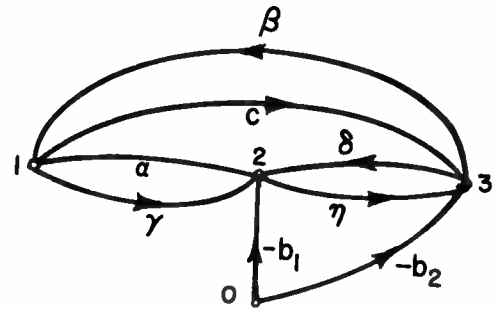

Fig. 2—Flow graph of the system (2).

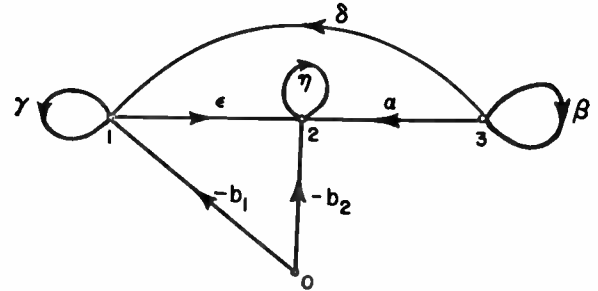

Fig. 3—Flow graph of the system (3).

Thus, once a system of linear homogeneous algebraic equations, such as (1), has been ordered in a fixed way, there is a one-to-one correspondence between the equations and the flow graph.

### III. ALGEBRAIC SOLUTION OF (1)

If the matrix of the coefficients of the  $x_j$ 's in (1) is nonsingular, the solution is given by

$$x_l = \frac{\sum_{k=1}^n \Delta_{kl} b_k}{\Delta} \quad (l = 1, 2, \dots, n) \quad (2)$$

where

$\Delta$  is the determinant of the coefficient matrix  $(a_{ij})$ .  $\Delta_{kl}$  is the cofactor of the element of the  $k$ th row and  $l$ th column.

In the following we shall devise a topological method for evaluating  $\Delta$  and products of the form  $b_k \Delta_{kl}$ .

### IV. TOPOLOGICAL EVALUATION OF $\Delta$

In order to evaluate  $\Delta$  by topological means, we require a few topological ideas; hence we define:

$G$  to be the flow graph of the system (1), where the equations are taken in the order in which they appear;

$G_0$  to be the flow graph obtained from  $G$  by deleting the source node 0.

Definition 2—A *connection* of the flow graph  $G$  is a subgraph of  $G$  such that

- 1) each node of  $G$  is included,

- 2) each node has only one branch terminating to it and one branch originating from it.

Definition 3—A *directed loop* is a connected subgraph whose branches  $b_1, b_2, \dots, b_l$  can be ordered in such a way that

- 1) The tip of  $b_k$  is the origin of  $b_{k+1}$  ( $k = 1, 2, \dots, l-1$ ).
- 2) The origin of  $b_l$  is the tip of  $b_1$ .
- 3) Each node along the directed loop is encountered only once.

Thus, a directed loop is precisely what is meant by a loop in the ordinary language. Fig. 4 illustrates the concept. Fig. 5(a) shows a flow graph  $G$  and Fig. 5(b) its five connections. It is clear that a connection is either a directed loop or a collection of nontouching directed loops (they are nontouching because of 2) in definition 2).

In addition, we shall need this definition:

Definition 4—The *connection-gain* of a connection of  $G$  is the product of the branch gains of the branches of that connection. It is denoted by  $C(G)$ .

The first link between the determinant  $\Delta$  and the flow graph  $G$  is obtained by referring to the definition of a determinant:<sup>1</sup>

$$\Delta = \sum_{P'} (\text{sgn } P) a_{1i_1} a_{2i_2} \cdots a_{ni_n} \quad (3)$$

where the summation is taken over all the  $n!$  permutations  $P = (i_1, i_2, \dots, i_n)$  of the integers,  $1, 2, \dots, n$  and  $(\text{sgn } P)$  is  $+1$  or  $-1$  depending on whether the permutation  $P$  is even or odd.<sup>11</sup>

Lemma 1: A product appears in (3) if and only if it is a connection-gain  $C(G_0)$  of the flow graph  $G_0$ .

*Proof:* Recall that  $G_0$  is the graph  $G$  with the source node 0 deleted. Consider a particular product  $\prod$  in the sum (3). Let  $\prod'$  be the set of all branches whose gain appear in the product  $\prod$ . Since  $\prod$  is a product of factors  $a_{ki}$ , with  $k$  running from 1 to  $n$ , there is one and only one branch of  $\prod'$  that terminates at each of the  $n$  nodes of  $G_0$ . Since  $i_1, i_2, \dots, i_n$  is a permutation of  $1, 2, \dots, n$ , there is one and only one branch of  $\prod'$  originating from each node of  $G_0$ . Hence  $\prod'$  is a connection of  $G_0$ .

Conversely, given an arbitrary connection of  $G_0$ , since it contains by definition one branch terminating in each of the nodes of  $G_0$  and one branch leaving each one of the same nodes, then its connection-gain can be written as

$$a_{1i_1} a_{2i_2} \cdots a_{ni_n}$$

where  $i_1, i_2, \dots, i_n$  is a permutation of the numbers  $1, 2, \dots, n$ . Hence, it will appear as one of the products of the expansion (3).

<sup>11</sup> The Appendix lists the three properties of determinants that will be used later.

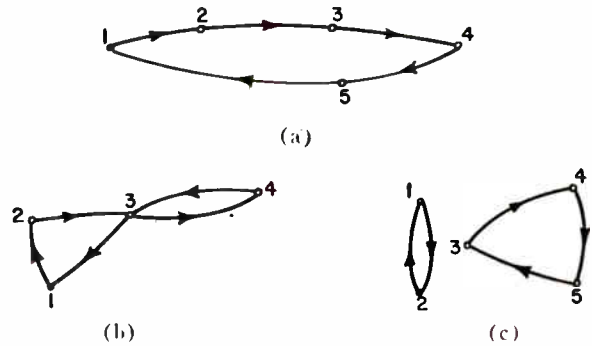

Fig. 4—(a) Example of a directed loop. (b) This is not a directed loop; when traversing the loop in the positive direction, node 3 is encountered more than once. (c) This is not a directed loop because it is not a connected subgraph.

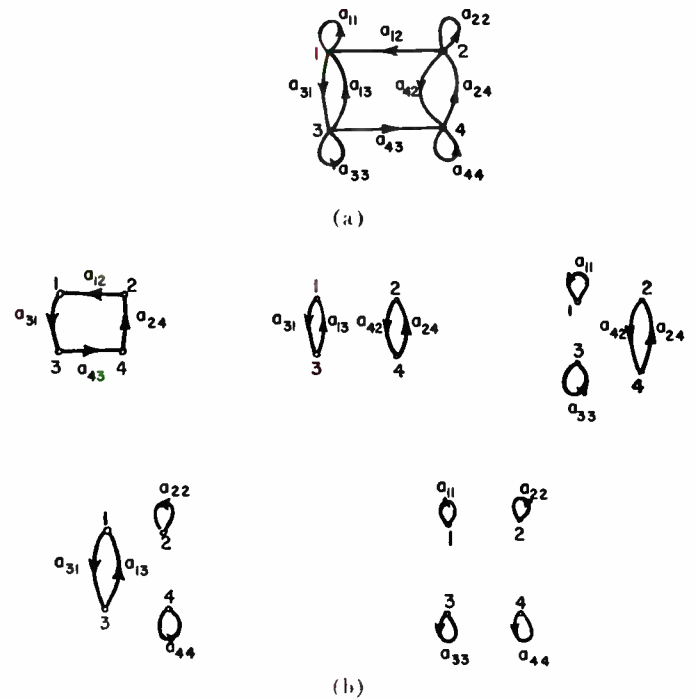

Fig. 5—(a) Flow graph associated with the matrix  $A$ . (b) The five connections of the flow graph shown in Fig. 5(a).

Thus by simply listing all the connections of  $G_0$ , as is done on Fig. 5, one obtains all the terms of the sum (3). The question of the signs remains. First let us make two rather obvious statements:

Statement 1—If, in a determinant, such as the one of the matrix  $A$ , any two rows are interchanged and the corresponding columns are also interchanged, the value of the determinant is not affected. (See Appendix, Property 3.)

Statement 2—Consider the system of equations (1) and its associated flow graph  $G$ . Suppose any two equations, say the  $i$ th and the  $k$ th, are interchanged and also the two variables located in the corresponding columns (*i.e.*,  $x_i$  and  $x_k$ ): then to the resulting set of equations (1') corresponds a new flow graph  $G'$ . A little thought will show that  $G$  and  $G'$  are identical

except for an interchange of the labels of the  $i$ th and  $k$ th node.

The method required for specifying the sign of each term of (3) is obtained by the following reasoning:

Consider again a particular product  $\prod$  of the sum (3) and its associated connection  $\prod'$  of the graph  $G_0$ .  $\prod'$  is a collection of directed loops; for simplicity let us assume that  $\prod'$  consists of three nontouching directed loops having respectively  $n_1, n_2, n_3$  nodes. Clearly,  $n_1 + n_2 + n_3 = n$ , since all nodes of  $G_0$  are included.

As a consequence of Statements 1 and 2 we can, without affecting any of the terms of the determinant expansion (3), relabel the nodes of  $\prod'$  so that along the first directed loop of  $\prod'$  as it is traversed in the positive direction one traverses the nodes 1, 2,  $\dots$ ,  $n_1$  in that order; and similarly for the other two directed loops. The branch gain product of the first directed loop is then

$$a_{1n_1} a_{21} a_{32} \dots a_{n_1, n_1-1}$$

Note that the factors of this product are ordered so that their row subscripts occur in their natural order as required by (3). Hence, the sign assigned to  $\prod$  is that assigned to the permutation, defined by the column subscripts:

$$n_1, 1, 2, 3, \dots, n_1 - 1; n_1 + n_2, n_1 + 1, \dots, (n_1 + n_2 - 1); (n_1 + n_2 + n_3), (n_1 + n_2 + 1), \dots, (n_1 + n_2 + n_3 - 1).$$

To rearrange this permutation in the natural order,  $(n_1 - 1) + (n_2 - 1) + (n_3 - 1) = n - 3$  interchanges between adjacent symbols are required. Hence, the sign of the permutation is  $(-1)^{n-3} = (-1)^n (-1)^{-3}$ . Note that there are three directed loops in the product  $\prod$ . It is clear that if the connection  $\prod'$  had  $L$  directed loops the sign would have been  $(-1)^{n+L}$ .

Thus, we obtain the general

*Theorem 1: The determinant  $\Delta$  of the system (1) can be evaluated from its flow graph  $G$  by the formula*

$$\Delta = (-1)^n \sum_p (-1)^{L_p} C(G_0)_p \quad (4)$$

where

$L_p$  is the number of directed loops in the  $p$ th connection.

$C(G_0)_p$  is the connection gain of the  $p$ th connection.  $G_0$  is the flow graph  $G$  with the source node 0 deleted.

The summation of the connection gains  $C(G_0)$  is taken over all connections of  $G_0$ .

*Example:* The determinant of the matrix associated with the graph of Fig. 5. From the graph  $G$  of Fig. 5, we obtain the matrix

$$A = \begin{bmatrix} a_{11} & a_{12} & a_{13} & 0 \\ 0 & a_{22} & 0 & a_{24} \\ a_{31} & 0 & a_{33} & 0 \\ 0 & a_{42} & a_{43} & a_{44} \end{bmatrix}$$

From the five connections of  $G$  shown on the figure,

$$\det A = -a_{12} a_{24} a_{43} a_{31} + a_{13} a_{31} a_{42} a_{24} - a_{11} a_{33} a_{42} a_{24} - a_{22} a_{44} a_{13} a_{31} + a_{11} a_{22} a_{33} a_{44}$$

This expansion can also be obtained by Mason's method, but his general formula will give 25 terms which will eventually reduce to the five listed above.

### V. EVALUATION OF THE NUMERATOR OF (2)

The numerator of (2) is a sum of terms all having the same form. Consider one of them in particular; say,  $\Delta_{kl} b_k$ . In other words, we are going to evaluate the numerator of (2) assuming that there is only one branch, with gain  $-b_k$ , connecting the source node 0 to the rest of the graph, as shown on Fig. 6(a). Since we know how to evaluate an  $n \times n$  determinant by topological means, let us note that  $\Delta_{kl} b_k$  is equal to the determinant obtained by replacing the  $l$ th column of  $\Delta$  by a column of zero except for the element of the  $k$ th row, which is  $b_k$ .

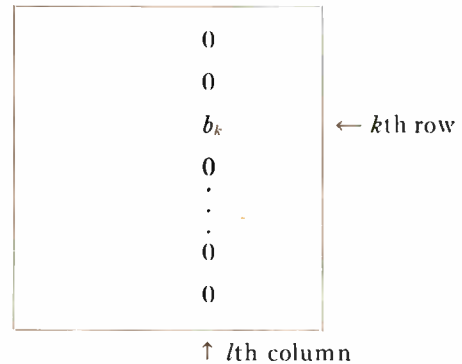

This determinant will not change if all the elements of the  $k$ th row, with the single exception of  $b_k$ , are replaced by zero. The result is the determinant  $\Delta'$ .

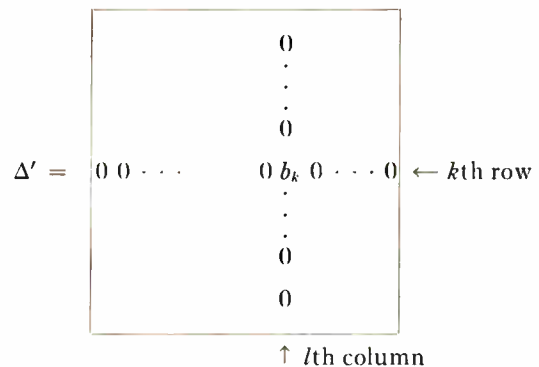

In order to evaluate  $\Delta'$  by topological means, let us note that the flow graph  $G'$  associated with  $\Delta'$  is obtained from  $G_0$  by: 1) deleting all branches leaving node  $l$  (the node with which the variable  $x_l$ , being sought, is associated); 2) deleting all branches coming into node  $k$ ; and 3) adding the branch  $b_k$  oriented from node  $l$  to node  $k$ . This operation is illustrated on Figs. 6(a) and



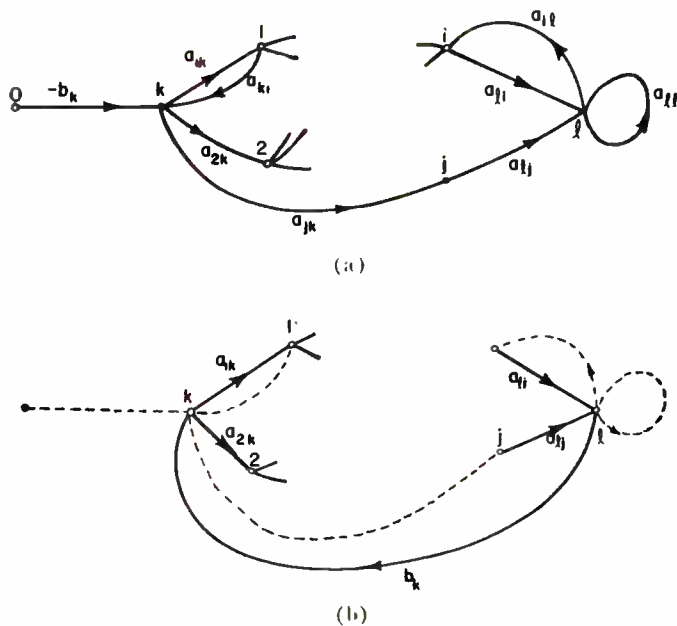

Fig. 6—(a) Flow graph  $G$ . (b) Flow graph  $G'$  obtained from  $G$  by deleting all branches leaving node  $l$ , deleting all branches coming into node  $k$  and adding branch  $b_k$  oriented from node  $l$  to node  $k$ .

6(b). From (4),

$$b_k \Delta_{kl} = \Delta' = (-1)^n \sum_{\tau} (-1)^{L_{\tau}} C(G')_{\tau}$$

where

$C(G')_{\tau}$  is the connection gain of the  $\tau$ th connection of  $G'$ .

$L_{\tau}$  is the number of directed loops of the  $\tau$ th connection.

The summation is taken over all connections of  $G'$ .

In order to interpret this result in terms of the graph  $G$ , let us define as follows:

**Definition 5**—A *one-connection* from  $p$  to  $q$  of a flow graph  $G$  is a subgraph of  $G$  which includes all the nodes of  $G$ , and such that

- 1) no branch terminates at  $p$  and only one branch of the subgraph originates from  $p$ , thus:

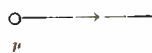

- 2) no branch originates from  $q$  and only one branch of the subgraph terminates at  $q$ , thus:



- 3) all other included nodes have exactly one incoming and one outgoing branch.

An example of a set of one-connections is shown on Figs. 7 and 8. It is apparent from Fig. 8 that, in general, a one-connection is a forward path together with some directed loops.

Consider Fig. 6(b). Each one of the connections of  $G'$

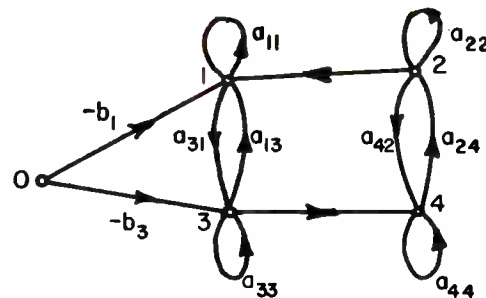

Fig. 7—Flow graph associated with the set of equations (6).

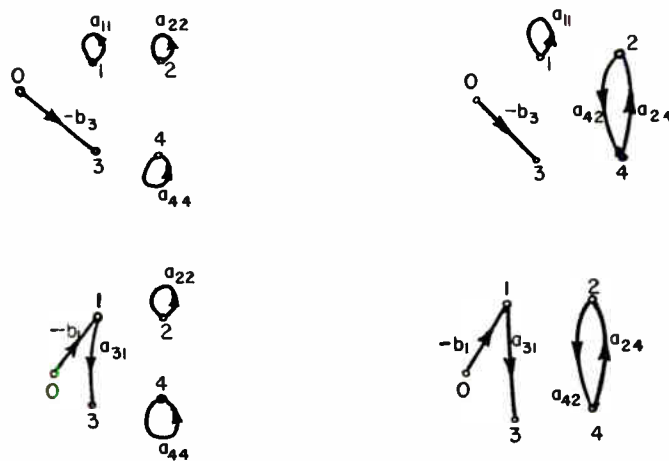

Fig. 8—The one-connections from 0 to 3 of the flow graph of Fig. 7.

includes the branch  $b_k$  because it is the only branch that leaves the  $l$ th node. In each one of these connections let us remove the origin of branch  $b_k$  from node  $l$  and place it at the source node 0 where it was originally in graph  $G$ . Finally, let us change the branch gain from  $b_k$  to  $-b_k$ . In each case the resulting configuration is a *one-connection* from 0 to  $l$  of flow graph  $G$ . Since by displacing the branch  $b_k$  one directed loop has been "opened," the number of directed loops in the one-connections of  $G$  is one less than that of the original connections of  $G'$ ; this will result in a change of sign which will cancel the one caused by the change of sign of the branch gain  $b_k$ . Consequently,

$$b_k \Delta_{kl} = \Delta' = (-1)^n \sum_{\sigma} (-1)^{L_{\sigma}} C(G; 0-l)_{\sigma}$$

where

$C(G; 0-l)_{\sigma}$  is the one-connection gain (*i.e.*, the product of the branch gains) of the  $\sigma$ th one-connection from 0 to  $l$  of the flow graph  $G$ .

$L_{\sigma}$  is the number of directed loops in the  $\sigma$ th one-connection.

The summation is taken over all one-connections from 0 to  $l$  of  $G$ .

VI. GENERAL FORMULA

In general, there is more than one branch connecting the source node to the rest of the graph; obviously, in such cases the individual contributions of each such branch must be summed and the result takes this form:

*Theorem 2: In order to solve for the variable  $x_1$  defined by the set of equations*

$$\sum_{j=1}^n a_{kj}x_j = b_k \quad (k = 1, 2, \dots, n) \quad (1)$$

- 1) Set up the associated flow graph  $G$  as specified in Section II.
- 2) Draw all the connections of the flow graph  $G_0$  (=graph  $G$  with source node 0 deleted) and list their connection gains:  $C(G_0)_1, C(G_0)_2, \dots$
- 3) Draw all the one-connections from the source node 0 to the node  $l$  of the graph  $G$  and list their one-connection gains:  $C(G; 0-l)_1, C(G; 0-l)_2, \dots$
- 4)

$$x_l = \frac{\sum_{\sigma} (-1)^{L_{\sigma}} C(G; 0-l)_{\sigma}}{\sum_{\rho} (-1)^{L_{\rho}} C(G_0)_{\rho}} \quad (5)$$

where

- $L_{\sigma}$  = number of directed loops in the  $\sigma$ th one-connection from 0 to  $l$  of the flow graph  $G$ .
- $L_{\rho}$  = number of directed loops in the  $\rho$ th connection of  $G_0$ .
- the summations are taken over all connections and one-connections from 0 to  $l$  of graphs  $G_0$  and  $G$  respectively.

*Example:* Consider the system of equations,

$$\begin{cases} a_{11}x_1 + a_{12}x_2 + a_{13}x_3 & = b_1 \\ a_{22}x_2 & + a_{24}x_4 = 0 \\ a_{31}x_1 & + a_{33}x_3 = b_3 \\ a_{42}x_2 = a_{43}x_3 & + a_{44}x_4 = 0. \end{cases} \quad (6)$$

Let us solve for  $x_3$ . The graph  $G$  is shown on Fig. 7. All the connections of  $G$  are listed in Fig. 5(b). The one-connections from 0 to 3 of  $G$  are shown on Fig. 8. Then, by (5), we have

$$x_3 = \frac{b_3 a_{11} a_{22} a_{44} - b_3 a_{11} a_{42} a_{24} - b_1 a_{31} a_{22} a_{44} + b_1 a_{31} a_{24} a_{42}}{\Delta}$$

where

$$\Delta = a_{11} a_{22} a_{33} a_{44} - a_{12} a_{24} a_{43} a_{31} + a_{13} a_{31} a_{42} a_{24} - a_{11} a_{33} a_{42} a_{24} - a_{22} a_{44} a_{13} a_{31}$$

The general expression (5) calls for two important comments.

Comment 1—*In general*, there can be no cancellation of terms in the algebraic sums of either the numerator or the denominator of (5).

The reason for this is quite obvious: Since each term is a connection gain (a one-connection gain) of a connection (one-connection) distinct from all the other connections (one-connections) there can, in general, be no cancellations; for it would imply the existence of special relationships between the gains of various branches.

There is, however, one simplification that any engineer worth his salt would instinctively take advantage of. Suppose  $x_1$  is to be computed and suppose there are some node variables  $x_{k_1}, x_{k_2}, \dots, x_{k_m}$  that have no effect on  $x_1$ , then these nodes may be deleted from the graph when  $x_1$  is computed.

This idea can be expressed precisely if the following definition is introduced:

Definition 6—A *forward path* from  $p$  to  $q$  of the flow graph  $G$  is a connected subgraph whose branches  $b_1, b_2, \dots, b_l$  can be ordered such that

- 1) the tip of  $b_k$  is the origin of  $b_{k+1}$  ( $k=1, 2, \dots, l-1$ )
- 2) each node of the forward path has only one branch terminating to it and one branch originating from it, with the exception of  $p$  and  $q$  which, respectively, have only one branch originating and terminating to them.

A forward path from  $p$  to  $q$  can be obtained from each one-connection from  $p$  to  $q$  by deleting from the one-connections all the directed loops.

The second comment takes the form

Comment 2—When solving for  $x_1$ , delete from the graph  $G$  all the nodes  $x_{k_1}, x_{k_2}, \dots, x_{k_m}$  which have the property that there is no forward path that connects each one of them to  $x_1$ .

*Example:* Consider the system

$$\begin{aligned} a_{11}x_1 + a_{12}x_2 & = 0 \\ a_{21}x_1 + a_{22}x_2 & = + b_2 \\ a_{32}x_2 + a_{33}x_3 + a_{34}x_4 & = 0 \\ a_{43}x_3 + a_{44}x_4 & = 0. \end{aligned}$$

The corresponding flow graph is shown in Fig. 9. It is obvious in this simple example, from the graph and from the equations, that the variables  $x_3$  and  $x_4$  may be disregarded in solving for  $x_1$ ; also, there is no forward path from 3 to 1 and from 4 to 1.

A straightforward analysis shows that if the nodes  $x_{k_1} \dots x_{k_m}$  are not deleted, all the connection gains and the one-connection gains of (5) will have a common factor which will cancel from numerator and denominator. This leads to the very important conclusion that, provided the precaution of Comment 2 is taken into ac-

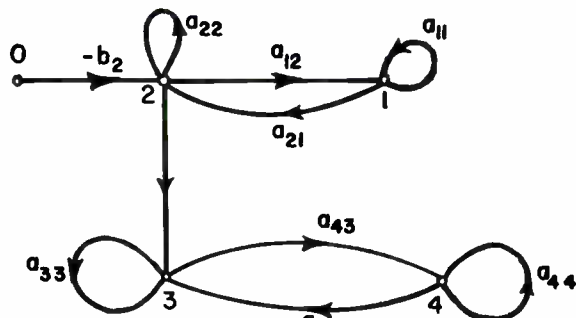

Fig. 9—Illustration of a flow graph that has no forward path from nodes 3 and 4 to node 1.

count, Theorem 2 gives the optimum gain formula for a flow graph.

Thus, the following important conclusion is reached: Given the problem of solving (1) by topological methods then, provided the Comment 2 is taken into account, the expression given in Theorem 2 is the simplest expression for the solution in terms of the  $b_k$ 's and  $a_{ij}$ 's.

### VII. THE RELATIONSHIP BETWEEN SIGNAL-FLOW GRAPHS (MASON) AND FLOW GRAPHS (COATES)

The process of association of a flow graph (Coates) to a set of equations has been described in detail in Section II. For reference let us note that the equations are written

$$\sum_{j=1}^n a_{kj}x_j = b_k \quad (k = 1, 2, \dots, n) \quad (1)$$

where

- $a_{kj}$  is the gain of the branch, directed from  $j$  to  $k$ , connecting node  $j$  to node  $k$ , and
- $-b_k$  is the gain of the branch connecting the source node to node  $k$ .

Mason,<sup>2</sup> on the other hand, writes his equations thus:

$$\sum g_{kj}x_j = x_k + b_k \quad (k = 1, 2, \dots, n) \quad (7)$$

where

- $g_{kj}$  is the gain of the branch, directed from  $j$  to  $k$ , connecting node  $j$  to node  $k$ , and
- $-b_k$  is the gain of the branch connecting the source node to node  $k$ .

Simply by looking at the equations we can see clearly that (1) and (7) will be identical if and only if

$$g_{kj} = a_{kj} \text{ if } k \neq j \text{ and } g_{kk} - 1 = a_{kk}.$$

This gives the following rules:

- 1) To obtain a flow graph (Coates) from a given signal-flow graph (Mason), simply subtract one from the gain of each existing self loop and to each node of the signal-flow graph devoid of self loop, insert one with gain  $-1$ .
- 2) To obtain a signal-flow graph (Mason) from a flow graph (Coates), add unity to the gain of each existing

self loop and to each node of the flow graph devoid of self loop, insert a self loop of gain  $+1$ .

Physically, we can interpret both graphs in terms of analog computer concepts:

#### A. Signal-Flow Graphs

Node variables  $x_j$ : potential of node  $j$  with respect to ground.

Gain  $g_{kj}$ : admittance of the branch connecting  $j$  to  $k$ , thus  $g_{kj}x_j$  is a current entering node  $k$ .

Node: electronic summing amplifier: its output voltage is equal to the sum of the input currents:

$$x_k = \sum_{j=1}^n g_{kj}x_j - b_k \cdot 1.$$

Note that this summing amplifier does not invert the sign as is usually the case with analog computer amplifiers.

#### B. Flow Graphs

Node variables  $x_j$ : potential of node  $j$  with respect to ground.

Gain  $a_{kj}$ : admittance of the branch connecting  $j$  to  $k$ .

Node: operational amplifier with its feedback loop open; thus if the output voltage  $x_k$  is in the linear range, the sum of the input currents is negligibly small in view of the high gain of the amplifier; hence

$$\sum a_{kj}x_j - b_k \cdot 1 = 0.$$

#### APPENDIX

By definition, the determinant<sup>4</sup> of a matrix  $A$  is

$$\det A = \Delta = \sum_P (\text{sgn } P) a_{1i_1} a_{2i_2} \dots a_{ni_n}$$

where  $\Sigma/P$  denotes that the summation is taken only over the  $n!$  permutations  $i_1, i_2, \dots, i_n$  of  $1, 2, \dots, n$  and  $(\text{sgn } P)$  is  $+1$  or  $-1$  depending on whether the permutation  $i_1, i_2, \dots, i_n$  is even or odd.

The key properties that are used in the paper are the following:

- 1) The interchange of any two adjacent symbols of a permutation changes the permutation into one of the opposite parity.
- 2) Exactly one element from each row and one element from each column appears in each term of the expansion of  $\Delta$ .
- 3) If any two parallel lines (rows or columns) of  $A$  are interchanged, the determinant of the resulting matrix is  $-\det A$ .



# A Broad-Band Cyclotron Resonance RF Detector Tube\*

FRANKLIN M. TURNER†, MEMBER, IRE

**Summary**—A tube is described which utilizes the cyclotron motion of electrons to provide a resonant system which is tuned by variation of the magnetic flux density. The amplitude of the cyclotron motion depends upon the relationship of the applied signal frequency and the electron cyclotron frequency; at resonance, the amplitude is maximum. Resonance is detected by shooting the spiraling electrons through a honey-comb type mesh grid; the current intercepted by the grid is greatest at resonance and is proportional to the RF signal power.

The tube is a complete TRF receiver (less video amplifier) within one vacuum envelope. The resonant frequency is a linear function of solenoid current; the tube can be tuned over a wide frequency range (at least 10:1) with a single control. The characteristics of the device have been investigated for resonant frequencies from 65 to 650 mc; the sensitivity and 3-db RF bandwidth can be varied within limits; typical signal sensitivity is  $-45$  dbm (500-kc video bandwidth) with a 4-mc 3-db RF bandwidth.

The measured characteristics and the theoretical predictions are in reasonable agreement.

## INTRODUCTION

AN electron beam, a static magnetic field parallel to the beam, and a perpendicular RF electric field may be combined to form a resonant system which can be tuned electronically over a wide frequency range. The application of this resonant system to the detection and frequency determination of RF signals had been explored by several investigators<sup>1-3</sup> and some tubes were constructed at Stanford University<sup>4,5</sup> prior to 1950. The sensitivity of these tubes was extremely poor, but it was nevertheless encouraging enough to support further efforts. From 1950 to 1954, tubes with much improved sensitivity were developed. Until recently, information concerning these tubes could not be widely disseminated due to security restrictions.

\* Original manuscript received by the IRE, August 4, 1959; revised manuscript received, December 14, 1959. The work described here was sponsored by the U. S. Air Force under contract AF 33(600)-27784, with Stanford University. This work is also based on previous research made possible through support extended to Stanford University by the U. S. Air Force, U. S. Army Signal Corps, and the U. S. Navy (Office of Naval Research, Bureau of Aeronautics, and Bureau of Ships).

† Stanford Elect. Labs., Stanford University, Stanford, Calif.

<sup>1</sup> J. Weber, "Some Notes on Indicators for Non-Scanning Radio Receivers," Internal Memorandum, Navy Dept., Bureau of Ships, Washington, D. C., September 6, 1946.

<sup>2</sup> S. F. Kaisel, "Analysis of a Proposal for a Non-Scanning Radio-Frequency Spectrum Analyzer," Electronics Res. Lab., Stanford University, Stanford, Calif., N6onr 25107; September 1, 1947.

<sup>3</sup> W. A. Harman, "An Electron Optical System for a Non-Scanning Radio-Frequency Spectrum Analyzer," Elec. Engrg. thesis, Stanford University, Stanford, Calif.; 1948.

<sup>4</sup> S. F. Kaisel, "An Investigation of Non-Scanning Techniques for RF Spectrum Analysis," Electronics Res. Lab., Stanford University, Stanford, Calif., Tech. Rept. No. 15, N6onr 25107; August 30, 1949. This was also a Ph.D. dissertation under the same title.

<sup>5</sup> E. C. Stelter, "Radio Frequency Circuits for a Non-Scanning Ultra-High-Frequency Spectrum Analyzer," Elec. Engrg. thesis, Stanford University, Stanford, Calif.; 1954.

The cyclotron resonance detector tube, or cyclotron detector tube, as it is sometimes designated, is essentially a nonamplifying resonant system followed by a detector; the resonant frequency of the system is the "cyclotron frequency"; the detector is a grid through which an electron beam is shot.

The cyclotron frequency is determined by the magnitude of the static magnetic field in which the electron beam is immersed. In one type of cyclotron resonance tube (the Spanatron) developed at Stanford,<sup>6-10</sup> the magnitude of the static magnetic field is made to vary spatially, in a known manner, across a sheet electron beam so that electrons in different sections of the beam have different resonant frequencies. The other, historically more recent, type consists of a pencil electron beam immersed in a uniform static magnetic field. Both types utilize the same basic phenomena. In the Spanatron, however, the frequency of an unknown signal is obtained by determining (with a detector grid) the section of the sheet beam that is in resonance with the unknown signal. Signal frequency is determined in the pencil beam tube by adjusting the magnitude of the uniform static magnetic field until resonance is indicated. This paper is concerned with the latter type of tube.

A photograph and a functional schematic representation of the cyclotron resonance detector tube to be described is shown in Figs. 1 and 2. A pencil electron beam is directed between the inner and outer conductors of a 50-ohm coaxial line. When an RF signal is applied to the coaxial line, an alternating electric field perpendicular to the beam is excited. If the RF frequency and the cyclotron frequency are nearly equal, the mutually perpendicular RF electric field and the uniform static magnetic field will cause individual electrons to spiral about axes parallel to the beam. The path radius of the spiraling electrons will be greatest when the RF fre-

<sup>6</sup> W. G. Worcester, "All-Metal Spanatron Tube and Magnet," Electronics Res. Lab., Stanford University, Stanford, Calif., Tech. Rept. No. 21, N6onr 22510; August 1, 1954.

<sup>7</sup> M. M. McWhorter, "Performance of a Cyclotron-Detector Microwave Spectrum Analyzer Tube (Spanatron)," Electronics Res. Lab., Stanford University, Stanford, Calif., Tech. Rept. No. 22, N6onr 22510; August 8, 1954.

<sup>8</sup> W. H. Kohl, "Construction of a Sealed-Off, All-Metal Cyclotron Resonance Tube," Electronics Res. Lab., Stanford University, Stanford, Calif., Tech. Rept. No. 23, N6onr 22510; August 15, 1954.

<sup>9</sup> L. A. Roberts, "The Extension of the Design for a Non-Scanning Microwave Intercept Receiver," Electronics Res. Lab., Stanford University, Stanford, Calif., Tech. Rept. No. 1, N6onr 25132; May 15, 1951. This was also a Ph.D. dissertation under the same title.

<sup>10</sup> W. G. Worcester, "An Investigation of Electrical Detection Methods for a Non-Scanning Microwave Spectrum Analyzer," Electronics Res. Lab., Stanford University, Stanford, Calif., Tech. Rept. No. 2, N6onr 25132; February 15, 1952. This was also a Ph.D. dissertation under the same title.

quency, as viewed by an observer moving at the axial velocity of the electrons, is equal to the cyclotron frequency. To detect the spiral motion of the electrons, the beam is passed through a grid which is composed of many honeycomb-like cells (Fig. 3); some electrons are captured by the grid. If the path radii of the spiralling electrons are relatively small, most of the beam will pass through the detecting grid to the collector. If the path radii of the electrons are increased, fewer of the electrons in the beam will reach the collector. Thus, a current whose amplitude is sensitive to the path radii of the electrons may be obtained either from the detecting grid or from the collector.

The characteristics of a detecting grid were first investigated by Roberts<sup>9</sup> and Worcester;<sup>10,11</sup> Stewart subsequently completed a statistical theory of detector

grid behavior. Stewart<sup>12-15</sup> also proposed and built cyclotron resonance detector tubes utilizing a coaxial line interaction structure. The tubes described here are refinements of Stewart's early models.

In the following portions of this paper a simplified analysis of the energy transfer from the RF electric field to the spiralling electrons will be presented, the mechanical details of the tube will be outlined, and the electrical characteristics, both predicted and measured, will be discussed. The theory of the detecting grid is presented elsewhere; only the observed characteristics of one particular grid are reported here.

#### DESCRIPTION OF CYCLOTRON RESONANCE DETECTOR TUBE

This section describes the mechanical details of a cyclotron resonance detector tube and typical operational procedures.

Construction of the tube is not difficult; many of the parts can be purchased commercially and those requiring fabrication are not complex. The tube is rugged, reliable, and simple to operate.

A major component of the tube is the 10-inch coaxial-line interaction structure. It is nonmagnetic stainless steel tubing; the inside diameter of the larger tubing is 0.36 inch, while the outside diameter of the smaller tubing is 0.15 inch. The outer coaxial cylinder is supported within the glass envelope by two support rings. Each support ring contains three synthetic sapphire balls (one of which is spring-loaded) which bear against the glass envelope. The tubing forming the inner coaxial conductor is supported at the gun end of the tube by an Aquadag coated glass bead. The glass bead, visible in Fig. 1, serves not only as a mechanical support, but also as the 50-ohm termination for the coaxial line.

The external RF connection to the tube is made at a coaxial Kovar seal near the collector. A short section of internal coaxial transmission line connects the interaction structure to the Kovar seal. RF is brought in at the collector end of the tube, not only to reduce the overall diameter of the tube, but also to keep the magnetic Kovar as far from the beam as possible.

A standard RCA cathode-heater assembly with a flat 0.12-inch oxide-coated cathode button provides the electron source. Both the anode and the detecting grid, which are mounted perpendicular to the beam, are of the type shown in Fig. 3. These grids, made available

<sup>12</sup> J. L. Stewart, "The Analytical Theory of Cyclotron Resonance Video Detectors and Mixers with Examples," Electronics Res. Lab., Stanford University, Stanford, Calif., Tech. Rept. No. 17, N6onr 25123; September 25, 1952. This was also a Ph.D. dissertation under the same title.

<sup>13</sup> J. L. Stewart, "The Theory of Cyclon Detectors and Mixers," Electronics Res. Lab., Stanford University, Stanford, Calif., Tech. Rept. No. 19, N6onr 25132; April 10, 1953.

<sup>14</sup> J. L. Stewart, "New Cyclon Detectors," Electronics Res. Lab., Stanford University, Stanford, Calif., Tech. Rept. No. 23, N6onr 25132; June 26, 1953.

<sup>15</sup> J. L. Stewart, "Electron flow through small tubes with magnetic focusing," *J. Appl. Phys.*, vol. 24, pp. 1236-1240; September, 1953.



Fig. 1—Cyclotron resonance detector tube. Overall dimensions,  $14\frac{3}{4} \times 1\frac{1}{2}$  inches.

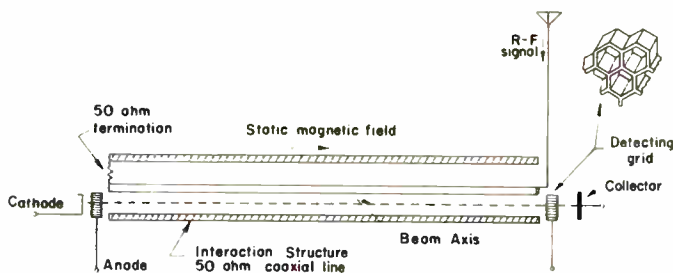

Fig. 2—Cyclotron resonance detector tube, functional schematic.

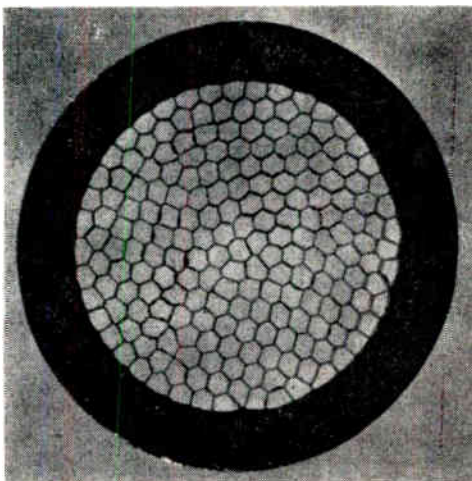

Fig. 3—Honey-comb detecting grid. Hexagonal cell diameter and depth, approximately 10 mils.

<sup>11</sup> Subsequent to his work at Stanford, Worcester and his associates at the Engrg. Exp. Sta., University of Colorado, Boulder, have continued the study of cyclotron resonance, with particular emphasis on the Spanatron. Tech. Repts. 1-7, Nonr-1147-01, describe their work during the 1953-1958 period.

through the courtesy of Varian Associates, have a cell diameter and depth of approximately 0.010 inch.

Typical applied potentials and resulting currents are: coaxial interaction structure, zero volts dc (outer conductor grounded); useful cathode voltage range,  $-3$  to  $-15$  volts; cathode current,  $50-60 \mu\text{a}$ ; collector current (in the absence of RF),  $5-15 \mu\text{a}$ ; dc collector potential, a few volts above ground (not critical); detecting grid, ground potential.

The beam voltage at which the tube is to be operated is chosen on the basis of RF bandwidth and sensitivity considerations (see Figs. 8 and 9); the anode potential is set one volt positive with respect to the cathode, and the tube's position in the magnetic field is adjusted to secure maximum collector current in the absence of a signal. A slight spatial re-alignment of the tube in the magnetic field, and adjustment of the anode potential, may be required to obtain maximum sensitivity when a test signal is applied.

The required magnetic field was generated by a wire-wound solenoid  $16\frac{1}{2}$  inches in length and  $4\frac{1}{2}$  inches in outside diameter. A reasonable amount of care must be exercised during construction of the solenoid to obtain winding uniformity. At a cyclotron frequency of 650 mc (232 gauss), the solenoid dissipated approximately 40 watts; a 1-ma change in the solenoid current varied the cyclotron frequency 3 mc.

#### DETECTION OF SPIRALLING ELECTRONS

The most satisfactory method discovered so far for detecting spiralling electrons is a honey-comb grid of the type shown in Fig. 3. It appears from geometrical considerations that, as a first approximation, the probability of electron interception by the detecting grid would be directly proportional to the radius of the electron's helical path. Observations indicated that this was not true; grid detection is more complicated than one might suspect. Consideration of the random phenomena created by the electrostatic field near the grid, and by thermal factors, suggested that a statistical approach to the problem might be fruitful. Both Worcester<sup>10</sup> and, more recently, Stewart<sup>12,13,15</sup> have analyzed detecting of grid behavior from a statistical viewpoint. Both these analyses correctly indicate that the change in intercepted current will be nearly proportional to the square of the signal-induced radius under small-signal conditions. That this is so may be inferred from Fig. 6 and (9). The actual sensitivity realized by the detecting grids is within a few db of that which is theoretically possible according to Stewart's analysis. For more details on the theoretical behavior of the honey-comb grids, the reader is referred to the references cited.

Theoretically the signal is negative at the detector grid (grid intercepts electrons) and positive at the collector; thus, it would seem, one would have a choice of video signal polarity. In practice, however, some detection occurs in the interaction structure; *i.e.*, some electrons spiral into the conductors of the RF transmission

line. Near the lower frequency limit of the tube described, the detected signal at the grid may change polarity—due to interception of electrons in the interaction structure. Since the polarity of the signal at the collector is always the same, it was used rather than the grid signal.

#### ENERGY TRANSFER MECHANISM

An electron entering the coaxial interaction structure with only an axial velocity would, in the absence of an RF signal, follow a straight-line trajectory parallel to the beam axis. However, should the electron acquire a velocity component transverse to the axial magnetic field, due to thermal emission effects, the RF field, or from any cause whatsoever, the electron trajectory will not be a straight line. The electron will instead spiral about a line parallel to the beam axis; in addition to its axial velocity, it will have acquired an angular velocity. Thus, the electron trajectory may be visualized as a helix of constant pitch with an axis parallel to the static axial magnetic field. The number of revolutions the spiralling electron completes each second (the cyclotron frequency) is uniquely determined by the magnetic flux density.

If the frequency of the RF field, as viewed by an observer moving at the axial velocity of the electron, is equal to the cyclotron frequency and if the phase relationship of the spiralling electron and the RF field is optimum, the electron will continuously gain energy from the transverse electric field. The radius of the spiralling electron will continuously increase as the electron moves through the interaction structure. If the observed RF frequency differs from the cyclotron frequency, the electron gains less energy, its path radius is less, and the current intercepted by the detector grid is less. Hence, the spiralling electrons form a resonant system. It is the purpose of the ensuing analysis to determine the characteristics of this resonant system.

In order to simplify the analysis, the terminated coaxial line structure used in the actual tube is replaced by a lossless, terminated parallel-plate transmission line in which all fringing fields are neglected. The parallel-plate structure and assumed coordinate system are shown in Fig. 4. The RF electric field is entirely in the  $y$  direction and independent of the  $x$  coordinate; the uniform static magnetic field is in the  $+z$  direction only. A partial list of the symbols used follows (mks units are used unless otherwise noted).

- $B$  = axial magnetic flux density,
- $e$  = electronic charge,
- $E_y$  = instantaneous RF electric field  
=  $E_0 \cos(\omega t + \beta z + \phi)$ ,
- $E_0$  = maximum value of RF electric field,
- $m$  = electron mass,
- $u_0$  =  $z$ -directed electron velocity,
- $v$  = RF phase velocity,
- $\beta$  = RF phase constant,



- $\phi$  = phase angle relating value of RF electric field and angular position of electron at  $t=0$ , i.e.,
- $-E_0 e \cos \phi$  is force acting on electron at  $t=0$ ,
- $\omega$  = angular frequency of RF input ( $\omega = 2\pi f$ ),
- $\omega_c$  = cyclotron angular frequency ( $\omega_c = 2\pi f_c$ ),
- $\omega_k$  = angular frequency of RF input viewed by moving electron, and
- $\tau$  = electron transit time through interaction space.

Neglecting the effects of other electrons, i.e., space charge, it is well known that an electron having a velocity component perpendicular to a static magnetic field will, under equilibrium conditions, perform a circular motion having an angular velocity:

$$\omega_c = 2\pi f_c = \left| \frac{e}{m} B \right|,$$

where  $f_c$  = cyclotron frequency in cps.

The incremental energy gained by the orbiting electron from the RF electric field (see Figs. 4 and 5) is:

$$dW = F \cdot ds = -E_y e r \omega_c \cos \omega_c t dt. \quad (1)$$

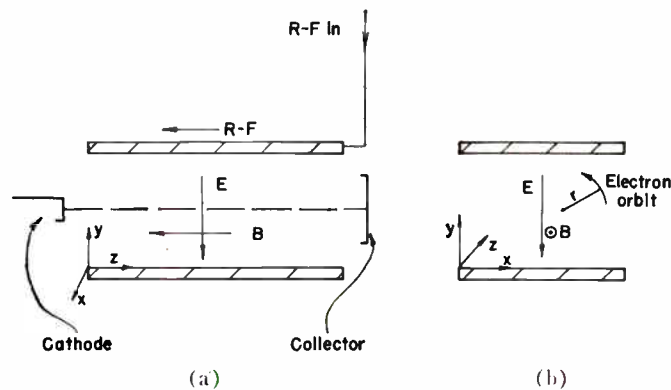

Fig. 4—Parallel-plate interaction structure, side and end views.

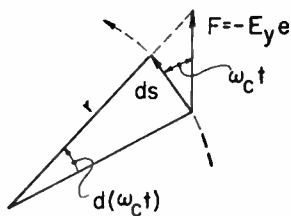

Fig. 5—Electron force diagram.

Since the energy of a spiralling electron is

$$W = \frac{1}{2} m r^2 \omega_c^2, \quad (2)$$

then

$$dW = m r \omega_c^2 dr.$$

Eliminating  $dW$  from (1) and (2),

$$dr = \frac{E_y}{B} \cos \omega_c t dt = \frac{E_0}{B} \cos (\omega t + \beta z + \phi) \cos \omega_c t dt. \quad (3)$$

The electron enters the interaction structure at  $z=t=0$ . The  $z$  coordinate of the electron is  $z=u_0 t$ , so that  $\beta z = \omega/v(u_0 t)$ . Eq. (3) may be written

$$dr = \frac{E_0}{B} \cos (\omega_k t + \phi) \cos \omega_c t dt, \quad (4)$$

where

$$\omega_k \triangleq \omega \left( 1 + \frac{u_0}{v} \right).$$

If the amount of energy absorbed by the electron is small,  $E_0$  can be assumed constant. Integrating (4) over the time interval 0 to  $\tau$ , where  $\tau$  is the electron transit time, one obtains

$$\begin{aligned} r &= \left| \frac{E_0 \tau}{2B} \left( \frac{\sin (\omega_c \tau - \omega_k \tau - \phi) + \sin \phi}{(\omega_c - \omega_k) \tau} \right. \right. \\ &\quad \left. \left. + \frac{\sin (\omega_c \tau + \omega_k \tau + \phi) - \sin \phi}{(\omega_c + \omega_k) \tau} \right) + r_0 \right| \\ &= |r_s + r_0|. \end{aligned} \quad (5)$$

In this equation,

- $r$  = total electron path radius at  $t=\tau$ ,
- $r_0$  = initial electron path radius prior to electronic interaction, and
- $r_s$  = component of electron path radius due to electronic interaction with RF field.

The absolute magnitude of (5) is taken since a negative value of  $r$  has no physical significance.

If the assumption is made that  $(\omega_c + \omega_k) \gg |\omega_c - \omega_k|$ , (5) can be written

$$\begin{aligned} r &= \left| \frac{E_0 \tau}{2B} \frac{\sin \frac{\Delta \omega \tau}{2}}{\frac{\Delta \omega \tau}{2}} \cos \left( \phi - \frac{\Delta \omega \tau}{2} \pm 2n\pi \right) + r_0 \right|, \\ n &= 0, 1, 2, \dots, \text{ and } \Delta \omega = \omega_c - \omega_k. \end{aligned} \quad (6)$$

Application of the assumption noted invalidates (6) near the zeros of the  $(\sin \Delta \omega \tau / 2) / (\Delta \omega \tau / 2)$  term. The equation can be used, however, to describe the maximum value of  $|r|$  as a function of the pertinent variables.

Presumably all values of  $\phi$  are possible in an actual tube so that the maximum possible electron path radius as a function of  $\Delta \omega \tau$  is observed by the detecting grid. This radius is

$$r = \left| \frac{E_0 \tau}{2B} \left[ \frac{\sin \frac{\Delta \omega \tau}{2}}{\frac{\Delta \omega \tau}{2}} \right] + r_0 \right|. \quad (7)$$

Maximum radius is obtained at  $\Delta\omega = 0$ ; resonance, therefore, occurs when  $\omega_c = \omega_k$ , *i.e.*, when

$$f_c = f \left( 1 + \frac{u_0}{v} \right). \quad (8)$$

The factor  $(1 + u_0/v)$  represents the increase in the signal frequency ( $f$ ) as "seen" by the electron due to the Doppler effect. If the RF wave on the parallel-plate transmission line were a standing-wave rather than a traveling-wave, resonance would occur at  $f = f_c$ .

The electron path radius at resonance is

$$r_m = \left| \frac{E_0\tau}{2B} + r_0 \right|. \quad (9)$$

Taking the ratio of (7) and (9) gives the relative electron-path radius with respect to the resonant radius. Assuming that the initial radius  $r_0$  is small compared to the signal induced radius, this ratio becomes

$$\frac{r}{r_m} = \left| \frac{\sin \frac{\Delta\omega\tau}{2}}{\frac{\Delta\omega\tau}{2}} \right|. \quad (10)$$

Both experimental and theoretical considerations indicate that the detecting grid output varies as the square of the electron path radius. Squaring (10), therefore, gives the relative response curve of the device as the signal frequency varies. If the signal frequency is held constant, and the magnetic field (cyclotron frequency) is varied, the response curve is given by the square of (10) provided  $\Delta\omega$ /resonant angular frequency  $\ll 1$ .

Eq. (10) has decreased to 0.707 of its maximum value when  $\Delta\omega\tau/2 = 1.39$ ; the 3-db bandwidth is, therefore,

$$\Delta f_{3db} = \frac{\Delta\omega}{\pi} = \frac{2.78}{\pi\tau}. \quad (11)$$

Since the energy transferred to a resonant electron is given by  $\frac{1}{2}m(E_0\tau/2B)^2\omega_c^2$ , the power transferred to a beam is

$$P_r = \frac{e}{m} I \frac{(E_0\tau)^2}{8}, \quad (12)$$

where  $I$  = beam current, and  $P_r$  = power transferred to the beam.

It will be noted from the preceding analysis that the resonant electron path radius is proportional to the product of the peak value of RF field and electron transit time [see (9)]. Once one has decided upon an interaction structure, the peak value of the transverse electric field is fixed for a given signal power input. Transit time, however, can be controlled by adjustment of the beam voltage.

Increasing the electron transit time (decreasing the beam voltage) decreases the signal power required to

attain a given resonant radius, and at the same time, decreases the 3-db bandwidth [see (11)]. As one might suspect, there is a practical limit as to how far the transit time may be increased. Experimentally, the minimum useful beam voltage has been determined to be approximately 3.5 volts for the 10-inch coaxial-tube line. This corresponds to a minimum 3-db bandwidth of about 4 mc. The 3-db bandwidth, as indicated by (11), has been found to be essentially independent of the resonant frequency, at least over the 10:1 frequency range investigated. Similarly, the power coupled to the beam at resonance is independent of frequency. Eq. (12) also indicates that the frequency range over which power can be satisfactorily coupled to the beam is determined only by the frequency characteristics of the interaction structure.

In arriving at (10), which describes the relative electron path radius, it was assumed that all values of  $\phi$  are possible because the time-relationship of electron entry and the peak RF field is random. Some electrons will, therefore, always acquire the maximum possible energy as the signal frequency varies about the cyclotron frequency. The response for off-resonance frequencies would, under these conditions, decrease in relative amplitude at the slowest possible rate; *i.e.*, the response given by (10) has the worst possible selectivity for this resonant system.

One is therefore led to inquire as to the possibility of obtaining a more selective response characteristic. Such a possibility exists; for  $\phi = 0$ , (10) becomes:

$$\frac{r}{r_m} = \left| \frac{\sin \Delta\omega\tau}{\Delta\omega\tau} \right|, \quad (13)$$

where  $r_m$  is given by (9). The 3-db bandwidth obtained for  $\phi = 0$  is exactly one-half of that given by (11).

#### CHARACTERISTICS OF THE CYCLOTRON RESONANCE DETECTOR TUBE

The tube responds to CW, AM, and FM signals; for convenience, however, pulsed signals were generally used in determining the characteristics described in this section.

The relative amplitude of detected RF pulses as a function of the peak RF power input is shown in Fig. 6. The detection is square law over the region where the slope of the curve is one, *i.e.*, over a power input range of 20 db. Saturation occurs at approximately 1/10 of a milliwatt; the input RF power dynamic range is approximately 35 db. The data for Fig. 6 were taken at resonance with a beam voltage of 4.0 volts at an RF input frequency of 230 mc. The detector characteristic observed at other frequencies (100 and 500 mc) is not significantly different from that shown in Fig. 6.

The relative response curve for the tube is shown in Fig. 7; the solid curve represents the actual response, while the dashed curves are the envelopes of the two the-

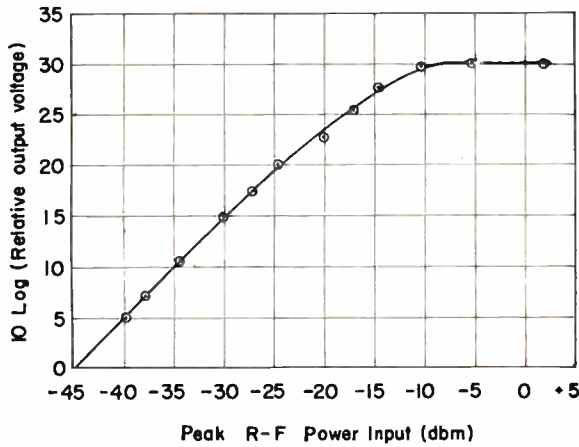

Fig. 6—Grid detector characteristic.

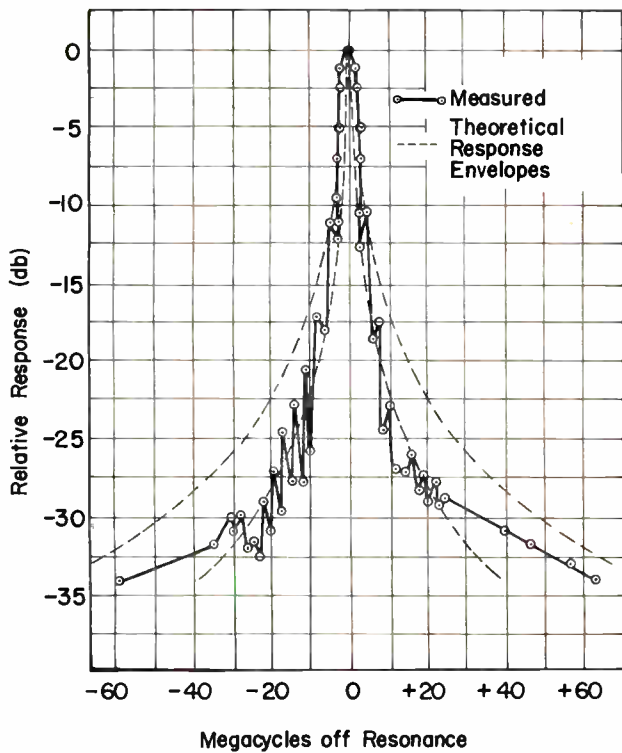

Fig. 7—Cyclotron resonance relative response curve.

oretical response characteristics obtained from (10) and (13), assuming the detector grid responds to the square of the relative electron path radius. Due to the assumption noted in connection with (6), only the envelope of the theoretical responses (curve through maximum values of  $|r/r_m|^2$ ) is shown in Fig. 7. The outer dashed curve is (10) squared and represents the envelope of the response one would expect to obtain; the inner, more sharply resonant, dashed curve is shown merely to indicate a more desirable response which is, at least theoretically, obtainable. Inspection of Fig. 7 shows that the agreement between experiment and theory is reasonable, but by no means perfect. Assumptions in-

involved in the analysis and the experimental error probably account for the discrepancy.

The characteristic shown in Fig. 7 is typical of the response curves observed for resonant frequencies greater than 100 mc. In the region of 100 mc and below, the response becomes noticeably asymmetric for reasons not clearly understood.

The selectivity of the resonant system is not particularly impressive: the 30-db/3-db bandwidth ratio is only about 14. One obvious means of improving the selectivity is to provide RF pre-selection ahead of the tube. For operation over an extensive frequency range, as well as for ease in tracking, the pre-selector also probably should be a device which utilizes the cyclotron resonance phenomena. Perhaps a device patterned after the Cuccia electron coupler<sup>16,17</sup>—but with wide-band transmission line input and output interaction-structures—would be an effective pre-selector.

The 3-db RF bandwidth as a function of beam voltage is shown in Fig. 8. The solid curve is plotted from measured data; the dashed curve is calculated from (11). The electron transit-time required for substitution in (11) was calculated on the basis of a 10-inch interaction length and an average axial velocity,  $u_0$ , given by the relation  $\frac{1}{2}mu_0^2 = eV$ , where  $V$  is the cathode voltage. The predicted and measured curves are nearly parallel for beam voltages greater than 3.5 volts, thus, at least qualitatively, providing verification of (11) in this region.

The abrupt change in the general trend of the solid curve in Fig. 8 at beam voltages of 3.5 volts and less is correlated with a similar change in the sensitivity-beam voltage characteristic (see Fig. 9).

Since the electron path radius at resonance is proportional to the transit time [see (9)], it is to be expected that sensitivity will decrease with an increase in beam voltage. In Fig. 9 the tangential signal sensitivity for a 1- $\mu$ sec pulse (500-kc video bandwidth<sup>18</sup>) is plotted as a function of beam voltage. At beam voltages of 3.5 volts and less, the general trend of the curve is reversed: in this region the tube also becomes acutely sensitive to minor changes in operating conditions. It is customary, therefore, to operate the tube at a beam voltage of four or even five volts when maximum sensitivity is desired.

The sensitivity-beam voltage characteristic is essentially independent of frequency, at least over the 65–650-mc range examined. The ordinate (sensitivity) will change with resonant frequency. The shape of the curve and of the abscissa, however, remain intrinsically unchanged.

<sup>16</sup> C. L. Cuccia, "The electron coupler—a developmental tube for amplitude modulation and power control at ultra-high frequencies—Part I," *RCA Rev.*, vol. 10, pp. 270–303; June, 1949.

<sup>17</sup> C. L. Cuccia, "The electron coupler—a developmental tube for amplitude modulation and power control at ultra-high frequencies—Part II," *RCA Rev.*, vol. 14, pp. 72–99; March, 1953.

<sup>18</sup> The post-detection (video) amplifier bandwidth must be chosen so as to amplify the detected modulation with satisfactory fidelity. This bandwidth will in turn affect the video amplifier noise and thereby the minimum detectable RF signal.



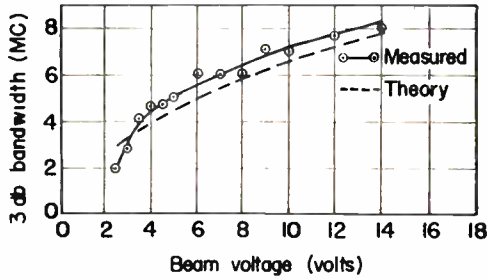

Fig. 8—3-db RF bandwidth vs beam voltage.

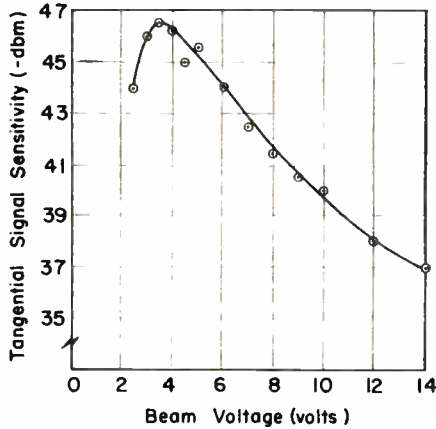

Fig. 9—Tangential signal sensitivity vs beam voltage, 500-ke video bandwidth.

The wide frequency range over which the cyclotron resonance detector tube can be operated is indicated in Fig. 10. The resonant frequency was varied by changing the current in the solenoid windings; no other adjustment was made. The sensitivity gave no sign of decreasing above 680 mc; data were not taken at higher frequencies because of solenoid dissipation. The sensitivity shown in Fig. 10 is for an RF bandwidth of 5 mc (5-volt beam) and for a 1- $\mu$ sec pulse (500-ke video bandwidth).

The poor sensitivity of the tube at the lower frequencies appears to be due primarily to beam transmission difficulties. At 56 mc, for example, the axial magnetic flux density required for resonance is only about 20 gauss. The useful low-frequency limit for these tubes would appear to be about 65 mc; operation near this low frequency limit requires that the solenoid be carefully shielded from the earth's magnetic field.

RF pre-amplification can be used to improve upon the basic sensitivity of the cyclotron resonance tubes. Low-noise, wide-band distributed amplifiers have been employed to obtain tangential signal sensitivities of  $-90$  to  $-95$  dbm over wide frequency ranges.

One of the unusual features of these tubes, possibly unique, is the electronically variable RF 3-db bandwidth. Fig. 8 would indicate that one need only vary the beam voltage to attain a desired 3-db bandwidth. It is true that the beam voltage controls the bandwidth, but usually a slight adjustment of anode voltage (and possibly of the tube's spatial alignment) is re-

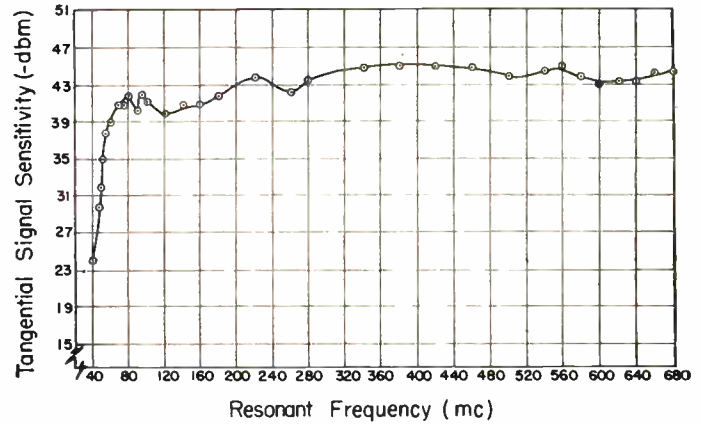

Fig. 10—Tangential signal sensitivity vs resonant frequency, 500-ke video bandwidth and 5-nc RF bandwidth.

quired to obtain maximum sensitivity following a change in the beam voltage. At most, the adjustments would take a few minutes; it might, however, be useful if one were able to change the bandwidth rapidly. This can be accomplished by distorting the axial magnetic field so as to achieve an effect analogous to staggered tuning.

The interaction structure of the cyclotron resonance tube and the magnetic field in which the tube is immersed are analogous to a resonant circuit which is tuned by varying the magnetic flux density. If the magnetic flux density over one-half the length of the interaction structure is different from that of the other half, the situation is analogous to that of two tuned circuits of different resonant frequencies connected in series. (In bandpass-amplifier theory, this combination would be called a "staggered pair.") Perhaps the simplest way to achieve a staggered magnetic field is to add a second winding to the solenoid which is wound clockwise for half the length of the solenoid and counter-clockwise for the remaining half. A current flowing in this winding will produce, ideally, an axial magnetic field which adds to the main field over one-half the length of the solenoid and subtracts from the main field over the other half. Since the added winding need only produce a magnetic field on the order of one or two gauss, the additional power required is negligible.

With the proper current flowing in the additional solenoid winding, a response curve with three peaks is obtained (see insert of Fig. 11). This response is nearly independent of the resonant frequency, as long as the beam voltage and the current in the additional winding remain unchanged. To change from the response of Fig. 7 to the three-peaked response of Fig. 11, one need only throw a switch to send a predetermined current through the additional winding. If the beam voltage is changed by more than 10 per cent, it is necessary to adjust the value of this current to obtain maximum results.

In Fig. 11 the 3-db bandwidths for the uniform and staggered magnetic fields are compared. The bandwidth is increased by a factor of approximately 3 (theoretic-

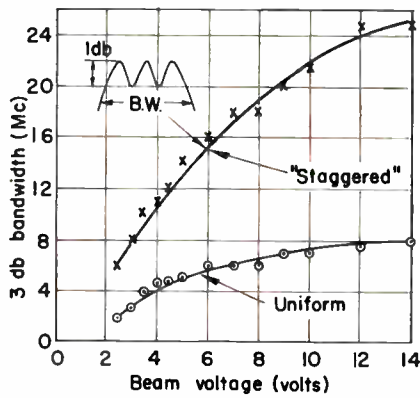

Fig. 11—3-db RF bandwidth vs beam voltage, uniform and "staggered" magnetic field.

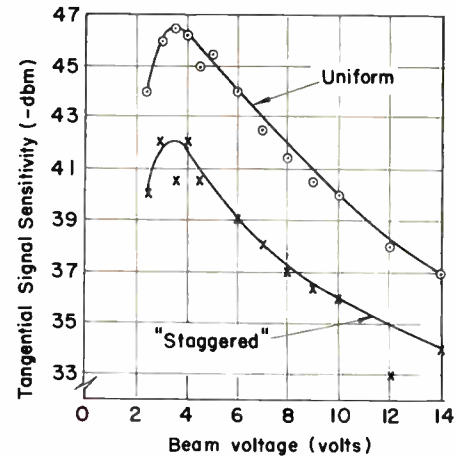

Fig. 12—Tangential signal sensitivity vs beam voltage, uniform and "staggered" magnetic field.

cally, 2.8) when the magnetic field is staggered. The increased bandwidth is acquired at the expense of sensitivity; the reduction of sensitivity (see Fig. 12) varies between 3 and 5 db depending upon the beam voltage.

The cyclotron resonance tubes are relatively immune to damage by high RF powers. Permanent damage is most likely to occur first at the terminating resistance. A small change in the value of the coaxial line termination is not detrimental. However, a large VSWR on the coaxial line would narrow the frequency range over which satisfactory sensitivity could be obtained. RF power of a magnitude far less than that which could cause any possible physical damage does, however, produce undesirable spurious responses.

If the RF input is sufficient to saturate the tube, that is, if it is greater than  $-10$  dbm, spurious responses—which have no apparent relationship to the applied signal frequency—appear over a wide frequency range. These responses are at least 30 db below the peak of the main response and are easily identifiable. A second type of spurious response—which may have more serious consequences—is observed when the input power exceeds approximately  $-20$  dbm. This response occurs when the cyclotron frequency is approximately half of the signal frequency: its amplitude is also at least 30 db below the main response, but the shape of its response-curve appears to be very similar to that of the main response (Fig. 7); hence, it can be mistaken for a weak legitimate signal.

## CONCLUSIONS

The idealized and simplified theory of energy transfer presented in this paper—along with the results from an analysis of detecting grid behavior<sup>13</sup>—is sufficient to predict many of the characteristics of a cyclotron resonance detector tube.

The cyclotron resonance tubes are characterized by an extremely broad frequency range (at least 10:1) over which operation is possible. Resonance may be electronically varied; tuning is linear and may be accomplished either with a single manual control, or by periodic variation of the solenoid current (automatic frequency scanning). The sensitivity, RF bandwidth, dynamic range, and selectivity of this device should prove adequate for many purposes.

## ACKNOWLEDGMENT

The author wishes to express his appreciation to L. D. Buchmiller for his suggestions and comments concerning the material in this manuscript. The author also desires to acknowledge the skill of H. R. Andrews, who constructed the tubes described.

The Stanford-developed cyclotron resonance tubes could not have been brought to their present state without the contributions of many people. In particular, the work of S. F. Kaisal, L. A. Roberts, W. G. Worcester, and J. L. Stewart was indispensable.

# Anomalies in the Absorption of Radio Waves by Atmospheric Gases\*

A. W. STRAITON†, FELLOW, IRE AND C. W. TOLBERT†, SENIOR MEMBER, IRE

**Summary**—This paper summarizes recent measurements of the attenuation of radio waves by atmospheric gases and compares the measured losses with those predicted by Van Vleck. Reasonably good agreement has been noted between the predicted and measured losses for oxygen, but the measured loss for water vapor is considerably in excess of that predicted. Various factors which may influence this discrepancy are discussed.

## INTRODUCTION

IN two classic papers in 1947, Van Vleck<sup>1,2</sup> evaluated the experimental evidence available on the absorption characteristics of atmospheric gases and predicted the magnitude of the attenuation of radio waves due to oxygen and water vapor. These papers have served as the starting point for most subsequent work in the field and the numerical predictions have been used frequently to estimate propagation losses.

The absorption of energy from a radio wave by atmospheric gases is due to the transition from one molecular rotation energy level to another caused by the electromagnetic wave. For gases at very low pressures, this energy change is associated with a very narrow band of frequencies. For increased pressures, the energy is absorbed over a wider range. The frequency dependence of microwave absorption was given by Van Vleck and Weisskopf<sup>3</sup> and the Van Vleck-Weisskopf equation as given in the Appendix has been the most commonly used means of predicting atmospheric losses.

Two critical constants are involved in each energy level transition. The first of these is the frequency associated with the energy transition. This may be determined from a knowledge of the energy levels or from direct measurement. Since the energy differences are very small for absorption lines in the microwave spectrum, the error involved in taking the difference of two nearly equal values is large. For this reason, direct measurement of resonant frequency is preferable where possible.

The second critical number is the line breadth constant associated with the frequency spread of the absorption. This value should be determined by direct measurement for the most reliable results.

\* Original manuscript received by the IRE, August 11, 1959; revised manuscript received, December 14, 1959. This work was sponsored by the Office of Naval Research under Contract Nonr 375(01).

† Electrical Engineering Research Lab., University of Texas, Austin.

<sup>1</sup> J. H. Van Vleck, "The absorption of microwaves by oxygen," *Phys. Rev.*, vol. 71, pp. 413-424; April 1, 1947.

<sup>2</sup> J. H. Van Vleck, "The absorption of microwaves by uncondensed water vapor," *Phys. Rev.*, vol. 71, pp. 425-433; April 1, 1947.

<sup>3</sup> J. H. Van Vleck and V. F. Weisskopf, "On the shape of collision-broadened lines," *Rev. Mod. Phys.*, vol. 17, pp. 227-236; April-July, 1945.

## VAN VLECK'S CHOICE OF LINE BREADTH CONSTANT

At the time of Van Vleck's papers, no propagation test had been made through the actual atmosphere in the millimeter wavelength region, and only a very few quantitative data were available in the centimeter region. On the basis of infrared studies, it had been possible to establish the molecular energy levels and the frequencies associated with their differences.

Oxygen losses in the millimeter spectrum result from the interaction of the magnetic moment of the O<sub>2</sub> molecule with the electromagnetic field. Transitions to the ground state occur with corresponding wavelengths grouped around 0.5 cm, and with one transition wavelength at 0.25 cm. In addition, nonresonant or Debye absorption provides a continuous spectrum of loss.

For line breadth constants of 0.05 or greater, the lines in the 5-mm wavelength band blend together to form a single line. On the basis of measurement of oxygen losses near 5 mm in waveguides by Berringer,<sup>4</sup> Van Vleck concludes that the appropriate line breadth constant should be 0.02 cm<sup>-1</sup> at one atmosphere. The losses calculated, using this constant, were plotted in Fig. 1. The attenuation curve is somewhat irregular at the first peak but the details are masked by the log-log scale.

Measurements by Lamont<sup>5</sup> of oxygen losses around 5 mm through the actual atmosphere were found to be adequately explained by the use of the line breadth of 0.02 cm<sup>-1</sup>. Laboratory measurements by Strandberg, *et al.*,<sup>6</sup> on pure oxygen and oxygen-nitrogen mixtures agreed with a line breadth constant between 0.015 and 0.02 cm<sup>-1</sup>.

For water vapor, one line occurs near 1.35 cm and one at 1.63 mm. In addition, there are a vast array of lines in the near millimeter region. Ghosh and Edwards<sup>7</sup> have listed 588 of these absorption lines. Of these, 149 with significant line strength have wavelengths between 0.05 and 1.0 mm. The direct measurement of the line breadth constant has been possible only for the 1.35-cm line. Van Vleck concluded, on the basis of resonant cavity measurements by Becker and Autler<sup>8</sup> at Columbia Uni-

<sup>4</sup> E. R. Berringer, "The absorption of one-half centimeter electromagnetic waves in oxygen," *Phys. Rev.*, vol. 70, pp. 53-57; July, 1946.

<sup>5</sup> H. R. L. Lamont, "Atmospheric absorption of microwaves," *Phys. Rev.*, vol. 74, p. 353; August, 1948.

<sup>6</sup> M. W. P. Strandberg, C. Y. Meng, and I. G. Ingersoll, "The microwave spectrum of oxygen," *Phys. Rev.*, vol. 75, pp. 1525-1528; May, 1949.

<sup>7</sup> S. N. Ghosh and H. D. Edwards, "Rotation Frequencies and Absorption Coefficients of Atmospheric Gas," Geophys. Res. Directorate, AF Cambridge Res. Ctr., Bedford, Mass., Rept. No. 82; March, 1956.

<sup>8</sup> G. E. Becker and L. H. Autler, "Water vapor absorption of electromagnetic radiation in the centimeter wave-length range," *Phys. Rev.*, vol. 70, pp. 300-307; September 1 and 15, 1946.



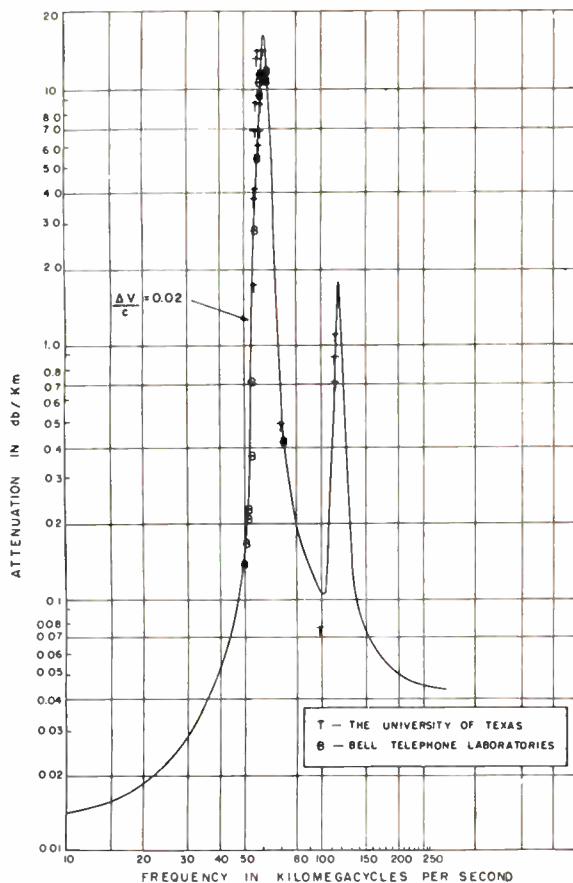

Fig. 1—Attenuation due to oxygen at one atmosphere.

versity, that this line breadth constant should be approximately  $0.1 \text{ cm}^{-1}$ . The assumption was made that this line breadth constant was the same for all water vapor lines and the spectral distribution of the water vapor losses was calculated. This theoretical attenuation as a function of frequency is shown in Fig. 2 for the line breadth constant of  $0.1 \text{ cm}^{-1}$  and also for a line breadth constant of  $0.27 \text{ cm}^{-1}$ .

#### DIFFICULTIES IN DIRECT TRANSMISSION LOSS MEASUREMENTS

It is rather surprising that there are very few reports in the technical literature of quantitative measurements of absorption by atmospheric gases on actual transmission paths. Dicke's<sup>9</sup> radiometric measurement of the sun at 1, 1.25 and 1.50 cm provided estimates of the water vapor loss, but required a knowledge of the water vapor distribution with height which can only be approximated.

The problem in millimeter measurements has been the lack of generators of sufficient power to make actual transmission tests. In recent years, however, improvements in millimeter techniques have extended the range over which propagation measurements could be made, and data are available at a good many frequencies.

<sup>9</sup> R. H. Dicke, R. Beringer, R. L. Kyhl, and A. B. Vane, "Atmospheric absorption measurements with a microwave radiometer," *Phys. Rev.*, vol. 70, pp. 340-348; September 1 and 15, 1946.

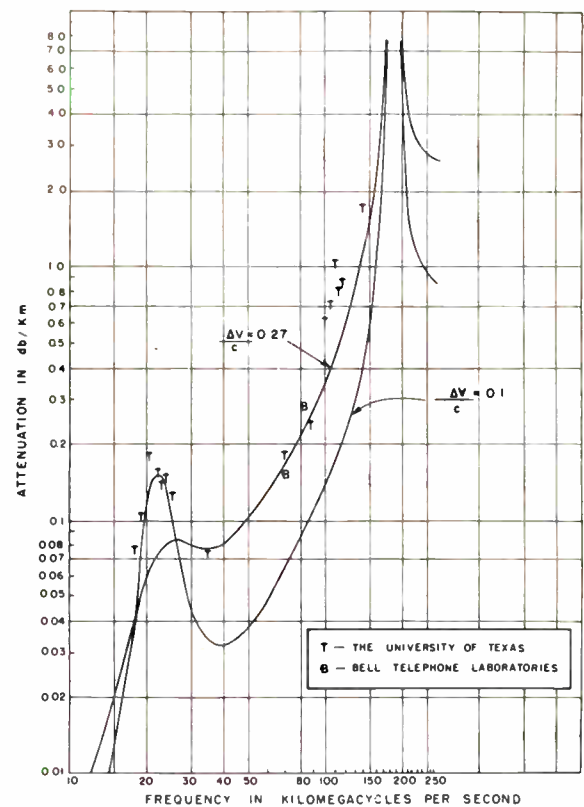

Fig. 2—Water vapor attenuation for  $7.5 \text{ g/m}^3$ .

In addition to the equipment problems, there are a number of difficulties encountered in the propagation tests that require them to be made with a great deal of care.

The general procedure for making the tests is to observe the signal level on a number of days and to plot this signal strength as a function of water vapor content in the atmosphere. The slope of this line provides the water vapor losses and the ordinate or y-axis intercept provides the oxygen loss.

Inhomogeneity in the water vapor content is known to exist both on small and large scales. In practice, the water vapor concentration is measured at both ends of the path and compared to data available from the U. S. Weather Bureau. The process of time averaging of the measurements and the use of many samples gives a measure of the variation of loss with water vapor concentration which is felt to be quite reliable.

Another annoyance in the measurement is the fact that considerable scintillation in the signal level may occur. The magnitude of these fluctuations is greater than can be explained by variations in the mean water vapor density and therefore must be attributed to refraction effects. The signal chosen as representative of a given sampling period is the mean level.

A third problem in propagation measurements is the presence of precipitation along the path. Care must be taken that the absorption measurements are made at a time when the atmosphere is free of rain or solid particulate matter.

## SUMMARY OF RECENT MEASUREMENTS

During recent years, improvements in generators and components have made possible a number of absorption measurements through the actual atmosphere. Such measurements have been made by Bell Telephone Laboratories<sup>10</sup> at wavelengths in the 5- to 6-mm region and at 4.3 and 3.7 mm. Similar measurements have been made by The University of Texas Electrical Engineering Research Laboratory at wavelengths in the range from 1.2 to 1.7 cm, at 8.6 mm, 4.3 mm, 3.35 mm, 2.15 mm, and at a number of wavelengths in the region from 2.5 to 3 mm.<sup>11</sup> The results of all these measurements have been plotted on Figs. 1 and 2 for comparison with the Van Vleck curves.

The points plotted on the log-log curves tend to give the impression of a closer agreement between the measured and theoretical values than actually exists. Some details of the spectrum will be considered later.

From Fig. 1, it is seen that the agreement between the measured and calculated values of absorption for oxygen are reasonably good, but for reasons pointed out later, care should be exercised in extrapolating the data to points very far from the frequencies at which they were measured.

From Fig. 2, it is seen that the water vapor losses are consistently larger than those predicted by Van Vleck for a line breadth constant of  $0.1 \text{ cm}^{-1}$ . These deviations will be discussed in greater detail in the following sections.

## RESIDUAL EFFECT OF SUBMILLIMETER WATER VAPOR LINES

In those sections of the microwave spectrum far removed from a water vapor absorption line, the attenuation is primarily controlled by the skirts of the submillimeter lines. This effect is shown in Fig. 3.<sup>12</sup> The line numbers are in the order of increasing frequency. It is noted in the frequency range from 50 to 130 kmc that the first 12 lines make a relatively small contribution to the total absorption and that line numbers 21 through 76 make approximately the same contribution as the first 20 lines.

The curves of Fig. 3 are based on the assumption that the line breadth constant is  $0.1 \text{ cm}^{-1}$  for all of the lines. Recent evidence has indicated that the line breadth may vary from line to line. Such variations could cause the attenuation curve to rise much more rapidly with frequency than is shown in Fig. 3.

<sup>10</sup> "Millimeter Wave Research—Final Report," Bell Telephone Laboratories, New York, N. Y., ONR Contract 687(00), Rept. No. 24261-15; May, 1955.

<sup>11</sup> C. W. Tolbert, A. W. Straiton, and J. H. Douglas, "Studies of 2.15 MM Propagation at an Elevation of 4 KM and the Millimeter Spectrum," Elec. Engrg. Res. Lab., The University of Texas, Austin, Rept. No. 104; November 1, 1958.

<sup>12</sup> W. E. Patterson, "Absorption of Microwaves of Millimeter Wavelength by Atmospheric Water Vapor," Master's Thesis, The University of Texas, Austin; June, 1957.

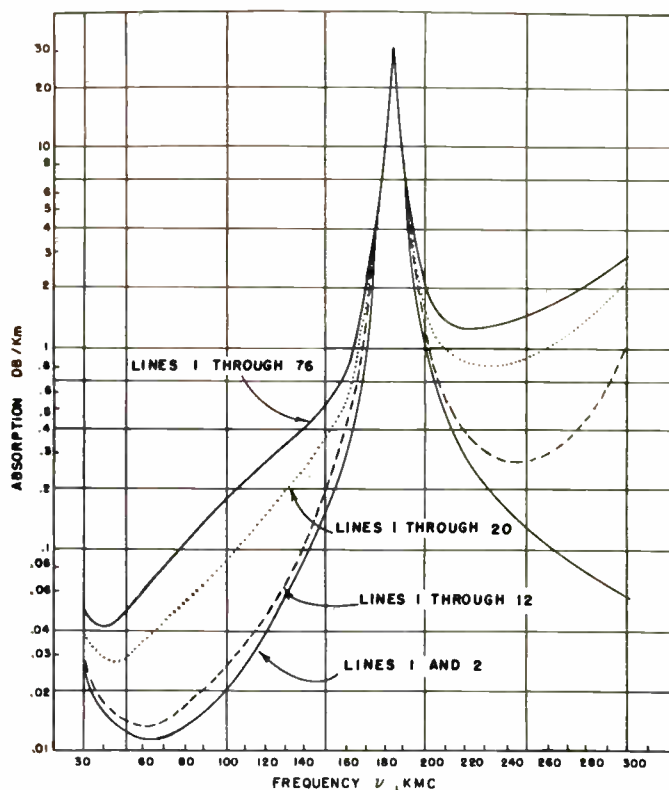

Fig. 3—Calculated water vapor absorption for  $7.5 \text{ g/m}^3$  for  $\Delta\nu/c = 0.1$ .

All of the water vapor loss measurements made prior to September 1958 could be approximately accounted for by the expediency of increasing the line breadth constant for the infrared residual lines from  $0.1$  to  $0.27 \text{ cm}^{-1}$ .

Recent measurements at The University of Texas, however, have uncovered several anomalies which have thrown out this simple panacea. These newer measurements are described in the following sections.

## MEASUREMENTS AROUND THE 1.35-CM LINE

In spite of the fact that the frequency of the 1.35-cm line has been known with precision for some time, quantitative measurements of the magnitude of its absorption through the actual atmosphere are very scarce. For this reason, data were recently taken by the Electrical Engineering Research Laboratory at a number of wavelengths in this region.<sup>13</sup>

These recent data are plotted in Fig. 4 together with the three points reported by Dicke, *et al.*<sup>9</sup> The curve is plotted on a linear basis for one gram of water vapor per cubic meter instead of for the standard atmosphere condition of 7.5 grams. Neither the Van Vleck-Weisskopf curve for the  $0.1 \text{ cm}^{-1}$  nor for the  $0.27 \text{ cm}^{-1}$  line breadth constant adequately represents the measured data even in the vicinity of the absorption line.

<sup>13</sup> C. W. Tolbert, A. W. Straiton, and C. O. Britt, "Propagation Studies Between 18.0 and 25.5 KMCS," Elec. Engrg. Res. Lab., The University of Texas, Austin, Rept. No. 110; July 10, 1959.

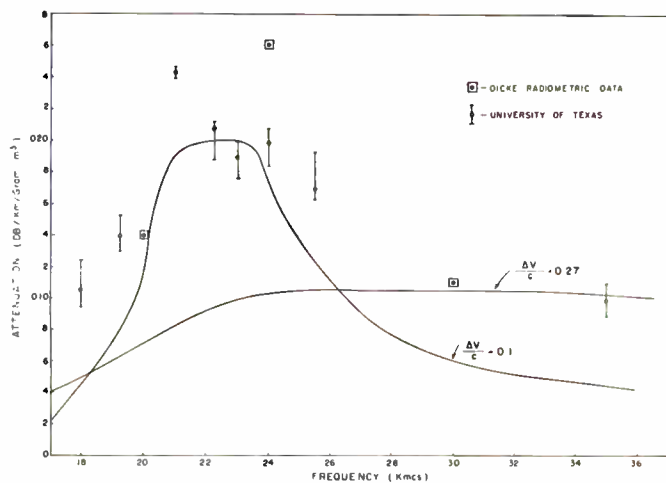

Fig. 4—Water vapor losses in 18.0- to 25.5-kmc spectrum.

### MEASUREMENTS IN THE 2.5 TO 3.0-MM REGION

#### Water Vapor Losses

The University of Texas has recently completed a series of measurements in the wavelength region from 2.5 to 3.0 mm.<sup>14</sup> Sufficient data were taken to obtain the slope of the water vapor line at frequencies of 100, 104.75, 110, 113 and 117.5 kmc, and these five points are shown in Fig. 2. Two anomalies are seen from these data. In the first place, the level of the attenuation is approximately 50 per cent higher than would be indicated by the Van Vleck-Weisskopf equation even for a line breadth constant of 0.27 cm<sup>-1</sup>. In the second place, the loss at 110 kmc is greater than the loss at the other four frequencies. Although no water vapor line has been predicted at 110 kmc, the increased attenuation at this frequency indicates that such a line may exist.

In addition to the five frequencies at which sufficient data were taken to obtain the water vapor slope, one or more soundings were made at 23 other frequencies in this region. The data were adjusted to the 7.5-grams-per-cubic-meter atmosphere by using a water vapor line slope obtained by interpolating between the values measured at the five frequencies. This may be done with some confidence since the correction applied was a function of the deviation from the standard atmosphere condition. The attenuation adjusted to the standard atmosphere is then shown in Fig. 5.

#### Oxygen Losses

From the shape of the smooth curve drawn through the higher frequency points, an oxygen absorption line may be fitted. It was found that a line with a resonant frequency of 118.75, a maximum attenuation of 1.7

<sup>14</sup> C. W. Tolbert, C. O. Britt, and J. H. Douglas, "Radio Propagation Measurements in the 110 to 118 KMCS Spectrum," Elec. Engrg. Res. Lab., The University of Texas, Austin, Rept. No. 107; April 15, 1959.

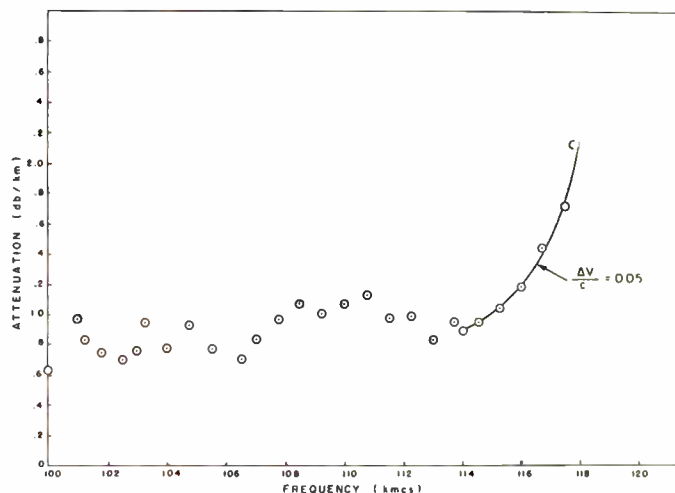

Fig. 5—Attenuation adjusted to standard atmosphere.

db/km and a line breadth constant of 0.05 cm<sup>-1</sup> would give the measured shape.

The line breadth constant at this frequency had been found by Anderson, *et al.*,<sup>15</sup> to be 0.12 cm<sup>-1</sup> at one atmosphere by laboratory methods. These measurements were made at a temperature of 190° K. A temperature correction to 300° K may be made using the line breadth as inversely proportional to temperature as measured by Hill and Gordy,<sup>16</sup> but the corrected value is still considerably greater than that determined by the propagation measurements.

A similar discrepancy exists around the 5-mm lines. Artman and Gordon<sup>17</sup> determined a line breadth of 0.049 cm<sup>-1</sup> from laboratory measurements on pure O<sub>2</sub> and O<sub>2</sub>-N<sub>2</sub> mixtures. Propagation measurements by Bell Telephone Laboratories and The University of Texas have indicated that the line breadth constant should be nearer 0.02 cm<sup>-1</sup>.<sup>10,18</sup>

#### Losses Due to Rare Gases

The data in the region from 100 to 106 kmc were found to be erratic with day-to-day variations which did not correlate with the water vapor density changes. It was therefore felt that these losses were due to some of the rarer gases in the atmosphere such as N<sub>2</sub>O, NO<sub>2</sub>, SO<sub>2</sub>, and O<sub>3</sub>, which have resonant frequencies in this general area. These irregular losses were about 0.2 db/km during the measurement period.

<sup>15</sup> R. S. Anderson, C. M. Johnson, and W. Gordy, "Resonant absorption of oxygen at 2.5 millimeters wavelength," *Phys. Rev.*, vol. 83, pp. 1061-1062; 1951.

<sup>16</sup> R. M. Hill and W. Gordy, "Temperature dependence of the line breadth of oxygen," *Phys. Rev.*, vol. 91, p. 222; July 1, 1953.

<sup>17</sup> J. O. Artman and J. P. Gordon, "Absorption of microwaves by oxygen in the millimeter region," *Phys. Rev.*, vol. 96, pp. 1237-1245; December 1, 1954.

<sup>18</sup> C. W. Tolbert, J. H. Douglas, and C. O. Britt, "Measured Absorption of Millimeter Wavelengths by Oxygen at Partial Atmospheric Pressures," Elec. Engrg. Res. Lab., The University of Texas, Austin, Rept. No. 100; May 15, 1958.



## CHANGE IN ATTENUATION WITH PRESSURE

High elevation measurements have been made by The University of Texas at wavelengths of 8.6,<sup>19</sup> 4.3<sup>20</sup> and 2.15<sup>11</sup> mm. These data were taken over paths between mountain peaks in Colorado with elevations from 12,000 to 14,000 feet. Losses due to water vapor were measured at all three wavelengths and the loss due to oxygen was measured at 4.3 mm. The oxygen losses at 8.6 and 2.15 were too small to measure with accuracy. The results of these measurements are shown in Table I.

TABLE I

Wavelength (mm)	Attenuation in db/km	
	Water Vapor (1g/m <sup>3</sup> )	Oxygen
8.6	0.03	0.22
4.3	0.10	
2.15	0.12	

It is generally assumed that at the resonant frequency the loss for the same concentration of the absorbing gas will be the same regardless of the total pressure of the atmosphere. It is also assumed that the line breadth constant is proportional to the total pressure.

The losses for the higher altitude may be calculated from the Van Vleck-Weisskopf equation by adjusting the line breadth constant for the pressure change starting with line breadth constants at one atmosphere of 0.27 cm<sup>-1</sup> for water vapor, and 0.02 cm<sup>-1</sup> for oxygen. Losses calculated on this basis were found to agree reasonably well with the measurements.

In the light of recent anomalies at 1.35 cm and 2.6 mm, however, it would be expected that additional anomalies may be found at high altitudes for other wavelengths. The use of the Van Vleck-Weisskopf equation for higher altitudes should then be limited to the part of the spectrum in which the measurements were made.

## DISCUSSION OF DEVIATION OF MEASURED AND PREDICTED ABSORPTION VALUES

In trying to fit the measured points with the Van Vleck-Weisskopf line broadening equation, we find that the use of a single line breadth constant is inadequate. The data may be approximately fitted by introducing a number of line strength and line width constants. In so doing, however, the equation loses much of its simplicity and utility. Some of the relationships that account for the anomalies will be discussed in this section.

<sup>19</sup> C. W. Tolbert and A. W. Straiton, "Radio Propagation Measurements Between Pike's Peak and Mount Evans at a Wavelength of 8.6 Millimeters," Elec. Engrg. Res. Lab., The University of Texas, Austin, Rept. No. 77; September 30, 1955.

<sup>20</sup> C. W. Tolbert and A. W. Straiton, "Radio Propagation Measurements Between Pike's Peak and Mount Evans at a Wavelength of 4.3 Millimeters," Elec. Engrg. Res. Lab., The University of Texas, Austin, Rept. No. 88; November 22, 1956.

## Variation of Line Breadth Constant from Line to Line

Benedict and Kaplan<sup>21</sup> point out that there is considerable theoretical and experimental evidence that the line width for the various water vapor lines is different depending on the rotational states involved. With the imposing array of lines which influence millimeter absorption, the absorption-frequency curve could take on a wide variety of shapes. The general effect would be that of having a greater increase in absorption with frequency as the shorter millimeter wavelengths are approached. This has been the general trend in the measured water vapor loss since the ratio of the measured losses to those predicted by Van Vleck vary from three to ten as the frequency goes from 35 to 140 kmc.

## Possibility of Unpredicted Lines

The measurements in the 100- to 118-kmc range indicated that a water vapor line occurs at 110 kmc. Although no line has been predicted at this frequency, it would not be surprising if one did occur because of the very complex nature of the water vapor transitions.

An alternate explanation of the water sensitive loss at 110 kmc is that an isotope of H<sub>2</sub>O or another of the rarer gases in the atmosphere would vary in concentration in proportion to the water vapor density. There is, however, little theoretical justification of the increased attenuation on this basis.

The effect of some of the rarer gases was observed in the 100- to 106-kmc region where erratic losses of approximately 0.2 db/km were noted. These losses did not vary in proportion to the water vapor concentration, but changed inconsistently from day to day. This is the only region where these effects could be noted, although they might be expected at other frequencies to a lesser amount.

## Nonlinearity of Water Vapor Absorption

Water vapor absorption curves as a function of water vapor concentration as measured by The University of Texas and by Bell Telephone Laboratories have shown a tendency to increase faster with water vapor concentration than at a straight line rate. The range of water vapor concentration and the variability of the result have made it difficult to determine the exact deviation from a straight line.

If such nonlinearity does exist, it must be due to the fact that H<sub>2</sub>O-H<sub>2</sub>O molecular collisions have a much greater effect on line broadening than do H<sub>2</sub>O-Air collisions. Becker and Autler estimate a ratio of 5 in the cross section of the H<sub>2</sub>O-H<sub>2</sub>O collision as compared to the H<sub>2</sub>O-Air collision.

<sup>21</sup> W. S. Benedict and L. D. Kaplan, "Calculation of line width in H<sub>2</sub>O-N<sub>2</sub> collisions," *J. Chem. Phys.*, vol. 30, pp. 388-399; February, 1959.

### Limitation on Van Vleck-Weisskopf Equation

As pointed out by Van Vleck,<sup>22</sup> an explanation of the deviation of theoretical and experimental determinations of atmospheric absorption could result from limitations of the Van Vleck-Weisskopf equation in the far wings. The validity of this equation when the line widths are in the same order of magnitude as the resonant frequency has been questioned.

On the high-frequency side of the absorption lines, the Van Vleck-Weisskopf equation predicts that the loss will approach a constant. This is known to break down in the infrared region, but the extent of its validity is difficult to predict.

The Van Vleck-Weisskopf equation is based entirely on the broadening of the absorption lines by collisions of the molecules. Other factors which affect line broadening include Doppler broadening, saturation broadening, and radiation broadening. Each of these effects has been discussed by Rogers.<sup>22</sup> Although these other broadening factors are generally considered to be negligible, the possibility of their making a significant contribution should not be overlooked.

### CONCLUSIONS

Measurements of the absorption of microwaves by the atmosphere have indicated that theoretical predictions of the losses are not entirely satisfactory. Oxygen losses in the vicinity of the absorption lines may be explained satisfactorily by the proper choices of the line breadth constants. The line breadth constants are, however, lower than those predicted on the basis of nonpropagation-type laboratory measurements.

The measured water vapor losses are consistently higher than predicted. No single line breadth constant will satisfactorily explain the experimental data.

It is felt, therefore, that the extension of experimental absorption data to frequencies, pressures, or mixture ratios considerably different from those used in the measurement programs should be avoided.

### APPENDIX

#### VAN VLECK-WEISSKOPF EQUATION

If a single spectral line, remote from all others, is

<sup>22</sup> T. F. Rogers, "Factors Affecting the Width and Shape of Atmospheric Microwave Absorption Lines," AF Cambridge Res. Ctr., Bedford Mass.; October, 1951.

considered, the attenuation in decibels per kilometer of an incoming electromagnetic wave is given by

$$\gamma = \frac{[10^6 \log_{10} e] 8\pi^2 N p \nu^2 |\mu_{JJ'}|^2 e^{-W_J/kT} S}{3ckTGP}$$

where

$\gamma$  = absorption coefficient, in decibels per kilometer

$c$  = speed of light =  $2.9979 \times 10^{10}$  cm per second

$k$  = Boltzmann's constant

=  $1.3802565 \times 10^{-16}$  erg per degree Kelvin

$p$  = partial vapor pressure of the absorbing gas, in mm of Hg

$P$  = total pressure of the atmosphere, in mm of Hg

$T$  = temperature of the atmosphere, in degrees Kelvin

$G$  = rotational partition function of the absorbing gas (dimensionless)

$N$  = number of molecules per cubic centimeter in the atmosphere

=  $9.66 \times 10^{18} \times P/T$

$\nu$  = frequency of the incoming electromagnetic wave, in cycles per second

$W_J$  = the energy of the absorbent lower rotational state  $J$ , in  $\text{cm}^{-1}$

$|\mu_{JJ'}|^2$  = square of the dipole moment matrix element associated with the absorbent rotational transition  $J \rightarrow J'$ , inclusive of the static dipole moment and weighting factors (dimensionless)

$S$  = the modified structure factor

$$= \frac{\Delta\nu}{(\nu_{JJ'} - \nu)^2 + (\Delta\nu)^2} + \frac{\Delta\nu}{(\nu_{JJ'} + \nu)^2 + (\Delta\nu)^2}$$

where

$\Delta\nu$  = absorption line half-intensity half-width, in cycles per second

$\nu_{JJ'}$  = the center or resonant frequency of the absorbent rotational transition  $J \rightarrow J'$ , in cycles per second.

As used throughout this paper, the line breadth constant is taken as  $\Delta\nu/c$  with the unit of  $\text{cm}^{-1}$ .

# Interaction Impedance Measurements by Propagation Constant Perturbation\*

P. R. McISAAC†, ASSOCIATE MEMBER, IRE, AND C. C. WANG‡, FELLOW, IRE

**Summary**—The perturbation in the complex propagation constant of a lossy, nonreciprocal, periodic waveguide produced by the insertion of a rod, which may be cylindrical or periodic, parallel to the waveguide axis is developed. The application to the experimental determination of the interaction impedance and electromagnetic field distribution of waveguides is presented, together with the approximations which are applicable. The perturbation formulas for three particular classes of circuit—lossless, reciprocal, cylindrical circuits; lossy, nonreciprocal, cylindrical circuits; and lossy, nonreciprocal, periodic circuits—of interest for traveling wave tubes and other extended interaction microwave tubes, are derived and the limitations discussed. Explicit interaction impedance relations for these circuits in terms of the phase constant perturbation, caused by a cylindrical or periodic rod, are given.

## I. INTRODUCTION

PERTURBATION techniques have proved to be useful for determining experimentally the electromagnetic field distributions both in resonant microwave structures, such as klystron cavities, and propagating structures, such as slow wave circuits for traveling wave tubes. In particular, the determination of the interaction impedance  $Z = E^2/2\beta^2 S$  of traveling wave tube circuits is readily accomplished using perturbation measurements ( $S$  is the total power on the circuit,  $\beta$  is the propagation constant, and  $E$  is the peak longitudinal electric field strength at the position where the electron beam will be located). The techniques for using a resonated section of the circuit (resonated using shorting plates) and obtaining the interaction impedance from a measurement of the change in resonant frequency of the section caused by the insertion of a small dielectric or metallic bead are well known.<sup>1,2</sup> One formulation of the relationship between the perturbing bead parameters, the change in the resonant frequency, and the electromagnetic fields in the resonant section which has a close relation to the treatment presented here has been given by Casimir.<sup>3</sup> There have been many

others as well.<sup>4-7</sup> Of course, the converse procedure of using the change in resonant frequency and  $Q$  of a standard cavity to investigate the dielectric and magnetic parameters of small samples of material introduced into the cavity is also well known.

For stability reasons, most traveling wave tube circuits are intentionally made somewhat lossy. These lossy circuits are not amenable to the resonant section technique because of their low  $Q$  and the resulting difficulty in measuring the resonant frequency accurately. In addition, there has been some interest in recent years in using ferrite loaded circuits to obtain nonreciprocal attenuation properties, and these circuits are not readily adapted to conventional resonant section perturbation techniques because of the nonreciprocity. Therefore, measurement techniques which are applicable to propagating circuits and use the perturbation of the propagation constant by a bead or rod to determine the electromagnetic field pattern and the interaction impedance are necessary. Of course, the propagation constant perturbation and the resonant frequency perturbation measurements are complementary and closely related. For example, measurements on a propagating circuit might be made by determining the change in applied frequency necessary to hold the propagation constant unchanged when a perturbing object is inserted. However, attention will be confined here to constant frequency measurements in which the propagation constant is perturbed.

Measurements of the interaction impedance of slow wave circuits using the technique of the perturbation of the propagation constant are, of course, not new.<sup>2</sup> Kino<sup>8</sup> has given a derivation of the propagation constant perturbation caused by a dielectric or metallic rod in a lossy, periodic, reciprocal system using normal mode techniques. Lagerstrom<sup>9</sup> has considered lossless, peri-

\* Original manuscript received by the IRE, August 14, 1959; revised manuscript received December 21, 1959.

† School of Electrical Engrg., Cornell University, Ithaca, N. Y.; formerly at Sperry Gyroscope Co., Great Neck, N. Y.

‡ Sperry Gyroscope Co., Great Neck, N. Y.

<sup>1</sup> E. Nalos, "Measurement of circuit impedance of periodically loaded structures by frequency perturbation," *Proc. IRE*, vol. 42, pp. 1508-1511; October, 1954.

<sup>2</sup> C. C. Wang and P. R. Melsaac, "Impedance Measurements Using Perturbation Techniques," paper presented at Conf. on Electron Tube Res., Michigan State University, East Lansing; June, 1955.

<sup>3</sup> H. B. G. Casimir, "Theory of Electromagnetic Waves in Resonant Cavities," *Philips Res. Repts.*, vol. 6, pp. 162-182; June, 1951.

<sup>4</sup> J. C. Slater, "Microwave Electronics," D. Van Nostrand Co., Inc., New York, N. Y.; 1950.

<sup>5</sup> W. W. Hansen and R. F. Post, "On the measurement of cavity impedance," *J. Appl. Phys.*, vol. 19, pp. 1059-1061; November, 1948.

<sup>6</sup> L. C. Maier, Jr., "Field Strength Measurements in Resonant Cavities," Res. Lab. of Electronics, M.I.T., Cambridge, Mass., TR No. 143; November 2, 1949.

<sup>7</sup> L. B. Mullett, "Perturbation of a Resonator," Atomic Energy Res. Est., Ministry of Supply, Harwell, Berkshire, Eng., G/R 853; February, 1952.

<sup>8</sup> G. S. Kino, "Normal Mode Theory in Perturbed Transmission Systems," Electronics Res. Lab., Stanford University, Stanford, Calif., TR No. 84; May 2, 1955.

<sup>9</sup> R. P. Lagerstrom, "Interaction Impedance Measurements by Perturbation of Traveling Waves," Stanford Electronics Labs., Stanford University, Stanford, Calif., TR No. 7; February 11, 1957.



odic, reciprocal systems and analyzed in some detail the effects of perturbing rod size as well as periodic rods. The treatment here will be applicable to lossy, periodic, non-reciprocal structures and is based on a field theory approach which gives a direct derivation of an exact relationship and facilitates the evaluation of approximations convenient for measurements. The derivation is basically analogous to Casimir's<sup>8</sup> treatment of lossless resonant cavities, but is a generalization and adaptation applicable to lossy, periodic, nonreciprocal, propagating structures. Several related treatments are also of interest. Goubau<sup>10</sup> has discussed the perturbation of the input impedance of an electromagnetic system caused by the insertion of a test body, while Redfield<sup>11</sup> has considered the perturbation of the admittance matrix of an electrodynamic system. Auld<sup>12</sup> has developed a related perturbation theorem for the scattering matrix at a junction.

## II. DERIVATION OF BASIC EQUATIONS

Consider a waveguide of arbitrary cross section which is periodic with period  $L$  in the direction of propagation  $z$  and which has a single frequency wave propagating in the  $z$  direction. It is assumed that only one of the possible modes of the structure is excited. By Floquet's theorem, the fields in the waveguide may be written as

$$\begin{aligned} E_i(x, y, z, t) &= E_0(x, y, z)e^{j\omega t - \Gamma_0 z} \\ &= \sum_n E_{0n}(x, y)e^{j\omega t - (\Gamma_0 + j2\pi n/L)z}, \quad (1a) \end{aligned}$$

$$\begin{aligned} H_i(x, y, z, t) &= H_0(x, y, z)e^{j\omega t - \Gamma_0 z} \\ &= \sum_n H_{0n}(x, y)e^{j\omega t - (\Gamma_0 + j2\pi n/L)z}, \quad (1b) \end{aligned}$$

where the propagation constant  $\Gamma_0 = \alpha_0 + j\beta_0$  is complex for a lossy waveguide. Note that  $E_0$  and  $H_0$  are periodic in  $z$  with period  $L$ , while the space harmonic field amplitudes  $E_{0n}$  and  $H_{0n}$  are independent of  $z$ . If the waveguide is cylindrical rather than periodic, all the  $E_{0n}$  and  $H_{0n}$  for  $n \neq 0$  are zero.

Now let a rod be inserted into the waveguide parallel to, but not necessarily coinciding with, the  $z$  axis. The "rod" may be either uniform in cross section, or be periodic in  $z$  with period  $L$ , e.g., a series of beads spaced at intervals equal to  $L$ . Hereafter, the term "rod" will refer to either of these configurations unless explicitly stated to the contrary. The final fields after the insertion of the rod will be

$$\begin{aligned} E_f(x, y, z, t) &= [E_0(x, y, z) + E_1(x, y, z)]e^{j\omega t - (\Gamma_0 + \Gamma_1)z} \\ &= \sum_n [E_{0n}(x, y) + E_{1n}(x, y)]e^{j\omega t - (\Gamma_0 + \Gamma_1 + j2\pi n/L)z} \quad (2a) \end{aligned}$$

$$\begin{aligned} H_f(x, y, z, t) &= [H_0(x, y, z) + H_1(x, y, z)]e^{j\omega t - (\Gamma_0 + \Gamma_1)z} \\ &= \sum_n [H_{0n}(x, y) + H_{1n}(x, y)]e^{j\omega t - (\Gamma_0 + \Gamma_1 + j2\pi n/L)z}. \quad (2b) \end{aligned}$$

It is assumed that only a single mode of the perturbed system has been excited, with a propagation constant  $\Gamma_0 + \Gamma_1 = \alpha_0 + \alpha_1 + j(\beta_0 + \beta_1)$ , and that this mode has a field distribution which is roughly similar to that of the original mode.

From Maxwell's curl equations,

$$\nabla \times E_0 - \Gamma_0(k \times E_0) = -j\omega B_0, \quad (3a)$$

$$\nabla \times H_0 - \Gamma_0(k \times H_0) = j\omega D_0, \quad (3b)$$

$$\begin{aligned} \nabla \times E_1 - (\Gamma_0 + \Gamma_1)(k \times E_1) - \Gamma_1(k \times E_0) \\ = -j\omega B_1, \quad (3c) \end{aligned}$$

$$\nabla \times H_1 - (\Gamma_0 + \Gamma_1)(k \times H_1) - \Gamma_1(k \times H_0) = j\omega D_1, \quad (3d)$$

where  $k$  is a unit vector in the  $z$  direction. By multiplying (3c) and (3d), respectively, by  $H_0^*$  and  $E_0^*$  (\* denotes complex conjugate), combining, and using a vector identity,

$$\begin{aligned} E_0^* \cdot \nabla \times H_1 - H_0^* \cdot \nabla \times E_1 &= -\nabla \cdot (E_0^* \times H_1 + E_1 \times H_0^*) \\ &\quad - E_1 \cdot \nabla \times H_0^* + H_1 \cdot \nabla \times E_0^* \\ &= -\Gamma_1 k \cdot (E_0 \times H_0^* + E_0^* \times H_0) - (\Gamma_0 + \Gamma_1)k \\ &\quad \cdot (E_1 \times H_0^* + E_0^* \times H_1) + j\omega(E_0^* \cdot D_1 + H_0^* \cdot B_1). \quad (4) \end{aligned}$$

After multiplication by  $\exp(-2\alpha_0 z)$  and utilization of a vector identity, integration over one period of the waveguide, and the application of Gauss' theorem, there results

$$\begin{aligned} \Gamma_1 \iiint_V k \cdot (E_0 \times H_0^* + E_0^* \times H_0) e^{-2\alpha_0 z} dv \\ + \Gamma_1 \iiint_V k \cdot (E_0^* \times H_1 + E_1 \times H_0^*) e^{-2\alpha_0 z} dv \\ = j\omega \iiint_V (E_0^* \cdot D_1 - D_0^* \cdot E_1 + H_0^* \\ \cdot B_1 - B_0^* \cdot H_1) e^{-2\alpha_0 z} dv \\ + \iint_A n \cdot (E_0^* \times H_1 + E_1 \times H_0^*) e^{-2\alpha_0 z} da. \quad (5) \end{aligned}$$

Here  $V$  denotes a volume corresponding to one period of the waveguide,  $A$  denotes the surface area enclosing this volume, and  $n$  is a unit vector normal to this surface, directed outward. Any currents present in materials with finite conductivity are included in the electric displacement vectors  $D_0$  and  $D_1$  by having the imaginary part of the dielectric constant include the conductivity as well as the dielectric loss term.

<sup>10</sup> G. Goubau, "Zur Ausmessung elektromagnetischer Felder mittels Testkörpern," *Hochfrequenz. und Elektrotrak.*, vol. 62, pp. 73-76; 1943.

<sup>11</sup> A. G. Redfield, "An electrodynamic perturbation theorem, with application to non-reciprocal systems," *J. Appl. Phys.*, vol. 25, pp. 1021-1024; August, 1954.

<sup>12</sup> B. Auld, "The synthesis of symmetrical waveguide circulators," *IRE TRANS. ON MICROWAVE THEORY AND TECHNIQUES*, vol. MTT-7, pp. 238-246; April, 1959.

We note that  $\mathbf{D}_0 = \hat{\epsilon}_i \cdot \hat{\mathbf{E}}_0$  and  $\mathbf{B}_0 = \hat{\mu}_i \cdot \mathbf{H}_0$ , where  $\hat{\epsilon}_i$  and  $\hat{\mu}_i$  are the dielectric constant and permeability of the material in the waveguide prior to the insertion of the perturbing rod. These, in general, will be functions of position within the waveguide and complex to account for losses. The circumflex indicates that these may be tensor quantities, as is, for example, the permeability of a ferrite material. Also, in all regions external to the perturbing rod,  $\mathbf{D}_1 = \hat{\epsilon}_i \cdot \mathbf{E}_1$  and  $\mathbf{B}_1 = \hat{\mu}_i \cdot \mathbf{H}_1$ . Since it is assumed that the rod is inserted only into regions which were previously empty, (5) may be rewritten as

$$\begin{aligned} & \Gamma_1 \iiint_V k \cdot (\mathbf{E}_0 \times \mathbf{H}_0^* + \mathbf{E}_0^* \times \mathbf{H}_0) e^{-2\alpha_0 z} d\tau \\ & + \Gamma_1 \iiint_V k \cdot (\mathbf{E}_0^* \times \mathbf{H}_1 + \mathbf{E}_1 \times \mathbf{H}_0^*) e^{-2\alpha_0 z} d\tau \\ & = j\omega \iiint_{\delta V} (\epsilon_0 \mathbf{E}_0^* \cdot \mathbf{P} + \mu_0 \mathbf{H}_0^* \cdot \mathbf{M}) e^{-2\alpha_0 z} d\tau \\ & + j\omega \iiint_{V-\delta V} [\mathbf{E}_0^* \cdot (\hat{\epsilon}_i \cdot \mathbf{E}_1) - \mathbf{E}_1 \cdot (\hat{\epsilon}_i \cdot \mathbf{E}_0)^* + \mathbf{H}_0^* \\ & \quad \cdot (\hat{\mu}_i \cdot \mathbf{H}_1) - \mathbf{H}_1 \cdot (\hat{\mu}_i \cdot \mathbf{H}_0)^*] e^{-2\alpha_0 z} d\tau \\ & + \int_{A_1} \mathbf{n} \cdot (\mathbf{E}_0^* \times \mathbf{H}_1 + \mathbf{E}_1 \times \mathbf{H}_0^*) e^{-2\alpha_0 z} da, \quad (6) \end{aligned}$$

where  $\mathbf{P} = \mathbf{D}_1/\epsilon_0 - \mathbf{E}_1$  and  $\mathbf{M} = \mathbf{B}_1/\mu_0 - \mathbf{H}_1$  are the polarization and magnetization of the rod.  $\delta V$  denotes the volume of one period of the rod and  $V - \delta V$  denotes the volume of one period of the waveguide exclusive of the rod volume. Eq. (6) is an exact expression relating the change in the propagation constant to the fields and the rod parameters. The first integral on the left is recognized to be four times the time average power in the  $z$  direction of the original unperturbed circuit integrated over a length in the  $z$  direction equal to one period of the structure. Thus, the first term on the left can be put in the form,

$$\begin{aligned} & \Gamma_1 \iiint_V k \cdot (\mathbf{E}_0 \times \mathbf{H}_0^* + \mathbf{E}_0^* \times \mathbf{H}_0) e^{-2\alpha_0 z} d\tau \\ & = 4\Gamma_1 \int_z^{z+L} S_0(z) dz, \quad (7) \end{aligned}$$

where  $S_0(z)$  represents the time average power in the  $z$  direction.  $S_0(z)$  is, of course, real so that by taking the real and imaginary parts of (6), expressions for  $\alpha_1$  and  $\beta_1$  can be obtained.

The integrals in (6) are taken over one complete period of the structure; this is precisely defined for the  $z$  direction, but is somewhat vague for the transverse directions. For structures with enclosing, perfectly conducting walls, it suffices to integrate over the volume enclosed by the walls. In this case, of course, all the fields external to the region enclosed by the walls are zero. For open boundary structures, e.g., an unshielded helix, the

fields exist out to infinity, and one must integrate out to infinity in the transverse directions. For structures with imperfectly conducting walls, the fields will again extend out to infinity in the transverse directions. Those fields external to the walls are clearly negligible when the waveguide walls are made of the usual metals. However, to cover all possible cases here, we will integrate out to infinity in the transverse directions, but we recognize that for many important cases the contribution from the fields external to the waveguide walls will be completely negligible. By integrating out to infinity, the surface integral of (6) may be simplified because the fields will go to zero at infinity for structures that propagate a mode carrying finite power in the  $z$  direction. Thus, in all cases there will be a contribution to the surface integral possible only over planes that are normal to the  $z$  axis.

Using this simplification, (6) may be written as

$$\begin{aligned} & 4\Gamma_1 \int_z^{z+L} S_0(z) dz \\ & + \Gamma_1 \iint_{A_c} k \cdot (\mathbf{E}_0^* \times \mathbf{H}_1 + \mathbf{E}_1 \times \mathbf{H}_0^*) e^{-2\alpha_0 z} d\tau \\ & = j\omega \iiint_{\delta V} (\epsilon_0 \mathbf{E}_0^* \cdot \mathbf{P} + \mu_0 \mathbf{H}_0^* \cdot \mathbf{M}) e^{-2\alpha_0 z} d\tau \\ & + j\omega \iiint_{V-\delta V} [\mathbf{E}_0^* \cdot (\hat{\epsilon}_i \cdot \mathbf{E}_1) - \mathbf{E}_1 \cdot (\hat{\epsilon}_i \cdot \mathbf{E}_0)^* + \mathbf{H}_0^* \\ & \quad \cdot (\hat{\mu}_i \cdot \mathbf{H}_1) - \mathbf{H}_1 \cdot (\hat{\mu}_i \cdot \mathbf{H}_0)^*] e^{-2\alpha_0 z} d\tau \\ & - (1 - e^{-2\alpha_0 L}) e^{-2\alpha_0 z} \iint_{A_c} k \\ & \quad \cdot (\mathbf{E}_0^* \times \mathbf{H}_1 + \mathbf{E}_1 \times \mathbf{H}_0^*) da. \quad (8) \end{aligned}$$

Here  $A_c$  represents the waveguide cross section at  $\mathbf{z} = z$  or  $\mathbf{z} = z + L$  (the cross section at these two points is the same because of the periodicity). As noted above,  $A_c$  may extend out to infinity. It should be observed that the equality in (8) is independent of the value of  $z$  chosen.

### III. APPLICATION TO INTERACTION IMPEDANCE MEASUREMENTS

Eq. (8) is the basic equation with which we will deal. As it stands, it is too cumbersome to be useful in practice, but in many cases of interest, approximations can be made which render it useful for the experimental measurement of the interaction impedance. In order to determine what approximations are valid and their implications, several special cases will be examined in some detail.

#### A. Lossless, Reciprocal, Cylindrical Waveguides

In this case  $\alpha_0 = 0$ , the dielectric constant and perm-

ability are real scalars, and since only the fundamental space harmonic fields exist, each of the integrands in (8) has the same  $z$  dependence,  $\exp(-2\alpha_0 z)$ , and the integration over  $z$  may be omitted.  $\beta_1$  is found by adding (8) to its complex conjugate.

$$\beta_1 = \omega \frac{\iint_{\delta A} [\epsilon_0(\mathbf{E}_0^* \cdot \mathbf{P} + \mathbf{E}_0 \cdot \mathbf{P}^*) + \mu_0(\mathbf{H}_0^* \cdot \mathbf{M} + \mathbf{H}_0 \cdot \mathbf{M}^*)] da}{8S_0 + \iint_{A_c} \mathbf{k} \cdot (\mathbf{E}_0^* \times \mathbf{H}_1 + \mathbf{E}_0 \times \mathbf{H}_1^* + \mathbf{E}_1 \times \mathbf{H}_0^* + \mathbf{E}_1^* \times \mathbf{H}_0) da} \quad (9)$$

$\delta A$  denotes the cross section of the perturbing rod which is cylindrical.

It will be observed that, so far, no restrictions have been placed on the constancy of the power before and after the rod insertion. Naturally,  $\beta_1$  is independent of the power level, but the individual integrals in (9) will vary with the power. For convenience, we will arbitrarily demand that the power level be kept constant throughout the measurements. That is,

$$S_0 = S_0 + S_1, \quad (10a)$$

$$S_1 = 0, \quad (10b)$$

where  $S_1$  is the change in power,

$$S_1 = \frac{1}{4} \iint_{A_c} \mathbf{k} \cdot (\mathbf{E}_0 \times \mathbf{H}_1^* + \mathbf{E}_0^* \times \mathbf{H}_1 + \mathbf{E}_1 \times \mathbf{H}_0^* + \mathbf{E}_1^* \times \mathbf{H}_0 + \mathbf{E}_1 \times \mathbf{H}_1^* + \mathbf{E}_1^* \times \mathbf{H}_1) e^{-2\alpha_0 z} da. \quad (11)$$

Therefore,

$$\begin{aligned} & \iint_{A_c} \mathbf{k} \cdot (\mathbf{E}_1 \times \mathbf{H}_1^* + \mathbf{E}_1^* \times \mathbf{H}_1) e^{-2\alpha_0 z} da \\ &= - \iint_{A_c} \mathbf{k} \cdot (\mathbf{E}_0 \times \mathbf{H}_1^* + \mathbf{E}_0^* \times \mathbf{H}_1 + \mathbf{E}_1 \times \mathbf{H}_0^* + \mathbf{E}_1^* \times \mathbf{H}_0) e^{-2\alpha_0 z} da. \quad (12) \end{aligned}$$

It should be noted that (12) is general and holds for lossy, nonreciprocal, periodic waveguides as long as the power is held constant.

$$\beta_1 = \omega \frac{\iint_{\delta A} [\epsilon_0(\mathbf{E}_0^* \cdot \mathbf{P} + \mathbf{E}_0 \cdot \mathbf{P}^*) + \mu_0(\mathbf{H}_0^* \cdot \mathbf{M} + \mathbf{H}_0 \cdot \mathbf{M}^*)] da}{8S_0 - \iint_{A_c} \mathbf{k} \cdot (\mathbf{E}_1 \times \mathbf{H}_1^* + \mathbf{E}_1^* \times \mathbf{H}_1) da} \quad (13)$$

This expression, which is exact, can be simplified by making two assumptions about the perturbing rod's parameters. 1) The rod's cross-sectional dimensions are small compared to the waveguide dimensions and the wavelength of the propagating wave. 2) The combined effect of the perturbing rod's dielectric constant, permeability, and cross-sectional area is such that, external to the rod, the perturbation of the fields is small. These assumptions imply that  $|\beta_1| \ll \beta_0$ .

As a consequence of these assumptions, we can relate

the components of the polarization and magnetization in the rod to the components of the initial electric and magnetic fields at the rod location through the use of the effective electric and magnetic susceptibilities  $\chi_e$  and  $\chi_m$  of the rod material and the effective depolarizing and

demagnetizing factors for the rod geometry. This use of geometrical factors implies that the rod cross section is at least elliptical. The polarization and magnetization components are given by  $P_x = \chi_e E_{0x} / (1 + N_{ex} \chi_e)$ ,  $M_x = \chi_m H_{0x} / (1 + N_{mx} \chi_m)$ , etc., where  $N_{ex}$ ,  $N_{mx}$  are the effective depolarizing and demagnetizing factors for fields in the  $x$  direction. With the assumptions above,  $N_e$  and  $N_m$  are given by the static values for an elliptic body. When several field components are simultaneously present, then each will separately produce a perturbation whose magnitude depends on the  $N$  value for the particular direction. The geometry of the rod may be adjusted to emphasize or minimize the perturbation caused by the field in any particular direction by controlling the  $N$  values.

The assumption that the fields in the rod are essentially uniform over the cross section means that the integrand in the numerator of (13) is independent of position in the rod. Finally, by assumption 2), it is seen that the second term in the denominator will be small compared to  $4S_0$ . Letting the subscript  $r$  refer to the value of the fields at the rod location, the change in the propagation constant is approximately given by

$$\beta_1 \cong \omega \delta A \frac{\left[ \frac{\epsilon_0 \chi_e}{1 + N_e \chi_e} |E_0|_r^2 + \frac{\mu_0 \chi_m}{1 + N_m \chi_m} |H_0|_r^2 \right]}{4S_0}, \quad (14)$$

which is the customary expression.

It has also been tacitly assumed that the rod itself is lossless. If the rod were lossy, then one or both of  $\chi_e$ ,  $\chi_m$  would be complex and (14) would change slightly. Also,  $\alpha_1$  could be written down by subtracting (8) from its complex conjugate. For cases where the fields are not uniform over the rod cross section so that using the static values of  $N_e$  and  $N_m$  is not justified, correction factors may be obtained by examining the integral in the numerator of (9) for particular cases (Lagerstrom<sup>9</sup> has discussed correction factors in some detail).



Eq. (14) indicates that, by using dielectric rods for which  $\chi_m = 0$ , or metallic rods so shaped as to emphasize the effective  $\chi_e$  relative to the effective  $\chi_m$ , the interaction impedance can be obtained by measuring  $\beta_0$ ,  $\beta_1$ , and the rod parameters.

$$Z = \frac{|E_0|_r^2}{2\beta_0^2 S_0} \cong \frac{2\beta_1}{\omega\beta_0^2 \delta A \frac{\epsilon_0 \chi_e}{1 + N_e \chi_e}} \quad (15)$$

Eq. (15) also holds for lossless, reciprocal, periodic waveguides if the rod is cylindrical and inserted at a location where only one of the space harmonic fields has an appreciable magnitude. In this case, the impedance is that of the particular space harmonic, and  $E_0$  should be replaced by  $E_{0n}$  in (15).

*B. Lossy, Nonreciprocal, Cylindrical Waveguides*

Again, since only the fundamental space harmonic can exist, all of the integrands of (8) have the same  $z$  dependence so that integration over  $z$  may be omitted. Eq. (8) now reduces to

$$\begin{aligned} 4\Gamma_1 S_0(z) + \Gamma_1 \iint_{A_c} k \cdot (E_0^* \times H_1 + E_1 \times H_0^*) e^{-2\alpha_0 z} da \\ = j\omega \iint_{\delta A} (\epsilon_0 E_0^* \cdot P + \mu_0 H_0^* \cdot M) e^{-2\alpha_0 z} da \\ + j\omega \iint_{A_c - \delta A} [E_0^* \cdot (\hat{\epsilon}_i \cdot E_1) - E_1 \cdot (\hat{\epsilon}_i \cdot E_0^*) \\ + H_0^* \cdot (\hat{\mu}_i \cdot H_1) - H_1 \cdot (\hat{\mu}_i \cdot H_0^*)] e^{-2\alpha_0 z} da. \quad (16) \end{aligned}$$

Inasmuch as the most important sources of nonreciprocal effects at microwave frequencies are ferrite materials,  $\hat{\mu}_i$  will be taken as a tensor but  $\hat{\epsilon}_i$  will be regarded as a scalar. Therefore, in the last integral of (16),

$$E_0^* \cdot (\hat{\epsilon}_i \cdot E_1) - E_1 \cdot (\hat{\epsilon}_i \cdot E_0^*) = E_0^* \cdot E_1 (\epsilon_i - \epsilon_i^*). \quad (17)$$

$$\beta_1 \cong \frac{\omega \delta A e^{-2\alpha_0 z}}{4S_0(z)} \left\{ \frac{\epsilon_0}{2} \left[ \left( \frac{\chi_e}{1 + N_e \chi_e} \right) + \left( \frac{\chi_e}{1 + N_e \chi_e} \right)^* \right] |E_0|_r^2 + \frac{\mu_0}{2} \left[ \left( \frac{\chi_m}{1 + N_m \chi_m} \right) + \left( \frac{\chi_m}{1 + N_m \chi_m} \right)^* \right] |H_0|_r^2 \right\}, \quad (19a)$$

$$\begin{aligned} \alpha_1 \cong \frac{\omega \delta A e^{-2\alpha_0 z}}{4S_0(z)} \left\{ \frac{\epsilon_0}{2} \left[ \left( \frac{\chi_e}{1 + N_e \chi_e} \right) - \left( \frac{\chi_e}{1 + N_e \chi_e} \right)^* \right] |E_0|_r^2 + \frac{\mu_0}{2} \left[ \left( \frac{\chi_m}{1 + N_m \chi_m} \right) - \left( \frac{\chi_m}{1 + N_m \chi_m} \right)^* \right] |H_0|_r^2 \right\} \\ + \frac{j\omega e^{-2\alpha_0 z}}{8S_0(z)} \iint_{A_c - \delta A} [(\epsilon_i - \epsilon_i^*)(E_0^* \cdot E_1 + E_0 \cdot E_1^*) + (\mu_{ep} - \mu_{ep}^*)(H_0^* \cdot H_1 + H_0 \cdot H_1^*)] da. \quad (19b) \end{aligned}$$

$E_0^* \cdot E_1$  will be real in the lossless case and not far different for the usual range of traveling wave tube attenuation.  $(\epsilon_i - \epsilon_i^*)$  will be nonzero only in regions where there is lossy dielectric material or material with finite conductivity. Since  $(\epsilon_i - \epsilon_i^*)$  is pure imaginary, (17) will be nearly pure imaginary. Therefore, its con-

tribution to  $\beta_1$  will be negligible, although the contribution to  $\alpha_1$  may be significant.

The situation regarding the magnetic field terms of the last integral in (16) is somewhat more complex. In general, there can be a contribution to  $\beta_1$  from these terms even in the lossless case because of the off-diagonal elements of the permeability tensor. Thus, it is not clear in the general case what the relative magnitude of the contribution to  $\beta_1$  from these terms will be. However, there is one important class of ferrite loaded waveguide structures about which more may be said. If the magnetic fields within the ferrite are circularly polarized in a plane perpendicular to the direction of the applied dc magnetic field, then the effective permeability tensor becomes diagonal.<sup>13</sup> If we assume that the perturbing rod is so located that the perturbed field is also circularly polarized in the ferrite, then

$$H_0^* \cdot (\hat{\mu}_i \cdot H_1) - H_1 \cdot (\hat{\mu}_i \cdot H_0^*) = H_0^* \cdot H_1 (\mu_{ep} - \mu_{ep}^*), \quad (18)$$

where  $\mu_{ep}$  represents the effective permeability in this case. This is the same form that occurred in (17) so that the remarks made there apply here as well. It is reasonable to assume that, in the more practical cases where the fields are not exactly circularly polarized but are nearly so in the ferrite, the contribution to  $\beta_1$  of the term in (18) will still be negligible. This case, where the ferrite is located in a circularly polarized microwave field, is the one of most practical importance and most widespread use in traveling wave tubes.

In the more general situation of arbitrary polarization of the fields in the ferrite, the contribution to  $\beta_1$  of the tensor permeability terms will be small if the perturbation is such that the change in the field energy stored within the ferrite associated with the off-diagonal permeability elements is small compared to the total change in field energy stored in the whole structure.

Assuming, then, that the above discussion is applicable, and introducing the two assumptions made in Section III, A,

The expression for  $\beta_1$  is in a form similar to (14) so that the remarks made there about the application to interaction impedance measurements apply here as well.

<sup>13</sup> D. Polder, "On the theory of ferromagnetic resonance," *Phil. Mag.*, vol. 40, pp. 99-115; January, 1949.

$$Z \cong \frac{4\beta_1}{\omega\beta_0^2\delta_z\epsilon_0 \left[ \left( \frac{\chi_e}{1+N_e\chi_e} \right) + \left( \frac{\chi_e}{1+N_e\chi_e} \right)^* \right]} \quad (20)$$

The expression for  $\alpha_1$  reveals several interesting points. Under certain circumstances, a lossy rod may be used to make interaction impedance measurements by noting the change in attenuation of the structure when the rod is inserted. For this to be possible, the effective value of

$$\left( \frac{\chi_e}{1+N_e\chi_e} \right) - \left( \frac{\chi_e}{1+N_e\chi_e} \right)^*$$

relative to

$$\left( \frac{\chi_m}{1+N_m\chi_m} \right) - \left( \frac{\chi_m}{1+N_m\chi_m} \right)^*$$

lossless region. If this same rod were inserted along one of the waveguide walls, then  $\alpha_1$  might be positive since the percentage of the total field energy in the lossy region might increase.

C. Lossy, Nonreciprocal, Periodic Waveguides

For periodic structures it is necessary to retain the integration in  $z$  over a complete period of the waveguide since  $E_0, E_1, H_0, H_1$ , etc., are periodic functions of  $z$ .  $S_0(z)$  will no longer vary as  $\exp(-2\alpha_0z)$  although it is still true that  $S_0(z+L)$  differs from  $S_0(z)$  by  $\exp(-2\alpha_0L)$ . The  $z$  dependence of  $S_0(z)$  will depend on the distribution of the lossy material in the waveguide. The discussion in Section III, B relative to the contribution of the dielectric loss terms and the tensor permeability to  $\beta_1$  and  $\alpha_1$  applies to the periodic structure as well. Therefore, utilizing this and the assumptions made in Section III, A, (8) may be reduced to the following pair of equations for  $\beta_1$  and  $\alpha_1$ ,

$$\beta_1 \cong \frac{\omega\delta_z \int_z^{z+L} \left\{ \frac{\epsilon_0}{2} \left[ \left( \frac{\chi_e}{1+N_e\chi_e} \right) + \left( \frac{\chi_e}{1+N_e\chi_e} \right)^* \right] E_0 \cdot E_0^* + \frac{\mu_0}{2} \left[ \left( \frac{\chi_m}{1+N_m\chi_m} \right) + \left( \frac{\chi_m}{1+N_m\chi_m} \right)^* \right] H_0 \cdot H_0^* \right\} e^{-2\alpha_0 z} dz}{4 \int_z^{z+L} S_0(z) dz} \quad (22a)$$

$$\alpha_1 \cong \frac{j\omega\delta_z \int_z^{z+L} \left\{ \frac{\epsilon_0}{2} \left[ \left( \frac{\chi_e}{1+N_e\chi_e} \right) - \left( \frac{\chi_e}{1+N_e\chi_e} \right)^* \right] E_0 \cdot E_0^* + \frac{\mu_0}{2} \left[ \left( \frac{\chi_m}{1+N_m\chi_m} \right) - \left( \frac{\chi_m}{1+N_m\chi_m} \right)^* \right] H_0 \cdot H_0^* \right\} e^{-2\alpha_0 z} dz}{4 \int_z^{z+L} S_0(z) dz}$$

$$+ \frac{j\omega \int_z^{z+L} \int_{\epsilon-\delta_1} \int_{\epsilon-\delta_1} [(\epsilon_i - \epsilon_i^*)(E_0 \cdot E_1^* + E_1 \cdot E_0^*) + (\mu_{ep} - \mu_{ep}^*)(H_0 \cdot H_1^* + H_1 \cdot H_0^*)] e^{-2\alpha_0 z} dadz}{8 \int_z^{z+L} S_0(z) dz} \quad (22b)$$

must be large and the structure must either be originally low-loss and reciprocal, or the rod geometry and placement be such that the contribution to  $\alpha_1$  from the last integral of (19b) be negligible. Under these conditions,

$$Z \cong \frac{4\alpha_1}{j\omega\delta_z\beta_0^2\epsilon_0 \left[ \left( \frac{\chi_e}{1+N_e\chi_e} \right) - \left( \frac{\chi_e}{1+N_e\chi_e} \right)^* \right]} \quad (21)$$

$\alpha_1$  may be either positive or negative in general, depending on the field distribution relative to the lossy regions before and after inserting the rod. For example, if a lossless, high dielectric constant rod is inserted along the center of a waveguide with lossy walls, then  $\alpha_1$  will be negative because the rod causes an increased percentage of the total field energy to be concentrated in the

Each of the fields  $E_0, H_0$ , is made up of an infinite set of space harmonics. Because of the attenuation factor,  $\exp(-2\alpha_0z)$ , the space harmonic fields are not orthogonal over the interval  $L$  so that cross-product terms of the space harmonics will appear in the integrals if  $E_0$  and  $H_0$  are replaced by  $E_{0n}$ ,  $\exp(-j2\pi nz/L)$  and  $H_{0n}$ ,  $\exp(-j2\pi nz/L)$ , respectively. Therefore, the propagation constant perturbation  $\beta_1$  will be, in general, a measure of an averaged field in the rod.

If only one space harmonic field has an appreciable amplitude at the rod location, then a cylindrical rod that perturbs primarily the electric field

$$\frac{\chi_e}{1+N_e\chi_e} \gg \frac{\chi_m}{1+N_m\chi_m}$$

may be used. This leads to

$$\beta_1 \cong \omega \delta \cdot l \frac{(1 - e^{-2\alpha_0 L}) e^{-2\alpha_0 z}}{8\alpha_0 \int_z^{z+L} S_0(z) dz} \frac{\epsilon_0}{2} \cdot \left[ \left( \frac{\chi_e}{1 + N_e \chi_e} \right) + \left( \frac{\chi_e}{1 + N_e \chi_e} \right)^* \right] |E_{0n}|_r^2. \quad (23)$$

It is easily seen that if  $\alpha_0$  approaches zero, (23) approaches (14) (with  $\chi_m = 0$ ). If only a single space harmonic field is assumed to be present everywhere in the structure, then (23) approaches (19a) (with  $\chi_m = 0$ ).

In some periodic circuits,  $S_0(z)$  will still vary as  $\exp(-2\alpha_0 z)$  so that (23) will simplify to (19a) in these cases. This is true, for example, for a helix inside a glass envelope with the lossy material distributed uniformly around the circumference. It would not be precisely true for a helix supported by lossy rods, but the discrepancy

$\beta_n = \beta_0 + 2\pi n/L$ . Thus, a cylindrical rod is an adequate perturbation for a lossy glass enclosed helix as well as a lossy rod supported helix if the measurements are made on the helix axis where only the fundamental space harmonic field exists.

In regions where several space harmonics have appreciable amplitudes, a periodic array of beads may be used to determine  $Z_n$ . It will probably be necessary to use beads whose geometry is such as to cause an anisotropic perturbation in order to determine the field along a particular direction of interest. One effective arrangement is to use an array of needle shaped beads. For large length-to-diameter ratios, these will cause a perturbation when there is a component of field parallel to the long dimension but relatively little perturbation for components perpendicular to this direction. If the bead length as well as the cross section is small compared to a wavelength, then the field inside each bead is uniform and (22a) becomes

$$\beta_1 \cong \frac{\omega \delta V_b e^{-2\alpha_0 z'} \frac{\epsilon_0}{2} \left[ \left( \frac{\chi_e}{1 + N_e \chi_e} \right) + \left( \frac{\chi_e}{1 + N_e \chi_e} \right)^* \right] (E_0 \cdot E_0^*)_{z'}}{4 \int_z^{z+L} S_0(z) dz}, \quad (27)$$

is probably not large. However, for the normal range of traveling wave tube attenuation,  $\alpha_0 L$  will be small enough that

$$\frac{1 - e^{-2\alpha_0 L}}{2\alpha_0} \cong L \quad (24)$$

to a good approximation. Then (23) becomes

$$\beta_1 \cong \frac{\omega \delta \cdot l}{4} \left[ \frac{e^{-2\alpha_0 z}}{\frac{1}{L} \int_z^{z+L} S_0(z) dz} \right] \frac{\epsilon_0}{2} \cdot \left[ \left( \frac{\chi_e}{1 + N_e \chi_e} \right) + \left( \frac{\chi_e}{1 + N_e \chi_e} \right)^* \right] |E_{0n}|_r^2. \quad (25)$$

This relates  $\beta_1$  to the average power in one period of the structure. For lossy, periodic circuits, the quantity

$$\frac{1}{Le^{-\alpha_0 L}} \int_z^{z+L} S_0(z) dz / Le^{-2\alpha_0 z}$$

is the proper average value of power to insert into the interaction impedance formula, so that

$$Z_n \cong \frac{4\beta_1}{\omega \delta \cdot l \beta_n^2 \epsilon_0 \left[ \left( \frac{\chi_e}{1 + N_e \chi_e} \right) + \left( \frac{\chi_e}{1 + N_e \chi_e} \right)^* \right]}, \quad (26)$$

where  $Z_n$  is the interaction impedance of the  $n$ th space harmonic, recalling that only the  $n$ th space harmonic has an appreciable amplitude at the rod location, and

where  $z'$  denotes the position of the bead in the period of the structure under consideration.  $\delta V_b$  is the volume of one bead.  $(E_0^* \cdot E_0)_{z'}$  may be written as

$$(E_0 \cdot E_0^*)_{z'} = \sum_n \sum_m E_{0n} \cdot E_{0m}^* e^{-j2\pi(n-m)z'/L} \quad (28)$$

which displays the periodic nature of this term. If  $\beta_1$  is measured as a function of bead position,  $z'$ , as the periodic array of beads is moved through one complete period of the structure, then  $Z_n$  can be determined. The plot of  $\beta_1$  vs  $z'$  is seen from (27) and (28) to be given by a product of an exponential function  $\exp(-2\alpha_0 z')$  and a periodic function  $(E_0 \cdot E_0^*)_{z'}$ . After extracting the exponential portion, the remaining periodic curve can be Fourier analyzed to determine the amplitudes of the space harmonic fields. From this, of course, the interaction impedance can be calculated.

#### IV. CONCLUSIONS

General relations for the perturbation of the real and imaginary parts of the propagation constant of lossy, nonreciprocal, periodic waveguides by a perturbing rod placed parallel to the axis have been developed. The rod may be either cylindrical or periodic, and lossless or lossy. Approximate formulas valid when the perturbation is small are readily obtained if the rod cross section is small compared to the wavelength so that the fields may be considered uniform, or nearly so, inside the rod.

The application of the propagation constant perturbation formulas to the measurement of the interaction impedance of propagating structures can be made, and



hold for the partition method also hold for the Taylor-Cauchy transforms. They are listed below for reference:

- 1) The linear operator  $Z(D)$  has an impulsive response  $y(t)$  of exponential type and order one.
- 2) The forcing function  $g(t)$  is a function of exponential type and order one.
- 3) The nonlinear function  $\phi(x, \dot{x}, \dots)$  is single-valued and continuous and satisfies the following condition:

Given a pair of positive constants  $M$  and  $a$  and two continuous functions  $u(t)$  and  $v(t)$  which are asymptotically like  $e^{-at}$ , then  $\phi$  must satisfy the condition that

$$|\phi[v(t)] - \phi[u(t)]| < Me^{-at}|v(t) - u(t)|$$

for all  $t \geq 0$ .

In Wolf,<sup>2</sup> it is shown that the polynomial satisfies restriction 3) under certain conditions. Some transcendents<sup>6</sup> whose inverse functions possess algebraic derivatives can also be made to satisfy restriction 3). In this paper transforms are developed for the case in which  $\phi$  is a polynomial nonlinearity such as

$$\phi(x) = \sum_{n=2}^{N_2} \beta_n x^n. \tag{5}$$

It is noted that any power-function combination of  $x$  and its derivatives is also admitted<sup>3</sup> in this method.

Eq. (1) as restricted possesses a unique solution which is an analytic function of  $t$ . Polynomials composed of the solution and its derivatives are also analytic functions. Hence, if terms are transposed from the left to the right member of (1), the new right member is an analytic function and may be written as a Taylor series.

In the partition method, from which the Taylor-Cauchy transform method is developed, the nonlinear terms in (1) are transposed. The combination of the forcing function,  $g(t)$ , and these transposed terms defines the *auxiliary forcing function*,  $f(t)$ , which is expressed as a Taylor series, the coefficients of which must be solved for. This is accomplished by convolving the series with the impulsive response of the linear terms in the left member to obtain an expression for  $x(t)$  in terms of the coefficients of the series. This expression for  $x(t)$  is substituted in the defining equation for the auxiliary forcing function to yield the coefficients.

Some or all of the linear terms except the term containing the *highest derivative* may also be transposed and included in the auxiliary forcing function. The auxiliary forcing function thus defined is, of course, a different function from that obtained when only the nonlinear terms are transposed. No matter how terms containing  $x(t)$  and its derivatives (except the highest

derivative) are transposed from the left to the right member of (1), the unique solution,  $x(t)$ , is obtained. Taylor-Cauchy transform methods yield the same solution in a more direct manner.

### III. DESCRIPTION OF THE METHOD

Eq. (1) can be transformed into (6) below by the Taylor-Cauchy transformation, namely,

$$\mathfrak{J}_c[Z(D) \cdot x(t)] + \mathfrak{J}_c[\phi(x, \dot{x}, \dots)] = \mathfrak{J}_c[g(t)] \tag{6}$$

where  $\mathfrak{J}_c$ , the direct transform, is defined by

$$\mathfrak{J}_c[F(\lambda)] = \frac{1}{2\pi j} \int_c \frac{F(\lambda)}{\lambda^{n+1}} d\lambda, \quad n = 0, 1, 2, \dots \tag{7}$$

in which  $\lambda$  is a complex time variable<sup>5</sup> which replaces the real variable  $t$  in this transform method, and  $F(\lambda)$  is any of the quantities inside the brackets in which  $t$  is replaced by  $\lambda$  and  $x$  is replaced by  $W$ . Thus

$$\begin{aligned} F_1(\lambda) &= Z(D) \cdot W(\lambda) \\ F_2(\lambda) &= \phi(W, \dot{W}, \dots) \\ F_3(\lambda) &= G(\lambda) \\ D &= \frac{d}{d\lambda} \\ W &= W(\lambda) \\ \dot{W} &= \frac{dW(\lambda)}{d\lambda}. \end{aligned} \tag{8}$$

$C$  denotes a closed contour in the  $\lambda$ -plane enclosing the singularities of  $F(\lambda)$ , and  $n$  is a discrete variable taking on discrete values  $0, 1, 2, \dots$ .

It is noted that (6) is written as the sum of the transforms of the parts of (1), rather than as the transform of the sum of the parts of (1). In addition, the operation  $\mathfrak{J}_c$  is commutative with a constant. That is to say,

$$\mathfrak{J}_c[aF(\lambda)] = a\mathfrak{J}_c[F(\lambda)]. \tag{9}$$

The additivity and commutivity properties of  $\mathfrak{J}_c$  are often referred to in engineering literature as the linearity property of the transform. These properties follow immediately from the definition of the transform given in (7).

After performing the operations indicated in (6), one obtains a recurrence relation in a new function  $w_n$ , where  $w_{n,k}$  is the  $\mathfrak{J}_c$ -transform mate of  $W^{(k)}(\lambda)$ , in which  $n$  is the discrete variable in the real positive  $n$ -half-line corresponding to the complex variable  $\lambda$  in the  $\lambda$ -plane, and  $k$  is the order of the system under analysis. This new equation is solved for  $w_n$  and by means of the inverse transform,  $\mathfrak{J}_c^{-1}$ , the response function,  $W^{(k)}(\lambda)$ , is recovered. This is the  $k$ th derivative of the desired solution. The inverse transform is given by

$$\mathfrak{J}_c^{-1}[w_n] = \sum_{n=0}^{\infty} w_n \lambda^n = W^{(k)}(\lambda). \tag{10}$$

<sup>6</sup> A. A. Wolf, "Analysis of Transcendental Nonlinear Systems," presented at the Summer General Meeting of AIEE, Buffalo, N. Y., paper 58-995; June 25, 1958.

Formally, then, applying (7) to (1) and noting (8) and (9), one sees that (6) becomes

$$\frac{1}{2\pi j} \int_c \frac{F_1(\lambda)}{\lambda^{n+1}} d\lambda + \frac{1}{2\pi j} \int_c \frac{F_2(\lambda)}{\lambda^{n+1}} d\lambda = \frac{1}{2\pi j} \int_c \frac{F_3(\lambda)}{\lambda^{n+1}} d\lambda \quad (11)$$

whereupon utilizing (2) and (5) leads to

$$\frac{1}{2\pi j} \int_c \frac{F_1(\lambda)}{\lambda^{n+1}} d\lambda = \frac{1}{2\pi j} \int_c \sum_{k=0}^{N_1} \alpha_k W^{(k)}(\lambda) \frac{d\lambda}{\lambda^{n+1}} \quad (12)$$

$$\frac{1}{2\pi j} \int_c \frac{F_2(\lambda)}{\lambda^{n+1}} d\lambda = \frac{1}{2\pi j} \int_c \sum_{k=2}^{N_2} \beta_k W^k(\lambda) \frac{d\lambda}{\lambda^{n+1}} \quad (13)$$

and

$$\frac{1}{2\pi j} \int_c \frac{F_3(\lambda)}{\lambda^{n+1}} d\lambda = \frac{1}{2\pi j} \int_c \frac{g(\lambda)}{\lambda^{n+1}} d\lambda. \quad (14)$$

#### IV. THE TAYLOR-CAUCHY TRANSFORM: ITS PROPERTIES AND DERIVATION

The Taylor-Cauchy transform is defined by the following pair of equations:

$$W^{(k)}(\lambda) = \sum_{n=0}^{\infty} w_{n,k} \lambda^n \quad (15)$$

and

$$w_{n,k} = \frac{1}{2\pi j} \int_c \frac{W^{(k)}(\lambda)}{\lambda^{n+1}} d\lambda \quad (16)$$

where

$k$  denotes the order of the system, *i.e.*, the order of the highest linear derivative in the differential equation describing the system;

$n$  is a running discrete positive index taking values 0, 1, 2,  $\dots$ ;

$W^{(k)}(\lambda)$  denotes the  $k$ th derivative of a time function; and

$w_{n,k}$  denotes the transform of  $W^{(k)}(\lambda)$ .

This transformation pair will now be established. In another paper<sup>1</sup> it is shown that in order to develop recursion formulas which will uniquely solve (1), among other things,<sup>7</sup> it is sufficient to partition at the highest-order linear derivative. Following this idea and noting, moreover, the analytic existence of (1), we are entitled to write (15).<sup>8</sup> It should be noted that if any other derivative were selected, one could not ensure obtaining a recurrence relation which would be solvable. Furthermore, if the partition is made at any other derivative, it is easy to show examples of nonlinear differential equations that yield nonconvergent or false results. This

difficulty does not arise in linear systems; hence, one can assume a power series solution for such systems.

Eq. (15) is an infinite series uniformly convergent in some circle. Generally, since  $W(\lambda)$  is an entire function of exponential type, the circle is the entire  $\lambda$ -plane. This usually occurs in the physical nondissipationless networks. As a consequence we require

$$w_{n,k} = 0 \quad \text{when } n < 0 \text{ and for all } k. \quad (17)$$

Multiplying both members of (15) by  $\lambda^{-m-1}$  gives

$$\lambda^{-m-1} W^{(k)}(\lambda) = \lambda^{-m-1} \sum_{n=0}^{\infty} w_{n,k} \lambda^n \quad (18)$$

where  $m > 0$  and is an integer. Since  $n$  is only a running index of the sum, (18) may be written

$$\lambda^{-m-1} W^{(k)}(\lambda) = \sum_{n=0}^{\infty} w_{n,k} \lambda^{n-m-1}. \quad (19)$$

Let us select a suitable circular-closed contour  $C$  in the  $\lambda$ -plane with its center at the origin, the radius of which is such that all the poles of  $\lambda^{-m-1} W^{(k)}(\lambda)$  are enclosed. With this contour  $C$  we integrate (19):

$$\frac{1}{2\pi j} \int_c \frac{W^{(k)}(\lambda)}{\lambda^{m+1}} d\lambda = \frac{1}{2\pi j} \int_c \sum_{n=0}^{\infty} w_{n,k} \lambda^{n-m-1} d\lambda. \quad (20)$$

Since (15) is uniformly convergent, the order of summation and integration may be interchanged. This gives

$$\frac{1}{2\pi j} \int_c \frac{W^{(k)}(\lambda)}{\lambda^{m+1}} d\lambda = \sum_{n=0}^{\infty} w_{n,k} \frac{1}{2\pi j} \int_c \lambda^{n-m-1} d\lambda. \quad (21)$$

Now consider the integral in the right-hand member of (21). From Cauchy's integral theorem this integral is unity when  $n = m$ , and zero otherwise. Consequently, the integral is formally recognized as a Kronecker delta function, *i.e.*,

$$\frac{1}{2\pi j} \int_c \lambda^{n-m-1} d\lambda = \delta_{n-m} \quad (22)$$

where

$$\delta_{n-m} = \begin{cases} 1, & n = m \\ 0, & n \neq m \end{cases}. \quad (23)$$

Substituting (22) in (21) yields

$$\frac{1}{2\pi j} \int_c \frac{W^{(k)}(\lambda)}{\lambda^{m+1}} d\lambda = \sum_{n=0}^{\infty} w_{n,k} \delta_{n-m} \quad (24)$$

from which (16) immediately follows. Therefore (15) and (16) define a transformation pair. Using this pair, one can develop a table of transforms.

It was pointed out earlier that  $W$  replaces  $x$  and  $\lambda$  replaces  $t$ . Since  $t$  is a real variable,  $x$  is a function of a real variable. Because of the analytic properties of  $x$  we can extend this function by the principle of analytic continuation, thereby giving rise to a function of a complex variable  $W(\lambda)$ . Ku and Wolf<sup>5</sup> show how one

<sup>7</sup> See Section II.

<sup>8</sup> The right member of (15) is uniformly convergent in some circle in the  $\lambda$ -plane, the center of which is at the origin.

can utilize information obtained in the complex  $\lambda$ -plane to determine the degree of stability of a system along the real half-line  $t$ .

V. OPERATIONAL PROPERTIES

We note that the Taylor-Cauchy transforms satisfy the following operational properties:

$$\mathfrak{J}_c\{\mathfrak{J}_c^{-1}[1]\} = \mathfrak{J}_c^{-1}\{\mathfrak{J}_c[1]\} \tag{25}$$

$$\mathfrak{J}_c[F(\lambda)] \neq F(\lambda) \cdot \mathfrak{J}_c[1] \tag{26}$$

$$\mathfrak{J}_c[0] = 0 \cdot \mathfrak{J}_c[1] = 0 \tag{27}$$

$$\mathfrak{J}_c(1) = \delta_n \text{ (Kronecker's delta function)} \tag{28}$$

$$\mathfrak{J}_c^{-1}[1] = \frac{1}{1-\lambda} \text{ in } |\lambda| < 1 \tag{29}$$

$$D \cdot \mathfrak{J}_c^{-1}[1] \neq \mathfrak{J}_c^{-1}[D \cdot 1]. \tag{30}$$

We note in (30) particularly that

$$D \cdot \mathfrak{J}_c^{-1}[1] = \frac{d}{d\lambda} \left( \frac{1}{1-\lambda} \right) \text{ (from 29)}$$

so that

$$D \cdot \mathfrak{J}_c^{-1}[1] = \frac{-1}{(1-\lambda)^2} \tag{31}$$

and

$$D^n \cdot \mathfrak{J}_c^{-1}[1] = \frac{(-1)^n}{(1-\lambda)^{n+1}}. \tag{32}$$

We also note that

$$D^{-1} \cdot \mathfrak{J}_c^{-1}[1] = -\log \left( \frac{1}{1-\lambda} \right) = \log(1-\lambda). \tag{33}$$

VI. EXAMPLES OF TAYLOR-CAUCHY TRANSFORM PAIRS

A. Operational Pairs: The Mates  $F(\lambda) \Leftrightarrow f_n$

1) Additivity:<sup>9</sup>

$$\mathfrak{J}_c[F_1(\lambda) + F_2(\lambda)] = \mathfrak{J}_c[F_1(\lambda)] + \mathfrak{J}_c[F_2(\lambda)]$$

Proof:

$$\mathfrak{J}_c[F_1(\lambda) + F_2(\lambda)] = \frac{1}{2\pi j} \int_c \frac{F_1(\lambda) + F_2(\lambda)}{\lambda^{n+1}} d\lambda. \tag{34}$$

Since the integral of a sum is equal to the sum of its integrals,

$$\mathfrak{J}_c[F_1(\lambda) + F_2(\lambda)] = \mathfrak{J}_c[F_1(\lambda)] + \mathfrak{J}_c[F_2(\lambda)]. \tag{35}$$

<sup>9</sup> This signifies that the operator is distributive with respect to addition and assumes that both terms in the right-hand member exist.

2) Commutivity:<sup>10</sup>

$$\mathfrak{J}_c[aF(\lambda)] = a\mathfrak{J}_c[F(\lambda)]$$

Proof:

$$\mathfrak{J}_c[aF(\lambda)] = \frac{1}{2\pi j} \int_c \frac{aF(\lambda)}{\lambda^{n+1}} d\lambda = a\mathfrak{J}_c[F(\lambda)]. \tag{36}$$

3) Change of Scale:

$$\mathfrak{J}_c \left[ F \left( \frac{\lambda}{a} \right) \right] = \frac{\mathfrak{J}_c[F(\lambda)]}{a^n}$$

Proof:

$$\mathfrak{J}_c \left[ F \left( \frac{\lambda}{a} \right) \right] = \frac{1}{2\pi j} \int_c F \left( \frac{\lambda}{a} \right) \lambda^{-n-1} d\lambda. \tag{37}$$

Let  $\zeta = \lambda/a$ . Hence,  $d\zeta = d\lambda/a$  and the right member of (37) becomes

$$\frac{1}{2\pi j} \int_c F(\zeta) (\zeta a)^{-n-1} a d\zeta = \frac{1}{2\pi j} \int_c \frac{F(\zeta)}{a^n \zeta^{n+1}} d\zeta \tag{38}$$

so that

$$\mathfrak{J}_c \left[ F \left( \frac{\lambda}{a} \right) \right] = a^{-n} \mathfrak{J}_c[F(\lambda)]. \tag{39}$$

4) Initial Value:

$$\lim_{\lambda \rightarrow 0} F(\lambda) = \lim_{n \rightarrow 0} f_n.$$

This follows immediately from the definition of the direct transform.

B. Terms Involving  $\lambda^m$

$$1) \mathfrak{J}_c[\lambda^m] = \delta_{n-m}, \text{ where } n, m = 0, 1, 2, \dots$$

Thus

$$\mathfrak{J}_c[\lambda^m] = \frac{1}{2\pi j} \int_c \lambda^{m-n-1} d\lambda = \delta_{n-m}. \tag{40}$$

$$2) \mathfrak{J}_c[\lambda^m] = 0 \text{ when } m \text{ is nonintegral.}$$

This result follows from (40), noting that  $n$  is always integral-valued.

C. Terms in  $W^{(k-m)}(\lambda)$

$$1) \mathfrak{J}_c[W^{(k-1)}(\lambda)] = \frac{w_{n-1,k}}{n} + A_{k-1} \delta_n. \tag{41}$$

If  $W^{(k)}(\zeta)$  is the  $k$ th derivative of  $W$  with respect to  $\zeta$  and is analytic in a region of the  $\zeta$ -plane, and if 0 and  $\lambda$  are the terminal points of any path lying within this analytic region,

<sup>10</sup> This signifies that the operator is commutative with respect to multiplication by a constant.



$$\int_0^\lambda W^{(k)}(\zeta) d\zeta = W^{(k-1)}(\lambda) - W^{(k-1)}(0) \quad (42)$$

or

$$W^{(k-1)}(\lambda) = \int_0^\lambda W^{(k)}(\zeta) d\zeta + A_{k-1} \quad (43)$$

where

$$A_{k-1} = W^{(k-1)}(0). \quad (44)$$

Substituting (15) into (43) gives, on interchanging the order of summation and integration,

$$W^{(k-1)}(\lambda) = \sum_{n=0}^\infty \frac{w_{n,k}}{n+1} \lambda^{n+1} + A_{k-1}. \quad (45)$$

Transforming (45) according to (16) yields

$$\begin{aligned} \mathfrak{J}_c[W^{(k-1)}(\lambda)] &= \frac{1}{2\pi j} \int_c \sum_{m=0}^\infty \frac{w_{m,k}}{m+1} \lambda^{m+1} \lambda^{-n-1} d\lambda \\ &\quad + \frac{1}{2\pi j} \int_c A_{k-1} \lambda^{-n-1} d\lambda \\ &= \frac{w_{n-1}}{n} + A_{k-1} \delta_n. \end{aligned} \quad (46)$$

$$2) \mathfrak{J}_c[W^{(k-2)}(\lambda)] = \frac{w_{n-2,k}}{n(n-1)} + A_{k-1} \delta_{n-1} + A_{k-2} \delta_n.$$

If  $W^{(k)}(\zeta)$  is analytic in a region of the  $\zeta$ -plane, then all its derivatives exist and are analytic therein. Consequently,

$$W^{(k-2)}(\lambda) = \int_0^\lambda W^{(k-1)}(\zeta) d\zeta + A_{k-2} \quad (47)$$

where

$$A_{k-2} = W^{(k-2)}(0). \quad (48)$$

Substituting (45) into (47) and performing the indicated integration gives

$$W^{(k-2)}(\lambda) = \sum_{n=0}^\infty \frac{w_{n,k}}{(n+1)(n+2)} \lambda^{n+2} + A_{k-1} \lambda + A_{k-2}. \quad (49)$$

Transforming (49) according to (16) yields

$$\begin{aligned} \mathfrak{J}_c[W^{(k-2)}(\lambda)] &= \frac{1}{2\pi j} \int_c \sum_{m=0}^\infty \frac{w_{m,k}}{(m+1)(m+2)} \lambda^{m+2} \lambda^{-n-1} d\lambda \\ &\quad + \frac{1}{2\pi j} \int_c A_{k-1} \lambda^{-n-1} d\lambda + \frac{1}{2\pi j} \int_c A_{k-2} \lambda^{-n-1} d\lambda \\ &= \frac{w_{n-2,k}}{n(n-1)} + A_{k-1} \delta_{n-1} + A_{k-2} \delta_n. \end{aligned} \quad (50)$$

$$\begin{aligned} 3) \mathfrak{J}_c[W^{(k-r)}(\lambda)] &= \frac{w_{n-r,k}}{n(n-1) \cdots (n-r+1)} + \sum_{q=1}^r \frac{A_{k-q}}{(r-q)!} \delta_{n-r+q}. \end{aligned}$$

Proceeding as in the previous cases, we integrate  $W^{(k)}(\lambda)$   $r$  times. This gives

$$\begin{aligned} W^{(k-r)}(\lambda) &= \sum_{n=0}^\infty \frac{w_{n,k}}{(n+1)(n+2) \cdots (n+r)} \lambda^{n+r} \\ &\quad + \sum_{q=1}^r \frac{A_{k-q}}{(r-q)!} \lambda^{r-q} \end{aligned} \quad (51)$$

in which

$$A_{k-q} = W^{(k-q)}(0). \quad (52)$$

Now (51) is transformed according to (16) giving

$$\begin{aligned} \mathfrak{J}_c[W^{(k-r)}(\lambda)] &= \frac{1}{2\pi j} \int_c \sum_{m=0}^\infty \frac{w_{m,k}}{(m+1)(m+2) \cdots (m+r)} \lambda^{m+r-n-1} d\lambda \\ &\quad + \frac{1}{2\pi j} \int_c \sum_{q=1}^r \frac{A_{k-q}}{(r-q)!} \lambda^{r-q-n-1} d\lambda \\ &= \frac{w_{n-r,k}}{n(n-1)(n-2) \cdots (n-r+1)} \\ &\quad + \sum_{q=1}^r \frac{A_{k-q}}{(r-q)!} \delta_{n-r+q}. \end{aligned} \quad (53)$$

$$\begin{aligned} 4) \mathfrak{J}_c[W(\lambda)] &= \frac{w_{n-k,k}}{n(n-1) \cdots (n-k+1)} \\ &\quad + \sum_{q=1}^k \frac{A_{k-q}}{(k-q)!} \delta_{n-k+q}. \end{aligned}$$

This is a special case of (53) in which  $r = k$ .

#### D. Terms in $\lambda^\rho W^{(k-r)}(\lambda)$

$$1) \mathfrak{J}_c[\lambda^\rho W^{(k)}(\lambda)] = w_{n-\rho,k}.$$

To obtain this transform, first multiply (15) by  $\lambda^\rho$ . Then applying the  $\mathfrak{J}_c$ -transform gives

$$\mathfrak{J}_c[\lambda^\rho W^{(k)}(\lambda)] = \frac{1}{2\pi j} \int_c \sum_{m=0}^\infty w_{m,k} \lambda^{m+\rho-n-1} d\lambda = w_{n-\rho,k}. \quad (54)$$

The latter result is obtained on interchanging the order of summation and integration, which is justified because of the uniformity of convergence of the sum.

$$\begin{aligned} 2) \mathfrak{J}_c[\lambda^\rho W^{(k-r)}(\lambda)] &= \frac{w_{n-r-\rho,k}}{(n-\rho)(n-\rho-1) \cdots (n-\rho-r+1)} \\ &\quad + \sum_{q=1}^r \frac{A_{k-q}}{(r-q)!} \delta_{n-\rho-r+q}. \end{aligned}$$

To obtain this result proceed as before by first multiplying  $\Pi^{(k-r)}(\lambda)$  by  $\lambda^p$  and then transforming, so that

$$\mathfrak{J}_c[\lambda^p \Pi^{(k-r)}(\lambda)] = \frac{1}{2\pi j} \int_C \sum_{m=0}^{\infty} \frac{\tilde{w}_{m,k}}{(m+1) \cdots (m+r)} d\lambda + \frac{1}{2\pi j} \int_C \sum_{q=1}^r \frac{\lambda^{k-q}}{(r-q)!} \lambda^{r-q+p-n-1} d\lambda \quad (55)$$

which yields the above result on integration.

E. Transforms of Nonlinear Terms

In the previous paragraphs we have illustrated the use of the Taylor-Cauchy transform to obtain transform mates of linear terms. Now we show how to obtain corresponding mates of nonlinear terms.

1) *The Convolution Sums:* The higher convolution sums were developed by Wolf in other papers.<sup>1-3</sup> Here we shall collect for reference some of these sums.

Let  $C_{n,k,0}^{(\nu)}$  symbolize a transform of the zeroth derivative of a function raised to the  $\nu$ th power. The superscript  $\nu$  in this case does not represent a derivative as it would in the time function. The subscript 0 refers to the zeroth derivative, and the  $n$  and  $k$  are defined as previously.

In general let  $C_{n,k,0,1,2,\dots,m}^{(\mu)}$  symbolize the transform of the product of the zeroth, first,  $\dots$ , and  $\mu$ th derivatives of a given time function. For our purposes let us define

$$C_{n,k,k-r} = \frac{\tilde{w}_{n,k}}{(n+1)(n+2) \cdots (n+r)} \quad (56)$$

Eq. (56) is a relation between the linear term  $\tilde{w}_{n,k}$  and the linear term  $C_{n,k,k-r}$ . The superscript  $\nu=1$  is omitted. When  $\nu=0$  the corresponding  $C$  is a Kronecker delta function, and the symbol for the latter will always be used instead. Thus

$$C_{n,k}^{(0)} = \delta_n \quad (57)$$

or

$$C_{n-m,k}^{(0)} = \delta_{n-m} \quad (58)$$

We now develop the higher-order functions of  $C$  in terms of its linear function (56):

$$C_{n,k,k-r}^{(2)} = \sum_{q_1=0}^n C_{q_1,k,k-r} C_{n-q_1,k,k-r} \quad (59)$$

To display the convolution property sharply, let  $k=r$  and drop the second subscript,  $k$ . Then (59) becomes

$$C_n^{(2)} = \sum_{q_1=0}^n C_{q_1} C_{n-q_1} \quad (60)$$

$C_n^{(3)}$  and  $C_n^{(4)}$  may be written as

$$C_n^{(3)} = \sum_{q_2=0}^n \sum_{q_1=0}^{q_2} C_{q_1} C_{q_2-q_1} C_{n-q_2} \quad (61)$$

$$C_n^{(4)} = \sum_{q_3=0}^n \sum_{q_2=0}^{q_3} \sum_{q_1=0}^{q_2} C_{q_1} C_{q_2-q_1} C_{q_3-q_2} C_{n-q_3} \quad (62)$$

In general

$$C_n^{(\nu)} = \sum_{q^{\nu-1}=0}^n \cdots \sum_{q_2=0}^{q_3} \sum_{q_1=0}^{q_2} C_{q_1} C_{q_2-q_1} \cdots C_{n-q^{\nu-1}} \quad (63)$$

Eqs. (60)–(63) display the general procedure for writing convolution sums. We note that the  $C$ 's which go inside the summations depend on the nature of the problem. Thus (59) shows a case where the  $C$ 's are obtained from the nonlinearity of degree two in the  $(k-r)$ th derivative of a function.

In writing the above equations  $q$  denotes a running index with the subscript of  $q$  denoting a particular running index. The latter subscript is always one less than the order of the  $C$  in the left member, and the number of sums is also one less than the order of the  $C$  in the left member. We note also that the  $C$ 's inside the summation sign have subscripts beginning with  $q_1$ . The next subscript is found by subtracting the running index of the inside summation from its upper bound, namely,  $q_2 - q_1$ . The process is continued until all the necessary sums are written.

2) *Certain Simplifying Procedures in Subscripts and Equations:* If  $k$  is taken to be the order of the highest derivative of the nonlinear differential equation under analysis, then it turns out that the  $w$ 's become independent of the second subscript,  $k$ , if all the terms are referred to the second subscript. To illustrate this, assume  $k=2$ . Then the following pairs result for the second and first derivatives in the absence of initial conditions:

$$\Pi^{(2)}(\lambda) \Leftrightarrow \tilde{w}_{n,2} \quad (64)$$

and

$$\Pi^{(1)}(\lambda) \Leftrightarrow \tilde{w}_{n,1} \quad (65)$$

If (65) is developed in terms of the highest-order derivative, *i.e.*,  $k=2$ , it becomes

$$\Pi^{(1)}(\lambda) \Leftrightarrow \frac{\tilde{w}_{n,2}}{n} = \tilde{w}_{n,1} \quad (66)$$

It is evident that if (64) and (66) are used, the symbol  $\tilde{w}_{n,2}$  is now independent of  $k(=2)$ . To show this further consider the following example of a third-order system:

$$\ddot{x} + \dot{x} + x\dot{x} = b \quad (67)$$

subject to the conditions at  $t=0$

$$x(0) = a \quad (67a)$$

$$\dot{x}(0) = b \quad (67b)$$

$$\ddot{x}(0) = 0. \quad (67c)$$

Replacing  $x$  by  $W$  and  $t$  by  $\lambda$  as described above and applying the Taylor-Cauchy transform, one obtains the following recursion formula:

$$w_{n,3} = -C_{n-4,3,0,2}^{(2)} - b \frac{\tilde{w}_{n-2,3}}{n-1} - a \frac{\tilde{w}_{n-1,3}}{n} - \frac{\tilde{w}_{n-2,3}}{n(n-1)} - \frac{\tilde{w}_{n-1,3}}{n} \quad (68)$$

where

$$C_{n-4,3,0,2}^{(2)} = \sum_{q_1=0}^{n-4} \frac{\tilde{w}_{q_1,3} \tilde{w}_{n-q_1-4,3}}{(q_1+1)(q_1+2)(q_1+3)(q_1-n-3)}. \quad (69)$$

We note that on referring everything to the third derivative the subscript  $k(=3)$  is superfluous since  $w$  is independent of  $k$  under these conditions. Therefore, whenever the terms in the transform are all referred to the highest order derivative we shall drop the second subscript,  $k$ , so that  $w_{n,3}$  becomes simply  $w_n$  in this example.

3) *Certain Nonlinear Transform Pairs Containing Terms in  $[W^{(k-r)}(\lambda)]^r$ :*

a) *Zero initial conditions:* Given  $A_{k-1} = A_{k-2} = \dots = A_{k-r} = 0$ , then

$$[W^{(k-r)}(\lambda)]^r = \left[ \sum_{n=0}^{\infty} C_{n,k,k-r} \lambda^{n+r} \right]^r \quad (70)$$

where  $C_{n,k,k-r}$  is defined by (56). First factor out  $\lambda^r$ , to give

$$[W^{(k-r)}(\lambda)]^r = \lambda^{r^2} \left[ \sum_{n=0}^{\infty} C_{n,k,k-r} \lambda^n \right]^r. \quad (71)$$

Utilizing the results of Section VI-E, 1) on convolution sums, we may write (71) as<sup>11</sup>

$$[W^{(k-r)}(\lambda)]^r = \lambda^{r^2} \sum_{n=0}^{\infty} C_{n,k,k-r}^{(r)} \lambda^n. \quad (72)$$

Transforming (72) yields

$$\begin{aligned} \mathfrak{J}_c \{ [W^{(k-r)}(\lambda)]^r \} &= \frac{1}{2\pi j} \int_C \sum_{m=0}^{\infty} C_{m,k,k-r}^{(r)} \lambda^{m+r^2-n-1} d\lambda \\ &= C_{n-r^2,k,k-r}^{(r)}. \end{aligned} \quad (73)$$

b) *Nonzero Initial Conditions.* Given  $A_{k-1} \neq A_{k-2} \neq \dots \neq A_{k-r} \neq 0$ ,

$$[W^{(k-r)}(\lambda)]^r = \left[ \sum_{n=0}^{\infty} \frac{\tilde{w}_{n,k}}{(n+1)(n+2)\dots(n+r)} \lambda^{n+r} + \sum_{q=1}^r \frac{A_{k-q}}{(r-q)!} \right]^r. \quad (74)$$

<sup>11</sup> For convenience  $C_{n,k,k-r}^{(r)}$  is defined in Table I, page 921. The second subscript,  $k$ , is dropped there in accordance with Section VI-E, 2).

Utilizing the binomial theorem, we may write (74) as

$$\begin{aligned} & [W^{(k-r)}(\lambda)]^r \\ &= \sum_{i=0}^r \binom{r}{i} \left[ \sum_{n=0}^{\infty} \frac{\tilde{w}_{n,k}}{(n+1)(n+2)\dots(n+r)} \lambda^{n+r} \right]^{r-i} \\ & \cdot \left[ \sum_{q=1}^r \frac{A_{k-q}}{(r-q)!} \lambda^{r-q} \right]^i \\ &= \sum_{n=0}^{\infty} C_{n-r^2,k,k-r}^{(r)} \lambda^n \\ & + \sum_{n=0}^{\infty} \sum_{i=1}^{r-1} \binom{r}{i} \sum_{q=1}^r C_{n-(\nu-i+1)r-q,k,k-r}^{(\nu-i)} A_{r-q}^{(i)} \lambda^n \\ & + \sum_{q=1}^r A_{r-q}^{(r)} \lambda^{r-q} \end{aligned} \quad (75)$$

in which  $A_{r-q}^{(i)}$  and  $A_{r-q}^{(\nu)}$  are defined generally by

$$A_{r-q}^{(\nu)} = \sum_{\beta_{j-1}=0}^{r-q} \dots \sum_{\beta_2=0}^{\beta_3} \sum_{\beta_1=0}^{\beta_2} \frac{A_{k+\beta_1-r}}{\beta_1!} \frac{A_{k+\beta_2-\beta_1-r}}{(\beta_2-\beta_1)!} \dots \frac{A_{k-\beta_{j-1}-q}}{(r-q-\beta_{j-1})!}. \quad (76)$$

Transforming (75) yields the following result:

$$\begin{aligned} & \mathfrak{J}_c \{ [W^{(k-r)}(\lambda)]^r \} \\ &= C_{n-r^2,k,k-r}^{(r)} + \sum_{i=1}^{r-1} \sum_{q=1}^r \binom{r}{i} C_{n-(\nu-i+1)r-q,k,k-r}^{(\nu-i)} A_{r-q}^{(i)} \\ & + \sum_{q=1}^r A_{r-q}^{(r)} \delta_{n-r+q}. \end{aligned} \quad (77)$$

In (77) the first term in the right-hand member is the transform of the function for zero initial conditions, the double sum is the transform of the cross products, and the third sum is the transform of the initial conditions raised to the  $\nu$ th power.

4) *Transform of Nonlinear Terms in  $[W^{(k-r_1)}(\lambda)] [W^{(k-r_2)}(\lambda)]$ :*

a) *Zero initial conditions:* Given  $A_{k-1} = A_{k-2} = \dots = A_{k-r_1} = A_{k-r_2} = 0$ , the product becomes

$$\begin{aligned} & [W^{(k-r_1)}(\lambda)] [W^{(k-r_2)}(\lambda)] \\ &= \left[ \sum_{n=0}^{\infty} \frac{\tilde{w}_{n,k}}{(n+1)(n+2)\dots(n+r_1)} \lambda^{n+r_1} \right] \\ & \cdot \left[ \sum_{n=0}^{\infty} \frac{\tilde{w}_{n,k}}{(n+1)(n+2)\dots(n+r_2)} \lambda^{n+r_2} \right] \\ &= \sum_{n=0}^{\infty} C_{n,k,k-r_1,k-r_2}^{(2)} \lambda^{n+r_1+r_2} \end{aligned} \quad (78)$$

in which the coefficient of  $\lambda$  in (78) is defined as above and is recorded in the Appendix. On transforming (78), we obtain

$$\mathfrak{J}_c \{ [W^{(k-r_1)}(\lambda)] [W^{(k-r_2)}(\lambda)] \} = C_{n-r_1-r_2,k,k-r_1,k-r_2}^{(2)} \quad (79)$$



b) *Nonzero initial conditions*: Given  $A_{k-1} \neq A_{k-2} \neq \dots \neq A_{k-r_1} \neq \dots \neq A_{k-r_2} \neq 0$  and  $r_2 > r_1$ , the product becomes

$$\begin{aligned}
 & [W^{(k-r_1)}(\lambda)] [W^{(k-r_2)}(\lambda)] \\
 &= \left[ \sum_{n=0}^{\infty} \frac{w_{n,k}}{(n+1)(n+2) \cdots (n+r_1)} \lambda^{n+r_1} \right. \\
 &\quad \left. + \sum_{q=1}^{r_1} \frac{A_{k-q}}{(r_1-q)!} \lambda^{r_1-q} \right] \\
 &\cdot \left[ \sum_{n=0}^{\infty} \frac{w_{n,k}}{(n+1)(n+2) \cdots (n+r_2)} \lambda^{n+r_2} \right. \\
 &\quad \left. + \sum_{q=1}^{r_2} \frac{A_{k-q}}{(r_2-q)!} \lambda^{r_2-q} \right]. \quad (80)
 \end{aligned}$$

After multiplying the above sums, applying the technique used previously, and denoting by  $A_{n,k,r_1,r_2}^{(2)}$  the sum

$$A_{n,k,r_1,r_2}^{(2)} = \sum_{\beta=0}^{r_1-1} \frac{A_{k+\beta-r_1}}{\beta!} \frac{A_{k+n-\beta-r_2}}{(n-\beta)!} \quad (81)$$

transforming the result yields

$$\begin{aligned}
 \mathfrak{J}_c \{ \{ W^{(k-r_1)}(\lambda) \} \{ W^{(k-r_2)}(\lambda) \} \} &= C_{n-r_1-r_2,k,k-r_1,k-r_2}^{(2)} \\
 &+ \sum_{q=1}^{r_2} \frac{A_{k-q}}{(r_2-q)!} \frac{w_{n-r_1-r_2+q,k}}{(n-r_1-r_2+q+1)(n-r_1-r_2+q+2) \cdots (n-r_2+q)} \\
 &+ \sum_{q=1}^{r_1} \frac{A_{k-q}}{(r_1-q)!} \frac{w_{n-r_1-r_2+q,k}}{(n-r_1-r_2+q+1)(n-r_1-r_2+q+2) \cdots (n-r_1+q)} \\
 &+ \sum_{m=0}^{r_1+r_2-2} A_{m,k,r_1,r_2}^{(2)} \delta_{n-m}. \quad (82)
 \end{aligned}$$

In a similar manner transforms for higher-order products of nonlinear and linear terms may be obtained. Taylor-Cauchy transform pairs are given in Tables II-IV on pages 921-922.

### VII. APPLICATION OF TAYLOR-CAUCHY TRANSFORM TO SOLUTION OF NONLINEAR DIFFERENTIAL EQUATIONS ARISING FROM CIRCUITS

*Example 1*: Consider a series *RL* circuit shown in Fig. 1. The inductor, *L*, is linear; while the resistor, *R*, is

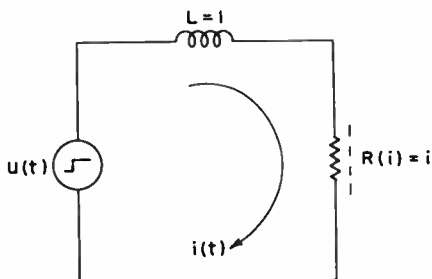

Fig. 1—First-order nonlinear circuit.

nonlinear, varying in direct proportion to the instantaneous current flowing through it. If the circuit is initially quiescent and a unit voltage step is applied at  $t=0$ , the resulting nonlinear differential equation is

$$\frac{di}{dt} + i^2 = u(t) \quad (83)$$

for  $L=1$  and  $R=i$ , where  $u(t)$  is the unit step defined in the conventional manner. Also,

$$i(0) = 0. \quad (84)$$

Since (83) is a first-order equation,  $k=1$ .

Writing  $W^{(1)}(\lambda)$  for  $di/dt$  and  $[W(\lambda)]^2$  for  $i^2$  gives

$$W^{(1)}(\lambda) + [W(\lambda)]^2 = 1 \quad (85)$$

and

$$A_0 = 0. \quad (86)$$

Transforming (85) with the aid of Table III appearing at the end of the paper leads to

$$w_n + C_{n-2,0}^{(2)} = \delta_n \quad (87)$$

in which

$$C_{n-2,0}^{(2)} = \sum_{\beta=0}^{n-2} \frac{w_{\beta}}{\beta+1} \frac{w_{n-\beta-2}}{n-\beta-1}. \quad (88)$$

We note that the subscript  $k(=1)$  is dropped in accordance with the remarks in Section VI-E, 2). Thus

$$w_{n,1} = w_n. \quad (89)$$

Solving (87) and (88) for  $w_n$  gives, recursively,

$$w_0 = 1$$

$$w_1 = 0$$

$$w_2 = -1$$

$$\begin{aligned}
 w_3 &= 0 \\
 w_4 &= \frac{2}{3} \\
 w_5 &= 0 \\
 w_6 &= -\frac{17}{45} \\
 &\dots
 \end{aligned}
 \tag{90}$$

$$\frac{d^2i}{dt^2} + (2 + i) \frac{di}{dt} + i = -e^{-2t} \tag{99}$$

Now we see that  $k=2$ . Thus writing  $W^{(2)}(\lambda)$  for  $d^2i/dt^2$ ,  $W^{(1)}(\lambda)$  for  $di/dt$ , and  $W(\lambda)$  for  $i$  leads to the equation

$$W^{(2)}(\lambda) + 2W^{(1)}(\lambda) + [W^{(1)}(\lambda)][W(\lambda)] + W(\lambda) = -e^{-2\lambda} \tag{100}$$

Since

$$W(\lambda) = \sum_{n=1}^{\infty} \frac{w_{n-1}}{n} \lambda^n + A_0 \tag{91}$$

for this case, the solution is obtained on substituting (86) and (90) into (91):

$$W(\lambda) = \lambda - \frac{\lambda^3}{3} + \frac{2}{15}\lambda^5 - \frac{17}{315}\lambda^7 + \dots \tag{92}$$

But (92) is recognized as the series expansion of the hyperbolic tangent. Hence

$$W(\lambda) = \tanh \lambda \tag{93}$$

and

$$i(t) = \tanh t \tag{94}$$

*Example 2:* Consider the nonlinear circuit shown in Fig. 2 having the initial conditions

$$i(0) = -1 \tag{95}$$

$$v_c(0) = 1 \tag{96}$$

with parameters as shown and a forcing function  $V = \frac{1}{2}e^{-2t}$ . The nonlinear integro-differential equation of this circuit is, on applying the initial conditions,

$$\frac{di}{dt} + \left(2 + \frac{i}{2}\right)i + \int_0^t i \, d\tau + 1 = \frac{1}{2}e^{-2t} \tag{97}$$

We note that using (95) together with (97) gives

$$\frac{di(0)}{dt} = 1. \tag{98}$$

Clearing (97) of integrals by differentiating yields

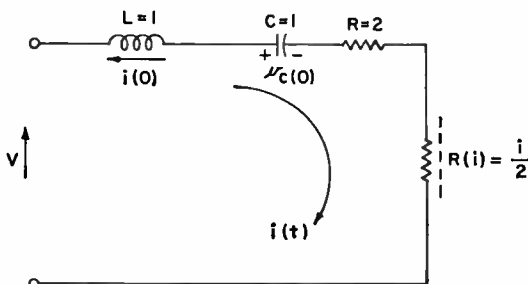

Fig. 2—Second-order nonlinear circuit.

with

$$A_0 = -1 \tag{101}$$

$$A_1 = 1. \tag{102}$$

Applying the Taylor-Cauchy transform with the aid of Table III gives

$$\begin{aligned}
 w_n &= -\frac{(-2)^n}{n!} - 2\delta_{n-1} - \frac{w_{n-1}}{n} - 2\frac{w_{n-2}}{n(n-1)} \\
 &\quad - \frac{w_{n-2}}{n-1} - C_{n-3,1,0}^{(2)}
 \end{aligned}
 \tag{103}$$

where

$$C_{n-3,1,0}^{(2)} = \sum_{\beta=0}^{n-3} \frac{w_\beta}{\beta+1} \frac{w_{n-\beta-3}}{(n-\beta-2)(n-\beta-1)} \tag{104}$$

Solving (103) and (104) recursively for  $w_n$ , gives

$$\begin{aligned}
 w_0 &= -1 \\
 w_1 &= 1 \\
 w_2 &= -\frac{1}{2} \\
 w_3 &= \frac{1}{3!} \\
 w_4 &= -\frac{1}{4!} \\
 &\dots
 \end{aligned}
 \tag{105}$$

Since

$$W^{(k-2)}(\lambda) = W(\lambda) = \sum_{n=2}^{\infty} \frac{w_{n-2}}{n(n-1)} \lambda^n + A_1\lambda + A_0 \tag{106}$$

substituting (101), (102), and (105) in (106) yields the result

$$W(\lambda) = -1 + \lambda - \frac{\lambda^2}{2!} + \frac{\lambda^3}{3!} - \frac{\lambda^4}{4!} + \dots \tag{107}$$

The latter equation is recognized as the series expansion for  $-e^{-\lambda}$ . Hence

$$i(t) = -e^{-t} \tag{108}$$

VIII. CONCLUSION AND COMMENTS

This paper has presented a transform method for solving a certain class of ordinary nonlinear differential equations. The method essentially converts a given nonlinear differential equation into a corresponding algebraic equation which can be solved recursively. Under certain conditions, namely, when the general term can be found, the solution can be put in closed form.

It turns out that this method comprises an elegant transform method yielding the same results as the partition method. Actually the method given here is another way of looking at the partition method with a powerful mathematical probe. The Taylor-Cauchy transform is related in a general way to the Mellin-Stieltjes transform.<sup>12,13</sup>

The transform is particularly suited for the analysis

of systems with randomly varying inputs.<sup>14</sup> With the transform the randomness is transferred from the continuous functions to discrete functions, thus enabling one to utilize the vast body of material available for the analysis of discrete random processes.

The analysis of linear time-varying systems is also easily handled. It appears that such systems can be analyzed in closed form, or at least an analytic description can be given of the behavior of the stability accurately in the complex frequency plane.

ACKNOWLEDGMENT

The authors wish to acknowledge the support extended them by the National Science Foundation in making these studies in nonlinear-system theory. They also wish to thank Drs. J. G. Brainerd and Harry Solon for their interest and encouragement in this work.

<sup>14</sup> Y. H. Ku and A. A. Wolf, "Transform-ensemble method for analysis of linear and nonlinear systems with random inputs," *Proc. NEC*, vol. 15; March, 1959.

<sup>12</sup> A. Erdélyi, et al., "Tables of Integral Transforms," McGraw-Hill Book Co., Inc., New York, N. Y., vol. 2, pp. xi-xii; 1954.

<sup>13</sup> D. V. Widder, "The Laplace Transform," Princeton University Press, Princeton, N. J., pp. 246-247; 1941.

TABLE I  
SOME NONLINEAR CONVOLUTION SUMS

$$\begin{aligned}
 1) \ C_{n,k-r}^{(r)} &= \sum_{q_{p-1}=0}^n \cdots \sum_{q_2=0}^{q_1} \sum_{q_1=0}^{q_2} \frac{\hat{w}_{q_1}}{(q_1+1)(q_1+2)\cdots(q_1+r)} \frac{\hat{w}_{q_2-q_1}}{(q_2-q_1+1)(q_2-q_1+2)\cdots(q_2-q_1+r)} \cdots \\
 &\quad \frac{\hat{w}_{n-q_{p-1}}}{(n-q_{p-1}+1)(n-q_{p-1}+2)\cdots(n-q_{p-1}+r)} \\
 2) \ C_{n-\nu r, k-r}^{(\nu)} &= \sum_{q_{\nu-1}=0}^{n-\nu r} \cdots \sum_{q_2=0}^{q_1} \sum_{q_1=0}^{q_2} \frac{\hat{w}_{q_1}}{(q_1+1)(q_1+2)\cdots(q_1+r_1)} \frac{\hat{w}_{q_2-q_1}}{(q_2-q_1+1)(q_2-q_1+2)\cdots(q_2-q_1+r)} \cdots \\
 &\quad \frac{\hat{w}_{n-\nu r-q_{\nu-1}}}{(n-\nu r-q_{\nu-1}+1)(n-\nu r-q_{\nu-1}+2)\cdots(n-\nu r-q_{\nu-1}+r)} \\
 3) \ C_{n-r_1-r_2, k-r_1, k-r}^{(2)} &= \sum_{q_1=0}^{n-r_1-r_2} \frac{\hat{w}_{q_1}}{(q_1+1)(q_1+2)\cdots(q_1+r_1)} \frac{\hat{w}_{n-r_1-r_2-q_1}}{(n-r_1-r_2-q_1+1)(n-r_1-r_2-q_1+2)\cdots(n-r_1-q_1)}
 \end{aligned}$$

TABLE II  
TAYLOR-CAUCHY TRANSFORM PAIRS—OPERATIONAL FORMS

1	$F(\lambda)$	$f_n$
2	$F(\lambda) + H(\lambda)$	$f_n + h_n$
3	$aF(\lambda)$	$af_n$
4	$\lambda F(\lambda)$	$f_{n-1}$
5	$\lambda^m F(\lambda)$	$f_{n-m}$
6	1	$\delta_n = \begin{cases} 1, & n = 0 \\ 0, & n \neq 0 \end{cases}$
7	$\lambda$	$\delta_{n-1} = \begin{cases} 1, & n = 1 \\ 0, & n \neq 1 \end{cases}$
8	$\lambda^m$	$\delta_{n-m} = \begin{cases} 1, & n = m \\ 0, & n \neq m \end{cases}$



TABLE III  
TRANSFORMS—ZERO INITIAL VALUES

1	$W^{(k)}(\lambda)$	$\frac{\omega_n}{n}$	9	$[W^{(k)}(\lambda)]^2$	$C_{n,k}^{(2)}$
2	$W^{(k-1)}(\lambda)$	$\frac{\omega_{n-1}}{n}$	10	$[W^{(k)}(\lambda)]^p$	$C_{n,k}^{(p)}$
3	$W^{(k-2)}(\lambda)$	$\frac{\omega_{n-2}}{n(n-1)}$	11	$\lambda^m [W^{(k)}(\lambda)]^p$	$C_{n-m,k}^{(p)}$
4	$W^{(k-r)}(\lambda)$	$\frac{\omega_{n-r}}{n(n-1) \cdots (n-r+1)}$	12	$[W^{(k-1)}(\lambda)]^2$	$C_{n-2,k-1}^{(2)}$
5	$W(\lambda)$	$\frac{\omega_{n-k}}{n(n-1) \cdots (n-k+1)}$	13	$[W^{(k-1)}(\lambda)]^p$	$C_{n-2p,k-1}^{(p)}$
6	$\lambda W^{(k)}(\lambda)$	$\omega_{n-1}$	14	$[W^{(k-r)}(\lambda)]^p$	$C_{n-pr,k-r}^{(p)}$
7	$\lambda^m W^{(k)}(\lambda)$	$\omega_{n-m}$	15	$[W(\lambda)]^p$	$C_{n-p,k,0}^{(p)}$
8	$\lambda^m W^{(k-r)}(\lambda)$	$\frac{\omega_{n-m-r}}{(n-m)(n-m-1) \cdots (n-m-r+1)}$	16	$\lambda^m [W^{(k-r)}(\lambda)]^p$	$C_{n-m-pr,k-r}^{(p)}$
			17	$[W^{(k-r_1)}(\lambda)][W^{(k-r_2)}(\lambda)]$	$C_{n-r_1-r_2,k-r_1,k-r_2}^{(2)}$
			18	$\lambda^m [W^{(k-r_1)}(\lambda)] \cdot [W^{(k-r_2)}(\lambda)]$	$C_{n-m-r_1-r_2,k-r_1,k-r_2}^{(2)}$

TABLE IV  
TRANSFORMS—NONZERO INITIAL CONDITIONS

1	$W^{(k-1)}(\lambda)$	$\frac{\omega_{n-1,k}}{n} + A_{k-1}\delta_n$
2	$W^{(k-2)}(\lambda)$	$\frac{\omega_{n-2,k}}{n(n-1)} + A_{k-1}\delta_{n-1} + A_{k-2}\delta_n$
3	$W^{(k-r)}(\lambda)$	$\frac{\omega_{n-r,k}}{n(n-1) \cdots (n-r+1)} + \sum_{q=1}^r \frac{A_{k-q}}{(k-q)!} \delta_{n-r+q}$
4	$W(\lambda)$	$\frac{\omega_{n-k,k}}{n(n-1) \cdots (n-k+1)} + \sum_{q=1}^k \frac{A_{k-q}}{(k-q)!} \delta_{n-k+q}$
5	$\lambda^m W^{(k-r)}(\lambda)$	$\frac{\omega_{n-m-r,k}}{(n-m)(n-m-1) \cdots (n-m-r+1)} + \sum_{q=1}^r \frac{A_{k-q}}{(r-q)!} \delta_{n-m-r+q}$
6	$[W^{(k-r)}(\lambda)]^p$	$C_{n-pr,k-r} + \sum_{i=1}^{p-1} \sum_{q=1}^r \binom{p}{i} C_{n-(p-i)r-q}^{(p-i)} A_{r-q}^{(i)} + \sum_{q=1}^r A_{r-q}^{(p)} \delta_{n-r+q}$ in which $A_{r-q}^{(i)}$ and $A_{r-q}^{(p)}$ are defined generally by $A_{r-q}^{(j)} = \sum_{s_1=0}^{r-q} \cdots \sum_{s_{j-1}=0}^{s_{j-2}} \frac{A_{k+s_1-r}}{s_1!} \frac{A_{k+s_2-s_1-r}}{(s_2-s_1)!} \cdots \frac{A_{k-s_{j-1}-q}}{(r-q-s_{j-1}-1)!$
7	$\lambda^m [W^{(k-r)}(\lambda)]^p$	$C_{n-m-pr,k-r} + \sum_{i=1}^{p-1} \sum_{q=1}^r \binom{p}{i} C_{n-m-(p-i)r-q}^{(p-i)} A_{r-q}^{(i)} + \sum_{q=1}^r A_{r-q}^{(p)} \delta_{n-m-r+q}$
8	$[W^{(k-r_1)}(\lambda)][W^{(k-r_2)}(\lambda)]$	$C_{n-r_1-r_2,k-r_1,k-r_2}^{(2)} + \sum_{q=1}^{r_2} \frac{A_{k-q}}{(r_2-q)!} \frac{\omega_{n-r_1-r_2+q,k}}{(n-r_1-r_2+q+1)(n-r_1-r_2+q+2) \cdots (n-r_2+q)} + \sum_{q=1}^{r_1} \frac{A_{k-q}}{(r_1-q)!} \frac{\omega_{n-r_1-r_2+q,k}}{(n-r_1-r_2+q+1)(n-r_1-r_2+q+2) \cdots (n-r_1+q)} + \sum_{m=0}^{r_1+r_2-2} A_{m,r_1,r_2}^{(2)} \delta_{n-m}$ in which $A_{m,r_1,r_2} = \sum_{s=0}^{r_1-1} \frac{A_{k+s-r_1}}{s!} \frac{A_{k+n-s-r_2}}{(n-s)!}$
9	$e^{\alpha\lambda}$	$\frac{(\alpha)^n}{n!}$
10	$\sin \beta\lambda$	$\frac{(-1)^n (\beta)^{2n-1}}{(2n+1)!}$
11	$\cos \beta\lambda$	$\frac{(-1)^n (\beta)^{2n}}{(2n)!}$
12	$e^{\alpha\lambda} \sin \beta\lambda$	$\sum_{k=0}^n \frac{(-1)^k \beta^{2k+1}}{(2k+1)!} \frac{\alpha^{n-k}}{(n-k)!}$
13	$e^{\alpha\lambda} \cos \beta\lambda$	$\sum_{k=0}^n \frac{(-1)^k \beta^{2k}}{(2k)!} \frac{\alpha^{n-k}}{(n-k)!}$
14	$\sum_{n=0}^{\infty} a_n \lambda^n$	$a_n$
15	$\frac{1}{1-\alpha\lambda}$	$\alpha^n$
16	$\frac{1-(\alpha\lambda)^{m+1}}{1-\alpha\lambda}$	$\begin{cases} \alpha^n, & n \leq m \\ 0, & n > m \end{cases}$

# Laurent-Cauchy Transforms for Analysis of Linear Systems Described by Differential-Difference and Sum Equations\*

Y. H. KU†, SENIOR MEMBER, IRE, AND A. A. WOLF‡, MEMBER, IRE

**Summary**—The Taylor-Cauchy transform for the analysis of nonlinear systems was presented at the 1959 IRE National Convention.<sup>1</sup> In this paper it is shown that the Laurent-Cauchy transform can be derived from the Taylor-Cauchy transform by a simple mapping. Whereas a complex  $\lambda$  plane is used in the Taylor-Cauchy transform, a complex  $\rho$  plane is used in the Laurent-Cauchy transform where the two complex variables are related by  $\lambda = 1/\rho$ . In the Taylor-Cauchy transform method,  $W^{(k)}(\lambda)$ , the  $k$ th derivative of  $W(\lambda)$ , converges inside a circle. However, in the Laurent-Cauchy transform method,  $H(\rho)$  converges outside of a circle of radius  $R$ . Thus,  $W^{(k)}(\lambda)$  is expressible by a Taylor series whose general term is

$$\sum_{n=0}^{\infty} w_{n,k} \lambda^n$$

and  $H(\rho)$  is expressible by a Laurent series whose general term is

$$\sum_{n=0}^{\infty} h_n \rho^{-n}.$$

In either case, the relation between the coefficients of the power series and the function of a complex variable is given by Cauchy's integral. In conjunction with the Laplace transform, the Laurent-Cauchy transform can be used to analyze discrete-continuous systems such as digital servomechanisms, retarded feedback control systems, certain analog-digital computer systems, and pulsed-data systems. If  $n$  is replaced by  $nT$ , where  $T$  is a sampling time, and  $h_n$  is taken to mean  $h(nT)$ , the Laurent-Cauchy transform reduces to the  $Z$ -transform. A table of Laurent-Cauchy transforms, several theorems, and three examples are given in the paper.

## I. INTRODUCTION

IN a previous work<sup>1</sup> a transform method, the Taylor-Cauchy transform, was developed as a formal consequence of a mathematical theory for analysis of nonlinear systems.<sup>2-5</sup> The Taylor-Cauchy transform method was presented at the 1959 IRE National Convention, and now appears as a companion paper in this issue. This method, the Taylor-Cauchy transform, is one member of a broad class of transforms which correspond to

\* Original manuscript received by the IRE, May 25, 1959; revised manuscript received, December 11, 1959. This work was done under a research grant from the National Science Foundation.

† The Moore School of Electrical Engineering, University of Pennsylvania, Philadelphia. Dr. Ku is also a consultant to RCA, Camden, N. J.

‡ Stromberg-Carlson Co., Rochester, N. Y. Formerly with The Moore School of Electrical Engineering, University of Pennsylvania, Philadelphia.

<sup>1</sup> Y. H. Ku, A. A. Wolf, and J. H. Dietz, "Taylor-Cauchy transforms for the analysis of a certain class of nonlinear systems," this issue, pp. 912-922. See also 1959 IRE NATIONAL CONVENTION RECORD, pt. 2, pp. 49-61.

<sup>2</sup> A. A. Wolf, "A Mathematical Theory for the Analysis of a Class of Nonlinear Systems," Ph.D. dissertation, University of Pennsylvania, Philadelphia; 1958.

<sup>3</sup> A. A. Wolf, "Recurrence relations in the solution of a certain class of nonlinear systems," *Trans. AIEE*, vol. 79, to be published, March or April, 1960.

<sup>4</sup> A. A. Wolf, "Generalized recurrence relations in the solution of nonlinear systems," *Trans. AIEE*, vol. 79, to be published during 1960.

<sup>5</sup> Y. H. Ku and A. A. Wolf, "A stability criterion for nonlinear systems," *Trans. AIEE*, vol. 78, pt. 2, pp. 144-148; July, 1959.

a given class of generalized or modified forcing functions. Another member of this class of transforms is developed in this paper. The new transform method, the Laurent-Cauchy transform, can be derived from the Taylor-Cauchy transform by a simple mapping. A new complex variable  $\rho$ , used in the Laurent-Cauchy transform, is related to the complex variable  $\lambda$ , used in the Taylor-Cauchy transform, by the simple relation  $\lambda = 1/\rho$ . In the Taylor-Cauchy transform method,  $W^{(k)}(\lambda)$ , the  $k$ th derivative of  $W(\lambda)$ , converges inside a circle. In the Laurent-Cauchy transform method,  $H(\rho)$ , a function of the complex variable  $\rho$ , converges outside a circle of radius  $R$ . Thus  $W^{(k)}(\lambda)$  is expressible by a Taylor series whose general term is

$$\sum_{n=0}^{\infty} w_{n,k} \lambda^n$$

whereas  $H(\rho)$  is expressible by a Laurent series whose general term is

$$\sum_{n=0}^{\infty} h_n \rho^{-n}.$$

Just as  $w_{n,k}$  is related to  $W^{(k)}(\lambda)$  by the Cauchy integral, so it is shown that  $h_n$  is related to  $H(\rho)$  by the Cauchy integral with a different contour.

The Laurent-Cauchy transform is particularly useful in the analysis of physical systems described by differential-difference and sum equations. Used in conjunction with the Laplace transform, it makes possible the analysis of discrete-continuous systems such as digital servomechanisms, retarded feedback control systems, certain analog-digital computer systems, and pulsed-data systems. In addition, if the input is a random process, the Laurent-Cauchy transform can be used with the transform-ensemble method<sup>6</sup> to obtain information about the statistics of the response of the discrete systems.

## II. DERIVATION OF THE LAURENT-CAUCHY TRANSFORM FROM THE TAYLOR-CAUCHY TRANSFORM

The Taylor-Cauchy transform pair<sup>1</sup> is given by (1) and (2) below:

$$w_{n,k} = \frac{1}{2\pi j} \int_{C'} \frac{W^{(k)}(\lambda)}{\lambda^{n+1}} d\lambda \quad (1)$$

$$W^{(k)}(\lambda) = \sum_{n=0}^{\infty} w_{n,k} \lambda^n \quad (2)$$

<sup>6</sup> Y. H. Ku and A. A. Wolf, "Transform-ensemble method for analysis of linear and nonlinear systems with random inputs," *Proc. NEC*, vol. 15; March, 1959.

where

- $w_{n,k}$  denotes the direct Taylor-Cauchy transform of  $W^{(k)}(\lambda)$ ,
- $W^{(k)}(\lambda)$  denotes the  $k$ th derivative of a complex time function  $W(\lambda)$ ,
- $W(\lambda)$  denotes a function of the complex variable  $\lambda$  corresponding to a function of the real time variable  $t$ ,
- $n$  denotes the real discrete variable in the transform half-line corresponding to the complex time variable  $\lambda$  in the complex time plane,
- $\lambda$  denotes a complex time variable corresponding to the real time variable  $t$ , and
- $C'$  denotes a contour in the  $\lambda$ -plane defining the domain of definition of the complex time function  $W(\lambda)$  and enclosing the singularities of the integrand of (1).

Consider now the transformation given below:

$$\lambda = \frac{1}{\rho} \tag{3}$$

where  $\rho$  defines a complex frequency variable in the complex  $\rho$ -plane. Eq. (3) is a bilinear transformation with the property that points inside the unit circle in the  $\lambda$ -plane map into corresponding points outside the unit circle in the  $\rho$ -plane. The differential of  $\lambda$  is given by

$$d\lambda = -\frac{d\rho}{\rho^2} \tag{4}$$

Substituting (3) and (4) into (1) and (2) yields

$$w_{n,k} = \frac{1}{2\pi j} \int_C W^{(k)}\left(\frac{1}{\rho}\right) \rho^{n-1} d\rho \tag{5}$$

and

$$W^{(k)}\left(\frac{1}{\rho}\right) = \sum_{n=0}^{\infty} w_{n,k} \rho^{-n} \tag{6}$$

Let us denote  $w_{n,k}$  by  $h_{n,q}$  and  $W^{(k)}(1/\rho)$  by  $H^{(q)}(\rho)$  respectively. Thus

$$h_{n,q} = w_{n,k} \tag{7}$$

$$H^{(q)}(\rho) = W^{(k)}\left(\frac{1}{\rho}\right) \tag{8}$$

Thus, we may write (5) and (6) as

$$h_{n,q} = \frac{1}{2\pi j} \int_C H^{(q)}(\rho) \rho^{n-1} d\rho \tag{9}$$

$$H^{(q)}(\rho) = \sum_{n=0}^{\infty} h_{n,q} \rho^{-n} \tag{10}$$

The nature and restrictions concerning the functions  $h_n$  and  $H(\rho)$  are discussed in Section III. The contour  $C$  encloses the singularities of  $H^{(q)}(\rho)\rho^{n-1}$  corresponding to the contour  $C'$  by means of the mapping given in (3). The index  $q$  in (8) can be omitted in practical cases. Formally, the index  $q$  may denote the  $q$ th derivative of

$H(\rho)$  with respect to  $\rho$ . We allow  $q$  to be different from  $k$  so that (11) is satisfied:

$$0 \leq q \leq k. \tag{11}$$

For certain applications such as differential-difference and sum equations we have  $h_n$  and  $H(\rho)$  as functions of time  $t$ , a real variable. Thus, after dropping  $q$  and introducing  $t$  explicitly, we get

$$h_n(t) = \frac{1}{2\pi j} \int_C H(\rho, t) \rho^{n-1} d\rho \tag{12}$$

$$H(\rho, t) = \sum_{n=0}^{\infty} h_n(t) \rho^{-n} \tag{13}$$

As functions of a real variable  $t$ ,  $h_n(t)$  and  $H(\rho, t)$  in (12) and (13) are Laplace transformable. For the sake of clarity, we may keep the symbols  $h_n$  and  $H(\rho)$  to represent the Laurent-Cauchy transform pairs, irrespective of whether  $h_n$  and  $H(\rho)$  are functions of  $t$  or of their Laplace transforms.

In Table I (Appendix I),  $q$  is taken as zero as in (12) and (13). Furthermore, we shall omit  $t$ , understanding its presence implicitly. The implication of this selection and other geometric interpretations are given in a note<sup>7</sup> previously published.

### III. RESTRICTIONS ON THE FUNCTIONS AND NOTATION

In this section we shall briefly discuss some of the pertinent restrictions on the functions  $h_n$  and  $H(\rho)$ . Let us now rewrite (12) and (13) consistent with the conditions of the last paragraph:

$$h_n = \frac{1}{2\pi j} \int_C H(\rho) \rho^{n-1} d\rho \tag{14}$$

$$H(\rho) = \sum_{n=0}^{\infty} h_n \rho^{-n} \tag{15}$$

We make the following assumptions.

$$1) \quad h_m = O(r^m) \tag{16}$$

where  $r > R > 0$ ,  $r = |\rho|$ , and

$$R^{-1} = \limsup_{n \rightarrow \infty} |h_n|^{1/n} \tag{17}$$

$R$  is the radius of a circle in the complex  $\rho$ -plane outside of which the series of (15) converges.

2) If  $h_n = h_n(t)$ , then

$$h_n(t) = O(e^{\alpha_n t}); \alpha_n \text{ constant for each } n. \tag{18}$$

3)  $H(\rho)$  converges outside of a circle of radius  $R$ .

4) If  $H(\rho) = H(\rho, t)$ , then

$$H(\rho, t) = O(e^{\beta_\rho t}); \beta_\rho \text{ constant for each } \rho. \tag{19}$$

5) The contour  $C$  is determined from (17) and (20):

$$\rho = r e^{j\theta} \tag{20}$$

<sup>7</sup> A. A. Wolf, "On the significance of transients and steady-state behavior in nonlinear systems," Proc. IRE, vol. 47, pp. 1785-1786; October, 1959.



where  $\theta$  is the angle of direction in the  $\rho$ -plane with the center of the circle at the origin, and  $r$  is the magnitude of  $\rho$ .

We note that (15) can be considered as a means of transforming a function of a discrete variable,  $h_n$ , into a continuous function of a complex frequency variable,  $H(\rho)$ . This mapping is illustrated in Fig. 1.

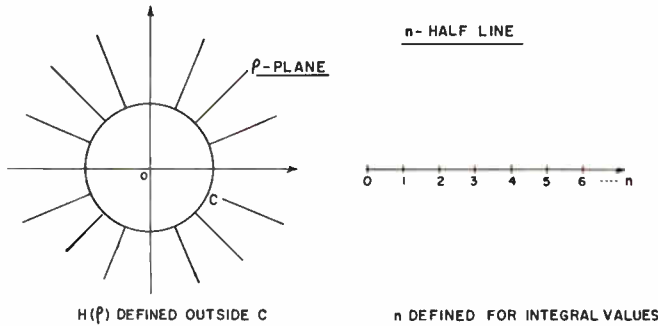

Fig. 1—Mapping of Laurent-Cauchy transform.

#### IV. APPLICATION OF THE LAURENT-CAUCHY TRANSFORM METHOD

Let us denote the direct Laurent-Cauchy transform and its inverse by the symbols  $\mathcal{L}_c$  and  $\mathcal{L}_c^{-1}$ , respectively. We choose (15) to define  $H(\rho)$  as the direct Laurent-Cauchy transform of  $h_n$  such that

$$\mathcal{L}_c[h_n] = H(\rho). \tag{21}$$

This is similar to the symbolic relation in Laplace transforms:  $\mathcal{L}[y(t)] = Y(s)$ , where  $y(t)$  is a function of the real variable  $t$  and  $Y(s)$  is a corresponding function of the complex variable  $s$ . The inverse Laurent-Cauchy transform is then defined by (14) and expressed symbolically by (22):

$$\mathcal{L}_c^{-1}[H(\rho)] = h_n. \tag{22}$$

Comparing (14) with the well-known complex integral form of  $\mathcal{L}^{-1}[Y(s)]$ , we see that in both cases the inverse transform can be obtained by contour integration. Thus, we may consider both the Laurent-Cauchy transform and the Laplace transform (as well as the Fourier transform) as members of a general class of transforms. It is logical to ask whether the Z-transform also belongs to this general class. If  $n$  is replaced by  $nT$ , where  $T$  is a sampling time, and the discrete variable  $h_n$  is taken to mean  $h(nT)$ , we see that (12) and (13) reduce to the Z-transform.

Difference equations are used to approximate the differential equations that describe a continuous system. Mixed difference-differential equations are sometimes encountered. Here we shall consider a more general form given by (23) which may be termed a differential-difference and sum equation:

$$\sum_{m=0}^M \sum_{k=0}^K \alpha_{km} y_{n+m}^{(k)} + \sum_{k=0}^n \beta_k y_k(t) = x_n(t). \tag{23}$$

We desire to determine  $y_n(t)$  in terms of  $\alpha$ 's,  $\beta$ 's and the forcing function  $x_n(t)$ . Note that  $y_n^{(k)}(t)$  denotes the  $k$ th derivative of  $y_n(t)$  with respect to time. An equation like (23) could describe a pulsed data or retarded feedback control system. Letting the Laplace transforms of  $y_n(t)$  and  $x_n(t)$  be denoted by  $h_n(s)$  and  $g_n(s)$ , respectively,

$$h_n(s) = Y_n(s) = \mathcal{L}[y_n(t)]; \quad g_n(s) = X_n(s) = \mathcal{L}[x_n(t)]. \tag{24}$$

The Laurent-Cauchy pairs can be given as follows, similar to (12) and (13):

$$h_n(s) = \frac{1}{2\pi j} \int_C H(\rho, s) \rho^{n-1} d\rho \tag{25}$$

$$H(\rho, s) = \sum_{n=0}^{\infty} h_n(s) \rho^{-n}. \tag{26}$$

Similar pairs can be given for  $g_n(s)$  and  $G(\rho, s)$ . Assuming that the system is initially at rest and noting that the Laplace transform of  $y_{n+m}^{(k)}(t)$  equals  $s^k h_{n+m}(s)$ , we apply first the Laplace transform and then the Laurent-Cauchy transform to (23) to give

$$\sum_{m=0}^M \sum_{k=0}^K \alpha_{km} s^k \mathcal{L}_c[h_{n+m}(s)] + \mathcal{L}_c \left[ \sum_{k=0}^n \beta_k h_k(s) \right] = \mathcal{L}_c[g_n(s)]. \tag{27}$$

From (26) and Appendix I, we have

$$\mathcal{L}_c[h_n(s)] = H(\rho, s) \tag{28}$$

$$\mathcal{L}_c[h_{n+m}(s)] = \rho^m H(\rho, s) \tag{29}$$

$$\mathcal{L}_c[g_n(s)] = G(\rho, s). \tag{30}$$

In Section VI it is shown that

$$\mathcal{L}_c \left[ \sum_{k=0}^n \beta_k h_k(s) \right] = \left( \frac{\rho}{\rho - 1} \right) \frac{1}{2\pi j} \int_C \frac{B(\gamma) H \left( \frac{\rho}{\gamma}, s \right)}{\gamma} d\gamma \tag{31}$$

where  $\gamma$  denotes a complex variable like  $\rho$ , and  $B(\gamma)$  is the Laurent-Cauchy transform of  $\beta_k$ . On utilizing (28), (29), (30), and (31) we obtain from (27) the transform equations in  $\rho$  and  $s$  as follows:

$$H(\rho, s) \sum_{m=0}^M \sum_{k=0}^K \alpha_{km} s^k \rho^m + \frac{\rho}{\rho - 1} \frac{1}{2\pi j} \int_C \frac{B(\gamma) H \left( \frac{\rho}{\gamma}, s \right)}{\gamma} d\gamma = G(\rho, s). \tag{32}$$

Eq. (32) is a linear integral equation of the kind which may be solved by a convergent iteration process.<sup>1,2</sup> The general solution of (32) in terms of the elementary functions is not known. Let us examine a special case in which  $\beta_k = \beta$  for all  $k \geq 0$ , where  $\beta$  is a constant. With this condition, (32) simplifies to

$$H(\rho, s) \sum_{m=0}^M \sum_{k=0}^K \alpha_{km} s^k \rho^m + \frac{\rho\beta}{\rho - 1} H(\rho, s) = G(\rho, s). \quad (33)$$

Therefore

$$H(\rho, s) = \frac{G(\rho, s)}{D(\rho, s)} \quad (34)$$

where

$$D(\rho, s) = \sum_{m=0}^M \sum_{k=0}^K \alpha_{km} s^k \rho^m + \frac{\rho\beta}{\rho - 1}. \quad (35)$$

To recover  $y_n(t)$ , it is necessary first to have a knowledge of the zeros of  $D(\rho, s)$  given by (35). Knowing the zeros of  $D(\rho, s)$ , the residue theorem can be applied first to the inverse Laplace transform and then to the inverse Laurent-Cauchy transform. Formally, this gives

$$y_n(t) = \mathcal{L}^{-1} \mathcal{L}_c^{-1} [H(\rho, s)] = \mathcal{L}^{-1} \mathcal{L}_c^{-1} [H(\rho, s)]. \quad (36)$$

The operators  $\mathcal{L}^{-1}$  and  $\mathcal{L}_c^{-1}$  are commutative with respect to the operand. In complicated cases the roots of  $s$  might involve radicals of the variable  $\rho$  and conversely. Thus, higher order singularities may lead to branch points and the solution may then involve transcendental functions of higher order.

V. COMPUTER CONTROLLED FEEDBACK SYSTEM

To illustrate the use of (12), (13), (25) and (26), let us consider an example involving continuous-discrete processes. Referring to Fig. 2, a simple servo is controlled by a computer (shown in Fig. 3) so that its out-

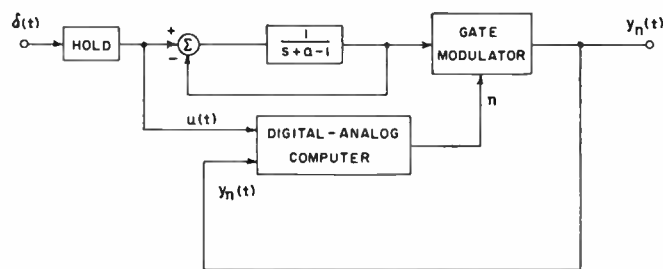

Fig. 2—An exponential pulse response feedback computer control system.

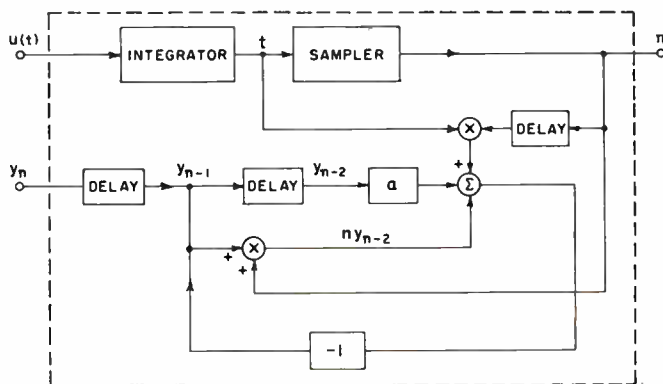

Fig. 3—Digital-analog computer of Fig. 2.

put is suitably modulated. It is possible in this system to separate the continuous process from the discrete process. This is equivalent to saying mathematically that the difference equation is separate from the continuous equation. In such cases, the total solution is usually the product of the separate solutions. In other words, one process amplitude modulates the other. To illustrate the present method, no notice will be made of the separability property from the system configuration. Instead, we shall solve this as a mathematical problem.

Example 1: Consider the equation

$$y'_{n+1}(t) + \frac{a}{n+1} y_n(t) = 0 \quad (37)$$

where the prime denotes a time derivative,  $a$  denotes a constant, and  $n$  denotes gate-time pulses taking the discrete values  $n=0, 1, 2, \dots$  only. The initial conditions are

$$y_n(0) = \frac{1}{n!}. \quad (38)$$

Eq. (37) can be rewritten as

$$(n+1)y'_{n+1}(t) + ay_n(t) = 0. \quad (39)$$

Taking the Laplace transform gives

$$(n+1)sY_{n+1}(s) + aY_n(s) = (n+1)y_{n+1}(0) = \frac{(n+1)}{(n+1)!} = \frac{1}{n!}. \quad (40)$$

Denoting  $Y_n(s)$  by  $h_n(s)$  as in (24) and noting  $Y_{n+1}(s) = h_{n+1}(s)$ , (40) becomes

$$s(n+1)h_{n+1}(s) + ah_n(s) = \frac{1}{n!}. \quad (40a)$$

From Table I (Appendix I) we get

$$\mathcal{L}_c [(n+1)h_{n+1}] = -\rho^2 H'(\rho) \quad (41)$$

where  $H'(\rho) = dH(\rho)/d\rho$ :

$$\mathcal{L}_c \left[ \frac{1}{n!} \right] = e^{1/\rho}. \quad (42)$$

Taking the Laurent-Cauchy transform of (40) and utilizing the results of (28), (41) and (42), we get the transform equation

$$-s[\rho^2 H'(\rho, s)] + aH(\rho, s) = e^{1/\rho}. \quad (43)$$

Solving for  $H(\rho, s)$  gives

$$H(\rho, s) = \frac{e^{1/\rho}}{s+a}. \quad (44)$$

The correctness of the above solution can be checked by noting that  $dH/d\rho = (-1/\rho^2)H$  and that the left-hand terms of (43) add up to  $(s+a)H(\rho, s)$ . Inverting (44) with respect to  $\rho$  gives

$$h_n(s) = \frac{1}{n!(s+a)} \tag{45}$$

Noting that  $h_n(s) = Y_n(s)$ , according to (24), and taking the inverse Laplace transform, gives

$$y_n(t) = \frac{e^{-at}}{n!} \tag{46}$$

Eq. (46) signifies a sequence of functions defined for discrete values of  $n=0, 1, 2, \dots$  so that

$$y_0(t) = e^{-at}; y_1(t) = e^{-at}; y_2(t) = \frac{e^{-at}}{2}; \dots \tag{47}$$

Eq. (47) gives the values for the interval corresponding to  $n$ . Thus,  $y_0(t)$  defines the value for the interval 0 to 1,  $y_1(t)$  defines the value for the interval 1 to 2,  $y_2(t)$  defines the value for the interval 2 to 3, and so on. The physical implications of such systems will not be discussed here except to say that phenomena exist which decay rapidly with time. Then, a system of pulses which also decay rapidly with time may be useful as a timing reference.

From the above example, we see that by using both the Laplace transform and the Laurent-Cauchy transform we are able to separate the two processes, one continuous and one discrete. The final answer is then found to be the product of the two separate solutions.

VI. DERIVATION OF PRODUCT AND SUM TRANSFORMS

Transform of Sum of Sequence Functions

In certain physical applications it is required to sum a set of  $n$ -sequence functions as shown in Fig. 4. A

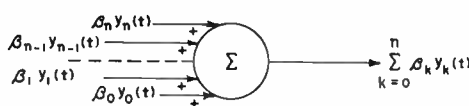

Fig. 4—Summation of time sequence functions.

knowledge of the transform of the sum is therefore necessary. Such a sum appears in (23) and its transform is given in (31) and (32). We now show details of obtaining this transform. By definition, as given in (15),

$$\mathcal{L}_c \left[ \sum_{k=0}^n \beta_k h_k(s) \right] = \sum_{n=0}^{\infty} \sum_{k=0}^n \beta_k h_k(s) \rho^{-n} \tag{48}$$

The right-hand member of (48) may be written as

$$\sum_{k=0}^{\infty} \sum_{n=k}^{\infty} \beta_k h_k(s) \rho^{-n}$$

by interchanging the order of summation. Thus (48) becomes

$$\mathcal{L}_c \left[ \sum_{k=0}^n \beta_k h_k(s) \right] = \sum_{k=0}^{\infty} \beta_k h_k(s) \sum_{n=k}^{\infty} \rho^{-n} \tag{49}$$

Now

$$\sum_{n=k}^{\infty} \rho^{-n} = \frac{\rho^{-k}}{1 - \rho^{-1}} = \frac{\rho}{\rho - 1} \rho^{-k} \tag{50}$$

Substituting (50) into (49) gives

$$\mathcal{L}_c \left[ \sum_{k=0}^n \beta_k h_k(s) \right] = \frac{\rho}{\rho - 1} \sum_{k=0}^{\infty} \beta_k h_k(s) \rho^{-k} \tag{51}$$

$$= \frac{\rho}{\rho - 1} \mathcal{L}_c [\beta_k h_k(s)] \tag{51a}$$

The right-hand member of (51a) is reduced by use of

$$\beta_k = \frac{1}{2\pi j} \int_c B(\gamma) \gamma^{k-1} d\gamma \tag{52}$$

where  $\gamma$  is a complex variable like  $\rho$ . Thus

$$\mathcal{L}_c [\beta_k h_k(s)] = \sum_{k=0}^{\infty} \left[ \frac{1}{2\pi j} \int_c B(\gamma) \gamma^{k-1} d\gamma \right] h_k(s) \rho^{-k} \tag{53}$$

$$= \frac{1}{2\pi j} \int_c B(\gamma) \gamma^{-1} \left[ \sum_{k=0}^{\infty} h_k(s) \left( \frac{\rho}{\gamma} \right)^{-k} \right] d\gamma \tag{54}$$

But by definition, as given in (15), we have

$$H \left( \frac{\rho}{\gamma}, s \right) = \sum_{k=0}^{\infty} h_k(s) \left( \frac{\rho}{\gamma} \right)^{-k} \tag{55}$$

Substituting (55) into (54) and this result into (51a) gives

$$\mathcal{L}_c \left[ \sum_{k=0}^n \beta_k h_k(s) \right] = \frac{\rho}{\rho - 1} \frac{1}{2\pi j} \int_c B(\gamma) \gamma^{-1} H \left[ \frac{\rho}{\gamma}, s \right] d\gamma \tag{56}$$

Eq. (56) is the same as (31) and is the transform of a sum of sequence functions.

Special Case of the Sum of Sequence Functions

Consider a special case of (56), namely, when  $\beta_k = \beta$  for all values of  $k$  greater or equal to zero. Since  $\beta$  is a constant, we may remove  $\beta$  from under the summation sign. Therefore, we have

$$\mathcal{L}_c \left[ \beta \sum_{k=0}^n h_k(s) \right] = \frac{\rho\beta}{\rho - 1} \sum_{k=0}^{\infty} h_k(s) \rho^{-k} \tag{57}$$

Since

$$H(\rho, s) = \sum_{k=0}^n h_k(s) \rho^{-k} \tag{58}$$



substitution of (58) into (57) gives

$$\mathcal{L}_c \left[ \beta \sum_{k=0}^{\infty} h_k(s) \right] = \frac{\rho\beta}{\rho - 1} H(\rho, s). \quad (59)$$

A number of other transforms appear in Table I on pages 930 and 931. In the table, the variable  $t$  is often understood and does not appear explicitly.

VII. SUMMATION THEOREMS

The Laurent-Cauchy transform is very useful in summing certain series, examples of which are

$$\sum_{n=0}^{\infty} f_n, \quad (60)$$

$$\sum_{n=0}^{\infty} f_n y_n, \quad (61)$$

$$\sum_{n=0}^k f_n, \quad (62)$$

etc.

The problem of summing such series in a general way has been the subject of works of many prominent mathematicians.<sup>8</sup> We shall show how the following theorems are obtained.

First Summation Theorem

Given a discrete function  $f_n$  whose Laurent-Cauchy transform  $F(\rho)$  is known. Then

$$\sum_{n=0}^{\infty} f_n = \frac{1}{2\pi j} \int_c \frac{F(\rho)}{\rho(1 - \rho)} d\rho. \quad (63)$$

Proof: Since

$$f_n = \frac{1}{2\pi j} \int_c F(\rho) \rho^{n-1} d\rho \quad (64)$$

then as

$$\sum_{n=0}^{\infty} f_n = \frac{1}{2\pi j} \int_c F(\rho) \sum_{n=0}^{\infty} \rho^{n-1} d\rho \quad (65)$$

utilizing the summation formula

$$\sum_{n=0}^{\infty} \rho^{n-1} = \rho^{-1} \frac{1}{1 - \rho}; \quad |\rho| < 1 \quad (66)$$

we obtain (63).

Second Summation Theorem

Given a discrete function  $f_n$  whose  $\mathcal{L}_c$ -transform is  $F(\rho)$ . Then

$$\sum_{n=0}^k f_n = \frac{1}{2\pi j} \int_c \frac{F(\rho)(1 - \rho^{k+1})}{\rho(1 - \rho)} d\rho. \quad (67)$$

The proof follows a pattern similar to the previous theorem.

Third Summation Theorem

Given two  $\mathcal{L}_c$ -transformable discrete functions  $f_n$  and  $y_n$  with  $\mathcal{L}_c$ -transforms  $F(\rho)$  and  $Y(\rho)$ , then

$$\sum_{n=0}^{\infty} f_n y_n = \frac{1}{2\pi j} \int_c \rho^{-1} F(\rho^{-1}) Y(\rho) d\rho. \quad (68)$$

Proof: Let

$$y_n = \frac{1}{2\pi j} \int_{C_1} Y(\rho) \rho^{n-1} d\rho \quad (69)$$

and  $f_n$  is defined as before with a contour  $C_2$ . Let  $C = C_1 + C_2$ , then

$$y_n f_n = \frac{1}{2\pi j} \int_c Y(\rho) \rho^{n-1} f_n d\rho. \quad (70)$$

Summing both sides of (70) yields

$$\sum_{n=0}^{\infty} y_n f_n = \frac{1}{2\pi j} \int_c Y(\rho) \sum_{n=0}^{\infty} \rho^{n-1} f_n d\rho; \quad (71)$$

utilizing

$$\sum_{n=0}^{\infty} f_n \rho^n = F(\rho^{-1}) \quad (72)$$

we obtain the theorem given in (68).

Other Summation Theorems

We state here the results of two other summation theorems:

$$\sum_{n=0}^{\infty} y_{n+1} \Delta f_n = \frac{1}{2\pi j} \int_c Y(\rho) F(\rho^{-1}) \frac{1 - \rho}{\rho} d\rho \quad (73)$$

and

$$\sum_{n=0}^{\infty} y_n \Delta f_n = \frac{1}{2\pi j} \int_c Y(\rho) F(\rho^{-1}) \frac{1 - \rho}{\rho^2} d\rho \quad (74)$$

where

$$\Delta f_n = f_{n+1} - f_n. \quad (74a)$$

VIII. EXAMPLES

To illustrate some of the above theorems we shall consider the following examples.

Example 2—A Simple Sum: Given  $f_n = n$

$$f_n = n \quad (75)$$

$$F(\rho) = \frac{\rho}{(\rho - 1)^2} \quad (76)$$

<sup>8</sup> G. Boole, "A Treatise on the Calculus of Finite Differences," G. E. Stechert and Co., New York, N. Y.; 1860.

thus

$$\sum_{n=0}^k n = \frac{1}{2\pi j} \int_C \frac{\rho(1 - \rho^{k+1})}{(1 - \rho)^2(1 - \rho)\rho} d\rho. \tag{77}$$

Simplifying (77),

$$\sum_{n=0}^k n = \frac{1}{2!} \frac{d^2}{d\rho^2} [\rho^{k+1} - 1]_{\rho=1} \tag{78}$$

$$\sum_{n=0}^k n = \frac{k(k+1)}{2}. \tag{79}$$

This result checks the well-known result for this sum.

*Example 3—1. Simple Product Sum:* Consider

$$y_n = a^n \tag{80}$$

$$Y(\rho) = \frac{\rho}{\rho - a} \tag{81}$$

and

$$f_n = \frac{1}{n!} \tag{82}$$

$$F(\rho) = e^{1/\rho} \tag{83}$$

$$F\left(\frac{1}{\rho}\right) = e^\rho. \tag{84}$$

Then

$$\sum_{n=0}^{\infty} \frac{a^n}{n!} = \frac{1}{2\pi j} \int_C \rho^{-1} \frac{\rho}{\rho - a} e^\rho d\rho \tag{85}$$

$$= \frac{1}{2\pi j} \int_C \frac{e^\rho}{\rho - a} d\rho \tag{86}$$

$$= e^a. \tag{87}$$

Eq. (87) is known to be correct. The correspondence is evident upon expanding  $e^a$  by a Taylor series.

### IX. COMPARISON OF LAURENT-CAUCHY AND TAYLOR-CAUCHY TRANSFORMS

The Taylor-Cauchy transform is one member of a general class of transforms useful in the analysis of certain physical systems. It is useful in the analysis of nonlinear systems. The direct Taylor-Cauchy transform is defined by (1) and can be symbolically expressed as

$$\mathfrak{J}_c[H^{(k)}(\lambda)] = \bar{w}_{n,k}. \tag{88}$$

The inverse Taylor-Cauchy transform is defined by (2) and can be symbolically expressed as

$$\mathfrak{J}_c^{-1}[\bar{w}_{n,k}] = H^{(k)}(\lambda). \tag{89}$$

Thus, the direct Taylor-Cauchy transform is defined by Cauchy's integral, whereas its inverse is given in the form of a Taylor series, the summation of  $w_{n,k}\lambda^n$ .

The Laurent-Cauchy transform is another member of a general class of transforms. It is useful in the analysis of systems involving discrete processes, whereas the Taylor-Cauchy transform deals with continuous nonlinear processes. The direct Laurent-Cauchy transform is defined by (21), where the left-hand member represents symbolically the summation of  $h_n\rho^{-n}$ , which has the form of a Laurent series. On the other hand, the inverse transform defined by (22) takes the form of Cauchy's integral given in (14). Thus, not only are the two complex variables reciprocals of each other as defined in (3), the complex contour integral (1) defines the direct transform in the case of the Taylor-Cauchy transform, whereas the complex contour integral (14) defines the inverse transform in the case of the Laurent-Cauchy transform. In the Taylor-Cauchy transform method,  $H^{(k)}(\lambda)$ , the  $k$ th derivative of  $H(\lambda)$ , converges inside a circle. In the Laurent-Cauchy transform method,  $H(\rho)$  converges outside a circle of radius  $R$  defined in connection with (16) and (17). Although both the Laurent-Cauchy and Taylor-Cauchy transforms belong to a general class of transforms, each has a realm of usefulness in the analysis of physical systems.

### X. CONCLUSION AND DISCUSSION

This paper has presented some aspects of a discrete-to-continuous transform method for analyzing certain linear systems. Since the use of sequence functions reduces the labor in solving problems arising in the analysis of systems which are modulated in some manner, the Laurent-Cauchy transform is useful. In addition, if  $t$  is fixed, we can solve sum-difference equations and evaluate the sum of certain series which are  $\mathcal{L}_c$ -transformable. Further, if  $n$  is considered as a discrete time variable, we can solve equations representing retarded feedback control systems such as a difference frequency AFC.<sup>9</sup> In the latter connection, if  $n$  is replaced by  $nT$ , where  $T$  is a sampling time, and the discrete variable  $h_n$  is taken to mean  $h(nT)$ , we see that (12) and (13) reduce to the  $Z$ -transform.<sup>10-12</sup> If the input to a given discrete system is random, the Laurent-Cauchy transform can be used in the transform-ensemble method in determining the response of the system statistically.<sup>6</sup>

### XI. ACKNOWLEDGMENT

The authors wish to acknowledge the support extended them by the National Science Foundation in making these studies on nonlinear theory and related fields, and the encouragement of Dr. J. G. Brainerd. Thanks are also due to Dr. R. Weller and K. Lord of the Stromberg-Carlson Company.

<sup>9</sup> A. A. Wolf, "A Mathematical Theory of AFC," M. S. thesis, The Moore School of Electrical Engineering, University of Pennsylvania, Philadelphia; 1954.

<sup>10</sup> J. R. Ragazzini and L. A. Zadeh, "Analysis of sampled-data systems," *Trans. AIEE*, vol. 71, pt. 2, pp. 225-232; November, 1952.

<sup>11</sup> E. I. Jury, "Sample-Data Control Systems," John Wiley and Sons, Inc., New York, N. Y.; 1958.

<sup>12</sup> J. Tou, "Digital and Sampled-Data Control Systems," McGraw-Hill Book Co., Inc., New York, N. Y.; 1959.

TABLE I  
LAURENT-CAUCHY TRANSFORMS

1) Operational Forms		2) Functional Forms	
$h_n$	$H(\rho)$	$h$	$H(\rho)$
$C_1 h_n \pm C_2 g_n$	$C_1 H(\rho) \pm C_2 G(\rho)$	$e^{-an}$	$\frac{1}{1 - e^{-a}\rho^{-1}}$
$\Delta h_n = h_{n+1} - h_n$	$(\rho - 1)H(\rho)$	$1 - e^{-an}$	$\frac{\rho^{-1}(1 - e^{-a})}{(1 - \rho^{-1})(1 - e^{-a}\rho^{-1})}$
$\Delta^2 h_n = h_{n+2} - 2h_{n+1} + h_n$	$(\rho - 1)^2 H(\rho)$	$\sin an$	$\frac{\rho \sin a}{\rho^2 - 2\rho \cos a + 1}$
$\Delta^k h_n$	$(\rho - 1)^k H(\rho)$	$\frac{1}{n!}$	$e^{1/\rho}$
$u_n = \begin{cases} 1; & \text{for } n \geq 0 \\ 0; & \text{otherwise} \end{cases}$	$\frac{\rho}{\rho - 1}$	$\cos an$	$\frac{1 - \rho^{-1} \cos a}{1 - (2 \cos a)\rho^{-1} + \rho^{-2}}$
$\delta_n = \begin{cases} 1; & n = 0 \\ 0; & n \neq 0 \end{cases}$	1	$a^{bn}$	$\frac{\rho}{\rho - ab}$
$\delta_{n-k}$	$\rho^{-k}$	$a h_n$	$a H(\rho)$
$n$	$\frac{\rho}{(\rho - 1)^2}$	$h_{n\tau}$	$H(\rho^{-\tau})$
$n^2$	$\frac{\rho(\rho + 1)}{(\rho - 1)^3}$	$\sum_{r=0}^k a_r \rho_r^{n-1}$	$\frac{(\rho - q_0) \cdots (\rho - q_m)}{(\rho - \rho_0) \cdots (\rho - \rho_k)}$
$n^3$	$\frac{\rho(\rho^2 + 4\rho + 1)}{(\rho - 1)^4}$	where:	
$n^k$	$(-1)^k D^k \left( \frac{\rho}{\rho - 1} \right); D = \rho \frac{d}{d\rho}$	$a_r$ are the residues of the transform	
$a^{-n} h_n; a > 0$	$H(a\rho)$	$-\frac{1}{n}$	$(\rho - 1) + \log(\rho - 1)$
$a^n h_n$	$H\left(\frac{\rho}{a}\right)$	$e$	$\frac{e^\rho}{\rho - 1}$
$h_{n+k}$	$\rho^k H(\rho) - \sum_{r=0}^k h_r \rho^{k-r}$	$e^{a^n}$	$\frac{e^\rho}{\rho - a}$
$h_{n-k}$	$\rho^{-k} H(\rho)$	$a^n \sin a$	$\frac{\sin \rho}{\rho - a}$
$e^{an} h_n$	$H(e^{-a}\rho)$	$a^n \sin a (1 - (-1)^n)$	$\frac{\sin \rho}{\rho^2 - a^2}$
$\sum_{k=0}^n h_k g_{n-k} = \sum_{k=0}^n g_k h_{n-k}$	$H(\rho)G(\rho)$	$(\sin a)^{n-1}$	$\frac{1}{\rho - \sin a}$
$\sum_{k=0}^n h_k g_{n-k}$	$-H'(\rho)G(\rho)$	$(\sin a)^n$	$\frac{\rho}{\rho - \sin a}$
$\sum_{k=0}^n k^n h_k g_{n-k}$	$(-1)^n H^{(n)}(\rho)G(\rho)$	$(\cos a)^{n-1}$	$\frac{1}{\rho - \cos a}$
$\sum_{k=0}^n g_k g_{n-k}$	$G^2(\rho)$	$(\cos a)^n$	$\frac{\rho}{\rho - \cos a}$
$h_{n+k} = h_n$	$\frac{\sum_{r=0}^k h_r \rho^{k-r}}{\rho^k - 1} = \frac{\sum_{r=0}^k h_r \rho^{-r}}{1 - \rho^{-k}}$	$a^n \log a$	$\frac{\rho \log \rho}{\rho - a}$
$h_{n+k} = -h_n$	$\frac{\sum_{r=0}^k h_r \rho^{-r}}{1 + \rho^{-k}}$	$-n^3 h_n$	$\frac{\rho^3 H'''(\rho) + 3\rho^2 H''(\rho)}{\rho^2 - 2e^{-a}\rho \cos a + 1}$
$-n h_n$	$\rho H'(\rho)$	$e^{-an} \sin an$	$\frac{\rho e^{-a} \sin a}{\rho^2 - 2e^{-a}\rho \cos a + 1}$
$n(n-1)h_{n-1}$	$\rho H''(\rho)$	$\frac{e^{-an} - e^{-bn}}{e^{-a} - e^{-b}}$	$\frac{\rho}{(\rho - e^{-a})(\rho - e^{-b})}$
$-n(n-1)(n-2)h_{n-2}$	$\rho H'''(\rho)$	$\frac{(-1)^{m-1}}{(m-1)!} \frac{\partial^{m-1}}{\partial a^{m-1}} (e^{-an})$	$\frac{(-1)^{m-1}}{(m-1)!} \frac{\partial^{m-1}}{\partial a^{m-1}} \frac{\rho}{(\rho - e^{-a})}$
$(-1)^k n(n-1) \cdots (n-k+1)h_{n-k+1}$	$\rho H^{(k)}(\rho)$	$n^{[k]} h_n$	$(-1)^k \rho^k \frac{d^k}{d\rho^k} [H(\rho)]$
$h_{n+1}$	$\rho H(\rho) - h_0 \rho$	where:	
$n^2 h_n$	$\rho^2 H''(\rho) + \rho H'(\rho)$	$n^{[k]} \equiv n(n-1) \cdots (n-k)$	
$\sum_{k=0}^n h_k h_{n-k}$	$\frac{\rho H(\rho)}{\rho - 1}$	$\frac{(n+k)!}{(n-1)!} h_{n+k}$	$(-1)^k \rho^{2k} \frac{d^k}{d\rho^k} [H(\rho)]$
$\sum_{k=0}^n k^2 g_k h_{n-k}$	$G''(\rho)G(\rho)$	$a^{n-1} \log a$	$\frac{\log \rho}{\rho - a}$
$\sum_{k=0}^n k g_k g_{n-k}$	$-G'(\rho)G(\rho)$		
$-(n-1)h_{n-1}$	$H'(\rho)$		
$(n-1)(n-2)h_{n-2}$	$H''(\rho)$		
$-(n-1)(n-2)(n-3)h_{n-3}$	$H'''(\rho)$		
$(-1)^k (n-1) \cdots (n-k)h_{n-k}$	$H^{(k)}(\rho)$		



TABLE I (Continued)

2) Functional Forms (Continued)		3) Theorems
$h_n$	$H(\rho)$	
$\frac{(n-1)(n-2) \cdots (n-k-1)}{(k-1)!} a^{n-k-1}$	$\frac{1}{(\rho-a)^k}$	a) Initial value theorem $\lim_{n \rightarrow \infty} h_n = \lim_{\rho \rightarrow \infty} H(\rho).$
$\frac{a^n}{a(a-b)} + \frac{b^n}{(b-a)b}$	$\frac{1}{(\rho-a)(\rho-b)}$	b) Final value theorem $\lim_{n \rightarrow \infty} h_n = \lim_{\rho \rightarrow -1} (\rho-1)H(\rho).$
$\frac{a^n}{a-b} + \frac{b^n}{b-a}$	$\frac{\rho}{(\rho-a)(\rho-b)}$	c) Unit value theorem Case I: $H(\rho)$ has no poles in the contour $C$ $\sum_{n=0}^{\infty} h_n = \lim_{\rho \rightarrow 1} H(\rho).$
$\frac{a^n}{2a^2} + \frac{(-a)^n}{2a^2}$	$\frac{1}{\rho^2 - a^2}$	Case II: $H(\rho)$ has poles inside the contour $C$ $\sum_{n=0}^{\infty} h_n = \frac{1}{2\pi j} \int_C \frac{H(\rho)}{\rho-1} d\rho.$
$\frac{a^n}{2a} + \frac{(-a)^n}{2a}$	$\frac{\rho}{\rho^2 - a^2}$	d) Summation Theorems
$(n+1)h_{n+1}$	$-\rho^2 H'(\rho)$	$\sum_{n=0}^{\infty} f_n = \frac{1}{2\pi j} \int_C \frac{F(\rho)}{\rho(1-\rho)} d\rho$
$n(n+1)h_n$	$\rho^2 H''(\rho)$	$\sum_{n=0}^k f_n = \frac{1}{2\pi j} \int_C \frac{F(\rho)(1-\rho^{k+1})}{\rho(1-\rho)} d\rho$
$nh_{n+1}$	$-\rho H'(\rho) - H(\rho) - h_0$	$\sum_{n=0}^{\infty} y_n h_n = \frac{1}{2\pi j} \int_C \rho^{-1} Y(\rho) H(\rho^{-1}) d\rho$
$\frac{h_{n+2}}{n+1}$	$h_0 \rho^2 + h_1 \rho \log \rho - \rho \int H(\rho) d\rho$	$\sum_{n=0}^{\infty} y_n^2 = \frac{1}{2\pi j} \int_C \rho^{-1} Y(\rho) Y(\rho^{-1}) d\rho.$
$\frac{h_{n+2}}{n+1}; \begin{cases} h_0 = 0 \\ h_1 = 0 \end{cases}$	$-\rho \int H(\rho) d\rho$	
$\frac{1}{(n+1)!}$	$\rho e^{1/\rho}$	

## CORRECTION

J. J. Bussgang, P. Nesbeda, and H. Safran, authors of "A Unified Analysis of Range Performance of CW, Pulse and Pulse Doppler Radar," which appeared on pages 1753-1762 of the October, 1959, issue of PROCEEDINGS, have requested that the following corrections, resulting from an inquiry by M. Skolnik, be made to their paper.

In Case 3, on page 1756, a pulse Doppler radar was compared with a pulse radar of the same average power, antenna gain and noise figure. It was found incorrectly that the former type of radar had a detection range 80 per cent greater than the latter. The error which occurred was due to the fact that the conditions of this Case were not consistent with the earlier text.

Specifically, in the second column on page 1757, the last sentence before the subheading states: "For the pulse radar,  $N$  is the actual number of pulses." This is consistent with the earlier statement on page 1756, immediately following (6): "In (6)  $B_{IF}$  is assumed to match the pulse width"; i.e.,  $B_{IF}\tau = 1$ .

However, our Case 3 is not consistent with this assumption, namely,

$$B_{IF}\tau = (5 \times 10^6)(2 \times 10^{-6}) = 10.$$

Thus each pulse is constituted of 10 independent samples and we should have taken

$$N = (\text{number of pulses}) \times (B_{IF}\tau),$$

or, for Case 3,

$$N = 10 \times 10 = 100, \text{ with } N = 100;$$

in Fig. 5, we now read

$$(R/R_0)_p = 1.14. \tag{35'}$$

Hence the over-all result should have been

$$\begin{aligned} (R)_d/(R)_p &= \frac{(R/R_0)_d}{[(R/R_0)_p] \cdot [(R_0)_p/(R_0)_d]} \\ &= \frac{0.76}{1.14 \times 0.55} = 1.21 \end{aligned}$$

rather than  $(R)_d/(R)_p = 1.8$ .

Thus in this particular Case, the pulse Doppler radar has 21 per cent more detection range.

Apart from noting this error, the authors wish to emphasize that it was not their intent to claim in this example that the pulse Doppler radar is superior in performance to the pulse radar under all circumstances. The purpose of the example was to demonstrate a method of comparison. Were a different set of parameters selected, the conclusions may well have been reversed. In particular, in this example the IF bandwidth was much wider than would be normally required and was quite unfavorable to a pulse radar.

# Correspondence

## Radio Frequency Scattering from the Surface of the Moon\*

Several investigations of the lunar surface, using pulses which are short compared to lunar dimensions, have identified the marked "high-light" returned by quasispecular reflection from the central region of the lunar face.<sup>1-3</sup> Our observations, using a high-power, 400-mc radar show that the moon behaves not only as a smooth reflector but also as a diffuse scatterer. It is the purpose of this communication to show that weak, transient echoes are present from the entire lunar surface that is within view of the earth, provided that sufficient equipment sensitivity is employed.

Two radars, each equipped with a fully-steerable parabolic reflector, have been used in the course of these investigations and are described in Table I.

A typical intensity-modulated, range vs time display of the echoes observed with the more sensitive radar in Scotland is shown in Fig. 1. Transient echoes are detectable out to ranges corresponding to the limbs of the moon. The echoes appear to change range rapidly, a phenomenon which is presumably explainable by interference between energy packets arriving from the moon at the same time but having different Doppler shifts. A better indication of the manner in which received power falls off with distance is shown by the 15-second superposition of A-scope pulses shown in Fig. 2. A strong echo from the first 400 kilometers is the most prominent feature, followed by a linear decrease of echo energy<sup>6</sup> with range.

If each element of the lunar surface is assumed to scatter energy isotropically, *i.e.*,  $P(\phi) = 1$ , where  $P(\phi)$  = polar diagram of elementary scatterer and  $\phi$  = angle with respect to the direction of specularly-reflected energy, then simple considerations show that the echo power as a function of range should decrease linearly as follows:

$$P_r \propto R \left( 1 - \frac{x}{R} \right) dx$$

\* Received by the IRE, January 22, 1960. This work was supported by Rome Air Dev. Ctr. under Contract AF 30(602)-1871.

<sup>1</sup> B. S. Yaplee, R. H. Bruton, K. J. Craig, and N. G. Roman, "Radar echoes from the moon at a wavelength of 10 cm," *Proc. IRE*, vol. 46, pp. 293-297; January, 1958.

<sup>2</sup> J. H. Trexler, "Lunar radio echoes," *Proc. IRE*, vol. 46, pp. 286-292; January, 1958.

<sup>3</sup> T. B. A. Senior and K. M. Siegel, "Radar reflection characteristics of the moon," in *Paris Symposium on Radio Astronomy*, R. N. Bracewell, ed., Stanford University Press, Stanford, Calif., pp. 29-46; 1959.

<sup>4</sup> J. S. Hey and V. A. Hughes, "Radar observations of the moon at 10-cm wavelength," in *Paris Symposium on Radio Astronomy*, R. N. Bracewell, ed., Stanford University Press, Stanford, Calif., pp. 13-18; 1959.

<sup>5</sup> A. W. Straiton, and C. W. Tolbert, "Bistatic Moon Reflection Measurements between Malvern, England and Austin, Texas at 3 KMCS," *Electrical Engrg. Res. Lab., University of Texas, Austin, Rept. No. 5-38*; November 30, 1959.

<sup>6</sup> The receiver output amplitude shown in Fig. 2 was originally taken to be proportional to input power. Actually, the output is proportional neither to input power nor voltage but to some function between these limits.

TABLE I  
RADAR PARAMETERS

	College, Alaska	Fraserburgh, Scotland
Antenna diameter	60 feet	142 feet
Antenna gain	36 db	43 db
Transmitter peak power	50 kw	130 kw
Frequency	398 mc	401 mc
Pulse length	1000 micro-seconds	300 microseconds
PRF	30 cps	30 cps
Receiver bandwidth	1 kc	6 kc
Polarization transmitted	Linear horizontal	Linear vertical
Received	Horizontal and vertical	Vertical

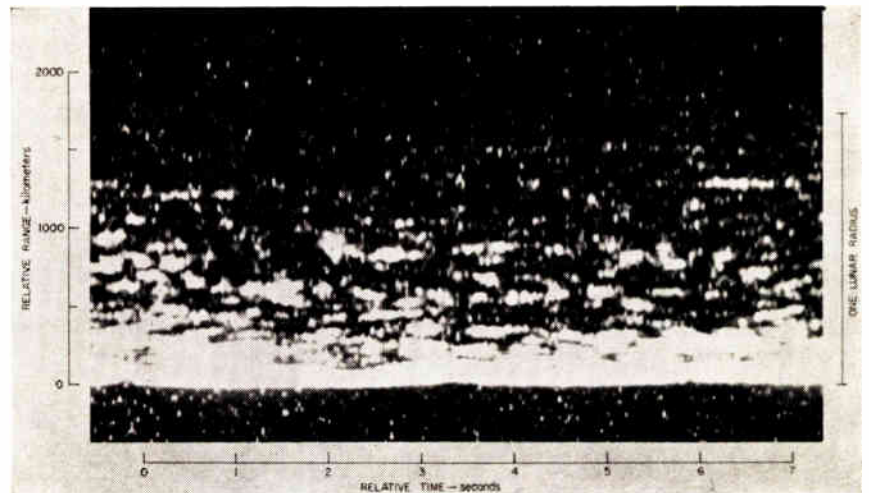

Fig. 1—Intensity-modulated range vs time display of typical lunar echoes observed with Scotland radar. (0550 GMT, December 24, 1959.)

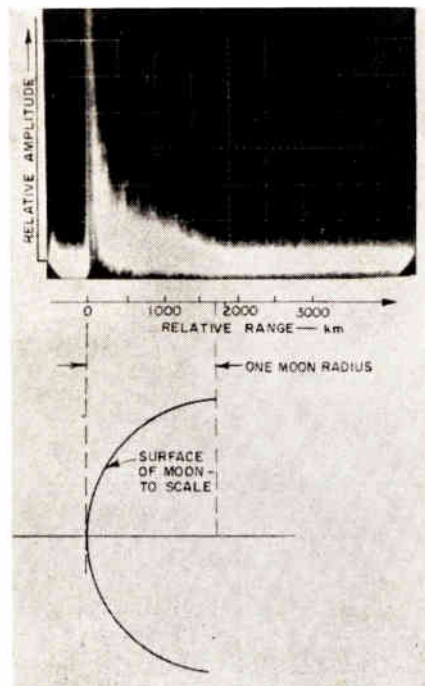

Fig. 2—Amplitude vs range display of lunar echoes with 15 seconds of integration at a pulse repetition frequency of 30 cps.

where

- $P_r$  = power reflected,
- $R$  = radius of the moon,
- $x$  = range measured from front face of the moon,
- $dx$  = increment of range.

However, if each element of the lunar surface is assumed to reflect according to a law

$$P(\phi) \propto \left( \frac{\sin \phi}{\phi} \right)^n,$$

then a fit to the initial sharp leading echo might be obtained by selecting an appropriate value for the unknown exponent  $n$ .

The echo shown in Fig. 2 shows evidence of both components being present. The two can be separated by fitting a straight line to the tail of the echo and considering the main leading edge to be superimposed on this linear variation. The results of this procedure yield an empirical scattering law of the following form,

$$P(\phi) \propto \left( \frac{\sin \phi}{\phi} \right)^{20 \pm 6} + \frac{1}{10}$$

where  $-\pi < \phi < \pi$ .

The discovery of this residual echo can be directly attributed to the use of an unusually sensitive radar. In earlier short-pulse experiments, this component was generally

immersed in the receiver noise. Its presence is sufficient to explain the observed 20-db discrepancy<sup>2</sup> between the lunar equivalent cross-section values derived by short-pulse, and by continuous wave techniques. In the latter case, the weak component, because of its long time duration, is remarkably effective in contributing to the total echo energy.

The use of short pulses allows the moon to be divided into range increments which appear to the observer as a family of concentric rings (see Fig. 3). On the other hand, a property of a rotating sphere is that loci of constant Doppler shift appear to the observer as linear strips, each parallel to the instantaneous axis of rotation<sup>7</sup> (which can be calculated for the moon). By simultaneously recording both range and Doppler shift (on the order of a few cps at 400 mc), the lunar surface might be mapped with the present equipment without resorting to further resolution in angle.

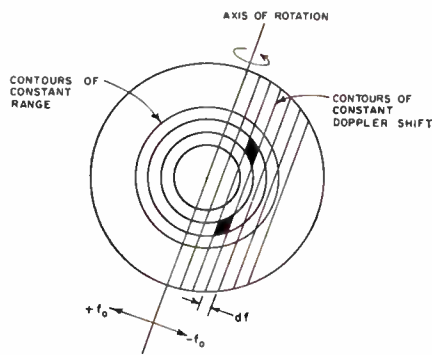

Fig. 3—Sketch illustrating a scheme for mapping the moon by utilizing range increments and Doppler shift increments. The uncertainty indicated by the blacked areas can be solved by observing the moon at a time when the instantaneous axis of rotation is aligned in a different direction.

R. L. LEADABRAND  
R. B. DYCE  
A. FREDRIKSEN  
R. I. PRESNELL  
J. C. SCHLOBOHM  
Stanford Res. Inst.  
Menlo Park, Calif.

<sup>7</sup> R. Manasse, "The Use of Radar Interferometer Measurements to Study Planets," M.I.T. Lincoln Lab., Cambridge, Mass., Special Rept. 312-23; March 18, 1959.

### Measurements of Lunar Reflectivity Using the Millstone Radar\*

A new method<sup>1</sup> for mapping the source of radar echoes from distant rotating targets has been applied to lunar echoes obtained by the Millstone Radar of Massa-

\* Received by the IRE, February 8, 1960. The work reported in this paper was performed by M.I.T. Lincoln Lab., Lexington, Mass., with the joint support of the U. S. Army, Navy and Air Force.  
<sup>1</sup> P. Green, "Detection Techniques for Interplanetary Radar Observations," presented at URSI, San Diego, Calif., October, 1959. Also available as M.I.T. Lincoln Lab. Group Rept., Lexington, Mass., No. 34-84; January, 1960.

achusetts Institute of Technology's Lincoln Laboratory. In this method, an accurate spectral analysis of power density is carried out for each of many range intervals encompassing the extent of the returned signal in frequency and time. For a given apparent target rotation or libration with respect to the radar line of sight there is a proportional relation between the differential frequency displacement of the return and its location along an angular coordinate perpendicular to the instantaneous axis of libration.<sup>2,3</sup> A simultaneous determination of the range will thus fix the return as lying at the intersection of the appropriate range and frequency contour. In the case of a spherical body like the moon, the contours will take the form shown in Fig. 1. Viewed from the side, these contours form a simple rectangular grid bounded by the spherical surface of the moon. The presence of a two-fold ambiguity in the mapping of such data back to the lunar surface should be noted.

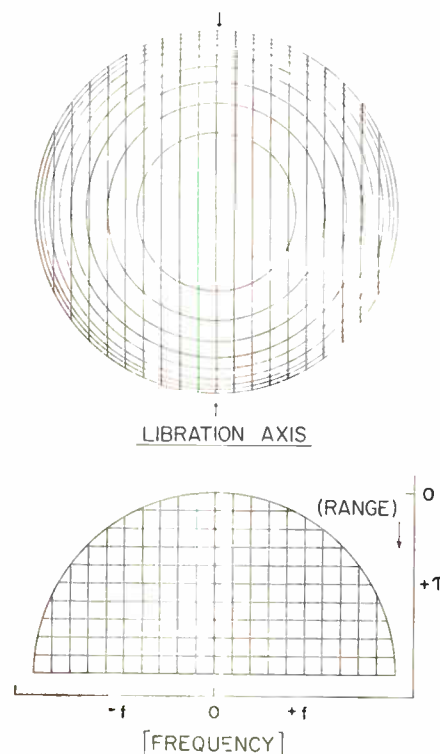

Fig. 1—Range-frequency contours for the moon as viewed from the earth. The Doppler shift arising from motion of the lunar center of mass has been removed.

By the use of a coherent train of short pulses, where the interpulse interval is chosen to be greater than the radar depth of lunar echoes, 11.6 msec, highly accurate frequency data have been obtained at no sacrifice in range resolution. Synthesis of all frequencies used in both transmitter and receiver from a common ultra-stable 1-mc/sec crystal oscillator ensured a maximum of stability. Measurements carried out at a time of exceptionally low lunar libration

showed an over-all frequency stability of better than 5 parts in 10<sup>11</sup> over the echo time of approximately 2.5 seconds. Digital recording of the returned signal waveform, in both amplitude and phase, allowed analysis at a later time with no loss in accuracy.

Fig. 2 shows a typical set of results obtained using the radar parameters listed in Table I. The format employed may be compared directly with Fig. 1. Each horizontal line displays in compressed form a Fourier analysis of the power density at a given range where the factor necessary to reduce the scale to a common maximum value is shown at the left. A scale factor threshold has been used to suppress noise on those traces devoid of echoes. Receiver and sky noise yields an average power of some 1 or 2 units on the scale shown, or some 50 db below the peak returned signal density. Range increments are in multiples of 500  $\mu$ sec. The frequency resolution which results from the 9-second pulse train used is approximately 0.1 cps, yielding more than 100 elements transverse to the axis at times of maximum libration.

The qualitative features which are immediately obvious are: the presence of substantial echoes out to the limbs, the sharp bounds to the spectra set by the geometrical constraints of the moon's surface, and the concentration of signal near the upper and lower frequency limits at the longer delay. The latter effect is geometrical and results from the tangential intersection of range and frequency contours in those areas. Each run is processed and displayed automatically by the CG 24 digital computer located at the radar site. Since absolute frequency is preserved in the processing, an interesting byproduct of the experiment is the ability to determine the radial component of the lunar motion with a high degree of accuracy. During periods of low libration it appears possible to achieve a precision of approximately 0.02 cps or 2 parts in 10<sup>6</sup> of the observed Doppler frequency. A measurement of this accuracy may have application to geodesy and astronomy.<sup>4</sup>

The instantaneous axis of libration as viewed from moderate latitudes moves through an angle with respect to the selenographic polar axis which may be quite substantial over the course of a day. Therefore, it should be possible to resolve the remaining hemispheric ambiguity in the source of an echo at least for those cases where one hemisphere dominates. Three runs, spaced apart several minutes in time, have been made to study this effect. Preliminary analysis shows relatively little detailed correlation among the three. It is obvious that much patient work lies ahead before detailed correlation with optical photographs may be attempted. Perhaps of more immediate interest is the ability to select returns from areas of the lunar surface which appear to be optically uniform, and from these to build up a scattering law for unperturbed regions which may yield more precise information on the smoothness of the lunar "seas."

<sup>2</sup> F. J. Kerr and C. A. Shain, "Moon echoes and transmission through the ionosphere," Proc. IRE, vol. 39, pp. 230-242; March, 1951.  
<sup>3</sup> R. Manasse, "The Use of Radar Interferometer Measurements to Study Planets," M.I.T. Lincoln Lab. Group Rept., Lexington, Mass., No. 312-23; March, 1959.

<sup>4</sup> A. B. Thomas, "Certain physical constants and their relation to the Doppler shift in radio echoes from the moon," *Australian J. Science*, vol. 11, pp. 187-191; June, 1949.





TABLE I  
SUMMARY OF EQUIPMENT PARAMETERS

	Radar	Bus	Truck
Transmitter power	50 kw, peak	—	—
Antenna	60-foot diameter parabolic dish	Square array of 16 four-element Yagis	Square array of 16 four-element Yagis
Antenna beamwidth	12°	15°	15°
Received polarization	Horizontal and vertical	Vertical	Vertical
Receiver bandwidth	Approx. 200 cps	Approx. 200 cps	Approx. 200 cps
Location (first test) (second test)	37.4°N, 122.2°W same as above	5.7 km, west 1.8 km, north	2.9 km, north same as above

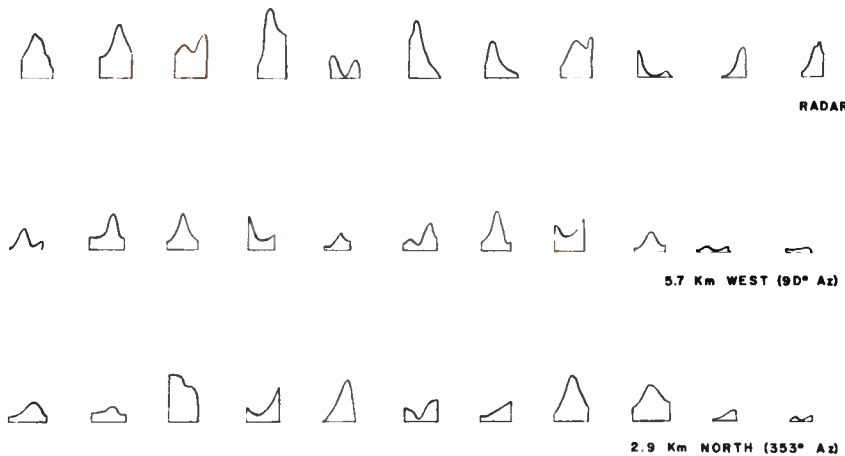

Fig. 1—Echoes from the moon on 106.1 mc, showing uncorrelated fluctuations at separated receivers, on January 11, 1958, at 0500-0501 PST, when the moon was near upper culmination. (Azimuth, 177°; elevation, 47°.)

absolute range,<sup>6</sup> and pulse broadening,<sup>7-9</sup> have been described by previous authors. This communication describes an attempt to measure the size of the patches of energy reflected onto the earth's surface and their possible velocities of motion along the earth's surface.

The moon, located in the broad beam of the transmitter, can be regarded as an irregularly-illuminated aperture having an irregular phase distribution. Thus, the moon may behave as an antenna having a complicated radiation pattern but having a narrowest lobe size given by the effective "width" of the lunar aperture. Thus, the minimum size of each of these patches is dependent upon the maximum subtended angle of the effective reflecting portion of the lunar surface.

In conjunction with the 106.1-mc radar employed by Stanford Research Institute for lunar echo studies, two partially mobile antennas, receivers, and recorders were assembled for use as remote receiving stations. (See Table I.) The antennas were directed at the moon approximately every 15 minutes using precomputed values of azimuth and

elevation. Each of the three sites was equipped with a frequency-converter, Collins 51J4 receiver (bandwidth of approximately 200 cps) and a pen-chart (Brush) recorder capable of following the fastest variations of the libration-caused lunar echo fading. The transmitter was turned on (CW) for about 2.4 seconds and repeated every 5.1 seconds. With this timing, the echo from the moon began to return shortly after the transmitter pulse had ended, giving a useful received signal 40 per cent of the total period.

Typical results from the first test are shown in Fig. 1. Correlation between these traces is less than 0.02. In April, 1958, the bus was moved to a convenient location approximately bisecting the line between the truck and the radar. Again, the results were largely uncorrelated. For the closest spacing used (1.15 kilometers north-south or 0.8 km projected) and after compensating for gain changes during the runs, the best correlation that could be achieved was 0.26. A search was made for similar amplitude fluctuation patterns shifted in time, in hopes of establishing a westward drift because of the earth's eastward motion. No pattern drift was found, possibly because the transmitter is not fixed with respect to the moon.

This result implies that much, if not all, of the lunar surface is effective in echoing a man-made signal. More definitive results would result, of course, using short-pulse experiments. For communication via the moon, this result implies that a diversity distance of about one kilometer projected at right angles to the radio ray is certainly sufficient spacing to achieve diversity reception.

The research was made possible through the initiative of R. L. Leadabrand and through the willing efforts and long hours of more than a dozen assistants within the laboratory.

R. B. DYCE  
Communication and Propagation Lab.  
Stanford Research Institute  
Menlo Park, Calif.  
R. A. HILL  
Physics Dept.  
Michigan State University  
East Lansing, Mich.  
Summer employee of  
Stanford Research Institute  
Menlo Park, Calif.

### Noise Figure of Tunnel Diode Mixer\*

An analysis has been made of the noise figure of a tunnel diode used as a mixer. The assumptions made were 1) the diode sees a short circuit at the image frequency, 2) the only source of noise in the diode is the shot noise associated with the tunnel current, 3) the series resistance of the diode and the losses of the input and output tuned circuits are negligible, and 4) the diode capacitance is constant. Because of the second assumption, consideration is limited to that portion of the i-v characteristic of the diode extending from reverse voltages up to, or somewhat beyond, the point of maximum negative conductance. In particular, the valley of the i-v characteristic is excluded from consideration because considerable excess 1/f-type noise<sup>1</sup> has been observed in this region and this type of noise is not taken into account in the analysis.

Since the conductance of a tunnel diode can assume negative values, the possibility of a conversion gain greater than unity may be anticipated. The midband conversion power gain of a nonlinear resistance type of diode, defined as the ratio of IF output power to the power available from the RF source is

$$G = \frac{4r_1r_2g_1^2}{[(1 + g_0r_1)(1 + g_0r_2) - g_1^2r_1r_2]^2} \quad (1)$$

In (1),  $r_1$  and  $r_2$  are the resistances seen by the diode at RF and IF, respectively,  $g_0$  is the average conductance of the diode over the local oscillator cycle, and  $g_1$  is the conversion conductance of the diode. The values of  $g_0$  and  $g_1$  are obtained from the Fourier series representation of the instantaneous incremental conductance  $g$  of the diode considered as a function of the local oscillator phase  $\theta$ . Thus

$$g(\theta) = g_0 + 2g_1 \cos \theta + 2g_2 \cos 2\theta + \dots \quad (2)$$

If  $g(\theta)$  is restricted to non-negative values then  $0 \leq |g_1| \leq g_0$  and the maximum possible value of  $G$  for positive  $r_1$  and  $r_2$  is unity.

\* Received by the IRE, January 22, 1960.

<sup>1</sup> T. Yajima and L. Esaki, "Excess noise in narrow germanium p-n junctions," *J. Phys. Soc. Japan*, vol. 13, pp. 1281-1287; November, 1958.

<sup>6</sup> B. S. Yapple, R. H. Bruton, K. J. Craig, and N. G. Roman, "Radar echoes from the moon at a wavelength of 10 cm," *Proc. IRE*, vol. 46, pp. 293-297; January, 1958.

<sup>7</sup> J. H. Trexler, "Lunar radio echoes," *Proc. IRE*, vol. 46, pp. 286-292; January, 1958.

<sup>8</sup> J. S. Hey and V. A. Hughes, "Radar observations of the moon at 10-cm wavelength," in "Paris Symposium on Radio Astronomy," R. N. Bracewell, ed., Stanford University Press, Stanford, Calif.; 1959.

<sup>9</sup> R. L. Leadabrand, R. B. Dyce, A. Fredriksen, R. I. Presnell, and J. C. Schlobohm, "Radio frequency scattering from the surface of the moon," Pp. 932-933, this issue.

However, if  $g(\theta)$  is free to assume negative values, then  $g_0 < |g_1|$  is possible and the conversion gain cannot only exceed unity, but will become infinite for

$$r_2 = r_{2c} = \frac{1 + g_0 r_1}{g_1^2 r_1 - g_0(1 + g_0 r_1)} \quad (3)$$

It can be shown that for stable operation the quantities  $(1 + g_0 r_1)$  and  $(1 + g_0 r_2)$  must both be positive or both negative. Assuming that both are positive, the condition that  $r_{2c}$  be positive is that

$$\gamma = \frac{|g_1| r_1}{1 + g_0 r_1} > \frac{g_0}{|g_1|} = \alpha \quad (4)$$

For values of  $r_2$  slightly below  $r_{2c}$ , the mixer gain is similar to that of a negative resistance amplifier; i.e., the product of voltage gain and bandwidth is constant.

The noise figure of the tunnel diode mixer is

$$F = 1 + \frac{q(I_{of} + I_{or})}{2kT_1 |g_1|} \frac{1 + \gamma^2 \pm 2K\gamma}{\gamma(1 - \alpha\gamma)} + \frac{1}{\gamma(1 - \alpha\gamma)} \frac{1}{|g_1| r_2} \frac{T_2}{T_1} \quad (5)$$

$$\gamma_{opt} = \frac{\left\{ \alpha^2 \left(1 - \frac{\alpha}{M}\right)^2 + \left(1 - \frac{\alpha}{M}\right) \left[ 1 - \alpha \left(2K - \frac{1}{M}\right) \right] \right\}^{1/2} - \alpha \left(1 - \frac{\alpha}{M}\right)}{1 - \alpha \left(2K - \frac{1}{M}\right)} \quad (9)$$

In (5)

$$K = - \frac{I_{1f} + I_{1r}}{I_{0f} + I_{0r}}$$

$T_1$  and  $T_2$  are the temperatures of  $r_1$  and  $r_2$ , respectively,  $q$  is the electronic charge,  $k$  is Boltzmann's constant, and the  $\pm$  sign is to be taken as positive or negative according as  $g_1$  is positive or negative. The quantities  $I_{of}$  and  $I_{1f}$  denote the dc and fundamental components of the forward component of the tunnel current as defined by the Fourier series

$$i_f(\theta) = I_{of} + 2I_{1f} \cos \theta + 2I_{2f} \cos 2\theta + \dots \quad (6)$$

Similarly  $I_{or}$  and  $I_{1r}$  are the dc and fundamental components of the reverse component  $i_r$  of the tunnel current. The net tunnel current that is measurable is  $i = i_f - i_r$ . To separate  $i$  into  $i_j$  and  $i_s$ , the relations,

$$i_j = \frac{i}{1 - \exp(-q\varphi/kT)}$$

$$i_s = i_j \exp(-q\varphi/kT) \quad (7)$$

may be used. These relations can be derived from the theoretical expression for the tunnel current given in Esaki.<sup>2</sup> In (5) the first term represents thermal noise associated with the resistor  $r_1$ , the second term represents shot noise of the diode and the third term the thermal noise associated with  $r_2$ .

The derivation of (5) is similar to the derivation of the noise figure of a diode mixer

given in Strutt,<sup>3</sup> except that the mean square shot noise at any point in the local oscillator cycle is set equal to  $2q(i_s + i_r)\Delta f$  instead of  $4kT_s g \Delta f$  as in (5) of Strutt.<sup>3</sup>

According to (5) of this note, the larger  $r_2$  the better the noise figure of the mixer.

$$F = 1 + \frac{r_b' + \frac{r_c}{2}}{R_s} + \frac{(1 - \alpha_s) \left[ 1 + \left( \frac{f}{\sqrt{1 - \alpha_s f \alpha}} \right)^2 \right] (r_b' + r_c + R_s)^2}{2\alpha_s r_c R_s} \quad (1)$$

However, the mixer conversion gain is more critically dependent on  $r_2$  and high conversion gain is desirable to minimize the over-all noise figure of the system. In the absence of specific information concerning the noise figure of the IF amplifier, it appears reasonable to choose

$$r_2 \cong r_{2c} = \frac{1}{|g_1|(\gamma - \alpha)} \quad (8)$$

For this choice of  $r_2$ ,  $F$  has a minimum for  $\gamma = \gamma_{opt}$  where

### Effect of External Base and Emitter Resistors on Noise Figure\*

Neilsen<sup>1</sup> has shown that the noise figure of a transistor in the common-emitter configuration is

where  $R_s$  is the source resistance. The value of  $R_s$  for which  $F$  is minimum is

$$R_{s_{opt}} = \sqrt{\frac{2\alpha_s r_c \left( r_b' + \frac{r_c}{2} \right)}{(1 - \alpha_s) \left[ 1 + \left( \frac{f}{\sqrt{1 - \alpha_s f \alpha}} \right)^2 \right] + (r_b' + r_c)^2}} \quad (2)$$

These expressions neglect both excess  $(1/f)$  noise in the transistor and the noise contribution of any external elements such as bias resistors.

Middlebrook<sup>2</sup> has derived expressions for the noise figure and optimum source resistance of a common-emitter transistor amplifier containing external base and emitter resistors, but these expressions do not account for the effect of the transistor input resistance.

It is possible to derive expressions for the noise figure and optimum source resistance of an amplifier which neglect only excess noise in the transistor. Fig. 1 shows an ap-

and

$$M = \frac{q(I_{of} + I_{or})}{2kT_2 |g_1|} \quad (10)$$

The above results were used to calculate the noise figure as a mixer of a G.E. ZJ56 germanium tunnel diode. The calculation was made for various values of bias and local oscillator drive on the assumption that the local oscillator voltage across the diode is sinusoidal. The best value obtained for the noise figure was 8.3 db for a forward bias of 100 mv and a peak local oscillator voltage of 90 mv. For this set of operating conditions  $g_0 = +0.0029$  mho,  $g_1 = -0.0069$  mho,  $I_0 = 0.924$  ma,  $I_1 = -0.346$  ma,  $r_1_{opt} = 135$  ohms and  $r_{2c} = 600$  ohms. By way of comparison, the same diode used as a negative-resistance amplifier has a noise figure of about 5 db. The noise figure as a mixer is thus poorer than the noise figure as an amplifier. This result is to be expected unless more effective use can be made of "noise compensation" in the mixer.<sup>1</sup> Unfortunately, to obtain significant noise compensation, Class C operation of the diode is required and this mode of operation is not possible for the tunnel diode.

D. I. BREITZER  
Airborne Instruments Lab.  
Melville, L. I., N. Y.

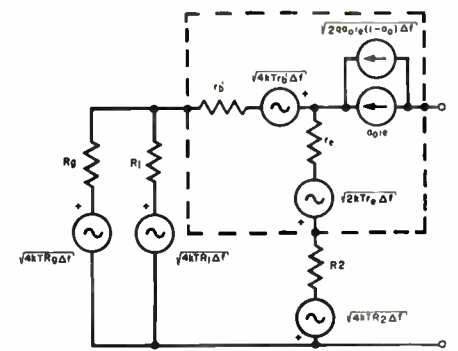

Fig. 1—Equivalent circuit of a common-emitter amplifier containing noise sources.

proximate equivalent circuit of a common-emitter amplifier.  $R_1$  is a base biasing resistor and  $R_2$  is an unbypassed emitter resistor. The noise figure of this circuit is

$$F' = 1 + \frac{R_s}{R_1} + \left( 1 + \frac{R_s}{R_1} \right)^2 \left[ \frac{r_b' + \frac{r_c}{2} + R_2}{R_s} + \frac{(1 - \alpha_s)(r_b' + r_c + R_2 + R_s)^2}{2\alpha_s r_c R_s} \right] \quad (3)$$

\* Received by the IRE, January 4, 1960.

<sup>1</sup> E. G. Neilsen, "Behavior of noise figure in junction transistors," *Proc. IRE*, vol. 45, pp. 957-963; July, 1957.

<sup>2</sup> R. D. Middlebrook, "Optimum noise performance of transistor input circuits," *Semiconductor Products*, vol. 1, pp. 14-20; July-August, 1958.

<sup>2</sup> L. Esaki, "New phenomenon in narrow Ge  $p-n$  junctions," *Phys. Rev.*, vol. 109, pp. 603-604; January, 1958.

<sup>3</sup> M. J. O. Strutt, "Noise figure reduction in mixer stages," *Proc. IRE*, vol. 34, pp. 942-950; December, 1946.

<sup>4</sup> A. van der Ziel, "Noise," Prentice-Hall, Inc., New York, N. Y., pp. 249-250; 1954.



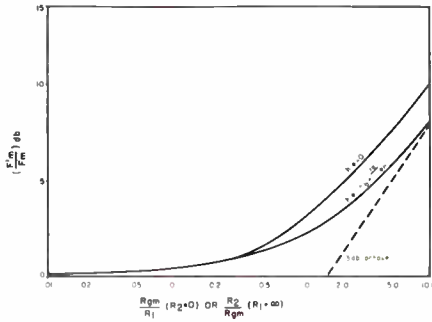

Fig. 2—Increase in minimum noise figure caused by  $R_1$  or  $R_2$ .

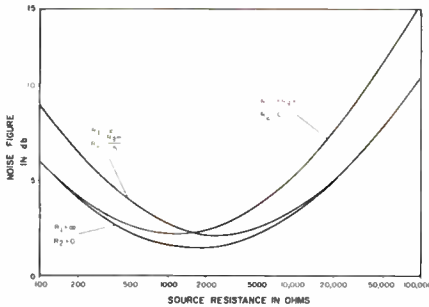

Fig. 3—Variation of noise figure vs source resistance with  $R_1$  and  $R_2$  as parameters.

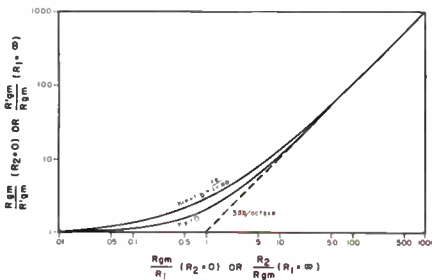

Fig. 4—Optimum source resistance  $R_{gm}'$  as a function of  $R_1$  or  $R_2$ .

where  $R_p$  is  $(R_1 R_2)/(R_1 + R_2)$ . In (3), it is assumed that  $f \ll \sqrt{1 - \alpha_0} \alpha_0$ .

The amplifier noise figure ( $F'$ ) has a minimum value for  $R_0 = R_{gm}'$ , where  $R_{gm}'$  is related to  $R_{gm}$  by

$$\frac{R_{gm}}{R_{gm}'} = \left[ 1 + \frac{R_{gm}^2 + K_2(2h_{ie} + R_2)}{R_1^2} + \frac{2(h_{ie} + R_2)}{R_1} \right]^{1/2} \cdot \left[ 1 + \left( \frac{R_2}{R_{gm}} \right)^2 + \frac{2h_{ie}R_2}{R_{gm}^2} \right] \quad (4)$$

In (4),  $h_{ie} = r_b' + r_e/(1 - \alpha_0)$  and is the low-frequency, common-emitter input resistance of the transistor.

Eq. (3) shows that the presence of  $R_1$  and  $R_2$  increases the amplifier noise figure. In Fig. 2, the ratio of the minimum amplifier noise figure to the minimum transistor noise figure, in db, is plotted vs  $R_{gm}/R_1$  and  $R_2/R_{gm}$ , for a typical transistor having the following parameters:

$$\begin{aligned} r_e &= 50 \text{ ohms} \\ r_b' &= 250 \text{ ohms} \\ \alpha_0 &= 0.990. \end{aligned}$$

The ratio  $F_m'/F_m$ , in db, approaches an asymptote of 3 db per octave. Note that the effect of the input resistance is to shift the "break point" of the curve from a normalized value of unity to some greater value. The input resistance, therefore, reduces the degradation of the noise figure caused by  $R_1$  and  $R_2$ .

Fig. 3 shows the variation of amplifier noise figure vs source resistance for typical values of  $R_1$  and  $R_2$ . In accord with (4), it is seen that a finite value of  $R_1$  decreases the value of the optimum source resistance, while a nonzero value of  $R_2$  increases the optimum source resistance. Fig. 4 shows the behavior of the optimum source resistance with variation in  $R_1$  and  $R_2$ . At low values of  $R_1$ ,  $R_{gm}'$  approaches  $R_1$ , while at high values of  $R_2$ ,  $R_{gm}'$  approaches  $R_2$ . The input resistance accentuates the effect of a given  $R_1$  or  $R_2$  on the optimum source resistance.

J. W. HALLIGAN  
Lansdale Tube Co.  
Lansdale, Pa.

### A Ferromagnetic Amplifier Using Longitudinal Pumping\*

A number of ferromagnetic parametric amplifiers using a transverse RF magnetic field as the pump have been proposed and investigated.<sup>1-4</sup> However, for various reasons none of these amplifiers has resulted in a practical device. It now appears that a ferromagnetic amplifier can be built using longitudinal pumping (RF magnetic field parallel to the dc magnetic field). Early experimental results on this type of amplifier have given a CW gain of 25 db with a signal frequency in the 4000-mc range using an X-band pump power of less than a watt.

The amplifier consists of a sample of ferromagnetic material mounted in a cavity, resonant at the pump frequency, with a transmission line to couple energy into the sample at the signal frequency. Resonances at the signal and idler frequencies are provided by normal modes of the ferromagnetic material.<sup>5</sup> The normal modes of a spheroidal sample of ferromagnetic material have been obtained by Walker,<sup>6</sup> and a straightfor-

ward calculation shows that certain pairs of these modes can be pumped parametrically by an RF field in the longitudinal direction. The calculation indicates which pairs of modes can be pumped and their respective thresholds for oscillation. The restriction on the pairs of modes which can be pumped comes from the form of the magnetostatic potentials as obtained by Walker and can be expressed as a set of selection rules. The magnetic field must, of course, be adjusted so that the resonant frequencies of the modes add up to the pumping frequency.

The ferromagnetic sample was a sphere of single-crystal yttrium iron garnet 0.043 inches in diameter mounted in a half-wave X-band cavity at a point of maximum RF magnetic field and spaced 0.075 inches from the cavity wall. The sphere, which had a linewidth of 0.40 oersteds, was furnished by Spencer and LeCraw. A loop of wire was threaded through holes in the wall of the cavity and around the sphere in a plane containing the dc and RF magnetic fields, to provide coupling from a coaxial line into the sample. A measure of the strength of coupling between the loop and the sample modes was obtained by observing the reflection of a signal in the coaxial line in the absence of the pump: 64 resonances were readily resolved as the dc magnetic field was varied. CW pump excitation of the cavity at 9196 mc was then applied at a power level of 500 mw. At each of a number of dc field values, a pair of modes was observed to undergo steady oscillation. Amplification was obtained by setting the dc field to single out one such pair and by reducing the pump power. Amplifier operation for a typical pair of modes is illustrated in Fig. 1, which shows reflection by the sphere of a swept frequency signal in the coaxial line without pumping [Fig. 1(a)] and with pumping [Fig. 1(b)]. Note that a number of absorptions due to sample modes appear in Fig. 1(a); the notch in the center is due to a wavemeter at 4598 mc (half the pumping frequency). The modes at 4626 and 4570

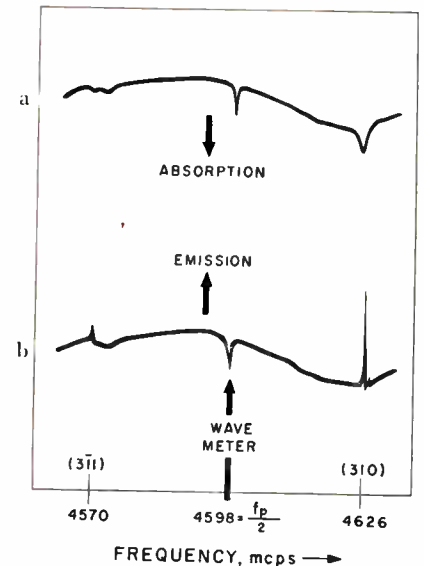

Fig. 1—Walker mode resonances in a YIG sphere. (a) Without pumping. (b) With pumping.

\* Received by the IRE, March 7, 1960.

<sup>1</sup> H. Suhl, "Theory of the ferromagnetic microwave amplifier," *J. Appl. Phys.*, vol. 28, pp. 1225-1236; November, 1957.

<sup>2</sup> M. T. Weiss, "A solid-state microwave amplifier and oscillator using ferrites," *Phys. Rev.*, vol. 107, p. 317; July, 1957.

<sup>3</sup> A. D. Berk, L. Kleinman, and C. E. Nelson, "Modified semistatic ferrite amplifier," 1958 WESCON CONVENTION RECORD, pt. 3, pp. 9-12.

<sup>4</sup> E. G. Spencer and R. C. LeCraw, "Magnetoacoustic resonance in yttrium iron garnet," *Phys. Rev. Lett.*, vol. 1, pp. 241-243; October, 1958.

<sup>5</sup> This type of operation is similar to that reported by Spencer and LeCraw<sup>4</sup> except that the modes referred to here are magnetic, whereas there they were acoustic vibrations.

<sup>6</sup> L. R. Walker, "Magnetostatic modes in ferromagnetic resonance," *Phys. Rev.*, vol. 105, pp. 390-399; January, 1957.

me have been identified as the 310 mode and the 311 mode (Walker's notation).<sup>6</sup> It may be observed that they satisfy the frequency relation for parametric pumping. They also satisfy the selection rules referred to above. These are the modes which are amplifying in Fig. 1(b). Fig. 2 also shows the energy reflected from the sphere, but on an expanded frequency scale centered about the 310 mode. The gain measurement was per-

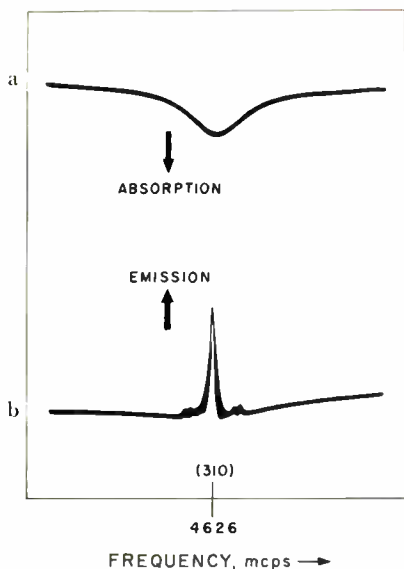

Fig. 2—Walker mode resonance (310) on an expanded scale. (a) Without pumping. (b) With pumping.

formed using a signal generator, the amplifier, and a detector on the arms of a three-port circulator. The detector output was compared with that obtained when a shorting plate was substituted in the amplifier arm, showing a gain of 25 db. Work is still in a very early experimental stage; measurement of bandwidth, noise figure, and other characteristics is proceeding.

This amplifier appears capable of fulfilling the expectations which have made the ferromagnetic parametric amplifier principle attractive; namely, it operates at room temperature but being a magnetic device can also, of course, be operated at low temperatures; it is not susceptible to burnout or long-term saturation caused by high-power transients; and it is capable of being used up to very high signal frequencies. In the style of operation reported here, use at high frequencies ought to present no special difficulties; this amplifier also exhibits the advantages of low pump power and lower dc magnetic field than required in some other proposals.

The investigation of longitudinal pumping which led to this new type of amplifier was stimulated by the work of Schlömann, *et al.*,<sup>7</sup> on the theory of spin-wave excitation,

and the studies of LeCraw and Spencer.<sup>8</sup> Spencer and LeCraw have been very generous in devoting time to discussions, offering suggestions, and providing experimental assistance. The author would like to thank J. A. Weiss for many helpful and stimulating discussions. V. Czarniewski has contributed very skillful technical assistance.

R. T. DENTON  
Bell Telephone Labs., Inc.  
Murray Hills, N. J.  
and  
Dept. of Elec. Engrg.  
Univ. of Michigan  
Ann Arbor, Mich.

<sup>8</sup> R. C. LeCraw and E. G. Spencer, "Spin-Lattice Relaxation of Low  $k$ -Number Spin Waves in Yttrium Iron Garnet: I Frequency Dependence," and "Spin-Lattice Relaxation of Low  $k$ -Number Spin Waves in Yttrium Iron Garnet: II Temperature Dependence," to be presented at the 1960 Meeting of the American Physical Society, Washington, D. C., 1960.

### Parametric Phase Distortionless L-Band Limiter\*

A. E. Siegman<sup>1</sup> has predicted, from theoretical considerations, that a parametric device could be made to limit at *pump* frequency, without phase distortion. Such a limiter, operating at L-band, has successfully

observed to be less than  $\pm 2^\circ$ , which was the accuracy of the measurements.

Fig. 1 is a schematic of the limiter. Three shorted coaxial transmission line cavities (pump and two idlers) are joined at a tee. A Microwave Associates MA460A VARACTOR is placed in shunt with all three cavities at their junction. Provisions are made for biasing the VARACTOR over the range  $\pm 4$  volts, with suitable RF bypassing. Two loops couple pump signal in and limited pump signal out of the pump arm. Additional loops are provided in the idler arms for monitoring idler frequencies.

Siegman did not describe an actual device; however, he did suggest, in an example, that the pump cavity be designed to resonate in two degenerate modes at pump frequency. Coupling between modes would be afforded by the nonlinear element. Pump signal would be coupled into one mode, while output signal would be coupled to the second. Limiting occurs when the device breaks into oscillation, causing the nonlinear coupling between the two degenerate modes to "clamp." It appears, from our experience, that such coupled degenerate modes are not a necessary feature for the device to function. In our device, the dimensions of the coaxial pump cavity are such that all higher TE and TM modes are well below cutoff. Both input and output loops couple to the TEM mode, for which no degeneracy exists.

Tests of the dynamic limiting capabilities were made at 1000 mc, using  $3\frac{1}{2}$ - $\mu$ sec (half amplitude width) pseudo-Gaussian RF pulses. Photographs taken using a high-speed X-Y oscilloscope are shown in Fig. 2.

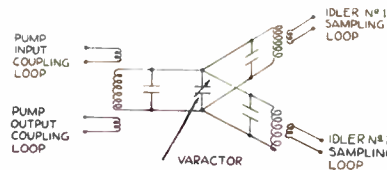

Fig. 1—Schematic of limiter.

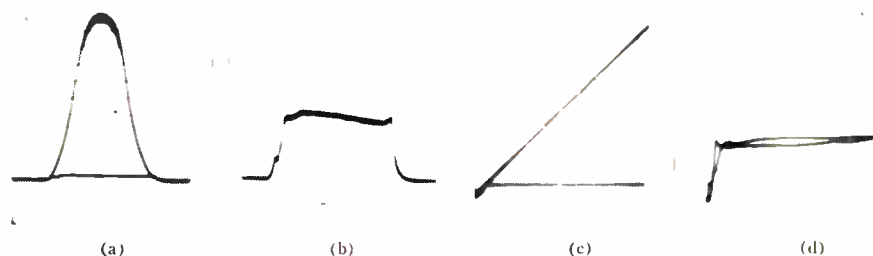

Fig. 2—Oscilloscope photographs of pulsed limiter action. (a) Pseudo-Gaussian input pulse and limited output pulse (dual trace). (b) Expanded output pulse. (c) X-Y presentation, input vs input ( $45^\circ$  line) and output vs input. (d) Expanded X-Y presentation, output vs input.

been developed in our laboratory. Over 30 db of dynamic limiting has been observed at 1000 mc, with the parametric limiter operating in the degenerate mode. Phase distortion measurements have been made over a 16-db range of limiting. The phase distortion was

In Fig. 2(a), a dual trace is shown of the pseudo-Gaussian input pulse and of the limited output pulse. The output pulse is shown again in Fig. 2(b), amplified to show greater detail. Fig. 2(c) is an X-Y presentation showing output vs input. The  $45^\circ$  trace is a plot of input vs input, provided for comparison. Fig. 2(d) is again an X-Y presentation of output vs input; the output signal has been amplified to show greater detail of the limiting action. The limiter was operat-

<sup>7</sup> E. Schlömann, J. J. Green, and U. Milano, "Recent Developments in Ferromagnetic Resonance at High Power Levels," presented at Conf. on Magnetism and Magnetic Materials, Detroit, Mich., November, 1959.

\* Received by the IRE, December 28, 1959.  
<sup>1</sup> A. E. Siegman, "Phase distortionless limiting by a parametric method," Proc. IRE, vol. 47, pp. 447-448; March, 1959.

ing in the degenerate mode (both idler frequencies at one-half pump frequency). Average input power was 280 mw. Peak input power was in excess of 15 watts.

Phase distortion measurements were conducted under pulsed conditions at 1000 mc, with the limiter operating in the degenerate mode. It is essential, in such measurements, that the phase of the input signal to the limiter does not vary as its amplitude is varied. In other words, the device used to vary input signal amplitude must not in itself introduce phase distortion. Several variable attenuators were found to be lacking in this respect. The problem was solved in the manner illustrated in Fig. 3.

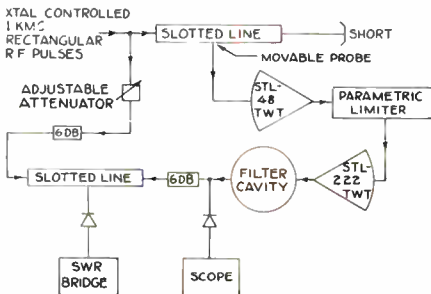

Fig. 3—Experimental setup for phase distortion measurement.

A crystal-controlled source of rectangular pulses at 1000 mc was fed into a shorted slotted line, creating an infinite VSWR on that line. A well-known property of such a standing-wave pattern is that the phase of the RF voltage between adjacent minima is independent of distance along the line. Thus, by moving a probe back and forth between a minimum and a maximum of such a standing-wave pattern, the RF output from the probe could be made to vary over a wide range, the phase remaining constant. It is necessary that the probe be only lightly coupled to the slotted line; otherwise the perturbation of fields introduced by the probe will destroy the above relationship. Therefore, the insertion loss of this amplitude varying device is necessarily high.

The high insertion loss was overcome by amplifying the signal out of the probe to a sufficient level to drive the limiter. A Sperry STL-48 TWT was used for this purpose. This is a high-power (200-watt CW) TWT, chosen so that the power levels at which our phase measurements were to be made were well down in the small signal region, to avoid amplitude-to-phase conversion introduced by the TWT itself. A separate check of this phase distortion due to the TWT was made; over the amplitude range used, it was less than  $\pm 2^\circ$ , which was the accuracy of our measurement.

The limited output was amplified using a Sperry STL-222 TWT, passed through a cavity filter tuned to pump frequency, then through 6 db of lossy cable to one end of a slotted line. A sample of the crystal-controlled RF drive was fed through 6 db of lossy cable to the other end of the slotted line, as phase reference signal. By adjustment of the amplitude of the phase reference signal, an infinite VSWR was established on that slotted line. Any phase shift in the

limited output signal caused a corresponding shift in the position of the minimum of standing-wave pattern, which could be correlated directly to phase shift in degrees. Over a 16-db range of limiting, the phase shift was observed to be less than  $\pm 2^\circ$ , the accuracy of our measurement.

It will be noted that the block diagram of Fig. 3 includes a filter cavity, tuned to pump frequency, in the output line of the limiter. Its purpose was to filter out any idler frequencies which might be coupled to the output loop. We found that the limiter worked better when this filter was present. It will also be noted that this filter is isolated from the limiter by a nonreciprocal circuit element (the STL-222 TWT). Thus, the limiter saw an impedance of 50 ohms. We found that this order of component placement worked best. When the filter cavity and the TWT were reversed in position, some "ringing" occurred on the output pulse. This ringing was affected by filter cavity tuning.

The operation of the limiter was observed to be critically dependent upon the tuning adjustment of all three cavities, as well as upon the bias adjustment. There appeared to be a broad combination of idler frequencies  $F_1$  and  $F_2$  satisfying the relationship

$$F_1 + F_2 = F_p$$

such that limiting would occur. However, it was found that the best limiting action occurred when the limiter operated in the degenerate mode, where

$$F_1 = F_2 = F_p/2.$$

The authors wish to express their appreciation to J. R. Ashley, who suggested the experimental technique used for monitoring phase distortion.

A. D. SUTHERLAND  
D. E. COUNTISS  
Sperry Electronic Tube Div.  
Sperry-Rand Corp.  
Gainesville, Fla.

junction diodes, in an attempt to develop a four-terminal microwave amplifier with broad-band properties. In addition to broad-band behavior, the helix structure is directional and the signal and pump sources can be isolated by the helix. It is fairly easy to couple to the helix and this can be done at any point along it if, for instance, distributed pump coupling is desired. *A priori*, a large variation in amount and kind of loading is possible. Experience with the loaded coaxial line has indicated that a small loading per unit length, distributed over the structure, is desirable.

The helix is shown in Fig. 1. It is of silver-plated tungsten wire (20-mils diameter). Designed for S-band operation, it is 6 inches long, has a 0.276-inch mean diameter, and has approximately 13 turns per inch. The diodes,<sup>3</sup> mounted between turns of the coil, are of germanium, alloyed-diffused, and have the following characteristics:

Capacitance (-1 volt)	0.2-1 $\mu\mu\text{f}$ .
Series resistance	2-15 ohms.
Cutoff frequency (nominal)	20-100 kmc.

They were assembled in ceramic cylinders about 0.1 inch in diameter, of axial dimension quite close to that of the interturn spacing of the helix.

The test apparatus is shown schematically in Fig. 2. It was found that the position of each diode on the helix was critical, as was the pump power and pump frequency. No general relations among pump frequency,

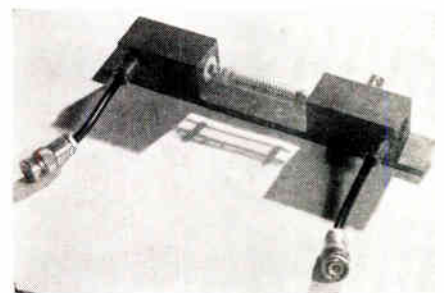

Fig. 1—The helix.

### The Diode-Loaded Helix as a Microwave Amplifier\*

Earlier work on traveling-wave parametric structures has included cavity devices and transmission line devices.<sup>1</sup> Theoretical and some experimental work has been done at these Laboratories with a diode-loaded coaxial line.<sup>2</sup>

More recently, exploratory work was done with an S-band helix-loaded with  $p$ - $n$

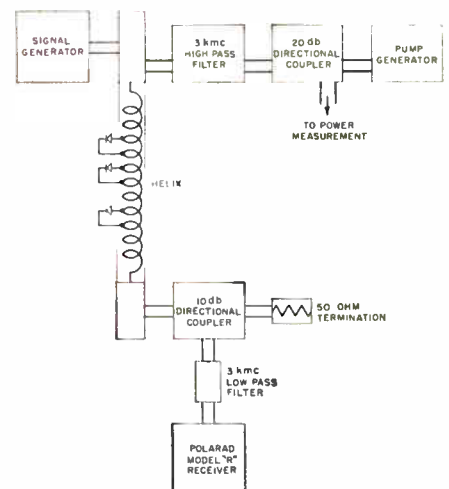

Fig. 2—Schematic of test set-up.

\* Received by the IRE, January 26, 1960. This work was sponsored in part by the Electronics Res. Directorate of the AF Cambridge Res. Center, Air Research and Development Command, under Contract No. AF 19(604)-4980.

<sup>1</sup> P. K. Tien, "Parametric amplification and frequency mixing in propagating circuits," *J. Appl. Phys.*, vol. 29, pp. 1347-1357; September, 1958.

<sup>2</sup> G. Heilmeier, "An analysis of parametric amplification in periodically loaded transmission lines," *RCA Rev.*, vol. 20, pp. 442-454, September, 1959; also, "Research and Development on Parametric Amplifiers," AF Cambridge Res. Ctr., Cambridge, Mass., 2nd Quart. Rept., Contract AF19(604)-4980, June 30, 1959.

<sup>3</sup> Thanks are due C. W. Mueller's Device Group, in these Laboratories, for a supply of developmental diodes.



signal frequency and diode position and characteristics were observed.

Typical operating data are shown in Table I.

TABLE I

Signal frequency	2800 mc
Pump frequency	3800 mc
Number of diodes	2
Pump power	60 mw
Unloaded helix insertion loss	6 db
Net power gain	26 db
Voltage gain bandwidth	30 mc
Noise figure	5.7 db

It can be seen that the bandwidth is quite low, presumably because of the loading introduced by the diodes. The broad-band properties are retained to the extent that, at least for some diode arrangements, the structure can be tuned by varying the pump frequency and power. Thus, for a pump frequency variation of 100 mc, the signal frequency has been moved through an 80-mc range.

G. CONRAD  
K. K. N. CHANG  
R. HUGHES  
RCA Labs.  
Princeton, N. J.

**A High Field Effect Two-Terminal Oscillator\***

As early as 1953,<sup>1</sup> charge multiplication in reverse biased *p-n* junctions was reported. A rather rigorous treatment by McKay<sup>2</sup> in 1954 prompted additional work by Eber and Miller,<sup>3</sup> Kidd, *et al.*,<sup>4</sup> and many more. Recently Gunn<sup>5</sup> and Yamaguchi and Hamakawa<sup>6</sup> have discussed the negative resistance properties associated with avalanche multiplication. The purpose of this note is to indicate the application of this phenomenon to sinusoidal oscillators using readily available solid-state devices.

It is interesting to note that this breakdown effect can be observed at the collector-base junction of most low-power transistors. A typical volt ampere characteristic for a 2N147 (linear gradient) unit is shown in Fig. 1. Characteristics for both step and linear gradient junctions have been obtained and are quite similar in nature.

The requirement of a negative resistance device in two-terminal oscillators is known,<sup>7</sup>

and in an effort to exploit the high field effect more fully, the oscillator of Fig. 2 was constructed. The equivalent of Fig. 2 is shown in Fig. 3, where  $-R$  is the average negative resistance value of the junction over the operating range.

*Minimum Negative Resistance Requirement*

From elementary circuit theory,

$$E_{in} = \frac{sC_1^2 [e_1(0^-) - e_2(0^-)] - (g_c + sC_1) [C_1 e_1(0^-) - (C + C_1) e_2(0^-)]}{(g_c + sC_1) \left[ sC - sC_1 + \frac{1}{R_1} - \frac{1}{R_1^2 \left( \frac{1}{sL} + \frac{1}{R_1} \right)} \right]} - s^2 C_1^2 \quad (1)$$

From (1) the characteristic equation is

$$s^3 LC_1(C_c - C_1) + s^2 [Lg_c C_c + R_1 C_1 C_c - C_1^2 R_1] + s [R_1 g_c C_c + C_1] + g_c = 0 \quad (2)$$

where

$$R_c = \frac{1}{R_L} - \frac{1}{R}$$

$$C_c = C - C_1$$

Under the linearized assumptions, a minimum condition for oscillation requires that the conjugate roots of (2) be purely imaginary. Thus (2) is of the form

$$(s + a)(s^2 + \omega^2) = 0 \quad (3)$$

or

$$s^3 + as^2 + \omega^2 s + a\omega^2 = 0 \quad (4)$$

Comparing (4) and (2) yields

$$\omega = \sqrt{\frac{R_1 g_c C_c + C_1}{LC_1(C_c - C_1)}} \quad (5)$$

or a minimum average value of negative resistance is found as

$$|-R| \geq \frac{R_L R_1 (C - C_1)}{R_1 (C - C_1) - R_1 \omega^2 LC_1 (C - 2C_1) + R_L C_1} \quad (6)$$

For the oscillator circuit of Fig. 2,  $\omega = 52,300$  rad sec, and

$$|-R| \geq 1.29 \text{ ohms}$$

*Maximum Negative Resistance Requirement*

Assuming  $C_1 = C$  and  $\omega_c \cong 1/(2CL)$ , the Thevenin antiresonant impedance at the *p-n* junction terminals is

$$R_{ar} = \frac{4R_1 R_L L}{4R_1 L + R_L L + 2R_L R_1^2 C} \quad (7)$$

To satisfy the requirement that the average ac power dissipated by the load resistance and tank circuit be supplied by the negative resistance device places an upper limit on the average value of the negative resistance as

$$|-R| \leq R_{ar} \quad (8)$$

For the circuit of Fig. 2,

$$|-R| \leq 143 \text{ ohms.}$$

Observed waveforms (Fig. 4) indicate that a very low distortion signal may be developed.

A difficulty arises, however, since biasing the device in the negative resistance region causes rather large quiescent currents to flow through the narrow base region. The junction temperature rises, which quite abruptly results in the deterioration of oscillator performance.

In addition to work done with collector-base junctions, an investigation has been

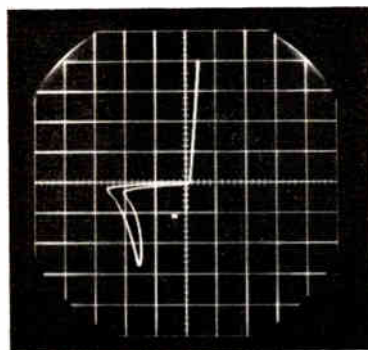

Fig. 1—*P-N* junction volt ampere characteristic. Vertical, 10 ma/cm; horizontal, 10 v/cm.

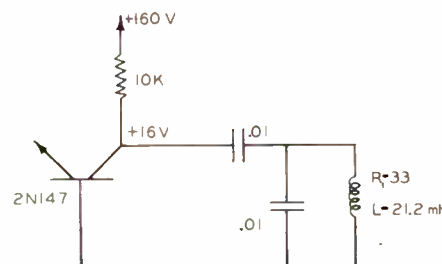

Fig. 2—Schematic diagram of a two-terminal oscillator.

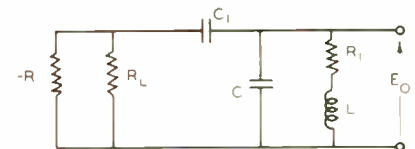

Fig. 3—Equivalent circuit (ac) of Fig. 2.

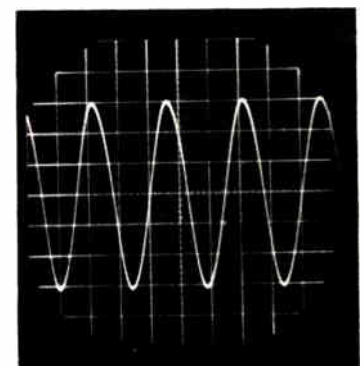

Fig. 4—Oscillator output voltage. Vertical, 2 v/cm; horizontal, 50 usec/cm.

\* Received by the IRE, January 11, 1960.  
<sup>1</sup> K. G. McKay and K. B. McAttee, "Electron multiplication in silicon and germanium," *Phys. Rev.*, vol. 91, pp. 1079-1089; September, 1953.  
<sup>2</sup> K. G. McKay, "Avalanche breakdown in silicon," *Phys. Rev.*, vol. 94, pp. 877-884; May, 1954.  
<sup>3</sup> J. J. Ebers and S. L. Miller, "Alloyed junction avalanche transistors," *Bell Sys. Tech. J.*, vol. 34, pp. 883-902; September, 1955.  
<sup>4</sup> M. C. Kidd, *et al.*, "Delayed collector conduction, a new effect in junction transistors," *RCA Rev.*, vol. 16, pp. 16-33; March, 1955.  
<sup>5</sup> J. B. Gunn, "Progress in Semiconductors," John Wiley and Sons, Inc., New York, N. Y., vol. 2, p. 213; 1957.  
<sup>6</sup> J. Yamaguchi and Y. Hamakawa, "High electric field effects in germanium *p-n* junction," *J. Phys. Soc. Japan*, vol. 14 pp. 15-21; January, 1959.  
<sup>7</sup> A. W. Lo, *et al.*, "Transistor Electronics," Prentice-Hall, Inc., New York, N. Y., p. 368; 1955.

begun which employs commercially available alloyed junction diodes for this application. The usefulness of these units in two-terminal oscillators would be enhanced if lower breakdown voltage devices were available, permitting the use of lower supply voltages.

R. W. LADE  
T. R. SCHLAX  
Dept. of Elec. Engrg.  
Marquette University  
Milwaukee, Wis.

### Generating a Rotating Polarization\*

By relatively simple means, it is possible to generate an arbitrarily-polarized wave whose polarization can be caused to rotate at virtually any desired angular rate. It is well known that any polarized wave can be resolved into components of right- and left-handed circular polarizations, or that any polarization can be constructed from appropriate combination of two oppositely sensed circularly polarized components.

Consider a two-port circularly polarized antenna, one port of which couples to the right circularly polarized mode, and a second port which couples to the left circularly polarized mode of radiation. At microwave frequencies, such an antenna is readily realized by incorporating a quarter-wave plate in a circular waveguide dual-mode transducer as represented in Fig. 1. A signal fed into port *A* is converted to right circular polarization (RCP) by the device, while a signal fed into port *B* is converted to left circular polarization (LCP). By controlling the relative phase and amplitudes of inputs to ports *A* and *B*, it is possible to generate any desired polarization.

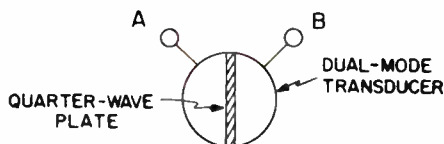

Fig. 1—A two-port circularly polarized antenna.

If signals entering ports *A* and *B* (Fig. 1) are the same frequency and equal in amplitude, the two oppositely-sensed CP waves which are generated add vectorially to form a linearly polarized wave. The plane of polarization of this linearly polarized wave is determined by the angular phase relationship between the signals entering ports *A* and *B*. If signals into ports *A* and *B* are made unequal in amplitude, the wave generated by the device will be elliptically polarized, and its sense will be determined by the sense of the larger CP component. Thus, the sense

and the axial ratio of the resultant wave is controlled simply by varying the ratio of input amplitudes to ports *A* and *B*, while the plane of polarization (or orientation of the major axis of the ellipse) is determined by the phase relationship of the two inputs. This simple mechanism, involving just two independent variables, provides complete control of polarization.

As the spatial orientation of the polarized wave is a function of the phase relationship between the right- and left-handed CP components, one can rotate the polarization simply by introducing a relative phase change between the inputs to *A* and *B*. By introducing a continuous phase change, as by rotating a continuous type phase shifter, the rotation of polarization can be made continuous. To cause the polarization to rotate at a constant angular rate requires introduction of a constant rate-of-change-of-phase between inputs to ports *A* and *B*. This, however, amounts to introducing a frequency difference between inputs *A* and *B*; hence, to generate a polarized wave which rotates at a constant angular rate, one need only introduce signals at ports *A* and *B* which differ in frequency. The relative amplitudes are adjusted to obtain the desired sense and axial ratio, and the frequency difference is chosen to obtain the desired rate of rotation. The rotation frequency will be one-half the frequency difference between inputs to *A* and *B*; that is,

$$f_R = \frac{f_A - f_B}{2}$$

The achievable rate of rotation is limited only by the bandwidth of the RF components.

If one detects this wave by using a linearly polarized antenna, the shape of the modulation envelope would suggest that the transmission was a double-sideband suppressed carrier signal having an effective carrier frequency,

$$f_C = \frac{f_A + f_B}{2}$$

The RF envelope is the same as would be obtained if a transmitting antenna of the same axial ratio, radiating at frequency  $f_C$ , was rotated mechanically about its radiation axis at frequency  $f_R$ . For a rotating linear polarization the "sidebands" would be equal in amplitude; for a rotating elliptical polarization, they would be unequal.

In generating a wave having a rotating polarization, a stable rotation rate can be achieved if signals  $f_A$  and  $f_B$  are derived by using single-sideband generator techniques to develop separate upper and lower sidebands with carrier suppressed.

If one employs a two-mode circularly polarized antenna to receive a wave having a rotating polarization, it follows that the outputs from the RCP and the LCP ports will be at different frequencies,  $f_A$  and  $f_B$ , in accordance with the equations already given. If the rotating wave is elliptically polarized, this fact will be indicated by amplitude inequality of the two CP outputs.

P. J. ALLEN  
U. S. Naval Res. Lab.  
Washington, D. C.

### A "Z-Transform-Describing-Function" for On-Off Type Sampled-Data Systems\*

The study of on-off type control systems with sampled data by means of the describing function technique has been made previously by Chow<sup>1</sup> and Russell.<sup>2</sup> In these early investigations, the nonlinear element for which the describing function is derived includes the sampling switch, the zero-order hold circuit, and the on-off relay. For a sinusoidal input whose period is an integral multiple of the sampling period *T*, the output of the nonlinear element is a periodic rectangular wave. Thus the conventional describing function technique for continuous systems can be applied directly; the nonlinear sampled data system is essentially treated as a continuous system. The method is subject to limitations that a zero-order hold circuit must be used, and there is only one sampling switch in the system which samples the error signal  $e(t)$  (Fig. 1).

The present investigation involves the derivation of a new describing function utilizing the Z transformation. The nonlinear element *N* in this case includes only the on-off relay. The new describing function permits the study of on-off type sampled-data systems of the following types: 1) systems with or without zero-order hold circuit, 2) finite-pulse-width consideration with flat-topped approximation, and 3) systems with more than one synchronized sampling switch.

The block diagram of the nonlinear system with sampled-data under consideration is shown in Fig. 1. The sampling rate of the sampler is assumed to be uniform and the sampling duration is assumed negligible, i.e., ideal sampler. The operational characteristic of the relay is shown in Fig. 2.

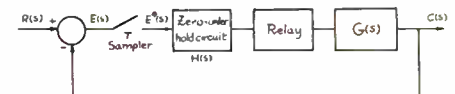

Fig. 1.

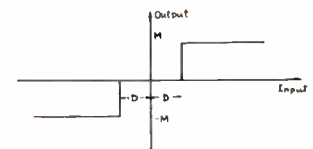

Fig. 2.

If the error signal  $e(t)$  is sinusoidal with a period of  $T_c = nT$ , where *T* is the sampling period of the sampler, and  $n = 2, 3, 4, \dots$ , the output of the sampler  $e^*(t)$  is an impulse train of the same period since  $e^*(t)$  can have values only at the sampling instants.

As a first step in the study of the system, it is seen that the system behavior is not

\* Received by the IRE, November 16, 1959.

<sup>1</sup> C. K. Chow, "Contactor servomechanisms employing sampled data," *Trans. AIEE*, vol. 73, pt. II, pp. 51-64; March, 1954.

<sup>2</sup> F. A. Russell, "Design Criterion for Stability of Sampled-Data On-off Servomechanisms," Ph.D. dissertation, Columbia University, New York, N. Y.; 1953.

\* Received by the IRE, January 26, 1960.

altered if the hold circuit and the relay shown in Fig. 1 are exchanged in position; the modified system is shown in Fig. 3.

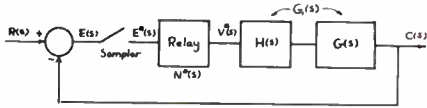

Fig. 3.

It is apparent that the system behavior is not altered by this change. The nonlinear element  $N$  in this case contains only the on-off relay. Since the transfer function of the zero-order hold  $H(s)$  and  $G(s)$  are both linear, the function,

$$G_1(s) = H(s)G(s) = \frac{1 - e^{-Ts}}{s} G(s), \quad (1)$$

is also linear.

The derivation of the describing function  $N(z)$  for the relay is based on the assumption that the input signal to the sampler is a sinusoid, and, consequently, the input to  $N$  is an impulse train with a sinusoidal envelope. The  $Z$ -transform-describing function is defined as the ratio of the  $Z$  transform of the output and the  $Z$  transform of the input to the relay.

Thus,

the  $Z$ -transform describing

$$\text{function } N(z) = \frac{V(z)}{E(z)} \quad (2)$$

where

$E(z)$

$$= Z\text{-transform of } [e(t) = E \cos(at + \phi)]. \quad (3)$$

The output transform of the system shown in Fig. 3 is

$$C(s) = G_1(s)V^*(s) = G_1(s)N^*(s)E^*(s). \quad (4)$$

Thus,

$$\begin{aligned} E(s) &= R(s) - C(s) \\ &= R(s) - G_1(s)N^*(s)E^*(s). \end{aligned} \quad (5)$$

But since

$$E^*(s) = \frac{1}{T} \sum_{n=-\infty}^{\infty} E(s + jn\omega_s), \quad (6)$$

substituting (5) into (6), we have

$$E^*(s) = \frac{1}{T} \sum_{n=-\infty}^{\infty} [R(s + jn\omega_s) - G_1(s + jn\omega_s) \cdot N^*(s + jn\omega_s) \cdot E^*(s + jn\omega_s)]. \quad (7)$$

Since for a fixed frequency  $a$ , the describing function  $N^*(s)$  can be shown to be a linear function of  $e^{st}$ ,

$$N^*(s) = N^*(s + jn\omega_s) \quad (8)$$

and it is well known that

$$E^*(s) = E^*(s + jn\omega_s). \quad (9)$$

Eq. (7) becomes

$$E^*(s) = R^*(s) - G_1^*(s)N^*(s)E^*(s) \quad (10)$$

where

$$R^*(s) = \frac{1}{T} \sum_{n=-\infty}^{\infty} R(s + jn\omega_s) \quad (11)$$

and

$$G_1^*(s) = \frac{1}{T} \sum_{n=-\infty}^{\infty} G_1(s + jn\omega_s). \quad (12)$$

Solving for  $E^*(s)$  in (10), we get

$$E^*(s) = \frac{R^*(s)}{1 + N^*(s)G_1^*(s)} \quad (13)$$

from which

$$\frac{C^*(s)}{R^*(s)} = \frac{N^*(s)G_1^*(s)}{1 + N^*(s)G_1^*(s)} \quad (14)$$

or

$$\frac{C(z)}{R(z)} = \frac{N(z)G_1(z)}{1 + N(z)G_1(z)}. \quad (15)$$

The study of the condition of self-sustained oscillation of the nonlinear sampled-data system now involves the investigation of

$$G_1(z) = -\frac{1}{N(z)}. \quad (16)$$

In general, if the hold circuit is absent and the finite pulse width has to be considered, the transfer function  $H(s)$  can be replaced by

$$H_p(s) = \frac{1 - e^{-ps}}{s} \quad (17)$$

where  $p(p \leq T)$  is the pulsewidth (flat-topped approximation).

For a system with feedback element  $B(s)$ , and a synchronized sampling switch in the feedback path (Fig. 4), the closed-loop

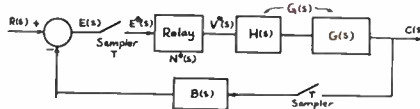

Fig. 4.

transfer function is

$$\frac{C(z)}{R(z)} = \frac{N(z)G_1(z)}{1 + B(z)G_1(z)N(z)}, \quad (18)$$

which means that the stability of the system is investigated from

$$B(z)G_1(z) = -\frac{1}{N(z)}. \quad (19)$$

The Derivation of  $N(z)$

As an example, the describing function  $N(z)$  will be derived for the case when  $e(t)$  is a sinusoid of period  $T_c = 4T$ . This means that the relay may have either one or two positive (or negative) corrections during one period  $T_c$ . If the number of corrections is designated by  $\Delta$  ( $\Delta$  can be either one or two in this case), considering  $\Delta = 1$ , the relay output can be written as

$$\begin{aligned} V(z) &= 1 - z^{-2} + z^{-4} - z^{-6} + \dots \\ &= \frac{z^2}{z^2 + 1}. \end{aligned} \quad (20)$$

The  $Z$  transform of  $e(t) = E \cos(at + \phi)$  is

$$\begin{aligned} E(z) &= \frac{Ez}{z^2 - 2z \cos aT + 1} \\ &\cdot [(z - \cos aT) \cos \phi - \sin aT \sin \phi] \end{aligned} \quad (21)$$

and for  $T_c = 4T$ ,

$$aT = \pi/2, \quad z = e^{j\omega T} = j.$$

Thus,

$$\begin{aligned} N(z) &= \frac{V(z)}{E(z)} = \frac{z^2}{z^2 + 1} \times \frac{z^2 + 1}{Ez(z \cos \phi - \sin \phi)} \\ &= -\frac{1}{E} \times \frac{1}{\cos \phi + j \sin \phi}. \end{aligned} \quad (22)$$

B. C. KUO  
Dept. of Electrical Engrg.  
University of Illinois  
Urbana, Ill.

### A Note on the Steady-State Response of Linear Time-Invariant Systems to General Periodic Input\*

In the following discussion, a simple procedure is presented for obtaining the steady-state response of linear systems to non-sinusoidal periodic inputs. This procedure is based on applying the final value theorem to the modified  $z$ -transform of the output. It is known that the modified  $z$ -transform method is widely used for the analysis of sampled-data and finite pulsed systems; its use to the above problem is readily evident. A very brief discussion of this method is hereby presented.

Suppose that the Laplace transform of part of the output<sup>1</sup>  $C_1(s)$  (which contains only finite poles and has a higher degree denominator in  $s$  than numerator) is given. Then its modified  $z$ -transform denoted as  $C_1^*(z, m)$  is given by the following complex convolution integral.<sup>2</sup>

$$\begin{aligned} C_1^*(z, m) &= Z_m [C_1(s)] \\ &= \frac{e^{-Ts}}{2\pi j} \int_{c-j\infty}^{c+j\infty} C_1(p) \frac{e^{mpT}}{1 - e^{-T(s-p)}} dp, \end{aligned} \quad (1)$$

where  $T$  is the input period.

One method of evaluating the above integral is to integrate around a closed path in the left half of the complex  $p$ -plane that encloses all the finite singularities of  $C_1(p)$ , applying the residue theorem. In this case (1) becomes

$$\begin{aligned} C_1^*(z, m) &= z^{-1} \sum_{\text{poles of } C_1(p)} \text{residue of} \\ &\left[ C_1(p) \frac{e^{mpT}}{1 - e^{pT} z^{-1}} \right] \Big|_{z=e^{Ts}}. \end{aligned} \quad (2)$$

For instance, if  $C_1(s) = 1/s + a$ , (2) yields for its modified transform

\* Received by the IRE, December 11, 1959; revised, January 14, 1960.

<sup>1</sup> The Laplace transform of the output in this case can always be represented as

$$C(s) = C_1(s) \frac{1}{1 - e^{-Ts}}.$$

<sup>2</sup> E. I. Jury, "Sampled Data Control Systems," John Wiley and Sons, Inc., New York, N. Y., chs. 2, 9; 1958.



$$C_1^*(z, m) = Z_m \left[ \frac{1}{s+a} \right] = \frac{e^{-amT}}{z - e^{aT}}, \quad 0 < m < 1. \quad (3)$$

In the literature, extensive tables of modified  $z$ -transform pairs<sup>2,3</sup> are given that can be readily used for more complicated forms of  $C_1(s)$ . However, in some cases  $C_1(s)$  (having simple poles) can be represented by partial fraction expansion as the sum of single time constants. Then its modified  $z$ -transform can be readily obtained as the sum of the terms of the form of (3).

The final value theorem developed for the modified  $z$ -transform can be briefly stated as follows:<sup>2,3</sup>

$$\lim_{n \rightarrow \infty} c(n, m)T = \lim_{z \rightarrow 1} \frac{z-1}{z} C^*(z, m), \quad 0 \leq m \leq 1, \quad (4)$$

if the limit exists where  $C^*(z, m)$  is the modified  $z$ -transform of the output  $C(s)$ .

Furthermore, the continuous output in a closed form is also given by the inverse  $z$ -transform<sup>2</sup> as follows:

$$c(n, m)T = Z^{-1}[C^*(z, m)] = \frac{1}{2\pi j} \int_{\Gamma} C^*(z, m) z^{n-1} dz, \quad 0 \leq m \leq 1$$

$$t = (n-1+m)T$$

$$n = \text{positive integer} \quad (5)$$

where  $\Gamma$  is a closed path of integration in the  $z$ -plane that enclosed all the poles of  $C^*(z, m)$ .

For the purpose of this discussion only the final value theorem is applied to obtain the steady-state response. The following two cases are discussed:

Case 1:

$$C(s) = F(s) + C_1(s) \frac{1}{1 - e^{-Ts}}. \quad (6)$$

$F(s)$  in (6) is a rational function of  $s$  and has a final value  $f_{ss}$  that can be obtained from  $\lim_{s \rightarrow 0} sF(s)$ . Hence, the steady-state output yields

$$c_{ss} = f_{ss} + \lim_{z \rightarrow 1} \frac{z-1}{z} Z_m \left[ C_1(s) \frac{1}{1 - e^{-Ts}} \right] = f_{ss} + \lim_{z \rightarrow 1} Z_m [C_1(s)],$$

since

$$Z_m \left[ \frac{1}{1 - e^{-Ts}} \right] = \frac{z}{z-1} \Big|_{z=e^{aT}}. \quad (7)$$

Case 2:

$$C(s) = F_1(s) \frac{F_2(e^{\tau_n s})}{1 - e^{-\tau_n s}} = C_1(s) \frac{1}{1 - e^{-\tau_n s}}, \quad (8)$$

the sum of all  $\tau_n$  is less than  $T$ .

In general the steady-state output of (8) is composed of several regions depending on ( $\tau_n$ ); thus in obtaining the modified  $z$ -transform of (8) the several regions should be observed. Mathematically, this indicates that due care should be exercised in observing the convergence of the integral along the infinite semicircle in evaluating (1). This is best illustrated with the given example.

Example a: Consider the steady-state voltage of  $v_0(t)$  across the condenser<sup>4</sup> in Fig. 1(a) for an input of the form of rectified sine wave shown in Fig. 1(b).

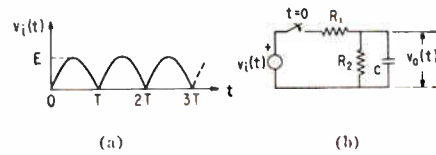

Fig. 1—(a) Rectified sine wave. (b) A parallel RC circuit with series resistance.

$V'_0(s)$  in this example equals

$$V'_0(s) + \frac{K}{s^2 + (\pi/T)^2} \frac{1 + e^{-Ts}}{1 - e^{-Ts}} \times \frac{1}{s+a} \quad (9)$$

where

$$K = \frac{\pi E}{TR_1 C}, \quad a = \frac{R_1 + R_2}{R_1 R_2 C}.$$

The steady-state voltage is given by

$$V'_{0ss} = \lim_{z \rightarrow 1} 2KZ_m \frac{1}{[s^2 + (\pi/T)^2][s+a]},$$

since

$$\lim_{z \rightarrow 1} Z_m [1 + e^{-Ts}] \Big|_{z=e^{Ts}} = 2. \quad (10)$$

$$V'_R^*(z, m) = \frac{1 - z^{-1} + z^{-1} - z^{-1}}{(z-1)(1-z^{-1})}$$

$$- \frac{[1 - e^{-(T-h_1)R/L} z^{-1} + e^{-(T-T_1)R/L} z^{-1} - e^{-(T-T_1-h_2)R/L} z^{-1}]}{(z - e^{-(R/L)T})(1 - z^{-1})} e^{-mTR/L}. \quad (13)$$

The steady-state value

$$v'_{ss} = \left[ 1 - \frac{(1 - e^{-(T-h_1)R/L} + e^{-(T-T_1)R/L} - e^{-(T-T_1-h_2)R/L})}{(1 - e^{-(R/L)T})} e^{-mTR/L} \right], \quad 0 \leq mT \leq h_1 \quad (14)$$

By using partial fraction expansion of

$$\frac{1}{[s^2 + (\pi/T)^2][s+a]}$$

the modified  $z$ -transform can be obtained.<sup>5</sup> The steady-state voltage is obtained by applying the final value theorem.

$$V'_{0ss} = \left[ \frac{K}{a^2 + (\pi/T)^2} \right] \left[ \frac{2e^{-amT}}{1 - e^{-aT}} - \cos \pi m + \frac{aT}{\pi} \sin \pi m \right], \quad 0 \leq m \leq 1. \quad (11)$$

Example b: This example illustrates the application of the theorem to a periodically

varying (cyclic) pulsed system.<sup>6</sup> Obtain the steady-state voltage of  $v_R(t)$  across the resistance shown in Fig. 2(a) for a periodically varying (cyclic) input shown in Fig. 2(b).

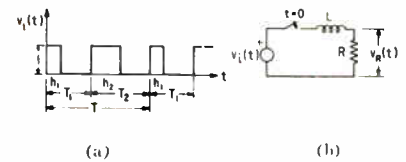

Fig. 2—(a) Periodically time-varying (cyclic) wave. (b) Series RL circuit.

The Laplace transform of the voltage across the resistance,  $R$ ,

$$V'_R(s) = R/L \frac{[1 - e^{-h_1 s} + e^{-T_1 s}(1 - e^{-h_2 s})]}{s(s + R/L)(1 - e^{-Ts})} = \frac{[1 - e^{-h_1 s} + e^{-T_1 s} - e^{-(T_1+h_2)s}]}{s(1 - e^{-Ts})} = \frac{[1 - e^{-h_1 s} + e^{-T_1 s} - e^{-(T_1+h_2)s}]}{(s + R/L)(1 - e^{-Ts})} \quad (12)$$

In this case the steady-state is composed of four regions as follows: I,  $0 \leq mT \leq h_1$ ; II,  $h_1 \leq mT \leq T_1$ ; III,  $T_1 \leq mT \leq h_2 + T_1$ ; IV,  $T_1 + h_2 \leq mT \leq T$ . For region I, the modified  $z$ -transform yields<sup>7</sup>

It is of interest to note that for a fixed pulse-width,  $h_2 = 0$ ,  $h_1 = h$ ,  $T_1 = T$ , the steady-state voltage

$$V'_{ss} = \left[ 1 - \frac{(1 - e^{-(T-h)R/L})}{1 - e^{-(R/L)T}} e^{-mTR/L} \right], \quad 0 \leq mT \leq h. \quad (15)$$

For the continuous case,  $h_1 = T_1 = T$ ,  $h_2 = T = T_1$ , we obtain unity as the steady-state value.

Similarly for regions II, III, and IV the following is obtained for this general case:

<sup>5</sup> E. I. Jury and T. Nishimura, "Analysis of finite pulse systems with periodically varying sampling rate and pulse width," to be published in *Trans. AIEE*, October, 1959.

<sup>7</sup> It should be noted that for region I,

$$Z_m \left[ \frac{e^{-h_1 s}}{s + (R/L)} \right] = Z_m \left[ \frac{e^{-Ts} e^{(T-h_1)s}}{s + (R/L)} \right] = \left[ z^{-1} \frac{e^{-(T-h_1)(R/L)}}{z - e^{-(R/L)T}} e^{-mTR/L} \right].$$

This stems from the consideration of the convergence of the integral in (1) in the left half of the  $p$ -plane (see ref. 2).

<sup>3</sup> J. Cypkin, "Theory of Pulse Systems," State Press for Physics and Mathematical Literature, Moscow, USSR, ch. 4; 1959.

<sup>4</sup> D. K. Cheng, "Analysis of Linear Systems," Addison Wesley Publishing Co., Inc., Reading, Mass., ch. 7; 1959.

<sup>5</sup> It should be noted that  $V'_0^*(z, m)$  can also be obtained by the use of available extensive tables to be found in refs. 2 and 3.

$$v_{ss} = 0 - \left( \frac{1 - e^{h_1 R/L} + e^{-(T-T_1)R/L} - e^{-(T-T_1-h_2)R/L}}{1 - e^{-(R/L)T}} \right) e^{-mTR/L}, \quad h_1 \leq mT \leq T_1; \quad \text{II. (16)}$$

$$v_{ss} = 1 - \frac{[1 - e^{h_1 R/L} + e^{T_1 R/L} - e^{-(T-T_1)R/L}]}{1 - e^{-(R/L)T}} e^{-mTR/L}, \quad T_1 \leq mT \leq T_1 + h_2; \quad \text{III. (17)}$$

$$v_{ss} = 0 - \left( \frac{1 - e^{h_1 R/L} + e^{T_1 R/L} - e^{(T_1+h_2)R/L}}{1 - e^{-(R/L)T}} \right) e^{-mTR/L}, \quad T_1 + h_2 \leq mT \leq T; \quad \text{IV. (18)}$$

A plot of  $v_{ss}$  for the four regions is shown in Fig. 3.

In conclusion, an alternate<sup>8-10</sup> and in some cases a simpler procedure is introduced in this work than is sometimes used for determining the steady-state response.<sup>1</sup> The procedure is based on assuming that the periodic input is described in time which is Laplace transformable and that the system is stable. It might be also mentioned that the procedure introduced has also been applied to obtain a closed form of an infinite convergent Fourier series.<sup>2</sup>

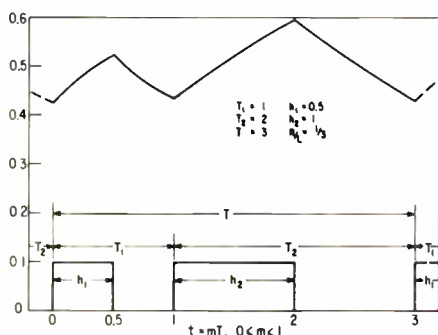

Fig. 3—Steady-state response  $v_{ss}$  of voltage in Fig. 2(a).

ELIAHU I. JURY  
University of California  
Berkeley, Calif.

<sup>8</sup> C. A. Desoer, "Transmission through a linear network containing a periodically operated switch," 1958 IRE, WESCON Convention, pt. 2, pp. 34-41.

<sup>9</sup> S. Seshu and N. Balabanian, "Linear Network Analysis" (book), John Wiley and Sons, Inc., New York, N. Y., ch. 5; 1959.

<sup>10</sup> A. Fettweis, "Steady-state analysis of circuits containing a periodically-operated switch," IRE TRANS. ON CIRCUIT THEORY, vol. CT-6, pp. 252-260; September, 1959.

## WWV and WWVH Standard Frequency and Time Transmissions\*

The frequencies of the National Bureau of Standards radio stations WWV and WWVH are kept in agreement with respect to each other and have been maintained as constant as possible with respect to an im-

proved United States Frequency Standard (USFS) since December 1, 1957.

The nominal broadcast frequencies should, for the purpose of highly accurate scientific measurements, or of establishing high uniformity among frequencies, or for removing unavoidable variations in the broadcast frequencies, be corrected to the value of the USFS, as indicated in the table below.

The characteristics of the USFS, and its relation to time scales such as ET and UT2, have been described in a previous issue,<sup>1</sup> to which the reader is referred for a complete discussion.

The WWV and WWVH time signals are also kept in agreement with each other. Also they are locked to the nominal frequency of the transmissions and consequently may depart continuously from UT2. Corrections are determined and published by the U. S. Naval Observatory. The broadcast signals are maintained in close agreement with UT2 by properly offsetting the broadcast frequency from the USFS at the beginning of each year when necessary. This new system was commenced on January 1, 1960. The last time adjustment was a retardation adjustment of 0.02 s on December 16, 1959.

### WWV FREQUENCY WITH RESPECT TO U. S. FREQUENCY STANDARD

1960 February 1600 UT	Parts in 10 <sup>10</sup> †
1	-145
2	-145
3	-145
4	-145
5	-145
6	-145
7	-145
8	-144
9	-144
10	-145
11	-145
12	-145
13	-145
14	-146
15	-146
16	-146
17	-147
18	-147
19	-147
20	-147
21	-147
22	-147
23	-147
24	-147
25	-146
26	-146
27	-146
28	-146
29	-146

† A minus sign indicates that the broadcast frequency was low.

NATIONAL BUREAU OF STANDARDS  
Boulder, Colo.

<sup>1</sup> "United States National Standards of Time and Frequency, Proc. IRE, vol. 48, pp. 105-106; January, 1960.

## Electronically-Variable Phase Shifters Utilizing Variable Capacitance Diodes\*

In many applications which require electronically-variable phase shifters for operation in the UHF and microwave region, ferrite devices or traveling-wave tubes are not suitable because of excessive weight, size, or demand for control power. The use of variable capacitance diodes for high-frequency phase shifting has been under study for more than a year and has resulted in a compact, fast, and efficient electronically-controlled phase shifter. On the debit side, the device is at present useful only at lower power levels and also has limited phase shift-bandwidth product.

If a transmission line is terminated in a pure reactance, all the energy incident upon the termination is reflected and the phase shift of the reflected wave is a function of the magnitude of the reactance. When the reactive termination is used in a circuit which completely separates the incident and reflected waves (circulator or a properly phased balanced circuit), a variation in the terminating reactance will produce a change in the phase of the reflected output wave and the complete unit will be well matched and efficient.

In practice, two variable capacitance diode terminations have been used with hybrid rings, hybrid junctions, and certain types of 3-db couplers. One of the simplest configurations results if the coupling circuit is a waveguide short-slot coupler or its coaxial or stripline equivalent, as shown in Fig. 1. The phase of the output wave varies as the bias voltage on the diodes is changed. Stripline techniques permit miniaturization, and very little control power is required because of the high reverse impedance of the diodes. Some RF loss is introduced by the spreading resistance of the diodes, but this is not serious if the diode has reasonably high  $Q$ .

In this circuit, the rate of change of phase shift with reactance is greatest at  $X=0$ . Therefore, for maximum phase shift, the diode termination should be adjusted for resonance in the center of the diode's capacity variation range. This can be done by properly adjusting "stubs" behind the diode. Maximum insertion loss also occurs at resonance, so phase shift can be traded, to some extent, for decreased insertion loss.

Phase shifters utilizing variable capacitance diodes have been constructed at 0.5, 1.0, 6.0, and 9.0 kmc. A phase shift of over 180° was obtained with a single unit at 1 kmc, 110° at 6 kmc, and 41° at 9 kmc. Maximum insertion loss varied from 1.2 db at 1 kmc to 3.9 db at 9 kmc, although the latter figure was improved considerably by decreasing phase shift. Fig. 2 shows the phase-shift and insertion-loss variation with bias voltage at 1 kmc.

The data was obtained at a power level of 1 milliwatt using Hughes Products (HPA 2800) diodes. These diodes have a capacity variation from about 2.5 to 1.0  $\mu\mu\text{f}$  with a bias voltage change from 0 to 5 volts; the reverse breakdown voltage is about 7

\* Received by the IRE, March 28, 1960.

\* Received by the IRE, August 24, 1959.

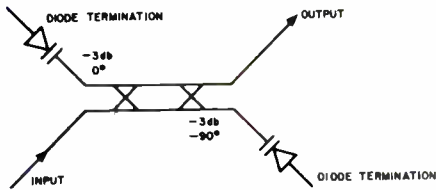

Fig. 1—A variable capacitance diode phase shifter using a 3-dB coupler.

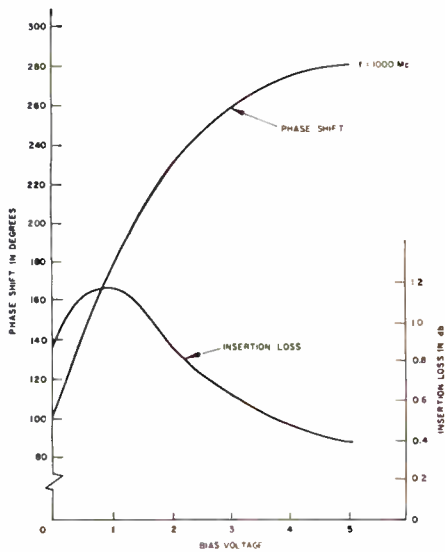

Fig. 2—Phase shift and insertion loss as a function of diode bias at 1 kmc.

volts. The insertion loss of phase shifters using these diodes increases with RF power; at 20 mw, for example, the loss is 6.4 db. This rapid increase in loss at higher powers results in a limiting action and is caused by power loss in harmonic generation and because of the onset of both forward and backward diode conduction.

In order to increase the operating power level of the phase shifter, a high-*Q* variable capacitance diode with a high reverse breakdown voltage is needed. This feature would permit higher RF voltages without driving the diode into conduction, and harmonic generation would be reduced because the capacity variation with voltage would be decreased. Unfortunately, high reverse breakdown voltage and small spreading resistance are somewhat incompatible. However, some improvement over parametric amplifier diodes is possible and further development may improve the power handling capability of the phase shifter. The phase-shift bandwidth product can be increased by the use of several diodes in a traveling-wave circuit.

The diode phase shifter is a compact and very fast device requiring negligible control power. It may be useful in electronically-scanned receiving arrays, in low power satellite transmitting arrays and in many other applications.

R. H. HARDIN  
E. J. DOWNEY  
J. MUNUSHIAN  
Microwave Lab.  
Hughes Aircraft Co.  
Culver City, Calif.

### Gallium Arsenide Microwave Diode at X Band\*

J. J. Wysocki of RCA has kindly supplied us with five of the GaAs microwave diodes described by Jenny<sup>1</sup> in order that we might make measurements at X band.

The measurements were made at 9375 mc and the diodes were matched to the local oscillator. As originally received, the diodes performed rather poorly; typical values of conversion loss *L* and noise temperature ratio *t* were 7 db and 3 times, respectively.

The diodes were then rebuilt by resetting the whisker on the crystal so as to maximize the short-circuit rectified current produced by the local oscillator. Fig. 1 gives the results for a typical rebuilt crystal. Note the lack of bias dependence [Fig. 1(b)]. The best diode (of approximately 15 resets) had an *L* of 5.6 db and a *t* of 1.14 times.<sup>2</sup>

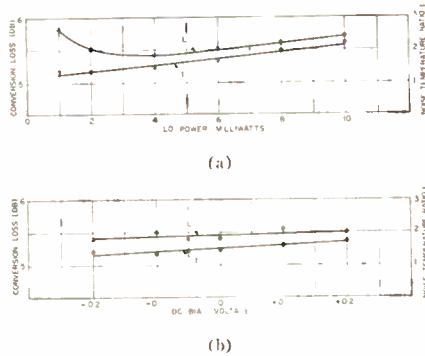

Fig. 1—Performance of typical GaAs microwave diode at X band. (a) The dc voltage bias is constant at zero volts. (b) The LO power is constant at four milliwatts.

Thus it appears that GaAs diodes can be made with *L* and *t* at X band which compare favorably with silicon and germanium diodes. In addition, they are less bias sensitive than germanium diodes and, judging from band-gap data, are promising for high temperature applications.

M. HERNDON  
A. C. MACPHERSON  
U. S. Naval Res. Lab.  
Washington, D. C.

\* Received by the IRE, September 14, 1959.  
<sup>1</sup> D. A. Jenny, "A gallium arsenide microwave diode," *Proc. IRE*, vol. 46, pp. 717-722; April, 1958.  
<sup>2</sup> W. M. Sharpless, "High-frequency gallium arsenide point contact rectifiers," *Bell Sys. Tech. J.*, vol. 38, pp. 259-269; January, 1959.

### A Wide Band Phase Shifter\*

One of the several applications which require a network giving a 90° phase shift over a wide band of frequencies is the phase-cancelling method of single sideband genera-

\* Received by the IRE, October 28, 1959.

tion.<sup>1</sup> There are various networks which give an almost constant phase shift of 90° over the audio band.<sup>2</sup>

The arrangement here described achieves the same end in a novel way. It provides exactly 90° phase shift over a bandwidth determined by the characteristics of the filters used in it.

The signal is mixed in a balanced mixer [① in Fig. 1] with a local oscillation (*f*<sub>0</sub>) of



Fig. 1—90° phase shifter.

higher frequency than the highest modulation frequency used. Of the various combinations and harmonics that result, the upper sideband is selected by a filter. This sideband is then demodulated in each of two balanced mixers [② and ③ in Fig. 1] by mixing again with (*f*<sub>0</sub>) in one case, and by mixing with (*f*<sub>0</sub>) shifted through 90° in the other. Of the resulting combinations and harmonics, the lower sideband is selected in each case, giving the original signal at two outputs differing in phase by 90°. The action should be clear from the diagram.

After mixing in mixer ①, the lower sideband could have been used but in this case, the signal voltage appearing in the modulator output because of lack of balance will not be attenuated in the subsequent filter since this would have to pass frequencies of the same order. This could then be obviated only by raising the local oscillator frequency to a value of at least twice the highest modulation frequency used. This would be undesirable since it would render the separation of desired frequencies close to the local oscillator frequency more difficult.

Band-pass filters would be better than high-pass or low-pass filters because of the presence of harmonics and various other undesired combination frequencies resulting from the modulators. Since the powers involved are quite low, the same techniques can be used as in carrier telephony, whereby simple rectifier modulators may be used, simplifying the apparatus. Clearly, any other desired constant phase shift may be obtained by varying the phase of (*f*<sub>0</sub>) supplied to modulator ③.

Experiments carried out indicate that the method gives the results expected.

Very sincere thanks are due Dr. F. Tank for his constant encouragement and for all the facilities which he has made available.

A. A. AHMED  
Inst. for High Frequency Tech.  
Fed. Inst. Tech.  
Zurich, Switzerland

<sup>1</sup> O. G. Villard, Jr., "A high level single sideband transmitter," *Proc. IRE*, vol. 36, pp. 1419-1425; November, 1948.  
<sup>2</sup> R. B. Dome, "Wideband phase-shift networks," *Electronics*, vol. 19, pp. 112-115, December 1946; H. J. Orchard, "Synthesis of wideband two-phase networks," *Wireless Engr.*, vol. 27, pp. 72-81, March, 1950; and vol. 28, p. 30, January, 1951.



### Bandwidth of Lower Sideband Parametric Up-Converters and Parametric Amplifiers\*

In an article by Rowe,<sup>1</sup> an expression is derived for the gain of a lower-sideband up-converter as a function of a stability factor  $\alpha$  and a frequency factor  $x$ . Because of the complexity of this expression, the bandwidth of the device as a function of  $\alpha$  could not be expressed in closed form. A simplified form of the expression allows the bandwidth to be expressed directly as a function of  $\alpha$ , thereby permitting evaluation of the bandwidth and the (gain)<sup>1/2</sup>-bandwidth product for any value of gain from zero to infinity.

In Rowe<sup>1</sup> an expression for the conversion gain from IF to the lower side frequency was given as follows:<sup>2</sup>

$$G_{IL} = \frac{f_{-m}}{f_{lm}} \frac{4\alpha}{(1-\alpha)^2} \frac{1+x^2}{1 + \frac{(3+\alpha^2)}{(1-\alpha)^2}x^2 + \frac{(3+2\alpha)}{(1-\alpha)^2}x^4 + \frac{1}{(1-\alpha)^2}x^6} \quad (1)$$

where

- $\alpha$  = a stability factor,
- $x$  = the relative frequency deviation,
- $f_{lm}$  = the IF, at midband, and
- $f_{-m}$  = the lower side frequency at midband.

The down-conversion gain is identical to the above expression except that the ratio  $f_{lm}/f_{-m}$  replaces the ratio of  $f_{-m}/f_{lm}$ .

The bandwidth of the system is proportional to  $x_0$ , where  $x_0$  is the value of  $x$  which causes the gain to drop 3 db below its midband ( $x=0$ ) value. It was stated by Rowe<sup>1</sup> that the value of  $x_0$  as a function of  $\alpha$  could not be found in closed form; therefore, two special cases were selected for calculating the bandwidth.

In a separate derivation, the writer of this letter, by a different approach from that used by Rowe, arrived at

$$G_{IL} = \frac{f_{-m}}{f_{lm}} \frac{4\alpha}{(1-\alpha)^2} \frac{1}{1 + \frac{(2+2\alpha)}{(1-\alpha)^2}x^2 + \frac{1}{(1-\alpha)^2}x^4} \quad (2)$$

In seeking compatibility between this expression and that obtained by Rowe, it was found that the numerator of Rowe's expression is a factor of the denominator, and that (1) and (2) are identical.

To find  $x_0$ ,

$$\frac{1}{(1-\alpha)^2}x^4 + \frac{2+2\alpha}{(1-\alpha)^2}x^2 = 1,$$

must be solved for  $x$ . The two real roots are

$$x_0 = \pm \left[ \sqrt{2(1+\alpha^2)} - (1+\alpha) \right]^{1/2} \quad (3)$$

For  $\alpha$  very near unity this reduces to

$$x_0 \approx \pm \frac{1}{2}(1-\alpha)$$

which agrees with Rowe's result.

From (3) the bandwidth and (gain)<sup>1/2</sup>-bandwidth product of the up-converter may be found directly as a function of all values of  $\alpha$  for  $0 \leq \alpha < 1$ , where  $\alpha = 1$  represents the threshold of oscillation.

If the negative admittance at the IF or lower side frequency port is used to give gain by reflection, it develops that when the gain is large compared to unity, the same frequency characteristics apply.

S. T. FISHER  
Research Division  
Philco Corp.  
Philadelphia, Pa.

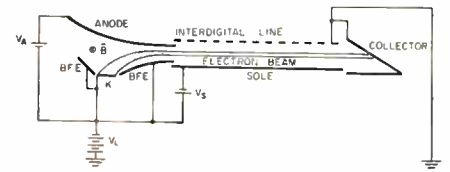

Fig. 1—Schematic of experimental crossed-field backward-wave amplifier.

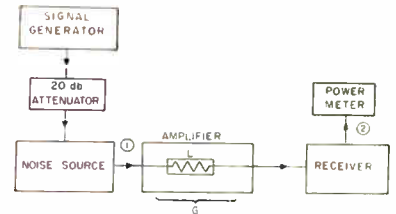

Fig. 2—Experimental arrangement for noise figure measurements.

is approximately one-half that of the sole. An oxide cathode is used in the gun.

Three types of noise measurements have been performed: 1) noise figure, 2) signal-to-noise ratio, 3) velocity spread. A block diagram of the basic arrangement for measuring the noise figure is shown in Fig. 2. Under the conditions that the bandwidth of the receiver is much less than the bandwidth of any of the other components and that the impedance of the noise source as seen by the backward-wave amplifier is matched, the noise figure of the amplifier is expressed as,

$$N.F. = \frac{1}{G} \left[ \frac{\left( \frac{P_{2on}}{P_r} - 1 \right)}{\left( \frac{P_{2off}}{P_r} - 1 \right)} \left( \frac{P_{ns}}{LP_1} \right) + 1 \right]$$

where

- $P_{ns}$  = noise source output power in excess of thermal noise.
- $P_1 = kTB$ , the thermal noise input to the tube under matched conditions.
- $P_{2off}$  = power delivered to the power meter with the electron beam off and the noise source on.
- $P_{2on}$  = power delivered to the power meter with the electron beam on and the noise source off.
- $P_r$  = noise power at the receiver with both electron beam and noise source off.
- $G$  = amplifier gain.
- $L$  = input power/output power is the cold loss through the amplifier.

The results of the measurements are presented in Table I. Accuracy of the noise figure is  $\pm 2$  db, and the 3-db bandwidth of the amplifier is 0.9 per cent of the signal frequency. The dc beam transmission to the collector during these measurements was between 88 and 92 per cent. The receiver bandwidth was 300 kc.

Signal-to-noise ratio measurements were performed for a variety of operating conditions but all with a well-focused electron beam at space-charge limited emission. No distinct coherent sidebands were observed at any appreciable level above the noise output of the tube within a 40-mc band cen-

### Noise Measurements on an M-Type Backward-Wave Amplifier\*

Up to the present time, full utilization of crossed-field amplifiers has not been realized because of the high level of noise output associated with these devices. The noisiness of the crossed-field beam is usually accompanied by large electron currents collected on an electrode, known as the sole, even when it is biased negatively with respect to the cathode. This aspect of the noise behavior has been extensively studied but is not yet fully understood.<sup>1</sup> The purpose of this letter is to report noise measurements that have been made on an experimental M-type backward-wave amplifier. A schematic diagram of the electrode configuration of the device is presented in Fig. 1. The unique feature of this tube is the electron gun design which is based on an analysis by Kino and Kirstein.<sup>2,3</sup> The gun is designed to produce a well-defined, space-charge limited, laminar-flow electron beam with negligible rippling and spread as the beam drifts to the collector. Such beam behavior has been visually observed and is accompanied by negligible sole current. The area convergence of the electron gun is four to one resulting in a beam whose thickness is one-seventh of the line-sole spacing. The width of the beam

\* Received by the IRE, September 28, 1959; revised, October 1, 1959. This work was supported by the Signal Corps, under Contract DA 36-039 SC-74981.

<sup>1</sup> R. P. Little, H. M. Ruppel and S. T. Smith, "Beam noise in crossed electric and magnetic fields," *J. Appl. Phys.*, Vol. 29, p. 1376; September, 1958.

<sup>2</sup> T. Midford and G. S. Kino, "Crossed-field electron guns," presented at the 17th Annual Conf. on Electron Tube Research, Mexico City, Mex.; June 24, 1959.

<sup>3</sup> P. T. Kirstein, "On the determination of the electrodes required to produce a given electric field distribution along a prescribed curve," *Proc. IRE*, Vol. 46, pp. 1716-1722; October, 1958.

\* Received by the IRE, July 10, 1959.  
<sup>1</sup> H. E. Rowe, "Some general properties of nonlinear elements. II. Small signal theory," *Proc. IRE*, pp. 851-860; May, 1958.  
<sup>2</sup> *Ibid.*, (59).

TABLE I

Tube Parameters	Frequency (mc)	Cathode Emission	Noise Figure (db)
Gain = 15.5 to 23.8 db	800	space-charge limited	30.4
$I_{cathode} = 35$ ma	850	space-charge limited	30.6
$B = 125$ gauss	875	space-charge limited	35.0
Pressure = $5 \times 10^{-7}$ mm Hg	900	space-charge limited	36.6
Gain = 10 db	800	space-charge limited	27.3
$I_{cathode} = 10$ ma	800	temperature limited	24.3
$B = 135$ gauss			
Pressure = $5 \times 10^{-7}$ mm Hg			

TABLE II

Frequency (mc)	Cathode Current (ma)	Input Power Level (dbm)	Gain (db)	Signal Noise (db)
870	40.7	36.6 (tube saturated, output = 15 watts cw)	5	65
790	30.0	8.8	9	50
795	45.0	-0.2	11	48
785	30.0	-51.4	16	40

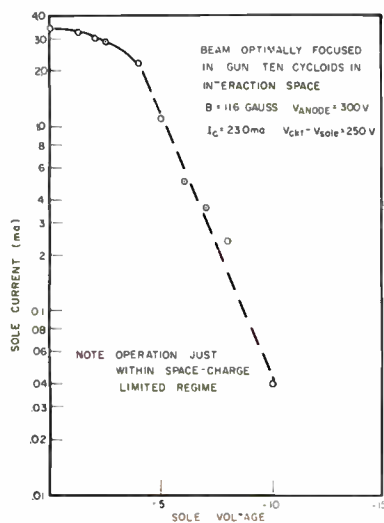

Fig. 3—Sole current distribution.

tered about the signal frequency. The results of these measurements are summarized in Table II. The measured signal-to-noise ratios are in the same range as has been reported for a forward-wave *M*-type amplifier.<sup>1</sup> The significance of the results presented in Table II is that this type of amplifier can maintain good sensitivity over an extremely wide range of input signal level.

Finally, a few measurements of the velocity spread in the electron beam have been achieved. For space-charge limited conditions and a well-focused beam in the gun region, the line-sole electric field was decreased so that the beam path in the drift region came close to the sole. The beam thickness remained approximately constant throughout the drift region. The velocity spread in the beam can then be estimated from the sole current-sole voltage distribution. This distribution was found to be not half-Maxwellian, as can be seen in Fig. 3. However, the distribution is approximately half-Maxwellian at low sole currents and on this basis, the equivalent temperature of the electron beam is 40,900°K. This corresponds

<sup>1</sup> O. Doehler, A. Dubois, and D. Maillart, "An *M*-type pulsed amplifier," *Proc. IRE*, part B, suppl. no. 10, vol. 105, pp. 454-457; May, 1958.

to a decrease of sole current by a factor *e* at a sole potential of -1.5 volts. From these measurements, it is concluded that even with an electron gun which produces a well-focused laminar beam the characteristic energy spread of crossed-field tubes is still present, although perhaps to a lesser extent than in similar tubes employing less well-behaved beams.

However, the noise figure and signal-to-noise ratio of this *M*-type backward-wave amplifier has been measured and is found to be of the same magnitude as in *O*-type tubes when attention was first directed toward their noise problem. No attempt was made to design the present tube for low noise output. Therefore, it is entirely possible that the noise figure of an *M*-type backward-wave amplifier, utilizing a well-behaved beam, can be reduced further.

The helpful discussions and assistance of C. K. Birdsall, H. L. Jory, T. Van Duzer, and J. R. Whimery are gratefully acknowledged.

J. R. ANDERSON  
Electronics Res. Lab.  
Dept. of Elec. Engrg.  
University of California  
Berkeley, Calif.

### On the Start Oscillation of the *O*-Type Backward Wave Oscillator\*

The conditions that the *O*-type backward wave oscillator satisfy at the start of oscillation are such that  $\theta$  and *CN* satisfy the following:

$$\eta^3 - 2\theta\eta^2 + (\theta^2 - H^2)\eta + (2\pi CN)^3 = 0, \quad (1)$$

where the roots of (1),  $\eta_1$ ,  $\eta_2$ , and  $\eta_3$  must satisfy

$$\frac{\eta_3 - \eta_2}{\eta_1} e^{j\eta_1} \cos 2 + \frac{\eta_1 - \eta_3}{\eta_2} e^{j\eta_2} + \frac{\eta_2 - \eta_1}{\eta_3} e^{j\eta_3} = 0;$$

\* Received by the IRE, August 13, 1959.

and

$$\begin{aligned} \theta &= (\beta_i - \beta_e)L, \\ H &= \omega_p L / u_0, \\ CN &= \text{the } CN \text{ parameter of Pierce's,} \\ \beta_e &= \text{propagation constant of the unperturbed circuit wave,} \\ \beta_i &= \omega / u_0, \\ u_0 &= \text{electron drift velocity,} \\ L &= \text{length of interaction space,} \\ \omega_p &= \text{plasma frequency of the beam,} \\ \omega &= \text{tube oscillation frequency.} \end{aligned}$$

Among the various discussions of the solutions of (1), Heffner<sup>1</sup> gave the numerical values of  $\theta$  corresponding to the first two oscillation modes (designated *n*=0 and 1 modes) for values of *H* ranging from 0 to 10. Gould<sup>2</sup> further gave the asymptotic solutions for  $H \gg 1$  in the terms of a coupled-mode theory. Physically, this corresponds to the asymptotic case in which the space charge density of the electron beam is so high that the propagation constants of the unperturbed slow and fast space-charge waves are far enough apart that the fast space-charge wave can be neglected in so far as the interaction between the slow space-charge wave and the backward circuit wave is concerned. Heffner's and Gould's results are reproduced in Fig. 1.

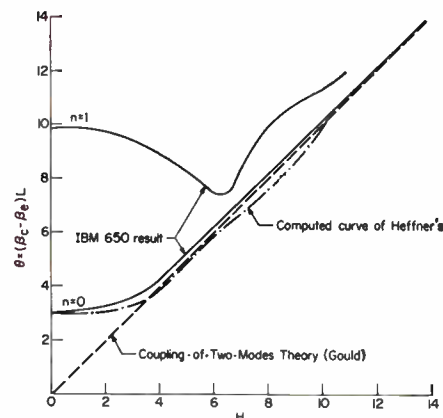

Fig. 1—Start-oscillation frequency condition of a matched backward-wave oscillator.

In connection with a recent study of some anomalous behavior of backward-wave oscillators, we had the occasion to obtain the solution of (1) on the IBM 650 computer.<sup>3</sup> The result thus obtained (see Fig. 1) showed an interesting disagreement with Heffner's result. Although the quantitative discrepancy is small, the physical meaning of this discrepancy seems significant. It is noticed that for the lowest mode (*n*=0), Heffner's curve intersects the asymptotic two-wave solution of Gould at  $H \approx 3.5$ . For  $H > 3.5$  the value of  $\theta$  according to Heffner's result becomes less than the asymptotic solution. The

<sup>1</sup> H. Heffner, "Analysis of the backward-wave traveling-wave tube," *Proc. IRE*, vol. 42, pp. 930-937; June, 1954.

<sup>2</sup> R. W. Gould, "A coupled mode description of the backward-wave oscillation and the Kompier dip condition," *IRE TRANS. ON ELECTRONIC DEVICES*, vol. ED-2, pp. 37-42; October, 1955.

<sup>3</sup> Details are available in C. L. Tang, "Backward Wave Oscillator Mismatching and Spurious Oscillations," Res. Div., Raytheon Mfg. Co., Waltham, Mass., Rept. No. R-42; 1959.

curve corresponding to the IBM 650 result, however, lies above the asymptotic two-wave solution for all values of  $H$  and asymptotically approaches the latter from above as  $H$  increases. In view of the previous discussion about the physical meaning of the solutions of (1) and the asymptotic two-wave solution of Gould, the implication of the discrepancy is immediately clear. Our result indicates that the effect of the fast space-charge wave on the interaction of the slow space-charge wave and the backward circuit wave is largest when the phase velocities of the three waves are the closest, or  $H$  is small. As  $H$  increases, or as the phase velocity of the fast space charge wave becomes increasingly faster than the synchronous phase velocity of the circuit wave and the slow space-charge wave, the interaction between the latter two is affected less and less by the fast space-charge wave. Such an effect is, however, always present.

Heffner's result indicates, on the other hand, that the effect of the fast space-charge wave on the interaction of the circuit wave and the slow space-charge wave is opposite for  $H < 3.5$  and  $H > 3.5$ . ( $\theta$  increases or decreases for  $H < 3.5$  or  $H > 3.5$ , respectively, because of the presence of the fast space-charge wave.) At  $H \approx 3.5$ , the fast space-charge wave has no effect on the interaction of the circuit wave and the slow space-charge wave in so far as  $\theta$  (or, equivalently, the tube oscillation frequency) is concerned. On purely intuitive grounds, it seems also that our IBM 650 result is the more reasonable of the two.

C. L. TANG  
Res. Div.  
Raytheon Manufacturing Co.  
Waltham, Mass.

**Negative Resistance in Transistors Based on Transit-Time and Avalanche Effects\***

In this communication, we propose a simple semiconductor device which should exhibit a negative resistance characteristic at frequencies of the order of the carrier inverse transit time in the space-charge or depletion region of a reverse-biased  $p-n$  collector junction. Previously, others have proposed negative resistance structures using transit-time effects<sup>1</sup> or both transit-time effects and avalanche multiplication.<sup>2</sup> We also use the latter combination in our device. Our device, structurally speaking, is identical to a transistor; however, it requires a rather small collector capacity and extrinsic base resistance.

The basic idea underlying its operation is as follows: Consider a grounded-base transistor biased at the emitter with a direct current source which produces the usual minority carrier distribution in the base region. The collector junction is reverse biased. The collector-base terminals are the two terminals at which the active impedance is to be produced. Suppose, now, that an alternating voltage of high frequency (far exceeding the  $\alpha$ -cutoff) is applied to the collector. In response to this, the boundaries of the collector space-charge region will pulsate in position at the same frequency. We are interested in the oscillation of the latter, the injected emitter minority current entering the space-charge region and flowing to the collector is modulated at the plane of the space-charge boundary. If the frequency and amplitude are high enough, the minority carriers will fail to follow the moving space-charge edge and the above current will actually be "bunched." For the small signal case, however, only a sinusoidal modulation of the direct current will be produced. We consider the latter case in this communication. For a suitably chosen collector bias voltage, near avalanche breakdown, this alternating component of particle current, when it arrives at the collector junction, will give rise to an additional (multiplied) particle current consisting of the opposite type carrier. This multiplied component will dominate the injected component in magnitude when the avalanche multiplication factor exceeds two. Because of the finite carrier transit time through the space-charge region (from the edge to the junction plane), there will be frequencies at which the multiplied particle current (or a component of it) is 180° out of phase with the collector signal. At these frequencies, a negative resistance will be produced which may be utilized in amplifiers and oscillators.

OUTLINE OF ANALYTIC TREATMENT

Fig. 1 shows a schematic sketch of a  $p-n-p$  alloyed transistor which will serve as our model. Denote the width of the space-

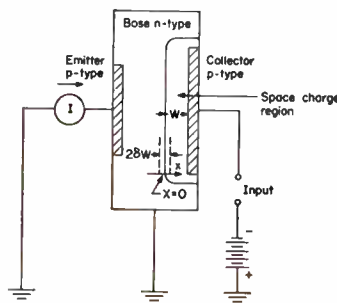

Fig. 1—Schematic presentation of device.

charge region in the base- or  $n$ -region by  $W$  and let the amplitude of its boundary modulation produced by an applied collector signal be called  $\delta W$ . We assume that at the instantaneous edge of this boundary, the injected hole density produced by the emitter

bias current is approximately zero. An approximate solution of the diffusion equation in the base region gives

$$p(x) = -\frac{J_{dc}}{qD}x - \frac{J_{dc}\delta W'}{qD} \cdot \exp\left(\sqrt{\frac{\omega}{2D}}(1-i)x\right) \exp(-i\omega t) \quad (1)$$

In (1),  $J_{dc} = I_{dc}/A$  is the density of the injected minority carrier current  $I_{dc}$  entering the space-charge region, where  $A$  is the cross-sectional area. In the usual notation,  $q$  is the electronic charge,  $D$  the diffusion constant of holes,  $\omega$  the frequency, and  $t$  is the time.

From (1), one obtains the alternating particle current density  $j_i$  entering the space-charge region at approximately  $x=0$

$$j_i = -qD \frac{\partial p}{\partial x} \Big|_{x=0} = J_{dc}\delta W' \sqrt{\frac{\omega}{D}} \exp\left(-\frac{i\pi}{4}\right) \exp(-i\omega t) \quad (2)$$

This particle current gives rise to a space-charge wave which travels to the collector junction and produces an additional multiplied component consisting of electrons which travel back in the reverse direction. Assuming that the multiplication takes place at the collector junction plane  $x=W$  and that the drift velocity is constant and saturated at a constant value  $v$ , then the space-charge wave is given by

$$\rho(x) = \frac{j_i}{v} [\exp ikx - \bar{m} \exp -ik(x-2W)] \cdot \exp -i\omega t \quad (3)$$

where  $k = \omega/v$ ,  $\bar{m} = m-1$ , and  $m$  is the avalanche multiplication factor.

The calculation proceeds now as follows: Using Poisson's equation, we can obtain from (3) an additional voltage developed across the space charge. For the integration we assume zero electric field at the base-side edge of the space-charge region. We also assume that  $\rho$ , as given by (3), is small as compared to the built-in space charge resulting from the ionized donor atoms. We designate this additional voltage by  $V_{particle}$ . Similarly, we can calculate an additional current density  $j_{particle}$  consisting of the true particle current and a displacement current. Since it is immaterial where this current is calculated, we chose the plane  $x \approx 0$ . At this plane, the additional displacement current vanishes. The total impedance looking into the base-collector terminals thus may be written

$$Z = \frac{1}{A} \frac{V_{displacement} + V_{particle}}{j_{displacement} + j_{particle}} \approx \frac{V_{displacement}}{j_{displacement} A} + \frac{V_{particle}}{j_{displacement} A} - \frac{V_{displacement} j_{particle}}{(j_{displacement})^2 A} \quad (4)$$

In (4),  $V_{displacement}$  and  $j_{displacement}$  are the voltage and the current density which would be produced in the absence of any injected current by the oscillating space-charge edge. In the expansion (4), which holds for sufficiently small injected current, the first term is simply the usual space-charge capacitive

\* Received by the IRE, August 27, 1959; revised, October 2, 1959.

<sup>1</sup> W. Shockley, "Negative resistance arising from transit time in semiconductor diodes," *Bell Sys. Tech. J.*, vol. 33, pp. 799-826; July, 1954.

<sup>2</sup> W. T. Read, Jr., "A proposed high-frequency, negative-resistance diode," *Bell Sys. Tech. J.*, vol. 37, pp. 401-446; March, 1958.



term of the collector junction  $(-i\omega\epsilon_1/W)^{-1}$ , which is purely reactive. The remaining two terms are contributions of the injected mobile charge. By carrying out the above outlined integration, we obtain from these latter two terms the additional impedance

$$Z_{\text{add}} = \frac{I_{dc}W^3}{A^2\sqrt{D\tau\epsilon^2\rho_f}} \left\{ \frac{\exp\left(-i\frac{\pi}{4}\right)}{\sqrt{\omega\tau}} \cdot \left[ \frac{(\exp i\omega\tau - 1)}{i(\omega\tau)^2} (\exp i\omega\tau) \right] \right\} \quad (5)$$

The quantity in the curly brackets denoted  $f(\omega\tau)$ , is plotted in Fig. 2 as a function of

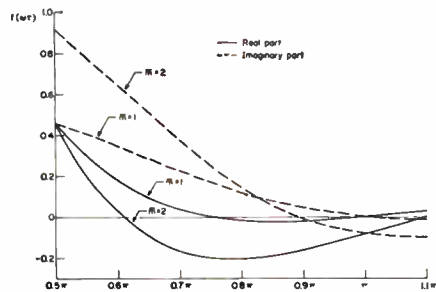

Fig. 2—Real and imaginary parts of  $f(\omega\tau)$ .

$\omega\tau$  for  $\bar{m}=1$  and  $\bar{m}=2$ . It is seen that at approximately  $\omega\tau=0.8\pi$  and  $\bar{m}=2$  there is a negative resistance region. The magnitude of the negative resistance, according to (5), obviously increases linearly with bias current.

Table I, below, summarizes the results of a calculation of the real and imaginary parts of  $Z$  at  $\omega\tau=0.8\pi$  for two arbitrary

TABLE I  
SEVERAL EXAMPLES OF  $Z$  COMPUTED  
FOR GERMANIUM

	Case I	Case II
Base resistivity $n$ -type (ohm-cm)	2.5	0.35
Donor density (cm <sup>-3</sup> )	$7 \times 10^{14}$	$5 \times 10^{13}$
Avalanche breakdown (volts)	200	40
Collector bias (volts)	180	36
Avalanche multiplication factor $m$	3	3
Space-charge width $W$ (cm)	$2 \times 10^{-3}$	$3.3 \times 10^{-3}$
Transit time $\tau$ (sec)	$3 \times 10^{-10}$	$5 \times 10^{-11}$
Frequency at which $\omega\tau=0.8\pi$ (kinc)	1.3	7.8
Bias current $I_{dc}$ (ma)	0.6	2.5
Collector diameter (cm)	$1.25 \times 10^{-2}$	$5 \times 10^{-3}$
Negative resistance (ohms)	-96	-24
Capacitive reactance (ohms)	1500	160

cases for a germanium structure. To get the actual impedance of an idealized three-dimensional structure, one must add to  $Z$  the extrinsic base resistance  $r_b'$ . Thus for values of  $r_b' < 96$  ohms, a negative real part will be exhibited by the structure of Case I.

There remains one additional point to investigate, namely, the effect of the modulation of the avalanche multiplication fac-

tor  $m$  by the varying collector voltage. Since  $m$  is voltage dependent, an additional alternating component of space-charge current will be generated at the collector junction by the interaction of the bias current  $I_{dc}$  and the time-varying  $m$ . It can be shown rather straightforwardly that this contributes a term to  $Z$  given by

$$Z_{\text{multiple}} = \frac{W^4 I_{dc} \left(\frac{dm}{dV}\right)}{\epsilon^2 v^2 I^2} \frac{(\exp i\omega\tau - 1)}{i(\omega\tau)^3} \quad (6)$$

This term, however, contributes a positive real part at  $\omega\tau=0.8\pi$ . Putting in numbers for the two examples illustrated previously, we obtain real parts of 33 ohms and 20 ohms for Cases I and II, respectively. It is seen that for the higher-frequency example, the positive resistance becomes rather large and almost compensates the calculated negative resistance.

It should be mentioned at this point that one may use, however, only  $Z_{\text{multiple}}$  of (6) in a sample in which the space-charge boundary is not allowed to oscillate. Such a case is practically found in diffused base transistors. Then,  $\omega\tau$  has to be chosen to lie in a range between  $\pi$  and  $2\pi$ . For a given current level, the amount of negative resistance obtainable is smaller than the values quoted in Table I.

#### DISCUSSION

It appears entirely possible to obtain a negative resistance at microwave frequencies with transistor-like structures using a combination of avalanche multiplication and transit-time effects. It is quite feasible in practice to realize low enough extrinsic base resistances which will not mask the calculated negative resistance effect. The carrier diffusion time through the neutral part of the base region is unimportant in the proposed device.

The required dc power levels, because of the rather high collector bias voltages needed (near avalanche breakdown) and relatively large currents, are of the order of a fraction of a watt for the examples cited. Provisions for rapid heat dissipation are therefore required. A decrease in this power requirement can be had, of course, by a reduction in the area, but only at the expense of a higher impedance level. For one of the examples discussed, Case I, a desirable impedance level was attained at 1300 mc with a collector diameter of  $1.25 \times 10^{-2}$  cm (5 mils). Higher-frequency units naturally require smaller diameters.

The use of avalanche multiplication unfortunately restricts the allowable voltage amplitude at the collector for linear operation. In addition, the avalanche mechanism is known to introduce excess noise. It has also been assumed that avalanche multiplication has a build-up time shorter than the discussed inverse frequencies.

HERMAN N. STATZ  
ROBERT A. PUCCEL  
Research Div.  
Raytheon Co.  
Waltham, Mass.

#### Charge Analysis of Transistor Operation\*

Beaufoy and Sparkes<sup>1</sup> have pointed out the usefulness of the charge concept in the analysis of transistor operation. One of the principle virtues of this method is that the time-dependent behavior of the transistor can be calculated from a knowledge of the dc properties of the device. In this note, we give a more general derivation of the basic equation used in charge analysis.

Consider a neutral region where  $n$  is the density of excess carriers of either sign in that region. Continuity requires

$$-\nabla \cdot J_n = \frac{n}{\tau} + \frac{\partial n}{\partial t} \quad (1)$$

where  $J_n$  is the particle current density and  $\tau^{-1}$  is the recombination rate. Integrating (1) over the volume of the region, and assuming  $\tau$  is constant in the region, we have

$$-\int \nabla \cdot J_n dV = \frac{N}{\tau} + \frac{\partial N}{\partial t} \quad (2)$$

where  $N = \int n dV$  is the total number of excess carriers of a given sign in the region. By Gauss' theorem we have

$$\Delta I = \frac{N}{\tau} + \frac{\partial N}{\partial t} \quad (3)$$

where  $\Delta I$  is the net particle current of a given type into the region. Multiplying through by  $q$ , the electronic charge, we finally have

$$q\Delta I = \frac{Q}{\tau} + \frac{\partial Q}{\partial t} \quad (4)$$

where  $Q = qN$  is the total excess charge of either type in the region. Eq. (4) is the basic equation used in charge analysis. It is dependent only on the recombination model used and is independent of any of the other details of the region such as geometry, aiding or retarding fields, conductivity modulation, etc. Since the region is neutral, we may consider either majority or minority carrier flow at our convenience.

Under dc conditions, the charge in the base is given by

$$\frac{Q}{\tau} = \frac{1-\beta}{\beta} I_c = \gamma(1-\beta)I_c = \frac{\gamma(1-\beta)}{1-\alpha} I_B$$

where  $\beta$  is the base transport factor and  $\gamma$  the emitter efficiency. Defining the transit time<sup>2</sup> as the ratio of base charge to collector current, we have

$$\tau_t = \frac{(1-\beta)\tau}{\beta}$$

\* Received by the IRE, October 21, 1959.  
<sup>1</sup> R. Beaufoy and J. J. Sparkes, "The junction transistor as a charge-controlled device," *AT&T J.*, vol. 13, pp. 3-20, October, 1957; also in *Proc. IRE*, vol. 45, 1740-42, December, 1957. For a discussion of charge control in various devices, see E. O. Johnson and A. Rose, "Simple general analysis of amplifier devices with emitter, control, and collector junctions," *Proc. IRE*, vol. 47, pp. 407-418; March, 1959.

<sup>2</sup> L. J. Varnerin, "Stored charge method of transistor base transit analysis" *Proc. IRE*, vol. 47, pp. 523-527; April, 1959.

As an example of the charge method of analysis, we calculate the transient response of a grounded emitter transistor to a step in base current. For simplicity, we neglect the charging of the collector capacitance. We then have

$$q\Delta I = I_B - (1 - \gamma)I_c = \gamma I_B - (1 - \gamma)I_c$$

$$= \frac{Q}{\tau} + \frac{\partial Q}{\partial t} \quad (5)$$

At dc,  $Q = \tau I_c$ . We assume that  $Q(t) = \tau I_c(t)$  at all times; i.e., the collector current is proportional to the total charge in the base and is not dependent upon its distribution.

Then (5) becomes

$$\left(\frac{\alpha}{1 - \alpha}\right) I_B = I_c + \frac{1}{\omega} \frac{\partial I_c}{\partial t} \quad (6)$$

where

$$\omega = \frac{1 - \alpha}{(1 - \beta)\tau} = \frac{1 - \alpha}{\beta\tau_i}$$

For  $I_c(0) = 0$ , we have

$$I_c(t) = \left(\frac{\alpha}{1 - \alpha}\right) I_B(1 - e^{-\omega t})$$

This agrees with the usual expression where the delay time,  $t^*$  has been neglected. By this treatment, however, we see that reducing the emitter efficiency is equivalent to a feedback that reduces the gain, but increases the frequency response, of a grounded emitter transistor.

A. N. BAKER  
Bell Telephone Labs., Inc.  
Murray Hill, N. J.

### Determination of the Orbit of an Artificial Satellite\*

Two recent letters have considered the determination of the orbit of an artificial satellite by means of multi-station Doppler tracking systems. In the first,<sup>1</sup> a system was indicated which was independent of the initial ranges, and could therefore be utilized to acquire as well as track vehicles in space, without previous position information. In the second,<sup>2</sup> it was pointed out that such a system would be open and require iteration, unless one relation in addition to the Doppler equations was obtained. This follows immediately from the fundamental relations for  $n$  stations and  $m$  successive time intervals:

$$\Delta R_{ij} = R_{i1} - R_{ij} \quad i = 1, \dots, n \quad (1)$$

$$j = 1, \dots, m$$

where the  $R_{ij}$  are the slant ranges, the  $\Delta R_{ij}$  are the range increments, obtained from the Doppler data, and  $R_{i1} = R_i$  are the initial ranges. Eq. (1) will result in  $n-1$  equations in  $n$  unknowns. This clearly shows the need for an outside condition on the ranges.

As observed by Carrara, Checchacci and Ronchi, any of the  $R_{i1}$  may be expressed in terms of the remaining initial ranges; thus, one initial range in (1) may be expressed as a function of the other  $n-1$  initial ranges. Recent work in this laboratory,<sup>3,4</sup> based upon these observations, has resulted in a solution of (1) for the ranges. The result derives from the existence of a geometrical relation among ranges to four stations in an arbitrary configuration in a common ground plane from a point in space.

The work may be outlined as follows. Writing the equations for four stations arranged in a cross as

$$(x_j \pm a)^2 + y_j^2 + z_j^2 = R_{ij}^2, \quad i = 1, 2 \quad (2)$$

$$j = 1, 2, 3, \dots$$

$$x_j^2 + (y_j \pm a)^2 + z_j^2 = R_{ij}^2, \quad i = 3, 4 \quad (3)$$

$$j = 1, 2, 3, \dots$$

and combining (2) and (3), one obtains the geometrical property

$$R_{1j}^2 + R_{2j}^2 = R_{3j}^2 + R_{4j}^2 \quad (4)$$

Since this is a purely geometrical relation, it holds for any  $j$ . As the difference of any two successive time-dependent values of any  $R_{ij}$  is equal to a range increment, proportional to the Doppler data obtained during the interval, one can write, for four successive observations:

$$(R_1 + \Delta R_{1j})^2 + (R_2 + \Delta R_{2j})^2 =$$

$$(R_3 + \Delta R_{3j})^2 + (R_4 + \Delta R_{4j})^2$$

$$j = 1, 2, 3, 4. \quad (5)$$

These may be linearized by use of (4); the resulting equation may be solved for the  $R_i$  and, with these, the succeeding ranges are obtained from (1). For a particular  $j$  any three of the four  $R_{ij}$  will serve to find the coordinates,  $x_j, y_j, z_j$  from (2) and (3). The Jacobian of this transformation yields a criterion for choosing the three  $R$ 's resulting in the most accurate values of  $x_j, y_j, z_j$ .

These results may be generalized to include an arbitrary configuration of stations in the ground plane.

PETER L. BESAG  
JULIAN T. ANDERSON  
Philco Western Dev. Labs.  
Palo Alto, Calif.

### Radiation Damage and Transistor Life in Satellites\*

Evidence in support of a region of intense nuclear radiation surrounding the earth became indisputable with the flight of the satellite 1958 $\epsilon$  [1] on July 26, 1958, in the wake of 1958 $\alpha$  and  $\gamma$ . Several theories of the origin and nature of the radiation were proposed, each of which would partially remove the ambiguity of the particles comprising the radiation and allow an estimate of radiation damage. Equal *a priori* weight was attached to theories suggesting protons [2] and electrons [3]. Further uncertainty arose when the results [4] of the Pioneer I flight (October 1958) were compared with previous results. The interpretational difficulties imposed by this mass of data were resolved for altitudes below 1200 km by the experiment reported by Freden and White [5]. In this experiment a stack of nuclear emulsions was carried to an altitude of 1230 km and recovered after the flight. Analysis of the tracks in the emulsions verified that protons comprise the inner charged particle radiation band and permitted an accurate estimate of the energy spectrum.

The Freden and White proton-energy spectrum has been employed as the basis for estimating the rate of atomic displacements produced in silicon and germanium transistors during exposure to the inner charged particle belt. Previous estimates [6], by failing to account properly for the importance of high energy protons in producing displacements, have yielded displacement production rates far lower than those obtained here. The present estimates are also in better agreement with the limited experimental data for radiation damage produced by high energy protons.

In calculations of radiation damage to semiconductors, e.g., Si or Ge, the practice has been to consider atomic displacements only and to ignore all but the Rutherford-type energy losses of the incident particle and successive knock-on Si or Ge atoms. The effect of inelastic ( $n, n'\gamma$ ) nuclear encounters has usually been dismissed on the grounds that the cross section for these events is relatively small at the energies usually considered and, moreover, is assumed to have a  $1/E$  dependence, presumably well above their threshold.

Above 20 mev, however, nonelastic encounters (e.g., neutron and charged particle emission) become of increasing importance [7]. Above 100 mev (which embraces almost 50 per cent of the radiation belt protons), nuclear disintegrations begin to dominate in importance over all other interactions, with increasing production of "stars" or small-scale spallation effects. Monte Carlo calculations based on high-energy "evaporation" models [8]-[17] and the phenomenological data obtained, mainly from analyses of nuclear emulsion events, indicate the importance of these phenomena in producing atomic displacements. These displacements occur not because of the knock-ons produced by incident protons,

\* Received by the IRE, September 8, 1959.

\* Received by the IRE, November 5, 1959.  
<sup>1</sup> N. Carrara, P. F. Checchacci and L. Ronchi, "Determination of the Orbit of an Artificial Satellite," PROC. IRE, vol. 47, p. 75; January, 1959.  
<sup>2</sup> J. T. Anderson, "Determination of the Orbit of an Artificial Satellite," PROC. IRE, vol. 47, pp. 1658-1659; September, 1959.

<sup>3</sup> P. T. McCormick, "Tracking of a CW Transmitter-Carrying Vehicle with a Four-Station System by Utilizing the Doppler Effect," Philco WDL Memo; August, 1959.  
<sup>4</sup> C. H. Dawson, "A Note on Radial Coordinates," Philco WDL Memo; September, 1959.

but by virtue of the nuclear disintegrations in which they give rise to neutrons, protons, alphas, etc., of just about the right energy (5–20 mev) to produce a large number of atomic displacements by Rutherford collision within a thin Si or Ge wafer.

This is of importance, *a fortiori*, when it is contrasted with the small energy loss of an incident proton of 100 mev and more when it passes through the material in which the possibility of nuclear disintegrations has not been included. Smoluchowski reports on the results of irradiation of alkali halides with 100–400 mev protons [18] and concludes that at high energy the radiation effects caused by the secondary nucleons originating in the “inelastic” collisions are at least as important, if not more so, than those produced directly by elastic collisions of the incident protons.

For the reasons given, we have divided the problem into two parts:

- 1)  $E < 100$  mev,
  - 2)  $E > 100$  mev.
- 1)  $E < 100$  mev

Each primary knock-on energy  $E$  produces  $E_p/2E_d$  displacements [19], where  $E_d$  is the displacement energy which has been variously estimated as between 12–30 ev for Si and Ge [19], [20]. In calculating the total number of atomic displacements per target atom, the contributions of the primaries and successive knock-ons of lower order are summed separately; *i.e.*,  $N_d$  = primary displacements + progeny displacements. These relations are found [19], [20] to be:

$$N_d = \int_{E_d}^{E_{max}} N_p dE_p + \int_{2E_d}^{E_{max}} N_p \frac{E_p}{2E_d} dE_p$$

$$= \frac{CN_i}{E_i E_d} \left( 1 + \frac{1}{2} \ln \frac{E_{max}}{2E_d} \right);$$

where

$$C = \pi \left( \frac{Z_1 Z_2 e^2}{A_1 + A_2} \right)^2 A_1 A_2$$

- $N_i$  = Incident flux,
- $E_i$  = Energy of incident particle,
- $N_d$  = Rate of atomic displacement.

The results of our calculations at an altitude of 1200 km appear in Table I. The estimates are conservative in view of the  $1/E_i$  dependence assumed.

- 2)  $E > 100$  mev

The number of defects/cm<sup>3</sup> produced by high-energy protons cannot be determined accurately because the exact mechanism of defect production by the nuclear fragments is not sufficiently well known to permit quantitative evaluation. We rely for the present, therefore, on experimental results obtained with NaCl and KCl [18], [22] which indicate that 1000 to 5000 defects per cm<sup>3</sup> are formed by each incident proton per cm<sup>2</sup> above 100 mev. At an altitude of 1200

TABLE I

	$N_d$ /proton/cm <sup>3</sup>		$N_d$ /cm <sup>2</sup> -sec	
	$E_d = 25$ ev	$E_d = 12\frac{1}{2}$ ev	$E_d = 25$ ev	$E_d = 12\frac{1}{2}$ ev
Silicon	600	1200	.45 × 10 <sup>6</sup>	.92 × 10 <sup>6</sup>
Germanium	1000	2200	.75 × 10 <sup>6</sup>	1.7 × 10 <sup>6</sup>

TABLE II

	$N_d$ /cm <sup>2</sup> -sec		$N_d$ /proton/cm <sup>3</sup>	
	$E_i = 25$ ev	$E_i = 12\frac{1}{2}$ ev	$E_i = 25$ ev	$E_i = 12\frac{1}{2}$ ev
Silicon	0.85 × 10 <sup>6</sup>	1.7 × 10 <sup>6</sup>	1500	3000
Germanium	1.7 × 10 <sup>6</sup>	3.4 × 10 <sup>6</sup>	3000	6000

TABLE III

	$N_d$ /proton/cm <sup>2</sup>	$N_d$ /cm <sup>2</sup> -sec (1200 km)
Silicon	2000	2.6 × 10 <sup>6</sup>
Germanium	4000	5.1 × 10 <sup>6</sup>

km, an omnidirectional flux of 560 protons/cm<sup>2</sup>/sec above 100 mev produces about 2–4 × 10<sup>6</sup> defects/cm<sup>3</sup>/sec. Evidently, far from ignorable [6], each proton above 100 mev will form 1–5 times as many defects per cm<sup>3</sup> as the lower energy (1–20 mev) particles usually considered important. Since the nonelastic collision cross section for “star” reactions varies approximately as  $.12^{2/3}$ , the defect density from the high energy protons in Ge will be about twice that in Si. This is probably an underestimate since the fragments in the case of Ge will consist on the average of a higher mass with resultant increased ability to produce defects. Corresponding to the tabulated results for the lower energy proton component, the results for the protons above 100 mev at 1200 km are shown in Table II. The total damage rates, assuming a 12½ ev displacement energy are shown in Table III.

In order to estimate transistor lifetime, a criterion of damage must be decided upon. There are a number of possibilities. Without discussing the relative merits of each, it seems somewhat more desirable to draw upon the vast quantity of data from reactor irradiation of semiconductors, because the local defect distribution produced by protons bears a closer similitude to fast neutron damage [23], and because of the availability of statistical data [24] for a large number of transistor types. Considerable variation of radiation sensitivity is found between different transistors which requires a certain arbitrariness in selecting a damage criterion. The data suggests setting neutron doses of 10<sup>12</sup>n/cm<sup>2</sup> for silicon devices and 10<sup>13</sup>n/cm<sup>2</sup> for germanium transistors. However, a critical radiation dose for a particular device may vary considerably from the criteria which were selected. The resulting defect densities using the theory described by Dienes and Vineyard [25] are:

- Si, 5 × 10<sup>11</sup> displacements/cm<sup>3</sup>;
- Ge, 3.8 × 10<sup>15</sup> displacements/cm<sup>3</sup>.

These defect densities are produced at 1200 km altitude in 9.2 × 10<sup>7</sup> seconds (1060 days) in silicon and in 3.8 × 10<sup>8</sup> seconds (4060 days) in germanium.

Using the flux-altitude relation obtained by Van Allen [1] and assuming that the Freden and White energy spectrum is independent of altitude, a curve of transistor lifetime vs equatorial (±25°) altitude can be constructed (see Fig. 1). The curves

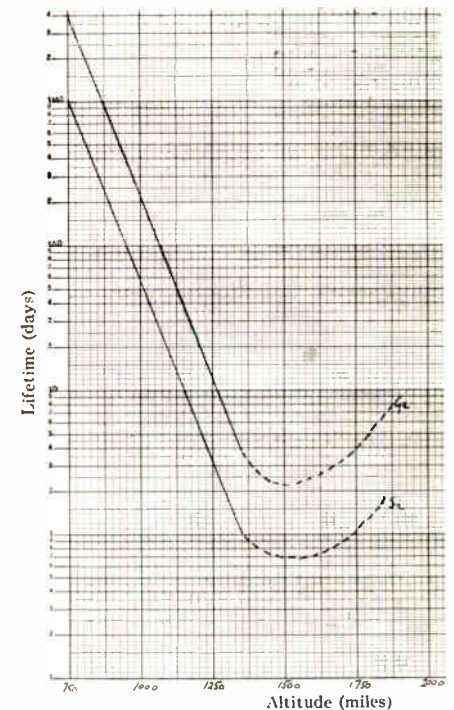

Fig. 1—Lifetime of semiconductors exposed in the inner equatorial (±25°) radiation belt as a function of altitude.

shown in Fig. 1 are necessarily limited to the inner radiation belt, for no accurate particle energy data for the outer belt have been obtained and are reliable only up to 1350 miles (2200 km), the highest data reported by Van Allen from 1958. The curves have been extrapolated through the anticipated maximum of the inner belt but are not supported by direct experimental measurement as are lower altitude data.

Clearly, semiconductor lifetime in satellites is an important consideration for altitudes in the 1500 mile (2500 km) range. If a one-year semiconductor life is desired,



equatorial altitudes between 1000 and 2200 miles are unsuitable. Of course, many orbits will not be restricted solely to equatorial latitudes, nor is it reasonable to expect circular orbits. These considerations tend to increase the lifetime in orbit.

Frequently it is desirable to operate in a high radiation area and protect equipment from shielding. We have not considered the shielding question in detail, but preliminary considerations seem to rule out protection by shielding for present payloads. The range of a 100-mev proton is about 1.5 cm in Pb; since about half of the damage is produced by the protons above 100 meV, it is clear that several cm of Pb will be required to increase semiconductor lifetime significantly. Furthermore, since the total cross section we are discussing for nucleon-nucleon encounters is a few barns in usual shield materials and these cascade products are forward scattered in addition to other less preferentially radiated products, it appears that the use of thin shields may lead to an increase in damaging radiation. This shielding paradox is receiving further attention, particularly with respect to various shield materials and thicknesses.

J. M. DENNEY  
D. POMEROY  
Systems Dev. Labs.  
Hughes Aircraft Co.  
Culver City, Calif.

REFERENCES

[1] J. A. Van Allen, C. F. McIlwain, and G. H. Ludwig, "Radiation observations with satellite 1958," *J. Geophys. Res.*, vol. 64, pp. 271-286; March, 1959.  
 [2] S. F. Singer, "Radiation belt," *Phys. Rev. Letters*, vol. 1, pp. 171-173; September, 1958. Also "Trapped Albedo theory of the radiation belt," pp. 181-183; September, 1958.  
 [3] J. A. Van Allen, G. H. Ludwig, E. C. Ray, and C. E. McIlwain, *Jet Propulsion*, vol. 28, p. 588; 1958.  
 [4] "1958 NASA/USAF Space Probes (Able I) Final Rept.," Space Tech. Labs., Inglewood, Calif.; February 18, 1959.  
 [5] S. C. Freden and R. S. White, "Protons in the Earth's Magnetic Field," UCRL-5581-T, May, 1959; to be published *Phys. Rev. Letters*.  
 [6] A. J. Heeger, T. R. Nisbet, and W. W. Happ, "An estimate of transistor life in satellite applications," *Proc. IRE*, vol. 47, p. 991; May, 1959.  
 [7] A. B. Whitehead and J. S. Foster, "Activation cross sections for  $C^{12}(p, pn)^{11}$ ,  $O^{16}(p, \alpha)N^{15}$  and  $F^{19}(p, pn)F^{18}$ ," *Can. J. Phys.*, vol. 36, pp. 1276-1285; September, 1958.  
 [8] I. Dostrowsky, et al., "Monte-Carlo calculations of high energy nuclear interactions. I. Systematics of nuclear evaporation," *Phys. Rev.*, vol. 111, pp. 1659-1676; September, 1958.  
 [9] S. S. Markowitz, et al., "Reactions at proton energies from .3 to 3 bev," *Phys. Rev.*, vol. 112, pp. 1295-1302; September, 1958.  
 [10] N. Metropolis, et al., "Monte-Carlo calculations on intranuclear cascades. I. Low energy studies," *Phys. Rev.*, vol. 110, pp. 185-203; April, 1958.  
 [11] N. Metropolis, et al., "Monte-Carlo calculations on intranuclear cascades. II. High energy studies," *Phys. Rev.*, vol. 110, pp. 204-219; April, 1958.  
 [12] G. Bernardini, et al., "Interactions of high energy neutrons with nuclei, Part I," *Phys. Rev.*, vol. 85, pp. 826-834; March, 1952.  
 [13] G. Bernardini, et al., "Interactions of high energy neutrons with nuclei, Part II," *Phys. Rev.*, vol. 88, pp. 1017-1026; December, 1952.  
 [14] J. D. Jackson, "A schematic model for  $(p, xn)$  cross sections in heavy elements," *Can. J. Phys.*, vol. 34, pp. 767-779; August, 1956.  
 [15] R. W. Fink and E. O. Wiig, "Reactions of cesium with 240 mev protons," *Phys. Rev.*, vol. 94, pp. 1357-1361; June, 1954.  
 [16] R. W. Fink and E. O. Wiig, "Reactions of cesium with protons at 60, 80, 100, 150 and 240 mev," *Phys. Rev.*, vol. 96, pp. 185-189; October, 1954.  
 [17] G. D. Wagner and E. O. Wiig, "Reactions of cobalt with protons at 60, 100, 170 and 240 mev," *Phys. Rev.*, vol. 96, pp. 1100-1103; November, 1954.  
 [18] P. Smoluchowski, "Effects of nuclear irradiation on ionic crystals," *Proc. International Conference, Geneva, Switzerland*, pp. 676-681; September, 1955.  
 [19] G. A. Kinchin and R. S. Pease, "The displace-

ment of atoms in solids by radiation," *Repts. Progr. Phys.*, vol. 18, pp. 1-51; 1955.  
 [20] F. Seitz and J. S. Koehler, "Displacement of atoms during irradiation," *Solid State Phys.*, vol. 2, pp. 307-448; 1956.  
 [21] E. W. J. Mitchell, "The effect of radiation damage on the electronic properties of solids," *Brit. J. Appl. Phys.*, vol. 8, pp. 179-188; May 1957.  
 [22] E. M. Baroody, "Influence of mass ratio on displacement cascades in diatomic solids," *Phys. Rev.*, vol. 112, pp. 1571-1576; December, 1958.  
 [23] J. H. Crawford and J. W. Cleland, "Nature of Bombardment Damage and Energy Levels in Semiconductors," Gallinburg Conference, Tennessee; May, 1959.  
 [24] G. L. Keister and H. V. Stewart, "The effect of nuclear radiation on selected semiconductor devices," *Proc. IRE*, vol. 45, pp. 931-937, July, 1957; also unpublished data from Convair, Fort Worth, Tex., June, 1959.  
 [25] G. J. Dienes and G. H. Vineyard, "Radiation Effects in Solids," Interscience Publishers, Inc., New York, N. Y.; 1957.

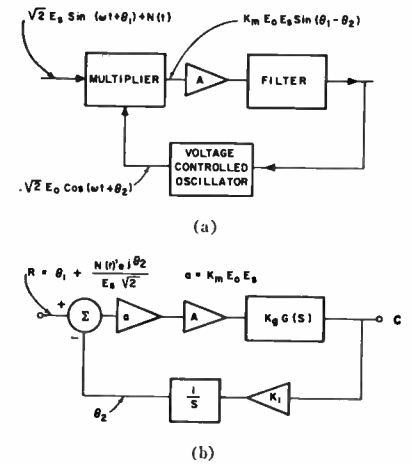

Fig. 1—(a) A phase-locked loop. (b) The linear equivalent  $N(t)$  is  $N(t)$  translated from  $\omega$  to a center frequency of zero.

Increasing the Dynamic Tracking Range of a Phase-Locked Loop\*

The transient response and effective noise bandwidth of a phase-locked loop are related to the dynamic tracking range. However, the latter often can be adjusted without adversely affecting the first two. "Dynamic tracking range" refers to the range in frequency over which a phase-locked loop will track a signal of slowly-varying frequency (i.e., Doppler shift) once the loop has locked on.

Consider the loop of Fig. 1. Fig. 1(a) shows a typical configuration, and Fig. 1(b) is the linear equivalent after Jaffe and Reichtin.<sup>1</sup> The low-frequency component out of the multiplier due to the signal is

$$K_m E_s E_0 \sin(\theta_1 - \theta_2)$$

where  $K_m$  is a constant associated with the multiplier. Amplifier  $K_1$  represents the change in frequency vs voltage (cps/volt). Let the filter have unity dc gain. Since the maximum output from the multiplier is  $\pm K_m E_s E_0$ , the maximum frequency change of the (dynamic tracking range) VCO for a signal of slowly-varying frequency (almost dc from the multiplier) is:

$$\Delta f_m = \pm K_m E_s E_0 A K_1 \quad (1)$$

The generalized feedback equation for a negative sign on the summer is:

$$\frac{C(S)}{R(S)} = \frac{K_a F(S)}{1 + K_a K_b F(S) H(S)} \quad (2)$$

where  $K_a F(S)$  is the transfer function in the feed-forward path and  $K_b H(S)$  is the transfer function in the feed-backward path. Writing  $F(S)$  and  $H(S)$  in terms of their poles and zeros shows that the poles of

$H(S)$  and the zeros of  $F(S)$  are the zeros of (2). The poles of  $C(S)/R(S)$  may be found by solving for the roots of the equation:<sup>2</sup>

$$K_a K_b H(S) F(S) = -1 \quad (3)$$

For the loop of Fig. 1(b), (3) is

$$A K_m E_s E_0 K_1 \frac{G(S)}{S} = -1 \quad (4)$$

or

$$\left| \frac{G(S)}{S} \right|_{P_0} = \frac{1}{A K_m E_s E_0 K_1} \quad (5)$$

and

$$\angle \frac{G(S)}{S} = 180^\circ \quad (6)$$

where

$$F(S) = G(S)$$

and

$$H(S) = \frac{1}{S}$$

Then the closed loop will have one zero at the origin (due to  $1/S$ ) and other zeros due to the zeros of  $G(S)$ .

If  $K_a G(S)$  has unity dc gain,

$$\lim_{S \rightarrow 0} K_a \frac{\prod_i (S + a_i)}{\prod_j (S + b_j)} = \lim_{S \rightarrow 0} K_a G(S) = 1 \quad (7)$$

Then

$$K_a = \frac{\prod_i b_i}{\prod_j a_j} \quad (8)$$

Assume that the transient response requires poles of  $C(S)/R(S)$  at  $P_0$  and  $P_0^*$  of Fig. 2. Eq. (6) is satisfied when

$$\sum_j \theta_j - \sum_{i=2}^n \phi_i - \phi_1 = \pi; \quad (9)$$

$n$  is the number of poles in  $G(S)$ ,  $\theta_j$  is the angle from the  $j$ th zero to  $P_0$ , and  $\phi_i$  is the angle from the  $i$ th pole. The graphical

\* Received by the IRE, October 9, 1959.  
<sup>1</sup> R. Jaffe and E. Reichtin, "Design and performance of phase-locked circuits capable of near optimum performance over a wide range of input signal and noise levels," IRE TRANS. ON INFORMATION THEORY, vol. IT-1, pp. 66-76; March, 1955.

<sup>2</sup> "Reference Data for Radio Engineers," International Telephone and Telegraph Corp., New York, N. Y., Fourth Ed., pp. 354-358; 1956.

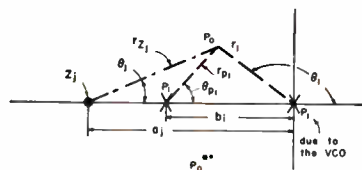

Fig. 2—S-plane plot  $Z_j$  is the  $j$ th zero of  $G(S)$ ;  $P_i$  is the  $i$ th pole of  $G(S)/S$ .

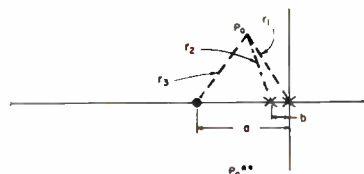

Fig. 3—S-plane plot when  $K_g G(S)$  is the network of Fig. 4.

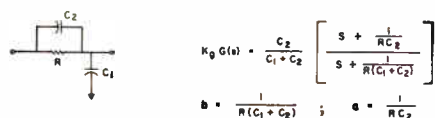

Fig. 4—A typical  $K_g G(S)$ .

method of finding the absolute magnitude gives<sup>3</sup>

$$\left| \frac{G(S)}{S} \right|_{P_0} = \frac{\prod_j r_{z_j}}{r_1 \prod_{i=2}^n r_{p_i}} \quad (10)$$

Using (1), (8), and (10), (5) may be written:

$$AK_m F_0 F_n K_1 = r_1 \frac{\prod_{i=2}^n \frac{r_{p_i}}{b_i}}{\prod_j \frac{r_{z_j}}{a_j}} = |\Delta f_m| \quad (11)$$

If  $G(S)$  is the simple lag network shown in Figs. 3 and 4, (11) is

$$|\Delta f_m| = r_1 \frac{\frac{r_2}{b}}{\frac{r_3}{a}} \quad (12)$$

where  $a$  and  $b$  are as defined in Figs. 3 and 4.

If  $b \ll a$ , it is clearly seen that as  $b$  decreases,  $|\Delta f_m|$  increases, allowing more or less independent adjustment. In theory,  $|\Delta f_m|$  can be made arbitrarily large by making  $b$  arbitrarily small. Notice that the dynamic tracking range is directly proportional to  $r_1$  which is a measure of the closed-loop bandwidth. This is in agreement with the observation that  $|\Delta f_m|$  is often approximately the same as the loop bandwidth. A more complex filter may be required to shape the transient response, and for a multisection filter, (11) will give the value of  $|\Delta f_m|$ . With a slowly-varying signal frequency, these calculations should be very close to the value obtained in practice.

C. S. WEAVER  
Western Development Labs.  
Philco Corp.  
Palo Alto, Calif.

<sup>3</sup> J. A. Aseltine, "Transform Method in Linear System Analysis," McGraw-Hill Book Co., Inc., New York, N. Y., pp. 101-106; 1958.

### Combined AM and PM for a One-Sided Spectrum\*

Chakrabarti<sup>1</sup> declares that he has not seen any report about the method of obtaining single-sideband modulation by simultaneous amplitude and phase modulation. The late Professor Barkhausen<sup>2</sup> pointed out the identity of single-sideband amplitude modulation with simultaneous amplitude and phase modulation, illustrating the theory with diagrams. He also discussed the matter in classroom lectures.

A. H. TAYLOR  
Read Island, B. C.  
Canada

\* Received by the IRE, October 13, 1959.

<sup>1</sup> N. B. Chakrabarti, "Combined AM and PM for a one-sided spectrum," Proc. IRE, vol. 47, p. 1663; September, 1959.

<sup>2</sup> H. Barkhausen, "Elektronenröhren," Verlag Julius Springer, Leipzig, Ger., vol. 4, pp. 159 ff.; 1937.

### On the Large-Signal Aspect of the Broadband Multicavity Klystron Problem—Theory and Experiment\*

In previous work by the author<sup>1</sup> and others,<sup>2-5</sup> methods have been devised (and applied to some problems) to calculate the performance of multicavity klystrons, namely, their broadband response and other characteristics under small signal conditions, including the effects of space-charge.

The present communication deals with an extension of the previous procedure which will be applicable at large signal levels. Although either an analog or a digital computer can be employed, we shall concern ourselves only with an analog solution and experimental verification in the case of a specific tube.

With the aid of the assumptions already indicated<sup>6</sup> one writes for a drift region

$$i_b = [i_a \cos \theta_{ab} + v_a j g \sin \theta_{ab}] e^{-j\psi_{ab}},$$

$$v_b = [v_a \cos \theta_{ab} + i_a j g^{-1} \sin \theta_{ab}] e^{-j\psi_{ab}} \quad (1)$$

and, at a resonator gap, we have

$$i_b' = i_a' e^{-j\psi_g},$$

$$v_b' = \left[ M^2 Z(\omega) \frac{\eta}{u_0} i_a' + v_a' \right] e^{-j\psi_g} \quad (2)$$

\* Received by the IRE, September 25, 1959.

<sup>1</sup> S. V. Yadavalli, "Application of the potential analog in multicavity klystron design and operation," Proc. IRE, vol. 45, pp. 1286-1287; September, 1957.

<sup>2</sup> K. H. Kreuchen, B. A. Auld, and N. E. Dixon, "A study of the broadband frequency response of the multicavity klystron amplifier," J. Electronics, vol. 2, p. 520; May, 1957.

<sup>3</sup> W. L. Beaver, R. L. Jepsen, and R. L. Walter, "Wideband klystron amplifier," 1957 IRE WESCON CONVENTION RECORD, pt. 3, pp. 111-113.

<sup>4</sup> L. D. Smullin and A. Bers, "Stagger tuned multicavity klystrons," presented at the Conference on Electron Tube Research, Berkeley, Calif.; June, 1957.

<sup>5</sup> H. J. Curnow, "Factors influencing the design of multicavity klystrons," SERL Tech. J., vol. 8, p. 42; January, 1958.

<sup>6</sup> S. V. Yadavalli, *op. cit.*; these assumptions are inherent to the Llewellyn-Peterson equations in an appropriate form.

where the quantities  $i$  ( $i$  and  $i'$ ) and  $v$  ( $v$  and  $v'$ ) represent the ac current and ac velocity of the beam, respectively. Subscripts  $a$  and  $b$  denote the earlier and later planes transverse to the electron beam; i.e., the beam is traveling from  $a$  to  $b$ .

$$g = - \frac{\omega I}{\omega_0 u_0}$$

$I$  is the dc current,  $\omega$  the operating angular frequency,  $u_0$  the dc velocity of the beam and  $\omega_0$  is the reduced plasma angular frequency.

$$\theta_{ab} = \frac{\omega_0 d_{ab}}{u_0}$$

$d_{ab}$  = distance between planes  $a$  and  $b$

$$\psi_{ab} = \frac{\omega d_{ab}}{u_0}$$

$M$  is the beam coupling coefficient,  $Z(\omega)$  is the shunt impedance across the gap, and  $\eta = e/m$  (charge to mass ratio) for an electron.

Eqs. (1) and (2) completely describe the behavior of any arrangement of cavities and drift spaces under the assumption of small signals. By a repeated application of (1) and (2), then, we can determine gain, power, bandwidth, etc., under small signal conditions.

Suppose, then, that an  $n$ -cavity klystron is considered. Let the ac voltage across the  $m$ th cavity be  $V_m$ ; then

$$V_m = M_m Z_m i_m \quad (3)$$

where  $M_m$ ,  $Z_m$ , and  $i_m$  represent the beam coupling coefficient, shunt impedance and the entering ac current at the  $m$ th gap.

One can also write

$$i_m = -j \sum_{k=1}^{m-1} \alpha_{km} V_k, \quad (4)$$

but for a phase factor, where,

$$\alpha_{km} = -M_k g \frac{\eta}{u_0} \sin \theta_{km} = M_k Y_0 \sin \theta_{km},$$

for instance,

$$\theta_{km} = \omega_0 \frac{d_{km}}{u_0},$$

$$Y_0 = - \frac{g \eta}{u_0}$$

$d_{km}$  = axial distance between cavities  $k$  and  $m$ . From (3) and (4) the ac voltage across cavity  $n-1$  is

$$V_{n-1} = \left( \sum_{k=1}^{n-2} F_{k,n-1} V_k \right) e^{-j\psi_1}, n-1,$$

where

$$F_{k,n-1} = -j M_{n-1} Z_{n-1} \alpha_{k,n-1}$$

$$\psi_{1,n-1} = \frac{\omega}{u_0} d_{1,n-1}. \quad (5)$$

If  $V_1$  is the ac voltage exciting the input cavity and  $V_{n-1}$  is the ac voltage across the penultimate cavity, the following expressions for voltage gain can be written:

$$\frac{V_{n-1}}{V_1} = e^{-j\psi_1}, n-1 [F_{1,n-1} + F_{2,n-1} F_{12} + F_{3,n-1} (F_{23} F_{12} + F_{13}) + \dots]. \quad (6)$$

The large signal aspect is included as follows. Although the effects of large signals should be included even at an earlier stage in the solution of the problem, we assume here that small signal theory holds up to the computation of  $i_{n-1}$  (the current exciting the penultimate cavity). For the computation of the ac current exciting the  $n$ th (output) gap, the following approximation<sup>7</sup> is made

$$i_n = 2IJ_1(X_{n,n-1}), \quad (7)$$

where  $J_1$  is a Bessel function of the first kind of order one

$$X_{n,n-1} = \left( M_{n-1} \frac{\omega \eta V_{n-1}}{\omega_q t_0^2} \sin \theta_{n,n-1} \right). \quad (8)$$

From a knowledge of  $i_n$ ,  $(R/Q)$ , and  $Q_n$ , it is not a difficult matter to calculate the power output and efficiency of the tube, since

$$V_n = M_n Z_n i_n, \\ P_{out} = \eta_c P_n = \frac{1}{2} \frac{|\Gamma_n|^2}{Z_n} \eta_c,$$

$\eta_c$  being the output circuit efficiency. The electronic efficiency of the tube is  $P_{out}/V_0 i$  where  $V_0$  is the dc beam voltage.

The analogy with IF amplifier design has been discussed previously and will not be repeated here. Some details about the computer method of solution have been given elsewhere in literature.<sup>8</sup>

Employing the above model, computations have been made on an analog computer<sup>9</sup> to obtain the optimum bandwidth with a five-cavity X-band klystron. Fig. 1 shows the theoretical output power and

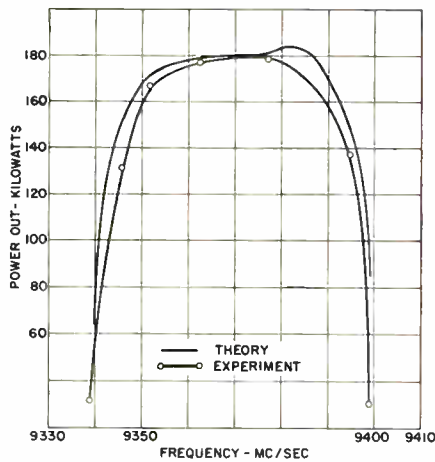

Fig. 1—Performance characteristics of five cavity X-band klystron (theory and experiment).

the experimental verification of the same. The theoretical 3-db bandwidth is 59.0 mc, as compared with the experimental value of 57.0 mc. As can be seen, the agreement between theory and experiment is very good.

The author would like to thank John H. Trumpler of the General Electric Microwave Lab., Palo Alto, Calif. for taking the experimental data.

S. V. YADAVALLI  
Stanford Research Institute  
Engineering Division  
Menlo Park, Calif.  
Formerly with General Electric  
Microwave Lab.  
Power Tube Dept.  
Palo Alto, Calif.

it is clear that to nullify the right hand term in (3), either one of the two components of  $i_p$  must be its negative; such as,

$$-g_m e_{o1} = e \left( \frac{1}{R_{eq}} + \frac{1}{sL} + sC \right).$$

Upon rearranging, this becomes:

$$\frac{e_{o1}}{e} = -\frac{1}{g_m} \left( \frac{1}{R_{eq}} + \frac{1}{sL} + sC \right). \quad (4)$$

One method of providing this transfer function is through use of the circuit of Fig. 2.<sup>3</sup>

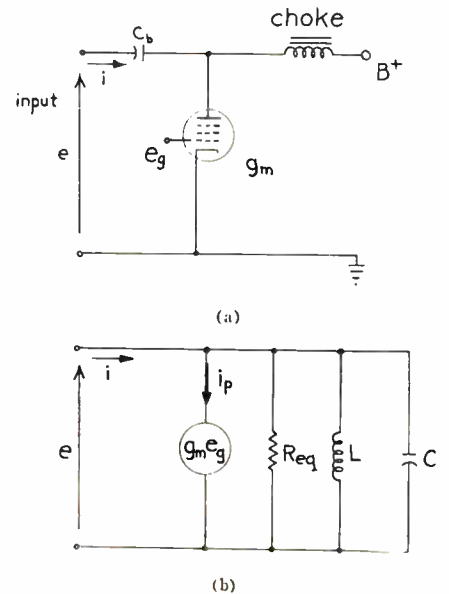

Fig. 1—Reactance tube circuit and its current generator equivalent network.

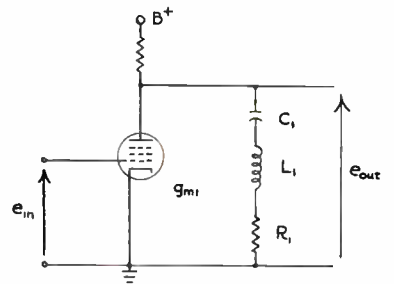

Fig. 2—Network to realize nullifying transfer function.

### High Q Inductance Simulation\*

An improvement which can be made to the pentode simulation of reactance,<sup>1</sup> particularly inductive reactance, is the elimination of the resistance component. This gives the simulated inductance an infinite Q. An advantage of such a simulator besides the high Q is that it has a smaller volume and lighter weight than an equivalent wire-wound iron-cored inductor. Circuits for simulation of components have been investigated by several authors and an extensive bibliography is contained in a recent survey by Cooperman and Franklin.<sup>2</sup>

The resistance component results from the plate resistance  $r_p$  and the resistance present in the plate load. This can be seen by referring to the equivalent current generator circuit of Fig. 1. The parallel combination of  $r_p$  and plate load resistance component is represented by  $R_{eq}$ . The choke prevents the ac input from being shorted out by the plate voltage power supply.

The input current can be expressed as follows:

$$i = i_p + e \left( \frac{1}{R_{eq}} + \frac{1}{sL} + sC \right). \quad (1)$$

The turn-to-turn capacitance is represented by C. Tube interelectrode capacitances are neglected as is the large input blocking capacitor  $C_b$ .

To nullify any effect of the plate load on the input terminals, one component of the pentode excitation voltage  $e_g$  causes a cancellation current to flow. The other component provides excitation voltage of the correct phase so as to make the pentode draw reactive current from the input.

The pentode current can be represented by two components as follows:

$$i_p = g_m e_g = g_m e_{o1} + g_m e_{o2}. \quad (2)$$

Substituting (2) into (1),

$$i = g_m e_{o1} + g_m e_{o2} + e \left( \frac{1}{R_{eq}} + \frac{1}{sL} + sC \right), \quad (3)$$

Here a series R-L-C circuit loads the plate of a pentode and provides a network transfer function of:

$$\frac{e_{out}}{e_{in}} = \frac{-g_{m1}}{\frac{1}{R_n} + \frac{1}{\frac{1}{sC_1} + sL_1 + R_1}}. \quad (5)$$

The parallel combination of plate resistance and plate load resistance is represented by  $R_n$ .

<sup>3</sup> J. G. Truxal, "Control System Synthesis," McGraw-Hill Book Co., Inc., New York, N. Y., p. 187; 1955.

<sup>7</sup> This approximation appears to be valid and quite adequate at the present time.

<sup>8</sup> D. M. Byck and A. Norris, "On the solution of some microwave problems by an analog computer," 1958 IRE WESCON CONVENTION RECORD, pt. 1, pp. 70-87.

<sup>9</sup> These computations have been made by the EAI computation center, Los Angeles, Calif.

\* Received by the IRE, September 14, 1959.  
<sup>1</sup> War Training Staff of the Cruft Lab., Harvard University, Cambridge, Mass., "Electronic Circuits and Tubes," McGraw-Hill Book Co., Inc., New York, N. Y., p. 667; 1947.

<sup>2</sup> J. I. Cooperman and P. J. Franklin, "Circuit techniques to eliminate large volume components, a literature survey," *Electronic Design*, vol. 7, no. 6, pp. 52-61; March, 1959.





cause of its time constants. Secondly, close distance records depend on the height of the cloud base above ground, as most of the emissions originate from inside the cloud.

Extraneous noises always affect the records. There is always the noise from distant thunderstorms and, perhaps, galactic noise as a background. There are additional complications at close distances; there can be electrostatic fields arising from various causes; and furthermore, pulses from the return strokes and dart leaders may be received after ionospheric reflection along with  $M$ -components or  $J$  or  $F$  field change fluctuations. (It is not impossible to get such reflected pulses even when they are ruled out by MUF considerations, one of the several reasons for this being the abnormal ionization associated with thunderstorms.) The contributions from such extraneous noises are small and do not significantly affect the peak amplitude  $A$ . But, in other cases, what is recorded is the resultant amplitude deduced by applying the method of Friis.<sup>8</sup>

#### POWER PER FLASH

The rms field strength  $B$  per flash can be calculated from Table I in terms of  $A$  as follows:

$B$  for a ground flash

$$= \sqrt{\frac{6 \cdot A^2 + 11 \cdot \frac{A^2}{16} + 25 \cdot \frac{A^2}{64} + 150 \cdot \frac{A^2}{256}}{200}} \quad (1)$$

$$= (0.2) \cdot A. \quad (2)$$

$B$  for a cloud discharge as calculated earlier<sup>3</sup> is

$$\sqrt{\frac{4}{200}} \cdot A = (0.14) \cdot A. \quad (3)$$

$B$  for a ground flash is about 3 db higher but, in actual records, it may even appear to be as much as 10 db higher due to extraneous contributions, etc., discussed. We conclude, therefore, that the HF noise powers involved in ground and cloud discharges are not very significantly different. Interference calculations will probably require either  $A$  or the quasi peak value, as described in Fig. 3 of Aiya.<sup>2</sup> The present analysis indicates that neither of these two quantities would be seriously affected by the subsidiary radiations in a ground flash.

#### TEMPERATE REGION RECORDS

Horner and Clarke<sup>9</sup> and Horner<sup>10</sup> have published photographs of noise bursts in England at 11 mc with a 300-cps bandwidth. The photographs, their statements, and the fact that they have recorded VLF noise also simultaneously in most cases, indicate that their records are for ground flashes. There does not appear to be any feature in the photographs which is not covered by the discussion in this letter. It is, however, not unlikely that there would be some differences in the nature of atmospherics radi-

ated by sources located in tropical and temperate regions but it would be premature to draw conclusions on the point at present.

Horner and Clarke<sup>9</sup> have measured the peak amplitudes on their records for distances of storm  $d$ , varying from 1 to 18 km. This peak amplitude corresponds to  $A$  and it can be calculated from (7) in Aiya.<sup>2</sup> For a space wave at 11 mc with 300-cps bandwidth, we get

$$A = (2.40) \cdot \frac{\sin \theta}{r} \mu V/m \quad (4)$$

where,  $\theta$  = angle the direction of radiation makes with the axis of the dipole and  $r$  = distance of the source in 10<sup>6</sup> meters.

Close-distance calculations require the height of the cloud base,  $h$ , which is not given and has, therefore, to be estimated. As measured by them,  $d$  is the hypotenuse of a right-angled triangle of which  $H$ , the mean height of the radiator, is only one side. Since  $d$  could even be 1 km, it follows that  $H$  must be less than 1 km. Assuming  $h = 0.3$  km, a not uncommon value, there would be no stage II for the leaders and stage I of first leader would start from cloud base and extend to 1 km above, i.e.,  $H = 0.8$  km. For stage I of second leader,  $H = 0.8 + 0.7 = 1.5$  km, and so on. (It may be pointed out that other possible assumptions for values of  $h$  will not materially change the calculated values.) Values from (4) and the measured values of Horner and Clarke are given in Table II. In the tropics, it is expected that measured values on individual storms would lie within  $\pm 3$  db of the calculated values from (4) in the majority of cases. Hence, the agreement in Table II for temperate regions should be considered very satisfactory.

TABLE II  
CALCULATED AND MEASURED VALUES OF PEAK AMPLITUDES IN  $\mu V$ /METER

Source distance in km	Leader number	Stage I height in km	Calculated value	Measured value of Horner and Clarke
1	First	0.8	1440	1400
3	First	0.8	771	varies from 900 to 550
	Second	1.5	693	
	Third	2.2	545	
1 to 18	—	—	1440 to 133	1500 to 50

S. V. CHANDRASHEKHAR AIYA  
Dept. of Elec. Commun. Engrg.  
Indian Inst. of Science,  
Bangalore 12, India

### Experimental Proof of Focusing at the Skip Distance by Backscatter Records\*

For some years, the fieldstrength near the skip distance and its variation with time and space has been the subject of different cal-

culations<sup>1-3</sup> and measurements,<sup>4,5</sup> but the focusing which was expected has not yet been proved in an unequivocal manner. However, this seems to be a result of technical rather than other difficulties.

For more than half a year, we have made backscatter records every day, on a fixed frequency of 16.65 mc. The film speed was low, so the time scale was rather narrow; with a pulse duration of 100  $\mu$ sec we had a good resolution of distances.

In spite of the poor information we have with respect to ground scatter, it seems that backscatter observations are quite useful for our problem because focusing must be active twice whenever it occurs, viz., on the direct as well as on the return way. In fact, clear focusing has been observed nearly every day for some time, often for many hours and for both magneto-ionic components [Fig. 1(a)].

The effect of focusing was less pronounced in summer than in winter. Also, the focusing phenomena observed at Breisach near Freiburg were less frequent and less important when observations were made in the direction of 250° (South-West) and especially 280° (West) than they were in the direction of 220° (South). These variations according to season and direction can be adequately explained by the following facts: the ionospheric turbulence should be greater in a northern direction; the disturbance of geometrical optics by the existence of  $E_s$  layers must be more important in summer; and the defocusing effect of the refraction by the normal  $E$  layer<sup>6</sup> should be greater in summer.

Occasionally we found a clear focusing even for the two-hop rays (2F.); in these cases the difference of the skip distance for both components is twice that for 1F. This can be seen from Fig. 1(b).

Note with respect to the records that we use a 66-cps pulse recurrence frequency at the transmitter side, but 33 cps for the receiver sweep; only half of this sweep (corresponding to 2250 instead of 4500 km) is recorded, viz., the delay between two successive transmitter pulses (dark lines at the lower and upper margin of the record). Thus we have an overlapping of two reflection patterns. Distinction of both patterns is made possible by switching the transmitter to 33 cps; this is done for a two-minute interval every quarter of an hour. The 1F. backscatter is the lower trace in Fig. 1(b) which has the quarter-hourly interruptions. It belongs to a pulse which was 1/66 second

<sup>1</sup> H. Bremner, "Terrestrial Radio Waves," Elsevier, New York, N. Y., pp. 182-190; 1949.

<sup>2</sup> K. Rawer, "Calcul du champ de l'onde d'espace," *Rev. Sci.*, vol. 85, pp. 234-235, February, 1949; pp. 287-288, March, 1947; pp. 361-362, April, 1947; vol. 86, pp. 481-485, June, 1948; pp. 585-600, October, 1948.

<sup>3</sup> H. Poyerlein, "Fieldstrength near the skip distance," AF Cambridge Res. Center, Bedford, Mass., Tech. Rept. No. TR-54-104; 1955.

<sup>4</sup> J. Grosskopf, "Über einige Beobachtungen bei Feldstärkerregistrierungen im Kurzwellenbereich," *Telegr., Fernspr., Funk und Fernsicht-tech.*, vol. 29, pp. 127-137; May, 1940.

<sup>5</sup> B. Bechmann, W. Menzel, and F. Vilbig, "Grenzwellen und Streustrahlung in der Funkausbreitung," *Telegr., Fernspr., Funk und Fernsicht-tech.*, vol. 30, pp. 43-52; February, 1941.

<sup>6</sup> K. Bibl, K. Rawer, and E. Theissen, "Le rôle de l'occlusion dans la propagation des Ondes Décimétriques," *Rapport du Service de Prevision Ionosphérique, France, No. R11; December, 1951.* Also, "An improved method for the calculation of the fieldstrength of waves reflected by the ionosphere," *Nature*, vol. 169, pp. 147-150; January, 1952.

<sup>8</sup> H. T. Friis, "Noise figure of radio receivers," *Proc. IRE*, vol. 32, pp. 419-422; July, 1944.

<sup>9</sup> F. Horner and C. Clarke, "Radio noise from lightning discharges," *Nature*, vol. 181, pp. 688-690; March, 1958.

<sup>10</sup> F. Horner, "The relationship between atmospheric radio noise and lightning," *J. Atmos. Terres. Phys.*, vol. 13, pp. 140-154; December, 1958.

\* Received by the IRE, October 19, 1959.

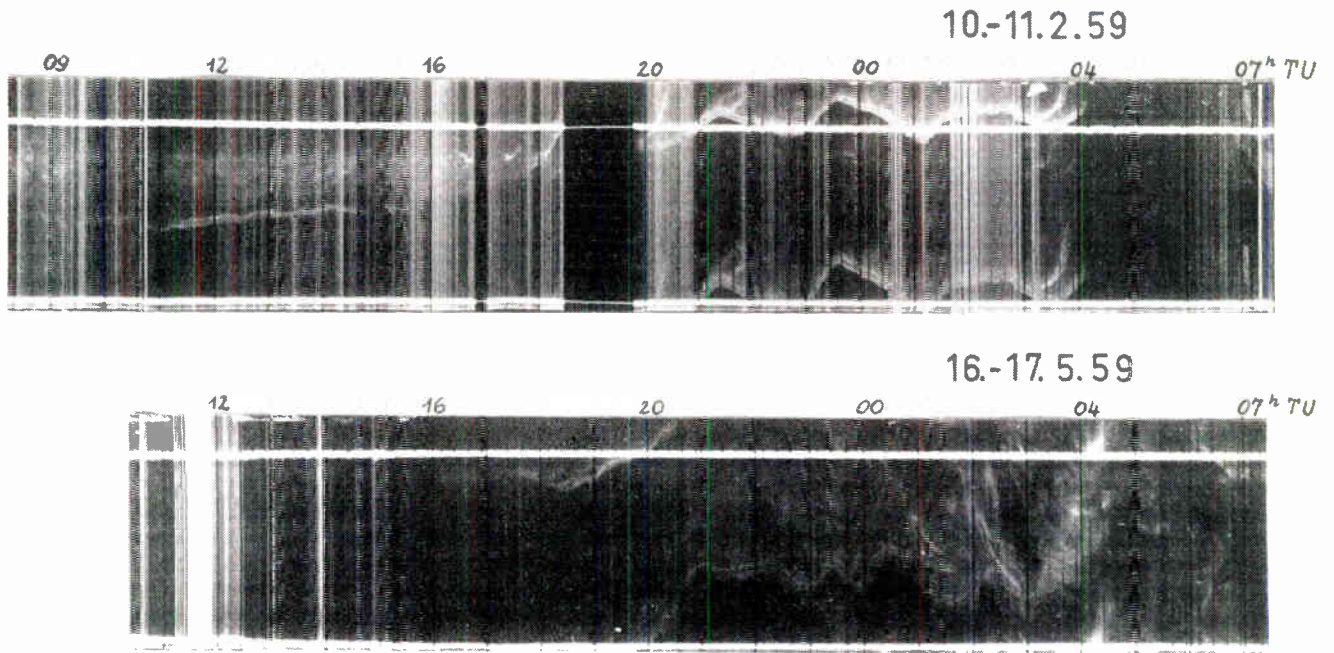

Fig. 1—Records (markers correspond to one hour and 150 km. (a) Winter focusing (10-11.2.59); (b) focusing on 1F, and 2F. (16-17.5.59).

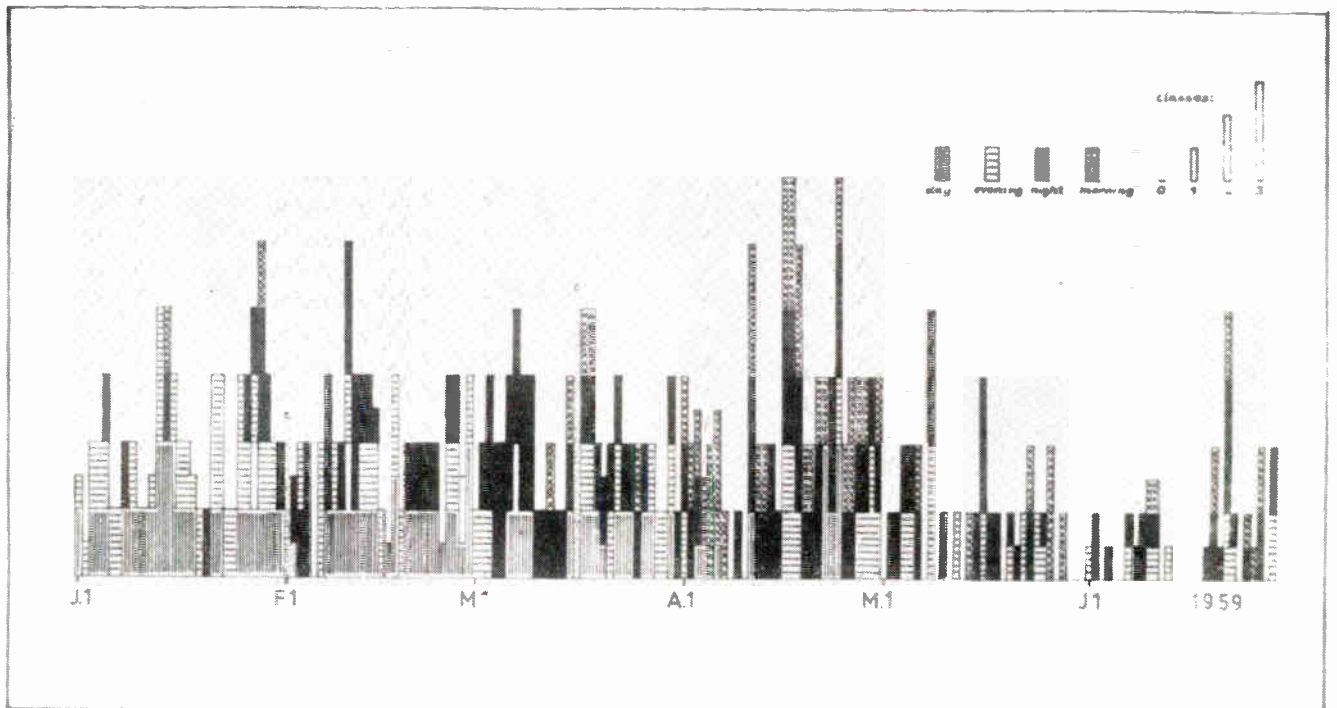

Fig. 2—Statistical results for the South and South-West directions

below the lower black line; thus we must add 2250 km to the range as measured from this line. The 2F. backscatter is the upper trace in Fig. 1(b). The corresponding pulse is 2/60 second below the lower black line, so we must add 4500 km. In our example, the 2F. backscatter came from a distance of 5000 to 6000 km; this is about the distance from the United States to Freiburg.

In order to give a general view of the frequency of focusing, Fig. 2 gives day-to-day statistics for the last six months. Four periods of the day been represented separately (four colors). The importance of focusing has been classified in four grades: 0=no focusing, 1=weak focusing; 2=both components distinctly visible at skip distance; 3=lasting a long time and compo-

nents distinctly visible. On our frequency, daytime focusing was only present in winter, nighttime focusing was most frequent in spring; the over-all importance decreased in summer.

K. BUBL  
Ionosphären Inst. im Fernmeldetech.  
Zentralamt der Deutschen Bundespost  
Breisach am Rhine, Germany



# Contributors

Arthur E. Anderson was born in East Windsor, Conn., on June 2, 1923. He received the B.S.E.E. and M.S.E.E. degrees from the University of Connecticut, Storrs, in 1944 and 1951, respectively.



A. E. ANDERSON

During World War II, he was a Radio-Radar Officer—Carrier Aircraft Service Units—in the USNR. From 1946 to 1951, he was an instructor in mathematics and electrical engineering at the University of Connecticut. Since 1951, he has been with the Westinghouse Research Laboratories, Pittsburgh, Pa., where he is presently manager of the Physics Project Laboratory. He has contributed to the development of the X-ray image intensifiers, direct view and signal generating visible image pickup tubes, color kinescopes, electroluminescent-ferroelectric field solid-state displays, high definition television and reduced bandwidth television systems.

Mr. Anderson is a member of Eta Kappa Nu, Tau Beta Pi, and Sigma Xi.



Frank R. Arams (S'44-A'49-SM'55) was born on October 18, 1925 in the Free City of Danzig. He received the B.S.E. degree in electrical engineering and mathematics from the University of Michigan, Ann Arbor, in 1947; the M.S. degree in applied physics from Harvard University, Cambridge, Mass., in 1948; and the M.S. degree in business management from Stevens Institute of Technology, Hoboken, N. J., in 1953. He is presently completing the requirements for the doctorate degree in electrical engineering at the Polytechnic Institute of Brooklyn, Brooklyn, N. Y. His dissertation concerns an investigation of new types of solid-state masers employing harmonic spin coupling effects.



F. R. ARAMS

During World War II, he served in the Army Signal Corps as communications chief of Radio Receiver Station WXH, Ketchikan, Alaska. He joined the Radio Corporation of America, Lancaster, Pa., in 1948, where he was project engineer on various development programs on microwave magnetrons, traveling-wave tubes, and plasma-filled cavities. From 1953 to 1956, he was employed at RCA Tube Division, Harrison, N. J., where he was in charge of the microwave tube application engineering group. In 1956, he joined the Airborne Instruments Laboratory, a di-

vision of Cutler-Hammer, Inc., Melville, L. I., N. Y., where he is presently associated with the department of applied electronics as Consultant, and is concerned with theoretical and experimental work on microwave solid-state devices, such as new types of solid-state maser amplifiers, microwave ferrite devices, etc. He is presently directing advanced programs in the microwave ferrite and traveling-wave maser fields.

Mr. Arams was a 1944 Donovan Scholar at the University of Michigan, and is a member of Tau Beta Pi, Eta Kappa Nu and the American Physical Society.



Robert R. Bockemuehl was born in Omaha, Neb., on October 17, 1927. He received the B.S.E.E. degree from the University of Michigan, Ann Arbor, in 1952.



R. R. BOCKEMUEHL

He has worked at the General Motors Research Laboratories, Warren, Mich. since 1952. Until 1958, his activities primarily included development of highly specialized instrumentation and control systems for use in scientific measurements and automotive testing. He is currently a Senior Research Engineer in the Physics Department of the General Motors Research Laboratories where he is engaged in basic and applied research in the field of solid-state electronic devices and compound semiconductor materials.

Mr. Bockemuehl is a member of Tau Beta Pi, Eta Kappa Nu and Phi Kappa Phi.



Kern K. N. Chang was born in Shanghai, China, on September 9, 1919. He received the B.S. degree from the National Central University, Nanking, China, in 1940, the M.S.E.E. degree from the University of Michigan, Ann Arbor, in 1948, and the D.E.E. degree from the Polytechnic Institute of Brooklyn, N. Y., in 1954.



K. K. N. CHANG

From 1940 to 1945, he was associated with the Central Radio Manufacturing Works, Kunming, China, working on radio receivers. From 1945 to 1947, he was a radio instructor in the Office of Strategic Services, U. S. Army, China Theater. Since 1948, he has been at RCA Laboratories, Princeton, N. J., where he has been engaged in research on magnetrons, traveling-wave

tubes, beam-focusing devices, and parametric and tunnel-diode devices.

Dr. Chang is a member of Sigma Xi.



John W. Coltman (SM'49-F'55) was born in Cleveland, Ohio, on July 19, 1915. He received the B.S. degree in physics from Case Institute of Technology, Cleveland, in 1937, and the Ph.D. degree from the University of Illinois, Urbana, in 1941.

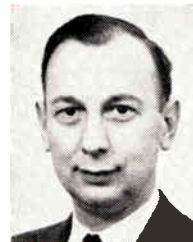

J. W. COLTMAN

He joined the Westinghouse Research Laboratories, Pittsburgh, Pa., in 1941, and spent the war years in research and development on microwave magnetrons. In 1946, he organized a group to undertake the development of a means to increase the brightness of fluoroscopic X-ray images. It was during the course of this work that he invented, with Fitz-Hugh Marshall, the scintillation counter. The project culminated in the first successful X-ray image amplifier, the Fluorex. Since 1949, he has been manager of the Electronics and Nuclear Physics Department of the Westinghouse Laboratories, guiding and participating in programs concerned with infrared and optical imaging, communications, underwater acoustics, microwaves, electron physics, solid-state physics, and nuclear physics.

Dr. Coltman has been a member of the Board of Editors and an Editorial Reviewer for the IRE, and is a Fellow of the American Physical Society and member of Tau Beta Pi and Sigma Xi.



Charles A. Desoer (S'50-A'53-SM'57) was born in Brussels, Belgium, in 1926. He received the radio engineer's degree from the University of Liège, Belgium, in 1949. He went to Massachusetts Institute of Technology, Cambridge, and obtained the D.Sc. degree in 1953. He joined the Bell Telephone Laboratories, where he worked in the transmission systems group, principally in the field of network theory. In 1958, he joined the Department of Electrical Engineering at the University of California, Berkeley. His main interest lies in systems and communication theory.



C. A. DESOER

Dr. Desoer is a member of Sigma Xi.

James H. Dietz (S'51-A'52-M'57), was born in Baltimore, Md., on January 18, 1927. He received the B.S. degree in physics from Loyola College, Baltimore, Md., in 1950 and the M.S.E.E. degree from the University of Pennsylvania, Philadelphia, in 1959.



J. H. DIETZ

From 1951 to 1953 he worked at the Radiation Laboratory of The Johns Hopkins University, Baltimore, where he was a member of a group engaged in the development of proximity-fuze circuits. Later, from 1953 to 1956, he was employed by the Bendix Radio Division, Towson, Md., working on the development of missile-guidance systems. He is presently a research associate on the staff of the Moore School of Electrical Engineering, University of Pennsylvania.



George H. Heilmeier (S'58) was born in Philadelphia, Pa., on May 22, 1936. He received the B.S.E.E. degree from the University of Pennsylvania, Philadelphia, in 1958, and is presently a candidate for the Doctor's degree at Princeton University, Princeton, N. J., under the sponsorship of RCA Laboratories.



G. H. HEILMEIER

Since 1958, he has been working in the general area of solid-state microwave devices with emphasis on distributed parametric structures, and he will receive the M.S. degree from Princeton in June, 1960, for his contributions in this area. He has also investigated the generation of millimeter waves by parametric methods.

Mr. Heilmeier is a member of Sigma Xi, Tau Beta Pi, and Eta Kappa Nu.



Y. H. Ku (SM'53), was born in Wusih, China on December 24, 1902. He received the B.S. degree in 1925, the M.S. degree in 1926, and the D.Sc. degree in 1928, all from the Massachusetts Institute of Technology, Cambridge.



Y. H. KU

From 1932 to 1937, he was dean of Engineering, Tsing Hua University, Peiping, China, and from 1944 to 1945, he was president of Central

University, Chungking, China. During World War II, he served as Vice-Minister of Education in the National Government of the Republic of China and later served as Commissioner of Education, Shanghai. He is presently a professor at the Moore School of Electrical Engineering, University of Pennsylvania, Philadelphia.

Dr. Ku is a fellow of the AIEE and the Academia Sinica, and is an elected member of the General Assembly of the International Union of Theoretical and Applied Mechanics. He is also a member of Sigma Xi and Eta Kappa Nu.



Paul R. Melsaac (A'59) was born on April 20, 1926, in Brooklyn, N. Y. He received the B.E.E. degree from Cornell University, Ithaca, N. Y., in February, 1949, after serving for two years in the U. S. Navy. He received the M.S.E. and Ph.D. degrees from the University of Michigan, Ann Arbor, in 1950 and 1954, respectively. During 1952, he was engaged in studying ferromagnetic metals



P. R. MELSAAAC

at high frequencies at the University of Leeds, England.

From 1954 to 1959, he was employed by the Sperry Gyroscope Co., Great Neck, N. Y. where he worked on problems associated with the microwave circuits and the interaction theory for microwave tubes. At present, he is an associate professor of electrical engineering at Cornell University.

Dr. Melsaac is a member of Sigma Xi.



William W. Mumford (A'30-SM'46-F'52) was born in Vancouver, Wash., on June 17, 1905. He received the B.A. degree in 1930 from Willamette University, Salem, Ore., majoring in physics and mathematics. He served in the U. S. Coast Guard as a radio operator on the Cutter *Algonquin* in 1923 and 1924, and as a telegraph operator, clerk and manager with the Western Union Telegraph



W. W. MUMFORD

Company, in Washington and Oregon during the next two years. From 1928 to 1930, he was associated with the Oregon State Highway Commission Testing Laboratory. In 1930, he joined the Technical Staff of the Bell Telephone Laboratories with the Radio Research Department at Holmdel, N. J.

In 1953, he transferred to the Military Development Department of Bell Telephone Laboratories, Whippany, N. J., where he is now supervisor of a group engaged in the study of microwave radar problems and the exploratory development and exploitation of the latest techniques for improving noise figures of receivers.

He has worked on ultra-short-wave propagation and microwave components for radio relay systems and radars, and has studied the published literature concerning biological effects of microwaves as related to microwave radiation hazards. His contributions in the microwave field include the directional coupler, wideband coaxial-to-waveguide transducers, helix-to-waveguide transitions as used in the traveling-wave tube and the gas-discharge noise generator. These are covered in 31 published papers and 13 patents.

Mr. Mumford is a licensed Professional Engineer in New Jersey.



Seymour Okwit was born on August 31, 1929, in New York, N. Y. He received the B.S. degree in physics from Brooklyn College, Brooklyn, N. Y., and the M.S. degree in applied mathematics and physics from Adelphi College, Garden City, N. Y., in 1952 and 1958, respectively. He is presently doing work toward the doctoral degree in mathematical physics.



S. OKWIT

From 1952 to 1954, he was in the armed forces. He was assigned to the detection division of the Chemical and Radiological Laboratories of the Army Chemical Center, Edgewood, Md., where he did extensive development work on instrumentation for the detection and analysis of the poisonous "G" nerve gases. Detection instruments that he worked on include an infrared scanning system and a system utilizing microwave spectroscopy. From 1954 to 1955, he was associated with the radar department of Arma Corporation, where he was concerned with boresight studies on monopulse antennas. He joined the Airborne Instruments Laboratory, a division of Cutler-Hammer, Inc., Melville, L. I., N. Y., in November, 1955, as an engineer in the Department of Applied Electronics, where he was concerned with the design and development of RF, IF, and microwave components and systems. Since 1958 he has been responsible for, and has performed considerable theoretical and experimental work on, solid-state devices such as low-loss circulators, low-level ferrite limiters, and cavity and traveling-wave masers. Mr. Okwit is now a group leader in the applied electronics department at AIL, and is currently directing programs in the development of advanced solid-state devices including maser, parametric amplifiers, and novel ferrite components.



H. John Prager was born in Vienna, Austria, in 1915. He received the B.S.E.E. degree from the University of Vienna in 1938



H. J. PRAGER

and the M.S.E.E. degree from the University of Michigan, Ann Arbor, in 1940. From 1940 to 1942, he was associated with the Research Laboratory of the Detroit Edison Company, Detroit, Mich. In 1943, he joined the Electron Tube Division of RCA in Harrison, N. J., as a production engineer of small power and receiving tubes. In 1944, he transferred to the Receiving Tube Development Group where he served as Design Engineer, Technical Coordinator, and Unit Leader until 1959. His various assignments there included the design of several entertainment-type receiving tubes as well as premium industrial tubes, gas-filled tubes and UHF pencil tubes. From 1954 until 1959, he served as a member of the JETEC-12 Committee, and also was an Evening Instructor at the Newark College of Engineering, Newark, N. J. He is presently engaged at the RCA Laboratories, Princeton, N. J., working on semiconductor-microwave devices.



Archie W. Straiton (M'47-SM'49-F'43) was born in Arlington, Tex., on August 27, 1907. He received the B.S.E.E. degree in 1929, the M.A. degree in 1931, and the Ph.D. degree in 1939, all from The University of Texas, Austin.



A. W. STRAITON

He taught at Texas College of Arts and Industries, Kingsville, from 1931 to 1943. Since 1943, he has taught at The University of Texas, Austin, where he is now Professor of electrical engineering and Director of the Electrical Engineering Research Laboratory.

Dr. Straiton is a member of Eta Kappa Nu, Tau Beta Pi, Sigma Xi and the American Society for Engineering Education. He was a former member of the U.S.A. National Committee and Chairman of Commission II of URSI.



Charles W. Tolbert (M'49-SM'55) was born in Homer, La., on August 28, 1920. He received the B.S. degree in general

engineering from Texas College of Arts and Industries, Kingsville.

He was employed for two years by the National Geophysical Company, Dallas, Tex., before coming to the University of Texas, Austin, as an instructor in 1945. Shortly afterwards, he joined the staff of the University's Electrical Engineering Research Laboratory, where he has been responsible for much of the experiment program, and, in recent years, has been in charge of the millimeter studies.



C. W. TOLBERT



Franklin M. Turner (S'49-A'52-M'56) was born in Southington, Conn., on August 18, 1925. He received the A.A. degree from Grant Technical College, Del Paso Heights, Calif., in 1948. In 1950, he received the B.S. degree, and in 1951 the M.S.E.E. degree, both from Stanford University, Stanford Calif.



F. M. TURNER

From 1951 to 1952, he studied microwave tubes as a research assistant with the Electronics Research Laboratory at Stanford University. In 1952, he became a staff member of this laboratory. He is currently a research associate with the Systems Techniques Laboratory, one of the five laboratories constituting the Stanford Electronics Laboratories at Stanford University. His present work is concerned with the development of new components and systems techniques related to electronic countermeasures.

Mr. Turner is an associate member of Sigma Xi.



Chao C. Wang (A'43-SM'49-F'57) was born in Shanghai, China on October 20, 1914. He received the B.S.E.E. degree in 1936 from Chaio-Tung University, Shanghai, and the M.S. and Ph.D. degrees, both in radio communications, in 1938 and 1940, respectively, from Harvard University, Cambridge, Mass.

Since 1940, he has been engaged in microwave tube research and development. In 1940-1941, he studied vacuum tube manu-

facturing methods at the RCA Manufacturing Co., Harrison, N. J. During World War II, he worked on microwave tubes for radar applications at Westinghouse Electric Co., Bloomfield, N. J. Since that time he has worked in the investigation of problems in electron beam focusing by magnetic fields, and development of interaction and circuit theory of traveling-wave tubes. He has been Engineering Department Head for microwave tube research in the Sperry Electronic Tube Division, Sperry Gyroscope Co., Great Neck, N. Y., since 1956. In this capacity, he is also heading research in solid-state microwave electronics, thermionic emission, microwave gaseous plasma interaction, and computer development. He is also Victor Emanuel Professor at Cornell University, Ithaca, N. Y., for the Spring Term, 1960.



C. C. WANG

Dr. Wang is a member of the American Physical Society and the AAAS.



Alfred A. Wolf (S'49-A'49-M'55), was born on July 21, 1925 in Philadelphia, Pa. He received the B.S.E.E. degree from Drexel Institute of Technology, Philadelphia, Pa., in 1948, the M.S.E.E. degree from the Moore School of Electrical Engineering, University of Pennsylvania, Philadelphia, in 1954 and the Ph.D. degree from the University of Pennsylvania in 1958.



A. A. WOLF

From 1949 to 1954, he was on the staff of the Anti Submarine Warfare Division of the Naval Air Development Center. Then, from 1954 to 1959, he was associated with the Moore School of Electrical Engineering of the University of Pennsylvania. He joined the Stromberg-Carlson Division of the General Dynamics Corp., Rochester, N. Y., in 1959, where he is at present applying his theory of nonlinear systems to the development of a sophisticated fault detection theory in which he relates statistically measured quantities at the output of the system being tested to deterministic quantities determining the configuration of the structure in response to white noise.

Dr. Wolf has principally been interested in the theory of nonlinear systems and related stochastic processes and has published a number of papers on these subjects.



# Books

## Probability and Statistics, Ulf Grenander, Ed.

Published (1959) by John Wiley and Sons, Inc., 440 Fourth Ave., N. Y. 16, N. Y. 434 pages. 6×9½. \$12.50.

This book, subtitled "The Harald Cramér Volume," is a collection of studies in probability and statistics which was presented to Professor Cramér in honor of his 65th birthday. It is thus a somewhat heterogeneous collection of both exposition and research by some of the most eminent probabilists and statisticians throughout the world. The papers range from theory of estimation, nonparametric inference, and design of experiments in the field of statistics to Markov chain theory and Brownian motion in the fields of probability and stochastic processes.

A more exact view of the contents of this volume can be conveyed by listing the authors and titles: T. W. Anderson—Some Scaling Models and Estimation Procedures in the Latent Class Model; M. S. Bartlett—The Impact of Stochastic Process Theory on Statistics; J. L. Doob—A Markov Chain Theorem; G. Elfving—Design of Linear Experiments; W. Feller—On Combinatorial Methods in Fluctuation Theory; E. Fix, J. L. Hodges and E. L. Lehmann—The Restricted Chi-Square Test; U. Grenander—Some Non-Linear Problems in Probability Theory; M. Kac—Some Remarks on Stable Processes with Independent Increments; D. G. Kendall—Unitary Dilations of Markov Transition Operators, and the Corresponding Integral Representations for Transition-Probability Matrices; P. Lévy—Construction du Processus de W. Feller et H. P. McKean en Partant du Mouvement Brownien; P. Masani—Cramér's Theorem on Monotone Matrix-Valued Functions and the Wold Decomposition; P. Masani and N. Wiener—Non-Linear Prediction; J. Neyman—Optimal Asymptotic Tests of Composite Statistical Hypotheses; H. Robbins—Sequential Estimation of the Mean of a Normal Population; M. Rosenblatt—Statistical Analysis of Stochastic Processes with Stationary Residuals; C. O. Segerdahl—A Survey of Results in the Collective Theory of Risk; J. W. Tukey—An Introduction to the Measurement of Spectra; S. S. Wilks—Nonparametric Statistical Inference; H. Wold—Ends and Means in Econometric Model Building.

These collected papers fill 434 pages and represent a most interesting cross section of modern probability and statistics. The articles are carefully written and the authors have supplied excellent references to each of the topics, many of which were advanced by Cramér's researches.

Although this book was not written specifically by and for members of the engineering profession but rather by and for probabilists and statisticians, it will serve as a source of valuable material, especially to those engineers conducting investigations involving stochastic processes. For example, the papers by Bartlett, Kac, Lévy, Rosen-

blatt and Tukey will be of particular interest. The printing is excellent and great credit is due Ulf Grenander for his excellent work as editor. Thanks also should be given to John Wiley and Sons for publishing "The Harald Cramér Volume" during Professor Cramér's lifetime.

H. P. EDMUNDSON  
Planning Research Corp.  
Los Angeles, Calif.

## Materials and Techniques for Electron Tubes, by Walter H. Kohl

Published (1960) by Reinhold Publishing Corp., 430 Park Ave., N. Y. 22, N. Y. 603 pages+20 index pages+13 appendix pages+xxvii pages. Illus. 6½×9½. \$16.50.

"Materials and Techniques for Electron Tubes" is a revised and updated version of the former "Materials Technology for Electron Tubes" (1951) written as a reference book for tube engineers and scientists. Its seventeen chapters cover, in a remarkably complete manner, much of the vacuum tube materials work performed during the last decade. As stated by the author, "This . . . is not a textbook from which to learn first concepts, but it is a very useful reference book to be used in conjunction with other texts."

The book has chapters on glass, ceramic and mica materials. Metals are covered by chapters on carbon and graphite, iron and steels, copper, nickel, precious metals, tungsten, molybdenum, tantalum and niobium, and a chapter each on getters, brazing metals and cathode metals. Although materials application techniques are discussed throughout the various chapters of this book, individual chapters are devoted to glass-to-metal seals and ceramic-to-metal sealing. The latter chapter of forty-nine pages reflects the increasing importance of this type of seal to the tube industry and appears to be quite complete. The chapters on iron and steels, precious metals and getters are welcome additions. With the single exception of the chapter on Joining of Metals by Brazing, which has been condensed, all other chapters have been revised and greatly expanded.

As was the case in his earlier book, Dr. Kohl has compiled a comprehensive and valuable list of references for each of his chapters. Most of the reference material (nearly 1200 separate listings) has been published since 1952. Sufficient information is included in the references to permit one to locate the material quite easily.

The chapter on Precious Metals deals largely with the solution of grid emission problems and might well be expanded in a future edition. Similarly, the section on oxide-coated cathodes should be expanded, particularly with respect to the role of the nickel base alloys and the influence they have on cathode performance as a function of temperature, time, alloying elements, etc. A very good list of references is cited in this chapter. In general one might wish to see more information on the properties of materials at high temperatures in high vacuum;

however, these data are very hard to locate, and in many cases the engineer or scientist must be guided by reported application experience.

The chapters on Ceramic-to-Metal Sealing and Tungsten are very well done and Table 12.1 entitled "Brazing Filler Metals for Electron Tubes," showing properties of 143 high temperature materials is an outstanding example of the factual information available throughout this book.

Dr. Kohl has written a very valuable comprehensive reference book which should be of great assistance not only to tube engineers but to others working with these materials as well.

A. P. HAASE  
General Electric Co.  
Owensboro, Ky.

## Mathematics for Communication Engineers, by S. J. Cotton

Published (1959) by the Macmillan Co., 60 Fifth Ave., N. Y. 11, N. Y. 229 pages+5 index pages+x pages+10 answer pages. Bibliography at end of each chapter. Illus. 6½×10. \$7.50.

The preface starts "It would be justifiable for anyone to exclaim: 'Another textbook on mathematics!' Yet this book was started in answer to a request from a number of students to bridge a gap which certainly does exist." On the one side is the mathematician with his proofs, and on the other side is the communications engineer needing to use advanced mathematics in his work. The book bridges this gap by giving developments of the ideas of advanced mathematics without always giving a full proof. Enough is given to make the result seem reasonable, and the results, especially in the early chapters of the book, are given in such a way that the communications engineer will find this a good book to use as a reference.

The topics covered are Review of Calculus, Determinants, Infinite Series, Trigonometric Functions, Complex Functions, Further Integration and Differentiation, Differential Equations Applied to Lines and Networks, Theory of Functions of a Complex Variable, Harmonic Analysis, Vector Analysis, Special Functions and Equations, and Probability and Statistics. Each chapter contains examples of the application of the mathematics to a problem in communication engineering. There are exercises at the end of each chapter, and further exercises at the end of the book. Answers to the exercises are also given, so the book is well suited to self-study.

The book is well written and should be a real help to both students and practicing engineers. Once in a while the reader will run into wording which must be carefully studied. For example, in line 3 on page 142, reference is made to "any point in the region." Does the author mean that the condition he is imposing must apply to *all* points in the region, or only to *one* point in the region?

In the statement of the Laplace Transform (page 174) the same functional nota-

tion is used for the time-domain function,  $f(t)$ , and for the  $p$ -domain function,  $f(p)$ . This may be a mistake in typesetting, with  $F(p)$  having been intended to show that these two are different functions as well as having different variables.

Some topics, such as matrix theory and advanced algebra, are not included in the book, nor are there any tables of functions.

The book is a compact package, reasonable in cost, with much advanced mathematics useful to the communications engineer. It lives up to its title quite well.

GEORGE B. HOADLEY  
North Carolina State College  
Raleigh, N. C.

### Telemetering Systems, by Perry A. Borden and W. J. Mayo-Wells

Published (1959) by Reinhold Publishing Corp., 430 Park Ave., N. Y. 22, N. Y. 331 pages +11 index pages +6 appendix pages +ix pages. Illus. 64 × 91. \$8.50.

The field of telemetry is a rapidly expanding one. However, there are very few books on this subject. This book is therefore a welcome one and represents a modernization of a previous book by Borden and Thynell. The authors have made a particular effort to unify the older fields of industrial telemetry with the modern developments having application to aircraft and missile testing. It is particularly valuable in setting forth the components and concepts of industrial telemetering which are covered in the chapters on current, voltage and position systems of telemetering. There is an extensive section on the FM/FM system of telemetering which has considerable application in the aircraft and missile testing field. This, however, has been covered under the heading of "Frequency Systems of Telemetering."

The recent PCM system of telemetering is to be found in the chapter on "Impulse (Pulse) Systems of Telemetering." Also included in these chapters are the other pulse systems such as PPM, PDM, PAM, and two less known systems called Pulse Delta Modulation and Pulse Multiple Modulation.

The book also covers methods of reducing data collected by the telemeter in the chapters on Coordinating, Totalizing, Computing, and Integrating. The selection and application of telemetering systems are covered in a rather general way.

The manner of dealing with the subject matter is basically descriptive with some discussion of circuit details and block diagram configurations. There is little treatment from an analytic point of view of the design of telemetering equipment, of the analysis of bandwidth requirements and signal-to-noise considerations, or of the effect of interfering signals. Such considerations, for example, have been included in the radio telemetering field by Nichols and Rauch in their book "Radio Telemetry."

The authors have succeeded in their attempt to show the relationships between the older telemetering concepts and modern practice. However, some readers may find some difficulty in locating some of the newer systems in the framework of classification used in this book. The book will be found valuable to people working in the field because of the many examples of ingenious

earlier practice in telemetry and will help people entering this field to become acquainted with the nature of telemetering devices.

ELLIOT L. GRUENBERG  
IBM Corp.  
Bethesda, Md.

### Modern Network Analysis, by F. M. Reza and Samuel Seely

Published (1959) by McGraw-Hill Book Co., Inc., 330 W. 42 St., N. Y. 36, N. Y. 361 pages +5 index pages +6 appendix pages +xi pages. Illus. 64 × 91. \$10.00.

The objective of the authors in writing this book is to provide a link between available introductory texts (such as that of E. A. Guillemin and others) and the more mathematical works (of W. Cauer, R. M. Foster, and others). This text has been "classroom tested" and is intended for an advanced undergraduate or a first graduate course on the analysis and synthesis of linear networks. As is true of such texts, a considerable number of problems are given (with no answers).

The book is divided into three parts, the first of which comprises chapters on the complex  $s$  plane, matrices and determinants, network topology and equilibrium equations. Part II comprises three chapters devoted to application to two-port networks, image parameter and conventional filters, and linear systems with distributed parameters. The last, Part III, of the book comprises five chapters on the system functions of linear systems and their transient response to singularity functions, a brief review of Laplace transform theory, and realizability formulas in network synthesis.

The authors prefer to use the exponentially damped sinusoidal excitation  $e^{st}$  because the ensuing steady state response of a linear system differs from  $e^{st}$  only by multiplication by a complex quantity. They should have indicated, however, that a definable and separable steady state response can occur only for a nondamped sinusoidal excitation for which  $s = j\omega$ .

The chapter on linear algebra dealing with matrices and determinants is particularly useful as a body of formulas with applications. This also applies to the chapters on network topology and network equilibrium equations. A good description is given of the matrix interrelationship among the six methods of analyzing two-port linear systems. It concludes with a review of the realizability criteria for linear systems from considerations of the energy functions using, in particular, the matrices described in the text.

The book is recommended to all students interested in network analysis.

DR. M. J. D'ITORO  
Polytechnic Res. and Dev. Co.  
Brooklyn, N. Y.

### Introduction to Matrix Analysis, by Richard Bellman

Published (1960) by McGraw-Hill Book Company, Inc., 330 W. 42 St., N. Y. 36, N. Y. 301 pages +6 index pages +19 appendix pages +xx pages. 64 × 91. \$10.00.

To a very large extent, modern electrical engineering science is based on the concept of linearity. This is particularly true in the field of "systems" as opposed to "components." As a result of historical accidents

as well as of the parochial attitudes of engineering educators in the past, the "linear systems" field is at present dominated by the Laplace transform, to the virtual exclusion of any other tool. This is an unfortunate as it is unnecessary. The growth of mathematics during the last century has given rise to an impressive body of knowledge based on linearity, which is nowadays usually called "linear algebra and analysis." Crudely speaking, linear algebra is matrix theory, and linear analysis is that class of problems (and much more) which engineers at present usually treat by the Laplace transform.

In the preface, the author calls matrix theory "the arithmetic of higher mathematics." For a scientific worker who is willing to use nontrivial mathematics (pure or applied), continued study of matrix theory deserves the highest priority. The reviewer feels strongly that matrix theory, as yet greatly neglected, belongs to the core of the engineering science curriculum. The reasons are: matrix theory is a theory of *complexity*, very useful in dealing with large networks, digital computers, etc.—areas where the Laplace transform is not well suited to cope with practical problems; it provides the rudiments of abstract language and thinking, without which the results of modern mathematics cannot be utilized.

The distaste of many engineers for matrix methods may be the result of inadequate expositions. Too many books have been written with the purpose of "selling" matrix methods, by concentrating on this or that application. On the other hand, texts in pure mathematics are unsuitable for engineering instruction because of complete lack of applications. So it is especially fortunate that the author of this book is an active leader in the fields of analysis and dynamic systems and has been concerned for many years with the delicate interplay between theory and applications. Equally fortunate for electrical engineers is the choice of subject matter, which is closely related in many cases to current applied problems. [Additional volumes are promised in this Series on 1) computational methods (by G. Forsythe), 2) linear programming and combinatorics (by A. Hoffman) and 3) network theory (by L. Weinberg).]

The book consists of short, brisk chapters, the main theme being quadratic forms. An outline of the contents is as follows:

Chapter 1 deals with maxima and minima of functions of two variables from several points of view.

Chapter 2 introduces matrix notation, transpose, inner product, etc.

Chapter 3 defines eigenvalues and eigenvectors and then applies these concepts to the diagonalization of symmetric matrices with distinct eigenvalues.

Chapter 4 begins with a detailed discussion of the Gram-Schmidt orthonormalization process and then completes the problem of diagonalizing symmetric matrices including simultaneous reduction of quadratic forms.

Chapter 5 considers maximization of quadratic forms subject to linear constraints. There is an interesting digression on partitioned matrices.

Chapter 6 is a quick look at functions of



matrices, in cases where the matrix is diagonalizable. The integral of the Gaussian distribution is computed. Among the many interesting exercises is the Sylvester interpolation formula (No. 33) which can be regarded as the generalization of the partial-fraction expansions used in the theory of the Laplace transform.

Chapter 7 is devoted to the Rayleigh coefficient, the Fischer-Courant variational description of characteristic roots, etc.

Chapter 8 is a nice collection of inequalities, some not well known, such as those based on the formula for the Gaussian integral.

Chapter 9 is a quick, readable exposition of the elementary ideas of dynamic programming, from the point of view of matrices and quadratic forms.

Chapter 10 is perhaps of greatest interest to electrical engineers. It is concerned with linear matrix differential equations. Too many people do not yet know that the solution of the matrix differential equation  $dx/dt = Ax$  can be expressed in the form  $(\exp At) \times (0)$ , a formula which is simpler and yet more general than the corresponding expression by Laplace transforms. Theorem 6 of this chapter (which goes back to Lyapunov) makes it possible to determine the integrated square of transient responses by solving a set of linear algebraic equations—this is at present usually done by means of cumbersome tables.

Chapter 11 deals with explicit representations of matrices and matrix functions, Jordan canonic form, normal matrices, etc.

Chapter 12 is a very brief look at Kronecker sums and products—these are of interest in recent research in stability theory, random processes, etc.

Chapter 13 is a study of stability in linear systems, based mainly on the theorem of Lyapunov in Chapter 10. This is the modern approach to the Routh-Hurwitz criteria and deserves further serious study, particularly by control engineers.

Chapter 14 is concerned with Markov chains and processes from the matrix point of view.

Chapter 15 is an ultra-short (because so little is known) note on the theory of linear dynamic systems whose defining parameters change randomly with time.

Chapter 16 deals with matrices with positive elements, illustrating their significance by some typical problems from mathematical economics.

There are four appendixes; one dealing with the solution of linear algebraic equations, and the remaining three with somewhat advanced special topics in quadratic forms.

The problems and bibliographical comments should be singled out for special praise. The former, some frivolous, some straightforward, some important recent results or tricks, are highly educational for those who aim at mastery of the subject, but do not sidetrack the beginning student. The references include the "classical" papers, at least since the 1940's and are also very useful in getting started on new research.

This is a superb book and is warmly recommended. Its wealth of material and modern point of view should appeal to the specialist. As most of the exposition is ele-

mentary, it should be well received as a text for the classroom or self-study, at about the senior or first-year graduate level.

DR. R. E. KALMAN  
RIAS  
Baltimore, Md.

**The Theory of Optimum Noise Immunity, by V. A. Kotelnikov (translated from the Russian by R. A. Silverman)**

Published (1959) by McGraw-Hill Book Co., Inc., 330 W. 42 St., N. Y. 36, N. Y. 140 pages + xi pages. Illus. 7½ × 10½, \$7.50.

Vladimir Aleksandrovich Kotelnikov is one of the few electronics engineers ever to be elected Academician in the Academy of Sciences of the U.S.S.R. In 1947 he published a doctoral dissertation which was subsequently republished in book form in Russian. R. A. Silverman's excellent translation of this Russian classic should be of interest to English speaking communications engineers for both technical and historical reasons.

Kotelnikov deals with the problem of analyzing the performance of various communication systems in the presence of additive Gaussian noise. This performance is measured by minimum probability of error in the case of discrete messages and minimum mean square error in the continuous case. The organization of this little book is as neat and concise as Kotelnikov's mathematics. Part I serves to set the framework of the problems considered and to sharpen the few mathematical tools used in the rest of the book. Part II then treats the transmission of discrete messages, Part III the transmission of a continuous parameter value and Part IV the transmission of continuous time functions. Each of the latter three parts is peppered with examples of the application of the general theory to special types of communication systems—AM, FM, PAM, PPM, SSB, etc.

At a time when the space lag is exciting so much comment, it is interesting to examine this volume with a view to the possible existence of a "communication theory lag." The framework within which Kotelnikov solves his problems is one which we now call statistical decision theory. Statistical decision theory was developed in this country by Wald shortly before Kotelnikov first published his results in 1947. It was eight years later, however, before Middleton and Van Meter became the first to apply Wald's ideas to communication problems in this country.

Two other Sputniks of note in this volume are the geometrical interpretation of signals and the analysis of nonwhite noise filtering problems by the use of inverse filters. The former was first published in this country by Shannon in 1949, the latter by Bode and Shannon in 1950.

It seems fair to say that at the present time there is no single major concept (with the possible exception of the material in section 9-2) in Kotelnikov's work which is not known in this country. As noted above, this was not true as little as five years ago. This is not to say that the results have all been worked out in this country—they have not.

NORMAN ABRAMSON  
Stanford University  
Stanford, Calif.

**The Electric Arc, by J. M. Somerville**

Published (1960) by John Wiley and Sons, Inc., 440 Fourth Ave., New York 16, N. Y. 134 pages + 7 index pages + 9 bibliography pages + ix pages. 38 figures. 4½ × 6½, \$2.50.

The author of this interesting little book has made an important and useful addition to the Methuen series of monographs on physical subjects. Although the preface states that the monograph attempts to give a brief account of this "... well known, but by no means well understood, phenomenon" it really accomplishes much more. The various aspects selected for discussion are very well chosen and represent the most important aspects of our present knowledge of the subject. Clear physical interpretations are substituted for the extensive and detailed treatment of original sources. The figures are simplified, but present clearly the essential facts under consideration.

The first chapter is a brief introduction section that reviews the over-all characteristics of arcs. Following this, Part I covers the phenomena of "the stable arc" in two chapters. The first of these covers the principal phenomena and theory of the long column; such as the energy balance in a plasma in thermal equilibrium, the Gerdien (or vortex) arc, the column gradient over four decades of pressure, the column temperature over six decades of pressure, electron density, energy transfer, and radiation, use as light sources in lamps, and concluding with a short section on the possibility of thermonuclear reaction in arcs.

The second chapter of Part I (Chapter 3) contains a brief, authoritative treatment of the basic phenomena associated with arc electrodes. The best theories of the cathode spot are presented together with pertinent experimental data. Anode phenomena and electrode-vapor jets are discussed in short sections.

Part II (Chapters 4 and 5) is entitled "The Approach to the Stable Arc." The first chapter discusses the transient phenomena of the "spark" as it develops into a stable arc. Chapter 5 considers briefly the transition from a glow discharge to an arc, and the formation of an arc by separating current-carrying contacts.

The book concludes with a list of 186 important references, an author, and a subject index.

Professor Somerville's book will quickly and accurately orient the newcomer to the field with the best experimental and theoretical knowledge of the electric arc as it is now understood.

J. D. COBINE  
Research Laboratory  
General Electric Co.  
Schenectady, N. Y.

**Sound in the Theatre, by Harold Burris-Meyer and Vincent Mallory**

Published (1959) by Radio Magazines, Inc., Mineola, L. I., N. Y. 92 pages + 3 index pages. Illus. 8½ × 10½, \$10.00.

The authors of this book have pioneered in the use of modern equipment and techniques for sound control and special sound effects for drama and opera in live theatrical production. This book brings their experience to the neophyte, whether he is a theatrical person needing practical technical knowl-



edge, or an experienced engineer making his first entrance into the complex artistic realm. After a brief summary of basic facts of acoustics, there are chapters on architecture and scenery, sources and pickup of sound, control techniques, systems, input equipment, output equipment, organization and planning, and installation and use. Much of the information is specific to theatrical productions which the authors have assisted. The book may leave the reader asking questions, but it is an interesting introduction to the borderline field between electrical engineering and the theatrical arts.

DANIEL W. MARTIN  
The Baldwin Piano Co.  
Cincinnati 2, Ohio

### The Physics of Television, by Donald G. Fink and David M. Lutyens

Published (1960) by Doubleday and Company, Inc., 575 Madison Ave., N. Y. 22, N. Y. 153 pages+7 index pages. 44 figures. 4½×7½, paperbound. \$0.95.

This is a very remarkable book. It attempts in 150 pages and with practically no mathematics to present the story of television to the layman, up to and including color.

It starts with the brain wave associated with thought and surveys various forms of transmission of that thought, starting from hand signals up; explaining the limitations of each form and why more sophistication is desirable. The description of the technique of coding and scanning for television is excellent.

The discussion of basic physics is well written and really tries to make things simple and understandable to the layman. To my mind it is too detailed and presents concepts too difficult for the reader. The concept of electron jumps of different energy content is a very difficult one (particularly without mathematics) and I believe could well be skipped. Assumptions are made that the reader is already familiar with a transformer and that he knows a spiral drawing represents a coil of wire or maybe a transformer winding. As an old-time teacher I know that interpretation of symbolic diagrams is not easy and requires both explanation and practice. It has the fastest discussion of alternating current this reviewer has ever seen.

It seemed to me when I read the book that it was much too conceptually complex for the average reader, even though beautifully organized and written. Although I believed that if anyone could achieve this aim the present authors could. I was about to dismiss it as another "experiment noble in purpose."

To confirm my judgment, I lent the book to a friend who had no physics except in high school some years ago. To show how wrong I was I received this note, "Many thanks for the chance to read this book. I will buy a copy and continue reading—think it is excellent."

Imagine my confusion!

KNOX McILWAIN  
Burroughs Corp.  
Paoli, Pa.

### Class D Citizens Radio, by Leo G. Sands

Published (1960) by Ziff-Davis Publishing Co., 1 Park Ave., N. Y. 16, N. Y. 133 pages+3 index pages+38 appendix pages+x pages. Illus. 6½×9½. \$4.95.

According to this book, the FCC in mid-

1959 was processing 5000 applications per month for Class D citizens radio station licenses. This extraordinary activity may give some idea of the popularity of this radio service whereby any United States citizen over 18 years of age may install and operate a two-way private radiotelephone in his car, plane, boat or camp, home, or office.

The book explains in essentially non-technical language what this service is all about, how to get into it, how to buy and install and operate the equipment.

It is an excellent book for the radio engineer to recommend when he is asked to advise anyone on any aspect of the Class D portion of the so-called citizens radio spectrum. It is not a design book, nor a how-to-do-it book. It tells the reader what equipment is available, how much it costs, and the rules and regulations governing its use.

KEITH HENNEY  
Garden City, N. Y.

### Millimicrosecond Pulse Techniques, by I. A. D. Lewis and F. H. Wells

Published (1960) by Pergamon Press, 122 E. 55 St., N. Y. 22, N. Y. 360 pages+3 index pages+1 bibliography page+29 reference pages+22 appendix pages. Illus. 5½×8½. \$8.50.

Since its original publication in 1954, this book has enjoyed great popularity among physicists and electronic engineers as a ready reference on fundamental aspects of electronics and networks in the millimicrosecond range. The text of this newest second edition has been considerably revised and abounds with the latest advances including a special treatment of transistor switching techniques. It is a very welcome addition to the International Series of Monographs on Electronics and Instrumentation. It is intended to cover, in the words of the authors, "developments in the theory and design of electronic circuits and devices for operation in the range of time intervals which lie between the province of microsecond pulse circuits and the realm of microwave devices."

Some idea of the scope of the book can be obtained from the headings of the eight chapters into which it is divided. These chapters are entitled, "Theoretical Introduction," "Transmission Lines," "Transformers," "Pulse Generators," "Amplifiers," "Cathode Ray Oscilloscopes," "Applications To Nuclear Physics," and "Miscellaneous Applications."

Under "Theoretical Introduction," the reader is briefly guided into the domain of circuit analysis involving both sinusoidally varying and pulse waveforms. Fourier's Theorem is illustrated, the method of Laplace Transforms elaborated upon, and the importance of approximations stressed. The chapter concludes with remarks on the handling of switching phenomena and circuits with distributed parameters. In the latter, phase distortion rather than amplitude distortion may well determine the useful bandwidth.

The chapter on "Transmission Lines" contains an extremely wide range of topics covering conventional distributed circuit analysis, effects of discontinuities, pulse shaping, and the influence of loss. Also, a very interesting treatment of helical delay

lines is given in addition to limitations of lumped delay lines.

The role of distributed lines as pulse transformers is extensively described in the chapter on "Transformers" and includes an analysis of smooth tapered lines, the Gaussian line, the exponential line, and the linearly tapered coaxial line. It is followed by a compact description of special transformers composed of coaxial lines, such as the pulse inverter, stacked-line transformers, and a filament isolating transformer as well as an introduction to coupled-line transformers.

The treatment of "Pulse Generators" represents a remarkable review of the literature on diverse aspects dealing with basic concepts and principles. The major topics relate to discharge line type pulse generators, pulse generators employing secondary emission tubes, recycling pulse generators, attenuators, and pulse measuring equipments. The range includes microwave pulses.

The problem of amplifying pulses is considered under "Amplifiers" following a discussion of high-frequency limitations of conventional electron tubes and conventional circuits. Basic difficulties and inherent advantages are carefully described in connection with interstage coupling, cascade amplifiers, distributed amplifiers, and band-pass amplifiers, including traveling-wave tubes and the possibility of using modulated microwave carrier systems.

The introductory material in the chapter on "Cathode Ray Oscilloscopes" emphasizes transit-time limitations and methods for obtaining high deflection sensitivity. It is followed by selected topics relating to transient recording oscilloscopes, oscilloscopes for the display of recurrent waveforms, and oscilloscopes for recurrent pulses using pulse sampling techniques.

A detailed treatment of applications is contained in the chapter entitled "Applications to Nuclear Physics" and is continued in the last chapter on "Miscellaneous Applications." The first of these two chapters is devoted to measuring problems encountered in nuclear physics research and special mention is made of scintillation counters, spark counters, amplitude discriminators, fast scaling circuits, coincidence circuits, time interval measurement by integration methods, and recording oscilloscope measurements. The last chapter considers a number of other applications, mainly, pulse generators for narrow bandwidth radio receiver measurements, peculiarities of waveguide and cable testing, the Wamoscope, the measurement of time jitter in trains of video pulses, analysis of modulated electron beams and transistors in fast switching circuits.

The authors are to be commended for bringing to the attention of physicists and engineers the present day capabilities of pulse circuits. The bibliography of each chapter is very complete and many references are detailed enough to offer specific information as to their value. The text will definitely ease the task of all who seek to become informed about pulse techniques. It is an excellent contribution, one of the most balanced and most illuminating studies yet made of this complex field.

ANTHONY B. GIORDANO  
Polytechnic Institute of Brooklyn  
Brooklyn, N. Y.

# Scanning the Transactions

**Human Factors in Electronics** has become the 28th IRE Professional Group to commence publication of TRANSACTIONS, and its first issue starts off with a most provocative subject—man-computer symbiosis. Symbiosis is defined as a cooperative living together in intimate association of two dissimilar organisms. The hope is that in not too many years human brains and computing machines will be coupled together very tightly, and that the resulting partnership will think as no human brain has ever thought and process data in a way not approached by the information-handling machines we know today. In such a relationship the computer would no longer be confined to solving preformulated problems by means of predetermined programs, but would actively participate in the formulation of the very problems it must later solve and share, on a real-time basis, in the decision-making processes now performed by man alone. Man will still set the goals, formulate the hypotheses, determine the criteria and perform the evaluation, but the computing machine will do much of the routinizable work that must be done to prepare the way for insights and decisions. However, before the computer can enter into symbiotic association with man, man must first evolve a more sophisticated generation of computers with time-sharing capabilities, greatly improved memories and memory organization, a common man-machine language, and much improved input and output equipment. When these goals are reached—and they are within our eventual reach—man will be ready for what may prove to be intellectually the most creative and exciting chapter in the history of mankind. (J. C. R. Licklider, "Man-computer symbiosis," IRE TRANS. ON HUMAN FACTORS IN ELECTRONICS, March, 1960.)

**Dual-unit transistors**, reminiscent of multi-unit tubes, are making an entry into the semiconductor device field. A diode-triode transistor has been developed which consists of an alloyed  $p-n$  junction (diode unit) and an alloyed  $p-n-p$  junction (triode unit) constructed on one germanium pellet so that the  $n$ -type base region is common to both units. This construction provides direct connection between the diode and triode units and permits the use of fewer circuit components. The diode is intended for use as a detector and the triode as a Class A audio amplifier in a transistorized broadcast receiver. In addition to reducing the number of components required, the dual-unit transistor increases the detector efficiency of battery-operated receivers. (D. Thorne and R. V. Fournier, "Improvements in detection, gain-control, and audio-driver circuits of transistorized broadcast-band receivers," IRE TRANS. ON BROADCAST AND TELEVISIONS RECEIVERS, December, 1959.)

**Research on research** is an exciting and potentially fruitful new area of investigation which, it is hoped, will in time increase our understanding of and ability to manage the vital processes of Research, Development, and Engineering. It is a field that is in its early stages and the literature contributing to it is not yet readily accessible to the engineering manager—

a void which the current issue of IRE TRANSACTIONS ON ENGINEERING MANAGEMENT makes a noteworthy effort to fill. In glancing through the papers in the issue one is struck by the fact that most of the authors are not engineers but rather are economists, sociologists, and operations researchers. Apparently, much of the initial motivation for doing "research on research" stems from an interest in economic factors, in social behavior, or simply in problems that are intriguing to analyze. One is also struck by the degree in which mathematical tools are being employed to analyze the affairs of humans. Thus one finds the authors speaking of such things as stochastic models, regression models, sets of sets of sets, and logistic cubic functions in discussing the organization and operation of a research staff. Perhaps this is a sign that our understanding of the management process has progressed to a point where we are beginning to be able to formulate the problems to be solved. For before we can arrive at useful answers, we must first learn how to state the questions. (IRE TRANS. ON ENGINEERING MANAGEMENT, March, 1960.)

**Active networks** have a unique property: they can produce poles as well as zeros in the right half of the complex frequency plane. Such regenerative modes (exhibited in transient behavior as increasing exponentials) are essential for the operation of multivibrators, blocking oscillators, etc. In fact, the switching time, and thus the maximum repetition frequency, depends on the location of these right-half-plane natural frequencies. The farther away from the imaginary axis a regenerative mode is, the faster the operation possible. Now it turns out that if an RC network is used, the upper bound is fixed entirely by the physical active device and this upper bound can be easily computed directly from the active device. Not only is this extremely useful but it is satisfying to know that it can actually be realized. (E. S. Kuh, "Regenerative modes of active networks," IRE TRANS. ON CIRCUIT THEORY, March, 1960.)

**The powerful transistor.** In view of the fact that transistors are essentially low-power devices, it is surprising to note how much power they can be called on to handle in switching applications. Germanium transistors having ratings up to 70 volts and 15 amperes having been introduced and developmental germanium devices with current-carrying capacities up to about 100 amperes have been made. More recently, silicon transistors and  $n-p-n-p$  devices (called Trinistors) have been developed which extend the power-handling capacity of semiconductor switches from the 1-kw limit of germanium Trinistors to the region of 10 kw. The extension of the current range of Trinistors, presently at 20 to 50 amperes, to 100 and 200 amperes is progressing rapidly. Indeed it appears feasible that power Trinistors may eventually be developed for use in inverter circuits operating in the 50 to 75 kva range. (H. W. Henkels and F. S. Stein, "Comparison of  $n-p-n$  transistors and  $n-p-n-p$  devices as twenty-ampere switches," IRE TRANS. ON ELECTRON DEVICES, January, 1960.)

# Abstracts of IRE Transactions

The following issues of TRANSACTIONS have recently been published, and are now available from the Institute of Radio Engineers, Inc., 1 East 79th Street, New York 21, N. Y. at the following prices. The contents of each issue and, where available, abstracts of technical papers are given below.

Sponsoring Group	Publication	Group Members	IRE Members	Non-Members*
Automatic Control	AC-4, No. 2	\$0.95	\$1.25	\$2.55
Broadcast and Television Receivers	BTR-5, No. 3	1.10	1.65	3.30
Circuit Theory	CT-7, No. 1	1.35	2.00	4.05
Electron Devices	ED-7, No. 1	1.40	2.10	4.20
Engineering Management	EM-7, No. 1	1.00	1.50	3.00
Human Factors in Electronics	HFE-1, No. 1	2.15	3.30	6.45
Industrial Electronics	PGIE-11	1.10	1.65	3.30
Microwave Theory and Techniques	MTT-8, No. 1	2.10	3.15	6.30

\* Libraries and colleges may purchase copies at IRE Member rates.

## Automatic Control

VOL. AC-4, NO. 2,  
NOVEMBER, 1959

Papers Reprinted from Part 4 of the  
1959 IRE NATIONAL CONVENTION RECORD

**On Adaptive Control Processes**—R. Bellman and R. Kalaba (p. 1)

One of the most challenging areas in the field of automatic control is the design of automatic control devices that "learn" to improve their performance based upon experience, *i.e.*, that can *adapt* themselves to circumstances as they find them. The military and commercial implications of such devices are impressive, and interest in the two main areas of research in the field of control, the U.S.A and the U.S.S.R., runs high. Unfortunately, though, both theory and construction of adaptive controllers are in their infancy, and some time may pass before they are commonplace. Nonetheless, development at this time of adequate theories of processes of this nature is essential.

The purpose of the paper is to show how the functional equation technique of a new mathematical discipline, dynamic programming, can be used in the formulation and solution of a variety of optimization problems concerning the design of adaptive devices. Although, occasionally, a solution in closed form can be obtained, in general, numerical solution via the use of high-speed digital computers is contemplated.

Discussed here are the closely allied problems of formulating adaptive control processes in precise mathematical terms and of presenting feasible computational algorithms for determining numerical solutions.

To illustrate the general concepts, consider a system which is governed by the inhomogeneous van der Pol equation

$$\ddot{x} + \mu(x^2 - 1)\dot{x} + x = r(t), \quad 0 \leq t \leq T,$$

where  $r(t)$  is a random function whose statistical properties are only partially known to a feedback control device which seeks to keep the system near the unstable equilibrium state  $x=0$ ,  $\dot{x}=0$ . It proposes to do this by selecting the value of  $\mu$  as a function of the state of the system at time  $t$ , and the time  $t$  itself. By observing the random process  $r(t)$ , the controller may, with the passage of time, infer more

and more concerning the statistical properties of the function  $r(t)$  and thus may be expected to improve the quality of its control decisions. In this way the controller *adapts* itself to circumstances as it finds them. The process is thus an interesting example of adaptive control, and conceivably, with some immediate applications.

Lastly, some areas of this general domain requiring additional research are indicated.

**A Dynamic Programming Approach to Adaptive Control Processes**—M. Freimer (p. 10)

In many multi-stage decision processes we face the problem of dealing with random variables whose distributions are initially imperfectly known, but which become known with increasing accuracy as the process continues. In this paper the author shows how Dynamic Programming may be used to treat a class of such problems, which are currently called *adaptive processes*.

After discussing the general theory, the techniques are illustrated by a specific example. For this example simple computation algorithms are derived, which are typical of those obtained for the whole class of problems under consideration.

**On the Optimum Synthesis of Multipole Control Systems in the Wiener Sense**—H. C. Hsieh and C. T. Leonides (p. 16)

This paper is concerned with obtaining the optimum system in the Wiener sense for the multipole system shown in Fig. 1. Earlier literature has shown how to obtain the mean-square value of the error when the multipole system transfer function has been specified, but thus far no published work has shown how to solve the synthesis problem, in general, for this case. The principal reason that this problem has appeared to be impossible of analytic solution thus far for cross correlation between the inputs is based on the fact that the usual variational approach results in a set of untractable simultaneous integral equations involving many complicated cross products of the desired weighting functions and the variational functions.

The synthesis problem for the system of Fig. 1 is first solved for the case in which there is no correlation between the inputs to the various terminals. The result for the optimum weighting functions in this case is presented in (24), and the resultant mean-squared value of the error is shown in (25).

Following this, the far more complicated case of the synthesis problem when the inputs to all the various terminals are correlated is considered. In this case, a rather unique technique is utilized to avoid the difficulties inherent in the use of the usual variational techniques. Through the technique utilized in this paper, the usual set of untractable simultaneous integral equations is completely avoided, and instead a set of ordinary algebraic equations results. The set of equations for this case is shown in (64), and in matrix form in (65). The resultant solution for the optimum physically realizable transfer functions is shown in (77). It is also shown, as a check, that the solution for the case of correlated inputs reduces to the solution obtained for the case of uncorrelated inputs.

The paper then concludes with an illustrative example for the more complicated case of correlated inputs. The possibilities of applications of the results of this paper to such fields as the guidance and control of astronomical vehicles, military fire control systems, bombing navigation systems, process control systems, automatic milling machines, air traffic control, nuclear reactor control, etc., are fairly evident.

**On Adaptive Control Systems**—L. Braun, Jr. (p. 30)

An attempt is made in the paper to evolve a basic philosophy for adaptive control systems.

A method is described for determining the system impulse response from measurements of instantaneous system input and output. The impulse response is expanded in a Taylor series, to facilitate solution of the convolution integral.

From a knowledge of the impulse response and the system error, the necessary correction to the system forcing function is determined, in a manner similar to that used for determination of the impulse response.

The techniques developed are applied to two systems—one stable and one unstable. Curves of the results are presented.

**Extension of Phase Plane Analysis to Quantized Systems**—P. H. Ellis (p. 43)

The increasing applications of numerical control of processes have created a need for new methods of synthesis of control equipment. The method presented is applicable to systems commanded by discretely valued inputs, and processes whose outputs may be similarly quantized. Periodic sampling is not required. The most suitable sampling is by transmission of only significant data, as the new value obtained when the data are changed by a given increment. In certain cases, transmission of data by this means can be used to increase channel capacity. When the data are so quantized, the error signal is constrained to a finite number of discrete values, each of which may be associated with an area on the phase plane. Within each such area, the trajectories of any process subject to phase plane representation are a family of parallel curves. Thus, analytic synthesis may be simplified in the case of certain nonlinear processes. Graphical design is facilitated without requiring deduction of a mathematical representation of the process.

The method is illustrated by synthesis of several systems involving a simple linear process.

**Simplified Method of Determining Transient Response from Frequency Response of Linear Networks and Systems**—V. S. Levadi (p. 55)

Knowing the frequency response of a linear system, a method is presented for obtaining the time response of the system to an impulse, step, or ramp function input, without performing graphical integrations.



The transient response is of the form

$$f(t) = \sum_i A_i G(\omega_i t)$$

where a different function  $G$  is used to determine the response to each of the three types of input.

Tables of the functions  $G(x)$  are provided.

An example is given to illustrate the simplicity and accuracy of this method. The results are compared with the exact time response.

#### A New Method of Analysis of Sampled-Data Systems—A. Papoulis (p. 67)

In many sampled-data systems the sampling interval  $T$  is "small" and the response  $r_s(t)$  closely approximates the response  $r(t)$  of the continuous system; one is then interested in evaluating the difference  $r_s(t) - r(t)$  for various values of  $T$ . In this paper this difference is given as a power series in  $T$  whose coefficients can easily be determined in terms of the continuous response; if one wants to estimate the size of  $T$  for  $r_s(t)$  to equal  $r(t)$  within a specified error, the first term of this expansion will give an adequate measure of the error and hence of the maximum permissible  $T$ . Furthermore, since the resulting series converges rapidly, the expansion provides a simple method of evaluating  $r_s(t)$  for a given  $T$ .

The method is applied to a feedback system with a sampler; the singularities of the  $p$ -rational system function that gives the actual response at the sampling points, are obtained by a displacement of the singularities of the continuous system function.

#### Statistical Filter Theory for Time-Varying Systems—E. C. Stewart and G. L. Smith (p. 74)

The guidance and control accuracy of most aerodynamic and space vehicles is limited primarily by the noise disturbances which enter the guidance system. Present theory for the minimization of these noise effects does not take into account the forced kinematic time variations, such as is due to time-varying range, which occur in most guidance problems. Such time variations occur in interplanetary flight, satellite rendezvous, interception of missiles or bombers, and so forth. In this paper an analytical approach is presented for the optimization of systems which are forced both to be time varying and to operate with inputs contaminated with noise.

Two objectives are the establishment of the theoretical optimum performance and a method of synthesizing the optimum control system. Effects of restrictions on the capability of the output element in addition to the noise and the forced time variation are considered. Although an exact analytical solution of the problem does not appear feasible, it is shown how approximate solutions utilizing time-varying control systems can be found. The method is illustrated by a hypothetical example of a homing missile attacking a bomber.

#### On the Phase Plane Analysis of Nonlinear Time-Varying Systems—R. F. Whitbeck (p. 80)

A phase plane technique, which takes advantage of convenient relationships in other planes (for example, displacement versus time) to effect graphical solutions for a nonlinear time varying second order differential equation, is developed. Several special cases of this general second order equation are considered. The special case of most practical importance occurs when the differential equation is permitted to become piecewise linear. To demonstrate the simplicity of the technique, for the piecewise linear case, an example involving saturation in an inertially damped position servomechanism is given.

#### On the Use of Growing Harmonic Exponentials to Identify Static Nonlinear Operators—H. J. Lory, D. C. Lai and W. H. Huggins (p. 91)

The paper describes a method of obtaining a polynomial characteristic function for a non-

linear static system. This function,

$$F(x) = hx + mx^2 + dx^3,$$

is obtained by the application of a growing exponential  $x = \exp(t)$  to the input of the system and the filtering of the output

$$h \exp(t) + m \exp(2t) + d \exp(3t),$$

into its separate components  $h \exp(t)$ ,  $m \exp(2t)$ , and  $d \exp(3t)$ . The values of these three components at  $t=0$  are the polynomial coefficients  $h$ ,  $m$ , and  $d$  respectively. The identification of systems not exactly describable by a cubic gives rise to an error minimization problem; the technique described in this paper minimizes the weighted mean-square error, with a weighting function  $1/x$ . This method is compared with the more widely known sinusoidal analysis of nonlinear systems. Experimental results are given.

Papers reprinted from Part 4 of the  
1959 IRE WESCON CONVENTION RECORD

#### A Parameter Tracking Servo for Adaptive Control Systems—M. Margolis and C. T. Leondes (p. 100)

This paper describes one very general approach to the design of adaptive control systems. The particular systems considered are process adaptive. The dynamic characteristics of the physical process are determined by the parameter tracking servo. The parameters thus determined are used to program the process' controller.

The parameter tracking servo is a closed loop self-adjusting system. It consists of the following elements: 1) the physical process, 2) the learning model, 3) the adjusting mechanism. The learning model and the physical process are subjected to the same input signals. Their outputs are compared and the resultant error is fed to the adjusting mechanism where some function of this error is used to adjust the parameters of the learning model.

The mechanism will continuously track the parameters of the physical process as they change with time in some unknown manner. The adjusting mechanism operates on an approximation to the method of steepest descent. These equations are derived for a first order process and the over-all system is analyzed. The equations describing the tracking servo's operation are both nonlinear and non-autonomous. System response as a function of input signal, gain, and error function are described analytically. Experimental results are included to demonstrate the validity of the analytic solutions.

#### Maximum Effort Control for Oscillatory Element—H. K. Knudsen (p. 112)

Maximum effort control is a method of achieving deadbeat response for a step input to an undamped second order element (two poles on the  $j\omega$  axis of the  $s$ -plane) which is preceded by a saturating amplifier. This method of control supplies the maximum available energy to the element being controlled, by driving the amplifier to saturation whenever an error is present. The realization of a maximum effort control system for an oscillatory element is found through a phase plane analysis of the equations of motion of the oscillatory element. The control system topology is also found by the analysis of a phasor representation of the transients introduced in the oscillatory element by the output of the saturating amplifier.

The system was constructed to compare the experimental responses of step inputs and load disturbances, to the responses obtained from an idealized mathematical model of the system. The adaptability of the control system was tested by using it to control a damped oscillatory element.

The system described will be an aid in the design of the control system which will give optimum response for random inputs to an un-

damped second order element which is preceded by a saturating amplifier. It also provides a method of control for systems in which it is impossible to damp poles near the  $j\omega$  axis.

#### Identification and Command Problems in Adaptive Systems—E. Mishkin and R. A. Haddad (p. 121)

In order to satisfy stringent performance requirements in a dynamic process, a computer is incorporated as a central element in the feedback loop. The computer performs the dual task of identifying or measuring the process' dynamics, and thence generating an appropriate command or actuating signal so as to satisfy the over-all specifications. The family of singularity functions (steps, ramps, confluent parabolas) is used as the command signal. The process' dynamics are monitored and identified by the computer without recourse to interrupting test signals such as periodic impulses or white noise. The stored energy term inherent in many measurement problems in continuous processes is accounted for in a novel manner.

#### Evaluating Residues and Coefficients in High Order Poles—D. Hazony and J. Riley (p. 132)

The powerful Laplace transform method for transient analysis by the partial fraction expansion technique has become quite popular in the fields of circuit and servo design. The theory of residues is usually used to find the coefficients of these fractions. The process is quite simple until second and higher order poles are included in the denominator. Previously, this has required a return to the calculus to find the additional coefficients required.

This paper discloses a simple technique for finding these additional coefficients by algebraic processes. As a result both manual and machine computation can be performed more easily. The technique is described and its mathematical basis is rigorously proven.

#### Coherent Optical Data Processing—L. J. Cutrona, E. N. Leith and L. J. Porcello (p. 137)

Coherent optical systems, which utilize the wave nature of light and the consequent diffraction phenomena, may often be used to supplement or even replace complex electronic equipment. Such systems are particularly adapted to the performance of certain linear mathematical operations, particularly those of an integral transform nature such as spectral analysis, convolution, auto- and cross-correlation, and matched filtering. The two-dimensional nature of optical systems, contrasted with the inherent one-dimensional nature of an electronic channel, allows a great reduction in equipment complexity for certain classes of operations.

This paper discusses the theory behind optical channels and filters as outlined above, and also illustrates simple multi-channel optical systems which can carry out representative operations.

#### Pole Determinations with Complex-Zero Inputs—J. A. Brussolo (p. 150)

A method for the determination of the characteristic pole locations in simple systems and components is discussed. The techniques introduced are extended to include more complex systems. The method consists of applying a signal to the system from a "complex-zero-generator" and then observing the system output response on an oscillograph. The system pole locations are determined when the system output goes through a null, which occurs when the zeros generated by the "complex-zero-generator" cancel the system poles. Tests on experimental systems indicate that the pole locations can be determined accurately and rapidly for a wide variety of systems.

For testing purposes, a "complex-zero-generator" was built using two square-wave generators with a timed delay between them. This generator gives a signal which can contain complex zeros anywhere in the  $s$ -plane. This

signal is then applied to a number of systems containing several different relative pole orientations. The system outputs, as photographed on the oscillograph, are studied to develop rules and procedures to determine the pole locations. The rules are then applied to a number of "unknown" systems in order to determine their applicability and a study is made of the errors and limitations involved.

The results indicate that the method described is readily applicable to many systems and that, in many instances, the pole locations are determined more accurately and more rapidly than can be done through the use of a steady-state frequency analysis.

**Random Noise with Bias Signals in Non-linear Devices**—G. S. Axelby (p. 167)

A number of investigations have been made in recent years about the transmission of Gaussian noise through nonlinear devices. In many cases, simplification or approximations were needed to make analytical solutions possible, and only zero-average Gaussian input signals were used when the results were applied to feedback control systems.

This paper presents a different approach to the problem of noise transmission through nonlinear single-valued elements. Basically, amplitudes removed by nonlinear saturation or dead-zones are replaced by impulses in the amplitude distribution functions of the output signals, and the resulting first and second moments of the output distribution are computed to yield the average and rms value of the output signal. The solution may be found by graphical or mathematical integration, a visual representation of the phenomenon is obtained, and input signals with any distributions having non-zero average values may be considered.

It is shown that there is an equivalent transmission function or describing function for the average value of the noise, another for the rms value, and that one is a function of the other. Examples of the functions are given and the simpler functions with zero-average values are compared to the results obtained by other methods.

Finally, the application of the noise describing functions to feedback control systems is discussed. Theoretical results are compared with those obtained from analog simulations.

**Nongyroscopic Inertial Reference**—J. J. Klein (p. 182)

The space stabilizing capability of a servo controlled nonrotating inertial mass is analyzed and its drift rate performance compared with a high precision gyroscope. The results indicate that the nongyroscopic inertial reference and guidance system exceeds the performance of gyroscopic systems by several orders of magnitude. It is shown that a servo system materially contributes to the drift accuracy in the nongyroscopic system but not in the gyroscopic system. The navigation errors of the discussed scheme are directly proportional to the accelerometer errors and, therefore, are inherently smaller than in an equivalent gyroscopic system.

**Sampled Data Design by Log Chain Diagrams**—M. P. Pastel and G. J. Thaler (p. 192)

The bilinear transformation

$$z = (1 + w)/(1 - w)$$

converts a  $z$ -transform function  $G(z)$  of a sampled-data system into a new function  $G(w)$ , called the  $w$ -transform function, which is a rational function in variable  $w$ . This bilinear transformation maps the unit circle on the  $z$ -plane onto the imaginary axis of the  $w$ -plane. Consequently, it is now possible to draw log magnitude and phase diagrams readily against a frequency scale of the open-loop  $w$ -transform function of a sampled-data system by use of asymptotic techniques. Then, by use of a Nichols chart and correlation information available from continuous systems, it is possible

to predict the approximate time domain performance. Design by modification of the open-loop transfer function can be made on the diagram in the same manner as employed for continuous systems on the Bode diagram. The resulting  $w$ -transform can be converted to its equivalent Laplace transform. The ratio of this transform function and the original Laplace transform function of the system's equipment gives the required compensator. Remote  $s$ -plane poles may have to be added to have the compensator physically realizable. Restricting the modifying  $w$ -plane poles to lie between (0) and  $(-1)$  permits the compensator to be realizable as an RC network.

**Broadcast and Television Receivers**

VOL. BTR-5, No. 3,

DECEMBER, 1959

Editorial (p. 1)

PGBTR Administrative Committee (p. 2)

Papers Reprinted from Part 7 of the 1959 IRE NATIONAL CONVENTION RECORD

**Audio Applications of a Sheet-Beam Deflection Tube**—J. N. Van Scoyoc (p. 3)

A number of unusual audio circuits have been developed which make use of a sheet-beam tube, type 6AR8. The 6AR8 tube is a miniature double-plate sheet-beam tube which incorporates a pair of balanced deflectors to direct the electron beam to either of the two plates and a control grid to vary the intensity of the beam.

This tube may be connected as a variable gain push-pull amplifier by connecting the input signal between the two deflectors and taking the output differentially between the two plates. When the tube is connected in this manner the amplifier gain is determined by the control grid voltage and may be varied over an 80 db range with negligible distortion.

The applications of this circuit include expansion and compression circuits, remote control of gain and mixing circuits, improved A.V.C. circuits and phase inversion. A number of these circuit arrangements are given in some detail and other applications are outlined.

**A Drift-Free Direct-Coupled Amplifier Utilizing a Clipper-RC Feedback Loop**—J. N. Van Scoyoc and E. S. Gordon (p. 8)

A unique drift-free direct-coupled amplifier has been developed employing a clipper and an RC integrating circuit in a feedback loop for stability. Equations are developed and computed and experimental curves are given for amplitude and phase-shift response as a function of frequency showing an extremely sharp power drop-off at the low end.

An existing application of this type of amplifier in an instrument for automatic counting and sizing of aerosol particles is described, demonstrating wide dynamic range and other advantageous features of the amplifier. Other potential applications of the Direct-Coupled Clipper-RC amplifier are given such as those of random pulse rate measurement, low level dc amplification using only a single-pole single-throw (SPST) chopper, and low level dc amplification of up to 20 concurrent inputs using a single amplifier and a slow-speed rotary switch.

Finally, a practical general purpose vacuum tube circuit of this amplifier type which was developed is described, giving data on pertinent characteristics such as low zero-drift, low noise, and high output capability.

**The Application of the Voltage Variable Semiconductor Capacitor in Automatic Sweep Circuits and Signal-Seeking Receivers**—J. Black (p. 16)

The basic method of automatic frequency sweep by charging a voltage variable capacitor

is presented and the advantages over mechanically driven tuning capacitors are discussed.

The principle is extended by using the receiver automatic gain and/or frequency control for sweep control and station tracking, and practical circuits are shown embodying the principle.

Applications in the AM and FM fields, such as domestic and car radio receivers and television sets, are proposed.

The limitations of present devices and their effect on the application field are discussed.

**An Analysis of a Transistorized Class "B" Vertical Deflection System**—Z. Wiencek and J. E. Bridges (p. 20)

**Considerations in Transistor Automobile Receiver Front End Design**—R. Martinengo (p. 31)

This paper discusses the requirements which must be considered in the design of an RF amplifier stage and converter for a transistor automobile receiver. Several coupling networks for the antenna and interstage circuits are discussed and performance data are given for various combinations of circuits. Data are given for a converter circuit including voltage and temperature effects on frequency stability.

**A Five-Transistor Automobile Receiver Employing Drift Transistors**—R. A. Santilli and C. F. Wheatley (p. 38)

**Improvements in Detection, Gain-Control, and Audio-Driver Circuits of Transistorized Broadcast-Band Receivers**—D. Thorne and R. V. Fournier (p. 46)

**Application of Rotationally Non-Symmetrical Electron Lenses to TV Image Reproduction**—D. W. Taylor, N. W. Parker and H. N. Frihart (p. 54)

Recent developments in the art have dictated the division of this paper into two component parts. The first deals with a quadrupole, magnetic lens of rotational nonsymmetry used to achieve scan magnification with a television cathode ray tube. The second concerns the development of a negative, electrostatic, gauze lens exhibiting full rotational symmetry which is also used to provide scan magnification.

In the discussion, the quadrupole lens is synthesized from component fixed fields and the electron beam trajectories within the lens predicted. An analogy with crossed, positive and negative, cylinder lenses of light optics is expressed. The design of a complete, scan-magnified, image reproducing system is considered.

The theory of the rotationally symmetrical divergent lens is developed from an extension of the theory of bi-potential lenses. Problems of mesh scatter are treated and spot size increase due to mesh scatter is calculated. Other optical problems introduced by the mesh are discussed.

**A High Sensitivity Ultrasonic Microphone**—P. Desmares and R. Adler (p. 64)

Papers Reprinted from Parts 2 and 7 of the 1959 IRE WESCON CONVENTION RECORD

**The FM Multiplex Stereo Receiver**—H. N. Parker (p. 70)

**Circuit Aspects of Parametric Amplifiers**—H. Seidel and G. F. Hermann (p. 75)

Parametric amplifiers are distinguished from most active networks in that power is taken directly from an ac source and that the phase of this source is significant in the amplification process. As a consequence of the harmonic spectrum produced by the interaction of the power source (pump) and the nonlinear element, the introduction of a small signal generates a pair of sidebands about each harmonic. Networks with variable parameters may be handled with an extension of the conventional formalism into one of frequency as well as spatial scattering.

We deal with two cases. In the first we consider the lower sideband amplifier which re-



quires only a two frequency description; the signal and the lower sideband. Such a system may be optimized by adding equalizing networks whose synthesis stems from passive network procedures.

The second case considers a periodic cascade in which the pump phase is assumed to be varying uniformly. The nature of the natural modes of such a system are derived from general considerations of time and space symmetry. The reactive case is considered specially and orthogonality relations are produced which resemble those of a conventional network chain.

**Four Terminal Equivalent Circuits of Parametric Diodes**—C. S. Kim (p. 83)

Four terminal equivalent circuits of variable capacitance (parametric) diodes used in various configurations of converters and amplifiers are presented. These equivalent circuits are derived from small signal approximations for the nonlinear dynamic capacitance of a diode. The cases considered involve three frequencies, namely input and output signal frequencies and pumping frequency for converters or input signal frequency, idler and pumping frequencies for amplifiers.

These four terminal equivalent circuits are analogous to those for transistors and vacuum tubes. They help to give an understanding of parametric operation and may be used to obtain expressions for gain, bandwidth and noise figure.

## Circuit Theory

VOL. CT-7, No. 1, MARCH, 1960

**Iterative Traveling-Wave Parametric Amplifiers**—C. V. Bell and G. Wade (p. 4)

It is well known that the parametric principle can give low-noise amplification at microwave frequencies. The conventional parametric amplifier involves a single variable element and one or more resonant cavities. Such an amplifier is extremely narrow band, it suffers from large changes in gain due to small changes in pump level, and it must be used with a circulator if unilateral gain is desired. These difficulties can be overcome by using a number of variable elements in a traveling-wave circuit.

This paper presents the circuit considerations appropriate to wideband operation in a traveling-wave parametric amplifier. The model which is analyzed is a transmission line periodically loaded with parametric diodes. The diodes constitute the variable elements. Across each diode is fed a large pumping voltage which produces a time-varying capacitance.

A Brillouin diagram for the structure (*i.e.*, a plot of  $\omega$  vs  $\beta$ ) can be computed from the analysis. The conditions for high gain, wide band, and other desirable characteristics are conveniently determined from this diagram.

**On the Application of the Base Charge Concepts in the Design of Switching Circuits**—R. S. C. Cobbold (p. 12)

This paper described a new method of measuring the effective decay time of excess minority carriers in the base of junction transistors, the results of which show an approximately exponential decay with time. The relation between the decay-time constant and the normal and inverse transistor parameters is discussed, and it is shown how the experimental measurements can be directly applied to the design of transistor pulse circuits.

Using the Ebers and Moll equivalent circuit for a saturated transistor, an analysis is made of the effect on the charge storage caused by the passage of a collector current when the base connection is open circuit. The case of a transient collector current is also examined, and it is concluded that for typical alloy junction transistors the passage of a collector current plays little part in determining the charge storage. Thus, the storage time with open-circuit base is determined by the initial excess

charge, the collector current existing when the transistor enters the active region, and the decay time constant for minority carriers. A simple equivalent circuit for determining the decay of stored charge when a reverse base current is applied is also discussed.

**Element Coefficients for Symmetrical Two-Section Filters Having Tchebycheff Response in Both Pass and Stop Bands**—D. C. Pawsey (p. 19)

Elements coefficient for a normalized symmetrical low-pass filter, having "equal ripple" response in both pass and stop bands, are presented graphically. The coefficients are plotted against the relative selectivity of the filter, with a loss factor as independent parameter. The interval between curves is sufficiently small to permit interpolation with an accuracy of  $\pm 1$  per cent.

Frequency and impedance transformations are included to allow the elements of a practical filter to be derived from those of the appropriate normalized design.

The loss function corresponding to a particular design is readily formulated in terms of the Loss factor above and the appropriate frequencies of zero loss.

**Maximum Gain Realization of an RC Ladder Network**—A. Paige and E. S. Kuh (p. 32)

This paper is concerned with the synthesis of the voltage transfer function of an un terminated RC ladder network. Given

$$A(p) = \frac{V_2}{V_1} = K \frac{N(p)}{D(p)},$$

the constraint on  $N$  and  $D$  is well known and the realization procedure is straightforward. However, for many applications, it is important to realize the maximum possible gain ( $K_{max}$ ) associated with a given transfer function. This paper presents a method of determining  $K_{max}$  from the given  $A(p)$ . Furthermore, it is shown that if the maximum gain occurs at dc or at infinite frequency,  $K_{max}$  can be realized exactly. If the maximum gain occurs at a finite frequency,  $K_{max}$  can be approached arbitrarily closely.

**On Coefficients of Polynomials in Network Functions**—S. L. Hakimi and W. Mayeda (p. 40)

This paper presents a study of the relationships between the missing powers of polynomials in network functions and the network geometry. The elementary transformation of trees and the 2-trees of a network are introduced to obtain the necessary and sufficient conditions for polynomials in network functions to have missing powers. It is shown that the polynomial in the numerator of the transfer function of a grounded two-terminal-pair RLC network cannot have two successive missing powers unless some common factors of the numerator and the denominator are cancelled. This result is useful in topological synthesis where one must usually restore all the necessary surplus factors before deciding on the minimum number of vertices and the geometry of the network.

**A General Class of Maximally-Flat Amplitude Response Ladders**—Sid Deutsch (p. 45)

It is shown that the elliptical Tchebycheff pole array defines a general class of maximally-flat amplitude functions when the number of poles approaches infinity. The infinite-order pole array can be realized as an infinite cascade of identical two-terminal ladders. The amplitude characteristic of the driving-point impedance of the two-terminal ladder is flat up to the nominal cutoff frequency,  $\omega_0$ . Beyond  $\omega_0$ , the exact shape of the amplitude characteristic is determined by the eccentricity of the original pole array. The two-terminal ladder is a low-pass  $R$ ,  $L$ , and  $C$  structure that is infinitely long. Two special cases are considered: 1) when

the pole array becomes linear, the ladder is a constant- $k$  type; 2) when the pole array becomes circular, the shunt conductances and series resistances of the ladder rapidly taper toward zero while its  $C$  and  $L$  components taper toward a constant- $k$  type.

**Optimum Estimation of Impulse Response in the Presence of Noise**—Morris J. Levin (p. 50)

The problem considered is that of estimating the impulse response of a linear system from records of its input and output during a limited interval of time when the system output is obscured by additive random noise. Standard results from statistical estimation theory are applied to derive least squares and Markov estimates which are optimum in the sense of having minimum variance among all linear unbiased estimates. No special assumptions are required concerning the form of the input. Expressions for the variances of the sampling errors are given. The relationships of these estimates to other methods of estimation which have been suggested are discussed.

**Demodulated Lead Networks**—Erik V. Bohn (p. 56)

One of the possible types of compensating networks for carrier-frequency servo systems is the demodulator lead network. By means of synchronous switching, a nonlinear operation is performed on the envelope of the input. For the case of very high carrier-to-signal-frequency ratio, an equivalent linear circuit is derived which is that of a typical dc lead network. The response to a step input in conjunction with quasistationary Fourier analysis and description of function methods is used to derive the circuit elements. The equivalent circuit is verified experimentally and its range of validity discussed.

**Regenerative Modes of Active Networks**—E. S. Kuh (p. 62)

An active device with passive imbedding can produce natural frequencies in the right-half plane. In the design of regenerative circuits, it is important to find the permissible location of regenerative modes. In this paper the maximum real part of the natural frequency of an active device under arbitrary passive imbedding is determined. Furthermore, it is shown that this regenerative mode can actually be realized. For the case of a pentode, the required passive network is a gyrator.

**Reviews of Current Literature** (p. 64)  
**Correspondence** (p. 67)

## Electron Devices

VOL. ED-7, No. 1,  
JANUARY, 1960

**Tunnel Diodes**—R. N. Hall (p. 1)

This paper presents a review of the properties, principles of operation, and implications of the tunnel diode. Following a brief description of the unusual characteristics of this device, a discussion is given of the mechanism which leads to the negative resistance. Experiments showing the transition from the tunnel diode characteristic to that of a high-voltage avalanche diode are exhibited. The electrical characteristics of tunnel diodes are outlined making use of the small-signal equivalent circuit which represents the behavior in the negative resistance region. Diodes designed for high-frequency operation are described and examples are given of circuits which demonstrate their behavior as switches, radio receivers, and microwave oscillators. In connection with a discussion of the temperature dependence of these devices, experiments are described which demonstrate the importance of phonons in determining their characteristics at the temperature of liquid helium.



### Prediction of Storage Time in Junction Transistors—R. P. Nanavati (p. 9)

This paper points out that in the prediction of storage time one needs to know only a single fundamental device parameter, the storage time constant  $T_s$ . Several methods of measuring  $T_s$  are considered and compared both theoretically and experimentally. A single non-oscilloscope method of measuring  $T_s$  is discussed and its theory presented. This method holds out the best promise for the ability to predict the storage time of very fast transistors. It is therefore now possible to predict large signal transient response of transistors on the basis of small signal nonoscilloscope measurements.

### One-Dimensional Traveling-Wave Tube Analyses and the Effect of Radial Electric Field Variations—J. E. Rowe (p. 16)

The equivalence of the differential-equation and integral-equation approaches to the solution of the nonlinear traveling-wave amplifier problem is shown rigorously. The equations can be transformed one into the other without making any additional assumptions. The space-charge expression developed on the basis of considering the electron distribution in phase space is shown to give the same form for the space-charge weighting function as a space-charge expression based on the electron distribution in space. Efficiency calculations are compared for the two methods and the agreement is excellent. Corrections to earlier calculations are included. The effect of radial electric field variations due to the circuit is considered and it is shown that the efficiency for large streams is reduced in direct proportion to the square of the field reduction function.

### Small-Signal Analysis of the Helitron Oscillator—Richard H. Pantell (p. 22)

In this paper, a small-signal analysis of a microwave oscillator, discussed by Watkins and Wada is presented. This tube, the helitron, has an electron beam describing the trajectory of a helix between two concentric cylinders. Interaction is with a TEM mode supported on the inner cylinder, and the beam is focused by having a potential difference between the cylinders. This has been termed an E-type tube.

The E-type tube had originally been conceived as a device for exchanging electron potential energy of an electrostatically focused beam for RF energy. In this manner, one would expect to obtain the high efficiencies associated with an M-type tube, without requiring a magnetic field.

Watkins and Wada presented experimental results in their paper, and they indicated that the theory that had been developed did not predict the observed behavior. In particular, it was stated that if the propagation constants were those of an M-type tube, the measured starting current would be one-fiftieth of the theoretical starting current.

The small-signal analysis of the E-type tube developed in the main body of this paper has yielded two interesting results:

1) The electrons bunch along the direction of rotation, and lose kinetic energy. In this sense the E-type tube behaves similar to the O-type oscillator. Electron motion transverse to the dc path, which is important in the M-type tube, is not important for E-type operation.

2) Space charge forces tend to increase the bunching along the direction of rotation. This results in a negative value for the space-charge parameter, and an attendant reduction in starting current. Growing waves can exist on an electron beam that is electrostatically focused between two conducting cylinders, even without the presence of a circuit field. In this sense the E-type oscillator is similar to the M-type tube.

### Generation-Recombination Noise in Semiconductors—The Equivalent Circuit Approach

—Keith S. Champlin (p. 29)

Generation-recombination noise in semiconductors in thermal equilibrium is treated from the standpoint of thermal fluctuations in equivalent electrical circuits. For the general volume recombination model, a method based on network reduction is presented which allows one to calculate the spectral density of the electron and hole fluctuations without solving for the spectra of the fluctuations in occupancy of the recombination centers and traps. The method is extended to a surface recombination model, thereby avoiding the ambiguities found in previous formal treatments. It is shown that the concept of ambipolar diffusion, the location and spectral density of the random sources, and the spatial correlation of Fourier coefficients of carrier density fluctuations all have simple significance in electrical terms.

Using transmission line techniques, the generation-recombination (GR) spectrum is calculated for a two-level semiconductor where recombination occurs at opposite plane surfaces. This new result is examined in detail for the limiting cases approached when the recombination process is 1) volume-limited, 2) surface-limited, and 3) diffusion-limited. It is shown that, in the first two cases, the spectrum is identical with that obtained from a zero-dimensional analysis provided the time constant is properly defined. For the diffusion-limited case, however, the spectrum varies as  $1/\omega^{3/2}$  at high frequencies, and at low frequencies the noise is 5/6 that predicted by the simple theory. The new result is shown to compare favorably with measurements reported previously by Hill and van Vliet.

### Comparison of N-P-N Transistors and N-P-N-P Devices as Twenty-Ampere Switches—H. W. Henkels and F. S. Stein (p. 39)

A series of 20-ampere silicon *n-p-n* transistors and three-terminal *n-p-n-p* switches have been developed, and their characteristics are compared with respect to high-current switching applications. At the present time, collector-emitter voltages of the transistors are generally lower than those of the switches, which may exceed 400 volts. The *n-p-n* transistors are somewhat simpler to produce than the *n-p-n-p* structures. However, the ultimate current-handling capacity of the latter type of device is greater, because of the uniform current density. The saturation voltage drops at 20 amperes are comparable, being in the order of one to two volts. The switch has a distinct advantage in the turn-on speed, while the transistor has the equally important advantage that the base retains control for turn-off.

### Triode Electron Injection Systems for Hollow Beams—L. A. Harris (p. 46)

Novel electron guns, in which a conical hollow electron beam is projected at a large angle to the axis into a coaxial deflection region, were tested. The guns have a triode structure so that the perveance can be varied easily. The strong deflection increases the effective perveance of the beam and makes the trajectories insensitive to current variations. In the form of a device with the gun at a large radius and projecting the beam inward, the electron paths are sensitive to scattering in the gun. The inverted gun, projecting the beam outward, is relatively free from this difficulty. The systems generally behave as expected, and should be quite useful for initiating variable-current hollow electron beams in various available focusing arrangements.

### A New Concept in Microwave Gas Switching Elements—Ray S. Braden (p. 54)

A gas switching tube commonly known as a TR tube is an RF energy switch, the operation of which is a function of incident power level. Switch operation is achieved by gaseous ionization. The major problem in the design of gas switching devices has been that of achieving, simultaneously, a short recovery time and a

low arc loss. This problem has been eliminated by the development of the device described in this paper. The design objective was to produce a self-contained TR window for operation at very high powers. The arc loss developed by conventional tube design at these high power levels would be sufficient to melt any known window material. The design of this device is such that the ionizable gas blanket takes the form of a thin-walled cylinder suspended in the iris in a dielectric cylinder. This configuration presents a smaller volume of gas with a reduced cross section and a much shorter diffusion length. These changes result in lower leakage power, faster recovery time, and reduced arc loss.

As finally developed, the window does not involve glass-to-metal or ceramic-to-metal seals. The problem of metal sputtering or outgassing is therefore eliminated. By a unique spring pressure support, the problem of strain developed by differences of thermal coefficients of expansion is eliminated. The open-ended design of the cylinder provides excellent facilities for cooling the window.

Prototype units have been successfully operated in *L* band at power levels considerably in excess of 15 mw peak power and 30 kw average power. These units exhibited recovery times of 5 to 20  $\mu$ sec with high-level attenuation of 26 to 35 db and arc loss below the level of present measuring techniques, *i.e.*, <0.02 db.

A practical window for these high powers with a loaded  $Q$  of less than 1.5 has been fabricated.

### Transistor Behavior at High Frequencies—R. P. Abraham (p. 59)

The tee equivalent circuit for junction transistors has been modified to take account of electric field in the base region. This electric field is the result of a graded impurity density in the base region of the transistor. It is shown that a graded base improves the high-frequency performances of the common base stage; however, the improvement in common emitter performance is considerably less because of the increased "excess" phase which accompanies the improved high-frequency performance. The complex hybrid parameters are calculated for the common base and common emitter configurations; these calculations take into account the parasitic interterminal capacities of the transistor. The common emitter calculations are compared to measure data, and substantial agreement is obtained.

Contributors (p. 70)

## Engineering Management

VOL. EM-7, No. 1,

MARCH, 1960

Editorial (p. 1)

### A Stochastic Model for Determining the Size and Allocations of the Research Budget—Raoul J. Freeman (p. 2)

An analytical method is presented for determining the size of the research budget and allocating it among competing projects. A stochastic model is utilized. The over-all profit-maximization of the firm is used as a framework. A hypothetical example is given to illustrate the method.

### Regression Models for Company Expenditures on and Returns from Research and Development—Ira Horowitz (p. 8)

Data were gathered on the research expenditures, sales, and profits of a sample of large firms which had been conducting organized research for 25 years or more. A linear relationship is hypothesized for explaining the size of the research budget. Several factors influencing the size of the research budget are examined. A regression model is developed for

expressing the returns on R & D expenditures with lags up to six years. Suggestions are made for the application and possible uses of the method by an individual firm.

**Intracompany Systems Management—**  
Harry H. Goode (p. 14)

Research and Development on complex systems requires experimentation with the organizational form of the technical effort. Three levels of system design are distinguished—the set, the set of sets, and the set of sets of sets. The evolution of complex system design is described. Five organizational modes are examined and evaluated. The crossbar mode is suggested as best for large scale system projects and is described in detail.

**Enculturation in Industrial Research—**  
Robert W. Avery (p. 20)

The new researcher undergoes a learning experience in the laboratory, in which he attempts to relate his technical competence to the needs of his employer. More than one hundred members of ten industrial laboratories were interviewed in order to discover the kinds of things the new researcher learns, the problems he encounters, etc., as he first adapts himself to the milieu of the industrial laboratory. Emphasis is placed in the analysis of these data on the factors influencing the kinds of ideas he produces and how he handles ideas.

**Some Organizational Factors Affecting Creativity—**Norman Kaplan (p. 24)

Until recently, theoretical discussions and careful conceptual analyses have been rare in the literature on creativity. Studies of the organizational and environmental factors affecting the creativity of scientists have also been rare, but are becoming more common. This paper reports on the factors considered important in influencing creativity in a number of research laboratories. The data were gathered through interviews with research directors, administrators, and scientists. Five factors are identified and analyzed.

**Role Concept of Engineering Managers—**  
Simon Marcson (p. 30)

This paper contains preliminary results of a questionnaire survey among engineering managers in a large electronics company. Engineering managers are divided into three levels and compared with respect to their degree of business and professional orientation, their conception of authority, and their understanding of the problems of nonsupervisory engineers.

**On the Anatomy of Development Projects—**  
Peter V. Norden (p. 34)

The structure of an R & D project is described in terms of an Effort-Distribution Array. A logistic model is presented for the cumulative times series of effort devoted to a project, and problems of using such curves for prediction are discussed. A set of rules is given, which, with the aid of computer simulation, can be used to generate a project schedule. The consequences of several combinations of rules and restrictions are examined.

## Human Factors in Electronics

VOL. HFE-1, No. 1,

MARCH, 1960

**Frontispiece and Editorial—**Curtis M. Jansky (p. 2)

**Man-Computer Symbiosis—**J. C. R. Licklider (p. 4)

Man computer symbiosis is an expected development in cooperative interaction between men and electronic computers. It will involve very close coupling between the human and the electronic members of the partnership. The main aims are 1) to let computers facilitate formulative thinking, as they now facilitate the solution of formulated problems, and 2) to en-

able men and computers to cooperate in making decisions and controlling complex situations without inflexible dependence on predetermined programs. In the anticipated symbiotic partnership, men will set the goals, formulate the hypotheses, determine the criteria, and perform the evaluations. Computing machines will do the routinizable work that must be done to prepare the way for insights and decisions in technical and scientific thinking. Preliminary analyses indicate that the symbiotic partnership will perform intellectual operations much more effectively than man alone can perform them. Prerequisites for the achievement of the effective, cooperative association include developments in computer time sharing, in memory components, in memory organization, in programming languages, and in input and output equipment.

**Pattern Recognition and Display Characteristics—**W. R. Bush, V. M. Donahue and R. B. Kelly (p. 11)

This paper reports experimental results of human operator performance in a visual recognition task. The work began with a method of generating families of complex patterns to simulate certain characteristics of visual sensor displays, such as radar and infrared returns. The experimental effort was directed toward establishing criteria for predicting human operator performance in a map-matching task. The operators' task was to recognize which of four patterns presented simultaneously with a reference pattern belonged to the reference pattern family. The measure of performance was the time in seconds taken by the operator to make a selection. Response times were more rapid when the reference pattern was less complex than the comparison than when the reference pattern was the more complex. Analysis of the display characteristics led to the selection of four physical measures to be used in predicting operator performance. These measures—pattern length, pattern density, and two measures of pattern complexity—correlated highly with response time, were not highly intercorrelated, and were applicable to natural sensor returns. The four measures were found to account for a high degree of the total variance. Regression equations were derived which predict performance from known values of the four measures.

**The Use of Quickening in One Coordinate of a Two-Dimensional Tracking System—**  
J. W. Duey and R. Chernikoff (p. 21)

In a previous study, it was found that tracking error in one coordinate of a two-dimensional tracking system was affected by the dynamics used in the other coordinate. In particular, tracking performance progressively deteriorated as the dynamics in the two coordinates become more dissimilar. The present study seeks to extend these findings by determining how the introduction of quickening into one coordinate of a second-order, two-coordinate tracking system would affect the performance in the unquickened coordinate. In the light of the previous study, it might be expected that quickening one coordinate would degrade the performance of the other. On the other hand, the simplification of the tracker's task induced by quickening might effect an improvement in performance.

The findings suggest that a counterbalance of the above factors was achieved, since quickening one coordinate had no effect on performance in the other.

**Desirable Push-Button Characteristics—**  
Richard L. Deininger (p. 24)

This paper reports the results of studies in a series concerning the characteristics of push-button keysets that people can operate quickly, accurately and conveniently. The studies investigated push-button arrangements, button top and lettering characteristics, and push-button force-displacement characteristics. Considerable latitude exists in the design of keysets

if only keying performance is considered. The preference judgments were somewhat more selective, particularly for the force-displacement characteristics of the button mechanism.

**The Relation of Electronic and Optical Gain to System Performance—**S. Seidenstein and H. P. Birmingham (p. 30)

An experiment was conducted to investigate the effect of adjusting display gain upon man-machine system performance in a simple aided tracking system. Gain was varied in two ways: electrically by changing amplification, and optically by changing the distance from the scope to the eye. Manipulation of gain by each method produced similar changes in system performance. Over the ranges studied, system error decreased as display gain was increased. This result agrees with predictions based upon closed-loop control system theory and suggests the feasibility of including additional experimental variables within the theory.

**Communications (p. 33)**

**Reviews of Current Literature (p. 35)**

**Contributors (p. 41)**

## Industrial Electronics

PGIE-11, DECEMBER, 1959

**New Developments in Stream Analysis—**  
V. H. Adams and D. J. Fraude (p. 1)

**Nuclear Magnetic Resonance Applications—**  
Herbert Rubin (p. 9)

**Use of Infrared Techniques in Industrial Instrumentation—**H. L. Berman and G. F. Warnke (p. 15)

**Nondestructive Eddy Current Testing—**  
Glenn O. McClurg (p. 20)

**Electronic Photography—**M. L. Sugarman, Jr., M. B. Levine and N. P. Steiner (p. 26)

**Applying Military Reliability Research to Industrial Electronics—**H. L. Wuerffel (p. 34)

**Digital Control Systems—Present and Future—**Montgomery Phister, Jr. (p. 44)

**New Magnetic Recording Techniques for Data Processing—**Marvin E. Anderson (p. 47)

**Some Aspects of Magnetic Recording Useful for Industrial Control—**Edward G. Wildanger (p. 53)

**Recent Developments in Transducer Technology—**V. T. Li (p. 57)

## Microwave Theory and Techniques

VOL. MTT-8, No. 1,

JANUARY, 1960

**A Message from the Editor—**Donald D. King (p. 2)

**Microwave Price (p. 3)**

**Theoretical Limitations to Ferromagnetic Parametric Amplifier Performance—**R. W. Damon and J. R. Eshbach (p. 4)

It has been commonly expected that improved operation of the ferrite parametric amplifier could be obtained by use of materials of narrower resonance linewidth,  $\Delta H$ . This parameter is critical in determining the pumping power ( $P_p$ ) required for operation of the device. Also of importance, however, is the limitation of device properties determined by the dependence on  $\Delta H$  of the instability threshold of the spin-wave system. Considering this limitation, the maximum voltage gain-fractional bandwidth product ( $g_s \Delta \omega / \omega_1$ ) has been determined as a function of other device parameters, and typical values calculated for several modes of operation. In the electromagnetic mode, for example, there is an optimum  $\Delta H$  which yields maximum  $g_s \Delta \omega / \omega_1$  at a given pumping power. It is also shown that a minimum filling factor, also a function of  $\Delta H$  for some types of operation, is required to reach the oscillation threshold even in the unloaded device.



**An Extension of the Mode Theory to Periodically Distributed Parametric Amplifiers with Losses**—K. Kurokawa and J. Hamasaki (p. 10)

For the extension of the mode theory of the lossless periodically distributed parametric amplifier to the lossy case, a "conjugate circuit" is introduced in this paper. The conjugate circuit is an imaginary circuit which is obtained in the passband by replacing each resistance in the original circuit with the negative resistance of the same magnitude. The orthogonality properties between the modes of the original circuit and those of the conjugate circuit are derived. The power gain and the noise figure of the amplifier are calculated, showing the usefulness of this mode theory in accounting for the spreading resistance of the semiconductor diode.

**Action of a Progressive Disturbance on a Guided Electromagnetic Wave**—J. C. Simon (p. 18)

**Periodic and Guiding Structures at Microwave Frequencies**—A. F. Harvey (p. 30)

The paper reviews the properties of periodic and guiding structures which now play an important part in the operation of components, antennas, electron tubes and low-noise amplifiers. An account is first given of dispersive propagation in periodic-loaded lines, showing how the frequency characteristic breaks into pass and stop bands. The formation of forward and backward-space harmonics and the effects of systematic modification of loading are examined. A description is then given of the various types of surface-wave structures including dielectric rods, dielectric-clad metals, and corrugated surfaces, as well as surface wave instruments and circuits. Practical slow-wave structures such as ladder lines, coupled cavities and helices are finally treated. The survey concludes with a bibliography.

**Design of Mode Transducers**—L. Solyman and C. C. Eaglesfield (p. 61)

The propagation of the electromagnetic wave in a gradual transducer is discussed. It is shown that the incident mode and the geometry of the transducer determine the outgoing mode. Inverting this theorem, a method is suggested for the design of the transducer's surface for cases in which the desired modes in the uniform waveguides are given.

The application of the method is illustrated in three examples.

**UHF Resonator with Linear Tuning**—B. H. Wadia and R. L. Sarda (p. 66)

A novel method of tuning a transmission-line type resonator is described. The first-order theory of such a resonator is derived and presented in the form of design curves which indicate an extremely good tuning linearity. Experiments with a resonator designed on this principle agree with theory.

**Equivalent Circuits for Small Symmetrical Longitudinal Apertures and Obstacles**—Arthur A. Oliner (p. 72)

Formulas based on small aperture and small obstacle theory are presented for the determination of equivalent circuits for symmetrical longitudinal apertures and obstacles. These formulas are then applied to several examples of practical interest, including aperture discontinuities in trough waveguide and an obstacle array of interest to anisotropic radomes.

**On the  $TE_{n0}$  Modes of a Ferrite Slab Loaded Rectangular Waveguide and the Associated Thermodynamic Paradox**—A. D. Bresler (p. 81)

It has been known for some time that the secular equation for the  $TE_{n0}$  modes of a perfectly conducting rectangular waveguide loaded with a transversely magnetized dissipationless full height ferrite slab located against one of the narrow walls of the waveguide admits the possibility of the existence of only a single propa-

gating mode (transporting energy in one direction only). In this paper, it is established that if we admit the existence of a passive dissipationless uniform waveguide supporting only a single propagating mode we are led inescapably to a thermodynamic paradox. A uniqueness theorem is cited to establish that, for the waveguide described above, the paradox is associated with the  $TE_{n0}$  mode set alone. This conclusion motivates a thorough study of the secular equation for the  $TE_{n0}$  modes of this waveguide. This study is initiated by an investigation into the properties of the  $TE_{n0}$  surface waves guided along a plane interface separating a transversely magnetized dissipationless ferrite from free space. It is shown that two oppositely directed surface waves are guided along this interface. These two surface waves are admitted in different finite ranges of the parameter values which never coincide and which may or may not overlap. Each of the two surface waves has both a high- and a low-frequency cutoff and, in general, both a high and a low dc magnetic field cutoff. The propagation constant of one of the surface waves becomes infinite at the low field (high-frequency) cutoff.

The next step in the analysis consists of an examination of the behavior of these surface waves on finite thickness ferrite slabs located in different environments. It is shown that when one of the two interfaces bounding the slab approaches a short circuit the infinite propagation constant noted above behaves in a peculiar discontinuous fashion. Next, the  $TE_{n0}$  mode secular equation of the slab loaded rectangular waveguide is analyzed and information is developed leading to a description of the behavior of the propagation constants of all the propagating  $TE_{n0}$  modes. This analysis reveals that the possibility of the existence of only a single propagating mode is associated only with the surface wave mode of this waveguide. A resolution for the thermodynamic paradox is proposed based on the discontinuous behavior of one of the infinite propagation constants associated with this surface wave mode. It is shown that with a properly chosen secular equation for the waveguide under consideration there are always an even number of  $TE_{n0}$  propagating modes, half of which transport energy in one direction, half in the other. This demonstration is based, in part, on an analysis leading to relations between the direction of the power flow associated with a propagating mode and the derivative of its propagation constant with respect to the dc magnetic field.

**L-Band Ferromagnetic Resonance Experiments at High Peak Power Levels**—E. Schloemann, J. Saunders, and M. Sirvetz (p. 96)

Ferromagnetic resonance absorption at high peak power levels has been observed at 1300 mc in yttrium-gadolinium garnets and in a nickel ferrite-aluminate. In agreement with theoretical predictions, the critical field characterizing the onset of nonlinear effects, in a series of yttrium-gadolinium garnet disks of a given shape, was found to be very sensitively dependent on the gadolinium content. Similarly, for samples of a given composition, the critical field strength was sensitively dependent on the shape of the sample in agreement with theoretical predictions. At moderate power levels the susceptibility varies linearly with the square of the RF magnetic field strength over an appreciable range. This result can be understood in terms of an extension of Suhl's theory. The results can be used to predict the high power performance of these materials when used in isolators.

**High Power Ferromagnetic Resonance at X-Band in Polycrystalline Garnets and Ferrites**—J. J. Green and E. Schloemann (p. 100)

Resonance experiments have been performed at X-band on spherical samples of polycrystalline yttrium garnet, yttrium-gadolinium

garnet, yttrium-holmium garnet and nickel-cobalt ferrite. The RF field strength extended up to 60 Oersted. In the case of yttrium garnet the samples differed considerably in density and hence in linewidth. At fairly low power levels the susceptibility at resonance varies linearly with the square of the RF magnetic field strength. At high power levels the susceptibility is inversely proportional to the amplitude of the microwave magnetic field. The "spin-wave linewidth"  $\Delta H_k$  is inferred by extrapolation from the behavior at very high powers. It is found that  $\Delta H_k$  is, to a large extent, independent of the linewidth  $\Delta H$  observed by the usual low power experiments. In particular  $\Delta H_k$  was found to be essentially the same (approximately 4 Oe) for all yttrium iron garnets (single crystals and polycrystals with linewidth varying between 1.8 Oe and 450 Oe). On the other hand,  $\Delta H_k$  increases very rapidly if the yttrium is partially substituted by holmium ( $\Delta H_k \sim 11$  Oe for 1 per cent substitution).

**Microwave Diode Cartridge Impedance**—R. V. Garver and J. A. Rosado (p. 104)

In any application of a semiconductor microwave diode, the impedance of the diode cartridge plays a very important role. Two commonly made assumptions, which are quite erroneous, are that 1) the impedance of the diode cartridge consists simply of a shunt capacitance and whisker inductance, and 2) the metal-to-semiconductor junction at microwave frequencies behaves approximately as it does at 10 mc. In this paper it is shown that the impedance of the diode cartridge at microwave frequencies can be measured accurately by substituting a carbon die for the semiconductor.

**Theory of the Germanium Diode Microwave Switch**—R. V. Garver, J. A. Rosado and E. F. Turner (p. 108)

The application of a generally neglected theory of microwave detection to the poorly understood problem of metal-to-semiconductor junction behavior at microwave frequencies is discussed. Experimental results are disclosed which support the theory and appear to be the first experimental verification of it. It is shown how the theory predicts that germanium microwave diodes should exercise direct switching action upon microwaves while silicon microwave diodes should not, as had been observed in the past but with no explanation.

**Improvement in the Square Law Operation of 1N23B Crystals From 2 to 11 KMC**—A. Staniforth and J. H. Craven (p. 111)

Crystal rectifiers have been used for many years as video detectors in microwave measurements. In most of the applications the detection characteristic at low level is assumed to be square law. It is well known that, in general, this assumption is not justified, particularly if reasonable accuracy is desired. The conditions required to increase the dynamic range over which square law response may be achieved have been investigated experimentally. Results obtained in this laboratory have indicated that a forward bias current of 100 microamperes or more with a low video load resistance made the operation of the crystal closer to the ideal square law over a larger dynamic range.

**An N-Way Hybrid Power Divider**—Ernest J. Wilkenson (p. 116)

A circularly symmetric power divider is described which splits a signal into  $n$  equiphase equiamplitude parts where  $n$  can be odd or even. The power divider provides isolation between output terminals and approximately matched terminal impedances over about a 20 per cent band. A theory of operation is given which yields the necessary design parameters, and an experimental model is described which has a minimum isolation of  $-27$  db between output terminals, an output VSWR of 1.6, and an input VSWR of 1.2.

Correspondence (p. 119)



# Abstracts and References

Compiled by the Radio Research Organization of the Department of Scientific and Industrial Research, London, England, and Published by Arrangement with that Department and the *Electronic Technology* (incorporating *Wireless Engineer* and *Electronic and Radio Engineer*) London, England

NOTE: The Institute of Radio Engineers does not have available copies of the publications mentioned in these pages, nor does it have reprints of the articles abstracted. Correspondence regarding these articles and requests for their procurement should be addressed to the individual publications, not to the IRE.

Acoustics and Audio Frequencies . . . . .	973
Antennas and Transmission Lines . . . . .	974
Automatic Computers . . . . .	974
Circuits and Circuit Elements . . . . .	975
General Physics . . . . .	976
Geophysical and Extraterrestrial Phenomena . . . . .	977
Location and Aids to Navigation . . . . .	978
Materials and Subsidiary Techniques . . . . .	979
Mathematics . . . . .	982
Measurements and Test Gear . . . . .	982
Other Applications of Radio and Electronics . . . . .	983
Propagation of Waves . . . . .	983
Reception . . . . .	983
Stations and Communication Systems . . . . .	984
Subsidiary Apparatus . . . . .	984
Television and Phototelegraphy . . . . .	985
Tubes and Thermionics . . . . .	985
Miscellaneous . . . . .	987

The number in heavy type at the upper left of each Abstract is its Universal Decimal Classification number. The number in heavy type at the top right is the serial number of the Abstract, DC numbers marked with a dagger (†) must be regarded as provisional.

## UDC NUMBERS

Certain changes and extensions in UDC numbers, as published in PE Notes up to and including PE 666, will be introduced in this and subsequent issues. The main changes are:

Artificial satellites:	551.507.362.2	(PE 657)
Semiconductor devices:	621.382	(PE 657)
Velocity-control tubes, klystrons, etc.:	621.385.6	(PE 634)
Quality of received signal, propagation conditions, etc.:	621.391.8	(PE 651)
Color television:	621.397.132	(PE 650)

The "Extensions and Corrections to the UDC," Ser. 3, No. 6, August, 1959, contains details of PE Notes 598-658. This and other UDC publications, including individual PE Notes, are obtainable from The International Federation for Documentation, Willem Witsenplein 6, The Hague, Netherlands, or from The British Standards Institution, 2 Park Street, London, W.1., England.

## ACOUSTICS AND AUDIO FREQUENCIES

### 534.2 1084

**On Waveguide Sound Propagation in Layered Inhomogeneous Media**—E. P. Masterov. (*Akust. Z.*, vol. 5, no. 3, pp. 332-336; 1959.) Experimental investigation of sound propagation in a medium in which the square of the refractive index varies according to an exponential law.

A list of organizations which have available English translations of Russian journals in the electronics and allied fields appears at the end of the Abstracts and References section.

The Index to the Abstracts and References published in the PROC. IRE from February, 1959 through January, 1960 is published by the PROC. IRE, June, 1960, Part II. It is also published by *Electronic Technology* (incorporating *Wireless Engineer* and *Electronic and Radio Engineer*) and included in the April, 1960 issue of that Journal. Included with the Index is a selected list of journals scanned for abstracting with publishers' addresses.

### 534.2-13 1085

**On the Diffusion of Sound Waves in a Turbulent Atmosphere**—R. H. Lyon. (*J. Acoust. Soc. Amer.*, vol. 31, pp. 1176-1182; September, 1959.) The directional and frequency diffusion of a plane monochromatic sound wave in statistically homogeneous, isotropic, and stationary turbulence is analyzed theoretically.

### 534.2-14:534.88 1086

**Model Experiments on Sound Propagation in Shallow Seas**—A. B. Wood. (*J. Acoust. Soc. Amer.*, vol. 31, pp. 1213-1235; September, 1959.) Detailed report of an experimental study including a description of a scanning technique which gives a complete picture of a low-intensity sound field in a vertical plane in the water.

### 534.213-8 1087

**Measurement of Velocity and Attenuation of Ultrasonic Surface Waves in Solid Materials**—K. N. Vinogradov and G. K. Ulyanov. (*Akust. Z.*, vol. 5, no. 3, pp. 290-293; 1959.) Report of measurements made on metals, alloys and glass by a standing-wave method using a proximity magneto-acoustic converter. Damping was measured by a pulse method. Oxidation of an alloy sample increased the surface-wave attenuation at 8 mc from 0.08 to 0.25 db/cm.

### 534.213.4 1088

**Characteristic Parameters of Propagation in Lined Ducts**—R. S. Piazza. (*Acustica*, vol. 9, no. 3, pp. 129-134; 1959.)

### 534.213.4 1089

**Three-Dimensional Investigation of the Propagation of Waves in Hollow Circular Cylinders: Parts 1 and 2**—D. C. Gazis. (*J. Acoust. Soc. Amer.*, vol. 31, no. 5, pp. 568-578; May, 1959.) The frequency equation for the propagation of free harmonic waves along a cylinder of infinite extent is derived and evaluated for some representative cylinders.

### 534.232-8:537.228.1 1090

**On the Spatial Resolving Power of Barium Titanate and Quartz Plates for Ultrasonic-Field Imaging**—K. Hartwig. (*Acustica*, vol. 9, no. 2, pp. 109-117; 1959. In German.) Acoustic measurements of the amplitude distribution of forced vibrations of different-sized plates in the range 3.9-9.5 mc and with excitation restricted to a narrow region of the plate, are considered in relation to electrical measurements of their natural vibrations. Optimum thickness and frequency limits for piezoelectric plates in ul-

trasonic image converters [see e.g. 2084 of 1959 (Freitag and Martin)] are discussed.

### 534.26 1091

**Diffraction of a Convergent Cylindrical Wave by a Sphere**—I. N. Kanevskii. (*Akust. Z.*, vol. 5, no. 3, pp. 294-300; 1959.) An expression is derived for the resulting field potential and asymptotic expressions are obtained for the intensity of the scattered wave and the effective scattering cross section.

### 534.283:546.621 1092

**Acoustic Attenuation in Aluminium due to Electron-Lattice Interaction**—E. Lax. (*Phys. Rev.*, vol. 115, pp. 1591-1594; September 15, 1959.) Measured attenuation was proportional to the electrical conductivity and increased with the square of the frequency, but was 50 per cent greater than could be explained by existing theory.

### 534.283-8:546.815:538.6 1093

**The Effect of the Direction of a Transverse Magnetic Field on the Electronic Component of Ultrasonic Absorption in a Lead Single Crystal**—L. Mackinnon, A. Myers, and M. T. Taylor. [*Proc. Phys. Soc. (London)*, vol. 75, pp. 773-775; December 1, 1959.]

### 534.286-14 1094

**Compressional Relaxation in Liquids**—R. E. Nettleton. (*J. Acoust. Soc. Amer.*, vol. 31, pp. 557-567; May, 1959.)

### 534.286.2 1095

**The Oscillation of Air Particles in Porous Sound-Absorber Models**—H. W. Helberg. (*Acustica*, vol. 9, no. 3, pp. 155-163; 1959. In German.) Entry impedance is calculated for a given Rayleigh-type model and the damping and phase velocity in front of the absorber are determined for grazing incidence. Measurements on three models placed on the walls of a rectangular tube are described.

### 534.286.2 1096

**Absorption of Sound by a Strip of Absorptive Material in a Diffuse Sound Field**—T. D. Northwood, M. T. Grisaru, and M. A. Medcof. (*J. Acoust. Soc. Amer.*, vol. 31, pp. 595-599; May, 1959.) The method of Levitas and Lax (2314 of 1951) is extended to determine random-incidence absorption.

### 534.62 1097

**The New Anechoic Room of the Centre National d'Études des Télécommunications**—P. Chavasse and R. Lehmann. (*Ann. Télécomm.*, vol. 14, pp. 72-83; March/April,

- 1959.) The construction of the room is described in detail and its acoustic characteristics are given.
- 534.75** 1098  
**Binaural Listening and Interaural Noise Cross-Correlation**—I. Pollack and W. J. Trittipoe. (*J. Acoust. Soc. Amer.*, vol. 31, pp. 1250-1252; September, 1959.) The identification of different interaural correlations is examined over a wide range of reference correlations.
- 534.76:621.395.623.7** 1099  
**Listener Reaction to Stereophonic Reproduction by Reflected Sound**—S. E. Levy, G. W. Sioles, V. Brociner, and R. W. Carlisle. (*J. Acoust. Soc. Amer.*, vol. 31, pp. 1256-1259; September, 1959.) Data are presented on the evaluation of various loudspeaker arrangements making use of reflections from the walls of the room in which the stereophonic sound field is produced.
- 534.79** 1100  
**Curves of Equal Loudness for Octave-Filtered Noise in a Diffuse Sound Field**—L. Cremer, G. Plenge, and D. Schwarzl. (*Acustica*, vol. 9, no. 2, pp. 65-75; 1959. In German.) Measurement equipment and its mode of operation are described. A noise-level meter based on data for a diffuse sound field showing a fall of about 3 db per octave is considered.
- 534.79** 1101  
**On the Lambda Loudness Function, Masking, and the Loudness of Multicomponent Tones**—W. R. Garner. (*J. Acoust. Soc. Amer.*, vol. 31, pp. 602-607; May, 1959.) A computational procedure is presented for determining the loudness of multicomponent tones. See 1062 of 1959.
- 534.833:534.286.2** 1102  
**Three-Dimensional Multiresonant Sound Absorber**—M. Abramchik and I. Maletskif. (*Akust. Z.*, vol. 5, no. 3, pp. 275-281; 1959.) Description of a small absorber with perforated flexible walls of transparent material which can be hung from the ceiling. An experimental investigation of the optimum height and spacing of absorbers for noise reduction is reported.
- 621.395.623.7.001.4** 1103  
**Measurements on Loudspeakers in their Places of Use**—T. S. Korn and J. Hougardy. (*Acustica*, vol. 9, no. 3, pp. 121-126; 1959. In French.) Response curves of different loudspeaker units measured a) in an echo-free chamber and b) in listening rooms are compared. The lack of correlation between the two sets of curves is underlined. "Room amplification" is defined and a standard-listening-room procedure is suggested for practical measurements.
- 621.395.625.3** 1104  
**The Recording Process in Magnetic Sound Recording in Preisach's Representation**—G. Schwantke. (*Frequenz*, vol. 12, pp. 383-394; December, 1958.) The analysis of magnetization processes on the basis of Barkhausen-jump statistics using the Preisach diagram is developed. The study of the recording mechanism by this method provides a satisfactory explanation of certain observed effects (see 375 of February), and may give a quantitative interpretation of the recording process.
- 681.844.08** 1105  
**Analysis of a Piezoelectric Phonograph Transducer as a Function of the Clamping Position**—D. H. Howling. (*J. Acoust. Soc. Amer.*, vol. 31, pp. 620-627; May, 1959.) Recording and play-back response characteristics of a laterally vibrating transducer are investigated using a transmission-line analog.
- ANTENNAS AND TRANSMISSION LINES**
- 621.372.8:537.226** 1106  
**An Image-Line Coupler**—D. J. Angelakos. (TRANS. IRE ON MICROWAVE THEORY AND TECHNIQUES, vol. MTT-7, pp. 391-392; July, 1959.) A study of the coupling due to a hole made through the image plane. Results obtained with an experimental coupler at 24.4 kmc and a note on its application as a directional coupler are given.
- 621.372.823:621.372.852.22** 1107  
**Propagation Constants of Circular Cylindrical Waveguides Containing Ferrites**—H. K. F. Severin. (TRANS. IRE ON MICROWAVE THEORY AND TECHNIQUES, vol. MTT-7, pp. 337-346; July, 1959. Abstract, Proc. IRE, vol. 47, p. 1796; October, 1959.)
- 621.372.826** 1108  
**O-Guide and X-Guide: an Advanced Surface-Wave Transmission Concept**—M. Sugi and T. Nakahara. (TRANS. IRE ON MICROWAVE THEORY AND TECHNIQUES, vol. MTT-7, pp. 366-369; July, 1959. Abstract, Proc. IRE, vol. 47, p. 1796; October, 1959.)
- 621.372.829** 1109  
**The Transmission of  $TE_{01}$  Wave in Helix Waveguides**—T. Hosono and S. Kohno. (TRANS. IRE ON MICROWAVE THEORY AND TECHNIQUES, vol. MTT-7, pp. 370-378; July, 1959. Abstract, Proc. IRE, vol. 47, p. 1796; October, 1959.)
- 621.372.831** 1110  
**Design of Linear Double Tapers in Rectangular Waveguides**—R. C. Johnson. (TRANS. IRE ON MICROWAVE THEORY AND TECHNIQUES, vol. MTT-7, pp. 374-378; July, 1959. Abstract, Proc. IRE, vol. 47, p. 1796; October, 1959.)
- 621.372.831** 1111  
**Spurious Mode Generation in Nonuniform Waveguide**—L. Solymar. (TRANS. IRE ON MICROWAVE THEORY AND TECHNIQUES, vol. MTT-7, pp. 379-383; July, 1959. Abstract, Proc. IRE, vol. 47, p. 1796; October, 1959.)
- 621.372.831.2** 1112  
**Waveguide Bend**—D. Wray and R. A. Hastie. (*Electronic Tech.*, vol. 37, pp. 76-83; February, 1960.) A design procedure is given for a sharp bend of continuously changing radius of curvature. Results obtained with an experimental bend compare favorably with those for a "slow" bend of considerably greater size.
- 621.372.832.6** 1113  
**A High-Power Diplexing Filter**—L. Young and J. Q. Owen. (TRANS. IRE ON MICROWAVE THEORY AND TECHNIQUES, vol. MTT-7, pp. 384-387; July, 1959. Abstract, Proc. IRE, vol. 47, pp. 1796-1797; October, 1959.)
- 621.372.832.8** 1114  
**New Microwave Circulators**—H. N. Chait and T. R. Curry. (*Electronics*, vol. 32, pp. 81-83; December 18, 1959.) The operation of the Y-circulator is explained, and different methods of introducing the ferrite are discussed. Experimental results are given, and advantages and applications of the circuit are described.
- 621.372.832.8** 1115  
**Circulators at 70 and 140 kMc/s**—J. B. Thaxter and G. S. Heller. (Proc. IRE, vol. 48, pp. 110-111; January, 1960.) The design of H-plane Y-junctions and their insertion loss and isolation characteristics are given.
- 621.372.832.8** 1116  
**A Strip-Line L-Band Compact Circulator**—L. Davis, Jr., U. Milano, and J. Saunders. (Proc. IRE, vol. 48, pp. 115-116; January,
- 1960.) Isolation, insertion loss and VSWR characteristics are given for a symmetrical Y-type junction.
- 621.372.837.3** 1117  
**A Ferrite Cutoff Switch**—R. F. Soohoo. (TRANS. IRE ON MICROWAVE THEORY AND TECHNIQUES, vol. MTT-7, pp. 332-336; July, 1959. Abstract, Proc. IRE, vol. 47, p. 1796; October, 1959.) See also 1974 of 1958.
- 621.396.674.3** 1118  
**The Driving-Point Impedance of Cylindrical Antennas Conically Tapering at the Base**—R. Kimmich. (*Frequenz*, vol. 12, pp. 369-379; December, 1958.) Results are given of impedance measurements on microwave antennas which are conically tapered at the junction with the coaxial feeder. Locus curves of input impedance as a function of diameter/length ratio  $d/l$  are plotted for tapers of 45 degrees, 60 degrees and 90 degrees. Curves of resistance as a function of  $d/l$  for current and voltage resonances are derived, and comparisons are made with the results obtained by other authors.
- 621.396.674.3** 1119  
**The Performance of a Balanced Aerial when Connected Directly to a Coaxial Cable**—G. D. Monteath and P. Knight. (*Proc. IEE*, Part B, vol. 107, pp. 21-25; January, 1960.) Various configurations are discussed. Measured vertical and horizontal polar diagrams are given for dipoles and Yagi arrays having their elements vertical, and with the driven element connected directly to the coaxial down-lead. The vertical radiation patterns are appreciably distorted (less for arrays than for a dipole), and the sensitivity to interference from sources near to and below the antenna is increased.
- 621.396.676:629.19** 1120  
**Aerials in Space**—M. G. Chatelain. (*Onde élect.*, vol. 39, pp. 785-788; October, 1959.) Problems associated with communication in space are examined and the spherical equiangular spiral is proposed as a suitable antenna, having the required characteristics of large bandwidth and variable polarization.
- 621.396.677.3** 1121  
**Pattern Synthesis—Simplified Methods of Array Design to Obtain a Desired Directive Pattern**—G. H. Brown. (*RCA Rev.*, vol. 20, pp. 398-412; September, 1959.) Mathematical methods of determining the magnitude and phase of the current distribution over an extended linear antenna aperture are described. The radiation pattern and current distribution form a set of Fourier transforms.
- 621.396.677.83** 1122  
**The Backfire Antenna, a New Type of Directional Line Source**—H. W. Ehrenspeck. (Proc. IRE, vol. 48, pp. 109-110; January, 1960.) A Yagi antenna is directed at a plane reflector so that the surface wave traverses the elements a second time. Experimental results show that increases in gain greater than 3 db can be obtained.
- AUTOMATIC COMPUTERS**
- 681.142** 1123  
**Computers and Computer Equipment Design**—(*Electronic Equip. Engrg.*, vol. 7, pp. 63-98; October, 1959.) A group of nine papers on practical aspects of digital-computer design and recently developed techniques.
- 681.142** 1124  
**Electronic Computers and the Electronic Computer Study Centre at Pisa**—M. Conversi. (*Nuovo Cim.*, vol. 11, Supplement no. 3, pp. 376-396; 1959.) Outline of the program and future development of the Center with detail



of available equipment. See also 3966 of 1959 (Caracciolo and Guerri).

**681.142** 1125  
**Solid-State Digital Code-to-Code Converter**—R. Wasserman and W. Nutting. (*Electronics*, vol. 32, pp. 60–63; December 11, 1959.) 13 bits of Gray code can be changed to normal binary code by means of the converter described. The basic building block is a circuit comprising a magnetic core, a junction transistor, and a delay network. Thyratrons are used for the read-out display.

**681.142** 1126  
**A High-Speed Ferrite Storage System**—C. J. Quartly. (*Electronic Engrg.*, vol. 31, pp. 756–758; December, 1959.) A read/write cycle time of 0.5  $\mu$ sec can be achieved in the small store described.

**681.142** 1127  
**The Magnetic Drum Store of the "Mercury" Computer**—K. I. Turner and J. E. Thompson. (*Electronic Engrg.*, vol. 32, pp. 16–21; January, 1960.) Explanatory circuit diagrams, mechanical drawings, and performance data of the Type-1909 drum are given.

**681.142** 1128  
**Approximation Errors in Diode Function Generators**—N. Ream. (*J. Electronics Control*, vol. 7, pp. 83–96; July, 1959.) Errors resulting from fitting a piecewise-linear function to a smooth curve are discussed in relation to analog-computer applications. A simple integral based on best-fit criteria will give the relation between number of segments and error and also the break points between segments. Numerical results are given for typical functions.

**681.142:621.374.3** 1129  
**Theoretical Study and Method of Operation of a Logarithmic Integrator**—R. G. Nicolo. (*Onde Elect.*, vol. 39, pp. 816–822; October, 1959.) Description of a computer circuit based on a diode-pump action.

**681.142:621.382.3** 1130  
**The Construction of a Digital Computing System from a Basic Transistor Circuit**—P. L. Clout and G. E. Jackson. (*Electronic Engrg.*, vol. 32, pp. 37–43; January, 1960.) The computer uses 335 identical basic circuits to convert decimal numbers to and from the binary scale. Diagrams of the basic circuit and the system are given. Printed circuits are used.

**681.142:621.383.4** 1131  
**Light-Pen links Computer to Operator**—B. M. Gurley and C. E. Woodward. (*Electronics*, vol. 32, pp. 85–87; November 20, 1959.) Using a photodiode to read dots produced on a cr tube enables an operator to control an associated computer. By pointing the light-pen at certain dots, information can be written in to the computer.

**681.142:621.391.812.8** 1132  
**Computers aid Propagation Studies**—(See 1375.)

**681.142:621.397.3** 1133  
**Automatic Character Recognition**—D. A. Young. (*Electronic Engrg.*, vol. 32, pp. 2–10; January, 1960.) Limitations and future developments of existing machines are discussed. Further analysis of the semantic features of character patterns and of their recognition limits leads to a "semantic pattern definition" which is sufficiently general to permit recognition of nearly illegible characters.

**681.142:697.9** 1134  
**How Analogue Networks Solve Air-Conditioning Problems**—W. L. Wright and C. A.

Booker. (*Electronics*, vol. 32, pp. 34–37; December 25, 1959.) The thermal properties of a unit area of the structural elements are represented by an equivalent electrical circuit. A complete block diagram shows how these are used to simulate the thermal behavior of a room and its air conditioning system. Some detailed circuitry is given.

#### CIRCUITS AND CIRCUIT ELEMENTS

**621.3.049.7** 1135  
**Three Approaches to Microminiaturization**—R. Langford. (*Electronics*, vol. 32, pp. 49–52; December 11, 1959.) Construction methods for extremely small electronic circuits are detailed.

**621.3.049.7** 1136  
**British Approaches to Microminiaturization**—G. W. A. Dummer. (*Electronics*, vol. 33, pp. 71–75; January 1, 1960.) See 409 of February.

**621.318.4.042.1:621.397.62** 1137  
**The Properties of Ferrite U-Cores for Horizontal-Deflection Output Transformers**—R. Pälker and E. E. Hücking. (*Elektron. Rundschau*, vol. 13, pp. 3–9; January, 1959.) The results of measurements made with a special core tester (3057 of 1959) are given and discussed.

**621.318.57** 1138  
**Steering Circuits control Reversible Counters**—R. D. Carlson. (*Electronics*, vol. 33, pp. 86–88; January 1, 1960.) A four-stage bistable multivibrator system is used to provide decade counting. Complementary outputs from each stage are switched to succeeding stages to give either addition or subtraction.

**621.318.57:621.382.3** 1139  
**Approximate Calculation of Bistable Switching Circuits using Junction Transistors. Case of Switching Circuits with Common Emitter Resistance**—C. Mira. (*Compt. rend.* vol. 249, pp. 384–386; July 20, 1959.) Application of the method described earlier for the case of double-bias operation (53 of January).

**621.319:537.226/.228.1** 1140  
**Dielectric Devices**—G. T. Wright. (*Nature*, vol. 185, pp. 360–361; February 6, 1960.) Report of a conference held in the Electrical Engineering Department of the University of Birmingham, September 14–17, 1959.

**621.372:517.942** 1141  
**On Stochastic Linear Systems**—J. C. Samuels and A. C. Eringen. (*J. Math. Phys.*, vol. 38, pp. 83–103; July, 1959.) Systems governed by  $n$ th-order linear differential equations having random coefficients are studied and the methods developed are applied to a RLC circuit having random capacitance variations.

**621.372.413** 1142  
**Design of Open-Ended Microwave Resonant Cavities**—D. C. Thorn and A. W. Straiton. (*TRANS. IRE ON MICROWAVE THEORY AND TECHNIQUES*, vol. MTT-7, pp. 389–390; July, 1959.) Two types of cavity for refractive-index measurements are described, one rectangular in cross section, the other cylindrical. The cavities are terminated in short sections partitioned so that each subdivision is a waveguide operating below the cut-off frequency of the cavity.

**621.372.413:678.5** 1143  
**Plastic Microwave Cavities for EPR**—P. F. Chester, P. E. Wagner, J. G. Castle, Jr., and G. Conn. (*Rev. Sci. Instr.*, vol. 30, pp. 1127–1128; December, 1959.) An X-band TE<sub>102</sub> plastic cavity for studies of relaxation in electron paramagnetic resonance is described. It

has a  $Q$  of 4000 at room temperature and 6000 at 4.2°K.

**621.372.44** 1144  
**Generalization to Nonlinear Networks of a Theorem due to Heaviside**—S. Duinker. (*Philips Res. Rep.*, vol. 14, pp. 421–426; October, 1959.) A theorem, enunciated by Heaviside and proved by Lorentz for linear electromagnetic systems subjected to a suddenly impressed constant electric force, is extended to electrical networks comprising nonlinear reactances and linear resistance.

**621.372.5** 1145  
**Classes of 4-Pole Networks having Nonlinear Transfer Characteristics but Linear Iterative Impedances**—E. C. Cherry. (*Proc. IRE*, Part B, vol. 107, pp. 26–30; January, 1960.) A graphical representation is introduced which simplifies the analysis of networks containing nonlinear elements. The properties of "dual" nonlinear resistances, in which the  $I/V$  relation for one resistance is the same as the  $V/I$  relation for the other are considered. Such "duals," if realizable, would permit the design of nonlinear four-poles having linear iterative impedances, which could be cascaded.

**621.372.5:621.391.822** 1146  
**Theory of Noisy Two-Port Networks**—E. F. Bolinder. (*J. Franklin Inst.*, vol. 267, pp. 1–23; January, 1959.) The geometric-analytic theory presented is based on the isometric-sphere method (see 17 of 1958) and on a three-dimensional conformal transformation. 50 references.

**621.372.51** 1147  
**Impedance Transformations through Lossless Two-Ports Represented by Fractional Linear Transformations of the Unit Circle**—K. Jost. (*Philips Res. Rep.*, vol. 14, pp. 301–326; August, 1959.) The automorphism of a unit circle corresponding to an impedance transformation is characterized by three parameters and can be represented by three successive elementary transformations. This leads to a simple graphical method using Carter or Smith charts for the determination of the transformed impedance and for the treatment of cascades of lossless two-ports.

**621.372.54** 1148  
**Constant-Resistance All-Pass Networks with Maximally Flat Time Delay**—L. Weinberg. (*J. Franklin Inst.*, vol. 267, pp. 35–53; January, 1959.) Practical design tables are given and their use is illustrated by examples.

**621.372.54** 1149  
**The Loss Attenuation in the Pass Band of Wave Filters with Differing Coil  $Q$ -Factors**—J. Böhse. (*Frequenz*, vol. 12, pp. 380–383; December, 1958.) The loss contributions of the individual coils are summed using weighting functions. Application of the method to a crystal-filter half-section is explained.

**621.372.544:621.374.5** 1150  
**An Analysis of a Type of Comb Filter**—A. G. J. MacFarlane. (*Proc. IEE*, Part B, vol. 107, pp. 39–52; January, 1960.) A theoretical analysis and discussion of practical devices for use in radar as moving-target indicators and signal integrators. 28 references.

**621.372.6:621.391** 1151  
**Calculation of the Static Characteristic of a Nonlinear Multipole without Inertia when the Dynamic Characteristic is Known**—G. Papadopoulos. (*Ann. Télécommun.*, vol. 14, pp. 43–48; January/February, 1959.)

**621.372.63:621.372.54** 1152  
**High-Frequency Transistor Filter Synthesis**—L. M. Vallesse. (*Electronic Engrg.*, vol. 31,



pp. 748-752; December, 1959.) Two canonical ladder structures of hybrid-II and hybrid-T type are considered. The intrinsic feedback factor is ignored. Examples of cascaded structures are given.

**621.373.4 1153**  
**The Effect of Cathode Impedance on the Frequency Stability of Linear Oscillators**—C. T. Kohn. (Proc. IRE, vol. 48, pp. 80-88; January, 1960.) Long-term frequency instability, due to the growth of an interface layer between oxide coating and cathode, may be reduced by suitably adjusting the ratio of anode-to-grid RF voltages.

**621.373.4:621.396.62 1154**  
**Voltage Sensitivity of Local Oscillators**—W. Y. Pan. (RCA Rev., vol. 20, pp. 473-484; September, 1959.) The dependence of the oscillation frequency of tube oscillators on certain operating conditions is discussed and defined mathematically in terms of independent variables.

**621.373.44 1155**  
**How to Generate Accurate Sawtooth and Pulse Waves**—C. A. Von Uff and R. W. Altrons. (Electronics, vol. 32, pp. 64-66; December 11, 1959.) Two circuits giving stable sawtooth and rectangular pulse outputs are described, in which a high-speed switching transistor is controlled by a Zener diode. Pulse width and amplitude and waveform timing are independent of active elements in the circuit.

**621.374.4 1156**  
**A Method of Combining Two Frequencies**—L. R. Kahn. (Proc. IRE, vol. 48, pp. 118-119; January, 1960.) A new method of frequency synthesis is described in which two equal-amplitude tones are combined by limiting, phase inverting and selecting the correct polarity at a control gate.

**621.375.012 1157**  
**The Definition of Noise Factor when Applied to Systems containing Negative-Resistance Elements**—B. L. Humphreys. (J. Electronics Control, vol. 7, pp. 77-81; July, 1959.) The concept of available power and the definition of noise factor are extended to include negative resistance by using the idea of exchangeable power. See 2387 of 1957 (Haus and Adler).

**621.375.227 1158**  
**Wide-Band Analysis of Valve Phase-Splitting Circuits**—L. J. Giacoletto. (Electronic Engrg., vol. 31, pp. 733-735; December, 1959.) Accurate and approximate design data are developed and compared with results of measurements. Near-ideal operating conditions can be obtained up to a few megacycles with suitable load impedances.

**621.375.4 1159**  
**Analysis of the Transistor Cascode Configuration**—J. R. James. (Electronic Engrg., vol. 32, pp. 44-48; January, 1960.) Neutralization is not necessary; more gain per unit volume and weight is achieved than in other transistor configurations, while cost per unit gain is about equal to that of more conventional circuits.

**621.375.4:621.395.665.1 1160**  
**Transistor Constant-Volume Amplifier**—G. J. Pope. (Wireless World, vol. 66, pp. 88-91; February, 1960.) Design and circuit details of a microphone amplifier providing substantially similar output signal levels for various speech input levels.

**621.375.4.029.33:621.397.6 1161**  
**Transistors in Video Equipment**—P. B. Helsdon. (J. Brit. IRE, vol. 19, pp. 753-767; December, 1959. Discussion, p. 768.) The im-

portance of the product current-gain $\times$ bandwidth is discussed. A new design method is described which gives greater gain-bandwidth factors. The conditions for maximum signal-to-noise ratio are determined and confirmed experimentally. Signal-to-noise ratios and gain-bandwidth factors are comparable to those of tubes.

**621.375.4.121.2 1162**  
**Transistorized Distributed Amplifier**—C. W. McMullen. (Rev. Sci. Instr., vol. 30, pp. 1109-1113; December, 1959.) The characteristic impedance of both the base and collector transmission lines is 43.4  $\Omega$ . A four-section amplifier stage has a gain of about 5 db from 10 cps to 200 mc.

**621.375.9:538.569.4 1163**  
**Solid-State Maser Amplifier**—S. A. Ahern. (Electronic Tech., vol. 37, pp. 59-63; February, 1960.) The principles of maser operation are introduced and the essential details of a practical cavity maser system are described.

**621.375.9:538.569.4 1164**  
**Maser Operation with Signal Frequency Higher than Pump Frequency**—F. R. Arams. (Proc. IRE, vol. 48, p. 108; January, 1960.) An X-band solid-state maser is described using the four Zeeman levels in ruby.

**621.375.9:538.569.4 1165**  
**Investigation of the Oscillation Voltage of a Strong-Field Maser-Type Self-Oscillator**—H. Benoit and C. Fric. (Compt. rend., vol. 249, pp. 537-539; July 27, 1959.) Investigation of a maser of the type described earlier (798 of March) in which the macroscopic polarization of the protons is made antiparallel to the directive field. Experimental and theoretical  $E/Q$  curves are shown for different rates of flow.

**621.375.9:621.372.44 1166**  
**Experimental Verification of Parametric-Amplifier Excess Noise using Transformer Coupling**—S. Cohen. (Proc. IRE, vol. 48, pp. 108-109; January, 1960.) A method is described for measuring noise temperature at frequencies where circulators are not available.

**621.375.9:621.372.44:621.372.2 1167**  
**An Analysis of Parametric Amplification in Periodically Loaded Transmission Lines**—G. H. Heilmeyer. (RCA Rev., vol. 20, pp. 442-454; September, 1959.) The propagating structure is considered as a lossless transmission line periodically loaded with nonlinear capacitance in the form of back-biased semiconductor diodes. Information is given about the relation of diode parameters, spacing and circuit parameters to the gain and bandwidth of the structure.

**621.375.9:621.372.44:621.385.63 1168**  
**Fast-Wave Couplers for Longitudinal-Beam Parametric Amplifiers**—Aslkin, Louisell, and Quate. (See 1449.)

**621.375.9:621.376.029.65 1169**  
**Three-Level Maser Detector for Ultra Microwaves**—K. Shimoda. (J. Phys. Soc. Japan, vol. 14, p. 966; July, 1959.) Note on the principles of a device similar to the spectrometer described earlier (see 1355 below). The absorption at ultramicrowave frequencies changes the population of levels and results in an increase or decrease of absorption at a lower microwave frequency.

**621.375.9.121.2:621.372.44 1170**  
**Mode Theory of Lossless Periodically Distributed Parametric Amplifiers**—K. Kurokawa and J. Hamaaki. (TRANS. IRE ON MICROWAVE THEORY AND TECHNIQUES, vol. MTT-7, pp. 360-365; July, 1969. Abstract, Proc. IRE, vol. 47, p. 1796; October, 1959.)

**621.376.32:621.382.3 1171**  
**Reactance Transistor**—Y. Fujimura and N. Mii. (Proc. IRE, vol. 48, p. 118; January, 1960.) Frequency deviation curves calculated from the theoretical output admittance are compared with measurements for a given FM oscillator circuit.

#### GENERAL PHYSICS

**53.081.6 1172**  
**On Explanations of Electric and Magnetic Constants and Units**—A. T. Gresky. (J. Franklin Inst., vol. 267, pp. 201-210; March, 1959.) Using dimensional methods, the relation of free-space dielectric constant, and magnetic permeability constant to four fundamental quantities is considered. Other constants are also analyzed to obtain methods of understanding the submicroscopic nature of electric and magnetic phenomena. See also 3752 of 1958.

**537.311.1 1173**  
**Variational Approach to Deviations from Ohm's Law**—I. Adawi. (Phys. Rev., vol. 115, pp. 1152-1156; September 1, 1959.) Kohler's variational method has been used to obtain deviations from Ohm's law for a nondegenerate electron gas. Two important applications of the method are discussed.

**537.311.33 1174**  
**Many-Particle Approach to the One-Electron Problem of Insulators and Semiconductors**—A. Klein. (Phys. Rev., vol. 115, pp. 1136-1146; September 1, 1959.) Motion of an electron near the bottom of the conduction band in the presence of external electric and magnetic fields, whose variation over one lattice spacing is small, is governed by a simple Schrödinger equation.

**537.312.8 1175**  
**Energy Levels of Conduction Electrons in a Magnetic Field**—Y. Yafet. (Phys. Rev., vol. 115, pp. 1172-1176; September, 1959.) The energy levels can be obtained simply if the spherical approximation is made for the band structure. The free energy due to small departures from this assumption may be estimated using perturbation theory. Inclusion of spin-orbit coupling gives the  $g$  factor as a function of position in the band.

**537.525 1176**  
**The Current Sheet in a Gas Discharge**—N. J. Phillips. (Proc. Phys. Soc. (London), vol. 74, pp. 700-704; December 1, 1959.) Deals with the trapping of cold gas in the sheet.

**537.525:538.63 1177**  
**Studies of Cold-Cathode Discharges in Magnetic Fields**—J. Backus. (J. Appl. Phys., vol. 30, pp. 1866-1869; December, 1959.) The current is 75 per cent ionic. Mass-spectrometer measurements were made to determine the ion energies. The mechanism of the discharge is discussed.

**537.533.8 1178**  
**Theory of Secondary Electron Emission of Metals: the Excitation Process**—H. W. Streitwolf. [Ann. Phys., (Lpz.), vol. 3, pp. 183-196; March 24, 1959.] See also 1179 below and 3757 of 1959 (Stolz & Streitwolf).

**537.533.8 1179**  
**Theory of Secondary Electron Emission of Metals: the Transport Process**—H. Stolz. [Ann. Phys., (Lpz.), vol. 3, pp. 197-210; March 24, 1959.]

**537.56 1180**  
**Conductivity of a Warm Plasma**—L. Mower. (Phys. Rev., vol. 116, pp. 16-18; October 1, 1959.) "A theory for obtaining the conductivity

of a uniform plasma as a function of frequency and temperature is presented and compared with a number of recent treatments."

**537.56** 1181  
**Experiments with Plasma Rings**—L. Lindberg, E. Witalis, and C. T. Jacobsen. (*Nature*, vol. 185, pp. 452-453; February 13, 1960.) A brief description is given of a plasma gun discharging into a glass drift tube. Measurements have been made of the circuit current and the magnetic flux carried by the plasma.

**537.56:538.56** 1182  
**Oscillations in Plasma: Part 2.**—S. Kojima, K. Kato, S. Hagiwara, and R. Matsuzaki. (*J. Phys. Soc. Japan*, vol. 14, pp. 821-827; June, 1959.) Discrete oscillations reported in Part 1 (1699 of 1958) are studied in detail. Oscillations at the higher frequency are generated by the convergent beam in the central part of the tube, while those at the lower frequency seem to be generated near the wall of the tube by the divergent beam. Another oscillation having an intermediate frequency is often observed.

**537.56:538.561** 1183  
**Occurrence of Vavilov-Čerenkov Radiation in a High-Temperature Plasma**—J. Neufeld. (*Phys. Rev.*, vol. 116, pp. 1-3; October 1, 1959.) Analytical results indicate that radiation is not emitted by a particle moving through a high-temperature plasma at a velocity lower than the mean thermal velocity of plasma electrons.

**537.56:538.566** 1184  
**Longitudinal and Transverse Waves in a Lorentz Plasma**—K. Rawer and K. Suchy. [*Ann. Phys. (Lpz.)*, vol. 3, pp. 155-170; March 24, 1959.] The triple refraction in inhomogeneous plasma is discussed. See also 3641 of 1959.

**537.56:538.6** 1185  
**Radial Hydromagnetic Oscillations**—G. B. F. Niblett and T. S. Green [*Proc. Phys. Soc. (London)*, vol. 74, pp. 737-743; December 1, 1959.] The equation of motion of radial hydromagnetic oscillations of a plasma confined by an axial magnetic field is integrated and shown to give good agreement with experiment.

**537.56:538.63** 1186  
**Discharge Phenomena in Lorentz-Type Plasmas: Investigation of Electron Distribution in the Presence of a Magnetic Field**—P. Maroni. (*Compt. rend.*, vol. 249, pp. 881-883; August 24, 1959.) A partial differential equation derived by Kahan and Jancel (see 3453 of 1957 and back references) is integrated for the case where the collision frequency is constant. (For further discussion see *ibid.*, vol. 249, pp. 914-916; August 31, 1959.)

**538.566:535.42** + **534.26** 1187  
**The Half-Plane Diffraction Problem for Harmonic Time Dependence**—A. P. Burger. [*Proc. Roy. Soc. (London)*, A, vol. 252, pp. 411-417; September 29, 1959.] "Green's functions are obtained for the boundary-value problems of mixed type describing the general two-dimensional diffraction problems at a screen in the form of a half-plane (Sommerfeld's problem), applicable to acoustically rigid or soft screens, and to the full electromagnetic field at a perfectly conducting screen."

**538.566:535.42** 1188  
**The Diffraction of Scalar Waves on Paraboloïds of Revolution**—K. Klante. [*Ann. Phys. (Lpz.)*, vol. 3, pp. 171-182; March 24, 1959.]

**538.566:535.42** 1189  
**Diffraction by an Imperfectly Conducting Right-Angled Wedge**—W. E. Williams. (*Proc. Camb. Phil. Soc.*, vol. 55, Part 2, pp. 195-209;

April, 1959.) An exact solution is given for the diffraction of the field of an electric line current by an imperfectly conducting wedge of exterior angle  $3\pi/2$ .

**538.566:535.42** 1190  
**Diffraction of an E-Polarized Plane Wave by an Imperfectly Conducting Wedge**—W. E. Williams. [*Proc. Roy. Soc. (London)* A, vol. 252, pp. 376-393; September 29, 1959.] A new and exact solution is obtained for arbitrary wedge angle.

**538.566:538.6** 1191  
**Propagation of Electromagnetic Waves in a Multistream Medium at Gyromagnetic Resonance**—J. Neufeld. (*Phys. Rev.*, vol. 116, pp. 19-20; October 1, 1959.) Formulas are derived for the dispersion and the gyromagnetic resonance effects.

**538.569.4** 1192  
**Measurement Broadening in Magnetic Resonance**—O. E. Myers and E. J. Putzer. (*J. Appl. Phys.*, vol. 30, pp. 1987-1991; December, 1959.) Phase-detection techniques cause broadening; a method for correcting observed widths is described.

**538.652** 1193  
**Form Effect in Magnetostriction**—R. Gersdorf. (*J. Appl. Phys.*, vol. 30, pp. 2018-2019; December, 1959.) Comment on 2930 of 1959 (Stauss).

**539.2:537.311.33:537.52** 1194  
**A Simplified Theory of Two-Carrier, Space-Charge-Limited Current Flow in Solids**—M. A. Lampert. (*RCA Rev.*, vol. 20, pp. 682-701; December, 1959.)

**539.2:538.222** 1195  
**Zeeman Splitting of Paramagnetic Atoms in Crystalline Fields**—H. Stutz and G. F. Koster. (*Phys. Rev.*, vol. 115, pp. 1568-1577; September 15, 1959.) Energy levels of paramagnetic ions in crystalline surroundings are treated as a function of magnetic field.

**539.2:538.6** 1196  
**Theory of Block Electrons in a Magnetic Field: the Effective Hamiltonian**—W. Kohn. (*Phys. Rev.*, vol. 115, pp. 1460-1478; September 15, 1959.) For a nondegenerate band the eigenstates of the Hamiltonian of a Block electron in a static magnetic field can be calculated from an equivalent Hamiltonian whose properties and formulation are discussed.

#### GEOPHYSICAL AND EXTRATERRESTRIAL PHENOMENA

**523.152:629.19:061.3** 1197  
**Symposium on the Exploration of Space**—(*J. Geophys. Res.*, vol. 64, pp. 1647-1800; November, 1959.) The text is given with subsequent discussion of twelve papers read at a symposium in Washington, D. C., April 29-30, 1959.

**523.164** 1198  
**National Radio Astronomy Observatory**—R. M. Emberson. (*Science*, vol. 130, pp. 1307-1318; November 13, 1959.) The history and development of the radio observatory at Green Bank, W. Va., are reviewed.

**523.164** 1199  
**The Mullard Radio Astronomy Observatory**—M. Pyle. (*J. IEE*, vol. 6, pp. 14-19; January, 1960.) Two aperture-synthesis radio telescopes installed near Cambridge, Eng., are described and an outline is given of the present research program.

**523.164:621.396:677.833** 1200  
**The 600-Foot Radio Telescope**—E. F.

McClain, Jr. (*Sci. Amer.*, vol. 202, pp. 45-51; January, 1960.) Description of the steerable telescope under construction in West Virginia.

**523.164.32:523.78** 1201  
**Observations on the Solar Eclipse of October 2**—J. Aarons, J. P. Castelli, R. M. Straka, and W. C. Kidd. (*Nature*, vol. 185, pp. 230-231; January 23, 1960.) A report of measurements made simultaneously on 224, 1300 and 3000 mc at Hamilton, Mass., in 1959. At this location the sun rose partially eclipsed and was totally eclipsed at an elevation of about 1 degree.

**523.165** 1202  
**Nature of Corpuscular Radiation of the Upper Atmosphere**—I. S. Shklovskii, V. I. Krasovskii, and Yu. I. Gal'perin. (*Izv. Ak. Nauk S.S.S.R.*, no. 12, pp. 1799-1806; 1959.) The concentration of particles in the solar corpuscular stream is sufficient to renew the corpuscles of the outer radiation belt over a period of only a few hours. An estimation is made of the energy spectrum of protons and the velocity of generation of hard corpuscles in the inner belt.

**523.165** 1203  
**Heavy Primary Cosmic Rays at Geomagnetic Latitude of 41°N**—O. B. Young and H. Y. Chen. (*Phys. Rev.*, vol. 115, pp. 1719-1721; September 15, 1959.) Results from nine balloon flights at heights 70,000-100,000 feet. Charge spectra, flux, mean free paths and angular distributions are given.

**523.165** 1204  
**Primary Cosmic-Ray Proton and Alpha-Particle Intensities and their Variation with Time**—P. Meyer. (*Phys. Rev.*, vol. 115, pp. 1734-1741; September 15, 1959.) Results of a series of high altitude balloon flights in 1957 and 1958 made primarily to investigate the short-term variations of primary protons and alpha particles.

**523.165:523.152.3** 1205  
**Cosmic-Ray Measurements in the Vicinity of Planets and some Applications: Part 1—Primary Cosmic Radiation**—S. F. Singer and R. C. Wentworth. (*J. Geophys. Res.*, vol. 64, pp. 1807-1813; November, 1959.) The variation of the primary cosmic-ray intensity is calculated as a function of distance from a dipole in its equatorial plane. Scientific applications indicated include the determination of magnetic fields of the moon and planets.

**523.165:523.75** 1206  
**Low-Energy Cosmic-Ray Events associated with Solar Flares**—G. C. Reid and H. Leinbach. (*J. Geophys. Res.*, vol. 64, pp. 1801-1805; November, 1959.) Details are given of 24 events during the period May, 1957-July, 1959 which have been detected by the measurement of ionospheric absorption in arctic regions.

**523.165:537.746.5** 1207  
**The Apparent Sidereal Daily Variation of Cosmic-Ray Intensity during the Recent Sunspot Minimum**—S. P. Baliga and T. Thambiyappillai. (*Phil. Mag.*, vol. 4, pp. 973-984; August, 1959.)

**523.165:550.385.4** 1208  
**Magnetic Cut-Off Rigidities of Charged Particles in the Earth's Field at times of Magnetic Storms**—P. Rothwell. (*J. Geophys. Res.*, vol. 64, pp. 2026-2028; November, 1959.) Cut-off rigidities are calculated for charged particles at various locations and for different distances of the storm cloud from the earth.

**550.385** 1209  
**The Transmission of Geomagnetic Disturbances through the Atmosphere and Inter-**



planetary Space—J. H. Piddington. (*Geophys. J. R. Astr. Soc.*, vol. 2, pp. 173–189; September, 1959.) The theory of the propagation of slowly varying EM disturbances through partially ionized gas is developed and applied to the earth's atmosphere and interplanetary space. The medium is considered as two separate co-existing gases, an electron-ion plasma and neutral atoms which move to some extent independently. Quantitative results are given for a model atmosphere out to several earth radii.

**550.385.37** **1210**  
**Studies of Magnetic Field Micropulsations with Periods of 5 to 30 Seconds**—W. H. Campbell. (*J. Geophys. Res.*, vol. 64, pp. 1819–1826; November, 1959.) The studies were carried out in 1958 in southern California.

**550.385.4:551.510.535** **1211**  
**Geomagnetic Storms and Ionospheric Disturbances**—T. Obayashi. (*J. Radio Res. Labs, Japan*, vol. 6, pp. 375–514; June, 1959.) A collection of papers covering the morphology of geomagnetic and ionospheric storms, an application of the atmospheric dynamo theory to geomagnetic variations during disturbances and a study of hydromagnetic oscillations of the ionized upper atmosphere.

**550.385.4:551.547** **1212**  
**The Relationship between Geomagnetic Variations and the Circulation at 100 mb**—J. London, I. Ruff, and L. J. Tick. (*J. Geophys. Res.*, vol. 64, pp. 1827–1833; November, 1959.) A statistical study for a five-year period leads to the conclusion that there is no obvious relation between the two sets of data.

**550.389.2** **1213**  
**Radio and the I.G.Y.**—R. L. Smith-Rose. (*Wireless World*, vol. 66, pp. 52–58; February, 1960.) Summaries of the data collected, the analyses used, and the knowledge obtained about the ionosphere and outer space during the I.G.Y.

**551.501.81:061.3** **1214**  
**Proceedings of Fourth Meeting of the Joint Commission on Radio Meteorology of I.C.S.U.**—(*J. Atmos. Terr. Phys.*, vol. 15, pp. 181–293; October, 1959.) The text is given of papers presented at the Meeting held in New York, N. Y., August 14–16, 1957.

**551.507.362.2+629.19** **1215**  
**Artificial Earth Satellites and Space Travel: Part 1—The Satellite Orbits and their Changes with Time**—C. W. M. Tilenius. (*VIZ.*, vol. 102, pp. 1–9; January 1, 1960.) A table is included giving full details of earth satellites and moon probes successfully launched up to September 18, 1959.

**551.507.362.2** **1216**  
**Lunar and Solar Perturbations on Satellite Orbits**—E. Upton, A. Bailie, and P. Musen. (*Science*, vol. 130, pp. 1710–1711; December 18, 1959.) The lunar and solar effects on perigee height for satellite orbits of large eccentricity are investigated.

**551.510.535** **1217**  
**Determination of the True Distribution of Electron Density in the Ionosphere: Part 2**—W. Becker. (*Arch. elekt. Übertragung*, vol. 13, pp. 26–32; January, 1959.) The accuracy of the methods summarized in Part 1 (3603 of 1955) is discussed. Results obtained without consideration of the geomagnetic field are found to be completely uncertain.

**551.510.535** **1218**  
**On the Seasonal and Nonseasonal Annual Variations and the Semi-annual Variation in the Noon and Midnight Electron Densities of**

**the F<sub>2</sub> Layer in Middle Latitudes: Part 2**—T. Yonezawa. (*J. Radio Res. Labs. Japan*, vol. 6, pp. 651–668; October, 1959.) Previous work [4055 of 1959 (Yonezawa and Arima)] is continued using two groups of relatively high- and low-latitude stations. The seasonal variation for the high-latitude stations is markedly different from that of the low-latitude group while the nonseasonal variations do not show great differences between the groups. The semi-annual variations in the two graphs are also not markedly different.

**551.510.535** **1219**  
**A Statistical Study of World-Wide Occurrence Probability of Spread-F: Parts 1 and 2**—T. Shimazaki. (*J. Radio Res. Labs. Japan*, vol. 6, pp. 669–704; October, 1959.) Diurnal, seasonal and latitudinal variations in the occurrence of spread-F during the I.G.Y. are analyzed. Marked differences between high and low latitudes suggest an essentially different origin for the phenomenon in the two regions. The correlation of spread-F with geomagnetic activity is discussed and abnormal occurrences during magnetic storms are examined in detail.

**551.510.535:061.3** **1220**  
**Proceedings of Fifth Meeting of the Mixed Commission on the Ionosphere of I.C.S.U.**—(*J. Atmos. Terr. Phys.*, vol. 15, pp. 7–176; September, 1959.) The text is given of papers presented at the meeting held in New York, N. Y., August 14–16, 1957.

**551.510.535:621.391.812.33:551.507.362.2** **1221**  
**The Ionospheric Faraday Effect and its Applications**—F. B. Daniels and S. J. Bauer. (*J. Franklin Inst.*, vol. 267, pp. 187–200; March, 1959.) Measurements of ionospheric characteristics by means of lunar radio reflections and satellite radio transmissions using the Faraday effect are discussed.

**551.510.535:621.391.812.63** **1222**  
**Influence of Absorption on the Reflection Coefficient of the Ionosphere**—P. Poincelot. (*Ann. Télécommun.*, vol. 14, pp. 54–58; March/April, 1959.) The reflection coefficient of a stratified layer is considered, assuming that electron concentration varies linearly with height; absorption is represented by a viscous resistance proportional to the velocity of free electrons.

**551.510.535(98):621.391.812.631:523.164.32** **1223**

**Pre-SC Polar-Cap Ionospheric Blackout and Type IV Solar Radio Outburst**—Y. Hakura and T. Goh. (*J. Radio Res. Labs, Japan*, vol. 6, pp. 635–650; October, 1959.) Short-wave radio blackouts in polar-cap regions are often found to occur well before the sudden-commencement magnetic storms and this phenomenon is closely correlated with the occurrence of type IV solar RF bursts. A possible explanation of these effects is given which is consistent with other related phenomena such as cosmic-ray storms.

**551.510.535 "1959"** **1224**  
**Ionosphere Review 1959**—T. W. Bennington. (*Wireless World*, vol. 66, pp. 67–68; February, 1960.) Comparison of the condition of the ionosphere in 1959 with that of previous years, and deduction of the probable state for 1960.

**551.510.536:550.385** **1225**  
**Global Hydromagnetic Wave Ducts in the Exosphere**—H. A. Bomke, W. J. Ramm, S. Goldblatt, and V. Klemas. (*Nature*, vol. 185, pp. 299–300; January 30, 1960.) Magnetic-field perturbations originating from a high-altitude explosion have been observed at a number of stations. An analysis of results indicates that

hydromagnetic waves at high altitudes travel along great-circle paths in ducts which are concentric shells about the earth. "Slow" and "fast" signals are identified respectively with transverse and longitudinal hydromagnetic wave modes.

**551.594.5:621.396.96** **1226**  
**Aurora-Like Radar Echoes Observed from 17° Latitude**—R. B. Dyce, L. T. Dolphin, R. L. Leadabrand, and R. A. Long. (*J. Geophys. Res.*, vol. 64, pp. 1815–1818; November, 1959.) A note on anomalous echoes observed regularly at 32 and 140 mc by a shipborne radar located in British West Indies.

**551.594.6** **1227**  
**Correlation of Audio-Frequency Electromagnetic Radiation with Auroral Zone Micropulsations**—J. Aarons, G. Gustafsson and A. Egeland. (*Nature*, vol. 185, pp. 148–151; January 16, 1960.) A spectrum analysis in the range 10 cps–10 kc has been made of recordings obtained during three one-month periods near Kiruna, Sweden. There is excellent correlation between auroral-zone micropulsations and EM radiation. Two distinct frequency bands have been identified.

**551.594.6:550.385.4** **1228**  
**Rare Hiss, Earth Currents and Micropulsations on November 27, 1959**—E. M. Wescott, J. H. Pope, D. O. Dyer, and W. H. Campbell. (*Nature*, vol. 185, p. 231; January 23, 1960.) Brief report of hiss and micropulsations associated with a sudden commencement at 2351 GMT observed at College, Alaska.

**551.594.6:621.396.663** **1229**  
**Direction Findings on Whistlers**—J. M. Watts. (*J. Geophys. Res.*, vol. 64, pp. 2029–2030; November, 1959.) The use of a crossed-loop type of direction finder and the information on whistlers to be obtained from it are described.

**551.510.535** **1230**  
**The Magneto-Ionic Theory and Its Application to the Ionosphere** [Book Review]—J. A. Ratcliffe. Cambridge University Press, Eng. 206 pp.; 1959. (*J. Atmos. Terr. Phys.*, vol. 16, p. 398; November, 1959.)

## LOCATION AND AIDS TO NAVIGATION

**621.396.933.2** **1231**  
**Some Factors in the Design of V.H.F. Automatic Direction Finders**—S. A. W. Jolliffe. (*Marconi Rev.*, vol. 22, pp. 168–198; 4th Quarter, 1959.) Basic systems are analyzed and some of the more interesting design features of a preferred system are discussed in detail. The performance figures of a typical automatic direction finder are given.

**621.396.933.2** **1232**  
**Operational Applications of V.H.F. Direction Finders**—S. A. W. Jolliffe. (*Marconi Rev.*, vol. 22, pp. 199–214; 4th Quarter, 1959.) Factors limiting the accuracy of ground-based systems are discussed and comparisons are made in terms of technical performance and capital and operating costs.

**621.396.933.2** **1233**  
**The Marconi Automatic Plotter**—D. W. G. Byatt. (*Marconi Rev.*, vol. 22, pp. 215–224; 4th Quarter, 1959.) The plotter described is for use with automatic direction finders operating on aircraft in the VHF and UHF band. Provision is made for up to six bearing traces.

**621.396.933.2** **1234**  
**Bearing Errors in Medium-Frequency Automatic Direction Finders**—R. W. Sharples. (*Marconi Rev.*, vol. 22, pp. 225–233; 4th Quarter, 1959.) Errors due to spurious inputs to



the loop-drive motor and to lack of sensitivity in the servo system are analyzed.

621.396.933.2:621.317.7 1235

**A Method of Providing Test Signals of Calculable Strength for Airborne Radio Direction Finders**—R. W. Sharples. (*Marconi Rev.*, vol. 22, pp. 234–239; 4th Quarter, 1959.) A method is described in which the loop antenna is placed in a magnetic field of known strength in a screened enclosure. Measurements are within  $\pm 0.5$  db of the calculated value. Practical results show that the enclosure may be reduced to a size suitable for portable use without loss of accuracy.

621.396.934 1236

**Beam Riding**—P. Cave. (*Wireless World*, vol. 66, pp. 71–74; February, 1960.) A detailed introduction to missile guidance systems based on the principle of following a beam of radio signals.

621.396.96:551.594.5 1237

**Aurora-Like Radar Echoes Observed from 17° Latitude**—Dyce, Dolphin, Leadbrand, and Long. (See 1226.)

621.396.96:621.273.837.3 1238

**Duplexing a Solid-State Ruby Maser in an X-Band Radar System**—F. E. Goodwin. (*Proc. IRE*, vol. 48, p. 113; January, 1960.) Description of a ferrite TR-switch which attenuates the transmitter pulse by 30 db over a frequency band of 120 mc.

621.396.96.089.6:523.164.32 1239

**How Solar Noise Calibrates Radars**—J. A. Kuecken. (*Electronics*, vol. 32, pp. 44–45; December 25, 1959.) The sun is used as a distant source to check the relation of the beam direction to the aiming angle of C-band radar antennas. Accuracies within 0.03 degree have been obtained.

621.396.962.3 1240

**Introduction to Monopulse** [Book Review]—D. R. Rhodes. McGraw-Hill Book Co., Inc., New York, London, and Toronto, 119 pp.; 1959. (*Proc. Phys. Soc.*, vol. 74, p. 800; December 1, 1959.) Deals with a radar system of location based on simultaneous radiation lobes instead of sequentially emitted beams.

#### MATERIALS AND SUBSIDIARY TECHNIQUES

535.215:535.37:621.38 1241

**Solid-State Optoelectronics**—E. E. Loebner. (*RCA Rev.*, vol. 20, pp. 715–743; December, 1959.) Photoelectric and luminescence phenomena are classified and explained. The technology of opto-electronic devices, *i.e.* those having mixed optical and electrical signal and power access, is described. Application to logic nets and computer components is treated in detail, and the synthesis of picture-processing panels and computer systems is considered.

535.215:537.311.33 1242

**Depletion-Layer Photoeffects in Semiconductors**—W. W. Gärtner. (*Phys. Rev.*, vol. 116, pp. 84–87; October 1, 1959.) A theory of photoconduction through the reverse-biased *p-n* junction in semiconductors is developed; the treatment leads to a voltage dependence for the photocurrent and its spectral distribution. Transit-time effects occurring at high modulation frequencies are analyzed.

535.215:[546.32'863+546.36'863] 1243

**Structure in the Energy Distribution of Photoelectrons from  $K_2Sb$  and  $CaS_2b$** —E. A. Taft and H. R. Philipp. (*Phys. Rev.*, vol. 115, pp. 1583–1586; September 15, 1959.) Peaks in energy distribution seem to correlate with peaks in the optical absorption. A lower limit

for the electron affinity of the crystal may be deduced assuming that the effects arise directly from structure in the state-density of the valence band.

535.215:546.48'221 1244

**On the Problem of Measuring the Diffusion Length of Holes in Cadmium Sulphide**—N. A. Vitovskii and P. I. Maleev. (*Fiz. Tverdogo Tela*, vol. 1, pp. 984–985; June, 1959.) The diffusion length was determined from the variation with applied voltage of the amplitude of pulses produced by  $\alpha$ -particle irradiation. Measurements on three single-crystal samples gave values for diffusion length from 1.3 to 3.2  $\mu$ .

535.215:546.48'221 1245

**Dependence of the Hole Ionization Energy of Imperfections in Cadmium Sulphide on the Impurity Concentration**—R. H. Bube and A. B. Dreeben. (*Phys. Rev.*, vol. 115, pp. 1578–1582; September 15, 1959.) Photoconductivity measurements have been made in a series of CdS-Ga, Cu powders. Results are analogous to other recent observations of small hole ionization energies in CdS and CdSe crystals.

535.215:546.48'221 1246

**The Achievement of Maximum Photoconductivity Performance in Cadmium Sulphide Crystals**—R. H. Bube and L. A. Barton. (*RCA Rev.*, vol. 20, pp. 564–598; December, 1959.) Attempts to improve the photoconductivity performance of CdS crystals by reducing trapping-center concentration are described. This could be successfully accomplished by a) producing slight deviations from stoichiometry during growth, or b) incorporating a trace of donor impurity.

535.215:546.48'221 1247

**Quenching Effect of the Photoconductivity Decay in CdS**—M. Kikuchi and S. Iizima. (*J. Phys. Soc. Japan*, vol. 14, p. 856; June, 1959.) Decay of the photocurrent in a CdS rectifying cell (see 1258 below) may be accelerated by reducing the bias voltage to zero for 10 seconds.

535.215:546.48'221'241 1248

**Preparation of Mixed CdS-CdTe Single Crystals and some of their Properties**—I. Vitrikhovskii and I. B. Mizetskaya. (*Fiz. Tverdogo Tela*, vol. 1, pp. 996–999; June, 1959.)

535.215:546.48'241 1249

**Phase Equilibria and Semiconducting Properties of Cadmium Telluride**—D. de Nobel. (*Philips Res. Rep.*, vol. 14, pp. 361–399 and 430–492; August and October, 1959.) 47 references.

535.215:546.681'241 1250

**Photoconductivity of Gallium Selenide Crystals**—R. H. Bube and E. L. Lind. (*Phys. Rev.*, vol. 115, pp. 1159–1164; September, 1959.)

535.215:546.817'221 1251

**Preparation of Lead Sulphide Photoresistances by Chemical Deposition**—R. Ya. Berlaga, F. T. Novik, and L. P. Strakhov. (*Fiz. Tverdogo Tela*, vol. 1, pp. 995–996; June, 1959.) Brief note on the preparation of PbS films at room temperature by treatment of  $Pb(OH)_2$  with thiourea solution.

535.215:546.863'231 1252

**Conductivity and Photoconductivity of Antimony Triselenide**—B. T. Kolomiets, V. M. Lyubin, and D. V. Tarkhin. (*Fiz. Tverdogo Tela*, vol. 1, pp. 899–902; June, 1959.)

535.215:546.863'231 1253

**Photoconductivity of  $Sb_2Se_3$** —B. T. Kolomiets and A. Kh. Zeinally. (*Fiz. Tverdogo Tela*, vol. 1, pp. 979–980; June, 1959.) Experimental data show the photosensitivity of single crystals

to be much greater than that of polycrystalline material.

535.215:621.311.69 1254

**The Photovoltaic Effect and its Utilization**—P. Rappaport. (*RCA Rev.*, vol. 20, pp. 373–397; September, 1959.) A review of the theory of the photovoltaic effect and of its applications to solar energy conversion. Operating characteristics and conversion efficiencies of a number of materials including Si, GaAs, InP, and CdS are given and the high-voltage photovoltaic effect obtained with evaporated CdTe films is described.

535.37 1255

**Electroluminescence of Polycrystallites**—S. Larach and R. E. Schrader. (*RCA Rev.*, vol. 20, pp. 532–563; December, 1959.) General discussion of luminescence, and, in particular, various effects of electroluminescence.

535.37:061.3(47) 1256

**Transactions of the 7th Conference on Luminescence (Crystal Phosphors)**—(*Izv. Ak. Nauk S.S.S.R.*, vol. 23, pp. 1278–1400; November, 1959.) Texts are given of 25 papers presented at the conference in Moscow, June 26–July 3, 1958.

535.376:534.231–8 1257

**The Electroluminescent Panel in an Ultrasonic Field**—P. Greguss and J. Weiszburg. (*Acustica*, vol. 9, no. 3, pp. 183–184; 1959.) A note of an experiment in which a panel of ZnS-Cu,Pb powder with a filling material of high dielectric constant gave a yellow luminescence under ultrasonic irradiation.

535.376:546.48'221 1258

**Avalanche Electroluminescence in CdS Single Crystal**—M. Kikuchi and S. Iizima. (*J. Phys. Soc. Japan*, vol. 14, p. 852; June, 1959.) A CdS rectifying cell is described. When the forward voltage is increased to between 25 and 50 volts, the forward current increases rapidly and light is emitted. Characteristic curves for the cell are given.

537.227 1259

**Analogy of a Ferroelectric Phenomenon to a Ferromagnetic Phenomenon: Attenuation of Ferroelectric Hysteresis by Orthogonal Polarization**—Y. Angel and J. Bonnefous. (*Compt. rend.*, vol. 249, pp. 508–510; July 27, 1959.) Measurements have been made on ferroelectric plates of  $TiO_3Ba_xSr_{1-x}$  ceramic about 1-mm thick subjected to a direct longitudinal and alternating transverse electric field. Results analogous to those obtained with ferrite samples in orthogonal magnetic fields [3244 of 1959 (Angel and Boutry)] are reported.

537.227 1260

**Dielectric Property of Triglycine Sulphate Single Crystal at 9000 Mc/s Region**—A. Nishioka and M. Takeuchi. (*J. Phys. Soc. Japan*, vol. 14, p. 971; July, 1959.) Measurements at room temperature in the ferroelectric *b* axis give a dielectric constant of  $19.7 \pm 0.2$  and a loss tangent of  $0.043 \pm 0.002$ .

537.227 1261

**Action of an Electric Field on the Dielectric Properties of Glycine Sulphate**—J. Chapelle and L. Faurel. (*Compt. rend.*, vol. 249, pp. 378–380; July 20, 1959.) Polarization *P* is related to the electric field *E* along the binary axis of a crystal in accordance with an equation of the form  $E = aP + bP^3 + cP^5$ .

537.227 1262

**A Few Quarternary Systems of Perovskite—Type  $A^2B^4O_3$  Solid Solutions**—T. Ikeda. (*J. Phys. Soc. Japan*, vol. 14, pp. 1286–1294; October, 1959.) Structural and dielectric prop-

erties of the systems (Sr-Pb)(Ti-Zr)O<sub>3</sub> and (Ba-Pb)(Ti-Sn)O<sub>3</sub>.

**537.227** 1263  
**New Ferroelectrics of Complex Composition: Part 3—Pb<sub>2</sub>MgWO<sub>6</sub>, Pb<sub>2</sub>Fe<sub>2</sub>WO<sub>6</sub> and Pb<sub>2</sub>FeTaO<sub>6</sub>**—G. A. Smolenskii, A. I. Agranovskaya and V. A. Isupov. (*Fiz. Tverdogo Tela*, vol. 1, pp. 988-990; June, 1959.) A note of measurements of permittivity and loss tangent in the temperature range -200°C to +300°C.

**537.227** 1264  
**Dielectric Polarization of Solid Solutions in the System (Ba,Sr)(Ta,Nb)<sub>2</sub>O<sub>7</sub>**—G. A. Smolenskii, V. A. Isupov, and A. I. Agranovskaya. (*Fiz. Tverdogo Tela*, vol. 1, pp. 992-995; June, 1959.) Investigation of the temperature dependence of permittivity and loss tangent in the range -160°C to +160°C at a frequency of 1 kc.

**537.227/.228.1:546.33.882.5** 1265  
**Dielectric Polarization and Piezoelectric Properties of certain Ferroelectric Solid Solutions based on Sodium Niobate**—V. A. Isupov and V. I. Kosyakov. (*Fiz. Tverdogo Tela*, vol. 1, No. 6, pp. 929-934; June, 1959.)

**537.227:546.431'824-31** 1266  
**Further Experiments on the Sidewise Motion of 180° Domain Walls in BaTiO<sub>3</sub>**—R. C. Miller and A. Savage. (*Phys. Rev.*, vol. 115, pp. 1176-1180; September, 1959.) The electric-field dependence of the velocity of the sidewise motion is given by  $v_x \exp(-\delta/E)$  where  $\delta$  varies very slightly with applied field. The measurements have been made over the velocity range 10<sup>-7</sup>-10<sup>2</sup> cm-sec<sup>-1</sup>.

**537.227:621.318.57** 1267  
**Switching Mechanism in Triglycine Sulphate and other Ferroelectrics**—E. Fatuzzo and W. J. Merz. (*Phys. Rev.*, vol. 116, pp. 61-68; October 1, 1959.) A description of the switching properties as a function of applied electric field, temperature, and sample thickness. A proposed model is treated mathematically and results are compared with experimental data.

**537.228.1:621.382.2** 1268  
**Piezoelectric Effect in a Rectifying Contact of Semiconductor**—T. Tanaka and H. Kawamura. (*J. Phys. Soc. Japan*, vol. 14, p. 1455; October, 1959.) Results of experiments with a selenium rectifier and with a Ge p-n junction.

**537.311.33** 1269  
**A Statistical Theory of the Electrical Conductivity of Semiconductors: Part 1**—M. I. Klinger. (*Fiz. Tverdogo Tela*, vol. 1, pp. 861-872; June, 1959.) A general expression obtained by a density-matrix method is used to derive a formula for conductivity in the case of weak electron-phonon interaction. This new formula is examined and applied to the scattering of electrons by polarized phonons.

**537.311.33** 1270  
**Rate of Diffusion-Limited Annihilation of Excess Vacancies**—P. Penning. (*Philips Res. Rep.*, vol. 14, pp. 337-345; August, 1959.) "The rate of removal and the spatial distribution of excess vacancies are calculated for the case where the transport to vacancy sinks takes place by diffusion and where dislocations in the volume of the sample, the surface of the sample or both may act as sinks." See 2458 of 1958.

**537.311.33:537.32.083** 1271  
**On the Problem of Measuring Thermoelectric Properties of Semiconductors**—M. A. Kaganov, I. S. Lisker, and I. G. Mushkin. (*Fiz. Tverdogo Tela*, vol. 1, pp. 988-990; June, 1959.) A correction factor for heat loss applied to a formula of Harman (*J. Appl. Phys.*, vol.

29, pp. 1373-1374; September, 1958) is shown to be independent of the current intensity.

**537.311.33:[546.28+546.289** 1272  
**Crystalline Imperfections and 1/f Noise**—J. J. Prophy. (*Phys. Rev.*, vol. 115, pp. 1122-1125; September 1, 1959.) Experimental results indicate that increasing the crystalline imperfection densities in Ge and Si causes the 1/f noise level to decrease through reduction in minority-carrier lifetime.

**537.311.33:546.28** 1273  
**Surface Recombination of Silicon**—H. U. Harten. (*Philips Res. Rep.*, vol. 14, pp. 346-360; August, 1959.) Extension of investigations described earlier (560 of February).

**537.311.33:546.28** 1274  
**Ionized-Impurity Scattering Mobility of Electrons in Silicon**—D. Long and J. Myers. (*Phys. Rev.*, vol. 115, pp. 1107-1118; September, 1959.) The temperature dependence of electron mobility has been determined between 30° and 100°K for n-type samples of varying impurity content by combining data from electrical resistivity and Hall-effect measurements. The dependence is shown to be consistent with the Brooks-Herring scattering formula when the Born approximation is valid.

**537.311.33:546.28** 1275  
**Hall Effect and Impurity Levels in Phosphorus-Doped Silicon**—D. Long and J. Myers. (*Phys. Rev.*, vol. 115, pp. 1119-1121; September 1, 1949.) The measured splitting of the (1s) energy level agreed well with the value deduced theoretically from the Kohn-Luttinger model.

**537.311.33:546.28** 1276  
**Effects of Heat Treatment upon the Electrical Properties of Silicon**—Y. Matukura. (*J. Phys. Soc. Japan*, vol. 14, pp. 918-923; July, 1959.) A report of observations of changes in carrier density and minority-carrier lifetime in pulled crystals of Si over the temperature range 400°-1200°C.

**537.311.33:546.28** 1277  
**Influence of an External Electric Field on the Surface Recombination and Capacitor Photo-E.M.F. of n-Type Silicon**—O. V. Smitko. (*Fiz. Tverdogo Tela*, vol. 1, pp. 980-983; June, 1959.) Measurements were made on five single-crystal samples of thickness  $\sim 3 \times 10^{-2}$  cm. Graphs show the dependence of the dark conductivity and surface recombination velocity on the surface charge.

**537.311.33:546.28** 1278  
**Certain Improvements in the Method of Preparing Pure Silicon by Thermal Decomposition of Silane**—Ya. E. Pokrovskii, S. I. Kleshchevnikova, and E. I. Rumyantseva. (*Fiz. Tverdogo Tela*, vol. 1, pp. 999-1001; June, 1959.) An improved version of the apparatus described earlier [2780 of 1958 (Kleshchevnikova, et al.).]

**537.311.33:546.28:539.12.04** 1279  
**Infrared Absorption of Silicon of High Resistivity containing Radiation Defects**—V. S. Vavilov, A. F. Plotnikov, and G. V. Zakhvatkin. (*Fiz. Tverdogo Tela*, vol. 1, pp. 976-979; June, 1959.)

**537.311.33:[546.289+546.682'86** 1280  
**On the Delayed Yield in Germanium and Indium Antimonide**—D. Dew-Hughes and G. E. Brock. (*J. Appl. Phys.*, vol. 30, pp. 2020-2021; December, 1959.) The delay time for plastic yielding may be associated with impurity locking of dislocations.

**537.311.33:546.289** 1281  
**Kinetics of the Interchange of Electrons**

**between the Surface and the Bulk of Germanium**—A. E. Yunovich. (*Fiz. Tverdogo Tela*, vol. 1, pp. 908-912; June, 1959.) An equation is derived for the dependence of the field effect on frequency in the range 10<sup>2</sup>-10<sup>6</sup> cps. The relaxation time of the field effect coincides with the effective lifetime of nonequilibrium charge carriers. The dependence of the effective mobility on frequency is shown for p- and n-type samples in different atmospheres.

**537.311.33:546.289** 1282  
**Studies of Vacancies in Dislocation-Free Ge Crystals**—A. G. Tweet. (*J. Appl. Phys.*, vol. 30, pp. 2002-2010; December, 1959.) Experiments carried out to determine the number of vacancies incorporated into a Ge crystal during growth are described.

**537.311.33:546.289** 1283  
**Dislocation Acceptor Levels in Germanium**—R. K. Mueller. (*J. Appl. Phys.*, vol. 30, pp. 2015-2016; December, 1959.) A dislocation-band model is described which gives good agreement between acceptor levels observed in grain boundaries and those derived from carrier depletion data.

**537.311.33:546.289** 1284  
**The Field Dependence of the Mobility of Electrons in n-Germanium**—H. Sato. (*J. Phys. Soc. Japan*, vol. 14, pp. 1275-1285; October, 1959.) A theory is developed, based on an assumed momentum distribution, which indicates an appreciable energy loss of electrons due to acoustic-mode scattering at very high field strengths. Improved agreement with experimental data is obtained.

**537.311.33:546.289** 1285  
**Mechanism of the Increasing Long-Term Changes of the Field Effect**—V. I. Lyashenko and N. S. Chernaya. (*Fiz. Tverdogo Tela*, vol. 1, pp. 878-885; June, 1959.) Investigation of p-type Ge showed a decrease of the screening of the field with time. This is related to the conductor.

**531.311.33:546.289** 1286  
**Extraction of Copper and Nickel from Germanium**—K. P. Tissen. (*Fiz. Tverdogo Tela*, vol. 1, pp. 1001-1003; June, 1959.)

**537.311.33:546.289:538.632** 1287  
**Dependence of the Hall Effect on Pressure in p-Type Germanium of 50-Ohm cm Resistivity**—A. I. Likhter. (*Fiz. Tverdogo Tela*, vol. 1, pp. 895-898; June, 1959.)

**537.311.33:546.289:548.5** 1288  
**Investigation of the Oriented Growth of Germanium on a Fluorite Single Crystal**—J. Marucchi and N. Nifontoff. (*Compt. rend.*, vol. 249, pp. 435-437; July 20, 1959.)

**537.311.33:546.289:548.5** 1289  
**Dendritic Growth of Germanium Crystals**—A. I. Bennett and R. L. Longini. (*Phys. Rev.*, vol. 116, pp. 53-61; October 1, 1959.) A general description of the experimental technique and basic theory.

**537.311.33:546.47-31** 1290  
**The Diffusion of Excess Zinc in Zinc Oxide Crystals (Investigations of Electrical Conductivity)**—R. Pohl. (*Z. Phys.*, vol. 155, pp. 120-128; May 6, 1959.) Conductivity changes in ZnO first heated in Zn vapor and subsequently in air are measured as a function of time. The effects noted are interpreted on the basis of diffusion processes.

**537.311.33:546.57'24** 1291  
**Galvano- and Thermo-magnetic Effects in  $\alpha$ -Ag<sub>2</sub>Te**—S. Miyatani and I. Yokota. (*J. Phys. Soc. Japan*, vol. 14, pp. 750-754; June, 1959.)  
 Nernst coefficient, magnetoresistance and mag-



netothermoelectric power of  $\alpha$ -Ag<sub>2</sub>Te have been measured as functions of the EMF of a galvanic cell Ag/AgI/Ag<sub>2</sub>Te/Pt. See 3532 of 1958 (Miyatani).

537.311.33:546.681'19:538.639 1292

**The Nernst-Ettingshausen Effect in Gallium Arsenide**—O. V. Emel'yanenko and D. N. Nasledov. (*Fiz. Tverdogo Tela*, vol. 1, pp. 985-988; June, 1959.) Results of an experimental investigation of GaAs are in qualitative agreement with the theory of thermomagnetic effects and indicate the prevalence of scattering on impurity ions in nondegenerate and degenerate *n*-type GaAs at temperatures less than 300° to 400°K.

537.311.33:546.682'19:539.12.04 1293

**Electron Irradiation of Indium Arsenide**—L. K. Aukerman. (*Phys. Rev.*, vol. 115, pp. 1133-1135; September 1, 1959.) During irradiation with 4.5-mev electrons the carrier concentration in *n*-type InAs increases; this increase is followed to a carrier concentration 10<sup>17</sup>/cm<sup>3</sup>. Under the same conditions the concentration in *p*-type InAs decreases.

537.311.33:546.682'682'86 1294

**Equilibrium Solid Solutions in the InSb-GaSb System**—V. I. Ivanov-Omskii and B. T. Kolomiets. (*Fiz. Tverdogo Tela*, vol. 1, pp. 913-918; June, 1959.)

537.311.33:546.682'86 1295

**Preparation and Electrical Properties of Alloyed *p-n* Junctions of InSb**—C. A. Lee and G. Kaminsky. (*J. Appl. Phys.*, vol. 30, pp. 2021-2022; December, 1959.) Techniques for producing these junctions are described and some characteristics are given. The high electron mobility of InSb should have advantages in some applications.

537.311.33:546.682'86 1296

**Electrical Properties of *n*-Type InSb in High Electric Field at 77°K**—Y. Kanai. (*J. Phys. Soc. Japan*, vol. 14, pp. 1302-1308; October, 1959.) At high fields, the resistivity and Hall coefficient were found to decrease rapidly with increasing field. At the same time the Hall mobility decreased and the drift velocity passed through a maximum value.

537.311.33:546.682'86 1297

**Magnetic Susceptibility of InSb**—R. Bowers and Y. Yafet. (*Phys. Rev.*, vol. 115, pp. 1165-1172; September 1, 1959.) The observed susceptibility increases with increasing carrier density at low densities and decreases at high densities. The results depart from that expected from a parabolic conduction band but are consistent with Kane's band-structure calculation (3156 of 1958).

537.311.33:546.682'86:537.312.8 1298

**On the Anomalous Magnetoresistance Effect in *n*-InSb**—W. Sasaki and C. Yamanoeli. (*J. Phys. Soc. Japan*, vol. 14, p. 849; June, 1959.) The oscillatory magnetoresistance effect observed by Broom (2149 of 1958) at liquid-helium temperature is shown to be caused by the same mechanism as the de Haas-van Alphen effect. An assumed value of 0.015 *m* for the electron mass fits the experimental data given.

537.311.33:546.682'86:539.12.04 1299

**Electron Irradiation of Indium Antimonide**—L. W. Aukerman. (*Phys. Rev.*, vol. 115, pp. 1125-1132; September 1, 1959.) Experiments carried out on single crystals of *n*- and *p*-type InSb bombarded with 4.5-Mev electrons at 80° and 200°K are reported. Samples bombarded at 80°K showed three regions of rapid annealing as measured by the change in carrier concentration; the first two regions lay be-

tween 80° and 200°K, the third near room temperature.

537.311.33:546.817'241 1300

**On Galvanomagnetic Effects in *p*-Type Crystals of PbTe**—K. Shogenji. (*J. Phys. Soc. Japan*, vol. 14, pp. 1360-1371; October, 1959.) Measurements at 90°K indicate an electronic band structure represented by {111} energy spheroids, presumably prolate with a mass ratio of 0.3.

537.311.33:546.873'241 1301

**The Sintering of Bismuth Telluride**—W. R. George, R. Sharples, and J. E. Thompson. (*Proc. Phys. Soc.*, vol. 74, pp. 768-770; December 1, 1959.) Samples of BiTe<sub>3</sub> doped with iodine were sintered at various temperatures; thermoelectric power varied with sintering temperature, and showed changes in sign.

537.311.62:546.87 1302

**Anomalous Skin Effect in Bismuth**—G. E. Smith. (*Phys. Rev.*, vol. 115, pp. 1561-1568; September 15, 1959.) Surface resistance measurements have been made at 23.5 kmc on plane surfaces of single-crystal Bi at 2°K as a function of orientation.

537.324:537.311.33 1303

**Effect of Impurity Scattering on the Figure of Merit of Thermoelectric Materials**—R. W. Ure, Jr. (*J. Appl. Phys.*, vol. 30, pp. 1922-1924; December, 1959.) "The thermoelectric figure of merit  $z = a^2/\rho k$  is calculated for an extrinsic semiconductor with mixed acoustic-mode lattice scattering and ionized-impurity scattering. The result is compared to the value for pure acoustic-mode scattering. As the amount of ionized-impurity scattering is increased, the figure of merit increases by less than 10% and then falls slowly."

537.533.8 1304

**Variation of the Coefficient of Secondary Electron Emission of some Metals with respect to the Energy of Incident Ions**—P. Cousinčić, N. Colombičić, C. Fert, and R. Simon. (*Compt. rend.*, vol. 249, pp. 387-389; June 20, 1959.) Experimental results have been obtained for A<sup>+</sup> and H<sup>+</sup> ions with energies 5-40 kev.

538.221 1305

**Theoretical Approach to the Asymmetrical Magnetization Curve**—A. Aharoni, E. H. Frei, S. Shtrikman. (*J. Appl. Phys.*, vol. 30, pp. 1956-1961; December, 1959.) A calculation is made of the magnetization curve of an infinite cylinder of Co particles in a CoO shell; results are also given for an infinite slab.

538.221 1306

**Nuclear Orientation and the Hyperfine Structure Coupling in Cobalt Metal**—M. A. Grace, C. E. Johnson, N. Kurti, R. G. Scurlock, and R. T. Taylor. (*Phil. Mag.*, vol. 4, pp. 948-950; August, 1959.) The hyperfine structure coupling, represented as an effective magnetic field  $H_{eff}$  at the nucleus, is given by  $H_{eff} = 193 \pm 20$  kg.

538.221 1307

**Effect of Crystallographic Twins on the D.C. and A.C. Properties of Nickel-Iron-Alloys**—J. E. Thompson. (*Brit. J. Appl. Phys.*, vol. 10, pp. 511-516; December 1959.) Deleterious effects on the magnetic properties of 50 per cent Ni-Fe alloys due to twinning during the annealing process are discussed.

538.221:538.569.4 1308

**Dipolar Line Broadening and Enhanced Pseudo-dipolar Moments**—R. L. White. (*Phys. Rev.*, vol. 115, pp. 1519-1520; September 15, 1959.) The assumption of a strongly enhanced pseudo-dipolar moment in certain ferrimagnetic and antiferromagnetic materials is

shown to be incompatible with the paramagnetic-resonance line widths in these materials.

538.221:538.569.4 1309

**Note on the Saturation of the Main Resonance in Ferromagnetics**—H. Suhl. (*J. Appl. Phys.*, vol. 30, pp. 1961-1964; December, 1959.) "The course of  $\chi''$  at resonance versus applied power is traced for various ratios of intrinsic to scattering line widths. It is assumed that the line-width contribution from thermal spin-wave agitation is negligible."

538.221:538.632 1310

**Effective Field in the Ordinary Hall Effect in Ferromagnetics**—E. Tatsumoto and T. Okamoto. (*J. Phys. Soc. Japan*, vol. 14, pp. 976-977; July, 1959.) The effective field is shown to be the magnetizing field. See also 1311 below.

538.221:538.632 1311

**Extraordinary Hall Effect in Silicon-Iron Single Crystals**—E. Tatsumoto and T. Okamoto. (*J. Phys. Soc. Japan*, vol. 14, pp. 975-976; July, 1959.) A method is described for obtaining the extraordinary Hall coefficient from probe measurements of Hall resistivity at the edge and about 1.5 mm from the edge of the specimen. The effect is found to be isotropic.

538.221:539.23 1312

**Magnetic Anisotropy of Evaporated Films Formed in Magnetic Field**—M. Takahashi, D. Watanabe, T. Sasagawa, H. Saito, and S. Ogawa. (*J. Phys. Soc. Japan*, vol. 14, pp. 1459-1460; October, 1959.) Quantitative measurements of the anisotropy of Fe, Co, Ni and Ni-Fe films.

538.221:539.23:538.632 1313

**New Experimental Results concerning the Hall Effect in Thin Films of Nickel**—A. Colombani and G. Goureaux. (*Compt. rend.*, vol. 249, pp. 381-383; July 20, 1959.)

538.221:539.23:538.632 1314

**The Hall Constants of Thin Films of Nickel**—G. Goureaux and A. Colombani. (*Compt. rend.*, vol. 249, pp. 511-513; July 27, 1959.)

538.221:539.23:621.318.57 1315

**Isolation of Rotational Reversal in Ferromagnetic Films**—A. L. Hanzel and R. L. Conger. (*J. Appl. Phys.*, vol. 30, pp. 1932-1936; December, 1959.) The relative contributions of wall motion and domain rotation to the magnetization reversal process in thin ferromagnetic films are investigated experimentally.

538.221:621.317.42 1316

**Measurement of the Gradient of the Magnetic Field at the Boundary Surface of a Magnetic Body**—S. Yamaguchi. (*Z. Metallk.*, vol. 50, pp. 721-722; December, 1959.) A gradient of  $9 \times 10^4$  grams/cm was measured by an electron-diffraction method at the edge of a Ni film containing nickel oxide.

538.221:621.318.134 1317

**The Frequency and Temperature Characteristics of Complex Permeability of High-Permeability Ferrites**—D. Köhler. (*Arch. elekt. Übertragung*, vol. 13, pp. 1-12; January, 1959.) The results of measurements on Mn-Zn and Ni-Zn ferrites are analyzed and interpreted on the basis of existing theories. 36 references.

538.221:621.318.134 1318

**Electric Resistance and Cation Distribution of Fe-Mn Ferrite System**—Z. Funatogawa, N. Miyata, and S. Usami. (*J. Phys. Soc. Japan*, vol. 14, p. 854; June, 1959.)

538.221:621.318.134:537.311.3 1319

**The Electrical Resistivity of Oxygen-Deficient Nickel Ferrite**—R. Parker and H. Lord.



(*Proc. Phys. Soc.*, vol. 74, pp. 793-795; December 1, 1959.) Results of measurements are interpreted with reference to different "types" of conduction. See also 1220 of 1959 (Parker).

538.221:621.318.134:538.569.4 1320

**High-Power Effects in Ferrite Devices**—P. E. Seiden and H. J. Shaw. (*Proc. IRE*, vol. 48, p. 122; January, 1960.) Profile line-widths and the threshold for onset of decrease in susceptibility have been measured for ferrite samples.

538.221:621.318.134:538.569.4 1321

**Spin Temperature and High-Power Effects in Ferrimagnets**—M. T. Weiss. (*J. Appl. Phys.*, vol. 30, p. 2014; December, 1959.) Experimental results for Mn ferrite and Y-Fe garnet seem to confirm the hypothesis that high microwave power levels tend to increase the spin temperature and that this change is effective in changing the  $g$  factor.

538.221:621.318.134:538.569.4 1322

**Theory of Ferromagnetic Resonance in Rare-Earth Garnets: Part I— $g$  Values**—C. Kittel. (*Phys. Rev.*, vol. 115, pp. 1587-1590; September 15, 1959.) The  $g$  values observed in resonance experiments are analyzed. General features of experimental results are reproduced fairly well by calculated curves.

538.221:621.318.134:538.569.4 1323

**Ferrimagnetic Resonance Line Width in Polycrystalline  $Y_3Fe_5-xIn_xO_{12}$** —T. Miyadai, Y. Schichijo, and I. Tsubokawa. (*J. Phys. Soc. Japan*, vol. 14, p. 853; June, 1959.)

538.221:621.318.134:538.632 1324

**Hall-Effect Measurement on Magnetite and a Nickel Ferrite with Excess Iron**—W. Mann. [*Ann. Phys. (Lpz.)*, vol. 3, pp. 122-124; March 24, 1959.] Measurements were made on  $Fe_3O_4$  and  $(Fe_2O_3)_{0.65}(NiO)_{0.35}$  using a dc compensation method.

538.221:621.318.57 1325

**A Contribution to the Study of Switching in a Ferromagnetic Core Fed by a Perfect Current Source**—C. Durante and J. Lailheugue. (*Compt. rend.*, vol. 249, pp. 917-918; August 31, 1959.) A discrepancy between the theoretical and experimental results is explained. See also 253 of January (Durante).

538.222 1326

**The Ratio of the Isolated and the Adiabatic Susceptibility of Paramagnetic Crystals**—W. J. Caspers. (*Physica*, vol. 25, pp. 43-49; January, 1959.)

538.222:538.569.4 1327

**Theory of the Nuclear Magnetic Resonance Shift in Paramagnetic Crystals**—F. Keffer, T. Oguchi, W. O'Sullivan, and J. Yamashita. (*Phys. Rev.*, vol. 115, pp. 1553-1561; September 15, 1959.) A theoretical study is made of the shift of the  $F^{19}$  nuclear resonance in paramagnetic and antiferromagnetic  $MnF_2$  observed by Shulman and Jaccarino (see *ibid.*, vol. 108, pp. 1219-1231; December 1, 1957.) Results are in reasonable agreement with experiment.

538.222:538.569.4 1328

**Self-Absorption and Trapping of Sharp-Line Resonance Radiation in Ruby**—F. Varsanyi, D. L. Wood, and A. L. Schawlow. (*Phys. Rev. Lett.*, vol. 3, pp. 544-545; December 15, 1959.)

538.222:538.569.4 1329

**Optical Detection of Paramagnetic Resonance in an Excited State of  $Cr^{3+}$  in  $Al_2O_3$** —S. Geschwind, R. J. Collins, and A. L. Schawlow. (*Phys. Rev. Lett.*, vol. 3, pp. 545-548; December 15, 1959.)

538.222:538.569.4 1330

**Optical Detection of Paramagnetic Resonance in Crystals at Low Temperatures**—J. Brossel, S. Geschwind, and A. L. Schawlow. (*Phys. Rev. Lett.*, vol. 3, pp. 548-549; December 15, 1959.)

538.222:538.569.4:534.2-8 1331

**Saturation of Paramagnetic Spins by 13-Mc/s Ultrasonic Phonons**—R. D. Mattuck and M. W. P. Strandberg. (*Phys. Rev. Lett.*, vol. 3, pp. 550-551; December 15, 1959.) Experiments with ruby, Cr-doped MgO, and quartz are reported.

539.2:538.22 1332

**Energy Levels for Rare-Earth Ions Subject both to Exchange and Crystalline Fields**—R. L. White and J. P. Andelin, Jr. (*Phys. Rev.*, vol. 115, pp. 1435-1439; September 15, 1959.) The term splitting is calculated for the lowest  $J$  state of the rare-earth ions samarium to ytterbium, subjected simultaneously to exchange and crystalline fields. The crystalline field is taken to be cubic and the calculation is carried out for the magnetic axis in the [100] and [111] directions. Application to the rare-earth garnets is discussed.

539.2:548.0 1333

**Simplified LCAO Method for Zincblende, Wurtzite, and Mixed Crystal Structures**—J. L. Birman. (*Phys. Rev.*, vol. 115, p. 1493-1505; September 15, 1959.) Qualitative comparison of energy bands in the structures.

621.315.61.004.6 1334

**Life of Technical Dielectrics Operating in High-Frequency Fields**—A. T. Alad'ev. (*Fiz. Tverdogo Tela*, vol. 1, pp. 935-938; June, 1959.) An expression is derived showing the dependence of useful life on electric field intensity and frequency, and on the dimensions and distribution of pores in the dielectric. This equation applies in the range from several seconds to many thousand hours.

621.315.616 1335

**New High-Softening Dielectric Materials**—W. Mikucki. (*Brit. Commun. Electronics*, vol. 7, pp. 40-43; January, 1960.) Characteristics and electrical properties of new polymer materials with softening point above 100°C are tabulated.

## MATHEMATICS

517.534:538.566 1336

**On a Modification of Watson's Lemma**—F. Oberhettinger. (*J. Res. Nat. Bur. Stand.*, vol. 63B, pp. 15-17; July-September, 1959.) "The method of steepest descents is extended to the case when a saddle point and a pole of arbitrary order are involved. An application to a problem in diffraction theory is demonstrated."

## MEASUREMENTS AND TEST GEAR

621.317.3:621.391.822 1337

**I.R.E. Standards on Methods of Measuring Noise in Linear Two-Ports, 1959**—(PROC. IRE, vol. 48, pp. 60-68; January, 1960.) Standard 59 I.R.E. 20. S1.

621.317.33:537.312.8 1338

**Sensitive Method for Measurement of Magnetoresistance Effect with Direct Currents and with Microwaves**—D. E. Clark and J. G. Assenheim. (*Brit. J. Appl. Phys.*, vol. 11, pp. 35-38; January, 1960.) Measurements made using direct current and frequencies of 1.1, 1.5 and 9.2 kmc in fields up to 6270 oersteds are described. In general form the results agree with the theory of Donovan (2913 of 1954).

621.317.331:538.541 1339

**Eddy-Current Method for Measuring the Resistivity of Metals**—C. P. Bean, R. W. De-

Blois and L. B. Nesbitt. (*J. Appl. Phys.*, vol. 30, pp. 1976-1980; December, 1959.) The resistivity is calculated from the rate of decay of flux from a bar situated in an external magnetic field that has been rapidly reduced to zero.

621.317.335.029.6 1340

**Measurement of Dielectric Constants by the High-Order-Mode Interferometer**—J. I. Caicoya. (*Brit. Commun. Electronics*, vol. 7, pp. 32-34; January, 1960.) An application of microwave equipment described earlier (3495 of 1956). The angle of refraction (Snell's refraction law) is determined for a uniform plane wave obliquely incident upon a dielectric sheet. 42 references.

621.317.343:621.372.83 1341

**Measurement of the Impedance Matrix of Reciprocal Two-Port Junctions**—C. Montebello. (*Note Recensioni Notiz.*, vol. 8, pp. 48-55; January/February, 1959.) A graphical method is proposed; measurements are made at one port only.

621.317.444:537.53 1342

**Measurement of Ion Beam Currents using a Hall Effect Magnetometer**—W. S. Whitlock and C. Hilsium. (*Nature*, vol. 185, p. 302; January 30, 1960.) A technique is described for measuring currents without interrupting the beam. Hall voltages are developed in an InSb crystal placed in the air gap of a mumetal ring through which the beam is passed. Two methods of applying the technique are given; the lowest beam current detected was about 10  $\mu$ a.

621.317.444:550.380.8:629.136.3 1343

**A Rocket-Borne Magnetometer**—K. Burrows. (*J. Brit. IRE*, vol. 19, pp. 769-776; December, 1959.) The requirements of a rocket-borne magnetometer are outlined and the principles of measurement using a proton precession magnetometer are explained. The design, construction and testing of a practical instrument are described.

621.317.7 1344

**A Programmed Test Set**—D. W. Bradfield, A. M. East, and H. F. Rourke. (*Electronic Engrg.*, vol. 31, pp. 714-721; December, 1959.) Using uniselectors, complex electronic equipment can be checked more quickly and accurately than by manual methods.

621.317.733 1345

**Wagner-Earth and other Null-Instrument Capacity Neutralizing Circuits**—H. H. Wolff. (*Rev. Sci. Instr.*, vol. 30, pp. 1116-1122; December, 1959.) An exact theoretical treatment is given and its practical application to ac bridges discussed.

621.317.74:621.373.42.029.4 1346

**Low-Distortion Sine-Wave Generator**—A. R. Bailey. (*Electronic Tech.*, vol. 37, pp. 64-67; February, 1960.) Details are given of an RC oscillator operating in the range 10 cps-100 kc with distortion <0.02 per cent, designed for investigating the characteristics of sharply tuned retractor circuits.

621.317.742:621.372.86 1347

**Microwave Reflectometer Techniques**—G. F. Engen and R. W. Beatty. (*TRANS. IRE ON MICROWAVE THEORY AND TECHNIQUES*, vol. MTT-7, pp. 351-355; July, 1959.) Abstract, *Proc. IRE*, vol. 47, p. 1796; October, 1959.)

621.317.742:621.372.86 1348

**Magnified and Squared V.S.W.R. Responses for Microwave Reflection-Coefficient Measurements**—R. W. Beatty. (*TRANS. IRE ON MICROWAVE THEORY AND TECHNIQUES*, vol. MTT-7, pp. 346-350; July, 1959.) Abstract, *Proc. IRE*, vol. 47, p. 1796; October, 1959.)

621.317.755 1349

**Probability Density Measurement with an Electrode Mounted in the Face of a Cathode-Ray Tube**—H. Lien. (*Rev. Sci. Instr.*, vol. 30, pp. 1100-1102; December, 1959.) "A small electrode mounted inside the face of a cathode-ray tube gives a 'window' comparable to its own dimensions when the bias voltages are set so that secondary electron emission current dominates. Under these conditions the device can be used for measurement of probability densities of random signals."

621.317.755 1350

**Transient Storage Oscilloscope**—A. E. Cawkwell and R. Reeves. (*Electronic Tech.*, vol. 37, pp. 50-59; February, 1960.) Details are given of a commercial oscilloscope incorporating a storage tube Type E702A. Normal oscilloscope facilities are also available.

621.317.789.029.64 1351

**A Wide-Band High-Power Microwave Calorimeter**—T. Jaeger and M. V. Schneider. (*Arch. elekt. Übertragung*, vol. 13, pp. 21-25; January, 1959.) A constant-flow method is used with the flow system entirely outside the main rectangular waveguide, so preventing electrical breakdown. The dissipative structure is coupled to the main guide by a wire grid in the guide wall. Power is measured by a substitution method, the total error being less than 2 per cent.

621.317.79:621.395.625.3.001.41 1352

**A Versatile Clock System for Setting-Up and Testing Magnetic Drums**—J. S. Arnold and D. L. Hood. (*A.T.E.J.*, vol. 15, pp. 2-14; January, 1959.) A transistor counter circuit and its application are described.

621.317.794 1353

**Simplified Logarithmic Radiation Meter Using Noise**—C. E. Cohn. (*Rev. Sci. Instr.*, vol. 30, pp. 1097-1099; December, 1959.) "A logarithmic radiation meter has been developed which uses an a.c.-coupled logarithmic voltmeter to measure the random noise from a photomultiplier detector. A range of four decades has been obtained."

621.317.794 1354

**A Coaxial Film Bolometer for the Measurement of Power in the U.H.F. Band**—I. A. Harris. (*Proc. IEE*, Part B, vol. 107, pp. 67-72; January, 1960.) The bolometer element is a thin cylindrical film forming the center conductor of a coaxial line; the outer conductor has an axial section in the form of a tractrix tapering until it meets the center conductor. A wide-band bolometer for measuring powers of 2-200 mw from 200 mc to 4 kmc with an accuracy within 1 per cent is described; designs for 2 watts up to 3 kmc and 0.1 mw up to 20 kmc are feasible.

#### OTHER APPLICATIONS OF RADIO AND ELECTRONICS

538.569.4:535.33:621.375.9 1355

**Radio-Frequency Spectroscopy using Three-Level Maser Action**—K. Shimoda. (*J. Phys. Soc. Japan*, vol. 14, pp. 954-959; July, 1959.)

621.3.087.4:678.5:537.533 1356

**Thermoplastic Recording**—W. E. Glenn. (*J. Appl. Phys.*, vol. 30, pp. 1870-1873; December, 1959.) Information is written by an electron beam on a film coated with low-melting-point thermoplastic. The pattern of charge is converted to a deformation pattern by heating the material.

621.362+621.56 1357

**The Thermoelectric Figure of Merit and its Relation to Thermoelectric Generators**—R. P.

Chasmar and R. Stratton. (*J. Electronics Control*, vol. 7, pp. 52-72; July, 1959.) The figure of merit of a semiconductor of given carrier mobility and lattice thermal conductivity is evaluated numerically and presented graphically for various scattering indices. High-temperature limitations are considered and the results discussed in connection with various sulphides, selenides and tellurides.

621.362+621.56 1358

**The Figure of Merit of a Thermoelectric Generator**—R. Stratton. (*J. Electronics Control*, vol. 7, pp. 73-76; July, 1959.) Optimum conditions for a generator with *n*- and *p*-type semiconducting branches with different physical parameters are simply related to the optimum conditions for the figure of merit of a single substance.

621.362+621.56 1359

**Effect of Heat Transfer on the Characteristics of Semiconductor Thermopiles for Refrigerators and Heat Pumps**—G. Vikhorev and V. Naer. (*Fiz. Tverdogo Tela*, vol. 1, pp. 903-907; June, 1959.)

621.362 1360

**Thermoelectricity**—C. Celent. (*Electronic Ind.*, vol. 18, pp. 66-78; July, 1959.) A review of progress made in the development of thermoelectric and thermionic heat converters by manufacturers in U. S. A. Properties of a large number of materials are given in tabular form.

621.362:537.227 1361

**Ferroelectrics Generate Power**—(*Electronics*, vol. 32, pp. 88, 90; December 18, 1959.) The ferroelectric generator converts thermal to electrical energy by means of a ferroelectric capacitor. High output voltages may be obtained, and stages may be cascaded. One application is the generation of an ac voltage in a spinning satellite.

621.362:621.387 1362

**Characteristics of a Plasma Thermocouple**—Pidd, Grover, Salmi, Roehling, and Erickson. (See 1456.)

621.362:621.387 1363

**Space-Charge Neutralization by Fission Fragments in the Direct-Conversion Plasma Diode**—F. E. Jablonski, C. B. Leffert, R. Silver, R. F. Hill, and D. H. Loughridge. (*J. Appl. Phys.*, vol. 30, pp. 2017-2018; December, 1959.)

621.365.55:674 1364

**Radio-Frequency Heating in Wood Gluing**—J. Pound. (*Beama Jour.*, vol. 66, pp. 148-151; November, 1959.)

621.365.55:678.5 1365

**Radio-Frequency Heating in the Plastics Industry**—C. E. Tibbs. (*Beama Jour.*, vol. 66, pp. 144-147; November, 1959.) The use of preheating ovens and applications of dielectric welding of thermoplastic materials are described.

621.374.32:612.816 1366

**Pulse-Height Analyser for Neuro-physiological Applications**—R. M. Littauer and C. Walcott. (*Rev. Sci. Instr.*, vol. 30, pp. 1102-1106; December, 1959.) A five-channel instrument which allows the activity of one or more nerve fibres to be followed.

621.384.8:621.382.2 1367

**Performance of Germanium and Silicon Surface-Barrier Diodes as Alpha Particle Spectrometers**—J. W. Mayer. (*J. Appl. Phys.*, vol. 30, pp. 1937-1944; December, 1959.)

621.385.833:061.3 1368

**Summarized Proceedings of a Conference**

**on Electron Microscopy—Exeter, July 1959**—J. A. Chapman and M. J. Whelan. (*Brit. J. Appl. Phys.*, vol. 11, pp. 22-32; January, 1960.)

621.387.424 1369

**Self-Quenching Geiger Counters containing Mixtures of Permanent Gases**—A. J. L. Collinson, I. C. Demetopoulos, J. A. Dennis, and J. M. Zarzycki. (*Nature*, vol. 185, p. 369; February 6, 1960.) An investigation of counters containing mixtures of argon with small quantities of xenon, oxygen and nitrogen to total pressures of 700 mm Hg. General conclusions are reached on the role of various components of the mixture in the production of the Geiger plateau.

621.398:551.508.77:621.396.96 1370

**The Use of a Radar Beacon for Telemetering Precipitation Data**—D. R. Soltow and R. D. Tarble. (*J. Geophys. Res.*, vol. 64, pp. 1863-1866; November, 1959.) Description of a radar interrogating system for obtaining a PPI display of tipping-bucket rain-gauge data from remote stations.

#### PROPAGATION OF WAVES

621.391.812.62 1371

**Note on Amplitude Fluctuations of Distant Fields**—F. du Castel. (*Ann. Télécommun.*, vol. 14, pp. 91-92; March/April, 1959.) Amplitude fluctuations over three 430 mc trans-horizon radio links in West Africa have been analyzed. Results show an amplitude distribution frequently different from that given by a Rayleigh-type law.

621.391.812.621 1372

**Partial Reflections in the Atmosphere and Long-Distance Propagation: Part 3**—F. du Castel, A. Spizzichino, P. Misme, and J. Voge. (*Ann. Télécommun.*, vol. 14, pp. 33-40; January/February, 1959.) The reflected field is considered to have two components, one specular and the other diffuse, the characteristics of each component obeying different laws. Parts 1 and 2: 1006 of March.

621.391.812.624 1373

**A Note on Scatter Propagation**—E. D. Denman. (*Proc. IRE*, vol. 48, pp. 112-113; January, 1960.) Scattering from a periodic dielectric perturbation is theoretically greatly enhanced if a certain wavelength ratio exists between the periodic disturbance and the EM energy. Experimental evidence is presented to support the theory.

621.391.812.624/.63:621.396.2 1374

**Radio Transmission by Ionospheric and Tropospheric Scatter**—(See 1392.)

621.391.812.8:681.142 1375

**Computers aid Propagation Studies**—(*Electronics*, vol. 32, pp. 50, 52; December 25, 1959.) General description of the application of computer techniques at the National Bureau of Standards particularly in the prediction of propagation conditions and the preparation of ionospheric and tropospheric contour maps.

#### RECEPTION

621.376.23 1367

**Transient Cross-Modulation in the Detection of Asymmetric-Sideband Signals**—T. Murakami and R. W. Sonnenfeldt. (*RCA Rev.*, vol. 20, pp. 455-472; September, 1959.) Envelope and synchronous or product detection methods are compared with reference to transient cross-modulation. Under correct phasing conditions synchronous detection may be made distortionless for asymmetric-sideband signals.

621.391.812.3:621.3:621.3.087.6 1377

**Fading-Rate Recorder for Propagation Re-**



search—J. W. Koch, W. B. Harding and R. J. Jansen. (*Electronics*, vol. 32, pp. 78-80; December 18, 1959.) An instrument which provides strip-chart recordings simultaneously of signal strength and average fading rates from almost zero to 300 cps is described.

**621.391.821:621.317.34** 1378  
**The Measurement of Atmospheric Radio Noise by an Aural Comparison Method in the Range 15-500 kc/s**—J. Harwood and B. N. Harden. (*Proc. IEE*, Part B, vol. 107, pp. 53-59; January, 1960.) "Atmospheric noise received on a vertical aerial is compared with a locally generated keyed signal to estimate the level at which the signal is 95% intelligible. This method was used in earlier high-frequency equipment and has been adapted for the range 15-500 kc/s. The apparatus and its method of operation are described. Results obtained at a number of sites are discussed in relation to more objective measurements. In particular, deduced noise powers are compared with existing world-wide predictions, revealing some differences."

**621.391.822:621.317.794** 1379  
**Ultra-Low Noise Measurements using a Horn Reflector Antenna and a Travelling-Wave Maser**—R. W. DeGrasse, D. C. Hogg, E. A. Ohm, and H. E. D. Scovil. (*J. Appl. Phys.*, vol. 30, p. 2013; December, 1959.) Sky noise has been measured at 5.65 km cps with an antenna having a 2 degree beam width pointed at an angle of  $\theta$  to the zenith. When  $\theta=0$ , the sky temperature was found to be 2.5°K and it varied according to  $\sec \theta$  up to  $\theta=80$  degrees.

**621.391.822.001.2** 1380  
**Methods of Calculation for Noise Phenomena**—K. Lunze. (*NachrTech.*, vol. 8, pp. 530-537; December, 1958.) The calculation of the noise-power spectrum, and representation by equivalent noise quadrupoles are considered.

**621.391.827:621.396.41** 1381  
**Crosstalk due to Finite Limiting of Frequency-Multiplexed Signals**—C. R. Cahn. (*Proc. IRE*, vol. 48, pp. 53-59; January, 1960.) The case of a narrow gap in random noise is analyzed to determine the output signal/crosstalk ratio in the selected channel as a function of clipping level. An optimum level is determined and applied to frequency-multiplex binary data transmission.

**621.396.621.52:621.385.633** 1382  
**Application of a Backward-Wave Amplifier to Microwave Autodyne Reception**—J. K. Puffer. (*TRANS. IRE ON MICROWAVE THEORY AND TECHNIQUES*, vol. MTT-7, pp. 356-359; July, 1959. Abstract, *Proc. IRE*, vol. 47, p. 1796; October, 1959.)

**621.396.66:621.316.726.078.3** 1383  
**Spectrum-Selection Automatic Frequency Control of Ultra-Short-Pulse Signalling Systems**—H. Kilm and R. J. Kleusch. (*RCA Rev.*, vol. 20, pp. 499-517; September, 1959.) A system is described which maintains a constant frequency difference between a carrier frequency modulated by ultra-short pulses of 10 msec duration and a local electrically tuned oscillator.

**621.396.662.078** 1384  
**DOPLOC uses Phase-Locked Filter**—F. M. Gardner. (*Electronic Ind.*, vol. 18, pp. 96-99; October, 1959.) Description of an automatic Doppler-frequency tuning system which improves the signal-to-noise ratio of a received satellite signal by 43 db.

**621.396.666:621.391.812.3** 1385  
**Diversity Reception of Two Correlated Signals**—F. du Castel and J. Derennes. (*Ann.*

*Télécommun.*, vol. 14, pp. 41-42; January/February, 1959.) The influence of Gaussian signal distribution on diversity gain is examined and compared with the gain for a Rayleigh distribution [see 1862 of 1956 (Staras)].

**621.396.666:621.396.4** 1386  
**Multiple Diversity with Non-independent Fading**—J. N. Pierce and S. Stein. (*Proc. IRE*, vol. 48, pp. 89-104; January, 1960.) The performance of an optimum (maximal-ratio) combiner is analyzed for an arbitrary number of diversity branches. Possible correlation between components of various signals is considered. Simplifications can be made in special cases and examples of application to digital communication problems are given.

**STATIONS AND COMMUNICATION SYSTEMS**

**621.376.2** 1387  
**The Computation of Single-Sideband Peak Power**—W. K. Squires and E. Bedrosian. (*Proc. IRE*, vol. 48, pp. 123-124; January, 1960.) The average-to-peak SSB power ratio is derived for a continuous range of modulating signals from sinusoidal to square waveforms.

**621.391** 1388  
**Instantaneous Complex Frequency. Definition and Measurement**—P. Braffort and R. Castagne. (*Compt. rend.*, vol. 249, pp. 854-856; August 17, 1959.) The concept of instantaneous complex frequency may be used for a signal modulated in any way. Principles of measurement for certain cases are described.

**621.391** 1389  
**Instantaneous Spectrum and Analysis of a Signal Simultaneously in Frequency and Time**—P. Deman. (*Ann. Télécommun.*, vol. 14, pp. 21-32; January/February, 1959.) An analytical method is proposed for studying under interference conditions, a signal which is considered to be a succession of elementary signals represented in two dimensions by frequency and time. Practical aspects of the system are discussed.

**621.396:621.395** 1390  
**Voice Radio Systems for High-Noise Paths**—J. A. Greefkes and F. de Jager. (*Electronics*, vol. 32, pp. 53-57; December 11, 1959.) By transmitting speech amplitude and speech frequency on different channels a communications link can be operated under poorer noise conditions than with either SSB or FM systems. Operation is possible with a signal-to-noise ratio of 4 db.

**621.396.2:621.376.55** 1391  
**Phase-Shift Keying in Fading Channels**—H. B. Voelcker. (*Proc. IEE*, Part B, vol. 107, pp. 31-38; January, 1960.) A theoretical analysis of the effect of fading and noise on phase-shift keying, a modulation technique with reduced bandwidth and superior to frequency-shift keying at relatively low signal-to-noise ratios.

**621.396.2:621.391.812.624/.63** 1392  
**Radio Transmission by Ionospheric and Tropospheric Scatter**—(*Proc. IRE*, vol. 48, pp. 4-44; January, 1960.) A report of the U. S. Joint Technical Advisory Committee prepared as a supplement to *Radio Spectrum Conservation, 1952* (see 2446 of 1953). The report is in two sections covering ionospheric scatter transmission and long-range tropospheric transmission. Each section summarizes present knowledge concerning propagation theories, experimental data, design practice, fields of application, and factors affecting frequency allocation.

**621.396.4** 1393  
**Recent Communications Systems Developments**—M. M. Perugini. (*Electronics*, vol. 32, pp. 72-75; December 18, 1959.) A summary of five papers presented at the Fall Meeting of the AIEE, Chicago, 1959, covering recent developments in microwave, telegraph and telephone systems.

**621.396.43:551.507.362.2** 1394  
**Satellite Test Open to All**—(*Electronics*, vol. 32, pp. 44-45; December 18, 1959.) A note on "Project Echo" for which a 100-foot-diameter metallized balloon is to be launched into a 1000-mile-altitude earth orbit during spring 1960, to act as a passive communications reflector.

**621.396.65:621.372.55** 1395  
**Automatic Control of Distortion in Wide-Band-Frequency-Modulated Microwave Links**—J. Tolman. (*Electronic Engrg.*, vol. 31, pp. 722-725; December, 1959.) An experimental automatic equalizer for correcting group delay slope is described and results are given for a 600-channel circuit. The basic equations are developed, and curves are given for intermodulation group delay distortion.

**621.396.65:621.391.8** 1396  
**Investigation of the Telegraphic Quality in Transhorizon Radio Beams**—F. du Castel and J. P. Magnen. (*Ann. Télécommun.*, vol. 14, pp. 93-103; March/April, 1959.) An evaluation of the telegraphic quality obtained when some of the telephony channels of a multiplex system are used for telegraphy. Results show that, assuming good-quality telephonic reception, CCITT quality for telegraphy can only be ensured by the use of a diversity reception system. With a quadruple-diversity system the number of hours of interrupted service on the telegraphy link would be less than those for the telephone link. The influence of rapid fading on the telegraphic signal is discussed.

**621.396.65:621.397** 1397  
**Radio Link Equipment in the 3800-4200-Mc/s Band**—J. Dascotte. (*Onde elect.*, vol. 39, pp. 769-784; October, 1959.) Terminal equipment is described for an 819-line television link having two double-sideband channels.

**SUBSIDIARY APPARATUS**

**621-526:621.375.4** 1398  
**A Transistor Quadrature Suppressor for A.C. Servo Systems**—I. C. Hutcheon and D. N. Harrison. (*Proc. IEE*, Part B, vol. 107, pp. 73-82; January, 1960.) The spurious quadrature component in the error signal of an ac servo-system is cancelled by a self-balancing circuit including thermistors.

**621.3.087.9:621.383** 1399  
**Photoelectric Chart Reader of Recorded Ink Line**—H. Yulura, K. Nakajima, S. Kozumi, Y. Nakamura, and Y. Endow. (*J. Radio Res. Labs., Japan*, vol. 6, pp. 705-719; October, 1959.) Design and construction details are given of an equipment which samples the level of a recorded line once every second and produces an integrated analog output voltage.

**621.314.1:621.382.3** 1400  
**Transistor Regulated D.C./D.C. Converter**—A. Tailleux. (*Onde elect.*, vol. 39, pp. 795-801; October, 1959.) Regulation is controlled by a blocking oscillator whose frequency varies as a function of the error voltage. Details are given of a 100-watt regulator.

**621.314.63** 1401  
**On the Non-isothermal Diffusion Theory of Rectifiers**—T. Numata. (*J. Phys. Soc. Japan*, vol. 14, pp. 902-913; July, 1959.) A general theory is developed from formal conduction



theory; the rectification equation obtained depends upon temperature distributions in a barrier. Values of the dielectric constant of barrier materials in  $\text{Cu}_2\text{O}$  and Se rectifiers, determined by analysis of experimental results using the new theory, tend to approach those of the bulk materials.

621.316.721.078.3:538.569.4 1402

**Stabilization of a Direct Current or a Magnetic Field by Paramagnetic Resonance**—R. Reimann. (*Compt. rend.*, vol. 249, pp. 517–519; July 27, 1959.) Description of a system for current stabilization based on electron resonance in a sample of paramagnetic material such as diphenyl-picryl-hydrazyl.

621.316.721.078.3:621.318.381 1403

**A Simple Current Stabilizer for Electromagnets**—M. H. N. Potok. (*Electronic Engrg.*, vol. 31, pp. 745–746; December, 1959.) The design of a stabilizing circuit operating with an amplidyne generator is described which gives 10 amperes at 100 volts with stability within 5 parts in  $10^5$ .

621.316.721.078.3:621.318.381 1404

**A Transistorized Current Stabilizer for an Electromagnet**—J. C. S. Richards. (*Electronic Engrg.*, vol. 32, pp. 22–23; January, 1960.) An auxiliary electromechanical control system permits an output of up to 4 amperes at 200 volts with current stability within  $\pm 2$  parts in  $10^4$  over 10 hours.

#### TELEVISION AND PHOTOTELEGRAPHY

621.397:621.391.822 1405

**The Interference caused by Noise Fluctuations of Irregular Spectral Distribution**—E. Sennhenn. (*Elektron. Rundschau*, vol. 13, pp. 9–12; January, 1959.) Subjective tests were made to assess the dependence of the interference effect at different noise frequencies on picture brightness and content. The subjective noise sensitivity for the noise spectra of conventional scanning tubes is evaluated.

621.397.132 1406

**From Monochrome to Colour Television**—Santos and Dintzner. (*Onde élect.*, vol. 39, pp. 823–826; October, 1959.) General description of a closed-circuit simultaneous color-television system with a compact camera unit weighing 5 kg.

621.397.132:621.395.625.3 1407

**Magnetic Recording of Colour Television**—J. Roizen. (*Electronics*, vol. 33, pp. 76–79; January 1, 1960.) Description of a system used commercially giving details of the method of maintaining the timing accuracy within 2  $\mu\text{sec}$  for faithful color reproduction. Special attention is given to the servosystem which controls the tape transport.

621.397.132:621.397.331.222 1408

**Production of Fine Patterns by Evaporation**—S. Gray and P. K. Weimer. (*RCA Rev.*, vol. 20, pp. 413–425; September, 1959.) Methods for measuring the scattering of material at a wire masking grill are described. Various techniques for reducing the scattering have been applied in the construction of an experimental target for a tricolor camera tube.

621.397.331.22 1409

**The Testing and Operation of  $4\frac{1}{2}$ -in. Image-Orthicon Tubes**—D. C. Brothers. (*J. Brit. IRE*, vol. 19, pp. 777–805; December, 1959.) The basic principles of the image orthicon are described. The parameters affecting picture quality are examined in detail. Suggestions are made for the setting up and operation of this tube to obtain the best compromise between the requirements of the different parameters.

621.397.331.24:621.318.4 1410

**Bilateral Linearity Regulator**—R. Suhrmann and M. Meyer. (*Frequenz*, vol. 13, pp. 11–15; January, 1959.) In the device described, a coil wound on a magnetically soft ferrite tube with ceramic permanent-magnet core is used to correct deflection linearity at the beginning and end of the line.

621.397.6.001.4 1411

**The International Development of the Test-Line Technique in Television**—H. E. Fröling. (*Frequenz*, vol. 13, pp. 1–10, 147–155, and 175–183; January, May, and June, 1959.) Details are given of the test systems adopted by various international broadcasting organizations. See also 679 of February (Springer). 48 references

621.397.6.001.41:621.391.837 1412

**The Test Pattern of the Swiss Television Network**—H. Probst. (*Tech. Mitt. PTT*, vol. 37, pp. 41–44; February 1, 1959.) Technical details are given and the interpretation of the pattern is discussed.

621.397.743 1413

**Frequency Translators for the Television Service**—H. Hesselbach. (*Frequenz*, vol. 13, pp. 21–25; January, 1959.) German and U.S. equipment is described with reference to standardized requirements.

#### TUBES AND THERMIONICS

621.382 1414

**A CdS Analogue Diode and Triode**—W. Ruppel and R. W. Smith. (*RCA Rev.*, vol. 20, pp. 702–714; December, 1959.) A comparison is made between space-charge-limited current flow through a vacuum and through a solid insulator. Diode and triode operation analogous to the corresponding vacuum devices is obtained by applying ohmic and blocking contacts to the insulator. Practical operation of both diode and triode is described, using a CdS single crystal  $10\mu$  thick.

621.382:621.318.57 1415

**A Review of Semiconductor Switching Devices and Associated Design Requirements**—A. W. Matz. (*A.T.E.J.*, vol. 15, pp. 61–82; January, 1959.) 131 references.

621.382.2 1416

**Modulation of Diffusion Length as a New Principle of Operation of Semiconductor Devices**—V. I. Stafeev. (*Fiz. Tverdogo Tela*, vol. 1, pp. 841–847; June, 1959.) In diodes with a large  $d/L$  ratio, where  $d$  is the diode thickness and  $L$  the effective diffusion length, the forward current is highly sensitive to changes in  $L$ . Specially shaped diodes have been prepared which show a) high magnetic-field sensitivity, b) a negative-resistance region in the  $I/V$  characteristic, and c) high photosensitivity (up to 100 amp/lumen). An avalanche mechanism is described accounting for these characteristics and for phenomena occurring in Ge diodes with Au and Fe impurities. An amplifier operating on this basis with a supplementary  $p-n$  junction in the diode wafer is proposed.

621.382.2 1417

**On the Problem of the Volt-Ampere Characteristic of a Diode at Ultra-High Injection Levels**—V. I. Stafeev. (*Fiz. Tverdogo Tela*, vol. 1, pp. 848–850; June, 1959.) Development of an expression derived earlier (*Zh. tekhn. Fiz.*, vol. 28, pp. 1631–1641; August, 1958) giving the total voltage drop across a  $p-n$  junction diode.

621.382.2 1418

**Impact Ionization in an  $n-p$  Junction**—G. V. Gordeev. (*Fiz. Tverdogo Tela*, vol. 1, pp. 851–860; June, 1959.) Investigation of the current multiplication resulting from impact ionization.

The boundaries of the transition region and the potential drop in the  $n$  and  $p$  regions are examined and an expression is derived for the multiplication factor in the case of an abrupt junction.

621.382.2 1419

**Effect of Internal Heating on the Breakdown Characteristics of Silicon  $p-n$  Junctions**—B. Senitzky and P. D. Radin. (*J. Appl. Phys.*, vol. 30, pp. 1945–1950; December, 1959.) Simple avalanche theory explains the onset of the breakdown, but experiment shows that the shape of the  $V/I$  curve in this region is determined mainly by the internal heating.

621.382.2 1420

**Heat-Treatment Centres and Bulk Currents in Silicon  $p-n$  Junctions**—D. J. Sandiford. (*J. Appl. Phys.*, vol. 30, pp. 1981–1986; December, 1959.) Lifetime measurements on alloy  $p-n$  junctions made from heat-treated  $n$ -type Si show that space-charge generation is the important mechanism for diodes with the shortest lifetimes, while surface leakage is predominant for diodes in the  $\mu\text{sec}$  range.

621.382.2 1421

**The Optimum Noise Performance of Tunnel-Diode Amplifiers**—K. K. N. Chang. (*Proc. IRE*, vol. 48, pp. 107–108; January, 1960.) It is shown analytically that for a given  $I/V$  characteristic a minimum value exists for the product of the excess noise factor and a gain factor.

621.382.2/3:621.391.822 1422

**Investigation of the Temperature Variation of Noise in Diode and Transistor Structures**—C. A. Lee and G. Kaminsky. (*J. Appl. Phys.*, vol. 30, pp. 1849–1855; December, 1959.) "Measurements of the white noise of transistors (principally diffused-base structures) and diodes have been made at temperatures ranging from  $\sim 77^\circ\text{K}$  to  $300^\circ\text{K}$  for a range of about two decades in injection level, and from 10 kc/s to 10 Mc/s. Comparisons of the noise measurements with calculated levels are presented. The germanium transistors show a progressively increasing deviation from the theory as the temperature is decreased, and most of the silicon transistors exhibited excess white noise at room temperature and below."

621.382.3:539.12.04 1423

**Selecting Transistors for Radiation Environments**—J. R. Bilinski and R. Merrill. (*Electronics*, vol. 32, pp. 38–40; December 25, 1959.) Minority-carrier lifetime and hence the grounded-emitter current gain are degraded upon irradiation. Equations are derived for this effect and nomographs are drawn for Ge and Si transistors.

621.382.3:621.376.32 1424

**Reactance Transistor**—Fujimura and Mii. (See 1171.)

621.382.3:621.391.822.3 1425

**Shot Noise in Transistors**—A. van der Ziel. (*Proc. IRE*, vol. 48, pp. 114–115; January, 1960.) The modified shot-noise theory for Si transistors is discussed to take account of trapping effects in the emitter space-charge region. See 2413 of 1959 (Schneider and Strutt).

621.382.3-71:621.362 1426

**Transistor Operation Aided by Thermoelectric Refrigeration**—H. J. Goldsmid and R. A. Hiltbourne. (*Brit. Commun. Electronics*, vol. 7, pp. 26–30; January, 1960.) Thermoelectric cooling applied to Ge and Si transistors is considered. The range of temperature over which a Ge HF transistor may be operated can be extended upwards by at least  $50^\circ\text{C}$ .

- 621.382.333** 1427  
**Equivalent Circuit and Amplifier Characteristics of Junction Transistors**—W. Moortgat-Pick. (*Arch. elekt. Übertragung*, vol. 13, pp. 33-48 and 82-89; January and February, 1959.) The equivalent circuit given by Giacometto (1193 of 1955) is modified to enable transistor characteristics to be calculated accurately under small-signal conditions for emitter currents up to about 5 ma and frequencies up to 10 mc.
- 621.382.333** 1428  
**Variation of Input Conductance of a Grounded-Base Junction Transistors**—S. Deb and J. K. Sen. (*Electronic Engrg.*, vol. 31, pp. 753-755; December, 1959.) Methods are suggested for maintaining the variation linear over a wide range of currents. Methods of reducing thermal drift are also considered. Results are given.
- 621.382.333** 1429  
**Transistor Avalanche Voltage**—L. van Biljon. (*Electronic Tech.*, vol. 37, pp. 72-76; February, 1960.) An expression giving the collector avalanche voltage in an alloyed junction transistor as a function of base resistance is developed from simple considerations of transistor currents.
- 621.382.333** 1430  
**Frequency Dependence of the Noise and the Current Amplification Factor of Silicon Transistors**—E. R. Chenette. (*Proc. IRE*, vol. 48, pp. 111-112; January, 1960.) Experimental evidence is presented concerning the discrepancies between theoretical and experimental behavior of Ge transistors at low temperature and of Si transistors.
- 621.382.333.001.4** 1431  
**Life-Testing of Germanium Power Transistors**—B. J. Cooper and R. E. Ireland. (*Brit. Commun. Electronics*, vol. 7, pp. 14-19; January, 1960.) Heat-cycling and full-load tests have been done on a limited number of *p-n-p* junction transistors. Results indicate that unreliable transistors may be detected during an artificial aging process following manufacture.
- 621.383.27** 1432  
**An Image Intensifier with Transmitted Secondary-Electron Multiplication**—W. L. Wilcock, D. L. Emberson, and B. Weekley. (*Nature*, vol. 185, pp. 370-371; February 6, 1960.) An experimental image intensifier is described which produces a total electron multiplication of  $3.5 \times 10^3$  and a ratio of light output to input of  $8 \times 10^4$  when the incident light is of the same mean wavelength as the phosphor emission.
- 621.383.4** 1433  
**Sintered Cadmium Sulphide Photoconductive Cells**—C. P. Hadley and E. Fischer. (*RCA Rev.*, vol. 20, pp. 635-647; December, 1959.) Results of a long development program are given. Topics discussed include fabrication techniques, properties of the host materials, activation impurities, electrodes and packaging.
- 621.383.4:535.215-15** 1434  
**Infrared Photoconductive Detectors using Impurity-Activated Germanium-Silicon Alloys**—G. A. Morton, M. L. Schultz, and W. E. Harty. (*RCA Rev.*, vol. 20, pp. 599-634; December, 1959.)
- 621.383.4:535.371.07** 1435  
**The Role of Space-Charge Currents in Light Amplifiers**—A. Rose and R. H. Bube. (*RCA Rev.*, vol. 20, pp. 648-657; December, 1959.) Basic relations determining the performance of the photoconductive-electroluminescent light amplifier are given, and the importance of space-charge current flow in the photoconductor is emphasized. The performance capabilities of present photoconductors are analyzed.
- 621.383.4:535.371.07** 1436  
**Properties of a Single-Element Light Amplifier using Sintered Cadmium Selenide Photoconductive Material**—F. H. Nicoll. (*RCA Rev.*, vol. 20, pp. 658-669; December, 1959.) Moderate gains with high output luminance are possible with speeds in a range suitable for moving pictures. Operating characteristics are given.
- 621.383.4:535.371.07** 1437  
**Solid-State Image Intensifier under Dynamic Operation**—C. P. Hadley and R. W. Christensen. (*RCA Rev.*, vol. 20, pp. 670-681; December, 1959.) Simple theoretical analysis of dynamic operation is confirmed experimentally. Suggestions for improving performance are made.
- 621.383.4:535.371.07** 1438  
**Optical-Feedback-Type Storage Light Intensifiers**—H. O. Hook. (*RCA Rev.*, vol. 20, pp. 744-752; December, 1959.) Three designs of storage intensifier were tested. Constructional details are given and performances compared.
- 621.385.032.212:537.533** 1439  
**New Cold Cathode using Magnesium Oxide**—T. Imai, Y. Mizushima, and Y. Igarashi. (*J. Phys. Soc. Japan*, vol. 14, pp. 979-980; July, 1959.) Report of an effect observed using light pulses to initiate cathode emission. For a constant flash-time the integrated exposure time of the cathode before emission commenced was found to be independent of the time between flashes.
- 621.385.032.213.13** 1440  
**Doping Influences on Activator Diffusion Oxide-Coated Cathode Nickel**—H. Mizuno. (*J. Phys. Soc. Japan*, vol. 14, pp. 1295-1301; October, 1959.) Doping by Mn, Fe or Si decreases the diffusion coefficient of Mg, and doping by Mg increases the diffusion coefficient of Mn.
- 621.385.032.531** 1441  
**Determination of Lead-Wire Inductances in Miniature Tubes**—W. A. Harris and R. N. Peterson. (*RCA Rev.*, vol. 20, pp. 485-598; September, 1959.) Measurements of internal inductances and resonance frequencies in miniature valves operating in the UHF band are described.
- 621.385.3** 1442  
**Influence of Grid Current on the Oscillations of a Triode**—L. Sideriades and J. Bitoun. (*Onde élect.*, vol. 39, pp. 810-815; October, 1959.) The effect of grid current may be represented by simple resistance and capacitance elements in conjunction with the grid circuit inductance.
- 621.385.3** 1443  
**The Behaviour of Triodes in the Transit-Time Region under Large-Signal Conditions**—G. Heinzmann. (*Arch. elekt. Übertragung*, vol. 13, pp. 13-20; January, 1959.) The effect of increasing drive on input impedance, gain and efficiency is investigated theoretically, and the results are compared with those obtained from measurements by other authors.
- 621.385.3:621.317.723** 1444  
**Logarithmic Characteristic of Triode Electrometer Circuits**—S. K. Chao. (*Rev. Sci. Instr.*, vol. 30, pp. 1087-1092; December, 1959.) An electrometer tube Type CK5889 can be used as a logarithmic circuit element in the grid current range  $10^{-14}$ — $10^{-6}$  ampere. Its application in an ionization-chamber survey instrument is described.
- 621.385.6:621.391.822** 1445  
**Noise in Electron Beams and in Four-Terminal Networks**—M. T. Vlaardingerbroek. (*Philips Res. Rep.*, vol. 14, pp. 327-336; August, 1959.) Calculation of the minimum noise figure of electron-beam amplifiers, obtained by varying the properties of the drift space, is shown to be analogous to the calculation of the minimum noise figure of a quadrupole by varying the signal-source impedance.
- 621.385.6:621.391.822** 1446  
**Noise Propagation on Uniformly Accelerated Multi-velocity Electron Beams**—W. M. Mueller and M. R. Currie. (*J. Appl. Phys.*, vol. 30, pp. 1876-1880; December, 1959.) Low values of beam noisiness can be obtained by reducing the slope of the potential profile. Adjustment of this parameter provides a practical possibility of attaining low noise figures in slow space-charge wave amplifiers as the frequency is increased.
- 621.385.623.5.072.6** 1447  
**Frequency Stabilization of a Reflex-Klystron Oscillator**—F. Bruin and D. Van Lades-teyn. (*Physica*, vol. 25, pp. 1-8; January, 1959.) See 93 of 1954 (Bruin).
- 621.385.624.2** 1448  
**An Experimental Investigation of a Two-Cavity Klystron Operating under Large-Signal Conditions**—I. M. Stephenson. (*Proc. IEE*, Part B, vol. 107, pp. 60-66; January, 1960.) Measurements on a klystron with a variable drift space confirm the space-charge effects predicted by recent theory, both for small and large signals. The effect of a large signal is to reduce the optimum drift length. The change-over from small- to large-signal conditions is governed by the ratio of signal frequency to plasma frequency, as well as by the modulating RF voltage.
- 621.385.63:621.375.9:621.372.44** 1449  
**Fast-Wave Couplers for Longitudinal-Beam Parametric Amplifiers**—A. Ashkin, W. H. Louisell, and C. F. Quate. (*J. Electronics Control*, vol. 7, pp. 1-32; July, 1959.) Theoretical considerations lead to new methods of treating the problem and two special cases are considered. A design procedure is given for a system consisting of a Kompfner dip helix (3206 of 1950) preceded and followed by a velocity jump.
- 621.385.632** 1450  
**Medium-Power L- and S-Band Electrostatically Focused Travelling-Wave Tubes**—D. J. Blattner, F. E. Vaccaro, C. L. Cuccia, and W. C. Johnson. (*RCA Rev.*, vol. 20, pp. 426-441; September, 1959.) Description of the "Estiatron" which has a bifilar helix as both RF circuit and electrostatic focusing structure and can be used with either a parallel-flow or convergent-flow electron gun of conventional design.
- 621.385.632.3** 1451  
**General Aspects of Beating-Wave Amplification**—W. G. Dow and J. E. Rowe. (*Proc. IRE*, vol. 48, p. 115; January, 1960.) A method is suggested for large amplification under high-power conditions by coupling between electron beams with differing phase velocities.
- 621.385.633.1.029.65** 1452  
**Type-O Carcinotrons Operating at 2 mm Wavelength**—Yeou-Ta. (*Onde élect.*, vol. 39, pp. 789-794; October, 1959.) Results obtained with an experimental valve using permanent-magnet focusing are given. See also 4011 I of 1958 (Laborde et al.).

- 621.385.64** **1453**  
**Tuning and the Equivalent Circuit of Multi-resonator Magnetrons**—T. S. Chen. (*J. Electronics Control*, vol. 7, pp. 33–51; July, 1959.) An equivalent circuit is synthesized from the input-admittance function determined from the properties of the waveguide used to calculate wide-band tuning characteristics, which agree with measurements for waveguide tuning systems with and without iris coupling.
- 621.385.832.032.269.1** **1454**  
**Cathode-Ray-Tube Triode Gun with Beam Former Electrode**—W. F. Niklas. (*Proc. IRE*, vol. 1, pp. 120–121; January, 1960.) A substantial reduction in astigmatic aberrations has been obtained.
- 621.387:621.316.722.078.3** **1455**  
**The Characteristics and Applications of Corona Stabilizer Tubes**—E. Cohen and R. O. Jenkins. (*Electronic Engrg.*, vol. 32, pp. 11–15; January, 1960.) These hydrogen-filled tubes are suitable for voltage stabilization in the range 350–4000 volts. Minimum stabilized current is a few microamperes. Maximum continuous current varies from 400  $\mu$ a, for the low-voltage tubes, to 1 ma for the highest-voltage tubes. At 200  $\mu$ a the noise output varies from 6 mv rms for the smallest tubes to 165 mv for the largest.
- 621.387:621.362** **1456**  
**Characteristics of a Plasma Thermocouple**—R. W. Pidd, G. M. Grover, E. W. Salmi, D. J. Roehling, and G. F. Erickson. (*J. Appl. Phys.*, vol. 30, pp. 1861–1865; December, 1959.) The operation of a caesium thermocouple is described for a range of hot-junction temperatures from 1600° to 2600°K and for caesium pressures from  $10^{-5}$  to 2 mm Hg. The EMF's observed are between 1 and 4.5 volts and the largest short-circuit current density obtained is 62 amp/cm<sup>2</sup>.
- 621.387:621.362** **1457**  
**Space-Charge Neutralization by Fission Fragments in the Direct-Conversion Plasma Diode**—F. E. Jablonski, C. B. Leffert, R. Silver, R. F. Hill, and D. H. Loughridge. (*J. Appl. Phys.*, vol. 30, pp. 2017–2018; December, 1959.)
- 621.38:621.391.822** **1458**  
**Noise in Electron Devices** [Book Review]—L. D. Smullin and H. A. Haus (Eds.). Mass. Inst. Tech. Press, Cambridge, Mass.; John Wiley and Sons, Inc., New York, N. Y. and Chapman and Hall, London, Eng. 413 pp.; 1959. (*Proc. Phys. Soc.*, vol. 74, p. 800; December 1, 1959.)
- MISCELLANEOUS**
- 621.3.39+681.142** **1459**  
**Radio Electronics**—A. M. Kugushev. (*Uspekhi Fiz. Nauk.*, vol. 67, pp. 663–703; April, 1959.) Survey of progress since the early work of Popov (1859–1906) reviewing developments in radio communication, television, radar, radio astronomy, solid-state devices, particle accelerators and computers. 130 references.
- 621.37/.38** **1460**  
**Latest Trends in Electron Devices**—M. F. Wolff. (*Electronics*, vol. 32, pp. 31–33; December 25, 1959.) The developments outlined include improved storage and display devices, logic elements in the form of photoconductive-electroluminescent panels, various low-noise and solid-state amplifiers, and a concentric-electrode photomultiplier.
- 621.37/.39:061.3** **1461**  
**The Ninth Plenary Assembly of the C.C.I.R.**—J. W. Herbstreit. (*Proc. IRE*, vol. 48, pp. 45–53; January, 1960.) A summary of the work of the fourteen study groups at the assembly in Los Angeles, Calif. April, 1959.
- 621.39(047.1)** **1462**  
**Communication Engineering and Radiolocation**—(*VDI Z.*, vol. 102, pp. 177–190; February 11, 1960.) Progress report covering recent developments with references mainly to German literature. The following sections are surveyed:  
 a) **Sound Broadcasting and Television**—E. Schwartz (pp. 177–182). 121 references.  
 b) **Telecommunications**—W. Althans (pp. 182–184).  
 c) **Electroacoustics**—H. Harz (pp. 184–186).  
 d) **High-Frequency Measurements**—H. Brunswig (pp. 186–188).  
 e) **Radar and Radio Navigation**—W. Stanner (pp. 188–190).



# Translations of Russian Technical Literature

Listed below is information on Russian technical literature in electronics and allied fields which is available in the U. S. in the English language. Further inquiries should be directed to the sources listed. In addition, general information on translation programs in the U. S. may be obtained from the Office of Science Information Service, National Science Foundation, Washington 25, D. C., and from the Office of Technical Services, U. S. Department of Commerce, Washington 25, D. C.

PUBLICATION	FREQUENCY	DESCRIPTION	SPONSOR	ORDER FROM:
Acoustics Journal (Akusticheskii Zhurnal)	Quarterly	Complete journal	National Science Foundation—AIP	American Institute of Physics 335 E. 45 St., New York 17, N. Y.
Automation and Remote Control (Avtomatika i Telemekhanika)	Monthly	Complete journal	National Science Foundation—MIT	Instrument Society of America 313 Sixth Ave., Pittsburgh 22, Pa.
	Monthly	Abstracts only		Office of Technical Services U. S. Dept. of Commerce Washington 25, D. C.
Journal of Abstracts, Electrical Engineering (Reserativnyy Zhurnal: Elektronika)	Monthly	Abstracts of Russian and non-Russian literature		Office of Technical Services U. S. Dept. of Commerce Washington 25, D. C.
Journal of Experimental and Theoretical Physics (Zhurnal Eksperimentalnoi i Teoreticheskoi Fiziki)	Monthly	Complete journal	National Science Foundation—AIP	American Institute of Physics 335 E. 45 St., New York 17, N. Y.
Journal of Technical Physics (Zhurnal Tekhnicheskoi Fiziki)	Monthly	Complete journal	National Science Foundation—AIP	American Institute of Physics 335 E. 45 St., New York 17, N. Y.
Proceedings of the USSR Academy of Sciences: Applied Physics Section (Doklady Akademii Nauk SSSR: Otdel Prikladnoi Fiziki)	Bimonthly	Complete journal		Consultants Bureau, Inc. 227 W. 17 St., New York 22, N. Y.
Radio Engineering (Radiotekhnika)	Monthly	Complete journal	National Science Foundation—MIT	Pergamon Institute 122 E. 55 St., New York 22, N. Y.
	Monthly	Abstracts only		Office of Technical Services U. S. Dept. of Commerce Washington 25, D. C.
Radio Engineering and Electronics (Radiotekhnika i Elektronika)	Monthly	Complete journal	National Science Foundation—MIT	Pergamon Institute 122 E. 55 St., New York 22, N. Y.
	Monthly	Abstracts only		Office of Technical Services U. S. Dept. of Commerce Washington 25, D. C.
Solid State Physics (Fizika Tverdogo Tela)	Monthly	Complete journal	National Science Foundation—AIP	American Institute of Physics 335 E. 45 St., New York 17, N. Y.
Telecommunications (Elekprosvyaz')	Monthly	Complete journal	National Science Foundation—MIT	Pergamon Institute 122 E. 55 St., New York 22, N. Y.
	Monthly	Abstracts only		Office of Technical Services U. S. Dept. of Commerce Washington 25, D. C.
Automation Express	10/year	A digest: abstracts, summaries, annotations of various journals		International Physical Index, Inc. 1909 Park Ave., New York 35, N. Y.
Electronics Express	10/year	A digest: abstracts, summaries, annotations of various journals		International Physical Index, Inc. 1909 Park Ave., New York 35, N. Y.
Physics Express	10/year	A digest: abstracts, summaries, annotations of various journals		International Physical Index, Inc. 1909 Park Ave., New York 35, N. Y.
Express Contents of Soviet Journals Currently being Translated into English	Monthly	Advance tables of contents of translated journals		Consultants Bureau, Inc. 227 W. 17 St., New York 22, N. Y.
Technical Translations	Twice a month	Central directory in the U. S. of translations available from all major sources in the U. S.	OTS and Special Libraries Assoc.	Superintendent of Documents U. S. Gov't Printing Office Washington 25, D. C.

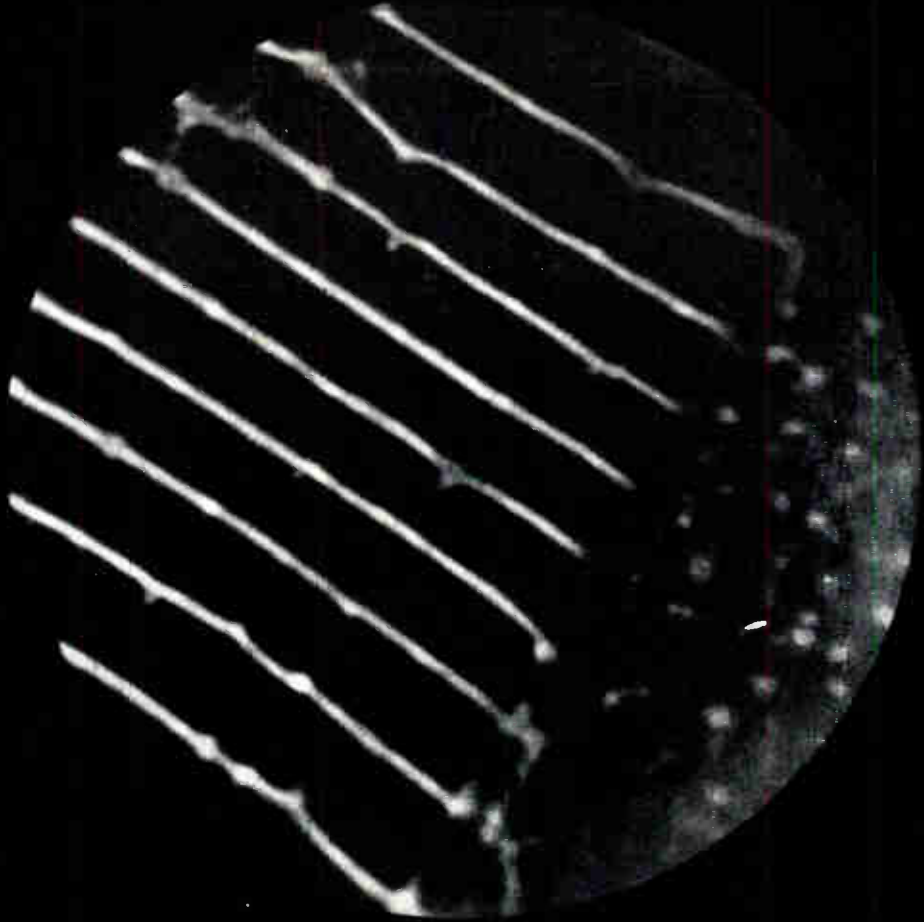

*Bit densities are revealed by the electron mirror microscope through the behavior of electrons reflected by the magnetic fringe fields of recorded data.*

## Reflections from an Electron Mirror

The photograph is a representation of the magnetic fringe fields above a small portion of a recording surface. Behind these magnified tracks of recorded data is the story of a device now decades old in principle, but which has only recently been applied to the study of high-density magnetic information storage.

The electron mirror microscope was constructed by IBM scientists as a laboratory instrument. Based on the excellent resolution capabilities of an electron beam, the electron mirror principle has its primary application in the observation of tiny magnetic fringe fields.

In the operation of an electron mirror microscope, an electron beam is acceler-

ated down a tube toward a specimen mounted on a conductive plate with a negative potential relative to the cathode. At the zero equipotential surface in the tube, the electrons traveling toward the specimen change their directions and are reflected in somewhat the same way light rays are reflected by a mirror. By controlling the potentials of the cathode and the conductive plate, the "mirror" can be placed at any height above the magnetic surface. When the mirror is set close enough to the surface to be in the fringe fields of recorded information, these fields distort the return paths of electrons in the beam. Passing the return beam through a magnetic lens results in a magnified repre-

sentation on a phosphor viewing plate, capable of resolving bit densities far greater than those in use in present systems.

It is well known that the "writing" abilities of present magnetic recording transducers exceed their "reading" abilities. The mirror microscope produces accurate evidence of all-bit-undetectable recorded information. Thus the magnetic recording process is no longer limited to verification by velocity-dependent readback capabilities. By the same token, the mirror microscope serves both as the spur to, and the measure of progress toward further refinements in the art of magnetic recording.

**IBM. RESEARCH**

*Investigate the many career opportunities available in exciting new fields at IBM.  
International Business Machines Corporation, Dept. 645Q, 590 Madison Avenue, New York 22, New York.*

for  
noise  
levels of  
less than  
2 db

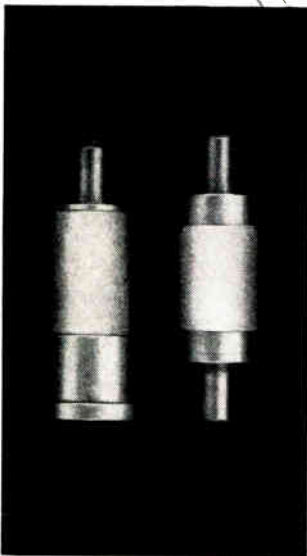
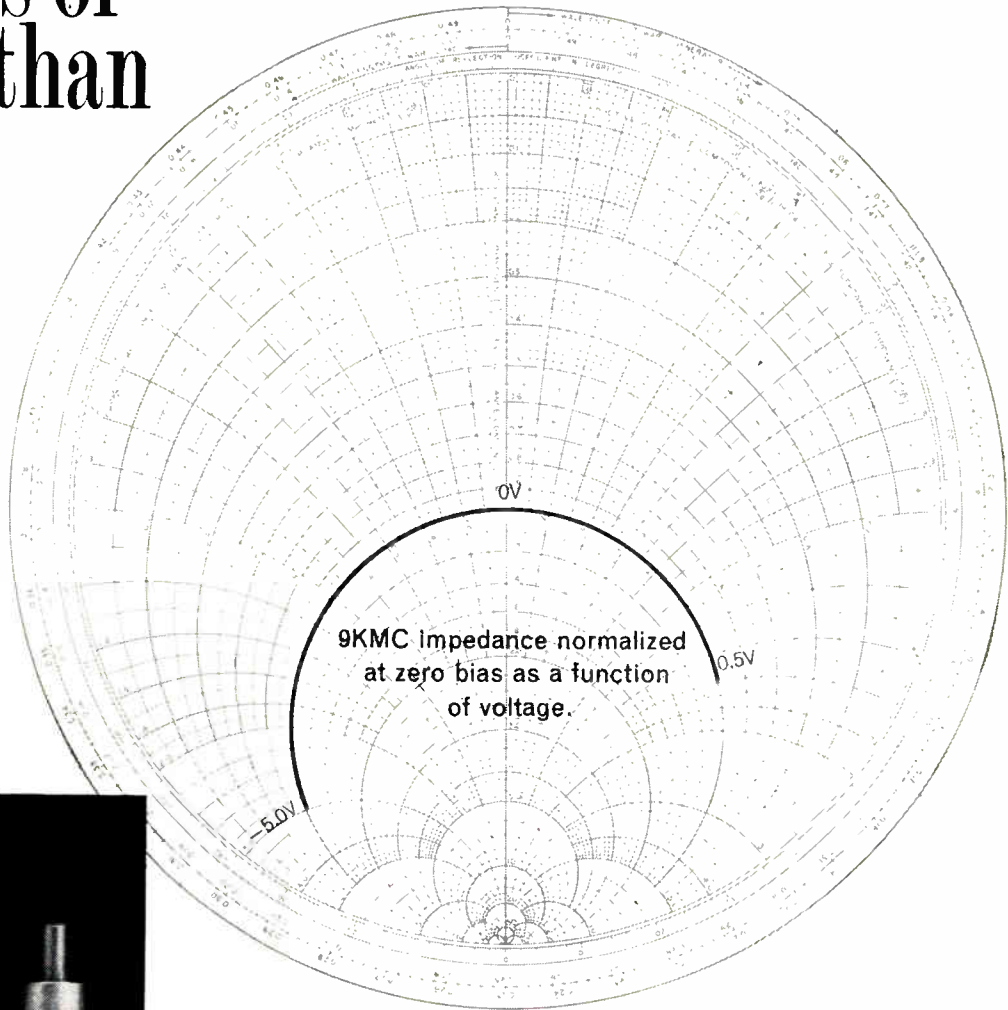

**Characteristics:**

Cut-off Frequency @ 9KMC at zero bias ..	30-70KMC
Capacity at zero bias .....	0.8 to 1.5 $\mu$ f
Working Voltage @ 10 $\mu$ A .....	3.5 to 5.5
Lead Inductance @ 2KMC .....	3.5m $\mu$ h

## Hughes S and X Band Parametric Amplifier Diodes

Hughes has designed parametric amplifier diodes that can give you noise levels of less than 2 db at X band using double sideband operation. In addition to low noise, these HUGHES<sup>®</sup> diodes also offer a number of other advantages. First, their high cutoff frequency means that you can obtain higher amplification and higher harmonic generation. Their ceramic package reduces stray capacitance and makes for more dependable performance levels.

With these characteristics, Hughes S and X Band Parametric Amplifier Diodes are ideally suited to the following applications: radar preamplifiers, frequency converters, phase shifters and harmonic and subharmonic generators.

For additional information, please write: Hughes, Semiconductor Division, Marketing Dept., Newport Beach, California. *For export write: Hughes International, Culver City 5, California.*

Creating a new world with ELECTRONICS

**HUGHES**

HUGHES AIRCRAFT COMPANY  
SEMICONDUCTOR DIVISION



# new, high-speed micro- microammeter



The new Keithley Model 415 micro-microammeter offers high speed of response, accuracy, and zero suppression.

A speed of response of less than 600 milliseconds to 90% of final value at  $10^{-12}$  ampere is possible where external circuit capacity is  $50\mu\text{f}$ . Accuracy is  $\pm 2\%$  of full scale on  $10^{-3}$  through  $10^{-8}$  ranges and  $\pm 3\%$  on ranges below. Zero suppression permits full scale display of one per cent variations of a signal.

The 415 is ideal for use with ion chambers, ionization gages, gas chromatography, mass spectrometry.

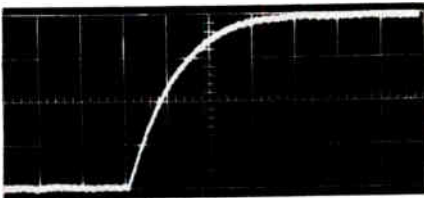

Response to a current step of  $10^{-12}$  amp. Input capacity is  $35\mu\text{f}$ . One major horizontal division equals 200 milliseconds.

## SPECIFICATIONS

**Ranges:**  $10^{-12}$ ,  $3 \times 10^{-12}$ ,  $10^{-11}$ ,  $3 \times 10^{-11}$ , etc. to  $10^{-3}$  ampere f.s.

**Accuracy:**  $\pm 2\%$  f.s.  $10^{-3}$  thru  $10^{-8}$  amp;  $\pm 3\%$  f.s.  $3 \times 10^{-9}$  thru  $10^{-12}$  amp.

**Zero Drift:** Below 2% of f.s. per day.

**Input:** Grid current below  $5 \times 10^{-14}$  amp.

**Output:** 1 v f.s. up to 5 ma. Noise less than 20 mv.

**Rise Time:** On  $10^{-12}$  amp range — at 50, 150, 1500  $\mu\text{f}$   $C_{in}$  — rise time is .6, .8, 2.5 sec. respectively to 90% of final values; decreasing to .001 sec. on all ranges at  $3 \times 10^{-9}$  amp and above for stated input capacitances.

**Price:** Model 415 . . . . . \$750.00

For full details, write:



**KEITHLEY  
INSTRUMENTS**

**12415 EUCLID AVENUE  
CLEVELAND 6, OHIO**

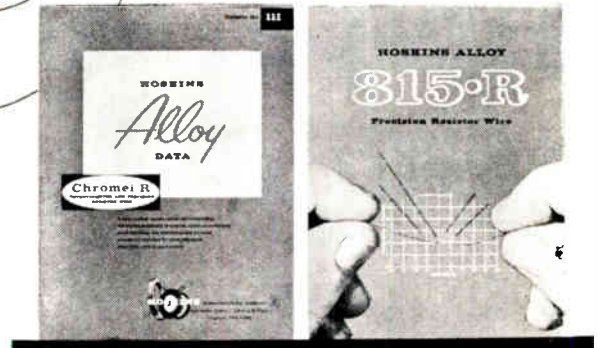

Here's an **EYEFUL** of technical data on precision resistor and potentiometer wire

Two new catalog-manuals containing complete information on

## TWO NEW HOSKINS 800 OHM ALLOYS

If you make potentiometers or precision wire wound resistors, these manuals are meant for you. They're loaded with helpful technical information—show all physical properties and electrical characteristics, list bare and enameled wire specifications. And they contain much useful application data compiled especially to help you produce more and better control components with these two new performance-proved alloys:

**Chrome-R:** A modified 80-20 type nickel-chromium alloy possessing electrical resistivity of 800 ohms per cmf at  $20^\circ\text{C}$ ., low temperature coefficient controlled within  $0 \pm 10$  ppm per  $^\circ\text{C}$ .—plus exceptional linearity and stability from  $-65^\circ$  to  $+150^\circ\text{C}$ .

**Alloy 815-R:** A lower density, higher resistivity fe-cr-al material that gives you 14% more ohms per pound. Has good strength and ductibility, excellent resistance to wear and corrosion. Resistivity is 815 ohms per cmf at  $20^\circ\text{C}$ ., temperature coefficient  $0 \pm 10$  ppm per  $^\circ\text{C}$ . in the range from  $-65^\circ$  to  $+150^\circ\text{C}$ .

Send for copies today—plus samples of both alloys!

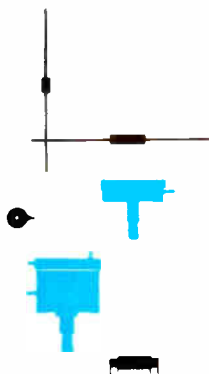

## HOSKINS MANUFACTURING COMPANY

4453 Lawton Avenue • Detroit 8, Michigan

In Canada: Hoskins Alloys of Canada, Ltd., 45 Racine Rd., Rexdale P.O., Toronto, Ontario

*Producers of Custom Quality Resistance, Resistor and Thermo-Electric Alloys since 1908*



TW-956H—1/2 ACTUAL SIZE

# Now...solve TWT space and temperature problems

## Magnetically shielded, temperature compensated TWTs

Sylvania research offers you two new S-band traveling-wave tubes of the permanent magnet focused type—TW-4002F and TW-956H— which give you these unique advantages:

**Magnetically shielded** — not affected by proximity to magnets and magnetic materials such as other TWTs, solenoids, and hardware. This permits close packing without hazard of performance loss.

**Temperature compensated** — they operate from  $-65^{\circ}\text{C}$  to  $+72^{\circ}\text{C}$  with minimum degradation of performance, and without requiring heater blankets.

**Periodic PM focusing** — they do not require weighty, space-and-power consuming solenoids.

**Broad band** — they have a relatively flat frequency response over an octave, from 2.0 to 4.0 KMC.

**Electrically superior characteristics** — at room temperature they have the following specifications:

**TW-4002F**—small signal gain is 37 db minimum; CW rf power output (saturation) is 10 milliwatts minimum

**TW-956H**—gain with 0.1 milliwatt input is minimum 37 db; CW rf power output (saturation) is 2 to 5 watts

**COMPACTNESS** — they are about 15" long, have 1.4" capsule diameter, weigh 3 pounds

**RUGGEDNESS** — specially designed for airborne and missile applications

Sylvania Electric Products Inc.— Special Tube Operations  
500 Evelyn Ave., Mountain View, Calif.

# SYLVANIA

Subsidiary of **GENERAL TELEPHONE & ELECTRONICS**





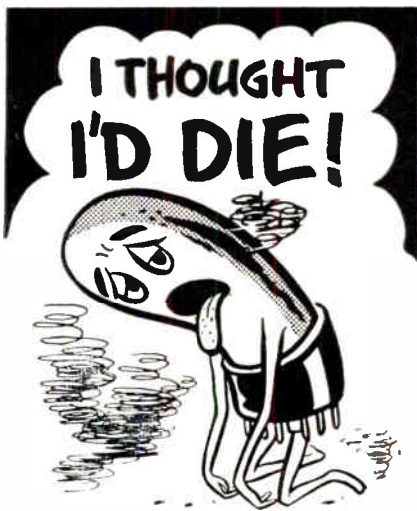

The life of any electronic component is a hard one, and added to the work, the heat was just too much! I was down for the count when a McLean blower saved my life. Now my work is a breeze!

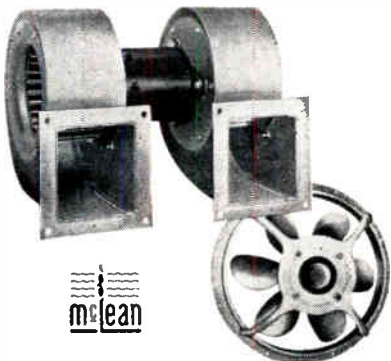

**McLEAN RING FANS & BLOWERS**  
Sturdy units for a variety of uses.

Extend the life of sensitive tubes, transistors and other components with McLean packaged cooling units. Prevent system failure . . . maintain calibration and accuracy. Find out how in McLean's 1960 catalog . . . 44 pages of helpful information on cooling electronic equipment. McLean's rack-mounted fans and blowers are smart, compact, easy-to-install and have a multitude of mounting possibilities. Over 100 models in various panel heights and CFM's. Mil. Spec. equipment for packaged cooling also available.

**WRITE TODAY!**  
44 Page Packaged  
Cooling Catalog



**McLEAN ENGINEERING LABORATORIES**  
World Leader in Packaged Cooling  
Princeton, N. J. • WALnut 4-4440  
TWX Princeton, New Jersey 636



Recent advances in equipment and techniques with measurements of 1 PPM resolution enable us to supply resistance networks of unusual accuracies and characteristics as required for computers, summing networks, voltage dividers, etc.

We are currently producing in quantity for major defense contractors to various specifications of phase angle, D.C. and A.C. ratios with controlled frequency characteristics.

Hermetic sealing or full encapsulation enable networks to meet applicable portions of MIL-R-93B and MIL-STD-202A.

Our Engineering Department will gladly advise the limits of accuracies and physical sizes that may be attained for your specifications.

**RESISTANCE PRODUCTS COMPANY**  
914 South 13th Street, Harrisburg, Pa.

For the latest advances in data illumination, read:

“PILOT  
**LIGHTS**  
that Enlighten”  
by **DIALCO**



The only Brochure devoted especially to visual indication by means of read-out lights, data display, placard lights, word and number discs, lenses-with-legends, etc. Applications: data processing, computers, automation, motor-controlled devices, automatic merchandising . . . Comprehensive, colorful. For a free copy, mail coupon now.

DIALIGHT CORP. 117-51-500  
60 Stewart Ave., Brooklyn 37, N.Y.  
Please send \_\_\_\_\_ copies of "Lights that Enlighten".

Name \_\_\_\_\_  
Position \_\_\_\_\_ Dept. \_\_\_\_\_  
Company \_\_\_\_\_  
Address \_\_\_\_\_  
City \_\_\_\_\_ Zone \_\_\_\_\_ State \_\_\_\_\_

Foremost Manufacturer of Pilot Lights  
**DIALIGHT CORPORATION**  
60 STEWART AVE., BROOKLYN 37, N.Y.  
HYACINTH 7-7600



# EFFICIENT AIR MOVING SYSTEMS ARE 'TAILOR MADE'

There's a highly advanced technology to the business of moving air efficiently, quietly, to precise requirements. It takes, for instance, upward of a million-dollar investment in laboratory, testing, sound-room, designing and experimental capabilities to tailor the **right** solution of the problem to the **total** systems requirement. That's the kind of capability Torrington has. And that's why Torrington is the world's finest in the specialized "science"\* of creating air moving systems for the full range of industrial and engineering applications. Cooling thought for the day: Keep the name in mind.



SPECIALTY BLOWER DIVISION

## THE TORRINGTON MANUFACTURING COMPANY

SPECIALTY BLOWER DIVISION Torrington, Connecticut

World Radio History

\* Knowledge obtained by study and practice—Webster

**Industrial Engineering Notes**  
DECEMBER 1961      NO. 1      1961      11      1961

(Continued from page 92A)

products: radio and TV transmitters; radio and TV receivers (including home-type, military and industrial); electronic search, detection, surveillance, and tracking devices; electronic navigational devices; electronic airborne computing and associated airborne information processing devices; electronic missile guidance and missile control devices; electronic weapons fire control devices; electronic sound distribution devices (including public address and music distribution apparatus, except records); electronic countermeasure devices; complete audio IF and RF amplification devices; amplification devices; and electronic power supplies for use in any of the foregoing classes of products.

Specifically excluded from this definition are: electron tubes and parts; solid-state semi-conductor devices and parts; functional electronic component parts (including but not limited to resistors, capacitors, relays, and connectors); complex components, packaged components, modules, and other similar components combinations or sub-assemblies manufactured as a single unit; structural electronic components (including but not limited to cabinets, blank panels, binding posts, wire and cable harnesses and assemblies, tube sockets, dial assemblies, and knobs and control handles); structural components

(Continued on page 112A)

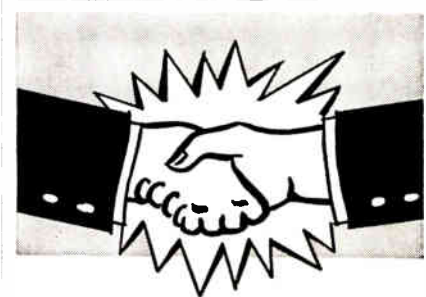

**35 YEARS of PROVEN DEPENDABILITY**



**ELECTROLYTIC  
AND  
PAPER TUBULAR  
CONDENSERS**

**COSMIC CONDENSER CO.**  
 853 WHITTIER STREET, BRONX, N. Y.  
 LUdlow 9-3360

To simplify your design problems —



1. Standard Seals

2. Special Seals

**E-I**  
**GLASS-TO-METAL**  
**SEALS**

— new expanded 3-way service !



3. Custom Sealing

**COMPLETE ENGINEERING AND SAMPLE SERVICE PLUS  
 A NATIONWIDE NETWORK OF FIELD ENGINEERS—**

E-I glass-to-metal seals are the industry standard for dependability . . . have been service-proven on vital space age projects and in critical commercial equipment. If you have a seal problem ask E-I for a recommendation. Sales engineers are located in all principal cities.

**1. STANDARD SEALS**  
 —The most complete range of economical standard seals affords widest design latitude. Includes single lead terminals, headers, miniature closures and threaded end seals.

**2. SPECIAL SEALS—**  
 For unusual requirements, E-I engineers will design seals to specifications or modify standard types for your particular application. Complete engineering facilities available.

**3. CUSTOM SEALING**  
 — Complete facilities for sealing components or assemblies of your own manufacture. Send samples or drawings for quotations. Fast service on reasonable quantities.

Patented in Canada, No. 523,390;  
 in United Kingdom, No. 734,583;  
 licensed in U. S. under No. 2561520



**ELECTRICAL INDUSTRIES**

A Division of Philips Electronics & Pharmaceutical Industries Corp. MURRAY HILL, NEW JERSEY

# 28 Fields of Special Interest-

The 28 Professional Groups are listed below, together with a brief definition of each, the name of

<p><b>Aeronautical and Navigational Electronics</b></p> <p>Annual fee: \$2.</p> <p><i>The application of electronics to operation and traffic control of aircraft and to navigation of all craft.</i></p> <p>Mr. Lewis M. Sherer, Chairman, RTCA, Washington, D.C.</p> <p>34 Transactions, *5, *6, &amp; *9, and *Vol. ANE-1, Nos. 2 and 3; Vol. 2, No. 1-3; Vol. 3, No. 2; Vol. 4, No. 1, 2, 3; Vol. 5, No. 2, 3, 4; Vol. 6, No. 1, 3, 4.</p>	<p><b>Antennas and Propagation</b></p> <p>Annual fee: \$4.</p> <p><i>Technical advances in antennas and wave propagation theory and the utilization of techniques or products of this field.</i></p> <p>Mr. Arthur Dorne, Chairman, Dorne &amp; Margolin, Westbury, L.I., N.Y.</p> <p>27 Transactions, *Vol. AP-2, No. 2; AP-4, No. 4; AP-5, No. 1-4; AP-6, No. 1, 2, 3, 4; AP-7, No. 1, 2, 3, 4.</p>	<p><b>Audio</b></p> <p>Annual fee: \$2.</p> <p><i>Technology of communication at audio frequencies and of the audio portion of radio frequency systems, including acoustic terminations, recording and reproduction</i></p> <p>Mr. H-S. Knowles, Chairman, Knowles Electronics, 9400 Belmont Ave., Franklin Park, Ill.</p> <p>50 Transactions, *Vol. AU-1, No. 6; *Vol. AU-2, No. 1, 4; Vol. AU-3, No. 1, 3, 5; Vol. AU-4, No. 1, 5-6; Vol. AU-5, No. 1, 2, 3, 4, 5, 6; AU-6, No. 1, 2, 3, 4, 5, 6; AU-7, No. 1, 2, 3, 4, 5, 6.</p>
<p><b>Automatic Control</b></p> <p>Annual fee: \$2.</p> <p><i>The theory and application of automatic control techniques including feedback control systems.</i></p> <p>Mr. John E. Ward, Chairman, Servomechanisms Lab., MIT, Cambridge 39, Mass.</p> <p>8 Transactions, PGAC-3-4-5-6, AC-4, No. 1; AC-5, No. 1.</p>	<p><b>Broadcast &amp; Television Receivers</b></p> <p>Annual fee: \$2.</p> <p><i>The design and manufacture of broadcast and television receivers and components and activities related thereto.</i></p> <p>Mr. Robert R. Thalner, Chairman, Sylvania Home Electronics, Batavia, N.Y.</p> <p>24 Transactions, 7, 8; BTR-1, No. 1-4; BTR-2, No. 1-2-3; BTR-3, No. 1-2; BTR-4, No. 2, 3-4; BTR 5, No. 1, 2, 3.</p>	<p><b>Broadcasting</b></p> <p>Annual fee: \$2.</p> <p><i>Broadcast transmission systems engineering, including the design and utilization of broadcast equipment</i></p> <p>Mr. George E. Hagerty, chairman, Westinghouse, 122 E. 42nd St., New York 17, N.Y.</p> <p>15 Transactions, No. 2, 4, 6, 7, 8, 9, 10, 11, 12, 13, 14; BC-6, No. 1.</p>
<p><b>Circuit Theory</b></p> <p>Annual fee: \$3.</p> <p><i>Design and theory of operation of circuits for use in radio and electronic equipment.</i></p> <p>Mr. Sidney Darlington, Chairman, Bell Tel. Labs., Murray Hill, N.J.</p> <p>26 Transactions, CT-2, No. 4; CT-3, No. 2; CT-4, No. 3-4; CT-5, No. 1, 2, 3, 4; CT-6, No. 1, 2, 3; CT-7, No. 1.</p>	<p><b>Communications Systems</b></p> <p>Annual fee: \$2.</p> <p><i>Radio and wire telephone, telegraph and facsimile in marine, aeronautical, radio-relay, coaxial cable and fixed station services.</i></p> <p>Mr. J. E. Schlaifjker, Chairman, IT&amp;T, 67 Broad St., New York 4, N.Y.</p> <p>16 Transactions, CS-2, No. 1; CS-5, No. 2, 3; CS-6, No. 1, 2; CS-7, No. 1, 2, 3, 4.</p>	<p><b>Component Parts</b></p> <p>Annual fee: \$3.</p> <p><i>The characteristics, limitation, applications, development, performance and reliability of component parts</i></p> <p>Mr. J. J. Drvostep, Chairman, Sperry Gyroscope Co., Great Neck, N.Y.</p> <p>18 Transactions, Vol. CP-3, No. 2; CP-4, No. 1, 2, 3-4; CP-5, No. 1, 2, 3, 4; CP-6, No. 1, 2, 3, 4.</p>
<p><b>Education</b></p> <p>Annual fee: \$3.</p> <p><i>To foster improved relations between the electronic and affiliated industries and schools, colleges, and universities.</i></p> <p>Dr. John G. Truxal, Chairman, Dept. of EE, PIB, Brooklyn, N.Y.</p> <p>9 Transactions, Vol. E-1, No. 3, 4; E-2, No. 1, 2, 3, 4; E-3, No. 1.</p>	<p><b>Electron Devices</b></p> <p>Annual fee: \$3.</p> <p><i>Electron devices, including particularly electron tubes and solid state devices.</i></p> <p>Dr. W. M. Webster, Chairman, RCA Labs., Princeton, N.J.</p> <p>27 Transactions, *Vol. ED-1, No. 3-4; ED-3, No. 2-4; ED-4, No. 3-5, 4; ED-5, No. 2, 3, 4; ED-6, No. 1, 3; ED-7, No. 1.</p>	<p><b>Electronic Computers</b></p> <p>Annual fee: \$4.</p> <p><i>Design and operation of electronic computers.</i></p> <p>Dr. A. A. Cohen, Chairman, Remington-Rand Univac, St. Paul 16, Minn.</p> <p>31 Transactions, EC-6, No. 2, 3; EC-7, No. 1, 2, 3, 4; EC-8, No. 1, 2, 3.</p>
<p><b>Engineering Management</b></p> <p>Annual fee: \$3.</p> <p><i>Engineering management and administration as applied to technical, industrial and educational activities in the field of electronics.</i></p> <p>Dr. Henry M. O'Bryan, Sylvania Elec. Products, 730 3rd Ave., New York 17, N.Y.</p> <p>17 Transactions, EM-3, No. 2, 3; EM-4, No. 1, 3, 4; EM-5, No. 1-4; EM-6, No. 1, 2, 3; EM-7, No. 1.</p>	<p><b>Engineering Writing and Speech</b></p> <p>Annual fee: \$2.</p> <p><i>The promotion, study, development, and improvement of the techniques of preparation, organization, processing, editing, and delivery of any form of information in the electronic-engineering and related fields by and to individuals and groups by means of direct or derived methods of communication.</i></p> <p>Mr. T. T. Patterson, Jr., Chairman, RCA Bldg. 13-2, Camden, N.J.</p> <p>5 Transactions, Vol. EWS-1, No. 2; EWS-2, No. 1, 2, 3.</p>	<p><b>Human Factors in Electronics</b></p> <p>Annual fee: \$2.</p> <p><i>Development and application of human factors and knowledge germane to the design of electronic equipment.</i></p> <p>Mr. Curtis M. Jansky, Chairman, Royal McBee Corp., Port Chester, N.Y.</p> <p>1 Transaction, HFE-1, No. 1.</p>

# THE INSTITUTE OF RADIO



# -IRE's 28 Professional Groups

the group chairman, and publications to date.

\* Indicates publications still available

<p><b>Industrial Electronics</b></p> <p>Annual fee: \$3.</p> <p><i>Electronics pertaining to control, treatment and measurement, specifically, in industrial processes.</i></p> <p>Mr. J. E. Eiselein, Chairman, RCA Victor Dev., Camden, N.J.</p> <p>11 Transactions, *PGIE 1, 3, 5, 6, 7, 8, 9, 10, 11.</p>	<p><b>Information Theory</b></p> <p>Annual fee: \$3.</p> <p><i>Information theory and its application in radio circuitry and systems.</i></p> <p>Dr. Peter Elias, Chairman, MIT, Cambridge 39, Mass.</p> <p>10 Transactions, *PGIT-4, IT 1, No. 2, 3; IT-2, No. 3; IT-3, No. 1, 2, 3, 4; IT-4, No. 1, 2, 3, 4; IT-5, No. 1, 2, 3, 4.</p>	<p><b>Instrumentation</b></p> <p>Annual fee: \$2.</p> <p><i>Measurements and instrumentation utilizing electronic techniques.</i></p> <p>Mr. C. W. Little, Jr., Chairman, C-Stellerator Assoc., Princeton, N.J.</p> <p>16 Transactions, 4; Vol. 1-6, No. 2, 3, 4; Vol. 1-7, No. 1, 2; Vol. 1-8, No. 1, 2, 3.</p>
<p><b>Bio-Medical Electronics</b></p> <p>Annual fee: \$3.</p> <p><i>The use of electronic theory and techniques in problems of medicine and biology.</i></p> <p>Mr. W. E. Tolles, Chairman, Airborne Instruments Lab., Mineola, N.Y.</p> <p>16 Transactions, 8, 9, 11, 12; ME-6, No. 1, 2, 3; ME-7, No. 1.</p>	<p><b>Microwave Theory and Techniques</b></p> <p>Annual fee: \$3.</p> <p><i>Microwave theory, microwave circuitry and techniques, microwave measurements and the generation and amplification of microwaves.</i></p> <p>Dr. A. A. Oliner, Microwave Research Institute, 55 Johnson St., Brooklyn 1, N.Y.</p> <p>28 Transactions, MTT-4, No. 3-4; MTT-5, No. 3, 4; MTT-6, No. 1, 2, 3, 4; MTT-7, No. 2, 3, 4; MTT-8, No. 1.</p>	<p><b>Military Electronics</b></p> <p>Annual fee: \$2.</p> <p><i>The electronics sciences, systems, activities and services germane to the requirements of the military. Aids other Professional Groups in liaison with the military.</i></p> <p>Mr. Henry Randall, Chairman, Office of Asst. Secy. Defense, Pentagon, Washington, D.C.</p> <p>8 Transactions, MIL-1, No. 1; MIL-2, No. 1; MIL-3, No. 2, 3, 4; MIL-4, No. 1.</p>
<p><b>Nuclear Science</b></p> <p>Annual fee: \$3.</p> <p><i>Application of electronic techniques and devices to the nuclear field.</i></p> <p>Dr. A. B. Van Rennes, Chairman, United Research, Inc., Cambridge, Mass.</p> <p>15 Transactions, NS-1, No. 1; NS-3, No. 2, 3; NS-4, No. 2; NS-5, No. 1, 2, 3; NS-6, No. 1, 2, 3, 4.</p>	<p><b>Production Techniques</b></p> <p>Annual fee: \$2.</p> <p><i>New advances and materials applications for the improvement of production techniques, including automation techniques.</i></p> <p>Mr. L. M. Ewing, Chairman, General Electric Co., Syracuse, N.Y.</p> <p>6 Transactions, No. 2-3, 4, 5, 6.</p>	<p><b>Radio Frequency Techniques</b></p> <p>Annual fee: \$2.</p> <p><i>Origin, effect, control and measurement of radio frequency interference.</i></p> <p>Mr. J. P. McNaul, Chairman, Signal Corps, USA's RDL, Ft. Monmouth, N.J.</p> <p>1 Transaction, RF-1, No. 1.</p>
<p><b>Reliability and Quality Control</b></p> <p>Annual fee: \$3.</p> <p><i>Techniques of determining and controlling the quality of electronic parts and equipment during their manufacture.</i></p> <p>Mr. P. K. McElroy, Chairman General Radio Co., West Concord, Mass.</p> <p>16 Transactions, *3, 5-6, 10, 11, 12, 13, 14, 15, 16.</p>	<p><b>Space Electronics and Telemetry</b></p> <p>Annual fee: \$2.</p> <p><i>The control of devices and the measurement and recording of data from a remote point by radio.</i></p> <p>Mr. C. H. Hoepfner, Chairman, Radiation, Inc., Melbourne, Fla.</p> <p>14 Transactions, TRC-1, No. 2-3; TRC-2, No. 1; TRC-3, No. 2, 3; TRC-4, No. 1; SET-5, No. 1, 2, 3, 4.</p>	<p><b>Ultrasonics Engineering</b></p> <p>Annual fee: \$2.</p> <p><i>Ultrasonic measurements and communications, including underwater sound, ultrasonic delay lines, and various chemical and industrial ultrasonic devices.</i></p> <p>Dr. Wilfred Roth, Chairman, Roth Lab., Hartford, Conn.</p> <p>8 Transactions, PGUE, 5, 6, 7; UE-7, No. 1.</p>
<p><b>Vehicular Communications</b></p> <p>Annual fee: \$2.</p> <p><i>Communications problems in the field of land and mobile radio services, such as public safety, public utilities, railroads, commercial and transportation, etc.</i></p> <p>Mr. A. A. MacDonald, Chairman, Motorola, Inc., 4545 W. Augusta Blvd., Chicago 51, Ill.</p> <p>13 Transactions, 5, 8, 9, 10, 11, 12, 13.</p>	<p style="text-align: center;"><b>USE THIS COUPON</b></p> <p>Miss Emily Sirjane <span style="float: right;">PG-3-60</span>          IRE—1 East 79th St., New York 21, N.Y.</p> <p>Please enroll me for these IRE Professional Groups</p> <p>..... \$ .....</p> <p>..... \$ .....</p> <p>Name .....</p> <p>Address .....</p> <p>Place .....</p> <p>Please enclose remittance with this order.</p>	

# ENGINEERS



1 East 79th Street, New York 21, N.Y.



## do you tremble at the sign of a sine?

Does a sine-cosine pot in your pet project mean special prices and annoying delay? No need to pay more . . . no need to wait. Ace has a full line of sine-cosine function pots — in sizes, conformities and driving resistances to meet all your requirements — and delivery is prompt. Our standard line — which meets 95% of your needs — we can ship promptly . . . AND a special one goes off to you with minimum delay! Ace offers, as standards, conformities in a  $\frac{7}{8}$ " or 1-1/16" size that you'd pay for as a special in a 2" size elsewhere! Consider the space, weight and money you save!

Ace's standard sine-cosine line includes sizes from  $\frac{3}{4}$ " to 3", driving resistances from 1K to 1 megohm, in comparable conformities from 0.5%, peak to peak. So if you think you have a special requirement — talk to us! Chances are it's an Ace standard sine-cosine pot!

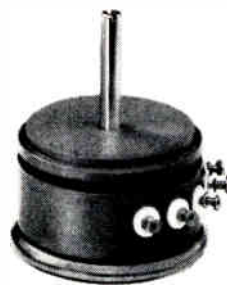

This  $\frac{3}{4}$ " sine-cosine ACEPOT® features conformity of 1.0%, peak to peak, in a resistance range of 1K to 30K. Other driving resistance ranges and conformities available.

**ACE** ELECTRONICS ASSOCIATES, INC.  
99 Dover Street, Somerville 44, Mass.  
SOMERSET 6-5130 TMX SMVL 181 West. Union WUX

Acepot®    Acetrim®    Aceset®    Aceohm®    \*Reg. Appl. for

## Industrial Engineering Notes

(Continued from page 108A)

and devices (including but not limited to antenna structures, pedestals, drives, launchers, trailers, platforms, pallets, elevators, gimbals, and handling equipment); computing and associated information processing devices (except airborne); scientific industrial and laboratory instruments; x-ray tubes and apparatus; electrotherapeutic and electromedical instruments and apparatus; telephone and telegraph equipment (including but not limited to radio telephone and radio telegraph devices of the kind generally manufactured for the use of public utility communications systems); and electronic control devices other than electronic missile guidance and missile control devices (including but not limited to signals, alarms and automatic industrial controls)."



## Section Meetings

### ALAMOGORDO-HOLLOMAN

"Modern or Third Channel Stereo," Paul Klipsch. 2/8/60.

### ALBUQUERQUE-LOS ALAMOS

"Engineering Problems Relative to Tektronix 519 Design and Applications," C. Moulton, Tektronix, Inc. 2/29/60.

### ANCHORAGE

"The Preservation of the History and Artifacts of Early Alaskan Communications," Col. C. A. Thorpe, HQ, Alaskan Command. 1/4/60.

"Polar Blackouts," Dr. G. C. Reid, Geophysical Institute. 2/1/60.

"Technical discussion of Generation of the Television Signal and Video Tape Recording," J. M. Walden, Northern Television, Inc. 3/7/60.

### BAY OF QUINTE

"Surface Wave Transmission Lines," A. P. Treu, Northern Electric Co., Ltd. 2/17/60.

### BENELUX

"Solar Radio Noise and Its Relation to Some Geophysical Phenomena," A. H. de Vooigt; F. R. Neubauer; A. D. Fokker; L. D. Feiter—all of Netherlands PTT. 3/5/60.

### BINGHAMTON

"The Next Hundred Years," Dr. C. C. Furnas, University of Buffalo. 2/24/60.

### CENTRAL FLORIDA

"Environmental Testing," Dr. Brittain, Electronic Communication, Inc. 2/18/60.

### CINCINNATI

"Some Color Slide and Color Television Experiments Using the Land Technique," Dr. W. L. Hughes, Iowa State University; "Piercing the Unknown" and "The Information Machine," J. Marquand, IBM Corp.; "A Transistorized Preamplifier for Magnetic Pickups," Prof. A. B. Bereskin, University of Cincinnati. 1/18/60.

"Function of the IRE," Dr. R. L. McFarlan, President of the IRE; "Behind the Scenes in Air Traffic Control," B. F. Green, Air Force Cambridge Research Center. 3/1/60.

(Continued on page 116A)

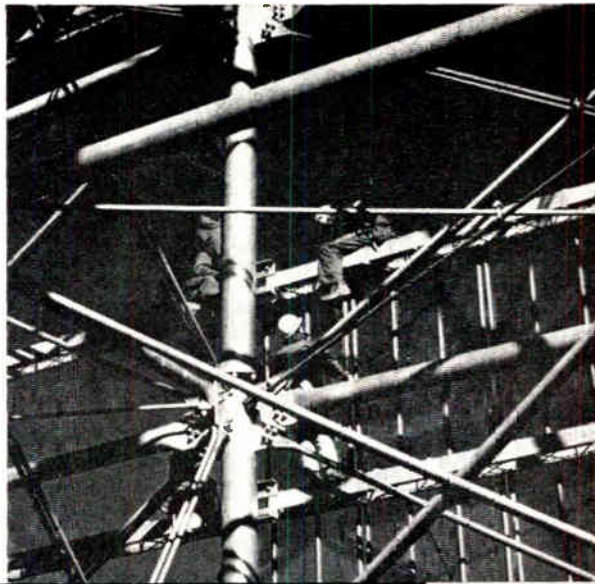

# Beyond the Black Boxes...



You'll find D. S. KENNEDY & CO. products will best complement your systems. From wave guide components to antennas larger than a football field; from Moon Bounce to BMEWS, KENNEDY knows what's needed. As pioneers in the field, KENNEDY has designed, fabricated and erected literally hundreds of types of antennas, in single units as well as production quantities in the thousands. This intimate knowledge of all phases of the antenna art plus KENNEDY's inherent ability to work efficiently and dependably as part of your team, can save you time, trouble and money.

Whether a few quality built wave guide components is all you need or intelligent cooperation in the development and erection of the world's largest antennas, it will pay you to call KENNEDY.



## D. S. KENNEDY & CO.

ANTENNA DIVISION  
Cohasset, Massachusetts  
EVergreen 3 1200

TRACKING ANTENNAS • RADIO TELESCOPES • RADAR ANTENNAS  
SCATTER COMMUNICATIONS ANTENNAS • MICROWAVE RESEARCH  
AND DEVELOPMENT • TRANSMISSION TOWERS  
SWITCHYARD STRUCTURES

Get the Facts about D. S. KENNEDY & CO. at the AFCEA Show — Booth 102 — May 24-26 — Washington, D. C.



# TARZIAN

## Silicon Rectifiers do more than replace these 40 tube types

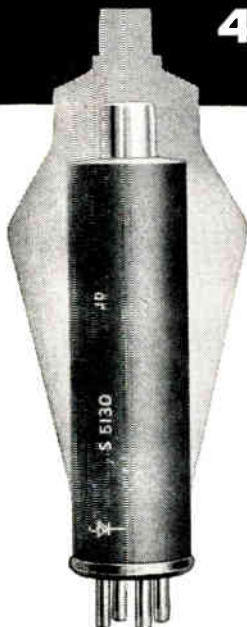

5AU4	5AW4	5AZ4	5T4
5U4	5V4	5Y4	5W4
5Y3	5Z4	6X4	6063
6202	80	82	83
83V	5Z3	0Z4	5X4
6AX5	6X5	5AU4	5931
6087	6106	5R4	6AU4
6AX4	6BL4	6U4	6W4
12AX4	17AX4	25W4	816
836	3B28	866	866A

Some common vacuum rectifier types that Tarzian silicon rectifiers replace

### THEY ALSO PROVIDE:

1. Higher current ratings
2. Inherently rugged construction
3. Instant operation; no warmup
4. Greater electrical stability
5. Improved voltage regulation

Tarzian tube replacement silicon rectifiers combine the advantages of solid state rectification and direct interchangeability with over 95% of all popular rectifier tube types. Although the silicon units are generally smaller than the tubes they replace, their dc current ratings are substantially higher, as much as three times as great in some ratings.

If you have a rectifier application requiring high efficiency, long life, rugged construction, or wide temperature range, Tarzian tube replacement silicon rectifiers may solve your problem. They are available in nine standard models. Special designs and modifications can be worked out on request.

For specifications and prices of tube replacement silicon rectifiers, contact your Sarkes Tarzian sales representative or distributor, or write to Section 4615F, Sarkes Tarzian, Inc., Semiconductor Division, Bloomington, Indiana.



**SARKES TARZIAN, INC.**

SEMICONDUCTOR DIVISION  
BLOOMINGTON, INDIANA

In Canada: 700 Weston Rd., Toronto 9, Ontario  
Export: Ad Aurlima, Inc., New York City

## Better than 1 $\mu$ v Audio-band Noise in a Stereo Preamp?



**marantz**  
*Stereo console*

Only an engineer can fully appreciate the performance characteristics and quality of construction offered in Marantz equipment. As an example, only the Marantz model 7 Stereo Console can give you these features:

- Unique very-low-noise input circuit
- Equivalent total noise input, 20-20000 cps: 0.8  $\mu$ v, typical; 1  $\mu$ v max. (total noise, 60db below 1 mv input where Zgen = 2000 ohms max.)
- Noise-selected film resistors in sensitive plate and cathode circuits.
- Mu-metal shielded, hum-bucking power transformer.
- Hum inaudible through thermal noise, even with RIAA phono curve.
- Well filtered DC for heaters.
- Carefully designed grounding system for minimum hum.
- Tubes and main assembly on heavy, fully shock-mounted turret terminal board.
- Laced cables.
- Incremental tone controls accurately resettable in each channel. Each step switches individual feedback network, "Flat" position cuts out reactive components.
- Hermetically sealed, ganged volume control with better than 2 db tracking at any setting to -85db. Attenuation range, 90db.
- Tape recording and monitoring facilities.
- I.M. distortion, 10 V equiv. pk. RMS, 60-7000 cps 4:1 ratio: less than 0.15% (Proportionately less at normal output levels)
- Gain: Phono (RIAA); 64 $\frac{1}{2}$ db @ 1000 cps. Stepup transformers not needed. High Level: 22 $\frac{1}{2}$ db.
- 15 Amp power switch. 6 AC line outlets for 1700 watts associated equipment.
- Heavy brushed aluminum panel, finely machined knobs, anodized pale gold color. Rack mounting to order in clear anodized aluminum finish at slightly higher cost.
- Every unit completely tested and adjusted to meet specs. Test card included.

The model 8 Stereo Amplifier is a perfect match in standard of performance and construction. While many amplifiers *measure* quite well on sine wave test, this has little relation to their behavior toward the transient signals encountered in musical material. The exceptionally clean overload characteristics, instantaneous recovery, and unconditional stability of the model 8, shows up where it counts—on the loudspeaker! It easily outperforms and outdrives high fidelity amplifiers presently available.

- More than 30 watts per channel (over 40 W with selected tubes)
- Silicon power supply includes Sprague 17D (telephone quality) Electrolytics for reliability.
- Metered adjustments for both static and dynamic balance.
- Open circuit noise 90db below rated power.
- Cool-running, conservative operation.
- Harmonic distortion at full rated power—less than 0.1% @ 1000 cps, 0.5% @ 20 cps, 1% @ 20 kc. Proportionately less at lower output.

Write for booklet 41-H

**marantz**  
25-14 Broadway, Long Island City 6, N.Y.

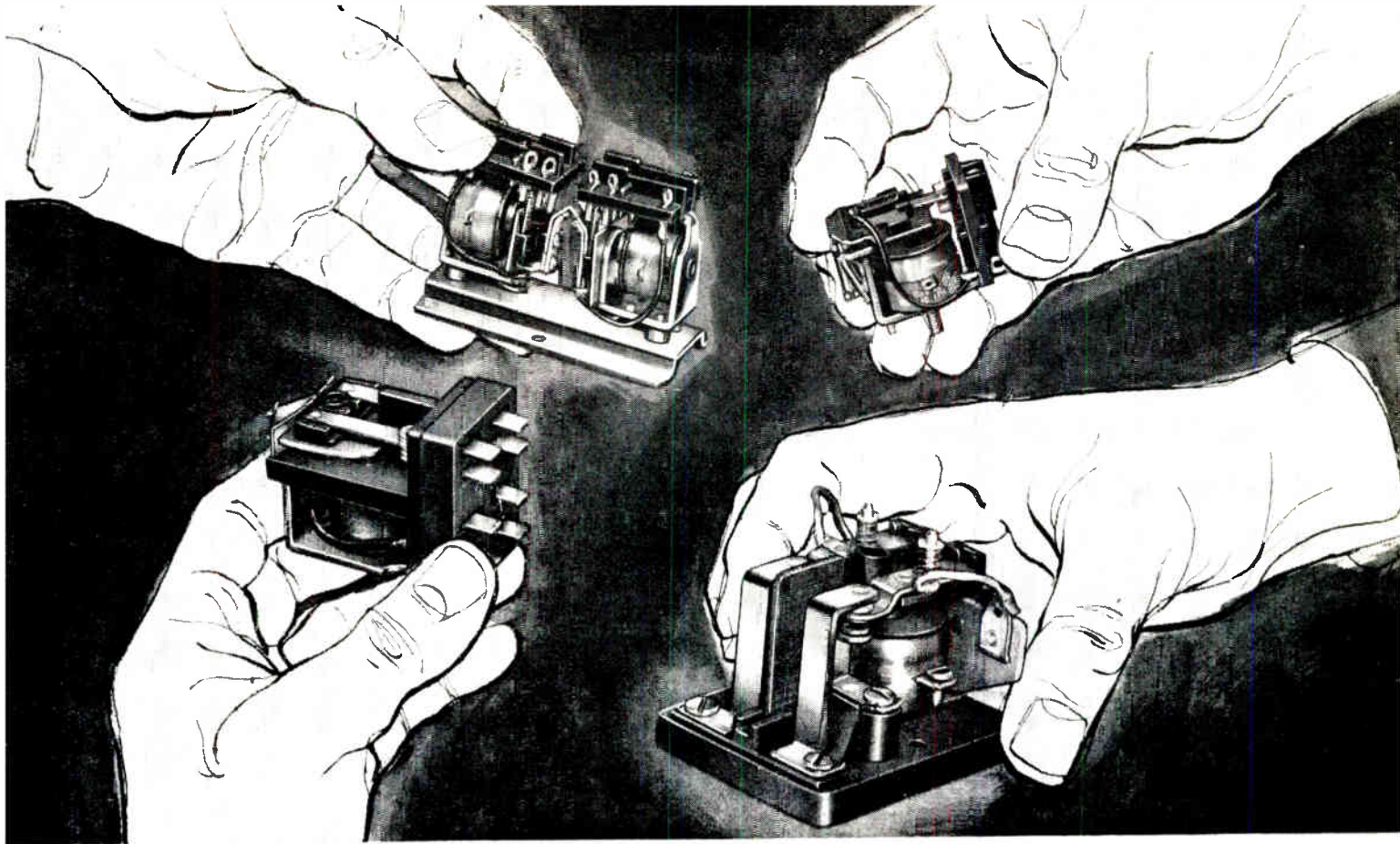

# save time! save money! call your parts distributor for P&B RELAYS



These important savings are yours when you order—from your Electronic Parts Distributor—P&B relays listed with Underwriters' Laboratories, Inc. and Canadian Standards Association:

**SAVE TIME.** You get fast, off-the-shelf delivery. Usually your order is shipped the day after it is received. And no waiting for U/L or CSA clearance . . . this has been done for you. Thus you get your project—and your product—off to a fast start!

**SAVE MONEY.** You save the cost of getting relays listed with U/L or CSA . . . and you need have no big investment in shelf inventory, either. Remember, you pay no premium over factory prices in quantities to 249.

More than 40 different standard P&B relays in 450 different coil voltages and contact arrangements are available from the leading Electronic Part Distributors in your area. For special applications, call your nearest P&B sales engineer.



**PR Series**

Type	Contact Arrangement*	Type	Contact Arrangement*
PR1AY	SPST-NO	PR5AY	SPDT
PR3AY	SPDT-NO-DM	PR7AY	DPST-NO
		PR11AY	DPDT

These relays are available in any of the following operating voltages: 6, 12, 24, 115, 230 volts 50/60 cycles AC. Contacts are rated at: 25 amps, 115/230 V. AC 1 phase. 1 hp for 115/230 volt AC motors 1 phase.

\*Read: NO normally open, NC normally closed, DB double break, DM double make.

U/L File E22575

CSA File 15734

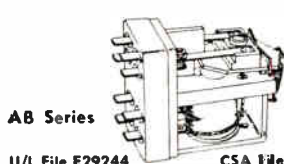

**AB Series**

U/L File E29244

CSA File 15734

For appliance and general purpose operations requiring long life and quiet operation. Quick connect terminals. Screw terminal adapters also furnished with each relay. Contact arrangement: DPDT. Rated at 10 amps, 115 V., 5 amps, 230 AC non-inductive by U/L and CSA.



**ABC Series**

U/L File E29244

CSA File 15734

Medium duty power relay in dust cover. For small motors, industrial controls and similar applications. Contact arrangement: DPDT. Rated at 10 amps, 115 V., 5 amps, 230 AC non-inductive by U/L and CSA.

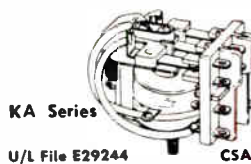

**KA Series**

U/L File E29244

CSA File 15734

Small, low cost, general purpose relay for handling automation work, small motors, solenoids, other relays. Contact arrangements: SPDT, DPDT and 3PDT. Rated at 5 amps, at 115 V., AC non-inductive by U/L and CSA.

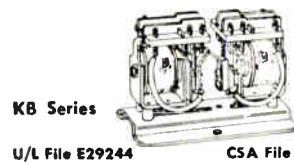

**KB Series**

U/L File E29244

CSA File 15734

Compact latch relay ideal for memory work and overload applications. Operates on momentary impulse to either coil. Contact arrangements: 4PDT and 6PDT. Rated at 5 amps at 115 V., AC non-inductive by U/L and CSA.



## POTTER & BRUMFIELD

DIVISION OF AMERICAN MACHINE & FOUNDRY COMPANY, PRINCETON, INDIANA

IN CANADA: POTTER & BRUMFIELD CANADA LTD., GUELPH, ONTARIO

World Radio History



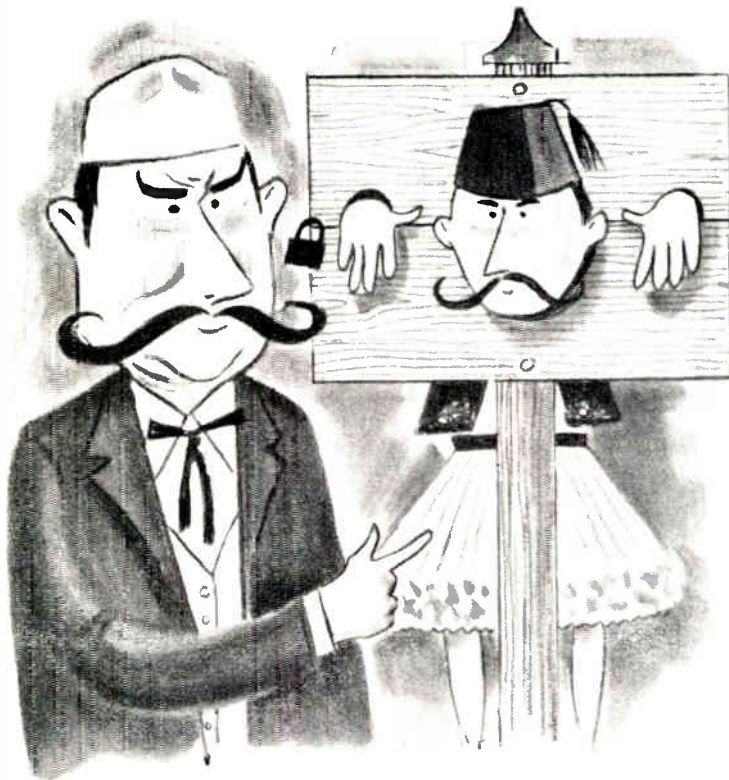

## Zoster on Education

"Education is the process of moving from cocksure ignorance to thoughtful uncertainty," said Dr. Herpes Sophocles Zoster (1823-1887), famed Athenian teacher, inventor of the Patent Disciplinator for Hardnosed Pupils, summing up some of our modern no-go missile experience years ahead of his time. We know one missileman who has hand-worked this sentiment in needlepoint to hang by his block-house window, where he can see it as he triggers the Mark VII-C Rocket Destructor.

But dawn is imminent. Emerging from its brown study of thoughtful uncertainty, HOOVER ELECTRONICS COMPANY has *Taken Steps*, and a whole family of accurate, reliable, versatile, flexible (even repeatable) Electronic Ground Support Equipment has been born: test sets, data translators, tracking equipment, instrumentation-control vans, and others. Steps toward Carefree Certainty, to say the least.

Well, to get to the point quickly space in this magazine being priced beyond rubies, we at HOOVER ELECTRONICS have produced a handsome 'older about the EGSE hinted at coyly above. We wouldn't be reluctant to send a copy, if you'd just put your name and address on a 'letterhead. Today, eh?



**HOOVER**  
**ELECTRONICS COMPANY**

SUBSIDIARY OF THE HOOVER COMPANY

110 WEST TIMONIUM ROAD • TIMONIUM, MARYLAND

Field Liaison Engineers  
Los Angeles, California



## Section Meetings

(Continued from page 112A)

### CLEVELAND

"Silicon Controlled Rectifiers," Panel discussion. Moderator, J. Flick, Jack & Heintz, Inc. Panelists: E. E. Von Zastrow, G.E. Co.; R. McKenna, Texas Instruments, Inc.; Eric Jackson, Transiron, Inc. 2/11/60.

### COLUMBUS

"The Technical Society in Your Life and Vice-versa," H. A. Bolz, Ohio State University. Presentation of Student Awards. 3/7/60.

### DALLAS

"Advanced Energy Conversion Principles," R. L. Petriz, Texas Instruments, Inc. 2/18/60.  
"Engineering Management," P. E. Haggerty, Texas Instruments, Inc. 2/23/60.  
"Radio Engineering in Controlled Fusion Research," W. W. Salisbury, Varo Mfg. Co.; 2/25/60.  
"Masers," F. R. Arams, Cutler-Hammer, Inc. 3/3/60.

### DAYTON

"Weapon System Management in a Decentralized Corporation," I. H. McLaren, Bendix Corp. 9/10/59.  
"Progress Report on the Department of Defense AdHoc Committee Study on Electronic Parts and Tube Specification Management for Reliability," A. W. Rogers, Fort Monmouth Signal Corp.; E. J. Nucci, Dept. of Defense, Pentagon; R. E. Moe, General Electric Co. 10/1/59.  
"Molecular Engineering Philosophy of Electronic System Design," Dr. S. W. Herwald, Westinghouse Electric Corp. 12/3/59.  
"Cesium Ion Propulsion," Dr. A. T. Forrester, Electro Optical Co. 2/4/60.

(Continued on page 120A)

## MINCOM

announces a new double-duty  
magnetic tape system

## the CM-100

records & reproduces **6 SPEEDS**

Greater bandwidths at lower speeds in both analog and pulse recording/reproducing (for example, 500 kc at 60 ips). All in one compact standard rack. Details? Write for brochure.

...WHERE RESEARCH IS THE KEY TO TOMORROW

**MINCOM** DIVISION



**M**INNESOTA  
**M**INING AND  
**M**ANUFACTURING  
COMPANY

2049 South Barrington Avenue, Los Angeles 25, Calif.



**FROM  
MOTOROLA**

# INDUSTRIAL TRANSISTORS WITH THE CERTIFIED RELIABILITY OF MILITARY UNITS

*Why MOTOROLA Introduced  
The MEG-A-LIFE Program*

In many industrial applications, assurance of semiconductor reliability is as desirable as it is for military applications. For this reason, Motorola has introduced "Meg-A-Life" . . . a quality assurance program patterned after the procedures used for standard military-approved components.

"Meg-A-Life" tests are in accordance with MIL-S-19500 (general military specifications for transistors). Sampling is based upon MIL-STD-105. In addition to electrical, mechanical and environmental tests (including shock, centrifuge, vibration, humidity and temperature tests), 1000-hour storage tests at 100°C and 1000-hour operating life tests at maximum rated power are performed.

Approved units are stored in a *bonded* area. Written certification of compliance to "Meg-A-Life" reliability requirements is available. Since all tests represent the most adverse conditions for which the devices are designed, Motorola's "Meg-A-Life" program provides the industrial user an assurance of reliability previously not available.

**FOR COMPLETE INFORMATION** on the Motorola "Meg-A-Life" program contact your Motorola Semiconductor district office:

BOSTON 385 Concord Ave., Belmont 78, Mass. . . . . IVanhoe 4-5070  
 CHICAGO 51, 5234 West Diversy Avenue . . . . . AVenue 2-4300  
 DETROIT 27, 13131 Lyndon Avenue . . . . . BRoadway 3-7171  
 LOS ANGELES 1741 Ivar Avenue, Hollywood 28, Calif. . . . . HOLlywood 2-0821  
 MINNEAPOLIS 27, 7731 6th Avenue North . . . . . LIBerty 5-2198  
 NEW YORK 1051 Bloomfield Ave., Clifton, N.J. . . . . GRegory 2-5300  
 from New York . . . . . WIsconsin 7-2980  
 SAN FRANCISCO 1299 Bayshore Highway, Burlingame, Calif. . . . . DIamond 2-3228  
 SYRACUSE 101 South Salina . . . . . GRanite 4-3321



**MOTOROLA**  
Semiconductor Products Inc.

A SUBSIDIARY OF MOTOROLA, INC.

**MOTOROLA "MEG-A-LIFE"  
INDUSTRIAL ALLOY TRANSISTORS**

The first industrial components available under the "Meg-A-Life" program are types 2N650A, 2N651A and 2N652A. Units provide extremely reliable amplifier and switching service in the audio frequency range and are designed for continuous operation at junction temperatures up to 100°C.

Type	$t_{r_s}$ ( $V_{CE} = 6V, I_E = 1 \text{ ma}$ )	
	MIN	MAX
2N652A	100	225
2N651A	50	120
2N650A	30	70

$P_c = 200 \text{ mw}$   $V_{CE0} = 45 \text{ volts}$   $V_{CEA}(R = 100) = 30 \text{ volts}$

good reasons for letting  
**KNAPIC** grow your  
**Silicon Crystals**

- HIGHEST QUALITY
- UNLIMITED PRODUCTION CAPACITY
- LOWEST COST PER GRAM
- NO CAPITAL INVESTMENT
- NEW MATERIAL RESEARCH
- SPECIFICATIONS TO ORDER

*KNAPIC specializes in Silicon and Germanium Crystals for Semiconductor, Solar Cell and Infrared uses*

Major manufacturers of semiconductor devices have found that Knapic Electro-Physics, Inc. can provide production quantities of highest quality silicon and germanium monocrystals far quicker, more economically, and to much tighter specifications than they can produce themselves.

The reason? Knapic Electro-Physics are *specialists* with accelerated experience in growing new materials to specification. Why not let us grow your crystals too?

*Check These Advantages*

- Extremely low dislocation densities.
- Tight horizontal and vertical resistivity tolerances.
- Diameters from 1/4" to 2". Wt. to 250 grams per crystal. Individual crystal lengths to 10
- Low Oxygen content  $1 \times 10^{17}$  per cc.,  $1 \times 10^{16}$  for special Knapic small diameter material.
- Doping subject to customer specification, usually boron for P type, phosphorous for N type.
- Lifetimes: 1 to 15 ohm cm.—over 50 microseconds; 15 to 100 ohm cm.—over 100 microseconds; 100 to 1000 ohm cm.—over 300 microseconds. Special Knapic small diameter material over 1000 microseconds.

**Specification Sheets Available**

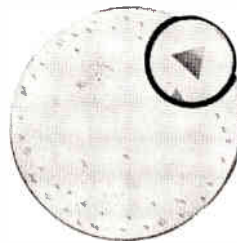

Dislocation density, Knapic silicon monocrystals grown by a modified Czochralski technique: Crystal diameter to 3/4"—None; 3/4" to 1 1/4"—less than 10 per sq. cm.; 1 1/4" to 2"—less than 100 per sq. cm.; 1 1/2" to 2"—less than 1000 per sq. cm.



**Knapic Electro-Physics, Inc.**

936-40 Industrial Ave., Palo Alto, Calif. • Phone DAVenport 1-5544

**SALES OFFICES:**

- Eastern**—405 Lexington Avenue, New York, N. Y. • Phone YUKon 6-0360
- Western**—204 South Beverly Dr., Beverly Hills, Calif. • Phone CRestview 6-7175
- European**—#2 Prins Frederick Hendriklaan, Naarden, Holland • Phone K 2959-8988

... Also manufacturer of large diameter silicon and germanium lenses and cut domes for infrared use





READY  
GET SET...  
(3, 2, 1...)

**ANDREW**

H E L I A X<sup>®</sup>

*A truly flexible  
air-dielectric cable*

At the zero second everything must function without failure. ANDREW HELIAX cable is used in postassembly and preflight checkouts of missile radio frequency systems. The cable forms a closed circuit over which interrogation and response signals are transmitted between checkout equipment and airborne radio frequency packages. The HELIAX cable runs from a mobile trailer to connecting points on the missile.

The ruggedness of HELIAX makes it well suited to this challenging task, where its low VSWR, low RF leakage and low attenuation give accurate measurement of systems performance. Flexibility permits the cable to be taken down, recoiled and subsequently reused many times.

If you require similar characteristics in a cable, consider the special advantages of HELIAX.

HELIAX is normally supplied as an assembly, complete with end fittings factory attached, reducing installation labor and improving quality.

Complete uniformity throughout its entire length gives HELIAX superior electrical characteristics.

HELIAX is always less difficult, less costly to install, easier to handle.

HELIAX is available in 7/8" size (Type H0) and 1 5/8" size (Type H1).

WRITE FOR FREE SAMPLE LENGTH

ANTENNAS • ANTENNA SYSTEMS  
TRANSMISSION LINES

**Andrew**  
CORPORATION

P. O. BOX 807 • CHICAGO 42, ILLINOIS

Offices: Boston • New York • Washington, D.C. • Los Angeles • Toronto

World Radio History



BECAUSE  
IT'S DIGITALLY  
PROGRAMMABLE—  
NEW  
CON AVIONICS  
DC POWER  
SOURCE...



...INSTANTLY PROVIDES ON COMMAND ANY VOLTAGE  
FROM 0.1 TO 50 VOLTS DC—UP TO 15 AMPERES

Another first by Con Avionics, this digitally programmable power source translates manual push-button setting or output of your program device into the selected voltage. It can be made to respond to any digital code from sources such as paper or magnetic tape readers, punched card readers, or keyboards. Voltages may be changed from any setting to any other within 300 milliseconds. Voltage is stable and accurate within  $\pm 0.1\%$  of the selected value. Ripple is less than 0.05% rms.

The completely self-contained design of the Con Avionics DC Power Source eliminates external rheostats, step switches and other devices.

This unit reduces equipment complexity in data systems, automatic checkout equipment or precision testing applications. Outstanding results are obtained both in the lab and on production work.

**CONSOLIDATED AVIONICS CORPORATION**

A SUBSIDIARY OF CONSOLIDATED DIESEL ELECTRIC CORPORATION

800 Shames Drive • Westbury, L. I. • EDgewood 4-8400



**Section Meetings**

(Continued from page 116,1)

DETROIT

"Simulation of Nervous System Processes with Artificial Neurons," L. D. Harman, Bell Telephone Labs.; 2/19/60.

EGYPT

"Non-destructive Testing of Materials Using X-Ray and Ultrasonics," Dr. R. O. Schumacher, Philips Hamburg Co., Germany; 2/5/60.

ERIE

"IRE Activities," Dr. R. L. McFarlan, 10/1/59.

FLORIDA WEST COAST

"Strontium 90, Skeleton in the Closet," Dr. Louis Polskiu, Private Physician; 2/17/60.

FORT HUACHUCA

"Motorola Commercial Two-way Communication Systems," John Byrne, Motorola, Inc; 2/29/60.

FORT WORTH

"Low Frequency Active Filters," Gifford White, White Instrument Labs; 2/9/60.

HOUSTON

"Printed Circuits for Motors and Missiles," John Calpera, Photocircuits Corp; 2/23/60.

HUNTSVILLE

"Design of Phase Lock Receivers," Arthur Kline, Motorola, Inc.; 2/24/60.

INDIANAPOLIS

"Power Transmission Without Wires Using Microwaves," Dr. R. L. McFarlan, President of the IRE; 2/26/60.

"Science and Engineering in Modern Society," Dr. R. L. McFarlan, President of the IRE 2/27/60.

LONDON

"The World's Sources of Energy," Dr. Robert Uffen, University of Western Ontario; 3/8/60.

Students Night. Five contestants as follows:

"100 KV Proton Accelerator"—Roy Kochlen, 1st prize

"A Logical Switching Demonstration"—Gus Leipens, 2nd prize

"Traveling Wave Tubes"—Ed Hartlin, 3rd prize

"Presure Pulse Measurements"—Bob Johnson

"Microwave Optics"—Dave Boyle 2/9/60.

LUBBOCK

"Microwave Applications," Larry Pease, Southwestern Bell Telephone Co. 2/23/60.

MONTREAL

"Tropospheric Extended Range Transmission," S. A. Stone, National Research Council; 2/17/60.

NORTHERN ALBERTA

"The IRE and Canada," A. P. H. Barclay, Director Region VIII; 2/22/60.

NORTHWEST FLORIDA

"The Use of Microwave Energy to Support Space Platforms," Dr. R. L. McFarlan, President of the IRE; 2/10/60

(Continued on page 111,1)

ANOTHER FAIRCHILD FIRST

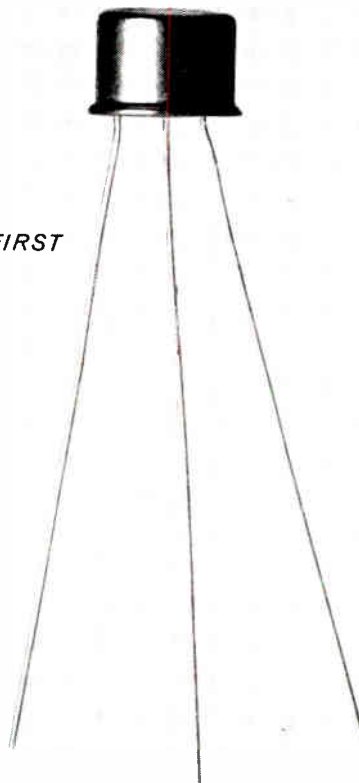

# THE UNIVERSAL TRANSISTOR

## FAIRCHILD'S 2N1613 DIFFUSED SILICON PLANAR TRANSISTOR

### GUARANTEED USEFUL BETAS FROM 100 $\mu$ A to 0.5A:

15 @ .1mA 20 @ 1mA 30 @ 150mA 15 @ 500mA  
Guaranteed minimum Beta over a 5,000 to 1 range of collector current makes the 2N1613 the most versatile transistor presently on the market.

**WIDE RANGE OF APPLICATIONS:** in Fast Switching (logic and high current); Amplifiers (low level, low noise, wideband, VHF power).

**RELIABILITY IN A NEW DIMENSION:** The Planar

Transistor is the most thoroughly proven transistor ever introduced commercially, with over 5,000,000 transistor hours plus 300°C. stabilization on all units.

**SOME IMPORTANT PARAMETERS:** 7 db—Noise Figure: 100 megacycles—Gain-bandwidth product; 0.0005 $\mu$ A I<sub>CBO</sub> typical at 60V, 25°C.

**IMMEDIATE AVAILABILITY:** Quantities from 1-999 from franchised Fairchild distributors at factory prices.

TENTATIVE SPECIFICATIONS— FAIRCHILD 2N1613		
f <sub>t</sub> typical		100 mc
P <sub>C</sub> @ 25°C. Case Temperature		3W
h <sub>FE</sub> (see Beta paragraph above)		Min 30
V <sub>CER</sub>		40V
V <sub>CBO</sub>		75V
V <sub>BE SAT.</sub> (Max.)		1.3V
V <sub>CESAT.</sub> (Max.)		1.5V
I <sub>CBO</sub> @ 25°C. (Max.) measured at 60V		25 $\mu$ A



545 WHISMAN ROAD / MOUNTAIN VIEW, CALIF. YORKSHIRE 8-8161

For full specifications, write Dept. E-5

A WHOLLY OWNED SUBSIDIARY OF  
FAIRCHILD CAMERA AND INSTRUMENT COMPANY

# Good electronic design you limit compromise by PROOF: G-E 7077 over a wide spectrum of

## LOCKHEED

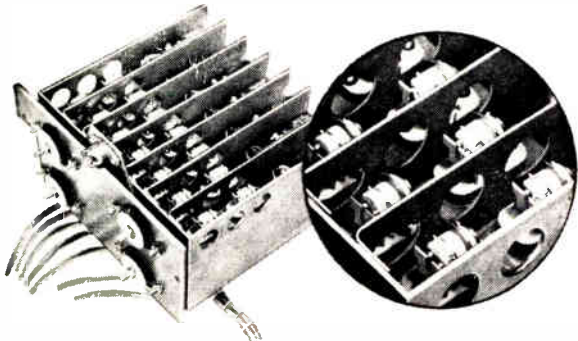

### WIDE-BAND TAPE RECORDER.

For Lockheed, California Division, 28 General Electric 7077's serve as pre-amplifiers in a 14-channel 500-ke 60"-per-second tape recorder that stores wide-band information from an air defense exercise five times as rapidly as before. Extreme requirements of frequency, timing accuracy, and reproducibility are met by the 7077's low noise, high impedance, and high  $G_m$ . Also, the tube's small size matches the miniaturization needs of the Lockheed tape-recorder equipment.

## MOTOROLA

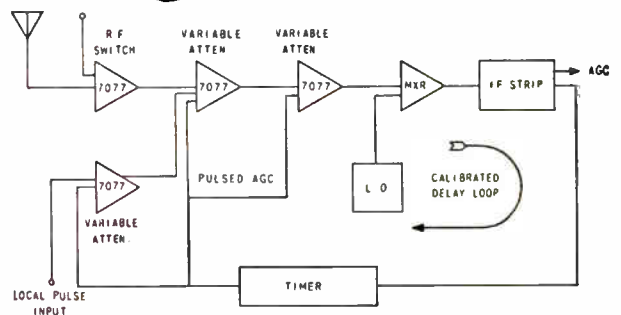

### GROUND-SURVEYING RADAR.

Motorola's Western Military Electronics Center in Phoenix uses four General Electric ceramic 7077's for high-speed RF switching and pulse attenuation in a 440-mc distance measuring circuit where timing to *one billionth of a second* is needed for pulse delay measurement. Minimum plate-to-cathode capacitance, high gain, low noise, and a configuration that makes the tube ideal for grounded-grid service, were reasons back of Motorola's choice of the G-E 7077.



involves trade-offs... but  
 using ceramic tubes.  
 meets designers' targets  
 frequency and function.

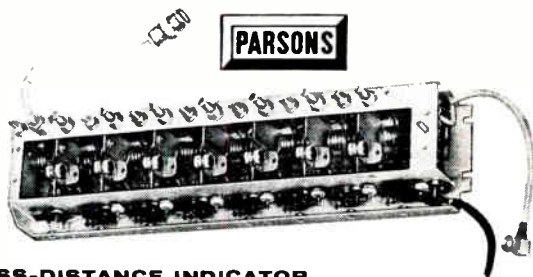

**MISS-DISTANCE INDICATOR.**

Ralph M. Parsons Company uses seven General Electric ceramic 7077's in tuned stages as high-gain, low-noise RF amplifiers in its PARAMI system for determining air-intercept missile accuracy. A 324-mc circuit, the Parsons PARAMI system has a gain-bandwidth product approaching the limit of the state of the art.

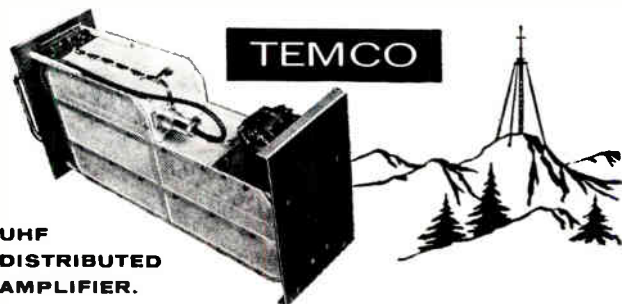

**UHF DISTRIBUTED AMPLIFIER.**

Many receivers—one antenna, with Temco Electronics' broadband distributed amplifier. Arranged in six five-stage units, 30 G-E 7077's are used as RF amplifiers, operating over a 750 mc bandwidth, between 250 and 1000-mc. Fills the frequency gap between TWT's and existing distributed amplifiers.

Phone your nearest General Electric Receiving Tube Department Office:

New York: Wisconsin 7-4065, 6, 7, 8

Chicago: Spring 7-1600

Los Angeles: Granite 9-7765

*Progress Is Our Most Important Product*

**GENERAL  ELECTRIC**

431-202

# UNPRECEDENTED EFFICIENCIES IN HARMONIC GENERATION...

**11 kMc  
input @  
500 mw**

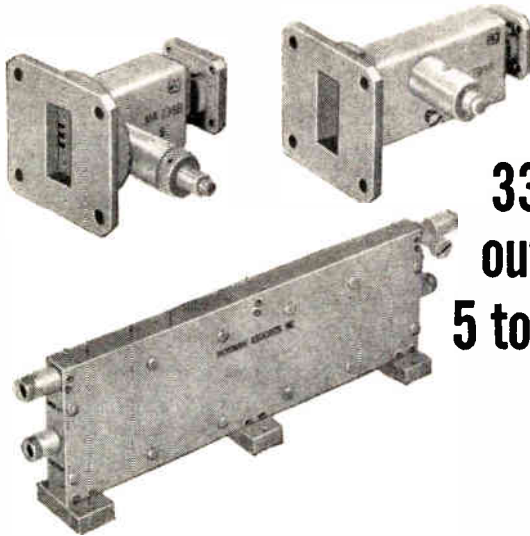

**33 kMc  
output @  
5 to 20 mw**

Nine new examples of Microwave Associates' capabilities in the design of harmonic generators are available now. These models feature exceptionally high output power with conversion losses well below existing devices.

New designs incorporating solid state elements can be used to eliminate costly klystrons, DC bias supplies and high voltage power supplies. All units feature broadband fixed-tuned operation, filters eliminating unwanted harmonics, and versatile coaxial, waveguide and

strip-line packaging. These models are typical examples of our progress to date . . . presently we are working for even greater efficiencies and performance. Additional models in development converting 1 watt at 2000 Mc to 100 mw or more, at 4000 and 6000 Mc, to be announced soon.

Your specific application problems are of prime interest to us. Our Applications Engineers would welcome the opportunity to design harmonic generators to meet your specifications.

## SPECIFICATIONS

Model	INPUT				OUTPUT				
	Connector Type UG-	Frequency Input kMc/s	Band	mw input	Connector Type UG-	Frequency Output kMc/s	Band	Conversion Loss (max.)	Output mw
MA796	23/U	0.26 — 0.28	P	20	23/U	1.30 — 1.43	L	13db	1
MA797	23/U	1.30 — 1.43	L	100	23/U	5.22 — 5.72	C	15db	3
MA798A	39/U	9.0 ± 150Mc	X	500	596/U	18.0 ± 300Mc	K	17db	10
MA798B	39/U	10.0 ± 150Mc	X	500	596/U	20.0 ± 300Mc	K	17db	10
MA798C	39/U	11.0 ± 150Mc	X	500	596/U	22.0 ± 300Mc	K	17db	10
MA798D	39/U	12.0 ± 150Mc	X	500	596/U	24.0 ± 300Mc	K	17db	10
MA799A	39/U	9.0 ± 100Mc	X	500	600/U	27.0 ± 300Mc	Ka	20db	5
MA799B	39/U	10.0 ± 100Mc	X	500	600/U	30.0 ± 300Mc	Ka	20db	5
MA799C	39/U	11.0 ± 100Mc	X	500	600/U	33.0 ± 300Mc	Ka	20db	5



Write or call:

**MICROWAVE ASSOCIATES, INC.**

BURLINGTON, MASSACHUSETTS

Western Union FAX-TWX: Burlington, Mass., 942 • BRowning 2-3000



## Section Meetings

(Continued from page 120A)

### ORLANDO

"Navigation and Communication Systems and Future Communications," H. Scarborough, I.T.T. Labs. 2/17/60.

### OTTAWA

"Tunnel Diodes," Dr. John Simpson and Mr. Pulford of the National Research Council, Ottawa. 3/3/60.

### PHILADELPHIA

"The IRE and Its Relation to Medical Sciences," Dr. R. L. McFarlan, President of the IRE. 3/20/60.

### PITTSBURGH

Presentation of Fellow Award by Dr. R. L. McFarlan, IRE President. 3/2/60.

"Low Noise Solid State Microwave Receivers," Dr. R. D. Hann, Jr., Westinghouse Research Laboratories. 3/7/60.

### PRINCETON

"Some Recent Developments in Infrared and Their Application to Missiles," Eric Wormser, Barnes Engineering Co. 1/14/60.

"Electrical Control of the Brain," Dr. Jose Delgado, Yale School of Medicine. 2/11/60.

### REGINA

"Description of Video System," L. McBride, CKCK-TV; "Filters," Dr. D. V. Tilston, Sinclair Radio Labs. 1/16/60.

"Present Day Electronics," A. P. H. Barclay, Director Region VIII, Tour and display of R.C.M.P. Crime Detection Lab. 2/17/60.

### RIO DE JANEIRO

"Automatization of the Telephone Service in the Area of Borda do Campo," Dr. V. Martins, Comp. Tel. da Borda do Campo. 3/9/60.

### ROCHESTER

"Cold Cathode Tubes," Dr. M. Skellett, Tung-Sol Electric, Inc. 9/24/59.

"EAST Time Assignment Speech Interpolation," E. F. O'Neill, Bell Telephone Labs. 12/3/59.

"Who's Ahead in the Battle of the Sexes—Or—How to Play Both Sides in Stereo," A. G. Schifano, Strouberg-Carlson. 12/8/59.

"Christmas Message," Dr. A. S. Turnipseed, Pastor, First Methodist Church. 12/15/59.

### SAN ANTONIO-AUSTIN

"The Log-Periodic Antenna," C. R. Graf, USAF Security Service. 2/19/60.

### SAN DIEGO

"Soviet Computing Technology 1959," Dr. W. H. Ware, The Rand Corp. 3/2/60.

### SYRACUSE

Presentation of Fellow Awards. 3/3/60.

### TOKYO

"Miscellaneous History on Radio Waves," Dr. Shogo Namba, Kokusai Denshin Denwa Co. Presentation of Fellow Award. 2/1/60.

### TORONTO

Field Tour of Radio Valve Co., Ltd. 11/23/59. "Tubes Versus Transistors," D. S. Simkin and J. H. Beardall, Philips Electronics Industries, Ltd. 12/14/59.

Field Tour of Maclean-Hunter Printing Plant, Toronto. 1/12/60.

"Students Night," 2/18/60.

"Backstage Impressions of the CBS.," F. Davis, CBS. 3/7/60.

(Continued on page 128A)

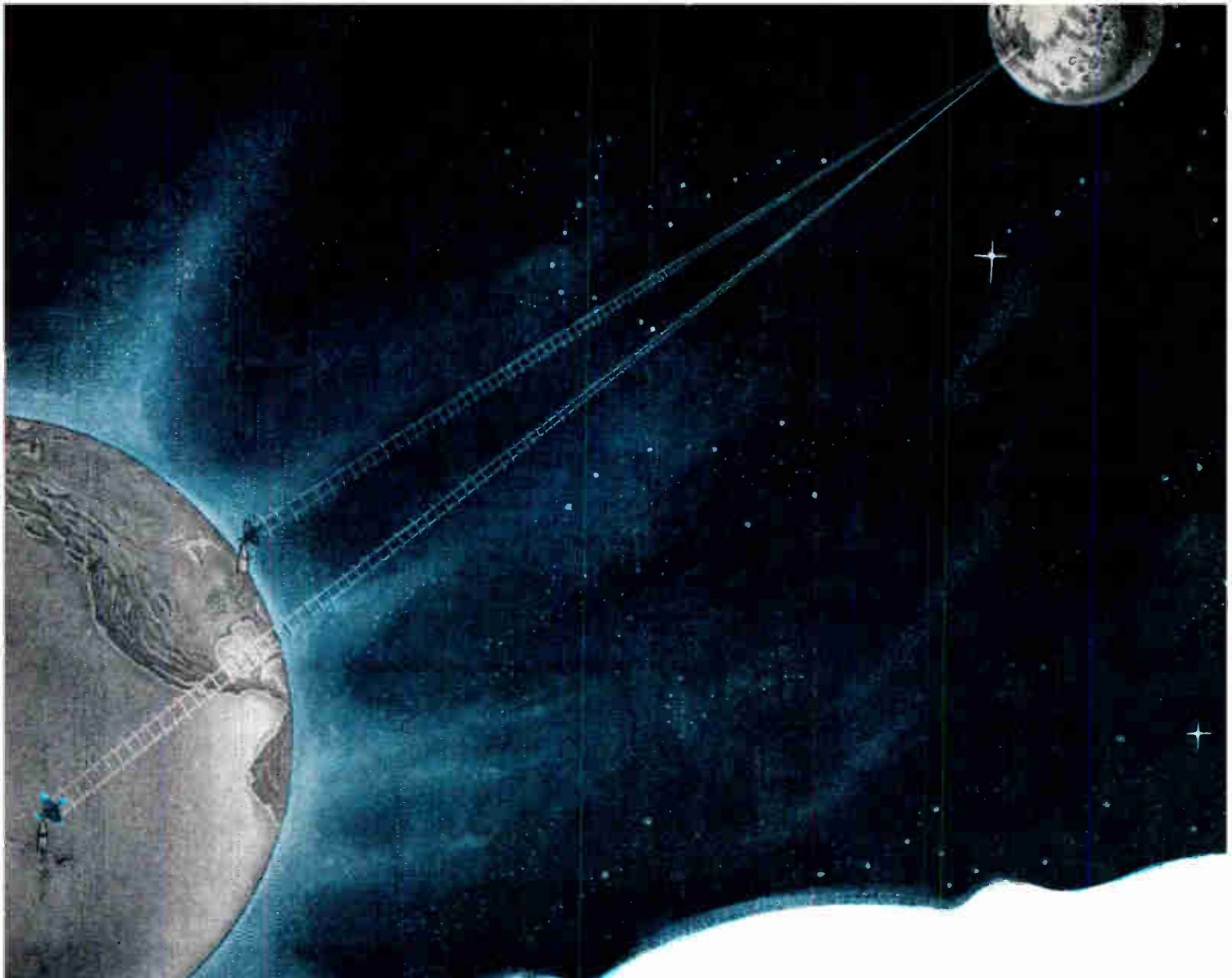

## WASHINGTON TO HAWAII VIA OUTER SPACE!

Right now the Navy's "moon bounce" transmitter is operational . . . virtually jamproof against enemy and immune to ionospheric storms.

Essentially, the Navy's "Communications Moon Relay" is a 4-channel multiplexed teletypewriter-facsimile circuit between Washington and Pearl Harbor via the moon. The narrow beam, highly directionalized L-Band signal pulses travel to the moon and bounce back to the receiver in  $2\frac{1}{2}$  seconds . . . utilizing a half million mile signal path to span 5,000 miles!

Continental Electronics' transmitter is 100 KW. conventional transmission, and is unusual for the high level of continuous power used. Each Transmitter-Receiver site uses an equatorially mounted, high gain, fully steerable dish-type antenna 84 feet in diameter, aimed at the moon by astronomical data.

When fully developed, this communications system opens a whole new spectrum of radio communications for our overcrowded Long Range Communications; the number of channels that can be carried by time-sharing on a single antenna is readily expanded.

*Another  
Continental Electronics  
Contribution  
in Super Power Radio*

*A Subsidiary of  
Ling-Altec Electronics, Inc.*

**Continental Electronics**

MANUFACTURING COMPANY

4212 S. Buckner Blvd. • Dallas 27, Texas

EVERgreen 1-1135





THE SHORTEST PULSE ON RECORD...

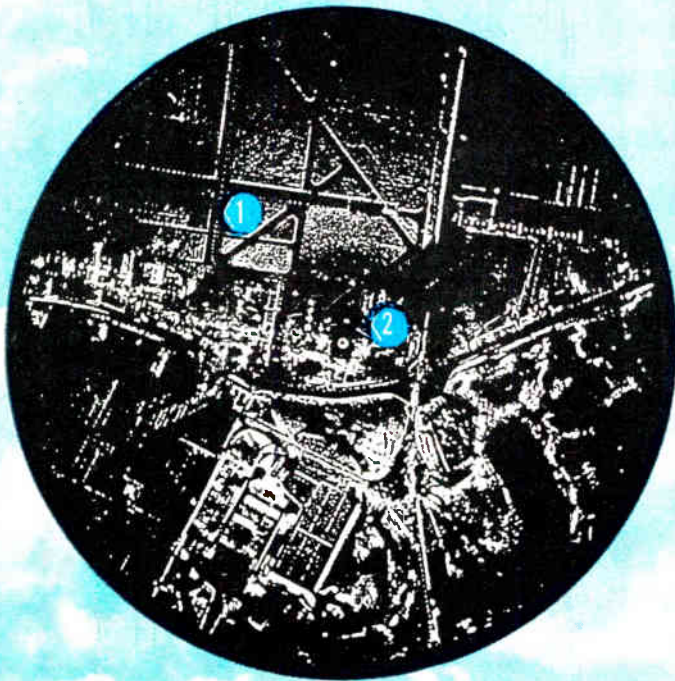

GENERATED BY THE NEW  
**Amperex®**  
TYPE 7093 K-BAND MAGNETRON



The 7093 permits the design of an extremely compact, short range radar system providing resolution of 4 meters at 1000 yards and a minimum range of only a few yards.

**NOTEWORTHY FEATURES OF THE AMPEREX TYPE 7093**

Frequency Range: 34,512 - 35,208Mc.

Power Output: 25KW

Pulse Length: 0.02 microseconds

Rise Time: 600KV per microsecond

Weight: 4.2 lbs.

Cathode: Philips dispenser-type

Immediately available in production quantities.

*Illustration above is a direct line-conversion from an unretouched radarscope photo of Schiphol Airport, Amsterdam, Netherlands. Range—1500 meters. 1 jeep traveling down runway at 55 mph. 2 slow moving vehicles and people walking.*



ask Amperex  
about  
microwave tubes  
for microwave applications

AMPEREX ELECTRONIC CORPORATION  
230 Duffy Avenue, Hicksville, Long Island, New York

Page  
... in new  
ultra modern  
laboratories  
and offices...

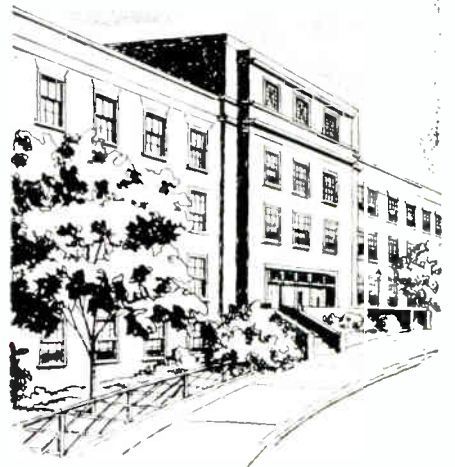

in the heart of Old  
Georgetown in the  
Nation's Capital

World-wide communications  
capability in

Submarine Cable

Microwave and HF

Tropo and Iono Scatter

Active and Passive Satellite  
Communications

**Engineers:**

For interesting and rewarding positions on our technical staff, address your inquiry to: Mr. J. P. Gaines, Pers. Mgr.

Page

**COMMUNICATIONS  
ENGINEERS, INC.**

*Subsidiary of Northrop Corporation*

2001 WISCONSIN AVENUE, N.W.,  
WASHINGTON 7, D.C.

# fast, direct-reading, easy-to-use

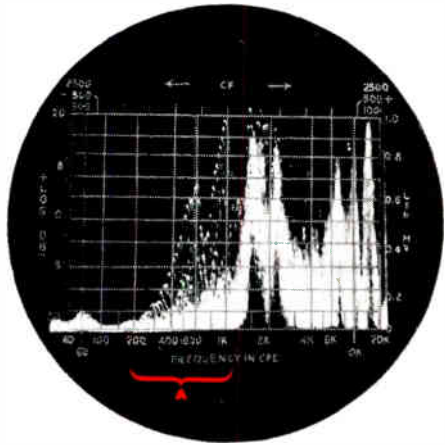

"Coast-down" analysis of Gyro Motor by Model LP-1a Spectrum Analyzer. Area A shows decreasing fundamental frequency, resonant rise and decay, and vibration components over 60 successive scans in one minute.

The Model LP-1a "quick-look" helps locate and evaluate discrete or random signals faster and easier by scanning the entire spectrum logarithmically from 40 cps to 20 kc. Once every second it automatically separates, measures and plots the frequency and voltage of waveform components on the calibrated X and Y axes, respectively, of a long persistence 5" CRT.

For very detailed analysis, linear segments 40 to 5000 cps wide, centerable between 0 and 20 kc, may be magnified on the screen.

Amplitude ratios of up to 40 db can be simultaneously measured.

High sampling rate and panoramic displays assure

- 1 Minimum risk of missing weak signals or spectrum holes.
- 2 Fast measurements by eliminating slow point by point plots.
- 3 Simultaneous measurement of signals with widely divergent amplitudes and/or frequencies.
- 4 Continuous analysis of rapid changes in spectral content or design parameters.

Proved in hundreds of research, design and production installations, the LP-1a is a valuable tool for Noise and Vibration analysis • Harmonic and IM measurements • General waveform studies • Power Spectral Density Analysis • Response Curve Tracing

## SUMMARY OF SPECIFICATIONS:

**Frequency Range:** 20 cps—22.5 kc.

(1) Preset linear frequency scans: any segment width of 200, 1000, 5000 cps centerable from 0-20 kc; Variable from 40 cps to 5000 cps with Auxiliary Function Unit C.

(2) Preset Log Scan—40 cps to 20 kc.

**Frequency Scales:** Linear and Log

**Center Frequency Control:** Calibrated 0-20 kc (used on lin scan)

**Dynamic Range:** 60 db

**Amplitude Scales:** Linear and 2 decade log (Expandable to 60 db)

**Sensitivity:** 500  $\mu$ v to 500 v for full scale linear deflection

**Voltage Accuracy:** Lin Sweep (40 cps—22.5 kc):  $\pm 5\%$  or  $\pm 0.5$  db. Log Sweep (40 cps—20 kc):  $\pm 10\%$  on lin. ampl. scale,  $\pm 1.5$  db on log ampl. scale.

**Scan Rate:** 1/sec., internally generated; adjustable with accessory equipments

**Resolution:** For log scan, automatically optimized. For lin scan, preset 30, 75 and 170 cps at 200, 1000 and 5000 cps sweepwidth, respectively. Variable from 10 cps to 1 kc with Auxiliary Function Unit C.

# PANORAMIC LP-1a

## SONIC SPECTRUM ANALYZER

### 20 cps-22.5 kc.

#### HIGHLIGHT FEATURES:

- 1-sec. "quick-look" at entire spectrum (40 cps—20 kc)
- Magnified analysis on reduced sweep widths
- Direct reading frequency-selective voltmeter
- Exceptionally stable circuitry: better than 5 cps/hr.
- Economical
- Simple Operation

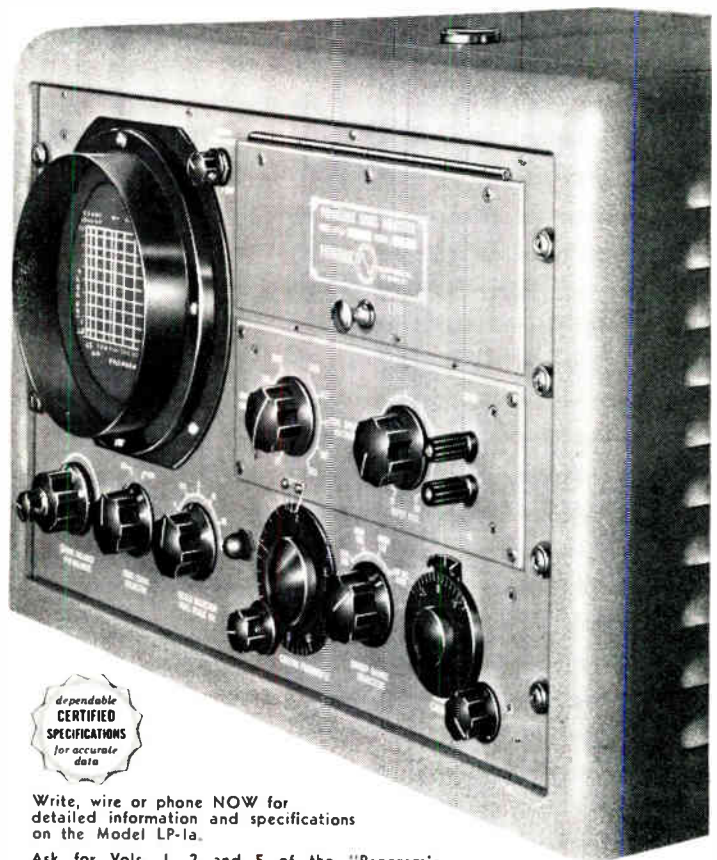

Write, wire or phone NOW for detailed information and specifications on the Model LP-1a.

Ask for Vols. 1, 2 and 5 of the "Panoramc Analyzer" . . . featuring applications and techniques of Spectrum Analysis, and get on our regular mailing list for this helpful publication. NEW CATALOG DIGEST AVAILABLE

**PANORAMIC RADIO PRODUCTS, INC.**

522 South Fulton Avenue, Mount Vernon, N.Y. • Phone: OWens 9-4600  
Cables: Panoramc, Mount Vernon, N.Y. State





**BARNSTEAD  
ENGINEERED  
WATER PURIFICATION  
EQUIPMENT**

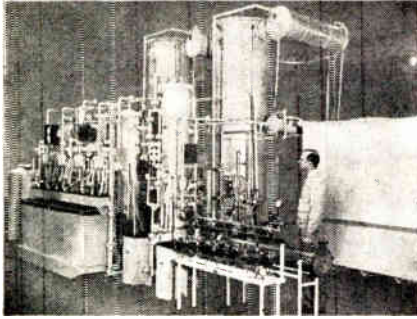

**18,000,000 OHM WATER**

This Barnstead equipment engineered in series consists of sand and carbon filter, high-capacity four-bed demineralizer, two Barnstead High-Purity Stills, Tin-lined tank, Mixed-Bed Demineralizer, MF Sub-micron Filter, Tin-lined Heater. Produces 18,000,000 ohm water in production quantities, completely free of minerals, organics, bacteria, and submicroscopic particles down to 0.45 micron.

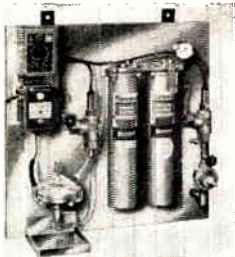

**COOLING WATER  
RE-PURIFYING SYSTEM**

adds thousands of hours to UHF transmitting tube life. Saves additional hours of maintenance ordinarily spent in citric acid cleaning procedures within the cooling system. Write for detailed Bulletin 149.



**TRANSISTOR WASHER**

Rinses transistors, diodes, and other small components in hot, ultra pure water. System filters out particles to 0.45 micron. Continuous re-purification system conserves water resulting in substantial savings. Write for Bulletin 146.

**Barnstead**  
STILL AND STERILIZER CO.

56 Lanesville Terrace, Boston 31, Mass.

<b>BOSTON</b> Jamaica 2-8490	<b>NEW YORK</b> Kingsbridge 8-1557	<b>CLEVELAND</b> Academy 6-6622
<b>CHICAGO</b> Rogers Park 1-6173	<b>PHILADELPHIA</b> Locust 8-1796	<b>WASHINGTON, D.C.</b> District 7-1142
<b>LOS ANGELES</b> RYan 1-6663	<b>SAN FRANCISCO</b> Templebar 2-5391	<b>DETROIT</b> Enterprise 7422

**PRIZE  
PROGRAMMED  
PULSE  
PACKAGE**

... for the engineer who needs fully controlled, bi-polar, high amplitude current pulses for R & D in thin magnetic films and high speed ferrites.

For eight step programming, large load handling capacity, multiple current outputs . . . Rese Model 1020 Programmed Current Pulse Generator. Write for Bulletin 57-B.

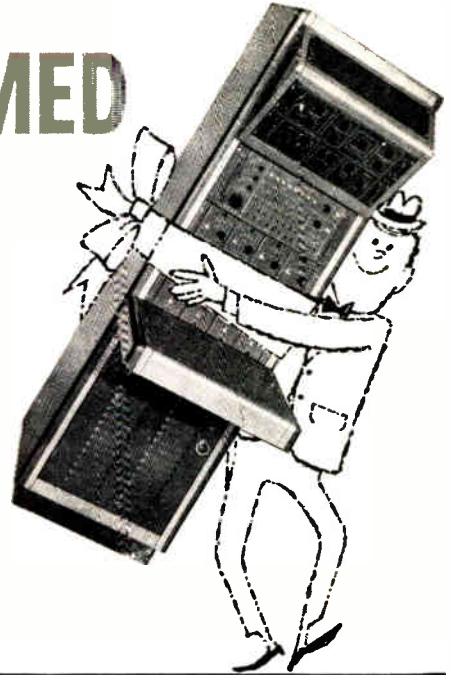

**rese engineering, inc.**  
731 ARCH ST., PHILADELPHIA 6  
MAGNETIC CORE TESTERS • HIGH SPEED MEMORIES • LOGIC CIRCUIT PLUG-INS



**Section Meetings**

(Continued from page 124A)

**TUCSON**

"Relativity, Atomic Clocks and Satellites," Dr. H. Lyons, Hughes Aircraft Co. 2/18/60.

**TULSA**

"Modern Stereo," P. W. Klipsch, Klipsch & Associates. 2/18/60.

**VIRGINIA**

"The Day The Earth Tumbles," C. P. Thomas, Hughes Aircraft Corp. 1/22/60.

"Project Mercury," G. V. Graves, NASA. 2/12/60.

**WESTERN MASSACHUSETTS**

"The Frontiers of Space," T. Mehlin, Williams College. 2/17/60.

**WICHITA**

"Your Institute of Radio Engineers," C. E. Harp, University of Oklahoma. 1/20/60.

"Electronic Switching," W. B. Quirk, Bell Telephone. 2/18/60.

**WILLIAMSBURG**

"State Police Radio," Lt. R. Bomboy, Pennsylvania State Police. 2/24/60.

**WINNIPEG**

"Electronics and the IRE," A. P. H. Barclay, Director Region VIII. 2/15/60.

(Continued on page 130A)

Send for your **FREE**



**1960  
CATALOG**

- HIGH FIDELITY
- HAM RADIO
- MARINE
- INSTRUMENTS



Over 150 do-it-yourself electronic kits are illustrated and described in this complete Heathkit Catalog.

**DO-IT-YOURSELF . . . IT'S FUN  
IT'S EASY & YOU SAVE UP TO 1/2!**

**HEATH COMPANY** a subsidiary of DAYSTROM  
Benton Harbor 4, Michigan

Please send the **FREE** Heathkit Catalog

NAME \_\_\_\_\_  
ADDRESS \_\_\_\_\_  
CITY \_\_\_\_\_ ZONE \_\_\_\_\_ STATE \_\_\_\_\_





# FLAT-FACE RADAR DISPLAY TUBES

Featuring face plate radius of 150 inches  
minimum and High Resolution  
Capabilities



Available in 22", 16", 12" and 8"  
Sizes . . . 22" Tube Types available  
with 70° or 53° Deflection Angle.

### AVAILABLE WITH ONE OF THE FOLLOWING THREE GUNS

- **Magnetic Focus Gun** . . . gives uniform line width across entire tube.
- **Electrostatic High Resolution Gun** . . . capabilities exceeding 1000 TV lines at a light output of 80 foot-lamberts.
- **Magnetic High Resolution Gun** . . . capabilities exceeding the electrostatic gun.

Rauland research makes possible these remarkably advanced Radar Display Tubes. Their Flat Face feature assures minimum parallax error, and their high resolution affords maximum display accuracy.



**SIGNAL STORAGE TYPE TUBE** - Has resolving capability of 1000 TV lines, half-tone presentation and storage characteristics variable from a few seconds to several minutes.



**HIGH-RESOLUTION, HIGH-BRIGHTNESS TUBE** - Round 21" high voltage CRT will resolve at least 1000 TV lines at 300-500 foot-lamberts light output. For displays under high ambient light conditions.



**SHUTTER IMAGE CONVERTER TUBE** - Used for ultra-fast photography with exposure times in the milli-microsecond range; will present a stroboscopic picture of high speed phenomena.

**CONSULT US ON ANY SPECIAL TUBE PROBLEM...ask for latest literature.**

## The RAULAND Corporation

4247 North Knox Avenue • Chicago 41, Illinois • MULberry 5-5000



A ZENITH SUBSIDIARY

Designed for



Application



90923

**RACK MOUNTED OSCILLOSCOPES**

Illustrated is No. 90923, one of the Millen line of rack mounted oscilloscopes. No. 90923 is complete with amplifiers and sweep. Good low frequency response and linearity. For monitoring, production test, or laboratory use. Compact. Uses type 3XP1 3" x 1 1/2" rectangular cathode ray tube.

**JAMES MILLEN MFG. CO., INC.**

**MALDEN  
MASSACHUSETTS**

**An engineer talks shop in the  
New York World-Telegram  
three times weekly—  
Monday, Wednesday, Saturday**

Rockets and computers are just part of Dick Slawsky's beat. As an engineer turned reporter he takes a lot of time to cover the machines that make miracles possible.

But his big job is keeping you posted on the developments in engineering today. Follow him as he reviews the facts behind our scientific breakthroughs... in a terse, timely column in the New York World-Telegram.

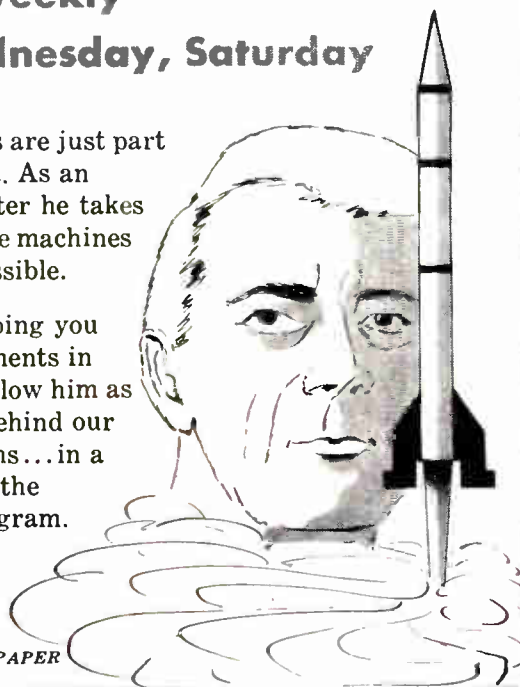

A SCRIPPS-HOWARD NEWSPAPER



**Section Meetings**

(Continued from page 128A)

**SUBSECTIONS**

**BUCENAVENTURA**

"Automation in Medicine," Robert Martin, Systems Development Corp. 2/17/60.

**EAST BAY**

"Recent Electronic Experience at Saclay, France"; "Recent Work in Photo Multipliers," Q. A. Kerns, Lawrence Radiation Lab. 2/15/60.

**FAIRFIELD COUNTY**

"State of the Art in the Field of Receivers as Pertains to Weak Signal Reception," F. S. Harris, Microwave Associates. 2/25/60.

**KITCHENER-WATERLOO**

"Parametric Amplifier," Dr. J. L. Ven, University of Toronto; Demonstration of Parametric Amplifiers by S. Demitrescu, University of Toronto. 2/22/60.

**LANCASTER**

"The Significance of Military Communication Satellites," C. D. May, Jr., Army Communication Service, Washington, D.C. 1/21/60.

**LEHIGH VALLEY**

"Facilities and Functions of the New Bethlehem Steel Company Research Laboratory," J. S. Marsh, Bethlehem Steel Co. 1/8/60.

"Inertial Guidance and Space Navigation," G. C. Anderson, North American. 2/21/60.

(Continued on page 122A)



**NEWEST way to write performance . . .**

*servo/riter*\*

**SELF-BALANCING POTENTIOMETRIC RECORDER**

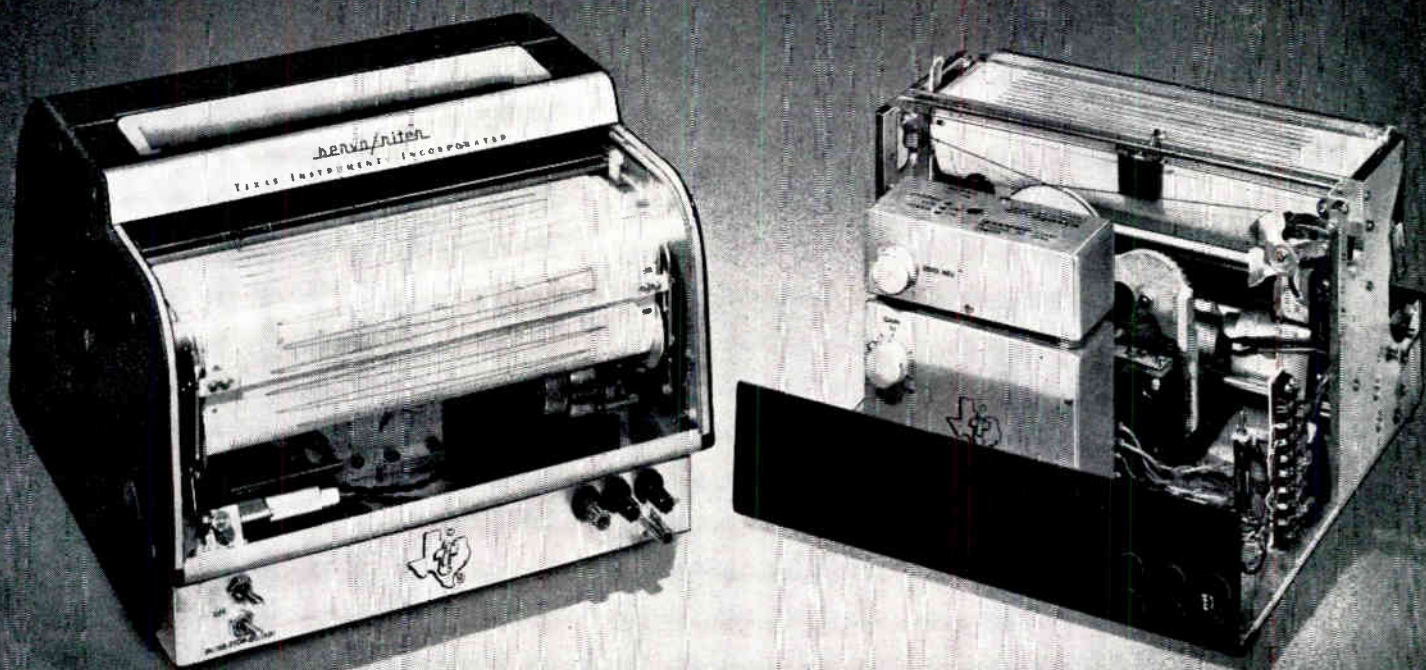

**OFFERS YOU MORE HIGH PERFORMANCE FEATURES  
THAN ANY OTHER RECORDER...at any price!**

The old cliché, "You can pay more but you can't buy better" was never more applicable than in the new "servo/riter" recorder. Texas Instruments has developed a self-balancing potentiometric recorder that incorporates *premium* engineering refinements, sensitivity, reliability and quality construction as *standard* equipment.

**High-Sensitivity** — Standard electrical span of 2.5 millivolt d-c with off-balance input resistance of 4 megohms gives a power sensitivity of better than  $10^{-17}$  watts.

**Fast Pen Speed** — Span step response is less than 0.5 second.

**High Interference Rejection** — Good filtering provides high orders of rejection to common-mode d-c and all types of 60 cps interference. Guard shields permit making full-accuracy measurements at hundreds of volts above ground.

**Long-Term Reliability** — Tube life is prolonged by

heat-dissipating shields. Amplifier gain is stabilized by partial negative feedback. Non-lash, non-wearing, toothed belt drive gives long consistent performance.

**Superior Operating Conveniences** — Recorder function is easily changed by plug-in input units. Presently standard are 2.5, 5, or 10 millivolt d-c electrical spans . . . special applications and ranges are easily accommodated. "Micrometer" control for zero adjustment and main amplifier gain control are readily accessible as are all other adjustments, connections, and controls. The popular 10-speed chart gears and the high-capacity, easy-prime ink handling system proved on the "recti/riter"<sup>®</sup> recorder are standard equipment on the "servo/riter" recorder.

There are four "servo/riter" recorder models to choose from . . . *Single Channel, Narrow Grid; Single Channel, Wide Grid; Dual Channel, Narrow Grids; and Dual Channel (overlapping pens), Wide Grid.* Write for technical literature and TI engineering assistance in your specific end or OEM use.



**TEXAS INSTRUMENTS  
INCORPORATED**

GEOSCIENCES & INSTRUMENTATION DIVISION  
3609 BUFFALO SPEEDWAY • HOUSTON 6, TEXAS • CABLE: TEXINS

The new "servo/riter" recorder is a companion to the proved "recti/riter" recorder.

\*"servo/riter" is a trademark of Texas Instruments



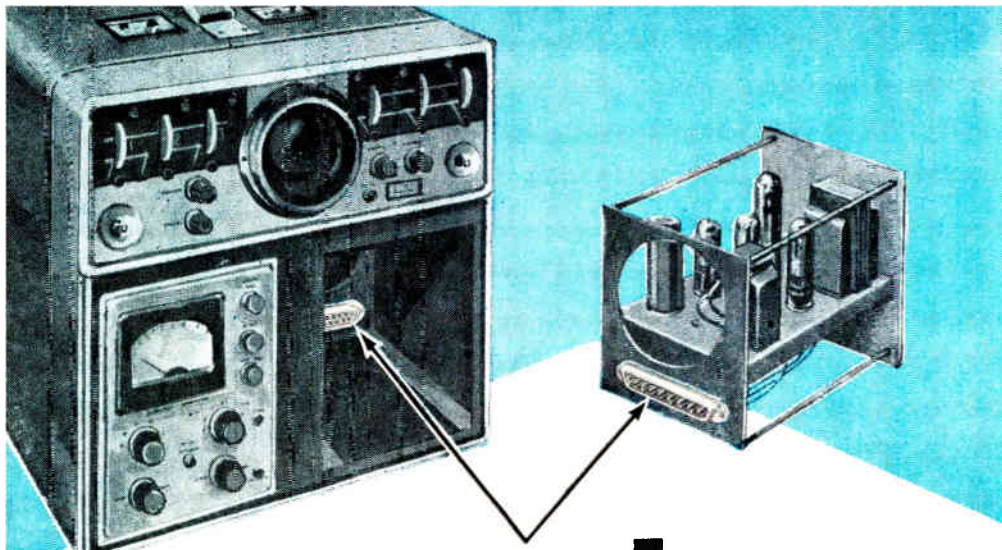

**new!**

# Min Rac 17

## miniature rack & panel connectors with POKE-HOME® contacts

Solve space, weight and size problems with AMPHENOL's new Min Rac 17 connectors, true miniatures with the "Big Plus" advantage of Poke Home contacts! Min Rac 17's are rack & panel connectors ideally suited for today's compact chassis designs, connectors half the size and weight of standards, delivering full size efficiency. And with the patented Poke Home contact concept (U.S. Pat. 2,419,018), Min Rac 17's are easily, reliably assembled—contacts are crimped or soldered outside the connector body, then "poked home" for assembly.

Min Rac 17's are available in 9, 15, 25, 37 and 50 contacts in rack & panel, cable-to-chassis and cable-to-cable designs. Contacts are gold plated. Shells may be ordered with clear chromate or gold iridite finish.

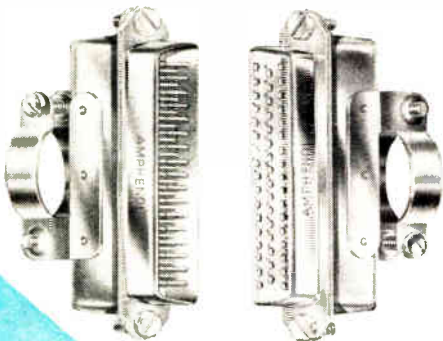

These remarkable connectors are available now—write for full catalog!

**AMPHENOL** CONNECTOR DIVISION

1830 S. 54th AVE., CHICAGO 50, ILLINOIS

Amphenol-Borg Electronics Corporation  
World Radio History



### Section Meetings

(Continued from page 130A)

#### MEMPHIS

"Engineering-Science Teaching as a Career," I. Freymuth, Southwestern at Memphis, 2/25/60.

#### MURRIMACK VALLEY

"The Hawk Missile System," J. J. Kirby, Raytheon Co. 2/15/60.

#### NORTHERN VERMONT

"Progress Report—Space Technology," D. E. Mullen, General Electric, 2/23/60.

#### SANTA ANA

"The Engineer's Status to His Company, the Profession and His Community," Panel discussion by I. J. Kaut and E. E. Ferry of Hoffman Electronics Corp., and Arthur Curtiss, RCA, 2/24/60.

#### SANTA BARBARA

"Monstrous Growth in High Energy Physics," Dr. H. Bradner, University of California, 1/22/60. "Millimetric Waves," J. Markin, Raytheon Co. 2/24/60.

#### WESTERN NORTH CAROLINA

"Properties of Teflon," J. P. Shoffner, Dupont. "Teflon Fabrication and Applications," B. Ely, Pennsylvania Fluorocarbon Co. 2/26/60.

10 TO 60 MILLIWATT SENSITIVITY!

SERIES 6000

*terado* MICRO RELAY

For Tube or Transistor Circuits.

Hermetic Seal  
Plug in or Terminals



(ACTUAL SIZE)  
SPECIFICATIONS

- S.P.D.T. Switch
- 60 Milliwatt Nominal (Special to 10 Milliwatt)
- Rating—1 Amp., 24 V. Non-Inductive
- 24 to 10,000 Ohm Coils
- Vibration Characteristics Excellent
- Built to Match Your Circuit

**TERADO COMPANY**

1065 RAYMOND AVE. • ST. PAUL 8, MINN.

# Tunnel Diode Switching Time Measurement with Tektronix Type N Sampling Plug-In Unit

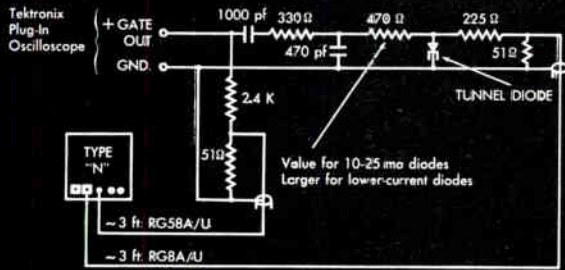

A convenient low-cost method of testing tunnel (Esaki) diodes with nanosecond switching speeds is shown above. A Tektronix Plug-In Oscilloscope provides both the current ramp source for the tunnel diode and the pretrigger for the Type N Unit. The N Unit is set up in the usual way — however, the oscilloscope main sweep generator is allowed to free run at  $1 \mu\text{sec/cm}$ . The + GATE OUT not only triggers the N Unit but also provides a delayed current ramp with a low rate of change — which allows the tunnel diode to switch at essentially its own rate.

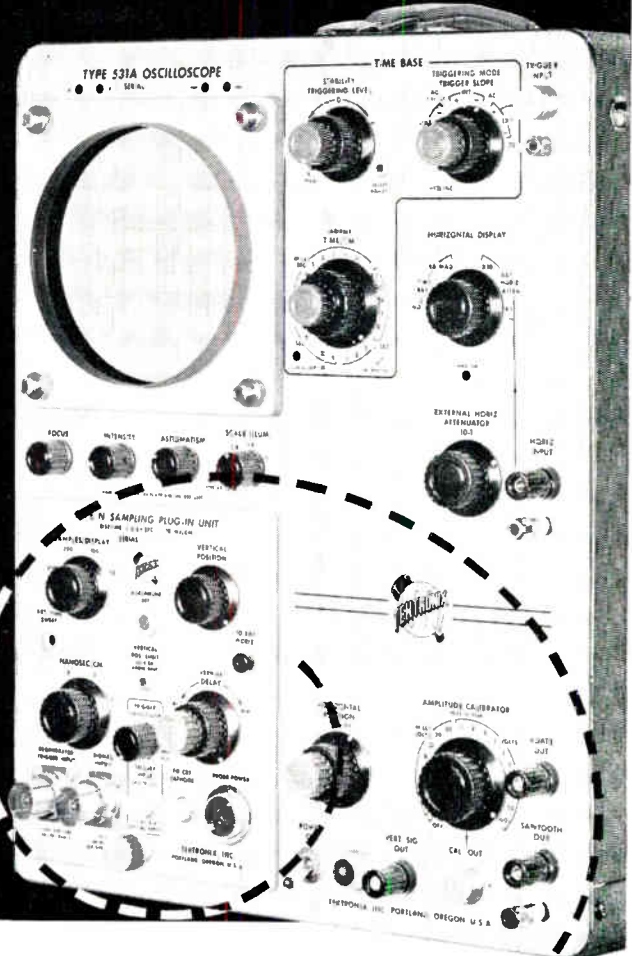
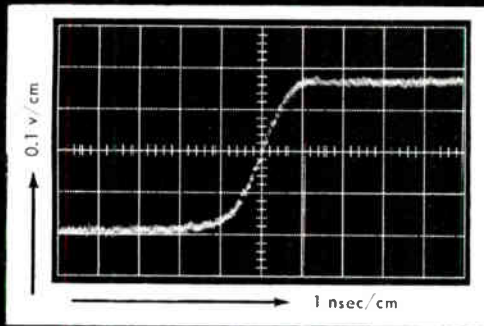

## NEW PULSE-SAMPLING UNIT for all Tektronix Plug-In Oscilloscopes

The new Type N Unit converts your Tektronix Plug-In Oscilloscope to a Pulse-Sampling Oscilloscope with a risetime of 0.6 nanoseconds. Applications in which the signal source can furnish a "pretrigger", such as that shown above, require no additional equipment.

For a completely versatile Pulse-Sampling System, Tektronix also manufactures a Pulse Generator and Trigger Takeoff, a 60-nsec Delay Line, a Pretrigger Pulse Generator, and several useful accessories. Please call your Tektronix Field Engineer for complete details and, if desired, a demonstration of the Type N Unit or the complete System.

### Tektronix, Inc.

P. O. Box 500 • Beaverton, Oregon  
Phone Mitchell 4-0161 • TWX—BEAV 311 • Cable: TEKTRONIX

**TEKTRONIX FIELD OFFICES:** Albuquerque, N. Mex. • Atlanta, Ga. • Baltimore (Towson, Md.) • Boston (Lexington, Mass.) • Buffalo, N.Y. • Chicago (Park Ridge, Ill.) • Cleveland, Ohio • Dallas, Texas • Dayton, Ohio • Denver, Colo. • Detroit (Livonia, Mich.) • Edicott (Endwell, N.Y.) • Greensboro, N.C. • Houston, Texas • Kansas City (Mission, Kan.) • East Los Angeles, Calif. • Minneapolis, Minn. • New York City Area (Albany, N.Y.) • New York • Stamford, Conn. • Union, N.J. • Orlando, Fla. • Philadelphia, Pa. • Phoenix, (Scottsdale, Ariz.) • San Diego, Calif. • San Francisco (Palo Alto, Calif.) • St. Petersburg, Fla. • Syracuse, N.Y. • Toronto (Willowdale, Ont.) • Canada • Washington, D.C. (Arlingdale, Va.)

**TEKTRONIX ENGINEERING REPRESENTATIVES:** Hawthorne Electronics, Portland, Oregon • Seattle, Washington. Tektronix is represented in twenty overseas countries by qualified engineering organizations. In Europe please write Tektronix Inc., Victoria Ave., St. Sampsons, Guernsey C.I., for the address of the Tektronix Representative in your country.

### Characteristics

- 0.6 nsec risetime (approximately 600 mc).
- 10 mv/cm sensitivity. (2 mv or less amplitude noise.)
- 1, 2, 5, and 10 nsec/cm equivalent sweep times (20 to 50 psec time noise).
- 50-ohm input impedance.
- 50, 100, 200, and 500 samples per display.
- Sampling rate — 50 c to 100 kc.
- $\pm 120$  mv minimum linear range (safe overload 4 v).
- Trigger input requirement: +0.5 v, 1 nsec duration, 40 nsec in advance of signal. Recovery time is 10  $\mu\text{sec}$ . Counts down from 50 mc.

PRICE . . . . . \$600  
f.o.b. factory





# digilock

the first orthogonal PCM system for ultra long range telemetry...  
... offering an unmatched efficiency

## SPACE ELECTRONICS CORPORATION

930 Air Way Glendale 1, California CHapman 5-7651

Those qualified to join an exceptional team of senior engineers and scientists  
are invited to inquire.

Space Electronics—a new and rapidly expanding dimension in creative electronics—offers an environment to senior engineers and scientists which embodies those challenges and opportunities vital to individual growth. Young, but possessing a wealth of experience in missile electronics that is unsurpassed by any comparable firm, Space Electronics already has made significant and practical contributions to our nation's missile and space program.

One such example is.....



## Positions Open



The following positions of interest to IRE members have been reported as open. Apply in writing, addressing reply to company mentioned or to Box No. ....

The Institute reserves the right to refuse any announcement without giving a reason for the refusal.

Proceedings of the IRE  
1 East 79th St., New York 21, N.Y.

### TEACHING POSITION

Expanding, recently organized dept. with a modern science-oriented curriculum, seeks a well-qualified person who is interested primarily in teaching. Advanced degree required. This is an unusually attractive position for the right individual. 12 month salary assured, if desired for approximately 10 1/2 months service. Possible to have every other summer off while earning full salary. Salary range is approximately \$6,000 to \$8,000. Private, medium-sized university in midwest. Send complete resume to Box 2011.

### ENGINEER

Electronics Research and Development Lab. needs man with experience in transistor-circuit development. Position carries opportunity to study for advanced degrees in Physics or Engineering. Salary consistent with training and experience. Applicants will be required to have BS. degree or better in Physics or Engineering to qualify. For more details write Research Foundation, Oklahoma State University, Stillwater, Okla., or call R. E. Buck, Frontier 2-6211, Ext. 579, after 5 P.M. or holidays call Frontier 2-8480.

### ELECTRICAL ENGINEERS

University appointments Electrical Engineering. Three openings including the Chair in Electrical Engineering in new Faculty of Applied Science with opportunity for advancement and research. Attractive salary schedule. New building under construction. Ph.D. or Master's degree desirable. Apply to F. A. DeMarco, Principal, Essex College, Windsor, Ontario.

### TEACHING POSITION

Expansion of graduate work in E.E. at Syracuse University has created several openings at the Assistant and Associate Professorial ranks. Except in very unusual circumstances, applicants should have a Doctorate in E.E. or a closely allied field. Opportunities exist for combination of teaching and research during the academic year, and for summer employment on research. Teaching is primarily at the graduate level. Salary depends on experience, but in most cases the yearly salary (for 11 months work) is reasonably competitive with industry. Write to Dr. W. R. LePage, Chairman, Dept. of E.E., Syracuse University, Syracuse 10, New York.

### ASSOCIATE OR ASSISTANT PROFESSOR

Expert in field of semiconductors. Ph.D. is minimum requirement, applicant must have some teaching experience. Academic rank and salary dependent on demonstrated ability and over-all experience. The man in this position will divide his time between teaching and research. Appointment begins Sept. 1960. Write, including resume to W. R. Beam, Head, E.E. Dept., Rensselaer Polytechnic Institute, Troy, N. Y.

(Continued on page 138A)



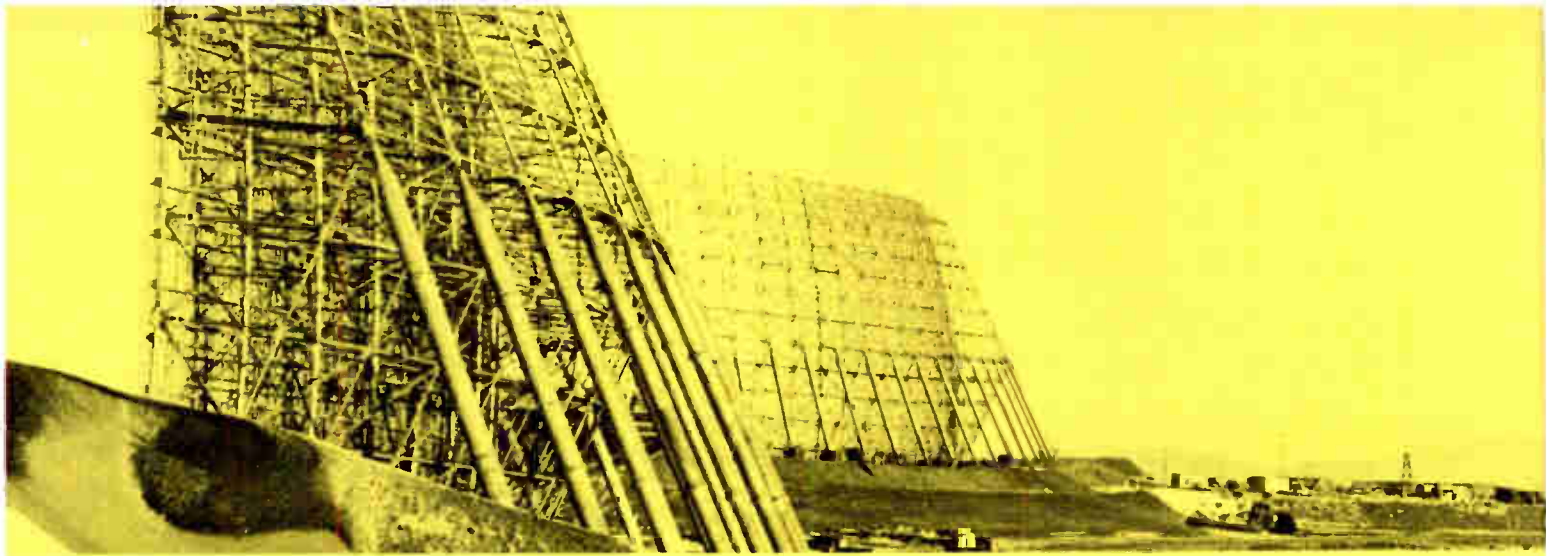

Professional placement report  
for Electronics Engineers

*How the continuous need  
to improve the nation's  
space surveillance  
capabilities opens  
avenues for new  
engineering careers*

The continuous need we are talking about at General Electric refers to the fact that future-generation missiles, satellites and deep space probes will require refined or entirely new detection techniques, including many that have not yet been conceived.

*For example, it is anticipated that for every technical discipline now utilized in the detection field, at least one more must be found to apply within the next 10-year period.*

With this in mind, General Electric is increasing its electronics engineering staff now working on advanced missile, satellite and deep-space probe detection systems. Keeping pace with this expansion, the Company added a new building last year, and another will be ready for occupancy in a few months.

First clues to this trend were obvious in General Electric's well known "Golfball Study," published five years ago. This study compared the problem of missile detection to that of locating a golfball 200 miles away, using the most advanced techniques available in 1954. The problem no longer has such proportions, thanks to the creative imagination of dedicated General Electric engineering, scientific, and technical personnel responsible for designing and developing the unique surveillance sub-system of the Ballistic Missiles Early Warning System (BMEWS) which is receiving headline attention today.

***Find out more about these creative and self-expressive opportunities now open to qualified personnel in one of the most vital technologies of the space age.***

GENERAL  ELECTRIC

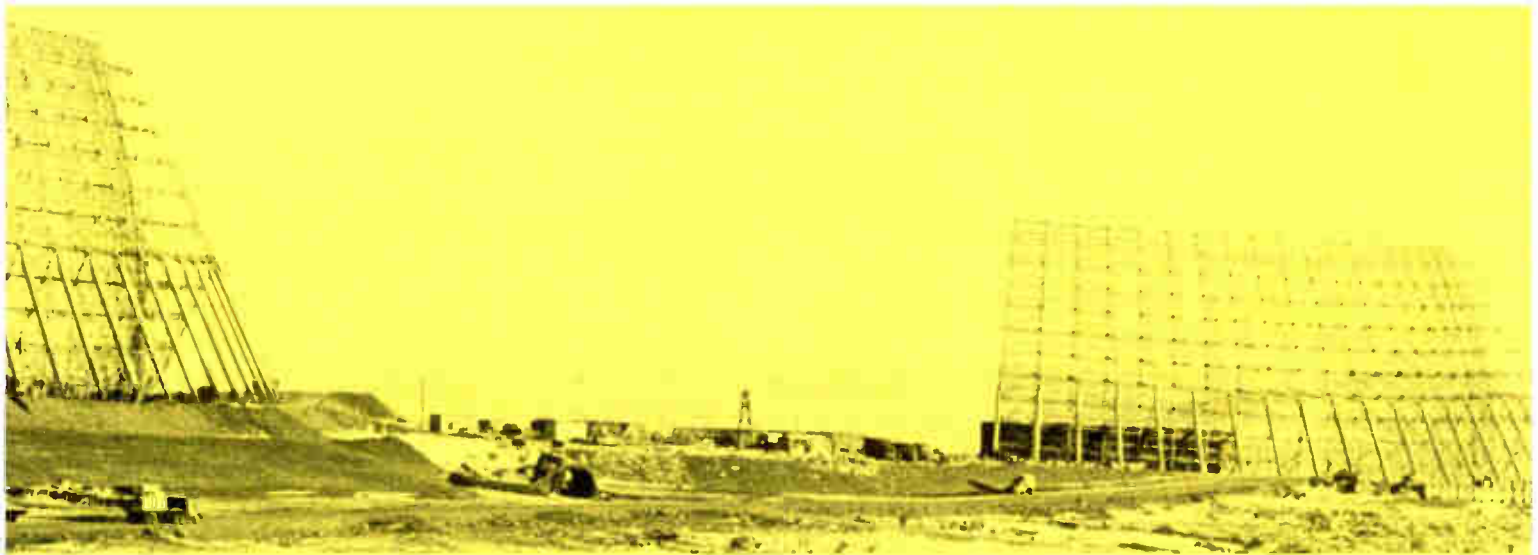

*Immediate openings  
for qualified  
electronics  
engineers*

**RADAR EQUIPMENT SYSTEMS SPECIALISTS** capable of conceiving and directing the design of long-range radar systems. Desirable experience includes 3 to 10 years in at least one of the following: radar systems design, antenna systems, RF components, transmitters, radar receiver systems or radar data processing systems. Salary structure is fully equal to the professional requirements of the job.

**ADVANCED SYSTEMS ENGINEERS** capable of defining future defense and space detection problems including deep space-probe tracking. Also the ability to conceive and establish the feasibility of optimum systems solutions to these problems—making use of the most advanced techniques and understandings. Also required is an ability to recognize the need for, and coordinate the development of, new techniques and the exploration of new phenomena. Experience requirements include a Bachelor degree plus a combination of advanced training and several years' experience in both the theoretical and practical aspects of detection systems engineering. A desire to work in the conceptual phase of systems design with the analytical ability required to evaluate and demonstrate the effectiveness of the proposed systems is essential.

**FIELD OPERATIONS ENGINEERS** for systems management teams to be deployed at complex radar systems installations of the BMEWS type. Systems-oriented Electronics Engineers are needed who have the ability to assume responsibility for installation, checkout, and integration of major radar systems. Background in high-powered Klystron transmitters, low-noise receivers and digital data processing equipment is desirable. A Bachelor degree is required.

**ADDRESS YOUR INQUIRY IN CONFIDENCE TO:  
MR. JOSEPH WOOL, PROFESSIONAL PLACEMENT, DEPT. T-4  
MISSILE DETECTION SYSTEMS SECTION  
HEAVY MILITARY ELECTRONICS DEPARTMENT  
GENERAL ELECTRIC COMPANY  
COURT STREET, SYRACUSE, NEW YORK**

Qualified applicants will be invited to visit us in Syracuse at Company expense. Relocation assistance will be provided. 177-25

**GENERAL  ELECTRIC**

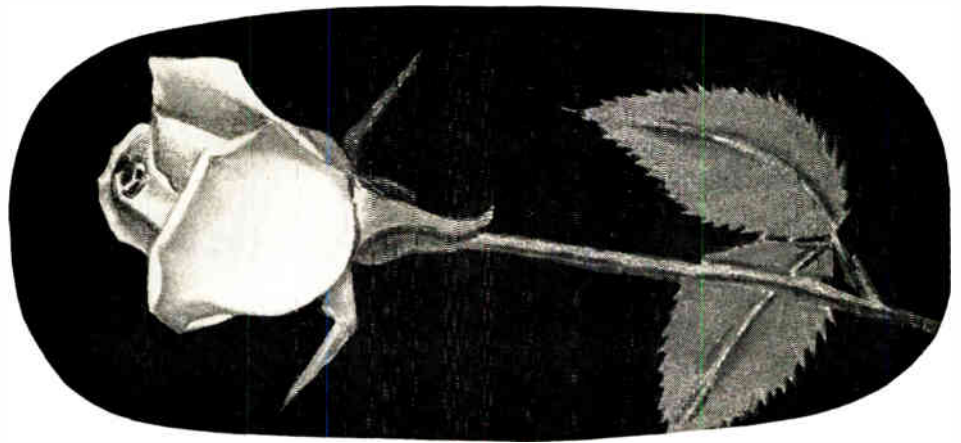

*At Bendix York, we have a number of immediate openings for Electronic Engineers and Physicists.*

*There are many worthwhile advantages awaiting the Professional Engineer who chooses to advance his career with us at Bendix York.*

## *A white rose . . .*

The white rose is a symbol at Bendix York . . . a symbol with two meanings. Both of vital importance to *your* future.

First, the white rose is the official flower of York, Pennsylvania. It is a symbol of the good life in our dynamic community, located in the heart of the scenic Pennsylvania Dutch region. It is a wholesome, happy area with excellent schools, delightful recreational opportunities and many cultural advantages. Here—away from high-pressure, high-cost, big-city living—you will enjoy the fuller, more rewarding life that you want for yourself and for your family.

Second, the white rose is a symbol of perfection . . . the perfection for which we strive at Bendix York—perfection in the engineering and scientific pioneering and development in missile electronics that is our principal objective.

We offer a small Division's assurance of individual recognition and advancement, and yet you have the security and employee benefits of a large corporation.

We would like to have the opportunity to tell you more about Bendix York. We invite you to contact us—by dropping us a post card, by giving us a call or, if you will, by sending us a brief resume. Address Professional Employment: Dept. P



**YORK DIVISION**

**York, Pennsylvania  
Phone: York 47-1951**



# ENGINEERS

**NOW—CHOOSE YOUR ASSIGNMENT  
AND LOCATION THROUGH OUR  
NATION-WIDE PLACEMENT SERVICE  
SALARIES \$7,500 TO \$18,000**

**We can offer you a large selection of diversified positions with America's foremost electronic organizations. Some positions for non-citizens.**

**The following are just a few of a large number of desirable opportunities.**

## SR. ENGR.—DIGITAL COMPUTERS—

Exp. required in systems, logical design, packaging, system integration or pulse circuitry. To \$15,000

**FLIGHT TEST EVALUATION—Sr. Opp** in Ground & Flight Test on data links, precision transducers, telemetering equipment, power supplies, circuit monitors and impedance matching units. To \$15,000

**RF ANTENNA—Proj. Engr.** \$15,000

**INFRA RED—Proj. Engr.** \$15,000

**CIRCUIT DESIGNERS — 2-5 years** Transistor experience. \$11,000

## ADVANCED SYSTEM DEVELOPMENT

—Supervisory position in digital computer, fire control or missile guidance development. To \$17,000

**PHYSICIST Phd.—Nuclear experience** pertaining to radiation from propulsion units—unusual opportunity. To \$18,000

**PROJECT LEADER—Antenna Pedestals.** \$13,000

**SR. ENGINEER—DEVELOP Airborne & spaceborne communications systems.** \$15,000

Just tell us what you would like to do and where you would like to locate, and we will handle everything for you without cost or obligation.

### LOCATION DESIRED

- New England
- Northern East Coast
- Southern East Coast
- Midwest
- Southwest
- West Coast

### POSITION DESIRED

- Systems
- Radar
- Transistors
- Tubes
- TV Receivers
- Microwave
- Anal. Computers
- Dig. Computers
- Antenna
- Servo-Mechanisms
- Navigation
- Counter Measures
- Telemetering
- Nucleonics
- Ind'l. Instruments
- Components
- Circuit Design

### WHAT SATISFIED ENGINEERS SAY:

Dear Mr. Brisk:  
*This is to advise you I have accepted employment with \_\_\_\_\_ Company as a project leader at \$15,000. Your service has been a real help to me, for I am sure I could not have found this unusual opening by myself. Thank you.*

H.M.P.

Dear Mr. Brisk:  
*I have today advised \_\_\_\_\_ Company that I would be pleased to accept their offer. I start August 1st as a senior engineer at \$13,000. The opportunity is one of the most outstanding I have seen.*

J.S.E.

**A National Electronic Placement Service Established in 1937. You are assured of prompt and completely confidential service by forwarding three resumes to HARRY L. BRISK, (Member IRE)**

**APB Accredited Personnel Service**

Employment Counselors Since 1937  
Department A

12 South 12th St., Philadelphia 7, Penna. WALnut 2-4460



## Positions Open



(Continued from page 134A)

### EDITOR

Scientific book publisher needs radio engineer to plan and develop new books. Publishing experience desirable. Write in detail. State salary. Box 2012.

### ENGINEERS

Major firm seeking (1) Section leader, Electromechanical design, (2) Section leader, testing and reliability, knowledge of Military acceptance testing, (3) Manufacturing engineers, knowledge of standards, process and tool engineering for electromechanical display equipment. Top future positions. Benefit programs. Salaries \$8,000-\$15,000. Contact Mr. W. Hart, Witty-Polon Management Consultants, 176 East 75 St., New York 21, N. Y. Telephone: Lehigh 5-4222.

### INSTRUCTOR AND ASSISTANT PROFESSOR

For those interested in teaching fundamental electrical & electronic subjects. Opening for fall semester beginning Sept. 1960. Salary depends on qualifications. New building and equipment. Opportunity for advancement and further study. 9 month academic year. Part time evening session work available. Health Insurance and Pension Plan. Send complete resume to Prof. I. L. Kosow, Dept. Head, Electrical Technology, Staten Island Community College, 50 Bay St., Staten Island 1, N. Y.

### ELECTRICAL ENGINEERING PROFESSORS

Fast growing Engineering School on west coast needs 3 electronic-electrical engineers able to teach circuits and electronics, with a specialty in communications, industrial electronics or computers. M.S. degree plus industrial experience is the minimum requirement; a Ph.D. is desirable. Salary and rank will depend on experience. The dept. has just moved into a new building and needs aggressive men who wish to develop curricula and labs. Apply L. Cromwell, Head, E.E. Dept., Los Angeles State College, 5151 State College Dr., Los Angeles 32, Calif.

### PROFESSOR

Assistant and/or Associate Professor of E. E. with interest and experience in one of the following areas: electromagnetic theory, information theory, digital computer logic and numerical methods, solid state. Ph.D. required, Combination of research, graduate and undergraduate teaching. Address inquiries to Dr. C. Polk, Head Dept. of E.E., University of Rhode Island, Kingston, Rhode Island.

### PROJECT ENGINEER

Project Engineer to supervise complete projects in design and development of automatically sequencing, self checking test equipment used to evaluate complex airborne guidance systems and components, as well as industrial process instrumentation. E.E. plus 5-7 years experience. Kearfott Div.—General Precision, Inc. Att: P. Kull, 1500 Main Ave., Clifton, New Jersey.

### SENIOR ELECTRICAL ENGINEER

E.E. degree and 8-10 years experience including experience in electronics. Interesting work in conjunction with a nuclear physics research program. Benefits include a reduced tuition rate for the employee and free tuition for children of employees with 5 or more years of service. If interested, send complete resume, in-

(Continued on page 143A)

This "bazooka" type cannon of 1395 fired lead, lapidary and finned missiles. Their main disadvantage — practically impossible to aim or guide to its target. The missile was named after Henry VIII because he was considered a connoisseur of walking sticks which were often used to conceal weapons.

Today, as a vital part of one of the world's largest electronics companies, Raytheon's Missile Systems Division is making significant contributions to the art of missilery. The exciting new Pin Cushion Project for selective missile identification, the constantly advancing Navy's air-to-air SPARROW III and Army's HAWK are examples of their outstanding creative work.

We are seeking highly creative people to maintain Raytheon's leadership in this challenging field. For these people, Raytheon's Missile Systems Division creates a climate for talent — perhaps *your* talent.

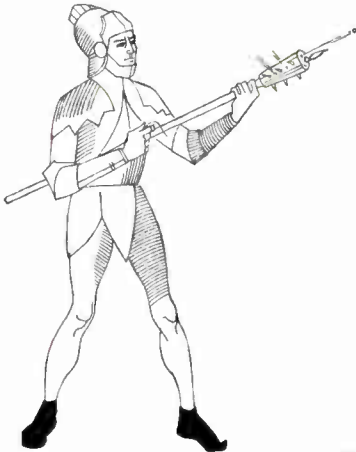

## 14<sup>th</sup> CENTURY WALKING STICK

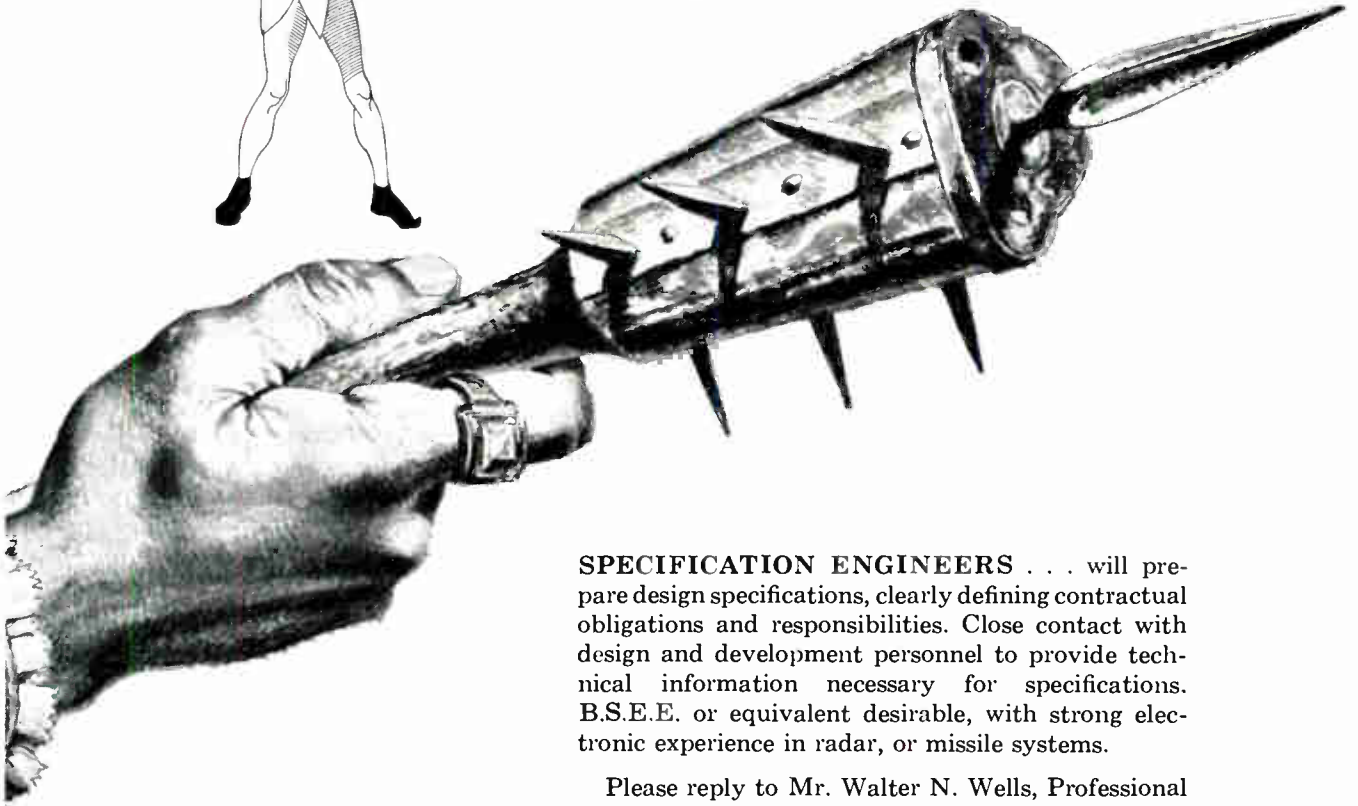

**SPECIFICATION ENGINEERS . . .** will prepare design specifications, clearly defining contractual obligations and responsibilities. Close contact with design and development personnel to provide technical information necessary for specifications. B.S.E.E. or equivalent desirable, with strong electronic experience in radar, or missile systems.

Please reply to Mr. Walter N. Wells, Professional Personnel, Missile Systems Division, Raytheon Company, 520 Winter Street, Waltham, Mass.

19WSE



**MISSILE  
SYSTEMS  
DIVISION**



*... creates a climate for talent.*

# How will this picture look

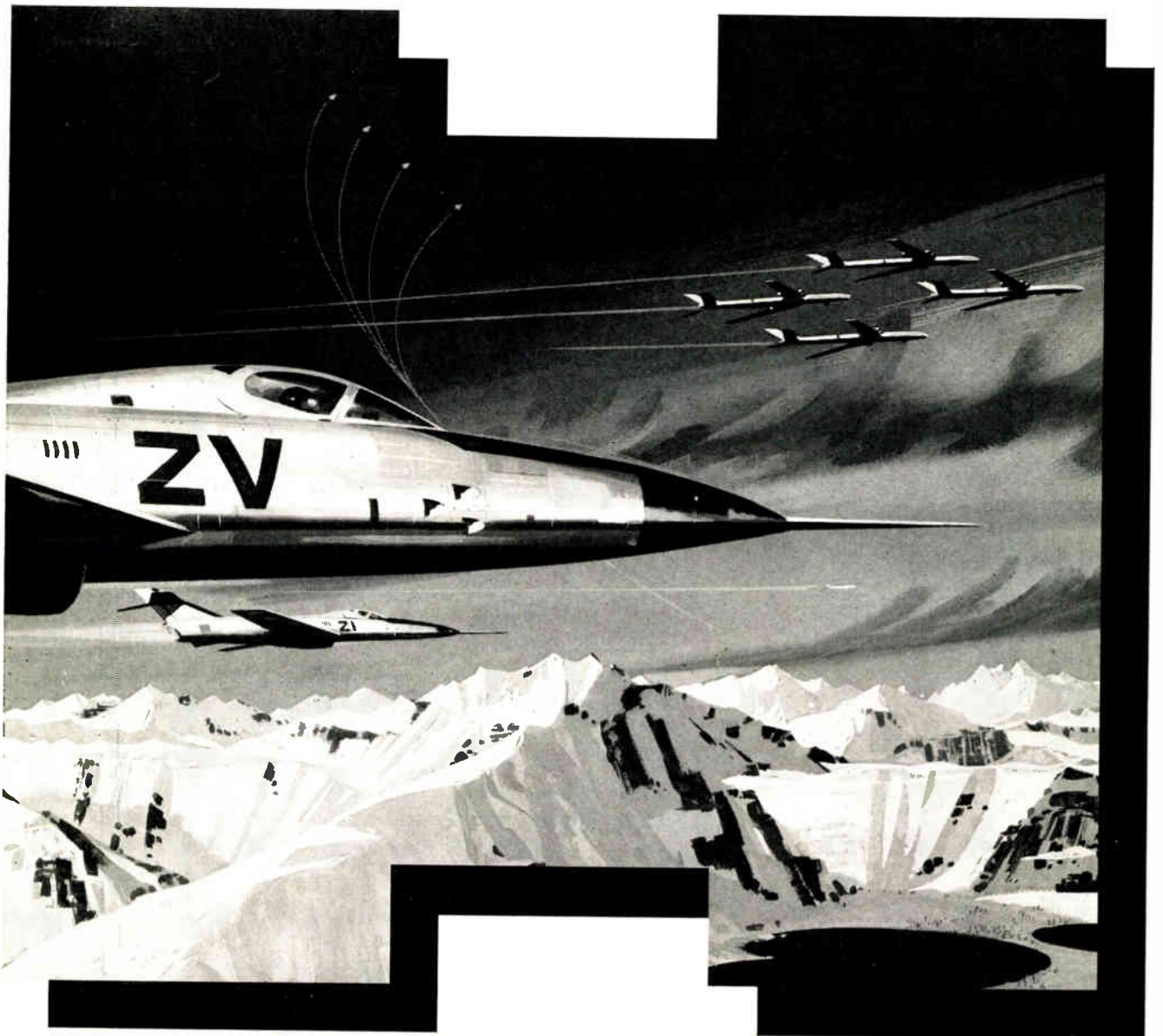



# in ten seconds?

**In ten seconds these aircraft, flying at jet speeds, will create an entirely new tactical picture. How do you keep track of hundreds of them at the same time?**

Hughes Fullerton engineers have solved this problem with a unique and highly advanced digital computer. This computer simultaneously tracks large numbers of aircraft and provides three-dimensional coordinate and velocity information on them.

These Fullerton engineers have designed the computer to provide extrapolated position data to the observer several times per second. In addition, it will measure the position and report velocity characteristics changes every few seconds for each of a large number of targets.

The computer utilizes advanced semiconductor circuitry throughout. The out-puts to the displays are made through high-speed digital to analog converters capable of providing an accuracy of one part in ten thousand – and within  $10 \times 10^{-6}$  seconds.



**This giant transmitting antenna creates the beam for experimental antenna pattern measurements – part of the Hughes microwave research and development programs.**

**Housed in the tip of this Hughes survey meter is the smallest, fastest, most accurate radiation detector ever devised – just one example of Hughes' activities in the expanding field of nuclear electronics.**



Utilizing the latest techniques in packaging and subminiaturization, Hughes Fullerton Engineers have designed this unit as a mobile system which will withstand rigorous field use.

Other Hughes activities provide similarly stimulating outlets for creative engineers. Constantly moving forward into new areas, Hughes projects include: hydrofoil systems, anti-submarine warfare systems, miniaturized communications systems, new solid state electronics devices, nuclear electronics systems and unique navigational systems – just to name a few.

The commercial activities of Hughes have many interesting projects for engineers in the research, development and manufacture of semiconductors, microwave components, storage tubes, radiation detectors, radiation handling equipment and microwave tubes.

Whatever your field of interest, you'll find Hughes' diversity of advanced projects gives you widest possible latitude for professional and personal growth.

*Newly instituted programs at Hughes have created immediate openings for engineers experienced in the following areas:*

Electroluminescence	Equipment Engineering
Infra-red	Microwave & Storage Tubes
Solid State Physics	Communications Systems
Digital Computers	Inertial Guidance
Reliability & Quality Assurance	Field Engineering
Systems Design & Analysis	Circuit Design & Evaluation

*Write in confidence to Mr. M. W. Welds  
Hughes General Offices, Bldg. 6-E5, Culver City, Calif.*

*Creating a new world with ELECTRONICS*

## HUGHES

**HUGHES AIRCRAFT COMPANY**

Culver City, El Segundo, Fullerton, Newport Beach, Malibu, Oceanside and Los Angeles, California; Tucson, Arizona.

## PRELIMINARY DEVELOPMENT

# SENIOR ENGINEERING SPECIALISTS

Honeywell Aero Preliminary Development Staff has several openings for technically qualified and mature engineers with significant military system development experience. Each man will provide guidance and support in his specialty to Honeywell design projects for the best use of advanced techniques in development of new airborne systems. These staff positions offer scope for original personal contributions and will require active participation in the formulation and execution of Division engineering programs. Among the openings are:

### WEAPON DELIVERY AND CONTROL SYSTEMS SPECIALIST

Background of system and computer development for bombing, fire control, or navigation. Firsthand experience with system analysis, tie-in requirements, analog and digital computers, operations analysis, and weapon effectiveness evaluation.

### DETECTION SYSTEMS SPECIALIST

Primary background of airborne radar development in one or more areas such as AMTI, Doppler, pulse Doppler, automatic tracking, and countermeasures. Experience in infrared or communications will be valuable. Experience should include system analysis, design requirements, equipment development, and performance evaluation.

### ELECTRONIC CIRCUIT AND PACKAGING SPECIALIST

Background of circuit design for advanced control and computation equipment. Should be familiar with dc, low frequency, pulse and rf techniques. Must be able to establish sound analytical basis for circuit design to specific levels of reliability and performance. Must be experienced with solid state devices and prepared to contribute to Aero Division work on microcircuit techniques.

*To discuss openings for these and other specialties, write or phone Mr. J. R. Rogers, Chief Engineer, Preliminary Development Staff, Dept. 610E, Aeronautical Division, 1433 Stinson Blvd., Minneapolis 13, Minn.*

## Honeywell

 Military Products Group

*To explore professional opportunities in other Honeywell operations coast to coast, send your application in confidence to H. K. Eckstrom, Honeywell, Minneapolis 8, Minnesota.*

## Electronic Engineers

EXCELLENT POSITIONS ARE OPEN IN

# PACIFIC MISSILE RANGE PROJECTS

Career civil service positions with the Navy are now open for qualified electronic engineering applicants. Salaries range from \$8810 to \$10,130, plus excellent additional benefits and established promotional and advancement opportunities.

Work involves project management, design, development and installation of vast-scale electronic instrumentation systems for the Pacific Missile Range.

Areas of employment are the Pacific Missile Range, Point Mugu, Calif.; the Naval Missile Facility, Point Arguello, Lompoc, Calif.; and the Office of Resident Industrial Manager, San Diego, Calif. Inquiries should be directed to the Industrial Relations Office, Dept. A.

## NRF

U. S. NAVAL REPAIR FACILITY

San Diego 36, California

# STANFORD RESEARCH INSTITUTE

Invites

**ELECTRONIC ENGINEERS**

**PHYSICISTS**

**MATHEMATICIANS**

*to participate in research for:*

**PROPAGATION**

**CONTROL SYSTEMS**

**MICROWAVE COMPONENTS**

**SYSTEMS ANALYSIS IN**

**Missiles**

**Space Systems**

**Communications**

**ANTENNAS**

**COMMUNICATIONS THEORY**

**MATHEMATICAL RESEARCH**

**INFORMATION THEORY**

**COMPUTER MAGNETIC DEVICES**



If you are interested in research as a way of life, SRI offers you varied and professionally stimulating research in an atmosphere of quiet dignity.

You can share rewarding professional association, excellent research facilities and responsible assignments with the delightful bonus of living and working in California's San Francisco Bay Area.

Projects are open to qualified personnel on the MS and PhD level who have 3 years or more experience in Electronic Engineering or Applied Physics.

*Advanced study opportunities  
Industrial level salaries.*

Write to...

**PROFESSIONAL EMPLOYMENT  
MANAGER  
STANFORD RESEARCH INSTITUTE  
MENLO PARK, CALIFORNIA**





## Positions Open



(Continued from page 138A)

cluding salary expectations to J. R. Whitley, Employment Supervisor, University of Rochester, 260 Crittenden Blvd., Rochester 20, N.Y.

### MEDICAL ELECTRONICS

Biophysical Electronics, Inc. devotes its efforts to the design and manufacture of instruments assisting the physician, psychologist, and research scientist to meet the challenge of preserving and extending life. Positions are open for: Senior Transistor Circuit Designer, Sales and Office Manager and experienced Electronic Technician. Submit resume, availability and salary requirements in first letter to Biophysical Electronics, Inc., New Hope, Pa.

### ELECTRONICS ENGINEER OR PHYSICIST

High qualifications and varied experience, particularly in control, rf or nuclear electronics. Appointment as Assistant Professor at \$7,000-\$8,900 or as Associate Professor at \$9,000-\$11,700, or to non-academic position at equivalent salaries. To supervise construction of a spiral-ridge cyclotron to produce 50 Mev protons. Apply to Dr. B. G. Whitmore, Physics Dept., University of Manitoba, Winnipeg 9, Manitoba, Canada.

### ENGINEER

To assist in construction of new cyclotron installation. Permanent position. Experience in building and maintaining scientific apparatus essential. Specific experience with cyclotrons desirable. Salary dependent on qualifications and experience. Apply to Dr. B. G. Whitmore, Physics Dept., University of Manitoba, Winnipeg 9, Manitoba, Canada.

(Continued on page 144A)

## SCIENTISTS ENGINEERS

# CALIFORNIA

offers you and your Family

- A world center of the electronic industry for CAREER ADVANCEMENT
- The High Sierra and the Pacific Ocean for RECREATION
- Some of the nation's finest public schools for your CHILDREN
- World Famous Universities for ADVANCED STUDY
- MAJOR CULTURAL CENTERS

while living in such places as  
Exciting San Francisco  
Fabulous Southern California  
Cultural Palo Alto

companies pay interview, relocation and agency expenses

submit resume in confidence to:

### PROFESSIONAL & TECHNICAL RECRUITING ASSOCIATES

(a Division of the  
Permanent Employment Agency)  
825 San Antonio Rd.  
Palo Alto, Calif.

## TAKE A GIANT STEP

...into your future and seek out the professional opportunities awaiting creative engineers and scientists at Martin-Denver... For here exists the most challenging problems in space and human engineering. Join with us and communicate with N. M. Pagan, Director of Technical and Scientific Staffing (Dept. DD-10), The Martin Company, P. O. Box 179, Denver 1, Colo.

# MARTIN

DENVER





Professional Opportunities Are Available For

## Electrical Engineers

with interest and experience  
in the following fields:

- Design and Development of:  
Industrial Electronics and Power  
Controls and Instrumentation  
Electronics
- Operation & Maintenance of  
Nuclear Devices

For information please write to:

Personnel Manager

### Brookhaven National Laboratory

UPTON, LONG ISLAND, N. Y.



## LINCOLN LABORATORY

invites inquiries from persons  
with superior qualifications.

**SOLID STATE** Physics, Chemistry, and Metallurgy

**RADIO PHYSICS** and **ASTRONOMY**

**NEW RADAR TECHNIQUES**

**COMMUNICATIONS:**

Techniques

Psychology

Theory

**INFORMATION PROCESSING**

**SYSTEMS:**

Space Surveillance

ICBM Detection and Tracking

Strategic Communications

Integrated Data Networks

**SYSTEM ANALYSIS**

Research and Development

## LINCOLN LABORATORY

Massachusetts Institute of Technology

BOX 16 • LEXINGTON 73, MASSACHUSETTS



## Positions Open



(Continued from page 143A)

### TEACHING-RESEARCH, ELECTRICAL ENGINEERS

Expanding university program provides unusual opportunities for positions combining teaching and research. Rank and salary open. Teaching in all E.E. fields. Research primarily in microwave electronics. Apply: Dean E. C. Easton, Rutgers University, New Brunswick, New Jersey.

### TEACHING AND RESEARCH

Attractive opening for Electrical Engineer with Ph.D. to help develop graduate program, supervise graduate research and do some teaching. Encouragement given to private research and consultation. Good salary and faculty ranking will be offered to exceptional individual. Position available Sept. 1960 or sooner. Write, Dean, School of Engineering, Vanderbilt University, Nashville 5, Tenn.

### ELECTRONIC ENGINEERS

Positions open to Electronic Engineers teaching lecture and laboratory courses in a rapidly growing 4 year college. A background of servo-mechanisms, circuit analysis, microwaves, and/or transistors is desired. Applications desired from both academic and industrial personnel. Write, Harold P. Skamser, Dean of Engineering, Calif. State Polytechnic College, Kellogg-Voorhis Campus, Pomona, Calif.

### TEACHER IN ELECTRICAL ENGINEERING

Teacher in E.E. beginning Sept. 1960. One qualified and interested in teaching fundamental undergraduate courses plus one graduate course. Ph.D. or MS. required with salary and rank dependent on qualifications. City location with many industrial contacts. Apply Dept. of E.E., Saint Louis University, St. Louis 8, Missouri.

### STAFF ENGINEER

Research engineering position for creative person to form nucleus of a new section in the Electro-physical Labs. Will propose and evaluate new electronic component, circuit and systems concepts. Minimum experience and educational background would be 5 years with at least an MS. in E.E. or Physics. A Ph.D. degree would be preferred with strong interests in electronics, theoretical physics or mathematics. Forward resumes to Mr. R. D. Williams, Employment Mgr., P. R. Mallory & Co. Inc. 3029 E. Washington St., Indianapolis, Ind.

### ANALYST

Research and consulting in fields such as transportation, logistics, equipment investment, inventory control, marketing, operations research, data processing. Educational background in economics, transportation, mathematics, statistics, engineering. United Research, Inc., 808 Memorial Dr., Cambridge, Mass. Mrs. Paulsen, Personnel Director.

### TEACHING POSITIONS

The E.E. Dept. of The City College of New York has several positions available on the teaching staff beginning September 1960. Rank and salary commensurate with qualifications and experience. Opportunity for graduate study. Applicants must be present resident of the U.S. Address inquiry to Prof. H. Taub, Dept. of E.E., The City College, Convent Ave., & 139th St., New York 31, N.Y.

(Continued on page 146A)



## SAN JOSE

Current Career  
Opportunities

In Commercial Products  
R & D

**ELECTRONIC ENGINEERS  
PHYSICISTS**

experienced in  
Industrial Electronics  
and Automation

Creative top level engineers and physicists are needed now to work on advanced assignments in the design of optimum systems using electronic and mechanical components.

FMC Central Engineering's current expansion into automatic measurement and control fields offers permanent career opportunities for technical accomplishment on important company-sponsored, long-range programs. Systems engineers, circuit designers and specialists needed to staff new million dollar laboratories.

With corporate headquarters in San Jose, California, FMC is highly diversified in both machinery and chemicals, with 15 divisions operating throughout the U. S. and overseas.

BS required and advanced degrees desirable for these responsible positions. Experienced applicants or recent graduates should send complete resume:

Contact E. M. Card, Jr., or C. F. Duvall at FMC Central Engineering, P.O. Box 760, San Jose, Calif. Phone: CYpress 4-8124.



*Putting Ideas to Work*

**Central  
Engineering  
Laboratories**

**FOOD MACHINERY AND  
CHEMICAL CORPORATION**

# An Invitation To Join ORO...Pioneer In Operations Research

Operations Research is a young science, earning recognition rapidly as a significant aid to decision-making. It employs the services of mathematicians, physicists, economists, engineers, political scientists, psychologists, and others working on teams to synthesize all phases of a problem.

At ORO, a civilian and non-governmental organization, you will become one of a team assigned to vital military problems in the area of tactics, strategy, logistics, weapons systems analysis and communications.

No other Operations Research organization has the broad experience of ORO. Founded in 1948 by Dr. Ellis A. Johnson, pioneer of U. S. Opsearch, ORO's research findings have influenced decision-making on the highest military levels.

ORO's professional atmosphere encourages those with initiative and imagination to broaden their scientific capabilities. For example, staff members are taught to "program" their own material for the Univac computer so that they can use its services at any time they so desire.

ORO starting salaries are competitive with those of industry and other private research organizations. Promotions are based solely on merit. The "fringe" benefits offered are ahead of those given by many companies.

The cultural and historical features which attract visitors to Washington, D. C. are but a short drive from the pleasant Bethesda suburb in which ORO is located. Attractive homes and apartments are within walking distance and readily available in all price ranges. Schools are excellent.

**For further information write:  
Professional Appointments**

## **OPERATIONS RESEARCH OFFICE**

**ORO The Johns Hopkins University**

6935 ARLINGTON ROAD  
BETHESDA 14, MARYLAND

# NEW OPPORTUNITIES IN

LOW-NOISE AMPLIFIERS      SEMICONDUCTOR DEVICES  
MICROWAVE CIRCUITS      PHOTOEMITTER SURFACES  
ELECTRON-BEAM DYNAMICS      DISPLAY DEVICES  
TV AND RADIO RECEIVER DESIGN



**Chicago, Ill., and Menlo Park, Calif.**

The continuing expansion program at Zenith has created new opportunities for engineers with experience in the above fields.

The fast-wave electron-beam parametric amplifier, conceived at Zenith, has opened up challenging new fields for research and development activity from UHF to SHF bands. Broad company interests in the microwave-tube area provide fertile atmosphere for original ideas and individual initiative.

An expanding research program in new fields centered around **compound semiconductors** provides opportunities for individuals with backgrounds in the solid-state art. Development of special devices for highly specific purposes, in collaboration with applications engineers, represents another area of active interest in the semiconductor field.

Positions are now available in the Research Department at Chicago; some openings are available in the San Francisco Bay Area. Congenial small-group atmosphere prevails, with all the advantages of a large, progressive company.

*Interested applicants please contact:*

**DR. ALEXANDER ELLETT**  
Zenith Radio Corporation  
6001 Dickens Avenue  
Chicago 39, Illinois

BErkshire 7-7500

## PROFESSORS

Electrical Engineering Faculty in new and rapidly expanding university has openings at senior levels. Duties include graduate teaching and research. Immediate opening for professor interested in developing courses and participating in research in logic, switching and computery. Ph.D. essential. Salary up to \$13,000. Apply Chairman, Electrical Engineering Department, University of Waterloo, Waterloo, Ontario.



**Positions  
Open**



(Continued from page 141A)

### ENGINEERS

The University of Denver's Research Institute is seeking graduate electronic engineers in the areas of circuit design and development, system design, and field engineering. Openings exist at all levels from engineers with advanced degrees and several years experience to recent graduates. Opportunities are available for advanced study or part-time teaching in the College of Engineering. Address inquiries to C. A. Hedberg, Head, Electronics Div., Denver Research Institute, University of Denver, Denver 10, Colo.

### ELECTRONICS PATENT ATTORNEY OR AGENT

Eastern U.S. company engaged in a broad line of developments in the electronics field has an opening for a patent attorney or agent. Applicant should have excellent comprehension of electronics, together with some experience in patent prosecution. Salary and position will be dependent on background and indicated ability. In reply please supply information as to education, experience and salary expected. Box 2017.

### PHYSICIST OR ELECTRICAL ENGINEER

Research on interaction between EM waves and structures or particles. An opportunity to do independent undirected research in the field of plasma or electron physics with excellent technical support and recognized colleagues. An experienced research with original ideas is desired. Salary \$10,000 plus, depending on training and experience level. Write Box 2018.

### ANALOG COMPUTER ENGINEER

The Standard Oil Co. (Ohio) has an immediate opening for an Analog Computer Engineer. A minimum of a B.S. in E.E. or Physics and 2-5 years analog experience is required. Applications are in the field of simulation and study of chemical and refining processes and process control systems. Salary commensurate with experience. Apply Mr. C. A. Bruggers, The Standard Oil Co. (Ohio), 1737 Midland Bldg., Cleveland, Ohio.

### MEDICAL ENGINEERING

Electronics Engineer or Physicist, Permanent position in Dept. of Surgical Research of a large eastern university, involves design of new instruments, supervision of maintenance of equipment, and consulting with physicians. Salary range open. Send complete resume to Box 2019.

### ENGINEER

Engineer to conduct a research and development program on instrumentation for data accumulation, reduction, and processing in geology, water resources investigations, photogrammetry, and allied fields including the development of new equipment and techniques for sensing, digitizing, logging, transmitting, storing, and processing of mass data. Contact Personnel Officer, U.S. GEOLOGICAL SURVEY, Washington 25, D.C.

### ELECTRONIC ENGINEER

Electronic Engineer to teach lecture and laboratory courses. Up-to-date knowledge of the field required. Working and living conditions excellent; salary and opportunity very attractive. Write to Dean of Engineering, California State Polytechnic College, San Luis Obispo, Calif.

(Continued on page 152A)



# active programs in 19 critical electronic areas



*Offer You Opportunities  
To Participate In Significant  
Advances at*

**STROMBERG-CARLSON**  
*Division of General Dynamics*

Top-calibre research and development teams at Stromberg-Carlson are tackling the prime problem areas in electronics affecting commercial communities and national defense. Programs and R & D staffs are expanding, backed by the vast resources of General Dynamics and the Stromberg-Carlson engineer-oriented management.

Every senior engineer and scientist who feels he can contribute to the expansion of man's capabilities in any of the following areas is invited to contact us.

---

*We are particularly interested in people with advanced degrees in Physics, Electrical Engineering or Mathematics and experience in one or more of the areas listed. Please send resume in confidence to Technical Personnel Department.*

#### **ENGINEERING AND ADVANCED DEVELOPMENT**

Advanced ICBM Communications  
Electronic Switching  
Nuclear Instrumentation  
High-Speed Digital Data Communications  
Electronic Reconnaissance Systems  
Single Sideband Communications  
Synchronous Data Transmission  
Advanced ASW Techniques  
Machine Tool Automation  
Radio Data Links • Tacan Equipment  
High Intensity Sound Generators  
Advanced Air Acoustics  
Shaped Beam Display Systems  
High-Speed Automatic Missile  
Check-Out Equipment  
Super-Speed Read-Out and Printing Equipment

#### **RESEARCH**

Paramagnetic Resonance • Ferroelectricity  
Thin Photoconductor Films  
Propagation and Coding • Speech Analysis  
Bandwidth Compression • Hydro-Acoustic Transducers  
Defect Solid State Physics  
Parametric Devices • Molecular Electronics  
Tunnel Diode Logic • Scatter Propagation Analysis

**STROMBERG-CARLSON**  
A DIVISION OF **GENERAL DYNAMICS**

1476 N. Goodman St., Rochester 3, New York

# CRYSTAL FILTERS

Within three years Hermes Electronics Co. has become the nation's leading producer of frequency selective devices utilizing piezoelectric crystal resonators. The growing demand for crystal filters and related devices has created a number of career opportunities for: Circuit Design Engineers, Crystal Physicists, and Network Theory Specialists.

Hermes Electronics Co. is a unique organization where responsibility and initiative are encouraged. Here you will also find the stimulation and environment of a young and growing company. Your association will be with staff members who are in the vanguard of many of today's rapidly expanding technical frontiers.

Salaries and other benefits are comparable to those of major research and development organizations. The company's location in Cambridge, Mass. affords unequaled cultural, living, and recreation facilities.

Liberal educational benefits are allowed for graduate study at leading universities in this area.

*Interested scientists and engineers are invited to address inquiries to: Mr. E. E. Landefeld, Personnel Director.*



**Hermes**  
Electronics Co.

75 CAMBRIDGE PARKWAY  
CAMBRIDGE 42, MASSACHUSETTS

Electronic Engineers • Physicists

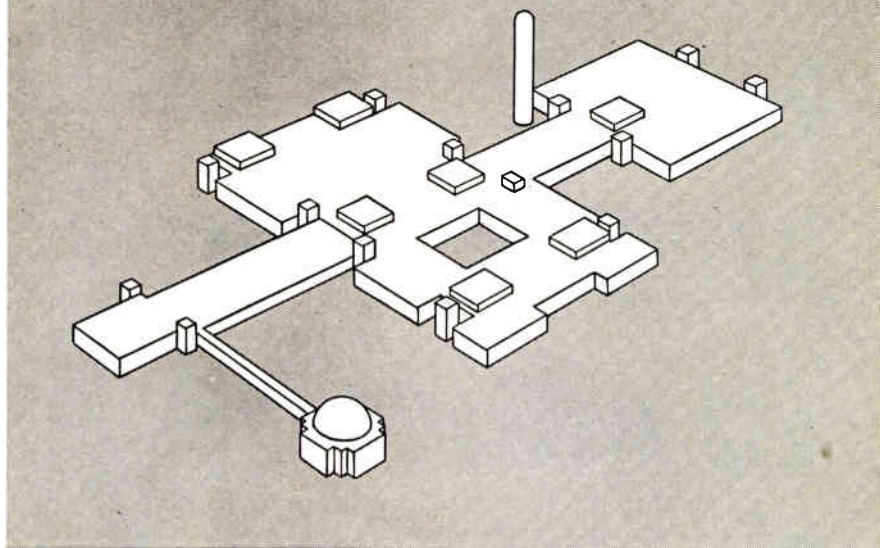

#### COMMUNICATIONS PHYSICIST

Plan applied research in such areas as telemetry and radar detection as affected by plasma sheaths. Interpret space communication needs and problems. MS or PhD in EE or applied physics.

#### SYSTEMS ENGINEER COMMUNICATIONS

EE or Physicist with 10 years' experience in systems design of airborne communications; to work on design of communication systems to meet requirements for future space vehicles.

#### ENGINEER-NAVIGATION AND GUIDANCE

To conduct analytical studies on inertial guidance and control for space vehicles. Should have background in closed-loop systems with 10 years of applicable experience and degree in EE or physics.

#### SYSTEMS ENGINEER NAVIGATION & CONTROL

EE with control systems background. Required are five years' experience in design of control and navigation systems, preferably in space vehicle systems.

#### ENGINEER ADVANCED ANTENNA & PROPAGATION STUDIES

To provide high level theoretical and experimental studies of antennas, propagation and target reflectors for all radio frequency bands, leading to new and improved concepts of equipment. BS, EE (advanced degree desirable). Six years' experience in above fields required.

#### ANALYSIS AND SYNTHESIS ENGINEER

Responsible for synthesis of new instrumentation and communication systems to meet missile and satellite requirements. Analytical knowledge in the field of instrumentation, communication and data processing with BS or MS EE essential.

#### INSTRUMENTATION SYSTEM TEST & EVALUATION ENGINEER

Coordinate tests on missile and satellite instrumentation systems. Requires experience in instrumentation and communication test and ground station equipment with BS, EE.

Other significant opportunities exist in the following areas:

Systems Engineering • Aerodynamics • Space Mechanics • Arming & Fuzing Systems • Airframe Structural Design • Materials Studies • Flight Test Analysis • Vibration Engineering • Producibility Engineering • Human Factors • Plasma Physics • Gas Dynamics • Applied Mathematics • Ground Support Equipment • Reliability Engineering • Project Engineering

For further information regarding opportunities here, write Mr. Thomas H. Sebring, Div. 53ME. You will receive an answer within 10 days.

MISSILE & SPACE VEHICLE DEPARTMENT

**GENERAL ELECTRIC**

3198 Chestnut Street, Philadelphia 4, Pa.

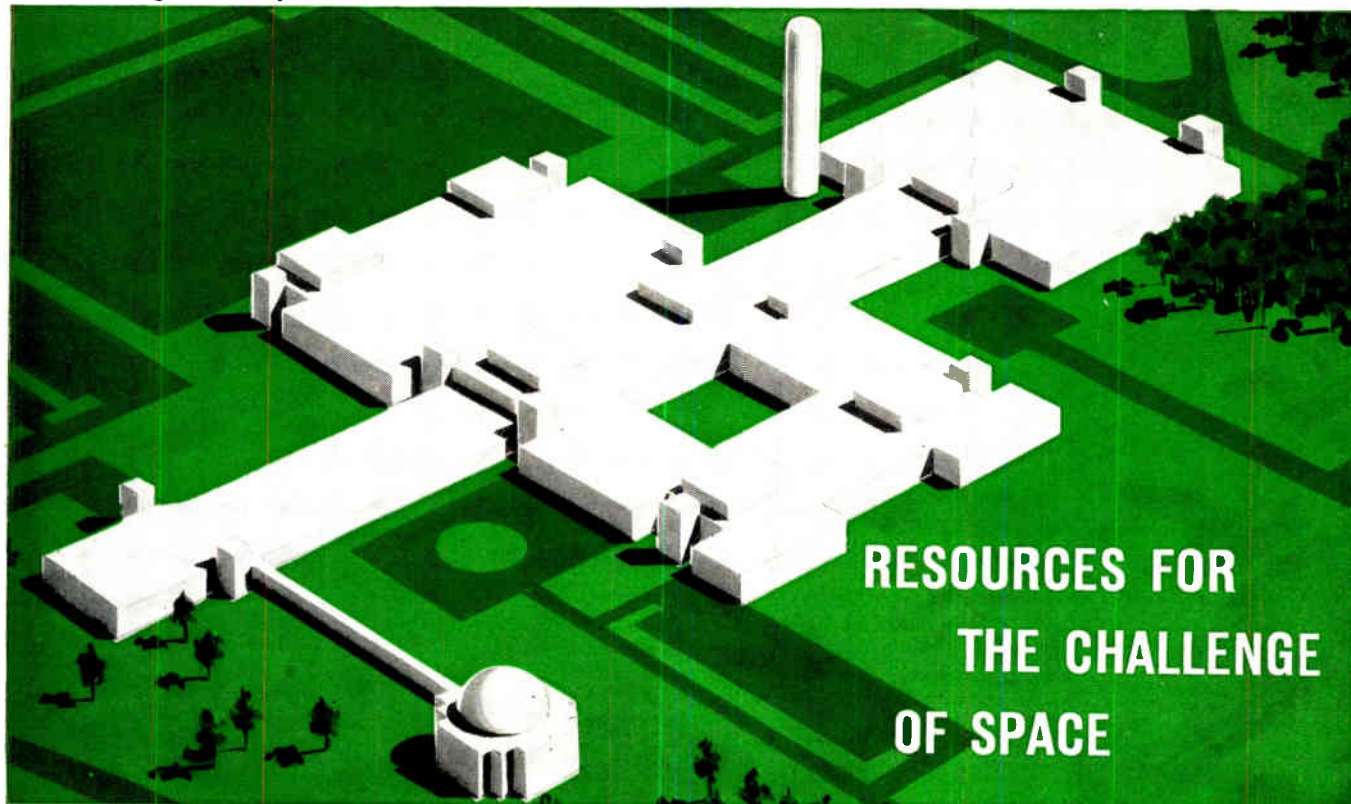

## ...General Electric's New \$14,000,000 Space Research Center, to be built near Valley Forge Park 17 miles from Philadelphia

General Electric is carrying its tradition of pace-setting electronics research into the field of space vehicle applications, primarily through the agency of its Missile and Space Vehicle Department.

Qualified engineers interested in working in these areas are invited to review the opportunities described on *this and the opposite page*. Those who join us will work in a professional atmosphere with other highly trained and competent people who have taken part in such G-E achievements as the FIRST demonstration of effective space vehicle stabilization control and navigation, and the FIRST measurements in space of earth's magnetic field and infrared radiation.

Upon completion of the Department's *Space Research Center* in suburban Valley Forge, new and unique facilities will be available to our staff, to further long range programs in space electronics.

### ENGINEER-TRANSISTOR CIRCUIT DESIGN

BS, EE or Physics with advanced degree desired. Five years' experience in circuit design, information theory and circuit philosophy.

### ENGINEER-TELEMETRY DESIGN

Will design and evaluate airborne and ground telemetry, voice and video circuits and components. Thorough knowledge of both transmitter and receiver design, five years' experience; BS, EE required.

### DIGITAL CIRCUIT DESIGN

To provide high level technical evaluation of digital techniques as applied to airborne digital and pulse circuitry, EE with five years' experience in this field.

### ENGINEER-CONTROLS

Will be responsible for analytical studies in adapted controls, non linear systems and analogue and digital computation. Requires ten years of controls background with BS, EE or related degree.

### ENGINEER-DYNAMICS

To conduct analytical studies in the dynamics of rigid bodies as applicable to navigation and control systems. Requires eight years of experience with MS degree in mechanics or physics.

### ENGINEER-SYSTEMS ANALYSIS

Requires eight to ten years experience in analytical studies of complex systems, with some control experience. Background in analogue and digital equipment also desirable.

Check additional openings listed to the left, and write to Mr. Thomas H. Sebring, Div. 53ME.

MISSILE & SPACE VEHICLE DEPARTMENT

**GENERAL**  **ELECTRIC**

3198 Chestnut Street, Philadelphia 4, Pa.



## COMPUTER SYSTEMS SUPERVISOR

We are seeking an engineer with a record of outstanding achievement in research and development to direct the activities of our Computer Systems Section. As supervisor of this important activity, you will have the opportunity to develop research programs of greatest appeal to you and your staff in the following areas:

- Analysis of Components and Systems
- Advanced Development
- Digital System Organization
- Logic
- Storage
- Input/Output
- Self-Organizing Systems

As a Foundation staff member you will be joining a mature, independent research organization with a staff of over 600 engineers and scientists contributing to a wide variety of military and industrial research programs.

You will receive a competitive salary plus liberal insurance and retirement benefits in addition to four weeks vacation after one full calendar year of service. Our location in a major midwestern city offers excellent cultural and recreational opportunities.

If this is the unusual professional opportunity you have been looking for, reply in confidence to:

**John F. Collins**

Armour Research Foundation  
of Illinois Institute of Technology  
10 West 35th Street  
Chicago 16, Illinois

## DESIGN ENGINEERS

*check these openings in advanced gyro and electrical components design*

In 1949, Honeywell developed and flight tested the floated gyro for control systems. Since then, its Gyro Design Group has become the focal point for a multi-million dollar component development program, supporting the inertial navigation industry. This is, perhaps, the most advanced program of its kind. It has expanded rapidly and now has openings for additional top level engineers.

This group is involved in all fields of gyro design. It works in such areas as *precision gyro and accelerometer design, hydro-dynamic bearings, vibratory mechanisms, precision electric suspension techniques and gyro magnetics.*

The men needed to fill these positions should be capable of developing advanced concepts for gyros and of following through on their projects. They should have a minimum of two years' (and up to twenty years') experience in such areas as *precision gyro mechanics, servo techniques, digital data handling, electronics packaging, advanced instrumentation, or magnetic component design.*

*To discuss these or other openings, write Mr. Bruce D. Wood, Dept. 610D, Aeronautical Division, 1433 Stinson Blvd., Minneapolis 13, Minn.*

## Honeywell

 *Military Products Group*

To explore professional opportunities in other Honeywell operations coast to coast, send your application in confidence to H. K. Eckstrom, Minneapolis 8, Minnesota.

## THE EXCEPTIONAL MAN



when the position you wish to fill is vital to your organization . . .

when the man you seek requires all the attributes of leadership . . . plus the ability to make significant technical contributions to the work for which he will be responsible . . .

when you need a man who can command the respect of his associates and subordinates because of his intimate knowledge of and first-hand experience in their fields . . .

when you need a man who is well educated and trained in the specialized fields of knowledge you require . . .

you need The Exceptional Man.

Let us locate him for you.

*Charles A. Binswanger* ASSOCIATES  
INCORPORATED

EXECUTIVE SEARCH SPECIALISTS

407 AMERICAN BUILDING • BALTIMORE 2, MD. • PLAZA 2-5013

# T/I S-C wants senior electro-mechanical engineers who prefer to pursue projects

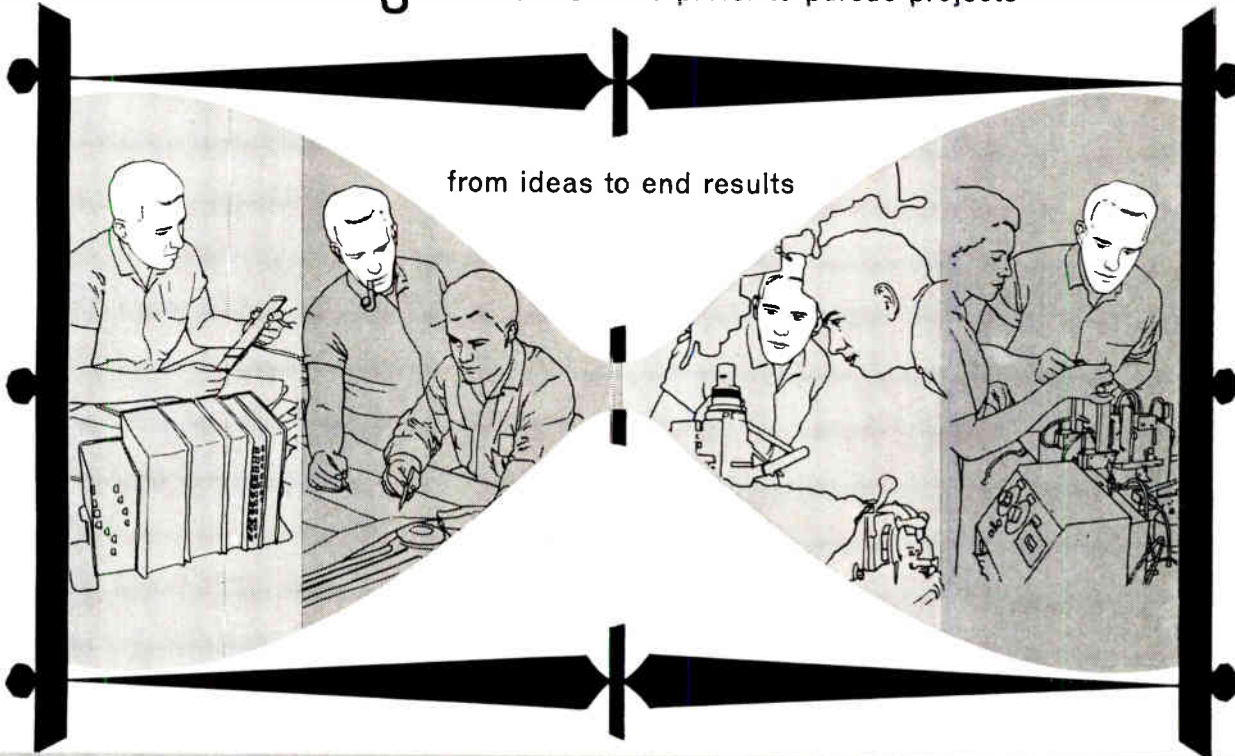

You won't find frustrating bottlenecks in TI's immense semiconductor mechanization program. Unhampered progress toward ideal end results is assured because TI permits mechanization engineers to stay with their projects from beginning to end. Hence the remarkably short time interval between conception and production of new TI semiconductor manufacturing machines and the devices they produce.

In a broader sense your work will be a cooperative venture. For at TI S-C you are free to work even in the shop with tool makers, as with all other professional and technical specialists whose



talents will help you convert your conceptions into realities. In this ideal working climate your challenging assignments will include design, development and evaluation of mechanical, electronic and electrical mechanization equipment of widely varying types and sizes.

Requirements include a BS or MS in Mechanical or Electrical Engineering with emphasis on mechanical or servo-mechanism design and at least three years in two of the following fields: design of semiconductor test equipment, mechanized semiconductor machinery, computers, servos.

*whether applying or not, mail coupon for your copy of T/Is today and learn more about T/I Semiconductor-Components division.*

INTERVIEWS are scheduled for your area. If qualified for this position please send confidential resume immediately to C. A. BESIO, Dept. 111

**TEXAS**  **INSTRUMENTS**  
INCORPORATED  
SEMICONDUCTOR - COMPONENTS DIVISION  
POST OFFICE BOX 312 • DALLAS, TEXAS



**TEXAS INSTRUMENTS INCORPORATED**  
Semiconductor-Components Division  
P. O. Box 312, Dept. 111 Dallas, Texas

Please send me T/Is, containing specific facts about now available T/I S-C assignments in my field, and related information.

NAME \_\_\_\_\_

ADDRESS \_\_\_\_\_

CITY \_\_\_\_\_ STATE \_\_\_\_\_

My professional field is \_\_\_\_\_

My specialty is \_\_\_\_\_

## SENIOR MICROWAVE ENGINEER

You will be given system responsibility for the development of new concepts in the generation, propagation and radiation of microwave power for heating, cooking and curing purposes, in numerous commercial and industrial applications. (Raytheon is one of the few electronics companies whose staff includes systems, advanced development, and design engineers in these fields).

You must have a BSEE or equivalent and should have 8 years of broad design or advanced development experience in the microwave field in order to handle the planned assignments. (Experience in radar development, for instance, or DC power generators or magnetrons.) Since we're looking for an exceptional individual—who will be rewarded accordingly—the deciding factor will probably be your creativeness and ingenuity, as evidenced by: patent disclosures; significant publications; or descriptions of accomplishments not formalized by patents or publication.

## MICROWAVE LICENSEE ENGINEER

You will serve as liaison between Raytheon and licensees, assisting in the design of microwave cooking units for these licensees' commercial ovens. This will involve working with the licensees' design engineers to solve such problems as heat, sanitary considerations, microwave distribution, wave modulation, insulation and cost reduction. You will also help translate licensees' suggestions into product improvements.

You should be a senior-level electronics engineer with a BSEE or equivalent and should have 5 years' applicable experience. Background in design of test equipment, high-power modulators, or commercial microwave equipment is especially useful, as is knowledge of magnetrons, underwriters' requirements and FCC regulations. Basically, we're looking for a top design and sales engineer (travel will be limited, however) so salary is commensurate—that is, excellent.

Both positions are in the suburban Boston area and offer attractive cultural, educational and recreational opportunities. Relocation assistance is available. Please phone collect (Bilgelo 4-7500) or forward your detailed resume to Mr. Paul R. Alexander, Manager of Professional Personnel, Commercial Apparatus & Systems Division, Raytheon Company, Watertown, Massachusetts.



Excellence in Electronics

**COMMERCIAL  
APPARATUS & SYSTEMS**

## Sophisticated Engineers: *A New State of the Art*

We have succeeded in the development of an entirely new concept for the SUCCESSFUL placement of qualified engineers and scientists. If your present position is frustrating, lacking financial reward or if your employer has failed to utilize your full potential why not communicate with us at once. We now have in excess of 4000 senior positions in the \$9,000.00 to \$35,000 bracket. Some of these positions offer bonus, stock participation, or profit sharing. For confidential consideration submit your resume in duplicate to Mr. Richard L. Berry (MEMBER IRE). Be sure to indicate your salary requirements and location preferences if any. All search fees and expenses paid by our clients.

**RICHARD BERRY ASSOCIATES**

1014-1015 Commercial Trust Bldg., Philadelphia 2, Penna. L0Cust 3-6654



## Positions Open



(Continued from page 146A)

### ELECTRICAL ENGINEERING

Excellent opportunities for qualified Ph.D.'s in logical design, network synthesis and other areas. Rank and salary commensurate with research and teaching qualifications. Teaching loads at all ranks are low. They are reduced further for those handling sponsored research projects. Each faculty member is expected to develop and maintain a strong research program. Send complete resume including research publications to Chairman, Dept. of E.E., Northwestern University, Evanston, Ill.

### ELECTRICAL ENGINEERS

Electrical Engineering staff openings. Both graduate and undergraduate courses. M.S. required, Ph.D. desirable. Modern facilities. Active research program. Write: Joseph C. Michalowicz, Head, E.E. Dept., Catholic University, Washington 17, D.C.



## Positions Wanted



### By Armed Forces Veterans

In order to give a reasonably equal opportunity to all applicants and to avoid overcrowding of the corresponding column, the following rules have been adopted:

The IRE publishes free of charge notices of positions wanted by IRE members who are now in the Service or have received an honorable discharge. Such notices should not have more than five lines. They may be inserted only after a lapse of one month or more following a previous insertion and the maximum number of insertions is three per year. The IRE necessarily reserves the right to decline any announcement without assignment of reason.

Address replies to box number indicated, c/o IRE, 1 East 79th St., New York 21, N.Y.

### ENGINEER

Ph.D., June 1960. 5 years industrial experience, several semesters experience teaching lecture courses at the senior EE level. Interested in teaching and research at progressive EE Dept. Prefer western U.S. Box 2049 W.

### SENIOR ELECTRONICS ENGINEER

BEE, MEE. Had project responsibility in audio, video, computer circuits and equipment; conscientious supervisor. Desires managerial responsibility and substantial challenge. Box 2058 W.

### ELECTRONICS ENGINEER

BEE. 1952. MEE. 1955. Age 31. Desires Project Engineering or managerial position with growth potential. 4 years experience, to Project Engineer level, designing and developing large radar systems. Some teaching and research experience. Former Signal Corps officer. Licensed Professional Engineer in New York. Box 2059 W.

(Continued on page 154A)



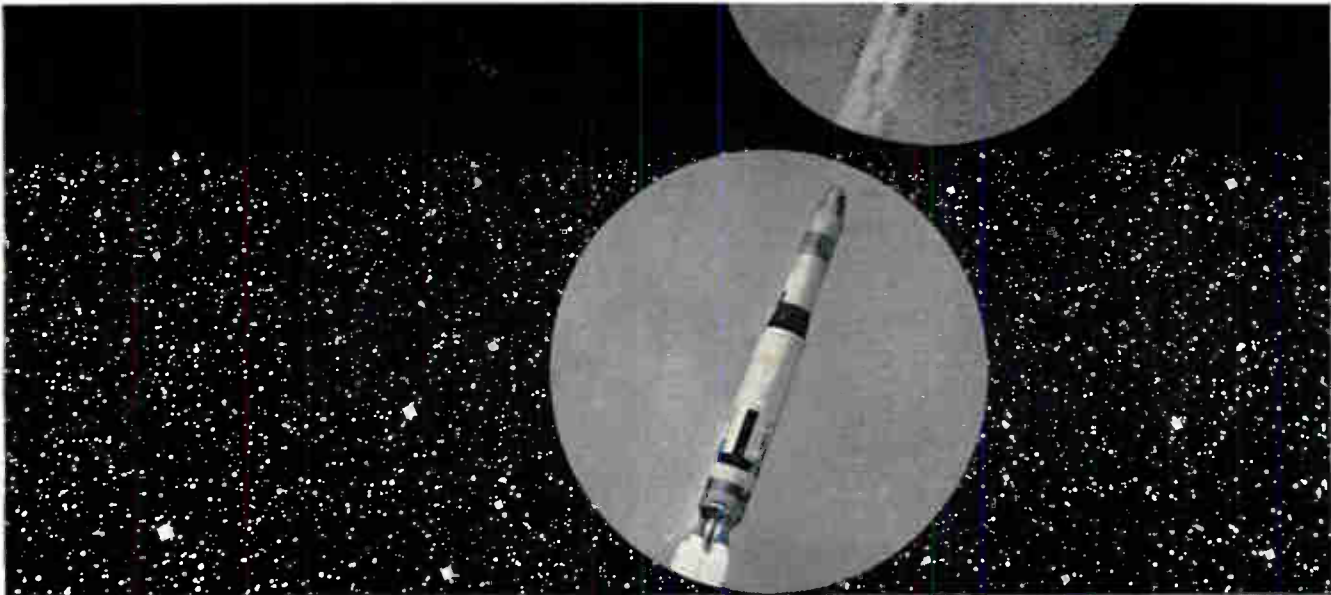

Building  
Strength  
Upon  
Strength...



The strength and prestige of this nation depends upon many things... important among these are the successes of the Air Force Ballistic Missile Program and related advanced space projects.

In turn, these programs depend upon the continuing flow of new ideas and inventions. All of these are part of a common pool of knowledge and know-how which are drawn upon for today's capability and tomorrow's advances.

the  
USAF  
Ballistic  
Missile  
Program



In building strength upon strength in the race for space technology leadership, the knowledge and experience gained from Atlas, Thor, and Titan ballistic missile systems development is being applied to advance Minuteman. For these programs, under the management of the Air Force Ballistic Missile Division, Space Technology Laboratories has had the direct responsibility for over-all systems engineering and technical direction. As these ballistic missile and related space programs go forward, STL continues to contribute technical leadership and scientific direction.

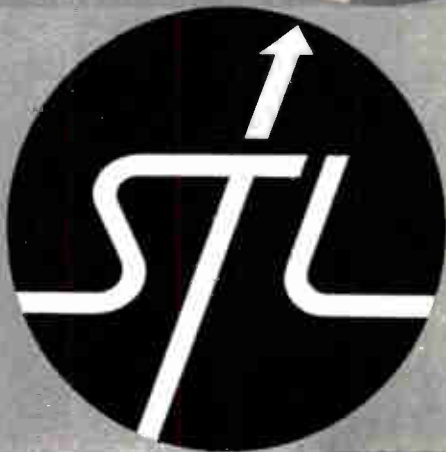

In this capacity STL offers unusual opportunities for creative work in the science and technology of space systems. To those scientists and engineers with capabilities in propulsion, electronics, thermodynamics, aerodynamics, structures, astrophysics, computer technology and other related fields and disciplines, STL now offers immediate opportunities. Please address your inquiries and/or resumes to:

**SPACE TECHNOLOGY LABORATORIES, INC.**

P. O. Box 95004, Los Angeles 45, California

Los Angeles • Santa Maria • Cape Canaveral • Washington, D. C.  
Manchester, England • Singapore • Hawaii

alpha has systems management capabilities in many fields

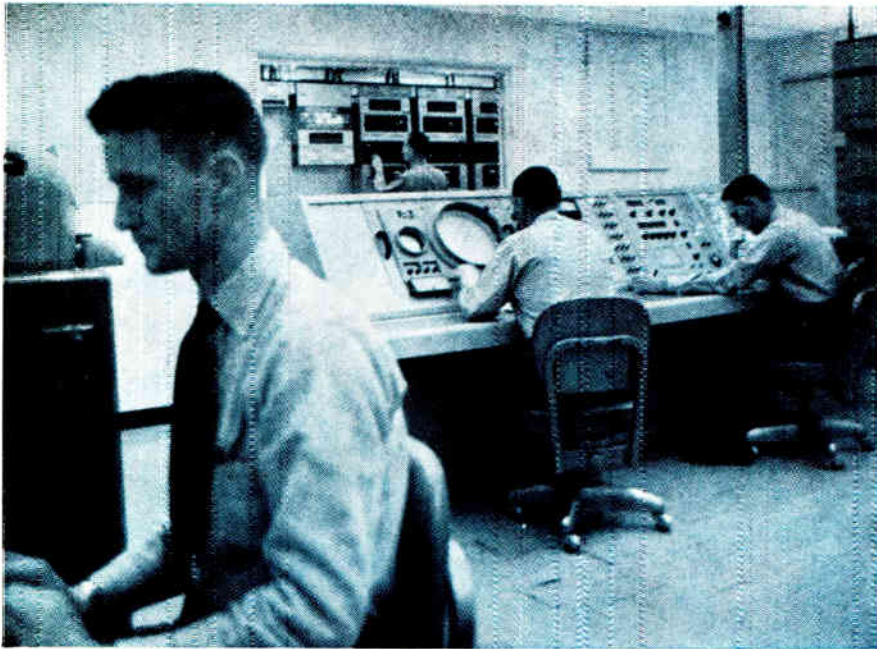

Telecommunication systems ... such as SAC's "Short Order" ... are just one of Alpha's areas of capability

## Do You Have Diverse Systems Engineering Capabilities?

Alpha functions at the systems level, depending upon reputable and competent manufacturers for the original design of subsystems. Alpha personnel devote their time and energies to the dynamic, economic, and logistic interaction of the individual entities which make up the system. Concentration upon the system as an entity enables Alpha to answer the need for centralized management control of complete systems.

- Alpha current prime contracts include:
- HF SSB communications systems for the Strategic Air Command
- Integrated Fleet Communications System for the U. S. Navy
- Ground based deep space and satellite surveillance systems for the Signal Corps (ARPA) and the Jet Propulsion Laboratory (NASA)
- Telecommunications and command-destruct systems for major missile ranges
- Ground and air transportable electronics systems, including high power communications
- Tropospheric scatter communication system in the Far East for the U. S. Army
- Scatter/microwave communications systems for commercial companies

Alpha assumes responsibility not only for the electronic equipment, but also for the outside plant and other equipments and structures necessary to an operative system. Do you have capabilities in the design, engineering and implementation of complete systems? Write:

C. P. NELSON  
Employment Manager



SYSTEMS DESIGNERS, ENGINEERS, CONSTRUCTORS, WORLD-WIDE • RICHARDSON, TEXAS • TELEPHONE DALLAS AD 5-2331



### Positions Wanted

By Armed Forces Veterans

(Continued from page 152A)

#### ENGINEER

Desires position not wholly technical involving possible overseas travel. LTJG USNR, Tau Beta Pi, Eta Kappa Nu, Unmarried, BS, and MS, in E.E. from large mid-western universities. Box 2060 W.

#### ELECTRONIC ENGINEER

BS, 1956; MS, 1957 in E.E., Stanford University. Experience 6 months digital circuitry design. 2½ years in trajectory computation and guidance analysis, including some programming for large digital computer for USAF. Attended special USAF course in Ballistic Missile Fundamentals. Desires position in missile or computer R & D with opportunity for responsibility. 1st Lt. Age 25, married. Available July 1960. Box 2064 W.

#### ELECTRONIC ENGINEER

BE and MS in E.E. (electronic option) from USC. Phi Kappa Phi, Tau Beta Pi, Eta Kappa Nu. Available July 1960 upon completion 5 years commissioned service with Navy (Lt.). Experience in shipboard electronics, teaching at Naval Academy. Interested in instrumentation, computer application. Southern Calif. area desired (possibly future in Latin America). Age 28, married. Resume upon request. Box 2065 W.

#### ELECTRONIC ENGINEER

BSEE, 1948. Heavy experience in industry controls and allied fields. Desires managerial position with strong and growing company in the field of industrial electronics. Location anywhere. Box 2067 W.

(Continued on page 157A)

Phone or send resume in confidence to:  
Engineering Placement Director

**CLEVITE**  
TTP

**CLEVITE**  
TRANSISTOR PRODUCTS

257 Crescent St., Waltham 54, Mass.  
Phone TWInbrook 4-9330



NASA announces...

THE TRANSFER OF THE DEVELOPMENT OPERATIONS DIVISION OF THE ARMY BALLISTIC MISSILE AGENCY TO THE NATIONAL AERONAUTICS AND SPACE ADMINISTRATION

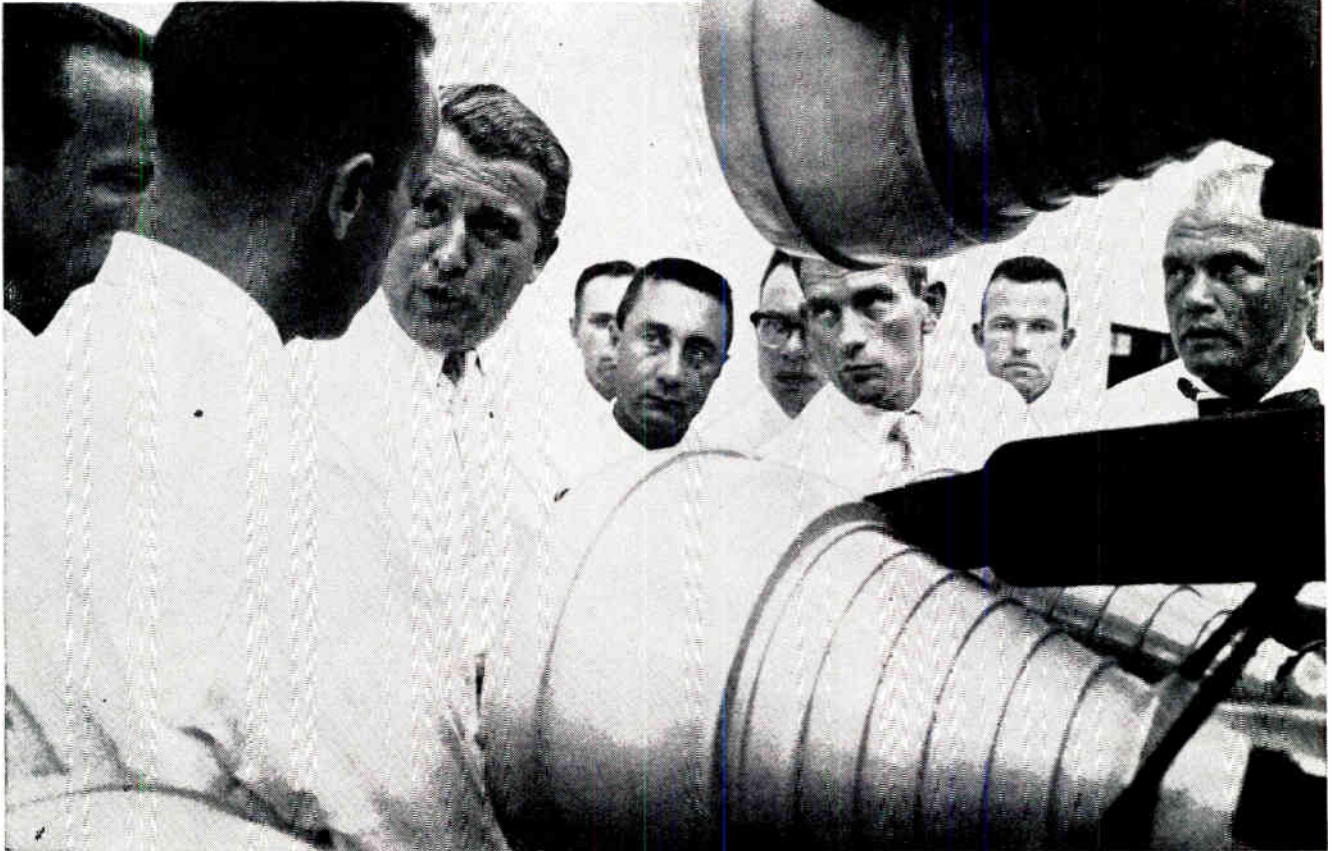

Dr. Wernher von Braun, director of the new NASA Marshall Space Flight Center in Huntsville, Ala., pictured with NASA's Mercury Astronauts

## Dr. Wernher von Braun and his space team join NASA

The National Aeronautics and Space Administration leads the nation's efforts to find, interpret and understand the secrets of nature as they are revealed in the laboratory of space.

This vigorous effort requires boosters for space vehicles which greatly exceed the thrust of any boosters currently available. For this reason, the \$100 million Huntsville plant, together with its famous space team, are being transferred to NASA. The new NASA facility in Huntsville will be known as the George C. Marshall Space Flight Center.

NASA is now the largest civilian research organization in the United States. For details about outstanding professional opportunities, address your inquiry to the Personnel Director of any of these NASA centers:

**NASA Goddard Space Flight Center**  
Washington 25, D. C.

**NASA Flight Research Center**  
Edwards, California

**NASA George C. Marshall Space Flight Center**  
Huntsville, Alabama

---

**NASA** National Aeronautics and Space Administration

---



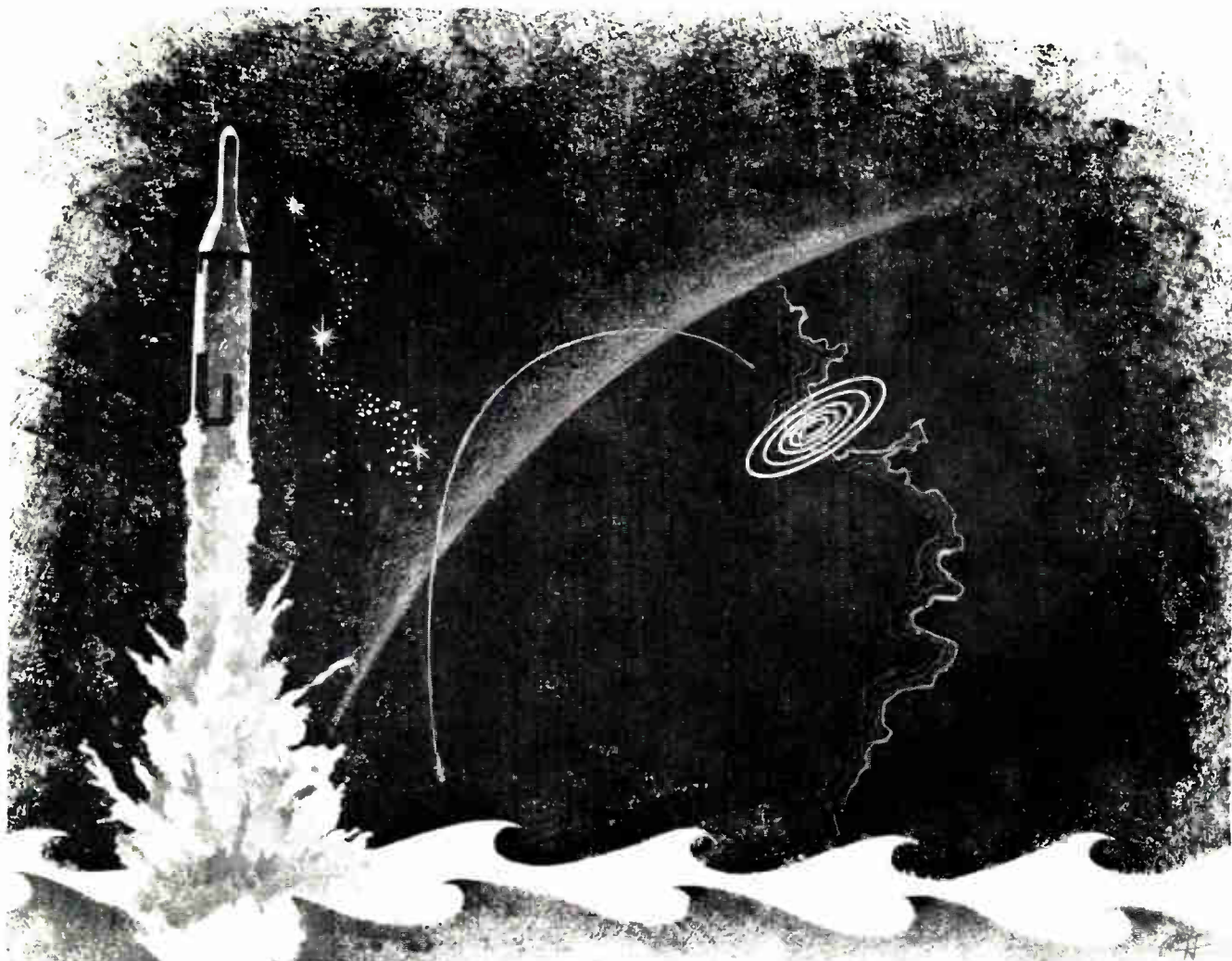

## po-si'tion

*Problem: Determine positional accuracy of automatic inertial navigation system.*

*Solution: Celestial check by Nortronics' visual Type 11 Periscope System or submarine Radiometric Sextant, Mark II.*

*Result: Bird away and on target.*

*Pioneering by Nortronics' Precision Products Department in the field of navigation and stabilization systems has created unique career opportunities in advanced design, production and applications engineering.*



# **NORTRONICS**

A Division of NORTHROP CORPORATION

**PRECISION PRODUCTS DEPARTMENT  
NORWOOD, MASSACHUSETTS**

Field Offices

Highway #46      2486 Huntington Drive  
Teterboro, New Jersey      San Marino, California



## Positions Wanted



### By Armed Forces Veterans

(Continued from page 151.1)

#### ELECTRONIC ENGINEER

BSEE, 1957, 1/14, USAF, Electronic instructor while on active duty. Some graduate work completed. Desires an R & D position in the mid-Atlantic area. Age 24, married, 1 child. Box 2068 W.

#### SALES ELECTRONICS

Experienced sales and engineering background in electronics to distributors, OEM and direct customers. Age 38 with excellent sales record in product and components. Experienced in sales promotion. Desires position with responsibility and future. Box 2069 W.

#### ELECTRICAL ENGINEER

BSEE, 1958, I.E. (JG) USNR. Completing 2 years as Electrical & Engineer officer afloat and ashore. Experience in repair and maintenance of various types of equipment and in personnel management. Married. Desires position in southwest. Available August 1960. Box 2070 W.

#### ENGINEERING EXECUTIVE

At 35, holding SBEE and MSEE electronics, and wonderfully settled with family in Honolulu, desires a position in this area. Unusually familiar with re-outlets, limitations and energetic future of Hawaii. 15 years experience with shipboard, missile and management of Naval Electronics. Box 2086 W.

#### SENIOR ENGINEER

MS, solid supervisory experience in transistor applications and technology, desires technical or administrative position in Europe with U.S. or European semiconductor manufacturer. Fluent French, some Italian; married with family. Box 2087 W.

#### SENIOR PROJECT ENGINEER—CHIEF

BSEE, all requirements MS but thesis. Age 36, married, 2 children. 10 years design and project supervision experience in air navigation systems, HF and VHF communications and industrial TV systems. Also teaching experience in transistors. Member IRE and Tau Beta Pi. Prefer location south or southwest. Box 2088 W.

#### ENGINEERING TECHNICIAN

Graduate of DeVry Technical Institute in Electronic Technology and Design; married; age 26, 5 years experience in radar and TV repair; 17 months experience as Service Manager for large Detroit electronic distributor; wants position with up-and-coming firm that is going places. Opportunity for further study and advancement desirable. Available July 1960. Box 2089 W.



## Membership



The following transfers and admissions have been approved and are now effective:

#### Transfer to Senior Member

Barrack, C. M., Pikesville, Md.  
Bates, D. J., Culver City, Calif.  
Beecher, D. E., Los Angeles, Calif.  
Boesch, P. W., Washington, D. C.  
Bull, R. W., Mount Prospect, Ill.  
Davis, L. W., Albuquerque, N. Mex.  
Feldman, N. E., Los Angeles, Calif.

Finley, J. D., Eau Gallie, Fla.  
Gross, V., Bayside, N. Y.  
Hendrix, C. E., China Lake, Calif.  
Horowitz, J., Brooklyn, N. Y.  
Hsu, H., Clay, N. Y.  
Jones, H. S., Jr., Washington, D. C.  
Kaprelian, E. K., Red Bank, N. J.  
Kennedy, D. D., Cincinnati, Ohio  
Klingler, D. E., Ann Arbor, Mich.  
Koesy, C. B., Panama City, Fla.  
Koss, N. A., Wakefield, Mass.  
Lofgren, F. W., Medford, Mass.  
Miller, D. C., Waldron, Ind.  
Mott, H., Raleigh, N. C.  
O'Brien, W. C., San Pedro, Calif.  
Parvin, R. H., St. Petersburg, Fla.  
Pizzicara, D. J., Plainview, L. I., N. Y.  
Platt, A. O., Fort Wayne, Ind.  
Rielman, L., Huntingdon Valley, Pa.  
Roberts, W. L., Rome, N. Y.  
Roth, H. H., Roslyn Heights, N. Y.  
Rubin, S. W., Long Island City, N. Y.  
Shepard, E. S., Sr., Phoenix, Ariz.  
Singleton, R. C., Palo Alto, Calif.  
Smith, D. S., Jr., Rochester, N. Y.  
Smith, G. W., Littleton, Colo.  
Southard, C. D., Endwell, N. Y.  
Stephens, J. F., Owensboro, Ky.  
Stone, E. W., Syracuse, N. Y.  
Weisz, W. J., Skokie, Ill.  
White, E. A., Fort Wayne, Ind.  
Wolfe, A. E., Lancaster, Calif.

#### Admission to Senior Member

Billings, A. R., Nedlands, Western Australia  
Blair, C. L., Little Silver, N. J.  
Bloom, S., Plainfield, N. J.  
Bnescher, R. H., College Park, Md.  
Cahn, H., Ashbury Park, N. J.  
Cameron, T. J., Lompoc, Calif.  
Chrupeala, W. J., Burbank, Calif.  
Collar, H. W., Sewell, N. J.  
Cooney, T. R., Dayton, Ohio  
Daly, E. J., Livermore, Calif.  
Davies, E. T., Ottawa, Ont., Canada  
Del Grosso, V. A., Washington, D. C.  
Donsmanis, G. C., Princeton, N. J.  
Emerson, W. H., District Heights, Md.  
Finkel, M., Rolling Hills, Calif.  
Frenzel, R. P., Cazenovia, N. Y.  
Graham, J. J., Oaklyn, N. J.  
Graul, D. P., Grubbs AFB, N. Y.  
Hamilton, J. J., Schenectady, N. Y.  
Hannon, R. J., Lexington, Mass.  
Harris, R. C., Plainfield, N. J.  
Hauser, H., Washington, D. C.  
Hernqvist, K. G., Princeton, N. J.  
Hey, H. C., Murray Hill, N. J.  
Hogan, M. B., Syracuse, N. Y.  
Hornbeck, A. J., Cleveland, Ohio  
Ivanek, F., Stamford, Calif.  
Jones, J. L., Eatontown, N. J.  
Klein, R. J., Oak Ridge, Tenn.  
Kornei, O., Ossining, N. Y.  
Kundu, M. R., Ann Arbor, Mich.  
Link, F. M., Westwood, N. J.  
Machuta, A. J., Hathoro, Pa.  
Malinowski, L. P., Riverside, Calif.  
Mandelbrot, B. B., Ossining, N. Y.  
Mano, K., Sakurakoji, Sendai, Japan  
Marshall, F. H. B., Drexel Hill, Pa.  
McCall, D. R. S., Sudbury, Mass.  
McGee, J. F., El Paso, Tex.  
McReynolds, O. J., Bethesda, Md.  
Miller, W. E., Urbana, Ill.  
Morita, M., Yokohama, Japan  
Nader, J. S., Cincinnati, Ohio  
Nimura, T., Sendai, Japan  
Oeli, S., Costa Mesa, Calif.  
O'Donnell, R. V., Freehold, N. J.  
Pawlowski, B. J., Wakefield, Mass.  
Phiskin, W. A., Poughkeepsie, N. Y.  
Pula, T. J., Baltimore, Md.  
Ricketts, M. V., Burbank, Calif.  
Rosenbaum, M., San Diego, Calif.  
Ruff, D., Washington, D. C.  
Schweiger, R. N., Wilmington, Mass.

(Continued on page 158.1)

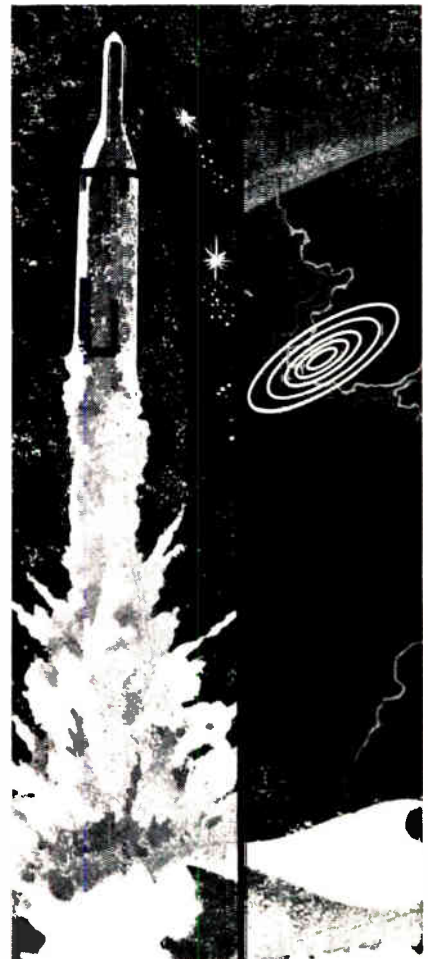

## po-si'tion

A NOTE FOR TALENTED ENGINEERS:

We invite your inquiry as to important positions that exist at Nortronics' Precision Products Department (formerly the Military Products Division of American-Standard).

Plan your future with Nortronics' Norwood team and stimulate your professional growth. If you can qualify in one of several electro-mechanical areas you will work on challenging programs with professionally dedicated associates.

FOOTNOTE: Excellent salaries for qualified engineers in both our Systems and Components Groups.

Contact E. P. REARDON, NORTRONICS Precision Products Department, Norwood, Massachusetts



A Division of NORTRON CORPORATION



# A Major New Power In Electronics Is Born

The recent formation of  
**LOCKHEED ELECTRONICS COMPANY**

marks the beginning of new expansion—entry into new markets and new activities in both military and non-military fields.

On the East Coast, Lockheed Electronics Company has organized 3 operating divisions. Immediate positions are available for experienced engineers and scientists who possess proficient experience in the following activities and who desire unlimited professional growth with a dynamic, new and expanding organization.

## Military Systems-Stavid Division

STAVID will continue to expand its present capabilities in military electronics, and will place special emphasis on: Airborne ASW research and development; Sonar; Sonobuoy systems; unique underwater detection devices; advanced radar systems; operations research—systems analysis; ECM and digital computer design.

## Information Technology Division

This new division is engaged in the development and marketing of data systems and sub-systems including: data processing, storage and display systems; telemetry; special purpose computers; systems analysis; communications and navigation systems. Special demand for solid-state circuit design engineers with particular emphasis on DC amplifier and low level, low noise amplifier design; VCO and FM discriminator design experience.

## Engineering Services Division

(FIELD OPERATIONS) will continue to expand and diversify in the areas of product service, test, evaluation, range instrumentation and operation, high quality engineering and consulting services. Current professional opportunities immediately available on programs involving: experimental data processing equipment; simulators and trainers; radar and navigation systems; missile guidance and associated general support equipment.

If you would like to investigate present and future opportunities in this growing company, you are invited to submit your professional resume in confidence to:

PROFESSIONAL PLACEMENT DEPT. PP

Interviews arranged promptly

**LOCKHEED ELECTRONICS COMPANY**  
PLAINFIELD, NEW JERSEY  
PLAINFIELD 7-1600



**Membership**

(Continued from page 157A)

Smith, D. D., Silver Spring, Md.  
Soderquist, G. W., Eau Gallie, Fla.  
Stegner, C. B., Verona, N. J.  
Sterrett, D. S., Charleston, S. C.  
van der Burgt, C. M., Eindhoven, Netherlands  
Watter, J. F., Washington, D. C.

### Transfer to Member

Anderson, R. J., Falls Church, Va.  
Appelbaum, G., New Rochelle, N. Y.  
Beamsley, G. V., Long Beach, Calif.  
Becker, H. D., Williamsville, N. Y.  
Beer, A. E., Sea Cliff, L. I., N. Y.  
Bellis, H. M., Park Ridge, N. J.  
Benjamin, H. L., New Hartford, N. Y.  
Berkowitz, B., Brooklyn, N. Y.  
Berwin, T. W., Encino, Calif.  
Bevan, R. K., Tarrytown, N. Y.  
Bickel, S. O., Kokomo, Ind.  
Bidner, H., Kew Gardens, L. I., N. Y.  
Biscoe, G. W., Glen Cove, L. I., N. Y.  
Board, C. Z., Tempe, Ariz.  
Borgh, R. P., Mountain View, Calif.  
Bowen, C. H., Arlington, Va.  
Bowker, M. W., Murray Hill, N. J.  
Brown, L., Haddonfield, N. J.  
Bubbers, J. J., Huntington, L. I., N. Y.  
Bull, T. R., Richmond Hill, Ont., Canada  
Busler, J. C., Tempe, Ariz.  
Buzzard, R. D., Ann Arbor, Mich.  
Carbine, I. L., Las Cruces, N. Mex.  
Cheeseman, P. R., Princeton, N. J.  
Chitouras, C. G., West Concord, Mass.  
Cipolla, A. P., Massapequa Park, L. I., N. Y.  
Coelho, C. A. B., Rio de Janeiro, Brazil  
Coerver, L. E., Jr., Los Angeles, Calif.  
Comeau, C. P., Oreland, Pa.  
Conway, P. W., Northbrook, Ill.  
Cooper, R. S., Cambridge, Mass.  
Cope, R. W., Towson, Md.  
Crowe, E. W., Berkeley, Mo.  
Cupp, J. D., Ontario, Calif.  
Dagostino, V. L., Stamford, Conn.  
Dalrymple, G. F., Lexington, Mass.  
Davies, W. R., Seattle, Wash.  
Davis, W. H., Pasadena, Calif.  
De Credico, R. J., Woodbury, N. J.  
Derzai, M., Montreal, Que., Canada  
Devereaux, R. N., Jackson, Mich.  
Didriksen, J. B., Riverside, Conn.  
Diem, C. W., Detroit, Mich.  
Donelson, L. E., Detroit, Mich.  
Dostator, R. H., Endicott, N. Y.  
Duff, T. O., Dover, Del.  
Duncan, H. P., Mangham, La.  
Eberhard, R. C., Fort Worth, Tex.  
Elmi, F. P., Alamogordo, N. Mex.  
Eisenberg, H., Chicago, Ill.  
Enander, B. N., Stockholm, Sweden  
Erb, J. J., Milwaukee, Wis.  
Evans, R. J., St. Paul, Minn.  
Fisher, R. D., Greendale, Wis.  
Fitzgerald, P. J., Elmhurst, L. I., N. Y.  
Freedman, I. M., Revere, Mass.  
Freeze, R. C., Thorofare, N. J.  
Fricke, L. H., Jr., Maplewood, Mo.  
Friedmann, D. C., Baltimore, Md.  
Gardner, T. W., Brigham City, Utah  
Garrett, W. A., Kansas City, Mo.  
Gerig, J. S., Palo Alto, Calif.  
Gilbert, E. M., Pikesville, Md.  
Glass, C. E., Richard, Wash.  
Golick, S., Bayside, L. I., N. Y.  
Goodwin, R. O., Nashan, N. H.  
Gosch, V. E., San Antonio, Tex.  
Graham, J. D., Brookfield, Wis.  
Granger, B. W., Lansdale, Pa.  
Gregory, L. A., Jr., Wayne, N. J.  
Grover, A. C., Jr., North Plainfield, N. J.  
Hamilton, R. H., Florissant, Mo.  
Hayman, R. A., Buffalo, N. Y.

(Continued on page 160A)





# men with ideas

are needed at HRB-SINGER in the following professional areas:

- Infrared
- Systems Design and Evaluation
- Microwave Circuit and Receiver Design
- Video Processing and Data Reduction
- System Reliability Study and Analysis
- Theories of Communication
- Electronic Circuitry Development

HRB offers the opportunity to work on vital electronic problems; an attitude of research emphasizing freedom of expression; a location combining the cosmopolitan atmosphere of a city with the advantages of small-town living. Through the tuition-refund plan employees are encouraged to pursue graduate study at the nearby Pennsylvania State University. Write in confidence to Personnel Director, Dept. R-3, HRB-SINGER, INC.

## HRB-SINGER, INC.

Science Park, State College, Pa.

A SUBSIDIARY OF

THE SINGER MANUFACTURING CO.

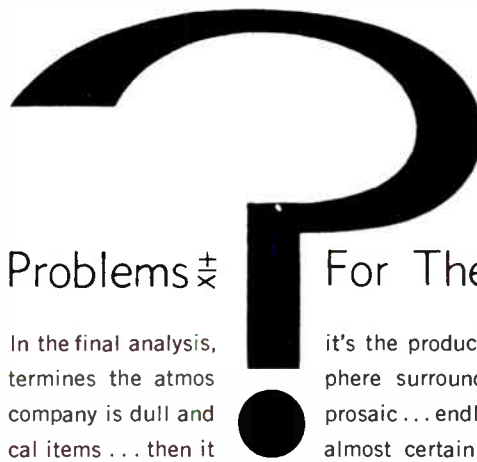

## Problems

## For The Inquiring Mind !

In the final analysis, determines the atmosphere surrounding an Electronic Engineer. If the company is dull and cal items ... then it

it's the product a company manufactures which de- prosaic ... endlessly stamping out millions of identi- almost certainly follows that so-called engineering

will be mundane and uninteresting.  On the other hand, it's quite possible to be involved in work that's so far out it is insecure. Take missiles versus aircraft, for example. It appears now that missiles will inherit the mantle ... but which ones? Yours might be a winner and it might not.  Ours is one of the select few companies which offers stability plus the excitement of almost infinite variety. You see, we are completely occupied with unique electronic engineering problems relating to the development and production of thousands of different extremely precise devices. We're about as far as you can get from an assembly line, operating as we do on a special project basis for the nuclear weapons program. This makes BENDIX a fascinating place to work. Our long-term prime contract with the Atomic Energy Commission makes it a secure place to work.  Our wonderful community adds the pleasures of comfortable suburban living to the rewards of a basically important line of endeavor. Our climate and terrain are much like those in Virginia. We have four mild but readily-identifiable seasons in a rolling, wooded landscape which is famous for its beauty. Housing is comfortable, inexpensive and close to work. We have excellent schools and universities, art galleries, a symphony orches-



**KANSAS CITY DIVISION**

tra and major league baseball.  You'll like BENDIX and you'll like Kansas City. We guarantee it. Write Tim Tillman, Technical Placement Supervisor, Box 303-PE, Kansas City 41, Missouri. He will supply you with all details.

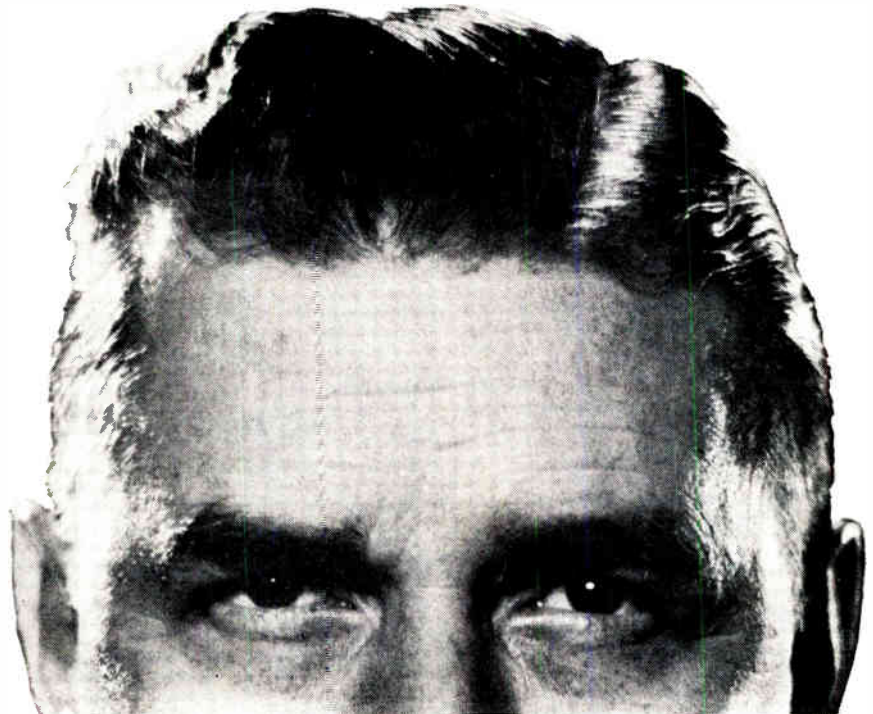

**SYSTEMS  
ENGINEERS**



**ELECTRONICS  
ENGINEERS**

## CHALLENGING R&D OPPORTUNITIES

Fundamental and applied research in the fields of hydrodynamics, acoustics, electronics, network theory, servomechanisms, mechanics, information theory and noise reduction. Also design of electronic instrumentation for underwater ordnance and application of analogue and digital computers.

**Opportunities for Graduate Study  
Faculty Appointments for Qualified Applicants  
Excellent Working and Living Conditions**

Send Resume to

ARNOLD ADDISON, PERSONNEL DIRECTOR  
**ORDNANCE RESEARCH LABORATORY**  
**THE PENNSYLVANIA STATE UNIVERSITY**  
BOX 30, UNIVERSITY PARK, PA.

## Mr. Engineer . . .

Retain your identity at

### BECKMAN'S SYSTEMS DIVISION In Orange County, California

Here's your chance to be a big fish in a small pond . . . not that our Systems Division is too small . . . it's just that we're not so large and over-organized that the individual and his efforts are submerged in a mass of humanity and a welter of paper work.

Our business is the design, development, and manufacture of proprietary electronic data processing and data acquisition system . . . research and development study projects pertaining to satellite programs . . . varied engineering design projects and other activities with both military and commercial significance.

There's ample elbow room for the non-organization man in any one of the following professional areas:

Logic Design	Systems Design	
Analog Design	Systems Engineering	Digital Design
Project Management	Project Engineering	
Electronic Design	Systems Evaluation and Modularization	
Field Engineering	Applications Engineering	

If you'd like to receive more information about us, we suggest you write to our Mr. J. W. Carlton enclosing a brief description of your background.

#### BECKMAN INSTRUMENTS, INC., SYSTEMS DIVISION

325 North Muller, Anaheim 5, California

(25 miles south of Los Angeles, near the Pacific Coast)

Beckman (R)

(C) 1960 B.I.I.



## Membership



(Continued from page 158A)

Heinzmann, F. C., Palo Alto, Calif.  
Heller, P. N., Cambridge, Mass.  
Hines, R. L., Fort Worth, Tex.  
Hoger, D. T., Haddon Heights, N. J.  
Holeczy, A. A., King of Prussia, Pa.  
Howard, W. R., Twinsburg, Ohio  
Howson, J. C., Salt Point, N. Y.  
Humphrey, C. D., Glastonbury, Conn.  
Huntley, W. P., Los Angeles, Calif.  
Ismail, M. A. W., Cairo, Egypt  
Jackson, D. A., San Francisco, Calif.  
Jamison, R. S., Los Angeles, Calif.  
Johansen, E. L., Ann Arbor, Mich.  
Johnson, E. P., Jr., Waltham, Mass.  
Johnson, H. S., Denver, Colo.  
Johnson, M. E., Tomawanda, N. Y.  
Jones, G. R., Greenbelt, Md.  
Kalviste, A., Seattle, Wash.  
Kamair, C. J., Jr., Reeds Ferry, N. H.  
Keltonic, F. J., Norwich, Conn.  
Kidwell, R. P., Las Cruces, N. Mex.  
Kieffer, G. H., Jr., Elkhart, Ind.  
Kinfinger, J. A., St. Paul, Minn.  
King, J. J., Huntsville, Ala.  
Kinsley, R. B., Utica, N. Y.  
Klinko, C. A., Campbell, Ohio  
Konesol, A. E., Kenmore, N. Y.  
Kos, S. M., East Northport, L. I., N. Y.  
Krupinski, J. A., Rome, N. Y.  
Lackey, R. B., Columbus, Ohio  
La Forte, J. T., Sauguit, N. Y.  
Lane, J. J., Huntington Station, L. I., N. Y.  
Leland, H. E., Dayton, Ohio  
Levin, H. L., Paterson, N. J.  
Lewin, N. L., Chicago, Ill.  
Lewis, D. E., Dayton, Ohio  
Lieberman, G., Haddonfield, N. J.  
Lincoln, C. F., Jr., Dallas, Tex.  
Litterer, J. E., Columbus, Ohio  
Lombard, W. A., Syracuse, N. Y.  
Madeson, A. H., Newton, Mass.  
Majeau, H. L., Brooklyn, N. Y.  
Malech, R. G., Carlisle, Mass.  
Mar, W. A., Los Angeles, Calif.  
Marantz, D. R., Rego Park, L. I., N. Y.  
March, J. W., Jr., Washington, D. C.  
Marino, D. J., Winchester, Mass.  
Martinelli, A. A., Waterbury, Conn.  
Mason, R. K., Binghamton, N. Y.  
May, H. A., Baltimore, Md.  
McCann, R. W., Bradford, Pa.  
McIntyre, J. W., Kenil, N. J.  
McIntyre, R. G., Toronto, Ont., Canada  
McKenzie, J. N., Gardena, Calif.  
McMath, D. C., Jr., Cocoa, Fla.  
Messina, A. S., Brooklyn, N. Y.  
Meyer, H. R., Concord, N. H.  
Mezger, J. P., Milwaukee, Wis.  
Michelsen, P. W., Seattle, Wash.  
Mieher, R. L., Waverly, Ill.  
Milano, U., Waltham, Mass.  
Minor, L. C., State College, Pa.  
Montroe, G. R., Poughkeepsie, N. Y.  
Montgomery, E. B., Phoenix, Ariz.  
Murphy, M. L., Midland, Tex.  
Nesenoff, N., Plainview, L. I., N. Y.  
Newhouse, V. L., Marion, Iowa  
Nixon, N. E., Littleton, Mass.  
Northrup, R. M., Emporium, Pa.  
Oen, J. A., St. Paul, Minn.  
Otto, J. L., New Orleans, La.  
Palatinus, A. C., Maspeth, L. I., N. Y.  
Pallange, E. P., Quaker Hill, Conn.  
Palmieri, C. A., New Hyde Park, L. I., N. Y.  
Reynolds, D. J., Poughkeepsie, N. Y.  
Richardson, R. L., Syracuse, N. Y.  
Rieders, A. T., New York, N. Y.  
Shrager, J. S., Philadelphia, Pa.  
Urban, L. R., Inglewood, Calif.  
Werner, R. E., Pleasanton, Calif.  
Wheeler, A. J., Somerville, N. J.

(Continued on page 161A)

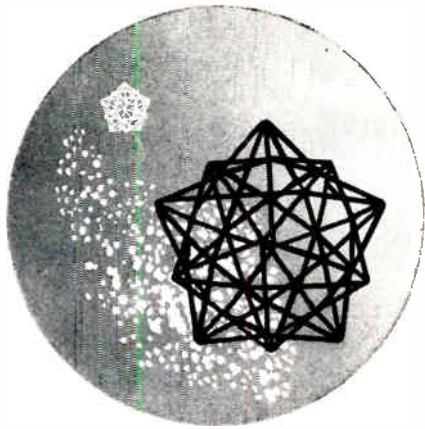

ENGINEERS  
SCIENTISTS

## FUTURISM in contemporary R&D

Radical departures from traditional forms of scientific investigation are the keynote of Republic Aviation's forward-looking programs in space exploration and upper atmosphere flight. In an environment that regards with skepticism the seeming validity of conventional conclusions, engineers and scientists seek below-the-surface solutions of problems... bypassing the superficial.

Expanding the scope and depth of present programs is Republic's recently completed \$14 million Research and Development Center. Extensive facilities here are an invitation to professional men to realize the future by solving today's most perplexing problems.

.....

### SENIOR LEVEL OPENINGS EXIST IN THESE IMPORTANT AREAS:

Navigation & Guidance Systems / Radar Systems / Information Theory / Radio Astronomy / Solid State & Thermionic Devices / Microwave Circuitry & Components / Countermeasures / Digital Computer Development / Radome & Antenna Design / Receiver & Transmitter Design / Miniaturization-Transistorization / Radiation & Propagation (RF, IR, UV) / Telemetry-SSB Technique

Please forward resumes to:  
Mr. George R. Hickman  
Technical Employment Manager,  
Department 111.



A message to  
Electronic Engineers  
from R. P. Gifford,  
Engineering Manager  
of General Electric's  
Communication Products  
Department in  
Lynchburg, Virginia—



“An electronic design engineer  
earning \$10,000 should be a  
decision-maker *beyond* his project's  
immediate technical problems.”

“I believe that any electronic design engineer earning \$10,000 or more welcomes the authority to make a variety of high-level business decisions—in such areas as features versus cost and reliability versus weight—working closely, of course, with his marketing counterparts in Product Planning and also with the Manufacturing Engineers.

“At Communication Products Department we give the experienced engineer the *necessary authority* to do just this. He generally enters the design project early in the development planning phase, so that he can take responsibility for estimating the project expense and schedule—thus contributing to the establishment of hoveys for product cost and delivery.

“Of course our communication systems must do the customer's job, but also they must be *marketable at a profit to the Department*; to make this come true is a vital part of the design engineer's challenge. This means exposure to many management problems and a rare opportunity to grow and move ahead rapidly.

“Our communication products are primarily commercial, including Mobile Radio, Microwave Radio Relay, Terminal Equipment, Telephone Carrier, Multiplex, and Personal Communication Systems. Military contracts also in the house include a 24-channel SSB tropospheric scatter system.”

Right now, we have immediate openings for Advance, Development, and Systems Engineers who have significant backgrounds in these areas:

<i>R.F. circuit design</i>	<i>Microwave plumbing,</i>	<i>Electronic equipment</i>
<i>Multiplex equipment</i>	<i>antennas</i>	<i>mechanical design</i>
<i>Microwave systems</i>	<i>Piezoelectric devices</i>	<i>Automatic test</i>
<i>design</i>	<i>Mobile transmitter,</i>	<i>equipment D &amp; D</i>
<i>Solid state devices</i>	<i>receiver design</i>	<i>Microminiaturization</i>

For prompt consideration, forward your resume in  
confidence to Mr. C. Fullmer, Dept. 53-ME

COMMUNICATION PRODUCTS DEPARTMENT

**GENERAL  ELECTRIC**

Mountain View Road, Lynchburg, Virginia



ACF ELECTRONICS DIVISION  
ELECTRO-PHYSICS LABORATORIES

Responsible assignments in furthering the state-of-the-art of Ionospheric Physics, combining competitive salaries and unusual growth potential, are offered to men who can contribute. Our present needs are for:

*Physicists*  
*Electronic Engineers*  
*Field Station Engineers*

FOR RESEARCH PROGRAMS IN  
IONOSPHERIC PROPAGATION  
& HF COMMUNICATIONS

**SENIOR IONOSPHERIC PHYSICISTS**

Ph.D. preferred, with several years' experience in the study of Ionospheric phenomena. Should be familiar with present knowledge of upper atmosphere physics and possess an understanding of current programs using rockets and satellites for studies in F-region and beyond. Qualified individuals with supervisory abilities will have an exceptional opportunity to assume project leadership duties on HF projects already under way involving F-layer propagation studies backed by a substantial experimental program.

**SENIOR DEVELOPMENT ENGINEERS**

Advanced degree in E.E. or Physics preferred. Must be familiar with present state-of-the-art in the design of advanced HF receivers and transmitters and possess working knowledge of modern HF networks employing ferrites and metallic tape cores. Strong theoretical background in modern linear circuit theory desired. Will carry out laboratory development and implementation of new HF communication systems.

**SENIOR ELECTRONIC ENGINEERS**

Advanced degree in E.E. preferred. Must be familiar with conventional pulse circuit designs and applications. Technical background should include substantial experience in data process and data recovery systems using both analog and digital techniques. Knowledge of principles and application of modern information theory including correlation techniques helpful. Will be responsible for the design of sub-systems.

**JUNIOR ELECTRONIC ENGINEERS**

To assist Senior Engineers and Scientists in the development of HF communications and data process equipment. Should have formal electronics schooling and 2 years' experience in circuit design, checkout or analysis of HF communications, Radar Pulse, Analog/Digital or Data Recovery equipment. Construction of prototypes of new and interesting equipment and design of individual components of communications and data processing systems will comprise the major efforts of selected applicants.

**FIELD STATION ENGINEERS**

B.S.E.E. or equivalent, consisting of combined civilian or military technical school, with work experience. Presently employed as a field engineer or project engineer with valid 1st or 2nd Class FCC license and a good command of some of the following: Radar, preferably high power; HF long-distance communications systems; Tropospheric or Ionospheric scatter systems. Must be willing to accept assignments in areas where dependents are not permitted for periods of up to one year. Differential paid for overseas assignments.

The Electro-Physics Laboratories are located in the suburban Washington, D.C. area, where post-graduate study is available in several nearby universities. Housing is plentiful in attractive, well-established neighborhoods. Our relocation allowance is liberal.

*All inquiries will be held in strictest confidence and answered promptly.*

*Please send resume to:*

ROBERT REID, PROFESSIONAL EMPLOYMENT SUPERVISOR  
ACF ELECTRONICS DIVISION

**acf**

Industries, Incorporated

Riverdale, Maryland

WARfield 7-4444

*analytical,*  
*systems,*  
*components*  
*engineers*

**CHECK THESE OPENINGS  
IN FLIGHT CONTROLS WITH  
HONEYWELL AERONAUTICAL**

Honeywell introduced the first successful electronic autopilot in 1941—the C-1 of World War II. Since, we have produced more flight control systems than any other company and have developed concepts in flight controls that are now standard in this field. Today, most top aircraft and missiles are equipped with Honeywell flight controls. Honeywell's Flight Control Systems Group has expanded steadily and now has openings for the following:

**ANALYTICAL ENGINEERS**—must be capable of simulating (mathematically on paper or computers) characteristics and problems in missiles and aircraft control, stability, and control systems. Should have good math backgrounds with analog computer experience.

**SYSTEMS ENGINEERS**—should be capable of interpreting analytical results into navigation, guidance, or flight control systems. Should be electrical engineers experienced in systems—ideally, with experience in flight control in the aviation industry.

**COMPONENTS ENGINEERS**—should be electronics men with emphasis on transistor circuitry. Will be responsible for designing components which go into the system. Must have circuitry design experience.

*To discuss these or other openings, write Mr. Bruce D. Wood, Dept. 610B, Aeronautical Division, 1433 Stinson Blvd., Minneapolis 13, Minn.*

**Honeywell**

 *Military Products Group*

To explore professional opportunities in other Honeywell operations coast to coast, send your application in confidence to H. K. Eckstrom, Minneapolis 8, Minnesota.

opportunities in design engineering

# COLLINS

Ideas — and experienced design engineers who can turn them into performing products — are the moving force behind Collins Radio Company. Right now, design engineers are needed for a wide range of electronic projects at Collins' three locations; Dallas, Texas, Burbank, California, and Cedar Rapids, Iowa. Projects include design and development problems on airborne communication, flight control, navigation and identification systems, missile and satellite tracking and communication, high speed digital data transmission, antenna design, amateur radio and broadcast. They afford full scope to your creative ingenuity. They give you unusual opportunities for advancement and professional recognition.

*Collins past achievements promise an outstanding future* — Collins design engineers have been responsible for the integrated electronics systems for America's newest Air Force and Navy fighters and bombers. These systems provide UHF communication, TACAN navigation, radar identification, UHF direction finding, navigation indicators.

From its inception, Collins has placed strong emphasis on research and development. The R&D division accounts for about 3,500 employees, of which 40% are engineers, physicists, mathematicians, and scientists. About \$22 million is spent annually on R&D activities.

Collins is a growth leader in the electronics field. Engineering minded management has balanced government and commercial business to the point where stable employment is assured. Military-commercial backlog exceeds \$200 million.

The steady growth of Collins is noted by comparing 1937 sales of \$500 thousand and 1945 sales of \$43.3 million with 1959 sales in excess of \$117 million.

If you are a qualified design engineer, you are invited to submit your resume in complete confidence to the location of your choice: L. R. Nuss, Collins Radio Company, 855 35th St., N.E., Cedar Rapids, Iowa; B. E. Jeffries, Collins Radio Company, 1930 Hi-Line Dr., Dallas 7, Texas or R. J. Olsen, Collins Radio Company, 2700 W. Olive Ave., Burbank, California.



COLLINS RADIO COMPANY • CEDAR RAPIDS, IOWA • DALLAS, TEXAS • BURBANK, CALIFORNIA



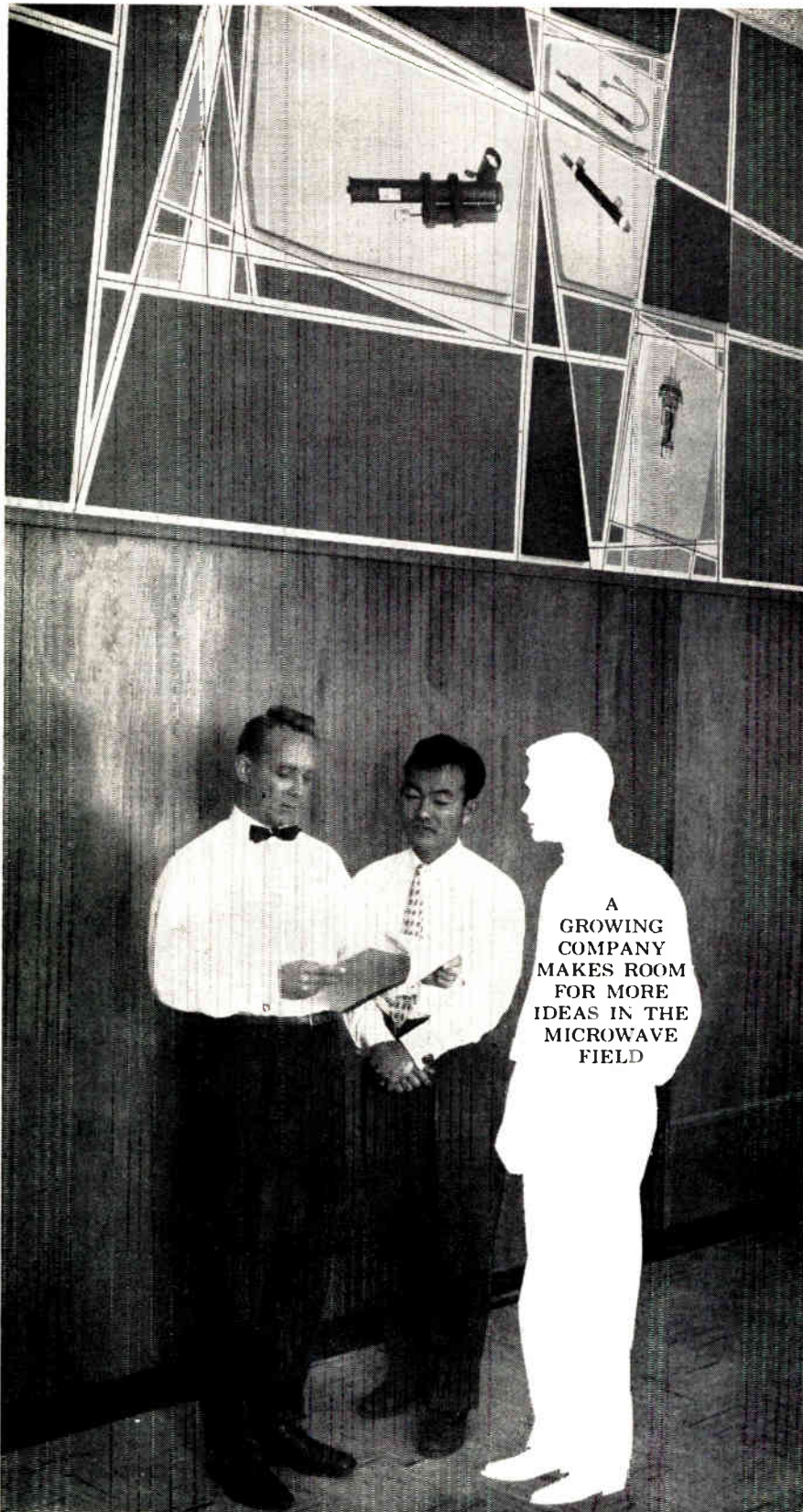

A  
GROWING  
COMPANY  
MAKES ROOM  
FOR MORE  
IDEAS IN THE  
MICROWAVE  
FIELD

Watkins-Johnson Company has substantially expanded its facilities in Stanford Industrial Park, Palo Alto, California. Through the policies of its technically-oriented management this company is providing ideal circumstances for creative activity.

And it plans to continue to expand to make room for more ideas.



WATKINS-JOHNSON COMPANY • 3333 HILLVIEW AVENUE • PALO ALTO, CALIFORNIA



## Membership



(Continued from page 160A)

### Admission to Member

Akerley, J. E., Beltsville, Md.  
Aria, P. U., Milano, Italy  
Anderson, D. E., Minneapolis, Minn.  
Applegate, G. W., West Belmar, N. J.  
Aptaker, I. M., Philadelphia, Pa.  
Ayas, M. H., Cairo, Maadi, Egypt  
Bacon, R. R., Nutting Lake, Mass.  
Baker, C. L., St. Louis, Mo.  
Belau, E. E., Holloman AFB, N. Mex.  
Berry, J. R., Baltimore, Md.  
Blickman, J. H., Orlando, Fla.  
Bloom, R. E., Montebello, Calif.  
Boehm, H. G., Poughkeepsie, N. Y.  
Bokros, P., Norristown, Pa.  
Bolognesi, G., Monza, Milano, Italy  
Boss, C. A., Puteaux, Seine, France  
Brinkman, K. L., Los Angeles, Calif.  
Brown, L. J., III, Drexel Hill, Pa.  
Bruce, P. E., Los Angeles, Calif.  
Bycoski, C. T., Terryville, Conn.  
Camatini, G., Milano, Italy  
Carlberg, N. E., Seattle, Wash.  
Casoria, A., Milano, Italy  
Cattaneo, G., Milano, Italy  
Chao, J. T., Pasadena, Calif.  
Chertoff, A. B., Flushing, N. Y.  
Chervenik, J., Endicott, N. Y.  
Choi, B., Kwangju, Chollanamdo, Korea  
Chu, R. H., Syracuse, N. Y.  
Ciner, E., Longchamps, FCGR, Argentina  
Clark, A. J., Jr., Albuquerque, N. Mex.  
Coburn, W. L., Charlottesville, Va.  
Collins, T. J., Rural Hall, N. C.

(Continued on page 166A)

## COMMUNICATIONS ENGINEERS

### Are you considering a change?

Consider, then, the ultimate in Stateside locations—San Carlos, California—the Center of West Coast Electronic Research and Development!

## LENKURT ELECTRIC CO., Inc.

has an immediate need for an  
experienced

### MICROWAVE RADIO ENGINEER

Experience in Microwave communications systems required. Broadband radio relay design work in telephone communications offers an outstanding challenge!

### APPLICATION ENGINEERS

Several positions currently open for men with BSEE and 5-10 years experience in telephone systems.

Inquiries for these and other Communications Engineering positions will be given immediate attention (and will be processed in strictest confidence).

Direct inquiries to

E. Jack Shannahan, Employment Mgr.  
LENKURT ELECTRIC COMPANY, Inc.  
1105 County Road  
San Carlos, California  
Or, for more convenient, phone collect:  
LYtel 1-8461.



\* The acceptance by business and industry of the Philco 2000 All-Transistor Data Processing System has created a number of significant advancement opportunities in our organization both at our new headquarters in suburban Philadelphia and at various key locations in other parts of the nation. You are invited to call, write or visit us to discuss your future in our growth organization.

# COMPUTER engineers\*

We have immediate assignments awaiting:

## ENGINEERING PERSONNEL

**Circuit Designers**—Opportunities for experienced engineers at Senior, Project and Specialist levels to work in advanced electronic circuitry for digital computer core and drum memory elements.

**Product Engineers** — Qualified by experience in electronic computer test and debugging for final product evaluation and acceptance of large-scale, high speed all-transistor digital computer system.

**Programmers** — Mathematicians and Physicists experienced in the elements of sophisticated automatic programming systems to develop efficient, logical programs for control computers.

## SALES & MARKETING MEN

**Sales Representatives** — Experienced in actual sales, installation and servicing of engineering and business data processing systems in major industrial concerns.

**Systems Analysts**—Degree required, with 5 years' experience in the analysis of Engineering, Scientific, business data processing and military problems.

**Programmers** — Experienced computer programmers in any of the following fields: Sophisticated Automatic programming systems • Engineering & Scientific Problems • Business, Industrial & Financial Applications • Military Tactical & Logistical Applications.

## Customer Service Engineers

Experienced computer engineers for local and out-of-State assignments in major metropolitan areas to install, start up and maintain large-scale, high speed digital computer systems. Advanced training on all-transistor equipment furnished prior to assignment. Also openings for instructors and technical writers with experience in the computer field.

**IF YOU QUALIFY, CALL OR WRITE TODAY**  
**Mr. Fred Ptucha, Director of Personnel, OLdfield 9-7700**

**PHILCO** **COMPUTER**  
 *Famous for Quality the World Over* **DIVISION**

**WILLOW GROVE, PENNSYLVANIA**

ENGINEERS • SCIENTISTS

## BRIDGING THE GAP

...from components, equipments, and subsystems  
to fully integrated control systems

This is one of the functions of The MITRE Corporation. Within a total system concept, MITRE is engaged in long-term engineering work which encompasses system design, experimental electronics development, operational evaluation, and integration of complex computer-control systems. Some of these systems are currently operational, some are in prototype, while others are in the study and planning stage.

Well trained engineers and scientists with an interest in large-scale electronics system engineering will find rewarding growth opportunities for creative contributions in the following areas:

- Radar System Development
- Communications
- Human Factors
- Operations Analysis
- Weapons System Analysis
- Air Traffic Control Systems
- Computer Technology
- Advanced System Design
- Electronic Countermeasures
- Military System Programming

*Inquiries may be directed in confidence to*  
VICE PRESIDENT — TECHNICAL OPERATIONS



POST OFFICE BOX 31, 4-MG — LEXINGTON, MASSACHUSETTS

*MITRE is an independent system engineering organization formed under the sponsorship of the Massachusetts Institute of Technology. Its convenient location in suburban Boston affords excellent opportunities for advanced study under MITRE's liberal educational assistance program.*

*Openings are also available at MITRE's facilities in Montgomery, Alabama and Fort Walton Beach Florida.*



**Membership**



(Continued from page 161A)

Cooper, B., Rome, N. Y.  
Costanza, J. L., Cleveland, Ohio  
Crawford, J. D., Dallas, Tex.  
Cruz, R., Aurora, Ill.  
Cuzzo, D., Lynn, Mass.  
Davis, J. A., Philadelphia, Pa.  
Day, A. C., West Acton, Mass.  
della Porta, P., Milano, Italy  
Derby, R. J., Fullerton, Calif.  
Devlin, M., Philadelphia, Pa.  
Dewhurst, D. R., Inglewood, Calif.  
DeYoung, C. M., Riverside, Calif.  
Dienes, G., Orland Park, Ill.  
Dionne, P. J., Richland, Wash.  
Dmytrijuk, W., Buffalo, N. Y.  
Donald, E. N., Somerton, Pa.  
Donovan, W. H., Jr., Towson, Md.  
Dougherty, E. V., Irvington, N. J.  
Driesse, W. H., Honesdale, Pa.  
Duda, F. A., St. Louis, Mo.  
Dunn, J. R., Toronto, Ont., Canada  
Edelman, W. E., Jr., Playa Del Rey, Calif.  
Elford, S., Philadelphia, Pa.  
Engle, A. W., Tulsa, Okla.  
Escoffery, C. A., Los Angeles, Calif.  
Ewing, G. D., Santa Clara, Calif.  
Ewing, R. W., State College, Pa.  
Falbroni, J. P., New York, N. Y.  
Farakbrooz, A., Lynchburg, Va.  
Faster, D. H., Burbank, Calif.  
Feigenbaum, M. H., Jackson Heights, N. Y.  
Feiss, C. L., Niles, Ill.  
Finberg, W. S., Great Neck, L. I., N. Y.  
Fox, J. A., Jr., Van Nuys, Calif.  
Freeman, R. J., Los Angeles, Calif.  
Frykman, R. W., St. Paul, Minn.  
Fulton, R., Manteca, Calif.  
Galat, E. J., Marlton, N. J.  
Gensler, P. L., Baltimore, Md.  
Gerngross, J. E., Washington, D. C.  
Ghobrial, I., Khartoum, Sudan, Africa  
Gillea, R. J., Havertown, Pa.  
Gilman, E., Farmingham Center, Mass.  
Giorgi, C. M., Fort Huachuca, Ariz.  
Gold, R. C., Reseda, Calif.  
Goodman, H. D., Monrovia, Calif.  
Gorham, J. N., Balboa, Canal Zone  
Grabowski, J. P., Dickson City, Pa.  
Granger, W. E., Hanover, Md.  
Green, J. D., Tupelo, Miss.  
Greenberg, Levittown, Pa.  
Greenmeyer, J. R., Inglewood, Calif.  
Gyrko, J. E., Tinley Park, Ill.  
Halverson, P. C., Anaheim, Calif.  
Harewood, C. P., Philadelphia, Pa.  
Hatch, G. M., Los Angeles, Calif.  
Havel, V. A., Jr., Wilmette, Ill.  
Havens, R. C., Phoenix, Ariz.  
Herman, J. C., Santa Clara, Calif.  
Hefni, I., Melrose, Mass.  
Herin, J. G., Playa Del Rey, Calif.  
Hertzog, W. F., Jr., San Francisco, Calif.  
Hilton, A. M., New York, N. Y.  
Hinds, J. F., Arlington, Mass.  
Hodara, H., Morton Grove, Ill.  
Holik, F. J., Sharon, Mass.  
Holt, A. R., Culver City, Calif.  
Horejsi, R. M., Los Angeles, Calif.  
Howe, H. V., Newark, Del.  
Howie, G. S., Pleasant Valley, N. Y.  
Jachowski, R. E., Palo Alto, Calif.  
Jahnke, C. E., Lake Zurich, Ill.  
James, R. L., Bloomfield, N. J.  
Jensen, A. K., Kenil, N. J.  
Jones, G. E., Agincourt, Ont., Canada  
Jones, J. C., Apalachin, N. Y.  
Jordan, A. G., Pittsburgh, Pa.  
Kavanagh, J. J., New York, N. Y.  
Kelley, F., Plainview, L. I., N. Y.  
Kenedi, R., Montreal, Que., Canada

(Continued on page 170A)

# SCIENTISTS . . . ENGLISH ELECTRIC AVIATION LIMITED

(Guided Weapons Division)

LUTON BEDS.

## LEADERS IN NEW PROJECTS AND ADVANCED STUDIES

Applications are invited from scientists for positions in which they will lead groups conducting feasibility studies in Advanced Weapons Systems and Satellite Projects.

Candidates should preferably have had experience of Research or Development work in related fields, but previous work on Guided Weapons, Aeronautics or Armaments is in no way essential. Degree or equivalent qualifications in either Physics, Mathematics, Electrical or Aeronautical Engineering is necessary.

For these posts (equivalent approximately to Principal Scientific Officer) the Company will give assistance with housing and removal expenses.

Please write to Dr. D. A. Layne, c/o Dept. C.P.S. Marconi House, 336/7, Strand, London, W.C.2, England, quoting reference 1395D.

### **Announcing an OUTSTANDING OPPORTUNITY for Research in Engineering ELECTRONICS AND PHYSICS**

Southern Research Institute has openings for senior electronic engineers or engineering physicists in the field of instrument development. Current activities on an expanding series of projects can be summarized by the title Photoelectronics. Successful progress on the work calls for advancing frontiers in electronic circuits, physical and geometrical optics, and kinematic design of instrument components.

An applicant should preferably have an M.S. or Ph.D. degree in electrical engineering or engineering physics, or equivalent experience, and should have a keen desire to become a leader in this field.

If you are looking for an opportunity to work in this interesting and challenging field, please write, giving a summary of your education and experience to

**SOUTHERN RESEARCH INSTITUTE**  
Birmingham 5, Alabama

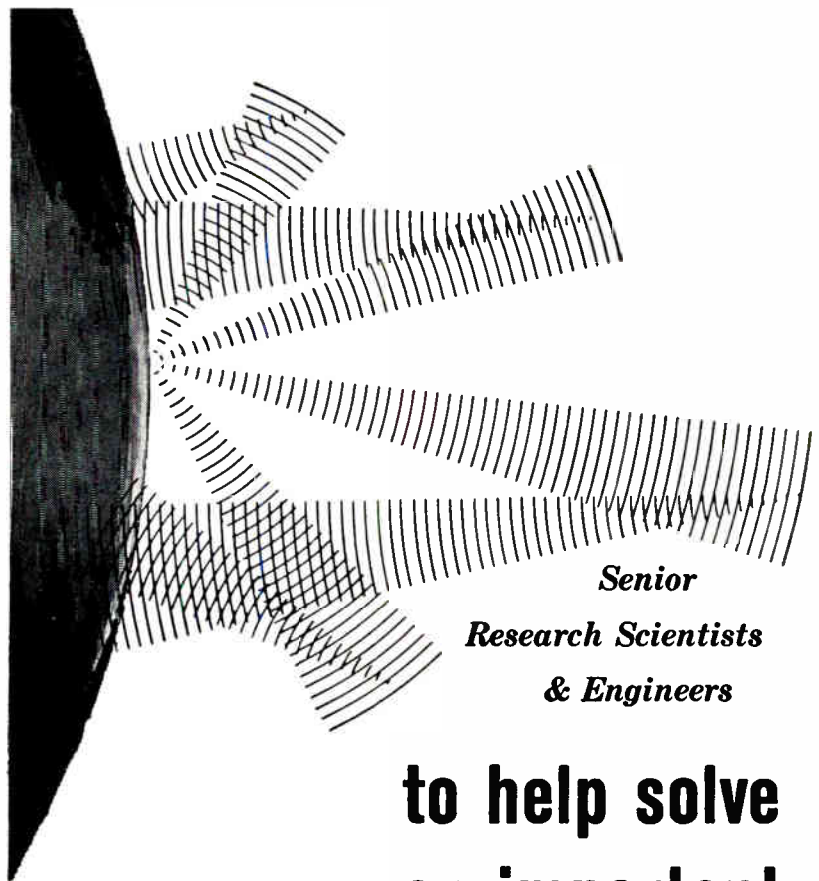

*Senior  
Research Scientists  
& Engineers*

## to help solve an important communications problem

The problem . . . to define the parameters and establish feasibility of a long-range, ECM-proof, single or multiple path communications system capable of negligible degradation and an ultra-high degree of reliability while operating in a constantly changing environment.

The solution, at present, is difficult . . . all known techniques, individually or multi-plexed, would provide only marginal performance.

Research Scientists and Engineers with advanced degrees who feel they can contribute new insight, new concepts, and the application of new techniques to the establishment of this vitally important system are invited to forward their confidential inquiry to:

Dr. R. L. San Soucie

Amherst Laboratory / SYLVANIA ELECTRONIC SYSTEMS  
A Division of

**SYLVANIA**  
Subsidiary of GENERAL TELEPHONE & ELECTRONICS

1144 Wehrle Drive—Williamsville 21, New York





## *working*

*The sphere represents perfection in many ways to the designer of inertial instruments. It can be decoupled completely from torques due to external magnetic, electric, and gravitational fields. It has perfect symmetry, can be formed to extreme accuracy by simple machine processes. It is the primary element of Honeywell's electrically suspended gyro.*

Fundamental ideas are the basis for continued advances in inertial sensors and systems. Honeywell engineers have a primary concern for developing new systems through applications of just such ideas. A consistent pattern of Honeywell investment in research and development facil-

ities and programs encourages ideas and their application, and is an important factor in Honeywell's continuing growth and reputation.

Typical of the results are electrically suspended navigation gyros, adaptive flight control systems, and guidance and control for space vehicles. Sergeant, Thor, Atlas, Titan, Polaris, F-104, B-58, WS 117L, Scout, Mercury . . . Honeywell equipment is on all of these and many more.

Current expansion has created openings for senior and junior engineers and scientists in these and similar programs. Your inquiry will get prompt and confidential attention.

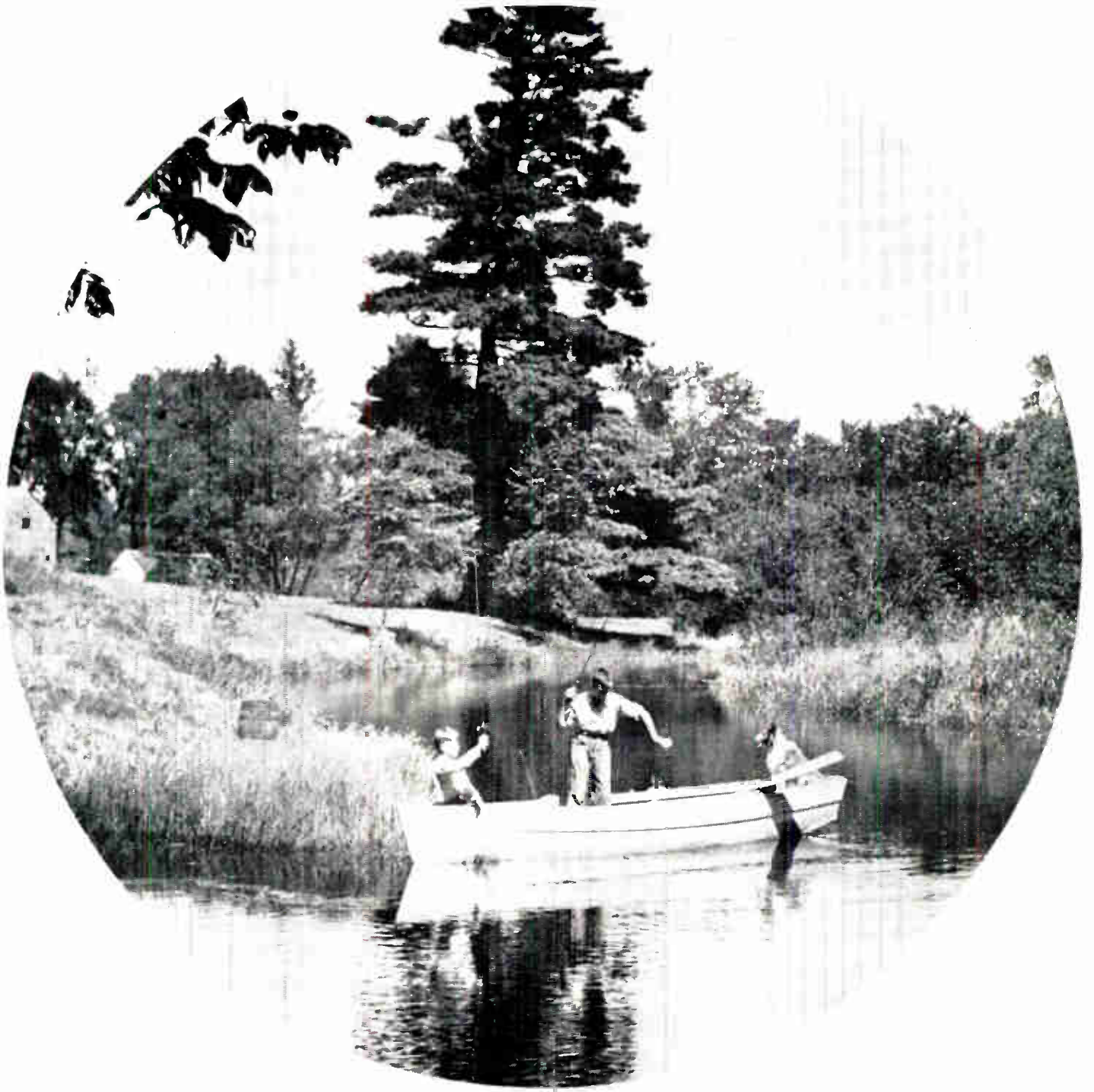

## *living*

Most Honeywell engineers and their families live in or around Minneapolis—a city of 22 lakes and 153 parks. This is good, healthful living—and it's fun. A twenty minute drive along elm-shaded streets and you're home . . . with more time to enjoy the family and the outdoors throughout the four seasons.

There is time for hunting, fishing, golfing, swimming—and in winter, skating, skiing, ice fishing and sleighriding. Then there is Laker basketball, Big Ten football. Or you may prefer theatre, opera, symphony or museums.

Schools in staff and facilities are among the nation's

best. There are six colleges in the Twin Cities, including the University of Minnesota only 2 miles away from Aero.

This is part of the living that Honeywell engineers and their families enjoy.

*For information on career opportunities, write Bruce D. Wood, Dept. 610A, Aeronautical Division, 1433 Stinson Blvd., Minneapolis 13, Minn.*

# Honeywell



*Military Products Group*

*To explore professional opportunities in other Honeywell operations coast to coast, send your application in confidence to H. D. Eckstrom, Honeywell, Minneapolis 8, Minnesota*

# FACTS and FIGURES about SANDERS That Add Up to TOP ENGINEERING OPPORTUNITIES

- 1 Dramatic growth in 8 years from an 11 to 1300-man organization.
- 2 Diversity—20 R&D contracts at time of writing.
- 3 Stability—substantial production activities as well as advanced R&D.
- 4 Backlog at beginning of '60—\$20,000,000.
- 5 Gross sales of \$10,600,000 in 1959—an increase of 18% over 1958.
- 6 A sales goal of \$15,000,000 in 1960 (with very reasonable expectations of meeting it).
- 7 A record of original engineering achievements such as PANAR<sup>®</sup> radar; FLEXPRINT<sup>®</sup> flexible printed circuits; TRI-PLATE<sup>®</sup> microwave products.
- 8 Location: Nashua, a progressive city of 50,000, is in the beautiful New Hampshire hill country less than an hour from downtown Boston. No state income or sales taxes.

*Continued Expansion Creates Openings for  
Imaginative Engineers in the Following Areas:*

## SYSTEMS ENGINEERS

Through Project Engineer level. Need not be specialists, but must have creative abilities and backgrounds of VHF transmitters and receivers, communications systems in general, data processing techniques, propagation and must be capable of translating this knowledge into complex integrated systems.

## RECEIVER DESIGN ENGINEERS

VHF electronically scanned airborne receivers, filters, problems in spurious response reduction and multiplexing.

## CIRCUIT DESIGN ENGINEERS

With particular emphasis on transistor application to analog and digital techniques; data handling equipment; audio; video; RF circuitry and switching.

## TRANSMITTER & MAGNETIC DESIGN ENGINEERS

*To learn more about opportunity for YOU at Sanders,  
send a resume to Lloyd Ware, Staff Engineer, Dept. 908.*



**SANDERS ASSOCIATES, INC.**

**NASHUA, NEW HAMPSHIRE**

®registered U.S. trademark



**Membership**

*(Continued from page 166A)*

Kohlstadt, H. M., Sept. Hcs. Que., Canada  
 Kraemer, B. J., Seattle, Wash.  
 Kupersmith, F., New York, N. Y.  
 Kyle, F. W., Nenia, Ohio  
 Lambert, H. R., Catonsville, Md.  
 Lang, W. W., Poughkeepsie, N. Y.  
 Lanz, R. W., Denver, Colo.  
 Lawson, A. N., Southgate, London, England  
 Leskaskas, F. C., Jr., Scranton, Pa.  
 Levin, H. M., Anaheim, Calif.  
 Levy, D., Teaneck, N. J.  
 Levy, M. A., Haddonfield, N. J.  
 Liebowitz, B. H., Great Neck, L. I., N. Y.  
 Lister, R. T., Berea, Ohio  
 Ljtniewe, A. L., Cedar Rapids, Iowa  
 Lowe, E. H., Graham, N. C.  
 Lyons, T. M., Huntington Station, N. Y.  
 MacAulay, G. D., Ste. Foy, Quebec, Que., Canada  
 Madden, J. J., Skokie, Ill.  
 Martens, A. E., Willowdale, Ont., Canada  
 Martin, M. H., Sun Valley, Calif.  
 Masterson, F. H., Poughkeepsie, N. Y.  
 Matthews, G. H., Titusville, Fla.  
 May, R. L., Edmonds, Wash.  
 McShane, J. L., Pittsburg, Pa.  
 Mendelsolm, M., Englewood, N. J.  
 Merchant, J., Brighton, Mass.  
 Mitchell, W. R., Cocoa Beach, Fla.  
 Mollerstuen, R. B., White Sands Missile Range,  
 N. Mex.  
 Morse, J. H. I., Holloman AFB, N. Mex.  
 Mosely, J. de S., New York, N. Y.  
 Mueller, M. M., Baltimore, Md.  
 Mueller, R. R., Baltimore, Md.  
 Murphy, G. V., Buffalo, N. Y.  
 Myslicki, R. L., Staten Island, N. Y.  
 Nahi, N. E., Los Angeles, Calif.  
 Nearman, G. M., Framingham, Mass.  
 Neddenriep, D. O., Philadelphia, Pa.  
 Neff, E. D., Lawndale, Calif.  
 Nelson, D. W., Ashland, N. J.  
 Nino, R. V., Garden City, L. I., N. Y.  
 Norrman, E. B., Williams Bay, Wis.  
 Norton, M. L., Birmingham, Ala.  
 Oakleaf, S. C., Simsbury, Conn.  
 O'Brien, D. B., Levittown, N. J.  
 O'Connor, C. G., Dallas, Tex.  
 O'Connor, J. C., Wellesley, Mass.  
 O'Donnell, J. R., Jackson Heights, L. I., N. Y.  
 Oharek, F. J., Orlando, Fla.  
 Palmgren, C. F., Salt Lake City, Utah  
 Paneratz, J. B., Seattle, Wash.  
 Peterson, W. R., Mountain View, Calif.  
 Pfeiffer, W. G., Hawthorne, Calif.  
 Plaut, T. Z., Poughkeepsie, N. Y.  
 Potter, D. R., Baltimore, Md.  
 Profera, C. E., Jr., Philadelphia, Pa.  
 Pyburn, R. W., Sunnyvale, Calif.  
 Rima, L. C., Bothell, Wash.  
 Ransom, V. L., Hollis, L. I., N. Y.  
 Reveal, C. A., Utica, N. Y.  
 Roberts, G., Abingdon, Berks., England  
 Rogal, E., New York, N. Y.  
 Rogers, A. J., New Carlisle, Ohio  
 Rose, T. E., North Syracuse, N. Y.  
 Rosenblatt, F., Buffalo, N. Y.  
 Roth, B. J., Hicksville, L. I., N. Y.  
 Rothrock, J. C., White Sands Missile Range,  
 N. Mex.  
 Rubin, L. S., Saxonville, Mass.  
 Sarlo, G. S., Newport Beach, Calif.  
 Saunt, G. H., Jr., Denver, Colo.  
 Sawada, T., Chiyodaku, Tokyo, Japan  
 Sawutz, G., Saugerties, N. Y.  
 Scheele, W. H., Moses Lake, Wash.  
 Schierff, F. O., Philadelphia, Pa.  
 Schinagel, M., Drexel Hill, Pa.  
 Schmidt, R. J., Severna Park, Md.  
 Schwerine, F. K., Long Beach, N. J.  
 Sciambi, A. F., Jr., Drexel Hill, Pa.

*(Continued on page 175D)*



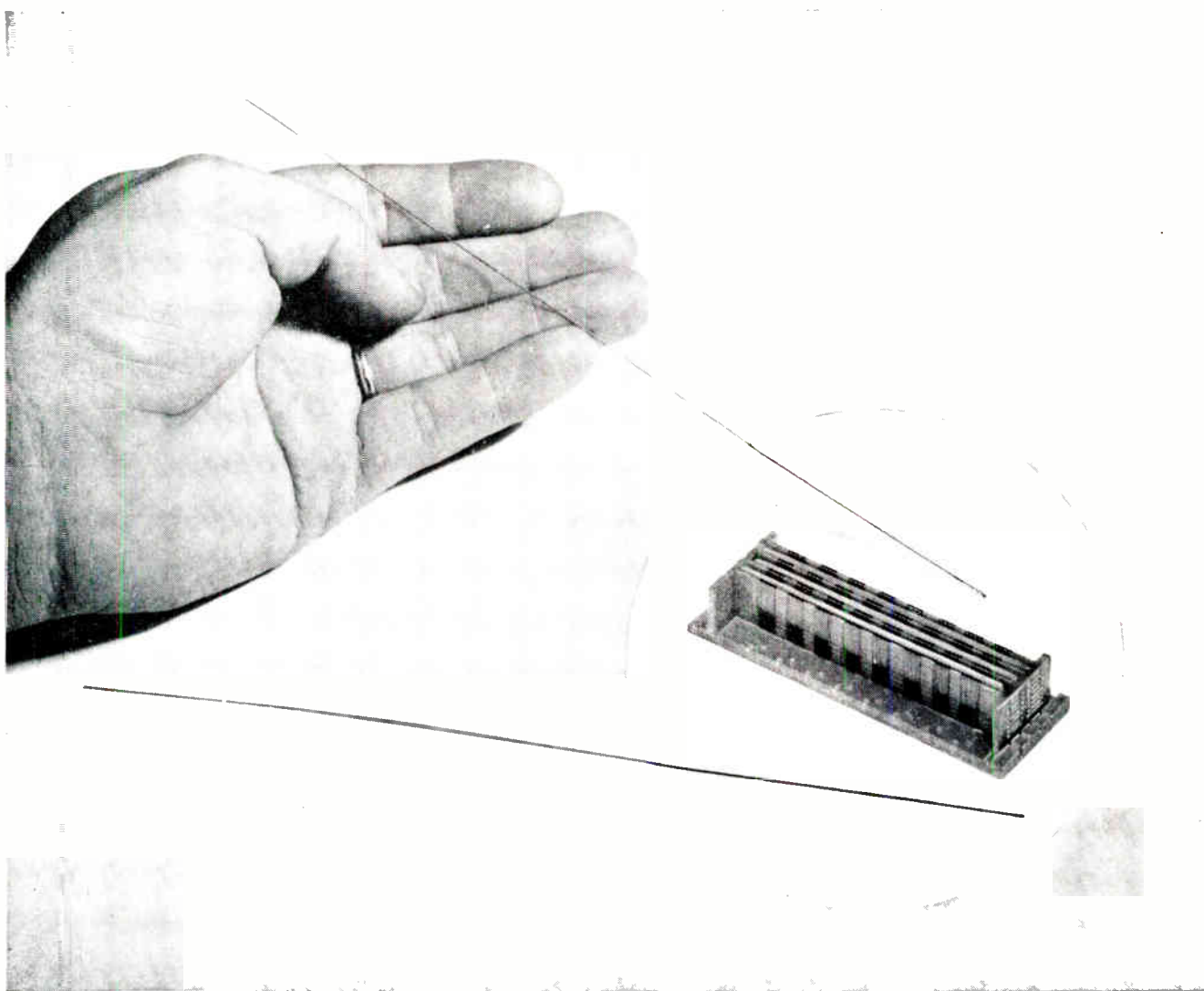

## National's "BIT WIRE"

### AMAZING NEW DEVICE FOR MEMORY AND LOGIC

"BIT WIRE" represents a recent NCR breakthrough in magnetic data storage and logic devices. Pictured above, in a linear memory employment, "Bit Wire" is a conductive wire electrodeposited with magnetic material. It offers the advantages of reliability, flexibility, and greater switching speeds... economic and compact component fabrication. In addition, this amazing wire is useful over a wide range of temperatures. Memory and logic are but a few of the applications to which it is ideally suited. Perhaps you can qualify for a rewarding career with this unique device... or with other challenging NCR projects...

**CHEMISTRY:** Plastics and polymers, micro-encapsulation (of liquids or reactive solids),

photochromic materials (compounds which can be alternated between two distinct color states), magnetic coatings.

**DATA PROCESSING:** Computer theory and component development, programming studies, high-speed non-mechanical printing and multi-copy methods, direct character recognition, systems design.

**SOLID STATE PHYSICS:** Electro, chemical, and vacuum deposited magnetic films ferrites and ferro-magnetics, advanced magnetic tape studies, electroluminescence-photoconductor investigations.

**ADVANCED ENGINEERING DEVELOPMENT:** High-speed switching circuits, random access memory systems, circuit design (conventional, printed, etched), advanced electron

beam type storage. The location of the new NCR Research and Development Center is progressive, energetic Dayton, Ohio. Facilities are extensive—a veritable "city within a city."

**COMPLETE INFORMATION** is yours by sending your résumé to Mr. T. F. Wade, Technical Placement Section F2-2. The National Cash Register Company, Dayton 9, Ohio. All correspondence will be kept strictly confidential.

THE NATIONAL CASH REGISTER COMPANY, DAYTON 9, OHIO

ONE OF THE WORLD'S MOST SUCCESSFUL CORPORATIONS

76 YEARS OF HELPING BUSINESS SAVE MONEY

\*TRADEMARK REG. U.S. PAT. OFF.

**National**\*

VERSATILE DATA PROCESSING  
 DIVERSIFIED CHEMICAL PRODUCTS  
 ADDING MACHINES • CASH REGISTERS  
 ACCOUNTING MACHINES • NCR PAPER

# GROW with Kollsman

Kollsman's leadership and continuing growth in the field of automatic navigation and flight instrumentation assures excellent opportunities for qualified men. Send resumes to Mr. T. A. DeLuca.



**kollsman** INSTRUMENT CORPORATION

80-08 45th AVENUE, ELMHURST, NEW YORK • SUBSIDIARY OF *Standard* COIL PRODUCTS CO. INC.

## Opportunities in:

### FLIGHT DATA INSTRUMENTS & SYSTEMS

Senior Project Engineers, EE & ME

For aircraft and missile instrumentation. 5 to 10 years project experience in precision electromechanical devices.

### AUTOMATIC ASTRO TRACKING SYSTEMS

Project Engineers, EE

For automatic astro tracking systems. Up to 5 years related experience.

### STAFF ENGINEERS & SPECIALISTS

- a. Experience in the research and development of transistors in servo, digital and instrumentation application. Minimum 3 years experience desired in transistor circuit design for military applications.
- b. Experienced with IR to UV radiation properties and applications, noise theory and detectors.
- c. Optics — IR through visual optical design, lens design, materials.
- d. Digital computers — logic or packaging experience.
- e. Theoretical mechanics — inertial and trajectory studies.



## Membership

(Continued from page 170A)

Seidel, R. E., Syracuse, N. Y.  
 Sharek, C. W., Corning, N. Y.  
 Sheen, E. M., Richland, Wash.  
 Silver, P. W., Baltimore, Md.  
 Sinacek, H. A., Jr., Minneapolis, Minn.  
 Simon, H., North Andover, Mass.  
 Sirks, J. C., Amstelveen, Netherlands  
 Skidmore, D., Bedford, Mass.  
 Smith, F. D., Camden, N. J.  
 Smith, J. C., Westchester, N. Y.  
 Snedecor, P. A., Jr., Poughkeepsie, N. Y.  
 Snell, L. W., Lake Katrine, N. Y.  
 Snyder, K. O. D., Anchorage, Alaska  
 Snyder, R. V., Minneapolis, Minn.  
 So, H-C., Rochester, N. Y.  
 Sohn, H. B., Jr., Midland Park, N. J.  
 Sokol, G. F., Nutley, N. J.  
 Somerville, D. W., Belleville, Ont., Canada  
 Sorgenfrei, G. H., Tacoma, Wash.  
 Sowyrda, J., Jr., Peabody, Mass.  
 Spiro, G. H., Levittown, Pa.  
 Squire, G. K., Inglewood, Calif.  
 Stewart, H. W., APO 23, New York, N. Y.  
 Stuart, R. M., Rosemont, Pa.  
 Stubbs, R. E., Bishops Cleeve, Herts., England  
 Suzuki, M., Yonezawa, Yamagata Pref., Japan  
 Swanson, S. C., Acron, Mass.  
 Sweeney, L. P., Indianapolis, Ind.  
 Tallant, W. T., Amundale, Va.  
 Taylor, B. H., Washington, D. C.  
 Teasley, C. J., Jr., Long Beach, Calif.  
 Thomas, J. W., Haddonfield, N. J.  
 Tol, J. M., Montreal, Que., Canada  
 Tradup, R. H., Mountain View, Alaska  
 Tripp, R. M., Saratoga, Calif.

(Continued on page 171A)

# Which area of progress in Electronics interests you most?

SCIENTISTS / ENGINEERS

With the outlook for the electronics industry in 1960 brighter than ever, a significant fact for career-conscious engineers is the breadth of opportunities at Electronics Park. Here General Electric research, development, design and manufacturing groups are actively engaged in almost every area of electronics—whether in the industrial, military, or entertainment fields.

A cross fertilization of products and talents characteristic of Electronics Park will help you advance along with the major advances in the electronics art.

Some of the many areas of research, development, and production at Electronics Park are listed to the right. Check your particular interest and mail the coupon to us today. Requirements for our current openings include a Bachelor's or Advanced Degree in Electronics, Physics, Mathematics, or Mechanical Engineering, and/or experience in electronics. All communications will be held in strict confidence.

**GENERAL**  **ELECTRIC**

To: GENERAL ELECTRIC COMPANY  
 Electronics Park Div. 53-ME  
 Syracuse, New York  
 Att.: Technical Personnel Dept.

### I am interested in

- Advanced Development
- Design
- Field Service
- Technical Writing
- Research

### in the field of

- Military Radio & Radar
- Multiplex Microwave
- Semiconductors
- Electronic Components
- Computers
- Missile Guidance
- Television Receivers
- Industrial Television
- Antennae
- Defense Systems
- Underwater Warfare
- Broadcast Equipment
- Technical Products

NAME \_\_\_\_\_

ADDRESS \_\_\_\_\_

DEGREE \_\_\_\_\_

## Expanding the Frontiers of Space Technology in

# ELECTROMAGNETICS

Lockheed Missiles and Space Division maintains extensive research capabilities for the development of antennas and electromagnetic devices for space vehicle applications.

Laboratory studies in antennas and electromagnetic propagation include the application of solid state materials to microwave transmission line component and parametric circuits; the design of antennas to survive the rigors of space flight; and the effects of scattering from missile and space vehicle structures.

Research is also being conducted in the application of MASERS; on problems of radio transmission between space vehicles and Earth; effects of reentry ionization on radio transmission and reception; and development of antennas for data link systems between satellites and ground stations.

### Engineers and Scientists

Lockheed Missiles and Space Division has complete capability in more than 40 areas of science and technology – from concept to operation. Its programs reach far into the future and deal with unknown and challenging environments. If you are experienced in electromagnetics or in related work, we invite you to share in the future of a company with an outstanding record of achievement and make an important individual contribution to your country's scientific progress. Write: Research and Development Staff, Dept. E-33, 962 W. El Camino Real, Sunnyvale, California. U.S. citizenship or existing Department of Defense industrial security clearance required.

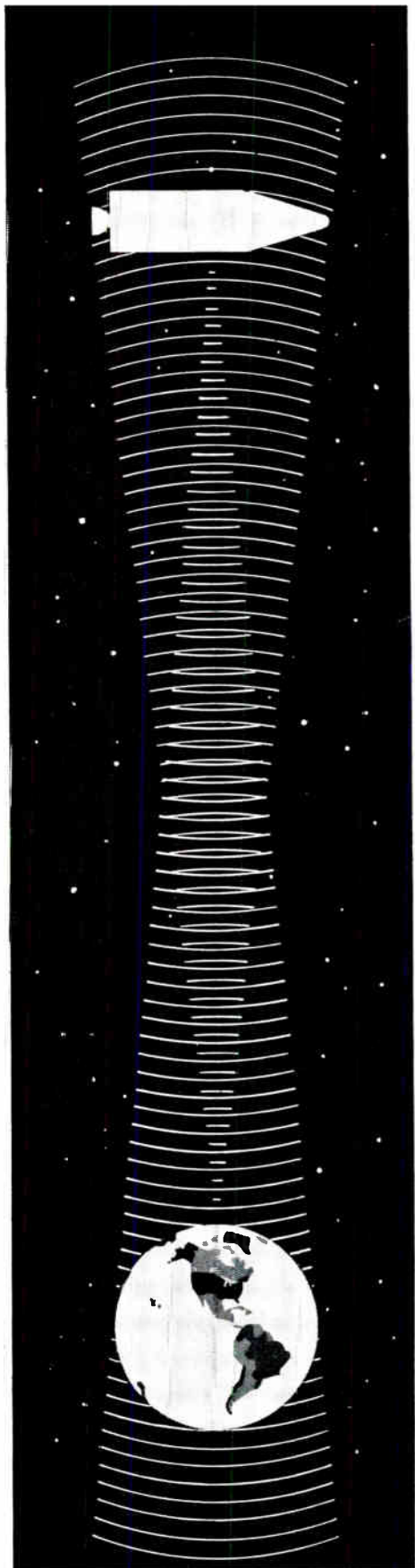

**Lockheed** / **MISSILES AND SPACE DIVISION**

*Systems Manager for the Navy POLARIS FBM; the Air Force AGENA Satellite in the DISCOVERER, MIDAS and SAMOS Programs; Air Force X-7; and Army KINGFISHER*

SUNNYVALE, PALO ALTO, VAN NUYS, SANTA CRUZ, SANTA MARIA, CALIF. • CAPE CANAVERAL, FLA. • ALAMOGORDO, N. M. • HAWAII



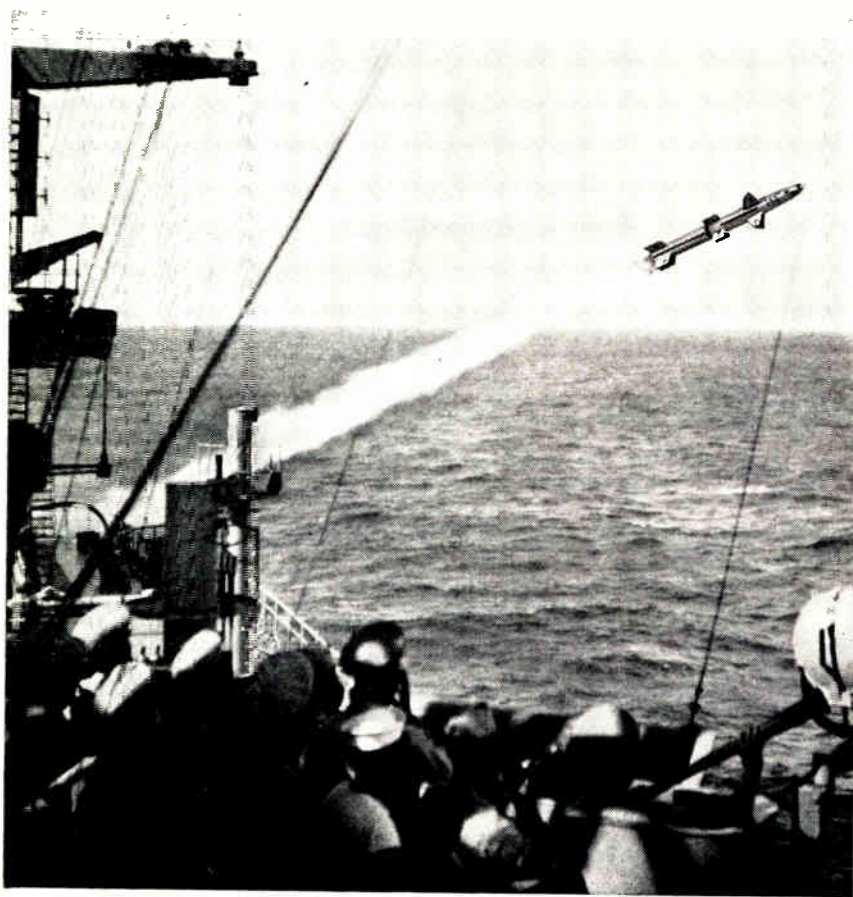

Talos missile, prime armament of the missile-age cruisers, blasts off from the U.S.S. Golveston.

## Bendix Talos— on target for your future!

Talos was on target from the start. The Navy credits it with consistently high accuracy and effectiveness. As a result, Talos was installed directly aboard first line cruisers, rather than auxiliary ships.

The established success of Talos by Bendix Missiles, its prime contractor, not only assures permanence to the present program but has opened the door to other advanced missile projects that offer new and challenging job opportunities in design, development, testing, and manufacturing.

Bendix Missiles, in addition to its direct responsibility for Talos and other advanced missile projects, is a key

division of Bendix Aviation Corporation. The corporation-wide activities of Bendix cover practically every phase of advanced technology with particular emphasis on systems design and development. Participation in this highly diversified corporation effort is your further assurance of a more secure future.

Enjoy living in the Midwest and find unmatched job opportunities with Bendix Missiles. Grow professionally as well as financially. Take the first step today. Mail the coupon for your copy of the interesting booklet "Opportunities Abound at Bendix Missiles."

**Bendix** PRODUCTS DIVISION **Missiles**



PRIME CONTRACTOR FOR THE TALOS MISSILE

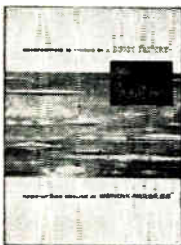

**Bendix Products Division—Missiles**

403E So. Beiger St., Mishawaka, Ind.  
Gentlemen: I would like more information concerning opportunities in guided missiles. Please send me the booklet "Opportunities Abound at Bendix Missiles."

NAME \_\_\_\_\_  
ADDRESS \_\_\_\_\_  
CITY \_\_\_\_\_ STATE \_\_\_\_\_



## Membership



(Continued from page 172.1)

- Troller, T. F., Chicago, Ill.
- Truex, E. H., Orlando, Fla.
- Trumble, W. M., Cleveland, Ohio
- Tuel, E. E., Lee's Summit, Mo.
- Ullman, R. S., Yonkers, N. Y.
- Uslan, G. M., Newark, N. J.
- Viswanathan, C. R., Los Angeles, Calif.
- Voth, R. J., Milwaukee, Wis.
- Votrian, E. R., Anaheim, Calif.
- Voyner, Z. F., Brookmans Park, Herts., England
- Wadler, R., North Dartmouth, Mass.
- Webb, A. L., Bethesda, Md.
- Weber, G. E., Indiana, Pa.
- Weber, P. O., Santa Ana, Calif.
- Welbers, J. A. L., St. Boniface, Man., Canada
- Weissberg, E., Los Angeles, Calif.
- Wendell, D. F., Chicago, Ill.
- Whale, D. J., Moorestown, N. J.
- Wheeler, W. S., Scottsdale, Ariz.
- Wileox, P. M., Oklahoma City, Okla.
- Williams, C. S., Rockaway, N. J.
- Williams, H. L., Hawthorne, Calif.
- Wilson, H. H., Van Nuys, Calif.
- Wilson, R. G., Havertown, Pa.
- Wilson, R. M., Medford Lakes, N. J.
- Winkler, G. M. R., Long Branch, N. J.
- Wool, F. W., Jr., Vienna, Va.
- Wood, T. A., Moorestown, N. J.
- Wooding, H. C., White Sands Missile Range, N. Mex.
- Woodson, H. L., Jr., Washington, D. C.
- Yamamoto, K., Los Angeles, Calif.
- Young, D. J., Los Angeles, Calif.
- Yu, K.-N., Cambridge, Mass.
- Zeutgraf, H. J., Poughkeepsie, N. Y.

(Continued on page 176A)

### A Successful Career Can Begin Here

Let Abbott's be your Personal Agent in presenting your qualifications to the nation's foremost employers of engineers and scientists. You'll find this specialized service extremely effective in placing you where your ability, background and effort will yield the greatest rewards.

If you are placed through us, our clients will pay all expenses and our service charges.

**SALARY RANGES—\$10,000-\$25,000**

**CHIEF ENGINEERS**—Navigation systems, military communications

**MARKETING MANAGERS**—Military & commercial

**DIRECTOR OF RELIABILITY**—EE systems

**STAFF ENGINEERS**—Radar, radio and electronic systems

**ENGINEERING MANAGERS**—Radar, data processing

**SECTION HEADS**—Radar, computers, quality control

**SENIOR ENGINEERS**—Gyros, instruments, systems, radar

**DEVELOPMENT ENGINEERS**—Navigation, systems, radar, components, tubes, semi-conductors

Recognized for over 37 years, among leading companies, for confidential placement of engineering, scientific and administrative people.

MR. LOUIS E. KAY



EMPLOYMENT SPECIALISTS

150 Tremont Street Boston 11, Massachusetts  
HAncock 6-8400

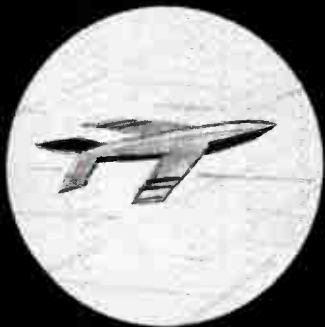

# CAREER OPPORTUNITIES AT ATLANTIC MISSILE RANGE

## AND FORT HUACHUCA

Service to scientific exploration has been performed by the Guided Missiles Range Division of Pan American World Airways since 1953.



Pan American has prime responsibility for the engineering, operation and maintenance of the Air Force Missile Test Center's 5,000 mile Atlantic Missile Range beginning at Cape Canaveral.

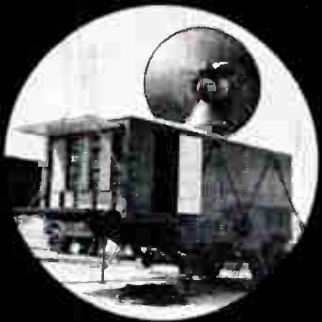

Now, having been awarded a prime contract by the Army Signal Corps, Pan Am has the new responsibility for engineering and operating an Electronic Environmental Test Facility near Fort Huachuca, Arizona. Fort Huachuca will be the brain center of the Test Facility, where information gathered in the field will be analyzed in the Army's automatic data processing facilities, among the most modern and complete in the world.

Additionally, Pan Am will engineer, install, operate and maintain facilities for a test range for Army drone aircraft, with drone flights to be monitored by radars, telemetry, and optical equipments.



To investigate career opportunities with Pan Am at the Atlantic Missile Range, contact J. B. Appledorn, Dept. C-16, Guided Missiles Range Division, Patrick AFB, Florida; or at Fort Huachuca, contact C. A. Hodgins, Dept. C-16, 1535 East Broadway, Tucson, Arizona.

### Openings for:

#### ENGINEERS

- Telemetry
- Optics
- Communications
- Command Control
- Microwave
- UHF
- VHF
- Civil
- Electrical

#### PHYSICISTS

#### MATHEMATICIANS

#### TECHNICIANS

- Radar Operators
- SCR 584
- MPQ 12
- FPS 16
- Telemetry
- Communications
- Optics



**GUIDED MISSILES RANGE DIVISION**

**PATRICK AIR FORCE BASE, FLORIDA**

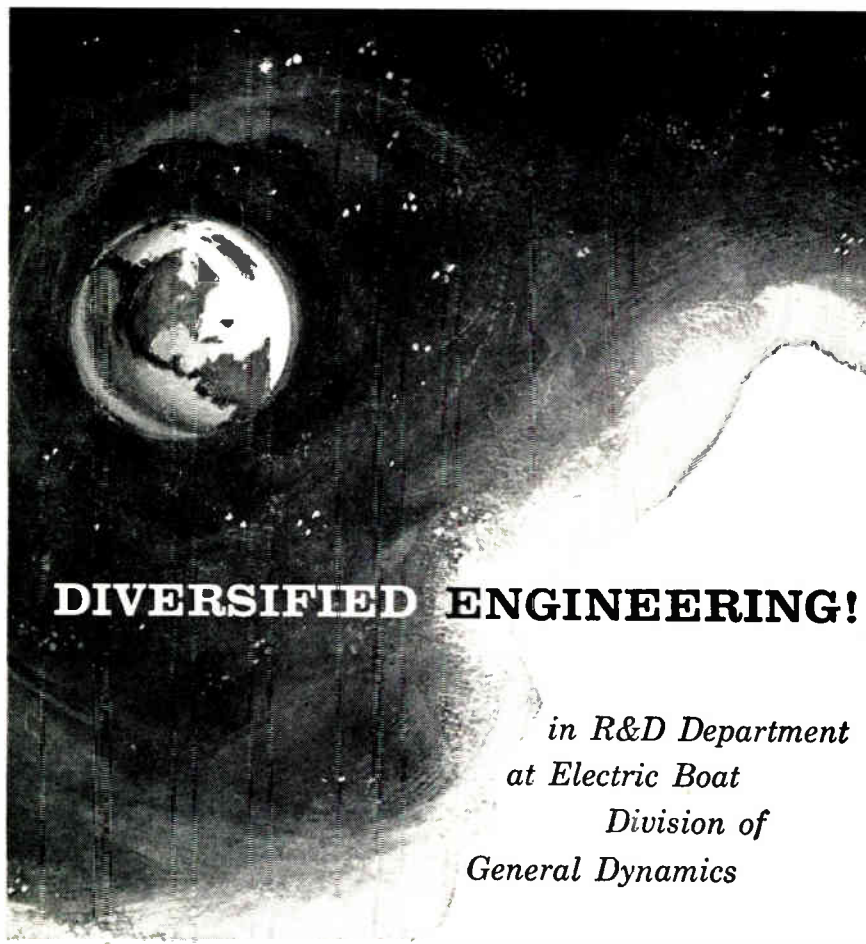

## DIVERSIFIED ENGINEERING!

*in R&D Department  
at Electric Boat  
Division of  
General Dynamics*

### SYSTEMS ENGINEERS

To perform conceptual engineering and systems analysis on complex electro-mechanical and hydraulic systems, co-ordinate the technical efforts of detail engineering, and perform customer technical liaison.

### ELECTRICAL ENGINEERS

To perform system analysis for determination of servo requirements, particularly for large horsepower applications; and to design special-purpose electronic circuits for use in control, computation measurement, and communications areas.

### SYSTEMS EVALUATION ENGINEERS

To perform conceptual engineering and production engineering of electronic equipment with particular regard to circuit development.

**Radio Telescope Control Systems  
Training Device Simulators  
Submarine Integrated Control Systems**

*Send your resume and salary requirements in complete confidence to  
James P. O'Brien, Technical Employment Supervisor*

## ELECTRIC BOAT GENERAL DYNAMICS

A DIVISION OF

Groton, Connecticut



## Membership



(Continued from page 174A)

### Admission to Associate

Abrams, E. Jr., Orlando, Fla.  
Bass, C. J., San Diego, Calif.  
Beck, L. C., Ashland, Mass.  
Bessey, R. C., Melbourne, Fla.  
Birbili, N., Hollywood, Calif.  
Boritz, S. L., Biloxi, Miss.  
Bouret, R. R., Mountain View, Calif.  
Boyd, R. W., Arlington, Va.  
Branigan, J. T., Chicago, Ill.  
Brennan, P. M., Lincoln Park, N. J.  
Bramley, C. C., Fort Huachuca, Ariz.  
Buckminster, I. H., Woodstock, N. Y.  
Bush, A., Los Angeles, Calif.  
Byerley, E. R., Hollywood, Calif.  
Cain, C. M., Las Vegas, Nev.  
Carroll, G. L., North Andover, Mass.  
Carter, C. O., Indianapolis, Ind.  
Center, G. A., Mountain View, Calif.  
Cenzatti, E., Mariano Comense (Como), Italy  
Chaturvedi, G. N., Thana, Bombay, India  
Cocker, W. T., Elizabeth, N. J.  
Colby, R. J., Chicago, Ill.  
Collette, M. M., Antwerp, Belgium  
Cooley, G. A., Jr., Chicago, Ill.  
Corneretto, A., New York, N. Y.  
Crowell, R. J., Panama City, Fla.  
Culbert, W. F., Winnipeg, Man., Canada  
Daburlos, K. E., Reading, Pa.  
Davis, S. B., Houston, Tex.  
De Artinano, F. C., Chino, Calif.  
De Mambro, J. A., Chestnut Hills, Mass.  
Demetrick, J., Jr., Lima, Peru, S. A.  
Doty, A. C., Jr., Franklin, Mich.  
Dowler, C. E., Modesto, Calif.  
Duncan, L. J., Chicago, Ill.  
Edwards, G. L., Chicago, Ill.  
Fausett, F., Jr., Cincinnati, Ohio  
Fink, W. K., Klamath Falls, Ore.  
Frazier, M. B., Jr., Memphis, Tenn.  
Friedman, T. D., Arlington, Va.  
Fukushima, K., Setagaya-ku, Tokyo, Japan  
Gish, D. F., Midwest City, Okla.  
Goldblatt, E., New York, N. Y.  
Gonthier, A. G., Lauzon, Lewis, Que., Canada  
Gorby, J. H., San Diego, Calif.  
Gordon, A., Johnson City, N. Y.  
Gordon, F. J., Jr., Hyde Park, N. Y.  
Green, K. B., Rome, N. Y.  
Griffin, G. A., Yonkers, N. Y.  
Hammer, R. P., Plainville, Mass.  
Hammers, G. A., Visalia, Calif.  
Hansen, J. E., Brigham City, Utah  
Harrington, J. D., Nashua, N. H.  
Harris, R. W., Kensington, Sydney, Australia  
Herrel, W. W., Parlin, N. J.  
Hikosaka, S., Setagaya-ku, Tokyo, Japan  
Hirshberg, I. H., Wakefield, Mass.  
Hopler, V. E., Boonton, N. J.  
Howard, D. W., Costa Mesa, Calif.  
Hrischenko, G., Ottawa, Ont., Canada  
Huymans, L. E., San Francisco, Calif.  
Iciri, S., Setagaya-ku, Tokyo, Japan  
Ipolyi, G., Mineola, L. I., N. Y.  
Ishii, A., Setagaya-ku, Tokyo, Japan  
Jacobson, F. O., East Cleveland, Ohio  
Johnson, R. L., St. Albans, L. I., N. Y.  
Kane, J. J., Cambridge, Mass.  
Kaufman, H., Lynchburg, Va.  
Kirnon, E. M., Brooklyn, N. Y.  
Kommel, B. B., Honolulu, Hawaii  
Kowalik, F., Jr., Detroit, Mich.  
Kurakake, Y., Setagaya-ku, Tokyo, Japan  
La Fever, R. C., Wheaton, Md.  
Le Blanc, L. F., Corpus Christi, Tex.  
Lichty, R. G., Cocoa Beach, Fla.  
Lurie, A. B., Syracuse, N. Y.  
MacLean, T. M., Montreal, Que., Canada  
Mazzuchin, G., Sulbury, Ont., Canada

(Continued on page 178A)



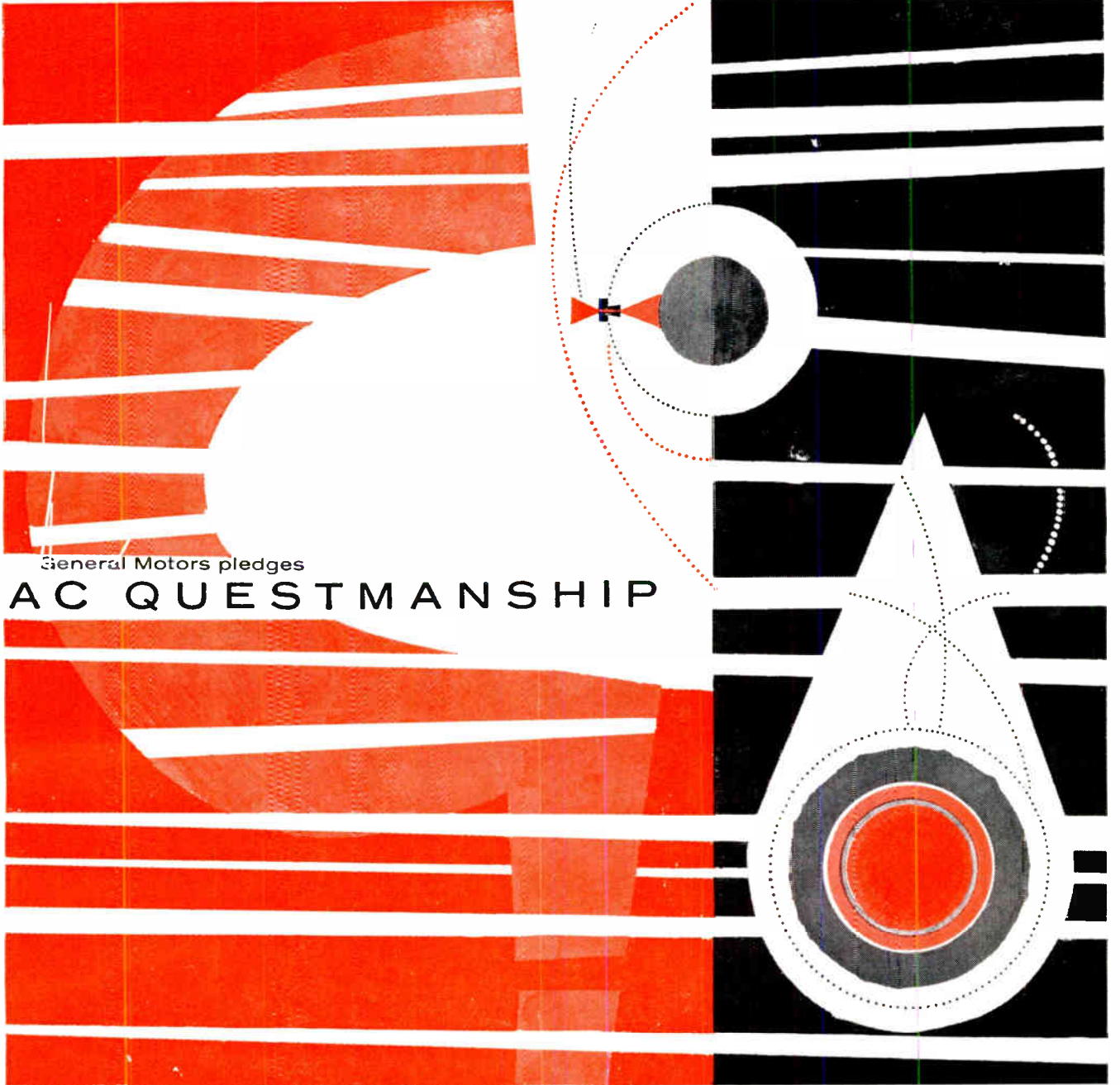

General Motors pledges

## AC QUESTMANSHIP

**AC Seeks and Solves the Significant**—Because of GM's large contribution in the international race for technological superiority, AC accepts a challenge. AC Research is on a scientific quest for solutions to significant problems . . . for accomplishments even more advanced than ACHIEVER inertial guidance for Titan. / We call this creative challenge . . . AC QUESTMANSHIP. It's an exciting quest for new ideas, components and systems . . . to advance AC's many projects in guidance, navigation, control and detection. / Right now Dr. Joseph F. Shea, AC's Director of Advanced Systems Research and Development, is drawing a group of competent men around him to build "the greatest R & D organization in the industry." And Dr. Shea adds strong support to the fact that AC offers "an excellent working atmosphere for a scientist or engineer who wishes to produce and progress." / You may qualify for our specially selected staff . . . if you have a B.S., M.S. or Ph.D. in the electronics, electrical or mechanical fields, plus related experience. If you are a "seeker and solver," write the Director of Scientific and Professional Employment, Mr. Robert Allen, Oak Creek Plant, 7929 So. Howell Ave., Milwaukee, Wisc.

**GUIDANCE / NAVIGATION / CONTROL / DETECTION / AC Spark Plug**  **THE ELECTRONICS DIVISION OF GENERAL MOTORS**



U. S. Navy P3V ELECTRA antisubmarine aircraft produced by Lockheed—equipped with TI-built AN/APS-80 surface search radar, AN/APA-125A indicator, AN/ASQ-8 magnetic anomaly detector and TD-239A intervalometer.

## TI RADAR & MAGNETICS IN ANTISUBMARINE SYSTEMS

APPARATUS  
DIVISION

**TEXAS INSTRUMENTS**  
INCORPORATED  
6000 LEMMON AVENUE • DALLAS 9, TEXAS



### CIRCUIT DESIGN

If this is your career interest, we have projects involving digital computers of extremely small size. Let us tell you more about this—confidentially. Write to Mr. S. L. Hirsch, Head, Research and Engineering Staff.



LITTON INDUSTRIES Electronic Equipments Division  
Beverly Hills, California



## Membership



(Continued from page 176A)

- McConnell, S. G., Lexington, Mass.  
McEwen, D. L., Henderson, Nev.  
Mitchell, W. R., Las Vegas, Nev.  
Mierzwinski, J., Montreal, Que., Canada  
Willer, F. E., Bay Village, Ohio  
Milo, P., Alexandria, Va.  
Molgaard, N. J., Waltham, Mass.  
Mundy, E. L., Bellefonte, Pa.  
Morton, C. B., Toronto, Ont., Canada  
Myers, J. A., Pasadena, Md.  
Nachlas, S., Houston, Tex.  
Nakamura, T., Setagaya-ku, Tokyo, Japan  
Osborne, M. H., Philadelphia, Pa.  
Owskey, R. D., Mea, Oahu, Hawaii  
Patterson, G. B., Anchorage, Alaska  
Patterson, G. E., Lancaster, Calif.  
Paullus, R. L., Canoga Park, Calif.  
Polan, M. J., Forest Hills, L. I., N. Y.  
Prisco, L. C., Huntington Station, L. I., N. Y.  
Proskauer, S. P., Phoenix, Ariz.  
Quick, E. C., Hornell, N. Y.  
Rucine, J. R., Berne, Switzerland  
Radnay, L. S., Great Neck, L. I., N. Y.  
Robinson, J. M., Randallstown, Md.  
Robinson, K. H., Jr., Ridgewood, N. J.  
Rothrich, J. F., Philadelphia, Pa.  
Rose, J. R., Long Beach, N. J.  
Rosenbaum, A., Whittier, Calif.  
Routlard, G. P., San Diego, Calif.  
Salzberg, R. B., Los Angeles, Calif.  
Sarazin, A., Alger, Algeria  
Sasaki, S. I., Jamaica, L. I., N. Y.  
Schacker, D. J., Long Beach, N. J.  
Schermerhorn, R. E., Syracuse, N. Y.  
Seliga, J., Bedford, Ohio  
Simpson, I. L., Baltimore, Md.  
Snoblen, J. J., Detroit, Mich.  
Spiegel, J., Lexington, Mass.  
Stannard, R. E., Los Angeles, Calif.  
Steele, C. G., Vancouver, B. C., Canada  
Sturdy, R. H., Newton, Mass.  
Suba, W. B., Utica, N. Y.  
Sulin, J. S., Oakfield, N. Y.  
Sumino, R. S., Haddonfield, N. J.  
Tansky, R. I., Los Angeles, Calif.  
Thomson, E. A., London, Ont., Canada  
Trajazzano, V. R., St. Petersburg, Fla.  
Tribe, A. C., Jr., Newbury Park, Calif.  
Turner, R. A., San Antonio, Tex.  
Van Kirk, D. J., Dearborn, Mich.  
Van Leer, S. S., Baltimore, Md.  
Volgin, V. V., New York, N. Y.  
Waks, L. I., New York, N. Y.  
Walker, R. A., Melbourne, Fla.  
Webber, D. W., Hayward, Calif.  
Wheeler, J. B., Jr., Griffiss AFB, N. Y.  
Wheeler, K. L., Vancouver, B. C., Canada  
Whelehel, W. M., Los Gatos, Calif.  
Wise, C. C., Chatsworth, Calif.  
Wolfe, R. N., Omaha, Neb.  
Zappitelli, C. A., Los Angeles, Calif.  
Zarate, E., Tulsa, Okla.  
Zauchner, J., Wappingers Falls, N. Y.



## Professional Group Meetings

AERONAUTICAL AND  
NAVIGATIONAL ELECTRONICS

Florida West Coast—February 8  
"The Primary Objectives of the IRE,"  
R. L. McFarlan, IRE.

(Continued on page 182A)



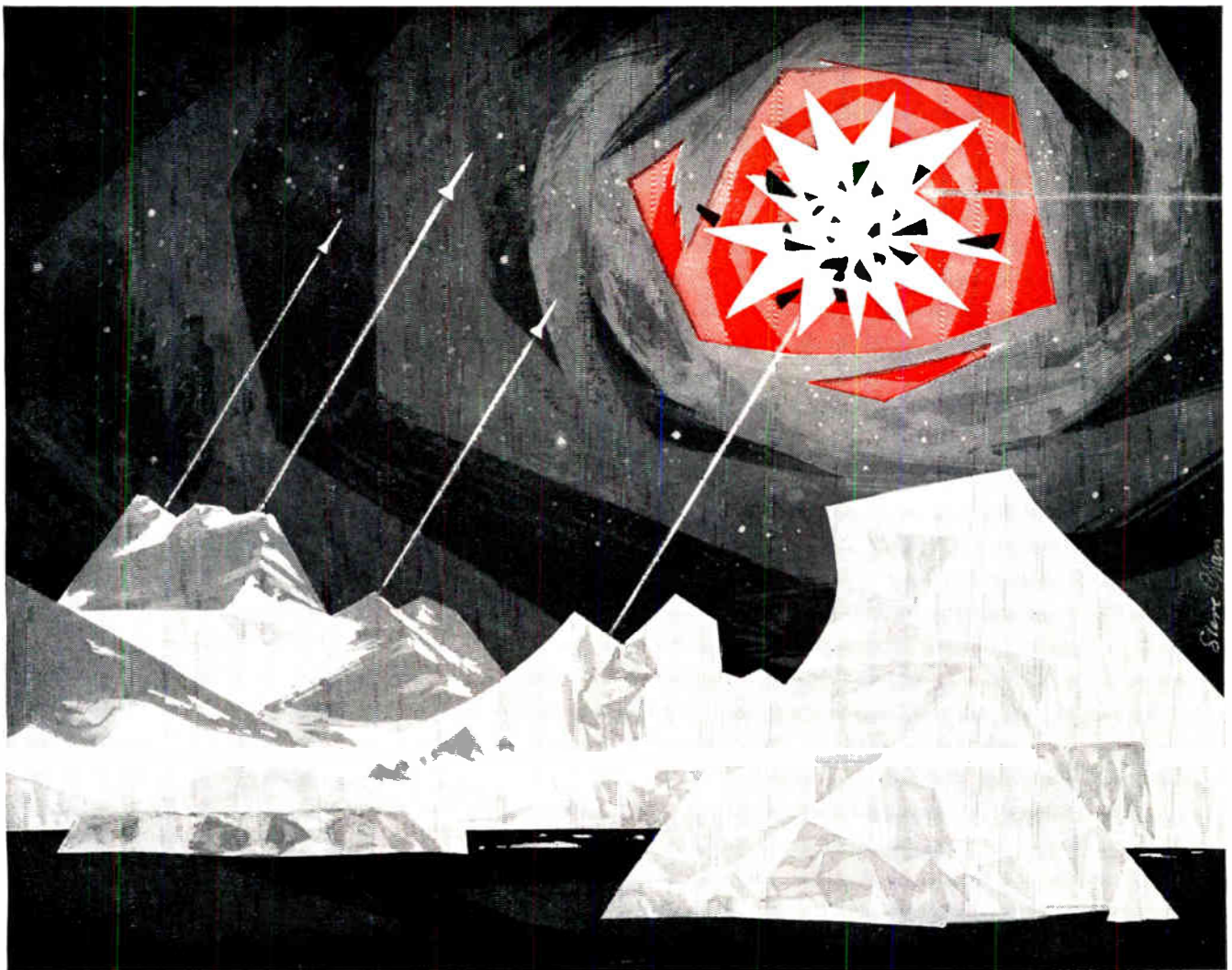

## WITH ONLY MINUTES TO ACT

If America should be attacked . . . from bases around the world Strategic Air Command bombers, tankers and surface-to-surface missiles will rise to action. Minutes only will be available.

To integrate and control this assault requires accessibility and handling of a staggering volume of data. In the missile era, present methods of gathering and processing data will be inadequate. SAC is automating the system.

As systems manager, International Electric Corporation is developing and will turn over to SAC a world-wide electronic

combat control system, an integrated complex of electronic subsystems. The system, employing digital techniques and equipment, will transmit, process and display information on a global basis . . . with only seconds involved.

Engineers whose interests lie in systems engineering, data processing and communications will find in this long-term project exceptional opportunity to exercise creative competence and individual initiative. For details of engineering assignments write B. J. Crawford, Director of Technical Staffing.

## INTERNATIONAL ELECTRIC CORPORATION

*An Associate of International Telephone and Telegraph Corporation*  
Route 17 & Garden State Parkway, Paramus, New Jersey





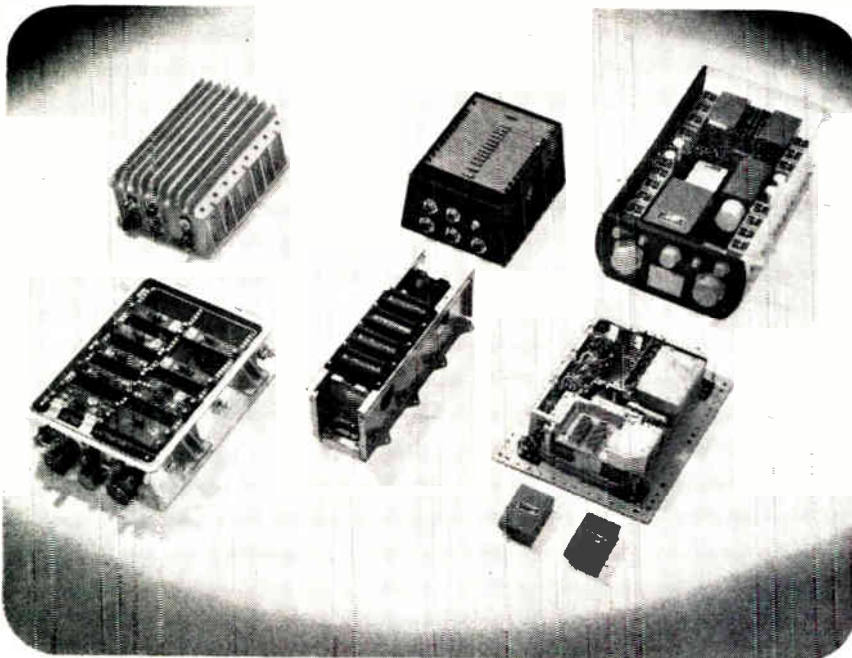

TI telemetry developments for CENTAUR, MINUTEMAN, TITAN, PERSHING, BOMARC and Project MERCURY.

## TI TELEMETRY IN MISSILE SYSTEMS



**TEXAS INSTRUMENTS  
INCORPORATED**  
6000 LEMMON AVENUE • DALLAS 9, TEXAS

## EXCELLENT EMPLOYMENT CONDITIONS

await Scientists and Engineers in  
**RADAR • SONAR • RF COMPONENTS**  
**SOLID STATE ELECTRONICS**

*Here's what the Naval Research Laboratory offers You:*

- Freedom of choice in research
- Continuing professional growth
- Science Education Program leading to advanced degrees
- Excellent facilities and equipment, and atmosphere conducive to high levels of research
- Liberal leave and retirement system, and greater job security through competitive Civil Service program of benefits

There is an unmistakable degree of professional pride evident when a scientist or engineer says, "I am a part of the Naval Research Laboratory." To become a part of NRL requires a considerable degree of competence, of course. To learn how you may qualify for the many excellent job opportunities at NRL, please write to the Personnel Officer.

**NRL**

**U. S. Naval Research Laboratory**  
WASHINGTON 25, D. C.



## digital computer designers

The Crosley Division of Avco Corporation has openings for electronic engineers with from two to ten years' experience for unusually responsible positions involving digital computer and data processing equipment design.

At Crosley, all projects offer engineers of talent and capability unlimited challenge and definite authority. An alert, aggressive management team provides maximum support and backing to each of the outstanding professional teams working on the frontiers of data processing for industrial systems.

Now is your opportunity to grow your own career in this new and exciting field. Experienced personnel can choose:

- transistorized circuit design
- digital systems design
- logic design

For complete information, write or call:

Mr. P. B. Olney  
Manager of Scientific and  
Administrative Personnel  
Department P-50  
Crosley Division  
Avco Corporation  
1329 Arlington Street  
Cincinnati 25, Ohio  
Phone: KIrbv 1-6600.

**Avco / Crosley**

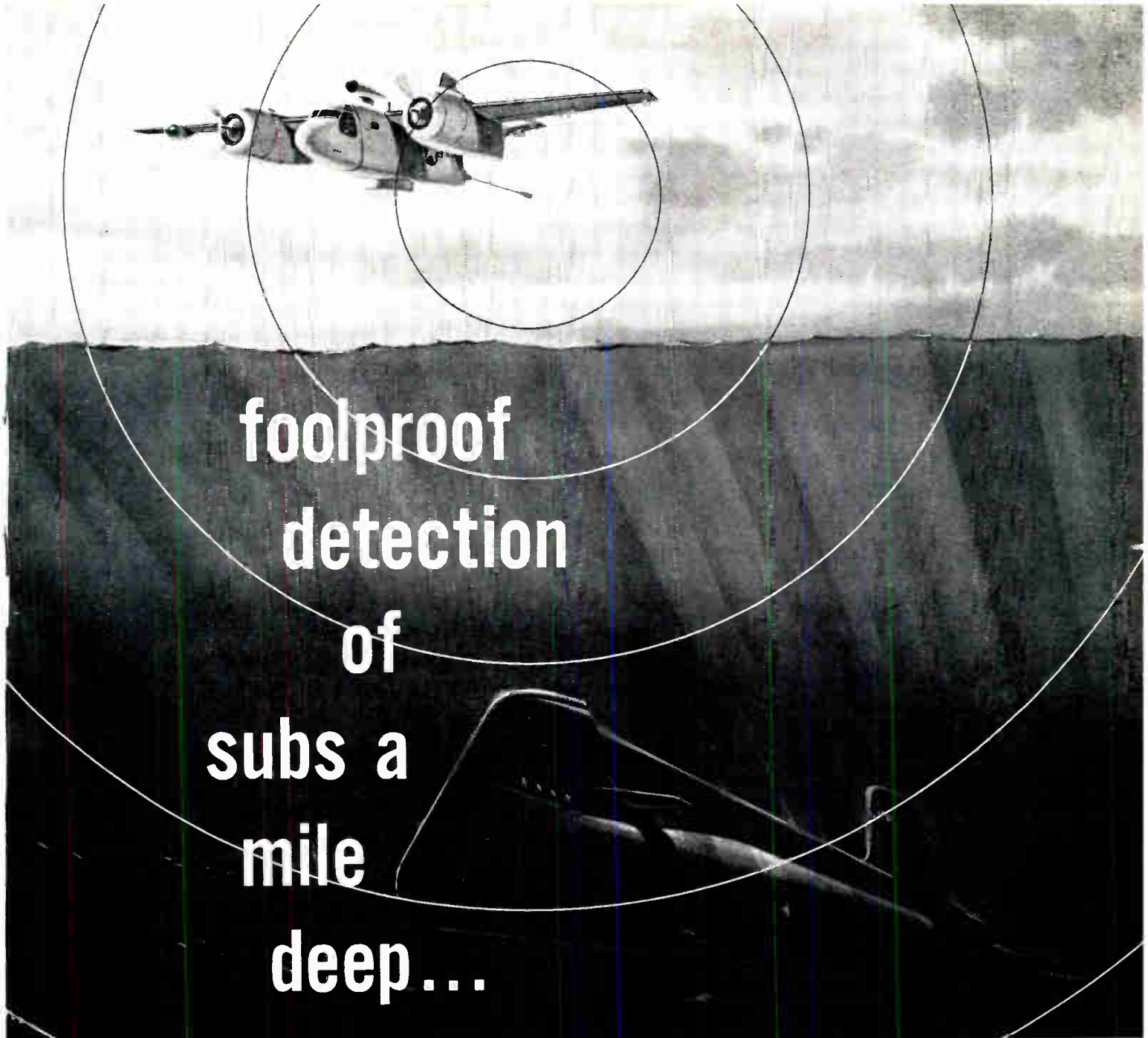

foolproof  
detection  
of  
subs a  
mile  
deep...

A CHALLENGE TO EXCITE ANY ELECTRONICS ENGINEER  
WORTH HIS SALT... THE KIND RYAN NEEDS RIGHT NOW

It's no secret that the Navy considers there is not yet an adequate defense against nuclear-powered submarines. As the search for more effective ASW detection methods goes on, the Navy relies heavily on Ryan navigation "brains" to help pinpoint "hostile" subs.

Nearly every flying weapon in the Navy's ASW arsenal has a Ryanav C-W doppler "brain." World leader in C-W doppler navigation systems, Ryan is the largest electronics firm in San Diego — *and the fastest growing!* If you are an electronics engineer ambitious to help advance the art, and your own career, we want you *now* at Ryan Electronics.

Ryan Electronics employs over 2000 people and has over one-third of the company's \$149-million backlog of business. Under the leadership of some of America's most prominent scientists and engineers, Ryan is probing beyond the known . . . seeking solutions to vital problems of space navigation.

Expanding facilities of Ryan Electronics at San Diego and Torrance in Southern California are among the most modern in the West. You enjoy living that's envied everywhere, plus facilities for advanced study. Send your resume or write for brochure today: Ryan Electronics, Dept. 3, 5650 Kearny Mesa Road, San Diego 11, Calif.



DIVISION OF RYAN AERONAUTICAL COMPANY  
SAN DIEGO & TORRANCE • CALIFORNIA

**RYAN ELECTRONICS**

World Radio History



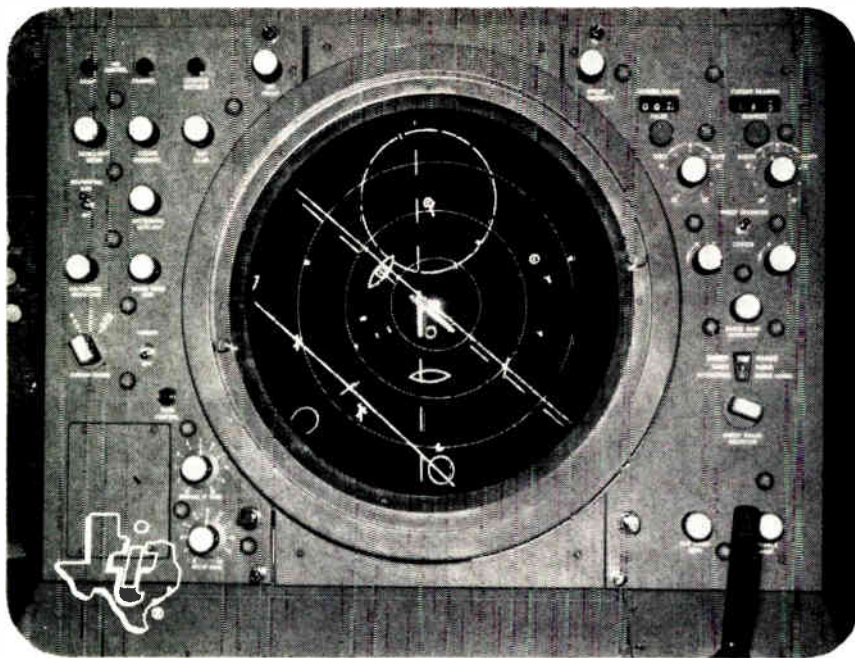

Ground clutter is eliminated by TI moving target indicator shown with video map at 20-mile range.

## TI IN HEAVY RADAR SYSTEMS



**TEXAS INSTRUMENTS**  
INCORPORATED  
6000 LEMMON AVENUE • DALLAS 9, TEXAS

## New High-Level Opportunities

### MILITARY • COMMERCIAL

Cowin Associates, specialists in the search for high-level engineers, scientists and managers for the electronics industry, offers a uniquely attractive range of growth openings for experienced professionals.

Our client companies, a select group chosen for their reputations as enlightened prestige organizations, are located in every part of the country and represent every area of electronics activity—including challenging commercial projects. Salaries in general run from \$8,000 to \$20,000.

You'll find that Cowin Associates' background in both professional electronic R & D and recruitment will expedite your move to a more responsible and more rewarding position. Relocation assistance, when necessary, is provided by our client companies—who also pay our search fees.

We invite you to forward your resume to Mr. D. M. Cowin.



**COWIN**  
**ASSOCIATES**  
600 OLD COUNTRY ROAD • GARDEN CITY, N. Y.



## Professional Group Meetings

(Continued from page 178A)

Philadelphia—January 19

"Sonic Detection Systems and Techniques," J. R. Howard, Herbert L. West, U. S. Naval Air Dev. Center.

Philadelphia—February 17

"Communications in High Intensity Noise," W. F. Meeker, RCA.

### ANTENNAS AND PROPAGATION

Boston—February 17

"The Simulation of Plasma by Artificial Dielectrics," W. Rotman, Air Force Cambridge Res. Center.

Orange Belt Subsection—January 19

"Plasma Resonances," W. D. Hershberger, Univ. of California.

### AUTOMATIC CONTROL

Boston—December 8

"Two-Mode Servo Controlled Weighing System," D. Martini, and P. Smith, Feedback Controls D Inc.

"A Unique Target-Position Computer," W. Parade and D. Stallard, Feedback Controls Inc.

Florida West Coast—February 8

"The Primary Objectives of the IRE," R. L. McFarlan, IRE.

Long Island—February 23

"A Semi Graphical Technique for Designing Third Order Systems," E. Gorczycki, Sperry Gyroscope Co.

Milwaukee—February 9

"Russian Engineering Education with Emphasis on Automatic Control," T. J. Higgins, Univ. of Wisconsin.

### BROADCASTING

Houston—January 19

"Tape Automation Utilizing the 'Blue Box'," J. E. Martin, Radio Station KNUZ.

Pittsburgh—January 14

"Principles and Practice of Video Tape Recording," (demonstration of AM-PEX recorder) H. E. Eames, WTAE-TV.

### CIRCUIT THEORY

Houston—January 19

"Circuit Theory—Simple Applications of Fourier Series and the Convolution Integral," W. P. Schneider, Schlumberger Well Surveying Corp.

Los Angeles—February 16

"Are Non-Linear Differential Equations Here to Stay, or Has Success Spoiled Mathematical Physics?" R. E. Bellman, The RAND Corp.

(Continued on page 181A)





*An Invitation  
for*

**ENGINEERS**

**AT ALL LEVELS**

**TO WORK ON**

**RESEARCH & DEVELOPMENT**

**AT THE**

**M. I. T.**

**INSTRUMENTATION LABORATORY**

The Laboratory, with its staff of 900 employees, is primarily engaged in the conception and perfection of completely automatic control systems necessary for the flight and guidance of missiles and space vehicles. Many "firsts" in these fields have been developed at the Laboratory.

**R and D opportunities exist in**

- Theoretical Analysis
- System Design
- High Performance Servomechanisms
- Power Supplies & Magnetic Amplifiers
- Digital & Analog Computers
- Electro-mechanical Components
- Transistor Circuitry & Pulse Circuitry
- Research, Design & Evaluation of Gyroscopic Instruments
- Computer Programming & Simulator Studies
- Logical Design
- and in many other areas

**CALL OR WRITE:**

**Ivan R. Samuels**  
*Director of Personnel*

**INSTRUMENTATION LABORATORY**

**MASSACHUSETTS INSTITUTE OF TECHNOLOGY**

68 Albany Street, Bldg. 5A  
Cambridge 39, Massachusetts  
UNiversity 4-6900, Ext. 3544

• Graduate courses may be taken for credit while earning full pay • U.S. Citizenship required

**DEVELOPMENT  
ENGINEERS**

**FOR PRECISION  
ELECTRONIC INSTRUMENTS**

**OPPORTUNITY.** Rapid advancement in an expanding engineering department. Project engineer positions open.

**QUALIFICATIONS.** Must be capable of engaging in original development work.

**EDUCATION.** B.S. in electrical engineering. An advanced degree is desirable but not essential.

**EXPERIENCE.** At least 3 years of applicable experience.

**LOCATION.** In the beautiful and highly desirable lake district of northern New Jersey.

This is an unusual opportunity for the engineer who grasps the immediate growth potential of an organization which, for 25 years, has distinguished itself in pioneering developments in the field of impedance measurements, FM-AM signal generators, air navigation test equipment, and similar devices.

Become a member of our development team now, when our organization is on the threshold of an unprecedented expansion program.

We invite your immediate inquiry. Write or call Mr. J. P. Van Duyne, Engineering Mgr.

**BOONTON RADIO CORP.**

BOONTON, N.J. DEerfield 4-3200

**Outstanding opportunity for scientists and engineers in**

**SOLID STATE DEVICES**

If you are a Physicist, Chemist, Metallurgist or Electrical Engineer, and have experience or interest in solid state development, or in related fields, you are invited to investigate the several excellent positions now open at IBM.

We are greatly expanding our development work in the theory, design and technology of solid state devices for use in new advanced computer systems.

This is an outstanding opportunity for experienced scientists and engineers who wish to undertake new and interesting work in this field.

Recent graduates are also invited to apply. Please write, outlining briefly your qualifications and experience, to:

Mr. B. N. Slade, Dept. 645Q2  
Product Development Laboratory  
IBM Corporation, Box 390  
Poughkeepsie, N. Y.

**IBM**<sup>®</sup>

INTERNATIONAL BUSINESS MACHINES CORPORATION

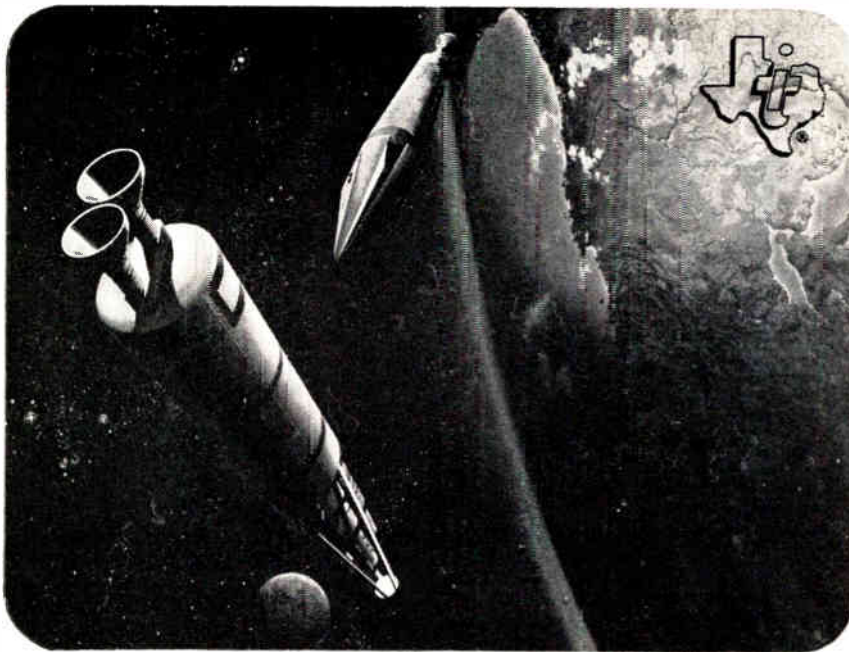

CENTAUR (A United States Space Vehicle) will report back through TI-built FM/FM telemetry.

## TI TELEMETRY IN MISSILE SYSTEMS



## Professional Group Meetings

(Continued from page 182A)

### COMMUNICATION SYSTEMS

Florida West Coast—February 8

"The Primary Objectives of the IRE,"  
R. L. McFarlan, IRE.

Los Angeles—February 22

"Information Theory—Panel Discussion,  
S. G. Lutz, E. Rechten, G. L. Turin,  
Hughes, Jet Propulsion Lab.

Oklahoma City—January 26

"New FCC Regulations as Affecting  
Radio Communications," D. F. Holaday,  
Federal Communications Comm.

Rome-Utica—October 5-7

"Communications—Tomorrow," H. W.  
Grant, U. S. Air Force.

"Intellectronics," S. Ramo, Ramo-  
Wooldridge Corp.

Rome-Utica—February 18

"Raytheon Airborne Microwave Plat-  
form," H. Letaw, Raytheon Manufac-  
turing Co.

(Continued on page 186A)

### RESEARCH AND DEVELOPMENT DEPARTMENT OF CONTINENTAL OIL COMPANY, PONCA CITY, OKLAHOMA

has immediate opening—EE or Physics. Advanced Degree or equivalent with experience in design and fabrication of electronic instruments. Salary commensurate with experience. Send detailed résumé to

INDUSTRIAL RELATIONS DEPARTMENT  
CONTINENTAL OIL COMPANY  
PONCA CITY, OKLAHOMA

### MILITARY DEVELOPMENT HEAD

Long range plans create a staff opening for a man (35-55) with sufficient experience and technical skill to head a department concerned with engineering and scientific military development.

Educational background must include advanced degree work in one or more of the basic, or engineering sciences. All applicants should have at least 5 years of work-experience in advanced military projects, plus proven line supervisory experience.

This challenging position requires not only administrative skills but also the ability to lead scientific specialists in wide areas of development.

The salary is open. Your inquiry will be kept in strict confidence and will be acknowledged promptly.

Reply to: T. F. Wade, Technical  
Placement N-Y  
The National Cash Register Company  
Main and K Street  
Dayton 9, Ohio

THE NATIONAL CASH REGISTER COMPANY, DAYTON 9, OHIO

### SEMICONDUCTOR PHYSICIST

Semiconductor physicist to develop germanium or silicon diodes and transistors in laboratory stage. Opportunity to proceed from fundamentals under general supervision only and to establish our own laboratory technique and processes. Excellent facilities and company benefits with nationally known diversified electronic component manufacturer located in Chicago suburb.

Advanced physics degree preferred and relevant experience essential. Salary to be commensurate with qualifications. Replies in confidence.

Box 2022  
Institute of Radio Engineers, Inc.  
1 East 79th St.  
New York 21, N.Y.

# ...Consider Carefully!

This Opportunity for  
**SENIOR ENGINEERS**

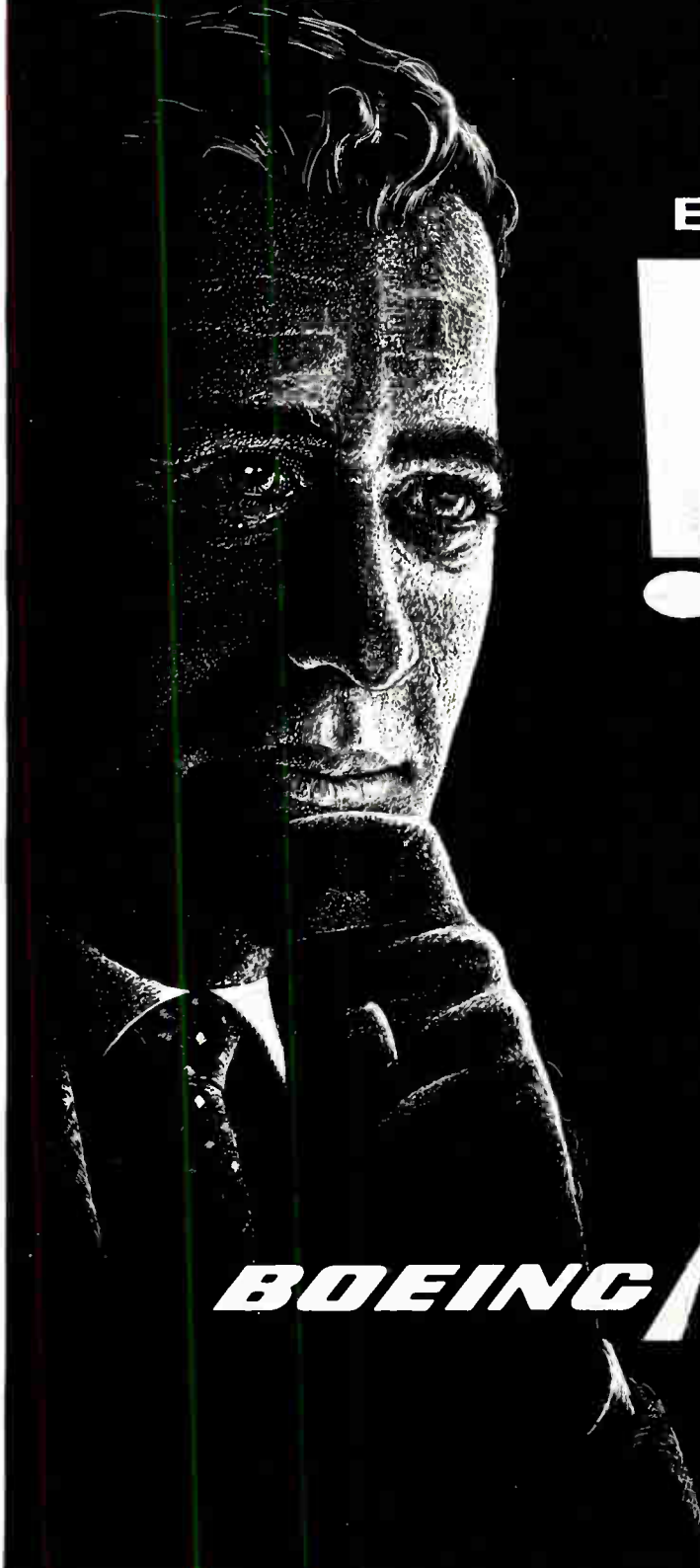

Making the RIGHT decision at the right TIME is the trademark of the serious engineer. His education and experience provide the background for making decisions that are right and timely.

Thoughtful men, with dynamic ideas, are finding their future at Boeing-Wichita, where the challenge of New Product Designs is stimulating their actions... and an expanding program offers greater variety and incentives for success.

Investigate the top-level opportunities in Electronics / Structures / Aerodynamics / Propulsion / Physical Sciences / Mechanical Equipment / Human Factors / Computer Sciences.

**BOEING / WICHITA**

Write Mr. Melvin Vobach  
Dept. IRE, Boeing Airplane  
Company, Wichita 1, Kansas



## Engineers and Physicists

# Your talent and time are worth more to you —and to your family—in Minneapolis

Talent and time are man's most precious tools—but, unfortunately, they are also his impediments.

If you suspect that you could put your talent and time to more productive and rewarding work, investigate opportunities at General Mills, in Minneapolis. We respect creative freedom, encourage innovation, recognize and appreciate professional competence. In short, we provide the environment that brings out the finest talents in engineers and scientists. And then we give these creative people rein to ply their talents against intriguing problems in fields that interest them most.

**Time?** Time in the laboratory. Time with your family. Ninety percent of our people

live within 25 minutes from work. A short drive takes them to some of the best hunting, fishing and camping sites anywhere. Some of them live right next to a park, lake or golf course.

live within 25 minutes from work. A short drive takes them to some of the best hunting, fishing and camping sites anywhere. Some of them live right next to a park, lake or golf course.

At General Mills, in Minneapolis, you have time to know your family, yourself and your contribution to the future.

**Make the most of your talent and time in one of these fields—at General Mills**

- Digital System Configuration
- Electronic Circuit Design
- Micro-wave Development
- Digital Computer Logic
- Electronic Packaging
- Advanced Pulse and Video Circuit Development
- Advanced Inertial Navigational System Development
- Optical and Infra-Red Equipment Engineering



**Mail Coupon for more facts, in confidence**

Mr. G. P. Lambert  
 Manager Professional Personnel  
 Mechanical Division General Mills  
 2003 East Hennepin Avenue, Dept. P5  
 Minneapolis 13, Minnesota

Name .....

Address .....

City ..... Zone ..... State .....

College ..... Degree ..... Year .....

## SUPERVISOR

### DATA RECORDING, INSTRUMENTATION, CONTROL SYSTEMS

Unusual opportunity exists with a well-known research organization for an electronics engineer with outstanding technical and administrative ability to supervise the activities of an expanding group of engineers engaged in research programs in the following areas:

- Servomechanisms and Regulators
- Analog Computation
- Missile Guidance Systems
- Industrial Process Control
- Reactor Control Systems
- Sensing Elements
- Magnetic Recording

Our environment is midway between academic and industrial research and offers an excellent opportunity to develop research programs of greatest interest to you and your associates. Liberal benefits including four week vacation. Our location in a major midwestern city offers unlimited cultural and recreational opportunities.

Please send complete resume including salary requirement. All replies held in confidence.

BOX 2013  
**INSTITUTE OF RADIO ENGINEERS**  
 1 EAST 79TH ST., NEW YORK 21, N.Y.

## Professional Group Meetings

(Continued from page 181A)

### COMPONENT PARTS

New York—October 20

"The Metallized Electrode Approach to Capacitor Miniaturization," A. Lunchick, U. S. Army Signal Res. and Dev. Lab.

"Metallized Capacitors—Designing for Reliability," W. E. Rieman, The Gudeman Co.

"Use of Metallized Capacitors in Military Airborne Equipment," J. A. MacDonald, General Precision Labs.

"Metallized Capacitors—How Reliable," A. A. Tiezzi, Sprague Elec. Co.

Philadelphia—February 9

"Effects of Nuclear Radiation on Electronic Component Parts and Devices," J. E. Drennan, Battelle Memorial Inst.

### ELECTRON DEVICES

Boston—October 26

"The Practical Utilization of Power Transmission by Electromagnetic Beams," W. C. Brown and N. Theodore, Raytheon Co.

Los Angeles—January 28

"Ion Propulsion for Space Flight," J. M. Teem, Calif. Inst. of Technology and Electro-Optical Systems, Inc.

New York—October 1

"A Half Watt CW Helix-Type Traveling Wave Amplifier For 5-6 mm Wavelength," H. L. McDowell, SFD Labs.

New York—November 5

"Recent Developments in Twistor Memories," A. H. Bobeck.

Syracuse—January 19

"Recent Developments in Quantum Electronics," B. Lax, Lincoln Labs.

### ELECTRONIC COMPUTERS

Binghamton—January 11

"Status of Electronic Microminiaturization," N. J. Doctor, Diamond Ordnance Fuse Lab.

Detroit—January 18

"The Atlas Ground Guidance System (ANGSQ-33)," R. Tackett, Burroughs Corp.

"The Sage Computer (AN/FST-2)," R. Shipman, Burroughs Corp.

Los Angeles—January 21

"The Tunneling Effect," R. A. Gudmundsen, Hughes Aircraft Co.

"Circuit Applications of Tunnel Diodes," G. Messenger, Hughes Aircraft Co.

(Continued on page 188A)

*Demanding Assignments for  
Senior Staff Members at*

SYLVANIA

**RSL**

## Reconnaissance Systems Laboratory on the **SAN FRANCISCO PENINSULA**

### SENIOR SYSTEMS ENGINEERS

System management responsibility for new programs at Sylvania's Reconnaissance Systems Laboratory offers the broad spectrum of challenging problems involved in large reconnaissance systems. A minimum of 10 years experience is required in progressive assignments leading to and including systems analysis, determination of functional systems requirements and synthesis and integration of subsystems with over-all program requiring knowledge of the capabilities and limitations of techniques and components. Should have background in analysis and synthesis of HF and VHF communication systems employing a variety of modulation techniques and/or digital data handling and automatic control systems.

### SENIOR DESIGN ENGINEERS

The design groups in RSL have openings for experienced engineers with six or more years of design and development background in one or more of these areas: communications receivers, digital tuning, RF distribution, DF equipment, magnetic tape recorders, teletype equipment, dynamic displays, demodulators, data transmission, data converters and computers. Opportunities for both technical specialists and supervisors.

### THE REWARDS

Work in a compact and growing laboratory which offers the creative engineer the opportunity to grow with an expanding organization. Take advantage of the individual recognition and advancement opportunities of a small organization (approximately 200 employees) with the security, benefits and diversified opportunities of a large corporation. Enjoy the ideal northern California climate in relaxed suburban communities with good schools and recreational facilities for your family. Live within 40 minutes of cosmopolitan San Francisco. Know the advantages of being close to leading universities (Stanford is five miles north of the laboratory).

Complete information may be obtained by writing, in confidence,  
to Mr. R. R. Keeffe at:

**Sylvania Reconnaissance Systems Laboratory**  
P. O. Box 188, Mountain View, California

**SYLVANIA ELECTRONIC SYSTEMS**  
Government Systems Management  
for **GENERAL TELEPHONE & ELECTRONICS**



*I want a "Whatcha-ma-call-it?"*

*It's a "thinga-ma-jig that . . . . ."*

How often have you struggled to remember the name of a component or electronic item. . . .  
Just could not think quickly what it is called?

## YOU CAN FIND IT IN THE IRE DIRECTORY!

*because*

- (1) The IRE Directory classifies products by purpose and use.
- (2) Its listings are fundamental—the way an engineer thinks.
- (3) "Terminology" is cross indexed in the pink pages—condensed, simple, not mixed in with firm names.
- (4) Ads face listings thus helping to identify products by actual pictures.
- (5) Product code numbers reduce complex and duplicate listings, saving you "searching" time and effort.

*Study it . . . save it . . . work it.*



**THE INSTITUTE OF RADIO ENGINEERS**

1 East 79th Street, New York 21, N.Y.

## **Professional Group Meetings**

*(Continued from page 186-A)*

Los Angeles—February 19

"Multiple Program Computer," P. Rosenthal, Remington Rand.

"Multiple Program Computer," R. C. Douhitt, Remington Rand.

New York—September 24

"IBM Serial Paper Document Reader," C. Allen, IBM.

New York—November 18

"Microwave Computing Techniques," P. Isaacs, Sperry Gyroscope Co.

Pittsburgh—October 15

Panel Discussion on Algol.

Pittsburgh—November 9

"Computer Chess Playing Programs," H. A. Simon, Carnegie Inst. of Technology.

Pittsburgh—December 3

"An Introduction to Robotics," L. G. Jones, Westinghouse Air Arm Div.

San Francisco—January 26

"The G.E. ERMA System—Evolution and Function," J. Leventhal, G.E. Computer Dept.

*(Continued on page 190-A)*

## **ELECTRONIC DESIGN ENGINEERS**

The location of your job is important to your family. Professional growth is important to you. To satisfy both of these very important needs why not consider a career with Sperry Products Company.

**We are located on beautiful  
Lake Candlewood in Danbury,  
Connecticut, only 65 miles  
from New York City.**

If you have a minimum of 2 years experience in pulse circuitry and general electronics, we feel you will qualify in the field of instrumentation for ultrasonic testing. Transistor experience also desirable.

Please forward resumes, in confidence, to: Mr. R. J. LoStocco



**SPERRY PRODUCTS CO.**

Division of Howe Sound Co.  
Shelter Rock Rd., Danbury, Conn.



Join General Electric's Electronics Laboratory  
 In Exploiting a Major State-of-the-Art Advance Promising  
 Long-Term Impact on Many Technologies

# THERMOPLASTIC RECORDING

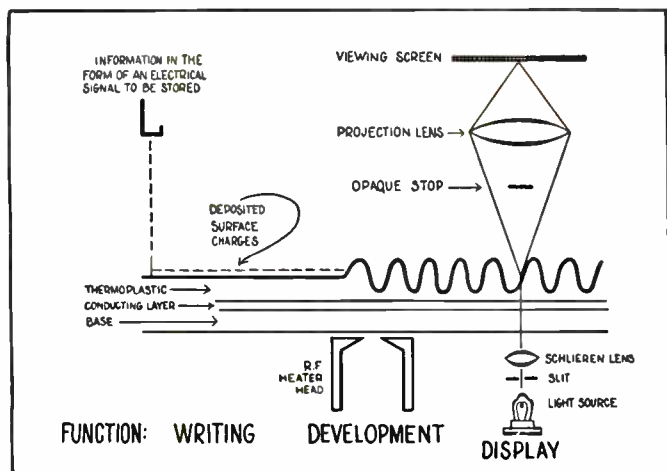

**BREAKTHROUGHS** are frequently talked about, infrequently accomplished. An article appearing in the December issue of *The Journal of Applied Physics*, written by Dr. W. E. Glenn of General Electric's Research Laboratory, has stimulated the imagination of the scientific/technological community. Titled *Thermoplastic Recording*, it describes a revolutionary new method of recording electrical signals. This process makes it possible for information to be written at extremely high density by means of an electron beam on a film consisting of a low melting thermoplastic material. Data can be projected as a black and white or full color image, or it can be converted to an electrical signal. The tape can be readily erased and reused. Summarizing, *Thermoplastic Recording* provides the equivalent of a high resolution, reusable "photographic" film developed by non-chemical means in the fraction of a second.

**New Programs** Utilizing invention and innovation, the Electronics Laboratory at Syracuse, New York is now engaged in a growing number of programs proving the feasibility of this new process for military and commercial applications which include direct image photography, projection displays, wideband analogue recording, sonar and radio signal correlation and processing.

**Anti-Submarine Warfare Program** Another program of current interest includes efforts devoted to submarine detection and classifica-

tion by means other than sonar, secure underwater communications and submarine-to-aircraft communication.

**Professional Opportunities** Highly creative and experienced engineers and physicists are required to accomplish the objectives of these ambitious programs. Major areas of professional interest should include one or more of the following areas listed to the right. ▶

*A reprint of Dr. Glenn's article describing in detail the Thermoplastic Recording Process is available upon request.*

- GEOMETRICAL, PHYSICAL AND ELECTRON OPTICS
  - CIRCUIT DESIGN
  - MECHANICAL DESIGN
  - VACUUM TECHNOLOGY
  - FEEDBACK THEORY • RADAR
  - OCEANOGRAPHY • TELEVISION
  - SOUND PROPAGATION
  - SURFACE PHYSICS • SONAR
  - IR PHENOMENA
- Additional openings in these areas:*
- MATERIALS • CIRCUITS
  - DEVICES • SYSTEMS
  - EQUIPMENT

For further information on current openings write in strict confidence to Mr. Robert Mason, Dept. 53-ME

**ELECTRONICS LABORATORY**

**GENERAL  ELECTRIC**

ELECTRONICS PARK, SYRACUSE, N. Y.

# INERTIAL SYSTEMS DEVELOPMENT

..... there are opportunities at Honeywell Aero for the engineer or scientist who is interested in participating in this growing field of technology. While specific inertial systems experience is desirable, you may also be qualified by your background and/or related experience for activities in the inertial systems development at this time. Specific openings include:

## SYSTEMS ANALYST

Mathematician or engineer with strong background in vector analysis, operational calculus, matrix algebra and related techniques. To carry out analysis of inertial systems configurations including error evaluation.

## DIGITAL SYSTEMS AND LOGIC DESIGNER

Familiar with digital logic techniques at current state of the art; capable of organizing computing systems to perform various tasks including logical design and critical parameter specification.

## ELECTRONIC ENGINEER

Electrical engineering degree plus experience in miniaturized semiconductor electronics development. To design servo, pickoff, and other electronics for use with gyros and accelerometers.

## ENGINEERING PHYSICIST

Physicist with practical and theoretical understanding of mechanics, magnetism and electricity to analyze and develop inertial sensors of novel and original design.

*To discuss these or other openings, write Mr. R. O. Maze, Chief Engineer, Marine Systems Group, Dept. 610C, Aeronautical Division, 1433 Stinson Blvd., Minneapolis 13, Minn.*

## Honeywell

 Military Products Group

*To explore professional opportunities in other Honeywell operations coast to coast, send your application in confidence to H. K. Eckstrom, Honeywell, Minneapolis 8, Minnesota.*

# Professional Group Meetings

(Continued from page 188-A)

"The G.E. ERMA System—Hardware and Performance," C. Tucker, G. E. Computer Lab.

Washington, D. C.—February 10

"Some Recent Developments in Character Recognition Machines," J. Rabinow, Rabinow Engineering Co., Inc.

## ENGINEERING MANAGEMENT

New York—December 17

"The Gentle Art of Encouraging Creativity," T. Allison, Weston Elec. Inst. Corp.

San Francisco—February 9

"Engineers' Management: Short Course for Wives," J. V. N. Granger, Granger Associates.

Twin Cities—October 22

Panel-Project Evaluation from R&D Through Shipping, F. Mullaney, Control Data Corp.; B. Kappel, Rosemount Engrg.

Twin Cities—January 28

"Revolution in the Filing Cabinet," D. Lake, Remington Rand Univac.

## ENGINEERING WRITING AND SPEECH

Boston—December 2

"Engineering Writing and Speech Techniques for Computer Customer Training," J. J. Davin, Sylvania Electric Prod. Inc.

Boston—February 23

"Use of Motion Picture Techniques in Preparing Engineering Reports," M. H. Read, Bay State Film Prod. Inc.

## INFORMATION THEORY

Boston—October 15

"The Coding Problem in Genetics," C. Levinthal, MIT.

## INSTRUMENTATION

Long Island—February 16

"Human Factors in Instrument Design," A. Goldman, Republic Aviation Corp.

Los Angeles—February 3

Tour of Shell Chemical Plant.

## MEDICAL ELECTRONICS

Los Angeles—January 21

"Effect of Ionizing Radiation on the Living Cell," L. R. Bennet, UCLA Med. Center.

"Technique of Measuring Ionizing Radiation in Living Tissue," L. Gardner, Litton Ind.

Los Angeles—February 18

"Current Instrumentation Problems in Anesthesiology," V. Brechner and R. Bauer, U.C.L.A. Medical Center.

New York—November 5

"An Implantable Self-contained Pacemaker for the Correction of Chronic Atrioventricular Block," W. Greatbach, Taber Instrument Co. and W. M. Chardack, Buffalo School of Medicine and Chief, Surgical Service, VA Hosp.

## MICROWAVE THEORY AND TECHNIQUES

Baltimore—February 10

"Millimeter Waveguides," D. D. King, Electronic Communications Inc.

Boston—February 25

"Microwave Applications and Circuit Principles of Tunnel Diodes," M. E. Hines, Bell Telephone Labs.

Long Island—January 21

"Geometrical Methods of Solving Antenna Problems," E. G. Fubini, Airborne Inst. Labs.

No. New Jersey—January 27

"Atomic Clock," M. Arditi, ITT Labs.

Washington—January 12

"Parametric Amplifiers," R. S. Engelbrecht, W. W. Mumford, Bell Telephone Labs.

## MILITARY ELECTRONICS

Long Island—January 12

"Strategy of Deterrence," H. Davis, Dept. of Defense.

Los Angeles—September 23

"Air Force Ballistic Missile Training Program," A. R. Sult, USAF Air Force Ballistic Missile Div.

Los Angeles—November 24

Paper and Panel Discussion: The Economic Challenge to the Military Systems Engineer, F. S. Pardee, Panel Moderator; F. G. Suffield, Panel Members; T. W. Johnson, W. E. Sweeney, Commander USN; R. S. Isensen, Lt. Col. USA; S. Greene, Lt. Col. USA.

North Carolina—February 11

"Inertial Navigation," D. R. Shelor, N. Carolina Labs. of B. T. L.

"Fundamentals of Gyroscopics," J. F. Hartnett, Western Elec. Co.

## NUCLEAR SCIENCE

Oak Ridge—January 21

"Ferrites and Pulse Transformers," P. E. Dicker, Aladdin Electronics Co.

(Continued on page 190-A)

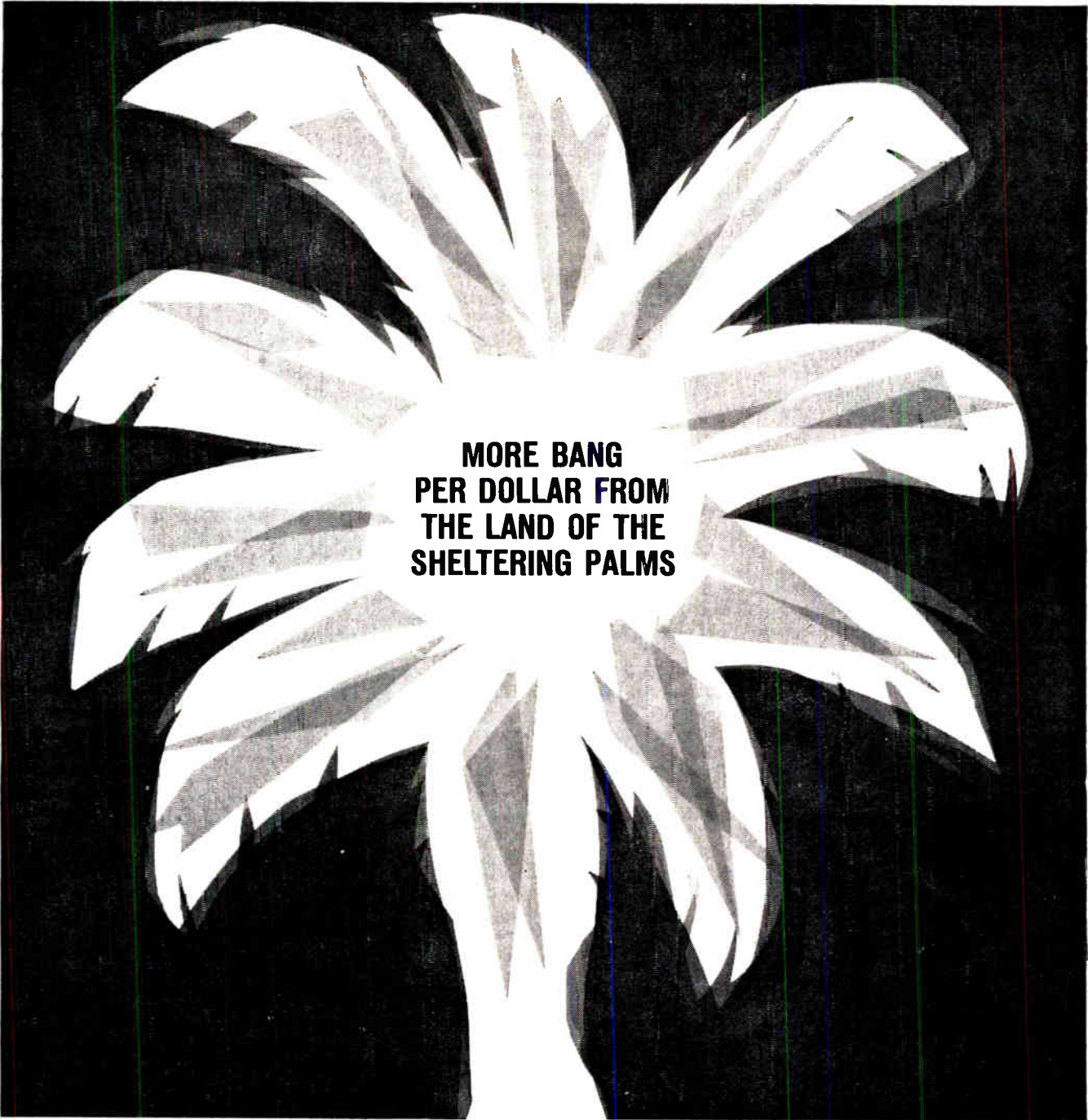

**MORE BANG  
PER DOLLAR FROM  
THE LAND OF THE  
SHELTERING PALMS**

Down where the lakes are only minutes away and the sea shore's just an hour's drive, Martin engineers came up with what is called a "pilot's missile"—the air-to-surface Bullpup. It requires no more special handling than a round of ammunition. It gives the biggest bang per dollar in U. S. missilery.

Bullpup, operational with the Navy (GAM-83B in R&D with AF), was designed and developed at Martin in sunny Florida. Bullpups are now rolling off production lines

for both the Navy and Air Force.

Other Martin-Orlando prime contracts include: Lacrosse, Missile Master, and Pershing.

We think Martin-Orlando is doing outstanding work because it has outstanding engineers and scientists . . . and because it has facilities second to none . . . and because *the man who can swim or sail with his son in the evening brings renewed energy and purpose to his job.* If you feel the same way about it, you'll feel at home in Orlando.

Write: C. H. Lang, Director of Employment, The Martin Company, Orlando 6, Florida, for a fully descriptive booklet, "Portrait of a Missile Maker."

**CURRENT OPENINGS** for engineers in these areas: ground and airborne electronics • advance design • systems • aerodynamics • quality and test • reliability • electronic manufacturing . . .

WORK IN THE CLIMATE OF ACHIEVEMENT

**MARTIN**  
O R L A N D O





# MICROWAVE TUBE R&D

The Electron Tube Division of Litton Industries has an international reputation for its capability in translating advanced concepts into microwave devices of high reliability. In part this is due to management by experienced engineers and, as a design engineer here, you will have well qualified support people on your team.

You will be working for a large company but...

You will be working in a small group on the product of your choice—TWT's, Superpowered Klystrons, crossed field amplifiers, or other sophisticated microwave devices.

Choose research or design and development, whichever field interests you most.

The location is in the San Francisco Bay Area. Your children will belong to one of the nation's great elementary school systems. You, yourself, will be close to all the cultural activities of San Francisco, the Berkeley campus of the University of California, Stanford University, San Jose State College, and the University of Santa Clara.

Openings exist for Senior, Project and Junior Engineers. Junior Engineers need have no experience beyond their baccalaureate in E.E. or Physics.

We assist with relocation expenses. Interviews may be arranged by writing, or telephoning collect to:

Mr. Thomas A. Fike  
960 Industrial Road  
San Carlos, California  
LYtell 1-8411



**LITTON INDUSTRIES**  
Electron Tube Division  
San Carlos, California

(Continued from page 42A)

## Precision Phase Detector

This instrument was designed by Ad-Yu Electronics Lab., Inc., 249 Terhune Ave., Passaic, N. J., for precision phase measurement. Based on a comparison principle which enables accurate measurement of phase angle at high frequency, it consists of a coaxial continuously variable delay line and a sensitive phase detector. The continuously variable delay line is used to shift the phase of the unknown signal until zero output is reached on the phase detector. The instrument is convenient for measuring frequency characteristics of radar amplifiers, RF cables, transmission networks and performance of location finding systems. In addition to measuring phase angle between two sine waves, this instrument can be used to measure phase angle of a pulse modulated sine wave or a continuous sine wave, or whether two pulse modulated sine waves are coincident.

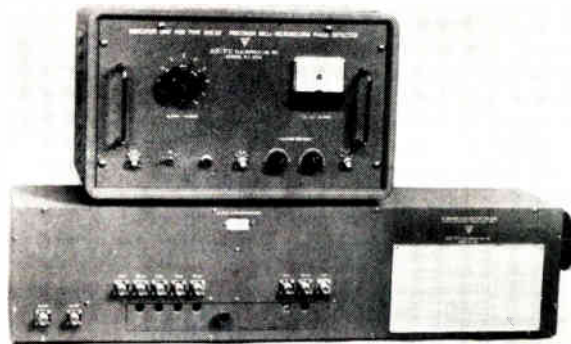

The specifications are as follows: The accuracy is  $\pm 0.05^\circ$  or  $\pm 1\%$  of the dial reading up to 1000 mc. The resolution is less than 0.01 micromicrosecond; the smallest phase angle which can be read on the dial is less than  $10^{-11} \times 360 \times$  frequency in cps. The time delay of the continuously variable delay line is adjustable from 0 to 1.4 millimicrosecond. Two step variable delay lines have total delay of 37.5 millimicroseconds in  $E_1$  channel and 7.5 millimicroseconds in  $E_2$  channel (in steps of 1 millimicrosecond). The frequency range is 200 to 1000 mc; the upper limit can be extended with relaxing accuracy, the lower limit is restricted only by the phase range as stated. The minimum input signal depends on the sensitivity of the receiver; approximately 20 microvolts for receiver having 5-microvolt sensitivity, and approximately 3 volts minimum is recommended for using panel meter as indicator. The characteristic impedance is 50 ohms nominal for input and output; type N connectors are used throughout.

## Repetitive Operation Feature For Analog Computers

A new product which adds another dimension to the art of analog computation has been announced by Electronic Associates, Inc., Long Branch, N. J. High Speed Repetitive Operation is now available as an accessory for all PACE 231R Analog Computers. This addition provides the operator with an accurate, versatile means of solving a variety of engineering problems that would be difficult through "real time" techniques alone. To obtain an optimum design in a problem with several variables, a great many problem runs are required. These are normally drawn on automatic recorders where speeds are limited by the mechanical characteristics of the recorders. With repetitive operation, the solution appears as a continuous plot on the 17 inch display screen. The effect of a change in the problem variables can be observed immediately on the display screen, without the necessity of resetting the equipment and drawing additional plots. When the optimum design is reached, the computer may be switched back to real time operation so permanent plots can be made of the final and more detailed solution. High Speed Repetitive Operation is par-

(Continued on page 191A)

New temperature controlled MICROSTACK® meets

# -55°C to +85°C

## MILITARY REQUIREMENT

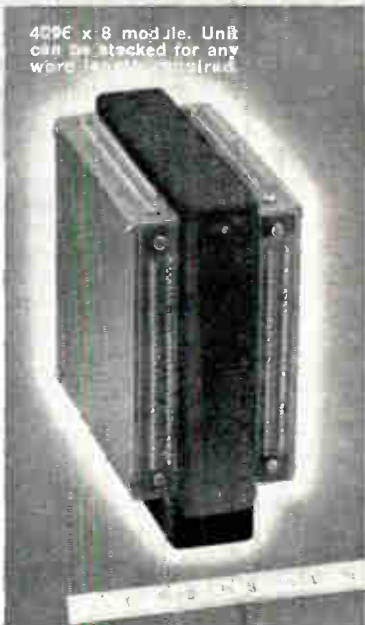
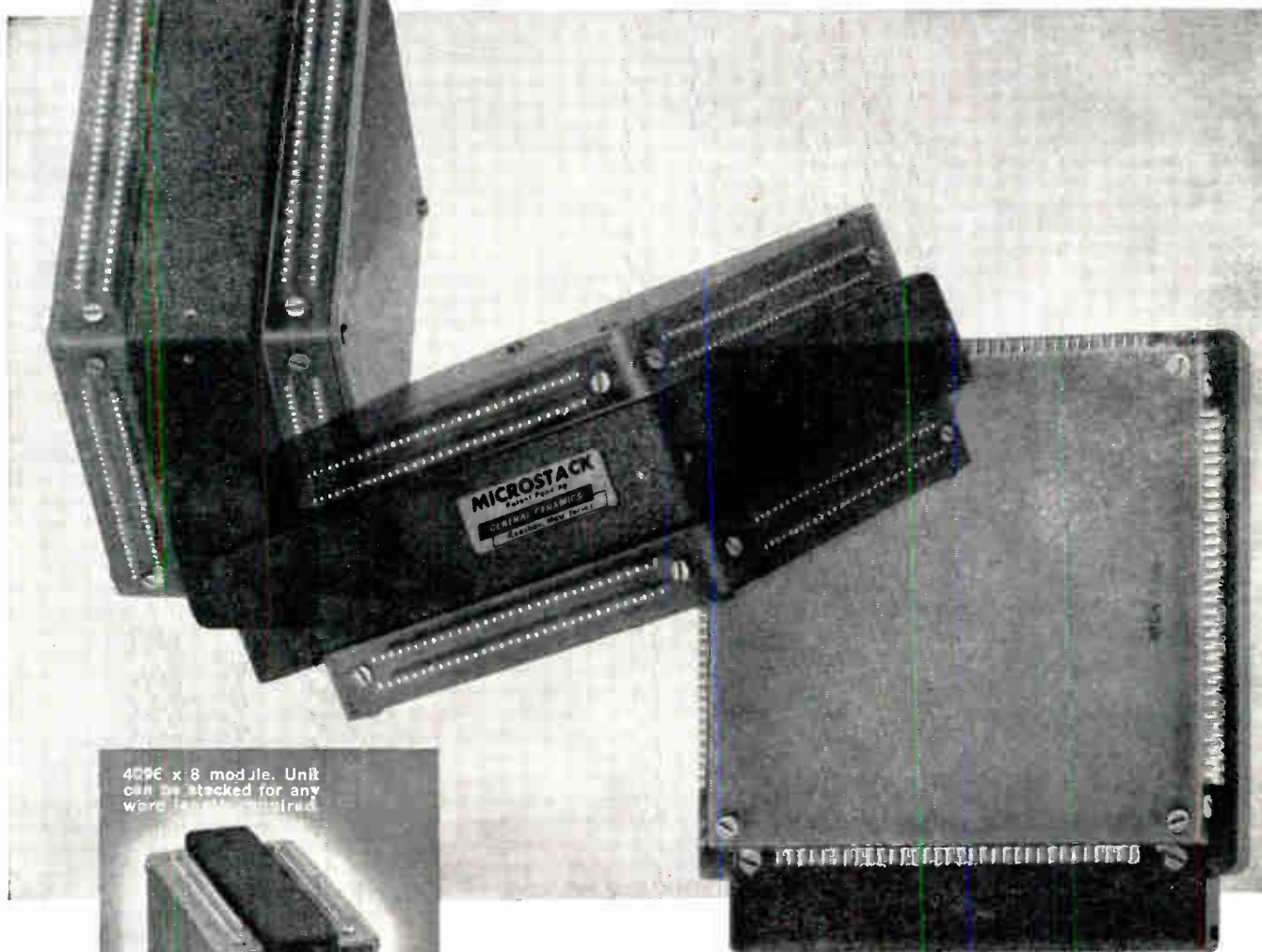

The General Ceramics MICROSTACK, one of the most important advances in memory core packaging, now operates in a temperature range of from  $-55^{\circ}\text{C}$  to  $+85^{\circ}\text{C}$ . Core characteristics remain constant. By maintaining temperature stability inside the MICROSTACK unit, General Ceramics engineers have developed a memory core package that is smaller, more rugged, requires no external cooling or heating, and meets MIL shock and vibration specifications.

For additional information, please write on company letterhead. Address inquiries to Section P.



APPLIED LOGIC DEPARTMENT  
**GENERAL CERAMICS**

KEASBEY, NEW JERSEY, U. S. A.

TECHNICAL CERAMICS, FERRITE AND MEMORY PRODUCTS



(Continued from page 192A)

# AMPERITE PREFERRED

by design engineers—because they're  
**MOST COMPACT • MOST ECONOMICAL  
SIMPLEST • HERMETICALLY SEALED**

## Thermostatic DELAY RELAYS

2 to 180 Seconds



Actuated by a heater, they operate on A.C., D.C., or Pulsating Current.

Hermetically sealed. Not affected by altitude, moisture, or climate changes.

SPST only—normally open or closed.

Compensated for ambient temperature changes from  $-55^{\circ}$  to  $+70^{\circ}$  C. Heaters consume approximately 2 W. and may be operated continuously. The units are rugged, explosion-proof, long-lived, and—inexpensive!

Also—Amperite Differential Relays: Used for automatic overload, under-voltage or under-current protection.

TYPES: Standard Radio Octal, and 9-Pin Miniature . . . List Price, \$4.00. Standard Delays

**PROBLEM? Send for Bulletin No. TR-81**

## BALLAST REGULATORS

Amperite Regulators are designed to keep the current in a circuit automatically regulated at a definite value (for example, 0.5 amp.) . . . For currents of 60 ma. to 5 amps. Operate on A.C., D.C., or Pulsating Current.

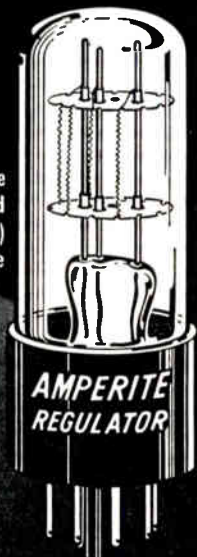
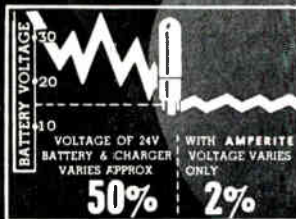

Hermetically sealed, they are not affected by changes in altitude, ambient temperature ( $-55^{\circ}$  to  $+90^{\circ}$  C.), or humidity . . . Rugged, light, compact, most inexpensive . . . List Price, \$3.00.

Write for 4-page Technical Bulletin No. AB-51

**A**MPERITE CO. Inc., 561 Broadway, New York 12, N. Y.  
Telephone: CAanal 6-1446

In Canada: Atlas Radio Corp., Ltd., 50 Wingold Ave., Toronto 10

ticularly well suited to problems involving the simulation of servo mechanisms, optimization of chemical, petro-chemical and physical systems, and the solution of boundary-value and eigen-value problems.

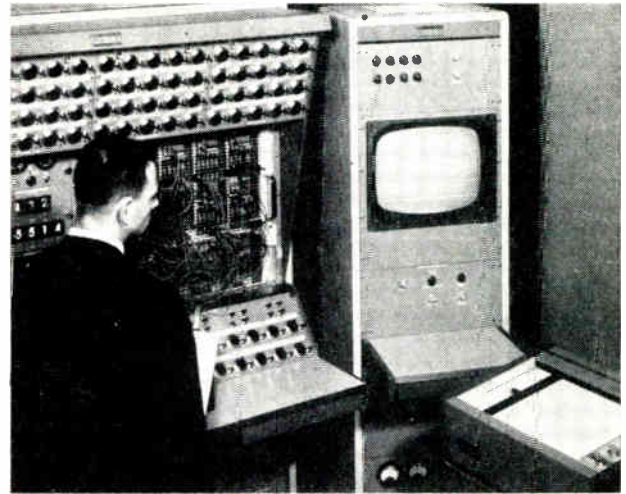

A computer equipped with High Speed Repetitive Operation can be operated either repetitively or as a real time simulator at the throw of a switch without degradation of its real time accuracy. Pre-patch panel arrangements remain the same in either repetitive or real time operation and do not require the use of more amplifiers than on real time studies.

Computing times of from 10 to 80 milliseconds are available and may be controlled from either the Repetitive-Operation Control Unit or the Display Unit. Both stepped and continuously variable control of computer time are provided to permit the operator to obtain maximum length of solution and avoid overloads.

The display unit consists of four chassis units in a single bay EAI rack and allows simultaneous viewing of eight problem variables plotted against time or seven variables plotted against an eighth on the 17 inch screen. In the Display Unit, 21 voltage calibration lines are references to computer voltage within 0.1%. Time lines are generated by a crystal oscillator accurate to 0.05%.

### Typical Applications

#### System Optimization

Usually, in the design of a system, certain compromises are necessary in the selection of parameter values which give the best over-all performance. The choice of these compromise values is often based on many repeated runs through the problem. When there are several parameters which can be varied, a large number of runs are required. High Speed Repetitive Operation provides the designer with this larger number of runs in a very short time. The variation of the system performance with each parameter is easily observed. By programming on the computer the selected criterion for optimization, the designer is able to observe the deviation of the performance for a particular choice of parameter values from optimum. With this capability, the designer is able to examine the performance over wide ranges of the parameter. This then facilitates his selection of the true "optimum" and avoids the danger of his being misled toward false "optimums."

#### Boundary Value Problems

Consider the problem of solving a higher order differential equation where final conditions rather than initial conditions are known. The solution then requires the selection of one or more initial conditions which will yield the proper final values. This requires iterative solution which can be readily accomplished with High Speed Repetitive Operation. The final values are constantly on the display screen and the operator simply varies the initial condition potentiometers to obtain a match at the other boundary. This technique is, of course applicable to a problem for which the conditions are known anywhere in the solution region.



# package-type TWT power amplifiers with NEC's new long life cathode



Production of traveling wave tubes at NEC began seven years ago and introduction of the package-type three years later. As chief supplier to Japan's complex network of microwave communications, NEC has become the world's largest maker of TW tubes. With the high development costs amortized and large manufacturing capacity, NEC is now able to supply these tubes at well below usual prices.

NEC's new doped nickel cathode core material, a 10-year development, increases both emission and tube life. It has been thoroughly field-proven in disc-sealed planar triodes for 2000-mc equipment of a large U.S. systems manufacturer (name on request). With its cooler operating temperature, evaporation rate of oxide is less than any other known core materials. This extends tube life up to 50%.

Designers will appreciate the compactness these tubes will give to their systems and operators the reliability and economy. Tubes connect to standard IEC waveguide flanges and can be shipped from stock.

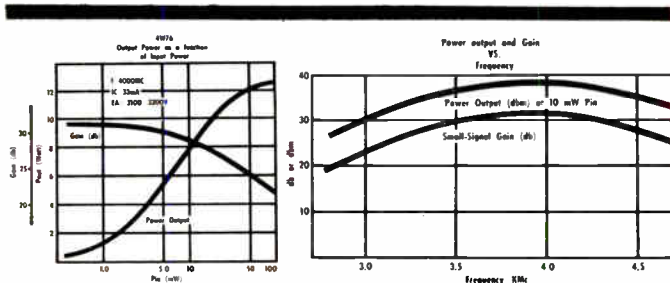

## 4W76

The 4W76 operates in the 4000-mc band and has nominal saturated power output of 10 watts. High amplification over a wide range of power levels results in small-signal gain of approx. 30 db. The band width at half-power points is 1400 mc, but the tube can be used in the frequency range of 2800 to 5000 mc.

### Typical Operating Characteristics at 4000 mc

First Anode Voltage	2,640 V	Saturated Power Output	12.5 watts
Helix Voltage	3,220 V	Small-Signal Gain	32 db
Helix Current	0.7 mA	Noise Figure	approx. 25 db
Collector Current	33 mA	VSWR	less than 2 to 1
Focusing Electrode Voltage	-40 V		(from 3500 to 4300 mc)

### NEC TRAVELING-WAVE AMPLIFIERS

#### PERMANENT MAGNET FOCUSED AMPLIFIERS

4W75	4000-mc band	1.5 watts	8W75	7000-mc band	1.5 watts
4W76	"	5-10 watts	8W76	"	5-10 watts
6W50	6000-mc band	5-10 watts	11W17	11000-mc band	1.0 watt

#### ELECTROMAGNET FOCUSED AMPLIFIERS

4W85	4000-mc band	0.1 watt	4W72A	4000-mc band	1.5 watts
4W86	"	1.0 watt	7W52	6000-mc band	5-10 watts

### Advantages of package-type

- NO focusing or impedance matching at installation
- NO dummy space for removal
- NO power source or current stabilizer for electromagnet



**Nippon Electric Company Ltd.** Tokyo, Japan

COMPONENTS / SYSTEMS

Give your Products

**MORE RELIABILITY and  
BETTER PERFORMANCE with**

**FREED  
QUALITY**

In stock for immediate delivery

**TOROIDAL INDUCTORS**



- MIL Grade 4 — Metal Case
- MIL Grade 5 — Molded
- Uncased Units
- Highest Q
- Highest self resonant freq.
- Low temperature coefficient
- No hum pickup-astatic construction
- Can be supplied with center taps



FREQUENCY RANGE: 500CP TO 15KC

Type	Max Q	Inductance Range
TI-11	290	1MH to 50Hy
TI-12	255	1MH to 30Hy
TI-1A	250	1MH to 30Hy
TI-1	210	5MH to 20Hy
TI-4	195	5MH to 5Hy
TI-5	130	5MH to 2Hy
TI-16	72	1MH to 2Hy

FREQUENCY RANGE: 10KC TO 50KC

TI-13	303	1MH to 500MH
TI-2	285	1MH to 500MH
TI-6	279	1MH to 400MH
TI-7	200	.500MH to 200MH
TI-17	110	.100MH to 100MH

FREQUENCY RANGE: 30KC TO 200KC

TI-18	115	.1MH to 100MH
TI-8	140	.1MH to 100MH
TI-10	185	1MH to 200MH
TI-9	175	1MH to 500MH
TI-19	100	.1MH to 5MH
TI-3	260	.1MH to 10MH
TI-3A	310	10MH to 100MH

**HIGH FREQUENCY  
TOROIDAL INDUCTORS**

FREQUENCY RANGE: 20KC TO 10MC

TI-21	205	.010MH to .150MH
TI-22	250	.010MH to .700MH
TI-23	210	.010MH to .500MH
TI-20	305	.050MH to 5MH



**Ruggedized,  
MIL STANDARD  
AUDIO TRANSFORMERS**

Cat. No.	Imped. level—ohms	Appl.	MIL Std.	MIL Type
MGA 1	Pri. 10,000 C.T. Sec. 90,000 Split & C.T.	Interstage	90000	TF4RX15AJ001
MGA 2	Pri. 600 Split Sec. 4, 8, 16	Matching	90001	TF4RX16AJ002
MGA 3	Pri. 600 Split Sec. 135,000 C.T.	Input	90002	TF4RX10AJ001
MGA 4	Pri. 600 Split Sec. 600 Split	Matching	90003	TF4RX16AJ001
MGA 5	Pri. 7,600 Tap @ 4,800 Sec. 600 Split	Output	90004	TF4RX13AJ001
MGA 6	Pri. 7,600 Tap @ 4,800 Sec. 4, 8, 16	Output	90005	TF4RX13AJ002
MGA 7	Pri. 15,000 C.T. Sec. 600 Split	Output	90006	TF4RX13AJ003
MGA 8	Pri. 24,000 C.T. Sec. 600 Split	Output	90007	TF4RX13AJ004
MGA 9	Pri. 60,000 C.T. Sec. 600 Split	Output	90008	TF4RX13AJ005

WRITE FOR FURTHER INFORMATION ON THESE  
UNITS OR SPECIAL DESIGNS.

Send for NEW 48 page transformer catalog. Also ask for  
complete laboratory test instrument catalog.

**FREED TRANSFORMER CO., INC.**

1720 Weirfield St., Brooklyn (Ridgewood) 27, N. Y



**Professional  
Group Meetings**

(Continued from page 190A)

Pittsburgh—November 17

"Growth of Digital Computing Appli-  
cations," J. J. Taylor, Westinghouse Elec-  
tric Corp.

**RELIABILITY AND QUALITY  
CONTROL**

Columbus—December 11

"How Reliability Affects You," K.  
Cochran, Battelle Memorial Inst.

Columbus—December 15

"A Heretical View of Reliability," H.  
Braner, Battelle Memorial Inst.

"Thermoelectricity," S. Angello, West-  
inghouse.

Los Angeles—January 18

"The Air Force Approach to Relia-  
bility in Ballistic Missile Weapon Sys-  
tems," V. J. Bracha, Air Force Ballistic  
Missile Div.

"Malfunction Reports and Their Re-  
quirements for Reliability," D. S. Burgess,  
Douglas Aircraft.

"Development of a Quality Control  
Program in Industry," S. Collier, Johns-  
Manville Corp.

New York—November 18  
Organizational Meeting.

**SPACE ELECTRONICS AND  
TELEMETRY**

Detroit—January 20

"The Maser," C. Kikuchi, Univ. of  
Michigan.

Los Angeles—January 19

"Space Canaries for Physiological  
Monitoring," B. L. Ettelson, Space Labs.

San Francisco—October 1

"A Satellite Orbit Simulator," R. F.  
Mitchell, Western Dev. Labs.

San Francisco—October 20

"The DCS Heterodyne Telemetry  
System," W. D. Collins, Data-Control  
Systems, Inc.

"A Wide-Band Analogue Magnetic  
Tape Recorder," K. Thompson, Ampex  
Corp.

San Francisco—November 10

"The Argus Experiment," N. C.  
Christofilos, Lawrence Radiation Lab.

San Francisco—December 15

"A Space Communication System,"  
J. C. Keyes, Philco Corp.

San Francisco—January 19

"The Explorer VI Experiment," C.  
Sommet, Space Technology Labs., Inc.

(Continued on page 198A)

from **DALOHM**  
better things  
in  
smaller packages

**DALE PRODUCTS, INC.**

1302 28th Ave.

Columbus, Nebraska

• Precision Resistors—wire wound,  
metal film and deposited carbon

• Trimmer Potentiometers

• Resistor Networks

• Hysteresis Motors

• Collet-Fitting Knobs

write for Full Line Brochure

**tubes**

and semi-conductors.

Over 5000 types always in stock at E. T. S.,

world's largest tube and transistor specialist. Special purpose,  
Transmitting, Receiving. All important brands. Name the type,  
name the brand, name the quantity—we have it. Famous nation-  
wide service—fast delivery anywhere. *Get your free subscription  
to the E.T.S. Bulletins* for authoritative, up-to-date new-item and  
new-availability news—write on your company letterhead today.

**ELECTRONIC TUBE SALES INC.**

74 Cortlandt St., New York 7, N. Y.

BArcly 7-4140

TWX-NY1-4042

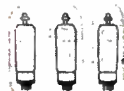

# Measure transistor characteristics—

Alpha ( $h_{fb}$ )

Beta ( $h_{fe}$ )

Input Resistance ( $h_{ib}$ )

—with the new BRC Type 275-A Transistor Test Set

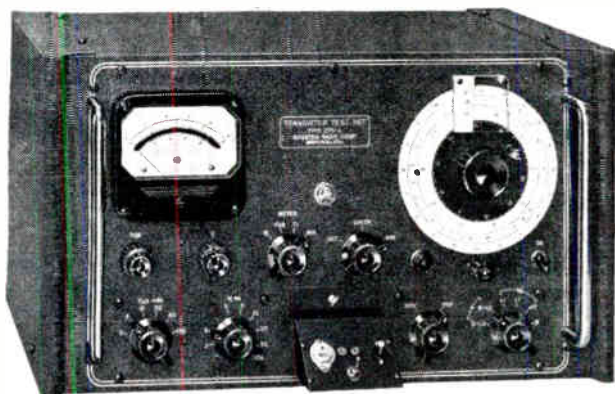

Price: \$935.00 F.O.B. Boonton, N. J.

## Exclusive BRC features—

- Unique null-type measuring circuit completely unaffected by signal level fluctuations
- Reads Alpha to three significant figures
- Accurately measures at extremely low emitter currents

## —plus

- Permanent Calibration
- Direct Readout of Alpha, Beta, and Input Resistance on large easy-to-read dial
- Built-in adjustable, metered collector and emitter power supplies
- Handles up to 5 amperes emitter current
- Measures both NPN and PNP transistors
- Special test circuit guards against transistor burnout

Precision Electronic Instruments since 1934



**BOONTON RADIO CORPORATION**

BOONTON • NEW JERSEY • U.S.A.

The BRC Type 275-A is an exceedingly flexible and efficient instrument for the precise measurement of basic transistor parameters over an extended range of operating conditions. It can also be used to measure the characteristics of diodes and other semi-conductor devices. Direct readout of the following parameters—

- Alpha ( $h_{fb}$ ) • Beta ( $h_{fe}$ )
- Input Resistance ( $h_{ib}$ )

is presented on a large, easy-to-read dial without correction or interpolation. Two built-in, fully regulated, low ripple power supplies furnish completely variable emitter current and collector voltage.

## SPECIFICATIONS

### Alpha Measurement ( $h_{fb}$ ):

RANGE: (a) 0.100 to 0.999 (b) 0.9001 to 0.9999

ACCURACY: (a)  $\pm (0.1 + \frac{0.09}{h_{fb}}) \%$  (b)  $\pm 0.2 \%$  \*

\*when  $f_r \geq 500$  Kc.

### Beta Measurement ( $h_{fe}$ ):

RANGE: 7 to 200

ACCURACY:  $\pm (0.6 + \frac{30}{h_{fe}}) \%$  \*

\*when  $f_r \geq 500$  Kc.

### Input Resistance Measurement ( $h_{ib}$ ):

RANGE: (a) 0.30 to 30 ohms (b) 3.0 to 300 ohms  
(c) 30.0 to 3000 ohms

ACCURACY: (a)  $\pm 3 \%$  \* (b)  $\pm 3 \%$  \* above 30 ohms  
(c)  $\pm 3 \%$  \*

\* for linear impedances

### Collector Voltage Supply:

RANGES: Internal: 0 to 100 V.D.C.

External: 0 to 100 V.D.C.

METERING: Range: 0 to 2, 5, 10, 20, 50, 100 volts

Accuracy:  $\pm 1.5 \%$  full scale

### Emitter Current Supply:

RANGE: Internal: 0 to 100 ma D.C.

External: 0 to 5 amp. D.C. \*

\*  $h_{fb}$  only;  $I_b \geq 100$  ma D.C.

$I_E$  and  $I_C$  metered externally

METERING: Ranges: 0 to 0.1, 0.2, 0.5, 1, 2, 5,  
10, 20, 50, 100 ma.

Accuracy:  $\pm 1.5 \%$  full scale



**JKTO-23  
Crystal-Controlled  
Transistorized  
Oscillator**

**100 KC  
AVAILABLE NOW**

A precision 100 KC plug-in signal source, currently in volume production. Incorporates a new, ultra-stable, 100 KC glass-sealed crystal design, and all-silicon solid state devices. Temperature controller incorporates precise long-lived, glass-sealed Edison-type thermostat. Meets applicable mil. specs., including shock and vibration over a 5 to 2000 cycle range.

**SPECIFICATIONS**  
**STABILITY CLASS:**  $5 \times 10^{-7}$ /Day.  
**FREQUENCY:** 100 KC (Other frequencies available).  
**OUTPUT:** One volt into 5000 ohms.  
**POWER:** 28 volt DC (Other voltages available). Built-in Zener voltage regulator.  
**VIBRATION:** 5 G's — 5 to 2000 cycles — less than one part per million.  
**ALTITUDE-HUMIDITY:** Available sealed or unsealed.  
**TEMPERATURE RANGE:** From  $-55^{\circ}\text{C}$  to  $+85^{\circ}\text{C}$ .  
**DIMENSIONS:**  $1\frac{3}{8}'' \times 1\frac{1}{2}'' \times 4\frac{3}{8}''$  H. Weight:  $6\frac{1}{4}$  Ounces.

For information, write stating requirements

**THE JAMES KNIGHTS  
COMPANY**  
Sandwich, Illinois



**ALUMINUM  
jack panels**

BY

**SWITCHCRAFT<sup>®</sup>**  
INC.

MEET REQUIREMENTS  
FOR  
**strength**  
AND  
lightness



Unique construction with strength and lightness of aluminum. (Weight approx. 25% less than Phenolic Panels). Double row design. Mounts 24 Jacks per row — 48 per strip. Offset ground terminal — easy to connect common terminals. Easy-to-change identification.

Write for Catalog J-102

**SWITCHCRAFT<sup>®</sup>**  
INC.

5545 N. Elston Ave., Chicago 30, Ill.

Canadian Rep.: Atlas Radio Corp., Ltd., 50 Wingold Ave., Toronto, Ontario

**"TWIN-JAX"**



Type MT-388 (JJ-088)

Frame double width with 2 mounting ears on  $1\frac{3}{8}''$  centers; bushings (sleeves) on  $\frac{5}{8}''$  centers. Special features. Catalog J-102.

**Professional  
Group Meetings**

(Continued from page 196A)

San Francisco—February 16

"Design Considerations for a PAM-FM Telemetry System," T. D. Lusk, Lockheed Missiles and Space Div.

**VEHICULAR COMMUNICATIONS**

New York—December 9

"Electronic Control of Automobiles," L. E. Flory, RCA Labs.

Washington—January 27

"Mobile Radio Maintenance Seminar," I. K. Redd, Mobile Communications; W. Switzer, Radio Communication Service; E. Williams, District of Columbia Govt.



**IRE People**



(Continued from page 85A)

William W. Lawrence, Jr. (M'57) has been promoted to advisory engineer in the Memory and Magnetics Engineering Department of the IBM Poughkeepsie Product Development Laboratory. He is engaged in high speed memory development using advanced semiconductor devices.

He joined IBM as a customer engineer at Boston in 1950. He came to Poughkeepsie in 1952 for work on magnetic cores in the Component Research Department and in 1953, engaged in work on the first magnetic core buffers on input-output equipment for the IBM 702 Computer. He became an associate engineer, assigned to the design of a matrix switch drive system for the IBM 704 and 705, in 1955, and was promoted to project engineer in March, 1956, in charge of a group working on high-speed core memory systems.

Mr. Lawrence received the B.A. degree from Amherst College, Amherst, Mass., and in 1948, the B.S.E.E. degree from Massachusetts Institute of Technology, Cambridge, in 1950.

John R. Lyon (M'57) has been promoted to the position of development engineer in Systems Components Engineering at the IBM Poughkeepsie Product Development Laboratory. He has responsibility for adaption of a standard disk file to all Data Systems Division computers, as well as the development of a disk synchronizer and high speed exchange for two advanced data systems.

He joined IBM in 1941 as a customer engineer. He became a technical engineer engaged in design and test of the IBM 704 in 1954 and has subsequently held positions as associate engineer, project engi-

(Continued on page 202A)

**NOW, pick only the parameters you need, order by model number!**

# NEW! 16 Low cost all-electronic totally-transistorized DIGITAL MULTIMETERS

Now in a single 5 1/4" or 8 3/4" x 19" panel Digital Multimeters for measuring any combination of AC/DC volts, AC/DC ratios, and resistance, with new pre-amps for higher sensitivities, optional electrical output and print command capabilities!

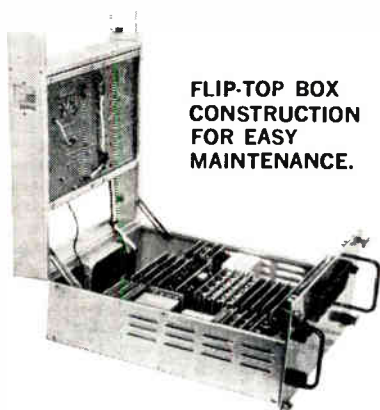

**FLIP-TOP BOX  
CONSTRUCTION  
FOR EASY  
MAINTENANCE.**

- 50 readings per second, average
- Inline "SUPER-NIXIE" readouts
- 0.01% accuracy
- 1000 megohm input impedance
- Automatic, manual and remote ranging
- Automatic polarity
- Twin Zener diode internal reference
- Front panel sensitivity control
- Etched circuits, plug-in card construction
- Will operate directly in multi-point scanning and print-out data logging systems without any additional circuitry or auxiliary equipment.



**MODEL 840**  
DC Volts/DC Ratios



**MODEL 841**  
DC Volts DC Ratios/Resistance

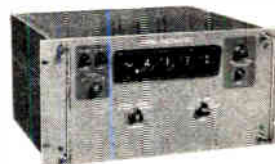

**MODEL 842**  
DC Volts DC Ratios AC Volts



**MODEL 843**  
DC Volts AC Ratio AC Volts/Resistance



**MODEL 844**  
DC Volts/Ratio/AC Pre-Amplifier

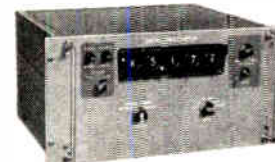

**MODEL 845**  
DC Volts/Ratio/Resistance DC Pre-Amplifier



**MODEL 846**  
DC Volts/Ratio/AC Volts-DC Pre-Amplifier

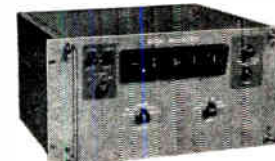

**MODEL 847**  
DC Volts/Ratio/AC Volts/Resistance/Pre-Amplifier

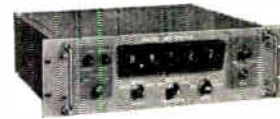

**MODEL 848**  
DC Volts/Ratio With Electrical Outputs



**MODEL 849**  
DC Volts/DC Ratio/Resistance With Electrical Outputs



**MODEL 850**  
DC Volts/DC Ratio AC Volts With Electrical Outputs

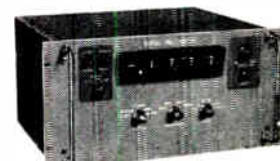

**MODEL 851**  
DC Volts DC Ratio AC Volt/Resistance With Electrical Outputs



**MODEL 852**  
DC Volts/Ratio/DC Pre-Amplifier With Electrical Outputs



**MODEL 853**  
DC Volts/Ratio/Resistance/DC Pre-Amplifier With Electrical Output

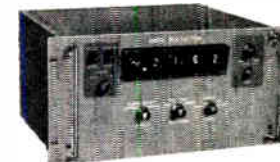

**MODEL 854**  
DC Volts/Ratio/AC Volts/DC Pre-Amplifier With Electrical Outputs



**MODEL 855**  
DC Volts/Ratio/AC Volts/Resistance Pre-Amplifier With Electrical Outputs

Many variations of these basic models including AC ratiometers, milliohmmeters, microvoltmeters and specialized measuring instruments tailored to individual systems requirements are available in the same physical configurations. Ask your EI sales office or representative for complete specifications today!

**Electro Instruments, Inc.**

**EI** 3540 AERO COURT  
SAN DIEGO 11, CALIF.



## A VACUUM WORKHORSE for Laboratories with Many and Varied Problems . . .

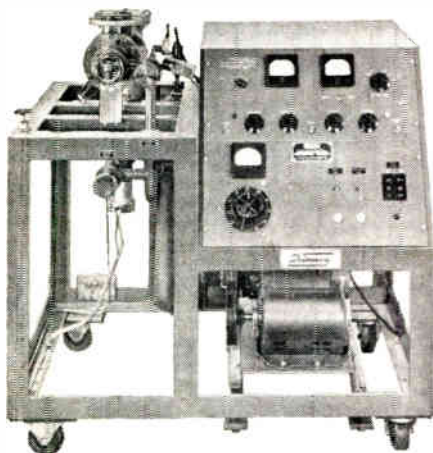

# Kinney®

## PW-200 PACKAGED PUMPING SYSTEM

The popularity of KINNEY Packaged Pumping Systems stems from the fact that they are so downright useful. They'll evacuate chambers, tanks, bell jars, furnaces, tubes or equipment — anywhere — and quickly. With main valve closed, the KINNEY PW-200 will attain ultimate pressures to  $5 \times 10^{-6}$  mm Hg with no coolant in the trap, ( $5 \times 10^{-7}$  mm Hg with coolant).

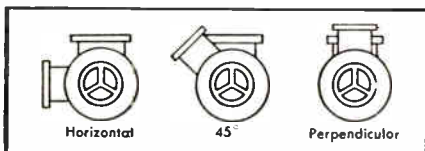

The Rotatable "T" Manifold is a Feature of KINNEY Packaged Pumping Systems. The stem of the "T" can be rotated a full  $90^\circ$  — from horizontal to vertical — so that the system is readily converted to form a complete Evaporator by the addition of a suitable baseplate. Get the facts on the PW-200 and other KINNEY Packaged Pumping Systems.

**KINNEY VACUUM DIVISION**  
THE NEW YORK AIR BRAKE COMPANY 

3631 E Washington Street • Boston 30 • Mass.

Please send me Bulletin No. 4000.1 describing KINNEY Packaged Pumping Systems.

Name \_\_\_\_\_

Company \_\_\_\_\_

Address \_\_\_\_\_

City \_\_\_\_\_ Zone \_\_\_\_\_ State \_\_\_\_\_

## Wide Band Amplifier Model 530



### GENERAL DESCRIPTION

The Model 530 Wide Band Amplifier has been designed to fill a need for an amplifier used principally for voltage amplification of CW or pulsed signals.

This model has many applications in the laboratory and also for television distribution systems. It may be used to increase the output from signal sources within its frequency range, and its bandwidth of 300 mc's makes it ideal for amplifying millimicrosecond pulses.

PRICE \$330.

### SPECIFICATIONS

Bandpass	10 KC to 300 MC
Voltage Gain	18 db
Input Impedance	135 ohms
Output Impedance	150 ohms
Max. Output Power (Into Matched Load)	.08W
Max Output Voltage (Into Matched Load)	3.5 Vrms
Max. Peak Pulse Output	7 V pos. or neg.
Rise Time	Less than $2 \times 10^9$ sec
Dimensions	19" front panel—16" wide, 9" deep $3\frac{1}{2}$ high. Power supply included. Provided on front panel
Gain Control	Two cascaded stages of eight 6AK5
Tube Complement	

INSTRUMENTS FOR INDUSTRY, Inc.  
101 New South Road, Hicksville, L. I., N. Y.



Graduate engineers with two or more years of circuit application in the fields of electronics or physics are invited to meet with Mr. John Hicks in an informal interview or send complete resume to: Dir. Personnel, IFI, 101 New South Road, Hicksville, New York.

*Very* **SMALL WIRE** *Electroplated*

Unusual and difficult engineering problems may be solved, at times, by single or multiple electroplating of small wires . . . A wide variety of metals is available, both as the core wire and as the plate. Inquiries invited.

SINCE  1901

Write for list of Products.



**SIGMUND COHN MFG. CO., INC.**

121 SOUTH COLUMBUS AVENUE, MOUNT VERNON, N. Y.



# NOW BUILD A PRINTED CIRCUIT IN YOUR LAB IN 15 MINUTES

... you simply mask, etch, and rinse new Corning FOTOCERAM\* grid boards for perfect circuits

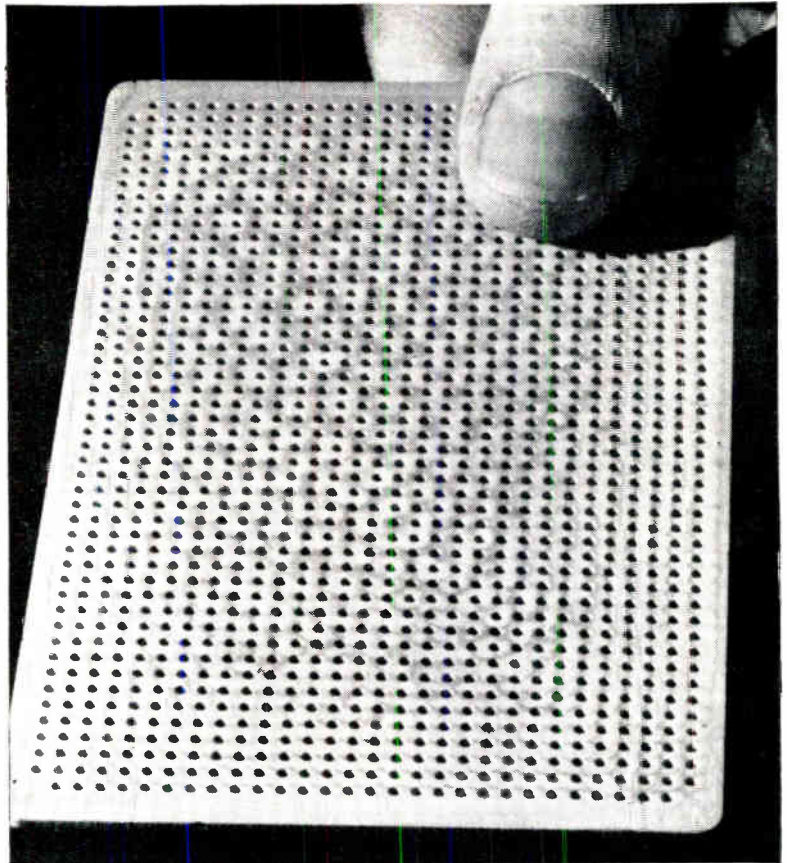

1. New Corning grid boards are already holed and coppered to give you maximum design flexibility.

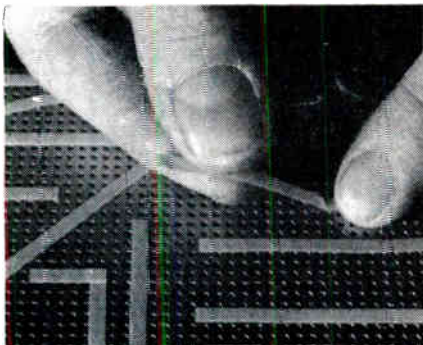

2. Lay out the circuit run you want on one or both sides with tape or chemical resist.

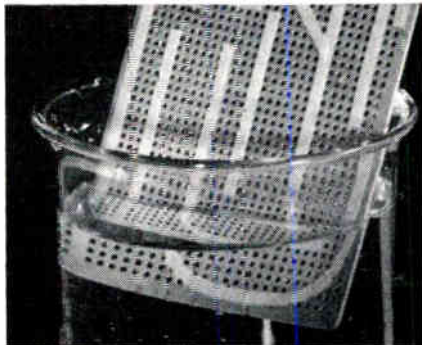

3. Immerse in a copper etchant to remove excess copper.

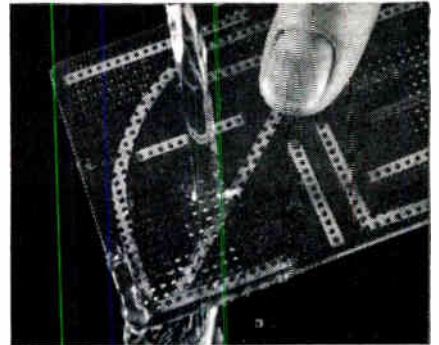

4. Rinse. That's all there is to making a board ready for use.

Take a new Corning FOTOCERAM copper-plated grid board. Apply a tape or chemical resist of your circuit pattern. Etch away the excess copper. Rinse the board, and strip the resist. You're ready to add components.

**No adhesives are used.** The board has 0.052 inch holes spaced 0.1 inch apart on centers. The holes, too, are already plated.

The base is FOTOCERAM, a glass-ceramic, a proved production material that's used widely in printed circuits which demand high strength, temperature resistance to 250°C., zero moisture absorption, nonflammability, and rigid dimensional stability.

**Excellent through-hole plating.** Hole plating is done with the same material used for circuit-run conductors. This provides exceptional thermal and electrical conductivity and negates the need for eyelets.

We have soldered, removed, and resoldered components to

these boards as many as fifty times without circuit-run failure.

**No bending, bowing, delaminating.** The FOTOCERAM base is a solid piece. There are no laminations which might bend, twist, or warp under high temperatures.

**Three sizes.** There are currently three boards, all  $\frac{1}{16}$ " thick: 3" x 5", 6" x 8", 9" x 12". They can be trimmed to any shape with a simple glass cutter.

**Small production runs.** Some of our customers are using these boards for small production runs as well as R&D work.

**Data sheets.** Write to Corning Glass Works, 542 High Street, Bradford, Pa., for data sheets on the grid boards and FOTOCERAM printed circuit boards. For orders of 250 or less, contact your distributor serviced by Erie Distributor Division.

\*Trademark



## CORNING ELECTRONIC COMPONENTS

CORNING GLASS WORKS, BRADFORD, PA.

# AT LAST—The IDEAL BARRIER TERMINAL STRIP

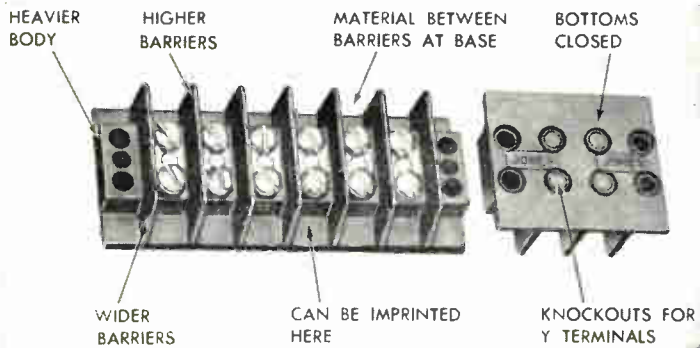

## JONES 500 SERIES LONGER—STURDIER

Wider and higher barriers for increased creepage distances. Closed bottoms for complete insulation. Material between barriers at the base adds to the strength and maintains the same creepage distance between contact to contact and contact to ground. Can be imprinted here. No insulating or marker strip required. Three series—540, 541 and 542 having the same terminal spacing as our 140, 141 and 142 series.

Complete listing in the new Jones No. 22 catalog. Write for your copy today.



**Jones**

**HOWARD B. JONES DIVISION**  
CINCH MANUFACTURING COMPANY  
CHICAGO 24 ILLINOIS  
DIVISION OF UNITED CARR FASTENER CORP

# FREE —

## NEW—UHF ATTENUATOR CATALOG

The full line of Stoddart precision coaxial attenuators and terminations, 2, 6 and 10-position turret-type step attenuators are presented in 16 pages with complete descriptions, applications, illustrations, specifications and curves. Attenuators in the frequency range of dc thru 3 kmc are described in any combination of types "N" or "C", male or female connectors; terminations from dc thru 7 kmc, types "N" or "C" connectors and from dc thru 1 kmc with types "TNC" or "BNC" connectors. Turrets are available in any combination of attenuation from 0.1 db thru 60 db.

**ATTENUATORS**  
BULLETIN AT-3

**STODDART**  
AIRCRAFT RADIO CO., INC.

**STODDART**  
AIRCRAFT RADIO CO., INC.

6644 Santa Monica Boulevard  
Hollywood 38, Calif. HOLLYWOOD 4-9292

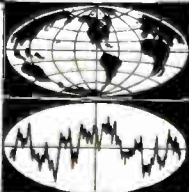

For your free copy, write on company letterhead to: "Sales Engineering" dept.



**IRE People**



(Continued from page 198A)

neer and staff engineer, engaged in design and development of the IBM 704 and another advanced system.

He received the B.S.E.E. degree from the University of California in 1941, is a veteran of the U. S. Navy, and presently a Lt. Commander in the U. S. Naval Reserve. Mr. Lyon is a member of Eta Kappa Nu.



The appointment of **Dr. Robert Malm** (SM'56) as a senior engineering specialist at the Amherst Engineering Laboratory of Sylvania Electric Products Inc. has been announced by Dr. Robert L. San Soucie, manager of the advanced communication systems department. Sylvania is a subsidiary of General Telephone & Electronics Corporation.

The Amherst Engineering Laboratory is a facility of the Buffalo Operations of Sylvania Electronic Systems, a division of the company. Affiliated with Sylvania Electronic Systems since 1957, Dr. Malm is responsible for communications physics at the Amherst laboratory.

He received the B.S. degree in electrical engineering from the University of Minnesota, Minneapolis, and the Ph.D. degree in physics from Massachusetts Institute of Technology, Cambridge. Prior to joining Sylvania, he served as an associ-

(Continued on page 207A)

## Proven, Dependable, Rear-Projection Type **ON-LINE** DIGITAL DISPLAYS

A Model and Size for Your Every Requirement



### OUTSTANDING FEATURES

- All digits displayed on front viewing screen
- All digits uniform in size and intensity
- High-contrast viewing screen
- Digit style of your choice
- Colored digits of your choice
- Individual units may be group assembled for panel mounting

WRITE TODAY FOR COMPLETE SPECIFICATIONS  
Representatives in principal cities

PRICES	
Series 10000	1 1/8" wide 2 5/8" high 5 3/8" long \$18.00 each
Series 80000	3 1/4" wide 5 1/4" high 11 1/8" long \$33.00 each
Series 120000	1" wide 1 1/8" high 3 3/8" long \$35.00 each
Quantity Prices On Request	

**INDUSTRIAL ELECTRONIC ENGINEERS, Inc.**  
5528 Vineland Avenue,  
North Hollywood, Calif.





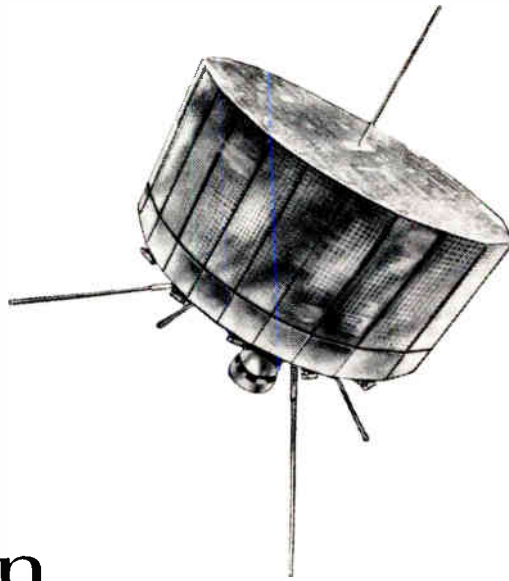

# TIROS relies on LAMBDA reliability

## Standard Lambda Regulated

**Power Supplies** have again been selected for a job where reliability and quality are of vital importance. They power the ground equipment in the primary and back-up stations that control and track America's newest missile—TIROS.

In TIROS as in SAGE, Digital Computer Intervention and Display System and other leading electronic projects, Lambda Power Supplies are specified because Lambda equipment has consistently proven its reliability.

This same Lambda quality is the reason Lambda Power Supplies are consistently selected *first* by engineers in independent surveys. To find out more about Lambda Supplies, which are guaranteed for a full five years, send today for the Lambda Catalog. It gives data on Lambda's complete line of tube models ranging up to 525 VDC and transistor models up to 10 Amps.

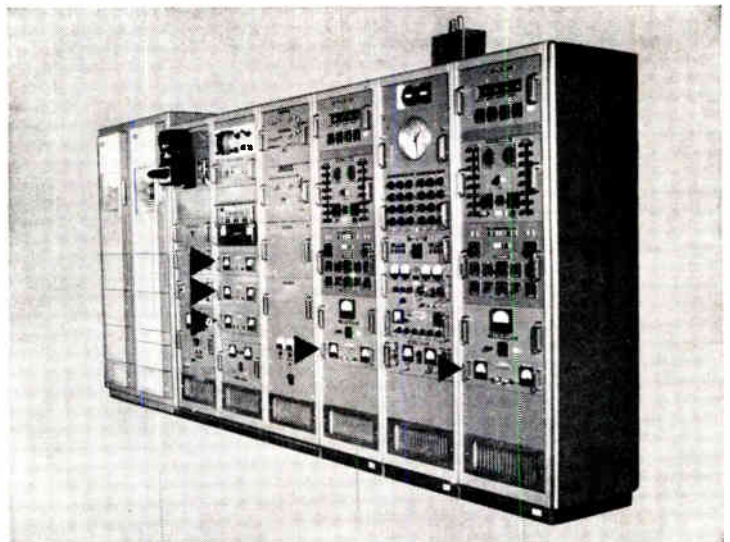

### The Tiros System

Sponsored: National Aeronautics and Space Administration  
Technical Direction: U. S. Army Signal Research and Development Laboratory  
Developed and Built: Astro- Electronic Products Division, Radio Corporation of America

LA104

 **LAMBDA ELECTRONICS CORP.**  
11-11 131 STREET • DEPT. 3 • COLLEGE POINT 56, N. Y. • INDEPENDENCE 1-8500





## Only Voltmeter with the Factual Fifth Figure



WHEN FOUR-DIGIT ACCURACY JUST ISN'T ENOUGH, specify the five-digit NLS V35 — world's most accurate digital voltmeter. Only the V35 gives you the "factual fifth figure" . . . full five-digit resolution of 0.001%. Here is the instrument for your measuring jobs demanding maximum accuracy — automatic missile checkout, readout and printout in data logging and computer systems, critical production inspection. Only the V35 offers you the benefits of "no-needless-nines" logic — greater reliability, increased speed, longer parts life. Contact NLS today for the full story.

V35 Specifications: Measures DC voltage from  $\pm 0.0001$  to  $\pm 999.99$ ; DC voltage ratio from  $\pm 00.0001\%$  to  $\pm 99.999\%$  . . . DC voltage accuracy is  $\pm 0.01\%$  of reading or  $\pm 1$  digit . . . overall accuracy for voltage ratio is  $\pm 0.005\%$  of reading or  $\pm 1$  digit . . . "factual fifth figure" — 0.001% resolution . . . transistorized "no-needless-nines" logic . . . plug-in modular construction . . . simple external connections for AC/DC converter, pre-amplifier and data logging accessories . . . one-package design —  $5\frac{1}{4}$ " high — for standard rack mount . . . automatic selection and indication of range and polarity . . . interchangeable plug-in stepping switch-resistor assemblies sealed in oil . . . \$3,750.00, complete. Available in four-digit model for \$3,150.00, complete.



Originator of the Digital Voltmeter

**non-linear systems, inc.**  
DEL MAR (SAN DIEGO), CALIFORNIA

## GPT-40K

- 4 to 28mc.
- 40,000 watts PEP
- ALDC
- Filtered air cooling
- Semi-pressurized cabinet
- Safety interlocks throughout

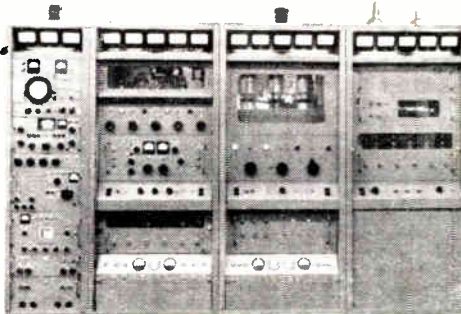

## AN/FRT-40

- ISB\*
- SSB\*
- DSB\*
- CW
- AM
- FS
- FAX

\*Suppressed carrier

# 40,000 WATTS

SEND FOR BULLETIN 206C

The TMC transmitter, Model GPT-40K, is a completely self contained unit including all power supplies and ventilating equipment. All components are housed in four modular assemblies occupying only 40 square feet of floor space.

The transmitter includes equipment for immediate monitoring and testing of all vital operating points.

To provide for complete flexibility in operation, 1 Kw or 10 Kw outputs are readily available for reduced power or emergency operation. The unit is available with or without synthesizer control.



**THE TECHNICAL MATERIEL CORP.**

MAMARONECK, NEW YORK

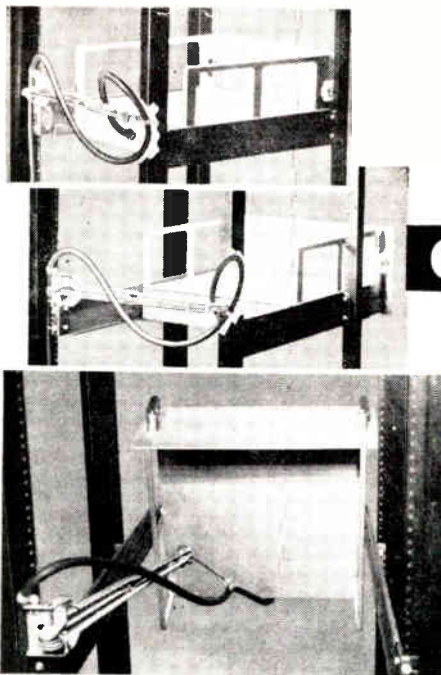

## PREVENTS ENTANGLING COMPONENTS

## CABLE RETRACTOR

Withdrawal of a chassis for service and its return to position no longer presents the old bugaboo of cable entanglement with and damage to tubes and components in the chassis immediately below it.

This new cable retractor's double action maintains a constant tension and correct suspension of cable at all times — permits adequate cable length for full extension and tilting of chassis without hazard of snagging.

May be used with all types of chassis or drawer slides, is adjustable to fit varying chassis lengths, is simple to install, and has proven thoroughly reliable in operation. Mounts on rear support rails on standard  $1\frac{3}{4}$ " hole increments. Cadmium plated cold rolled steel.

Write for complete data

ORegon 8-7827

### ONE SOURCE . . .

for VENTILATED RELAY RACK CABINETS, CONTROL CONSOLES, BLOWERS, CHASSIS, "CHASSIS-TRAK", RELATED COMPONENTS

## WESTERN DEVICES, INC.

600 W. FLORENCE AVE., INGLEWOOD, CALIF.

**APRIL PROCEEDINGS  
FOCUSES ON**

# SPACE ELECTRONICS

**VITAL NERVE  
CENTER OF MAN'S  
EXPLORATION OF  
THE UNIVERSE!**

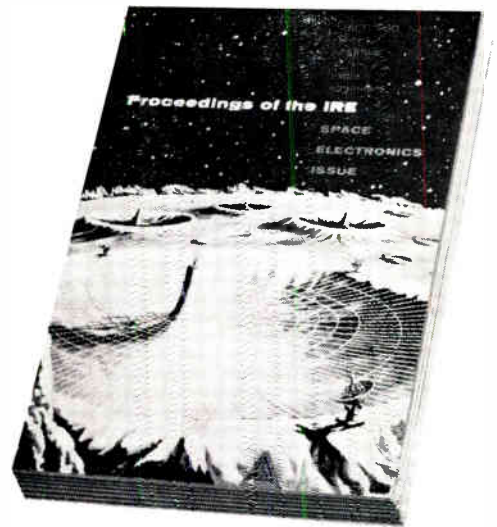

Man's escape from the confines of his planet offers him revolutionary opportunities for performing whole new ranges of scientific experiments, notably in such fields as astronomy, physics and geophysics. Electronics, because it provides the vital nerve system for such experiments, will be at the very center of these new exploits in space. Moreover, earth satellites, possibly in a 24-hour equatorial orbit, promise to open a new era in global communications in which almost limitless bandwidths may become available at relatively low cost.

**Comprehensive Report On The Present And Future Role of Electronics In Space Exploits**

In this important special issue are articles on propulsion, navigation and guidance, communication, tracking and surveillance, telemetry and instrumentation and measurements. There are over 50 of these studies, each one contributing to the radio-engineers' interest in space — for performing new scientific experiments, global communications and space travel.

This Space Electronics issue is another in the many services offered members of the IRE. Non-members of the Institute of Radio Engineers, however, are invited to reserve a copy of this vital report by returning the coupon below, today.

**PARTIAL CONTENTS OF THIS  
APRIL SPACE ELECTRONICS ISSUE:**

- "The NASA Space Science Program"
- "A Comparison of Chemical and Electric Propulsion Systems for Interplanetary Travel," by C. Salzer, R. T. Craig and C. W. Fetheroff
- "Photon Propelled Space Vehicles," by D. C. Hock, F. N. McMillan, and A. R. Tanguay, Radiation, Inc.
- "Interplanetary Navigation," by G. M. Clemence, USN Observatory
- "Navigation Using Signals from High Altitude Satellites," by A. B. Moody, USN Hydrographic Office
- "Inertial Guidance Limitations Imposed by Fluctuation in Gyroscopes," by G. C. Newton, Jr., MIT
- "Propagation and Communications Problems in Space," by J. H. Vogelmann, Dynamic Electronics-New York, Inc.
- "Communication Satellites," by D. L. Jacoby, U. S. Army Signal Research & Development Lab.
- "Interference and Channel Allocation Problems Associated with Orbiting Satellite Communication Relays," by F. E. Bond, C. R. Cahn and H. F. Meyer, Ramo-Wooldridge
- "Solar Batteries," by A. I. Daniel, USASRD
- "Extra-Terrestrial Radio Tracking and Communication," by M. H. Brockman, H. R. Buchanan, R. L. Choate and L. R. Malling, NASA-California Institute of Tech.
- "Tracking and Display of Earth Satellites," by F. F. Slack and A. A. Sandberg, AF Cambridge Research Center
- "Interplanetary Telemetry," by R. H. Dimond, Radiation, Inc.
- "The Telemetry and Communication Problem of Re-Entrant Space Vehicles," by E. F. Dirs, Admiral Corp.
- "Radiation and Instrumentation Electronics for the Pioneer III and IV Space Probes," by C. Josias, California Institute of Technology
- "Applications of Doppler Measurements to Problems in Relativity, Space Probe Tracking and Geodesy," by R. R. Newton, The Johns Hopkins University
- "High Speed Electrometers for Rocket and Satellite Experiments," by J. Praglin and W. A. Nichols, Keithley Instruments, Inc.



**THE INSTITUTE OF RADIO ENGINEERS**

**1 East 79th Street,  
New York 21, N. Y.**

Enclosed is \$3.00

Enclosed is company purchase order for the April, 1960, issue on Space Electronics.

All IRE members will receive this April issue as usual. Extra copies to members, \$1.25 each (only one to a member).

Name.....

Company.....

Address.....

City & State.....



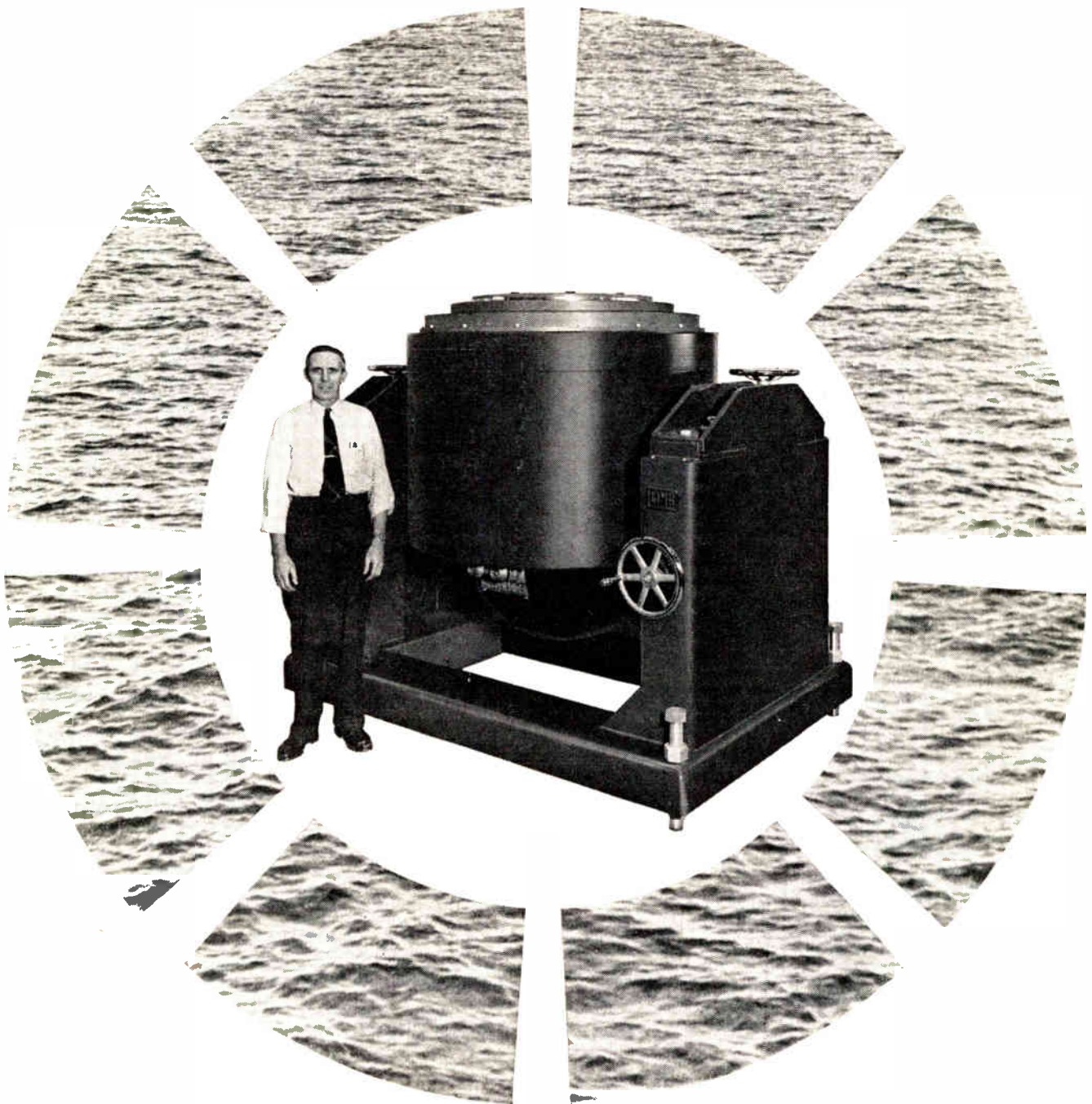

## LING'S LIQUID-COOLED SHAKERS DISSIPATE HEAT FAST WITH WATER

Improved system efficiency goes with the improved design of Ling's new series of liquid-cooled shakers. For instance, Model 249 shown above not only offers an impressive 28,000 pound force rating, but a number of other advantages. The new closed-loop cooling system, employing clean raw or distilled water, dissipates heat so efficiently that less is dumped on the testing site. The series also features a new web-design armature of lightweight aluminum. Force is transmitted to the table with maximum rigidity. Finally, special construction details make these liquid-cooled shakers adaptable for environmental chamber testing without special accessories. Tests can be conducted from  $-100^{\circ}\text{F}$  to  $300^{\circ}\text{F}$  at any altitude. Field and armature coils are designed to help eliminate corona at altitudes; special thermal barriers can be supplied which control heat flow from the shaker to the chamber. This built-in adaptability and high efficiency grow from Ling research; For details on the liquid-cooled shaker series, write to IRE-2, at either address below.

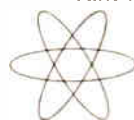

**L I N G**  
E L E C T R O N I C S

A DIVISION OF LING-ALTEC ELECTRONICS, INC. • 1515 SOUTH MANCHESTER, ANAHEIM, CALIFORNIA • 120 CROSS STREET, WINCHESTER, MASSACHUSETTS



The shaker at the left is just one of many design improvements to grow out of Ling's continued research and development program. Its high 28,000 pound force rating—one of the highest force ratings available—is another result of Ling's constant search for better equipment and better methods of vibration testing.

In addition to the special advantages offered by the efficient liquid-cooling system, this new series offers other important features which it has in common with the air-cooled shaker series.

Ling's dual magnetic field structure provides a low stray field and improved force-current linearity. Ling shakers are engineered to operate continuously at maximum force on low input, feature simplified compensation over wide bandwidths.

Check the ratings on the entire liquid-cooled series. The performance of the series is just one more proof that whatever your needs in high power electronics—vibration testing, acoustics or sonar—you can rely on Ling for the most advanced design and practical engineering.

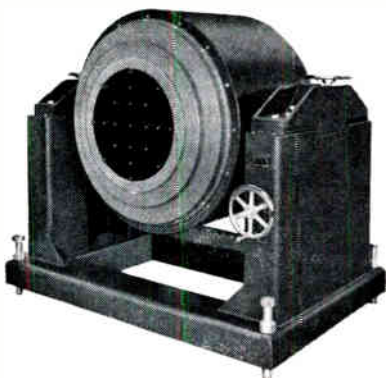

LING'S LIQUID-COOLED SHAKERS cover this useful range of force ratings:

- Model 245—2,000 lb. force rating
- Model A246—7,500 lb. force rating
- Model 275—10,000 lb. force rating
- Model 249—28,000 lb. force rating

**L I N G**  
E L E C T R O N I C S

HIGH-POWER ELECTRONICS FOR  
VIBRATION TESTING • ACOUSTICS • SONAR



(Continued from page 202A)

ate physicist at the Argonne National Laboratory and as a member of the technical staff of the Bell Telephone Laboratories.

Dr. Malm is the author of numerous technical papers. He is a member of the American Physical Society, The Association for the Advancement of Science and several other professional groups on antennas and propagation, information theory, communication systems and engineering management.



Electro-Mechanical Research, Inc., Sarasota, Fla., has established a new Sales District Office in Huntsville, Ala.

The new office will be managed by **Peter T. Miller** (M'55) who will represent the military telemetering components of both EMR and ASCOP division of EMR in the Huntsville area. He has had previous experience in electronics engineering with electronics companies, and in the TV and radio broadcasting industries. Before joining Electro-Mechanical Research, Inc., he was associated with the Chrysler Missile Division as Managing Engineer of Instrumentation stationed at Redstone Arsenal in Huntsville. He is Program Chairman of the Huntsville Section of the IRE.



P. T. MILLER

As of April 1st the office address will be Suite 21, Holiday Office Center, So. Memorial Pkwy., Huntsville, Alabama.



**Milton E. Mohr** (M'45-SM'53) has been appointed vice president, operations, and **Bernard Berman** (M'55) was named director, special projects for Ramo-Wooldridge, a division of Thompson Ramo Wooldridge Inc.

In his newly created post, effective immediately, Mr. Mohr will have responsibility for over-all direction of operations of the Ramo-Wooldridge Division located at the Ramo-Wooldridge Laboratories, Canoga Park, California. He was formerly vice president of engineering of the Ramo-Wooldridge Division.

Mr. Berman, as director of special projects, will be responsible for initial development of new areas of application for Ramo-Wooldridge systems, techniques and equipment.

Mr. Mohr joined Ramo-Wooldridge in 1954, with 22 years' experience in research and development of communication circuits and systems, and technical administration.

Prior to joining R-W, he was a department head in the radar laboratory of Hughes Aircraft Company where, for four

(Continued on page 208A)

a  
tradition  
in  
voltage  
regulated  
dc  
power  
supplies

**Kepeco**  
inc.

the  
standard  
for the  
"state  
of the  
art"  
for over  
14 years

More than  
120 standard  
active models  
•  
transistorized  
•  
vacuum tube  
•  
magnetic

For complete  
specifications  
send for  
Catalog B-601.

**Kepeco**  
inc.

131-42 SANFORD AVENUE  
FLUSHING 55, N. Y.  
IN 1-7000

TWX # NY 4-5196

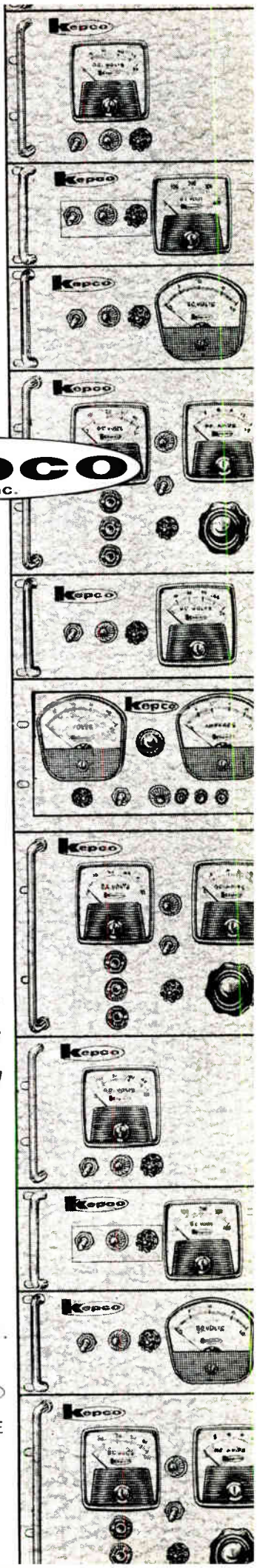

# Now... TOP HATS for everyone!



Protect electron tubes, relays, capacitors, other plug-in components for equipment reliability.

## These superior retainers now come in a variety of sizes and styles to fit nearly every plug-in component.

**Positive** — Top Hat® retainers hold components securely in any position . . . can't shake loose even when upside down.

**Corrosion Resistant** — Both hats and posts are of stainless steel for maximum reliability. Materials and finishes comply with all Military Specifications.

**Resilient** — Special spring action gives positive retention yet preserves desired flexibility and prevents strain on component.

**Easy on, easy off** — Simple finger pressure fastens or releases clamp —no tools to slip or waste time—no tiny parts to lose.

Top Hats clamp any components. If you have special requirements, write Dept. E for quotations.



## Westrex Corporation

A DIVISION OF LITTON INDUSTRIES



540 West 58th St., New York 19, N. Y.  
1523 J Street N.W., Washington 5, D. C.

Also distributed by



— U. S. Engineering Co., 13536 Saticoy St., P. O. Box 2368, Van Nuys, Calif.



**IRE People**



(Continued from page 207A)

years, he contributed to the development of advanced interceptor fire control systems. From 1938 to 1950, he was a member of the technical staff of the Bell Telephone Laboratories.

He has the B.S. degree in Electrical Engineering from the University of Nebraska, as well as an honorary doctorate of engineering from that school. He is the author of several technical papers and the holder of twenty-two patents.

Mr. Mohr is a member of the American Institute of Electrical Engineers, the New York Academy of Sciences, and the American Rocket Society. He is also a member of Sigma Tau, Sigma Xi, Eta Kappa Nu and Pi Mu Epsilon.

Mr. Berman joined R-W in 1954 with ten years' experience in design, development and flight test of airborne electronic systems. Prior to joining R-W, he directed flight test of E-series fire control systems, and development of techniques to achieve quantitative flight test data for a local aircraft company.

He has the B.S. and M.S. degrees in physics from the University of Minnesota, and is a member of Phi Beta Kappa and the American Physical Society.



(Continued on page 210A)

For the highest  
**RELIABILITY**  
**IN PRECISION**  
**COMPONENTS**

specify

## FAIRCHILD

**GYROS**

**PRESSURE  
TRANSDUCERS**

**ACCELEROMETERS**

**POTENTIOMETERS**

## FAIRCHILD

**CONTROLS CORPORATION**

COMPONENTS DIVISION  
225 Park Avenue  
Hicksville, L. I., N. Y.      6111 E. Washington Blvd.  
Los Angeles, Cal.

A Subsidiary of Fairchild Camera and Instrument Corporation



*For basic research, pilot plant studies and production of semiconductors*

## LINDBERG GASEOUS AND SOLID DIFFUSION FURNACES



These Lindberg four-tube furnaces at Microwave Associates, Inc., provide maximum continuous operating temperature to 1371°C. (2500°F.). Chamber accommodates four 2" O. D. and has a uniformity of plus or minus 5.0°C.

Microwave Associates, Inc., Burlington, Mass.; a leader in the development of specialized semiconductor products, must give careful consideration to the choice of technical equipment to assure maintaining their position in this highly competitive field. Consequently, the Microwave installation shown above was selected from Lindberg's complete line of gaseous and solid diffusion furnaces for quality transistor and semi-

conductor devices. This line provides a wide variety of standard sizes and capacities to enable manufacturers in the semiconductor field to have higher powered equipment adequately insulated and designed for its specific use. Models available in single and multiple zone types and a variety of tube sizes up to 4" I.D. These Lindberg furnaces are versatile, perfectly adaptable for basic research, pilot plant study and production.



**LINDBERG SOLID DIFFUSION FURNACE:** Preheat chamber 21" long with two zones of control—maximum temperature 900°C. (1652°F.). High heat chamber 16" long with two zones of control, maximum operating temperature 1300°C. (2372°F.).



*For full information call your local Lindberg Field Representative (see your classified phone book) or write for Bulletin No. 1081.*

**LINDBERG ENGINEERING COMPANY**  
2482 West Hubbard Street, Chicago 12, Illinois  
Los Angeles Plant: 11937 S. Regentview Ave., of Downey, California • In Canada: Birleco-Lindberg, Ltd., Toronto

**LINDBERG**  
heat for industry



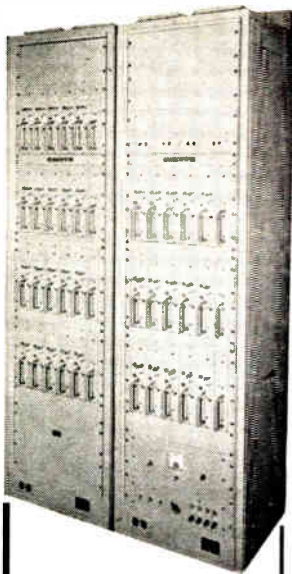

A NEW APPROACH TO . . .

## SOUND SPECTRUM ANALYSIS

Through this . . .

## ACTIVE FILTER FREQUENCY TRANSLATOR

Rixon's Active Filter Frequency Translator (AFFT) provides a solution to sound spectrum analysis requiring rapid and very detailed audio spectrum examination. The photo shows 35 independent channel units each capable of extracting any 150 cps wide portion from a broad spectrum (0 to 5 KC) and translating that portion to a new location for further processing by secondary analyzer equipment. The process is a first-time application of a "quadrature function" technique which filters while it translates and insures high rejection of undesired frequencies.

AFFT's applications in new areas of sound spectrum analysis are of as much interest to Rixon as they are to you. Write for Rixon Engineering Bulletin 267 to learn more about AFFT, and then, let's talk about your application.

# RIXON

**ELECTRONICS, INC.**

2414 Reedie Dr. • Silver Spring, Md. • LO 5-4578

### AFFT MODEL—804 SPECIFICATIONS

**INPUT FREQUENCY RANGE:**  
Signals from 150 cps to 5000 cps

**OUTPUT FREQUENCY RANGE:**  
10 cps to 150 cps flat to within 3 db for each channel unit

**UNDESIRE FREQUENCY REJECTION:**  
Greater than 50 db.

**SIGNAL INPUT LEVEL:**  
Wideband noise at a maximum level of zero dbv — — 50 dbv dynamic range

## IMPORTANT SWISS INDUSTRIAL CONCERN

with available capital, latest equipment, technical and scientific staff, qualified personnel, is interested in the manufacture of

### ELECTRONIC COMPONENTS

Either for own account, as associates, as sub-contractors or as licencees.

**Offers to Case Stand 358, Geneva, Switzerland.**



**IRE People**



(Continued from page 208A)

Appointment of **Kenneth C. Moritz** (M'53-SM'58) to the newly-created post of Vice President-Marketing of General Instrument Corporation's Semiconductor Division, has been announced by Maurice Friedman, Vice President and General Manager of the Division. Previously National Sales Manager for the Raytheon Company's Semiconductor Division, Mr. Moritz will be in charge of all semiconductor sales, marketing and advertising activities for General Instrument, directly under Mr. Friedman. He will make his office at the Company's Newark, N. J., headquarters plant.



K. C. MORITZ

Prior to his employment with Raytheon, he had been with Philco Corporation for 12 years in various government and industrial executive sales capacities, including Philco's European operations. He previously was an officer in the Signal Corps.

A graduate of New York University, Mr. Moritz did graduate work at George Washington University; he is a member of the American Management Association and the National Sales Executive Club.

Homer R. Denius, President of Radiation Incorporated, has announced the appointment of **Roy W. Murray, Jr.** (M'51) as Eastern Director of Marketing.

Prior to joining Radiation, he was Western Regional Manager for Tele-Dynamics, Inc., and TDI's resident engineer for customer indoctrination and engineering liaison.

Mr. Murray is a graduate of Dartmouth College with the B.A. degree in Electrical Engineering. He was past Program Chairman, Secretary and Chairman of the Los Angeles Chapter, IRE Professional Group on Space Electronics and Telemetry. Other memberships include the American Rocket Society and ISA.



R. W. MURRAY

**Robert C. Paulsen** (M'59) has been advanced to the position of advisory engineer at the IBM Poughkeepsie Product Development Laboratory. In his position, he is engaged in functional unit development in the Systems Engineering Department of Advanced Computational Systems.

He attended Newark College of Engineering, Newark, N. J., and joined IBM

(Continued on page 212A)

# NEW INSTRUMENTS

by Sensitive Research

## RF VOLTMEETER CALIBRATOR

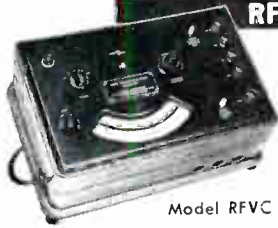

Model RFVC

**Model RFVC** — Radio Frequency Self Checking RMS voltmeter for the certification of VTVM's from DC to 10 Mc. Accuracy .3% of full scale  $\pm$  .2% frequency influence. Ranges .01, 1, 13 V. Checks its own accuracy against a .05% stable internal standard source

## DC POTENTIOMETERS



Type 9144

A new line of 6 figure instruments guaranteed 10X more accurate than any potentiometer commercially available today, having a subdivision of 1 part in 10<sup>6</sup> of the 1 volt setting and calibrated to be usable to an accuracy of  $\pm$  .0002% or better. Absolute accuracy guaranteed to  $\pm$  .001% nominal or better. Resolution excellent for comparison of saturated standard cells. Temperature controlled. High sensitivity Galvanometer, 4 terminal NBS Type resistors, ratio boxes and other primary standards available

## FORM FACTOR INSTRUMENT



Model E

**Model E** — supplies a direct reading correction factor for instruments affected by non-sinusoidal wave form deviation. Indicates ratio of true RMS values to average, positive peak, and negative peak values. Determines the true RMS values of average and peak reading instruments that are used on a distorted wave. Accuracy: .2% between 25-500 cps

## GENERAL PURPOSE PORTABLES



Model N

**Model N** — economically priced, stable and rugged .5% accurate DC current and voltage instrument. Long 6.1" scale. Employs a shielded "U" shaped magnet and not the common center core type characteristic of instruments in its price range. Model NP is for panel mounting. Model NSI is an AC version. All have molded bakelite cases and are available switch controlled.



Primary and secondary standards for the accurate measurement or certification of AC-DC current, voltage, power, power factor, frequency and magnetic quantities. All electrical instruments have hand-drawn mirrored scales and most are Diamond Pivoted, of course! Not illustrated above, but available, are a complete line of portable and panel types including: • Wattmeters • Electrostatic Voltmeters • Peak Voltmeters • Thermocouple Instruments • Differentials • Ratiometers • Corrosion Instruments • Panel Instruments • Test Sets • Fluxmeters and accessories such as Shunts and Multipliers. All SRIC instruments have their certification directly traceable to the National Bureau of Standards and are unconditionally guaranteed.

## CALIBRATION CONSOLES

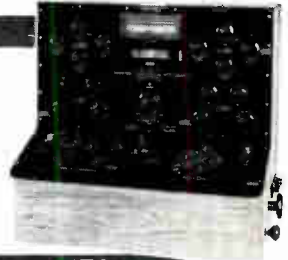

Model LTC

**Model LTC** — AC DC DC Accuracy .05% of actual reading. Ranges .5 V. to 1111 V.; 1 Ma (2 Ma on AC) to 11.11 amps. Resolution .01%. Frequency range DC to 25 KC. Direct % Error Readout. Model LT-PS — AC power supply to full capabilities of console. Harmonic distortion less than .1%. Other consoles available.

## EXPANDED SCALE INSTRUMENTS



Model INCRE

**Model INCRE** — Differential incrementer A NEW .05% f.s. accurate expanded scale DC standard for rack panel mounting or portable use. Combines the high comparison accuracy of the differential instrument with a .005% stable source. Scale has an effective length of 63" or 70", and a resolution of 1000 divisions. Each 10% of any range is expanded over the instrument's actual 6.3" or 7" scale length. Direct reading. No balancing or nulling. Single or multi-range combinations from 200  $\mu$  A. to 30 amps. and 200 mv. to 1 kv.

## DC VOLTAGE STANDARDS



Model STV

**Model STV** — Nominal output 1.0000 V. and 1.0185 V. Accuracy  $\pm$  .01%. Actual output certified within  $\pm$  .001% and guaranteed stable within  $\pm$  .005%. 115 V. 60 cps input. Unaffected by extremes of temperature, short circuiting, and vibration. Replaces the standard cell. OEM types available.

## AUTOMATIC OVERLOAD PROTECTION



Model 2AP

**Model 2 AP** — AC-DC Polyrange. Thermocouple type. Automatically protected for overloads of at least 5000%. Accuracy: .75%. Ranges from 2 ma. to 1 amp. and 2 V. to 500 V. Sensitivity: 500 ohms V. Diamond Pivoted. Other Polyranges with as many as 88 ranges available.

## AC-DC LABORATORY STANDARD AND POWER SUPPLY



Model THACH AND THACH-PS

**Model THACH** — AC DC Self Checking Volt-Amp Milliammeter. Accuracy  $\pm$  .2% f.s. to 4 kc. Ranges — 10 20 50 100 200 500 ma.; 1 2 5 Amps; 1 2 5 10 20 50 100 200 500 1000 V. f.s. Checks its own accuracy against an internal standard cell. Model THACH-PS — special regulated THACH Power Supply (optional) automatically shuts off power to the THACH when switching ranges, reducing possibility of accidental overloads. Output is DC or 60 cps. (50-2500 cps. can be plugged in). Combination serves as a calibrator, measuring instrument, and general purpose power supply.

NEW ROCHELLE, N. Y.

ELECTRICAL INSTRUMENTS  
OF PRECISION SINCE 1927



# SENSITIVE RESEARCH INSTRUMENT CORPORATION

# PROFESSIONAL CONSULTING SERVICES



**IRE People**



(Continued from page 219A)

## Advertising rates

### Professional Consulting Service Cards.

1 insertion \$ 25.00  
12 insertions \$180.00  
50% discount to IRE members on 3 or more consecutive insertions.

In IRE DIRECTORY \$25.00 flat rate.  
1 inch only, no cuts or display type.

New rate effective January 1961  
1 insertion \$30.00  
12 insertions \$240.00

50% discount to IRE members on 3 or more consecutive insertions.  
In IRE DIRECTORY \$30.00 flat rate

Advertising restricted to professional engineering and consulting services by individuals only. No product may be offered for sale, and firm names may not be mentioned in cards.

### Transistor Circuits ALBERT J. BARACKET MS IN EE & Staff

Development, and design of transistorized and standard regulated power supplies; broadcast and closed circuit TV camera and synchronizing circuitry both military and commercial.  
36 Commerce Road Cedar Grove, N.J.  
CEnter 9-6100

### W. J. BROWN & Staff

Fel.A.IEE., M.IEE., Sen.Mem.IRE.  
INTERNATIONAL CONSULTANTS  
35 Years Executive Electrical Engineering  
Experience in U.K. and U.S.A.  
71 Gurley Rd., Stamford, Conn., U.S.A.  
Cables—Browninter Stamford, Conn.

### MARKET DEVELOPMENT\*

A. D. Ehrenfried and associates

Technical product planning—product and market evaluation—market development programs—all by graduate engineers.  
\*Ref.: IRE/PGEM paper  
Concord, Massachusetts EMerson 9-5500

### M. D. ERCOLINO

Antenna Laboratories and Engineering Staff

Consultation and Development  
Antennas, Systems, Baluns, Rotators,  
Rotatable Antenna Masts  
Asbury Park, N.J. PProspect 5-7252

### HORST FÜNFSTÜCK

Electronics Consulting Engineer

Engineering Assistance • Test Equipment design • Technical translations (Span. & German) • Foreign Market Research (South America & Europe) •

7521 Paso Robles Ave., Van Nuys, Calif.  
DICKENS 2-4945

### CLYDE E. HALLMARK and associates

Specializing in Instrumentation—Automatic Control—Television—General Electronics—Semiconductor & Magnetics Application—Systems Research—Project Evaluation.

ENGINEERING SERVICE—CONTRACT R&D  
New Haven Indiana

### TECHNICAL PUBLICATIONS ENGINEERING

by Professionals  
(Member: I.R.E., S.T.W.E.)  
Reasonable per page and job rates for technical, grammatical and rhetorical editing; preparation of rough manuscripts and artwork for publication; ghostwriting.

EVAN JURO and associates  
Box 503 King of Prussia, Pa.

### LEONARD R. KAHN

Consultant in Communications and Electronics  
Single-Sideband and Frequency-Shift Systems  
Diversity Reception - Stereophonic Systems  
Television Systems

81 South Bergen Place, Freeport, L.I., N.Y.  
FReeport 9-8800

### LEN MAYBERRY

ELECTRONICS CONSULTING ENGINEER  
Laboratories and Staff

• Test Equipment Design • Proposal Writing  
• Product Design • Engineering Assistance  
111 South Oak Street ORegon 8-4847  
Inglewood, California

### EUGENE MITTELMANN, E.E., Ph.D.

Consulting Engineer, Physicist

ELECTRONICS FOR INDUSTRY  
Analysis, Research and Development

549 West Washington Boulevard  
CHICAGO 6, ILLINOIS  
CEntral 6-2983

### Telecommunications Consulting Engineers "Worldwide Experience"

V. J. Nexon S. K. Wolf M. Westheimer  
WIRE, CARRIER, RADIO, MICROWAVE,  
TROPO SCATTER

Feasibility Studies, Terrain Surveys, System Design, Job Supervision, Government Proposals, Market Research, Product Planning.  
1475 Broadway, New York 36, N.Y., BRyant 9-8517

### E. M. OSTLUND & associates

Electronic Engineers

Radio—Microwave—Carrier—  
Communication—Control—  
Systems and Equipment  
Consulting—Research—Development

ANDOVER, NEW JERSEY  
Tel: PArkway 9-6635 P.E.N.J.

### PAUL ROSENBERG & associates

Established 1945

Consultation, Research & Development  
in Applied Physics

100 Stevens Ave., Mt. Vernon, New York  
MOUNT VERNON 7-8040 Cable: PHYSICIST

### MYRON M. ROSENTHAL & staff

Microwave & Electronic Systems

19 Brookline Dr., North Massapequa, N.Y.  
PERShing 5-2501

### HAROLD A. WHEELER

Laboratories and Engineering Staff

Consultation — Research — Development  
Microwaves — UHF — VHF — VLF  
Antennas and Components

HUnter 2-7876 Great Neck, N. Y.  
Antenna Laboratory: Smithtown, N. Y.

in 1940 at World Headquarters as a technician. He was a customer engineer and later, field supervisor at various locations until 1944, when he went on military leave of absence. Rejoining IBM in 1946, he became an associate engineer in the WHQ Patent Development Department, serving there until 1953 when he transferred to Watson Laboratory. He came to Poughkeepsie attached to the Research Center in 1955 and assumed his present assignment on an advanced data system in 1958.



United Aircraft Corporation's Norden division has announced the promotion of Frank S. Preston (M'48-SM'55) to chief engineer, Edward R. Harris (M'52) to assistant chief engineer, and Leo Botwin (SM'54) to chief-engineering operations.

Mr. Preston has been associate technical director of the division's Norden Laboratories department in White Plains since 1956. He joined Norden in 1945 as an engineer and successively became project and systems manager and assistant director of engineering.

A native of Iowa City, Iowa, he received the B.S. degree in electrical engineering at the University of Washington in 1940 and later the M.S. degree at Massachusetts Institute of Technology.

He holds membership in the Association of Computing Machinery. He was an organizer of the Westchester branch of the IRE and served as its chairman in 1956. He also is a member of the Anti-Submarine Warfare Committee, National Security Industrial Agency.

Mr. Harris has been assistant technical director of Norden Laboratories. He joined the Laboratories project staff in 1953 and later became head of the television department where he directed the development of stabilized and unstabilized airborne television viewfinders.

He was born in Toms River, N. J., and received the B.S. degree in electrical engineering at Massachusetts Institute of Technology in 1940. He has made substantial contributions to hydraulic power flight control systems, including the development of the first longitudinal rate damping system.

Mr. Botwin has been assistant manager of engineering operations of the Laboratories since September, 1958. He joined the organization in 1956 and his assignments included that of project manager for the company's nose cone attitude control system program.

He received the B.S. degree (cum laude) in electrical engineering from City College of New York in 1943. He enlisted in the Army and was assigned to the National Advisory Committee for Aeronautics. Following the war he became a research fellow at Ohio State University and received the M.S. degree.

He is the author of a number of technical articles and is a member of the American Institute of Electrical Engineers.







# Advertising Index



IRE News and Radio Notes	14A
IRE People	46A
Industrial Engineering Notes	88A
Meetings with Exhibits	8A
Membership	157A
News—New Products	42A
Positions Oper	134A
Positions Wanted by Armed Forces Veterans	152A
Professional Group Meetings	178A
Section Meetings	112A
Table of Contents	1A-2A

## DISPLAY ADVERTISERS

A C Spark Plug Div. General Motors Corp.	177A
ACF Industries, Inc., ACF Electronics Div.	162A
Abbott's Employment Specialists	174A
Accredited Personnel Service	138A
Ace Electronics Associates, Inc.	112A
Ad-Yu Electronics Lab., Inc.	213A
Airborne Instruments Lab., Div. of Cutler-Hammer, Inc.	4A
Air-Marine Motors, Inc.	46A
Airpax Electronics, Inc.	66A
Alfred Electronics	12A
Alpha Corporation	154A
American Super-Temperature Wires, Inc.	68A
American Television & Radio Co.	100A
Amperex Electronic Corp.	126A
Amperite Company, Inc.	194A
Amphenol-Borg Electronics Corp., Amphenol Connector Div.	132A

Andrew Corporation	119A
Armed Forces Communications & Electronics Association	101A
Armour Research Foundation of Ill. Inst. of Technology	150A
Arnold Engineering Co.	61A
Avco Corporation, Crosley Div.	180A
Ballantine Labs., Inc.	79A
Baracket, Albert J.	212A
Barnstead Still & Sterilizer Co.	128A
Bassett, Inc., Rex	64A
Bead Chain Mfg. Co.	92A
Beckman Instruments, Inc.	160A
Beckman Instruments, Inc., Scientific-Process	58A
Bell Telephone Labs.	6A
Bendix Aviation Corp., Bendix Products Div.—Missiles	174A
Bendix Aviation Corp., Kansas City Div.	159A
Bendix Aviation Corp., Red Bank Div., Semiconductor Prods.	83A
Bendix Aviation Corp., York Div.	137A
Berry & Associates, Richard	152A
Binswanger Associates, Charles A.	150A
Bliley Electric Company	213A
Boeing Airplane Company, Wichita Div.	185A
Bomac Laboratories, Inc.	17A
Boonton Electronics Corp.	85A
Boonton Radio Corporation	183A, 197A
Borg Equipment Div., Amphenol-Borg Electronics Corp.	90A
Brookhaven National Lab.	144A
Brown, W. J.	212A
Burdny Corporation, Omaton Div.	80A
Bussmann Mfg. Div., McGraw Edison Co.	29A
Capitol Radio Engineering Institute	100A
Carad Corporation	86A
Carborundum Company	81A
Clare & Company, C. P.	37A
Clevite Transistor Products, Div. of the Clevite Corp.	51A-52A, 154A
Cohn Corporation, Sigmund	200A
Collins Radio Company	163A

# The New Standard Of STABILITY At 5 mc...



BLILEY TYPE: BG61AH-5

## ONE PART PER BILLION

(with temperature control)

Bliley BG61A-5 units have long been the unanimous choice for stability at 5 mc. Now, this outstanding crystal has been ruggedized for applications that demand high stability under shock and vibration. The

ruggedized unit, Bliley type BG61AH-5, will withstand vibration from 10 to 200 cps at 10G and acceleration of 50G with frequency change less than  $1 \times 10^8$ . Request Bulletin 519.

**BLILEY ELECTRIC COMPANY**  
UNION STATION BUILDING  
ERIE, PENNSYLVANIA

## PRECISION PHASE METERS

1 Cycle to 1000 Megacycles  
Accuracy 0.05° or 1%

Type 205A1-2:  
100 kc to 15 mc.  
Accuracy 0.05° or 1%.

Type 205B1-2:  
15 mc to 1000 mc.  
Accuracy 0.05° or 1%.

Type 202:  
20 cps to 150 kc.  
Accuracy 0.005°; 1° full scale sensitivity; direct reading in degrees.

### Type 405 Series



Specializing in

DELAY LINES  
PHASE METERS

Type 405 Series: Direct reading in degrees; 0.25° accuracy; no amplitude adjustment, no frequency adjustment.

Type 405:  
8 cps to 100 kc.

Type 405L:  
1 cps to 20 kc.

Type 405H:  
8 cps to 500 kc.

**AD-YU** ELECTRONICS LAB., Inc.  
FORMERLY ADVANCE  
249-259 TERMUNE AVENUE  
PASSAIC, NEW JERSEY

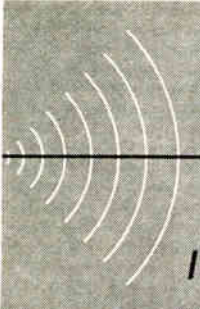

# IMPULSE

A DIGEST OF NEW DEVELOPMENTS  
IN ELECTRONICS AND AUTOMATION

PUBLISHED BY ROME CABLE DIV. OF ALCOA, ROME, N. Y.  
PIONEERS IN INSTRUMENTATION CABLE ENGINEERING

**SAGE MOVE?** If possible, the Government will give serious attention to the prospect of converting the SAGE System to air traffic control. Motive for such a move is the statement by the USSR that it will build no more bombers. If this be the case, a new use for SAGE will have to be found, or our huge investment will have to be scrapped.

**BIG BOUNCE.** The Navy recently demonstrated a new communications system using the moon as a relay for radio signals. With the moon serving as a passive reflector, photographs have been transmitted from Pearl Harbor to Washington, D. C. Signals are received about 2½ seconds after transmission. This new system can only be used between points which have the moon above the horizon at the same time.

**VOLT GETS A JOLT.** Amplifiers using voltage may be in for competition from a non-electric device referred to as a fluid amplifier. Essentially such a device is a block of hard material with passages for the flow of a fluid. Elements include a power jet input which corresponds to a tube cathode, output jets which correspond to plates, and control jets which correspond to control grids. Amplification of 10 to 100 has been accomplished with pure fluid amplifiers. Priced lower than tubes or transistors, these amplifiers have no moving parts and are virtually invulnerable to the effects of extreme heat or cold, humidity, and shock.

**BIG VOICE FROM LITTLE PACKAGE.** It looks like the United States' Pioneer V will be sending signals from 50 million miles away come August. The 26-inch payload is outstanding from an electronic standpoint in that it includes an ultra-long-distance communications system built around two miniature transmitters—one 5-watt, the other 150-watt capacity. The power supply consists of 4,400 solar cells and rechargeable nickel cadmium batteries. Parametric amplifiers are being used for the first time in the front part of two of the ground receivers.

**CABLEMAN'S CORNER.** The subject of cable testing is an important one. This is the phase of production that determines whether or not the cable you are purchasing is in accordance with your standards and requirements. In the field of electronics and automation, cables are required to suit various stringent electrical, mechanical, and/or chemical environments. Many years of study and testing have gone into the design of test equipment to be used for these critical tests. It is not enough to know that a cable has been tested in a manner that is "essentially" the same as the required standard. Slight variations in equipment design or methods of tests can mean the difference between conformance and non-conformance. Make sure the test data you receive gives a true picture of the performance of your cable. When you need cable, call on a cable specialist. Phone Rome 3000, or write: Rome Cable Division of Alcoa, Dept. 12-50, Rome, New York.

These news items represent a digest of information found in many of the publications and periodicals of the electronics industry or related industries. They appear in brief here for easy and concentrated reading. Further information on each can be found in the original source material. Sources will be forwarded on request.



## Advertising Index



Communication Accessories Co. ....	92A
Consolidated Avionics Corp. ....	120A
Continental Electronics Mfg. Co. ....	125A
Continental Oil Company ....	184A
Cornell-Dubilier Electric Corp. ....	Cover 3
Corning Glass Works ....	201A
Cosmic Condenser Company ....	108A
Cowin Associates ....	182A
Cubic Corporation ....	95A

Dale Products, Inc. ....	196A
Daven Company ....	41A
Delco Radio Div. of General Motors Corp. ....	39A, 99A
DeMornay-Bonardi ....	54A
Dialight Corporation ....	107A
Driver Company, Wilbur 8. ....	94A

E S C Corporation ....	55A
Eastern Industries, Inc. ....	72A
Ehrenfried, A. D. ....	212A
Eitel-McCullough, Inc. ....	47A
Electric Boat Div., General Dynamics Corp. ....	176A
Electrical Industries ....	109A
Electro Instruments, Inc. ....	199A
Electro Motive Mfg. Co., Inc. ....	31A
Electro-Optical Systems, Inc. ....	60A
Electronic Instrument Co., Inc. ....	60A
Electronic Tube Sales, Inc. ....	196A
Empire Devices Products Corp. ....	21A
English Electric Valve Co., Ltd. ....	97A
Ercolino, M. D. ....	212A

Fairchild Controls Corp. ....	208A
Fairchild Semiconductor Corp. ....	121A
Food Machinery & Chemical Corp. ....	145A
Freed Transformer Co., Inc. ....	196A
Funfstuck, Horst ....	212A

General Ceramics Corp., Div. of Indiana Gen- eral Corp. ....	193A
General Electric Co., Communication Products Dept. ....	161A
General Electric Co., Electronics Lab. ....	189A
General Electric Co., Heavy Military Electronic Dept. ....	93A, 135A-136A
General Electric Co., Missile & Space Vehicle Dept. ....	148A-149A
General Electric Co., Receiving Tube Div. ....	122A-123A
General Electric Co., Technical Personnel Dept. ....	172A

General Mills, Inc., Mechanical Div. ....	74A-75A, 186A
General Motors Research Laboratories ....	82A
General Products Corporation ....	58A
General Radio Company ....	Cover 4
Gudebrod Brothers Silk Co., Inc. ....	79A

HR8-Singer, Inc. ....	159A
Hallmark, Clyde E. ....	212A
Harrison Laboratories, Inc. ....	80A
Heath Company ....	128A
Hermes Electronics Co. ....	8A, 148A
Hewlett-Packard Co. ....	25A
Hoover Electronics Company ....	116A
Hoskins Mfg. Co. ....	105A
Huggins Laboratories ....	76A
Hughes Aircraft Company ....	140A-141A
Hughes Products, Semiconductor Div. ....	104A

Industrial Electronic Engineers, Inc. ....	202A
Institute of Radio Engineers .....	110A-111A, 188A, 205A
Instruments for Industry, Inc. ....	200A
Intam Limited ....	167A
Interelectronics Corp. ....	56A
International Business Machines Corp. ....	103A, 183A
International Electronic Research Corp. ....	50A
International Telephone & Telegraph Corp. ....	179A

Jet Propulsion Lab., Cal. Inst. of Technology ....	53A
Johns Hopkins University, Operations Resch. Office ....	145A





## Advertising Index



Jones Div., Howard B., Cinch Mfg. Co. .... 202A  
 Juro, Evan ..... 212A

Kahn, Leonard R. .... 212A  
 Kay Electric Company ..... 9A  
 Kearfott Div., General Precision, Inc. .... 98A  
 Keithley Instruments, Inc. .... 105A  
 Kennedy & Co., D. S. .... 113A  
 Kepco, Inc. .... 207A  
 Kinney Manufacturing Div., New York Air Brake Co. .... 200A  
 Kin Tel Div. of Cohu Electronics, Inc. .... 88A  
 Knapic Electro-Physics, Inc. .... 11EA  
 Knights Company, James ..... 198A  
 Kollsman Instrument Corp. .... 172A

Laboratory for Electronics ..... 19A  
 Lambda Electronics Corp. .... 203A  
 Lenkurt Electric Co., Inc. .... 164A  
 Lindberg Engineering Co. .... 209A  
 Ling Electronics, Inc. .... 206A-207A  
 Litton Industries, Inc., Electron Tube Div. .... 192A  
 Litton Industries, Inc., Electronic Equipments Div. .... 178A  
 Lockheed Aircraft Corp., Missiles & Space Div. .... 173A  
 Lockheed Electronics Co. .... 158A

Magnetics Inc. .... 89A  
 Marantz Company ..... 114A  
 Marconi Instruments, Ltd. .... 44A-45A  
 Marconi's Wireless Telegraph Co., Ltd. .... 215A  
 Martin Co., Denver Div. .... 143A  
 Martin Co., Orlando Div. .... 191A  
 Mass. Inst. of Techn., Instrumentation Lab. .... 183A  
 Mass. Inst. of Techn., Lincoln Lab. .... 144A  
 Mayberry, Len ..... 212A  
 McCoy Electronics Co. .... 54A  
 McLean Engineering Laboratories ..... 107A  
 Measurements, A McGraw Edison Div. .... 216A  
 Menlo Park Engineering ..... 68A  
 Microwave Associates, Inc. .... 124A  
 Millen Mfg. Co., Inc., James ..... 130A  
 Minneapolis-Honeywell Reg. Co., Aeronautical Div. 142A, 150A, 162A, 168A-169A, 190A  
 Minneapolis-Honeywell Reg. Co., Marion Instrument Div. .... 100A  
 Minnesota Mining & Mfg. Co., Mincom Div. .... 116A  
 Mitre Corporation ..... 166A  
 Mitronics, Inc. .... 56A  
 Mittelmann, Eugene ..... 212A  
 Motorola, Inc., Semiconductor Div. .... 117A

Natl. Aeronautics & Space Administration ..... 155A  
 National Cash Register Co. .... 171A, 184A  
 New Hermes Engraving Machine Corp. .... 76A  
 New York Air Brake Company ..... 203A  
 New York World-Telegram & Sun ..... 130A  
 Nexon, V. J., S. K. Wolf, M. Westheimer ..... 212A  
 Nippon Electric Company, Ltd. .... 195A  
 Non-Linear Systems, Inc. .... 204A

Ohmite Manufacturing Co. .... 91A  
 Ordnance Research Laboratory ..... 160A  
 Ostlund, E. M. .... 212A  
 Owen Laboratories, Inc. .... 72A

PRD Electronics, Inc. .... 27A  
 Page Communications Engineers, Inc. .... 126A  
 Pan American World Airways, Inc. .... 175A  
 Panoramic Radio Products, Inc. .... 127A  
 Permanent Employment Agency, Prof. and Techn. Rec. Assoc. .... 143A  
 Philco Corporation, Computer Div. .... 165A  
 Philco Corporation, Lansdale Div. .... 57A  
 Potter & Brumfield, Div. of American Machine & Foundry ..... 115A  
 Power Designs, Inc. .... 85A  
 Precision Apparatus Co., Inc. .... 96A  
 Precision Products Dept., Nortronics Div., Northrop Corp. .... 156A-157A

# Marconi in Telecommunications

The post and telegraph authorities of more than 80 countries use Marconi equipment

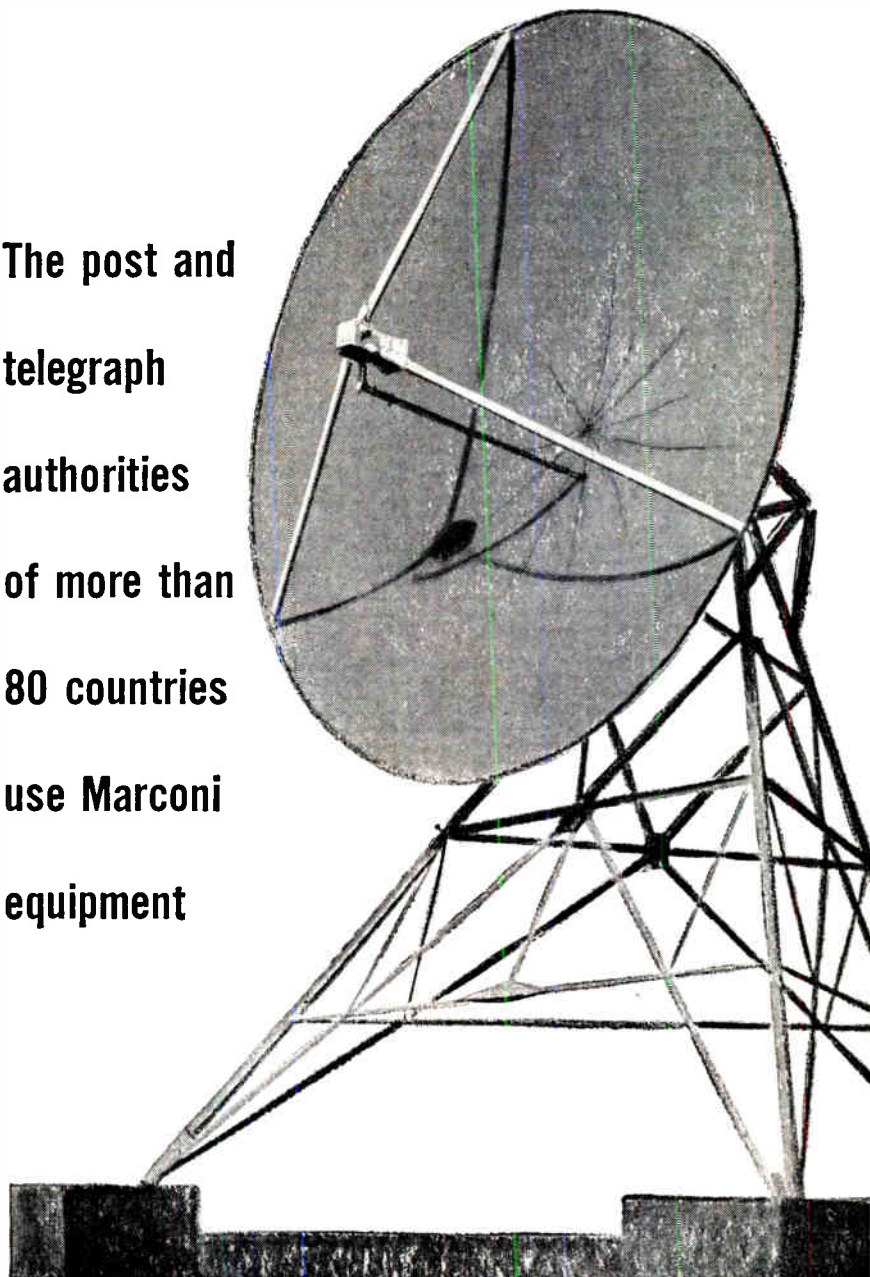

## MARCONI

COMPLETE COMMUNICATION SYSTEMS  
 SURVEYED · PLANNED · INSTALLED · MAINTAINED

MR. J. S. V. WALTON, MARCONI'S WIRELESS TELEGRAPH COMPANY LIMITED,  
 SUITE 1941, 750 THIRD AVENUE, NEW YORK 17, N.Y., U.S.A.

MARCONI'S WIRELESS TELEGRAPH COMPANY LIMITED, CHELMSFORD, ESSEX, ENGLAND  
 MI



# MEASUREMENTS' *NEW*



## VACUUM TUBE VOLTMETER

Provides RANDOM ACCESS to all functions and ranges through the use of push-button switches.

- For voltage and current measurements in laboratories, service shops and on production lines.
- For accurate rf and ac voltage measurements from 0.1 to 300 volts on electronic equipment from the low audio range through the VHF range.
- For dc voltage measurements from 0.01 to 1000 volts without disturbing circuit performance.
- For direct current measurements as low as 0.001 microampere.

\*Ohms range 0.2 ohms to 500 megohms in 7 decades with 10; 100; 1,000; 10,000; 100,000 ohms, 1 megohm and 10 megohms mid-scale rating.

Price: \$210.00 F.O.B. Boonton

**WRITE FOR BULLETIN**

MODEL 162-R\*

*Laboratory Standards*  **MEASUREMENTS**  
A McGraw-Edison Division  
BOONTON, NEW JERSEY

## NEW MEASUREMENTS Standard Signal Generator for mobile communications . . .

The Model 560-FM Standard Signal Generator is specifically designed to meet the exacting requirements of the Mobile Communications industry.



Model 560-FM  
Price - \$640.00

- Frequency ranges 25-54, 140-175, 400-470, 890-960 Mc.
- Fine tuning control shifts carrier  $\pm 8$  Kc.
- Peak deviation to  $\pm 16$  Kc. read directly on meter.
- Residual FM less than 100 cycles at 460 Mc.
- Output 0.1 to 100,000 microvolts accurate  $\pm 10\%$  across 50 ohm termination.
- Excellent stability.
- Modulation by 1000 cycle internal or by external source.

WRITE FOR BULLETIN

*Laboratory Standards*  **MEASUREMENTS**  
A McGraw-Edison Division  
BOONTON, NEW JERSEY



## Advertising Index

Radio Corp. of America, Defense Electronic Products	7A
Radio Corp. of America, Semiconductor & Materials Div.	102A
Radio Materials Company	59A
Ramo-Wooldrige Corporation	11A
Rauland Corporation	129A
Raytheon Co., Commercial Apparatus & Systems Div.	152A
Raytheon Co., Microwave & Power Tube Div.	43A
Raytheon Co., Missile Systems Div.	139A
Raytheon Co., Semiconductor Div.	69A-70A
Republic Aviation Corp.	161A
Rese Engineering, Inc.	128A
Resistance Products Company	107A
Rheem Semiconductor Corp.	65A, 67A
Rixon Electronics, Inc.	210A
Rohde & Schwarz Sales Company	78A
Rome Cable Corporation	214A
Rosenberg, Paul	212A
Rosenthal, Myron M.	212A
Ryan Aeronautical Co.	181A
Sage Electronics Corp.	64A
Sanborn Company	13A
Sanders Associates, Inc.	170A
Scientific-Atlanta, Inc.	84A
Sensitive Research Instrument Corp.	211A
Sola Electric Company	71A
Southern Research Institute	167A
Space Electronics Corporation	134A
Space Technology Labs.	153A
Sperry Products Co.	188A
Sprague Electric Company	3A, 5A
Stanford Research Institute	142A
Stoddart Aircraft Radio Co., Inc.	202A
Stromberg-Carlson Company	147A
Switchcraft, Inc.	198A
Sylvania Electric Products, Inc., Amherst Laboratory	167A
Sylvania Electric Products, Inc., Electronic Systems Div.	187A
Sylvania Electric Products, Inc., Electronic Tube Div.	33A-34A
Sylvania Electric Products, Inc., Special Tube Operations Div.	106A
Syntron Rectifier Div., Link-Belt Co.	100A
Syntronic Instruments, Inc.	96A
Tarzian, Inc., Sarks, Semiconductor Div.	114A
Technical Materiel Corp.	204A
Tektronix, Inc.	133A
Telrex Laboratories	80A
Terado Company	132A
Texas Instruments Incorporated, Apparatus Div.	178A, 180A, 182A, 184A
Texas Instruments Incorporated, Geosciences and Instrumentation Div.	131A
Texas Instruments Incorporated, Semiconductor Components Div.	23A, 48A-49A, 151A
Torrington Mfg. Co.	108A
Transitron Electronic Corporation	87A
Triad Transformer Corp.	10A
Tung-Sol Electric, Inc.	73A
U. S. Naval Repair Facility, Industrial Relations Dept.	142A
U. S. Naval Research Laboratory	180A
U. S. Stoneware Co., Alite Div.	77A
United Transformer Corporation	Cover 2
University of Waterloo	146A
Vitramon, Inc.	94A
Watkins-Johnson Company	164A
Western Devices, Inc.	204A
Westinghouse Electric Corp., Semiconductor Dept.	62A-63A
Westrex Corporation	208A
Wheeler, Harold A.	212A
Zenith Radio Corporation	146A



Consistently Dependable Capacitors

Cornell-Dubilier  
high-reliability  
capacitors...  
certified for  
complex  
electronic  
equipment

**MILITARY "CPM" SERIES**  
in accordance with Spec. MIL-C-14157A  
300, 400, 600 volts DC Working



Uninsulated Body Type CPM08



Insulated Body Type CPM09

CAPACITANCE RANGE: .001 mfd. to 1.0 mfd.  
TEMPERATURE RANGE: -55°C to +125°C without derating



**MILITARY & INDUSTRIAL "TWK" SERIES**  
in accordance with MIL-C-26244 (USAF)  
200, 300, 400, 600 volts DC Working

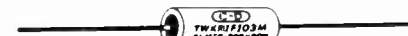

Uninsulated Body Type TWKN (equivalent to MIL-CPV08)



Insulated Body Type TWKP (equivalent to MIL-CPV09)

CAPACITANCE RANGE: .001 mfd. to 1.0 mfd.  
TEMPERATURE RANGE: -55°C to +125°C without derating

Cornell-Dubilier's *High-Reliability* Capacitors are designed to stand up to the most severe environmental and performance requirements for all military and industrial electronic equipment. And C-D puts it in writing! *Certification records* (covering the stringent qualification and acceptance test programs each capacitor undergoes) are furnished with *each inspection lot*. Fabricated in scrupulously clean, temperature-and-humidity-controlled surroundings, these miniature metal-cased tubulars with glass-to-metal end seals also

meet or surpass MIL-C-14157A and MIL-C-26244 (USAF) specifications.

So when you design electronic equipment in which *failure can't be tolerated*, specify Cornell-Dubilier *High-Reliability* Capacitors. For complete details and engineering assistance, write for Bulletins 188A-1 and 188A-2 to Cornell-Dubilier Electric Corporation, South Plainfield, New Jersey. *Manufacturers of consistently dependable capacitors, filters and networks for electronics, thermionics, broadcasting and utility use for 50 years.*



**CORNELL-DUBILIER ELECTRIC CORPORATION**

AFFILIATED WITH FEDERAL PACIFIC ELECTRIC COMPANY





## SEMI-AUTOMATIC BRIDGES for PRODUCTION TESTING

- ★ Fast . . . Self Balancing . . . Measurements are made as rapidly as components can be connected.
- ★ Rugged mechanically and electrically for continuous production-line use . . . Built to laboratory-equipment standards.
- ★ Easy to operate . . . Once set up, no further adjustments are necessary; measuring procedure reduces to simply connecting unknown to Bridge and reading meters.
- ★ Widely used as basic measuring elements in automatic sorting equipment.

### For D-C Resistance Measurements

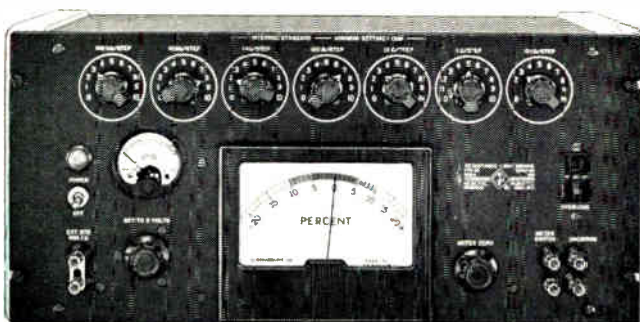

**Type 1652-A Resistance Limit Bridge . . . \$520**

Large, easily-read meter indicates directly component resistance as a percentage of value of internal standards. No computations, minimum possibility of mistake, saves valuable testing time.

**Range:** 1 to 1,111,111 ohms with internal resistance standard. 1 ohm to 2 megohms using external standards.

**Meter Range:** Meter reads from -20% to +20%. ±5% and ±10% scales clearly indicated with color coding.

**Accuracy:** As a limit bridge, 0.5% or better. For matching resistances, ±0.2%.

Three High-Sensitivity Models providing full-scale ranges of ±2%, ±5%, and ±10% can be supplied on special order.

### For R, L, C, and Impedance Measurements

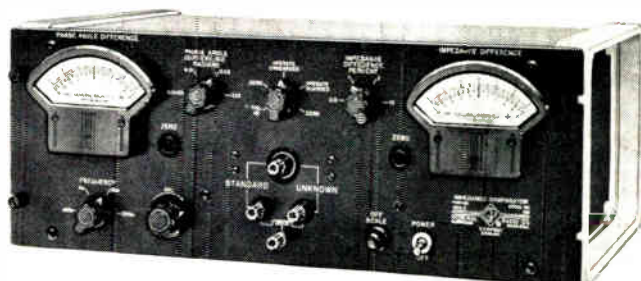

**Type 1605-A Impedance Comparator . . . \$800**

Indicates directly on two panel meters the differences in magnitude and phase angle between an unknown and an external standard. Measures impedance differences as small as 0.01% and phase angle differences of ±0.0001 radian.

**Ranges:** Impedance and resistance, 2 to 20 MΩ. Capacitance, 40 μf to 800 μf. Inductance, 20 μh to 10,000h.

**Meter Ranges:** Impedance Magnitude Difference; ±0.3%, ±1%, ±3%, ±10% full scale. Phase-Angle Difference (in radians): ±0.003, ±0.01, ±0.03, ±0.1 full scale.

**Accuracy:** 3% of full scale; i.e., for the ±0.3% range, accuracy is ±0.009% of the impedance magnitude being measured.

**Internal Oscillator Frequencies:** 100c, 1 kc, 10 kc, 100 kc.

Write For Complete Information

# GENERAL RADIO COMPANY

WEST CONCORD, MASSACHUSETTS

NEW YORK, WOrth 4-2722  
NEW JERSEY, Ridgefield, WHitney 3-3140

CHICAGO  
Oak Park  
Village 8-9400

PHILADELPHIA  
Abington  
HAncock 4-7419

WASHINGTON, D.C.  
Silver Spring  
JUniper 5-1088

SAN FRANCISCO  
Los Altos  
Wriitecliff 8-8233

LOS ANGELES  
Los Angeles  
HOLlywood 9-6201

IN CANADA  
Toronto  
CHerry 6-2171