

SEPTEMBER • 1955

# Proceedings



# OF THE IRE

## TESTING DEFLECTION YOKES

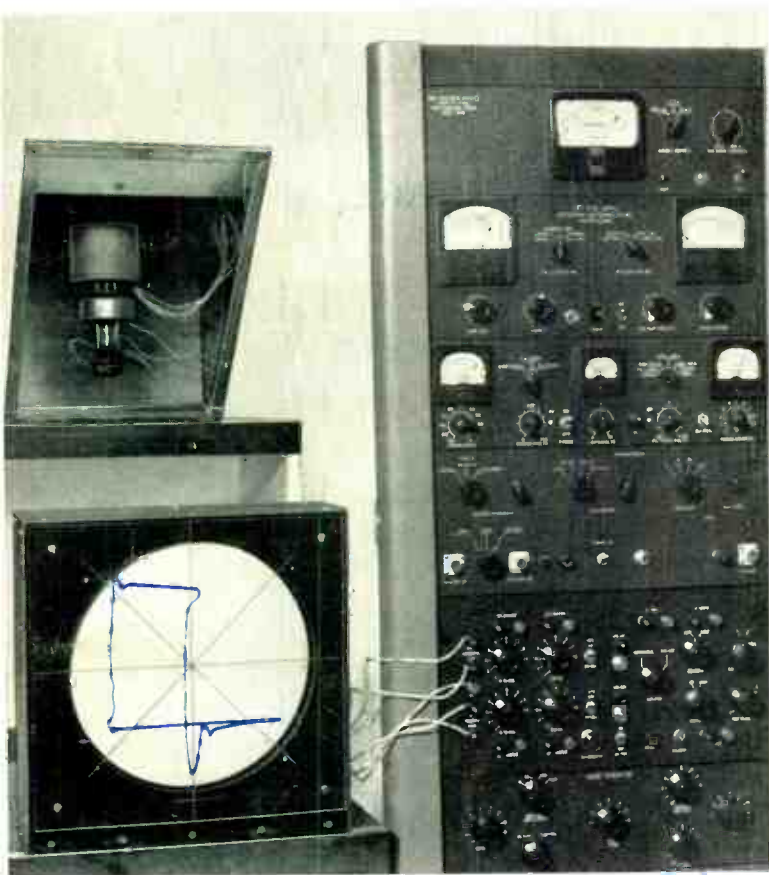

*Syntonic Instruments, Inc.*

The stringent requirements of modern high-speed display systems demand careful checking of deflection yoke characteristics. The yoke shown in the mirror above tube is being measured for transient response and resonant frequency.

Volume 43

Number 9

### IN THIS ISSUE

Frequency and Time Standards  
IRE Standards on Industrial Electronics  
IRE Standards on Waveguides  
Power Gain of Transistors  
IRE Standards on Radio Receivers  
A Microwave Phase Contour Plotter  
Dielectric Tuning of Panoramic Receivers  
Wide-Band Low-Noise Amplifiers  
Tuning of Microwave Cavities  
Resolution of Signals in Noise  
AGC of Transistor Amplifiers  
Optimum-Response Networks  
*Transactions Abstracts*  
Abstracts and References

TABLE OF CONTENTS, INDICATED BY BLACK-AND-WHITE MARGIN, FOLLOWS PAGE 96A

IRE Standards on Industrial Electronics terms, Waveguide Definitions, and Receiver Testing appear in this issue

# The Institute of Radio Engineers

World Radio History

OUR MILLIONTH FILTER SHIPPED THIS YEAR...

# FILTERS

## FOR EVERY APPLICATION



### TELEMETERING FILTERS

UTC manufactures a wide variety of band pass filters for multi-channel telemetering. Illustrated are a group of filters supplied for 400 cycle to 40 KC service. Miniaturized units have been made for many applications. For example a group of 4 cubic inch units which provide 50 channels between 4 KC and 100 KC.

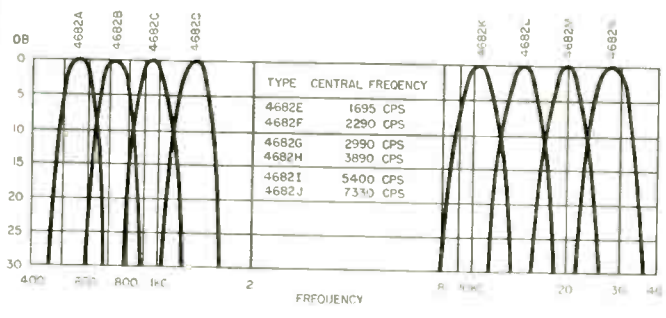

Dimensions:  
(4682A) 1 1/2 x 2 x 4"

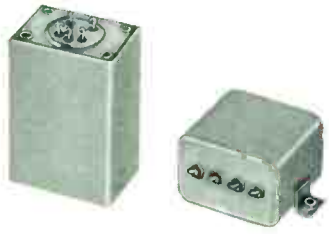

Dimensions:  
(3834) 1 1/4 x 1 3/4 x 2-3/16"  
(2000, 1) 1 1/4 x 1 3/4 x 1 5/8"

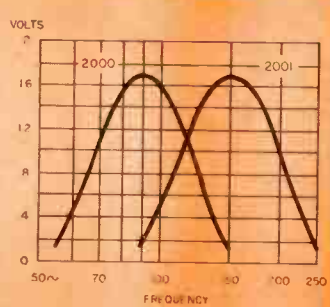
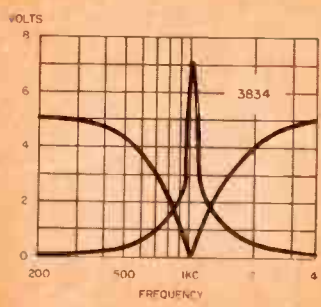

### AIRCRAFT FILTERS

UTC has produced the bulk of filters used in aircraft equipment for over a decade. The curve at the left is that of a miniaturized (1020 cycles) range filter providing high attenuation between voice and range frequencies. Curves at the right are that of our miniaturized 90 and 150 cycle filters for glide path systems.

### CARRIER FILTERS

A wide variety of carrier filters are available for specific applications. This type of tone channel filter can be supplied in a varied range of band widths and attenuations. The curves shown are typical units.

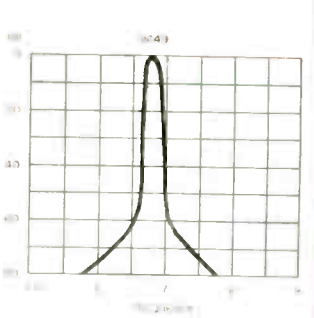
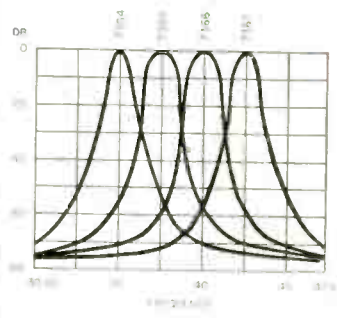

Dimensions:  
(7364 series) 1 3/8 x 1 5/8 x 2 1/4"  
(9649) 1 1/2 x 2 x 4"

### DISCRIMINATORS

These high Q discriminators provide exceptional amplification and linearity. Typical characteristics available are illustrated by the low and higher frequency curves shown.

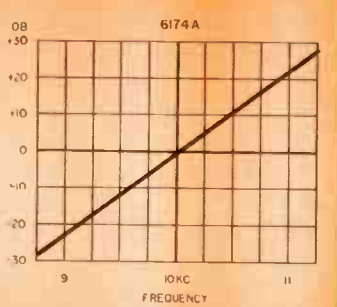
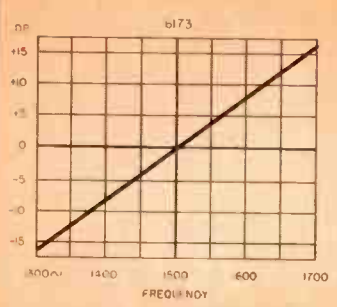

Dimensions:  
(6173) 1-1/16 x 1 3/8 x 3"  
(6174A) 1 x 1 1/4 x 2 1/4"

For full data on stock UTC transformers, reactors, filters, and high Q coils, write for Catalog A.

# UNITED TRANSFORMER CO.

150 Varick Street, New York 13, N. Y. EXPORT DIVISION: 13 E. 40th St., New York 16, N. Y. CABLES: "ARLAB"

# THIS IS IT

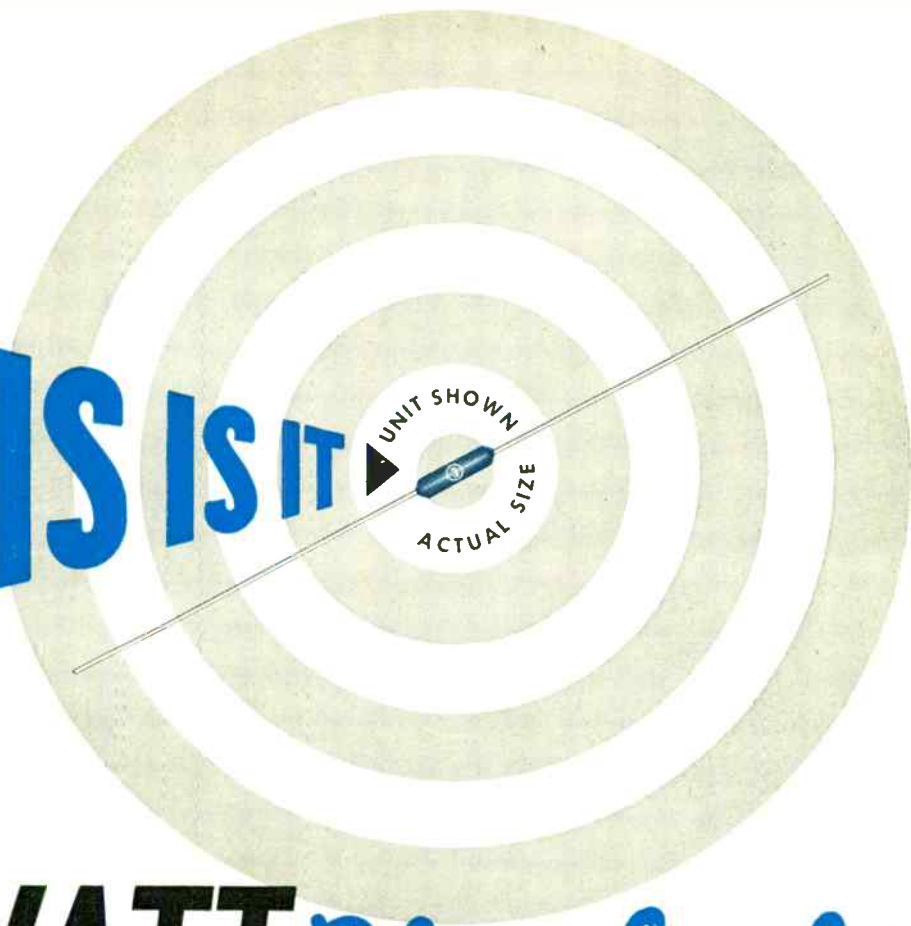

## NEW 3-WATT Blue Jacket<sup>®</sup> miniaturized axial-lead wire wound resistor

This power-type wire wound axial-lead Blue Jacket is hardly larger than a match head *but it performs like a giant!* It's a rugged vitreous-enamel coated job—and like the entire Blue Jacket family, it is built to withstand severest humidity performance requirements.

Blue Jackets are ideal for dip-soldered sub-assemblies . . . for point-to-point wiring . . . for terminal board mounting and processed wiring boards. They're low in

cost, eliminate extra hardware, save time and labor in mounting!

Axial-lead Blue Jackets in 3, 5 and 10 watt ratings are available without delay in any quantity you require. ★ ★ ★

| SPRAGUE TYPE NO. | WATTAGE RATING | DIMENSIONS L (inches) D |                 | MAXIMUM RESISTANCE |
|------------------|----------------|-------------------------|-----------------|--------------------|
| 151E             | 3              | 1 $\frac{1}{2}$         | 1 $\frac{3}{4}$ | 10,000 $\Omega$    |
| 27E              | 5              | 1 $\frac{1}{2}$         | 3 $\frac{1}{4}$ | 30,000 $\Omega$    |
| 28E              | 10             | 1 $\frac{1}{2}$         | 3 $\frac{1}{4}$ | 50,000 $\Omega$    |

Standard Resistance Tolerance:  $\pm 5\%$

# SPRAGUE



SPRAGUE ELECTRIC COMPANY • 235 MARSHALL ST. • NORTH ADAMS, MASS.

PROCEEDINGS OF THE IRE September, 1955, Vol. 43, No. 9. Published monthly by the Institute of Radio Engineers, Inc., at 1 East 79 Street, New York 21, N.Y. Price per copy: members of the Institute of Radio Engineers, one additional copy, \$1.00; non-members \$2.25. Yearly subscription price: to members, one additional subscription, \$9.00; to non-members in United States, Canada and U.S. Possessions \$18.00; to non-members in foreign countries \$19.00. Entered as second class matter, October 26, 1927, at the post office at Menasha, Wisconsin, under the act of March 3, 1879. Acceptance for mailing at a special rate of postage is provided for in the act of February 28, 1925, embodied in Paragraph 4, Section 412, P. L. and R., authorized October 26, 1927.

Table of Contents will be found following page 96A



*After initial adjustments are made, as in photograph, "Mr. Meticulous" automatically performs critical operations in making junction tetrode transistors—tiny experimental devices which may find important uses in the telephone system.*

## The machine we call "Mr. Meticulous"

Bell Laboratories scientists, who invented the junction transistor, have now created an automatic device which performs the intricate operations required for the laboratory production of experimental model transistors.

It takes a bar of germanium little thicker than a hair and tests its electrical characteristics. Then, in steps of  $1/20,000$  of an inch, it automatically moves a fine wire along the bar in search of an invisible layer of positive germanium to which the wire must be connected. This layer may be as thin as  $1/10,000$  of an inch!

When the machine finds the layer, it orders a surge of current which bonds the wire to the bar. Then it welds the wire's other end to a binding post. Afterward, it flips the bar over and does the same job with another wire on the opposite side!

Once only the most skilled technicians could do this

work, and even their practiced hands became fatigued. This development demonstrates again how Bell Telephone Laboratories scientists work in every area of telephony to make service better.

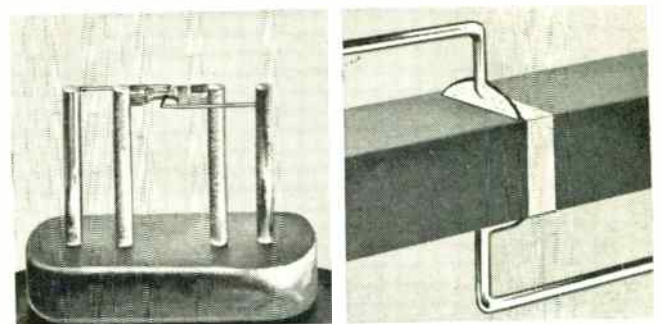

*Transistor made by new machine is shown in sketch at left above, magnified 6 times. At right is sketch of area where wires are bonded. The wires are  $2/1000$  inch in diameter, with ends crimped to reduce thickness.*

**BELL TELEPHONE  
LABORATORIES**



IMPROVING TELEPHONE SERVICE FOR AMERICA PROVIDES CAREERS FOR CREATIVE MEN IN MECHANICAL ENGINEERING

# Another Advancement by General Ceramics

## Presenting— **SUPER FERRAMICS**



### New Super-Grade Ferrites from the Laboratories of General Ceramics—

New Super-Ferramics are magnetic ferrites with properties once considered beyond the realm of achievement. The first of this series Ferramic O, (see property chart) has been released and is now available in production quantities. Engineers and product designers are invited to request complete information on Ferramic O. Call or write for data today!

#### Superior in Quality—Lower in Cost

- Higher Initial Permeability
- Higher Effective Permeability at Higher Saturation Levels
- Lower Core Loss Resulting in Less Temperature Rise
- Greater Uniformity Through Improved Production Techniques

#### MAGNETIC PROPERTIES OF FERRAMIC O-1

| PROPERTIES                             | UNIT                | FERRAMIC O-1 |
|--|---------------------|--------------|
| $\mu_0$ at 50 kcs.                     | —                   | 1200         |
| $\mu_{max}$                            | —                   | 6000         |
| Saturation Flux Density $B_s$          | Gauss               | 4100         |
| Residual Magnetism $B_r$               | Gauss               | 2500         |
| Coercive Force $H_c$                   | Oersteds            | 0.20         |
| Curie Temperature                      | + °C.               | 165          |
| Volume Resistivity                     | —                   | Low          |
| Loss Factor at 50 kcs.                 | $\frac{1}{\mu_0 Q}$ | 0.000010     |
| Temp. Coeff. of Initial Perm. (50 Kcs) | %/°C.               | +0.75        |



**General CERAMICS CORPORATION**  
TELEPHONE: VALLEY 6-5100

GENERAL OFFICES and PLANT: KEASBEY, NEW JERSEY

MAKERS OF STEATITE, ALUMINA, ZIRCON, PORCELAIN, SOLDERSEAL TERMINALS, "ADVAC" HIGH TEMPERATURE SEALS, CHEMICAL STONEWARE, IMPERVIOUS GRAPHITE, FERRAMIC MAGNETIC CORES

PERKIN... HAS A STANDARD POWER SUPPLY FOR YOUR EVERY NEED  
**IMMEDIATE DELIVERY!!**



**PERKIN**  
**TUBELESS!!**  
**MAGNETIC AMPLIFIER**  
**REGULATED DC**  
**POWER**  
**SUPPLIES**

MODEL  
**MR 532-15**  
**5 TO 32 V.**  
**@ 15 AMP.**  
**(CONT.)**



**REGULATION:**  $\pm 1\%$  (a) from 5-32V DC (b) from 1.5 to 15 amps. (c) from 105-125V AC. (single phase, 60 cps.)  
**RIPPLE:** 1% rms @ 32V and full load, increases to max. of 2% rms @ 5V and full load. **RESPONSE:** 0.2 sec.  
**METERS:** 4 1/2" AM and VM; 2% accuracy.  
**MOUNTING:** Cabinet or 19" rock panel.  
**FINISH:** Baked Grey Wrinkle.  
**WEIGHT:** 150 lbs.  
**DIMENSION:** 22" x 17" x 14 1/2"

MODEL  
**MG0 VMc**  
**0 TO 32 V.**  
**@ 25 AMP.**  
**(CONT.)**



**REGULATION:**  $\pm 1\%$  (a) at 28V DC; increases to 2% max. over the range 24-32V; does not exceed 2V regulation over the range 4-24V DC (b) from 1/10 full load to full load (c) at a fixed AC input of 115V.  
**RIPPLE:** 1% rms @ 32V and full load; 2% rms max. @ any voltage above 4V.  
**AC INPUT:** 115V, single phase, 60 cps.  
**FINISH:** Baked Grey Wrinkle.  
**WEIGHT:** 130 lbs.  
**DIMENSIONS:** 22" x 15" x 14 1/2"

MODEL  
**MR 1040-30**  
**10 TO 40 V.**  
**@ 30 AMP.**  
**(CONT.)**



**REGULATION:**  $\pm 1\%$  (a) from 10 to 40V DC (b) from 100 to 130V AC (c) from 3 to 30 Amps DC. **RIPPLE:** 1% rms.  
**AC INPUT:** 100-130V, 1 phase, 60 cycles.  
**RESPONSE:** 0.2 sec. **METERS:** 4 1/2" AM and VM.  
**MOUNTING:** Cabinet with 19" rack panel.  
**FINISH:** Baked Grey Enamel.  
**WEIGHT:** 200 lbs.  
**DIMENSIONS:** 22" x 15" x 23"

MODEL  
**MR2432-100X**  
**24 TO 32 V.**  
**@ 100 AMP.**  
**(CONT.)**



**REGULATION:**  $\pm 1/2\%$  (a) from no load to full load. (b) from 24-32V DC. (c) for 230\* (or 460) V  $\pm 10\%$ .  
**DC OUTPUT:** 24-32V @ 100 amps.  
**AC INPUT:** 230 or 460V  $\pm 10\%$ , 3 phase, 60 cycles.  
**RIPPLE:** 1% rms. **RESPONSE TIME:** 0.2 sec.  
**MOUNTING:** Cabinet or 19" rock panel.  
**WEIGHT:** 250 lbs.  
**DIMENSIONS:** 25" x 15" x 15"  
\*This unit will be supplied for 230V AC input unless 460V is specified.

ALSO AVAILABLE: Standard 5 and 115 volt models; Ground and Airborne Radar and Missile Power Supplies—Write for Perkin Bulletin.

**PERKIN**  
**ENGINEERING CORP.**

345 KANSAS ST. • EL SEGUNDO, CALIF. • Oregon 8-7215 or EAsgate 2-1375



**Meetings with Exhibits**

● As a service both to Members and the industry, we will endeavor to record in this column each month those meetings of IRE, its sections and professional meetings which include exhibits.

△

Sept. 12-16, 1955

**Tenth Annual Instrument Conference & Exhibit**, Shrine Exposition Hall & Auditorium, Los Angeles, Calif.  
**Exhibits:** Mr. Fred J. Tabery, 3442 So. Hill St., Los Angeles 7, Calif.

Sept. 26-27, 1955

**IRE Sixth Annual Meeting of the Professional Group on Vehicular Communications**, Hotel Multnomah, Portland, Ore.  
**Exhibits:** Mr. Henry S. Broughall, General Electric Co., 2727 N.W. 29th Ave., Portland, Ore.

October 3-5, 1955

**National Electronics Conference**, Sherman Hotel, Chicago, Ill.  
**Exhibits:** Mr. G. J. Argall, c/o DeVry Technical Institute, 4141 Belmont Ave., Chicago 41, Ill.

Oct. 31-Nov. 1, 1955

**IRE East Coast Conference on Aeronautical & Navigational Electronics**, Lord Baltimore Hotel, Baltimore, Md.  
**Exhibits:** Mr. C. E. McClellan, Westinghouse Electric Corp., Air Arm Div., Friendship International Airport, Baltimore, Md.

Nov. 3-4, 1955

**Annual Electronics Conference, Kansas City Section**, Town House Hotel, Kansas City, Kans.  
**Exhibits:** Mr. Charles V. Miller, Bendix Aviation Corp., P.O. Box 1159, Kansas City 41, Mo.

Nov. 7-9, 1955

**Eastern Joint Computer Conference (IRE-AIEE-ACM)**, Hotel Statler, Boston, Mass.  
**Exhibits:** Mr. J. D. Porter, Digital Computer Lab., Barta Building, M.I.T., Cambridge, Mass.

Nov. 28-30, 1955

**Instrumentation Conference & Exhibit**, Atlanta Biltmore Hotel, Atlanta, Ga.  
**Exhibits:** Mr. W. B. Wrigley, Engineering Experiment Station, Georgia Institute of Technology, Atlanta, Ga.

December 12-16, 1955

**EJC Nuclear Science and Engineering Congress**, Cleveland, Ohio  
**Exhibits:** Engineers Joint Council, 33 W. 39th St., New York, N.Y.

Feb. 9-11, 1956

**Eighth Annual Southwestern IRE, Conference and Electronics Show**, Municipal Auditorium, Oklahoma City, Okla.  
**Exhibits:** Mrs. Charles E. Harp, P.O. Box 764, Oklahoma City, Okla.

March 19-22, 1956

**IRE National Convention and Radio Engineering Show**, Waldorf-Astoria Hotel and Kingsbridge Armory and Palace, New York, N.Y.  
**Exhibits:** Mr. William C. Copp, Institute of Radio Engineers, 1475 Broadway, New York 36, N.Y.

# KAY

## NOISE FIGURE MEASUREMENT 10 - 3000 MC



### SPECIFICATIONS

- Frequency Range:**  
10 mc to 3,000 mc
- Output Impedance:**  
50 ohms unbalanced into Type N Connector
- Noise Figure Range:**  
0 to 20 db
- Filament Voltage Supply:**  
From regulated supply
- Meter Calibration:**  
Linear in db noise figure; logarithmic in D.C.M.A.
- Fuse Protection:**  
One Type 3AG, 2 amps
- Tubes:**  
1 Eclipse Pioneer TTI Diode
- Power Supply Source:**  
117 Watts  $\pm 10\%$ , 60 cps AC  
Available for 50 cps.
- Power Consumption:**  
130 Watts
- Price:**  
\$995. FOB plant

# KAY

## Mega-Node-Sr.

A calibrated random noise source providing an output from 10—3,000 mc, the Mega-Node Sr. may be used to measure noise figure and receiver gain and for the indirect calibration of standard signal sources.

At the lower end of the frequency range noise figure may be obtained directly from the meter. For greater accuracy at higher frequencies, corrections for diode transit time and termination mismatch are available from charts supplied with each instrument.

### KAY Rada-Node

Complete radar noise figure measuring set for IF and RF, including attenuators, detector and noise sources. Complete with power supplies. Frequency range: 5 to 26,500 mc; noise figure: range, up to 21 db, in lower part of spectrum. Prices on request.

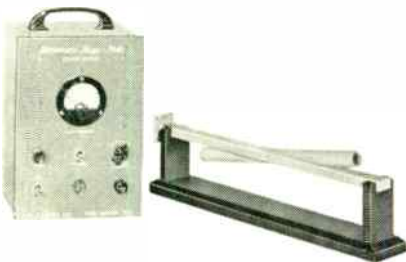

### KAY Microwave Mega-Nodes

Calibrated random noise sources in the microwave range, used to measure noise figure, and receiver gain and calibrate standard signal sources in radar and other microwave systems.

Available in following waveguide sizes to cover range of 960—26,500 mc.

- |                    |   |
|--------------------|---|
| RG-69/U ... \$400. | Available with fluorescent or inert gas (argon or neon) tubes. Noise output fluorescent tubes, 15.8 db $\pm$ .25 db; argon gas tubes, 15.2 db $\pm$ .1 db*; neon tubes, 18.0 db $\pm$ .5 db*. |
| †RG-48/U ... 195.  |   |
| †RG-49/U ... 195.  |   |
| †RG-50/U ... 195.  |   |
| †RG-51/U ... 195.  | *Noise output of inert gas tubes independent of operating temperature.  |
| †RG-52/U ... 195.  | Universal Power supply for both fluorescent or argon gas and all waveguide sizes: \$100.  |
| RG-91/U ... 250.   |   |
| RG-53/U ... 250.   |   |
- †\$167. per Guide when 3 or more are purchased with \$100. Power Supply  
WR-770; WR-650—\$595.00 each; WR-510; WR-430; WR-340—  
**NEW!** \$495.00 each. All WR numbers fluorescent only.



### KAY Mega-Node

Calibrated random noise source reading direct in db, for measurement of noise figure, receiver gain and for indirect calibration of standard signal sources. Frequency range, 5 to 220 mc; Output impedances, unbalanced—50, 75, 150, 300, Infinity; balanced—80, 150, 300, 600, Infinity; noise figure range, 0—16 db at 50 ohms 0—23.8 db at 300 ohms. Price: \$295. FOB plant.



### KAY Auto-Node

Designed for production-line noise figure measurement from 5 to 26,500 mc., the Auto-Node provides continuous interpolation over VHF, UHF and microwave frequencies. Two models are available:

| MODEL TV   | MODEL RADAR  |
|--|--|
| Freq. Range:<br>5—220 mc.                                    | Freq. Range:<br>2 IF Strips<br>30 and 60 mc; other<br>IFs available. |
| IF Strips:<br>20 or 40 mc. extra<br>IF Strips available.     | IF Noise Figure:<br>0—7 db   |
| Noise Figure Range:<br>0—24 db                               | Price:<br>\$950 with 2 IF strips.<br>FOB plant.                      |
| Price: \$795 FOB plant.<br>Additional IF strips,<br>\$125.00 |  |

For Complete Information Regarding these, and other Kay Instruments, Write:

## KAY ELECTRIC COMPANY

Dept. I-9, 14 Mople Avenue

Pine Brook, N.J.





# PORTABLE DIRECT READING SPECTRUM ANALYZER

10 TO 44,000 mcs

5 RF HEADS

UNI-DIAL TUNING



MODEL TSA

Now, a new Polarad spectrum analyzer only 21 inches high that covers the entire frequency range 10 to 44,000 mcs with 5 interchangeable RF tuning heads. The model TSA operates simply—single dial frequency control—with utmost frequency stability. It provides highest accuracy, and reliability for observation and true evaluation of performance over the entire RF spectrum—saving engineering manhours.

This instrument is designed for maximum utility and versatility in the laboratory and on the production line providing an easy-to-read 5 inch CRT display of the RF spectrum.

| Model No.         | Equipment                        |
|-------------------|----------------------------------|
| Model DSA.....    | Spectrum Display and Power Unit  |
| Model STU-1.....  | RF Tuning Unit 10-1,000 mc.      |
| Model STU-2A..... | RF Tuning Unit 910-4, 560 mc.    |
| Model STU-3A..... | RF Tuning Unit 4,370-12,000 mc.  |
| Model STU-4.....  | RF Tuning Unit 21,000-33,000 mc. |
| Model STU-5.....  | RF Tuning Unit 33,000-44,000 mc. |

#### SPECIFICATIONS:

Frequency Range: 10 mc to 44,000 mc.

Frequency Accuracy:  $\pm 1\%$

Resolution: 25 kc.

Frequency Dispersion: Electronically controlled, continuously adjustable from 400 kc to 25 mc per one screen diameter (horizontal expansion to 20 kc per inch)

Input Impedance: 50 ohms—nominal

#### \*Sensitivity:

STU-1 10-400 mcs —89 dbm

400-1000 mcs —84 dbm

STU-2A 910-2,200 mcs —87 dbm

1,980-4,560 mcs —77 dbm

STU-3A 4,370-10,920 mcs —75 dbm

8,900-22,000 mcs —60 dbm

STU-4 21,000-33,000 mcs —55 dbm

STU-5 33,000-44,000 mcs —45 dbm

Overall Gain: 120 db

#### Attenuation:

\*\*RF Internal 100 db continuously variable, IF 60 db

continuously variable

Input Power: 400 Watts

\*Minimum Discernible Signal

\*\*STU-1 STU-2A, STU-3A

The model TSA Spectrum Analyzer has these exclusive Polarad design and operating features

- Single frequency control with direct reading dial. No klystron modes to set. Tuning dial accuracy  $\pm 1\%$ .
- Five interchangeable RF tuning units for the entire frequency range 10 to 44,000 mcs.
- Temperature compensation of Klystron Oscillator.
- Swept IF provides 400 kc to 25 mc display independent of RF frequency setting.
- Internal RF attenuator.\*\*
- Frequency marker for measuring frequency differences from 40 kc to 25 mc.

AVAILABLE ON EQUIPMENT LEASE PLAN

FIELD MAINTENANCE SERVICE AVAILABLE THROUGHOUT THE COUNTRY

NEW! Write for Handbook of Spectrum Analyzer Techniques



ELECTRONICS CORPORATION 43-20 34th STREET, LONG ISLAND CITY 1, N. Y.

REPRESENTATIVES: □ Albuquerque • Atlanta • Baltimore • Bayonne • Bridgeport • Buffalo • Chicago • Dayton • Fort Worth • Los Angeles • New York • Newton • Philadelphia • San Francisco • Syracuse • Washington, D. C. • Westbury • Winston-Salem • Canada, Arnprior, Toronto—Export: Rocke International Corporation

MALLORY

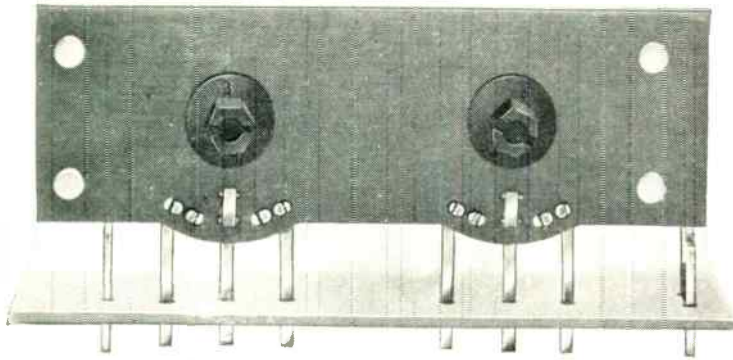

*Strip-type Mallory carbon control adapted for quick mounting and connection on printed circuits. Strips can be mounted in tandem to take minimum space on crowded chassis.*

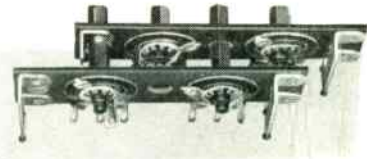

## Strip-Type Mallory Multiple Controls\*

*Save Space . . . Speed Assembly on Printed Circuits*

### Low cost way to get close tolerance fixed resistors

The economical cost of the Mallory strip-type controls makes them useful in place of close tolerance fixed resistors. Just adjust them to the exact resistance required in the circuit, and you will have a fixed carbon resistor. The stability of the specially developed carbon element assures you of highly constant resistance value.

NEW ECONOMIES in the production of printed electronic circuits are made possible by these Mallory strip-type controls. Available in single, dual and triple sections, they have straight tinned terminals which project through punched slots in the printed sheet for dip soldering.

Mounting is simple and fast. Shouldered tabs fixed to the ends of the strip hold the control assembly in place. To save space, multiple sections can be mounted about  $\frac{1}{2}$ " behind each other. Holes punched in the strip permit the shafts of the rear section to project through the front unit for adjustment.

For conventional chassis as well as printed circuits, this functionalized design reduces a carbon control to its simplest form. The resistance wafers are mounted directly on a phenolic panel. Due to this unique construction, Mallory is able to offer multiple units at a cost substantially lower than that of a similar number of single controls.

High stability of resistance, low noise and long service life are provided by the high-density Mallory control element. A complete range of resistance values from 250 ohms to 10 megohms is available. For full data, write or call Mallory today.

\*Patent pending

Serving Industry with These Products:

Electromechanical—Resistors • Switches • Television Tuners • Vibrators  
Electrochemical—Capacitors • Rectifiers • Mercury Batteries  
Metallurgical—Contacts • Special Metals and Ceramics • Welding Materials

*Expect more . . . Get more from*

P. R. MALLORY & CO. Inc.  
**MALLORY**

P. R. MALLORY & CO., Inc., INDIANAPOLIS 6, INDIANA

**Completely new!**

# 1 cps to 1 MC Square Wave Generator with 0.02 $\mu$ sec rise time

## Other Unusual Features

- 7 volt 75 ohm TV circuit
- 55 volt 600 ohm high level circuit
- Full amplitude variation
- External synchronization



## SPECIFICATIONS

- Frequency Range:** 1 cps to 1 MC, continuous coverage.
- Low Impedance Output:** 7.0 v peak-to-peak across 75 ohm internal impedance. Rise time less than 0.02  $\mu$ sec. BNC Connector.
- High Impedance Output:** 55 v peak-to-peak across 600 ohm internal impedance. Rise time less than 0.1  $\mu$ sec. Dual banana jacks —  $\frac{3}{4}$ " centers.
- Amplitude Control:** Low Impedance Output — Potentiometer and 60 db attenuator, variable in 20 db steps. High Impedance Output — Potentiometer.
- Frequency Control:** Dial calibrated "1 to 10" and decade multiplier switch. Six bands.
- Symmetry Control:** Allows exact square-wave balance.
- Sync Input:** Positive-going pulse or sine wave signal, minimum amplitude 5 volts peak. BNC connector.
- Power:** 115/230 v  $\pm 10\%$ , 50/60 cps, 195 watts.
- Size:**  $9\frac{3}{4}$ " wide,  $13\frac{7}{8}$ " high,  $13\frac{3}{8}$ " deep.
- Weight:** Net 22 lbs.; Shipping 44 lbs.
- Price:** \$265.00.

*Data subject to change without notice. Prices f.o.b. factory.*



**Complete Coverage,  
Highest Quality**

The new *-hp-* 211A Square Wave Generator permits fast measurement of audio and video amplifier frequency phase and transient characteristics up to several megacycles. In computer, pulse code and telemetering work, it materially simplifies triggering and switching. It is excellent for testing television circuitry, and ideal for modulating high frequency circuits, testing attenuators, filters and delay lines. In general laboratory use it is an excellent means of measuring time constants, indicating phase shift, frequency response and transient response.

Model 211A has many unique features. Besides the 0.02  $\mu$ sec rise time and two separate outputs (with full amplitude variation on both), the generator can be operated either free-running or externally synchronized. External synchronizing can be either with a positive going pulse or a sine wave signal of 3 volts amplitude. Much of the instrument's circuitry is etched to provide clean, trouble-free layout, compact size, freedom from stray capacity variations, and thus, a highly uniform product. The generator is of quality construction throughout and is housed in a streamlined, lightweight metal cabinet.

## SEND FOR OPERATING TECHNIQUES, CAPABILITIES, COMPLETE DATA

**HEWLETT-PACKARD COMPANY**  
3331D PAGE MILL ROAD., PALO ALTO, CALIFORNIA

Please send complete data on *-hp-* 211A Square Wave Generator

Name \_\_\_\_\_

Company \_\_\_\_\_

Street \_\_\_\_\_

City \_\_\_\_\_ Zone \_\_\_\_\_ State \_\_\_\_\_

Save, save, save . . . time, trouble, money . . . when purchasing molybdenum permalloy\* Powder Cores, for there can be no waste when you buy from Magnetics, Inc. Exclusively *Performance-Guaranteed*, these cores are also graded according to inductance, and color-coded so your assemblers *know* how many turns to put on without special testing. Write today for full details . . . Bulletin PC-103 and your Color-Coding Card . . . and remember . . .

# *PERFORMANCE - GUARANTEED*

.....

## Permalloy Powder Cores

*COST NO MORE-*

.....

*WHY TAKE LESS?*

**MAGNETICS inc.**



DEPT. I-24, BUTLER, PA.

\*Manufactured under a license agreement with the Western Electric Co.

### Standard Heavy-Duty Stacks



Extremely long life . . . with no maintenance problems. Thousands of voltage/ amperage combinations available. Sizes from 11/16" square cells to giant 6" x 10" plates . . . Federal can provide a power rectifier for almost every type of industrial and military equipment.

### Encapsulated Rectifiers

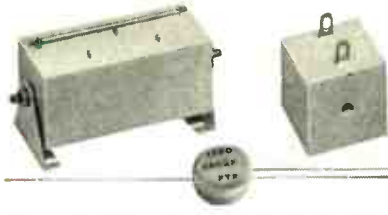

Maximum resistance to impact, acceleration, and vibration. Complete protection from harmful atmospheric conditions. Other electronic components may be encapsulated with rectifier to form a rugged, replaceable "potted" circuit.

### High-Voltage Stacks



250 to 5000 volts/5 to 40 milliamps. Encased in paper, glass, Bakelite, nylon, or metal tubes. Simple fuse-clip mounting of ferrule terminal types. Also, hermetically-sealed types. Uses: CRT high-voltage supplies, photoflash, insulation testers, etc.

### High-Temperature Stacks



For maximum operating life at ambient temperatures up to 150° C. A full range of voltage/ current combinations for medium and high temperatures. Ideal for aircraft and military equipment.

### Selenium Contact Protectors

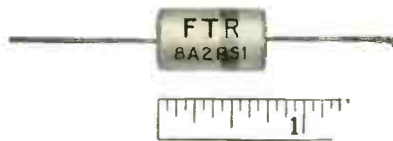

Extend contact life by over 1000 times. Used in inductive circuits to prevent erosion of switch contact surfaces . . . to suppress arcing and rf transients. Minimum effect on release time. Hermetic sealing meets JAN specs. For relays, electromagnets, and telephone systems.

### Magnetic Amplifier Rectifiers



Selenium cells and stacks precisely manufactured, tested, and selected to assure a high degree of stability and very low reverse current. For use with saturable reactors, regulated DC power supplies, etc.

**LET US KNOW** your AC-to-DC conversion problems. For further information on Federal Industrial Rectifiers, call NUTley 2-3600, or write to Dept. F-837.

# Why

## INDUSTRY and DEFENSE LOOK TO *Federal* FOR THE FINEST IN SELENIUM RECTIFIERS

### Pioneering Leadership

Federal is the *original* supplier of selenium rectifiers in the United States . . . leading the field in research, development and production.

### Facilities and Service

Federal's facilities can handle the largest and most complex orders . . . satisfy the rush requirements of customer production peaks. Every order—large or small—is processed through a skilled engineering staff.

### Quality and Economy

Federal's modern fabrication methods, mass production, intensive quality control, and rigid testing assure a product of highest quality and greatest economy.

### Federal Telephone and Radio Company

A Division of INTERNATIONAL TELEPHONE AND TELEGRAPH CORPORATION  
COMPONENTS DIVISION • 100 KINGSLAND ROAD • CLIFTON, N. J.

In Canada: Standard Telephones and Cables Mfg. Co. (Canada) Ltd., Montreal, P. Q.  
Export Distributors: International Standard Electric Corp., 67 Broad St., New York

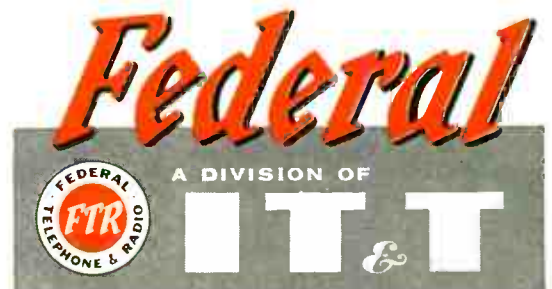

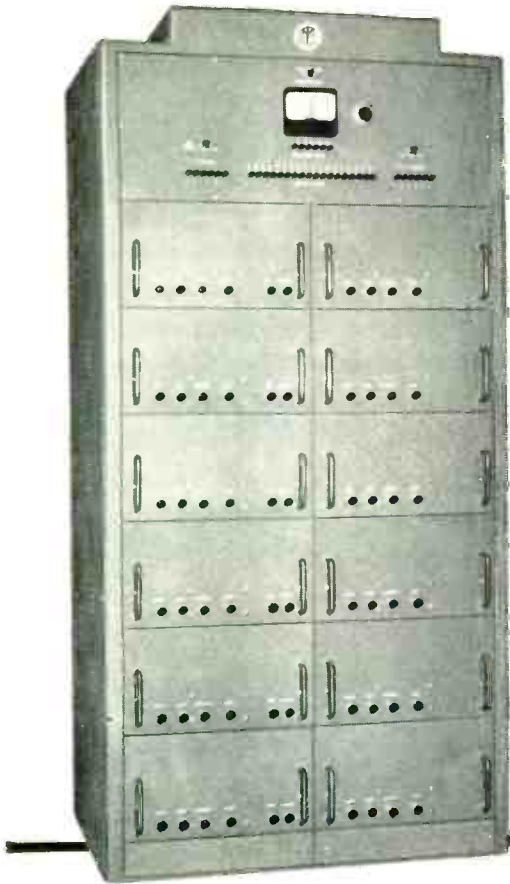

# "MID-CENTURY'S ELECTRONIC MULTIPLIER LICKED OUR PROBLEMS..."

because it has special high speed features  
for computing  
center work!"



The MC-700 AM-FM Electronic Multiplier is extremely accurate and performs at very high speed, thus saving many hours monthly in all types of computing center work. It consists of:

- 6 identical "A" units called MASTERS
- 12 identical "B" units called SLAVES
- Each Master Unit accepts two inputs, X and Y, and provides the product XY
- With the addition of the Slave Units, the products XZ and XW are obtained.

### These Specifications of the MC-700 provide four quadrant multiplication:

- 1 The input and output ranges are plus or minus 100 volts, with an input impedance of greater than one megohm, and an output impedance equal to that of the D-C Amplifier in the unit.
- 2 The static accuracy is within 0.2 volts over full range.
- 3 The frequency response at full amplitude is flat to 400 cycles, with less than one degree of phase shift at 100 cycles.
- 4 The noise is less than .05 volts RMS.
- 5 The drift does not exceed 0.2 volts over an 8 hr. period.

MAIL THIS TODAY TO SAVE TIME TOMORROW!

## MID-CENTURY INSTRUMATIC CORP.

611 Broadway, New York 12, N. Y.

*I am interested in obtaining more information on the following, without obligation*

- MC-700 Electronic Multiplier
- MC-300 Six Channel Recorder
- MC-400 Analogue Computer
- MC-500 D-C Analogue Computer
- MC-600 Six Channel Electronic Function Generator

FIRM NAME.....  
STREET.....  
CITY.....ZONE.....STATE.....  
BY.....



"precision is our business"

# MID-CENTURY INSTRUMATIC CORP.

611 BROADWAY

NEW YORK 12, N. Y.

# Now! For AMP Taper Pin Connectors

## E-I COMPRESSION HEADERS

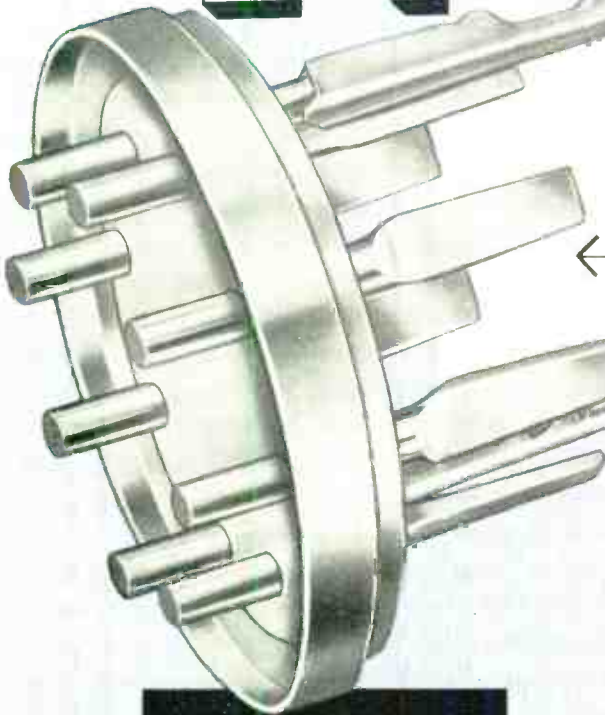

Type 90 GS/60W-AMP/S  
Compression Header, avail-  
able with from 8 to 14 ter-  
minals, shown four times  
actual size.

**...offering fast  
connect and disconnect,  
speedy assembly and  
positive connections  
without soldering!**

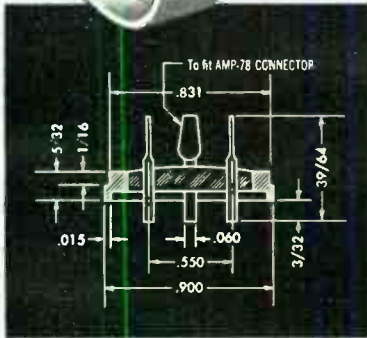

### Available

IN COMPRESSION HEADERS AND PRACTICALLY  
ALL STANDARD E-I SINGLE TERMINAL EYELETS —

E-I offers single and multiple terminal type compression headers and practically every standard E-I single terminal compression eyelet for use with Type 78 AMP connectors\*. For recommendations on specific sealed terminal applications, consult an E-I sales engineer, today!

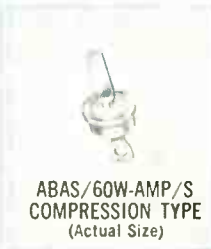
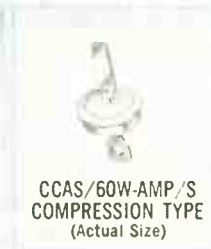
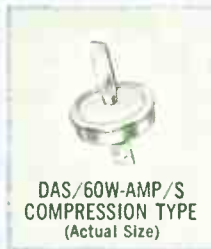

PATENTS PENDING —  
ALL RIGHTS RESERVED

\*Products of Aircraft-Marine Products, Inc. of Harrisburg, Pa.

Division of Ampcor Electronic Corporation



**ELECTRICAL INDUSTRIES**

44 SUMMER AVENUE, NEWARK 4, NEW JERSEY

World Radio History



September 1955

## Standard Ratio Transformer

Four new ruggedized standard ratio transformers have been added to the line of precision ac voltage dividers developed by **Gertsch Products, Inc.**, 11846 Mississippi Ave., Los Angeles 25, Calif.



The PT Series consists of nine models of both rack mounted and case models, specifically designed to divide ac voltage with accuracies as good as 0.005 per cent and resolution as good as 0.00001 per cent. Models are available to cover frequencies from 30 to 3,000 cps (to 10,000 cps at reduced accuracy).

The four new models have ruggedized heavy silver rotary switches, for use wherever severe continuous service is required. According to the manufacturer the permanent "built-in" accuracy contained in all models, is not subject to the variations normally experienced with resistive dividers.

Uses for the standard ratio transformers include core material investigation, ac meter calibration, transformer turns investigation, checking resolvers, servos, computers, synchros, selsyns, and ac transducers, bridge ratio arm, ac potentiometer checking, and as a ratio standard.

## LF Q Meter

The Kilo-Q, most recent addition to its line of electronic instruments was announced recently by **Kay Electric Co.**, 14 Maple Ave., Pine Brook, N. J.



A low frequency Q meter, the Kilo-Q will cover a range of 20

These manufacturers have invited PROCEEDINGS readers to write for literature and further technical information. Please mention your I.R.E. affiliation.

cps to 1 mc. For ease of operation, the unit combines a direct reading dial over the entire range, accurate to 1 per cent.

Two positions are provided on the Q Range Control with full scale Q readings of 0 to 125 and 0 to 250, respectively. For reading Q values between 250 and 500, it is necessary to set the lever control to the X2 position on the dial and double the reading on the 250 scale.

The instrument provides a tuning capacitor range of 60-1,200  $\mu\text{f}$ . A vernier capacitor control in shunt is provided to facilitate tuning of sharp "Qs."

Oscillator frequency accuracy, 2 to 5 per cent. Calibration capacitance accuracy, 1 per cent. Price \$695 f.o.b. plant. For complete information, write the manufacturer.

## Precision Phase Detector

This instrument manufactured by **Advance Electronics Co., Inc.**, 451 Highland Ave., Passaic, N. J., will measure time delay, phase delay, or envelope delay with error less than 1 per cent or  $0.1^\circ$  between two alternating voltages from 10 kc up to 15 mc. Essentially Type 205a precision phase detector consists of two input amplifiers, a continuously variable delay line, a step variable delay line, a differential tuned amplifier, a balanced phase detector, and a sensitive output indicator.

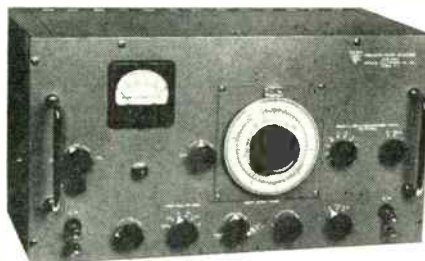

The smallest time delay that can be read on the dial is  $5 \times 10^{-10}$  seconds; the smallest phase angle in degrees that can be read on the dial is equal to  $5 \times 10^{-10} \times 36 \times$  frequency in cps. The frequency range is 10 kc to 15 mc. The time delay of the step variable delay

line is 5  $\mu\text{s}$  in step of 0.05  $\mu\text{s}$ . Three plug-in units of continuously variable delay lines are supplied with the instrument, 0 to 0.4  $\mu\text{s}$ , 0 to 0.25  $\mu\text{s}$ , and 0 to 0.05  $\mu\text{s}$ . The maximum phase range that can be measured with the instrument is equal to the total time delay of the continuously variable delay line plus the step variable delay line multiplied by the frequency of the signals and 360. The indicator sensitivity is approximately 0.01 volt full scale maximum without the probe, and 0.1 volt with the probe. Two low capacity probes with input capacitance less than 4  $\mu\text{f}$  are supplied with the unit. The panel binding post has about 1 megohm shunted with 12  $\mu\text{f}$  on both input channels.

## Paper Dielectric Tubulars

**Cornell-Dubilier Electric Corp.**, South Plainfield, N. J., announces the development of its new "Tiger Cub" type MGT, high temperature paper dielectric tubular capacitors. This new capacitor is designed to operate effectively at temperatures from  $-55^\circ\text{C}$  to  $+100^\circ\text{C}$ .



The capacitance stability of the new "Tiger Cub" is such that it varies less than 10 per cent over this temperature range. Longer service life is assured by Vikane impregnation. An external wax dip provides added moisture protection that will withstand 250 hours of continuous exposure in 90 per cent relative humidity at  $40^\circ\text{C}$ .

The "Tiger Cub" MGT paper tubular capacitors are available in capacities from 0.001  $\mu\text{f}$  to 1.0  $\mu\text{f}$  in 6 voltage ranges from 100 to 1,600 volts dc working. Low resistance lead wires are soldered to extended foils and held firmly in place by Polykane, the high temperature, non-melting end fill. Request Bulletin 168.

(Continued on page 16A)



# IN Attenuators

WHY DOES  
ONE NAME...

**DAVEN**

STAND OUT?

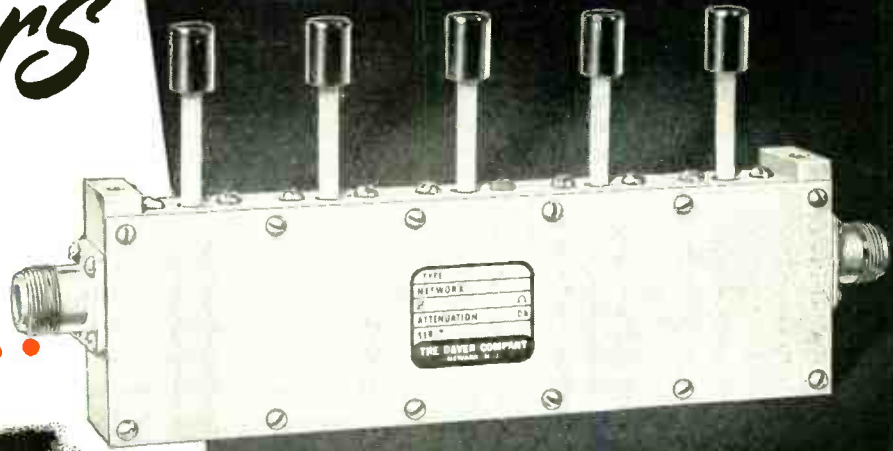

*Series 550-RF Attenuator*

In addition to Daven being the leader in audio attenuators, they have achieved equal prominence in the production of RF units. A partial listing of some types is given below.

DAVEN Radio Frequency Attenuators, by combining proper units in series, are available with losses up to 120 DB in two DB Steps or 100 DB in one DB Steps. They have a zero insertion loss and a frequency range from DC to 225 MC.

Standard impedances are 50 and 73 ohms, with special impedances available on request. Resistor accuracy is within  $\pm 2\%$  at DC. An unbalanced circuit is used which provides constant input and output impedance. The units are supplied with either UG-58/U\* or UG-185/U\* receptacles.

Because **DAVEN** makes the most complete, the most accurate line of **ATTENUATORS** in the world!

| TYPE             | LOSS                  | TOTAL DB | STANDARD IMPEDANCES               |
|------------------|-----------------------|----------|-----------------------------------|
| RFA* & RFB 540** | 1, 2, 3, 4 DB         | 10       | 50/50 $\Omega$ and 73/73 $\Omega$ |
| RFA & RFB 541    | 10, 20, 20, 20 DB     | 70       | 50/50 $\Omega$ and 73/73 $\Omega$ |
| RFA & RFB 542    | 2, 4, 6, 8 DB         | 20       | 50/50 $\Omega$ and 73/73 $\Omega$ |
| RFA & RFB 543    | 20, 20, 20, 20 DB     | 80       | 50/50 $\Omega$ and 73/73 $\Omega$ |
| RFA & RFB 550    | 1, 2, 3, 4, 10 DB     | 20       | 50/50 $\Omega$ and 73/73 $\Omega$ |
| RFA & RFB 551    | 10, 10, 20, 20, 20 DB | 80       | 50/50 $\Omega$ and 73/73 $\Omega$ |
| RFA & RFB 552    | 2, 4, 6, 8, 20 DB     | 40       | 50/50 $\Omega$ and 73/73 $\Omega$ |



*Series 640-RF  
Attenuation Network*



These units are now being used in equipment manufactured for the Army, Navy and Air Force.

Write for Catalog Data.

THE **DAVEN** CO.

195 CENTRAL AVENUE  
NEWARK 4, NEW JERSEY

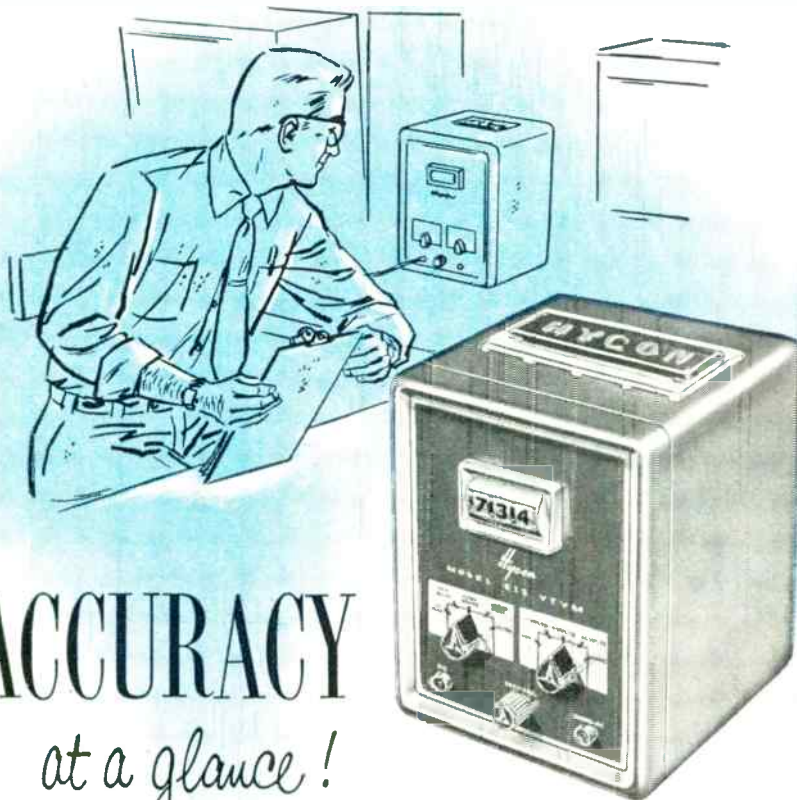

# ACCURACY at a glance!

Just select the range you want... Hycon's new Model 615 Digital VTVM does the rest... gives you a *direct* reading in numerical form, complete with decimal point and polarity sign. There's no interpolation, no chance of reading the wrong scale. Even inexperienced personnel find the Model 615 easy to use... you just *can't* read it incorrectly!

Ideal for both laboratory and production-line testing, here's what the Model 615 offers...

- ... 1% accuracy on DC and ohms; 2% on AC
- ... 12 ranges... 0 to 1000 volts DC and AC; 0 to 10 megohms
- ... Illuminated 3-digit scale, with decimal point and polarity sign
- ... Response (with auxiliary probes) to 250 mc
- ... Shielded case; rugged, bench-stacking design; lightweight

Two more Hycon test instruments... designed for tomorrow's circuitry... *ready for color TV...*

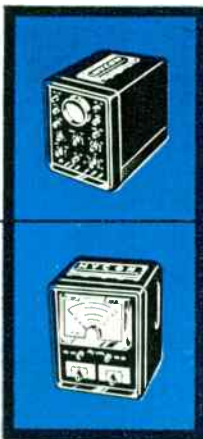

### MODEL 617 3" OSCILLOSCOPE...

Accurate enough for research, rugged enough for servicing. Features high deflection sensitivity (.01 v/in rms); 4.5 mc vertical bandpass, flat  $\pm 1$  db; internal 5% calibrating voltage. **SPECIAL FLAT 3" CRT FOR UNDISTORTED TRACE FROM EDGE TO EDGE.**

### MODEL 614 VTVM...

Maximum convenience combined with unprecedented low cost. Plus features include: 21 ranges (28 with p-p scales); 6½" meter; 3% accuracy on DC and ohms, 5% on AC; response (with auxiliary probe) to 250 mc. **TEST PROBES STOW IN CASE, READY TO USE.**

See these Hycon instruments... all in matching, bench-stacking cases... at your local electronic jobber.

## Hycon Mfg. Company

2961 EAST COLORADO STREET  
PASADENA 8, CALIFORNIA

"Where accuracy counts"

BASIC ELECTRONIC RESEARCH • ORDNANCE • AERIAL CAMERAS • ELECTRONIC SYSTEMS  
ELECTRONIC TEST INSTRUMENTS • GO NO-GO MISSILE TEST SYSTEMS • AERIAL SURVEYS



News-New Products

(Continued from page 11A)

## Miniature Power Transformers

Hycor Company, Inc., 11423 Vanowen St., North Hollywood, Calif., announces a new line of miniature power transformers for 400 cps and higher frequencies. The units are available with output power ratings up to 15 va with



multiple windings from 1 volt to 500 volts. They are available in miniature metal cases or in plastic encapsulated form to satisfy MIL-T-27 requirements. The toroidal construction minimizes external fields and results in extremely high efficiency. Bulletin WT lists stock types and is available upon request.

## Terminal Catalog

Hermetic Seal Products Co., 29 South Sixth St., Newark 4, N. J. announces the availability of their new 4-page brochure on Vac-Tite Compression, Single Terminal Feed-Thru's and Stand-Offs. This new 4-page brochure provides industry with a coordinated standardization of single terminal feed-thru's and stand-off's. The parts illustrated in the new brochure are of Vac-Tite construction, an exclusively developed glass-to-metal chemically bonded compression construction.

The brochure introduces a wide variety of specially designed flanged bodies offered to industry for use in projection weld assembly, for soldering to curved surfaces, and other special applications. In addition, designs capable of withstanding extremely high pressures are available in flanged or threaded bodies. Single terminal types have been developed by Hermetic that incorporate space within the seal for mounting small components. This type requires a flat plate for closure.

(Continued on page 181A)



2J32 MAGNETRON



2K28 KLYSTRON



## HELPING ESTABLISH RELIABILITY RECORDS

### Raytheon Magnetrons and Klystrons in proved Gilfillan ASR-1 Radar

Civil Aeronautics Administration reports record-breaking reliability of Gilfillan airport surveillance radar. Boston International Airport had 8,760 hours continuous performance with only  $7\frac{1}{3}$  hours involuntary outage—less than  $\frac{1}{10}$  of 1%—from their Gilfillan installation.

Check these performance records of Raytheon tubes in the Gilfillan ASR-1. Average life, 2J32 Magnetron: 4,000 hours. Average life, 2K28 Klystron: 2,500 hours.

Your microwave and radar equipment offers extra reliability when you specify Raytheon Magnetrons and Klystrons. Use these rugged, reliable tubes in your present and proposed systems. Contact Power Tube Sales to take advantage of Raytheon's Application Engineer Service, without obligation. Write for free Tube Data Booklets.

| Condensed Typical Operating Data |              |                       |                    |                   |                     |                 |        |
|----------------------------------|--------------|-----------------------|--------------------|-------------------|---------------------|-----------------|--------|
|                                  | Power Output | Frequency Range, mc   | Reflector Voltage  | Resonator Voltage | Maximum Temp. Coef. | Tuning          | Cavity |
| 2K28                             | 140 mw       | 1200-3750             | —140 v. to —300 v. | 300 v.            | ± .15               | Mech. Inductive | Ext.   |
|                                  | Power Output | Frequency Range, mc   | Anode kv           | Anode Amps.       | Pulse Width         | P. R. R.        |        |
| 2J32                             | 285 kw min.  | 2780-2820 Fixed freq. | 20                 | 30                | 1 μsec              | 1,000           |        |



*Excellence  
in Electronics*

RAYTHEON MANUFACTURING COMPANY, Microwave and Power Tube Operations, Section PL-33 Waltham 54, Massachusetts

The unique construction of the fly's eye, with numerous tiny lenses on a convex surface, gives the insect an extensive visionary area, in all directions.

Courtesy of the American  
Museum of Natural History

## Wider than a fly can see

Unlike most of nature's children, man's endeavors have carried him far beyond the use of his natural endowments. Spurred on by mental development, human efforts have created a dynamic way of life, demanding the most versatile mechanisms man is able to devise.

Scientists at Airborne Instruments Laboratory are constantly at work, creating electronic devices to aid industrial progress. In the Wide Range Power Oscillator, they have achieved an instrument, excellent in performance and quality, for testing over the wide frequency range of 300 to 2500 mc.

Equipped with a self-contained rectifier power supply and a single tuning control for grid-cathode and grid-plate lines, the Wide Range Power Oscillator is representative of Airborne's high standard of achievement in research, development and production. Here is another example of individual design, resulting in the universal appeal of ALL products.

*Write for descriptive literature.*



160 OLD COUNTRY ROAD • MINEOLA, NEW YORK

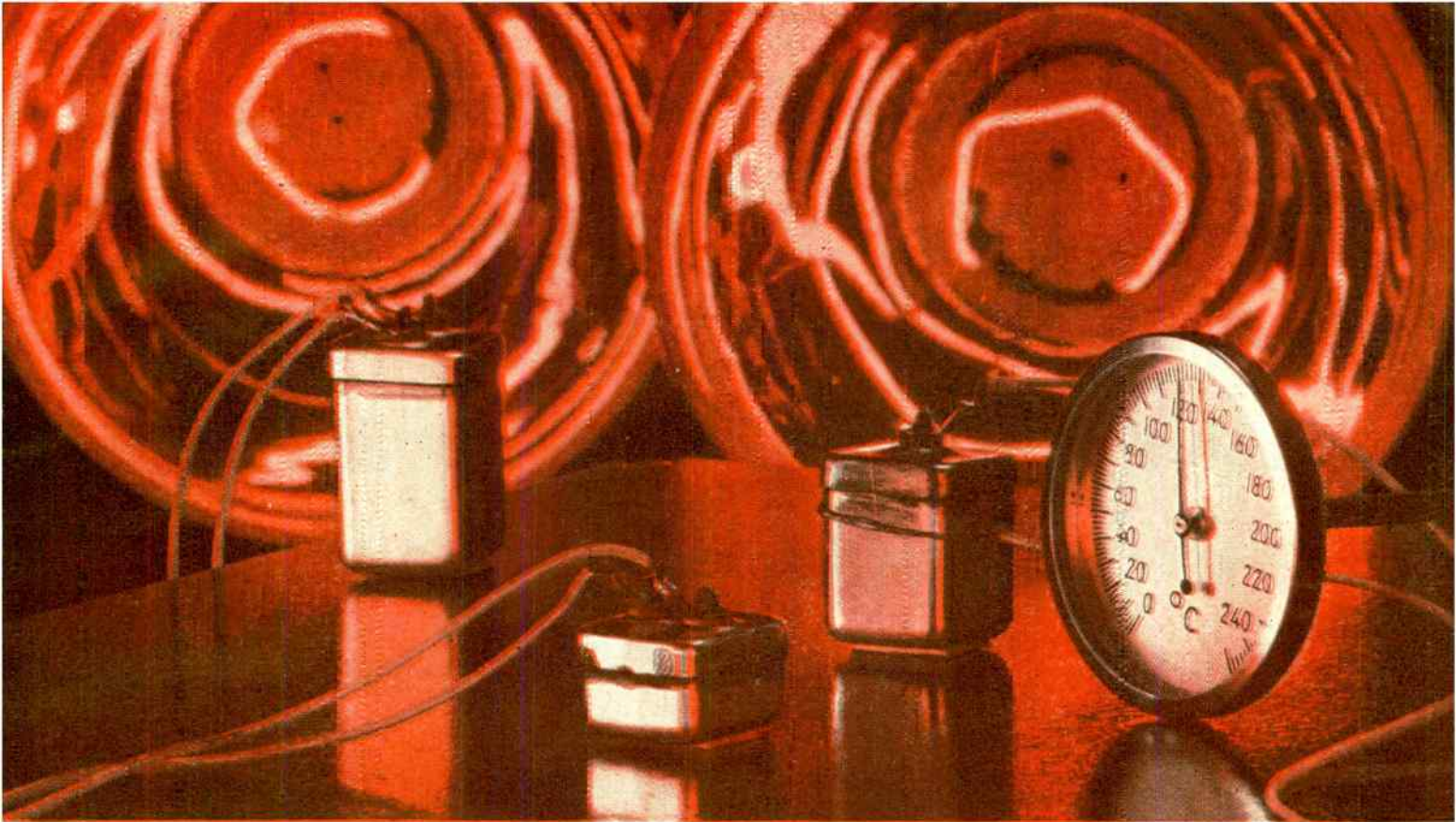

INFRA-RED LAMPS RAISE AMBIENT TEMPERATURE TO +125 C.

# NEW G-E TANTALYTIC\* CAPACITORS OPERATE AT +125°C AMBIENT

**Available in ratings from 36 uf at 100 VDC to 180 uf at 30 VDC**

Designed to operate at +125 C for 1000 hours with not more than 20% loss in initial +25 C capacitance, General Electric's new high-temperature Tantalum capacitors meet the tough requirements of miniaturized military equipment.

**FOIL CONSTRUCTION** assures the same long life, high quality, and stable operating characteristics provided by +85 C Tantalums. Unlike other types of Tantalum capacitors, the foil construction also offers:

- Both polar and nonpolar construction.
- Chemically neutral electrolyte . . . minimizes corrosion danger.
- Excellent mechanical stability . . . freedom from electrical noise under shock and vibration.
- Excellent reliability at rated temperatures . . . extended life at temperatures below +125 C.

**AVAILABILITY:** G-E high-temperature Tantalum capacitors can be obtained now in sample quantities for evaluation and prototype use. Production lots will be available by September in the following standard ratings:

| Voltage | uf Case 1<br>3/4" x 3/4" x 1 1/8" | uf Case 2<br>3/4" x 3/4" x 7/8" | uf Case 3<br>3/4" x 3/4" x 1/2" |
|---------|-----------------------------------|---------------------------------|---------------------------------|
| 30      | 180                               | 110                             | 55                              |
| 50      | 100                               | 60                              | 30                              |
| 75      | 60                                | 36                              | 18                              |
| 100     | 36                                | 24                              | 12                              |

For more information, see your G-E Apparatus Sales Representative or write for Bulletin GEA-6258, General Electric Company, Section 442-27, Schenectady 5, New York.

\*Reg. trade-mark of General Electric Co.

*Progress Is Our Most Important Product*

**GENERAL  ELECTRIC**

World Radio History

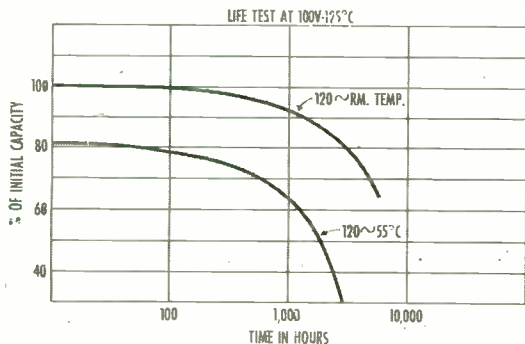

**LONG LIFE** of G-E high temperature Tantalum capacitors is shown by this graph of life vs loss of capacitance for typical 100 volt d-c unit.

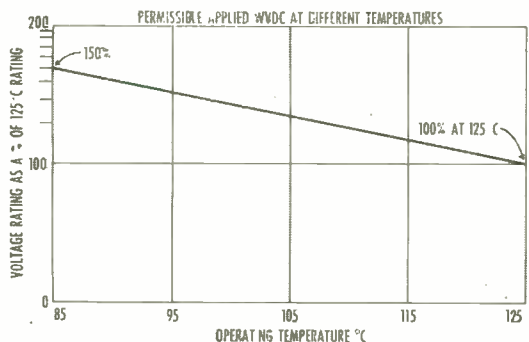

**HIGHER VOLTAGES** than 100 VDC can be applied . . . with no loss of life . . . at ambient temperatures below rated +125 C as shown above.



## Now... Univac Tells Itself What To Do!

Univac no longer asks for the detailed instruction codes required by other computers. Univac now *automatically* produces complex coded routines when given a simple instruction.

- This truly remarkable new Remington

Rand development cuts months from programming time... is easily adaptable to your individual requirements.

**If you would like more information about Univac automatic programming, write to the address below for EL264.**

ELECTRONIC COMPUTER DEPARTMENT **Remington Rand** ROOM 1961, 315 FOURTH AVE., NEW YORK 10, N. Y.  
DIVISION OF SPERRY RAND CORPORATION

**VARIAN KLYSTRONS** are designed and built to deliver top performance under extreme conditions of shock and severe G-loads . . . such as occurred in the impact of the Viking rocket, falling from an altitude of 158 miles.

# HERE'S SHOCK PROOF!

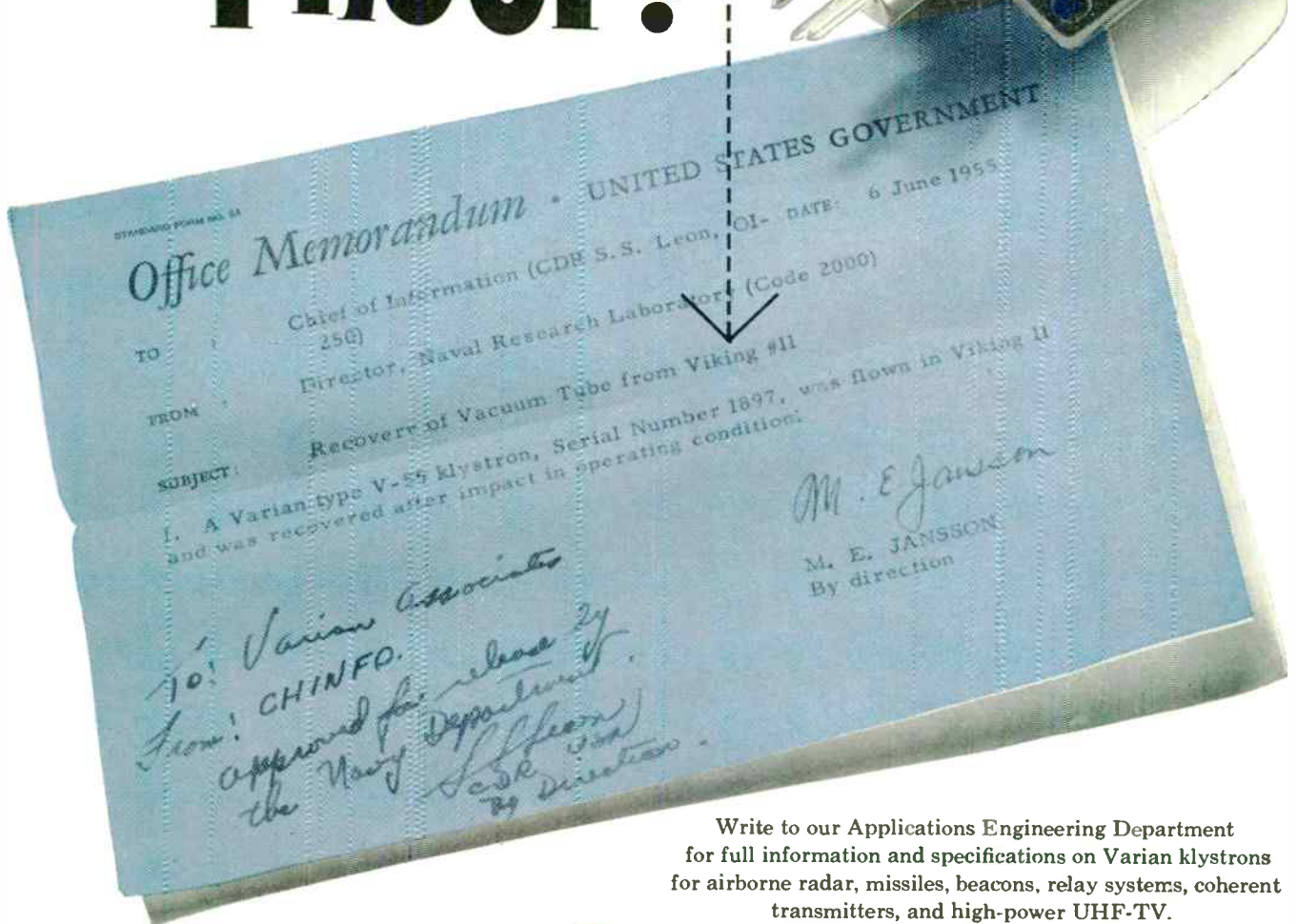
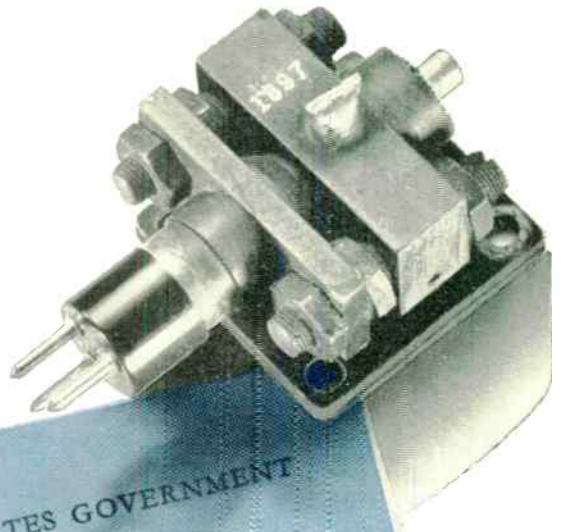

Write to our Applications Engineering Department for full information and specifications on Varian klystrons for airborne radar, missiles, beacons, relay systems, coherent transmitters, and high-power UHF-TV.

THE  
MARK OF  
LEADERSHIP



**VARIAN associates**  
PALO ALTO 2, CALIFORNIA

KLYSTRONS, TRAVELING WAVE TUBES, BACKWARD WAVE OSCILLATORS, R. F. SPECTROMETERS, MAGNETS, STALOS, UHF WATERLOADS, MICROWAVE SYSTEM COMPONENTS, RESEARCH AND DEVELOPMENT SERVICES

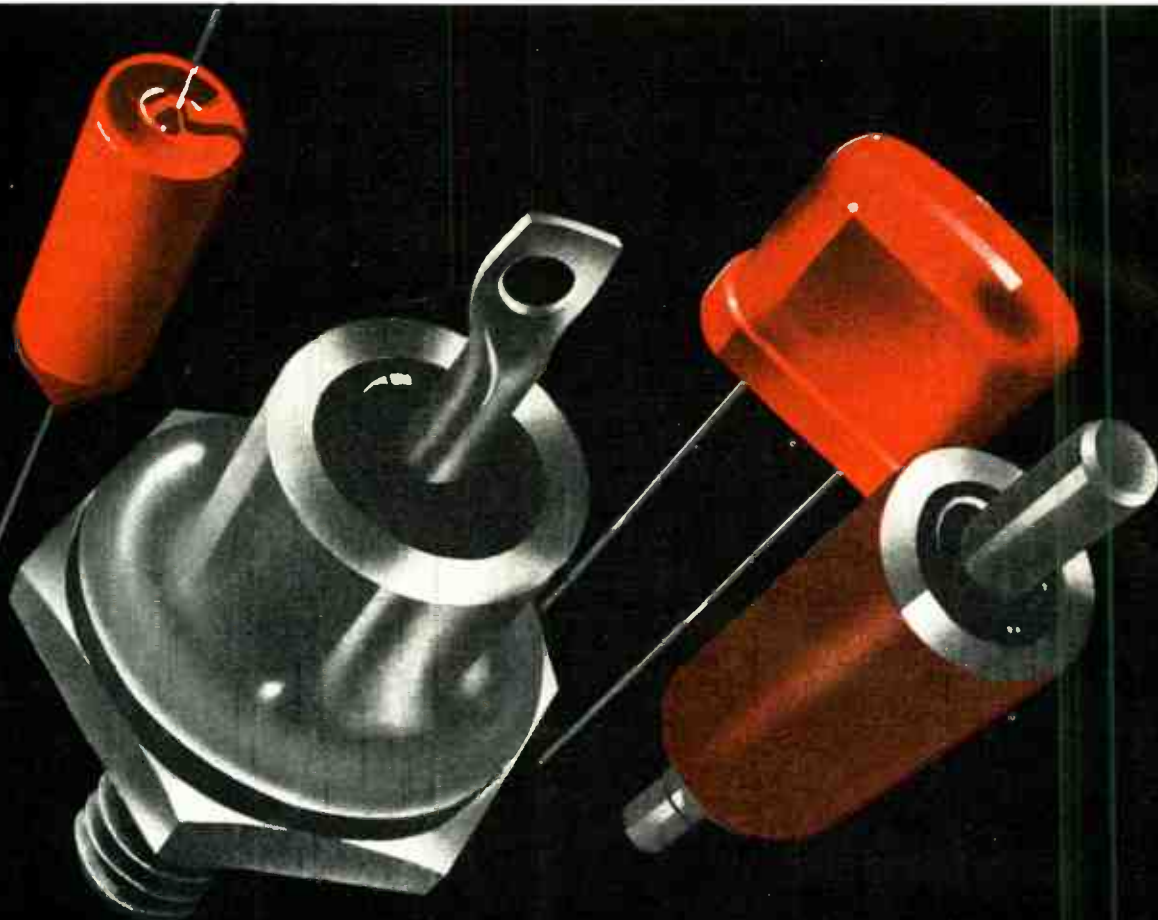

the world's foremost producer

of **SEMICONDUCTORS**

presents this comprehensive range of Raytheon  
DIODES, having the characteristics and the  
uniformly dependable performance that warrant your complete  
confidence and your specification as first choice

Preserve this Ready Reference Chart 

You'll find it a useful and dependable source of  
up-to-date information on Raytheon Diodes.

**RAYTHEON  
MANUFACTURING  
COMPANY**

*Semiconductor Division*

Home Office: 55 Chapel St., Newton 38, Mass., BR 7-7500

For application information write or call the Home Office or:  
2001 Grand Ave., Franklin Park (Chicago), Ill., TU 2-6309  
380 Fifth Avenue, New York 17, New York, PL 5-3300  
622 South La Brea Ave., Los Angeles 48, Cal., WE 2-6351

**RAYTHEON MAKES ALL THESE:**

RELIABLE SUBMINIATURE AND MINIATURE TUBES • SEMICONDUCTOR DIODES AND TRANSISTORS  
NUCLEONIC TUBES • MICROWAVE TUBES • RECEIVING AND PICTURE TUBES



## RAYTHEON POINT CONTACT GERMANIUM DIODES

These diodes combine good transient response, low capacity and high frequency capabilities with low cost and dependability. Ambient temperature range -50 to +100°C.

| Type                       | Dimension Outline | Peak Inverse Volts   | Average Rectified mA (max.) | Peak Rectified mA (max.) | Maximum Inverse Currents in $\mu$ A |  |                | Forward mA at +1v   |
|----------------------------|-------------------|--|-----------------------------|--------------------------|-------------------------------------|--|----------------|---------------------|
|                            |                   |  |                             |                          | at -5v                              | at -10v  | at -100v       |                     |
| 1N66 (CK705)               | A                 | 60   | 50                          | 150                      |                                     | 50   | 800            | 5.                  |
| 1N67                       | A                 | 80   | 35                          | 100                      | 5                                   |  | 50             | 4.                  |
| 1N68 (CK708)               | A                 | 100  | 35                          | 100                      |                                     |  | 625            | 3.                  |
| 1N294 (CK705A)             | A                 | 60   | 50                          | 150                      |                                     | 10   | 800            | 5.                  |
| 1N297 (CK707)              | A                 | 80   | 35                          | 100                      | 10                                  |  | 100            | 3.5                 |
| 1N298 (CK713A)             | A                 | 70   | 50                          | 150                      |                                     | 250 $\mu$ A (max.) at -40v.                        | (50°C)         | 30mA (min.) at +2v. |
| CK801                      | A                 | 60   | 50                          | 150                      |                                     |  | 50             | 5.                  |
| CK802                      | A                 | 80   | 50                          | 150                      |                                     |  | 100            | 7.5                 |
| <b>VHF and UHF</b>         |                   |  |                             |                          |                                     |  |                |                     |
| 1N82A                      | B                 | 5  | 50                          | 150                      | UHF mixer                           | 14 db max. noise — see data sheet for test circuit |                |                     |
| 1N295 (CK706A)             | A                 | 40   | 35                          | 125                      |                                     | 200  | Video detector |                     |
| CK715                      | A                 | 40   | 35                          | 125                      |                                     | Special tests for VHF to UHF freq. multiplier      |                |                     |
| <b>Multiple Assemblies</b> |                   |  |                             |                          |                                     |  |                |                     |
| CK709                      | C                 | Four 1N66 matched within 2.5% at +1.5 and -10 volts for bridge circuits              |                             |                          |                                     |  |                |                     |
| CK711                      | C                 | Four 1N67 matched from 0 to +3 volts. 30 $\mu$ A (max.) at -50v. for bridge circuits |                             |                          |                                     |  |                |                     |
| CK717                      | C                 | Four 1N66 matched within 2.5% at +1.5 and -10 volts for common anode circuits        |                             |                          |                                     |  |                |                     |
| CK719                      | C                 | Four 1N67 matched from 0 to +3 volts. 30 $\mu$ A (max.) at -50                       |                             |                          |                                     |  |                |                     |

## RAYTHEON GOLD BONDED GERMANIUM DIODES

This group of diodes features small size, high forward conduction, high back resistance, and good temperature characteristics. Because junction area is increased over that of point contact types, capacity is slightly higher, transient response slightly slower.

| Type          | Dimension Outline | Peak Inverse Volts (max.) | Average Rectified mA (max.) | Peak Rectified mA (max.) | Maximum Inverse Currents in $\mu$ A |         |         |          | Forward mA |         | Ambient Temperature Range °C |
|---------------|-------------------|---------------------------|-----------------------------|--------------------------|-------------------------------------|---------|---------|----------|------------|---------|------------------------------|
|               |                   |                           |                             |                          | at -10v                             | at -20v | at -50v | at -100v | at 0.8v    | at 1.0v |                              |
| 1N305 (CK739) | D                 | 60                        | 125                         | 300                      | 2.0                                 |         | 20      |          | 100        |         | -55 to +70                   |
| 1N306 (CK740) | D                 | 15                        | 150                         | 300                      | 2.0                                 |         |         |          | 100        |         | -55 to +70                   |
| 1N307 (CK742) | D                 | 125                       | 50                          | 300                      | 5.0                                 |         |         | 20       |            | 100     | -55 to +70                   |
| 1N308 (CK741) | A                 | 10                        | 100                         | 350                      | 500 $\mu$ A at -8 volts             |         |         |          |            | 300     | -55 to +90                   |
| 1N309 (CK747) | A                 | 40                        | 100                         | 300                      |                                     | 100     |         |          |            | 100     | -55 to +90                   |
| 1N310 (CK745) | A                 | 125                       | 40                          | 100                      |                                     | 20      |         | 100      |            | 15      | -55 to +90                   |
| 1N312 (CK748) | A                 | 60                        | 70                          | 250                      |                                     |         | 50      |          |            | 30      | -55 to +90                   |
| 1N313 (CK749) | A                 | 125                       | 40                          | 100                      |                                     | 10      |         | 50       |            | 15      | -55 to +90                   |

Note: 1N305-6-7 have very high back to forward ratio, high back resistance, sharp Zener characteristic, average transient response  
1N308-13 have good transient response with good forward characteristics, high back resistance

## RAYTHEON BONDED SILICON DIODES

Raytheon Bonded Silicon diodes provide high back resistance, a sharp Zener characteristic and fair transient response (large overshoot, fast recovery) over an ambient temperature range of -55 to +150°C.

| Type           | Dimension Outline | Peak Inverse Volts | Average Rectified mA | Peak Rectified mA | Maximum Reverse Currents in $\mu$ A |         |                | Forward mA at +1v | 100°C Average Rectified mA | Max. Reverse mA at -10v |
|----------------|-------------------|--------------------|----------------------|-------------------|-------------------------------------|---------|----------------|-------------------|----------------------------|-------------------------|
|                |                   |                    |                      |                   | at -5v                              | at -10v | at Volts shown |                   |                            |                         |
| 1N300 (CK735)  | D                 | 15                 | 40                   | 120               |                                     | 0.001   |                | 8                 | 15                         | 0.01                    |
| 1N301 (CK736)  | D                 | 70                 | 35                   | 110               |                                     | 0.01    | 0.05 at -50    | 5                 | 12                         | 0.2                     |
| 1N302 (CK737)  | D                 | 225                | 25                   | 80                |                                     | 0.01    | 0.2 at -200    | 1                 | 8                          | 0.2                     |
| 1N303 (CK738)  | D                 | 125                | 30                   | 100               |                                     | 0.01    | 0.1 at -100    | 3                 | 10                         | 0.2                     |
| 1N432 (CK856)  | D                 | 40                 | 40                   | 120               |                                     | 0.005   |                | 10                | 20                         | 0.05                    |
| 1N433 (CK860)  | D                 | 145                | 30                   | 100               |                                     | 0.03    | 0.3 at -125    | 3                 | 15                         | 0.5                     |
| 1N434 (CK861)  | D                 | 180                | 30                   | 100               |                                     | 0.05    | 0.5 at -160    | 2                 | 15                         | 1.0                     |
| 1N438 (CK852*) | D                 | 7                  | 100                  | 200               | 10                                  |         |                | 50                | 50                         |                         |

\*8 volt Zener regulator

Note: All ratings at 25°C unless otherwise indicated.

## RAYTHEON SILICON POWER RECTIFIERS

This new Raytheon silicon rectifier is the first to give high current rectifying capacity in extremely small volume. The rectifiers operate to 175°C, to 200 volts peak and to over 99% efficiency. Back to forward resistance ratio is over 100,000.

| Type               | Dimension Outline   |                     | Maximum Voltage |            | Maximum Current |                 | Typical Dissipation Watts |
|--------------------|---------------------|---------------------|-----------------|------------|-----------------|-----------------|---------------------------|
|                    |                     |                     | RMS Volts       | Peak Volts | Peak Amperes    | Average Amperes |                           |
| CK775              | E                   | Case Temp. 30°C*    | 40              | 60         | 50              | 15              | 40                        |
|                    |                     | Case Temp. 170°C*   | 40              | 60         | 15              | 5               | 10                        |
|                    |                     | No Heat Radiator    |                 |            |                 |                 |                           |
|                    |                     | Ambient Temp. 25°C  | 40              | 60         | 6               | 2.0             | 3.0                       |
| CK776              | E                   | Ambient Temp. 170°C | 40              | 60         | 2.0             | 0.5             | 0.5                       |
|                    |                     | Case Temp. 30°C*    | 125             | 200        | 50              | 15              | 40                        |
|                    |                     | Case Temp. 170°C*   | 125             | 200        | 15              | 5               | 10                        |
|                    |                     | No Heat Radiator    |                 |            |                 |                 |                           |
| Ambient Temp. 25°C | 125                 | 200                 | 6               | 2.0        | 3.0             |                 |                           |
|                    | Ambient Temp. 170°C | 125                 | 200             | 2.0        | 0.5             | 0.5             |                           |

### ADDITIONAL RATINGS (25°C)

Both CK775 and CK776 have maximum drop at 5 amperes of 1.5 volts  
CK775 has maximum reverse current at -60 volts of 25 mA  
CK776 has maximum reverse current at -200 volts of 25 mA

\*maintained by external heat radiator

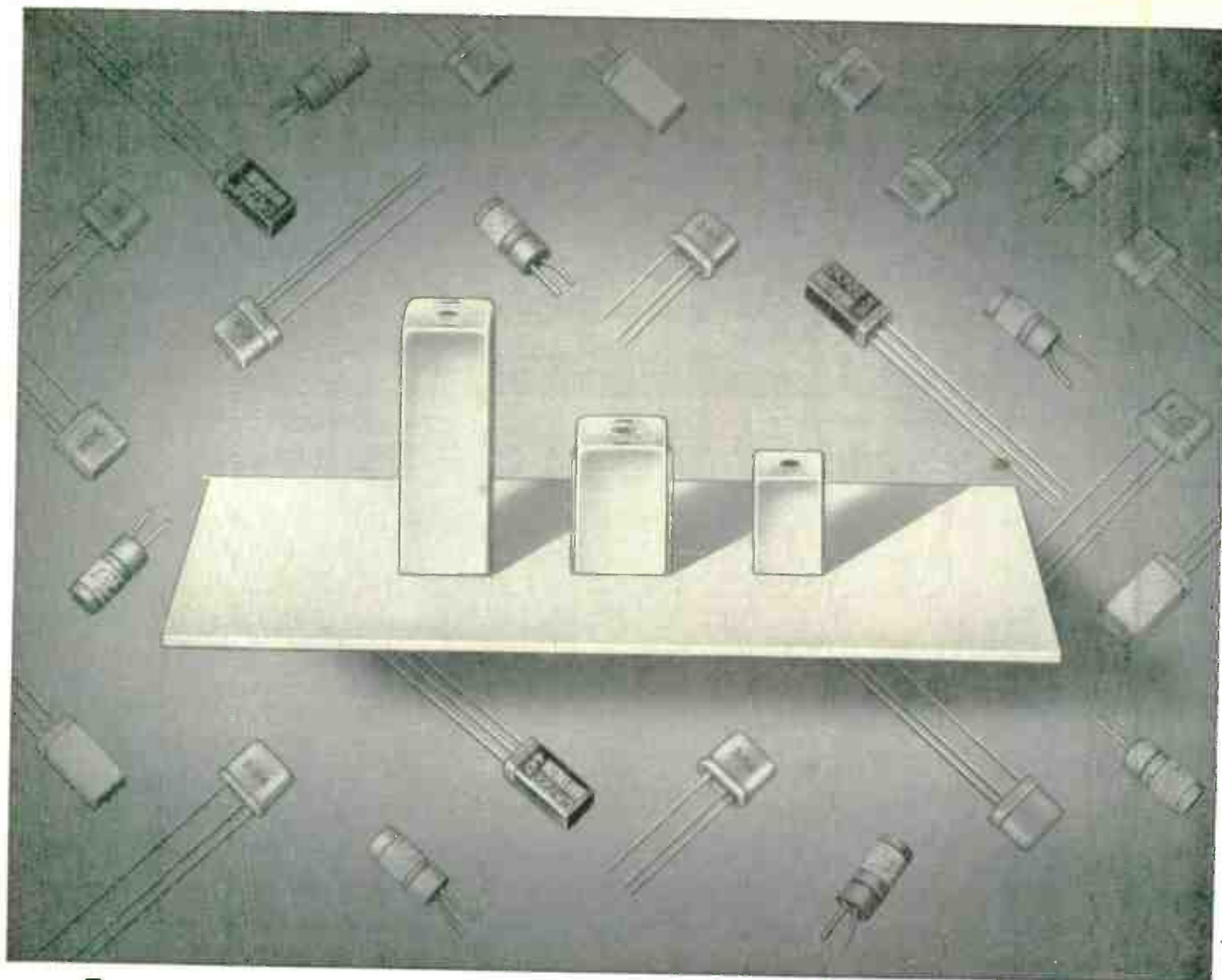

Photo actual size

# ***AUTOMATIC*** makes the only complete line of standardized **TRANSISTOR I.F.'s...K-TRANS**

You can order *all* your Transistor I.F.'s from a single source—Automatic Manufacturing Corp. This will save you time and money and give you I.F.'s with the exclusive K-Tran features: *positive threading and controlled torque*. In any electronic miniaturization program, the small physical dimensions, combined with the highest electrical performance of the Transistor K-Tran, give you tremendous advantages.

We make three styles of Transistor K-Tran. Each style has capacity built into the base, and is available in frequencies from 262 KC up through standard frequencies.

From left to right these are the three styles:

**STYLE 10.** Permits double ended tuning. ( $1\frac{1}{32} \times \frac{3}{64} \times \frac{3}{64}$ )

**STYLE 12.** Permits single ended tuning. ( $\frac{3}{64} \times \frac{3}{64} \times \frac{3}{64}$ )

**STYLE 15.** Specific for severe space limitations. Permits single ended tuning. ( $\frac{3}{64} \times \frac{1}{32} \times \frac{1}{32}$ )

Standard size K-Tran ( $1\frac{3}{32} \times \frac{3}{4} \times \frac{1}{4}$ ) are also available for transistor applications. Since the several types of the K-Tran\* I.F. Transformer are all assembled from the same components,

they are immediately available for orders of any size.

☆ ☆ ☆

For full engineering information on transistor and other type K-Tran, ask for your copy of the 45-page K-Tran Manual. It will help you design better transistor circuits.

**AUTOMATIC**  
MANUFACTURING  
CORPORATION

Subsidiary General Instrument Corporation

*Every part Automatic uses  
... Automatic makes.*

**MASS PRODUCERS OF  
ELECTRONIC COMPONENTS**

65 GOUVERNEUR ST.,  
NEWARK 4, N. J.

\*T.M. Reg. U.S. Pat. Off.

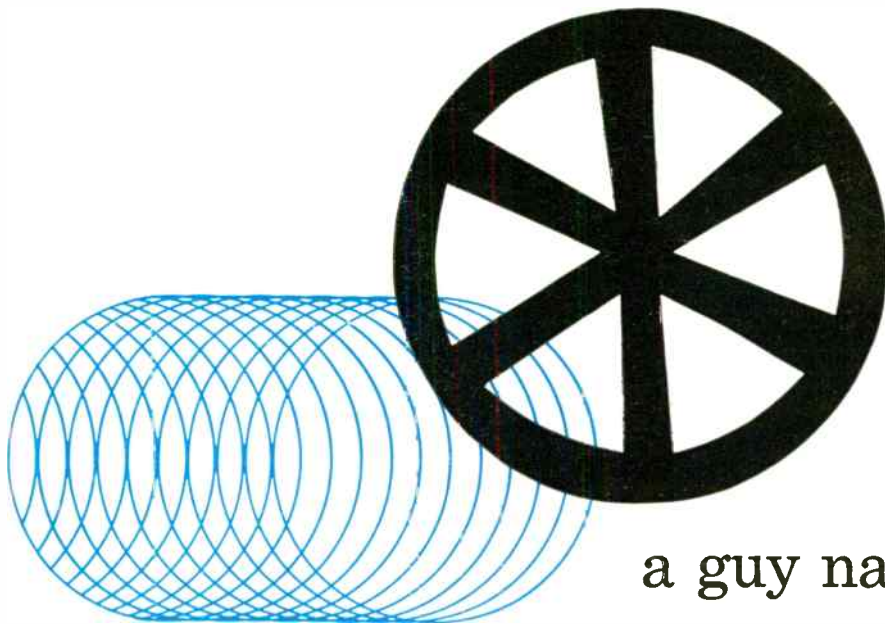

## a guy named Og

Once your name was Og. You tired of shouldering  
mastodon steaks...of dragging your mate by her hair.  
You invented the wheel.

Later, your name was Watt. Steam made your kettle-lid  
dance...and the Industrial Revolution was on.

Yesterday, you were a bicycle mechanic named Henry...today,  
your brainchild's descendants are counted in millions.

Your name is legion. You created every linkage...  
every device...every system.

You're an engineer.

You make things work better...faster...more accurately  
...more economically.

Next week...next month...next year...some system will need  
a better, faster, more accurate or more economical  
means of recording...or indicating...or computing...or  
controlling a process.

You'll want precision potentiometers.

You'll discover that Helipot makes the most complete line...  
linear and non-linear versions...in the widest choice  
of sizes, mounting styles and resistances.

*many models of HELIPOT\*  
precision potentiometers are  
stocked for immediate shipment  
...our engineers will gladly  
adapt standard HELIPOTS to your  
requirements...or build  
entirely new HELIPOTS for you.*

*for information and specifications  
...write for data file J03*



# Helipot

*first in precision potentiometers*

*Helipot Corporation/South Pasadena, California  
Engineering representatives in principal cities  
a division of BECKMAN INSTRUMENTS, INC.*



You're an engineer.  
Your career is in  
the making.  
Helipot would like  
to hear from you.

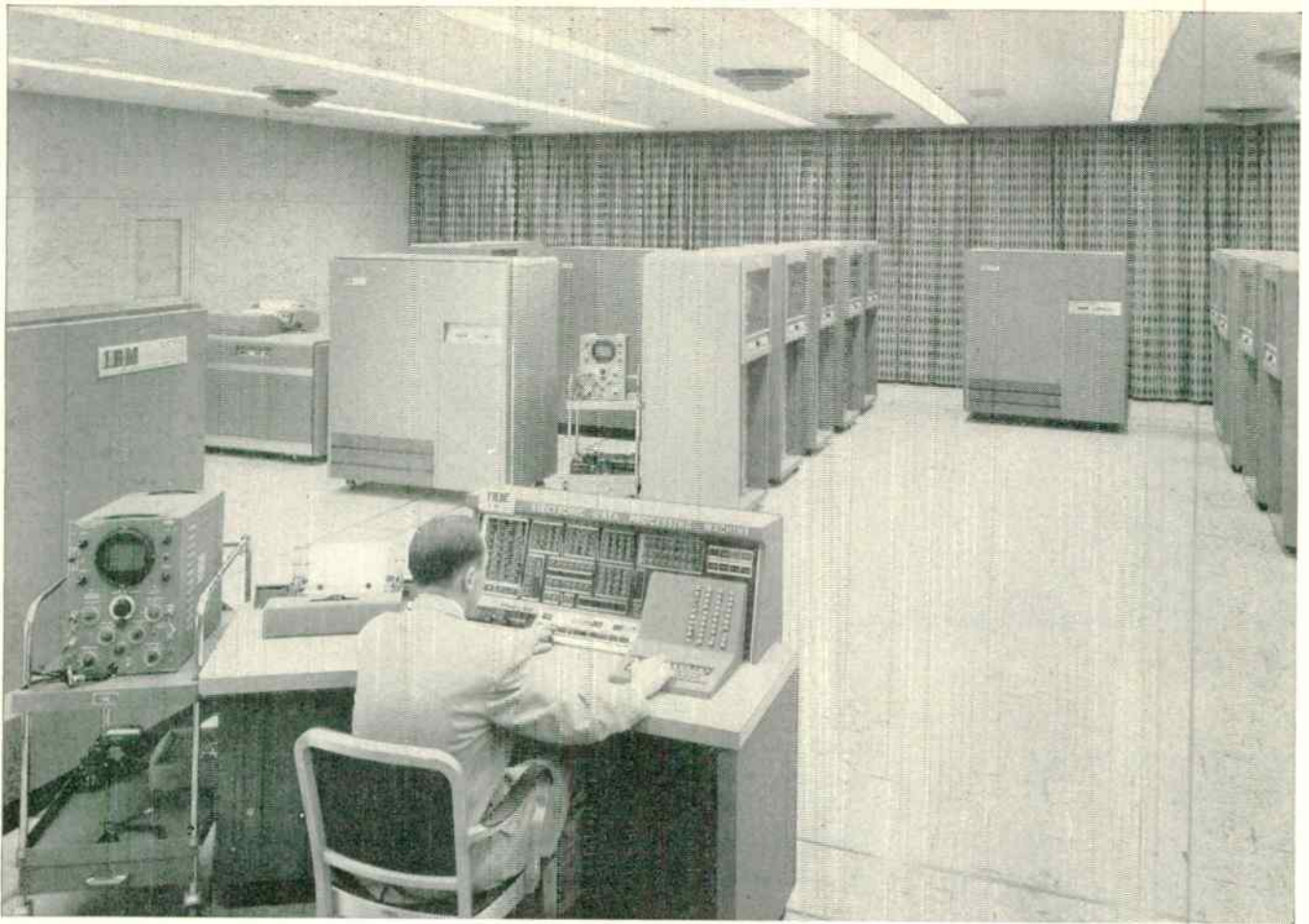

# IBM selects DU MONT TYPE 329\* as test oscillograph for their new type 702 computer



When IBM Corporation, world's largest manufacturer of computer equipment, produced their new Model 702, an essential phase of the project involved selection of a cathode-ray oscillograph to go into the field with each computer as standard test equipment. Requirements were strict.

IBM's approach to the problem was to conduct side-by-side evaluation with other competitive instruments. On the basis of actual performance, they selected the Du Mont Type 329 as their test oscillograph.

What are some of the primary reasons why IBM decided on the Du Mont Type 329? Excellent sensitivity—either d.c. or a.c. coupled. Precisely calibrated sweeps with movable notch magnification—ideal for making accurate measurements. Brightness—adequate for display of very fast pulses. Synchronization simplicity—

the Type 329 "locks in" on almost any type of signal. Stability—the trace remains steady as a rock despite power line fluctuations, etc. Reliability in service—calibration adjustment requires no extra test gear and is a simple one-step process. And virtually any tube may be replaced without special selection.

Another factor contributing to the selection of the Type 329 was the well known Du Mont Field Service Organization, which assures that regardless of where in the United States the equipment is used, swift, competent service facilities are in the immediate vicinity.

If you have instrumentation requirements, Du Mont facilities are always available for discussion and recommendations. Write us today for complete information on the Type 329, or on any problem you may have relating to cathode-ray instrumentation.

*\*"Modified slightly for IBM's application."*

# DU MONT

ALLEN B. DU MONT LABORATORIES, INC. • TECHNICAL SALES DEPARTMENT  
760 Bloomfield Avenue, Clifton, New Jersey

help yourself to more dollars worth of quiet  
specify the new, small



# 2N133 low noise TRANSISTOR

First of a new series of Raytheon hermetically sealed transistors, the 2N133 is the smallest yet — 1/3 to 1/4 the size of the CK727 it replaces — and as low in noise as they come.

### Type 2N133

Important Characteristics—Grounded Emitter (30°C)  
Current Amplification Factor (Ave.).....50  
Power Gain\* (Ave.).....38db  
Noise Factor† (Ave.).....6.5db  
Noise Factor† (Max.).....10db

\*Source: 1000 ohms; Load: 20,000 ohms  
†In a one-cycle band at 1000 cycles  
Above characteristics obtained with Vc — 1.5 volts;  
Ic 0.5 mA

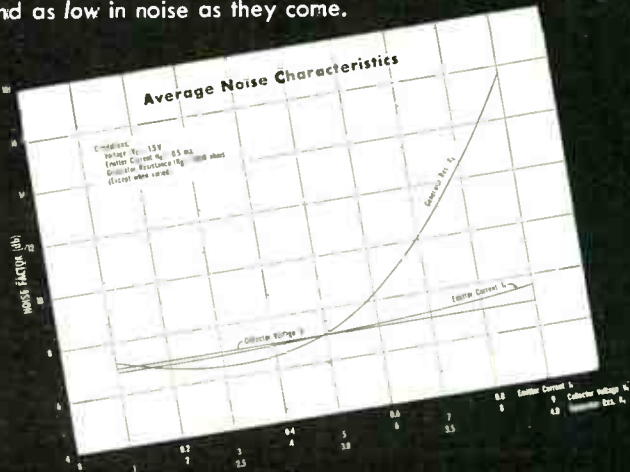
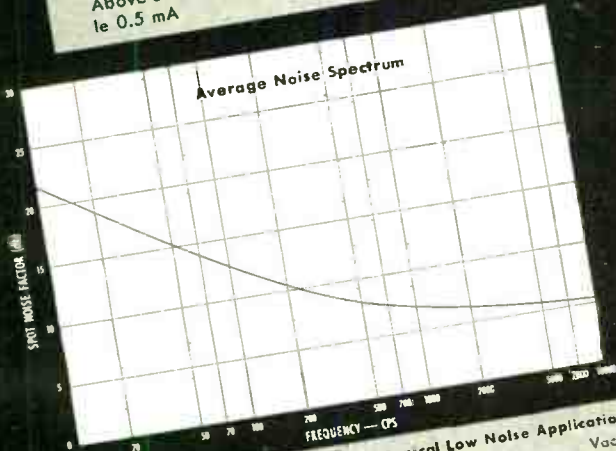

| Typical Low Noise Application PHONO PRE-AMPLIFIER  |                 |
|--|-----------------|
| No. of Stages  | 2               |
| Type of Response   | RIAA            |
| Gain (1KC)   | 32db            |
| Tube   | 1: 6SC7         |
| Transistors  | 0.4v<br>100 μv* |
| Signal Output†   | 72db            |
| Noise Output   |                 |
| S/N  |                 |
| †10 millivolts signal from reluctance cartridge<br>*exclusive of hum which may average 500 μv or higher with typical tubes |                 |

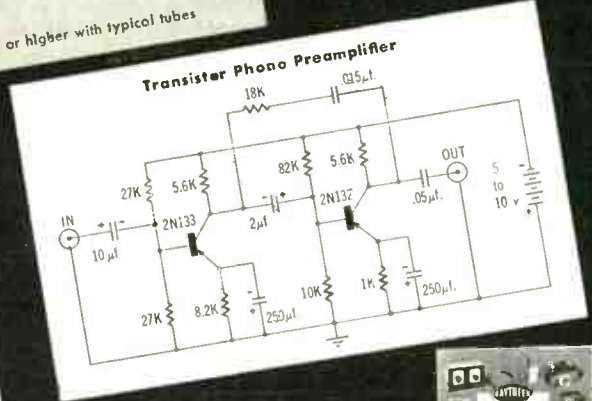
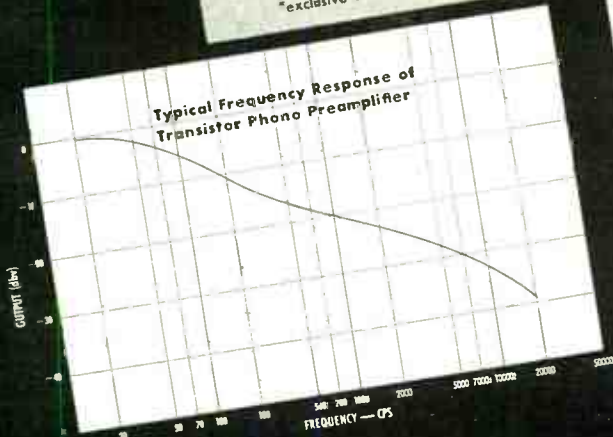

Get This RAYTHEON  
TRANSISTOR APPLICATION BOOK!  
116 pages — over 50 practical circuits  
including timers, receivers, oscillators, etc.  
all using low cost Raytheon Transistors.  
For your copy send 50¢ to Dept. P10,  
Raytheon Mfg. Co., Newton 58, Mass.



## RAYTHEON MANUFACTURING COMPANY

Semiconductor Division — Home Office: 15 Chapel St., Newton 58, Mass. Signal 4-7300  
For application information write or call the Home Office or: 2933 West Fullerton Avenue, Chicago 15, Illinois, NAional 2-7770  
589 Fifth Avenue, New York 17, New York, Plaza 9-3500 • 422 South La Brea Ave., Los Angeles 36, California, WEbster 8-2851



Excellence in Electronics

RAYTHEON MAKES ALL THESE:

RELIABLE COMMUNICATOR AND MINIATURE TUBES • SEMICONDUCTOR DIODES AND TRANSISTORS • MICROMECHANIC TUBES • MICROWAVE TUBES • RECEIVING AND PICTURE TUBES

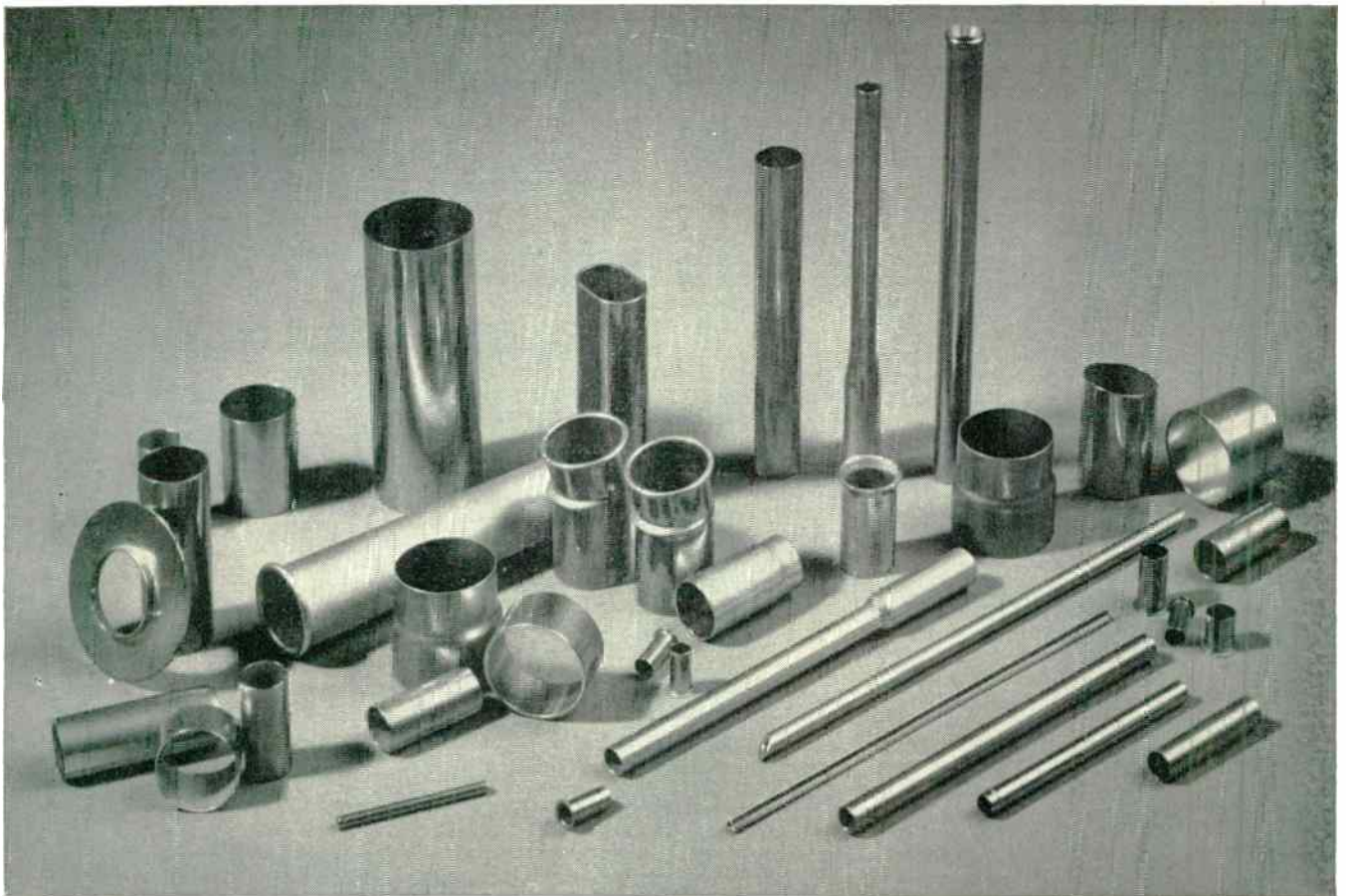

# Need close-tolerance tubular parts like these? Just send drawing

**Superior Tube has special facilities for doing complete job — efficiently, fast**

Save handling costs. When you need special close-tolerance tubular parts, let Superior Tube make them for you complete. Engineering assistance is available. Or just send drawing, indicating size, shape, metal analysis, temper and degree of finish desired.

Superior Tube's special facilities provide for flaring, cutting, deburring, expanding, bending, rolling ends, grooving, beading, coiling, flattening, punching, deep drawing, reducing, drilling, chamfering, shearing, slotting. A wide choice of different alloys of closely controlled analysis is available.

For prices and complete information on fabricated tubular parts on glass sealing alloys, write Superior Tube Company, 2506 Germantown Ave., Norristown, Pa.

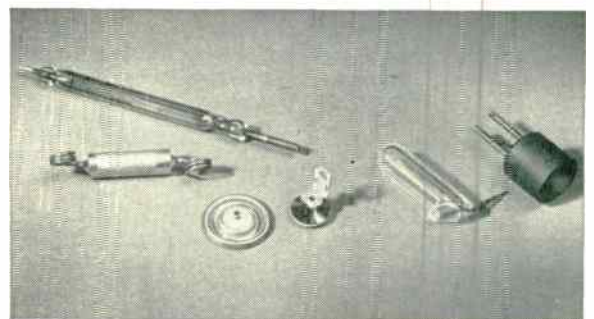

## GLASS SEALING ALLOYS

Glass-to-metal seals for conductor leads into vacuum tubes, hermetically sealed chambers, or controlled atmospheres. Typical uses are shown above, left to right: voltage regulator, capacitor, capacitor cap, button terminal, recording pen, refrigeration sniffer. Superior offers six standard uniform-expansion alloys cold drawn to close tolerances in Seamless or WELDRAWN\* tubing.

\*TM Superior Tube Co., Reg. U.S. Pat. Off.

# Superior Tube

The big name in small tubing

All analyses .010" to 5/8" O.D. Certain analyses in light walls up to 2 1/2" O.D.

**MISSILE TEST EQUIPMENT** For over ten years Farnsworth has participated in the design, development, and production of guidance and control systems and special test equipment for such missile programs as Terrier, Talos, Sparrow, and others. Numerous "firsts" in this field have been accomplished as a result of contributions in the form of missile receivers, control systems, power supplies and complete system analyses.

**IATRON** A charge-controlled cathode ray "memory" tube permits operator-controllable image persistence from one millisecond up to several minutes duration. Unusually brilliant picture presentation at a brightness level of up to 10,000 footlamberts for projection purposes.

**IMAGE CONVERTER TUBES** Used in any application where it is necessary or desirable to "see in the dark." Convert an infrared image into a visible image. Applications: medical and biological research, hot-body observation, temperature distribution, crime detection, security, and photography.

**INFRARED VIEWER** This unique, compact, easy to handle viewer is a valuable tool for crime detection, research and industrial application. Observation of objects or scenes in the dark is easily accomplished when they are illuminated by infrared radiation.

**PHOTOMULTIPLIER TUBES** Responsive in the near infrared spectrum featuring sensitivities as high as 50 amperes per lumen of incident radiation. Applications include photometric measurements for industrial and scientific uses.

**IMAGE DISSECTOR** A highly versatile TV camera tube particularly well adapted for use as a slide or facsimile scanner. This tube can be constructed in a variety of types to meet special requirements.

**RADAR RANGE CALIBRATOR, AN/UPM-11A** A precision instrument incorporating both "Radar" and "Beacon" functions. The equipment operates as a radar transponder in that pulsed r-f energy fed into the equipment results in a series of return echo pulses being fed back from the equipment to the radar under calibration. This simulates radar targets at accurately determined ranges.

**PORTABLE CABLE TESTER** Designed for testing all radio frequency cables that will accommodate, or can be adapted to, type "HN", "N", or "BNC" connectors. It will supply a d-c voltage up to 12,000 volts provided the current drain is negligible, and current surges of at least 3,000 amperes peak into a load of 0.05 ohm at room temperature.

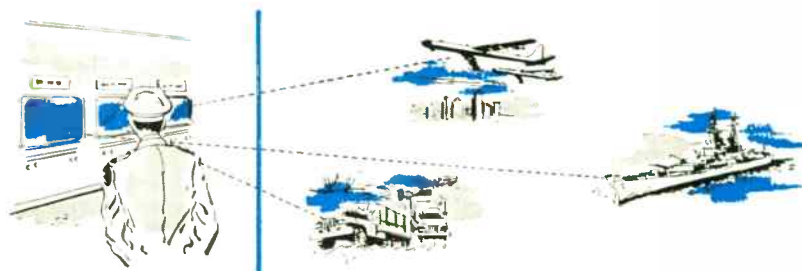





**MORE THAN 30 YEARS** experience in electronic television bring you Farnsworth's model 600A standard Industrial Television system. Military and industrial uses of this great new medium are rapidly becoming common-place but only Farnsworth can offer you this experience plus the skills accumulated over years of successful design and

# Farnsworth

*vision . . . beyond the range of sight . . .*

production of complex military electronic equipment. In the air, on the sea, in the factory, in your business—there is a place for industrial television in your future. Why not use the best?

|  |   |
|--|---|
| <p><b>ELECTRONICS</b><br/>THE KEY TO<br/>AMAZING<br/>TOMORROWS</p> |  <p>Applied Physics, Circuit Research, Solid State Physics, Low Temperature Physics.</p>         |
| <p><b>RESEARCH</b></p>   |  <p>Transmitters and Receivers, Computers, Microwave Components, Pulse-Coding and Circuitry.</p> |
| <p><b>RADAR</b></p>  |  <p>Photomultipliers, Storage Tubes, Image Tubes, Infrared Tubes.</p>                            |
| <p><b>ELECTRON TUBES</b></p>                                       |  <p>Guidance and Control Systems, Test Equipment.</p>  |
| <p><b>MISSILE</b></p>  |   |

**FARNSWORTH ELECTRONICS COMPANY • FORT WAYNE, INDIANA**  
a division of International Telephone and Telegraph Corporation

TOWER FOOTING  
INSULATORS FOR  
SELF-SUPPORTING  
RADIATORS

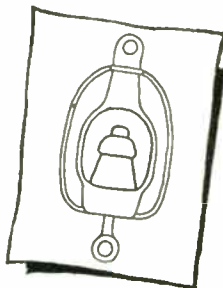
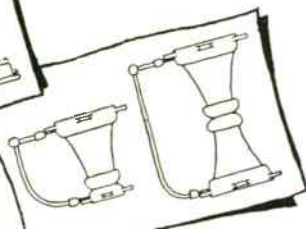
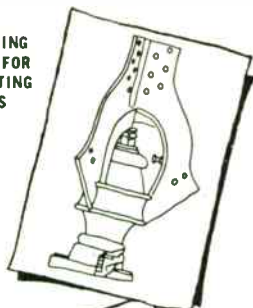
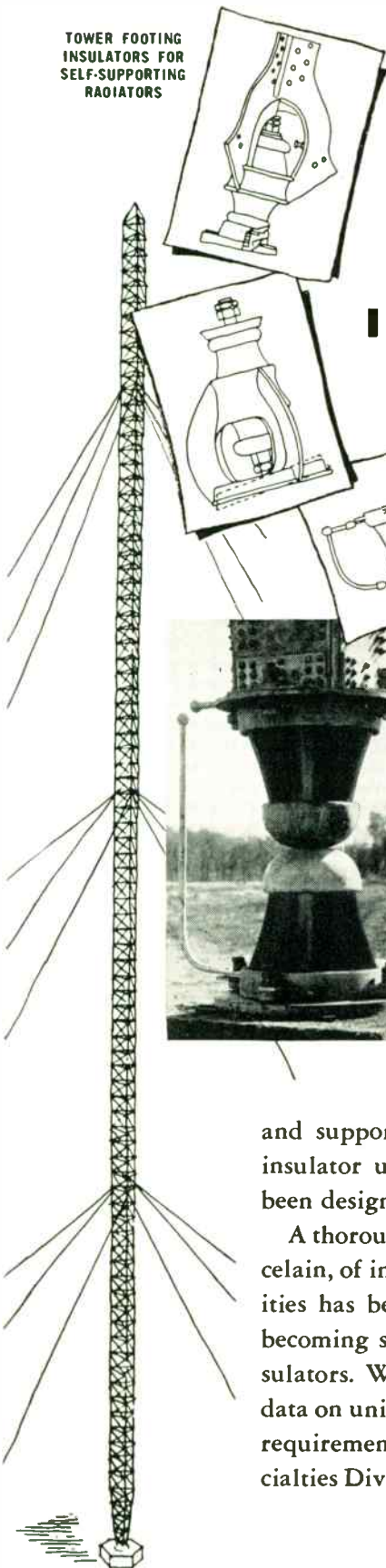

MAST BASE  
INSULATORS

RADIO GUY  
INSULATOR



## LAPP ANTENNA TOWER INSULATORS

We at Lapp are mighty proud of our record in the field of tower insulators. Over 30 years ago, the first insulated broadcasting tower was erected—on Lapp insulators. Since then, most of the large radio towers in the world have been insulated and supported by Lapp insulators. Single base insulator units for structures of this type have been design-tested to over 3,500,000 pounds.

A thorough knowledge of the properties of porcelain, of insulator mechanics and electrical qualities has been responsible for Lapp's success in becoming such an important source of radio insulators. Write for description and specification data on units for any antenna structure insulating requirement. Lapp Insulator Co., Inc., Radio Specialties Division, 254 Sumner Street, LeRoy, N. Y.

# Lapp

New Vectron VFS 250

Variable Frequency  
Power Supply



**FOR TESTING:**

Airborne Electronic Equipment  
Airborne Electrical Systems  
Servo Amplifiers and Equipment  
Synchro and Selsyn Systems  
Transformers and Inductors  
Export and Foreign Equipment

**FOR POWERING:**

Vibration Shakers  
Choppers and Vibrators  
Magnetic Amplifiers

**FOR CONTROLLING:**

Synchronous Motors  
Processing Equipment

- Full negative feedback networks for instantaneous voltage control.
- Built-in two range stabilized frequency generator.
- Grounded output with polarized receptacle for maximum safety.
- Full accessibility to all tubes and components.
- Compact, semi-portable package for bench use.

|                                     |  |
|-------------------------------------|--|
| Output Power at 100 to 130V         | 250VA continuous<br>300VA intermittent       |
| Output Frequency                    | 45-2,000 cycles                              |
| Output Voltage                      | 0-130 Volts                                  |
| Output Regulation zero to full load | ± 1% to 1,000 cycles<br>± 2% to 2,000 cycles |
| Line Regulation at 250VA            | ± 1% maximum change for 105-125V input       |

Flexible, can be supplied with limited frequency ranges 45-75 cycles and/or 320-480 cycles, with stabilized single frequency tuning fork or single range to cover entire frequency spread as required. An external frequency source may be used. Can be furnished with complete frequency programming equipment built in for fixed or variable cycle. Metering of output voltage, current and/or frequency can be included.



For detailed information, see your Vectron Commercial Test Equipment Representative or write direct for "Advance Bulletin" VFS 250.

**VECTRON, inc.**

Electronic and Electro-Mechanical Equipment  
402 MAIN STREET, WALTHAM 54, MASS.

VECTRON FOR DESIGN AND MANUFACTURE OF:  
Precision Electronic Components    Microwave Test Equipment  
Electronic Networks and Filters    Radar Units and Systems  
Complete Electronic Systems    Special Test Instruments  
Variable Frequency Power Supplies    Electronic Control Units



# Redesigned

## to solve your horizontal deflection problems



—these Sylvania deflection amplifier tubes offer higher plate currents, greater dissipation

Here is a full line of Sylvania Tubes—made to take the tighter conditions of horizontal deflection circuits in streamlined TV chassis designs.

New plate and grid designs achieve minimum zero bias plate to screen grid current ratios of 10 to 1. Plate dissipation has been increased to provide more stable performance throughout tube life. Designed to exhibit low plate knee characteristics, these tubes eliminate “snivet” problems when operated properly within ratings.

Whatever the nature of your TV design problem, Sylvania Tubes are “circuit-designed and circuit-tested” to meet your needs.

### Deflection Types for Transformer Circuits

6BQ6GTA    6CD6GA  
6CU6        6DQ6

### Deflection Types for Series—String circuits

12BQ6GTA    12CU6  
25BQ6GTA    25CD6GA  
12DQ6



SYLVANIA ELECTRIC PRODUCTS INC.  
1740 Broadway, New York 19, N. Y.  
In Canada: Sylvania Electric (Canada) Ltd.  
University Tower Building, Montreal

SYLVANIA ELECTRIC PRODUCTS INC.  
Dept. 132P, 1740 Broadway, New York 19, N. Y.

Please send complete data on “circuit-designed and circuit-tested” deflection amplifier types.

Check other tube interests.

- |  |  |
|--|--|
| <input type="checkbox"/> Other entertainment types | <input type="checkbox"/> Control equipment types |
| <input type="checkbox"/> Military types            | <input type="checkbox"/> Test equipment types    |
| <input type="checkbox"/> Special-Purpose types     | <input type="checkbox"/> _____ types             |

Name \_\_\_\_\_

Address \_\_\_\_\_

City \_\_\_\_\_ Zone \_\_\_\_\_ State \_\_\_\_\_

LIGHTING • RADIO • ELECTRONICS • TELEVISION • ATOMIC ENERGY

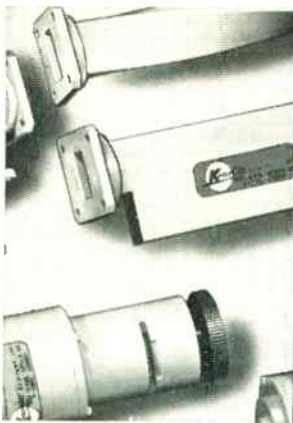

® PATENTED

FERRITE ISOLATOR  
MODEL W152-1A



# KEARFOTT ANNOUNCES a new rotation-type ferrite isolator\*

The new Ferrite Isolator is a useful device with applications such as oscillator isolation with the following advantages to system performance:

- Reduces long-line loading
- Prevents undesired frequency shift
- Insures uniform power output
- Improves transmitted pulse spectrum

The charts indicate the exceptional performance of this light-weight unit (less than 2 lbs.)

#### REVERSE ISOLATION

This shows very clearly the good unilateral decoupling effect between the antenna and transmitter.

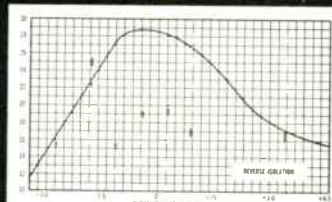

#### INSERTION LOSS

This illustrates the exceptionally low loss from the transmitter to the antenna.

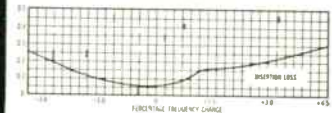

#### VOLTAGE STANDING WAVE RATIO

The VSWR introduced into the transmission line by the 'Isolator.'

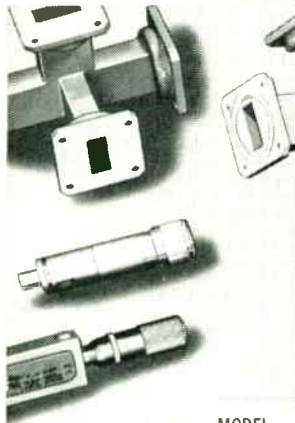
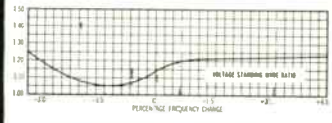

MODEL  
W154-1A



Special units can be produced by Kearfott to meet your frequency requirements.

FERRITE RESONANCE ABSORPTION TRANSVERSE FIELD ISOLATOR for use where high power handling capacity is required. This new model operates over a 10% band width, with these electrical characteristics:

- Greater than 9 db isolation
- Less than 0.4 db insertion loss
- VSWR less than 1.03

Write or call today for complete detailed information on Kearfott components and their application to your Radar Systems.

**Kearfott** COMPANY, INC.  
LITTLE FALLS, NEW JERSEY  
WESTERN MANUFACTURING DIVISION  
14844 OXNARD ST. • VAN NUYS, CALIF.  
A SUBSIDIARY OF GENERAL PRECISION EQUIPMENT CORPORATION

#### SALES OFFICES

Eastern Office:  
1378 Main Ave.  
Clifton, N.J.

Midwest Office:  
188 W. Randolph St.  
Chicago, Ill.

South Central  
Office:  
6115 Denton Drive  
Dallas, Texas

Western Area  
Office:  
253 Vinedo Ave.  
Pasadena, Calif.



The following admissions and transfers were approved and are now effective:

#### Transfer to Senior Member

- Aitken, K. M., Box 192, Merritt Island, Fla.  
Alexander, S. N., National Bureau of Standards, Bldg. 10, Washington, D. C.  
Atkins, G. T., 571 Nightingale Dr., Miami Springs, Fla.  
Barus, C., Electrical Engineering Dept., Swarthmore College, Swarthmore, Pa.  
Bowen, D. C., Radio Corp. of America, Bldg. 7-2, Camden 2, N. J.  
Brewer, I. F., 168 Ludlow St., Portland 5, Maine  
Buyer, E. M., 70 Grove St., Ramsey, N. J.  
Camillo, C. C., 4358 S. Artesian Ave., Chicago 32, Ill.  
Clayton, J. F., Bendix Aviation Corp., Research Laboratory Division, Bldg. 351, USNMATC, Pt. Mugu, Port Hueneme, Calif.  
Earls, H. G., 202 Byron Rd., Fayetteville, N. Y.  
Edgerly, J. J., Office of Naval Research, Special Devices Center, Port Washington, L. I., N. Y.  
Fannin, B. M., 5206 Valley Oak, Austin, Tex.  
Flemons, R. S., 1444 Sherwood Cres., Peterborough, Ont., Canada  
Fragola, C. F., Sperry Gyroscope Co., Lake Success, L. I., N. Y.  
Fraser, D. W., 2488B Morosgo PL, N.E., Atlanta, Ga.  
German, J. P., 1515 W. 32, Austin 3, Tex.  
Green, P. E., Jr., 29 Granison Rd., Weston 93, Mass.  
Haines, B. P., Philco Corporation, "C" & Tioga Sts., Philadelphia, Pa.  
Hampton, J. W., 1627 Mayflower Dr., Irving, Tex.  
Harpster, W. T., 48 Keats Ave., Town of Tonawanda, N. Y.  
Hartwig, W. H., University of Texas, Austin, Tex.  
Heavside, M. G., 27 Whitney Rd., Newtonville 60, Mass.  
Hogg, F. L., 37 Stormont Rd., Highgate, London N. 6, England  
Houghton, E. G., Box 134, Hq. USAF Security Service, San Antonio, Tex.  
Jackson, H. L., Westinghouse Electric Corp., 2519 Wilkens Ave., Baltimore 3, Md.  
Jacobson, H. P., Jr., 1500 Oakland Rd., N.E., Cedar Rapids, Iowa  
Junken, L. H., 118 Iroquois La., Liverpool, N. Y.  
Kellogg, D. S., 9 Bradley Farms, Chappaqua, N. Y.  
McCracken, L. G., Jr., 2340 Massachusetts Ave., N.W., Washington, D. C.  
Mercier, A. E., 391 Fifth Ave., Cedarhurst, L. I., N. Y.  
Meyerson, M., West Caranetta Terr., Lakewood, N. J.  
Mickey, D. D., Jr., General Electric Co., 316 E. Ninth St., Owensboro, Ky.  
Munn, A. J., Bell Telephone Laboratories, Inc., Whippany, N. J.  
Palmer, J. R., 324 Homan Ave., State College, Pa.  
Plotkin, M., Brookhaven National Laboratory, Upton, L. I., N. Y.  
Ringo, R. M., Collins Radio Co., Cedar Rapids, Iowa  
Roth, J. H., 430 Princeton Rd., Haddonfield, N. J.  
Ruehlmann, H. E., 1804 Jordan Park Apts., Fullerton, Pa.  
Schauer, J. D., 408 Cornell, S.E., Albuquerque, N. Mex.  
Shub, L., 299 University Ave., Kenmore 23, N. Y.  
Smith, D. A., 505 S. Mesa Dr., Mesa, Ariz.  
Waters, R. A., 4 Gordon St., Waltham 54, Mass.

(Continued on page 34A)



# Collins PRECISION VFO — Ready-to-Install ACCURACY and STABILITY

Accuracy and stability — the two most important features in Oscillator performance — can now easily be incorporated into your high-performance design, cutting engineering time to a minimum. Whether your project is a transmitter, receiver, test equipment, frequency standard or others, Collins offers a ready-to-install Variable Frequency Oscillator known for its linear calibration and stable output.

- Outstanding Stability
  - Average 24-hour stability under fixed-station conditions .003% or better.
  - Single-knob tuning with backlash of less than one cycle in 20 kc through use of mechanical loading and precision ballbearing construction.
  - Frequency modulation less than 100 cps under 5 G's acceleration at 60 cycles.
- Compact, ready-to-operate design.
- Linearity of calibration better than 1 kc throughout tuning range with multiple-turn tuning.
- Sealed against atmospheric changes.
- Available in fundamental ranges from 300 kc to 4 mc. Individual models achieve up to 2 to 1 tuning ratio.
- Uses standard power supply voltages.
- Each unit 100% tested under lab conditions to rigid specifications.
- Ease of installation.

### Frequency Ranges Available

|        |                |
|--------|----------------|
| 70E-1  | 1.0-1.5 mc     |
| 70E-10 | 600-800 kc     |
| 70E-12 | 1.955-2.955 mc |
| 70E-15 | 2.0-3.0 mc     |
| 70E-20 | 1.65-2.05 mc   |
| 70E-21 | 300-400 kc     |
| 70E-25 | 2.0-4.0 mc     |
| 70H-2  | 2.455-3.455 mc |
| 70H-3  | 1.5-3.0 mc     |

For requirements other than the above ranges or for detailed specifications write to the Collins office nearest you

**COLLINS RADIO COMPANY**

CEDAR RAPIDS, IOWA

261 Madison Avenue, NEW YORK 16, NEW YORK  
 1200 18th Street N.W., WASHINGTON, D. C.  
 1930 Hi-Line Drive, DALLAS 2, TEXAS  
 2700 W. Olive Avenue, BURBANK, CALIFORNIA  
 COLLINS RADIO COMPANY OF CANADA, LTD.  
 77 Metcalfe Street, OTTAWA 4, ONTARIO



# VARIABLE DELAY NETWORKS

by **ESC**

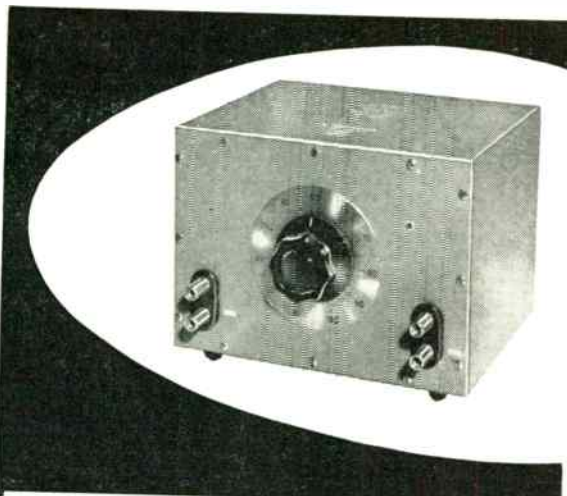

Unlike conventional tapped delay lines (which must be terminated in a high impedance at the selected tap), the #300 series provides a variable delay between matched impedances. Available in ranges of 2  $\mu$ sec to 2000  $\mu$ sec; the #300 series delay networks afford flexibility in obtaining long delays, with time delay proportional to angular rotation of the control shaft.

Write for complete, new catalog!

**C O R P O R A T I O N**

534 Bergen Blvd., Palisades Park, New Jersey



## Further Proof of

# Getting to the bottom of things

... is most clearly demonstrated by what we are doing every hour of every day—year in and year out—to make a finer fixed CAPACITOR.

One of the many things you as users are interested in is the "LIFE OF THE CAPACITOR" under a multitude of operating conditions. We in the FAST organization have spared no expense to give you honest-to-goodness answers on this important factor in providing quality capacitors.

What follows is a summary of what we are doing to give you just that...

### I: RESEARCH AND DEVELOPMENT TESTS

AC and DC tests at various temperatures and voltages.

- 1—Investigation of Impregnants: (a) New impregnants AC/DC—synthetic and natural oils, resins and waxes. (b) Studies of impurities and additives.
- 2—Investigation of electrode separators and electrode materials: (a) Kraft papers—standard, low PF varieties, sundry densities and deionized. (b) Films—regenerated cellulose, polystyrene, teflon, "Mylar", Etc. (c) Electrodes—Dry annealed and neutral aluminum; and tin.
- 3—Number of groups tested: AC: over 800 involving more than 8000 units. DC: over 3700 involving more than 78,000 units.
- 4—Duration of tests: AC: many have been continuously under test for over 6 years. DC: many have been continuously under test for over 10 years.
- 5—Voltage range of tests: AC: 70 to 2400 volts at 60 and 400 cycles. DC: 140 to 44,000 volts.
- 6—Temperature range of tests: AC: Room to 130°C. DC:—55°C to +150°C.

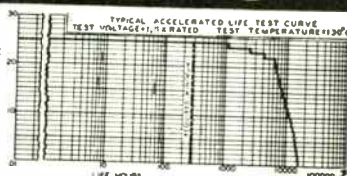

### II: PRODUCTION TESTS

#### A. Alternating Current

- 1—Heat runs on production lots—ultimate surface temperature rise.
- 2—Ultimate life hours of current production (periodic tests run).

#### B. Direct Current

- 1—Civilian Production: (a) ultimate life hours of capacitors taken from current production. (These test runs comprise over 1800 groups involving more than 21,000 units). (b) Ultimate life hours of capacitors after being stored in cartons from 1 to 24 months under normal variations in humidity and temperature. (These test runs comprise over 324 groups involving more than 3240 units).
  - 2—Military Production: (a) Test to applicable specifications (Mil-C-25; Mil-C-91; U. S. Army 71-1667; Etc). (b) These test runs comprise over 4200 groups involving more than 24,500 capacitors.
- Please note Carefully: at least 75% of the 134,740 capacitors included in the above tests were tested to ultimate destruction at voltages ranging from rated to 4 times rated and at operating temperatures from lower than, to maximum rated or in excess of. Many outside this group have not failed to date. Importantly too, this is a continuous policy of the company in sustaining its testing program throughout every day—year after year.

So, with pardonable pride, may we suggest "QUALITY CAPACITORS" is more than a catch-phrase as applied to FAST CAPACITORS?

\*Du Pont trade-mark for Polyester Film.

# JOHN E. FAST & Co.

Capacitor Specialists For  
Over A Third of A Century

3177 North Pulaski Road, Chicago 41, Ill.

"WHEN YOU THINK OF CAPACITORS . . . THINK FAST"



(Continued from page 32A)

Wilde, A. E., Jr., R.D. 1, Zeek Rd., Morris Plains, N. J.  
Williams, W. A., R.R. 3, Box 1033C, Evansville, Ind.

### Admission to Senior Member

- Albrecht, C. E., 2701 S. York St., Owensboro, Ky.  
Bahls, W. E., Radio Corp. of America, 415 S. Fifth St., Harrison, N. J.  
Callahan, J. G. P., 216 Telford Ave., Dayton 9, Ohio  
Collins, F. V., Bell and Howell, Dept. 804, 7100 McCormick Blvd., Chicago 45, Ill.  
Conillard, L. W., 2436 Franklin Ave., N.E., Cedar Rapids, Iowa  
Dickey, W. S., 5663 E. 18 St., Tucson, Ariz.  
Ferguson, S. A., 632 Giralda Dr., Los Altos, Calif.  
Froman, J., 1000 Geary St., San Francisco, Calif.  
Fuerst, L. L., Edif. "Venus," Venus a Quebrada Honda, Caracas, Venezuela  
Harries, W. L., 382 Marlborough St., Boston 15, Mass.  
Jackson, W. R., Vickers Armstrongs Ltd., Weybridge, Surrey, England  
Jones, H. S., Ireo Corp., 16 Hudson St., New York 13, N. Y.  
Lenzer, E., Fort Huachuca, Ariz.  
Moore, N. H., 148 Tuscaloosa Ave., Atlerton, Calif.  
Nesbit, E. E., 15719 Rayen St., Supelveda, Calif.  
Nicholas, J. C., Motorola Research Laboratory, 3102 N. Ingleside Dr., Phoenix, Ariz.  
Norton, C. A., c/o Remington Rand, Inc., Wilson Ave., S. Norwalk, Conn.  
Patin, O. E., 12563 DeBell St., Pacoima, Calif.  
Reeves, R., 96 Barons Ave., S. Hamilton, Ont., Canada  
Taylor, C. A., Conestoga Farms, Conestoga Rd., Malvern R.D. 1, Pa.  
Undesser, K., 3600 Bellevue Ave., Baltimore 6, Md.  
Vine, B. H., 51 Northview Dr., Lancaster, Pa.  
Vossen, B., 3903 N. Fourth St., Arlington 3, Va.

### Transfer to Member

- Abell, G. R., Jr., 82 College Ave., Poughkeepsie, N. Y.  
Abel-Harry, C. B., 60 Highbury, London, England  
Abrams, H., 123 Bragaw Ave., Newark 8, N. J.  
Achatz, R. V., Southern Indiana Telephone Co., Aurora, Ind.  
Achenbach, J. C., 50 Oak Ridge Dr., Haddonfield, N. J.  
Adams, J. T., 408 Diamond Ave., Gaithersburg, Md.  
Adams, M.M., 718 S. Delaware, Bartlesville, Okla.  
Adams, R. M., Box 8029, Austin 12, Tex.  
Adkison, W. M., 3509 Oakland Ave., S., Minneapolis, Minn.  
Aha, R. S., 726 Northern Hwy., East Hempstead L. I., N. Y.  
Ahearn, J. M., Box 442, Salt Lake City 10, Utah  
Ahern, C. R., 10405 Ewell Ave., Kensington, Md.  
Ahmad, M. M., c/o Mian Jamil Ahmad Sahib, Hous. No. 7-211, Mandi Bahaudin, Dist. Guirat, W. Pakistan  
Aird, A. W., RCA Communications, Inc., Rocky Point, L. I., N. Y.  
Albee, M. M., Aviation & Meteorological Dept., Army Elect. Proving Gd. Fort Huachuca, Ariz.  
Aldrich, D. H., R.D. 2, Baxter Apts., Endicott, N. Y.  
Aleo, J., 3861 Myron Ave., Dayton 6, Ohio  
Alexander, A. A., 58 Van Ness Ct., Maplewood, N. J.

(Continued on page 36A)

# INCREASE CIRCUIT RELIABILITY WITH **TI-RADELL** deposited carbon **RESISTORS**

newest line of precision components  
from Texas Instruments

For precise resistance values under extreme operating conditions, design with RADELL deposited carbon resistors — now manufactured by Texas Instruments. With resistance tolerance held to  $\pm 1\%$ , Texas Instruments RADELL resistors provide exceptional stability plus a wide range of resistance values. Like all TI components, they are manufactured to exacting instrument standards.

Texas Instruments RADELL resistors are mass-produced in three lines and in  $\frac{1}{2}$ , 1, and 2 watt sizes. Resistance values range from 25 ohms to 30 megohms.

**WRITE** for Bulletin No. DL-C 539 giving detailed specifications of all three lines of Texas Instruments RADELL resistors. Your best source for precision components, TI also manufactures a complete line of subminiature transformers as well as custom capacitors, delay lines, special transformers and other reliable electronic components.

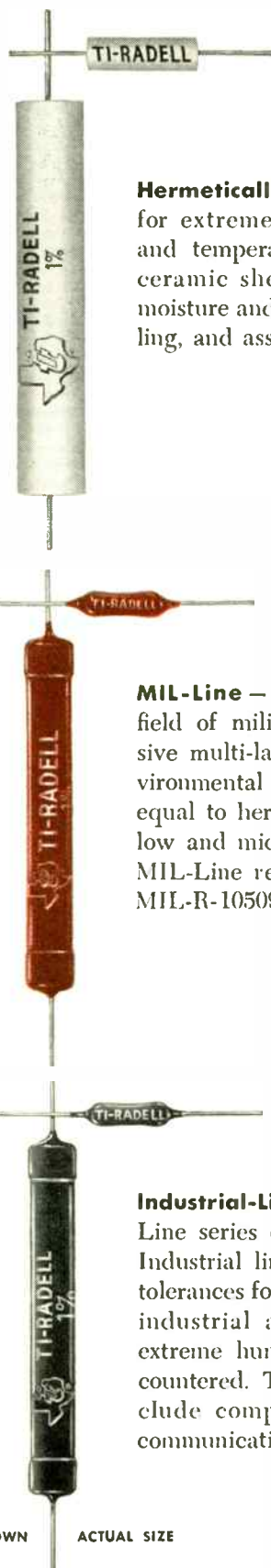

**Hermetically sealed line** — designed for extreme conditions of moisture and temperature. Specially treated ceramic shell effectively seals out moisture and air, resists abusive handling, and assures complete insulation.

**MIL-Line** — designed for the broad field of military applications. Exclusive multi-layer coating provides environmental protection substantially equal to hermetic sealing throughout low and middle ranges of resistance. MIL-Line resistors more than meet MIL-R-10509A specifications.

**Industrial-Line** — differs from MIL-Line series only in type of coating. Industrial line resistors provide close tolerances for military, instrument and industrial applications where less extreme humidity conditions are encountered. Typical applications include computers, test equipment, communication and control systems.

RESISTORS SHOWN      ACTUAL SIZE



**TEXAS INSTRUMENTS**  
INCORPORATED  
6000 LEMMON AVENUE      DALLAS 9, TEXAS

# SUPERSEDES 100-1000 MC SLOTTED SECTIONS!



- READS VSWR AND REFLECTION COEFFICIENT ANGLE DIRECTLY
- SMALL AND COMPACT
- LOW IN COST

## SPECIFICATIONS

Frequency Range:  
**100 to 1000 mc/s**

Residual VSWR:  
**Less than 1.05**

Accuracy of Reflection Coefficient Angle:  
**Better than  $\pm 5^\circ$**

Characteristic Impedance:  
**50 ohms**

Output Terminals:  
**Type N jack. Other interchangeable connectors**

Min. Input Signal:  
**Approx. 1 volt at 100 mc/s, 0.1 volt at 1000 mc/s**

Dimensions:  
**8" l. x 5" w. x 5 3/4" h.**

Weight:  
**4 1/2 lbs.**

The PRD Type 219 Standing Wave Detector is the *small package, low cost solution* for making measurements easily and accurately in the 100 to 1000 mc/s region. By connecting the output to a VSWR indicator, such as the PRD Type 277, VSWR may be read directly on the indicator meter. No special detection equipment is required. The reflection coefficient angle is easily determined merely by rotating the top drum dial to a minimum indication on the meter and reading the angle on the dial *directly in electrical degrees*. No calculations are required. The probe and crystal detector are self-contained.

Usually it is more convenient to work with VSWR and reflection coefficient angle directly instead of with other components of the measured impedance. When other quantities are also of interest, they can easily be read from a conventional impedance chart. Only \$475 f.o.b. N.Y. Write for PRD Reports, Vol. 3, No. 2, and for 1955 catalog.

## Polytechnic RESEARCH

202 TILLARY STREET  
BROOKLYN 1, N. Y.

Telephone:  
ULster 2-6800



## & DEVELOPMENT CO. INC

Midwest Sales Office:

1 SO. NORTHWEST HWY., PARK RIDGE, ILL. — TAICOT 3-3174

Western Sales Office:

737-41 SUITE 7, NO SEWARD ST HOLLYWOOD 38 CAL.-HD 5-5287



Membership

(Continued from page 34A)

- Alexander, R., 130 Lockland Ave., Framingham Center, Mass.
- Allen, J. E., Westinghouse Air Arm Div., Baltimore, Md.
- Allen, J. H., CINCNELM, Box 6, c/o FPO, New York, N. Y.
- Allen, M. H., Exeter Hotel, Seattle, Wash.
- Allen, R. L., Western Ontario University, London, Ont., Canada
- Allen, W. T., 206 Brompton Rd., Garden City, L. I., N. Y.
- Alliot, E. Jr., 455 W. 23 St., New York 11, N. Y.
- Allred, C. McK., National Bureau of Standards, Boulder, Colo.
- Alstad, N. J., Box 236, Weston 93, Mass.
- Amateek, K. V., 39-77—48 St., Long Island City 4, L. I., N. Y.
- Ambrosio, B. F., 459 1/2 Keiton Ave., Los Angeles 24, Calif.
- Ames, D., Oliver St., North Easton, Mass.
- Anoo, L. R., 425 Fourth St., S.W., Valley City, N. Dak.
- Anders, R. D., R.D. 2, Norristown, Pa.
- Andersen, R. K., 617 Birch Ave., Richland, Wash.
- Anderson, G. P., 5721—26 Ave., S., Minneapolis 17, Minn.
- Anderson, G. W., 9022 Keating, Skokie, Ill.
- Anderson, H. C., 136 Fleetwood Terr., Silver Spring, Md.
- Anderson, J. S., 4267 Coronado Ave., San Diego 7, Calif.
- Anderson, R. S., 1641—19 St., Manhattan Beach, Calif.
- Andrae, P. H., Directorate of Requirements, Rm. 50237, The Pentagon, Washington 25, D. C.
- Andreasen, I., 456-D Riva Ave., Milltown, N. J.
- Andrews, E., 237 McElroy Ave., Palisade, N. J.
- Andrews, F. T., Jr., Bell Telephone Labs., Inc., Murray Hill, N. J.
- Angevine, R. A., 46 Rhodes Dr., New Hyde Park, L. I., N. Y.
- Angst, D. C., 1933 Illinois, Vallejo, Calif.
- Anthony, D. J., 6431 Madrid Dr., San Diego 15, Calif.
- Apolenis, C. J., 301 Evergreen Dr., Moorestown, N. J.
- Applebaum, A., 1304 Ruppert Rd., Silver Spring, Md.
- Armour, R. B., 10711—23, N.E., Seattle 55, Wash.
- Armstrong, C. W., 17333 Sylvester Rd., Seattle 66, Wash.
- Armstrong, D. G., 297 Derby St., West Newton, Mass.
- Armstrong, H. D., 175 Yonge B'vd., Toronto 12, Ont., Canada
- Ash, E. A., Particle Laboratory, Queen Mary College, Mile End Rd., London, England
- Ashleman, F. C., Jr., 10723—23 Ave., N.E., Seattle, Wash.
- Ashman, A. B., 225 E. Fourth St., Cincinnati 2, Ohio
- Asmuth, J. L., Dept. of Electrical Engineering, University of Wisconsin, Madison, Wis.
- Astrow, M., 62-65 Saunders St., Rego Park, L. I., N. Y.
- Atkinson, C., Jr., 2433 Stanmore Dr., Houston 19, Tex.
- Atkinson, E. E., 1110 N. Vernon St., Arlington, Va.
- Atkinson, J. R., 334 S. Dixon Rd., Kokomo, Ind.
- Audo, P. D., 5669 N. Magnolia, Chicago 40, Ill.
- Augustus, I. M., 2650 Carpenter Rd., Ypsilanti, Mich.
- Austin, K. B., 5 Clare Terr., Crestwood, Tucka-hoe, N.Y.
- Aymar, E., 403 La Canada, La Joila, Calif.

(Continued on page 38A)

# RELIABILITY

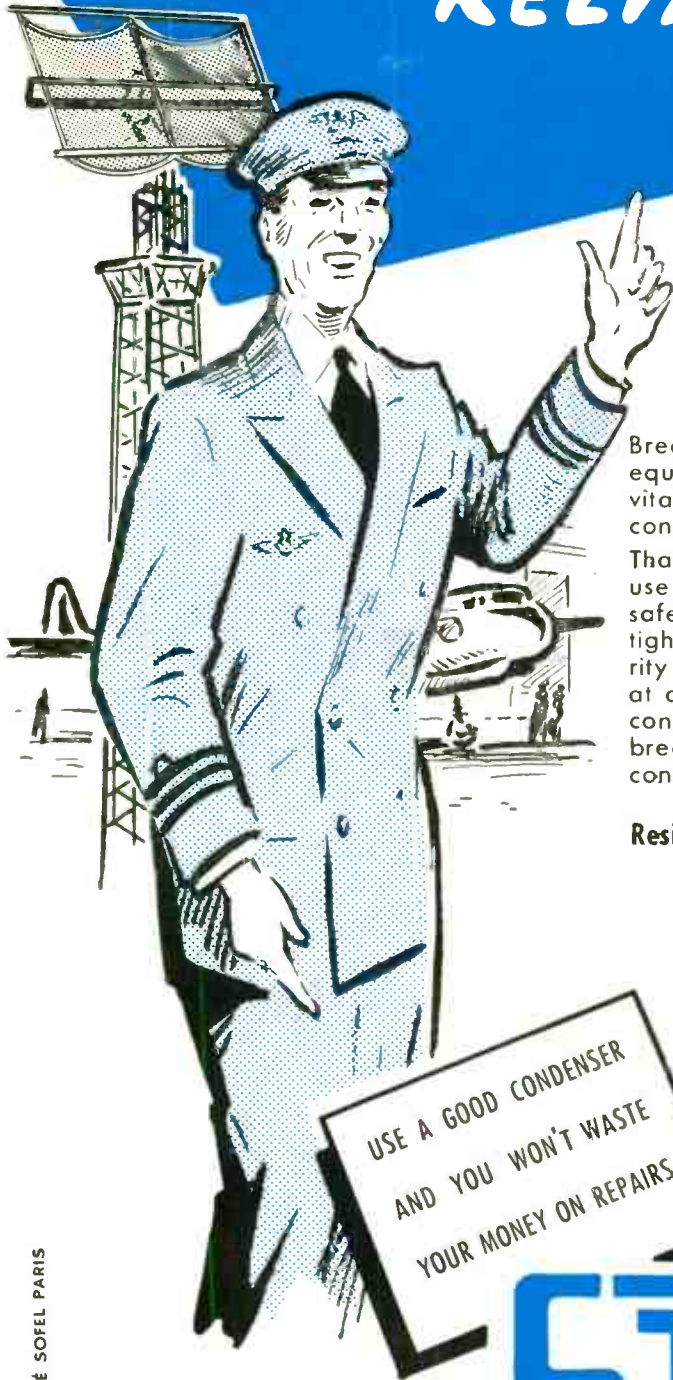

Breakdown of an airborne radio set or radar equipment may mean a plane crash. The vital component of any equipment is the condenser.

That's why aircraft equipment manufacturers use STEAFIX mica condensers for the greater safety of the passengers. Absolutely water-tight and stable, designed with a large security coefficient, submitted to exhaustive checks at all stages of manufacture, STEAFIX mica condensers insure a long service life without breakdown in all climatic and atmospheric conditions.

Resisting time and weather, the STEAFIX mica condensers insure your safety.

USE A GOOD CONDENSER  
AND YOU WON'T WASTE  
YOUR MONEY ON REPAIRS



# STÉAFIX

Société Anonyme au capital de 65.000.000 de Francs  
17, RUE FRANCOEUR, PARIS 18<sup>e</sup> - FRANCE  
TÉL. MONTmartre 02-93

*The European specialist in the mica capacitor*



(Continued from page 36A)

- Babbitt, E. B., 3917 W. 72 Terr., Prairie Village, Kans.
- Backmark, N., Skonstaholmsvagen 61, Stockholm, Sweden
- Backinoff, B., 12 Shetland Dr., Cranford, N. J.
- Bacon, D. R., 768 Boulevard, Westfield, N. J.
- Bailin, R. C., 224 Myrtle Ave., New Milford, N. J.
- Baird, G. A., B-3 Broadlawn Apts., 100 Charles Dr., Bryn Mawr, Pa.
- Baird, J. T., 1529 N. 37 St., Milwaukee 8, Wis.
- Baity, A. C., Jr., 2125 Patria St., Winston-Salem, N. C.
- Baker, A. L., Hq. Air Research & Development Command, Box 1395, Baltimore 3, Md.
- Baker, G. H., Bell Telephone Labs., Inc., 463 West St., New York, N. Y.
- Baker, G. W., Holbrook Dr., Stamford, Conn.
- Baker, H. F., 122 W. Maple Ave., Moorestown, N. J.
- Baker, J. H., Florida Hill Rd., Rt. 4, Ridgetield, Conn.
- Baldwin, R. S., KFRC, 1000 Van Ness Ave., San Francisco, Calif.
- Baldwin, T. W., 107-39 Princeton St., Jamaica 35, L. I., N. Y.
- Ball, M. T., 58 E. Quaker Rd., Orchard Park, N. Y.
- Baluta, R. E., 5518 Hoover St., Bethesda, Md.
- Bandtel, K. C., Radiation Laboratory, University of California, Bldg. 50, Rm. 235, Berkeley 4, Calif.
- Bankson, H. D., 4112 S. First St., Arlington 4, Va.
- Barkley, H. F., Box 155, Mapewood, N. J.
- Barlow, D. P., 16 Troy Pl., Schenectady, N. Y.
- Barlow, H. B., Jr., 2005 Industrial Trust Bldg., Providence, R. I.
- Barnard, E. H., 9621 Lorain Ave., Silver Spring, Md.
- Barnes, J. A., 452 Clemens Ave., Kirkwood 22, Mo.
- Barnes, L., Arabian American Oil Co., Dhahran, Saudi Arabia
- Barnes, O. C., 2910 N. 77 St., Bethel, Kans.
- Barnes, R. B., KRCA, National Broadcasting Co., Mt. Wilson, Calif.
- Barnett, J. T., 11296 Rudman Dr., Culver City, Calif.
- Barosin, S., 1050 Stratford Ave., New York 59, N. Y.
- Barriek, W. E., 2600 E. Oregon, Evansville, Ind.
- Bartholomew, D., 279 N. University St., Provo, Utah
- Bartik, W. J., 613 Delft Ln., Upper Moreland Twp., Halthoro, Pa.
- Bartlett, O. H., Jr., 3832 N. Ninth St., Arlington, Va.
- Bartlett, P. R., Radio Station KFRE, Fresno, Calif.
- Bateman, R., 5720 El Niño Rd., Falls Church, Va.
- Baumeister, E. A., 2350 N. 16 St., Milwaukee 6, Wis.
- Baumgartner, W. H., 328 Roslyn Ave., Glenside, Pa.
- Beane, T. E., 1335 Glenview St., Philadelphia 11, Pa.
- Beck, A. H. W., 119 North Hill, London N. 6, England
- Beckman, C., 817 Longshore St., Philadelphia 11, Pa.
- Bedford, S., Jr., 70 S. State St., Salt Lake City, Utah
- Beecher, D. W., 536 W. Montgomery Ave., Rockville, Md.
- Beecher, W. C., 3512 N. Nottingham, Arlington, Va.
- Beer, A. C., Battelle Memorial Institute, 505 King Ave., Columbus 1, Ohio
- Begeman, R. L., Sandborn, Ind.
- Beitz, R. E., 1101 S. Scoville Ave., Oak Park, Ill.

(Continued on page 40A)



THESE ARE ALWAYS OUR DESIGN OBJECTIVES IN BUILDING PRECISION COMPONENTS  
GYROS • SYNCHROS • SERVO MOTORS

From the time drafting pencil first touches paper until the inspector okays the finished product, every step we take with E-P precision components is geared directly to conform with Military Specifications.

So you can be sure that our Gyros, Synchros and Servo Motors will deliver required . . . or better . . . performance under all kinds of operating conditions.

Write, wire or call us for information on standard and special types . . . prices . . . and deliveries. ECLIPSE-PIONEER DIVISION, BENDIX AVIATION CORPORATION, TETERBORO, N. J.

*Eclipse-Pioneer*  
DIVISION



West Coast Office: 117 E. Provisencia, Burbank, Calif. • Export Sales: Bendix International Division, 205 E. 42nd St., New York 17, N. Y.



*Save assembly time . . .  
with quality-controlled ceramics*

*made of*

**ALSiMAG<sup>®</sup>**

Your line workers will appreciate the ease and speed with which they can assemble ALSiMag ceramics. Your production planning staff will be well pleased with the excellent quality as well as the rapid delivery of these parts.

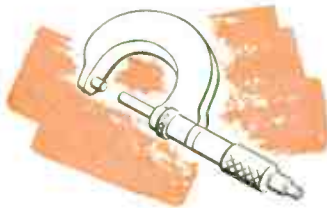

Physical dimensions and tolerances are checked at every key stage of manufacture by thoroughly trained Quality Control inspectors to insure shipment of a superior product.

Four large, completely equipped plants assure you of hundreds—or hundreds of thousands—of ALSiMag precision made parts when you want them.

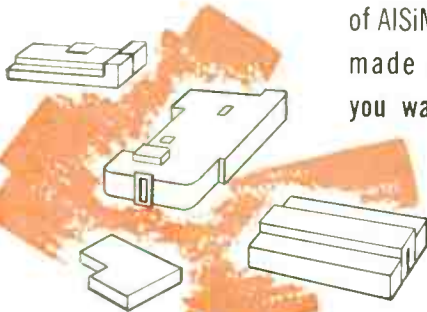

You can confidently specify ALSiMag ceramics—backed by over fifty years of specialized experience in the technical ceramics field.

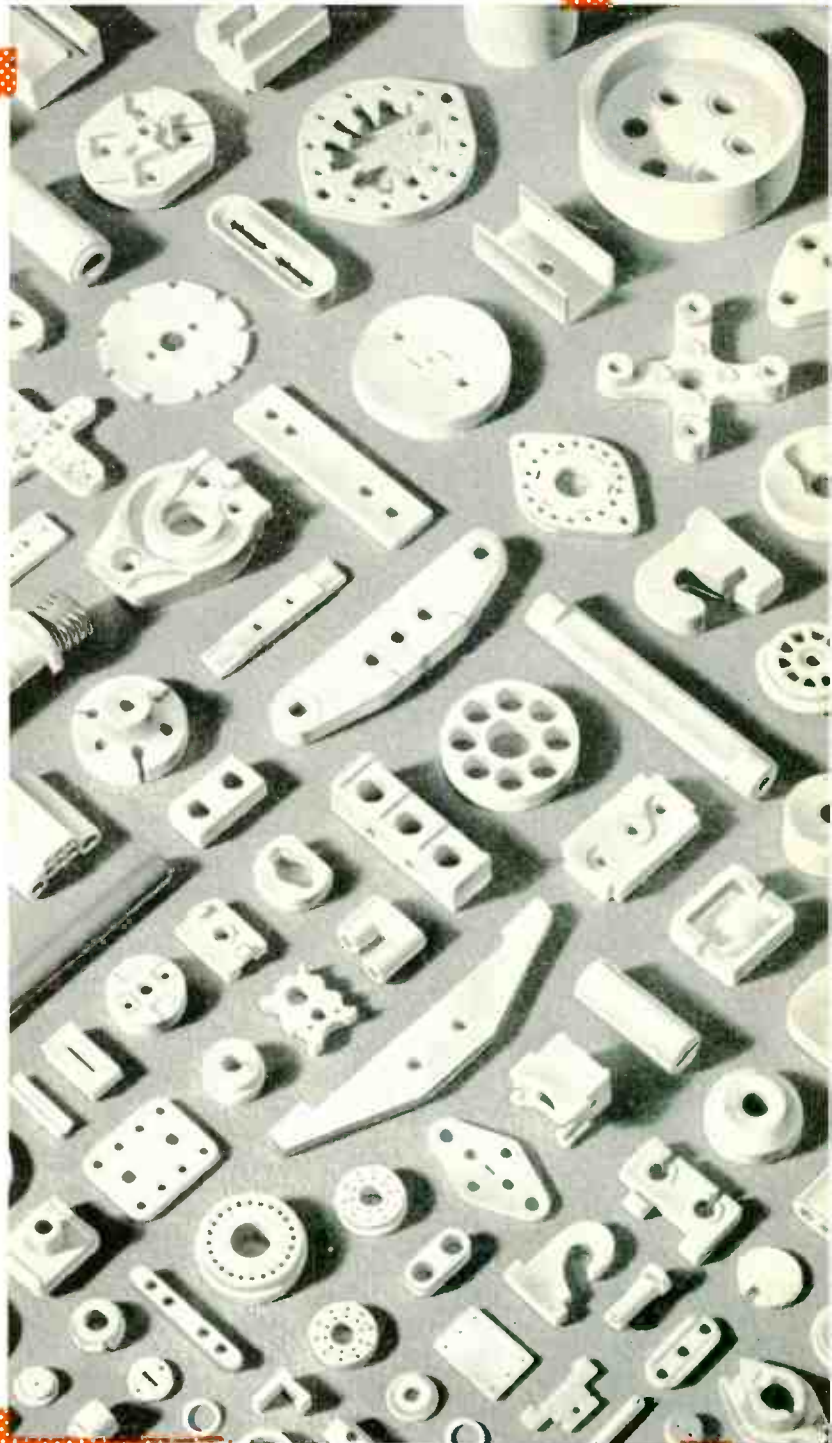

54TH YEAR OF CERAMIC LEADERSHIP

**AMERICAN LAVA CORPORATION**

A SUBSIDIARY OF MINNESOTA MINING AND MANUFACTURING COMPANY

CHATTANOOGA 5, TENNESSEE

Branch offices in these cities (see your local telephone directory): Cambridge, Mass. • Chicago, Ill. • Cleveland, Ohio • Dallas-Houston, Texas • Indianapolis, Ind. • Los Angeles, Calif. • Newark, N. J. • Philadelphia-Pittsburgh, Pa. • St. Louis, Mo. • South San Francisco, Calif. • Syracuse, N. Y. • Tulsa, Okla. Canada: Irvington Var-nish & Insulator Div., Minnesota Mining & Mfg. of Canada, Ltd., P. O. Box 757, London, Ontario. All other export: Minnesota Mining & Mfg. Co., International Division, 99 Park Avenue, New York, N. Y.

**This ONE instrument checks RF, IF,  
and AF performance of receivers**



MODEL 82

## MEASUREMENTS'

# Standard Signal Generator

Frequency Range: 20 cycles-50 mc.

The Model 82 Standard Signal Generator provides extremely wide frequency coverage. It comprises a low-frequency oscillator covering the range from 20 cycles to 200 kc., and a high-frequency oscillator in the range from 80 kc. to 50 mc.

It is designed for audio and radio frequency measurements of AM, FM and television receivers; for testing and checking the frequency response of audio systems; as a driving source for AF and RF bridges; for testing video and wide-band amplifiers.

### SPECIFICATIONS:

**FREQUENCY RANGE:** 20 cps to 200 kc. in four ranges. 80 kc. to 50 mc. in seven ranges, plus one blank range.

**FREQUENCY CALIBRATION:** Each range individually calibrated. 20 cps to 200 kc. accurate to  $\pm 5\%$ . 80 kc. to 50 mc. accurate to  $\pm 1\%$ .

**OUTPUT VOLTAGE AND IMPEDANCE:** 0-50 v. across 7500 ohms from 20 cycles to 200 kc.; Output voltage and impedance in this range can be reduced by external attenuator. 0.1  $\mu$ v. to 1 v. across 50 ohms over most of the range from 80 kc. to 50 mc.

**MODULATION:** Continuously variable from 0-50% from 20 cycles to 20 kc. from internal variable oscillator or external source.

**HARMONIC OUTPUT:** Less than 1% from 20 cycles to 20 kc.; 3% or less from 20 kc. to 50 mc.

**LEAKAGE AND STRAY FIELD:** Less than 1  $\mu$ v. from 80 kc. to 50 mc.

**POWER SUPPLY:** 117 v., 50-60 cycles. 75 watts.

### FEATURES:

- Continuous frequency coverage from 20 cycles to 50 mc.
- Direct-reading individually calibrated dials.
- Low harmonic content.
- Accurate, metered output.
- Mutual inductance type attenuator for high frequency oscillator.
- Stray field and leakage negligible.
- Completely self-contained.



**Membership**

(Continued from page 38A)

- Belfi, J. L., 10 Downing St., New York 14, N. Y.  
 Bell, J. S., 2424 Richelieu Pl., Scotch Plains, N. J.  
 Bemis, P. S., A. D. T. Co., Inc., 155 Sixth Ave., New York 13, N. Y.  
 Bender, D. R., 126 Village St., Marblehead, Mass.  
 Benkley, F. G., 31 Indian Hill Rd., Arlington 74, Mass.  
 Benson, S. E., 215 W. Walnut La., Philadelphia, Pa.  
 Bereza, A., 739 Second Ave., New York 16, N. Y.  
 Berge, P. J., 245-32-76 Ave., Bellerose, L. I., N. Y.  
 Berger, D., 6550 S. Ingleside, Chicago 37, Ill.  
 Berger, L. L., 514 W. Third St., Santa Ana, Calif.  
 Berger, J. L., 995 E. 181 St., New York 60, N. Y.  
 Berger, M., 3733 Laurel Ave., Brooklyn 24, N. Y.  
 Berghoefer, F. G., 1080 N. Manchester St., Arlington, Va.  
 Bergmann, H. M., 205 Edgewood Ave., New Haven 11, Conn.  
 Berkowitz, M. W., 50-36-190 St., Flushing, L. I., N. Y.  
 Berkowitz, R. S., 8312 Lynnewood Rd., Philadelphia 19, Pa.  
 Berlin, W. N., 5910 Melvin St., Tarzana, Calif.  
 Bernat, L., 135 S. LaSalle St., Chicago 3, Ill.  
 Bernhardt, E. C., R.R. 2, Box 200, Ventura, Calif.  
 Bernin, V. M., 105 Berkshire La., Mt. Prospect, Ill.  
 Bernsley, J. T., 75 Transverse Rd., Garden City, L. I., N. Y.  
 Berriman, M., 7363-255 St., Glen Oaks, L. I., N. Y.  
 Berry, R. E., 210 S. Lombard Ave., Lombard, Ill.  
 Bethge, C. E., 4434 St., Barnabas Rd., Washington 21, D. C.  
 Betzer, W. E., USS Mt. McKinley "AGC-7," FPO, San Francisco, Calif.  
 Bialek, S. T., 2446 N. California Ave., Chicago 47, Ill.  
 Biamonte, O. A., 5843 Hud-on Blvd., North Bergen, N. J.  
 Bianco, J. F., 39 Outlook Rd., Wakefield, Mass.  
 Biernat, W. M., 3034 W. Fullerton Ave., Chicago 47, Ill.  
 Biggs, O. H., 56 Colon St., Beverly, Mass.  
 Binzel, M. S., 431 Alice Ave., Kirkwood 22, Mo.  
 Biosca, L. F., 719 Dartmouth Ave., Silver Spring, Md.  
 Birch, R. S., Jr., 800 Sistina Ave., Coral Gables, Fla.  
 Birenbaum, L., 875 E. 180 St., New York 60, N. Y.  
 Birnbaum, G., 921-13 St., Boulder, Colo.  
 Bishop, H. M., 52 Montauk Ave., New London, Conn.  
 Bixby, W. L., 53 Florence St., Wollaston 70, Mass.  
 Black, D. R., 2614 Minnesota Ave., St. Louis, Mo.  
 Blackman, R. B., 463 West St., New York 14, N. Y.  
 Blanchard, J. W., 91 South St., Auburn, N. Y.  
 Blasdel, F. G., Jr., U.S. Naval War College, Newport, R. I.  
 Block, F. G., Chestnut View Dr., R.D. 1, Lancaster, Pa.  
 Block, K. A., 3567 Ray St., San Diego 4, Calif.  
 Bloemsma, J., Mient 551, The Hague, Holland  
 Blonder, I. S., 526-536 North Ave., Westfield, N. J.  
 Bloom, L., 34-74 Heather La., Wantagh, L. I., N. Y.  
 Bloom T., 17 Howe St., New Haven, Conn.  
 Blumenstock, N. R., 44-05 Macnish St., Elmhurst, L. I., N. Y.

(Continued on page 42A)

Laboratory Standards



**MEASUREMENTS  
CORPORATION**  
BOONTON · NEW JERSEY

- POTENT POWER +** Up to 5100 mmf at 300 vDCw  
Up to 3900 mmf at 500 vDCw
- SMALL SIZE** (size) Length 3/4", average Width 7/16", average Thickness 3/16" DM-20 shown actual size

# El-Menco Dur-Mica DM-20

DIPPED MICA CAPACITOR WITH PARALLEL LEADS

- PEAK PERFORMANCE** ideal for new miniaturized designs and printed wiring circuits
- MEETS ALL HUMIDITY, TEMPERATURE AND ELECTRICAL REQUIREMENTS OF **MIL-C-5 Specifications!**

## TEST IT AND COMPARE!

- El-Menco's Dur-Mica DM20 costs even less than our famous molded mica capacitors.
- Provides greater versatility — wider applications.
- Tougher phenolic casing assures *longer-life* and *greater stability* through wide ranges in temperature.
- Parallel leads simplify application in transistor and sub-miniature electronic equipment including printed circuits for military and civilian use.

For Extreme Miniaturization Use Our DM15

DM15 — Up to 510 mmf at 300 vDCw  
Up to 400 mmf at 500 vDCw

Available in 125°C operating temperature. Minimum capacity tolerance available  $\pm 1/2\%$  or 0.5 mmf (whichever is greater).



to meet modern miniature requirements

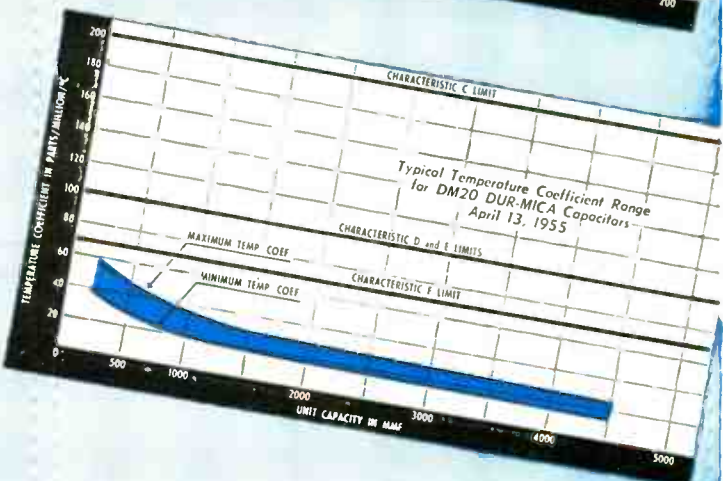
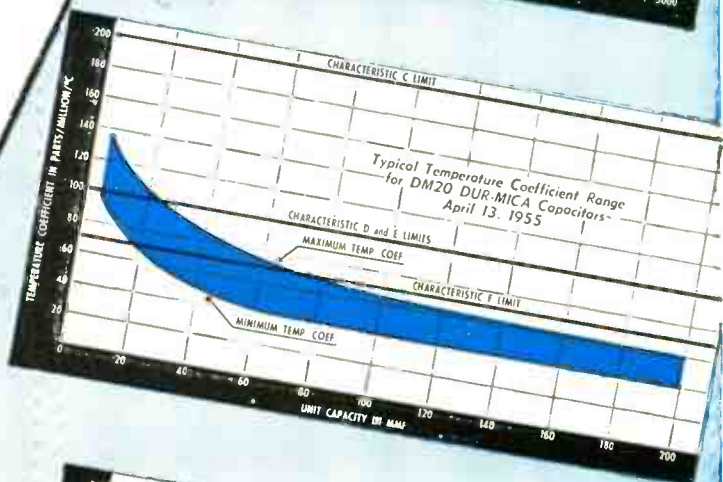
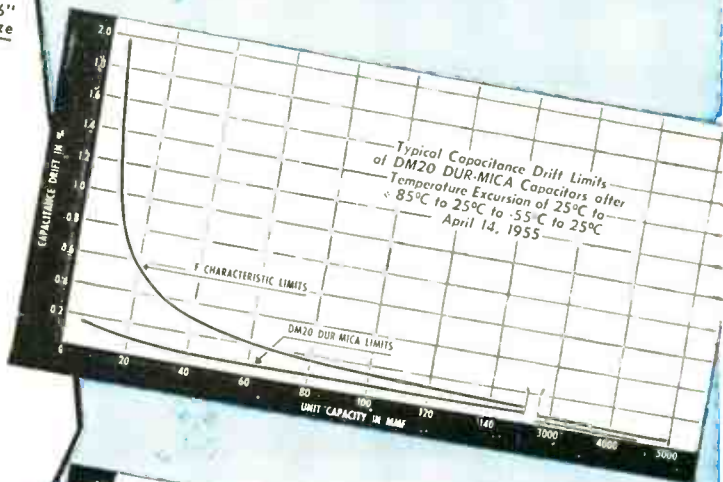

For your special requirements — we are pleased to offer information and assistance. Write for free samples and catalog on your firm's letterhead.

## THE ELECTRO MOTIVE MFG. CO., INC.

WILLIMANTIC CONNECTICUT

- molded mica • mica trimmer
- tubular paper • ceramic

Arco Electronics, Inc., 103 Lafayette St., New York, N. Y.  
Exclusive Supplier To Jobbers and Dealers in the U.S. and Canada

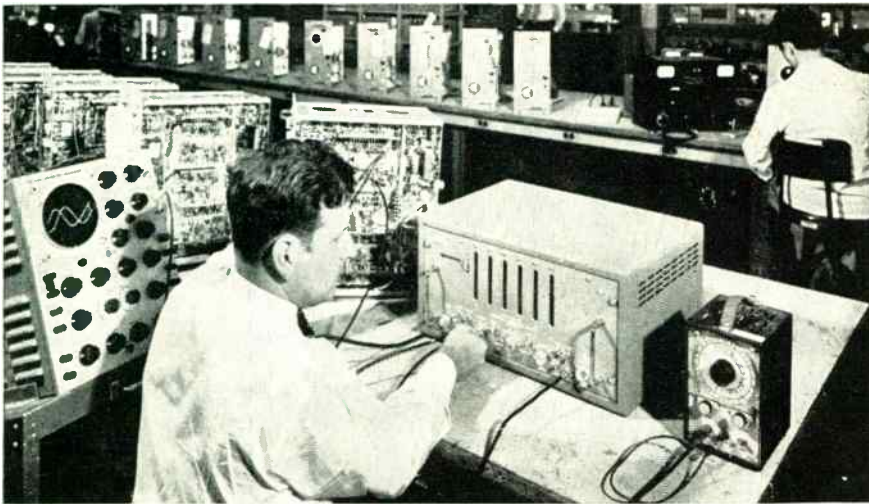

Typical Digital Phase-Shift Measurement Set-up Employing a BERKELEY Model 5510 Universal Counter and Timer, with a Shasta Oscillator as Reference Frequency Source & Oscilloscope to Provide Visual Check.

## Now-A Digital Method for Precise Phase Measurements

### ADVANTAGES:

- \* No interpolation required—results displayed in direct-reading digital form (in degrees, mils, or any desired unit of angular measure).
- \* Accuracies to  $0.1^\circ$
- \* Utilizes standard BERKELEY Universal Counter-Timer or Time Interval Meters.

### APPLICATIONS:

1. Calibration of synchros and resolvers
2. Measurement of gain-phase characteristics of closed-loop servo systems.
3. Low frequency response studies
4. Precise phase measurements at audio and sub-sonic frequencies

### TYPICAL INSTRUMENTATION:

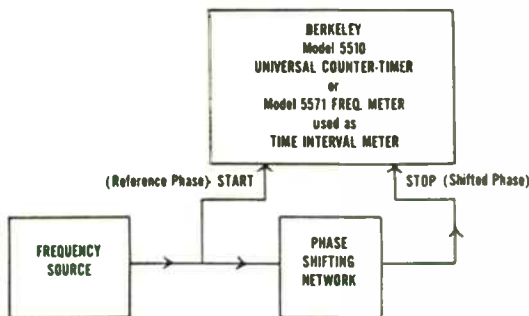

### COMPLETE DATA AVAILABLE

*Data File 107 completely describes the theory and practice of digital phase measurement, including set-up and operational instructions. A copy is yours for the asking; why not write now? Please address Dept. N-9*

# Berkeley

division

63

INDUSTRIAL CONTROL SYSTEMS

BECKMAN INSTRUMENTS INC.  
2200 Wright Avenue, Richmond 3, California

ANALOG COMPUTERS • COUNTERS • TEST & NUCLEAR INSTRUMENTS



(Continued from page 40A)

- Boatwright, L. T., Jr., Box 56, University Station, Urbana, Ill.
- Bohn, A. L., 10430 Brookmoor Dr., Silver Spring, Md.
- Bomberger, D. C., Bell Telephone Labs., Inc., 463 West St., New York 14, N. Y.
- Bondy, M. A., 1300 Alegria, Austin, Tex.
- Bonham, L. L., 5105 You St., S.E., Washington 27, D. C.
- Bonner, H. W., 597 San Luis Rd., Berkeley 7, Calif.
- Booker, C. A., Jr., 1337 Singer Pl., Wilkesburg 21, Pa.
- Booth, R. M., Jr., 921 Tower Bldg., Washington 5, D. C.
- Borden, E. W., 22 College Ave., Upper Montclair, N. J.
- Borgeson, P. W., 1641—21 St., Manhattan Beach, Calif.
- Bose, J. H., 150 Claremont Ave., New York 27, N. Y.
- Bosshart, R. F., 427 Ninth St., Wilmette, Ill.
- Bostwick, L. G., 463 West St., New York 14, N. Y.
- Bothun, R. B., 804 Sutter St., Palo Alto, Calif.
- Bouchy, S. H., 1907 Patterson Rd., Falls Church, Va.
- Bower, G. E., 420 McLeod Dr., Cocoa, Fla.
- Bowler, J. A., MAAG, APO 794, c/o PM, New York, N. Y.
- Bowley, R. J., 1914 Lycoming Ave., Willow Grove, Pa.
- Bowman, J. Y., 217 S. Circle Dr., San Gabriel, Calif.
- Brachman, R. J., 1368 N. 75 St., Philadelphia 31, Pa.
- Bracken, J. F., 3909 Grand Ave., Western Springs, Ill.
- Bracken, J. R., 204 Queens Dr., Little Silver, N. J.
- Brackett, H. H., 515 Summit Ave., Oradell, N. J.
- Brackett, R. T., 3952 Atascadero Dr., San Diego 7, Calif.
- Bradburd, E., 0-46 W. Amsterdam Ave., Fairlawn, N. J.
- Braden, J. R., 123 S. 13 St., Fort Pierce, Fla.
- Bradford, D. C., 38-58 Victoria Rd., Fairlawn, N. J.
- Bradshaw, G. V., 50 Greenbrier Rd., Levittown, Pa.
- Brandt, L. Uruguay 618, Buenos Aires, Argentina
- Brandt, W. L., Caixa Postal 435, Recife, Pernambuco, Brazil
- Brar, S. S., Box 299, Lemont, Ill.
- Braun, A. F., Bahnhofstr. 33, Urdorf B., Zurich, Switzerland
- Braun, C. G., 113 Cornelia St., Boonton, N. J.
- Braun, M., 126 Montgomery St., Highland Park, N. J.
- Brenner, M. M., Box 131-B, Atlantic Highlands, N. J.
- Bresee, W. H., 818 Park Ave., Williamsport, Pa.
- Brewer, M. S., 1936 Lombardy Dr., La Canada, Calif.
- Breymayer, K., 464 Spadina Rd., Toronto, Ont., Canada
- Brice, J. R., 2521 Edgewood Rd., Tampa 9, Fla.
- Bridges, J. E., 2706 Elder Ln., Franklin Park, Ill.
- Brinkman, H. A., 6506 Denison Blvd., Parma Heights 29, Ohio
- Britt, C. O., Box 7862, University Sta., Austin 12, Tex.
- Brody, J., 160-01—77 Ave., Flushing 66, L. I., N. Y.
- Brodzinsky, A., 3981 First St., S.W., Washington 20, D. C.
- Brogan, J. M., 396 Union St., Jersey City, N. J.
- Brogden, J. W., 118 Irvington St., S.W., Washington, D. C.

(Continued on page 44A)

hitch your missile to a star . . . 



## Navigation and Control Devices **PRODUCED** for Missiles and Aircraft

Kollsman has designed, developed and produced the following navigation and control systems and components:

### FOR NAVIGATION OR GUIDANCE

**CLASSIFIED**

**Photoelectric Sextants** for remote semi-automatic celestial navigation.

**CLASSIFIED**

**Automatic Astrocompasses** for precise automatic celestial directional reference and navigation.

**Photoelectric Tracking Systems** For many years Kollsman has specialized in high precision tracking systems.

**Periscopic Sextants** for manual celestial observations.

**CLASSIFIED**

**Computing Systems** to provide precise data for automatic navigation and guidance, operated by optical, electromechanical, and pressure sensing components.



**kollsman** INSTRUMENT CORPORATION

80-16 45th AVE., ELMHURST, NEW YORK • GLENDALE, CALIFORNIA • SUBSIDIARY OF *Standard* COIL PRODUCTS CO. INC.

### FOR CONTROL

*proven components  
now in production*

#### Pressure Pickups and Synchrotel Transmitters

to measure and electrically transmit

- true airspeed • indicated airspeed • absolute pressure
- log absolute pressure • differential pressure • log differential pressure • altitude
- Mach number • airspeed and Mach number.

**Pressure Monitors** — to provide control signals for altitude, absolute and differential pressure, vertical speed, etc.

**Acceleration Monitors** — for many applications now served by gyros.

**Pressure Switches** — actuated by static pressure, differential pressure, rate of change of static pressure, rate of climb or descent, etc.

**Motors** — miniature, special purpose, including new designs with integral gear heads.

#### SPECIAL TEST EQUIPMENT

optical and electromechanical for flight test observations.

*Please write us concerning your specific requirements in the field of missile or aircraft control and guidance. Technical bulletins are available on most of the devices mentioned.*

**PRECISION  
ATTENUATION  
to 3000 mc!**

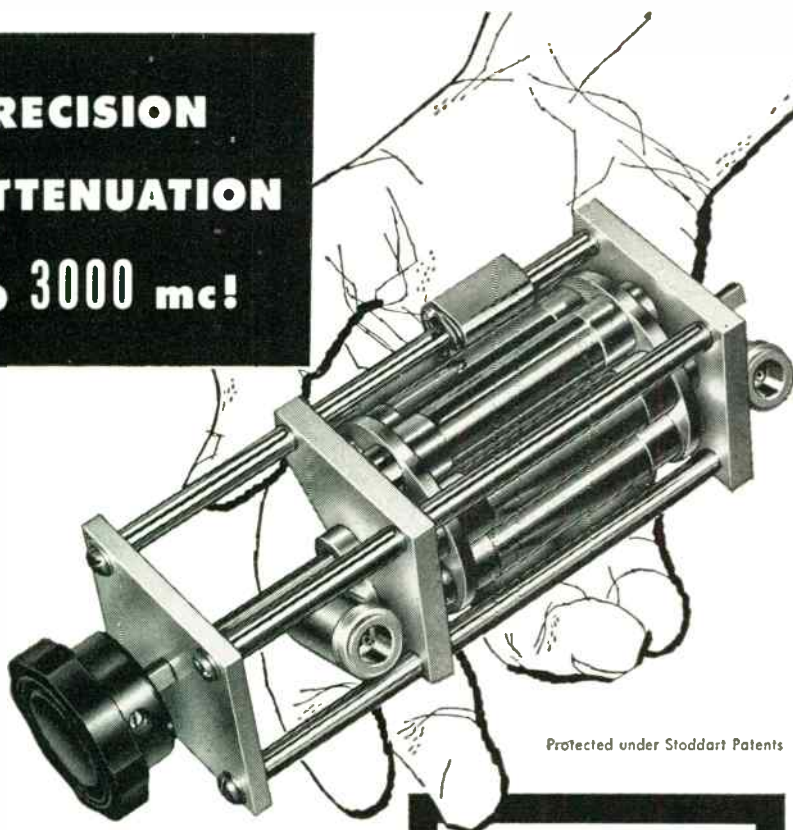

Protected under Stoddart Patents

six-position

**TURRET ATTENUATOR**

featuring **PULL-TURN-PUSH** action

**FREQUENCY RANGE:** dc to 3000 mc.  
**CHARACTERISTIC IMPEDANCE:** 50 ohms.  
**CONNECTORS:** Type "N" Coaxial female fittings each end.  
**AVAILABLE ATTENUATION:** Any value from 1 db to 60 db.  
**VSWR:** 1.2 max., dc to 3000 mc/s, values from 10 to 60 db. As value decreases below 10 db, VSWR increases to not over 1.5.  
**ACCURACY:**  $\pm 0.5$  db.  
**POWER RATING:** One watt sine wave power dissipation.

**SINGLE "IN-THE-LINE" ATTENUATOR PADS  
and 50 ohm COAXIAL TERMINATIONS**

This new group of pads and terminations features the popular Type C and Type N connectors, and permits any conceivable combination of the two styles. For example, the two connector types, either male or female, can be mounted on the same attenuator pad, with or without flanges, so that it may serve as an adapter as well as an attenuator. Frequency range, impedance, attenuation, VSWR, accuracy and power rating are as designated above. Send for free bulletin entitled "Measurement of RF Attenuation."



(Continued from page 42A)

- Brower, H. P., Box 1663, Los Alamos, N. Mex.
- Brown, A. E., 504—10 St., Alamogordo, N. Mex.
- Brown, B. B., RCA Victor Div., 415 S. Fifth St., Harrison, N. J.
- Brown, B. J., 3337 Corinth Ave., Los Angeles 34, Calif.
- Brown, F. L., 313 E. 40 St., New York 16, N. Y.
- Brown, H. A., Box 238, State College, N. Mex.
- Brown, J. T. L., Bell Telephone Labs., 463 West St., New York, N. Y.
- Brown, N. M., Jr., 18183 Rosita St., Tarzana, Calif.
- Brownell, H. R., 188 W. Fourth St., New York 14, N. Y.
- Browning, J. W., 1990 Martin Cir., Memphis, Tenn.
- Brubaker, G. P., Jr., 321 Thurston, Los Angeles 49, Calif.
- Bryan, K. W., 409 Meadow Park Dr., Fort Worth 8, Tex.
- Bryan, R. H., 544 N. Taylor Ave., Oak Park, Ill.
- Bryner, D. B., 1617 Chase Ave., Chicago 26, Ill.
- Buchholz, F. G., 7341 W. Rascher Ave., Chicago 31, Ill.
- Buchanan, H. R., 947 James St., Syracuse, N. Y.
- Bucher, T. T. N., 36 E. Central Ave., Moorestown, N. J.
- Buckingham, S. A., 8521 Georgia Ave., Silver Spring, Md.
- Bull, J. T., 904 E. Greenwich St., Falls Church, Va.
- Bullock, R. E., 1957 W. Hilldale Dr., Montrose, Calif.
- Bunker, E. R., Jr., 910 N. Garfield Ave., Alhambra, Calif.
- Burbeck, D. W., 7360 W. 89 St., Los Angeles 45, Calif.
- Burgwald, G. M., 60 E. 32 St., Chicago 16, Ill.
- Burke, M. H., Box 359, R.D. 2, Farmingdale, N. J.
- Burkhard, H. F., R.D. 1, Box 424, Eatontown, N. J.
- Burnett, J. R., School of Electrical Engineering, Purdue University, West Lafayette, Ind.
- Burns, M. C., 3017 Essex Rd., Cleveland Heights 18, Ohio
- Burlock, J., Pine Rd., Poquoson, Va.
- Bush, C. R., 4650 Lanark La., Beaumont, Tex.
- Bush, G. B., 222 Crestmoor Cir., Silver Spring, Md.
- Bush, N. E., 5807 Larsen St., Glen Burnie, Md.
- Bushnell, R. H., 432 Witwer St., North Canton, Ohio
- Busuttill, H. L., 16915 Ainsworth, Torrance, Calif.
- Butcher, J. H., 1365 Cass Ave., Detroit 26, Mich.
- Butler, E. R., 8406 Los Arboles Rd., Albuquerque, N. Mex.
- Butler, G. H., 26 Kilmer Rd., Larchmont, N. Y.
- Butler, G. T., Jr., 1408 Rangeley Ave., Dayton 3, Ohio
- Byrne, P. F., 2221 Howard Ave., San Carlos, Calif.
- Cahalan, E. T., 990 Sierra Madre Blvd., San Marino, Calif.
- Cahill, W. J., 465 Fairfield Ave., Ridgewood, N. J.
- Cahn, R. H., 6105 Madawaska Rd., Bethesda 16, Md.
- Callan, J. M., 530 Wynnewood Rd., Pelham Manor, N. Y.
- Campbell, J. R., 10243 Best Dr., Dallas 29, Tex.
- Campbell, R. E., Box 553, Benson, Ariz.
- Canty, E. T., 100-B Donor Ave., East Paterson, N. J.

(Continued on page 46A)

**STODDART AIRCRAFT RADIO Co., Inc.**  
 6644-C Santa Monica Blvd., Hollywood 38, California · Hollywood 4-9294

for faster, more accurate

# IMPEDANCE MEASUREMENTS

## New! -hp- 415B Standing Wave Indicator



**HEWLETT-PACKARD COMPANY**  
3339D PAGE MILL ROAD, PALO ALTO, CALIF., U.S.A.  
Cable "HEWPACK"

Sales representatives in all principal areas

- measures SWR with slotted lines
- expanded scale for low SWR
- output for recorder operation
- crystal detector for rf signals
- bridge or null indicator

Model 415B is a completely new instrument, similar to the time-tested -hp- 415A Standing Wave Indicator but containing advanced features never before incorporated in one instrument of its type.

Basically a high gain, low noise, amplifier operating at fixed audio frequency, -hp- 415B presents output on a square-law calibrated VTVM reading direct in SWR or db for operation with crystal detectors such as -hp- 440A and 444A, and -hp- 805 series slotted lines.

Among the many extra-convenience features are an expanded meter scale for accurate measurement of very flat systems; a 200 K input for null or bridge measurements; a bias current for use with bolometers; a 70 db calibrated range adjustable in 5 db steps so meter may be read in a favorable portion of the scale. Output connections for recorder operation are also provided.

-hp- 415B is normally supplied for operation at 1,000 cps, but simple "plug-in" units are available on special order for other frequencies 315 to 3,000 cps. The instrument is housed in a light, compact, rugged metal case.

### SPECIFICATIONS

**Frequency:** 1,000 cps  $\pm 2\%$ .

**Sensitivity:** 0.1  $\mu$ v at a 200 ohm level for full scale deflection.

**Noise Level:** Less than 0.03  $\mu$ f ref. to input operated from a 200 ohm resistor.

**Amplifier Q:** 25  $\pm 5$ .

**Calibration:** Square law. Meter reads SWR, db.

**Range:** 70 db. Input attenuator provides 60 db in 10 db steps. Accuracy  $\pm 0.1$  db per 10 db step.

**Scale Selector:** "Normal," "Expand," and "-5 db."

**Meter Scales:** SWR: 1-4; SWR: 3-10; Expanded SWR: 1-1.3; db: 0-10; Expanded db: 0-2.

**Gain Control:** Adjusts to convenient reference level. Range approx. 30 db.

**Input:** "Bolo" (200 ohms). Bias provided for 8.4 ma bolometer or 1/100 amp. fuse; or 4.3 ma low current bolometer.

"Crystal." 200 ohms for crystal rectifier.

"200,000 ohms." High impedance for crystal rectifier as null detector.

**Output:** Jack for recording milliammeter having 1 ma full scale deflection, internal resistance of approx. 1,500 ohms.

**Input Connector:** BNC.

**Power:** 115/230 v  $\pm 10\%$ , 50/60 cps, 60 watts.

**Dimensions:** Cabinet Mount: 7 $\frac{1}{4}$ " wide, 11 $\frac{1}{4}$ " high, 14" deep.  
Rack Mount: 19" wide, 7" high, 11" deep.

**Weight:** Net 20 lbs. Shipping 35 lbs. (cabinet mount).

**Price:** \$200.00.

Prices f.o.b. factory. Data subject to change without notice.



**ELECTRONIC MEASURING INSTRUMENTS**

# CONTINUOUSLY VARIABLE FILTERS

## MODEL 302

VARIABLE  
ELECTRONIC  
FILTER



### Fast, Accurate, Reliable

The — SKL — Model 302 includes two independent filter sections, each having a continuously variable cut-off range of 20 cps to 200 KC. Providing a choice of filter types each section has 18 db per octave attenuation. When cascaded 36 db is obtained in the high and low pass setting and 18 db in the band pass position. With low noise level and 0 insertion loss this versatile filter can be used as an analyzer in industry and the research laboratory or to control sound in the communications laboratory, radio broadcasting, recording and moving picture industries.

### SPECIFICATIONS

- CUT-OFF RANGE  
20 cps to 200 KC
- SECTIONS  
2—can be high, low and band pass
- ATTENUATIONS  
36 db/octave maximum
- INSERTION LOSS . 0 db
- NOISE LEVEL  
80 db below 1 volt
- FREQUENCY RESPONSE  
2 cps to 4 MC

**SKL SPENCER-KENNEDY LABORATORIES, INC.**  
181 MASSACHUSETTS AVE., CAMBRIDGE 39, MASS.

CO-AX

# 4 mmf/ft

**★ ULTRA LOW** capacitance & attenuation

WE ARE SPECIALLY ORGANIZED  
TO HANDLE DIRECT ORDERS OR  
ENQUIRIES FROM OVERSEAS  
**SPOT DELIVERIES FOR U.S.**  
BILLED IN DOLLARS—  
SETTLEMENT BY YOUR CHECK  
CABLE OR AIRMAIL TODAY



**NEW** 'MX and SM' SUBMINIATURE CONNECTORS  
Constant 50Ω-63Ω-70Ω impedances

| TYPE | μF/ft | IMPED.Ω | O.D.  |
|------|-------|---------|-------|
| C1   | 7.3   | 150     | .36"  |
| C11  | 6.3   | 173     | .36"  |
| C2   | 6.3   | 171     | .44"  |
| C22  | 5.5   | 184     | .44"  |
| C3   | 5.4   | 197     | .64"  |
| C33  | 4.8   | 220     | .64"  |
| C4   | 4.6   | 229     | 1.03" |
| C44  | 4.1   | 252     | 1.03" |

TRANSRADIO LTD. 138A Cromwell Rd. London SW7 ENGLAND CABLES: TRANSRAD, LONDON



Membership.

(Continued from page 44A)

- Carbonneau, V. J., 63 Jolly Hill Ave., Exeter, N. H.  
 Carlin, B., 67 Fairlawn Pkwy., Fairlawn, N. J.  
 Carpenter, L. B., 37 Newark Way, Maplewood, N. J.  
 Carr, L. H., Ft. Evans Farm, R.D. 1, Leesburg, Va.  
 Carrillo, E. B., 618 Allen St., Syracuse, N. Y.  
 Case, M. D., 302 E. Olive Ave., Sunnyvale, Calif.  
 Casey, T. J., 5300 W. 84 St., Minneapolis 20, Minn.  
 Cash, F. L., 179 Parkhouse St., Dallas 7, Tex.  
 Cavanaugh, D. E., 290 Noygrove Pl., Elberon, N. J.  
 Ceccarini, R. E., 4427 Auckland Ave., N. Hollywood, Calif.  
 Chadbourne, H. L., 2577 Ardath Rd., La Jolla, Calif.  
 Chadek, T. J., 2923 W. Solano Dr., N., Phoenix, Ariz.  
 Chalmers, P. H., 100 W. Terrace, Altadena, Calif.  
 Chamberlin, N. K., 5810 Greene St., Philadelphia 44, Pa.  
 Chambers, G. R., Rollins Associates, Moore Bldg., Rehoboth, Del.  
 Chambers, G. S., Philco Corp., 4700 Wissahickon Ave., Philadelphia, Pa.  
 Chambers, G. R., 535-13 Ave., N., Seattle, Wash.  
 Chambers, R. M., Jr., 4660 W. Florissant Ave., St. Louis 15, Mo.  
 Chandler, C. W., 3817 Muirfield Rd., Los Angeles 8, Calif.  
 Chapman, A. B., 4135 Grassmere Ln., Dallas 5, Tex.  
 Chapman, C. M., 317 W. Sixth Ave., Columbus 1, Ohio  
 Chase, D. G., 7411 Foster St., Dist. Hgts., Washington 28, D. C.  
 Chen, T. S., 39 W. 84 St., New York 24, N. Y.  
 Child, R. W., 2433 Allison Ave., Speedway, Ind.  
 Chosky, P., 1022 N. Negley St., Pittsburgh, Pa.  
 Christian, H. S., 2432 Prospect Ave., Evanston, Ill.  
 Christian, O. R., Electronics Test, U. S. Naval Air Station, Patuxent River, Md.  
 Cisne, L. E., 762 Hill Ave., Glen Ellyn, Ill.  
 Clapp, E. B., 5020 Colina Dr., La Mesa, Calif.  
 Clarence, A. L., Box 91, Warrington, Pa.  
 Clark, D., Jr., 4027C Abourne Rd., Los Angeles, Calif.  
 Clark, E. G., 87 Park Pl., Orelana, Pa.  
 Clark, G. L., 7208 Central Ave., Takoma Park, Md.  
 Clark, T. G., 21 Glenview Rd., North Caldwell, N. J.  
 Clarke, J. L., 530-44 Ave., Lachine, P. Q., Canada  
 Clarke, K. K., Dept. of Electrical Engineering, Clarkson College, Potsdam, N. Y.  
 Clarke, R. L., 4049 Pennsylvania, Kansas City 11, Mo.  
 Clemens, G. J., City College of New York, 138 St. & Convent Ave., New York, N. Y.  
 Clement, P. F., 1741 Los Kobles Dr., Bakersfield, Calif.  
 Clements, L. E., 306 W. Sherwood Terr., Ft. Wayne, Ind.  
 Clerc, M. C., 514 Ave., B. South Houston, Tex.  
 Clifford, M. L., 4060 N. Warner Rd., Lafayette Hill, Pa.  
 Coates, R. J., 3907 Pennsylvania Ave., S.E., Washington 20, D. C.  
 Cohen, E., 269 E. Broadway, New York 2, N. Y.  
 Cohen, J. E., 13457 Magnolia Blvd., Van Nuys, Calif.  
 Cohen, P., R.R. 1, Box 526, Melbourne, Fla.  
 Colby, N. C., R.D. 1, Moorestown, N. J.  
 Cole, B. T., 3810 Stearnlee St., Long Beach, Calif.

(Continued on page 48A)



For Quality, Accuracy & Dependability

USE THESE **FREED** TELEMETERING COMPONENTS

**TELEMETERING BAND PASS FILTERS**

Covers the frequency band from 400 cps to 70 kc. 3 DB Band width  $\pm 9\frac{3}{4}\%$  of center frequency. Features octal "plug in" header. Size  $2\frac{1}{8}'' \times 3\frac{1}{2}'' \times 4\frac{1}{2}''$ .



| FREED # | CENTER FREQUENCY | CHARACTERISTIC IMPEDANCE | 3 DB BAND W.DTH          |
|---------|------------------|--------------------------|--------------------------|
| FBP-34  | 400 cps          | 500 OHMS                 | $\pm 9\frac{3}{4}\%$ CF  |
| FBP-35  | 560 cps          | 500 OHMS                 | $\pm 9\frac{3}{4}\%$ CF  |
| FBP-36  | 730 cps          | 500 OHMS                 | $\pm 9\frac{3}{4}\%$ CF  |
| FBP-37  | 960 cps          | 500 OHMS                 | $\pm 9\frac{3}{4}\%$ CF  |
| FBP-38  | 1300 cps         | 500 OHMS                 | $\pm 9\frac{3}{4}\%$ CF  |
| FBP-39  | 1700 cps         | 500 OHMS                 | $\pm 9\frac{3}{4}\%$ CF  |
| FBP-40  | 2300 cps         | 500 OHMS                 | $\pm 9\frac{3}{4}\%$ CF  |
| FBP-41  | 3000 cps         | 500 OHMS                 | $\pm 9\frac{3}{4}\%$ CF  |
| FBP-42  | 3900 cps         | 500 OHMS                 | $\pm 9\frac{3}{4}\%$ CF  |
| FBP-43  | 5400 cps         | 500 OHMS                 | $\pm 9\frac{3}{4}\%$ CF  |
| FBP-44  | 7350 cps         | 500 OHMS                 | $\pm 9\frac{3}{4}\%$ CF  |
| FBP-45  | 10500 cps        | 500 OHMS                 | $\pm 9\frac{3}{4}\%$ CF  |
| FBP-46  | 12300 cps        | 500 OHMS                 | $\pm 9\frac{3}{4}\%$ CF  |
| FBP-47  | 14500 cps        | 500 OHMS                 | $\pm 9\frac{3}{4}\%$ CF  |
| FBP-48  | 22 KC            | 500 OHMS                 | $\pm 19\frac{1}{2}\%$ CF |
| FBP-49  | 30 KC            | 500 OHMS                 | $\pm 9\frac{3}{4}\%$ CF  |
| FBP-50  | 30 KC            | 500 OHMS                 | $\pm 19\frac{1}{2}\%$ CF |
| FBP-51  | 40 KC            | 500 OHMS                 | $\pm 9\frac{3}{4}\%$ CF  |
| FBP-52  | 40 KC            | 500 OHMS                 | $\pm 19\frac{1}{2}\%$ CF |
| FBP-53  | 52.5 KC          | 500 OHMS                 | $\pm 9\frac{3}{4}\%$ CF  |
| FBP-54  | 52.5 KC          | 500 OHMS                 | $\pm 19\frac{1}{2}\%$ CF |
| FBP-55  | 70 KC            | 500 OHMS                 | $\pm 9\frac{3}{4}\%$ CF  |
| FBP-56  | 70 KC            | 500 OHMS                 | $\pm 19\frac{1}{2}\%$ CF |
| FBP-57  | 70 KC            | 500 OHMS                 | $\pm 9\frac{3}{4}\%$ CF  |

CHARACTERISTIC IMPEDANCE 500 OHMS  
Band pass filters FBP-10 through FBP-33 feature the same attenuation characteristics as the above listing and are supplied with solder lug terminals.

**DISCRIMINATOR INPUT LOW PASS FILTERS**

Covers the frequency band of 400 cps to 70 kc. Less than .05 DB attenuation at  $\pm 9\frac{3}{4}\%$  of center frequency. 30 and 50 DB attenuation at the third and fifth harmonic of the pass band frequencies. Size  $1\frac{1}{2}'' \times 1\frac{1}{2}'' \times 4\frac{1}{2}''$ .



| LPI | Fo       |
|-----|----------|
| 10  | 400 CPS  |
| 11  | 560 CPS  |
| 12  | 730 CPS  |
| 13  | 960 CPS  |
| 14  | 1300 CPS |
| 15  | 1700 CPS |
| 16  | 2300 CPS |
| 17  | 3000 CPS |
| 18  | 3900 CPS |
| 19  | 5400 CPS |
| 20  | 7350 CPS |
| 21  | 10.5 KC  |
| 22  | 12.3 KC  |
| 23  | 14.5 KC  |

| LPI | Fo      |
|-----|---------|
| 24  | 22. KC  |
| 25  | 30 KC   |
| 26  | 40 KC   |
| 27  | 52.5 KC |
| 28  | 70. KC  |

**SLUG TUNED DISCRIMINATORS**

Covers the frequency band of 3 kc to 70 kc. Frequency deviation  $\pm 8\frac{1}{2}\%$  of center frequency.  $\frac{1}{2}\%$  linearity. Features slug tuned adjustment. Size  $1\frac{1}{4}'' \times 4\frac{1}{2}''$ .



| FREED # | DST  | Fo | FREQUENCY DEVIATION     | LINEARITY  | DC OUTPUT |
|---------|------|----|-------------------------|------------|-----------|
| 17      | 3    | KC | $\pm 8\frac{1}{2}\%$ Fo | WITHIN .5% | 32.5V     |
| 18      | 3.9  | KC | $\pm 8\frac{1}{2}\%$ Fo | WITHIN .5% | 32.5V     |
| 19      | 5.4  | KC | $\pm 8\frac{1}{2}\%$ Fo | WITHIN .5% | 32.5V     |
| 20      | 7.35 | KC | $\pm 8\frac{1}{2}\%$ Fo | WITHIN .5% | 32.5V     |
| 21      | 10.5 | KC | $\pm 8\frac{1}{2}\%$ Fo | WITHIN .5% | 32.5V     |
| 22      | 12.3 | KC | $\pm 8\frac{1}{2}\%$ Fo | WITHIN .5% | 32.5V     |
| 23      | 14.5 | KC | $\pm 8\frac{1}{2}\%$ Fo | WITHIN .5% | 32.5V     |
| 24      | 22   | KC | $\pm 8\frac{1}{2}\%$ Fo | WITHIN .5% | 32.5V     |
| 25      | 30   | KC | $\pm 8\frac{1}{2}\%$ Fo | WITHIN .5% | 32.5V     |
| 26      | 40   | KC | $\pm 8\frac{1}{2}\%$ Fo | WITHIN .5% | 32.5V     |
| 27      | 52.5 | KC | $\pm 7\frac{1}{2}\%$ Fo | WITHIN 1%  | 26V       |
| 28      | 70   | KC | $\pm 15\%$ Fo           | WITHIN 1%  | 26V       |
| 29      | 22   | KC | $\pm 15\%$ Fo           | WITHIN 1%  | 26V       |
| 30      | 30   | KC | $\pm 15\%$ Fo           | WITHIN 1%  | 26V       |
| 31      | 40   | KC | $\pm 15\%$ Fo           | WITHIN 1%  | 26V       |
| 32      | 52.5 | KC | $\pm 15\%$ Fo           | WITHIN 1%  | 26V       |
| 33      | 70   | KC | $\pm 15\%$ Fo           | WITHIN 1%  | 26V       |

| FREED # | Fo       | LINEARITY               | DC OUTPUT        |
|---------|----------|-------------------------|------------------|
| 10      | 400 cps  | $\pm 8\frac{1}{2}\%$ Fo | WITHIN .5% 32.5V |
| 11      | 560 cps  | $\pm 8\frac{1}{2}\%$ Fo | WITHIN .5% 32.5V |
| 12      | 730 cps  | $\pm 8\frac{1}{2}\%$ Fo | WITHIN .5% 32.5V |
| 13      | 960 cps  | $\pm 8\frac{1}{2}\%$ Fo | WITHIN .5% 32.5V |
| 14      | 1300 cps | $\pm 8\frac{1}{2}\%$ Fo | WITHIN .5% 32.5V |
| 15      | 1700 cps | $\pm 8\frac{1}{2}\%$ Fo | WITHIN .5% 32.5V |
| 16      | 2300 cps | $\pm 8\frac{1}{2}\%$ Fo | WITHIN .5% 32.5V |

**DISCRIMINATOR OUTPUT LOW PASS FILTERS**

Covers the frequency range from 6 cycles to 10,000 cycles. Features octal "plug in" header. Size  $4'' \times 6'' \times 4\frac{1}{2}''$ .

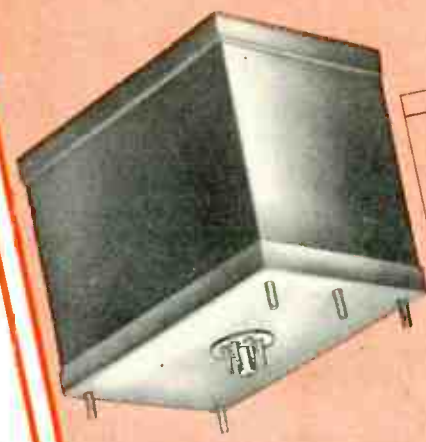

CHARACTERISTIC IMPEDANCE 330 OHMS  
ATTENUATION: LESS THAN .2DB UP TO 5 TIMES Fo  
LESS THAN .7DB FROM 5 Fo TO 1. Fo  
MORE THAN 20DB AT 2 TIMES Fo  
MORE THAN 30 DB FROM 3 TIMES Fo TO 100 KC

| LPO | Fo        |
|-----|-----------|
| 10  | 6 CPS     |
| 11  | 8 CPS     |
| 12  | 11 CPS    |
| 13  | 14 CPS    |
| 14  | 20 CPS    |
| 15  | 25 CPS    |
| 16  | 35 CPS    |
| 17  | 45 CPS    |
| 18  | 60 CPS    |
| 19  | 81 CPS    |
| 20  | 110 CPS   |
| 21  | 160 CPS   |
| 22  | 185 CPS   |
| 23  | 220 CPS   |
| 24  | 330 CPS   |
| 25  | 450 CPS   |
| 26  | 600 CPS   |
| 27  | 660 CPS   |
| 28  | 790 CPS   |
| 29  | 990 CPS   |
| 30  | 1050 CPS  |
| 31  | 1200 CPS  |
| 32  | 1600 CPS  |
| 33  | 2100 CPS  |
| 34  | 7200 CPS  |
| 35  | 10000 CPS |

IN STOCK FOR IMMEDIATE DELIVERY

Send for further information and catalog  
**FREED TRANSFORMER CO., INC.**

1720 Weirfield Street

World Building (Ridgewood) 27, New York

**AMPHENOL**

**PRIN-CIR  
CONNECTORS**

revolutionary  
**NEW**  
contact design

IN  
AMPHENOL  
PRINTED CIRCUIT  
CONNECTORS

Prin-Cir connectors are the result of careful design work by AMPHENOL Development Engineering. They feature compact bodies and a new contact design that is greatly superior to any available for printed circuit applications.

Prin-Cir contacts can't be set, can't be overstressed when used with standard .061" to .071" boards, have very low millivolt drop and extremely long life. This contact has an extra-long spring base and a circle-lip for good wiping action.

Prin-Cir connectors are available with 10, 15, 18 and 22 contacts in four contact tail styles: Standard Eyelet, Wire Wrap, Pin and Open End. They may be ordered with one or more polarizing keys in any contact location.

Bodies are molded of an improved version of AMPHENOL blue dielectric and contacts are gold-plated.

AMERICAN PHENOLIC CORPORATION  
chicago 50, illinois

In Canada:  
AMPHENOL CANADA LIMITED, Toronto

**AMPHENOL**

4 contact tail styles ---

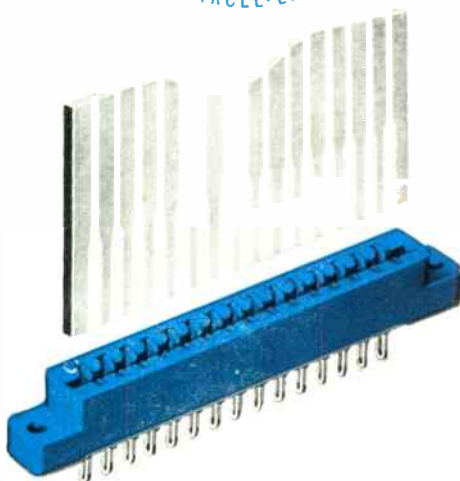
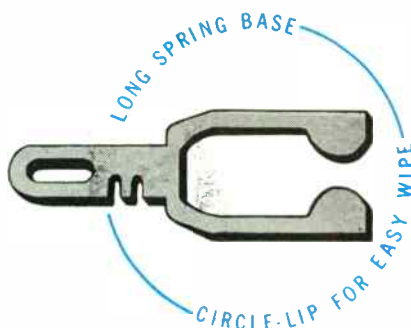

10, 15, 18, 22 contacts ---



(Continued from page 46A)

- Coleman, A. H., 42 Branchport Ave., Long Branch, N. J.  
Coleman, P. D., 812 W. Charles St., Champaign, Ill.  
Collins, G. S., 22 Kerwood Cresc., Box 476, Agincourt, Ont., Canada  
Conklin, H. A. Jr., 2262 Hill Pl, N. W., Washington 7, D. C.  
Connolly, J., Holy Cross College, Worcester 10, Mass.  
Conway, B. B., 312 W. Xenia Dr., Fairborn, Ohio  
Cook, K. H., 1401 Warner Rd., Great Bend, Kans.  
Cool, L. R., 3632 Lugo Ave., San Bernardino, Calif.  
Coolidge, J. E., 706 S. 25 Ave., Bellwood, Ill.  
Coombs, J. M., Engineering Lab., I.B.M. Corp., Poughkeepsie, N. Y.  
Coon, C. E., 26 Lowell Terr., Bloomfield, N. J.  
Cooney, J. R., Box 89, Waldoboro, Me.  
Cooper, A. E., Stratford Dr., R.D. 1, Vestal, N. Y.  
Cooper, F. S., Haskins Labs., 305 E. 43 St., New York 17, N. Y.  
Copp, R. S., 333 W. Monument Ave., Dayton 2, Ohio  
Corbin, J. E., Bell Telephone Labs., 463 West St., New York, N. Y.  
Corderman, C. L., 91 Bacon St., Winchester, Mass.  
Corp, D. E., 67 Ayer Rd., Williamsville 21, N. Y.  
Corson, B. R., 29 Holly Pl., Stamford, Conn.  
Coss, W. L., 803 Randolph St., Brook Farm, Falls Church, Va.  
Cottrell, McK., General Research Co., 120 La Grange St., Morenci, Mich.  
Couch, W. M., Jr., Machlett Labs., Inc., Springdale, Conn.  
Coulter, W. H., 3023 W. Fulton Blvd., Chicago 12, Ill.  
Cousins, V. M., River Rd., Chatham, N. J.  
Covell, D. F., 143 E. St., Redwood City, Calif.  
Covici, W., 43 Obre Pl., Shrewsbury, N. J.  
Cowles, R. I., Montmorenci Rd., Ridgway, Pa.  
Cox, W. W., 274 Grove St., Belmont, Mass.  
Crago, P. H., 2103 Collett La., Flossmoor, Ill.  
Craig, A. G., 801 Main St., Laurel, Md.  
Craig, A. G., Jr., 66 Chadwick St., Newport, R. I.  
Crane, H. D., Institute for Advanced Studies, Princeton, N. J.  
Crane, N. B., Jr., 347 Loveman Ave., Worthington, Ohio  
Crawford, D. J., 50 Ziegler Ave., Poughkeepsie, N. Y.  
Crawford, J. A., Box 464, China Lake, Calif.  
Crawford, R. D., 277 New Jersey Ave., Colingswood, N. J.  
Creamer, E. M., Jr., 1341 Colwyn St., Philadelphia 40, Pa.  
Credle, A. B., 903 Triphammer Rd., Ithaca, N. Y.  
Crentz, J., McLean, Va.  
Crews, F. H., Darby & Darby, 405 Lexington Ave., New York 17, N. Y.  
Crippen, E. G., 3829 N.W. 23, Oklahoma City 7, Okla.  
Cronshey, R. W., 35 Brown St., Baldwinsville, N. Y.  
Crossett, E. C., 1517 Lombardy Rd., Pasadena 5, Calif.  
Crowley, D. J., Jr., 137 Taylor St., Needham Heights, Mass.  
Culling, E. J., 10405 Tullymore Dr., Hyattsville, Md.  
Culver, R. H., Craven, Lohnes & Culver, 1242 Munsey Bldg., Washington 4, D. C.  
Cummings, A. P., 201 Dirston Ave., Syracuse 6, N. Y.  
Cunningham, E. W., 4224 E. Washington Blvd., Los Angeles 23, Calif.  
Curl, G. H., 1152 Moana Tr., San Diego 7, Calif.

(Continued on page 50A)

Write for special Product Bulletin!



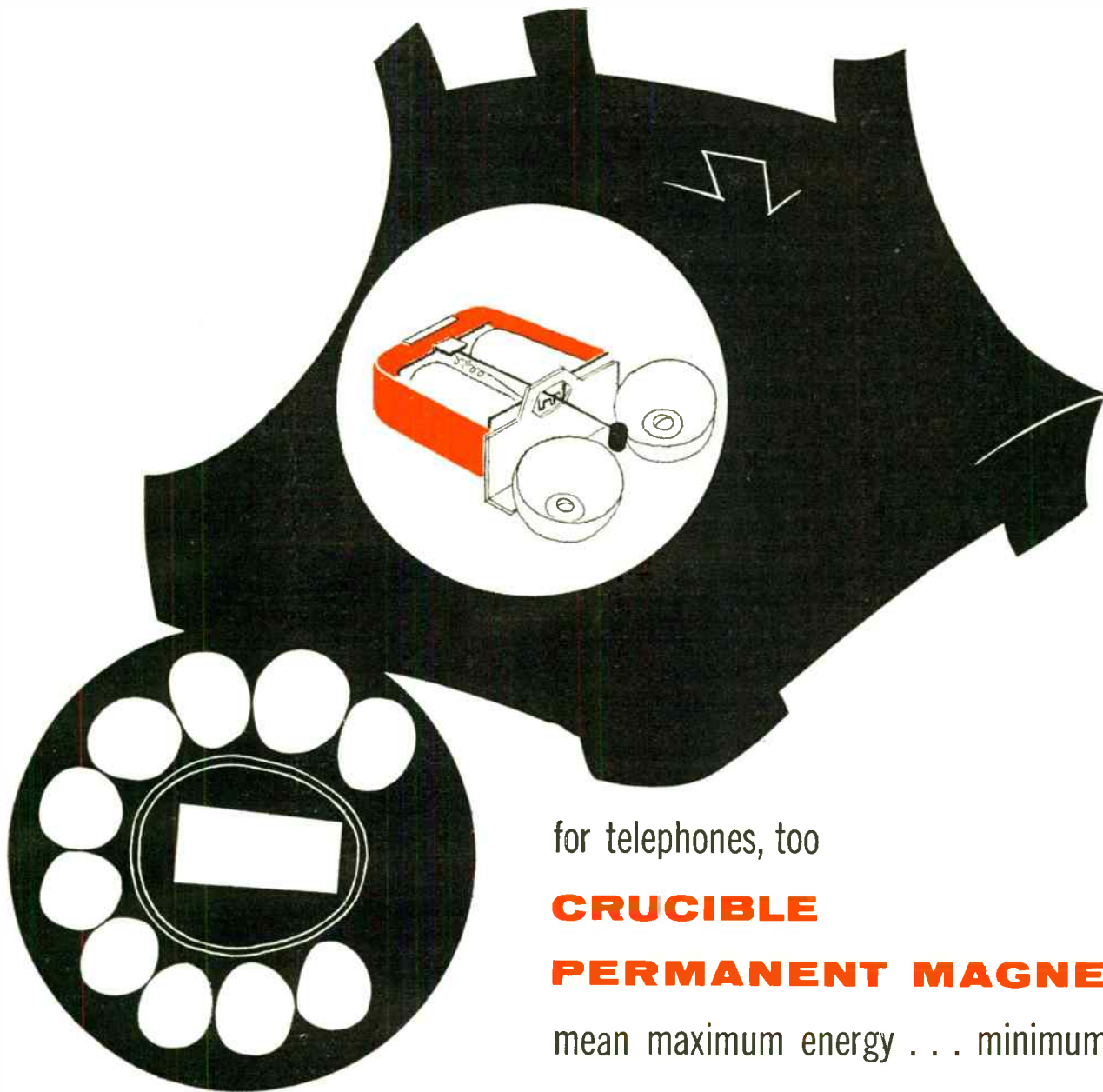

for telephones, too

**CRUCIBLE  
PERMANENT MAGNETS**

mean maximum energy . . . minimum size

You get *consistently higher* energy product from Crucible *prescription-made* alnico permanent magnets.

That means more energy from a smaller magnet . . . greater design freedom for manufacturers of telephone sets, high-fidelity sound equipment, controls, instruments, and magnet-equipped devices of all kinds.

Crucible, the nation's leading producer of *special purpose steels*, has been making these quality magnets ever since the development of alnico alloys. They're available sand cast, shell molded, or investment cast to meet every size, tolerance, shape and finish need.

For prompt delivery – or helpful advice on magnet problems – call Crucible. *Crucible Steel Company of America, Henry W. Oliver Building, Pittsburgh 22, Pa.*



first name in special purpose steels

**Crucible Steel Company of America**



**Membership**

*(Continued from page 48A)*

Build SORENSEN REGULATION into your products with these new

# MAGNETIC VOLTAGE REGULATORS

**CAPACITIES—15VA, 30VA, 60VA, 120VA, 250VA, 500VA.**

**TUBELESS—trouble free**

**COMPACT—saves space in your equipment**

**LIGHTER than comparable regulators**

**GOOD APPEARANCE—enhances your product**

**THERMALLY ISOLATED CASE—simplifies your design problems**

## ELECTRICAL SPECIFICATIONS

|                     |  |
|---------------------|--|
| Input voltage range | 95-130VAC, 1Ø, 60 cycles.                            |
| Output range        | 115VAC, RMS, 1Ø.                                     |
| Regulation accuracy | ±0.5% against line changes.                          |
| Load conditions     | ±0.5% against line at any given load from 0 to full. |
| Time constant       | From 2 to 6 cycles for line changes.                 |



**MVR15**



**MVR60**



**MVR250**



**MVR30**



**MVR120**



**MVR500**

GET MORE INFORMATION: Catalog MVR2 is yours for the asking; gives complete data on the new Magnetic Voltage Regulator line. Contact your local Sorensen representative, or write to General Sales Department, Sorensen & Co., Inc., 375 Fairfield Ave., Stamford, Conn.

CONTROLLED POWER FOR



RESEARCH AND INDUSTRY

# SORENSEN

- Curtis, R. B., 2309 Montgomery St., Bethlehem, Pa.
- Custer, C. J., Bell Telephone Labs., Murray Hill, N. J.
- D'Agostino, V. F., 494 Thoreau Terr., Union, N. J.
- Dairiki, S., 45 Kendal Common Rd., Weston 93, Mass.
- Dale, G. V., Bell Telephone Labs., Whippany, N. J.
- Dalrymple, H. C., 4 Sands Ave., Bayridge, Annapolis, Md.
- Daly, W. E., 4627 E. Eastland St., Tucson, Ariz.
- D'Amico, S. P., 1740 Kirkwood Ave., Merrick, L. I., N. Y.
- Daniels, L. H., 356 Ford Ave., Jackson, Miss.
- Dantine, W. A., Rua Brigadeiro Tobias 247, Sao Paulo, Brazil
- Darling, W., 606 W. Maple Ave., Merchantville, N. J.
- Daspit, J. I., 507 Ninth St., Santa Monica, Calif.
- Dausch, A. A., Jr., 17445 Lemac St., Northridge, Calif.
- Davenport, E., 229 E. 29 St., North Vancouver, B. C., Canada
- David, W. R., R.F.D. 2, Galway, N. Y.
- Davidson, D., 26 Brook St., Brookline 46, Mass.
- Davidson, E. D., 1505 W. Dorland St., Whittier, Calif.
- Davies, R. C., 1208-16 National Press Bldg., Washington 4, D. C.
- Davis, C., 7433 Poe Ave., Detroit 6, Mich.
- Davis, D. D., 16 Beverly Ct., Berkeley 7, Calif.
- Davis, E. W., 50 Elbow La., Levittown, L. I., N. Y.
- Davis, F. H., Smith Hill Rd., R.F.D., Monsey, N. Y.
- Davis, G. W., Box 410-A, Rt 1, Lorton, Va.
- Davis, J. H., 1678 Lee Dr., Mountain View, Calif.
- Davis, M. F., 323 E. Plymouth Ave., Silver Spring, Md.
- Davis, R. L., 535 Fountain St., Grand Rapids, Mich.
- Davis, S., 101 Hungry Harbor Rd., Valley Stream, L. I., N. Y.
- Davis, W. M., 31 Sherwood Rd., Glen Cove, L. I., N. Y.
- Davis, W. K., 552 N. Sparks St., Burbank, Calif.
- Day, W. B., 116 Yale St., Roslyn Heights, L. I., N. Y.
- Dayot, V. D., Philippine Military Academy, Loakan, Baguio City, P. I.
- Dazey, M. H., 1120 Via Nogales, Palos Verdes Estates, Calif.
- Deacon, N. E., 8750 Colesville Rd., Silver Spring, Md.
- Deakins, G., A-Bar Hotel, 2612 Guadalupe, Austin, Tex.
- Deal, J. B., Jr., Box 1663, Los Alamos, N. Mex.
- Dean, J. P., 4009 Woodman Ave., Sherman Oaks, Calif.
- Dean, W. E., Jr., 3236 N. Lockwood Dr., Chattanooga, Tenn.
- DeBell, J. M., Jr., 5 Albion St., Passaic, N. J.
- Decker, K. M., 680 Brandywine St., S.E., Washington, D. C.
- Deeken, J. W., 3025 Fairway, Dayton, Ohio
- Deer, J. W., 4108 S.E. 113, Portland 66, Ore.
- DeGregorio, J. F., 2022 Hermosa Dr., Boulder, Colo.
- DeHart, W. R., 2250 E. Ellsworth Rd., Rt. 6, Ann Arbor, Mich.
- DeLange, O. E., Bell Telephone Labs., Holmdel, N. J.
- DeLisle, J. E., 46 Frost St., Arlington, Mass.
- Delker, A. G., Jr., 2828 Cortelyou Pl., Cincinnati 13, Ohio
- Dellenbaugh, F. S., III, 141 Seven Bridges Rd., Chappaqua, N. Y.
- Delmerge, A. H., 1072 Brys Dr., S., Grosse Pte. Woods 36, Mich.

*(Continued on page 52A)*

Exceptional stability

Ruggedized construction (sectionalized)

Instrument type tuning with SCANSREAD\*

In communications receivers—  
*The Pay-Off is on Performance!*

Uniformly high sensitivity and ultra-high signal-to-noise ratio



High Image Rejection ON ALL 6 BANDS

Continuously calibrated bandspread OVER THE ENTIRE RANGE

Frequency readings to 1 part in 5000

You buy a communications receiver for just one thing—dependable performance. It's performance that counts, and the *NEW* Pro-310 was designed with performance in mind. It outperforms all the other receivers in its class. Here's why—

- 3 years engineering and design time in its development (including 1½ years to iron out the 'bugs') plus 5 years production experience on its military counterpart.
- The features shown above.

Check on the *NEW* Pro-310—it's made to order for your "tough-spot" service. Write for specs and other details to The Hammarlund Manufacturing Co. Inc., 460 West 34th Street, New York 1, N.Y. Ask for Bulletin I-9.



\*Completely new concept in precision electro-mechanical bandspread.

# HAMMARLUND

Since 1910

# MEASURE NOISE AND FIELD INTENSITY FROM 150 KC TO 1000 MC— WITH ONE METER!

Quickly • Accurately • Reliably

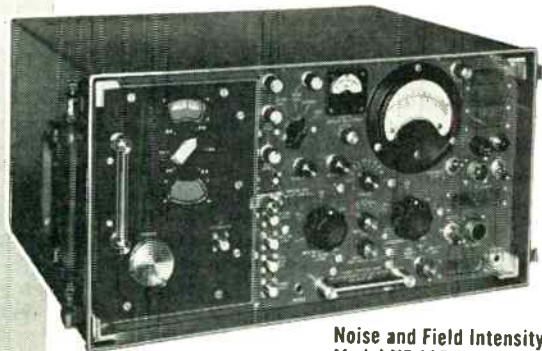

Noise and Field Intensity Meter  
Model NF-105  
(Commercial Equivalent of AN/URM-7)



TA/NF-105:  
150 KC-20MC



T1/NF-105:  
20-200MC



T2/NF-105:  
200-400MC



T3/NF-105:  
400-1000MC

Empire Devices Noise and Field Intensity Meter Model NF-105 permits measurements of RF interference and field intensity over the entire frequency range from 150 kilocycles to 1000 megacycles. It is merely necessary to select one of four individual plug-in tuning units, depending on the frequency range desired. Tuning units are readily interchangeable... can be used with all Empire Devices Noise and Field Intensity Meters Model NF-105 now in the field.

Each of the four separate tuning units employs at least one RF amplifier stage with tuned input. Calibration for noise measurements is easily accomplished by means of the built-in impulse noise calibrator. With this instrument costly repetition of components common to all frequency ranges is eliminated because only the tuners need be changed. The same components... indicating circuits, calibrators, RF attenuators, detectors and audio amplifier, and power supplies... are used at all times.

Noise and Field Intensity Meter Model NF-105 is accurate and versatile, it may be used for measuring field intensity, RF interference, or as an ultra-sensitive VTVM. A complete line of accessories is available.

*Additional information and literature upon request*

NEW YORK—Dlgbly 9-1240 • SYRACUSE—SYRacuse 2-6253 • PHILADELPHIA—SHerwood 7-9080 • BOSTON—WAltham 5-1955 • WASHINGTON, D.C.—DEcatur 2-8000 • ATLANTA—EXchange 7801 • DETROIT—BRoadway 3-2900 • CLEVELAND—EVERgreen 2-4114 • DAYTON—FULTon 8794 • CHICAGO—COlumbus 1-1566 • DENVER—MAIn 3-0343 • FORT WORTH—WEBster 8811 • ALBUQUERQUE 5-9632 • LOS ANGELES—REpublic 2-8103 • Palo Alto—DAvenport 3-4455 • CANADA: MONTREAL—UNiversity 6-5149 • TORONTO—WAlnut 4-1226 • HALIFAX 4-6487 • EXPORT: NEW YORK—MURray Hill 2-3760

**EMPIRE DEVICES  
PRODUCTS CORPORATION**

38-15 BELL BOULEVARD • BAYSIDE 61 • NEW YORK

manufacturers of

FIELD INTENSITY METERS • DISTORTION ANALYZERS • IMPULSE GENERATORS • COAXIAL ATTENUATORS • CRYSTAL MIXERS



(Continued from page 50A)

- DeLong, O. A., 180 Wildwood Ave., Upper Montclair, N. J.  
Demarr, J. D., 9624 Old Bladenburg Rd., Silver Spring, Md.  
Dembinski, L. J., 29 Mitchell Ave., Plainview, L. I., N. Y.  
Demere, R. M., Jr., 120 Cervantes Rd., Westbridge, Menlo Park, Calif.  
DeMotte, F. E., Bell Telephone Labs., Whippany, N. J.  
Denk, W. E., Steeplechase Rd., Devon, Pa.  
Dennison, P. R., 1539 Maple St., Pasadena 4, Calif.  
Denny, C. R., 30 Rockefeller Pl., New York 20, N. Y.  
Denny, W. B., Dept. of Physics, Grinnell College, Grinnell, Iowa  
Dent, W. U., 410 Bush St., San Francisco 8, Calif.  
Derey, C. H., 2608 Van Buren St., Bellevue, Nebr.  
Derganc, W., Marys La., Centerport, L. I., N. Y.  
Derrick, W. A., Cooke Bldg., Columbus Ave., Sandusky, Ohio  
Desch, J. R., 413 Greenmount Blvd., Dayton 9, Ohio  
DeShon, H. C., 42 Standish Rd., Watertown, Mass.  
Dethlefsen, D. G., Stanford Research Inst., 621 S. Hope St., Los Angeles 17, Calif.  
Detrick, D. M., 1230 Allan Ave., Falls Church, Va.  
Diamantides, N. D., 2053-11 St., Cuyahoga Falls, Ohio  
Dickinson, W. T., 5821 Franklin Ave., Falls Church, Va.  
Didinger, G. H., Jr., 259 Warren Ave., Hawthorne, N. Y.  
Dimasi, L. A., 627 California Ave., Oakmont, Pa.  
Dingman, E. H., 224½ W. Mountain Ave., Las Cruces, N. Mex.  
Dinnin, A. J., 2035 Guy St., Montreal, Que., Canada  
DiStadio, D., 440 Midland Ave., Garfield, N. J.  
Dittoe, R. E., Jr., 3372 E. Scarborough Rd., Cleveland, Ohio  
Dixon, T. K., Jr., 1973 W. Gray, Office 19, Houston 19, Tex.  
Dobbins, W. E., Box 605, Manhattan Beach, Calif.  
Dohan, W. R., 808 Wickfield Rd., Wynnewood, Pa.  
Dole, L. H., 229 W. Fifth St., Emporium, Pa.  
Dolinko, L., 710-B Broad Ave., Ridgefield, N. J.  
Donegon, R. E., 717 Orange St., Novato, Calif.  
Dong, J. G., 2 Flint Pl., Elmont, L. I., N. Y.  
Donovan, A. C., 43 Rowe St., Milton 86, Mass.  
Donovan, R., 16614 Monica, Detroit 21, Mich.  
Dooner, J. L., 59 Skytop Rd., Cedar Grove, N. J.  
Dorband, A. E., 7920 S. 112 St., Seattle 88, Wash.  
Dorsett, J. W., Jr., 2160 Mills Ave., Menlo Park, Calif.  
Dougherty, H. T., 8550 Concord La., Westminster, Colo.  
Douglas, W. H., Westinghouse Electric Corp., Sharon, Pa.  
Downey, C. E., 119 Villanova Dr., Oakland 11, Calif.  
Downing, R. E., 25 Garden St., Cambridge 38, Mass.  
Dreisbach, R. H., 908 Kinnaird Ave., Ft. Wayne 6, Ind.  
Drilling, N. G., 3002 Ashland Ave., Indianapolis 26, Ind.  
Driver, J. P., 2623 Norbert St., Flint, Mich.  
DuBose, G. P., 5103 Avenue H, Austin 5, Tex.  
Dudley, J. A., Brookeville, Md.

(Continued on page 54A)

**edp**

# THIS IS HELIAX<sup>®</sup>...

*The truly FLEXIBLE*

*Air dielectric cable*

This latest ANDREW cable, introduced just 18 months ago, has received phenomenal industry acceptance. This is easy to understand, when you consider that HELIAX offers electrical performance equal to that of the finest copper cables, yet is far lower in price and much easier to install.

HELIAX has its own complete series of connectors, matching the superior electrical performance of the cable.

These fittings are pressurized and weatherproofed, and attach easily without special tools.

For a maximum of convenience in the field, HELIAX is normally supplied in complete assemblies, with end fittings factory attached. Available in  $\frac{7}{8}$ " and  $1\frac{5}{8}$ " sizes.

Continuous lengths to 3,000 feet.

*Write now for complete engineering data and  
a sample of this remarkable cable.*

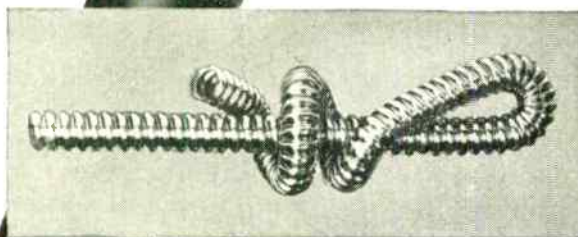

The secret of HELIAX lies in its corrugated outer conductor. As demonstrated at the left, this by itself can be bent on its own diameter without breaking, kinking or going out of round. These qualities give HELIAX its unusual flexibility, strength and ease of handling.

**Andrew**  
CORPORATION

363 EAST 75th STREET • CHICAGO 19



Offices: NEW YORK • BOSTON • LOS ANGELES • TORONTO  
ANTENNAS • ANTENNA SYSTEMS • TRANSMISSION LINES

# 28 foot TRANS-HORIZON ANTENNAS available NOW

Field proven for two years in over 50 installations, this versatile, rugged antenna is currently available from stock.

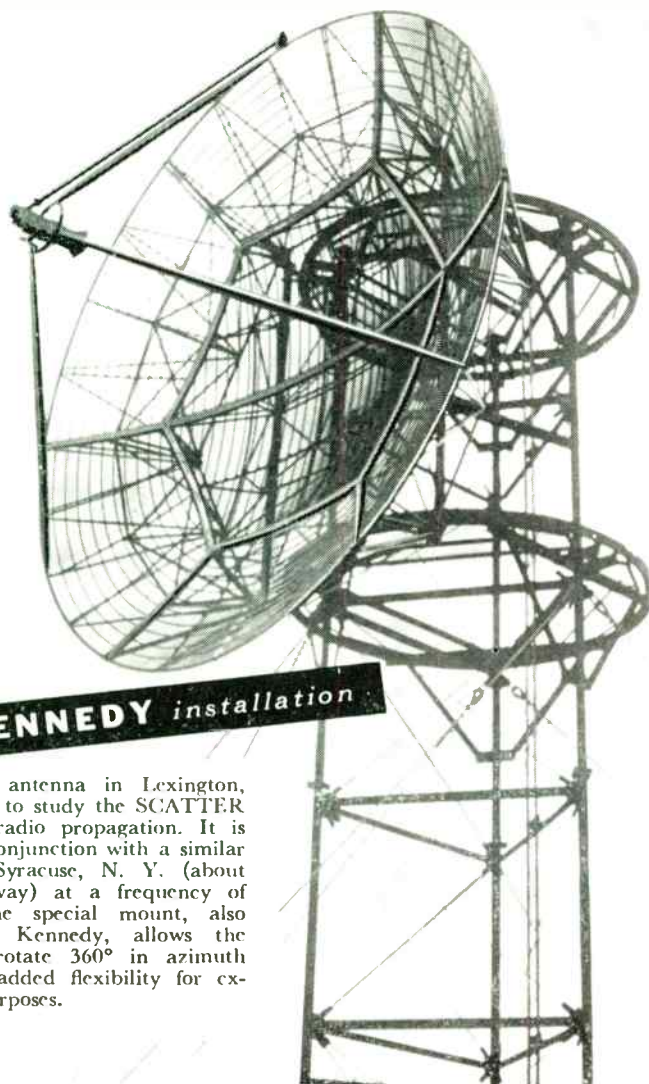

another **KENNEDY** installation

This 28-foot antenna in Lexington, Mass. is used to study the SCATTER principle of radio propagation. It is operated in conjunction with a similar antenna in Syracuse, N. Y. (about 250 miles away) at a frequency of 915 mc. The special mount, also designed by Kennedy, allows the antenna to rotate 360° in azimuth which gives added flexibility for experimental purposes.

ANTENNA EQUIPMENT

• **D. S. KENNEDY & CO.**

COHASSET, MASS. — TEL: CO4-0699



(Continued from page 52A)

- Duffy, M. P., Hazeltine Electronics Corp., Little Neck, L. I., N. Y.
- Dugan, D. I., 25 Maple Ave., Oakwood Pk., Mountd Rt., Camp Hill, Pa.
- Duncan, D. C., 4077 Garder Ave., Western Springs, Ill.
- Dunlap, J. F., 734 N. Pine Ave., Chicago 44, Ill.
- Dunlap, K. S., Bell Telephone Labs., Murray Hill, N. J.
- Dunn, J. L., General Delivery, Cloudcroft, N. Mex.
- Dunn, S. C., 14 Swift-green Rd., Luton, Beds., England
- Dunn, T. E., 56 Thorny Apple La., Levittown, Pa.
- Durlin, H. M., 125 Sylvan Glen Dr., South Bend 15, Ind.
- Durfee, G. H., 4414 Underwood Rd., Baltimore 18, Md.
- Durham, L. G., Electronic Dept., Hughes Aircraft Co., Culver City, Calif.
- Durkee, A. I., Bell Telephone Labs., 463 West St., New York, N. Y.
- Durr, E., 307.40 St., Sacramento, Calif.
- Dutton, W. P., 732 N. Edison St., Arlington 3, Va.
- Dwyer, R. J., 1522 E. Orange Grove Ave., Pasadena, Calif.
- Dye, R. E., 12217 Bushey Dr., Silver Spring, Md.
- Dyer, F. C., 448 Monssen Dr., Dallas, Tex.
- Dymond, C., 1419 Graybar La., Nashville, Tenn.
- Easterbrook, L. J., Jr., Box 832, International Airport Br., Miami, Fla.
- Eastlund, L. C., 471 S. E. 72 Ave., Portland, Ore.
- Eckess, W. S., 4305 Washington, Florissant, Mo.
- Eddy, W. L., 4519 Seeley Ave., Downers Grove, Ill.
- Edgerton, A. K., 826 N. Victory Blvd., Burbank, Calif.
- Edison, T. M., Llewellyn Park, West Orange, N. J.
- Edmunds, J. J., Jr., 198 Sylvan St., Rutherford, N. J.
- Edwards, C. F., Box 107, Red Bank, N. J.
- Edwards, N. P., R.F.D. 1, Hopewell Junction, N. Y.
- Eells, W. A., 207 Gilham, Philadelphia 11, Pa.
- Eggart, G. J., Jr., Ebasco International Corp., 2 Rector St., New York 6, N. Y.
- Eilers, C. G., 104 W. Maple St., Fairbury, Ill.
- Eisenberg, I., 805 E. 182 St., New York 60, N. Y.
- Ekblaw, W. E., Jr., Roy G. Miller, Inc., Monmouth, Ill.
- Ekrem, T. C., 952 S. Josephine, Denver, Colo.
- Elam, F. E., 204 N. Van Buren St., Rockville, Md.
- Elbert, C. H., 65 Greglawn Dr., Clifton, N. J.
- Ellerbeck, K. H., 2815-46, W., Seattle 99, Wash.
- Ellert, C. A., 2406 Everton Rd., Baltimore 9, Md.
- Elliott, L., 453 Whitfield Rd., Baltimore 28, Md.
- Elliott, S. J., Bell Telephone Labs., 463 West St., New York, N. Y.
- Ellis, J. W., Jr., 20951 Costanso St., Woodland Hills, Calif.
- Ellis, R. T., Jr., 2098 Dayton St., Silver Spring, Md.
- Ellison, M., Jr., 10404 Seventh Ave., Inglewood, Calif.
- Elmore, C. M., Jr., 3936 Highgrove Dr., Dallas, Tex.
- Elwell, H. G., Jr., 392 Lafayette Ave., Westwood, N. J.
- Emmerich, L., 408 Avenida De Jose, Redondo Beach, Calif.

(Continued on page 56A)



# DESIGN IS OUR BUSINESS

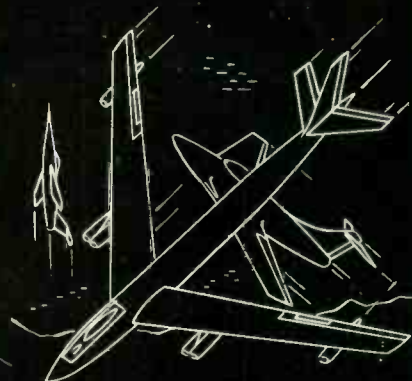
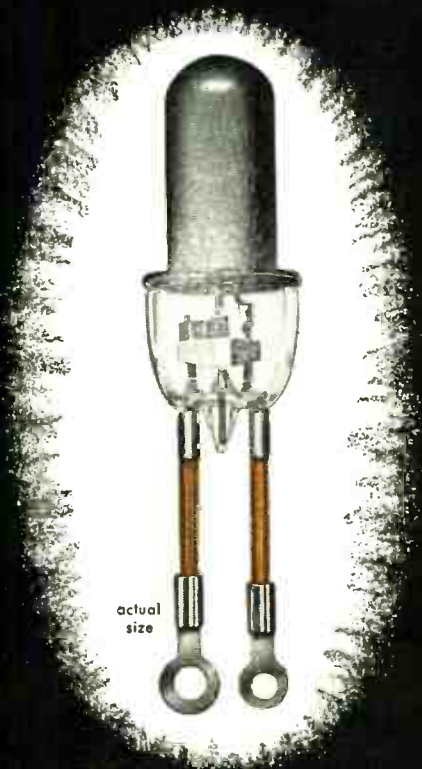
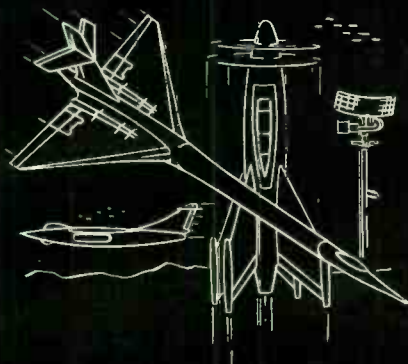

## ANNOUNCING **UNITED** TYPE 589 CLIPPER-DIODE RECTIFIER

Ever so small, and light for its power capabilities, our new type 589 electron tube will help immeasurably in concluding many electronic design problems, especially for aircraft and missile environment.

This new external anode tube weighs only a little over  $\frac{3}{4}$  of an ounce, is less than 2 inches long, yet is rated as a clipper diode for 10,000 volts epx, and for peak plate current of 8 amperes.

For oil emersed rectifier operation rated epx is 16,000 volts and average plate current rating is 65 mAdc.

For convection cooled rectifier operation rated epx is 16,000 volts and average plate current rating is 30 mAdc.

Shock rating is 300 g.

### MECHANICAL DATA

|                                 |                   |
|---------------------------------|-------------------|
| Nominal Overall Dimensions:     |                   |
| Length (Less lead).....         | 1.9 inches        |
| Lead Length.....                | 1.5 inches        |
| Diameter.....                   | .9 inches         |
| Anode Dimensions:               |                   |
| Length (for contact).....       | .8 inches         |
| Diameter.....                   | .6 inches         |
| Bulb.....                       | Per illustrations |
| Mounting and Anode Contact..... | Per illustrations |
| Filament Terminals.....         | Per illustrations |

|                                  |         |
|----------------------------------|---------|
| Type of Cooling.....             | Liquid  |
| Net Weight.....                  | 0.8 oz. |
| Shock Rating.....                | 300 g.  |
| Vibration Rating at 500 cps..... | 10 g.   |

### ELECTRICAL DATA

|  |                     |
|--|---------------------|
| General:                                   |                     |
| Heater Voltage.....                        | 6.3 Vac.            |
| Heater Current.....                        | 1.6 Aac.            |
| Cathode.....                               | Coated Unipotential |
| Maximum Rectifier Ratings (Liquid Cooled): |                     |
| Peak Inverse Voltage.....                  | 16.0 kv.            |

|                                   |          |
|-----------------------------------|----------|
| Peak Plate Current.....           | 250 ma.  |
| Average Plate Current.....        | 65 mAdc. |
| Maximum Coolant Temperature Range |          |
| -65° C to +165° C                 |          |

|  |          |
|--|----------|
| Maximum Rectifier Ratings (Radiation Cooled):  |          |
| Peak Inverse Voltage.....                      | 16.0 kv. |
| Peak Plate Current.....                        | 120 ma.  |
| Average Plate Current.....                     | 30 ma.   |
| Maximum Clipper Diode Ratings (Liquid Cooled): |          |
| Peak Inverse Voltage.....                      | 10.0 kv. |
| Peak Current.....                              | 8 a.     |
| Average Plate Current.....                     | 20 ma.   |

**UNITED**



**ELECTRONICS, 42 Spring Street, Newark 2, N. J.**



## A WINDING MACHINE FOR TINY TOROIDS

Tiny toroids — 14 OF THEM — produced on a Boesch Model SM Sub-miniature Coil Winding Machine are shown fitted inside a SIZE FIVE WEDDING RING.

Consider the importance of this comparison! By producing space and weight-saving subminiature toroids, the Boesch Model SM helps you design subminiaturized equipment.

For coils down to 5/64 ID, wire sizes as fine as #50, IT'S THE BOESCH MODEL SM Toroidal Winding Machine. Somewhat larger coils can be wound with wire as heavy as #36.



14K. gold wedding ring courtesy of Shreve, Crump & Low Company Boston, Massachusetts

Send us your specifications and a core sample. We will show you what our machines can do.

NOW — no licensing, no royalties required in the sale and use of BOESCH Machines.



## Membership

(Continued from page 54A)

- Endres, J. M., Jr., 29 Fulmer Ave., Haverstown, Pa.  
 Enestein, N. H., 7447 Henefer Ave., Los Angeles 45, Calif.  
 Engel, G. C., 460 Spring Ave., Ridgewood, N. J.  
 Engelhardt, G. B., 28 Club Way, Hartsdale, N. Y.  
 Engert, G. W., Ringwood Manor, State Park, Ringwood, N. J.  
 Epstein, M., 4 Clarence St., West End, N. J.  
 Erickson, R. S., 1860 Rome Ave., St. Paul 5, Minn.  
 Ernst, R. F., 16 Stuyvesant Oval, New York 9, N. Y.  
 Erwin, E. V., 4247 S. 172, Seattle 88, Wash.  
 Eubanks, J. M., 2302 Granada Blvd., Coral Gables, Fla.  
 Evans, J. C., 134 S. Bowling Green Way, Los Angeles 49, Calif.  
 Everett, F. C., 31 Maple St., Garden City, L. I., N. Y.  
 Everitt, R. S., 504 S. Los Robles Ave., Pasadena 5, Calif.  
 Evers, J. T., Pinewood Dr., Box 161, R.F.D. 2, Neptune, N. J.  
 Fahy, E. J., USN Underwater Sound Lab., Ft. Trumbull, New London, Conn.  
 Fair, I. E., Box 182, Eau Gallie, Fla.  
 Fairbanks, A. F., 2417 N. Angelus Ave., Garvey, Calif.  
 Fairweather, B. A., Bell Telephone Labs., Murray Hill, N. J.  
 Fairweather, R. W., 318 Colony St., West Hempstead, L. I., N. Y.  
 Fallows, R. S., 5 Bellingham St., Newton Highlands, Mass.  
 Fast, S., 96 First St., Fair Haven, N. J.  
 Faust, C. W., 1485 Arlington Ave., St. Louis 12, Mo.  
 Featherstone, R. P., 4933 Third Ave., S., Minneapolis 9, Minn.  
 Feigenbaum, I. A., 112 Cedar Ave., West End, N. J.  
 Fernbach, M., 7813 Farnsworth St., Philadelphia, Pa.  
 Fesko, J., Jr., 8259 E. Clarence Ave., San Gabriel, Calif.  
 Field, W. A., 522-A Nimitz, China Lake, Calif.  
 Filmer, W. L., R. D. 1, Mendham Rd., Morristown, N. J.  
 Findley, R. W., R. D. 2, Valencia, Pa.  
 Fingerhood, S. A., 25 W. 81 St., New York, N. Y.  
 Fishberg, S., 3400 Park Ave., New York 56, N. Y.  
 Fisher, S. G., R. D. 2, New Rt. 18, Sharon, Pa.  
 Fitts, W. F., 71 Walthery Ave., Ridgewood, N. J.  
 Flack, S. G., 15419 Hilliard Rd., Lakewood 7, Ohio  
 Fleming, J. J., Naval Research Lab., Code 5130, Washington, D. C.  
 Florinan, E. F., 2003 Bluebell Ave., Boulder, Colo.  
 Flower, R. A., 67 Topland Rd., White Plains, N. Y.  
 Flynn, H., 805 N. Overlook Dr., Alexandria, Va.  
 Flynn, J. G., 1937 Irving Blvd., Dallas, Tex.  
 Foley, T. U., 148 Ridge Rd., Erlton, N. J.  
 Follingstad, H. G., 611 Norwood Dr., Westfield, N. J.  
 Fonte, G., The Clough Brengle Co., 6014 Broadway, Chicago, Ill.  
 Foote, S. H., 14935 Hartsook St., Sherman Oaks, Calif.  
 Forbath, F. P., 4296 Vineland Ave., North Hollywood, Calif.  
 Forster, A. G., 1133 Oakland Ave., Piedmont 11, Calif.

(Continued on page 58A)

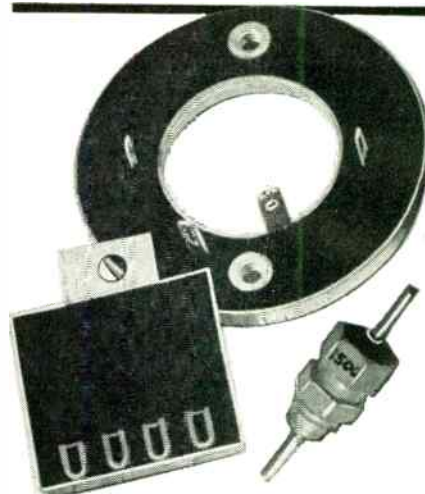

## CUSTOM-DESIGNED CERAMIC CAPACITORS

Among Hi-Q custom-designed units are ring capacitors to fit around metal-tube sockets, multiple-section rectangular capacitors in metal cans for by-pass applications, and new stand-off and feed-thru designs, all engineered to withstand severe mechanical and environmental stresses. These pieces reflect the skill of Hi-Q engineers in producing sturdy, compact components to meet the requirements of specialized applications.

Catalog on request. Let us collaborate on your requirements.



## for that short grid lead use the Sangamo

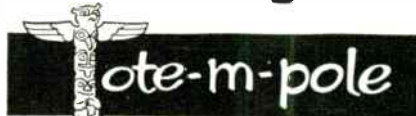

First used in Navy electronic gear, Tote-m-poles are invaluable for "bug-resistant" wiring of models and production units. Advantages: Short leads; high component density; improved ventilation.

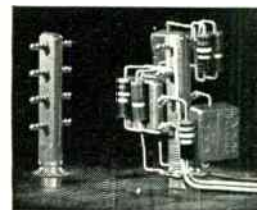

Tote-m-pole supporting "T" network of 5 resistors and 4 capacitors.

CUSTOM COMPONENTS DEPT.\*  
 SANGAMO ELECTRIC COMPANY  
 SPRINGFIELD, ILLINOIS

\*H. V. Power Supplies • Inductive Components  
 Servo Instruments • Low-X Resistors



Actual Size

*Highest  
quality...  
reliability...*

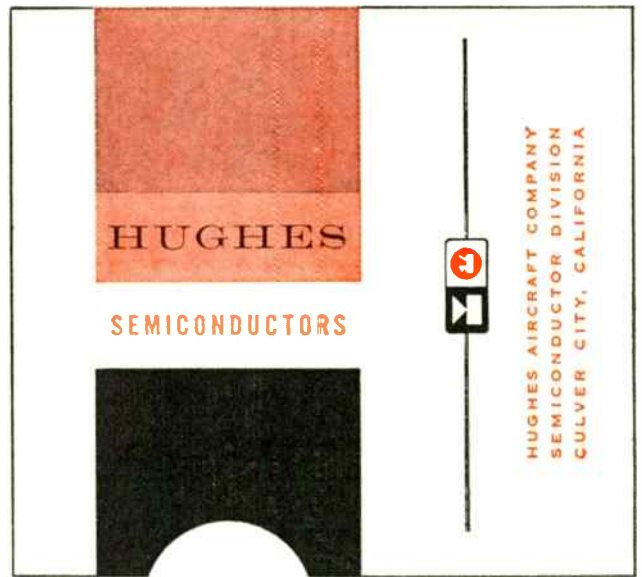

## HUGHES SILICON JUNCTION DIODES

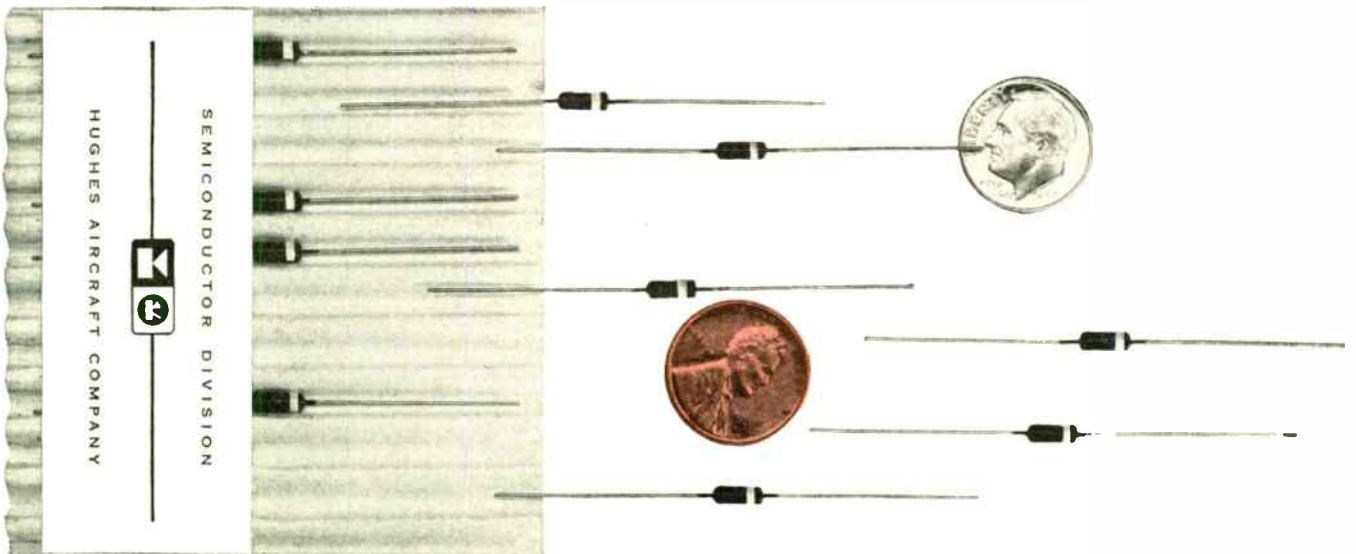

Actual Size

### features:

- HIGH TEMPERATURE OPERATION\*
- EXTREMELY HIGH BACK RESISTANCE
- VERY SHARP BACK VOLTAGE BREAKDOWN
- NO VOLTAGE DERATING AT HIGH TEMPERATURE
- EXCEPTIONALLY STABLE CHARACTERISTICS
- ONE-PIECE, FUSION-SEALED GLASS BODY
- AXIAL LEADS FOR EASY MOUNTING
- SUBMINIATURE SIZE\*\*

The one-piece, fusion-sealed glass body is impervious to penetration by moisture or other external contamination—ensures electrical and mechanical stability. Shipments—in quantity—of all types of Hughes Silicon Junction Diodes are now being made in new, compact volume packaging. When your circuit requirements call for diodes with high temperature or high back resistance characteristics, be sure to specify Hughes Silicon Junction Diodes. They are first of all—for RELIABILITY. Listed and described in Bulletin SP4.

\*Characteristics rated at 25°C and at 150°C. Ambient operating range, -80°C to +200°C.  
\*\*Actual dimensions, diode glass body—Length: 0.265-inch, max. Diameter: 0.105-inch, max.

# HUGHES

Aircraft Company, Culver City, California

SEMICONDUCTOR DIVISION

New York Chicago  
Los Angeles

# New Bi-Directional Power Monitor



**25 to 1,000 mc**  
**10 to 500 watts**  
**Only 2 plug-in elements**

**MODEL 164**

## Quickly measures incident or reflected power, simplifies matching loads to lines

New Sierra Model 164 is a compact, versatile, bi-directional monitor for intermittent or continuous measuring of incident or reflected power, or convenient and precise matching of loads to lines. The instrument offers unequalled measuring ease and economy, since only two plug-in elements are required for coverage of all frequencies 25 to 1,000 mc and wattages 10 to 500 watts. Two plug-in elements cover, respectively, 25 to 250 mc and 200 to 1,000 mc. Both have 4 power ranges: 10, 50, 100 and 500 watts. Accuracy is  $\pm 5\%$  full scale. No auxiliary power is required to operate the instrument.

Because of its compact size and wide range, Model 164 is ideal for portable applications (mobile, aircraft, etc.) as well as laboratory use. It is supplied in a sturdy carrying case (one or both plug-in elements supplied as ordered) and both meter and directional coupler may be removed from the case for remote monitoring. The monitor may be equipped for most connectors normally employed with 50 ohm lines. A twist of the wrist selects incident or reflected power, or any power range, without requiring removal of power. No exchange of plug-in elements is necessary to read low levels of reflected power.

### TENTATIVE SPECIFICATIONS

**Power Ranges:** 10, 50, 100 and 500 watts full scale direct reading.

**Accuracy:**  $\pm 5\%$  of full scale.

**Insertion VSWR:** Less than 1.08.

**Frequency Ranges:** 25 to 1,000 mc. Two plug-in elements.

**Low Frequency Element:** 25 to 250 mc.

**High Frequency Element:** 200 to 1,000 mc.

**Impedance:** 50 ohm coaxial line.

*Data subject to change without notice.*

**sierra**



**Sierra Electronic Corporation**  
 San Carlos 2, California, U. S. A.

**Sales representatives in major cities**  
 Manufacturers of Carrier Frequency Voltmeters, Wave Analyzers, Line Fault Analyzers, Directional Couplers, Wideband RF Transformers, Custom Radio Transmitters, VHF-UHF Detectors, Variable Impedance Wattmeters, Reflection Coefficient Meters.



**Membership**

*(Continued from page 56A)*

- Foster, J. F., 835 Mountain Pl., Pasadena 6, Calif.
- Fowler, J. A. B., Box 488, Fort Jones, Calif.
- Fowlie, W. D., 379 Barrington St., Halifax, N. S., Canada
- Fox, K. R., 2 E. Adelheidstraat 300, The Hague, Holland
- Fox, R. C., Westinghouse Electric Corp., Air Arm Div., Friendship Airport, Baltimore 27, Md.
- Frame, T. E., 1003 Upton Rd., Glen Burnie, Md.
- Franklin, R. M., Chrysler Corp., 2985 E. Jefferson Ave., Detroit, Mich.
- Franta, A. L., Code 535, Naval Research Lab., Anacostia Sta., Washington 25, D. C.
- Franz, J. P., Jr., 311 Delano Dr., Pittsburgh 36, Pa.
- Franzel, I. H., 336 Lacey Dr., New Milford, N. J.
- Frattali, F. A. V., 4403 Old Frederick Rd., Baltimore 29, Md.
- Frazier, R. V., 212 Maryland Ave., Towson 4, Md.
- Fredendall, B. F., 1907-B W. Alameda, Burbank, Calif.
- Freeland, R. R., Box 265, W. Warr Acres, P. O., Oklahoma City, Okla.
- Freeman, C. F., 100-B Halser Ave., China Lake, Calif.
- French, C. G., U. S. Steel Co., Fairless Works, Fairless Hills, Pa.
- Friedberg, I. S., 11 Longfellow St., N. W., Washington, D. C.
- Friedman, J. B., 5406 Woodlawn Ave., Chicago 15, Ill.
- Friesser, J. M., Box 648, Forge Rd., White-marsh, Md.
- Frohbach, H. F., 7132 Stevens Ave., S., Minneapolis 23, Minn.
- Fry, W. J., Electrical Engineering Research Labs., University of Illinois, Urbana, Ill.
- Fryncko, P., R.F.D. 1, Box 143, Seymour, Conn.
- Fuhrmeister, P. F., 4 Langhorne Rd., Warwick, Va.
- Fuller, I. W., Jr., 200 Ottawa St., S. E., Washington 21, D. C.
- Fulmer, J. W., 1504 W. Chester Pike, West-gate Hills, Havertown, Pa.
- Fulton, W. L., 29 Otterbein Ave., Dayton, Ohio
- Gaillard, R. L., 229 E. 12 St., New York 3, N. Y.
- Galamhos, L. G., 1149 Olsen, Toledo 12, Ohio
- Galidas, P., General Electric Co., Syracuse, N. Y.
- Gallo, F. J., 340A Vallejo St., San Francisco 11, Calif.
- Gams, T. C., N. J. Electronics Corp., 345 Carnegie Ave., Kenilworth, N. J.
- Gano, O. R., Rt. 1, Box 78-B, Melrose, Fla.
- Garafalo, J. J., 5817 W. 78 Pl., Los Angeles 45, Calif.
- Garcia, A., 583 Queen St., Woodbury, N. J.
- Gardner, R. O., 1014 Blvd., Cor. Ridge St., New Milford, N. J.
- Garkav, E., 7019 Pennsylvania Ave., Bywood, Upper Darby, Pa.
- Garoff, K., 116 N. Sunnycrest Dr., Little Silver, N. J.
- Garretson, H. W., Power Utilization, Bureau of Reclam., Denver Federal Center, Denver, Colo.
- Garrett, E. T., Box 3397, USAFIT, Wright-Patterson AFB, Ohio
- Garrigus, N. F., 96 Fairchild Cir., OFFUTT, Omaha, Nebr.
- Gates, W. F., 580 Pullman Rd., Burlingame, Calif.
- Gaydos, G. J., 14 Lafayette Ave., N. E. Grand Rapids, Mich.

*(Continued on page 60A)*

# REVERE

## ROLLED

### Printed Circuit Copper



No longer need the lack of material deter you from switching to printed circuitry. Revere *Rolled* Printed Circuit Copper is now available to laminators in standard coils of 350 lbs. in widths up to 38", and in .0015" and .0027" gauges weighing approximately 1 oz. and 2 oz. per square foot.

Revere *Rolled* Printed Circuit Copper is accurate in gauge, of high conductivity, and uniform density. It is easily etched and soldered.

The next time you order blanks from your laminator, specify Revere *Rolled* Printed Circuit Copper.

## REVERE

### COPPER AND BRASS INCORPORATED

*Founded by Paul Revere in 1801*

230 Park Avenue, New York 17, N. Y.

*Mills: Baltimore, Md.; Brooklyn, N. Y.; Chicago, Clinton and Joliet, Ill.; Detroit, Mich.; Los Angeles and Riverside, Calif.; New Bedford, Mass.; Newport, Ark.; Rome, N. Y.*  
Sales Offices in Principal Cities, Distributors Everywhere.

# Stupakoff

## CERAMIC MATERIALS

*At your fingertips...*

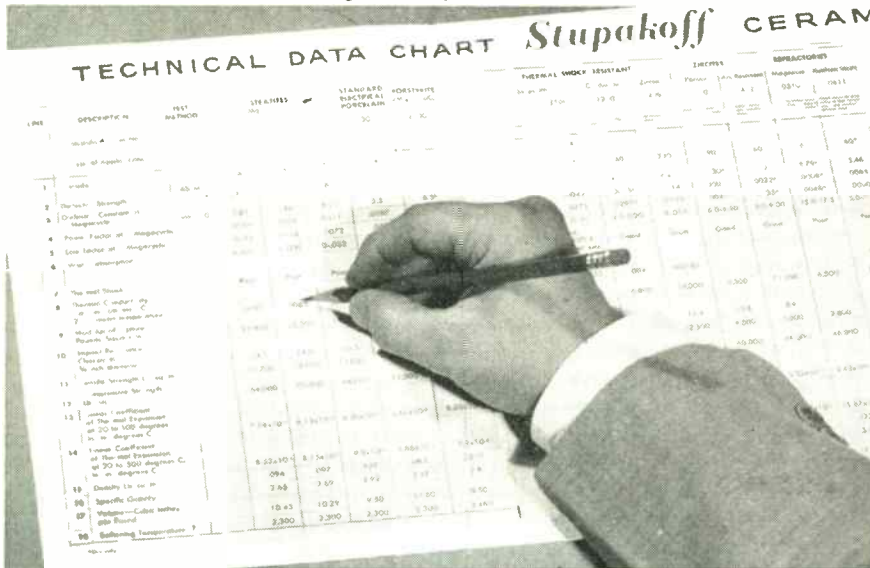

## NEW TECHNICAL DATA on Stupakoff CERAMIC MATERIALS

The very latest technical information on a wide range of ceramic materials is given in the new Stupakoff Technical Data Chart. Electrical and physical characteristics and the chemical composition of various grades of the following ceramic materials are included:

ALUMINA  
ALUMINUM SILICATE  
STEATITE

PORCELAIN  
STUPALITH  
CORDIERITE  
MAGNESIA

ZIRCON  
ZIRCITE  
FORSTERITE

Valuable design and application suggestions included in the Stupakoff Data Chart help you engineer your ceramic parts for lowest cost and greatest satisfaction.

*Send today for your free copy of the new Stupakoff Data Chart. Arranged for ready reference.*

WRITE  
DEPT. P.



# Stupakoff

Division of The CARBORUNDUM Company

LATROBE, PENNSYLVANIA



(Continued from page 58A)

- Gayle, A., Cavo Dr., Deerfield Acres, Poughkeepsie, N. Y.
- Geary, L. W. F., Head of Meadows Rd., Newton, Conn.
- Gegenheimer, R. F., 27 Longtellow Dr., Rahway, N. J.
- Geiger, J. M., 342 Woodland Dr., Brightwaters, L. I., N. Y.
- Geiger, R. F., 701 Elden, Whittier, Calif.
- Gellert, J., 67-09—210 St., Bayside, L. I., N. Y.
- Gemmill, F. Q., 82 Wyatt Rd., Garden City, L. I., N. Y.
- Gemulla, W., 3516 E. Third St., Long Beach, Calif.
- Genz, W. F., Tele-Ray Tube Co., Inc., 984 Saw Mill River Rd., Yonkers, N. Y.
- George, W. D., National Bureau of Standards, Boulder, Colo.
- Gerber, P. D., 118 Elm Ave., Woodlynne, Audubon 6, N. J.
- Gibbons, D. R., P. O. Box 506, Manasquan, N. J.
- Gilbs, D. R., 926 Sweetbriar Dr., Alexandria, Va.
- Gilbs, N. E., 24A Garden St., Cambridge, Mass.
- Gibson, F. C., Box 376, Broughton, Pa.
- Gibson, W. G., 645 Princeton Kingston Rd., Princeton, N. J.
- Gifford, J. S., 57 Hazel Ave., Livingston, N. J.
- Gilbertson, S. R., 16165 Stone Ave., Seattle 33, Wash.
- Gilden, M., Dept. of Electrical Engineering, University of Illinois, Urbana, Ill.
- Gillespie, H. C., 207 Pleasant Valley Ave., Moorestown, N. J.
- Gillette, K. G., 1433 Spring Rd., N. W., Washington 10, D. C.
- Gilman, B. S., 484 Laurel Rd., Rockville Centre, L. I., N. Y.
- Gilman, M. A., General Radio Co., 275 Massachusetts Ave., Cambridge 39, Mass.
- Gilmore, A. C., Jr., 292 Lyndhurst Ave., Lyndhurst, N. J.
- Ginsburg, C. P., 522 Orange Ave., Los Altos, Calif.
- Giulie, J. D., 11751 Plateau Ave., Los Altos, Calif.
- Glaser, R. A., c/o Mrs. A. S. Oliger, 12034—62 Ave., Seattle, Wash.
- Glass, M. S., Bell Telephone Labs., Murray Hill, N. J.
- Gleason, J. L., 707 North F St., Oxnard, Calif.
- Gleason, R. F., 2722 Ramblewood Dr., S. E., Washington, D. C.
- Gleghorn, G. J., 2400 Via Anacapa, Palos Verdes Estates, Calif.
- Gleimer, L., 63-61 Yellowstone Blvd., Forest Hills, L. I., N. Y.
- Glendinning, W., 9 Honor Oak Rise, Forest Hill, London, England
- Glidewell, J. J., Jr., 254 N. Delmar Ave., Dayton 3, Ohio
- Glueckler, E. J., 1314 Puritan Ave., Bronx 61, N. Y.
- Godbey, J. J., 6047 Ridgecrest Rd., Dallas, Tex.
- Goetz, J. A., 33 Hasbrouck Dr., Poughkeepsie, N. Y.
- Goff, R. H., Flight Determination Lab., White Sands Proving Ground, Las Cruces, N. Mex.
- Gold, D., 5262 Fountain Ave., Los Angeles 29, Calif.
- Goldbaum, S., 112-41—72 Rd., Forest Hills 75, L. I., N. Y.
- Goldberg, R. J., 347 Ave. T, Brooklyn 23, N. Y.
- Goldenthal, S., 1644 Northgate Rd., Baltimore, Md.
- Goldshine, A. D., 1122 Stuyvesant Ave., Irvington, N. J.

(Continued on page 62A)

THERE ARE **NONE FINER!**

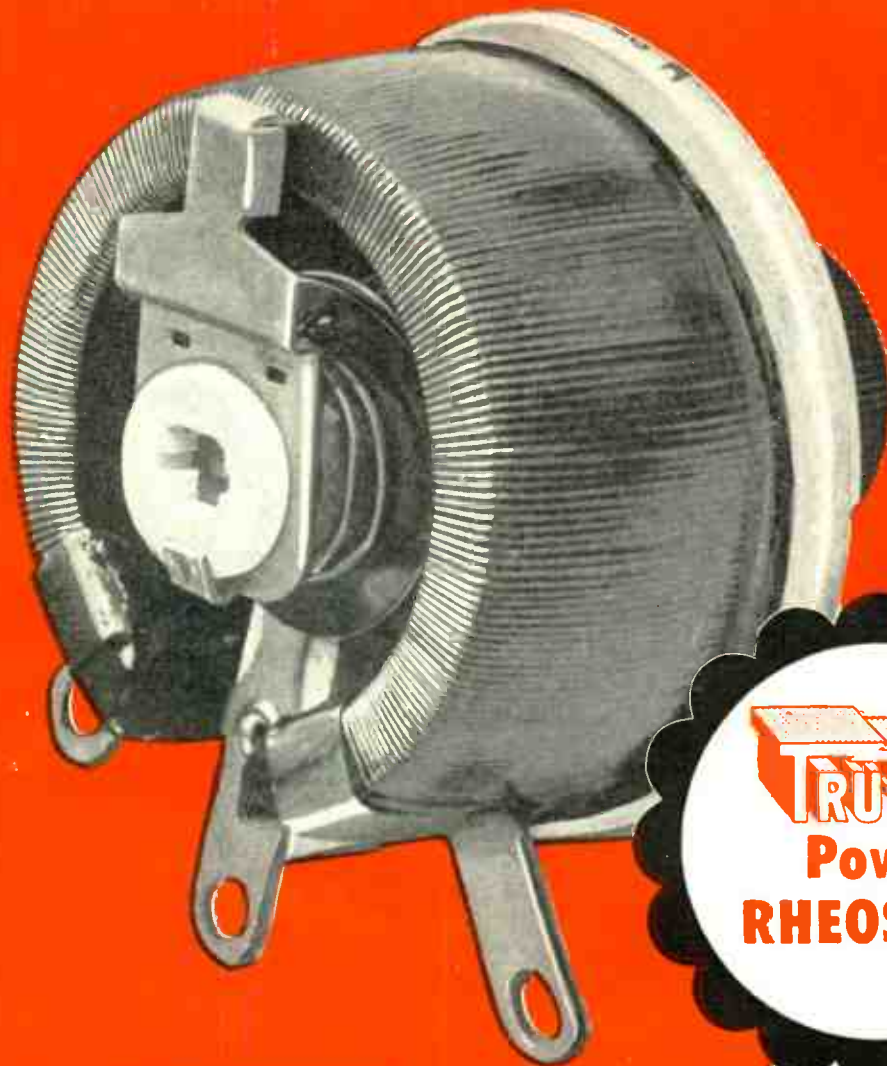

**TRU-OHM**  
Power  
**RHEOSTATS**

**TRU-OHM POWER RHEOSTATS**  
are more and more in demand and  
there are many reasons. These  
include finest quality, better service,  
and delivery; UL approval; variety from  
25 watts up; fairest prices; AND TRU-OHM  
expedites for YOU . . . TRU-OHM ships on time.

We invite your inquiry.  
Have you received our latest catalog? **WRITE TODAY!**



**TRU-OHM PRODUCTS**

Division of  
Model Engineering  
& Mfg., Inc.

General Sales Office: 2800 N. Milwaukee Avenue, Chicago 18, Ill.

Factory: Huntington, Indiana

"Largest producers of wire-wound resistors in the U.S.A."



MANUFACTURERS: Power Rheostats, Fixed Resistors, Adjustable Resistors, "Econ-ohm" Resistors, "Tru-rib" Resistors

# HYCON EASTERN

a complete facility for  
DESIGN • ENGINEERING • PRODUCTION



## CRYSTAL FILTERS

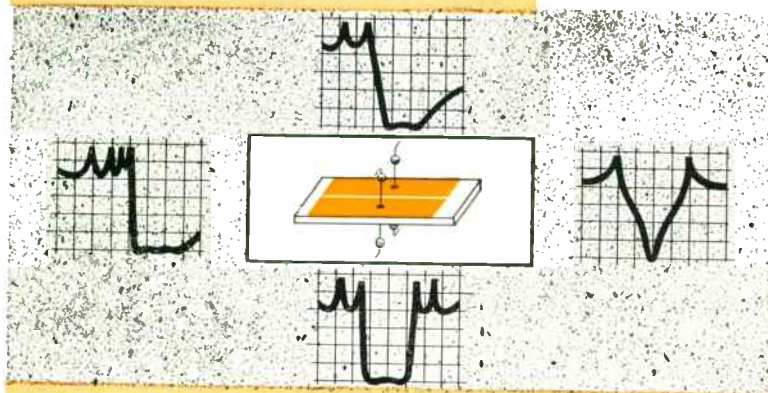

**FREQUENCY RANGE:** 10 kilocycles to 10 megacycles for all types of filters.

**BANDWIDTH RANGE:** 0.01% to 14% of center frequency.

**APPLICATIONS:** Carrier Communication Systems: Telephone Channel Filters, Pilot Selection Filters, Telemetry Channel Filters, Teletype Channel Filters, Other Frequency Multiplexing Systems. Single Side Band Filters. High Selectivity Amplifiers. Noise and Sound Analysers. Carrier Current Systems. Harmonic Selection.

ANNOUNCEMENT is made of a new technique for the synthesis of crystal filters which resolves many of the problems heretofore associated with their design and production. High initial cost and long lead time have been eliminated. System design no longer need be compromised because of the limited number of existing filters. Filters can be produced on short notice in large or small quantities to meet *exact* performance requirements. Curves shown above suggest the wide variety of characteristics. *Your inquiry is invited.*



**HYCON EASTERN, INC.**

75 Cambridge Parkway, Dept. B, Cambridge 42, Massachusetts



**Membership**

(Continued from page 60A)

- Goldsmith, P., Armour Research Foundation, 35 W. 33 St., Chicago 26, Ill.
- Goldstein, G. D., 9520 Saybrook Ave., Silver Spring, Md.
- Goldstein, S. J., Jr., 4220 N. Capitol Ave., Indianapolis, Ind.
- Goldstone, B. J., 32 Spiral La., Levittown, Pa.
- Goodling, G. G., Jr., 421 Lincoln St., York, Pa.
- Gorton, E. D., 1043 Lilac, N.E., Grand Rapids, Mich.
- Goss, C. G., 636 Long Rd., Glenview, Ill.
- Gottwald, C. H., 4009-50, San Diego 5, Calif.
- Gould, E. W., The Ramo-Wooldrige Corp., 8820 Bellanca Ave., Los Angeles 45, Calif.
- Gruebner, M. S. J., 2085 E. Arlington, St. Paul 6, Minn.
- Graf, V. V., Holwood, Keston, Kent, England
- Graham, E., Jr., 6424 Jocelyn Hollow Rd., Nashville 5, Tenn.
- Grandizo, L. A., 2175 Washington Ave., New York 57, N. Y.
- Grant, C. R., 8606 Melwood Rd., Bethesda 14, Md.
- Grant, J. H., 721 S. 28 St., South Bend 15, Ind.
- Grass, A. M., 101 Old Colony Ave., Quincy, Mass.
- Gratton, R. E., 3151 E. Colorado, Box 2, Pasadena 8, Calif.
- Graveson, R. T., 26 Overlook Rd., Ardsley, N. Y.
- Gravlee, G. P., 1116 Vellex La., Annandale, Va.
- Gray, C. M., Box 602, Birmingham 1, Ala.
- Gray, G. E., 39 Barnett Hill Rd., Livingston, N. J.
- Gray, H. J., Jr., 412 Colonial Park Dr., Springfield, Media, Pa.
- Grazda, E. E., 214-21-46 Rd., Bayside Hills, L. I., N. Y.
- Green, A. P., 14030 Margate St., Van Nuys, Calif.
- Green, D. B., 5 Arden Pl., Athens, Ohio
- Green, J. W., 3515 Veteran Ave., Los Angeles 34, Calif.
- Green, J. W., R.R. 2, c/o B. C. Winzer, Augusta, Kans.
- Green, W. M., Jr., 1201 Alabama, Bastrop, La.
- Greenbaum, M., 6361 W. 85 Pl., Los Angeles 45, Calif.
- Greenberg, H., Foordmore Rd., Kerhonkson, N. Y.
- Greenberg, S., 2183 Ryer Ave., New York 57, N. Y.
- Greenbhum, C., 31 Molly Pitcher Village, Red Bank, N. J.
- Greene, A. N., Det. 5, 604 AC&W Sq., 47 Air Base Gp., APO 22, c/o PM, New York, N. Y.
- Greenham, R. L., 214-14 St., N.W., Canton 3, Ohio
- Greenquist, R. E., 3804 Bailey Ave., New York 63, N. Y.
- Greenspan, S., 21 Cedar Ave., West End, Long Branch, N. J.
- Greenstein, P., New York University, University Heights, New York 53, N. Y.
- Greenwald, M. H., 2107 Belvedere Blvd., Silver Spring, Md.
- Greenwald, S., 2208 Woodberry St., Hyattsville, Md.
- Greenwood, P. E., Jr., 127 Dormar Dr., North Syracuse, N. Y.
- Gregory, C. N., Jr., 226 S. Eucalyptus Ave., Inglewood 1, Calif.
- Gridley, D. H., 3926 First St., S.W., Washington 24, D. C.
- Griemsmann, J. W. E., 90-64 Francis Lewis Blvd., Queens Village 8, L. I., N. Y.
- Griffin, S. J., 6629 N. Williamsburg Blvd., Arlington, Va.
- Grim, W. M., Jr., General Electric Labs., Inc., 18 Ames St., Cambridge 39, Mass.
- Grobowski, Z. V., Jansky & Bailey, 1735 DeSales St., N.W., Washington, D. C.

(Continued on page 64A)



# International Rectifier

## Selenium and Germanium Rectifiers

### International Selenium Products

*Pressed powder or vacuum process used as determined by our Applications Engineering Dept. The most widely used Industrial Power Rectifiers in Industry today!*

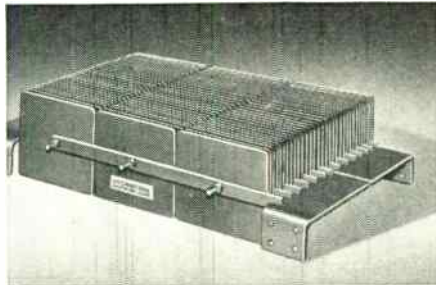

**INDUSTRIAL POWER RECTIFIERS**

For all DC power needs from microwatts to kilowatts. Features: long life; compact, light weight and low initial cost. Ratings: to 250 KW, 50 ma to 2,300 amperes and up. 6 volts to 30,000 volts and up. Efficiency to 87%. Power factor to 95%. **Bulletin C-349**

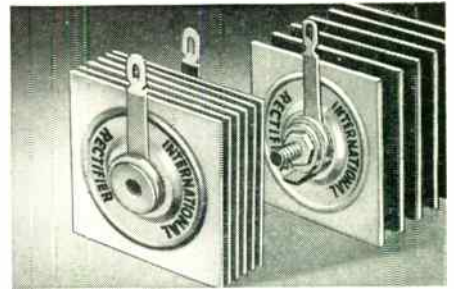

**TV AND RADIO RECTIFIERS**

The widest range in the industry! Designed for Radio, Television, TV booster, UHF converter and experimental applications. Input ratings from 25 to 195 volts AC and up. DC output current 10 to 1,200 MA. Write for application information. **Bulletin ER-178-A**



**HIGH VOLTAGE CARTRIDGE RECTIFIERS**

Designed for long life and reliability in Half-Wave, Voltage Doubler, Bridge, Center-Tap Circuits, and 3-Phase Circuit Types. Phenolic Cartridge and Hermetically Sealed types available. Operating temperature range:  $-65^{\circ}\text{C}$  to  $+100^{\circ}\text{C}$ . Specify **Bulletin H-2**

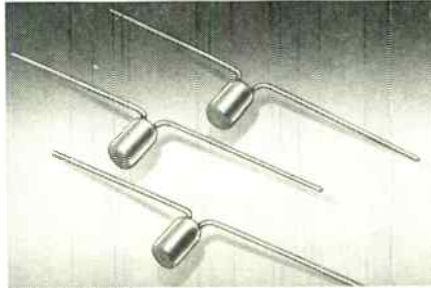

**SUB-MINIATURE SELENIUM DIODES**

Developed for use in limited space at ambient temperatures ranging from  $-50^{\circ}\text{C}$  to  $+100^{\circ}\text{C}$ . Encapsulated to resist adverse environmental conditions. Output voltages from 20 to 160 volts; output currents of 100 microamperes to 11 MA. **Bulletin SD-1B**

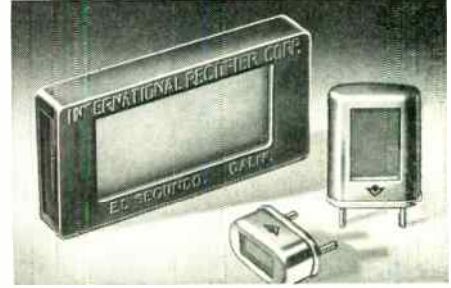

**PHOTOELECTRIC CELLS**

Self-generating photocells available in standard or custom sizes, mounted or unmounted. Optimum load resistance range: 10 to 10,000 ohms. Output from .2 MA to 60 MA in ave. sunlight. Ambient temperature range:  $-65^{\circ}\text{C}$  to  $+100^{\circ}\text{C}$ . **Bulletin PC 649**

### International Germanium Products

*High quality units of improved design are the results of years of experience in the production of exceptionally fine germanium crystals plus extensive research, development and field performance testing!*



**GERMANIUM POWER RECTIFIERS**

This new line features: High efficiency—up to 97%, Lowest forward drop, High reverse to forward current ratio, unlimited life expectancy. No reforming required after storage. Ratings: 26 to 66 AC input v. per junction: 150 to 100,000 amps DC output. Operating temperature range:  $-55^{\circ}\text{C}$  to  $+75^{\circ}\text{C}$ . In three styles. **Bulletin GPR-1**

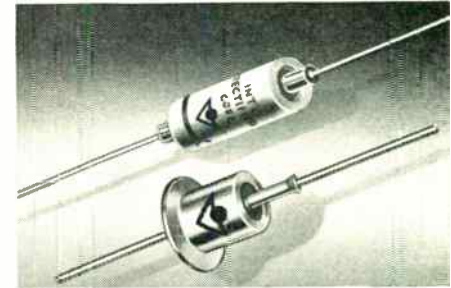

**GERMANIUM DIODES**

**POINT CONTACT.** High quality crystals—long reliable life—superior resistance to humidity, shock, temp.-cycling. **Bulletin GD-2**  
**JUNCTION POWER.** Hermetically sealed—welded construction. Available in Standard JETEC 1N91, 1N92, 1N93 types. For diodes to meet your specific requirements, consult our Semiconductor Division.

a world of difference through research!



For bulletins on products described **WRITE ON YOUR LETTERHEAD**  
to our **PRODUCT INFORMATION DEPARTMENT**

# International Rectifier

C O R P O R A T I O N

EXECUTIVE OFFICES: 1521 E. GRAND AVE., EL SEGUNDO, CALIFORNIA • PHONE OREGON 8-6281

**WORLD'S LARGEST SUPPLIER OF INDUSTRIAL METALLIC RECTIFIERS**

# Lamination users can now correlate va. and core loss figures with applications

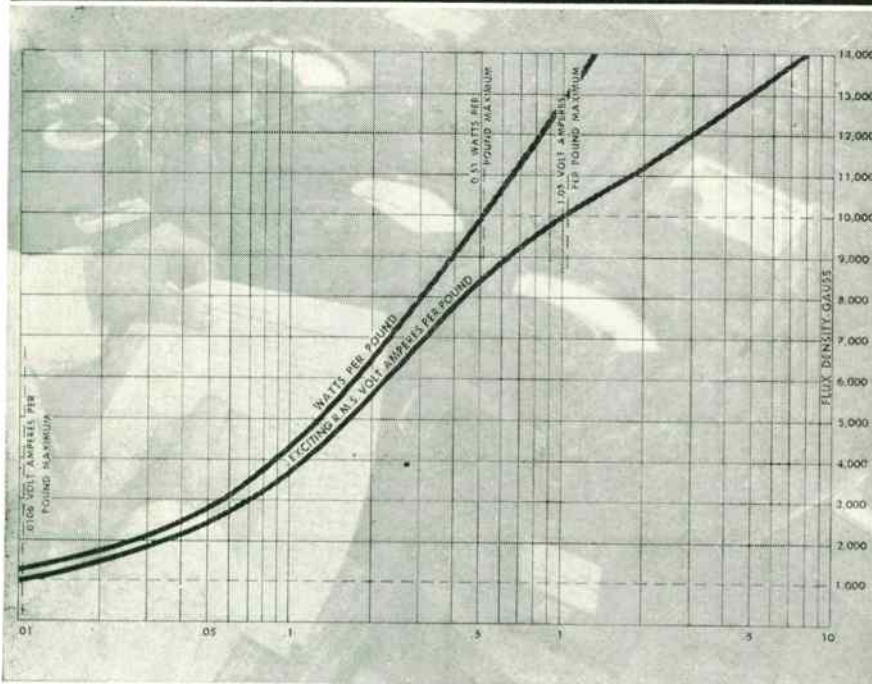

The above curve shows the maximum va. and watt loss of EI 1 1/4" 29 gauge Orthosil 3X laminations.

As a lamination user, you will want to know that guaranteed maximum va. and core loss is available for standard EI transformer laminations and that you can correlate the figures for your own applications.

This valuable information is offered exclusively by Thomas & Skinner. For several years, Thomas & Skinner has accumulated data on standard EI laminations. Based upon an analysis of this information, T&S has established maximum va. and maximum core loss values of each EI lamination at 1,000 and 10,000 gauss, 60 CPS.

A MATERIAL CERTIFICATION is furnished with each shipment of T&S laminations, and gives test figures for both core loss and exciting current on each heat annealed.

This CERTIFICATION attests that each shipment meets the specifications set by the customer.

*To you — as a lamination user — these test figures mean elimination of need for retesting, adding up to important savings in your production.*

WRITE TODAY for Technical Bulletin DMF-1 giving test details and tables showing core loss and maximum va. Also request new 40-page Bulletin No. L-355 (illustrated below), on special and standard laminations.

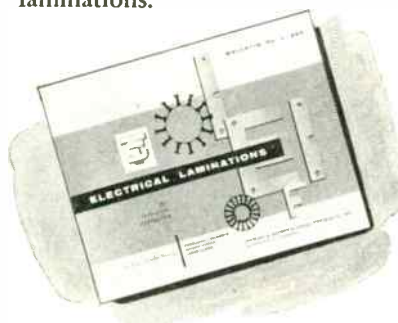

## SPECIALISTS IN MAGNETIC MATERIALS . . .

Permanent Magnets Laminations and Wound Cores

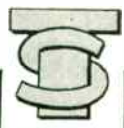

# Thomas & Skinner, Inc.

1125 East 23rd Street, Indianapolis, Ind.



(Continued from page 62A)

- Groce, J. C., 45 Joerg Ave., Nutley, N. J.
- Gross, F. J., 34 Albright Cir., Madison, N. J.
- Gross, S., 2091 Davidson Ave., New York 53, N. Y.
- Grossman, R., 78 Beaumont Cir., Tuckahoe, N. Y.
- Guarrera, J. J., 17160 Gresham Ave., Northridge, Calif.
- Gudaitis, W. V., 649 Chippewa, Mt. Clemens, Mich.
- Gudzin, M. G., 2704 Tisinger Ave., Dallas 28, Tex.
- Guernsey, E. D., 2350 Southway Dr., Columbus 12, Ohio
- Guglielmo, G., Via Palestrina 31, Milan, Italy
- Guimaraes, B. Q., Rua Sampaio Viana No. 391, Sao Paulo, Brazil
- Guinn, J. R., Jr., Engr. Div., Texas A & I College, Kinsville, Tex.
- Gumaer, H., 68 Elizabeth St., N. Hackensack, N. J.
- Guros, F. S., 308 E. Church, Roswell, N. Mex.
- Guyton, J. H., 2323 S. Park Rd., Kokomo, Ind.
- Haas, D. L., Rt. 3, Box 826-D, Fairfax, Va.
- Haas, N. V., 8638 Thouron Ave., Philadelphia 19, Pa.
- Hackman, E. H., 3904-14 St., N., Arlington, Va.
- Haddock, J. W., 105 Lake Dr., Allenhurst, N.J.
- Haddock, F. T., Jr., Naval Research Lab., Washington 25, D.C.
- Hagman, H. B., Sylvania Electric Products, Inc., Emporium, Pa.
- Hagnann, R. W., 333 N. Mary St., Lancaster, Pa.
- Hahn, J. H., Grafenwohr Sub-Area, 7822 A.U., APO 114, c/o PM, New York, N. Y.
- Haines, A. B., Bell Telephone Labs., Whippany, N. J.
- Haining, L. E., 231 S. Haviland Ave., Audubon, N. J.
- Hajek, A. F., 2330 S. 58 Ct., Cicero 50, Ill.
- Hales, E. B., 171 Astor Ave., Hawthorne, N. Y.
- Hall, C. F., 1603 Tibbits Ave., Troy, N. Y.
- Hall, G. D., Rtl. 1, Maple Bay, Clay, N. Y.
- Hall, H. H., 18459 Perth Ave., Homewood, Ill.
- Hall, R. E., 107 Sycamore Ave., Berkeley Heights, N. J.
- Hall, R. T., 1 Pierce Rd., Framingham, Mass.
- Hall, T. S., 6521 W. 81 St., Los Angeles 45, Calif.
- Hall, W. H. C., 2831 1/2 Mayview Rd., Raleigh, N. C.
- Hallenstein, N. A., Federal Communications Commission, 1600 Custom House, Boston 9, Mass.
- Hallford, B. R., 10628 Sylvania Dr., Dallas, Tex.
- Halsted, G. P., 22 Pine Ct., Snyder, N. Y.
- Halton, E. B., Providence College, Providence, R. I.
- Hamilton, H. E. S., c/o C.B.C., 354 Jarvis St., Toronto, Ont., Canada
- Hamilton, R. C., 915 Monarch Dr., Pasadena 3, Calif.
- Hammack, J. W., 504 Wayne Ave., Silver Spring, Md.
- Hammell, R., 24 Canoe Brook Pkwy., Summit, N. J.
- Hammer, R. V., 1961 Leahy St., Muskegon, Mich.
- Hammond, C. R., 5 Salem Cir., Evanston, Ill.
- Hampshire, J. R., 349 Avenel St., Avenel, N. J.
- Hampshire R. A., 9 Wilson Terr., West Caldwell, N. J.
- Hana, T. C., 58-25 Little Neck Pkwy., Little Neck, L. I., N. Y.
- Handelman, R. B., 54 Riverside Dr., New York 24, N. Y.
- Handy, F. E., 35 Brookline Dr., W. Hartford 7, Conn.
- Hannan, P. W., 6 Carey Rd., Great Neck, L. I., N. Y.
- Hanopol, L., 131 Washington St., Brighton 35, Mass.

(Continued on page 66A)

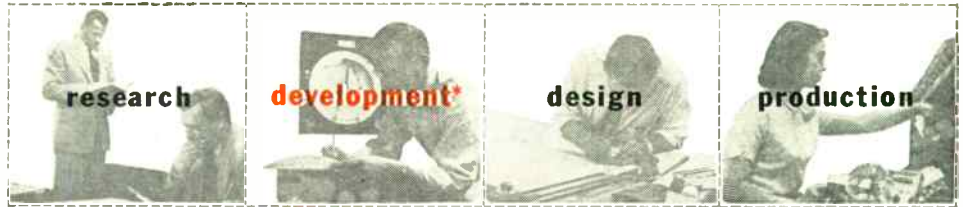

# INTEGRATED ELECTRONICS

THE IMAGINATION FOR RESEARCH PLUS THE SKILLS FOR PRODUCTION

Hoffman Laboratories maintains a highly specialized group of engineers whose entire efforts are devoted to the complex problem of developing and producing specialized tactical test equipment for airborne navigation radar, fire control, missile guidance systems, and other advanced electronic gear. To meet the high standards of quality and reliability set by Hoffman Laboratories, this test equipment group is an integral part of the engineering staff.

For the past 13 years Hoffman Laboratories has been successfully solving advanced design and development problems in electronics.

During this time Hoffman Laboratories has never undertaken a development program that has not successfully gone into production.

*Write the Sales Department for free booklet.*

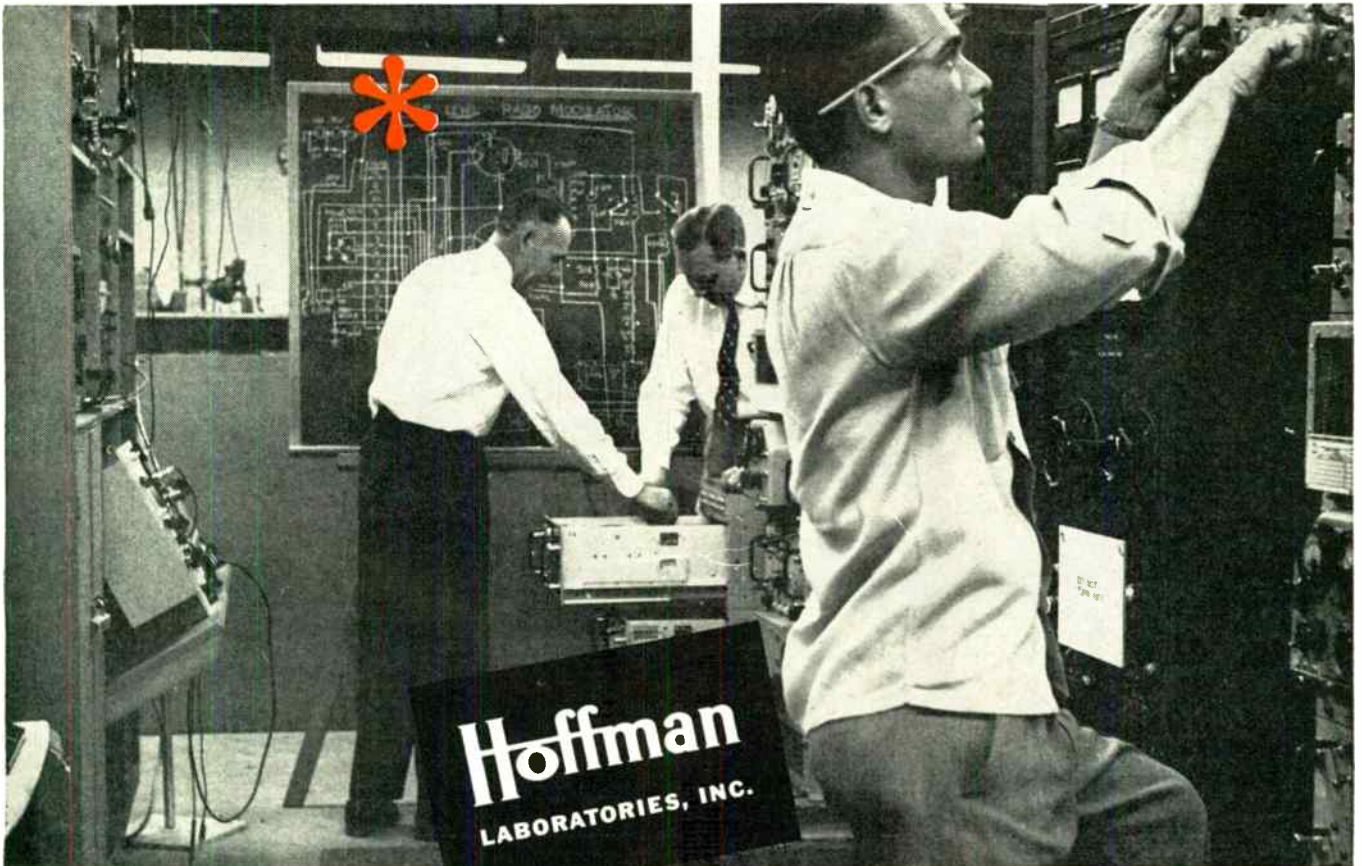

Radar, Navigational Gear  
Missile Guidance & Control Systems  
Noise Reduction  
Countermeasures (ECM)  
Computers  
Communications  
Transistor Application

A SUBSIDIARY OF HOFFMAN ELECTRONICS CORPORATION

Challenging opportunities for outstanding engineers to work in an atmosphere of creative engineering. Write Director of Engineering, Hoffman Laboratories, Inc., 3761 S. Hill St., Los Angeles 7, California.

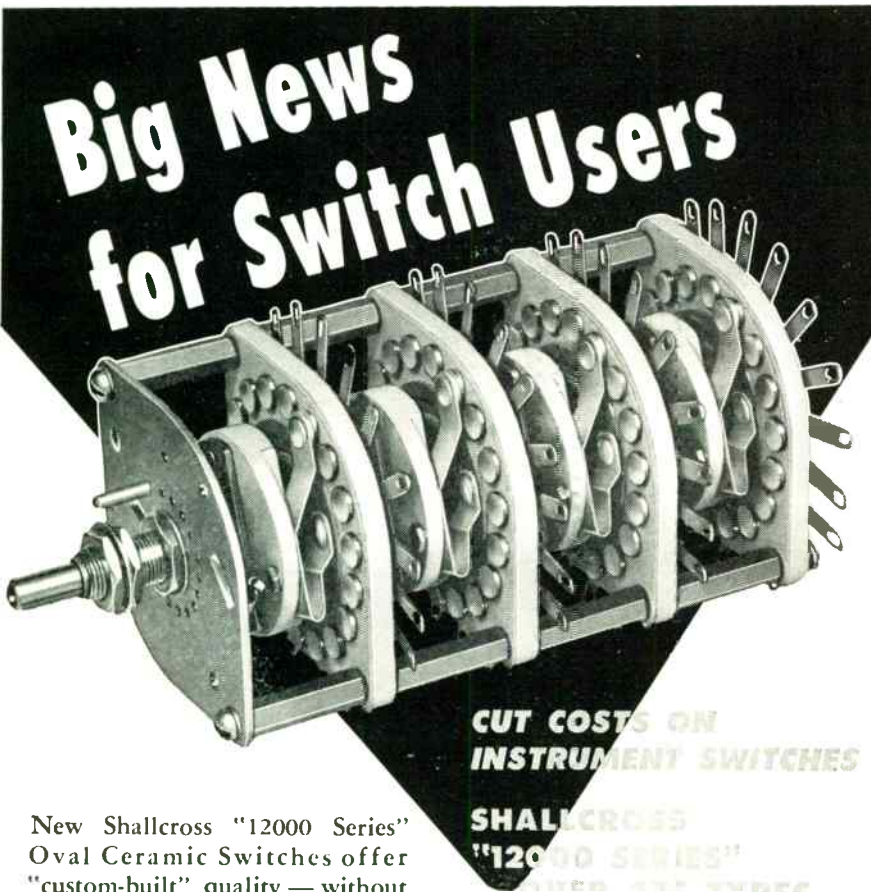

New Shallcross "12000 Series" Oval Ceramic Switches offer "custom-built" quality — without the delay and cost of specials.

With only a few basic interchangeable parts, constantly stocked by Shallcross, over 1000 different switch types can be quickly assembled. Delivery is immediate. Your specifications are matched exactly.

The use of solid silver contacts and collector rings, low-loss steatite decks, and silver plated beryllium-copper wiper pressure springs assures uniformly low contact resistance and exceptional durability for a wide variety of instrument switching applications.

For complete information on "12000 Series" Switches, write, wire, or phone for Shallcross Engineering Bulletin L-32 which catalogs 275 of the most popular types. SHALLCROSS MFG. CO., 524 Pusey Avenue, Collingdale, Pa.

**CUT COSTS ON  
INSTRUMENT SWITCHES**  
**SHALLCROSS**  
**"12000 SERIES"**  
**VARIOUS ACT TYPES**

**Shallcross 12000 Series  
Oval Ceramic Switches**

**NON-SHORTING ACTION**—40° or 60° indexing

**SHORTING ACTION**—20° or 30° indexing

**DETENT**—Optional. Positive-acting star wheel type.

**POLES PER DECK**—1, 2, or 3

**NUMBER OF DECKS**—Up to 10 decks may be ganged.

**ADJUSTABLE STOP**—Available on order

**SHAFT**—Completely isolated

**CONTACT RESISTANCE**—0.0025 ohm, ±0.0002 ohm

**RATINGS**—110 v., 1a., 50 cy.—nominal. 2500 v., 60 cy.—de-rated current. 40 amps—de-rated voltage.

Complete specifications in Bulletin L-32.



(Continued from page 61A)

Hansen, H. R., 1251¼ N. Detroit St., Los Angeles 46, Calif.

Hansen, R. C., 311 Elec. Engr. Research Lab., University of Illinois, Urbana, Ill.

Hanysz, E. A., 7120 Chalforte St., Detroit 21, Mich.

Happe, W. H., Jr., 18 Stockton Pl., Nutley 10, N. J.

Harbour, R. D., 410 Fountain St., Pullman, Wash.

Hardcastle, C., 167 Lichfield Rd., Bloxwich, Walsall, England

Hardie, F. H., 228 Reese Ave., Vestal, N. Y.

Hare, G. H., 1810 Alta Wood Dr., Altadena, Calif.

Hare, J., 48 Cochrane Park Ave., Newcastle-on-Tyne, England

Harper, E. E., 4712 Cable St., Bellingham, Wash.

Harper, H., 305 Beechwood Dr., Hollin Hills, Alexandria, Va.

Harpster, W. T., 48 Keats, Tonawanda, N. Y.

Harriman, D. E., Jr., 15255 El Soneto Dr., Friendly Hills, Whittier, Calif.

Harris, A. S., 2211 Muscoday Pass, Ft. Wayne 6, Ind.

Harris, D. J., 37 Maplewood Ave., West Hartford 7, Conn.

Harris, E. A., Jr., Div. 33, Naval Ordnance Lab., Corona, Calif.

Harris, F. H., R.F.D. 1, Box 61, Accokeek, Md.

Harris, F. M., 212 E. Hanover, Trenton, N. J.

Harris, H. N., 5428 Channing Rd., Baltimore 29, Md.

Harrison, C. W., Long Hill Rd., Millington, N. J.

Harrison, J. R., 8 Page Rd., Bedford, Mass.

Hartman, L. A., 52 Cameron Dr., Huntington, L. I., N. Y.

Hartman, R. B., 11, Remington Arms Co., Inc., Bridgeport, Conn.

Hartman, W. H., Rt. 3, Box 1213-A, Sacramento, Calif.

Hartmann, W. A., Jr., 943 Hartzell St., Pacific Palisades, Calif.

Hartnett, E. J., 545 Beverly Rd., Teaneck, N. J.

Hartz, F. M., 16703 Ashtan Rd., Detroit 19, Mich.

Harwood, F. E., 720 Cornell, Ypsilanti, Mich.

Hatfield, G. L., 1936 Edgewood Rd., Towson 4, Md.

Hathaway, S. D., 21 Lowell Ave., Summit, N. J.

Hartzakortzian, H. T., 424 E. 174 St., New York 57, N. Y.

Hausenbauer, C. R., College of Engr. University of Arizona, Tucson, Ariz.

Haushalter, C. H., Instrumentation Lab., M.I.T., Bedford Flight Facility, Box 249, Concord, Mass.

Hawes, J. G., 124 Shockey Dr., Huntington, W. Va.

Hawkins, B. C., Gate 20, Lakewood, Crystal Lake, Ill.

Hayden, J. R., 875 Michigan Ave., Columbus, Ohio

Hayman, W. H., 43 Stadtmayer Dr., Clifton, N. J.

Haynes, H. S., 45 Franklin Pl., Montclair, N. J.

Hayward, J. W., R.F.D. 2, Turwood Rd., Huntingdon Valley, Pa.

Hazlehurst, E., Powerville Rd., R.D. 2, Boonton, N. J.

Heasley, C. C., Jr., 1039 N. Monroe St., Arlington, Va.

Heath, J. W., 1641 First Ave., S.E., Cedar Rapids, Iowa

Heaton, H. T., 2141 S. Geddes St., Syracuse 4, N. Y.

Heckert, R. E., 8638 Belford Ave., Los Angeles 45, Calif.

Hedges, H. G., 1313 Haslett Rd., Haslett, Mich.

Hefter, M., 1270 Teller Ave., New York 56, N. Y.

Heick, B. K., 1 Dean Rd., Wesley Hills, Mass.

(Continued on page 68A)

**Shallcross**

**NEW**

# high-power rectifier

MINIATURIZED BY  
**amperex**



Only 2" (without leads) and 3/4" in diameter, the AMPEREX 6339, a miniaturized, ruggedized version of the 3B29, operates under more stringent conditions than its prototype. This miniature, high-vacuum, external-anode, clipper diode and rectifier tube is designed to be enclosed in a complete liquid-cooled package, including power supply and pulse modulator components. It may also be operated in air at reduced ratings, in applications where liquid cooling is not required.

**PARTIAL DATA — AMPEREX 6339**

|                        |      |
|------------------------|------|
| Filament Voltage ..... | 6.3  |
| Filament Current ..... | 1.55 |

| IN OIL                          | Maximum Ratings |              |
|---------------------------------|-----------------|--------------|
| Peak Inverse Voltage .....      | 10,000          | 16,000 volts |
| Peak Current .....              | 400             | 250 ma       |
| Average Current .....           | 100             | 65 ma dc     |
| Silicone Oil Coolant Temp. .... | -65°C to +165°C |              |

| Typical Operation (Three-phase, Bridge, Choke Input Filter) |                 |  |
|---|-----------------|--|
| No. of Tubes .....  | 6               |  |
| Peak Inverse Voltage .....                                  | 15,000 volts    |  |
| Peak Anode Current .....                                    | 195 ma          |  |
| Average Anode Current (per tube) .....                      | 65 ma dc        |  |
| Output Voltage .....  | 14,000 volts dc |  |
| Output Current .....  | 195 ma dc       |  |

| IN AIR                     | Maximum Ratings (sea level) |                       |
|----------------------------|-----------------------------|-----------------------|
|                            | Without Auxiliary Cooler    | With Auxiliary Cooler |
| Peak Inverse Voltage ..... | 12,000                      | 12,000 volts          |
| Peak Current .....         | 200                         | 400 ma                |
| Average Current .....      | 50                          | 100 ma dc             |
| Ambient Temperature .....  | -55 to +85 -55 to + 85°C    |                       |

| Typical Operation (Three-phase, Bridge, Choke Input Filter) |        |  |
|---|--------|--|
| No. of Tubes .....  | 6      |  |
| Peak Inverse Voltage .....                                  | 12,000 |  |
| Peak Anode Current .....                                    | 200 ma |  |
| Average Anode Current (per tube) .....                      | 33     |  |
| Output Voltage .....  | 10,500 |  |
| Output Current .....  | 100    |  |

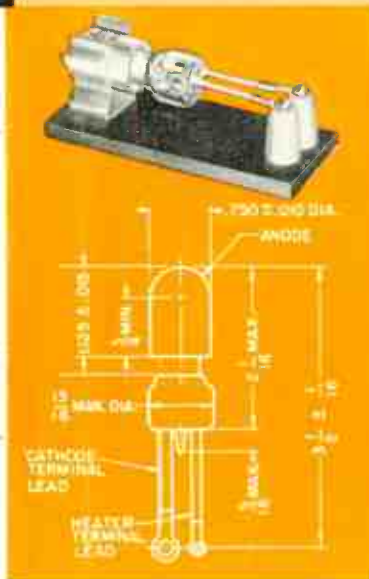

The AMPEREX 6339 may be mounted in a standard 60 amp. fuse clip, as illustrated. For high-power operation in air, an auxiliary cooler which will also serve as a mount may be used. Flexible leads terminating in #6 and #8 lugs are used for heater and cathode connection. These allow the tube to be mounted in an extremely small space, and the leads may be brought out to any convenient terminal strip or stand-off insulator.

AMPEREX 6339 ..... \$35.00 net  
See it at your local electronic parts distributor, or write direct to factory for detailed data sheets.

RETUBE WITH **amperex**  
**amperex** ELECTRONIC CORP.

230 Duffy Ave., Hicksville, L. I., N. Y.

In Canada: Rogers Majestic Electronics, Ltd.  
11-19 Brentcliffe Road, Leaside (Toronto 17)



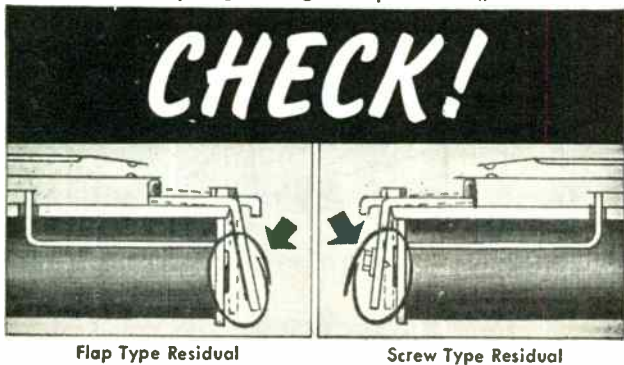

Flap Type Residual

Screw Type Residual

## The Difference in RESIDUALS

Careful analysis of performance of the various types of residuals can only result in the selection of the one which assures long-lived performance without losing its original adjustment.

### ENGINEERS KNOW...

... that the screw type residual with its point type contact eventually hammers a hole into the soft iron pole piece—reducing air gap.

... that reducing the residual air gap destroys the initial adjustment of the relay and can under severe conditions cause the armature to mechanically or magnetically lock up in a permanently operated condition.

... that screw type residuals require complicated mechanical construction. A lock nut and screw in a tapped hole are vulnerable to loosening through impact of operation.

### It's the Flap Type Residual Found on NORTH Relays...

... that distributes the impact of operation between the armature and pole piece over the entire surface—not on the tip of a screw.

... made of extremely hard non-magnetic material that insures long life.

... that provides fixed air gap, stable release and unvarying adjustment under any critical application.

... that eliminates the necessity of any adjustment in the field. We specify residual thickness to fit your requirement.

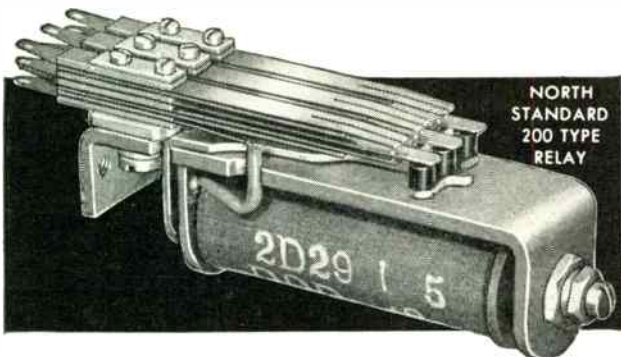

Flap type residuals are just another of the many critical details found in the NORTH Relay, shown above, which insure trouble-free repeat performance.

Detailed specifications available on request.

## THE NORTH ELECTRIC MANUFACTURING COMPANY

Originators of ALL RELAY Systems of Automatic Switching  
549 South Market Street, Galion, Ohio, U.S.A.



(Continued from page 66A)

- Heilprin, L. B., Falls Rd., R.F.D. 2, Rockville, Md.  
 Heininger, W. W. L., Rua Anchieta 5, Apt. 1001, Leme, Rio de Janeiro, Brazil  
 Heiser, W. W., East Lempster, N. H.  
 Heit, J. C., 9 Meadowview Dr., Penfield, N. Y.  
 Helgeson, V. L., 717 E. Henry Clay, Whitefish Bay, Wis.  
 Hellerman, H., 334 Mountainview Ave., Syracuse, N. Y.  
 Helmreich, L. W., 4 Wildwood La., Kirkwood 22, Mo.  
 Helsdon, P. B., 7 Trinity Rd., Chelmsford, Essex, England  
 Hemstreet, H. S., 76 Highland Ave., Binghamton, N. Y.  
 Henderson, J., General Delivery, Dahlgren, Va.  
 Hendry, A. J., Northern Pacific Railway Bldg., Signal Dept., St. Paul 1, Minn.  
 Henry, R. L., Jr., 415 Windsor St., Silver Spring, Md.  
 Henyan, G. W., General Electric Co., 1 River Rd., Schenectady, N. Y.  
 Herdman, T. L., 40F Wickham Rd., Beckenham, Kent, England  
 Herman, H., 1729 Webster St., N.W., Washington 11, D. C.  
 Herrera, J. C., 132 Ashcraft Rd., New London, Conn.  
 Herring, R. A., Jr., 4310 Fesenden St., N.W., Washington, D. C.  
 Herrmann, N. P., 6267 S.W. 12 St., Miami 44, Fla.  
 Hersh, J. F., 20 Prescott St., Cambridge 38, Mass.  
 Hershfield, L. L., 1109 Johnson St., Philadelphia 38, Pa.  
 Hertsch, D., Physics Lab., 99 Ft. Washington Ave., New York 32, N. Y.  
 Hertzberg, A., 11 Walnut St., Baldwin, L. I., N. Y.  
 Hertzog, W. K., 4307 S.E. Anthony Wayne Dr., Ft. Wayne, Ind.  
 Hess, D. C., 4425 Oakwood Ave., Downers Grove, Ill.  
 Hess, P. N., 1243 Rose Vista Ct., St. Paul 8, Minn.  
 Hesse, A. N., 90 Salisbury Ave., Garden City, L. I., N. Y.  
 Hewson, K. D., Rt. 3, Box 136, Larned, Kans.  
 Hexem, J., 911 Glenmoor La., Glendale 22, Mo.  
 Hicks, J. M., Naesu Field Engr., COMAIRPAC, Box 1270, Naval Air Station, San Diego, Calif.  
 Hilbourn, C. L., 302 Van Sant Dr., Palmyra, N. J.  
 Hildebrand, J. G., Jr., 45 Brighton St., Box 176, Belmont, Mass.  
 Hill, D. R., 285 Memorial Dr., Hawthorne, N. Y.  
 Hillier, R. J., Cable & Wireless Ltd., Porthcurno, Cornwall, England  
 Hills, C. E., Jr., Love Lane, Weston 93, Mass.  
 Hiltner, E. B., 47 Rector Pl., Red Bank, N. J.  
 Himmelstein, S., 1021 Arlington Blvd., Arlington 9, Va.  
 Hinchey, R. L., Sperry Gyroscope Co., Great Neck, L. I., N. Y.  
 Hinline, H. D., 425 Rich Ave., Mt. Vernon, N. Y.  
 Hinrichs, J. H., 2711 Sunland Vista, Tucson, Ariz.  
 Hintz, R. T., 8920 Park Lane, S., Woodhaven, L. I., N. Y.  
 Hirsch, J. D., 53 Darling Ave., New Rochelle, N. Y.  
 Hixson, E. L., Dept. of Elec. Engr., University of Texas, Austin, Tex.  
 Hlavaty, E. M., 301 Edge Ave., Valparaiso, Fla.  
 Hobbs, L. C., Apt. 7A-Parkway Apts., Haddonfield, N. J.  
 Hobbs, R. V., R.F.D. 2, Franklin, Tenn.  
 Hodder, W. K., 7920 Bleriot Ave., Los Angeles 45, Calif.

(Continued on page 70A)



**When you need a stable capacitor...**

# Specify **RMC** Type JL **DISCAPS**



## **Type JL**

The ideal cost-saving replacement for paper or general purpose mica capacitors, Type JL DISCAPS, afford exceptional stability over an extended temperature range. Maximum capacity change between  $-60^{\circ}$  and  $110^{\circ}$  C is only  $\pm 7.5\%$  of capacity at  $25^{\circ}$  C. Standard working voltage is 1000 V.D.C. providing a high voltage safety factor. Type JL DISCAPS are manufactured in capacities between 220 MMF and 5000 MMF.

In addition to the advantages of longer life, dependability, and lower initial cost, their smaller size and greater mechanical strength provide additional economies in assembly line operations.

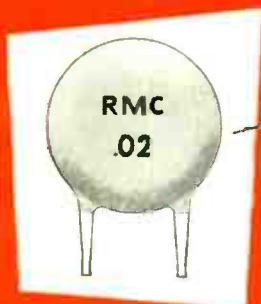

## **Wedg-loc**

Type JL stable-capacity DISCAPS, as well as temperature compensating and by-pass types, are available with RMC "Wedg-loc" leads for printed circuit assemblies. The exclusive design of these leads lock securely in place on printed circuits... the capacitors cannot fall out and a uniform soldered connection is assured.

Manufactured in capacities between 2 MMF and 20,000 MMF, "Wedg-loc" DISCAPS have the same electrical specifications and tolerances as standard wire lead DISCAPS. Suggested hole size is a .062 square.



## **Plug-in**

To simplify production line problems on printed circuits Type JL DISCAPS, temperature compensating and by-pass types, are available with plug in leads. These leads are No. 20 tinned copper (.032 diameter) and are available up to  $1\frac{1}{2}$ " in length. Plug-in DISCAPS will provide worthwhile savings on printed circuit assemblies and include all of the electrical and mechanical features that have made standard DISCAPS a favorite with leading television and electronic manufacturers.

Write today on your company letterhead for expert engineering help on any capacitor problem.

DISCAP  
CERAMIC  
CAPACITORS



**RADIO MATERIALS CORPORATION**

GENERAL OFFICE: 3325 N. California Ave., Chicago 18, Ill.

**FACTORIES AT CHICAGO, ILL. AND ATTICA, IND.**

Two RMC Plants Devoted Exclusively to Ceramic Capacitors

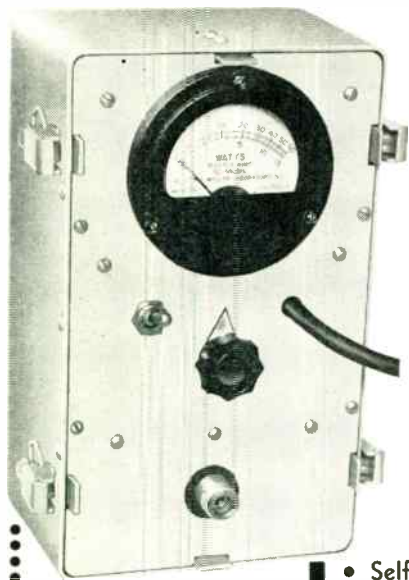

# NEW!

## RADIO FREQUENCY POWER METER

PM-19

5 FULL METER SCALES FROM 1½ TO  
120 WATTS

FREQUENCY RANGE .01 to 500 MEGACYCLES.  
(Can Be Calibrated at 60 cps.)

WRITE TODAY  
FOR COMPLETE  
INFORMATION

- Self-cooled.
- Accuracy  $\pm 5\%$ .
- Input Connector Type N.
- Input Impedance 52 ohms.
- Meter Ranges: 0 to 1½, 0 to 6, 0 to 15, 0 to 60, 0 to 120 watts.
- Input Power 115 Volts 60 cps or 6 Volts AC or DC.

## ELECTRO IMPULSE Laboratory

208 River Street • Red Bank, New Jersey • Phone: Redbank 6-0404

## Square Wave Generator

MODEL 183. This high-quality precision instrument provides square waves for testing the transient and frequency response of wide band amplifiers, and for accurately measuring their amplitude.

It features an output impedance of 100 ohms at a terminal box at end of 3'-cable; frequency range of 10 cps to 1 mc continuously variable over decade steps; rise time of 0.02 microseconds at the low impedance output.

Write for catalog



NEW LONDON  
INSTRUMENT

Company INC.

82 Union Street  
New London 4, Conn.

## MINIATURIZE with

VARI-  
CHOKE



Available in  
7 stock sizes  
covering range  
of 40 microhen-  
ries to .5 henry.  
Other values to  
specification.

SUPEREX

STOCK SIZE

## VARIABLE INDUCTANCES

HIGH INDUCTANCE RATIO—a series of variable inductances with a range as high as 10 to 1 within physical dimensions not considered possible until the introduction of the Ferrite Core.

WRITE for full line catalog:

INDUSTRIAL  
DIVISION  
Dept. I-9

successor to Grayburne  
SupereX Corp.  
4 Radford Pl., Yonkers, N.Y.



Membership

(Continued from page 68A)

- Hodge, A. H., Ballistic Research Lab., Aberdeen Proving Ground, Md.
- Hodgkinson, W. S., Fox Meadow La., Wayland, Mass.
- Hoffman, H. L., 804 Newbridge Ave., Westbury, L. I., N. Y.
- Hogie, W. I., Astoria, S. D.
- Hogin, P. E., 100 Central Ave., Kearny, N. J.
- Hogle, R. C., 9294 Quandt, Allen Park 10, Mich.
- Hole, W. G., 1109 Twinbrook Dr., Webster Groves 19, Mo.
- Hollander, J. M., 140 W. 86 St., New York 24, N. Y.
- Hollister, D. G., 16 Texas Ct., Syosset, L. I., N. Y.
- Holmes, J. S., 200 E. Walnut St., Kokomo, Ind.
- Holmes, W. H., c/o Officers Mess, RCAF, Trenton, Ont., Canada
- Holroyd, W. H., 5 Roycrest Ave., W., Willowdale, Ont., Canada
- Hom, R. N. G., 1689 Massachusetts Ave., Cambridge 38, Mass.
- Honda, H., 3703 Powelton Ave., Philadelphia 4, Pa.
- Hood, C. R., Teiner Engr. Corp., 115 Madison St., Malden, Mass.
- Hooper, J. R., Jr., 1606 Compton Rd., Cleveland Hgts., Ohio
- Hooper, J. S., 1936 Hubbard Ave., Salt Lake City 5, Utah
- Hoover, W. G., 586 Foothill Rd., Stanford University, Stanford, Calif.
- Hopkins, R. C., 6856 Calvin Ave., Reseda, Calif.
- Horner, R. G., 1721 Hudson Blvd., N. Bergen, N. J.
- Horniman, N. L., 720 Jennings Ave., Petoskey, Mich.
- Horrocks, S. W., Aerovox Corp., 700 Belleville Ave., New Bedford, Mass.
- Horseman, T. E., 2615 S.E. Salmon St., Portland 15, Ore.
- Houghton, H. V., Jr., 7 Wynnewood Rd., Livingston, N. J.
- Houpis, C. H., Elec. Engr. Dept., USAFIT, Wright-Patterson AFB, Ohio
- House, H. J., 129 Magnolia Dr., Levittown, Pa.
- Houseworth, G. H., 16 Walden Ave., Jericho, L. I., N. Y.
- Howard, E. G., Inspector of Naval Materiel, Camden, N. J.
- Howes, D. E., Worcester Polytechnic Institute, Worcester, Mass.
- Howes, E. T., 1590 Linda Vista Ave., Pasadena 3, Calif.
- Hoyt, W. A., 1316 Jefferson, Quincy, Ill.
- Hubbard, B. L., 28 Glover Ave., Haddonfield, N. J.
- Huber, P., 500 S. Highland, Dearborn 7, Mich.
- Hudson, A. E., 2559 Kingston Rd., Cleveland Hgts., Ohio
- Huebscher, H., 152-32 Melbourne Ave., Flushing, L. I., N. Y.
- Hufford, G., 404 B. Devereux Ave., Princeton, N. J.
- Huggins, L. L., 1800 Morrow, Austin, Tex.
- Hughes, K. E., 4808 Bergenline Ave., Union City, N. J.
- Hull, R. E., 30 Joyce Rd., Tenaflly, N. J.
- Hummel, C. F., 6610 Hillandale Rd., Chevy Chase, Md.
- Humphrey, A. J., 340 Dalwood Dr., Cleveland 10, Ohio
- Humphrey, H. C., 99 Durand Rd., Maplewood, N. J.
- Hundstad, C. E., 115 Orchard Dr., E., North Syracuse, N. Y.
- Hunkins, H. R., 27 College Ave., Upper Montclair, N. J.
- Hunt, R. A., Clinton & Bowen Rd., Elma, N. Y.
- Hurd, P. A., 521 Timberland St., Smyrna, Ga.
- Hurford, W. L., 301 Lees Ave., Collingswood, N. J.

(Continued on page 72A)



# OHMITE AMRECON<sup>®</sup> Relays

**HIGH QUALITY, GENERAL-PURPOSE  
RELAYS FEATURING COMPACTNESS,  
DEPENDABILITY AND LONG LIFE!**

*hermetically  
sealed or  
dust-protective  
enclosures*

**61 TYPES**  
available from  
**STOCK**

**Current ratings up to 25 amp, AC or DC**

When you want the utmost in relay dependability, investigate the Amrecon line. Amrecon relays are designed, produced, and tested in the new, air-conditioned Ohmite plant.

These ruggedly built relays have the ability to handle power loads usually requiring larger, heavier units. They are built to meet rigorous aircraft relay standards, and are particularly adapted to mobile equipment where severe shock and vibration are encountered.

Amrecon relays are available with screw, plug, or solder-wire terminals; in a variety of contact arrangements; with hermetically sealed or dust-protective enclosures. Order from the 61 stock types, or let Amrecon's engineers help you work out special relay applications.

## OHMITE<sup>®</sup>

MANUFACTURING COMPANY  
3677 Howard St., Skokie, Illinois (Suburb of Chicago)

Send for  
Catalog R-10



# Complete line of Microwave Components

## From Magnetron Through Antenna

### Designed and Produced by *Airtron* INC.

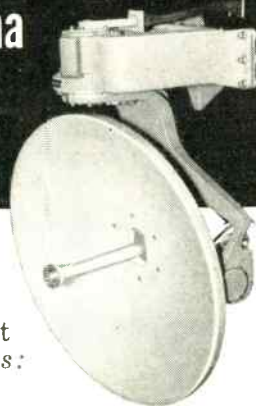

Whether it is "Standard" plumbing or designing an entirely new waveguide system, Airtrons complete facilities can substantially reduce the time and expense between concept and reality. Here are just a few examples:



**FLEXIBLE WAVEGUIDE ASSEMBLIES.** Flexible double ridge waveguide for airborne commercial weather radar. Beryllium copper flexible in convolute or type S construction. Waveguide sizes from Ka-Band to 9.750" x 4.875" I.D. in standard lengths or preformed to your installation.

**ROTARY JOINTS.** Waveguide rotary joints of the coaxial or circular waveguide type in many frequency ranges designed for high power VSWR performance. Produced in volume to your specifications or designed to meet requirements.



**WAVEGUIDE SWITCHES.** For frequent, rapid switching to or from noise sources, signal generators, dummy loads, etc. Reversing switches for dual channel systems in GCA or microwave relay radars. Low VSWR, excellent crosstalk characteristics, and high peak power performance. Switching tees, ferrite switches and other special designs.

**PRECISION CAST BALANCED MIXERS.** Low noise figures over a broad bandwidth are achieved by compact balanced mixer design and use of latest type crystals. Equipped with coaxial or waveguide crystal mounts for frequencies up to 40,000 mc. Standard and special types available. Mixer-Preamplifier packages designed to meet your requirements.



**ANTENNAS AND ASSOCIATED COMPONENTS.** Horn antennas and feeds for fire control, countermeasure, guided missile, navigational or weather radars. Designed to your specifications and produced in the Airtron precision casting foundry. Complete with rotary joints, flexible sections and associated waveguide assemblies.

#### OTHER AIRTRON PRODUCTS

Twists, Magnetron Transitions • RF and Pressure Contact Flanges and Gaskets • Quick Disconnects • RF Pressure Windows • Short-Slot Hybrids • Antenna Components • Test Horns • Dummy Loads • Jet Engine Power Cables and Thermocouples • Waveguide Bending and Twisting To Your Specifications.

#### NEW PRODUCT DEVELOPMENT PROGRAM

Including such MICROWAVE FERRITE COMPONENTS as duplexers, waveguide switches, high and low power load isolators, variable absorption attenuators and other special ferrite devices.

**Airtron** INC.  
Dept. C  
Linden, N. J.

**Branch Offices:** Albuquerque • Boston • Chicago • Dallas • Dayton • Detroit • Kansas City • London • Los Angeles • Montreal • Renfrew • San Francisco • Seattle • Toronto • Washington



(Continued from page 70A)

- Hurley, H. C., 7016 Broadway, Indianapolis 20, Ind.
- Hurney, P. A., Jr., 10 Flintlock Rd., Lexington, Mass.
- Huster, L. W., 271 Chesterfield Cir., Dayton 3, Ohio
- Hutchinson, N. D., 9991 Chireno St., Dallas 20, Tex.
- Hutchinson, R. W., 23201 Sherman Ave., Oak Park 37, Mich.
- Hutson, L. S., 232 Hart St., Brooklyn, N. Y.
- Hutter, E. C., Box 468, Princeton, N. J.
- Hyne, A. D., Box 429, Belmont, Calif.
- Ilman, R. W., 12258 Second Ave., N.W., Seattle 77, Wash.
- Ingerson, W. E., 5012 Timberwolf Dr., El Paso, Tex.
- Ingling, T. M., 1643 Oak Lawn Pl., Biloxi, Miss.
- Innes, F. T., R.D. 1, Malvern, Pa.
- Inslerman, H. E., 375 Westwood Ave., Long Branch, N. J.
- Irwin, Emmett M., 2179 Lorain Rd., San Marino 9, Calif.
- Ishii, F. K., 920 Deodar Ave., Oxnard, Calif.
- Jachym, T. M., R.D. 1, Ballston Lake, N. Y.
- Jackson, J. E., Rt. 1, Philpot, Ky.
- Jacobs, G. B., R.F.D. 2, Schoharie, N. Y.
- Jacobson, E. R., 446 Norton Pkwy., New Haven 11, Conn.
- Jacobson, L., 3 Belveal Rd., Darien, Conn.
- Jacobson, N., 27 Virginia St., Valley Stream, L. I., N. Y.
- Jaeger, M., 508 E. Bloomfield St., Rome, N. Y.
- Jagoe, R. W., 27 Greenvale Lane, Syosset, L. I., N. Y.
- James, E., 4833 W. 136th St., Hawthorne, Calif.
- James, G. E., 10 Fernald Dr., Cambridge 38, Mass.
- James, W. B., 2111 Taft St., Houston 6, Tex.
- Jamieson, F. C., London Rds. of Canada, Ltd., 736 Wellington St., Montreal, Que., Canada
- Jamison, J. W., Jr., 4136 S. Bronson, Los Angeles 8, Calif.
- Janes, A. W., 12 Overlook Rd., Caldwell, N. J.
- Jans, J. T., R.D. 1, Seneca Falls, N. Y.
- Jansen, J. J., Bell Tele. Labs., Murray Hill, N. J.
- Jarema, E. D., 409 Fourth Ave., Belmar, N. J.
- Jayne, A. W., 104 Holden Green, Cambridge 38, Mass.
- Jean, R. P., 6004 Suwanee Ave., Tampa 4, Fla.
- Jednacz, J. E., 1608 Walnut St., Phila. 3, Pa.
- Jeffers, G. N., R.R. 2, New Carlisle, Ohio
- Jelatis, D. G., Central Research Labs., Red Wing, Minn.
- Jenkins, R. L., 604 Meadow Dr., Kokomo, Ind.
- Jesse, E., 216 Ridge Vista, San Jose 27, Calif.
- Joehlin, N. C., 1350 Hartsough St., Plymouth, Mich.
- Johler, J. R., 5410 Independence, Arvada, Colo.
- Johnson, C. A., 1536 I St., Anchorage, Alaska
- Johnson, C. E., 837 N. Reese Pl., Burbank, Calif.
- Johnson, E. F., Waseca, Minn.
- Johnson, G. D., Jr., 97 Conover Pl., Red Bank, N. J.
- Johnson, H., Jr., 707 W. Monroe Ave., Greenwood, Miss.
- Johnson, J. S., 7541 Midfield Ave., Los Angeles 45, Calif.
- Johnson, J. H., Johnson & Hoffman Mfg. Co., 31 E. 2 St., Mineola, L. I., N. Y.
- Johnson, M. S., 405 E. Church St., Champaign, Ill.
- Johnson, R. E., 315 La Sierra Dr., Arcadia, Calif.
- Johnson, R. D., 15625 Hart St., Van Nuys, Calif.
- Johnson, W. C., 124 S. Cumberland Ave., Park Ridge, Ill.
- Johnston, E. L., Box 6908, Congress Hgts. Sta., Nichols Ave., Wash. 20, D. C.
- Johnston, J. L., 223 W. Park, Pittsburg, Kans.

(Continued on page 76A)

*speaking of TV Quality...*

**HERE'S HOW TO GET MORE**

**at LESS COST!**

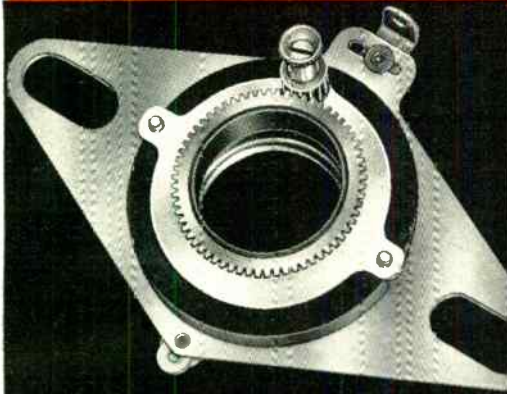

A Stackpole Ceramagnet ring  $3\frac{1}{8}$ " in diameter by  $\frac{1}{2}$ " thick forms the "heart" of this efficient, magnetic focusing unit produced by Glaser-Steers Corporation, Belleville, N. J. The entire unit weighs less than 13 ounces.

Quick, accurate focusing is obtained with simplified gear arrangement.

**FROM A COST STANDPOINT**, magnetic focusing of television picture tubes paves the way to important cost savings by comparison with electrostatic tube focusing methods. In actual instances, material savings alone have run from 50c to \$1.

**FROM A DESIGN STANDPOINT**, magnetic focusing lends itself well to the trend toward increased second anode voltages.

**FROM A PRODUCTION STANDPOINT**, the predictable higher quality of magnetic tubes reduces incoming inspection costs. Factory focusing of sets is done in less time with less skilled labor.

**FROM A PERFORMANCE STANDPOINT**, magnetic focusing quality is generally superior, more stable, and more effective over the entire face of large tubes. Focusing is less affected by voltage changes. When tube replacement becomes necessary, servicing adjustment is a relatively simple matter.

**STACKPOLE**

*Ceramagnet*<sup>®</sup>

**CERAMIC MAGNETS**

Magnetic picture tube focusing is but one of countless jobs, both electrical and mechanical, that can be done better and at less cost with this unique new Stackpole ceramic magnetic material.

Ceramagnet is highly uniform, powerful and permanent. Available in almost any shape or size, it opens important new engineering horizons wherever dependable, low cost magnetic attraction, repelling or even "cushioning" may be utilized.

Send details of your application for recommendations and Ceramagnet samples.

Electronic Components Division

**STACKPOLE CARBON COMPANY, St. Marys, Pa.**

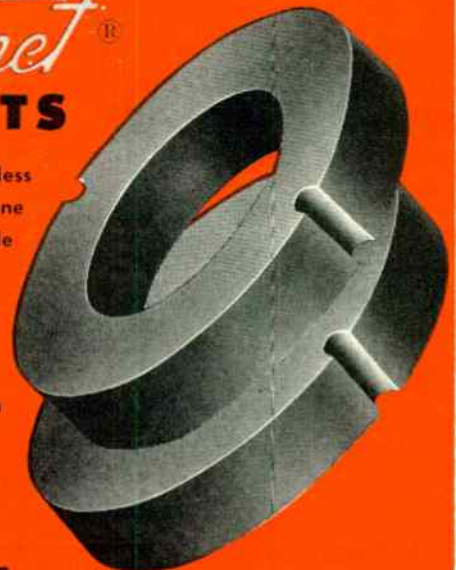

# NEW HIGH STANDARDS OF CAMERA-TUBE PRODUCTION



Extreme delicacy in processing parts for G-E camera tubes is shown as this glass technician fabricates an image-orthicon target. The glass bubble she holds is only 1/10,000 inch thick. After cutting out a small section, she seals this carefully to a metal ring. Any slip or other false movement would completely ruin the fragile target.



Without aid from magnification, the human eye cannot see the openings (250,000 to a square inch) in this copper mesh for a G-E image orthicon—shown here being welded to its ring. Note the rubber finger cots used by the General Electric worker, to avoid contaminating the silk-fine mesh!



Target and mesh are assembled, then riveted together with a spacing of 1/500 inch, to form a link between optical image and electrical signal. A single dust particle could mar tube performance; so before work starts, these G-E specialists sit quietly for ten minutes, to permit any dust to settle that may remain in the air after filtering and conditioning.



18-inch offset screwdrivers are used to tighten the set-screws holding target and mesh assembly in place in the camera tube. Skill, care, and time are needed to complete the delicate operation. Again, dust and lint are barred. An important step toward cleanliness, is the lint-free Nylon garments worn by all persons in the G-E camera-tube area.

# CRAFTSMANSHIP FEATURE BY GENERAL ELECTRIC!

To include image orthicons, vidicons, other commercial and military types.

G.E.'s entry into camera-tube manufacture is a project of major proportions. Extensive facilities and advanced equipment have been acquired; impressive engineering and technical skills have been assembled; workers have been exhaustively trained.

The purpose is high-quality, long-life camera tubes of all types—from TV image orthicons, now in full G-E production, to vidicons and other "seeing" tubes for commercial and military uses.

How improved performance is built into G-E camera tubes, these pictures show in part. Every operation described is rivalled by numerous others that call for the same or greater precision.

You are invited to familiarize yourself with G-E camera-tube manufacture, by written request for information. Problems involving camera tubes to meet your special design needs, will be welcomed. Tube Dept., General Electric Co., Schenectady 5, N. Y.

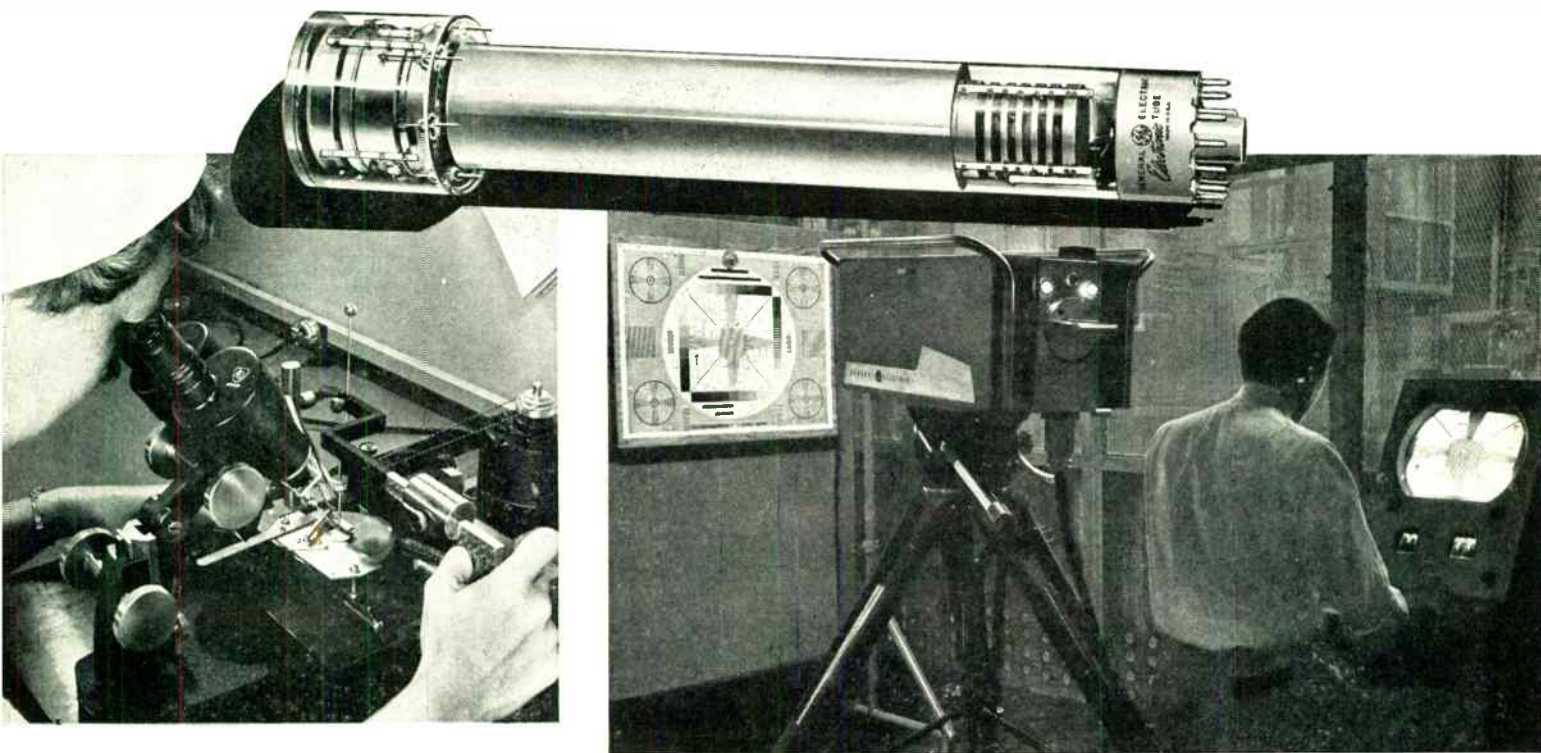

Powerful lenses aid trained hands. In building G-E camera tubes, numerous precision operations call for the aid of microscopes. Here a micro-drill operator drills a 1/500-inch hole—less than the diameter of a hair—for the beam-limiting aperture in the first dynode of a G-E image orthicon tube.

Final testing of a G-E image orthicon uses actual performance as the yardstick. Instrumentation supplements the verdict of the inspector's critical eyes. Life tests, under the most unfavorable conditions, also are regularly conducted by General Electric, to increase the service life and improve the performance of all G-E camera tubes . . . Above: a G-E image orthicon—Type GL-5820—ready for the TV camera.

*Progress Is Our Most Important Product*

GENERAL  ELECTRIC

World Radio History

162-184

# Engineer using BURROUGHS PULSE UNITS loses no time designing test equipment



(Continued from page 72A)

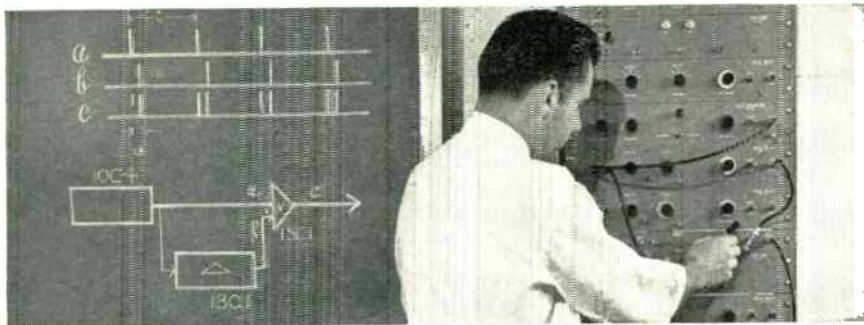

**1. FAST SET-UP.** Engineer draws pulse sequence, then determines by block diagram how to connect his Burroughs Pulse Units. Usually this can be done in a matter of minutes.



**2. JOB COMPLETED.** No time lost. Because engineer spends no time designing test equipment, he can spend his full time on the real problem. This means he can do more, accomplish more.

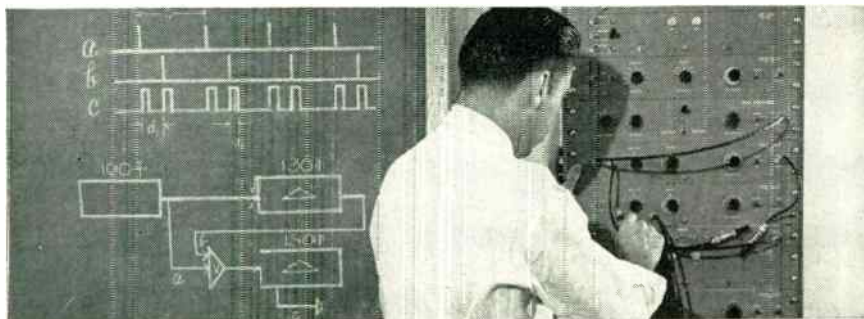

**3. NEXT ASSIGNMENT.** Without losing time, engineer simply determines the block diagram needed to produce the next pulse sequence and sets up his Burroughs Pulse Units. He shifts quickly from one assignment to the next—saving considerable time otherwise needed to design and build special test equipment.

## GET THE FACTS

Learn how you can make your time worth more. Burroughs Pulse Units save weeks of engineering, uncertainty, and considerable equipment cost. Can be used over and over again on different future projects. Immediate delivery from stock. Write for detailed brochure. *Burroughs Corporation, Electronic Instruments Division, Dept. 11-J, 1209 Vine St., Phila. 7, Pa.*



FIRST IN PULSE HANDLING EQUIPMENT

- Jones, D. H., 2405 Sorrell St., Pittsburgh 12, Pa.  
 Jones, E. A., 2827-7 St., Cuyahoga Falls, Ohio  
 Jones, F. W., 140 New Montgomery St., San Francisco 5, Calif.  
 Jones, G. E., Jr., Univ. of Pittsburgh, Pittsburgh 13, Pa.  
 Jones, H. I., Jr., 415 Sumners Dr., Alexandria 4, Va.  
 Jones, K. N., 13213 Leibacker Ave., Norwalk, Calif.  
 Jones, L. S., 269 Maple Dr., Sharon, Pa.  
 Jones, M. C., M. C. Jones Elec. Co., 185 N. Main, Bristol, Conn.  
 Jones, M. N., 4711 E. 36 St., Indianapolis, Ind.  
 Jones, R. C., Jr., 2604 N. Roosevelt St., Arlington 7, Va.  
 Jones, W. T., Box 3125, MCLI, USAFIT, Wright-Patterson AFB, Ohio  
 Jordan, H. G., Bell Tele. Labs., Murray Hill, N. J.  
 Jorgensen, B., Ilybenvej 55, Virum, Denmark  
 Joseph, D., Moore School, 33rd & Walnut Sts., Philadelphia, Pa.  
 Joss, E. T., 215 Jefferson St., Huntington, L. I., N. Y.  
 Juanillo, J. J., 50 Cayuga Dr., Peekskill, N. Y.  
 Judson, H. H., Jr., 2006-14 Ave., N., Seattle 2, Wash.  
 Jurek, W. M., 7913 Amherst St., Dallas 25, Tex.  
 Justice, L. E., 2462 S. Barrington Ave., Los Angeles 64, Calif.  
 Justman, S., 3-D Crescent Rd., Greenbelt, Md.  
 Juviler, P. H., 441 West End Ave., N. Y. 24, N. Y.  
 Kaar, J. M., 6 Robert S. Dr., Menlo Pk., Calif.  
 Kabell, J., 3633 S. Court, Palo Alto, Calif.  
 Kadow, A. C., Kadow Acoustic Devices, Elgin, Ill.  
 Kalakowsky, C. B., 55 Craigie St., Somerville, Mass.  
 Kalman, J., 5240 N. Sheridan Rd., Chicago 40, Ill.  
 Kaminoff, M., 1111-33 Ave., N. Seattle 2, Wash.  
 Kampinsky, A., 1200 D. St., Belmar, N. J.  
 Kane, J. R., 238 N. Pine St., Apt. 212, Chicago 44, Ill.  
 Kang, Y. O., 343 Iolani Ave., Honolulu, T. H.  
 Kannenstine, F. M., 1922 W. Gray, Houston 19, Tex.  
 Kant, M., 2090 Barnes Ave., Apt. 3H, Bronx 62, N. Y.  
 Kanter, J. I., 1517 Paula Dr., Silver Spring, Md.  
 Kaplan, M. N., 4045 Loma Alta Dr., San Diego 15, Calif.  
 Kardauskas, E., 24 E. Price St., Linden, N. J.  
 Karl, D. R., 5348 Blanco Way, Culver City, Calif.  
 Karmioli, Edwin D., 2065 Creston Ave., New York 53, N. Y.  
 Karr, P. R., 5903 Beech Dr., Bethesda, Md.  
 Kasdorf, G. R., 15725 Brentwood Dr., Rt. 12, Milwaukee 10, Wis.  
 Kaserman, F. S., 111 Carlisle Way, Norfolk 5, Va.  
 Kassner, M. H., 4387 Ernscliffe, Montreal, Que., Canada  
 Katahara, C., 183 Ku Dr., Wailukum Maui, Hawaii  
 Katz, S., Fort Plains Rd., R.D. 4, Freehold, N. J.  
 Kaylor, R. L., c/o Bell Tele. Labs., New York 14, N. Y.  
 Kazda, L. F., University of Michigan, Ann Arbor, Mich.  
 Kearney, H. B., Jr., 958 Washington, Ave., Tyrone, Pa.  
 Kearny, Donald, H., 66-10 Grand Central Pkwy., Forest Hills, L. I., N. Y.  
 Keary, H. F., 412 N. Bend Rd., Baltimore 29, Md.

(Continued on page 78A)

## Output vs. Input Voltage

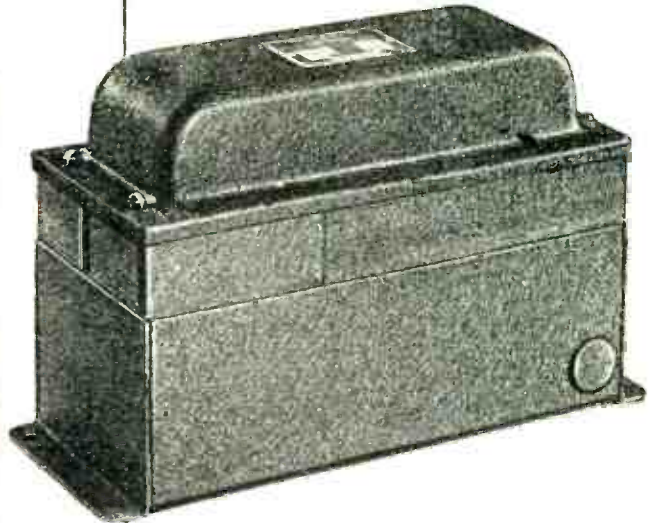
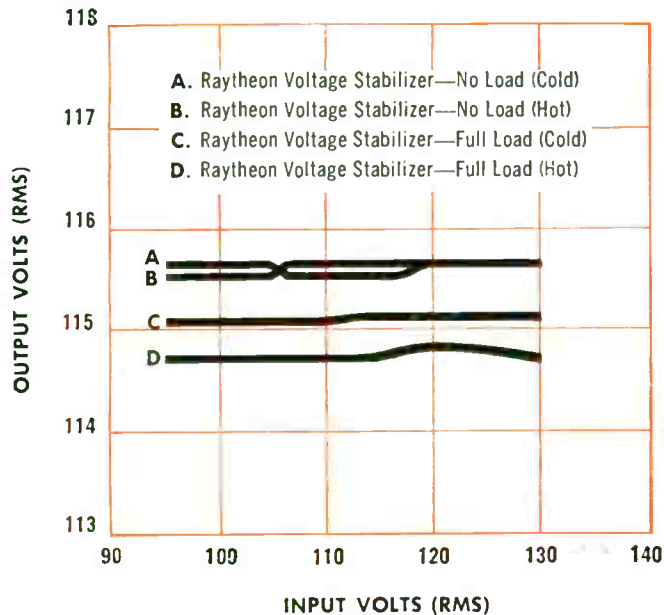

## Why Raytheon Voltage Stabilizers mean satisfied customers for you

When you incorporate a Raytheon Voltage Stabilizer in your equipment, you help assure complete customer satisfaction—for these important reasons:

1. Your equipment will operate as it was designed to, regardless of voltage variations of your customers' electrical source.
2. Since most components have maximum life when operating at their designed voltage, a Raytheon Voltage Stabilizer prolongs the life of components—and your equipment. A plus feature is provided by the short-circuit protection inherent in Raytheon Voltage Stabilizers.
3. Because Raytheon Voltage Stabilizers are superior to any other static type stabilizer under virtually all operating conditions, your equipment will work better and longer—characteristics your customers really appreciate.

### Check these important points of Raytheon Voltage Stabilizer superiority

Raytheon Model VR-6113 (120 watts) chosen at random and compared with a similarly rated competitive model.

- Guaranteed to deliver accurate AC voltage within  $\pm\frac{1}{2}\%$  (competitive model 1%)
- 14% lighter, 22% smaller
- Three times more accurate no-load to full-load regulation
- 17% less change in voltage output as frequency varies
- 28% closer regulation as temperature changes

For full information see your electronic supply house  
or write Dept. 6120

**RAYTHEON MANUFACTURING COMPANY**

Equipment Marketing Division, Waltham 54, Mass.



*Excellence in Electronics*

for service and lab. work

## Heathkit PRINTED CIRCUIT OSCILLOSCOPE KIT FOR COLOR TV!

① Check the outstanding engineering design of this modern *printed circuit* Scope. Designed for color TV work, ideal for critical Laboratory applications. Frequency response essentially flat from 5 cycles to 5 Mc down only 1½ db at 3.58 Mc (TV color burst sync frequency). Down only 5 db at 5 Mc. New sweep generator 20-500,000 cycles, 5 times the range usually offered. Will sync wave form display up to 5 Mc and better. Printed circuit boards stabilize performance specifications and cut assembly time in half. Formerly available only in costly Lab type Scope. Features horizontal trace expansion for observation of pulse detail—retrace blanking amplifier—voltage regulated power supply—3 step frequency compensated vertical input—low capacity nylon bushings on panel terminals—plus a host of other fine features. Combines peak performance and fine engineering features with low kit cost!

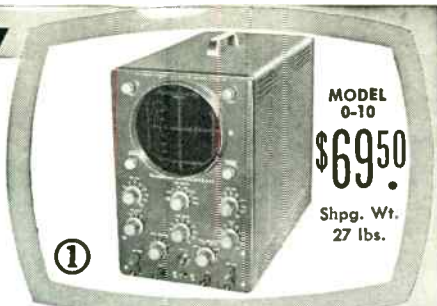

MODEL  
O-10  
**\$69.50**  
Shpg. Wt.  
27 lbs.



MODEL  
TS-4  
**\$49.50**  
Shpg. Wt.  
16 lbs.

Heathkit TV

## SWEEP GENERATOR KIT ELECTRONIC SWEEP SYSTEM

② A new Heathkit sweep generator covering all frequencies encountered in TV service work (color or monochrome). FM frequencies too! 4 Mc—220 Mc on fundamentals, harmonics up to 880 Mc. Smoothly controllable all-electronic sweep system. Nothing mechanical to vibrate or wear out. Crystal controlled 4.5 Mc fixed marker and separate variable marker 19-60 Mc on fundamentals and 57-180 Mc on calibrated harmonics. Plug-in crystal included. Blanking and phasing controls—automatic constant amplitude output circuit—efficient attenuation—maximum RF output well over .1 volt—vastly improved linearity. Easily your best buy in sweep generators.



(Continued from page 76A)

- Keigher, B. J., 103 Garden Rd., Red Bank 20, N. J.
- Keim, D. Y., 145 Chestnut St., Garden City, L. I., N. Y.
- Keith, Walter S., 47-45—43 St., Woodside, L. I., N. Y.
- Keithley, R. D., 4437 Spatz Ave., Ft. Wayne, Ind.
- Kell, R. F., 4455 Genesee St., Buffalo 21, N. Y.
- Keleher, R. L., 66 Wickey Ave., Westbury, L. I., N. Y.
- Keller, J. E., 3191 Acalanes Ave., Lafayette, Calif.
- Kellerman, D., 206-16—35 Ave., Bayside, L. I., N. Y.
- Kelley, G. G., Rt. 3, Kingston, Tenn.
- Kelley, J. J., Oak Pl., Ayrlawn, Bethesda, Md.
- Kelley, L. A., 3438—87 St., Jackson Hghts., L. I., N. Y.
- Kelly, H. P., 588 Valley Rd., Watchburg, Plainfield, N. J.
- Kelly, R. S., 120—25 St., Hermosa Beach, Calif.
- Kelly, V., 99-1215 Aiea Hghts., Dr., Aiea, Hawaii
- Kelvin, William, 120 Hilldale Rd., Albertson, L. I., N. Y.
- Kenny, J. A., 27 Lion Lane, Westbury, L.I., N. Y.
- Kent, J. S., 3332 Buchanan St., Mt. Rainier, Md.
- Kenyon, F. R., 803 S. Virginia Ave., Marion, Ill.
- Keppel, R. A., 7315 McCool Ave., Los Angeles 45, Calif.
- Kerby, G. A., 14 Dimitri Pl., Larchmont, N. Y.
- Kessler, G. W., 2918 Windermere Rd., Schenectady, N. Y.
- Kessler, S., 4705 Kansas Ave., N.W., Washington 11, D. C.
- Kidd, Deane E., Box 197, Oceanport, N. J.
- Kidd, G. B., 24 S. Cherrywood Ave., Dayton 3, Ohio
- Killion, R. H., 507 Salt Springs Rd., Syracuse, N. Y.
- Kim, Y. S., 121 Montfort St., Apt. 12A, Boston 15, Mass.
- Kime, Joseph M., 471 Greenwood Ave., Akron 20, Ohio
- King, A. D., 142 Main St., Northampton, Mass.
- King, A. M., 2901 Erie St., S.E., Washington 20, D. C.
- King, R. E., 122—A Haddon Hills, Haddonfield, N. J.
- Kirkland, R. E., 6 Hawthorne St., Belmont 77, Mass.
- Kissel, M. M., Rt. 1, Mansfield, Ohio
- Kiver, M. S., 900 Fairview Rd., Highland Pk., Ill.
- Klamm, C. F., Jr., U.S. Naval Postgrad School, Monterey, Calif.
- Kleason, D. B., 580 S. Snelling Ave., Apt. 2., St. Paul 5, Minn.
- Klein, M. M., 50 Cromwell Pl., Sea Cliff, L. I., N. Y.
- Klein, S., 6468 Milton St., Philadelphia 19, Pa.
- Klima, W. M., 6209 Wedgewood Rd., Bethesda, Washington 14, D. C.
- Kline, A., 179 Ocean Pkwy., Brooklyn 18, N. Y.
- Klinke, E. R., 1161 Greenhills Rd., Sacramento, Calif.
- Kloga, P. J., 1533 N. Keating Ave., Chicago 51, Ill.
- Klug, S. H., 55 Hanson Pl., Box 1165, Brooklyn 17, N. Y.
- Knaut, J. E., Apt. 6, 10626 Wilshire Blvd., Los Angeles 24, Calif.
- Knight, H. M., 264 Park Ave., Arlington 74, Mass.
- Knight, S. J., Jr., 3040 E. Exposition Ave., Denver 9, Colo.
- Knitel, Erich J. M., 2120 Prieur St., E., Montreal 12, P. Q., Canada

(Continued on page 80A)

## Increased Insulation BETTER CONNECTIONS JONES BARRIER TERMINAL STRIPS

Leakage path is increased—direct shorts from frayed terminal wires prevented by bakelite barriers placed between terminals. Binder screws and terminals brass, nickel-plated. Insulation, black molded bakelite. Finest construction. Add much to equipment's effect.

Jones Means Proven Quality

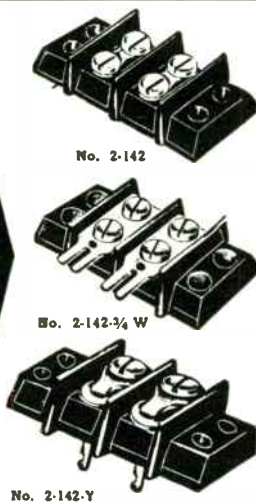

Illustrated: Screw Terminals—Screw and Solder Terminals—Screw Terminal above Panel with Solder Terminal below. Every type of connection.

Six series meet every requirement: No. 140, 5-40 screws; No. 141, 6-32 screws; No. 142, 8-32 screws; No. 150, 10-32 screws; No. 151, 12-32 screws; No. 152, ¼-28 screws.

Catalog No. 20 lists complete line of Barrier Strips, and other Jones Electrical Connecting Devices. Send for your copy.

**HOWARD B. JONES DIVISION**  
CINCH MANUFACTURING CORPORATION  
CHICAGO 24, ILLINOIS  
SUBSIDIARY OF UNITED-CARR FASTENER CORP.



# leadership in semi-conductors from Transitron®

**SILICON**

**GERMANIUM**

Transitron

SILICON POWER  
RECTIFIERS

Send  
for  
Bulletin  
TE-1321



Transitron

SUBMINIATURE GLASS  
GERMANIUM DIODES

Send  
for  
Bulletin  
TE-1319



Transitron

MEDIUM POWER  
SILICON RECTIFIERS

Send  
for  
Bulletin  
TE-1321 D



Transitron

HIGH POWER  
SILICON RECTIFIERS

Send  
for  
Bulletin  
TE-1321 C



Transitron

SILICON BONDED  
DIODES

Send  
for  
Bulletin  
TE-1308



Transitron

SILICON JUNCTION  
DIODES

Send  
for  
Bulletin  
TE-1322



Transitron

POWER  
TRANSISTORS

Send  
for  
Bulletin  
TE-1320 C



Transitron

GOLD BONDED GERMANIUM  
DIODES

Send  
for  
Bulletin  
TE-1300



Transitron

MATCHED  
QUADS

Send  
for  
Bulletin  
TE-1310



Transitron

AUDIO  
TRANSISTORS

Send  
for  
Bulletin  
TE-1320



All Transitron semi-conductors are produced to the most rigid military and commercial specifications to assure long life and complete reliability. They provide the trouble-free, dependable performance that is so essential in modern complex electronic equipment.

Whether your requirements are for Germanium or Silicon, the solution can be found in Transitron's diversified line of semi-conductors. A wide variety of standard types, along with over 300 special types, are available. Your inquiries are invited.

**Transitron®**

electronic corporation

melrose 76, massachusetts





SINCE 1915 LEADERS IN AUTOMATIC CONTROL

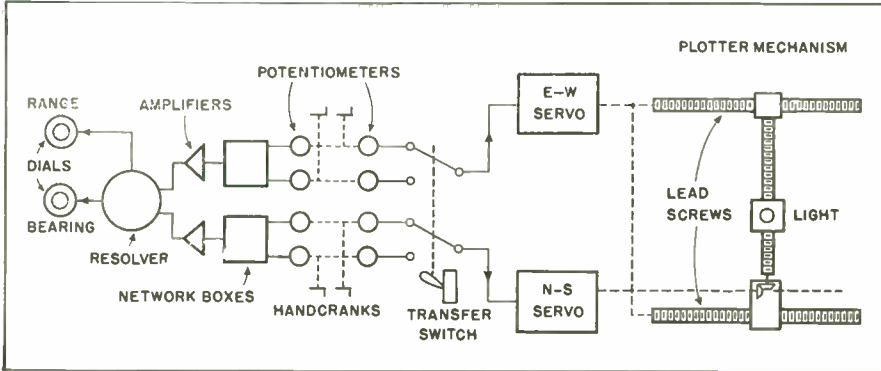

# Continuous Distance and Bearing Solutions with Unique Plotter-Resolver System

**Problem:** Determine automatically and continuously the distance and relative bearing of any two points on a map.

**Ford Instrument's Solution:** A combination of two standard components — a map plotter and an electrical resolver.

**Result:** Equipment can operate with maps up to a yard square — whose scale varies over a wide range. This means real flexibility because it does not restrict plotter just to maps — since photographs — even sketches can be used.

**Here's how it works:** The plotter proper has a smooth unobstructed glass top on which the map is placed. Under the glass there is a light traveling on screws. The screws are driven horizontally (E-W) and vertically (N-S) by servo motors actuated by a computing mechanism. The position of the light on the plotter is controlled by four handcranks. Two of the handcranks are used to position the light under the first point; a transfer switch is then thrown and the other two handcranks used to position the light under the second point. The map coordinates of the two points are algebraically added in two network boxes, the resultant voltage from the network boxes being the N-S and E-W distances between the two points. The resolver converts these two distances into range and bearing, which are indicated on two dials. Such a technique results in astounding accuracy. In a computer employing this principle, the maximum range error is on the order of one yard in a thousand, and the maximum bearing error is 10'. The average errors are about half the maximum.

If you have a problem in any phase of automatic control, it will pay you to discuss it with Ford engineers.

Visit our Booth #15 at 1st Annual Trade Fair of Atomic Industry — Sept. 26-29, Washington, D. C.



**FORD INSTRUMENT COMPANY**

DIVISION OF SPERRY RAND CORPORATION  
31-10 Thomson Avenue, Long Island City 1, N. Y.

**ENGINEERS**

of unusual abilities can find a future at FORD INSTRUMENT COMPANY. Write for information.



Membership

(Continued from page 78A)

- Knoll, D. W., 1849 Vesta Way, Sacramento 21, Calif.
- Knox, J. L., Central Philippine Univ., Iloilo City, P. I.
- Knox, R. V., 123 Manhattan Ave., Hawthorne, N. Y.
- Knutson, H. C., 1309 Slade Run Dr., Falls Church, Va.
- Koch, D. G., 24 N. Summit Ave., Chatham, N. J.
- Koch, H. J., 149 Branch Brook Dr., Belleville, N. J.
- Koch, J. F. A., 1 Maple Dr., Great Neck, L. I., N. Y.
- Koch, J. G., 10 High Point Rd., Old Bridge, N. J.
- Koesan, E. S., 102 Midway Dr., Ferndale, Johnstown, Pa.
- Kodera, C. F., 7606 Stetson Ave., Los Angeles 45, Calif.
- Koen, F. T., 34 Chestnut St., Danvers, Mass.
- Koenig, J. G., Timken Roller Bearing Co., Canton 6, Ohio
- Koenreich, J. L., Trans-Arabian Pipe Line Co., Box 1348, Beirut, Lebanon
- Koepfel, B. W., Seismograph Service Corp., Box 1590, Tulsa 1, Okla.
- Koepsel, W. W., Southern Methodist Univ., Dallas, Tex.
- Koerner, C. T., 1112 Cortez Dr., Glendale 7, Calif.
- Koerner, H., 3256 E. Terra Alta Tucson, Ariz.
- Koerner, L. F., Bell Tele. Labs., Murray Hill, N. J.
- Koesy, C. B., 1813 Moates Ave., Panama City, Fla.
- Kofter, E. J., A C-S Comm. Hqrs., 12 AF, APO 12, c/o P. M., New York, N. Y.
- Kohler, E., Jr., 40 Greenhouse Dr., Dayton 9, Ohio
- Konkel, T. C., 3334 Campus St., Claremont, Calif.
- Konrad, L., 117 Fairmont Ave., Philadelphia 23, Pa.
- Korby, I., 18900 Wisconsin Ave., Detroit 21, Mich.
- Kosmaczewski, I., 118 Cleremont Ave., Irvington, N. J.
- Kostyal, S. P., 9850 S. Central Pk., Evergreen Park 42, Ill.
- Kotera, W. J., Wow, Omaha, Neb.
- Kotlewski, J. P., 3222 Maple St., Toledo, Ohio
- Kouchnerkavich, T. A., Civil Aero, Adminis., 17 & Constitution Aves., Wash. 25, D. C.
- Kovach, L., Warren St., Whippany, N. J.
- Kowitz, A. E., 4518 W. George St., Chicago 41, Ill.
- Kovitzky, W. J., 223 Jamaica Ave., Brooklyn 7, N. Y.
- Krainin, S., 105-30—66 Ave., Forest Hills, L. I., N. Y.
- Kramer, A. W., 110 S. Dearborn St., Chicago 3, Ill.
- Krantz, C. H., 953-D 19 St., Santa Monica, Calif.
- Krasnick, B., 10 Mangano Ct., Watertown, Mass.
- Kraus, F. A., 7535 Beverly Rd., Philadelphia 38, Pa.
- Krause, C. K., R.R. 2, Box 1277, Parsippany, N. J.
- Kreider, P. A., 6909 S. Vanport Ave., Whittier, Calif.
- Krieger, H. C., Rt. 1, Osterbaut Lake, Grand Junction, Mich.
- Krivanich, M. A., 413 F. St., White Sands Proving Gr., Las Cruces, N. Mex.
- Krody, J. L., Rt. 2, Box 51, Bethel, Ohio
- Krogh, R. A., 4108 Via Largavista, Palos Verdes Estates, Calif.
- Kruse, F. W., Jr., 2770 Ross Rd., Palo Alto, Calif.
- Ktistes, P. J., 100 Wash. St., Gloucester, Mass.

(Continued on page 83A)

# MICROWAVE SIGNAL GENERATORS AND SIGNAL SOURCES

*for extremely  
high frequencies  
12,400 to 50,000 mc*

Rugged, compact, completely integrated units. Designed to save engineering manhours in the laboratory and on the production line. Operate simply with direct-reading continuously variable dials. No calibration charts.

Frequency is measured by direct-reading reaction-type wave-meters that assure extreme accuracy. VSWR is exceptional—Signal Generators 1.7 to 1; Signal Sources 1.7 to 1 when attenuated. Calibration accuracy is given special attention.

Consult Polarad on all your EHF problems.

SG-1218



POLARAD MICROWAVE SIGNAL GENERATORS  
12.4 TO 39.7 KMC

SS-1218

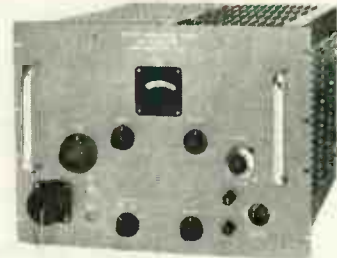

POLARAD MICROWAVE SIGNAL SOURCES  
12.4 TO 50.0 KMC

| Frequency Range  | SIGNAL GENERATORS  |              | SIGNAL SOURCES |                        |
|--|--|--------------|----------------|------------------------|
|  | Model Number   | Output Power | Model Number   | Power Output (Average) |
| 12.4 to 17.5 KMC   | SG 1218*   | -10 DBM      | SS 1218        | 15 mw                  |
| 18.0 to 22.0 KMC   | SG 1822  | -10 DBM      | SS 1822        | 10 mw                  |
| 22.0 to 25.0 KMC   | SG 2225  | -10 DBM      | SS 2225        | 10 mw                  |
| 24.7 to 27.5 KMC   | SG 2427  | -10 DBM      | SS 2427        | 10 mw                  |
| 27.27 to 30.0 KMC  | SG 2730  | -10 DBM      | SS 2730        | 10 mw                  |
| 29.7 to 33.52 KMC  | SG 3033  | -10 DBM      | SS 3033        | 10 mw                  |
| 33.52 to 36.25 KMC   | SG 3336  | -10 DBM      | SS 3336        | 9 mw                   |
| 35.1 to 39.7 KMC   | SG 3540  | -10 DBM      | SS 3540        | 5 mw                   |
| 37.1 to 42.6 KMC   | * External Source Power Measurement<br>Range +10 to +30 DBM<br>Accuracy with Correction: ±2 DB |              | SS 3742        | Approx. 3 mw           |
| 41.7 to 50.0 KMC   |  |              | SS 4150        | Approx. 3 mw           |
| Modulation:<br>1. Internal<br>1000 CPS Square Wave<br>2. External<br>a. Pulse<br>Pulse Width: 0.5 to 10 Microseconds<br>PRF: 50 to 10,000 PPS<br>Pulse Amplitude: 10 volts Pk to Pk Min.<br>Polarity: Positive<br>b. Sawtooth or Sinusoidal<br>Frequency: 50 to 10,000 CPS<br>Amplitude: 15 Volts RMS Min. |  |              |                |                        |

### SPECIAL FEATURES OF EHF SIGNAL GENERATORS

- Unique power measurement system employs waveguide components of unusual design — allows continuous and front panel monitoring.
- Attenuation is independent of power set and frequency.
- 1000 cycles cps square wave modulation and external fm or pulse modulation provided over entire frequency range.

For complete information write to your nearest Polarad representative or directly to the factory.

**AVAILABLE ON EQUIPMENT LEASE PLAN**

**FIELD MAINTENANCE SERVICE AVAILABLE  
THROUGHOUT THE COUNTRY**



**ELECTRONICS CORPORATION**  
43-20 34th STREET, LONG ISLAND CITY 1, N. Y.

REPRESENTATIVES • Albuquerque • Atlanta • Baltimore • Bayonne • Boston • Buffalo • Chicago • Dayton • Fort Worth • Los Angeles • New York  
Philadelphia • San Francisco • Syracuse • Washington, D.C. • Westbury • Winston-Salem • Canada, Arnprior, Toronto—Export: Rocke International Corporation

# You can get complete FM-AM coverage

## 100 KC to 216 MC

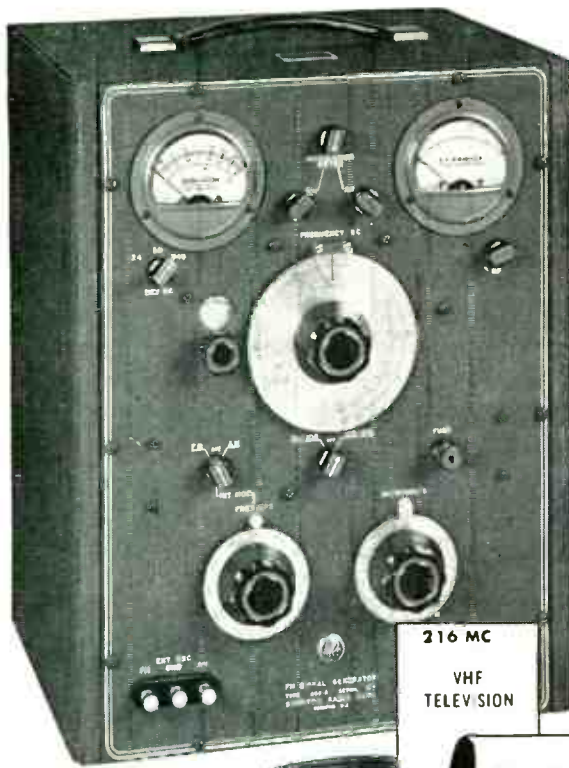

PRICE: \$975.00  
F. O. B. Boonton, N. J.

### FM-AM SIGNAL GENERATOR Type 202-B

#### SPECIFICATIONS

FREQUENCY RANGE: 54—216 MC  $\pm$  0.5%  
 FM MODULATION: 0—240 KC continuously variable.  
 FM DISTORTION: Less than 2% at 75 KC.  
 AM MODULATION: 0—50% continuously variable.  
 AM DISTORTION: Approximately 5% at 50% AM.  
 INTERNAL MODULATING FREQUENCIES: 50, 100, 400 cycles; 1, 5, 7.5, 10, 15 KC.  
 R. F. OUTPUT VOLTAGE: 0.1 to 200,000 microvolts continuously variable from source impedance of 26.5 ohms.  
 POWER SUPPLY: 105—125 volts, 50/60 cycles (internally regulated)

### UNIVERTER Type 207-A (When used with 202-B)

#### SPECIFICATIONS

FREQUENCY RANGE: 100 KC—55 MC.  
 FREQUENCY RESPONSE: Flat within  $\pm$  1 db. over frequency range.  
 FM-AM MODULATION: See 202-B.  
 FM DISTORTION: No appreciable distortion at any level.  
 AM DISTORTION: No appreciable distortion at carrier levels below 0.05 volt and modulation of 50%.  
 RF OUTPUT VOLTAGE: 0.1 to 100,000 microvolts continuously variable from source impedance of 26.5 ohms; also approximately 1.5 volts from 330 ohms into open circuit.  
 POWER SUPPLY: 90—130 volts, 60 cycles (internally regulated).



The Type 202-B FM-AM Signal Generator and the Type 207-A Univerter provide complete FM-AM signal coverage from 100 KC continuously through 216 MC in two compact portable units.

The Type 202-B FM-AM Signal Generator was designed to meet the exacting requirements set forth by leading engineers throughout the country and has found widespread acceptance as the essential laboratory instrument for receiver development and research work.

The Type 207-A Univerter was designed to provide additional frequency coverage of commonly used intermediate and radio frequencies and enables the modulation and attenuation calibration features of the 202-B to be utilized at these lower frequencies.

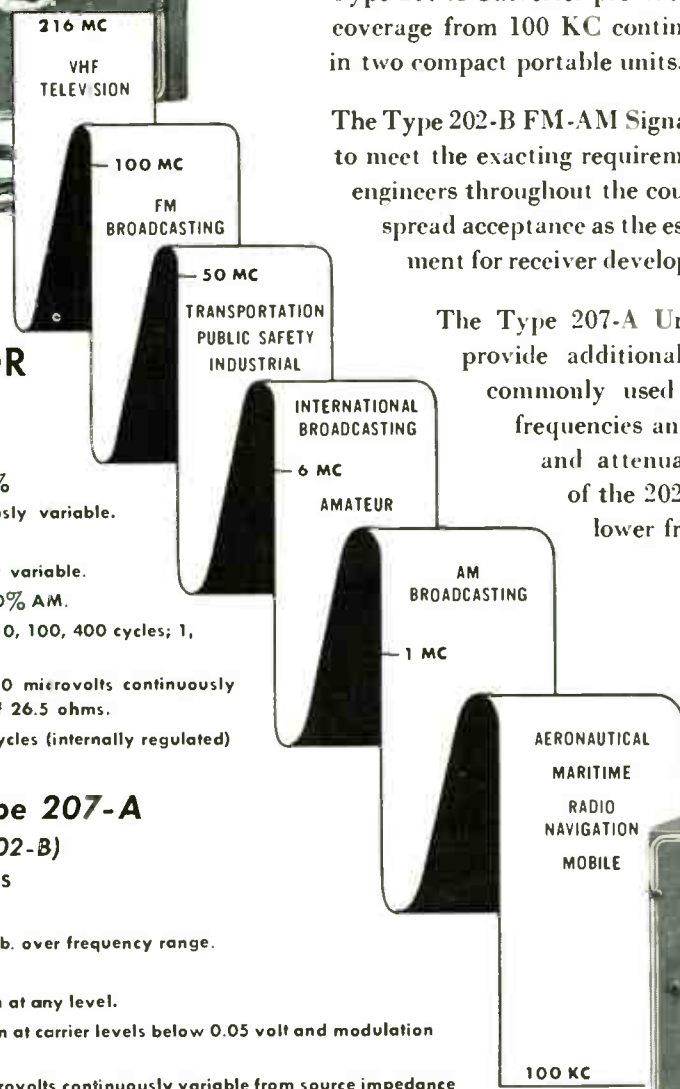

Write for CATALOG "J"

PRICE: \$345.00  
F. O. B. Boonton, N. J.



## Membership

(Continued from page 80-A)

- Kuba, R. E., 19391 Votrobeck Dr., Detroit 19, Mich.  
 Kubala, A. M., 7725 Lamphere St., Detroit 28, Mich.  
 Kuczun, C. G., 17 Whittier Rd., Reading, Mass.  
 Kugler, F., 8106 MaCarthur Rd., Philadelphia 18, Pa.  
 Kullback, I., 157 3 Ave., Long Branch, N. J.  
 Kunde, W. W., Jr., 1610 W. York Lane, Wheaton, Ill.  
 Kunst, A. F., 3451 W. 66 St., Chicago 29, Ill.  
 Kuykendall, J. H., 822 Mitchell Ave., Arlington Hights., Ill.  
 Kyburz, U. L., 4211 Crestview Dr., Rockford, Ill.  
 Kyne, T., 1998 Upland Way, Philadelphia 31, Pa.  
 Lahn, F. C., Box 156, Melbourne Beach, Fla.  
 Laing, J. T., Westinghouse Elec. Corp., Sharon, Pa.  
 Lamb, F. X., Weston Elec. Instru. Corp., 614 Frelinghuysen Ave., Newark 5, N. J.  
 Lambert, T. M., 1944 Diamond St., San Diego 9, Calif.  
 Lane, A. L., 706 Chillum Rd., Hyattsville, Md.  
 Lane, E. F., 1810 N. 47 St., Phoenix, Ariz.  
 Lane, F. A., 126 Essex Ave., Montclair, N. J.  
 Langdon, G. G., Sao Paulo Tramway Light & Power Co. Ltd., Caixa Postal 8026, Sao Paulo, Brazil  
 Lapidos, R. W., 325-B Princeton Rd., Haddonfield, N. J.  
 Lapp, R. S., Lapp Insulator Co., Leroy, N. Y.  
 Larsen, H. F., 8714 Melva, Downey, Calif.  
 Larson, R. P., 808 N. Humphrey Ave., Oak Pk. Ill.  
 Lasby, R. O., Parkway Apts., Munn Ave., Haddonfield, N. J.  
 Lashier, H. M., Emmanuel Missionary Coll., Berrien Springs, Mich.  
 Laskin, H. J., 395 Belmont Ave., Brooklyn 7, N. Y.  
 Latham, N. D., 2010 Narberth Ave., Haddon Hghts., N. J.  
 Lathrop, L. L., 1100 Monroe St., S.E., Albuquerque, N. Mex.  
 Laube, O. T., 366 N. Pkwy., E. Orange, N. J.  
 Lauderdale, D. M., Univ. of Tex., Austin, Tex.  
 Lautenberger, H. W., 23 Garfield Rd., Baldwin, L. I., N. Y.  
 Lautz, C. F., Jr., 887 Parkside Ave., Buffalo 16, N. Y.  
 Lawrence, G. M., 124 Westwood Rd., Columbus 14, Ohio  
 Leahy, E. F., 1149 Greentree Rd., Pitts. 20, Pa.  
 Leavitt, W. E., 5229 Janice Lane, Wash. 22, D. C.  
 Lebert, A. W., Bell Tel. Labs., Mt. Ave., Murray Hill, N. J.  
 Lee, F. B., 1319 Powell St., San Fran. 11, Calif.  
 Lee, R. C., 1833 Shelby St., Seattle 5, Wash.  
 Leef, G. R., 54 Rector St., Millburn, N. J.  
 Le Grand, C., 5909 W. Colgate Ave., Los Angeles 36, Calif.  
 Legrand, J. S., 348 Innes Rd., Wood-Ridge, N. J.  
 Leinbach, H. J., Jr., 2959 Tilden St., N.W., Wash. 8, D. C.  
 Leiphart, J. P. C., 4642 Cedar Ridge Dr., Wash. 21, D. C.  
 Leming, J. G., 2499 So. Ave., Niagara Falls, N. Y.  
 Lemmond, C. Q., 1 River Rd., Schenectady 5, N. Y.  
 Lenfest, G. C., Jr., 3458 Homestead, Wantagh, L. I., N. Y.  
 Lenigan, T. E., Radio Dev. Dept., Bell Tel. Labs., Whippany, N. J.  
 Lentz, J. J., Int'l Bus. Mach., 612 W. 115 St., N. Y. 27, N. Y.  
 Leonard, R. R., 52 Beacon St., Boston 8, Mass.  
 Leppert, M. L., 4012 First Pl., S.W., Wash. 24, D. C.

(Continued on page 84A)

# TWIN POCKETSCOPE

by

# Waterman

MODEL S-15-A

TWO IDENTICAL INDEPENDENT OSCILLOSCOPES WITH COMMON TIME BASE



Size:  
12" x 6" x 7"  
16 1/4 Pounds

ANOTHER EXAMPLE OF **Waterman** PIONEERING...

The WATERMAN TWIN POCKETSCOPE, model S-15-A, presents a new concept in multiple trace oscilloscopy with independent vertical channels each having a sensitivity of 10 millivolts rms/inch, and a response within -2 db from DC to 200 KC—a pulse rise time of 3 microseconds. These features combined with the provisions for intensity modulating either, or both, traces, results in greater flexibility. The sweep generator is operated either in the repetitive or triggered mode from 0.5 cycles to 50 KC with synchronization polarity optional. All attenuators and gain controls are of the non-frequency discriminating type. Remember that portability has not been overlooked! The amazing small size of the S-15-A tips the scales of opinion heavily in its favor. Imagine, all of these essential characteristics in an instrument weighing only 16 1/4 lbs. You can carry it to any job, anywhere!

## WATERMAN PRODUCTS CO., INC.

PHILADELPHIA 25, PA.

CABLE ADDRESS: POKETSCOPE

WATERMAN PRODUCTS INCLUDE

- S-4-C SAR PULSESCOPE®
- S-5-A LAB PULSESCOPE
- S-6-A BROADBAND PULSESCOPE
- S-11-A INDUSTRIAL POCKETSCOPE®
- S-12-B JANized RAKSCOPE®
- S-14-A HIGH GAIN POCKETSCOPE
- S-14-B WIDE BAND POCKETSCOPE
- S-15-A TWIN TUBE POCKETSCOPE
- RAYONIC® Cathode Ray Tubes and Other Associated Equipment



## WATERMAN PRODUCTS

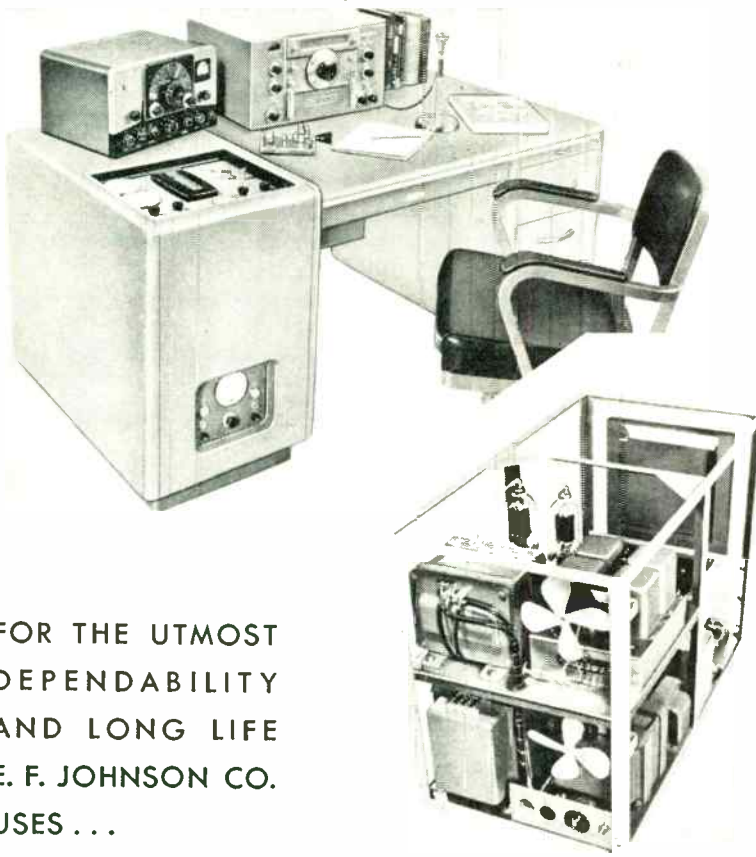

FOR THE UTMOST  
DEPENDABILITY  
AND LONG LIFE  
E. F. JOHNSON CO.  
USES . . .

**CHICAGO**

*the World's Toughest*  
**TRANSFORMERS**

in the *Viking* KILOWATT

This superbly designed and engineered "Transmitter of Tomorrow" will meet the most rigid electrical, mechanical and performance specifications.

E. F. Johnson engineers chose CHICAGO "Sealed-in-Steel" transformers for the Viking Kilowatt . . . modulation, filaments, screen voltage, bias filament, plate and matching choke and filter chokes . . . eleven in all, including many stock units.

Here is further proof of the rugged, trouble-free construction of CHICAGO transformers. Learn about the full line of the world's toughest transformers by writing for the latest CHICAGO Catalog. It is available from your local electronic parts distributor or from Chicago Standard Transformer Corporation.



Export Sales:  
Roburn Agencies, Inc.  
431 Greenwich St.,  
New York 13, N. Y.

**CHICAGO STANDARD**  
**TRANSFORMER CORPORATION**  
ADDISON & ELSTON • CHICAGO 18, ILL.



(Continued from page 83A)

- Leslie, C. B., 916 Robin Rd. Silver Spring, Md.  
Leslie, F., Emerson Radio, 14 & Coles Sts., Jersey City 2, N. J.  
Lessen, M., 2527 Ford Ave., Detroit 6, Mich.  
Leuteritz, H. C., 51 Canterbury Rd., Rockville Center, L. I., N. Y.  
Lev, G. N., 200 Carlton Ave., Westmont, N. J.  
Le Van, J. D., 53 Raymond St., Nashua, N. Hamp.  
Levenson, D. W., 1121 Main St., Wheeling, W. Va.  
Levenstein, H., 26 Hanscom Pl., Oceanside, L. I., N. Y.  
Levine, A. M., 154 Lozier Terr. River Edge, N. J.  
Levinthal, J. G., 344 King Rd., W., Ithaca, N. Y.  
Levitsky, J., 65 Rutgers Pl., River Edge, N. J.  
Levy, B., 34-58 90 St., Jackson Hghts., L. I., N. Y.  
Levy, L., 535 Parkside Ave., Bklyn. 26, N. Y.  
Lewis, G., WCAU Inc., City Ave. At Mount-  
ment Rd., Philadelphia 31, Pa.  
Lewis, M. B., 2202 64 St., Brooklyn, N. Y.  
Lewis, R. F., Product Dev. Co., Kearny, N. J.  
Liang, D., 315 Brierwood Ave., Ann Arbor,  
Mich.  
Libbey, W. M., 135 W. Broadway, Bangor, Me.  
Libby, H. L., 1324 Stevens Dr., Richland, Wash.  
Libby, R. L., Glen Rd., Rome, N. Y.  
Liepold, R. B., 350 Oakdale Ave., Chicago 14,  
Ill.  
Lang, E. T., 3226 Walbridge Pl. N.W., Wash-  
ington, D. C.  
Lang, J. M., Gen. Elec. Co., Schenectady, N. Y.  
Lange, W. W., 8300 Gross Pt. Rd., Morton  
Grove, Ill.  
Lieberman, E., 48 Helen Ave., Plainview, L. I.,  
N. Y.  
Light, L., Fed. Comm. Com., 7435 New Post  
Off. Bldg., Washington 25, D. C.  
Lindemann, H. B., 1533 Park Grove Rd., Balti-  
more 28, Md.  
Lindley, P. L., Burroughs Research Center,  
Paoli, Pa.  
Lindner, N. J., 332 W. 89 St., New York 24,  
N. Y.  
Lindsay, J. C., Nottingham Rd., Rt. 2, Newark,  
Del.  
Lindsay, P. A., 18 Aspley Rd., London S.W.  
18, England.  
Lindstrom, G., Limmegatam 25 A, Linkoping,  
Sweden  
Link, J. C., 7213 Halleck St., S.E., Washing-  
ton 28, D. C.  
Linkletter, R. L., 1108 N. Lafayette Ave.,  
Brenerton, Wash.  
Linton, T. B., 11561 Cand. La., Garden Grove,  
Calif.  
Lipin, B., 808 E. 73 St., Kansas City, Mo.  
Lipkin, L., 3025 Richton Ave., Detroit 6, Mich.  
Lippel, B., 401 West End Ave., Long Branch,  
N. J.  
Lisle, J., 729 Delaware Ave., Bethlehem, Pa.  
Little, N. C., 8 College St., Brunswick, Me.  
Lob, C. G., Gen. Elec. Co. Syracuse, N. Y.  
Lochanthi, B. N., 2552 Boulder Rd., Altadena,  
Calif.  
Lockhart, J. C., 306 Oreland Mill Rd., Oreland,  
Pa.  
Loewenthal, M., 186 Commonwealth Ave., Boston  
16, Mass.  
Loftis, H. J., 2223 S. 11 St., Ironton, Ohio  
Long, J. V., 4120 Fifth Ave., San Diego 3,  
Calif.  
Long, M. B., Bell Tel. Labs., 463 W. St., New  
York 14, N. Y.  
Long, M. C., Dept. of the Navy, Washington  
25, D. C.  
Looney, H. C., 103 Hilltop Rd., Silver Spring,  
Md.  
Looney, L. A., 50 Winans Dr., Youkers, N. Y.  
Lorence, E. L., 521 Distel Dr., Los Altos, Calif.  
(Continued on page 86A)

**IN TOP QUALITY CORES**

# FOR HIGHER FREQUENCIES

**FROM 20 TO 300 MC.**

# TYPES SF, J AND W

**GA&F® CARBONYL IRON POWDERS**

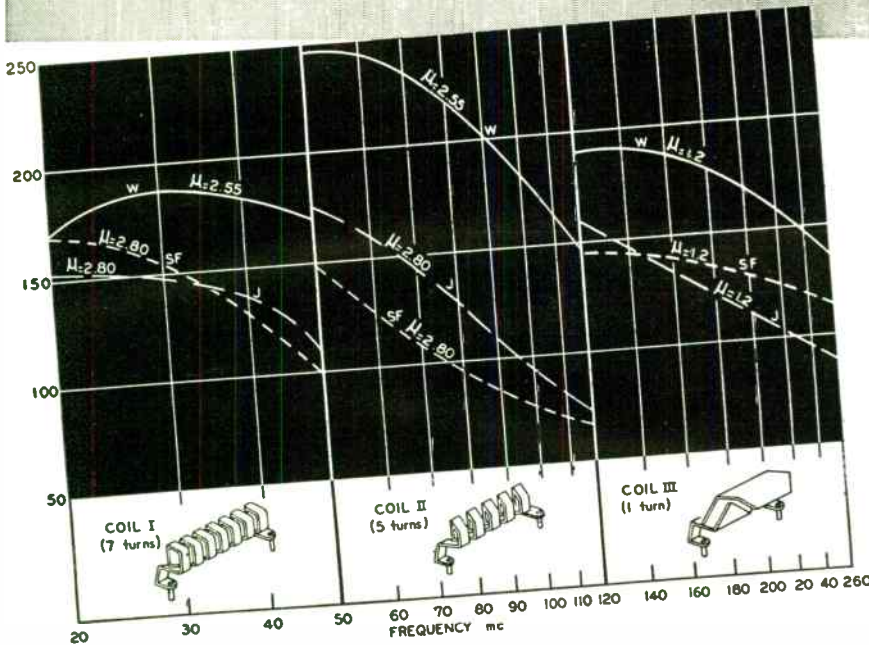

Three types of G A & F Carbonyl Iron Powders are particularly satisfactory in cores designed for use at the higher frequencies. To assure low losses and good magnetic and temperature stability at 20 mc. to 300 mc., we invite you to test Types SF, J and W. These powders are microscopic, almost perfect spheres—ranging from 3 to 9 microns in diameter—with the same rigorous uniformity that characterizes all G A & F Carbonyl Iron Powders.

Today, Carbonyl Iron Powders—a total of ten types—are widely used in the production of cores for transformers and inductor coils—to increase Q values, to vary inductances, to reduce coil size, to confine stray fields or to increase the coupling factors.

We urge you to ask your core maker, your coil winder, your industrial designer, how G A & F Carbonyl Iron Powders can increase the efficiency and performance of the equipment or product you make, while reducing both the cost and the weight.

We offer you two books—one covering SF, J and W Powders only—the second covering the other seven types. In both books, characteristics and applications are given with diagrams, performance charts and tables. For either or both books, address Department 40.



| PHYSICAL CONSTANTS  | W     | J     | SF    |
|---|-------|-------|-------|
| Percent retained by 325 mesh screen.....  | trace | trace | trace |
| Weight-average particle diameter<br>(Roller Analyzer) $d = \sum d_i^4 / \sum d_i^3$ (microns).....          | 3     | 9     | 3     |
| Surface-average particle diameter (Fischer Sub-Sieve-Sizer)<br>$d = \sum d_i^3 / \sum d_i^2$ (microns)..... | 2.5   | 4.5   | 2.5   |
| Density of particles, g/cm <sup>3</sup> .....   | 7.35  | 7.35  | 7.81  |
| Apparent density, g/cm <sup>3</sup> .....   | 2.6   | 2.8   | 3.0   |



**ANTARA CHEMICALS**

A SALES DIVISION OF GENERAL ANILINE & FILM CORPORATION  
435 HUDSON STREET • NEW YORK 14, N. Y.



*From Research to Reality...*

# Specialists

## in BROAD-BAND Amplification

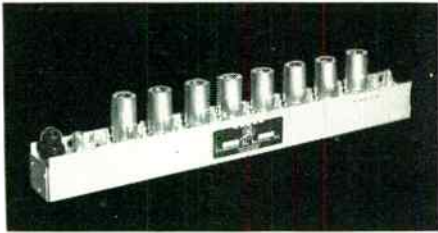

Standard adaptable amplifiers delivered from stock...  
Expert engineering service for your particular broad-band problems...  
Development service on all types of broad-band systems...  
Ask for bulletin E-13

Here are a few typical I.F.I. amplifiers available:

**M 200 Miniature i.f. Amplifiers**  
Band Centers ..... 30 or 60 mc  
Band Width ..... 2 to 10 mc

**Model 400 High Power Distributed Amplifier**  
Output Power ..... 100 w CW  
Band Pass ..... 300 mc

**Model 500 Distributed Amplifier**  
Output Power ..... 3 w  
Band Pass ..... 250 mc

**TV 100 Broad-Band Amplifiers**  
Gain ..... 50 db  
Band Pass ..... 52-90 or 171-219 mc



**INSTRUMENTS FOR INDUSTRY, Inc.**

159 GLEN COVE RD., MINEOLA, N. Y. • PHONE: PIONEER 2-5300

Representatives

G. E. Moxon, 422 La Jolla Avenue, San Mateo, California  
Hunter & Salsbury, Inc., 258 Herricks Road, Mineola, New York



(Continued from page 84A)

- Lorenzen, H. O., 3713 Bangor St., S.E., Washington 20, D. C.  
Lourie, N. M., 100 Memoria Dr., Cambridge, Mass.  
Love, A. L., 58 Pinewoods Ave., Troy, N. Y.  
Love, C. E., 12763 Brooklake St., Los Angeles 66, Calif.  
Love, J. E., 235 Hawthorne Ave., Haddonfield, N. J.  
Loveberg, A. G., Jr., 9135 Lemon Ave., La Mesa, Calif.  
Lowe, D. M., 9209 Shirley Ct., La Mesa, Calif.  
Lowell, R., Bell Tel. Lab., Whippany, N. J.  
Lowery, H. R., 1424 12 Ave. S., Birmingham, Ala.  
Lowrie, R. W., 23 Antoinette Ave., Poughkeepsie, N. Y.  
Lozo, K. G., Camp Asan, Sta. 8, Guam, M. I.  
Lucas, F. G., 9331 Lenore Dr., Garden Grove, Calif.  
Luecker, G., American Embassy, Beirut Lebanon, Fgn. Ser., Washington, D. C.  
Lukas, W., 115 Belvidere Rd., Glen Rock, N. J.  
Lund, C. O., Destervoldgade 10-G, Copenhagen K, Denmark  
Lundin, J. A., 5 Joval Ct., Brooklyn 29, N. Y.  
Lundquist, G. A., 8012 Piney Branch Rd., Silver Spring, Md.  
Lundstrom, O. C., 305 Calle De Andalucia, Hollywood Riviera, Redondo Beach, Calif.  
Luntz, J. D., Nucleonics, 330 W. 42 St., New York 36, N. Y.  
Lurie, E. M., 226-38 Mentone Ave., Laurelton, L. I., N. Y.  
Lurye, J. R., 135-24 Hoover Ave., Kew Gardens, L. I., N. Y.  
Luse, J. D., 4 Potter Pk., Cambridge 38, Mass.  
Lush, M. J., Old Rd. to Nine Acre Corner, Concord, Mass.  
Luster, E. W., 400 Wychwood Rd., Westfield, N. J.  
Lyman, F., Jr., Cambridge Thermionic Corp., 445 Concord Ave., Cambridge 38, Mass.  
Lynn, P. R., 139 Central Ave., W. Caldwell, N. J.  
Lyon, D. J., 941 Geranium, Baton Rouge, La.  
Lyons, E. F., 2805 Croydon Ct., Oklahoma City 14, Okla.  
Lyons, L. H., 500 California Ave., Santa Monica, Calif.  
Lyons, R. C., 25 Woodland St., Huntington, L. I., N. Y.  
MacCallum, J. M., Jr., 43 Meehan Dr., Dayton, Ohio  
MacInnes, N. A., 424 B Whitman Dr., Haddonfield, N. J.  
Mack, A., 197 Queens Dr., Little Silver, N. J.  
Mackey, C. L., Westerville, N. Y.  
MacLean, W. D., Sperry Gyroscope Co., Great Neck, L. I., N. Y.  
MacMillan, T. S., 184 Highview Dr., West Paterson, N. J.  
MacNabb, V. C., 171 W. 73 St., Indianapolis 20, Ind.  
Macnichol, E. F., Jr., Belfast Rd., Sparks, Md.  
Magasiny, I. P., 4522 "D" St., Philadelphia 20, Pa.  
Maget, R., c/o Industrias Electricas y Musicales Odeon, Avda. Corrientes 485, Buenos Aires, Argentina  
Maginniss, F. J., Analytical Div., General Electric Co., Schenectady, N. Y.  
Maglathlin, R. N., R.F.D., Cozasset, Mass.  
Maguire, W. W., 7418-88 Pl., Los Angeles 45, Calif.  
Mahaffey, G. N., 4532 N. Chelsea La., Bethesda, Md.  
Mahren, A. A., 5602 187 St., Flushing, L. I., N. Y.  
Maier, R. H., 228 N. Oak Park Ave., Oak Park, Ill.

(Continued on page 89A)



**ALPHA METALS, INC.**  
61 Water St., Jersey City, N.J.

general purpose **SOFT SOLDER**

# FLUX KIT

IT IS A **TIMESAVER** FOR DESIGNERS,  
ENGINEERS AND PRODUCTION MEN

## IN SOLVING FLUXING PROBLEMS

A FLUX for each of your soft soldering operations. This Flux Kit contains a complete assortment of the most useful Fluxes for ELECTRONIC ASSEMBLIES, PRINTED CIRCUITS, TINNING and HOT SOLDER DIPPING, STAINLESS STEEL SOLDERING and ALUMINUM SOLDERING. It enables a rapid determination of the proper Flux for a soldering job. The Flux Kit is the result of thousands of customers' service problems submitted to Alpha's Research Laboratory. Special Fluxes can be compounded to suit individual needs at Alpha's modern Research Laboratory.



**AMPLITUDE  
LINEARITY  
MODEL ALT-2  
TESTER**

The ALT-2 is a linear staircase generator for differential gain measurements of television systems or individual units. Supplies composite video signal with adjustable sync pulse, blanking level, and staircase amplitude. Steps variable from 3 to 14. Step exponent 1.0 to 2.75. Internal r-f modulates steps from 1.0 mc to 3.75 mc.

Modulating steps with studio 3.58 subcarrier permits simultaneous differential phase and amplitude measurements using a Wickes VDE-3A Vector Display Equipment or a CPA-1 Color Phase Analyzer.

Write for descriptive literature.

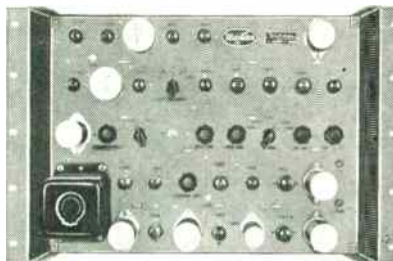

**Wickes ENGINEERING AND CONSTRUCTION COMPANY**  
12TH STREET AND FERRY AVENUE ESTABLISHED 1920 CAMDEN 4, NEW JERSEY



# Here's the Relay for today's high speed devices

**Highly Sensitive  
No Contact Bounce  
Billions of Operations**

● Announcement of the CLARE Type T High Frequency Relay two years ago set off such a deluge of inquiries for samples and information that it is only just now that production facilities permit us to mention it again.

Originally designed for use in an analog computer, this relay is ideal for designs which call for a highly sensitive relay completely free from contact bounce and capable of billions of operations at extremely high speeds.

Pull-in time of this relay, for instance, is 120 microseconds. With dropout time of 100 microseconds, the relay follows up to 2500 cycles per second; aperiodic to 1000 cycles per second.

Manufacture of the CLARE Type T Relay, with its high speed, no bounce and other unusual characteristics, necessitated the development of entirely new techniques. It is built to extremely close tolerances, with a high degree of precision and fabricated under conditions of utmost cleanliness.

**THE CLARE TYPE T**  
High Frequency  
Impulse relay

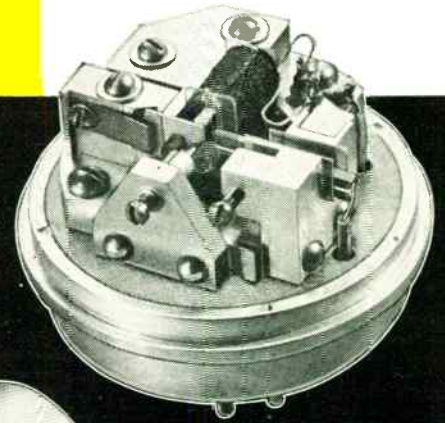

● Shown above with dust-tight cover removed (left) ready for mounting.

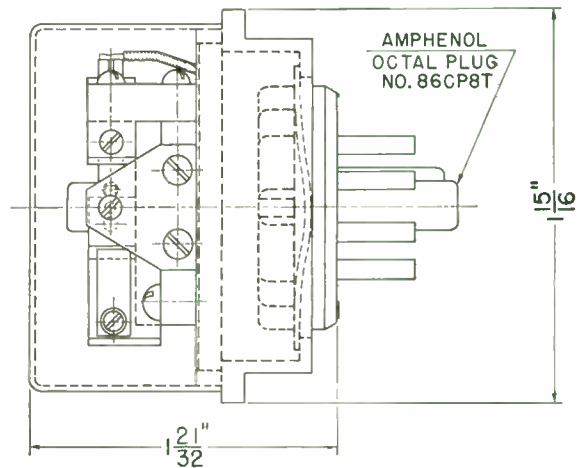

## SPECIFICATIONS

### MECHANICAL

**Size:** 1-15/16 in. dia. x 2-3/16 in. overall.  
**Weight:** 5 oz.

**Mounting:** Equipped with plug, to fit standard 8-pin octal socket.

**Cover:** Removable dust-tight cover.

### Contacts:

**Type:** Form A (s.p.s.t., normally open)

**Material:** Platinum-iridium

**Gap:** 0.0005 inch

**Pressure:** 30 grams, min. (Coil energized with 50 ampere-turns)

### Coil:

**Type:** Single winding, bobbin-wound.

**Wire:** Heavy formex.

### ELECTRICAL

**Operate Ampere-Turns:** 8 to 20.

**Release Ampere-Turns:** 1 to 4 less than operate ampere-turns.

**Nominal Ampere-Turns for High-Speed Operation:** 16 to 40.

**Speed of Operation:** will follow 2500 cycles per second; aperiodic to 1000 cycles per second.

**Operate Time:** 100 to 180 microseconds.

**Release Time:** 60 to 120 microseconds.

**Contact Bounce:** None.

**Contact Current Rating:** 0.05 amp., max.

**Contact Voltage Rating:** 150 V., max.

**Dielectric Strength:** 500 V., rms.

**Coil Resistance:** up to 600 ohms.

**Life Expectancy:** 5 x 10<sup>9</sup> operations (determined by contact load).

### TYPICAL CHARACTERISTICS

**Coil Resistance:** 135 ohms.

**Coil Inductance:** .35 Hy.

**Operate Current:** 10 to 12 ma.

**Release Current:** 8 to 10 ma.

**Nominal Current:** 40 ma., steady state; 20 ma., average.

**Operate Time:** 130 microseconds.

**Release Time:** 100 microseconds.

**Energizing Circuit:** Coil in plate circuit of vacuum tube with 300 volt plate supply.

*For full information on the CLARE Type T Relay—or for consultation on any relay problem—see your nearest CLARE Sales Engineer or write C. P. Clare & Co., 3101 Pratt Blvd., Chicago 45, Illinois. In Canada: Canadian Line Materials Ltd., Toronto 13. Cable Address: CLARELAY.*

Send for Clare Bulletin Number 117

FIRST IN THE INDUSTRIAL FIELD

# CLARE RELAYS



CHICAGO  
NOV. 14-17  
1955

## A New World at your fingertips

Just reach for your date pad and reserve four days to explore your new world of production . . . attend the Second International Automation Exposition at Chicago's Navy Pier, November 14-17, 1955.

### FOR THE VISITOR —

- Computer and Automation application clinics and special related symposia.
- Exhibits of leading manufacturers displaying the latest developments in automation.

### FOR THE EXHIBITOR —

- A show of proven merit for finding new and exciting markets, and expanding 'old' ones.
- For exhibitor information, and a report on the success of the First Automation Show, write to Richard Rimbach Associates at the address shown or use the coupon below.

### FOR VISITOR AND EXHIBITOR —

to help you keep step in the double-time march of production progress — read **INSTRUMENTS & AUTOMATION**, the world's leading magazine of measurement and automatic control (since 1928).

**SECOND INTERNATIONAL  
AUTOMATION EXPOSITION**  
867 Ridge Avenue, Pittsburgh 12, Pa.

- Send EXHIBITOR information.
- Send show visitor registration data.
- Send sample copy of the magazine **INSTRUMENTS & AUTOMATION**.

Name ..... Title .....

Company .....

Address .....

City ..... Zone ..... State .....

**marion**  
advancement  
in instrument  
design

**NO  
GASKETS  
NO  
CEMENTS**



The  
"ORIGINAL"

MIL-M-10304

**RUGGEDIZED  
PANEL  
INSTRUMENT**

Hermetically sealed  
glass-to-metal

MIL 2½" and 3½" sizes. ua,  
ma, amp, mv, volt, kv, AC rectifier  
types for voltage, decibel and VU  
measurement, manufactured to  
MIL-M-10304. Standard ranges from  
stock. Twelve page booklet on request.



**marion electrical instrument co.**

Greiner Field, Manchester, N.H., U.S.A.

Manufacturers of Ruggedized and "Regular"  
Panel Instruments and Related Products.

copyright 1956 M.E.I. Co.

**marion meters**

**NOW!**  
**over 15 million**  
**Microdot® coax**  
**combinations**

Microdot cuts design time by multiplying possibilities . . . with the world's smallest, lightest microminiature coax connectors and cables available at 50, 70 or 93 ohms to meet your rigorous environmental requirements. Write today for applications data.



1/3 BNC diameter  
1/10 BNC weight!



**MICRODOT**  
1826 FREMONT AVENUE  
SO. PASADENA • CALIF.

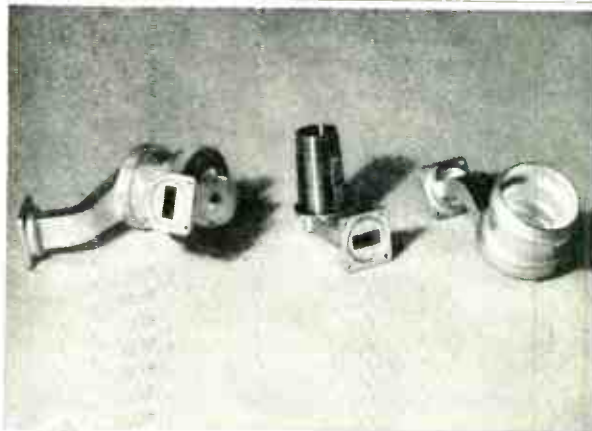

**N.R.K. MFG. & ENGINEERING CO.**

4601 W. Addison St., Chicago 41, Ill., SPing 7-2970

West Coast Representatives

TUBERGEN ASSOCIATES, 2232 W. 11th St., Los Angeles 6, Calif.

Microwave  
Assemblies,  
Radar Components,  
and Precision  
Instruments . . .  
manufactured and  
designed to your  
specifications.





(Continued from page 86-1)

- Main, W. F., Jr., 527 Galveston Pl., S.E., Washington, D. C.
- Mains, M. C., Officers Mail Rm., Box 120, APO 323, San Francisco, Calif.
- Majlinger, A., 43-18-49th St., Sunnyside 4, L. I., N. Y.
- Makar, R. T., 24 Sharia Said, Heliopolis, Cairo, Egypt
- Malkin, S., 248 S. Lincoln Ave., Elberon, N. J.
- Mallalieu, R. F., P. O. Box 151, Oxford, Pa.
- Malta, S. V., 1135 Slocum St., Philadelphia 19, Pa.
- Mandel, M., 131 Stonehouse Rd., Glen Ridge, N. J.
- Maufredi, R. E., 2027 Cardiff Rd., Schenectady, N. Y.
- Mankoff, L. L., 7244 Spruce St., Upper Darby, Pa.
- Mann, A., 424 Compass St., Uniondale, L. I., N. Y.
- Manning, F. W., 12 E. Circle La., Norris, Tenn.
- Manoogian, H., Box 460, Doylestown, Pa.
- Marantz, S. A., 104 Arlington Ave., Brooklyn 7, N. Y.
- Marcus, J. A., 3011 Edwin Ave., Fort Lee, N. J.
- Marcuvitz, N., 10 Garden St., Great Neck, L. I., N. Y.
- Margolin, A. R., 3536 McLaughlin Ave., Los Angeles, Calif.
- Margolin, B., 6 Ellsworth Ave., Cambridge 38, Mass.
- Marquez, J., Dr. J. M. Vertiz 16, Mexico, D.F., Mexico
- Marolda, J., 2088 Ryer Ave., New York 57, N. Y.
- Marsh, C. O., Jr., 36 Conklin Ave., Hillsdale, N. J.
- Marsh, S. V., 5300 Vantage St., N. Hollywood, Calif.
- Marshall, A. R., 5 Wellington Ave., Waltham, Mass.
- Marshall, R., 1009 N. 1st Ave., Arcadia, Calif.
- Marshall, T. A., 82 Daisy Ave., Floral Park, L. I., N. Y.
- Marteena, J. M., Agr. & Technical College, Greensboro, N. C.
- Martin, D. W., 1042 S. Waugh, Kokomo, Ind.
- Martin, E. O., 100 Franklin St., Bldg. 5-A3, Morristown, N. J.
- Martin, H. B., 409 Preston La., High Park, Hatboro, Pa.
- Martin, J. F., Bell Tel. Labs., Whippany, N. J.
- Martin, J. L., 17 Hawthorne St., Massapequa, L. I., N. Y.
- Martin, J. W., 23804 W. 54 St., Edmonds, Wash.
- Martin, S. J., 64 Forest St., Closter, N. J.
- Masnik, M., Jr., 309 Houston Ave., Syracuse, N. Y.
- Mason, A. F., Jr., 113 E. Leona St., Uvalde, Tex.
- Mason, R. S., 383 Canterbury Dr., Box 311, Ramsey, N. J.
- Massa, F., 373 Atlantic Ave., Cohasset, Mass.
- Masucci, C., 208 Cottage Blvd., Hicksville, L. I., N. Y.
- Mather, D. L., 114 Ardmore Pl., Syracuse 8, N. Y.
- Mathes, R. H., 2601 Gaither St., S. E., Hillcrest Hts., Washington, D. C.
- Mathison, W. W., 144 Coggeshall Ave., Newport, R. I.
- Matson, L. E., Jr., 416-B Park View Apts., Collingswood, N. J.
- Matt, S., 210 Eastwood Ave., Ithaca, N. Y.
- Matthias, L. H., 1849 E. Fox La., Milwaukee 11, Wis.
- Mauldin, H. W., Jr., 2480 Berkeley La., N. E., Atlanta, Ga.
- Mavroides, J. G., 60 Crestview Rd., Waltham 54, Mass.

(Continued on page 90A)

# Sub-miniature Assemblies To Gigantic Electronic Systems . . . . .

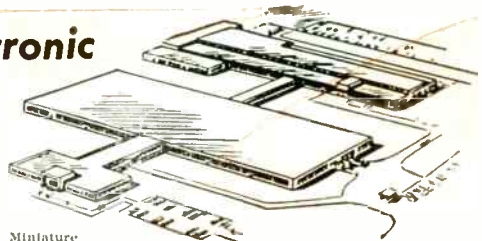

Miniature Solenoid Drive



Miniature Gear Reduction Unit

Sub-miniature Circuits  
—Transistorized Application



Tuning Drive Assembly

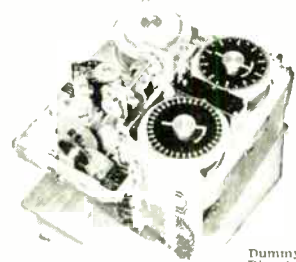

Dummy Director Assembly

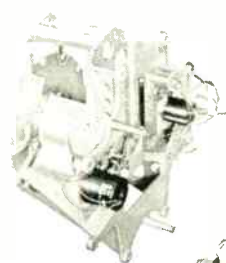

Antenna Drive Housing

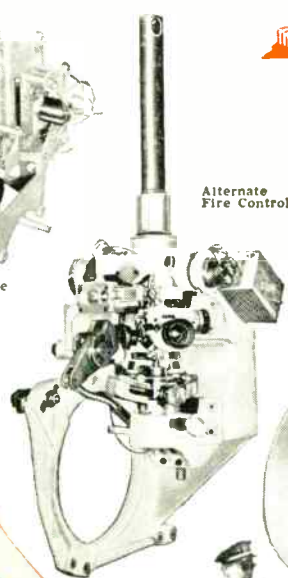

Alternate Fire Control

**DAYSTROM INSTRUMENT** has produced tiny precision assemblies . . . to gigantic gun directors and fire control systems—all within their modern 350,000 sq. ft. plant. When you combine Daystrom's team of skilled engineers with efficient production methods and modern facilities, you'll understand how Daystrom has been able to achieve mass production of such products—on time and at low cost—for every branch of the Armed Forces and industry.

## For the NAVY

Radar Fire Control Systems, Mine Detecting Devices, Anti-Submarine Attack Directors, Catapult Speed Indicators, Servo Control Systems, Torpedo Assemblies.

## For the AIR FORCE

Capacitance Testers, All-Altitude Servo Indicators, Transistorized Receivers, R F Switches, Potentiometers.

## For the ARMY

Mechanical Fire Control Systems, Fuzes, Communication Systems and other instrumentation for all branches of the Army.

## For INDUSTRY

Test Equipment, Computing Devices, Radar Equipment, Nuclear Equipment, Gyro Mechanisms, Electronic and Electro-Mechanical Devices.

Write For Our  
Facilities Report



**DAYSTROM  
INSTRUMENT**

**ARCHBALD, PENNA.**  
Div. of Daystrom, Inc.



Mark 56 Director

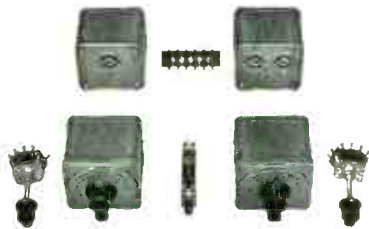

## simplify custom FILTER installation

The 4200 Variable Filter and 4201 Program Equalizer are now available in component form, as illustrated, for the custom builder.

In addition to the flexibility of installation, all the features and characteristics of the standard models are retained.

The high and low sections of either model may be obtained separately. Complete wiring instructions included.

Send for Bulletin TB-4



Model 4200 Variable Filter  
(Send for Bulletin S)



Model 4201, Program Equalizer  
(Send for Bulletin E)

Representatives in  
Principal Cities

**HYCOR**  
Company Inc.

Subsidiary of International Resistance Company  
11423 VANOWEN STREET  
NORTH HOLLYWOOD 6, CALIF.



## Membership

(Continued from page 89A)

- Mayfield, S. A., 1417 Byrd Dr., Fort Worth 14, Tex.
- Mazel, L. G., 72-36 112th St., Forest Hills, L. I., N. Y.
- McAllister, J. A., San Francisco Naval Shipyard, San Francisco, Calif.
- McAlpine, W. N., Radio Sec., Anaconda Mining Co., Weed Heights, Nev.
- McAnally, D. G., 4416 Emerson St., Dallas, Tex.
- McAulay, W. H., Box 715, San Carlos, Calif.
- McCann, J. G., 534 Erskine Dr., Pacific Palisades, Calif.
- McClamrock, J. M., 7637 S. Yakima, Tacoma, Wash.
- McCormack, T. L., 12 Rainbow Ave., Chelmsford, Mass.
- McCourt, A. R., 1333 Selby St., Butte, Mont.
- McDermott, E., 6000 Lemmon Ave., Dallas 9, Tex.
- McDowell, H. I., Free Acres, Emerson Ia., Berkeley Heights, N. J.
- McElroy, W. J., 3502 Manor Dr., Minneapolis 22, Minn.
- McFarland, R. B., 7226 N. Hamilton, Chicago, Ill.
- McGarvey, H. J., 325 S. Main, Dubois, Pa.
- McGinnis, S. E., 138 Fifth Ave., S. E., Oelwein, Iowa
- McHenry, G. A., 100-27 Ave., Seattle 22, Wash.
- McKay, H. B., 1379-35 Ave., San Francisco 22, Calif.
- McKay, W. M., 2100 E. Galer St., Seattle 2, Wash.
- McKee, G. R., Jr., 3630 Merrick Rd., Philadelphia 29, Pa.
- McLaren, I. H., 209 Claremont, Dearborn, Mich.
- McMullen, G. D., 1128 Rugby Rd., Schenectady 8, N. Y.
- McNamara, F. T., 322 Thornton St., Hamden 14, Conn.
- McPherson, R. R., 813 E. Kingsley St., Ann Arbor, Mich.
- McWhortor, W. F., 3147 Bouham Dr., Indianapolis, Ind.
- Meier, A. S., 691 Evergreen Ave., Hamden, Conn.
- Meier, W. M., 4305 Alan Dr., Baltimore 29, Md.
- Meier, W. I., Chatham Electronics Corp., 630 Mt. Pleasant Ave., Livingston, N. J.
- Mekota, J. E., Jr., 211A Lexington St., Waverley 79, Mass.
- Melton, G. H., 2300 Colston Dr., Silver Spring, Md.
- Melvin, E. A., 9620 Lorain Ave., Silver Spring, Md.
- Mendel, F. S., 870 Seward, 402, Detroit 2, Mich.
- Menes, H., 515 Grandview Ave., Wyckoff, N. J.
- Menneken, C. E., Box 451, Pebble Beach, Calif.
- Merrill, H. M., 924 S. Serrano Ave., Los Angeles 6, Calif.
- Messenheimer, A. D., 2005 Woodberry St., Hyattsville, Md.
- Messinger, H. P., Inst. for Air Weapons Research, Museum of Science and Industry, Chicago 37, Ill.
- Meyer, A. W., 4630 Manordene Rd., Baltimore 29, Md.
- Meyer, D. R., 8511 Winnetka Ave., Canoga Park, Calif.
- Meyer, M. A., 19 Sherwood Rd., Natick, Mass.
- Meyer, R. C., Jr., Box 486-A, Louise Dr., Milltown, N. J.
- Meyer, R. W., 65 Trudy Dr., Lodi, N. J.
- Mezger, G., 175 W. 21 St., Huntington Station, L. I., N. Y.
- Michaud, R. E., Apt. 4, 934-14 St., Santa Monica, Calif.

(Continued on page 93A)

## color TV shadow masks

We are now delivering shadow masks, the precision heart of the color television tube, etched to specifications. Mass production methods, perfected during more than 40 years of precise metal etching experience, enable us to meet today's exacting demands for quality and delivery.

## etched and electro formed precision parts

With the technical experience and production know-how gained in producing fine metal etching and in electro-forming, we are now manufacturing many components for the electronic industry. Some specifications call for fine mesh up to 1,000,000 holes per square inch. Send us your drawings for a prompt quotation.



**BUCKBEE  
MEARS  
COMPANY**

Lindeke Building  
SAINT PAUL 1, MINNESOTA

**... from field-testing harvesters  
to checking jet starter performance ...  
SANBORN OSCILLOGRAPHIC  
RECORDING SYSTEMS  
prove their versatility**

**FOR INTERNATIONAL HARVESTER'S  
ENGINEERING TEST AND DEVELOPMENT DEPT.**

A specially housed and shock-mounted Sanborn 2-channel recorder provides dynamic strain measurement data on a field forage harvesting machine, during actual field use. In the photographs, rotor shaft torque and RPM are being recorded, one of several uses International Harvester has found for the Sanborn System in field testing their farming equipment.

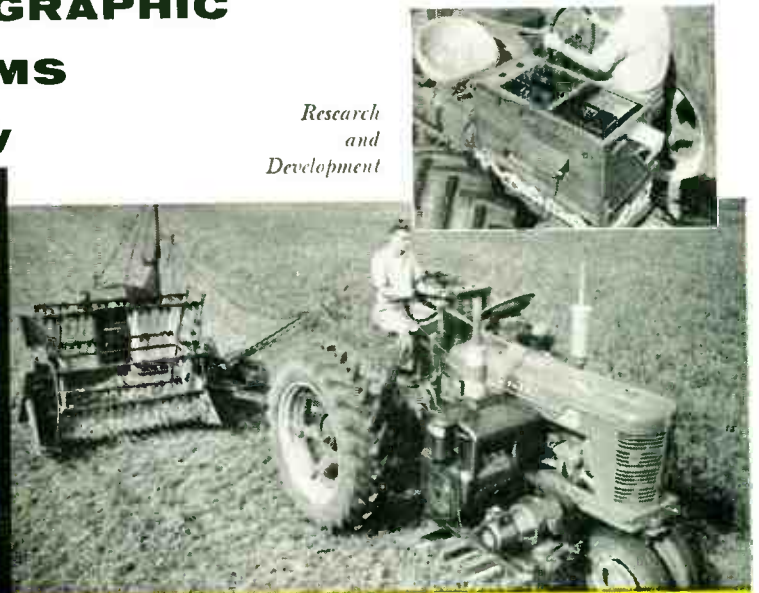

*Research  
and  
Development*

**AT ARCH GEAR WORKS, QUINCY, MASS. . . .**

A record of tooth regularity of various types of precision gears is obtained on a single-channel Sanborn Model 141 System, used in conjunction with a special gear checking instrument devised by Arch Gear Works. The equipment permits visual spot checking of gears, helps maintain a high rate of acceptability and provides a permanent record of tests often required by customers.



*Production  
Testing*

**AT G. E.'S AIRCRAFT GAS TURBINE DIV. . . .**

Engineers record performance data such as temperatures, pressure, RPM and starting time of jet engine starters, using a modified Sanborn Model 67 System. Six channels of information are recorded in this four-channel unit, equipped with three DC amplifiers, one Triplexer, a four-channel DC Converter, two-channel zero suppression network and two modified strain gage amplifiers. The data also provides G. E. engineers with an indication of the performance of all production units.

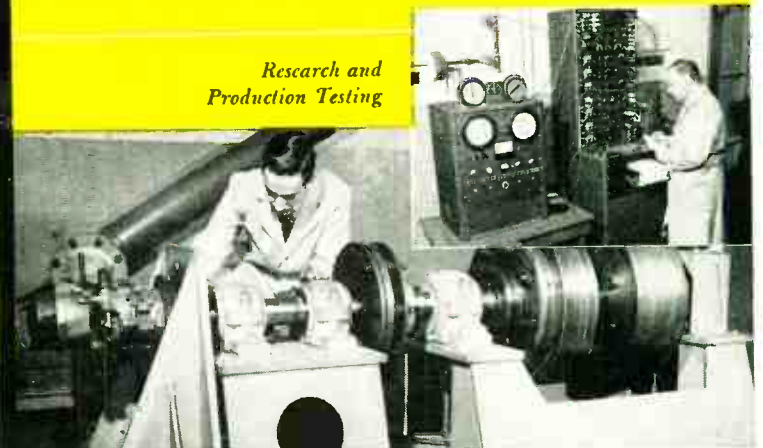

*Research and  
Production Testing*

These typical applications indicate the scope of usefulness of standard and modified Sanborn Recording Systems. Wherever accurate, permanent, graphic registration of electrical phenomena in the 0-100 cps range is required, the versatility and flexibility of Sanborn one-, two-, four-, six- and eight-channel systems will prove invaluable. A wide variety of readily interchangeable, plug-in preamplifiers enable one basic system to meet many recording requirements. Standard instrument features include inkless recording in true rectangular co-ordinates, high torque galvanometer movement, time and code marking, and a choice of nine chart speeds.

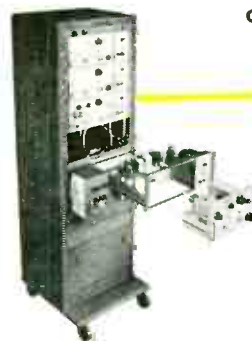

**CATALOG AND TECHNICAL DATA  
AVAILABLE ON REQUEST**



**SANBORN  
COMPANY**

**INDUSTRIAL DIVISION  
CAMBRIDGE 39, MASS.**

# ACCURATE

HIGH RELIABILITY  
HIGH PRECISION  
HIGH QUALITY

LOW WEIGHT  
SMALL SIZE  
ECONOMICAL

# FREQUENCIES

## FREQUENCY STANDARD

240 to 800 Cycles

Type 50 C

$\pm .02\%$  at  $-65^{\circ}$  to  $85^{\circ}\text{C}$

Type R 50 C

$\pm .002\%$  at  $15^{\circ}$  to  $35^{\circ}\text{C}$

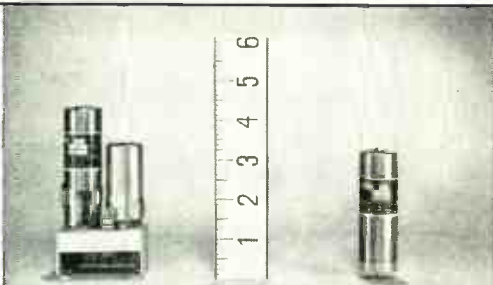

8 oz.

4 oz.

## PRECISION FORK UNIT

240 to 800 Cycles

Type 50

$\pm .02\%$  at  $-65^{\circ}$  to  $85^{\circ}\text{C}$

Type R 50

$\pm .002\%$  at  $15^{\circ}$  to  $35^{\circ}\text{C}$

## FREQUENCY STANDARD

200 to 4000 Cycles

Type 2003 C

$\pm .02\%$  at  $-65^{\circ}$  to  $85^{\circ}\text{C}$

Type R 2003 C

$\pm .002\%$  at  $15^{\circ}$  to  $35^{\circ}\text{C}$

Type W 2003 C

$\pm .005\%$  at  $-65^{\circ}$  to  $85^{\circ}\text{C}$

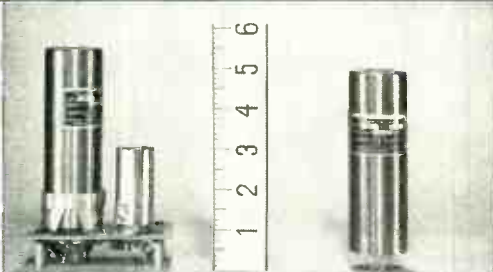

10 oz.

6 oz.

## PRECISION FORK UNIT

200 to 4000 Cycles

Type 2003

$\pm .02\%$  at  $-65^{\circ}$  to  $85^{\circ}\text{C}$

Type R 2003

$\pm .002\%$  at  $15^{\circ}$  to  $35^{\circ}\text{C}$

Type W 2003

$\pm .005\%$  at  $-65^{\circ}$  to  $85^{\circ}\text{C}$

## FREQUENCY STANDARD

200 to 2000 Cycles

Sub-miniature Tube

Type 2007

$\pm .02\%$  at  $-65^{\circ}$  to  $85^{\circ}\text{C}$

Type R 2007

$\pm .002\%$  at  $15^{\circ}$  to  $35^{\circ}\text{C}$

Type W 2007

$\pm .005\%$  at  $-65^{\circ}$  to  $85^{\circ}\text{C}$

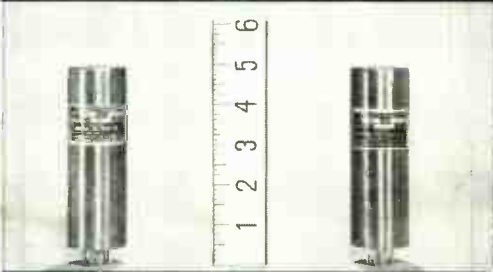

6 oz.

8 oz.

## FREQUENCY STANDARD

240 to 1000 Cycles

Transistorized

Type 2007 T

$\pm .02\%$  at  $-65^{\circ}$  to  $85^{\circ}\text{C}$

Type R 2007 T

$\pm .002\%$  at  $15^{\circ}$  to  $35^{\circ}\text{C}$

Type W 2007 T

$\pm .005\%$  at  $-65^{\circ}$  to  $85^{\circ}\text{C}$

## FREQUENCY STANDARD

200 to 3000 Cycles

Type 2001-2

$\pm .001\%$  at  $20^{\circ}$  to  $30^{\circ}\text{C}$

WHEN REQUESTING  
INFORMATION  
PLEASE SPECIFY  
TYPE NUMBER

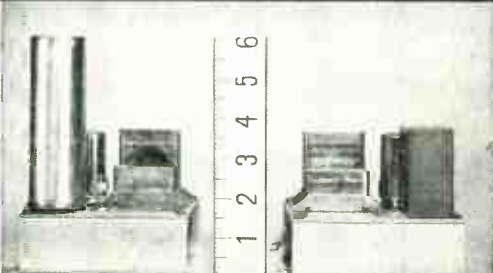

26 oz.

15 oz. av.

## ACCESSORY UNITS

for Type 2001-2

- L—for low frequencies, multi-vibrator type, 40-200 cy.
- D—for low frequencies, counter type, 40-200 cy.
- H—for high freqs., up to 20 KC
- M—Power Amplifier, 2W output
- P—Power Supply.

# American Time Products, Inc.

580 Fifth Avenue

New York 36, N. Y.

OPERATING UNDER PATENTS OF WESTERN ELECTRIC COMPANY



(Continued from page 90A)

- Mickelson, T. H., 137 Orchard Dr., N. Syracuse, N. Y.
- Milunowski, A. S., Ferris St., Peekskill, N. Y.
- Millard, J. W., 311 Blvd., Pompton Plains, N. J.
- Miller, C. E., 37945 Radde, Mt. Clemens, Mich.
- Miller, F. P., 635 Jefferson St., Fairborn, Ohio
- Miller, H. C., 250 W. Portola Ave., Los Altos, Calif.
- Miller, L. A., 1641 A Waverly Way, Baltimore 12, Md.
- Miller, R. A., Bell Tel. Lab., Murray Hill, N. J.
- Miller, R. L., 429 Manor Rd., Hatboro, Pa.
- Miller, W. F., Knollwood Rd., Whippany, N. J.
- Miller, W. A., 465 E. Juniper, Oxnard, Calif.
- Miller, W. B., 8138 Redfern Dr., Houston 21, Tex.
- Mills, C. W., 1310 Poston Cir., Gastonia, N. C.
- Mills, H. J., 470 Piaget Ave. 'D-11,' Clifton, N. J.
- Mills, T. L., Rt. 1, Box 1872, Bremerton, Wash.
- Mino, H. R., Cruft Lab., Harvard Univ., Cambridge, Mass.
- Ming, D. L., 407 S. Cherry Wood Ave., W. Covina, Calif.
- Minter, J., Box 1, Boonton, N. J.
- Mischler, W. D., Bell Tel. Labs., Murray Hill, N. J.
- Misey, J. J., Rm. 40, Civilian Billet T 2001, Aberdeen Proving Ground, Md.
- Mitchell, B. B., 5156 Tenth Ave., Los Angeles, Calif.
- Mitchell, F. A., Stromberg-Carlson Co., 100 Carlson Rd., Rochester 3, N. Y.
- Mitchell, H. F., Jr., Remington Rand Inc., 315 4th Ave., New York, N.Y.
- Mitchell, J. A., 377 Nott St., Wethersfield 9, Conn.
- Mitchell, W. R., 3309 Mocking Bird Lane, Dallas, Tex.
- Mitchell, W. T., 208 N. Parkway, Prospect Heights, Ill.
- Mittleman, W., 54 Frances St., Shrewsbury, N. J.
- Miyake, I., Univ. of Hawaii, Honolulu, T. H.
- Mobley, M. C., 901 Nichols Dr., Laurel, Md.
- Modry, J. F., 1841 Portsmouth Ave., Westchester, Ill.
- Moe, W. J., 1903 Tatum St., St. Paul, Minn.
- Mohr, H. F., 3 Fox Lane Apt. 1J, Flushing, L. I., N. Y.
- Mond, L. I., 49 Brook Ave., Little Silver, N. J.
- Mooers, C. N., 40 Grozier Rd., Cambridge, Mass.
- Moon, R. F., Comdr., Electronics Officer, Boston Naval Shipyard, Boston 29, Mass.
- Moons, A. G., 1218 Central Ave., Westfield, N. J.
- Moore, H. N., Lt. Col., 803 Ring Bldg., 1200 18 St., Washington 6, D. C.
- Moore, M. H., 7700 Winnetka Ave., Winnetka, Calif.
- Moore, S. F., Amer. Mach. & Foundry Co., 261 Madison Ave., New York, N. Y.
- Moore, W. E., 248 Southern Rd., San Diego, Calif.
- Moorhead, G. H., 56 N. Hillside Ave., Chatham, N. J.
- Moose, L. F., R.D. 2, Quakerstown, Pa.
- More, C. C., 20 Harrison Ave., Erlton, N. J.
- Morehouse, G. D., 2703 San Simeon Way, Riverside, Calif.
- Morelli, A., 33 Daly Rd., Medford, Mass.
- Moreno, T., 3167 Leonello St., Los Altos, Calif.
- Morgan, W. E., Jr., 7 Spiral Lane, Levittown, L. I., N. Y.
- Morison, R., 1155 Medford Rd., Pasadena 8, Calif.
- Moritz, C. Dr., 1 Gray St., Cambridge 38, Mass.
- Morrell, G. A., Jr., c/o Asiatic Corp., Conneaut, Ohio
- Morris, G. W., Col., 239 N. 24 St., Camp Hill, Pa.

(Continued on page 94A)

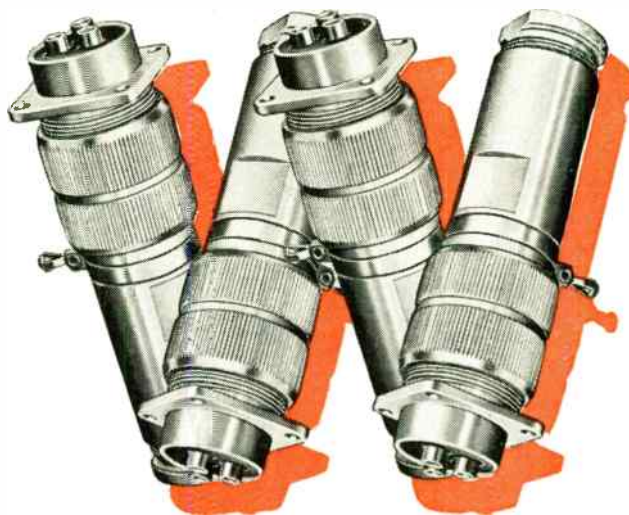

**For long life under  
extreme conditions of shock,  
vibration, corrosion,  
humidity and temperature**

**Bendix W type**

**HEAVY-DUTY  
ELECTRICAL CONNECTOR**

Here is the electrical connector designed and built for maximum performance under rugged operating conditions.

Intended for use with jacketed cable and not requiring ground return through mating surfaces, this connector incorporates sealing gaskets at all mating joints.

W-Type Bendix\* Connectors also incorporate standard Scinflex resilient inserts in established AN contact arrangements. Shell components are thick-sectioned high-grade aluminum for maximum strength. All aluminum surfaces are grey anodized for protection against corrosion.

For the real tough jobs, be sure to specify the W-Type Electrical Connector.

Our Sales Department will gladly furnish complete specifications and details on request.

\*REG. TRADE-MARK

**SCINTILLA DIVISION**

SIDNEY, NEW YORK



Export Sales: Bendix International Division, 205 East 42nd St., New York 17, N. Y.

FACTORY BRANCH OFFICES: 117 E. Providencia Ave., Burbank, Calif.  
Stephenson Bldg., 6560 Cass Ave., Detroit 2, Mich. • 512 West Ave.,  
Jenkintown, Pa. • Brouwer Bldg., 176 W. Wisconsin Ave., Milwaukee,  
Wisc. • American Bldg., 4 S. Main St., Dayton 2, Ohio • 8401 Cedar  
Springs Rd., Dallas 19, Texas



(Continued from page 93A)

- Morrison, D. A., 508 West St., R.D., Reading, Mass.
- Morrison, E. D., R.F.D. 1 Whippany Rd., Whippany, N. J.
- Morrissey, D. J., 14404 Benefit St., Sherman Oaks, Calif.
- Morrow, C. T., Hughes Aircraft Res., Lev. Labs., Culver City, Calif.
- Morse, J. E., 8 Bobrich Dr., Apt. 20, Rochester, N. Y.
- Mortenson, K. E., 4 Sanford Ave., Troy, N. Y.
- Moster, C. R., 14 Webster St., Summit, N. J.
- Motchan, H. L., 7809 Milan, University City 14, Mo.
- Moule, W. N., 806 Mt. Vernon Ave., Haddonfield, N. J.
- Mucher, G. J., Clarostat Mfg. Co., Inc., Dover, N. H.
- Muchnick, P., 2239 Creston Ave., Bronx 53, N. Y.
- Mueller, A. A., 1101 N. Yale Ave., Arlington Heights, Ill.
- Mueller, F. L., 105 W. Adams St., Chicago 3, Ill.
- Mueller, P. L., 4407 Fourth Ave., Temple, Pa.
- Mueller, W. A., Warner Bros. Pictures, Burbank, Calif.
- Mullenger, K. E., Larchmont Acres, Apt. 422-A, Larchmont, N. Y.
- Mullins, W. H., 1607—19 St., Manhattan Beach, Calif.
- Mumford, I. G., 333 E. 21 St., Owensboro, Ky.
- Munson, L. A., Rt. 1, Box 54, Phoenix, Md.
- Mural, F., 354 S. Lombardy Rd., Drexel Hill, Pa.
- Murphy, C. E., 405 S. Union St., Galion, Ohio
- Murray, J. H., 3631 Huntington Ave., Minneapolis 16, Minn.
- Murrell, T. A., Dept. of EE, Univ. of Illinois, Urbana, Ill.
- Mushrush, R. S., Jr., 213 Salt Springs St., Fayetteville, N. Y.
- Mut, S. C., 6317 Orchid Lane, Dallas 5, Tex.
- Muth, J., Jr., 18 Orchard Pl., Valley Stream, L. I., N. Y.
- Myers, J. L., 2417-A W. Oak St., Burbank, Calif.
- Myers, O. C., 2659 Woodland Ave., Columbus 11, Ohio
- Myers, V. V., Jr., 701 Cagua S.E., Albuquerque, N. Mex.
- Nagy, L., Jr., 2711 Gracewood Rd., Toledo 13, Ohio
- Nash, A., 639 West End Ave., New York 25, N. Y.
- Nathan, A. M., 36 W. 69 St., New York 23, N. Y.
- Naybor, E. V., 15 Salem Lane, Port Washington, L. I., N. Y.
- Naylor, A. F., 208 Kingswood Dr., S. E., Grand Rapids 6, Mich.
- Nebel, C. N., Bell Tel. Labs., Ins., Whippany, N. J.
- Needham, D. P., 1610 E. Minnehaha Pkwy., Minneapolis 7, Minn.
- Neely, G. M., 1614 Myrtle St., N.W., Washington 12, D. C.
- Neill, G. W., Rt. 2, Lake Garda, Unionville, Conn.
- Neitzert, C., Stevens Inst. Tech., Hoboken, N. J.
- Nelson, E. K., 19850 E. Arrow Hgwy., Covina, Calif.
- Nelson, R. P., 3405 Manchester Rd., Wantagh, L. I., N. Y.
- Nessmith, J. T., Jr., 623 Wayne Rd., Haddonfield, N. J.
- Neu, W. J., 2017 Hudson Terr., Ft. Lee, N. J.
- Neuland, J. G., 408 E. Elm St., Brea, Calif.
- Nevitt, R. G., 613 S. Western Pkwy., Louisville 11, Ky.
- New, R. F., 16 Stever Dr., Binghamton, N. Y.
- Newhouse, G. B., 2630 Lambert Dr., Pasadena, Calif.

(Continued on page 98A)



**FULL  
SIZE**

3" x 3" x 4"

**Kearfott**  
**3" VERTICAL  
GYRO**

*Unsurpassed*  
**IN PERFORMANCE**  
*Unequaled*  
**IN COMPACTNESS**

**CHARACTERISTICS**

- 2 degrees of freedom  
... 360° in roll, ±82° in pitch
- Repeatability to established vertical  
... 15 Minutes max. of ½ cone angle
- Free drift rate  
... 0.5° Minute
- Erection Time  
... 3 minutes at start
- Erection Rate  
... 3° minute-Normal 80°/minute-Fast
- Synchro Output (each axis)  
... 11.8 volts, 400 cycles

Only Kearfott can offer a *Miniature* Vertical gyro with big gyro *Performance*. Completely self contained, this gyro requires *No External Erection Amplifiers*. A gravity sensitive electrolytic device, within the gyro, directly associated with the torquer motors, provides the necessary vertical reference.

*Hermetically Sealed*, filled with a dry, inert gas. Satisfies the requirements of MIL-F-5272 as regards shock test (Procedure II) humidity, salt spray, fungus resistance, rain, sand, dust, immersion and explosion proof.

This gyro duplicates the performance of the Kearfott T2108 series in *1/8 the volume and weight*.

**KEARFOTT COMPONENTS INCLUDE:**

Gyros, Servo Motors, Synchros, Servo and Magnetic Amplifiers, Tachometer Generators, Hermetic Rotary Seals, Aircraft Navigational Systems, and other high accuracy mechanical, electrical and electronic components.

**Engineers:** Many opportunities in the above fields are open. Please write for details today.

A SUBSIDIARY OF GENERAL PRECISION EQUIPMENT CORPORATION



**KEARFOTT COMPANY, INC., LITTLE FALLS, N. J.**

Sales and Engineering Offices: 1378 Main Avenue, Clifton, N. J.  
Midwest Office: 188 W. Randolph Street, Chicago, Ill. South Central Office: 6115 Deaton Drive, Dallas, Texas  
West Coast Office: 253 N. Vinedo Avenue, Pasadena, Calif.



# new versatile data tape recorder

## THE MOBILE AMPEX 800

records the broadest combination of data ever obtained concurrently on one magnetic tape—performs with laboratory precision under severe field, airborne, shipboard and vehicular conditions—and furnishes data compatible with the most widely used playback equipment.

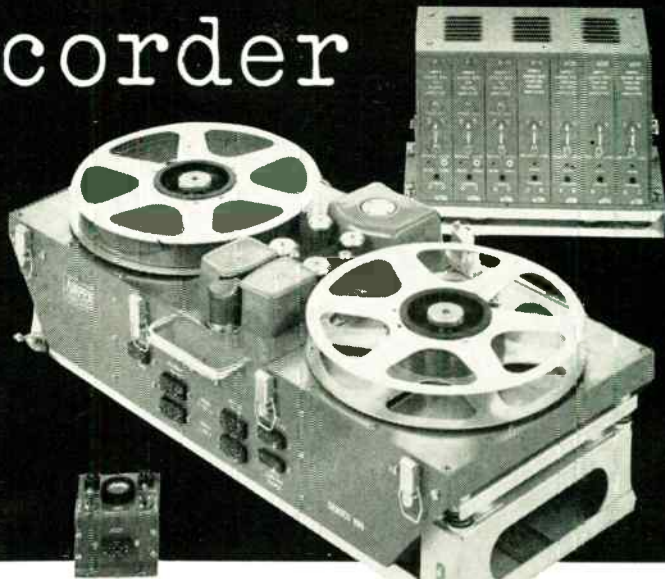

The Ampex 800 can provide from 1 to 28 data channels. By interchangeable amplifier units, each one can be adapted to any one of three basic magnetic recording techniques:



- /// **Direct recording** — 300 to 35,000-cycle response for wide-band data or multiple recording of RDB subcarriers.
- ||| **FM-carrier type recording** — D.C. to 5000 cycles and high instantaneous accuracy suitable for shock and vibration data.
- /// **Pulse-width modulation recording** — Up to 90 instrument readings commutated on to each tape track with frequency response 0 to 2 cycles/sec. With fewer instrument readings, frequency response is greater.

## ADAPTS TO

**ANY DATA REQUIREMENT** The Ampex 800's three available recording techniques can satisfy practically any test requirement by simple insertion of the proper plug-in amplifiers. Separate channels can be assigned to measurements requiring wide-band response or high transient accuracy. And by using pulse-width techniques, many relatively steady instrument readings can be commutated on to a single channel. All will have a common time base.

## WITHSTANDS THE RIGORS OF AIRBORNE, SHIPBOARD, VEHICULAR AND GENERAL MOBILE USE

The Ampex 800 will perform within specifications under vibrational forces as high as 10G—operates over a temperature range from  $-65^{\circ}\text{F}$ . to  $130^{\circ}\text{F}$ .—is unaffected by altitudes to 50,000 feet—and withstands a relative humidity of 100% up to  $122^{\circ}\text{F}$ . The Ampex 800 is light in weight. It operates on 27.5 volts D.C. and 115 volts, 400 cycle, A.C. All operating functions can be remotely controlled.

## RETAINS WIDELY ESTABLISHED

**RECORDER STANDARDS** The majority of all magnetic recorders now in instrumentation use are Ampex machines. Their recording characteristics, tape speeds, track widths and other parameters have become standards. The Ampex 800 retains these while greatly extending the environmental and mechanical conditions under which accurate test data can be gathered.

Performance specifications, descriptions and explanations have necessarily been limited by the space on this page. A full description and detailed specifications on the Ampex 800 are available by writing Dept. G-2328

**AMPEX**

CORPORATION

## FIRST IN MAGNETIC TAPE INSTRUMENTATION

934 CHARTER STREET • REDWOOD CITY, CALIFORNIA

*Branch Offices:* New York; Chicago; Atlanta; San Francisco; Dayton; College Park, Maryland (Washington D.C. area)

*Distributors:* Radio Shack, Boston; Bing Crosby Enterprises, Los Angeles; Southwestern Engineering & Equipment, Dallas and Houston; Canadian General Electric Company, Canada

# RCA WT-100A Electron-Tube MICROMHOMETER

## NEW VERSATILE TUBE TESTER!



### RCA-WT-100A

Electron-Tube MICROMHOMETER  
Suggested User Price: \$785.00

#### Practical for:

- Radio, Phonograph, and TV Set Manufacturers
- Electronic Equipment Manufacturers
- Electronic Research and Development Groups
- Electronic Maintenance and Service Groups
- Communication and Broadcast Stations
- Tube Manufacturers

**... has accuracy approaching that of tube-factory equipment for measuring true gm**

The new RCA-WT-100A Electron-Tube MICROMHOMETER is especially suited for laboratory and production-line testing, and circuit design engineering. Unique design makes possible the testing of receiving tubes, receiving-type tubes for industry and communications, and small transmitting tubes under actual operating voltage and current conditions. This feature permits *direct correlation* of test results with *tube manufacturers' published data*—and, in design work, permits the determination of a tube's performance under a given set of current and voltage conditions. The MICROMHOMETER is manufactured in accordance with the same rigid standards of high quality that account for the outstanding reputation of RCA tubes. The WT-100A weighs only 50 pounds; measures 23½" x 8" x 18½".

Plug-in, multiple-socket attachments—new socket types easily added!

Separate voltage controls for each element!

Burn-out proof meter—electronically protected!

AC heater-current measurements—including 600 ma types at rated voltages!

Built-in gm calibrating circuit!

Tube-pin selector switches—up to 14 pins!

Voltage-drop measurements across tubes, dry-disc rectifiers, and crystal diodes!

Measures currents up to 300 ma in 11 ranges—as low as 5  $\mu$ amp full scale!

Control grid-to-plate and suppressor grid-to-plate transconductance measurements to 100,000 micromhos!

Storage compartment for plug-in multiple-socket attachments!

No inconvenient patchcords—no external null indicators required! Highly accurate, repeatable measurements! Built-in voltage-regulated power supply provides voltages to 300 volts; provides currents to 300 ma!



**RADIO CORPORATION of AMERICA**  
TUBE DIVISION

HARRISON, N. J.

World Radio History

For descriptive information, call or write your RCA Representative or write Commercial Engineering, RCA, Section 135Q, Harrison, N. J.

BOARD OF DIRECTORS, 1955

J. D. Ryder, *President*  
 Franz Tank, *Vice-President*  
 W. R. G. Baker, *Treasurer*  
 Haraden Pratt, *Secretary*  
 John R. Pierce, *Editor*  
 J. W. McRae, *Senior Past President*  
 W. R. Hewlett, *Junior Past President*

1955

S. L. Bailey  
 A. N. Goldsmith  
 A. V. Loughren  
 C. J. Marshall (R5)  
 L. E. Packard (R1)  
 J. M. Pettit (R7)  
 B. E. Shackelford  
 C. H. Vollum  
 H. W. Wells (R3)

1955-1956

E. M. Boone (R4)  
 J. N. Dyer (R2)  
 J. T. Henderson (R8)  
 A. G. Jensen  
 George Rappaport  
 D. J. Tucker (R6)

1955-1957

J. F. Byrne  
 Ernst Weber

●  
 George W. Bailey,  
*Executive Secretary*

●  
 John B. Buckley, *Chief Accountant*  
 Laurence G. Cumming,  
*Technical Secretary*  
 Evelyn Davis, *Assistant to the*  
*Executive Secretary*  
 Emily Sirjane, *Office Manager*

EDITORIAL DEPARTMENT

Alfred N. Goldsmith,  
*Editor Emeritus*  
 John R. Pierce, *Editor*  
 E. K. Gannett,  
*Managing Editor*  
 Marita D. Sands,  
*Production Manager*

ADVERTISING DEPARTMENT

William C. Copp,  
*Advertising Manager*  
 Lillian Petranek,  
*Assistant Advertising Manager*

EDITORIAL BOARD

John R. Pierce, *Chairman*  
 D. G. Fink  
 E. K. Gannett  
 T. A. Hunter  
 W. R. Hewlett  
 J. A. Stratton  
 W. N. Tuttle



Responsibility for the contents of papers published in the PROCEEDINGS of the IRE rests upon the authors. Statements made in papers are not binding on the IRE or its members.



Change of address (with 15 days advance notice) and letters regarding subscriptions and payments should be mailed to the Secretary of the IRE, 1 East 79 Street, New York 21, N. Y. All rights of publication, including foreign language translations are reserved by the IRE. Abstracts of papers with mention of their source may be printed. Requests for republication should be addressed to The Institute of Radio Engineers.

# PROCEEDINGS OF THE IRE

*Published Monthly by*

The Institute of Radio Engineers, Inc.

VOLUME 43

*September, 1955*

NUMBER 9

CONTENTS

|  |   |                            |
|--|---|----------------------------|
| A Worthy Project.....  | <i>T. A. Hunter</i>                                   | 1044                       |
| 5472. Frequency and Time Standards.....  | <i>F. D. Lewis</i>                                    | 1046                       |
| 5473. IRE Standards on Industrial Electronics: Definitions of Industrial Electronics Terms, 1955.....                          |   | 1069                       |
| 5474. IRE Standards on Antennas and Waveguides: Definitions for Waveguide Components, 1955.....                                |   | 1073                       |
| 5475. High-Frequency Power Gain of Junction Transistors.....   | <i>R. L. Pritchard</i>                                | 1075                       |
| 5476. IRE Standards on Radio Receivers: Method of Testing Receivers Employing Ferrite Core Loop Antennas, 1955.....            |   | 1086                       |
| 5477. A Microwave Phase Contour Plotter.....   | <i>J. S. Ajioka</i>                                   | 1088                       |
| 5478. The Application of Dielectric Tuning to Panoramic Receiver Design.....   | <i>T. W. Butler, Jr., W. J. Lindsay and L. W. Orr</i> | 1091                       |
| 5479. Note on the Design of Wide-Band Low-Noise Amplifiers.....  | <i>D. Weighton</i>                                    | 1096                       |
| Correction to "The Minimum Noise Figure of Microwave Beam Amplifiers," by H. A. Haus and F. N. H. Robinson.....                |   | 1101                       |
| 5480. Wide-Range Electronic Tuning of Microwave Cavities.....  | <i>F. R. Arams and H. K. Jenny</i>                    | 1102                       |
| 5481. The Resolution of Signals in White, Gaussian Noise.....  | <i>C. W. Helstrom</i>                                 | 1111                       |
| 5482. Automatic Gain Control of Transistor Amplifiers.....   | <i>W. F. Chow and A. P. Stern</i>                     | 1119                       |
| 5483. Two Network Theorems for Analytical Determination of Optimum-Response Physically Realizable Network Characteristics..... | <i>S. S. L. Chang</i>                                 | 1128                       |
| Correspondence:  |   |                            |
| 5484. VHF and UHF Signals in Central Canada.....   | <i>D. R. Hay and R. C. Langille</i>                   | 1136                       |
| 5485. On Reciprocal Inductance.....  | <i>E. J. Baghdady</i>                                 | 1136                       |
| 5486. Rebuttal.....  | <i>Harry Stockman</i>                                 | 1136                       |
| 5487. Empirical Relationships with the Munsell Value Scale.....  | <i>J. H. Ladd and J. E. Pinney</i>                    | 1137                       |
| 5488. Effects of Impurities on Resonator Properties of Quartz.....   | <i>A. R. Chi, D. L. Hammond, and E. A. Gerber</i>     | 1137                       |
| Contributors.....  |   | 1138                       |
| IRE News and Radio Notes:  |   |                            |
| Annual Meeting of the Dallas-Fort Worth Section.....   |   | 1141                       |
| Transactions of the IRE Professional Groups.....   |   | 1142                       |
| Professional Group News.....   |   | 1145                       |
| Technical Committee Notes.....   |   | 1145                       |
| 5489-5493. Books.....  |   | 1146                       |
| Professional Group Chairmen.....   |   | 1148                       |
| Section Chairmen.....  |   | 1148                       |
| 1955 Industrial Electronics Conference.....  |   | 1150                       |
| Radio Fall Meeting Program.....  |   | 1150                       |
| Second Annual Meeting of Professional Group on Nuclear Science.....  |   | 1151                       |
| 5494. Abstracts of Transactions.....   |   | 1152                       |
| 1955 IRE Student Awards.....   |   | 1155                       |
| 5495. Abstracts and References.....  |   | 1156                       |
| Meetings with Exhibits.....  | 4A  | Positions Wanted..... 145A |
| News and New Products.....   | 14A   | Positions Open..... 148A   |
| Membership.....  | 32A   | IRE People..... 154A       |
| Industrial Engineering Notes.....  | 134A  | Section Meetings..... 172A |
| Professional Group Meetings.....   | 175A  |                            |

Copyright, 1955, by the Institute of Radio Engineers, Inc.



## A Worthy Project

T. A. HUNTER, EDITOR, IRE STUDENT QUARTERLY



During the past few months I have had an opportunity to visit a number of sections actively participating in programs designed to be of service to our student members. Generally, these programs take the form of a student paper context, presentation of outstanding student awards, field trips, or career conferences. A recent innovation, undertaken by the Los Angeles Section, provides a student with the opportunity to discuss each area of the electronics industry, its future and the outstanding problems yet to be solved, with a representative of the Professional Groups. My experience with our student program indicates that this last type of program is by far the most effective and I wish to call it to your attention.

On May 3, 1955, the Los Angeles Section was host to four engineering colleges in Southern California with IRE Student Branches: California Institute of Technology, California State Polytechnic, University of California, and the University of Southern California. Mr. John O'Halloran, Student Branch Co-ordinator for the Los Angeles Section supervised the preparations. The student members, about 300 from the four colleges, were addressed by outstanding engineers, each representing one of the Professional Groups. Twenty minutes were allowed each group in addition to the open discussion which followed. A social hour concluded the afternoon program. Following the afternoon program students were allowed to

discuss each group informally with the speakers in private rooms set aside for this purpose. During a dinner banquet following the conference Joseph Pettit, Regional Director, gave a short talk on IRE organization with emphasis on PG activities.

My own opinion of this meeting is certainly not as important as the opinion of the student body of the four schools. For this reason I have asked two students, Herbert Leach of California State Polytechnic College, and Paul Rude of the University of Southern California, to state their opinion of the meeting, together with those opinions they felt typified the views of the entire student body. Following are a few of their comments:

"On May 3 the Los Angeles Section held a joint meeting with its student branches. The meeting was, we hope, the first of many. The purposes of the meeting were to promote the general professional development of the students through a better knowledge of the function of the IRE, to acquaint the students with leaders active in the IRE Professional Groups and to assist the students in selecting the phase of electronics in which they might wish to work after graduation.

"The Los Angeles Section and its Student Relations Committee deserve much credit for a well-planned and very interesting day. The talks were presented in a manner so as to be of interest primarily to the students present. It

seemed that all of the speakers went out of their way to talk to the students and this consideration was quite effective.

"The afternoon session was sponsored by the various Professional Groups. The session was opened by a talk by Dr. Joseph Pettit of Stanford University, in which he discussed the attitude which the present IRE organization had towards the Professional Groups and how they have recently expanded. He and many of the following speakers emphasized the use of the Professional Groups by men in the field and the value of these groups in aiding members to keep abreast of the ever-changing electronics scene. Other speakers during this session spoke on their respective Professional Groups. These talks were of particular value to the students in that they dealt with basic philosophies in scientific and engineering investigations.

"Following dinner, recognition was paid to the chairmen of the student groups and student awards were presented to a student member from each of the student branches by Dr. Pettit. Following the presentation, Dr. Pettit spoke on 'What I Should Expect from the IRE,' giving a clear picture of the organization.

"During the regular section evening meeting Dr. Ernest Krause of Lockheed Missile Systems and Mr. John Byrne of Motorola spoke. Dr. Krause discussed the replacement of build and test, trial and error, experimental work in the field of missiles. Mr. Byrne spoke on recent developments in the field of mobile communication service.

"We feel, that as a whole, the meeting was very successful. We have made an attempt to contact some of the other students who attended the day-long session, and they seem to be in

complete agreement with this opinion. Such meetings should be continued and held once each year. This type of meeting allows the student a chance to obtain a clear idea as to the organization and function of the IRE. Also students can meet with students from other colleges and broaden their views as to the various curricula and programs of the other student branches. Possibly in future meetings the students will be allowed to partake in the program itself. From the viewpoint of the Los Angeles Section the day should have been a success. Attendance was high and the response of the group was excellent. The section should take this hint and plan to continue such events."

I concur with both gentlemen and, based on my experience as editor of the *Student Quarterly*, I would further suggest that a recent graduate of an engineering college be invited to talk about his experience during his first year in industry. I have found that the readers of the *Student Quarterly* are most enthused about this type of material. I would also like to point out that the above response is truly typical of the many favorable comments brought to my attention—by the students themselves—during the conference.

On the basis of the enthusiasm shown it seems that the time and effort which went into making the program possible have been fully rewarded. As I left Los Angeles I felt pride in the fact that the IRE had members who would take the time to provide the student with such an unusual service. Any section wishing to undertake such a project is invited to write to Mr. John O'Halloran or me for a more complete description of the program. You will find the pattern one which is worthy of duplication.



# Frequency and Time Standards\*

F. D. LEWIS†, SENIOR MEMBER, IRE

The following is one of a planned series of papers written at the invitation of the IRE, in which men of recognized standing review recent developments in, and the present status of, various fields in which noteworthy progress has been made.—*The Editor.*

**Summary**—Improvements in astronomical time measurement techniques and in the definition of time have kept pace with developments in frequency standards. Quartz crystal frequency standards are described, including Essen rings, bars, GT-cut plates, and contoured AT-cut plates. Stable oscillator circuits for quartz-crystal frequency standards are described, including the Meacham bridge-stabilized circuit, the Gouriet-Clapp circuit, and the Lea quartz-resonator-servo circuit. A discussion of the present status of atomic and molecular frequency standards includes the ammonia absorption cell, ammonia oscillator (MASER), and cesium atomic-beam apparatus. Instrumentation for precision frequency measurement is outlined, and a current listing of standard-frequency broadcast stations is included.

## INTRODUCTION

MEASUREMENTS of frequency and time have advanced in accuracy as the instrumentation for these measurements has improved. With each improvement in accuracy of measurement, new problems of stability, precision, calibration, and interpretation have become apparent. A review of the recent advances in frequency and time measurement technique is of interest to the radio engineer as an indication of the progress which has been made and of the improvements to be expected in the near future.

## TIME MEASUREMENT

The basis of frequency measurement is, axiomatically, time measurement, and conversely, time measurement can be based on frequency measurement. Before the discovery of atomic or molecular frequency standards, there were not available any alternatives to the calibration of frequency standards by means of astronomical observations. In view of the present early stage in the development of the atomic and molecular frequency standards, it is not yet possible to state that these atomic standards have been used to measure the constancy of astronomical time. However, the groundwork has been laid and soon it will be possible to calibrate astronomical time measurements against spectral-line frequencies. Further discussions of the spectral-line frequency standards are given in another section of this paper.

Accurate time is determined by astronomical observations at a designated observatory in each country where suitable observatories exist. The U. S. Naval Ob-

servatory is the only observatory in the United States regularly carrying out such measurements, and is thus the source of all accurate time determinations in this country. Time signals giving time as determined by the Naval Observatory are broadcast by naval radio stations,<sup>1</sup> and in cooperation with the Bureau of Standards, by stations WWV and WWVII which are operated by the Bureau of Standards.

A number of observatories in other countries are cooperating with agencies of their respective governments to furnish time measurements for radio transmission, and many of these observatories provide time measurements of very high accuracy. International comparison of time is carried on principally by means of radio transmission. (See section below on Standard Frequency Broadcasts.)

The problems of time measurement, and even of the definition of "time," have been familiar to the astronomer since long before the days of Sir Isaac Newton.<sup>2</sup> It is nevertheless true that our modern scientific notions of time are derived from the fact that time is the independent variable of Newtonian mechanics. Minor corrections, to take account of relativity, have enabled the original Newtonian concept of time to survive, and to provide a firm basis for astronomical time reckoning. As the stability of time-keeping devices has improved, it has become apparent that astronomers need to agree on a standard unit of time to use for astronomical calculations, and also to provide a basis for checking any variations in such time standards as the rotation of the earth. Consequently, in 1950 an international conference on astronomy recommended that the term Ephemeris Time be used to denote uniform or Newtonian time, and this term (Ephemeris Time) was adopted by the International Astronomical Union in September, 1952, as defining uniform time related to the revolution of the earth about the sun.<sup>1,3</sup> At the present writing,<sup>4</sup> it is impending that the International Committee on Weights and Measures will adopt a definition of the second, as a unit of time, as "the fraction  $1/31,556,925.975$

<sup>1</sup> Circular No. 49, U. S. Naval Observatory, Washington, D. C.; March 8, 1954.

<sup>2</sup> Dirk Brouwer, "The accurate measurement of time," *Physics Today*, vol. 4, pp. 6-15; August, 1951.

<sup>3</sup> Time Service Notice No. 1, U. S. Naval Observatory, Washington, D. C.; May 28, 1953.

<sup>4</sup> E. C. Crittenden, "International weights and measures, 1954," *World Radio Science*, vol. 120, p. 1008; December 17, 1954.

\* Original manuscript received by the IRE, June 24, 1955.

† General Radio Co., Cambridge 39, Mass.

of the tropical year 1900." The adoption of this standard unit will serve to provide a time which may be used for data of great precision, such as may be required in frequency standardization.

In the preceding paragraph, the term Ephemeris Time was defined as denoting time based on the orbit of the earth around the sun. It is of interest to discuss the kinds of time and their significance in terms of astronomical phenomena. Ephemeris Time is determined by measurement of the tropical year. The tropical year is the time taken by the earth to make an orbit around the sun from vernal equinox to vernal equinox. By means of clocks, one can divide this tropical year into smaller intervals for application to various problems.

The time which is commonly used as "standard" time on the earth is determined by measuring the rotation of the earth about its own axis, especially with respect to the sun. Because of the ellipticity of the earth's orbit around the sun and the inclination of the earth's equator to the orbital plane, the length of an apparent solar day varies with the position of the earth on the ecliptic. In order to make the keeping of time independent of the seasons, the apparent solar day has been replaced by the "mean solar day," the duration of which is the average value of the apparent solar day over a period of a year. Very precise time measurements require corrections for the variation in longitude (apparent zenith) of the observing station and other small corrections known to astronomers.<sup>5</sup> Time determined by measuring the rotation of the earth was designated by the International Astronomical Union, September, 1952, as Universal Time. By international agreement, Universal Time is also defined as Greenwich Mean Time.

In order to provide a time measurement obtaining in one operation simultaneous data on the rotation of the earth and the rotation of a pair of bodies in space with a substantially constant rotational speed, observations of the moon and stars simultaneously have been undertaken.<sup>6</sup> The data obtained from such observations provides information on both Ephemeris Time and Universal Time, and it is thus possible to obtain an accurate difference term which enables precise conversion of one to the other.

It is expected that the above-mentioned improvements in observation techniques and method of computation of time will enable absolute frequency based on time measurements to be determined to approximately  $\pm 1 \times 10^{-9}$ .

The frequency of WWV, and of all standard frequency broadcast stations, is presently computed with respect to Universal Time (G.M.T.) which is mean solar time, thus automatically limiting the absolute accuracy to approximately  $\pm 2 \times 10^{-8}$ . This accuracy

could be improved somewhat if corrections for short term variations in the earth's rotation were included in the computations.

#### ASTRONOMICAL TIME MEASURING INSTRUMENTS

Time determination requires specialized apparatus for the required astronomical observations. When visual observation is employed, the instrument most frequently used is the meridian transit telescope, which is constructed and mounted in such a way that it can be directed only at points along the meridian. The observer then operates the mechanism for recording the times of transit of the selected stars. Early designs of recording mechanisms depended on the reaction time of the observer to some extent. Improved designs have reduced the variation in observation from this cause, but the ultimate accuracy of measurement can only be reached when the observation can be made independent of the observer. Such independence from observer error can be achieved by photographic means, as in the apparatus described below.

#### PHOTOGRAPHIC ZENITH TUBE

The principal device used by the U. S. Naval Observatory for the routine determination of star transits is the photographic zenith tube (PZT).<sup>7</sup> This device consists of a telescope of a special design for photographing stars near the zenith. A vertical tube is mounted above a mercury basin which, when used as a mirror, supplies automatically the vertical reference as a normal to its surface. The vertical or zenith view of this type of telescope minimizes the effects of atmospheric refraction and thus reduces observational errors. The upper end of the telescope tube supports the lens and the holder for the photographic plate used to record the positions of the stars. The plate holder is driven horizontally by an electric motor at a rate which synchronizes with the motion of the star images during two periods of exposure of the plate. Between the exposures, the carriage is rotated 180 degrees (images on opposite sides of the center of the photographic plate) thus providing simple and accurate geometrical determination of the meridian transit. The times at which the plate is at particular positions during the exposures are recorded on a chronograph driven by the crystal-controlled clocks of the Observatory. The positions of the stars are known, and it is thus possible to compute the correct time. An outline of the steps involved in the determination of time and transmission of time signals by the U. S. Naval Observatory is shown in Fig. 1 (next page). A photograph of a photographic zenith tube, PZT No. 3, at the U. S. Naval Observatory, is shown in Fig. 2 (page following).

Recent improvements in design of the plate carriage, motor drive, and chronographic pick-up of PZT have resulted in improved accuracy of time measurement.

<sup>7</sup> W. Markowitz, paper on Photographic Zenith Tube now in preparation (U. S. Naval Observatory).

<sup>5</sup> H. M. Smith, "The estimation of absolute frequency in 1950-51," *Proc. IEE*, vol. 99, pt. IV (Monographs), Monograph 39, pp. 273-278; December, 1952.

<sup>6</sup> W. Markowitz, "Photographic determination of the moon's position, and applications to the measurement of time, rotation of the earth, and geodesy," *Astron. Jour.*, vol. 59, pp. 69-73; March, 1954.

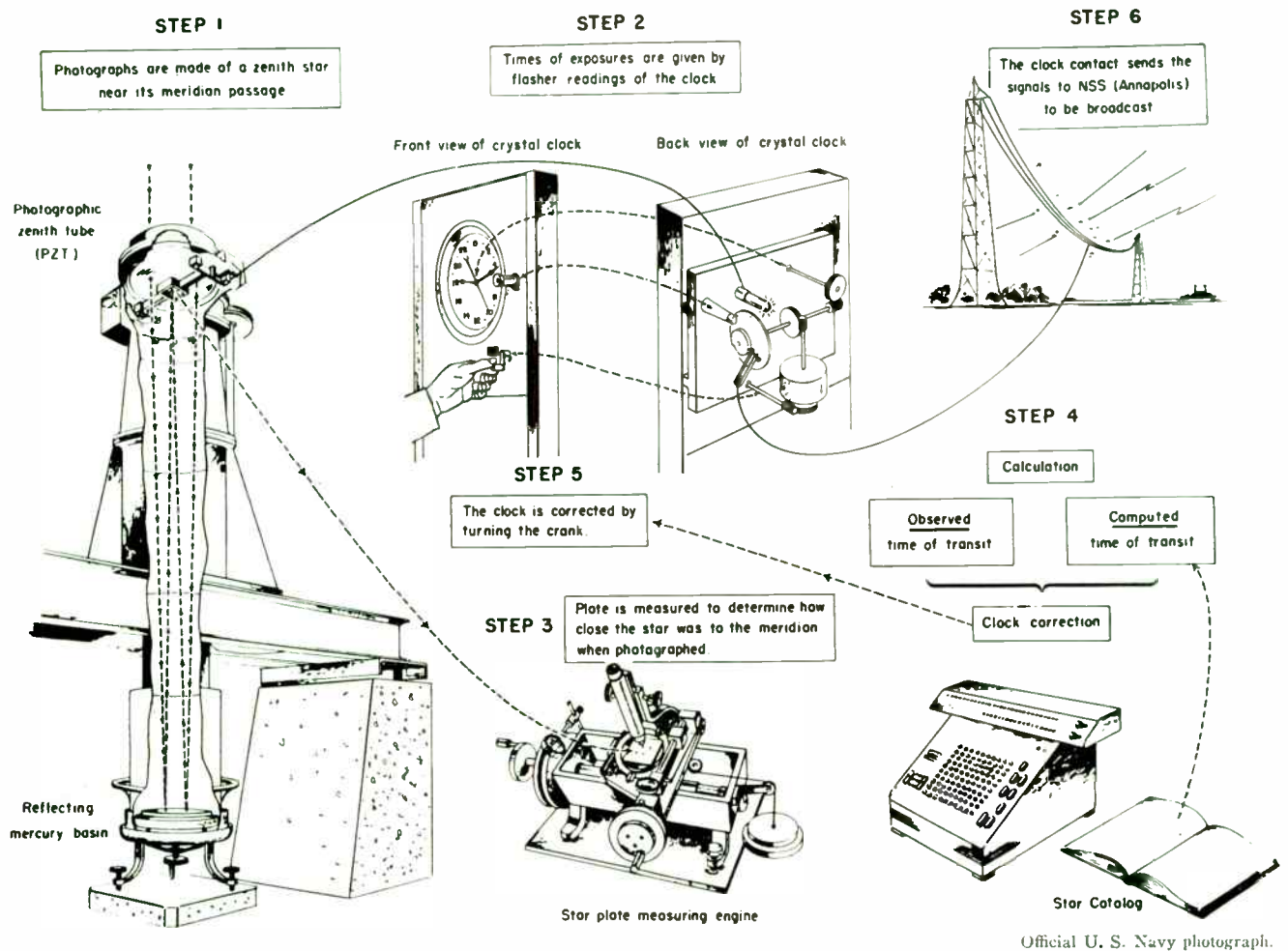

Fig. 1—Steps involved in the determination of time and transmission of time signals.

### DUAL-RATE MOON POSITION CAMERA

Recently developed apparatus for observation and measurement of the position of the moon is now being applied to the problem of the precise measurement of time. The equipment and technique for obtaining a photograph of the moon simultaneously with that of the necessary stars for the calculation of the moon's position have been developed by W. Markowitz at the U. S. Naval Observatory.<sup>6</sup> The apparatus, or camera, for use on a refracting telescope comprises a special plate holder with a synchronous motor driving a micrometer screw to move the photographic plate at the sidereal rate corresponding to the moon's declination. The clock drive normally used to move the telescope tube is not used during this observation, the moving plate-holder being used instead. The image of the moon falls on a dark filter (attenuator) with a transmission factor of 0.001. This filter is a glass disk, with plane-parallel sides, 1.8 mm thick. Tilting of this disk about an axis parallel to its plane surfaces causes a translation of the image of the moon. A second synchronous-motor-and-micrometer drive controls the speed of tilt of this disk to hold the moon image fixed relative to the stars. A further adjustment enables selection of the axis about which the disk tilts. A chronograph contact registers the instant

at which the photographic plate and the filter disk are parallel, i.e., the instant at which there is no relative shift in position between moon image and star images on the photographic plate. This instant thus defines the epoch of observation for time-measurement purposes.

A photograph of the dual-rate moon position camera installed on the 12-inch refractor of the U. S. Naval Observatory is shown in Fig. 3 (opposite page).

With the development of a satisfactory moon-star camera, it has now become feasible to institute a program of observation to chart the long-period variations in the rotation of the earth, and to compare them directly with Ephemeris Time determined from the same observations. (A group of photographic observations of moon and star positions was obtained at Harvard College Observatory, in 1911-17, and reduced at Princeton, but using another method.<sup>6</sup>) An extended series of such observations by several separated observatories is expected to be able to provide a basis for the determination of absolute frequency to 1 part in  $10^9$ .

### FREQUENCY STANDARDS

As may be inferred from the preceding discussion, the measurement of time by astronomical observation eventually requires extremely stable clocks in order to





Official U. S. Navy photograph.

Fig. 2—Photographic zenith tube, PZT No. 3, Naval Observatory, Washington, D. C.

provide means for subdividing a tropical year into 31,556,925.975 parts, each alike in duration. This extreme requirement for clock stability will be partially alleviated by the moon observation program which will provide monthly time checks. Clocks of the highest stability are necessary for scientific purposes such as the measurement of the short-period variations in the earth's rotation and the standardization of frequency.

The first crystal-controlled clock was constructed by W. A. Marrison and J. W. Horton in 1927.<sup>8</sup> Since that date, many engineers and scientists have made important improvements in the various components of the crystal-controlled clock, resulting in the stability mentioned above, and in impressive reliability as a laboratory tool for daily use, a reliability infrequently surpassed by any other electronic devices. Since the crystal clock is essentially a frequency standard with a cycle-counting device attached,<sup>9</sup> we shall here consider the various component parts of the crystal-controlled clock as being frequency standards and associated items, for it is as frequency standards that the radio engineer most often meets these elements of the crystal clock.

<sup>8</sup> J. W. Horton and W. A. Marrison, "Precision determination of frequency," *Proc. IRE*, vol. 16, p. 137; February, 1928.

<sup>9</sup> W. A. Marrison, "The evolution of the quartz crystal clock," *Bell Sys. Tech. Jour.*, vol. 27, pp. 510-588; July, 1948. Also published as "Bell Telephone System Monograph B-1593," Bell Tel. Lab., New York City, and in *Horological Journal*, vol. 90, pp. 274 ff; May-October, 1948.

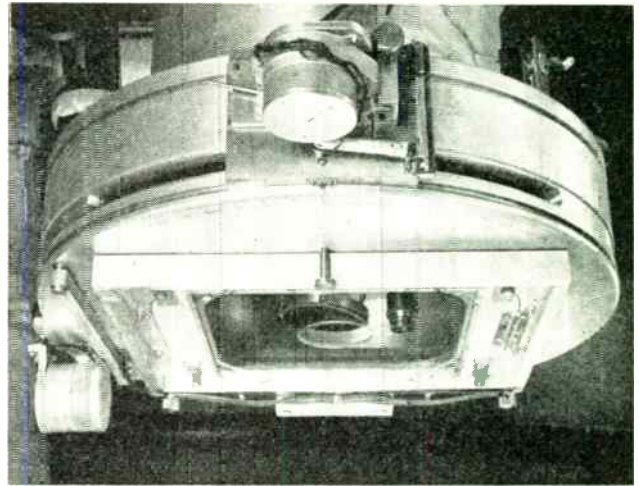

Courtesy Sky and Telescope

Fig. 3—Moon position camera, attached to the 12-inch refractor of the Naval Observatory.

### CRYSTAL-CONTROLLED FREQUENCY STANDARD OSCILLATORS

In order to set forth the recent progress in frequency standard apparatus, it seems expedient to consider individually the elements making up such equipment. Most crystal-controlled frequency standards comprise (1) a control element, i.e., the quartz crystal unit, (2) a negative resistance element, i.e., the oscillator circuit using vacuum tubes or transistors to supply the power, (3) a thermostat or temperature-control device to keep the control element and other circuit elements at constant temperature, (4) suitable frequency dividers or other means for producing lower output frequencies, which may be used to operate (5) integrating devices, such as clock indicators, to keep a record of the number of cycles in a given period for comparison with astronomical time measurements. A suitable power supply (6) is, of course, required. Item (5) is sometimes eliminated in a secondary frequency standard if adequate reception is available from one or more of the standard frequency broadcasts now being transmitted by various agencies. Various other items of auxiliary equipment are frequently associated with crystal-controlled frequency standards for the purpose of calibration and standardization of the standards themselves, or for the use of the standards in frequency and time measurement.

### QUARTZ CRYSTAL CONTROL ELEMENTS<sup>10-12</sup>

Two outstanding properties of crystalline quartz make it especially attractive as a control element for a piezo-electric oscillator, namely, the possibility of obtaining resonators of high  $Q$  value, and the exceedingly good stability of the quartz itself insofar as aging effects are concerned. Much of the frequency-standard work

<sup>10</sup> R. A. Heising, "Quartz Crystals for Electrical Circuits." D. Van Nostrand Co., New York, N.Y., 1945.

<sup>11</sup> P. Vigoureux and C. F. Booth, "Quartz Vibrators," His Majesty's Stationery Office, London, England, 1950.

<sup>12</sup> J. P. Buchanan, "Handbook of Piezoelectric Crystals for Radio Equipment Designers," Wright Air Dev. Center (USAF) Tech. Rep. 54-248, Wright-Patterson AF Base, Ohio; December, 1954.

of recent years has been directed to the improvement of  $Q$  and aging characteristics of crystals.<sup>13-15</sup> The variation of frequency with temperature, an important matter for a stable oscillator, is a function of the shape of the crystal element, its dimensions and its angle of cut from the mother crystal. The pertinent properties of various types of crystal resonators currently considered suitable for use as frequency standards are considered herewith.

#### RINGS AND BARS

Crystal resonators operating in extensional modes offer some attractive properties for use at low frequencies. The choice of a suitable shape generally will provide one or more nodes suitable for use as mounting points, and the proper dimensioning, combined with a proper angle of cut, will produce a low coefficient of frequency vs temperature usually over a relatively narrow, specified temperature range. Such resonators at frequencies of the order of 100 kc have been made in the form of bars or rings.

#### ESSEN RING<sup>16</sup>

A ring-type resonator, developed by Essen of the British National Physical Laboratory, has shown great stability in frequency-standard use. This resonator operates in the extensional mode with six half-wavelength sectors alternately extending and contracting in a direction along its circumference. The exciting voltage is applied to electrodes concentric with the inner and outer surfaces of the ring. Since the motion of the quartz is mainly along the circumference, there is only a little contraction and expansion of the surface of the ring and hence only a small power loss caused by ultrasonic radiation. An evacuated, sealed container has been used to keep the aging rate low, and incidentally also eliminate any residual losses caused by radiation from the ring or its mounting. The British-Post-Office Essen rings are reported to have a  $Q$  of two million,<sup>16</sup> while the earlier pin-type mount produced a  $Q$  of one million.

The Essen ring requires a fairly sophisticated mounting in order to take full advantage of its inherent high  $Q$  value. The mounting problem is simplified to some extent by the existence of the six nodal planes, which are zones of minimum vibration at 60 degrees angular separation around the ring. The earliest mountings made by Essen at N.P.L. employed pointed pins set into grooves cut into three of these nodal planes. Although the pins provided rugged support points, the rings seemed to exhibit some small frequency instability which was

thought to be ascribable to the pin mountings. Consequently, a string or thread-type mounting was devised at the British Post Office for the Essen-ring crystal elements used in frequency standards designed there. Fig. 4 is a photograph of the Post Office Essen Ring, and



Courtesy H. M. Postmaster General.

Fig. 4—Photograph of 100 kc Z-cut quartz ring mounted on thread suspension in crystal holder W6, with cover removed.

Fig. 5 shows a sketch of the string mounting. The string-type mounting appears to have overcome the random frequency shifting observed with the pin-type support, but still leaves unsolved a few of the problems with respect to shipment or transportation of the finished quartz ring. The large mass of the Essen-ring crystal element imposes a requirement for relatively great care in shipment, requiring the type of shipment and handling normally reserved for delicate scientific instruments.

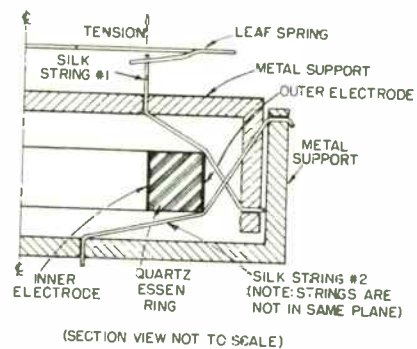

Fig. 5—Sketch of one of three string support points of Essen-ring crystal element.

Long term drift of the Essen-ring crystal is very small.<sup>17,18</sup> Values of drift rates of approximately  $1 \times 10^{-8}$  per month, or approximately  $3 \times 10^{-10}$  per day, have been observed for the Essen-ring oscillators at the U. S. Naval Observatory,<sup>19</sup> with the expectation that lower drift rates will be reached in the future. The lowest

<sup>13</sup> J. P. Griffin, "High-stability 100-kc crystal units for frequency standards," *Bell Lab. Rec.*, vol. 30, pp. 433-437; November, 1952.

<sup>14</sup> A. W. Warner, "High-frequency crystal units for primary frequency standards," *Proc. IRE*, vol. 40, pp. 1030-1033; September, 1952.

<sup>15</sup> L. Essen, "A new form of frequency and time standard," *Proc. Phys. Soc. (London)*, vol. 50, p. 413; 1938.

<sup>16</sup> H. T. Mitchell and A. L. Dobbie, "100 Kc/s Oscillator of High Precision Incorporating an Essen Type Quartz Ring," paper presented at Congrès International de Chronometrie, Paris, France, October, 1954.

<sup>17</sup> H. M. Smith, "The determination of time and frequency," *Proc. IEE*, vol. 98, part II, pp. 143-153 (plus discussion); April, 1951.

<sup>18</sup> L. Essen, "Frequency standardization," *Proc. IEE*, vol. 98, part II, pp. 154-163 (plus discussion); April, 1951.

<sup>19</sup> Private communication.

drift rates of two such oscillators reported by the British Post Office are  $0.25$  and  $0.4 \times 10^{-10}$  per day over periods of several hundred days.<sup>16</sup> The British Post Office radio laboratory group considers that an Essen-ring oscillator unit is satisfactory for delivery to a user only if its drift rate is less than  $5.0 \times 10^{-10}$  per day averaged over 10 days. The excellent performance of the Essen ring with respect to long-term stability is ascribable, in part, to the fact that the frequency of oscillation of the ring is a function of the mean diameter of the ring, and that the loss, or acquisition, of a uniform layer of material over the entire surface would thus produce only a second-order change in the frequency. Careful processing of the ring and use of the evacuated mounting have further reduced the probability of changes in the crystal frequency.

An Essen ring ground for a frequency of 100 kc has an outside diameter of almost  $2\frac{1}{2}$  inches (actually 61.26 mm in one case). This dimension is an indication of the difficulty of fabrication of such a crystal element, since it is necessary to obtain a quartz crystal free from defects with maximum dimensions large enough to allow cutting the ring from it. Because of this drastic requirement for large pieces of high-grade raw quartz-crystal, commercial Essen-ring frequency-standard units intended for moderate-quantity production have not been introduced.

### BARS

Quartz bars vibrating in the extensional or longitudinal mode are widely used in frequency-standard oscillators. The attractive features of such bars include the availability of one or more nodal planes for the attachment of mountings, a large ratio of mass to surface for the finished crystal, and only a moderate size requirement for the raw quartz blank. In addition, the processing required is similar to that required for the more commonly used plates, i.e., plane lapping.

Frequency-standard crystals operating in the extensional mode have been used for many years. The German Physikalische Technische Reichsanstalt group (Giebe, *et al.*) designed, constructed and operated for many years a quartz-controlled frequency standard using a 60-kc Y-cut bar.

A commercial frequency standard using a 50-kc X-cut bar was produced by the General Radio Company, Cambridge, Massachusetts, in 1928.<sup>20</sup>

A new design of overtone-operated X-cut bar was developed by Clapp<sup>21</sup> for use at 100 kc in the present model of the General Radio Company frequency standard (since 1947). This quartz bar (Type 1190-A Quartz Bar), shown in Fig. 6, operates at the second overtone, having two half-wavelength extensional mode sections

operating in push-pull, i.e., the portion of the bar from the center to one end extends as the portion from the center to the other end contracts. A nylon-monofilament string suspension is used to support the bar at the two nodal planes, the filaments being maintained in tension by coil springs. Adjustable baffles at the ends of the bar are used to reflect ultrasonic radiation and thus reduce damping and change in frequency caused by changes in air pressure, as the mounting is not evacuated or hermetically sealed. Plated electrodes are applied directly to the surface of the bar on its sides, and are interconnected for second-overtone excitation in the extensional mode. The  $Q$  of this bar is approximately 170,000 in the mounting described.

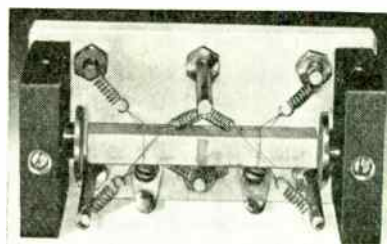

Courtesy General Radio Company.

Fig. 6—Quartz bar for operation at 100 kc in second overtone mode. Note the end baffles to reduce ultrasonic radiation losses, and the string suspension at the two nodes.

Frequency stability of the commercial model bridge-stabilized oscillator, with which this bar is supplied in its temperature-controlled oven, reaches a value of approximately  $0.5 \times 10^{-8}$  per day or better, after an aging period of approximately one year. Many of these oscillators demonstrate considerably better stability than this figure. The long-term drift rate of the frequency standard in use at the General Radio Company has been approximately  $5 \times 10^{-7}$  per year since 1945, an aging rate of  $1.2 \times 10^{-9}$  per day averaged over 10 years.

Extensional-mode bars suitable for stable oscillator use have been made by other crystal manufacturers. Bars of the +5-degree X-cut, fundamental-mode longitudinal-vibration type, which were wire mounted with plated electrodes, have been used in a quartz-crystal-controlled clock in Switzerland.<sup>22</sup> These bars, mounted in evacuated glass envelopes, were supplied by Salford Electrical Instruments (British General Electric Company). They gave stabilities of the order of  $0.5 \times 10^{-8}$  per day, or better, when used in a Gouriet-Clapp oscillator circuit with automatic level control.

### GT-CUT PLATES

The GT-cut plate, originated by Mason,<sup>23</sup> has been developed to a highly advanced state for use in frequency standardization work.<sup>13</sup> This type of quartz

<sup>20</sup> L. M. Hull and J. K. Clapp, "A convenient method for referring secondary frequency standards to a standard time interval," *Proc. IRE*, vol. 17, pp. 252-271; February, 1929.

<sup>21</sup> J. K. Clapp, "On the equivalent circuit and performance of plated quartz bars," *Gen. Rad. Experimenter*, vol. XXII; March-April, 1948.

<sup>22</sup> P. Chalande, "The realization of a group of piezo-electric time-keepers," *La Suisse Horlogere* (International Edition in English), La Chaux-de-Fonds, Switzerland, pp. 41-44; October, 1952.

<sup>23</sup> W. P. Mason, "A new quartz crystal plate, designated the GT, which produces a very constant frequency over a wide temperature range," *Proc. IRE*, vol. 28, pp. 220-223; May, 1940.

plate can be made to have a temperature coefficient of frequency which is less than  $2 \times 10^{-7}$  per degree C., over a relatively wide temperature range. For the plates used as frequency standards, the temperature vs frequency curve is reasonably flat between 0 degrees and 100 degrees C., with optimum flatness in the range from approximately 20 degrees to 90 degrees C. Thus, the GT-cut plate can be made to serve as a stable element at temperatures approximating room temperature, and also at thermostatically controlled oven temperatures.

Early GT-cut plates were mounted on pressure-point contacts.<sup>9,13,24</sup> It is necessary to leave the edges of the GT-cut plate unsupported because they are vibrating with the greatest amplitude of any point on the crystal. Consequently, centrally located mounting points are desirable, the theoretical nodal point being at the center of the rectangular plate. Actually, because of couplings to other modes, the plates are not completely at rest at the central point. In addition, the desirability of keeping the attachment points small and flexible requires the use of several support points, which are now generally made in the form of thin wires attached to the surface of the crystal plate near the center, along the center line of the length of the plate.

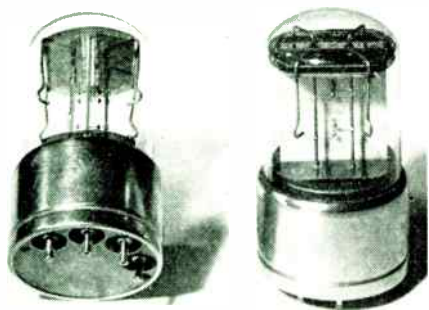

Courtesy Bell Telephone Laboratories.

Fig. 7—100 kc GT-cut plates (D168670) in evacuated mountings as used in LORAN timer oscillators.

The use of GT-cut plates in frequency-standard oscillators was given impetus by the LORAN development during World War II which required stable oscillators for timing the pulses used in this radio-navigation system. Wire-mounted-silver-plated-electrode GT-cut plates were manufactured in evacuated glass envelopes for use in the LORAN timer oscillators. These crystals were a development of the Bell Telephone Laboratories, and represent an achievement of considerable magnitude in making a crystal unit largely independent of temperature, atmospheric changes, aging effects caused by exposure to the air, and a fair amount of rough handling in shipment. This crystal unit was designated by the number D-168670 (shown in Fig. 7, above).

<sup>24</sup> C. F. Booth and F. J. M. Laver, "A standard of frequency and its applications," *Jour. IEE*, vol. 93, part III, pp. 223-241 (with discussion); July, 1946.

Further refinement of this type of GT-cut plate has produced excellent results.<sup>13</sup> The improvements consist of reduction in the diameter of the support wires and their attachment points, improved methods of processing the soldered connections, and careful annealing to relieve strains. Final adjustment to frequency is accomplished by etching the edges. The electrodes are of gold to take advantage of the inherently stable character of this metal in this application. Twenty crystals were constructed for the National Bureau of Standards incorporating these improved design features, and are now in use by the Bureau of Standards at Boulder, Colorado, and at WWV.

The  $Q$  value of the D-168670 GT-cut crystals was approximately 140,000 and the frequency drift with time was approximately  $1 \times 10^{-8}$  per day in the LORAN oscillator. The  $Q$  value of the improved design is of the order of magnitude of a million, with some values as high as 4,000,000. The daily drift rate of the special GT-cut crystals in use at the National Bureau of Standards is reported as low as 1 to  $5 \times 10^{-10}$  per day, whereas the drift rate of the earlier design was reported as 1 to 3 parts in  $10^9$  per day after one year of aging.<sup>13,25,26</sup>

The principal advantage of the GT-cut appears to lie in its low temperature coefficient of frequency, and the consequent ability to provide a stable frequency even in the absence of precise temperature control. The National Bureau of Standards has demonstrated that it is possible to use a crystal resonator buried in the earth as a reasonably accurate frequency reference without further temperature control.<sup>27</sup> Such a system has the advantage that continuity of power supply is not necessary in order to preserve continuity in measurement of the aging curve of the crystal resonator, and that it is thus possible to use such a crystal as an emergency standard during a power failure.

It has been determined that GT-cut plates are sensitive to the amplitude of the driving current within the range of current experienced in the bridge-stabilized oscillator circuits normally used with these plates.<sup>25</sup> Although some improvement has resulted from re-design of the oscillator bridge networks to balance at lower values of crystal current, the National Bureau of Standards has incorporated into the group of crystals used as frequency standards several crystals which are used only as reference resonators; i.e., which are not running continuously in oscillator circuits but are measured in bridge circuits at low excitation current levels.<sup>26</sup>

<sup>25</sup> J. M. Shaull, "Adjustment of high-precision frequency and time standards," *Proc. IRE*, vol. 38, pp. 6-15; January, 1950.

<sup>26</sup> J. M. Shaull and J. H. Shoaf, "Precision quartz resonator frequency standards," *Proc. IRE*, vol. 42, pp. 1300-1306; August, 1954.

<sup>27</sup> T. A. Pendleton, "Underearth quartz crystal resonators," *Proc. IRE*, vol. 41, pp. 1612-1614; November, 1953.

## AT-CUT PLATES

The AT-cut quartz crystal plate was developed by Lack, Willard, and Fair in 1934.<sup>28</sup> Other investigators, notably I. Koga, also published data on similar low-temperature-coefficient cuts. This type of plate vibrates in the thickness-shear mode and may be made to have a low temperature coefficient of frequency. It is possible to orient the cut angle to produce an inflection point on the frequency-vs-temperature curve, that is, a zero temperature coefficient of frequency, in the range of temperatures normally used in temperature-controlled ovens. Such a crystal cut has obvious applications as a frequency standard.

Early efforts to use the AT-cut plates as standards<sup>24</sup> were hampered by the difficulty of mounting the plate in such a way as to achieve a mount which would not influence the frequency of the crystal. Low aging drift is almost impossible to attain unless a mount is used which affects the frequency of the crystal to a minimum degree. Booth of the British Post Office used nodal-plane pin-mounted AT-cut plates, operating at 1000 kc, with air-gap electrodes, in partially evacuated holders (air-pressure 3 cm Hg).<sup>29</sup> These crystals were operated at 50 degrees C. They gave drift rates averaging 2 to  $5 \times 10^{-9}$  per day over the years 1941-1944. In view of the fact that the nodal plane is in the center of the thin edges of the AT-cut plate (1.65 mm thick), the difficulty in constructing a stable mounting by this method was considerable.

The most promising recent development in the design of AT-cut plates for frequency-standard use has been carried out by Warner.<sup>30</sup> Warner has shown that a circular AT-cut plate with one side plane and the other side ground to spherical contour, operating at 5 mc in the 5th-overtone mode, can be made with a  $Q$  of approximately 2,500,000. A photograph of this crystal unit in an evacuated glass envelope is shown in Fig. 8. Warner further reports a 1 mc crystal of similar design<sup>31</sup> with a  $Q$  of  $12 \times 10^6$ . These remarkably high  $Q$  values are ascribable to the use of the overtone mode and to the spherical contouring, which "mismatches" the zones of the crystal away from the exact center of the convex side of the plate. The zones near the edge of the crystal are thus rendered incapable of resonant vibration at the excitation frequency and are consequently quiescent. The edge of the contoured plate is thus made suitable for the attachment of rugged mounting supports and

connecting leads to the electrodes. The use of a glass-envelope evacuated mounting for this type of crystal plate has resulted in the high  $Q$  value quoted above, and in a low aging rate which is currently being verified at a number of laboratories. Indications are that the aging drift of this type of contoured AT-cut plate in an evacuated mount will be as low as that of any previously designed crystal units.

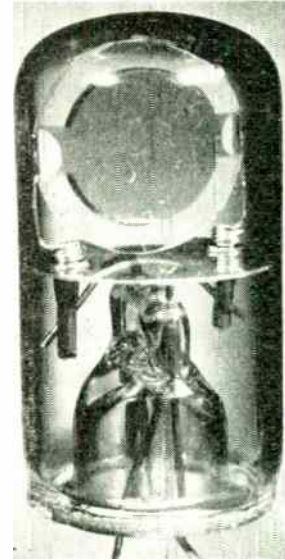

Courtesy Bell Telephone Laboratories.

Fig. 8 -5 mc AT-cut contoured plate in evacuated glass envelope, operating in 5th overtone mode.

The advantages of the overtone-mode contoured 5 mc-plate for commercially produced equipment are centered in the relatively small size of the quartz blank required, and the ease of getting a satisfactory mounting. Careful processing is still necessary in order to attain low rates of frequency drift with time, but the ruggedness of the crystal unit and its small size have already suggested numerous applications.

Fundamental-mode AT-cut plates are capable of low rates of frequency change with time if properly processed and mounted, and if used in applications, such as high-stability circuits, where the constancy of the crystal can be exploited. Lea has used a fundamental-mode 5 mc plate in experimental oscillators of high stability,<sup>32</sup> and Sulzer has developed a 1 mc oscillator using a fundamental-mode contoured AT-cut plate.<sup>33</sup>

#### OSCILLATOR CIRCUITS FOR FREQUENCY STANDARDS

Resonant devices can be made to oscillate with good frequency stability only if appropriate means are selected for maintaining them in oscillation. Pendulum clocks furnish elegant illustration of this requirement.

<sup>28</sup> F. R. Lack, G. W. Willard, and I. E. Fair, "Some improvements in quartz crystal circuit elements," *Bell Sys. Tech. Jour.*, vol. 13, pp. 453-463; July, 1934.

<sup>29</sup> C. F. Booth, "The application and use of quartz crystals in telecommunications," *Jour. IEE*, vol. 88, part III, pp. 97-144 (with discussion); June, 1941.

<sup>30</sup> A. W. Warner, "High-frequency crystal units for primary frequency standards," *Proc. IRE*, vol. 40, pp. 1030-1033; September, 1952.

<sup>31</sup> A. W. Warner, "High-frequency crystal units for primary frequency standards," *Proc. IRE*, vol. 42, p. 1452; September, 1954.

<sup>32</sup> N. Lea, "Quartz resonator servo—a new frequency standard," *Marconi Rev.*, vol. 17, pp. 65-73; 3rd Quarter, 1954.

<sup>33</sup> "High-stability one-megacycle frequency standard," *NBS Tech. News Bull.*, vol. 38, pp. 162-163; November, 1954.

The Shortt clock, representing a highly developed form of the gravity pendulum clock using electrically supplied impulses to maintain oscillation, gives stability approaching that of crystal-controlled clocks. This stability is achieved by a combination of a stable resonator (free-pendulum), and an "oscillator circuit" which supplies a constant amount of power at the same point in every cycle. Similar requirements hold for quartz-crystal-controlled oscillators, each increase in stability of crystal elements calling for improvements in oscillator circuits.

The principal property susceptible to improvement is the stability of the phase shift in the "negative resistance" or amplifier element of the oscillator. There are currently at least three distinct approaches to the oscillator circuit problem, and possibly a great many more as yet not known to the author of this review. The first approach consists of the use of an amplifier with a positive feedback connection to provide regeneration and also frequency control through incorporation of the crystal element in this feedback path, with a negative feedback connection to stabilize amplifier gain and phase characteristics. The second approach comprises the use of the most stable elements in the "optimum" simple oscillator circuit with stabilization of the oscillator active element by appropriate means. The third approach adds to the second approach a servo-operated device for adjusting the circuit elements to maintain the oscillation frequency at a value which gives a constant value of impedance or phase shift in the crystal element.

#### BRIDGE-STABILIZED OSCILLATORS

The oscillator circuit which has been most widely used for frequency standard oscillators is the bridge-stabilized circuit originated by Meacham.<sup>34</sup> In this circuit [Fig. 9(a)], the feedback voltage which drives the amplifier is the unbalance voltage at the output terminals of a bridge network which includes the crystal with associated adjusting reactances, a resistor with a positive temperature coefficient of resistance, two linear-resistive arms and the tungsten lamp resistance. The values of the resistors are so chosen, with respect to the crystal series resistance and the tungsten lamp resistance, that the bridge is unbalanced at low levels of applied signal in such a direction that positive feedback results from the bridge-unbalance output signal. As the amplitude of oscillation builds up, more current flows through the bridge arms, causing the tungsten lamp to increase its resistance and the bridge to approach the balance condition. The ultimate amplitude of oscillation is reached when the bridge unbalance signal becomes small enough so that the transmission loss through the bridge network equals the gain through the amplifier.

The excellence of the bridge-stabilized oscillator circuit stems from two important properties which are the

result of the use of the bridge network in the feedback path. The first property is a function of the phase relationship of the input voltage of a bridge with respect to its unbalanced output, or detector output, voltage. Near the balance point of the Meacham bridge, incorporating the crystal resonator as one element, the slope of the phase shift of output voltage vs input voltage is greater than the slope of the phase shift of input voltage vs current through the crystal element alone. This improvement in slope enables design of oscillators in which improvement in stability is accomplished by provision of additional gain to make up for the loss involved in the operation of the bridge network close to the balance point. Improvement in frequency stability generally will result from increase in amplifier gain since the voltage gain goes up as the power of the number of stages, whereas the amplifier phase shift instability generally increases only directly with the number of stages.

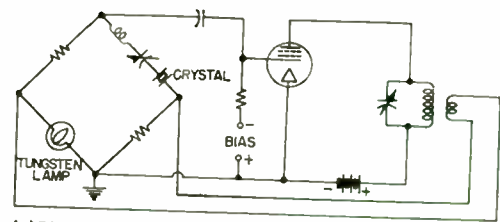

(a) BRIDGE STABILIZED OSCILLATOR (MEACHAM)

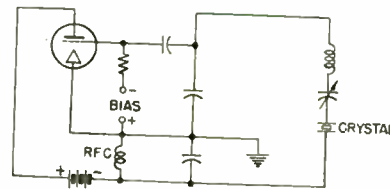

(b) GOURIET-CLAPP OSCILLATOR

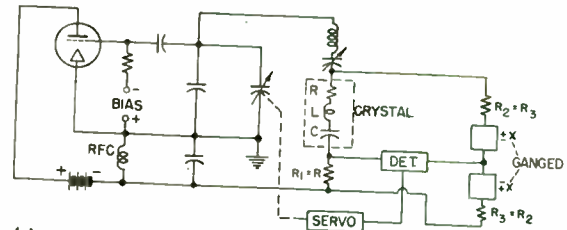

(c) SERVO-CONTROLLED (LEA)

Fig. 9—Oscillator circuits for frequency standards.

The second property of the bridge-stabilized oscillator, one which is at once an asset and a liability, is the amplitude stabilization property of the bridge network. The tungsten lamp has been almost universally used as the amplitude stabilizing device in the bridge because of its simplicity, ruggedness, and low drift with time. Some efforts have been made to use elements with negative temperature coefficients of resistance, such as thermistors, but the tungsten lamp is, in general, the accepted element. The amplitude stabilization resulting from the self-balancing bridge feedback network is effective, holding its amplitude setting well for long periods. However, the range of levels over which the bridge

<sup>34</sup> L. A. Meacham, "The bridge stabilized oscillator," *PROC. IRE*, vol. 26, pp. 1278-1294; October, 1938.

network can be made self-balancing, depends on the characteristics of the lamp, and generally higher levels are required than would be desirable for use with some crystal elements.<sup>25</sup>

The above-described properties of the bridge-stabilized oscillator are related to the general properties of amplifiers with feedback connections. It has been shown<sup>26</sup> that the performance of the bridge-stabilized crystal oscillator can be analyzed by separating the feedback circuit into a negative feedback path which stabilizes the gain and phase shift of the amplifier and a positive feedback path including the crystal unit, which determines the frequency of oscillation of the system. From this analysis, it appears that it may be profitable to explore further means for the stabilization of the amplifier circuits of oscillators.

Examples of the Meacham bridge-stabilized oscillator are provided by the LORAN timer oscillator (U. S. Navy, R. F. Oscillator Type 0-76/U),<sup>26</sup> the General Radio Company commercial frequency standard Type 1100-A, and the British Post Office Essen-ring oscillator, a photograph of which is shown in Fig. 10.

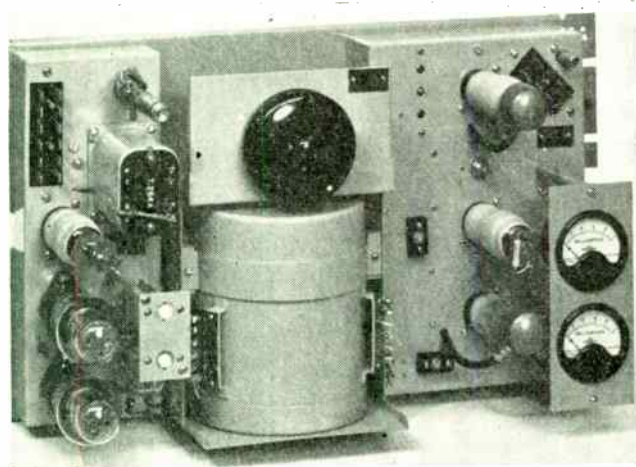

Courtesy H. M. Postmaster General.

Fig. 10—British Post Office precision frequency standard oscillator, showing oven (center) containing 100 kc Essen ring. This oscillator uses the bridge-stabilized circuit.

Because of unavoidable stray inductance and capacitance, it has been generally found that the bridge-stabilized oscillator circuit is most useful at frequencies of 1 mc or below. Frequency-standard oscillators designed for operation at higher frequencies have, therefore, used the circuits described below.

#### GOURIET-CLAPP OSCILLATOR

The Gouriet-Clapp crystal oscillator circuit, shown in Fig. 9(b), has been used for many years in frequency monitors for broadcasting and in other applications

<sup>25</sup> E. J. Post and H. F. Pit, "Alternate ways in the analysis of a feedback oscillator and its application," *PROC. IRE*, vol. 39, pp. 169-174; February, 1951.

<sup>26</sup> J. A. Pierce, A. A. McKenzie, and R. H. Woodward, "Loran," McGraw-Hill Book Co., New York, N. Y. ("Model UE-1 Oscillator," pp. 237-240, describes the Type 0-76/U Oscillator); 1948.

where stable, simple oscillators are required. (This oscillator circuit is sometimes called a "modified Pierce" or "modified Colpitts" circuit. U. S. Patent No. 2,012,497 was granted to J. K. Clapp for this crystal oscillator circuit in 1935, the series capacitance and inductance being adjusted to series resonance at the crystal series-resonant frequency. A similar circuit was developed independently by G. G. Gouriet of the B. B. C.) Recent availability of stable high-frequency crystals (See section on AT-Cut Plates, above) has prompted application of the Gouriet-Clapp circuit to frequency-standard oscillators in the megacycles/second range. An analysis (See Appendix) of the Gouriet-Clapp circuit with regard to the variations in frequency caused by changes in various circuit elements shows that an oscillator stability of the order of 1 or 2 parts in  $10^9$  should be realizable with this circuit using a crystal<sup>30</sup> with  $Q = 2.6 \times 10^6$ . Application of automatic-gain-control to this oscillator circuit by controlling the grid bias of the vacuum tube with an amplified delayed-AGC circuit stabilizes the input impedance of the oscillator tube as well as the gain and crystal current.

Application of this circuit to frequency-standard oscillators has been carried out by Felch and Israel,<sup>37</sup> and in considerably modified form, by Lea (See Servo-Controlled Oscillators, below). The stability achieved has been  $3 \times 10^{-9}$  per day or better, using the 5 mc overtone-mode AT-cut plate,<sup>30</sup> by the former group. A photograph of this 5 mc oscillator unit is shown in Fig. 11.

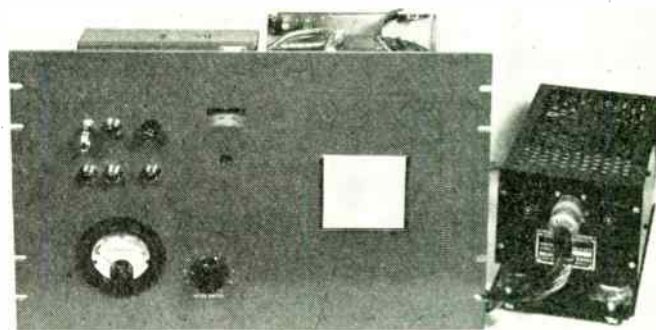

Courtesy Bell Telephone Laboratories.

Fig. 11—Photograph of USAF Type 0-269 (XW-1)/UR Oscillator, using 5 mc overtone-mode contoured AT-cut plate (see Fig. 8).

#### SERVO-CONTROLLED CRYSTAL OSCILLATORS

All of the oscillator circuits described above have relied on the steep slope of phase-change with frequency in the crystal element to provide corrections for the drifts of phase in the oscillator circuit in order to maintain a constant frequency of oscillation. The bridge-stabilized oscillator alone has provided an enhanced phase-change system to assist the phase-vs-frequency

<sup>37</sup> E. P. Felch and J. O. Israel, "A simple circuit for frequency standards employing overtone crystals," *PROC. IRE*, vol. 43, pp. 596-603; May, 1955.

slope of the crystal element. An oscillator circuit which provides a somewhat different method of frequency control has been developed by Lea.<sup>32</sup> A simplified circuit diagram of his servo-controlled oscillator is shown in Fig. 9(c). It should be noted that the servomechanism has been added to an oscillator circuit which, for purposes of illustration, is similar to the Gouriet-Clapp oscillator of Fig. 9(b). The short-term or cycle-to-cycle phase stability of the oscillator is thus dependent on the  $Q$  of the crystal, which  $Q$  has been degraded to  $\frac{1}{2}$  of its original value by the addition of  $R_1 = R$  (crystal series resistance). The phase "noise" or phase instability of this circuit may thus be twice that of the Gouriet-Clapp circuit using the same crystal unit. However, the long-term stability (for any period longer than the correction time of the servo control) is determined by the ability of the servo system to maintain the oscillator frequency at that value which appears to result in a constant value of impedance in the crystal unit. A bridge circuit comprising the crystal ( $R, L, C$ )  $R_1, R_2, R_3$  and ganged modulating reactances  $\pm X$  and  $\mp X$  is provided by adding  $R_1 = R$  in series with the crystal, and adding  $R_2, \pm X, \mp X$  and  $R_3$  in parallel with the crystal branch.  $R_2$  should be equal to  $R_3$ , but be large compared with  $R$  (crystal) and  $R_1$ . A detector, comprising a sensitive AM receiver, is provided with a phase-detector output circuit synchronized with the modulation rate of  $\pm X$  and  $\mp X$ . If the frequency applied to the crystal deviates from the frequency of the crystal series resonance, the voltage drop across the crystal arm of the bridge will change both in magnitude and in phase. The modulating reactances,  $\pm X$  and  $\mp X$ , being modulated continuously at a fairly constant rate, will enable sensing of the direction of phase change of the bridge unbalance voltage (detector output) by scanning back and forth through a small range of reactance unbalance in the modulating arms, and using a phase-sensitive circuit tuned to the modulation frequency at the output of the detector. The output signal from this detector will then be proportional to the magnitude of the deviation from bridge balance, and will have a phase or sign which indicates the direction of deviation of the applied frequency from the crystal resonant frequency. The detector output signal is then applied to a servo system to readjust the oscillator circuit to reduce the frequency deviation to a minimum. By increasing the gain of the detector circuit, it is possible to reduce the magnitude of the deviation required to operate the servo device until the limiting signal-to-noise ratio is reached.

The servo system is thus used to correct for such instability as may arise in the "negative resistance," that is, in the vacuum tube (or transistor) and associated reactive elements. Instability is thought to arise from such factors as cathode-interface impedance, space-charge capacitance, changes in tube geometry with age, transit time variation, and perhaps Miller-effect capacitance changes in addition. A delayed-automatic-gain-control is used by Lea to stabilize level and grid input

impedance. The correction time of the servo control used is fairly short, a variable capacitor being driven by a motor to effect the adjustment of the circuit reactance. In its present state of development,<sup>38</sup> the servo-controlled oscillator is stable to better than  $\pm 3 \times 10^{-11}$ , and the average frequency to approximately  $\pm 1 \times 10^{-11}$ , for periods in excess of 10 seconds, the ultimate drift rate for long periods thus being dependent only on the constancy of the crystal element except for the  $\pm 3 \times 10^{-11}$  error of the circuit. This figure includes changes of tubes, drift of the feedback circuit elements, and supply voltage changes.

Further application of this servo-control principle has produced comparable results using slightly different circuit details. Lea makes use of a motor-driven variable inductance as a single modulated reactance, dispensing with the second modulated element, and delayed AGC. Sulzer<sup>39</sup> has used a chopper to commutate small capacitors in the modulated reactance positions, and a limiter to control level. Both systems operate at a modulation rate different from the power frequency in order to avoid "hum" troubles.

#### TUNING FORKS AS FREQUENCY STANDARDS

Tuning forks have been used as frequency standards.<sup>24</sup> The advantages of the tuning fork as a clock-driving source derive mainly from the low frequency of oscillation of the fork and the simplified auxiliary apparatus needed to drive the clock. Interest in small, lightweight, frequency standards for airborne applications has kept the tuning fork from being completely eclipsed. Several manufacturers are producing hermetically-sealed temperature-compensated tuning forks operating in the frequency range of 400 to 1,000 cps, and also at 50–60 cps, and at some frequencies above 1 kc. Performance of the best of these tuning-fork units is comparable with that of commercial-grade crystals as far as stability is concerned. For example, one of these forks (at the Riverbank Laboratories, Geneva, Illinois), operating without temperature control at room temperature in an amplitude-stabilized oscillator circuit, has given stability of the order of  $\pm 1 \times 10^{-6}$  for several weeks. The  $Q$  realizable in a tuning fork is limited, and consequently, the instantaneous phase stability of an oscillator circuit using fork control has to be made as high as possible in order to keep the frequency from fluctuating rapidly. With a modern tuning-fork-controlled oscillator, it is possible to realize a portable time and frequency standard with stability adequate for many purposes.

#### MICROWAVE SPECTRAL LINES OF ATOMS AND MOLECULES AS FREQUENCY STANDARDS

Much has been written of the many proposals for the use of the constant properties of atoms and molecules as standards of frequency. It will not be possible here to

<sup>38</sup> Private communication, February 1, 1955.

<sup>39</sup> P. G. Sulzer (National Bureau of Standards), "High stability bridge-balancing oscillator," paper in preparation.



give a complete description of the status of the various projects in this field of endeavor, but the projects which appear most promising will be covered briefly. Of the many possible spectrum lines in the microwave region, the 3,3 inversion-line of the ammonia molecule ( $\text{NH}_3$ ) and the transition (4,0 3,0) of the cesium atom seem to be nearest to practical application. Both of these spectrum lines have already been used as the bases of frequency calibrating apparatus,<sup>40</sup> and it is probable that their use will result in the first frequency standards of high precision with complete freedom from long-term aging drift. If present theories of atomic structure are rigorously correct, and there appears to be no reason for suspecting otherwise, then the frequencies representing the spectral lines should never change. We should, therefore, be able to use these invariant frequencies as frequency standards without reference to astronomical phenomena except for initial calibration. It is probable that the first frequency and time standardization using these spectral lines as standards will be done by using them as calibration standards to measure the constancy of the frequency of a conventional frequency standard or of the oscillator of a quartz-crystal-controlled clock, and thus enable accurate establishment of the time-keeping rate of the clock for comparison with astronomical time. As the perfection of atomic frequency standards progresses, it may prove feasible to use them as standard-frequency oscillators for routine laboratory measurements.

The problem then resolves itself into the design of equipment and the application of the information obtained from the equipment. Since the techniques for the two spectrum lines mentioned above are so widely different, they will be treated individually.

#### AMMONIA SPECTRUM LINE DEVELOPMENTS

It is probable that the earliest published reference to the possibility of using microwave spectrum lines as frequency-stabilizing elements is in a paper by Pound<sup>41</sup> published in 1946, although other investigators had perceived the possibility of using the microwave spectral lines as frequency calibration points. Shortly after publication of Pound's paper, a paper by Smith, de Quevedo, Carter and Bennett<sup>42</sup> confirmed the application of Pound's method of stabilization using the 3,3 line of ammonia ( $\text{NH}_3$ ) as the frequency reference. The stabilized oscillator system comprised a reflex klystron, a wave-guide hybrid system, a wave-guide resonator filled with ammonia, and a "dc" feedback connection to the klystron repeller electrode to close the loop. In effect, the ammonia was used as a resonant element to provide a rapid change of phase of a reflected wave in a

Pound-type discriminator, the rate of change of phase with frequency being rapid enough to give an effective  $Q$  estimated at 12,500.

The use of the 3,3 inversion line of ammonia at approximately 23,870 mc for this stabilization experiment was the extension of many years of investigation of this particular spectrum line. Cleeton and Williams measured this ammonia absorption in 1934,<sup>43</sup> and a number of papers appeared immediately after World War II<sup>44-46</sup> giving further information which indicated that the 3,3 line of ammonia was a strong line (high absorption of energy), and that it was not affected in frequency by such variable factors as pressure, temperature, and magnetic field, although the apparent resolution or breadth of the line depends on pressure and temperature.

The most accurate determination of the frequency of the 3,3 inversion line of ammonia appears to be that by Shimoda,<sup>47</sup> who gives a value of  $23,870,130.97 \pm 0.10 \pm 1$  kc for this line. This figure includes terms of  $\pm 0.10$  kc instrumental error, and  $\pm 1$  kc uncertainty concerning the absolute value of the reference frequency standard.

#### SERVO-CONTROLLED AMMONIA OSCILLATORS

A method of oscillator stabilization using a control loop and an ammonia absorption cell as a frequency-stable element has been applied to frequency-standard oscillators. Hershberger and Norton<sup>48</sup> stabilized a klystron oscillator at the ammonia-line frequency, and also offset from this frequency by a known intermediate frequency increment. Lyons<sup>40,49</sup> applied a similar approach to the stabilization of a crystal-controlled frequency-standard oscillator, and thus to the control of a clock by reference to the ammonia absorption-line frequency. Fletcher and Cooke stabilized a klystron at the ammonia-line frequency.<sup>50</sup>

The basic principles of such a servo-controlled oscillator are shown in Fig. 12(a) (next page). An oscillator, with a controllable frequency adjustment, supplies a signal to a modulation system which adds modulation to the signal, which is then referred to the ammonia-filled absorption cell. The signal is modified by passage through the cell, the modification then being detected and evaluated by the circuits of the servo control with

<sup>43</sup> C. E. Cleeton and N. H. Williams, "Electromagnetic waves of 1.1 cm wavelength and the absorption spectrum of ammonia," *Phys. Rev.*, vol. 45, pp. 234-237; February 15, 1934.

<sup>44</sup> C. H. Townes, "The ammonia spectrum and line shapes near 1.25 cm wavelength," *Phys. Rev.*, vol. 70, p. 665; November, 1946.

<sup>45</sup> W. E. Good, "The inversion spectrum of ammonia," *Phys. Rev.*, vol. 69, p. 539; May, 1946.

<sup>46</sup> B. Bleaney and R. P. Penrose, "Ammonia spectrum in the 1 cm wavelength region," *Nature*, vol. 157, p. 339; May, 1946.

<sup>47</sup> K. Shimoda "Atomic clocks and frequency standards on an ammonia line," *Jour. Phys. Soc. Japan*; Part III, 1954.

<sup>48</sup> W. D. Hershberger and L. E. Norton, "Frequency stabilization with microwave spectral lines," *RCA Rev.*, vol. 9, pp. 38-49; March, 1948.

<sup>49</sup> H. Lyons, "The atomic clock, an atomic standard of frequency and time," *NBS Tech. News Bull.*, vol. 33, pp. 17-24; February, 1949.

<sup>50</sup> E. W. Fletcher and S. P. Cooke, "The stabilization of a microwave oscillator with an ammonia absorption line reference," *Cruft Laboratory, Harvard University, Tech. Report No. 5*; 1948, *Tech. Report No. 64*; 1950.

<sup>40</sup> H. Lyons, "Spectral lines as frequency standards," *Ann. N. Y. Acad. Sci.*, vol. 55, pp. 831-871; November, 1952.

<sup>41</sup> R. V. Pound, "Electronic stabilization of microwave oscillators," *Rev. Sci. Instr.*, vol. 17, p. 490; November, 1946.

<sup>42</sup> W. V. Smith, J. L. G. de Quevedo, R. L. Carter, and W. S. Bennett, "Frequency stabilization of microwave oscillators by spectrum lines," *Jour. Appl. Phys.*, vol. 18, p. 1112; December, 1947.

reference to the modulation system. The servo control then supplies a correction to adjust the frequency of the controlled oscillator to the desired value.

Hershberger and Norton<sup>48</sup> swept the frequency of a separate klystron local oscillator back and forth across the frequency of the ammonia cell, and detected the pulse resulting from the absorption peak. Simultaneously, they applied this FM signal to a mixer with a signal from the controlled oscillator (a reflex klystron) and amplified the beat-notes near zero-beat (pulses) resulting from this interaction. The phase of the two sets of pulses was compared, and a correction signal obtained which was contrived to move the controlled oscillator pulse to coincidence with that from the ammonia cell. A further arrangement was constructed which used an offset, or intermediate-frequency, beat-note from the controlled-oscillator part of the circuit to provide the control pulses. By using a stabilized intermediate frequency, a stable controlled frequency resulted.

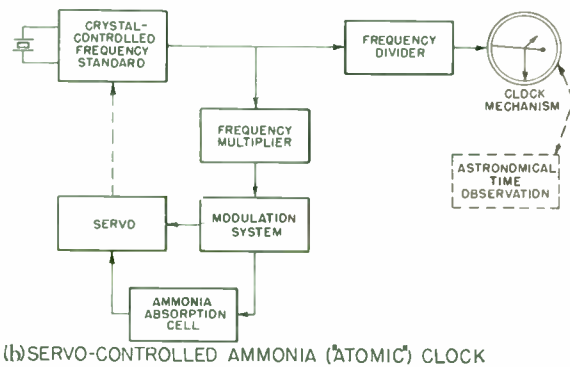
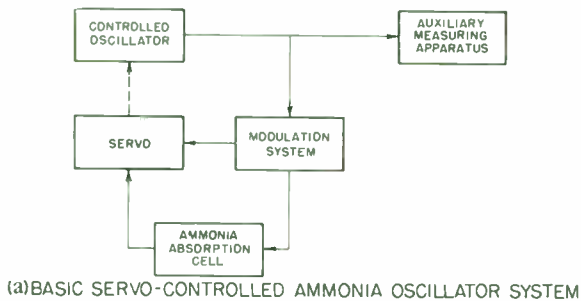

Fig. 12—Servo-controlled ammonia-absorption-cell oscillator systems.

The atomic clock development program under Lyons at the Bureau of Standards has explored the possibility of stabilizing a crystal-controlled frequency standard against the ammonia absorption cell.<sup>40,49</sup> The ammonia-stabilized clock uses a system of stabilization similar to the one discussed above [see Fig. 12(b)], but resulting in a lower output frequency which can be used to operate a clock mechanism for comparison with astronomical time measurements. The controlled oscillator feeds a frequency multiplier chain which eventually provides output near the frequency of the ammonia line. At one stage in the multiplier system, a frequency-modulated

signal is added to that from the multiplier stage, and the proper sideband signal selected to provide a harmonic falling on the 23,870 mc frequency of the ammonia cell. Thus it is possible to provide a frequency-modulated signal derived from the frequency standard, sweeping back and forth in the vicinity of the ammonia frequency, with good short-term stability of the center (or carrier) frequency. The intermediate-frequency frequency-modulated signal (that which was added to the multiplied frequency of the controlled oscillator) is compared with the appropriate harmonic of the controlled frequency-standard oscillator, a signal pulse being produced each time the swept intermediate-frequency signal passes a given reference frequency. The FM signal, at 23,870 mc  $\pm$  modulation, undergoes absorption each time it sweeps past the ammonia absorption frequency in the cell, this absorption being observed as a negative reference pulse out of the detector at the receiving end of the ammonia absorption cell. The servo circuits are operated by the phase or time difference between these two pulses and are arranged to produce a correction of the crystal oscillator frequency to keep the crystal-controlled frequency standard locked to the ammonia line. The result which is sought is to produce a clock with no net long-term drift in its time-keeping rate, and with good short term stability, or low acceleration. A clock constructed on these principles gave a performance estimated at  $\pm 2 \times 10^{-8}$  for a period of the order of one week. The average frequency or integrated time error was not determined. A photograph of the first ammonia clock built at the National Bureau of Standards (1948–1949) is shown in Fig. 13 (opposite). The ammonia absorption cell is mounted in a coil around the large clock indicator above the racks.

A different approach to the servo-control system problem was used by Fletcher and Cooke.<sup>50</sup> Their modulation system used frequency modulation of the controlled oscillator at a relatively high modulation frequency but with a low modulation index. This modulation produced two sidebands which were on either side of the frequency range affected by the ammonia absorption line. An amplitude-modulation detector was used at the output of the absorption cell. If the phase of the carrier (23,870 mc) of the FM oscillator became shifted from its original phase by the action of the ammonia absorption, amplitude modulation resulted upon recombination with the unshifted sidebands.<sup>51</sup> This amplitude modulation occurred at the modulation frequency of the FM ("intermediate frequency"), the AM signal being recovered by the AM detector at the receiving end of the absorption cell. This intermediate frequency signal was then amplified and compared in phase with the modulating signal, the output of the phase comparison circuit being applied to the repeller electrode of the controlled klystron oscillator as a dc adjustment of the average frequency of oscillation.

<sup>51</sup> M. G. Crosby, "Communication by phase modulation," *Proc. IRE*, vol. 27, pp. 126–136; February, 1939.

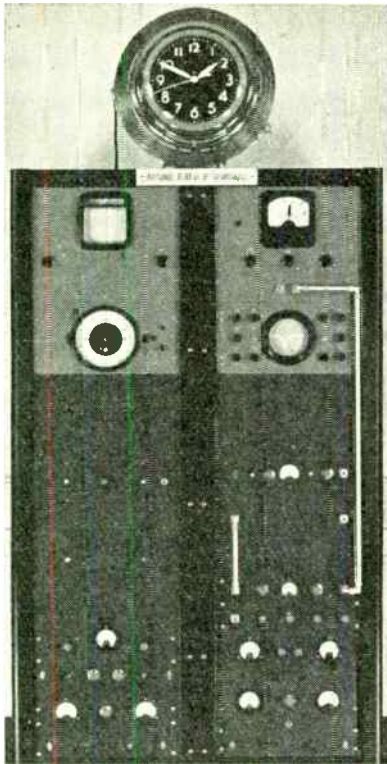

Courtesy *Annals of New York Academy of Sciences*

Fig. 13—Photograph of first ammonia clock built at National Bureau of Standards.

A stabilized oscillator using an ammonia absorption cell modulated by a Stark-effect modulator was constructed by Townes<sup>52</sup> in 1951.

#### *Difficulties in the Use of Ammonia Absorption to Stabilize Oscillators*

Certain basic difficulties beset the use of the ammonia absorption technique for the stabilization of oscillators.<sup>40,52</sup> The principal difficulties of an inherent nature (properties of molecules) are (1) the natural breadth of the spectral line, (2) Doppler-effect broadening, (3) pressure broadening caused by collisions between molecules, (4) broadening caused by collisions with the walls of the absorption cell, and (5) saturation effects. The natural line breadth is related to the radiation from the molecule and the amount of thermal radiation falling on it. It is inherent and cannot be changed except by choice of the molecule or atom to be used. The other effects are usually much greater, in any case. Doppler-effect broadening is proportional to the velocity of the gas molecules parallel to the propagation direction of the radio-frequency energy in the cell. It can be reduced by cooling, but the ammonia freezes<sup>46</sup> out if cooled far enough to provide much reduction. Pressure broadening results because the energy absorption process is interrupted if a molecule collides with another during the absorption, and has to start again with a new phase possible. This effect can amount to 15 mc bandwidth at a

pressure of 1 mm of Hg, but it diminishes with pressure reduction. Wall collisions cause broadening, but amount to a relatively minor item, of approximately 15 kc bandwidth maximum. Saturation effects result from the possibility of all available molecules having already been excited to the higher energy state, and those which are emitting energy supplying enough quanta to re-excite those which require excitation. The only energy then absorbed at the inversion line frequency is that lost to thermal radiation by collision and radiation damping of the molecules. The power input level to the absorption cell at which saturation effects set in is proportional to the square of the pressure in the cell, and hence is conflicting with pressure broadening effects as far as the selection of a pressure level for the cell is concerned.

In addition to the theoretical limitations set forth in the preceding paragraph, the design and construction of the microwave rf system for an ammonia-absorption-cell stabilized oscillator is complicated by the difficulties of working in the frequency range close to 23,870 mc. The signal-to-noise ratio of the system is affected by the noise in the detector, in particular, and could be improved if the saturation effects did not limit the allowable power input. The design of a cell to hold the ammonia gas is complicated by the necessity for maintaining a low standing-wave ratio over the band of frequencies used by the modulation system chosen. A schematic showing the principal features of one design of ammonia absorption cell is shown in Fig. 14 (next page), and a photograph of an ammonia absorption cell is shown in Fig. 15 (next page).

Further work on the solution of these problems appears unlikely in the future as a result of the success of other approaches to the atomic-frequency-standard problem, although experimental work on absorption cells will undoubtedly continue.

#### AMMONIA OSCILLATOR

A completely different arrangement for the use of the 3,3 inversion-line of  $\text{NH}_3$  as a frequency standard has been devised by Townes,<sup>53</sup> of the Department of Physics, Columbia University, New York City. Ammonia gas at room temperature contains molecules in various energy states. Slightly less than half of the molecules are in the upper-energy states, while the remaining molecules are in the lower states. The lower-energy-state molecules have an electric dipole moment which makes it possible to accelerate them in a given direction by putting them in an electric-field gradient. The molecules in the upper states are accelerated in the opposite direction along this same electric-field gradient. Thus a sorting or selecting device may be constructed by setting up an appropriately shaped transverse-electric-field gradient in a region traversed by a stream of ammonia molecules, the lower-energy-state molecules being diverged away

<sup>52</sup> C. H. Townes, "Atomic clocks and frequency stabilization on microwave spectral lines," *Jour. Appl. Phys.*, vol. 22, pp. 1365-1372; November, 1951.

<sup>53</sup> J. P. Gordon, H. J. Zeiger, and C. H. Townes, "Molecular microwave oscillator and new hyperline structure in the microwave spectrum of  $\text{NH}_3$ ," *Phys. Rev.*, vol. 95, pp. 282-284; July 1, 1954.

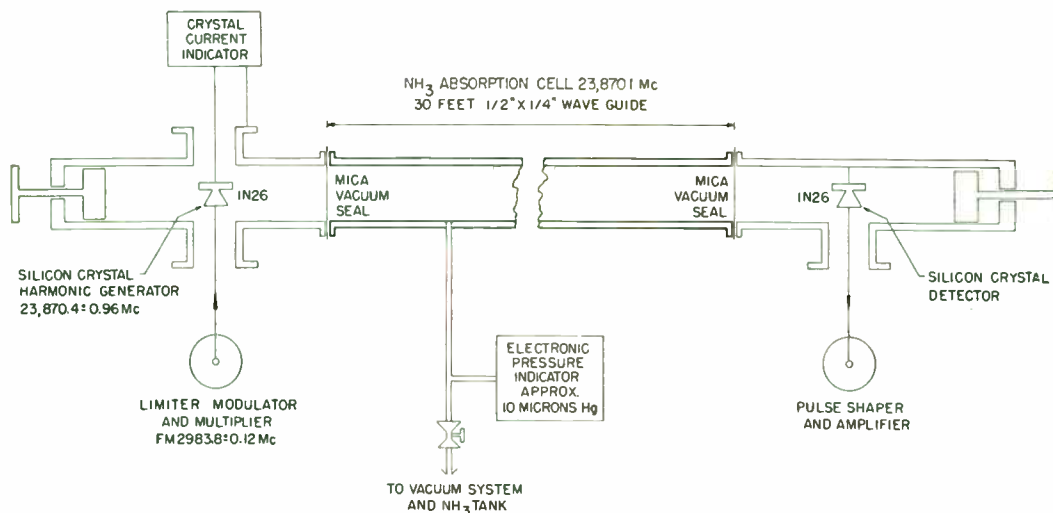

Courtesy *Annals of New York Academy of Sciences*

Fig. 14—Diagram of ammonia absorption cell for atomic clock.



Courtesy *Annals of New York Academy of Sciences*

Fig. 15—Photograph of ammonia absorption cell for atomic clock.

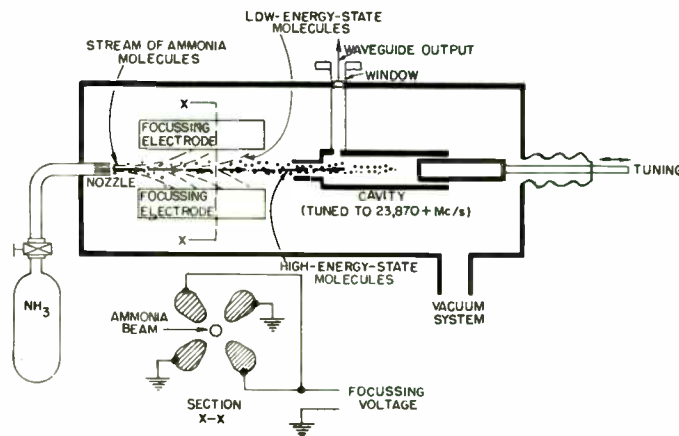

Fig. 16—Ammonia oscillator (Townes).

emission of energy. Some of the molecules in the cavity undergo transition to the lower state by emission of a quantum of energy at 23,870 mc. When the rf field at this frequency builds up to a sufficient value, the transitions are stimulated and the molecules then give up their quanta in an ordered, coherent manner, thus providing a source of power at 23,870 mc. The magnitude of the power available is adequate to supply the losses in the radio-frequency circuit, and to provide an additional small amount of power for measurement purposes (estimated  $10^{-8}$  to  $10^{-9}$  watt).

The general class of devices of this sort has been designated MASER, from the initials of the description "microwave amplifier by stimulation of emitted radiation." In the case discussed above, the gain of the amplifier is greater than the losses in the system, and hence an oscillator is the result.

The exact frequency at which the oscillations are produced depends on several factors, the two most significant ones being the  $Q$  of the cavity and the tuning of the cavity relative to the inversion-line frequency. In the first experimental models of this device, detuning

from the axis, and the higher-energy-state molecules converged by the focusing system. By this means, a useful portion of the high-energy molecules in a given stream may be selected and focused at the end of the electrode system.

Such a system is shown schematically in Fig. 16, with a resonant cavity to receive the focused high-energy molecules through a waveguide-below-cutoff entrance port. This device operates to produce oscillations at the inversion-line frequency of the ammonia by the following mechanism: the high-energy-state molecules which enter the resonant cavity are acted upon by any radio-frequency fields present in the cavity, and also these molecules contribute to these field components by

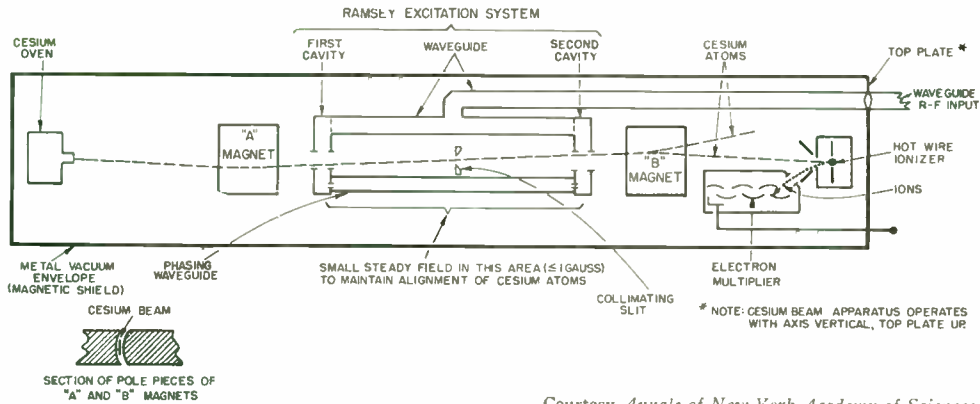

Courtesy *Annals of New York Academy of Sciences*

Fig. 17—Cesium atomic-beam frequency-standard apparatus.

the cavity produced a "pulling" effect of approximately  $\pm 2,000$  cycles. At the present time, the best method of estimating the correct center frequency of the 3,3 inversion line of ammonia appears to be setting to the mid-point of the pulling range. Other methods may be devised with better reproducibility of setting, such as the use of the frequency at which oscillations are just observable when the  $Q$  of the system (cavity plus load) is reduced to the point where self-oscillations are barely possible.

Two of these oscillators are reported to have been operated simultaneously, beating one against the other in a receiver tuned to their frequency. The oscillators were detuned to produce a 50-cps beat note, and the instability was observed to be less than  $\pm 0.1$  cps. Over a period of an hour, the average variation in the beat-note was less than  $\pm 2.5$  cps and the peak deviation was less than 5 cps.

It is estimated that a fully engineered version of this type of oscillator may reach a long-term stability of  $\pm 1 \times 10^{-12}$ . The absolute accuracy of the oscillation frequency cannot now be specified, but it is apparent that the oscillator may be set by simple methods to within approximately  $\pm 20$  cps of the correct frequency, or  $\pm 1 \times 10^{-9}$ , and that improvements in setting techniques will improve this figure.

#### CESIUM ATOMIC-BEAM FREQUENCY STANDARD<sup>40,54,55</sup>

Another atomic spectrum line which may be used for frequency standardization is the line at  $9,192.63197 + mc$  which is observed in cesium of atomic weight 133 by atomic-beam techniques. The atomic or molecular beam apparatus for measuring nuclear magnetic moments by resonant absorption was developed by Rabi and co-workers at Columbia University.<sup>56</sup> The original labo-

<sup>54</sup> J. R. Zacharias and J. G. Yates, "VIII, Atomic Beam Research; A Cesium Clock," Quarterly Progress Report, Research Laboratory of Electronics, Mass. Inst. Tech., Cambridge, Mass., pp. 30-34; October 15, 1954.

<sup>55</sup> N. F. Ramsey, "Nuclear Moments," John Wiley and Sons, Inc., New York, N. Y., ch. 3, sec. D, "Molecular Beam Resonance Methods," pp. 37-52 (An extensive bibliography is given on this general type of molecular beam apparatus); 1953.

<sup>56</sup> I. I. Rabi, S. Millman, P. Kusch, and J. R. Zacharias, "The molecular beam resonance method for measuring nuclear magnetic moments," *Phys. Rev.*, vol. 55, pp. 526-535; March 15, 1939.

ratory equipment gave a minimum indication upon the absorption of a quantum of any frequency, whereas the present models give a maximum indication upon the absorption of a quantum at the desired frequency only. The energy level difference corresponding to this frequency in the cesium atom is associated with the spin vector of the valence electron and its relation to the nuclear magnetic moment of the atom, the two energy levels corresponding to the case of the electron spin vector being aligned with and in the same direction as the nuclear magnetic moment, and the case in which the spin vector is directly opposed to that of the nucleus. When an atom of cesium is acted upon by a magnetic field of exactly the correct frequency, the internal structure of the atom can absorb a quantum of energy corresponding to the transition described above. The external evidence of this change in energy level is provided by a change in the magnetic moment of the atom. The atomic-beam apparatus shown in Fig. 17 is designed to enable detection of the changed magnetic moment of the atoms, and hence to determine the correctness of the frequency of the exciting field in the cavities. The width of the resonance curve of the absorption line is inversely proportional to the time the atom spends in the exciting field, the time in this case, using the two-cavity excitation method, being the time taken to traverse the path from the entrance of the first cavity to the exit from the second cavity.

The cesium-beam apparatus shown in the diagram (Fig. 17) is typical of current designs. A stream or beam of cesium atoms is emitted by the oven through a nozzle which provides a ribbon-shaped beam of approximately 0.02-inch thickness, the emission of cesium being approximately  $10^{-6}$  grams per day. The atoms pass through the inhomogeneous magnetic field between the pole-pieces of the *A* magnet. Those atoms with the appropriate dipole moment are deflected by the magnetic field gradient of the *A* magnet as indicated in the diagram, and are turned back toward the axis of the apparatus. The cesium atoms then traverse the first rf cavity in which they are exposed to a magnetic field at  $9,192 + mc$  which can produce the energy level change desired in the atoms. The atoms then drift through the

distance between the cavities (50 to 100 cm) and then through the second rf cavity. The radio-frequency magnetic field in the cavities is set to the same phase by careful adjustment and is checked by means of a probe inserted in the phasing waveguide connecting the two cavities. The net effect of the use of two separate in-phase cavities is similar to the effect obtained by using a long cavity with zero phase-shift between the ends, with the exception that, at frequencies slightly separated from the center of the resonance curve, an interference pattern occurs which shows up as a large amplitude ripple in the main absorption curve. This method of excitation, originated by Ramsey,<sup>57</sup> provides a sharper peak at the center of the resonance curve than is provided by the use of a single excitation field, reducing as it does the Doppler effect to a very small value. The atoms which have absorbed (or emitted) a quantum in the space between the magnets have then changed their magnetic dipole moment and are deflected in the opposite direction by the magnetic field gradient in the *B* magnet, while those atoms which have not "flopped" are deflected a second time, as before, and are not re-focused on the detection device. The detection device comprises a surface ionizer, of the hot wire type, which is hit by the neutral atoms, and ionizes them. The cesium ions thus formed are then accelerated and focused by the appropriate electrodes and injected into the secondary-emission electron multiplier. The output current of the electron multiplier collector electrode is thus a measure of the number of atoms making the transition, and hence of the resonance curve of the transition.

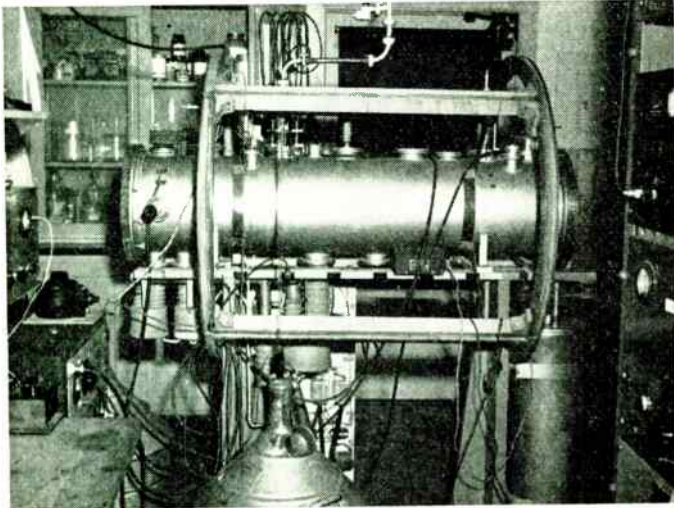

Courtesy National Bureau of Standards.

Fig. 18—The National Bureau of Standards cesium atomic-beam equipment.

Fig. 18 shows a photograph of the atomic-beam portion of the cesium-beam frequency-standard apparatus

<sup>57</sup> N. F. Ramsey, "A molecular beam resonance method with separate oscillating fields," *Phys. Rev.*, vol. 78, pp. 695-699; June 15, 1950.

constructed at the National Bureau of Standards.<sup>40</sup> The path length between the rf cavities is 50 cm. The effective *Q* obtained was 30 million. The atomic beam was horizontal in this apparatus. The excitation for the rf system is supplied through the waveguide entering the top of the container. Control of the ambient magnetic field affecting the equipment is provided by the large coils surrounding the vacuum envelope. The crystal-controlled excitation system is not shown in this photograph.

Current practice makes use of a small amount of frequency modulation of the exciting oscillator and appropriate phase-sensitive circuits to control the average frequency of the exciting oscillator. Hence the cesium-beam apparatus is a form of servo-controlled oscillator with a highly specialized form of absorption cell in which the Doppler effect is very small, collision broadening is absent, and which uses a very sensitive, low-noise, detection circuit not heavily limited by saturation or detector thermal noise level.

The excitation oscillator used in such a system must be adequately stable in order to avoid spurious effects, and the auxiliary equipment associated with the atomic-beam apparatus requires careful design in order to provide the best stability and accuracy for the over-all frequency-standard apparatus. The excitation system used at the Bureau of Standards is crystal-controlled at a relatively low frequency and uses a multiplier chain to reach the operating frequency of the cesium beam. Another suitable oscillator system has been constructed at M.I.T., using a Western Electric Type 416-B microwave triode working at approximately 3,064 mc and tripling with crystal diodes.

The cesium-beam apparatus which has been run at M.I.T. is reported to have a stability of  $\pm 1 \times 10^{-9}$  for short periods, with the mean frequency showing less drift than this value. Refinements in this apparatus are expected to improve the over-all stability. A newer projected design is also being undertaken in an effort to improve the over-all performance by several orders of magnitude.

A commercial model of the cesium-beam atomic frequency standard is now being designed (by the National Company, Malden, Massachusetts) and should be available shortly.

#### FURTHER ATOMIC FREQUENCY STANDARDS

Although the spectrum lines of atoms and molecules in the microwave frequency range are almost limitless in number, only a few of these spectrum lines offer attractions comparable with those of the lines described above. Dicke is carrying out work at Princeton which may result in the use of a line of the sodium spectrum as a reference. Some frequency calibration measurements on oxygen absorption lines are being carried out at the National Bureau of Standards. However, at the

TABLE I  
PRINCIPAL CHARACTERISTICS OF STANDARD-FREQUENCY AND TIME-SIGNAL STATIONS

| Stations  | Hawaii                       | Johannesburg <sup>5</sup>     | Rugby                          | Tokyo                            | Torino                          | Uccle <sup>22</sup> | Washington                   |
|---|------------------------------|-------------------------------|--------------------------------|----------------------------------|---------------------------------|---------------------|------------------------------|
| Call-sign Service   | WWVH                         | ZUO                           | MSF                            | JJY                              | IBF                             | —                   | WWV                          |
| Carrier Power (kW)  | Experm'l<br>2 <sup>1</sup>   | Experm'l<br>0.1               | Experm'l<br>0.5                | Experm'l<br>1                    | Experm'l<br>0.3                 | Experm'l<br>0.02    | Regular<br>10 <sup>1</sup>   |
| Type of antenna   | Vertical dipole              | Inverted L                    | Vertical dipole                | Vertical dipole                  | Horizontal dipole <sup>18</sup> | —                   | Vertical dipole              |
| Number of simultaneous transmissions                            | 3                            | 1                             | 3                              | 1                                | 1                               | 1                   | 6                            |
| Number of frequencies used                                      | 3                            | 1                             | 3                              | 3                                | 1                               | 1                   | 6                            |
| Transmission  |                              |                               |                                |                                  |                                 |                     |                              |
| Days per week   | 7                            | 7                             | 7                              | 7-2 <sup>12</sup>                | 1 <sup>19</sup>                 | 7                   | 7                            |
| Hours per day   | 22                           | 24 <sup>6</sup>               | 24 <sup>9</sup>                | 24                               | 6 <sup>20</sup>                 | 22                  | 24                           |
| Standard frequencies used                                       |                              |                               |                                |                                  |                                 |                     |                              |
| Carriers (mc)   | 5, 10, 15                    | 5                             | 2.5, 5, 10 <sup>10</sup>       | 2.5, 5, 10 <sup>15, 16</sup>     | 5                               | 2.5                 | all                          |
| Modulations (cs)  | 1, 2, 440, 600               | 1 <sup>7</sup>                | 1, 2, 1,000                    | 1, 1 <sup>17</sup> , 1,000       | 1, 2, 440, 1,000                | None                | 1, 2, 440, 600               |
| Duration of tone modulation (minutes)                           | 4 in every 5 <sup>3</sup>    | —                             | 5 in every 15                  | 9 in every 20                    | 5 in every 10 <sup>21</sup>     | —                   | 4 in every 5 <sup>3</sup>    |
| Accuracy of frequencies (10 <sup>-8</sup> )                     | ±2                           | ±2 <sup>8</sup>               | ±2                             | ±2                               | ±2                              | ±1                  | ±2                           |
| Max. oscillator drift (10 <sup>-8</sup> ) per month             | +2                           | +4                            | +0.5                           | +1                               | +4                              | —                   | +1                           |
| Max. value of steps of frequency adjustment (10 <sup>-8</sup> ) | 1                            | 2                             | 2                              | 2                                | 2                               | —                   | 1                            |
| Duration of time signals in minutes                             | continuous                   | continuous                    | 5 in every 15                  | continuous                       | 5 in every 10                   | None                | continuous                   |
| Accuracy of time intervals                                      | ±2×10 <sup>-8</sup><br>±1 μs | ±2×10 <sup>-8</sup><br>±10 μs | ±2×10 <sup>-8</sup><br>±1 μs   | ±2×10 <sup>-8</sup><br>±1 μs     | ±2×10 <sup>-8</sup><br>±1 μs    | —                   | ±2×10 <sup>-8</sup><br>±1 μs |
| Method of adjusting time signals                                | Steering <sup>4</sup>        | Steering <sup>4</sup>         | By steps of 50 ms <sup>2</sup> | Adjusted to mean of time signals | Steering <sup>4</sup>           | —                   | Steering <sup>4</sup>        |

<sup>1</sup> Maximum values, reduced power is used on certain frequencies and on certain days, <sup>2</sup> 5 cycles of 1,000 cps modulation pulses, <sup>3</sup> 440 and 600 cps alternately, <sup>4</sup> No phase adjustment to the signals themselves, <sup>5</sup> Transmission by the Union Observatory (Union of South Africa), <sup>6</sup> Interruptions for short periods, <sup>7</sup> 100 cycles of 1,000 cps modulation pulses, <sup>8</sup> In relation to WWV, <sup>9</sup> Interruption from the 15th to the 20th minutes of each hour, <sup>10</sup> Transmission on 60 ks also, <sup>11</sup> The 1st of the month, if necessary, <sup>12</sup> See carrier frequencies, <sup>13</sup> From 0700 to 2300 U.T., <sup>14</sup> Mondays, <sup>15</sup> Wednesdays, <sup>16</sup> Transmissions on 4 and 8 mc too, <sup>17</sup> Interruptions during 20 ms, <sup>18</sup> Maximum radiation: North-East and South-West, <sup>19</sup> Tuesdays, <sup>20</sup> From 0800 to 1100 and from 1300 to 1600 U.T., <sup>21</sup> 440 and 100 cps alternately, <sup>22</sup> Transmission by the Belgian Royal Observatory.

present time it seems safe to assume that the spectrum lines discussed above will be the first for which practical application will be found as frequency standards.

#### STANDARD FREQUENCY BROADCASTS

Standardized radio frequencies are now broadcast by a number of agencies in various nations,<sup>57, 58</sup> and usually include time signals. Table I, above, provided by the International Radio Consultative Committee, through the courtesy of B. Decaux, International Radio Consultative Committee Study Group VII, gives the principal characteristics of standard-frequency and time-signal stations. This table is correct as of August, 1954.

#### CHANGES IN WWV TRANSMISSIONS<sup>59</sup>

The presently used method of adjustment of the frequency of WWV is a slight modification of the method described in a previous reference,<sup>25</sup> namely, that the frequency of the standard-frequency oscillator is steered to keep Universal Time as determined by the

<sup>58</sup> H. B. Law, "Standard frequency transmission equipment at Rugby radio station," *Proc. IEE*, vol. 102, part 3, pp. 166-173; March, 1955.

<sup>59</sup> U. S. Bureau of Standards Letter Circular LC 1009, and Supplement; December 1, 1954.

U. S. Naval Observatory, which advises WWV on regulation of the oscillator. The slight modification is that the frequency is readjusted by no more than  $1 \times 10^{-9}$  parts per day. The frequency of WWV is measured by the National Bureau of Standards at Boulder, Colorado, and the correction data are supplied for the adjustment of the transmitter. Tables of corrections to the broadcast time signals are furnished, as previously, by the Time Service, U. S. Naval Observatory.

The transmitters at WWV are using single-sideband transmission of tone modulation on some of the carrier frequencies. The carrier is radiated continuously by one transmitter unit, the sideband giving the tone modulation being generated from the same frequency-standard oscillator by appropriate frequency dividers, modulators, and filters, and then radiated through a separate antenna.

#### PRECISION FREQUENCY MEASURING EQUIPMENT

Extension of the frequency range and accuracy of precision frequency measuring equipment has, of necessity, been carried out to keep pace with the microwave measurement field and the improved stable oscillators described above.

## PRECISION STANDARD-FREQUENCY CALIBRATORS

As was stated in the section of this paper devoted to time standards, the exact calibration of a quartz-crystal-controlled clock in terms of time is the only method now available for establishing an accurate frequency calibration of the oscillator driving the clock. The accuracy of a frequency measurement carried out by comparison with astronomical time measurements has been limited in the past by the errors in the measurements of time, by the fluctuations in the rate of rotation of the earth itself, and by the fluctuations in the rate of the clock driven by the crystal-controlled oscillator.<sup>5,7,17,25</sup> Clock stability having now been improved by a significant amount, it is expected that the new methods of astronomical observation (see Dual-Rate Moon Position Camera, above) and improvements on the standard methods of observation (improved photographic zenith tube) will result in better data on the relative variations of the variable factors.

In order to provide the high-stability clocks described above, it has been found essential to maintain several quartz-crystal clocks in a frequency-standard installation, and to intercompare these clocks to establish their performance as to relative rate and acceleration, i.e., their rates relative to each other. Current practice for such intercomparison in the United States appears to favor the use of one frequency-standard oscillator slightly off-set from the correct standard frequency to produce beat-notes with the other correctly adjusted, standard-frequency oscillators. Such a system then permits measuring and recording of the relative frequencies of the various oscillators by measuring and recording the beat-note frequency. The precision of measurement of such a system may then be increased by multiplying the frequencies of the oscillators to be compared, and using the beat-note measuring equipment as before.<sup>9,25,60</sup> Beat frequency measuring equipment has been constructed using digital electronic counters to measure the duration of a beat cycle between two standard oscillators, and to record this duration as a voltage produced by a suitable resistance-bridge circuit.<sup>61,62</sup>

Other methods of measurement involving comparison of frequencies have been devised. One system makes use of a frequency-multiplier stage multiplying the frequency,  $f_1$ , of the oscillator to be measured, by 10, and of a similar multiplier stage for multiplying the frequency of the reference standard,  $f_2$ , by 9. The two signals,  $10f_1$  and  $9f_2$ , are then beat together, the beat-note being at approximately the frequency of  $f_1$  or  $f_2$  but containing 10 times the error of  $f_1$  and 9 times the error of  $f_2$ . This process is then repeated except that the original  $9f_2$  signal is used to heterodyne the 10th harmonic of the first beat note. By continuing this process on to the desired point, and subtracting out the original  $f_2$

frequency in the final beating process, the error frequency can be multiplied sufficiently to increase the sensitivity of indication of the frequency change to the required degree. Recording may then be accomplished by utilizing commercially-available recording-type frequency meters.<sup>26</sup>

An interesting variation on these methods makes use of an off-set reference frequency produced by means of a rotary phase-shifter capable of continuous rotation. This phase-shifter is driven at a constant rate by a synchronous-motor-drive operated by the frequency standard, the input frequency from the reference standard thus being shifted by 1 cycle per second for each revolution-per-second of the 360 degree phase shifter. The unknown frequency is then heterodyned by this shifted standard frequency, which has been multiplied to the appropriate value, and the resulting beat note recorded as above.<sup>62</sup>

Although the methods of frequency measurement described above are those most recently described, spark chronographs and other electric time recorders are still widely used, and integrating phase meters, similar to the polyphase modulator device described by Marrison,<sup>9</sup> are sometimes used for comparing the relative frequencies of frequency standard oscillators.

## MICROWAVE FREQUENCY MEASURING EQUIPMENT

Accurate measurements of frequencies in the microwave range require apparatus for the generation of standard frequencies and for comparison of these frequencies with the unknown frequencies to be measured, with appropriate interpolating equipment to provide accurate measurement over a continuous range of frequencies. Apparatus for precision frequency measurement in the microwave region generally includes (1) frequency multipliers or harmonic generators to produce harmonics of known standard frequencies, and (2) a receiver or detector for mixing the unknown signal with the standard frequency in order to produce a beat frequency, which is then measured by (3) an interpolation system.<sup>18,63-65</sup> Application of frequency-scanning or spectrum-analyzer techniques to the detector unit has been used to improve ease of operation. Digital electronic counters have been applied to the problem of measuring the beat-note for interpolation purposes.

The most effective way presently available for generating microwave harmonics of standard frequencies appears to be by means of the use of crystal diodes as harmonic generators.<sup>61-66</sup> The driving power for a crystal-diode harmonic generator is usually furnished by a conventional negative-grid vacuum-tube frequency-multiplier chain,<sup>61</sup> although klystrons are used at the extreme end of the range.<sup>65</sup> Application of crystal-diode

<sup>63</sup> R. G. Talpey and Harold Goldberg, "A microwave frequency standard," *Proc. IRE*, vol. 35, pp. 965-969; September, 1947.

<sup>64</sup> C. G. Montgomery, Ed., "Technique of Microwave Measurements," McGraw-Hill Book Co., New York, N. Y., pp. 343-375; 1947.

<sup>65</sup> L. J. Rueger and A. E. Wilson, "The microwave frequency standard," *Radio-Electronic Engrg*, pp. 5-ff.; March, 1953.

<sup>66</sup> F. D. Lewis, "Harmonic generation in the U-H-F region by means of germanium crystal diodes," *Gen. Rad. Experimenter*, vol. 26, pp. 6-8; July, 1951.

<sup>60</sup> J. M. Shaull, "High precision automatic frequency comparator and recorder," *Tele-Tech*, vol. 14, pp. 58 ff.; January, 1955.

<sup>61</sup> J. M. Shaull, "Frequency multipliers and converters for measurement and control," *Tele-Tech*, vol. 14, pp. 86 ff.; April, 1955.

<sup>62</sup> J. McA. Steele, "The standard frequency monitor at the national physical laboratory," *Proc. IEE*, vol. 102, part 3, pp. 155-165 (with discussion); March, 1955.



harmonic generators has produced some relatively simple calibrating equipment covering frequencies up to 10,000 mc. (Model 100, Presto Recording Corp., Paramus, New Jersey).

The use of locked-oscillators in frequency-multiplier systems has been extended to the microwave range, one piece of apparatus of this type designed specifically for microwave measurement purposes now commercially available (Model FM-4, Gertsch Products Inc., Los Angeles, California).

### FREQUENCY DIVIDERS

Although many frequency measurement systems require frequency multipliers to reach the microwave region, it is also possible to use a microwave oscillator as a source and to divide its frequency for the operation of auxiliary measuring equipment, such as interpolation systems, and clock mechanisms. The regenerative-modulator divider circuit<sup>67</sup> appears to be well suited to use with presently available microwave components.<sup>68</sup> Frequency divider systems operating at lower frequencies can have a wider choice of circuits, regenerative-modulator dividers,<sup>9</sup> multivibrators,<sup>20</sup> and counter-type dividers<sup>69-71</sup> being widely used.

### DECADE FREQUENCY GENERATORS

Standard-frequency oscillators of extremely high stability are usually constructed in such a manner that their frequency of operation can be adjusted by relatively small amounts only.<sup>66</sup> Hence for measurement purposes, it is desirable to be able to generate frequencies controlled by the reference standard oscillator in order to provide known standard frequencies in the region in which it is desired to make measurements.

The easiest solution to this problem requires only a harmonic generator, or distorter, which can be tuned to the harmonic desired. This solution is usually inadequate for general measurement purposes since only a narrow range is covered at any one harmonic, and the exact calibration of this range must be established during the measurement. Furthermore, even though the range covered is narrow, the harmonics of lower-frequency stages of the system frequently interfere to cause ambiguity and difficulty in identification of the harmonic actually desired.

If the entire range of harmonics of a standard frequency is available simultaneously, it is usually possible to count the intervals from a known reference point. This system is widely used in commercial frequency-standard apparatus.

<sup>67</sup> R. L. Miller, "Fractional frequency generation utilizing regenerative modulation," *Proc. IRE*, vol. 27, pp. 446-457; July, 1939.

<sup>68</sup> H. Lyons, "Microwave frequency dividers," *Jour. Appl. Phys.*, vol. 21, pp. 59-60; January, 1950.

<sup>69</sup> R. W. Frank, "A computer-type decade frequency synthesizer," 1954 IRE CONVENTION RECORD, PART 10, "Instrumentation and Industrial Electronics," p. 46; 1954.

<sup>70</sup> R. W. Stuart, "A high speed digital frequency divider of arbitrary scale," 1954 IRE CONVENTION RECORD, PART 10, "Instrumentation and Industrial Electronics," p. 52; 1954.

<sup>71</sup> G. K. Jensen and J. E. McGeogh, "Four-decade frequency divider," *Electronics*, vol. 28, pp. 154-155; April, 1955.

As the maximum frequency range of measurements has increased, techniques for improving the facility of identification of a given harmonic frequency have been developed. These techniques have taken the form of tuned selective circuits of narrow bandwidth for selecting an individual harmonic,<sup>72</sup> and of relatively complex systems of harmonic generation, harmonic selection, mixing, and filtering to generate a given frequency relatively free from spurious components. Commercial models of this type of standardized-decade-frequency generator<sup>73</sup> have been produced having good rejection of spurious beat notes and unwanted modulation components.

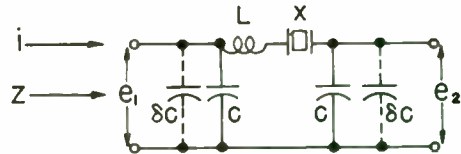

Fig. 19—Case I.

### APPENDIX

#### Case I (Fig. 19)

$C, C$  = Shunt capacitive elements (assumed equal).

$L$  = Series inductance to bring crystal to series resonance when  $e_2$  is 180 degrees out of phase with  $i$ .

$X$  = Crystal.

$\delta C, \delta C$  = Output and input capacitances of driving and driven tubes (assumed equal).

$i$  = Input current.

$e_1$  = Input voltage developed.

$e_2$  = Output voltage.

*Crystal Parameters.*<sup>74</sup>

$$Q_x = 2.6 \times 10^6,$$

$$R_x = 100 \Omega,$$

$$L_x = 8.27 \text{ h},$$

$$C_x = 0.000122 \mu\text{mf},$$

$$f = 5 \text{ mc.}$$

*Circuit Analysis* (Assuming crystal operating at series resonance). Let:

$$X_L = \omega L = 2X_c$$

where  $X_L$  is reactance of  $L$ ,  $X_c$  is reactance of one capacitance,  $C$ . The resistance of  $L$  is assumed small enough to be neglected.

$$B = \omega(C + \delta C).$$

Then

$$e_1 = \frac{i (1 - BX_L) + jBR_x}{iB (2 - BX_L) + jBR_x}$$

$$e_2 = \frac{i}{B - BR_x + j(2 - BX_L)}$$

<sup>72</sup> J. M. Shaull, "Wide range decade frequency generator," *Tele-Tech*, vol. 9, p. 36; November, 1950.

<sup>73</sup> The Plessey Co., Ltd., Ilford (Essex), Eng.; A. Schomandl, Munich, Germany; Rohde and Schwarz, Munich, Germany; Telefunken, A. G., Berlin, Germany.

<sup>74</sup> A. W. Warner, "High-frequency crystal units for primary frequency standards," *Proc. IRE*, vol. 40, pp. 1030-1033; Sept. 1952.

For  $e_2$  180 degrees out of phase with  $i$

$$B = \frac{2}{X_L}$$

$$\frac{e_1}{i} = Z = \frac{X_L^2}{4R_x} - j \frac{X_L}{2}$$

$$\frac{e_2}{i} = - \frac{X_L^2}{4R_x}$$

*Numerical Values.*

Let

$$\frac{e_2}{i} = - \frac{X_L^2}{4R_x} = - \frac{100}{3}$$

(This value of transfer impedance is also satisfactory for Case II, thus enabling direct comparison.) Then:

$$X_L = 115.5 \Omega$$

$$L = 3.68 \mu\text{h}$$

If the  $Q$  of  $L$  is 230, which is reasonable for a coil of this inductance at this frequency, then

$$X_L/R_L = 230 = 115.5/R_L$$

$$R_L = \frac{115.5}{230} \approx 0.5 \Omega,$$

which is negligible, as assumed above.

$$C + \delta C = 552 \mu\mu\text{f}.$$

Assume 0.1 per cent change in  $L$ :

$$X_L = 115.5 \times 10^{-3} = 0.1155 \Omega.$$

This change in reactance must be balanced by a change in crystal reactance to correct phase back to original value. This requires a small change of frequency,  $\Delta f$ . For small changes of frequency close to the series resonance frequency, the crystal reactance

$$X_q = X_0 \left( \frac{\omega}{\omega_0} - \frac{\omega_0}{\omega} \right)$$

where  $X_0$  is reactance of crystal inductance,  $X_L$ , at series-resonance frequency;  $X_0 = 2(5 \times 10^6) \times 8.27 = 2.6 \times 10^6 \Omega$ :

$$X_q = X_0 \left( \frac{f + \Delta f}{f} - \frac{f}{f + \Delta f} \right)$$

$$X_0 \frac{(f + \Delta f)^2 - f^2}{f(f + \Delta f)} \cong X_0 \frac{2f\Delta f + \Delta f^2}{f(f + \Delta f)}$$

Neglecting higher order terms,

$$X_q = X_0 \frac{2\Delta f}{f}$$

$$\frac{X_q}{2X_0} = \frac{\Delta f}{f}$$

$X_q$  then must equal  $\Delta X_L$ :

$$\frac{\Delta f}{f} = \frac{\Delta X_L}{2X_0} = \frac{0.1155}{2.6 \times 10^6} = 2 \times 10^{-10}.$$

Assume 0.1 per cent change in each shunt capacitance,  $C$ :

$$\frac{\Delta f}{f} = 2 \times 10^{-10}.$$

(This is equivalent to 0.5  $\mu\mu\text{f}$  in each tube capacitance.)

Assume 1  $\mu\mu\text{f}$  change in one tube capacitance:

$$\frac{\Delta f}{f} = 2 \times 10^{-10}.$$

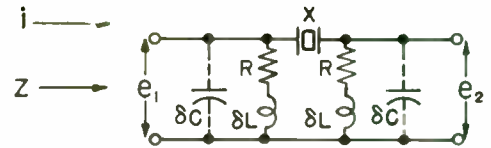

Fig. 20—Case II.

*Case II (Fig. 20)*

$R, R$  = Shunt resistive elements,  $X$  = crystal,  $\delta C, \delta C$  = output and input capacitances of driving and driven tubes, assumed equal;  $\delta L, \delta L$  = compensating inductances,  $i$  = input current,  $e_1$  = input voltage developed, and  $e_2$  = output voltage.

*Crystal Parameters.* Same as Case I.

*Circuit Analysis.*  $e_2$  will be in phase with  $i$  when crystal is at series resonance if the shunt impedances are both resistive. This occurs when

$$L = R^2 \delta C$$

$$\frac{e_1}{i} = \frac{R(R + R_x)}{2R + R_x}$$

$$\frac{e_2}{i} = \frac{R^2}{2R + R_x}$$

*Numerical Values.* Let:

$$\frac{e_2}{i} = \frac{R^2}{2R + R_x} = \frac{100}{3}$$

Then:

$$R = 100 \Omega.$$

Assume:

$$C = 10 \mu\mu\text{f},$$

then

$$L = 0.1 \mu\text{h} = R^2 C.$$

Assume 0.1 per cent change in each shunt resistance,  $R$ :

$$\frac{\Delta(2R^2 \delta C)}{L_x} = 4.8 \times 10^{-11},$$

$$\frac{\Delta f}{f} = 2 \times 10^{-11}.$$

Assume 0.1 per cent change in each compensating inductance,  $\delta L$ :

$$\frac{\Delta f}{f} = 1 \times 10^{-11}.$$

Assume 1  $\mu\mu\text{f}$  change in one tube capacitance,  $\delta C$ :

$$\frac{\Delta f}{f} = 6 \times 10^{-10}.$$

### Recapitulation

On the assumption that these circuits operate so that the crystal is at series resonance, and that the transfer impedance  $e_2/i$  is the same for both (100/3), there is little to choose between them. Case II is less sensitive to changes in circuit constants than Case I by an order of magnitude ( $2 \times 10^{-11}$  vs  $2 \times 10^{-10}$ ), but Case I is less sensitive to changes in tube capacitance by half an order of magnitude ( $2 \times 10^{-10}$  vs  $6 \times 10^{-10}$ ).

If over-all stability of  $10^{-9}$  is assumed to be about all that can be reasonably expected, the frequency variations ascribed to the crystal coupling network and associated tube capacitances therefore do not seem to present a problem in either circuit. The next part of the analysis is devoted to the remaining part of the closed loop.

### Loop Closure

Assume: Transconductance of tubes =  $g_m = 1,000 \mu\text{mho} = 10^{-3}$ . Then:

Gain of crystal-coupling-circuit portion

$$= \frac{100}{3} \times 10^{-3} = \frac{1}{30}$$

from grid of driving tube to grid of driven tube. Gain of remainder of closed loop must therefore = 30.

Assume: Two tubes, coupled through simple parallel-resonant circuit, transconductance of tubes =  $g_m = 1,000 \mu\text{mho} = 10^{-3}$ .

$$\text{Gain} = 30 = R_\beta g_m = 10^{-3} R_\beta$$

$$R_\beta = 30 \text{ k}\Omega = 3 \times 10^4$$

where  $R_\beta$  = impedance of coupling network at resonance.

Assume: Interstage capacitance = 20  $\mu\mu\text{f}$ , coil resonant with this capacitance.

$$C_\beta = 20 \mu\mu\text{f}$$

$$X_\beta = 1,592 \Omega \text{ at } 5 \text{ mc}$$

$$L_\beta = 50.7 \mu\text{h}$$

$$Q_\beta = 18.9 \text{ at } 5 \text{ mc}$$

$$\tan \theta_\beta = Q_\beta \left( \frac{\omega_\beta}{\omega} - \frac{\omega}{\omega_\beta} \right),$$

where  $R_\beta$ ,  $C_\beta$  and  $L_\beta$  are tuned-circuit parameters,  $Q_\beta$  is the storage factor at the resonant frequency  $f_\beta = \omega_\beta/2\pi$ , and  $\theta_\beta$  is the phase angle of the coupling system.

Assume: 1  $\mu\mu\text{f}$  change in one tube capacitance

$$\frac{\Delta \omega_\beta}{\omega_\beta} = 2.5 \times 10^{-2}$$

$\tan \theta_\beta = 0.943$  (actual frequency  $f = \omega/2\pi$  assumed constant). For crystal coupling network,

$$\tan \theta_\mu = Q_\mu \left( \frac{\omega_\mu}{\omega} - \frac{\omega}{\omega_\mu} \right),$$

where  $Q_\mu$  is the storage factor at the resonant frequency  $f_\mu = \omega_\mu/2\pi$ , and  $\theta_\mu$  is the effective phase angle of the crystal coupling network.

### Case I

$$Q_\mu = Q_z = 2.6 \times 10^6$$

$$\frac{\Delta f}{f} = 2 \times 10^{-7}$$

### Case II

$$Q_\mu = \frac{2.6 \times 10^6}{3}$$

$$\frac{\Delta f}{f} = 6 \times 10^{-7}.$$

*Recapitulation.* Frequency shift from change in phase-shift of the loop is more important than changes in the crystal coupling network by three orders of magnitude ( $6 \times 10^{-7}$  vs  $6 \times 10^{-10}$ ). Case I is less sensitive than Case II to changes in capacitance in the closing loop by a half order of magnitude because a factor of three in effective  $Q_\mu$  is sacrificed in Case II to work the crystal in and out of shunt resistive elements. Both circuits, however, are seriously limited by phase-shift in the closing loop.

It was noted that the coupling circuit was tuned entirely by the interstage capacitance, but this assumption need not be made. If additional capacitance is added at this point, the effect of a change in tube capacitance on the resonant frequency will be reduced, but the storage factor,  $Q_\beta$ , and consequently the rate of change of phase with frequency will be increased to the same extent. The phase shift introduced by a given change in tube capacitance will therefore remain the same, whether or not additional shunt capacitance is employed. If no extra capacitance is added the effect of any change in inductance is a minimum, however, and can be ignored.

It should be noted that in Case II there is zero phase shift in the crystal coupling network, whereas in Case I there is 180 degrees phase shift. Case II is therefore more readily adaptable to two-tube operation. A reasonably simple solution for Case I might be the use of a cathode-coupled twin triode for one of the two tubes.

Coupling systems designed for lower rate of change of phase shift might be worked out, but it would seem a

more promising avenue of approach to eliminate the network entirely by going to a single-tube circuit in which the driven and driving tube for the crystal coupling network were one and the same.

#### Single-Tube Version

To make a single-tube version, the reverse problem exists regarding phase-shift in the Case II and Case I circuits. Case I is more readily adaptable than Case II because of its 180 degree phase shift in the crystal coupling network. To make the Case II circuit work it would be necessary to go to some such expedient as use of a cathode-coupled twin triode.

Since there is no additional gain provided elsewhere, the gain from the grid of the "driving" tube to the grid of the "driven" tube must be unity (actually the same grid), and this specification therefore determines the transfer impedance of the crystal coupling network in terms of the tube transconductance. Assume:

$$\begin{aligned} \text{Transconductance} &= g_m = 1,000 \mu\text{mho} = 10^{-3} \\ i &= i_p = -g_m e_g = -10^{-3} e_g = -10^{-3} e_2. \end{aligned}$$

#### Case III

$$\begin{aligned} \frac{e_2}{i} &= -10^3 = \frac{-X_L^2}{4R_x}, \\ X_L &= 632 \Omega \\ L &= 20.1 \mu\text{h} \\ C, C &= 101 \mu\mu\text{f} \end{aligned}$$

Assume 0.1 per cent change in  $L$ :

$$\frac{\Delta f}{f} = 1 \times 10^{-9}.$$

Assume 0.1 per cent change in each shunt capacitance,  $C$ :

$$\frac{\Delta f}{f} = 1 \times 10^{-9}.$$

Assume 1  $\mu\mu\text{f}$  change in one tube capacitance:

$$\frac{\Delta f}{f} = 6 \times 10^{-9}.$$

#### Case IV (Two-Tube Circuit)

$$\begin{aligned} \frac{e_2}{i} &= 10^3 = \frac{R^2}{2R + R_x} \\ R &= 2,050 \Omega \\ \delta L &= 42 \mu\text{h} = R^2 \delta C. \end{aligned}$$

Assume 0.1 per cent change in each shunt resistance,  $R$ :

$$\begin{aligned} \frac{\Delta(2R^2\delta C)}{L_x} &= 2 \times 10^{-8} \\ \frac{\Delta f}{f} &= 1 \times 10^{-8}. \end{aligned}$$

Assume 0.1 per cent change in each compensating inductance,  $\delta L$ :

$$\frac{\Delta f}{f} = 5 \times 10^{-9}.$$

Assume 1  $\mu\mu\text{f}$  change in one tube capacitance,  $\delta C$ :

$$\frac{\Delta f}{f} = 3 \times 10^{-7}.$$

*Recapitulation.* In the single-tube version, Case I is markedly superior to the Case II circuit. To obtain the necessary gain, the impedance level of the crystal coupling network of Case II becomes too high, and dependence of frequency upon circuit parameters is substantial. The worst variation comes from changes arising from variations in tube capacitance, which are worse than those in Case I by almost two orders of magnitude.

In the single-tube, Case I, oscillator (Case III), however, the changes in frequency from this source are still only  $6 \times 10^{-9}$ , and it seems probable that sensible circuit design could reduce tube capacitance variations to about 0.1  $\mu\mu\text{f}$ , rather than 1  $\mu\mu\text{f}$ . Requirements of 0.1 per cent stability in circuit parameters are not unreasonable, and it therefore seems feasible to construct an oscillator of this type to yield circuit stability of  $10^{-9}$ .

The advantage of using dc control of effective  $g_m$  for amplitude control, rather than a thermal bridge, is indicated by the sensitivity of the frequency to phase shift in circuits other than the crystal coupling network. Anything that reduces gain around the loop requires increased gain elsewhere, and this gain can only be obtained at the expense of great care in maintaining low rate of change of phase shift. It seems probable that the simple Case III circuit, using one oscillator tube and a stable, amplified, delayed AVC system with semi-starved operation of the oscillator tube will give not only an inexpensive solution but, perhaps, the best one.

#### ACKNOWLEDGMENT

The author wishes to thank Dr. W. D. George and Dr. Harold Lyons of the National Bureau of Standards, Dr. William Markowitz of the U. S. Naval Observatory, Dr. A. E. Gerber of the Signal Corps Engineering Laboratory, Messrs. R. A. Sykes, F. G. Merrill, A. E. Warner and J. P. Griffin of Bell Telephone Laboratories, Dr. C. H. Townes of Columbia University, Dr. J. R. Zacharias of M.I.T., Dr. R. T. Daley of National Company and Dr. J. G. Yates for their kind assistance in supplying information for this paper. Thanks are also due to Messrs. H. T. Mitchell of the British Post Office, Norman Lea of Marconi's Wireless Telegraph Co., Ltd., and H. J. Finden of the Plessey Company, Ltd., for supplying information on recent developments in Great Britain, to Mr. J. K. Clapp of the General Radio Company, and to Dr. D. B. Sinclair, who provided the circuit analysis given in the Appendix.

# IRE Standards on Industrial Electronics: Definitions of Industrial Electronics Terms, 1955\*

## COMMITTEE PERSONNEL

### Subcommittee on Definitions for Induction and Dielectric Heating

C. F. SPITZER, *Chairman*

G. P. Bosomworth  
J. M. Cage

J. L. Dalke  
E. Mittelmann

W. Richter

### Industrial Electronics Committee 1951-55

J. E. EISELEIN, *Chairman*, 1954-55

J. L. DALKE, *Chairman*, 1951-54

E. MITTELMANN, *Vice-Chairman*,  
1951-55

G. M. Bosomworth  
Cledo Brunetti  
J. M. Cage  
E. W. Chapin  
D. W. Cottle  
J. L. Dalke

J. E. Eiselein  
C. W. Frick  
H. C. Gillespie  
G. W. Klingaman  
T. P. Kinn  
H. R. Meahl  
M. P. Vore

J. H. Mennie  
E. Mittelmann  
P. E. Ohmart  
H. W. Parker  
S. I. Rambo  
W. Richter

E. H. Schulz  
C. F. Spitzer  
W. C. Rudd  
W. R. Thurston  
R. S. Tucker  
L. P. Tuckerman

J. Weinberger

### Standards Committee 1955-56

E. WEBER, *Chairman*

M. W. BALDWIN, JR., *Vice-Chairman*

L. G. CUMMING, *Vice-Chairman*

R. F. SHEA, *Vice-Chairman*

J. Avins  
W. R. Bennett  
J. G. Brainerd  
P. S. Carter  
P. S. Christaldi  
A. G. Clavier  
J. E. Eiselein  
A. W. Friend

V. M. Graham  
R. A. Hackbusch  
H. C. Hardy  
P. J. Herbst  
Hans Jaffe  
Henry Jasik  
A. G. Jensen  
J. L. Jones

J. G. Kreer, Jr.  
E. A. Laport  
A. A. Macdonald  
Wayne Mason  
D. E. Maxwell  
K. R. McConnell  
H. R. Mimno  
M. G. Morgan

G. A. Morton  
H. L. Owens  
C. H. Page  
P. A. Redhead  
R. Serrell  
R. M. Showers  
H. R. Terhune  
J. E. Ward

W. T. Wintringham

### Definitions Co-ordinator

M. W. BALDWIN, JR.

### AIEE Subcommittee on Induction and Dielectric Heating

W. C. RUDD, *Chairman*, 1954-55

J. EISELEIN, *Chairman*, 1953-54

R. M. Baker  
G. M. Bosomworth  
E. W. Chapin  
F. T. Chesnut  
L. M. Duryee  
J. E. Eiselein  
C. W. Frick

G. W. Klingaman  
W. H. Hickok  
R. J. Hunn  
T. P. Kinn  
E. Mittelmann  
W. Paulen  
W. C. Rudd

G. W. Scott, Jr.  
J. T. Thwaites  
R. S. Tucker  
J. T. Vaughan  
D. E. Watts  
O. Weitmann

\* Reprints of this Standard, 55 IRE 10.S1 may be purchased while available from the Institute of Radio Engineers, 1 East 79 Street, New York, N. Y., at \$0.50 per copy. A 20 per cent discount will be allowed for 100 or more copies mailed to one address.

**Applicator** (Applicator Electrodes), (*Dielectric Heating* usage). Appropriately shaped conducting surfaces between which is established an alternating electric field for the purpose of producing *dielectric heating*.

**Applicator Impedance, Loaded** (*Dielectric Heating* usage). See *Loaded Applicator Impedance*.

**Applicator Impedance, Unloaded** (*Dielectric Heating* usage). See *Unloaded Applicator Impedance*.

**Autoregulation Induction Heater.** An induction heater in which a desired control is effected by the change in characteristics of a magnetic charge as it is heated at or near its *Curie point*.

**Channel, Melting.** See *Melting Channel*.

**Charge.** See *Load (Induction and Dielectric Heating usage)*.

**Contact, Load.** See *Load Switch (Load Contactor)*.

**Converter, Mercury Arc, Pool Cathode.** See *Pool Cathode Mercury Arc Converter*.

**Converter, Quenched Spark Gap.** See *Quenched Spark Gap Converter*.

**Converter, Mercury Hydrogen Spark Gap.** See *Mercury Hydrogen Spark Gap Converter*.

**Core Type Induction Heater or Furnace.** A device in which a *charge* is heated by induction and a magnetic core links the inducing winding with the charge.

**Coreless Type Induction Heater or Furnace.** A device in which a charge is heated by induction and no magnetic core material links the charge.

Note—Magnetic material may be used elsewhere in the assembly for *flux guiding* purposes.

**Coupling** (*Induction Heating* usage). The percentage of the total magnetic flux produced by an inductor which is effective in heating a *load* or *charge*.

**Curie Point** (*Induction Heating* usage). The temperature in a ferromagnetic material above which the material becomes substantially nonmagnetic.

**Decalescent Point** (of a metal). The temperature at which there is a sudden absorption of heat as the metal is raised in temperature.

**Depth of Heating** (*Dielectric Heating* usage). The depth below the surface of a material in which effective *dielectric heating* can be confined when the *applicator electrodes* are applied adjacent to one surface only.

**Depth of Penetration** (*Induction Heating* usage). The thickness of a layer extending inward from the surface of a conductor, which has the same resistance to direct current as the conductor as a whole has to alternating current of a given frequency.

Note—This term is useful only in cases where the surface is substantially flat.

**Dielectric Dissipation Factor.** The cotangent of the *dielectric phase angle* of a dielectric material.

**Dielectric Heating.** The heating of a nominally insulating material in an alternating electric field due to its internal losses.

**Dielectric Phase Angle.** The angular difference in phase between the sinusoidal alternating voltage applied to a dielectric and the component of the resulting alternating current having the same period as the voltage.

**Dielectric Power Factor.** The cosine of the *dielectric phase angle*.

**Dielectric Strength.** The maximum potential gradient that a material can withstand without rupture.

**Domestic Induction Heater.** A cooking device in which the utensil is heated by current, usually of commercial line frequency, induced in it by a primary inductor associated with it.

**Dual Frequency Induction Heater or Furnace.** A heater in which the *charge* receives energy by induction, simultaneously or successively, from a *work coil* or coils operating at two different frequencies.

**Efficiency, Over-all Electrical.** See *Over-all Electrical Efficiency (Induction and Dielectric Heating usage)*.

**Efficiency, Load Circuit.** See *Load Circuit Efficiency (Induction and Dielectric Heating usage)*.

**Field Strength Meter.** A calibrated radio receiver for measuring field strength.

**Flux Guide** (*Induction Heating* usage). Magnetic material to guide electromagnetic flux in desired parts.

Note—The guides may be used either to direct flux to preferred locations or to prevent the flux from spreading beyond definite regions.

**Gaseous Tube Generator.** A power source comprising a gas-filled electron tube oscillator, a power supply, and associated control equipment.

**Glue Line Heating** (*Dielectric Heating* usage). An arrangement of electrodes designed to give preferential heating to a thin film of material of relatively high loss factor between alternate layers of relatively low loss factor.

**Heater Coil.** See *Load Coil (Induction Heating usage)*.

**Heating Pattern.** The distribution of temperature in a *load* or *charge*.

**Heating Station.** Location which includes *work coil* or *applicator* and its associated production equipment.

**High-Frequency Induction Heater or Furnace.** A device for causing electric current flow in a *charge* to be heated, the frequency of the current being higher than that customarily distributed over commercial networks.

**Horizontal Ring Induction Furnace.** A device for melting metal comprising an angular horizontally-placed open trough or *melting channel*, a primary inductor winding and a magnetic core which links the *melting channel* with the primary winding.

**Hysteresis Heater.** An induction device in which a *charge* or a muffle about the *charge* is heated principally by hysteresis losses due to a magnetic flux which is produced in it.

Note—A distinction should be made between *hysteresis heating* and the enhanced *induction heating* in a *magnetic charge*.

**Induced Current** (*Induction Heating* usage). Current in a conductor due to the application of a time-varying electro magnetic field.

**Induction-Conduction Heater.** A heating device in which electric current is conducted through but is restricted by induction to a preferred path in a *charge*.

**Induction Heating.** The heating of a nominally conducting material in a varying electro magnetic field due to its internal losses.

**Induction Ring Heater.** A form of *core-type induction heater* adapted principally for heating electrically conducting *charges* of ring or loop form, the core being open or separable to facilitate linking the *charge*.

**Interference** (*Induction* or *Dielectric Heating* usage). The disturbance of any electric circuit carrying intelligence, caused by the transfer of energy from an *induction* or *dielectric heating* equipment.

**Load** (*Induction* and *Dielectric Heating* usage) (*Charge*). The material to be heated.

**Load Circuit** (*Induction* and *Dielectric Heating* usage). The network including leads connected to the output terminals of the generator.

Note—The load circuit consists of the coupling network and the load material at the proper position for heating.

**Load Circuit Efficiency** (*Induction* and *Dielectric Heating* usage). The ratio of the power absorbed by the *load* to the power delivered at the generator output terminals.

**Load Coil** (*Induction Heating* usage). An electric conductor which, when energized with alternating current, is adapted to deliver energy by induction to a *charge* to be heated.

**Load Leads** (*Induction* and *Dielectric Heating* usage). The connections or transmission line between the power source or generator and *load*, *load coil* or *applicator*.

**Load Matching** (*Induction* and *Dielectric Heating* usage). The process of adjustment of the *load circuit* impedance to produce the desired energy transfer from the power source to the *load*.

**Load Matching Network** (*Induction* and *Dielectric Heating* usage). An electric network for accomplishing *load matching*.

**Load Matching Switch** (*Induction* and *Dielectric Heating* usage). A switch in the *load matching network* to alter its characteristics to compensate for some sudden change in the *load* characteristics, such as passing through the *Curie point*.

**Load Switch** (*Load Contactor*). The switch or contactor in an *induction heating* circuit which connects the high-frequency generator or power source to the *heater coil* or *load circuit*.

**Load Transfer Switch.** A switch to connect a generator or power source optionally to one or another *load circuit*.

**Loaded Applicator Impedance** (*Dielectric Heating* usage). The complex impedance measured at the point of application with the load material at the proper position for heating, at a specified frequency.

**Low-Frequency Induction Heater or Furnace.** A device for inducing current flow of commercial power line frequency in a *charge* to be heated.

**Magnetron.** An electron tube characterized by the interaction of electrons with the electric field of a circuit element in crossed steady electric and magnetic fields to produce ac power output.

**Melting Channel.** The restricted portion of the *charge* in a *submerged resistor* or *horizontal ring induction furnace* in which the induced currents are concentrated to effect high energy absorption and melting of the *charge*.

**Mercury Arc Converter, Pool Cathode.** See *Pool Cathode Mercury Arc Converter*.

**Mercury Hydrogen Spark Gap Converter.** A spark gap generator or power source which utilizes the oscillatory discharge of a capacitor through an inductor and a spark gap as a source of radio-frequency power. The spark gap comprises a solid electrode and a pool of mercury in a hydrogen atmosphere.

**Motor Effect.** The repulsion force exerted between adjacent conductors carrying currents in opposite directions.

**Motor Field Induction Heater.** An *induction heater* in which the inducing winding typifies that of an induction motor of rotary or linear design.

**Oscillator.** A nonrotating device for producing alternating current, the output frequency of which is determined by the characteristics of the device.

**Over-all Electrical Efficiency** (*Induction* and *Dielectric Heating* usage). The ratio of the power absorbed by the load material to the total power drawn from the supply lines.

**Pad Electrode.** One of a pair of electrode plates between which a *load* is placed for *dielectric heating*.

**Pinch Effect.** The result of an electromechanical force that constricts, and sometimes momentarily ruptures, a molten conductor carrying current at high density.

**Pool Cathode Mercury Arc Converter.** A frequency converter using a mercury arc power converter.

**Proximity Effect.** The redistribution of current in a conductor brought about by the presence of another conductor.

**Quenched Spark Gap Converter.** A spark gap generator or power source which utilizes the oscillatory discharge of a capacitor through an inductor and a spark gap as a source of radio frequency power. The spark gap comprises one or more closely-spaced gaps operating in series.

**Radio Frequency Converter.** A power source for producing electrical power at a frequency of 10 kc and above.

**Radio Frequency Generator—Electron Tube Type** (*Industrial and Dielectric Heating* usage). A power source comprising an electron tube oscillator, an amplifier if used, a power supply and associated control equipment.

**Recalescent Point** (of a metal). The temperature at which there is a sudden liberation of heat as the metal is lowered in temperature.

**Rotary Generator** (*Induction Heating* usage). An alternating-current generator adapted to be rotated by a motor or prime mover.

**Shield.** Material used to suppress the effect of an electric or magnetic field within or beyond definite regions.

**Stirring Effect.** The circulation in a molten *charge* due to the combined forces of *motor* and *pinch effects*.

**Submerged Resistor Induction Furnace.** A device for melting metal comprising a melting hearth, a depending *melting channel* closed through the hearth, a primary induction winding and a magnetic core which links the *melting channel* and the primary winding.

**Unloaded Applicator Impedance** (*Dielectric Heating* usage). The complex impedance measured at the point of application, without the *load* material in position, at a specified frequency.

**Wave Heating.** The heating of a material by energy absorption from a traveling electro magnetic wave.

**Work Coil.** See *Load Coil* (*Induction Heating* usage).





# IRE Standards on Antennas and Waveguides: Definitions for Waveguide Components, 1955\*

## COMMITTEE PERSONNEL

### Subcommittee on Waveguide and Transmission Line Definitions 1953-55

G. A. DESCHAMPS, *Chairman*, 1954-55  
H. JASIK

P. H. SMITH, *Chairman*, 1953-54  
R. L. Mattingly  
W. Sichak

### Committee on Antennas and Waveguides 1953-56

P. H. SMITH, *Chairman*, 1954-55  
H. JASIK, *Vice-Ch.*, 1954-55

H. JASIK, *Chairman*, 1955-56  
G. A. DESCHAMPS, *Vice-Ch.*, 1955-56

D. C. PORTS, *Chairman*, 1953-54  
P. H. SMITH, *Vice-Ch.*, 1953-54

|                 |                |              |                 |             |
|-----------------|----------------|--------------|-----------------|-------------|
| P. S. Carter    | A. G. Fox      | W. C. Jakes  | R. L. Mattingly | J. Ruze     |
| G. A. Deschamps | S. Frankel     | E. T. Jaynes | A. A. Oliner    | W. Sichak   |
| J. E. Eaton     | A. G. Giordano | O. E. Kienow | K. S. Packard   | G. Sinclair |
| H. A. Finke     | H. Jasik       | P. A. Loth   | D. C. Ports     | P. H. Smith |
|                 | K. Tomiyasu    | W. E. Waller | M. S. Wheeler   |             |

### Standards Committee 1955-56

E. WEBER *Chairman*

|  |                                  |                                     |                 |               |
|--|----------------------------------|-------------------------------------|-----------------|---------------|
| M. W. BALDWIN, JR., <i>Vice-Chairman</i> | R. F. SHEA, <i>Vice-Chairman</i> | L. G. CUMMING, <i>Vice-Chairman</i> |                 |               |
| J. Avins                                 | J. E. Eiselein                   | Hans Jaffe                          | A. A. Macdonald | G. A. Morton  |
| W. R. Bennett                            | A. W. Friend                     | Henry Jasik                         | Wayne Mason     | H. L. Owens   |
| J. G. Brainerd                           | V. M. Graham                     | A. G. Jensen                        | D. E. Maxwell   | C. H. Page    |
| P. S. Carter                             | R. A. Hackbusch                  | J. L. Jones                         | K. R. McConnell | P. A. Redhead |
| P. S. Christaldi                         | H. C. Hardy                      | J. G. Kreer, Jr.                    | H. R. Mimno     | R. Serrell    |
| A. G. Clavier                            | P. J. Herbst                     | E. A. Laport                        | M. G. Morgan    | R. M. Showers |
|  | H. R. Terhune                    | W. T. Wintringham                   | J. E. Ward      |               |

### Definitions Co-ordinator

M. W. BALDWIN, JR.

### INTRODUCTION

A set of definitions of basic waveguide terms prepared by the Technical Committee on Antennas and Waveguides was published as IRE Standards in December, 1953 (53 IRE 2. S1). The present Standards on Waveguide Components, Definitions of Terms, represent an extension of the work of this committee from 1953 to 1955.

Waveguide component terms have not previously been standardized by the IRE; however, with continuing development in this field the need for such definitions has become increasingly apparent. The present list comprises only the more general, basic and established terms. For example, *Waveguide Transformer* is defined but the many specific types of waveguide transformer such as *Double Stub Transformer*, *Quarter-Wave Sleeve Transformer*, *Probe Transformer*, *Eccentric Line Transformer*, and others are not defined.

As used in the following definitions, *Waveguide* is a generic term which includes *transmission line* and *uniconductor waveguides* as special cases. For specific definitions see 53 IRE 2. S1.

### DEFINITIONS

**Attenuator, Waveguide.** A waveguide device for the purpose of producing attenuation by any means, including absorption and reflection.

**Bend, Waveguide.** A section of waveguide in which the direction of the longitudinal axis is changed.

**Butt Joint.** A connection between two waveguides which provides physical contact between the ends of the waveguides in order to maintain electrical continuity.

**Cavity Resonator (in Waveguides).** A resonator formed by a volume of dielectric bounded by reflecting walls.

**Cavity Resonator Frequency Meter.** A cavity resonator used to determine frequency of an electromagnetic wave.

\* Reprints of this Standard, 55 IRE 2.S1, may be purchased while available from The Institute of Radio Engineers, 1 East 79 Street, New York 21, N. Y., at \$0.25 per copy. A 20 per cent discount will be allowed for 100 or more copies mailed to one address.

**Choke Joint.** A connection between two waveguides which provides effective electrical continuity without metallic continuity at the inner walls of the waveguide.

**Connector, Waveguide.** A mechanical device for electrically joining separable parts of a waveguide system.

**Coupling Aperture (Coupling Hole, Coupling Slot).** Aperture in wall of waveguide or *cavity resonator* designed to transfer energy to or from an external circuit.

**Coupling Loop.** A conducting loop projecting into a waveguide or *cavity resonator*, designed to transfer energy to or from an external circuit.

**Coupling Probe.** A probe projecting into a waveguide or *cavity resonator* designed to transfer energy to or from an external circuit.

**Directional Coupler.** A four-branch junction consisting of two waveguides coupled together in a manner such that a single traveling wave in either guide will induce a single traveling wave in the other, direction of latter wave being determined by direction of the former.

**E-H Tuner.** An *E-II tee* used for impedance transformation having two arms terminated in adjustable plungers.

**E-H Tee.** A junction composed of a combination of *E* and *II-plane tee* junctions having a common point of intersection with the main guide.

**E-plane Bend.** For a rectangular uniconductor waveguide operating in the dominant mode, a bend in which the longitudinal axis of the guide remains in a plane parallel to the electric field vector throughout the bend.

**E-plane Tee Junction.** For a rectangular uniconductor waveguide, a tee junction of which the electric field vector of the dominant wave of each arm is parallel to the plane of the longitudinal axes of the guides.

**H-plane Bend.** For a rectangular uniconductor waveguide operating in the dominant mode, a bend in which the longitudinal axis of the guide remains in a plane parallel to the plane of the magnetic field vector throughout the bend.

**H-plane Tee Junction.** For a rectangular uniconductor waveguide, a tee junction of which the magnetic field vector of the dominant wave of each arm is parallel to the plane of the longitudinal axes of the guides.

**Hybrid Junction.** Waveguide arrangement with four branches which, when branches are properly terminated, has the property that energy can be transferred from any one branch into only two of remaining three.

Note—In common usage, this energy is equally divided between the two branches.

**Hybrid Tee.** A *hybrid junction* composed of an *E-H Tee* with internal matching elements, which is reflectionless for a wave propagating into the junction from any arm when the other three arms are match terminated.

**Iris (Diaphragm).** In a waveguide, a conducting plate or plates, of thickness small compared to a wavelength, occupying a part of the cross section of the waveguide.

Note—When only a single mode can be supported an *iris* acts substantially as a shunt admittance.

**Line Stretcher.** A section of waveguide whose physical length is variable.

**Magic Tee.** See *Hybrid Tee*.

**Mode Filter.** A selective device designed to pass energy along a waveguide in one or more modes of propagation and substantially reduce energy carried by other modes.

**Mode Transducer (Mode Transformer).** A device for transforming an electromagnetic wave from one mode of propagation to another.

**Phase Shifter, Waveguide.** A device for adjusting the phase of a particular field component (or current or voltage) at output of device relative to the phase of that field component (or current or voltage) at the input.

**Plunger, Waveguide.** In a waveguide, a longitudinally movable obstacle which reflects essentially all the incident energy.

**Post, Waveguide.** In a waveguide, a cylindrical rod placed in a transverse plane of the waveguide and behaving substantially as a shunt susceptance.

**Resonator, Waveguide (Resonant Element).** A waveguide device primarily intended for storing oscillating electromagnetic energy.

**Rotating Joint.** A coupling for transmission of electromagnetic energy between two waveguide structures designed to permit mechanical rotation of one structure.

**Series Tee Junction.** A *tee junction* having an equivalent circuit in which the impedance of the branch guide is predominantly in series with the impedance of the main guide at the junction.

**Shunt Tee Junction.** A *tee junction* having an equivalent circuit in which the impedance of the branch guide is predominantly in parallel with the impedance of the main guide at the junction.

**Slug Tuner.** A *waveguide tuner* containing one or more longitudinally adjustable pieces of metal or dielectric.

**Stub, Waveguide.** An auxiliary section of waveguide with an essentially nondissipative termination and joined at some angle with the main section of waveguide.

**Taper, Waveguide.** A section of *tapered waveguide*.

**Tapered Waveguide.** A waveguide in which a physical or electrical characteristic changes continuously with distance along the axis of the guide.

**Tee Junction.** A junction of waveguides in which the longitudinal guide axes form a T.

Note—The guide which continues through the junction is the main guide; the guide which terminates at a junction is the branch guide.

**Transformer, Waveguide.** A device, usually fixed, added to a waveguide for the purpose of impedance transformation.

**Tuner, Waveguide.** An adjustable device added to a waveguide for the purpose of impedance transformation.

**Tuning Probe.** An essentially lossless probe of adjustable penetration extending through the wall of the waveguide or *cavity resonator*.

**Twist, Waveguide.** A waveguide section in which there is a progressive rotation of the cross section about the longitudinal axis.

**Wye Junction.** A junction of waveguides such that the longitudinal guide axes form a Y.

# High-Frequency Power Gain of Junction Transistors\*

R. L. PRITCHARD†, SENIOR MEMBER, IRE

**Summary**—The purpose of this paper is three-fold. First, the subject of maximum available power gain at high frequencies is discussed briefly. Also, maximum gain for a four-terminal network driven by a generator having a purely resistive internal impedance is calculated in terms of *small-signal parameters* of the network. Then a theoretical model of a junction transistor comprising the ideal one-dimensional model plus a base impedance, which may be complex and frequency-dependent as in the case of grown-junction transistors, is introduced for the network to obtain an expression for maximum available power gain in terms of *fundamental device parameters*. Experimental results, which are given for a number of grown-junction transistors, tend to confirm the theoretical expression. Finally, an idealized model of a grown-junction transistor is introduced, and theoretical power gain is calculated in terms of *physical parameters*. Such calculations show, for example, that 30 db of gain should be available at 5 mc and that such transistors should be capable of oscillating up to several hundred mc.

## INTRODUCTION

THE SUBJECT of the high-frequency performance of a junction transistor has received considerable attention during the past few years. Variation of transistor parameters with frequency has been discussed in some detail,<sup>1</sup> and recently several writers have presented equations for relating high-frequency power gain to transistor parameters for transistors having constant base-spreading resistance.<sup>2</sup> The purpose of the present paper is three-fold. First, the different ways in which power gain at high frequencies may be defined is discussed briefly. Then an equation is presented for calculating high-frequency power gain in terms of *four-pole* parameters for a transistor which is conjugate-matched at the output and which is driven by a generator having a purely resistive internal impedance. Second, a new, different expression relating high-frequency gain to *fundamental device* parameters is presented for the case of junction transistors in which base-spreading resistance is *not constant* at high frequencies, e.g., as in *grown-junction* transistors. Results of measurements of

power gain for approximately 60 grown-junction transistors are shown which tend to confirm the validity of this theoretical expression. Third, values of high-frequency power gain are calculated for an idealized theoretical model of a grown-junction transistor triode, in order to illustrate what upper limit exists on power gain from such transistors. For example, calculations show that 30 db of power gain should be available at 5 mc, and that such transistors should be capable of oscillating up to several hundred mc.

## DEFINITION OF HIGH-FREQUENCY POWER GAIN

At high frequencies, there is no clear-cut interpretation for the maximum gain of a junction transistor, since under proper terminations a transistor may oscillate. Hence, maximum gain could be infinity. Accordingly, in general, gain must be maximized subject to certain constraints. One measure of power gain is the unilateral power gain, or *U* function, proposed by Mason.<sup>3</sup> On the other hand, J. G. Linvill has derived an expression for the maximum gain available from a general linear four-terminal network in terms of the series-parallel *h* parameters.<sup>4</sup> This expression yields a value of gain within 3 db of the maximum possible gain available, unless the transistor would oscillate under proper terminations. By an additional simple calculation, it is possible to determine whether or not oscillations could be obtained, i.e., whether or not the transistor is potentially unstable.



Fig. 1—Four-terminal network with variable load admittance and with generator having resistive internal impedance.

Alternatively, the writer has calculated the maximum gain available from a four-terminal network when driven by a generator having a purely *resistive* internal impedance, as shown in Fig. 1. The importance of such a calculation lies in the fact that experimental determination of high-frequency gain often is made as shown in Fig. 1.<sup>5</sup> By employing this type of measurement, it is

\* Original manuscript received by the IRE, March 7, 1955; revised manuscript received, June 20, 1955.

† General Electric Research Laboratory, The Knolls, Schenectady, N. Y.

<sup>1</sup> For example, J. M. Early, "Design theory of junction transistors," *Bell Sys. Tech. Jour.*, vol. 32, pp. 1271-1312; November, 1953.

R. L. Pritchard, "Frequency variations of junction-transistor parameters," *PROC. IRE*, vol. 42, pp. 786-799; May, 1954. Presented at Transistor Research Conference, State College, Pa.; July 6, 1953.

H. Johnson, RCA Laboratories, unpublished paper presented at Transistor Research Conference, State College, Pa.; July 6, 1953.

<sup>2</sup> R. L. Pritchard, "Frequency Response of Grounded-Base and Grounded-Emitter Junction Transistors," presented at AIEE Winter Meeting, New York; January 22, 1954.

J. M. Early, "*Pnp* and *npn* junction transistor triodes," *Bell Sys. Tech. Jour.*, vol. 33, p. 519; May, 1954.

L. J. Giacoletto, "The study and design of alloyed-junction transistors," 1954 IRE CONVENTION RECORD, Part 3, p. 102. Also, "Study of *p-n-p* alloy junction-transistor from dc through medium frequencies," *RCA Rev.*, vol. 15, p. 555; December, 1954.

H. Statz, E. A. Guillemin, and R. A. Pucel, "Design considerations of junction transistors at higher frequencies," *PROC. IRE*, vol. 42, p. 1627; November, 1954.

<sup>3</sup> S. J. Mason, "Power gain in feedback amplifiers," *TRANS. IRE*, vol. CT-1, pp. 20-25; June, 1954. Note, however, that Mason points out that under certain conditions (of lossy coupling) a transistor can yield more gain than that calculated from the *U* function (corresponding to lossless coupling).

<sup>4</sup> J. G. Linvill, "The Relationship of Transistor Parameters to Amplifier Performance," presented at IRE-AIEE—University of Pennsylvania Conference on Transistor Circuits, Philadelphia, Pa., February 17, 1955.

<sup>5</sup> See, for example, J. I. Pankove and C. W. Mueller, "A *p-n-p* triode alloy-junction transistor for radio-frequency amplification," *PROC. IRE*, vol. 42, p. 390; February, 1954; *RCA Rev.*, vol. 14, p. 596; December, 1953.

often possible to avoid oscillations which otherwise might result if an attempt is made to conjugate match at both output and input terminals simultaneously. The very important question of how much gain can be obtained with a potentially unstable transistor (gain vs stability question) is *not* considered in this paper. What *is* required here is a relationship between network parameters and network performance. For this purpose, (1), based on the circuit of Fig. 1, is quite satisfactory (although Linvill's result<sup>4</sup> is more general), and experimental results can be obtained easily with the circuit of Fig. 1. Furthermore, as noted below, under certain conditions (which are satisfied quite well by most junction transistors in grounded-emitter operation at *high* frequencies) the maximum gain available from the circuit of Fig. 1 will be within a few db of the maximum gain available from the transistor under *any* conditions of termination.

The maximum available power gain for the circuit of Fig. 1 is given by the equation (see Appendix A):

$$G_{av} = |h_{21}|^2 / [2r_{11}g_{22}(1 + p_m) - H_r], \quad p_m > 0, \quad (1)$$

where

$$r_{11} \equiv \text{Re}(h_{11}), \quad g_{22} \equiv \text{Re}(h_{22}), \quad H_r \equiv \text{Re}(h_{12}h_{21}), \quad (2)$$

and

$$p_m \equiv \left\{ 1 + \left( \frac{x_{11}}{r_{11}} \right)^2 - \frac{H_r}{r_{11}g_{22}} \left[ 1 + \left( \frac{x_{11}}{r_{11}} \right) \left( \frac{H_i}{H_r} \right) \right] \right\}^{1/2}, \quad (3)$$

with

$$x_{11} \equiv \text{Im}(h_{11}), \quad H_i \equiv \text{Im}(h_{12}h_{21}). \quad (4)$$

Here Re and Im denote real and imaginary part, respectively.

Physically, parameter  $p_m$  of (3) may be identified as the ratio of generator resistance  $R_{gm}$  required for maximum gain, with conjugate matching at output circuit, to short-circuit input resistance  $r_{11}$ ; i.e.,  $p_m = (R_{gm}/r_{11})$ .

It should be emphasized that (1) is valid *only* for  $p_m > 0$ . For the conditions that yield  $p_m = 0$ , the circuit determinant vanishes; this corresponds to the condition for oscillations in the circuit shown in Fig. 1. Infinite gain, i.e., oscillations, also may be obtained for other values of  $p_m$ , e.g., if the denominator of (1) vanishes. Consequently, since the parameter  $H_r$  in (3) above may be positive for a junction transistor,<sup>6</sup> under proper conditions a transistor may oscillate in the circuit shown in Fig. 1, even with a purely resistive generator impedance.

A few additional remarks concerning (1) and (3) may be in order. First, note that at low frequencies all reac-

tive terms vanish, and (1), together with (3), reduces to the exact equation for calculating maximum gain of a purely resistive four-terminal network.<sup>7</sup> Second, note that at high frequencies, calculations for (3) may be simplified somewhat by neglecting terms involving the reactive part  $x_{11}$  of the short-circuit input impedance  $h_{11}$ . Physically, this would correspond to tuning out the *short-circuit* input reactance, i.e., to adding in series with  $R_g$  a reactance  $-x_{11}$ . Since the *actual* input reactance of the transistor may be quite different from  $x_{11}$ , this would *not* correspond to conjugate matching at the input. W. N. Coffey of this Laboratory has considered the resulting gain expression in some detail and has pointed out that<sup>8</sup> the value of gain obtained from (1) by setting  $x_{11} = 0$  in (3) *also* represents the maximum gain available with a variable *complex* generator impedance  $Z_g$  and a variable load conductance  $G_L$ , with the open-circuit output susceptance  $b_{22}$  tuned out, i.e.,  $I_m(Y_L) = -b_{22}$ . Finally, it might be noted that if the short-circuit input reactance  $x_{11}$  is equal to zero or can be tuned out and if  $(H_r/r_{11}g_{22})$  is small relative to unity, then  $p_m$  may be replaced by the first two terms of its series expansion, and (1) reduces to the expression given by Linvill.

#### HIGH-FREQUENCY POWER GAIN IN TERMS OF FUNDAMENTAL TRANSISTOR PARAMETERS

In order to calculate available gain for a given transistor, it is necessary merely to substitute measured values of the four complex  $h$  parameters into the appropriate equation by which gain is to be defined. However, by considering an appropriate model of a junction transistor, it is possible to relate the  $h$  parameters to certain fundamental device parameters of the transistor and hence to obtain an expression for high-frequency gain in terms of these fundamental parameters. The model comprises the usual ideal one-dimensional transistor in series with a base impedance  $z_b'$  [Fig. 2(a), next page]. For most fused-junction transistors,  $z_b'$  is real and is the base spreading resistance  $r_b'$ . However, for grown-junction transistors, in general, the distributed nature of the transistor parameters in the transverse direction of the base region must be taken into account. Results of a theoretical analysis<sup>9</sup> of a two-dimensional (distributed) model have shown that under simplifying conditions, such a transistor may be represented by the model

<sup>7</sup> Equations for calculating low-frequency maximum power gain have been given, in different form, by R. L. Wallace, Jr., and W. J. Pietenpol, "Some circuit properties and applications of  $n-p-n$  transistors," *Bell Sys. Tech. Jour.*, vol. 30, pp. 546-549; July, 1951; *Proc. IRE*, vol. 39, pp. 759-761; July, 1951. See also H. E. Hollmann, "Transistortheorie und Transistorschaltungen," *Arch. elekt. Übertragung*, vol. 7, p. 326; July, 1953.

<sup>8</sup> W. N. Coffey, Personal communications and unpublished memorandum.

<sup>9</sup> R. L. Pritchard and W. N. Coffey, "Small-signal parameters of grown-junction transistors at high frequencies," 1954 IRE CONVENTION RECORD, Part 3, pp. 90-98. Also, R. L. Pritchard, "Theory of grown-junction transistor at high frequencies," presented at Semiconductor Device Research Conference, Minneapolis, Minn., June 29, 1954; planned for publication.

<sup>6</sup> Generally,  $H_r$  is positive for grounded-emitter operation and is negative for grounded-base.

shown in Fig. 2(a), in which case  $z_b'$  may be complex and frequency dependent at high frequencies. Hence, the two-dimensional distributed model actually may be represented by the ideal one-dimensional model plus a complex base impedance.

The  $h$  parameters for the ideal transistor have been described previously in general terms in some detail.<sup>1</sup>

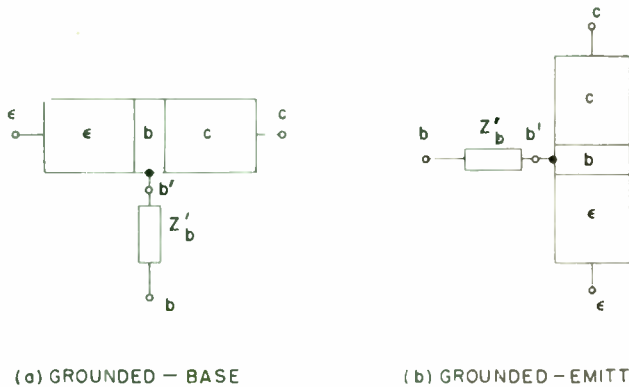

Fig. 2—Ideal transistor plus base impedance; (a) Grounded-base operation, (b) Grounded-emitter operation.

However, in order to obtain a relatively simple expression for maximum gain, certain assumptions can be made, consistent with what may be expected in commercially available transistors under practical operating conditions. For example, the emitter-efficiency term  $\gamma$  in the expression for current-amplification factor can be assumed to equal unity at all frequencies. Moreover, this assumption will be valid for practical transistors at not too high nor too low values of dc emitter current.<sup>10</sup>

Under such assumptions, fairly simple analytical expressions can be obtained for the  $h$  parameters for frequencies up to approximately twice the  $\alpha$ -cutoff frequency. For example, see the equivalent circuit in Appendix B. Unfortunately, however, for grounded-base operation a relatively simple expression for gain does not result, although numerical calculations can be carried out fairly easily. Furthermore, if the subject of stability is investigated with the help of Linvill's gain-stability criterion,<sup>4</sup> it is found that the grounded-base configuration may be unstable at frequencies up to approximately the  $\alpha$ -cutoff frequency.

On the other hand, if the grounded-emitter configuration is considered, a relatively simple, compact expression can be obtained for maximum gain. Furthermore, when Linvill's criterion is applied to this case, it is

<sup>10</sup> At low emitter current, emitter-base barrier capacity causes a decrease in  $\gamma$ . On the other hand, at high emitter currents,  $\gamma$  may decrease because of high-level injection effects. High-level injection was discussed first by W. M. Webster, "On the variation of junction transistor current-amplification factor with emitter current," presented at Transistor Research Conference, State College, Pa., July 7, 1953; PROC. IRE, vol. 42, pp. 914-920; June, 1954. See also E. S. Rittner, "Extension of the theory of the junction transistor," *Phys. Rev.*, vol. 94, pp. 1161-1171; Jun 2, 1954.

found that stable maximum gain can be obtained down to much lower frequencies.

For grounded-emitter operation, the  $h$  parameters of the transistor model which are shown in Fig. (2b) are as follows:

$$[h^{(\epsilon)}] = \begin{bmatrix} z_b' + h_{11}^{(\epsilon)} & h_{12}^{(\epsilon)} \\ h_{21}^{(\epsilon)} & h_{22}^{(\epsilon)} \end{bmatrix}, \quad (5)$$

where  $h^{(\epsilon)}$  denotes the grounded-emitter  $h$  parameter for the theoretical model. Note that the base impedance  $z_b'$  appears only in one parameter, viz., in  $h_{11}$ . General expressions for the grounded-emitter  $h^{(\epsilon)}$  parameters are given in Appendix B.

For calculating available power gain, the following simplifying assumptions will be made:

1. Emitter efficiency  $\gamma = 1$  at all frequencies. This can be achieved in practice at not too high nor too low dc emitter currents.<sup>10</sup>
2. Limiting case of low frequencies is excluded, e.g., low-frequency interterminal conductances are neglected. This is equivalent to assuming  $(1 - \alpha_0) = 0$ . As a result of this assumption, the gain calculated according to the expression given below will be too high at low frequencies. Low-frequency gain can be calculated separately using completely different parameters, i.e., the low-frequency parameters, in order to determine when the high-frequency result becomes inapplicable.<sup>7</sup>
3. The effect of the base impedance is the dominant part of the input resistance  $r_{11}$ , i.e.,  $r_{11} \gg r_e'$ , where  $r_e' \equiv (kT/q_0 I_e)$  is the Shockley, *et al.*, emitter resistance. This will be true at larger values of dc emitter current.
4. The collector-base diffusion capacity  $C_d$  is much smaller than the collector-base barrier capacity  $C_c$ . This will be true for not too large values of dc emitter current density. Hence, high-frequency output conductance  $g_{22}$  is predominantly due to the effect of collector-base barrier capacity  $C_c$ . Also, it follows that the feedback due to  $C_c$  is much larger than that due to Early effect at high frequencies, i.e., in the expression for  $h_{12}^{(\epsilon)}$  (see Appendix B),  $\mu_{oc} \ll 0.8\omega_c C_c r_e'$ , where  $\mu_{oc}$  is the Early feedback factor.<sup>11</sup>

Consideration of the assumptions shows that, in general, gain will be decreased at low emitter currents and at high emitter currents. Actually, assumptions 1, 3, and 4 may be removed at only a slight expense in complexity. This is done below for the case of the grown-junction transistor.

Under the above assumptions and over a limited frequency range,<sup>12</sup> with  $(\omega/\omega_c) < 2$ , where  $\omega_c/2\pi$  is the  $\alpha$ -

<sup>11</sup> J. M. Early, "Effects of space-charge layer widening in junction transistors," PROC. IRE, vol. 40, p. 1403; November, 1952.

<sup>12</sup> Under the assumption that  $(1 - \alpha_0) = 0$ , (6) are valid down to zero frequency. However, in a practical transistor with  $(1 - \alpha_0) \neq 0$ , (6) will be valid for  $(1 - \alpha_0) \ll (\omega/\omega_c) < 2$ .

cutoff frequency, the following approximate expressions may be obtained for the parameters required in calculating gain (see Appendix B):

$$\left. \begin{aligned} r_{11} &\doteq \operatorname{Re}(z_{b'}), & g_{22} &\doteq 0.8 \omega_c C_c, \\ |h_{21}|^2 &\doteq (1.2 \omega/\omega_c)^{-2}, \end{aligned} \right\} \text{and}^{13}$$

$$\operatorname{Re}(h_{12}h_{21}) \equiv H_r \doteq - \left[ \frac{\mu_{ec}}{6} + (\omega_c C_c r_e') \frac{(\omega/\omega_c)^2}{15} + (\omega_c C_c r_e')^2 \left( 1 + \frac{C_c}{3C_c} \right) \right] \quad (6)$$

where  $C_c$  is the emitter-base barrier capacity. As a consequence of assumptions 3 and 4 above,

$$-\frac{H_r}{r_{11}g_{22}} = \frac{\mu_{ec}}{5r_{11}\omega_c C_c} + \left( \frac{r_e'}{r_{11}} \right) \left[ \frac{(\omega/\omega_c)^2}{12} + 1.2(\omega_c C_c r_e') \left( 1 + \frac{C_c}{3C_c} \right) \right] \ll 1. \quad (7)$$

For a transistor having a constant base spreading resistance  $r_b'$ , e.g., a normal fused-junction transistor,  $r_{11} = r_b'$ , and  $(x_{11}/r_{11}) \ll 1$ . Then (6) and (7) may be substituted in (1) to yield the now familiar expression,<sup>2</sup>

$$G_{av} = \frac{0.22}{\omega^2} \left( \frac{\omega_c}{r_b' C_c} \right) \approx \frac{1}{25f_c^2} \left( \frac{f_c}{r_b' C_c} \right) \quad (8)$$

$0.05-0.1 < (\omega/\omega_c) < 2.$

#### GROWN-JUNCTION TRANSISTOR

On the other hand, for the distributed model of the transistor, e.g., a *grown*-junction transistor with a base contact that approximates a line contact, analysis<sup>9</sup> indicates that under the assumptions described above,

$$r_{11} \doteq [R_b r_e' / 2.4 (\omega/\omega_c)]^{1/2}, \text{ provided} \quad (9)$$

$$\left[ \frac{R_b (\omega/\omega_c)}{r_e'} \right]^{1/2} > 2,$$

where  $R_b$  is the transverse base resistance of the transistor. (For a tetrode transistor,  $R_b$  would be the base-base resistance.)

If this inequality is not satisfied, the grown-junction transistor behaves like a fused-junction transistor with

<sup>13</sup> This result is complete only for assumption 2 that  $(1-\alpha_0) = 0$ . In a practical transistor, a considerably more important contribution to  $H_r$ , especially at lower frequencies, arises from the factor  $(1-\alpha_0)$ . The contribution in this case is

$$H_r \doteq \frac{(1-\alpha_0)}{(\omega/\omega_c)^2} [(\omega_c C_c r_e') + 0.6\mu_{ec}], (\omega/\omega_c)^2 \gg 0.6(1-\alpha_0)^2.$$

It should be emphasized that *this* term, which is positive, may be sufficiently large in magnitude to satisfy the conditions required for infinite gain, i.e., oscillations, in (1) and (3). Since this term decreases with increasing frequency, such oscillations are most likely to occur at moderately low frequencies relative to  $f_c$ . Accordingly, it is desirable to limit the validity of the equations given below for gain from a theoretical model of a junction transistor to frequencies *greater* than perhaps  $0.05 \omega_c - 0.1 \omega_c$  (although perfectly stable gain may be obtainable at lower frequencies). Linvill's stability criterion applied to the theoretical model, yields the result that stable gain can be obtained for  $(\omega/\omega_c) > 0.4(r_e'/r_{11})$ .

a simple base-spreading resistance  $r_b' = R_b/3$ .<sup>14</sup> This will be true in general at low and medium frequencies. Accordingly it is convenient to substitute this *frequency-independent* value of  $r_b'$  for  $R_b$  (which is not generally known for a triode) in (9); this yields:

$$r_{11} \doteq [r_b' r_e' / 0.8 (\omega/\omega_c)]^{1/2} \quad [r_b' (\omega/\omega_c) / r_e']^{1/2} > 1. \quad (9a)$$

In this case,  $(x_{11}/r_{11})$  being  $\doteq -1$ , is not negligible, and the expression for  $p_m$  of (3) becomes a bit cumbersome. Hence, in order to obtain a simple expression for gain, it is convenient to assume that  $p_m$  can be approximated by unity in (3).<sup>15</sup> In this particular case, the resulting expression for gain becomes identical with that calculated from Linvill's expression (since  $H_r/r_{11}g_{22}$  is negligible<sup>13</sup>).

Substitution of (9a) together with (6) in (1) and (2), with  $p_m = 1$ , yields,

$$G_{av} \doteq \frac{0.2}{\omega^3} \frac{\omega_c^{1/2}}{C_c (r_b' r_e')^{1/2}}, \quad 0.05-0.1 < (\omega/\omega_c) < 2. \quad (10)$$

$[r_b' (\omega/\omega_c) / r_e']^{1/2} > 1.$

Comparison of this result (applicable for *grown*-junction transistors) with (8) (applicable for *fused*-junction transistors) shows that the available power gain at high frequencies still is dependent upon the same parameters, viz., medium-frequency base-spreading resistance  $r_b'$ , collector-base capacity  $C_c$ , and  $\alpha$ -cutoff frequency  $\omega_c/2\pi$ . Note, however, that the dependence is different for the distributed model (*grown*-junction transistor), e.g., gain at a given frequency is proportional to the *square root* of the  $\alpha$ -cutoff frequency, and gain varies with frequency at the rate of 15 db per decade rather than at 20 db per decade. Note also that for the distributed model, gain varies inversely as  $r_e'^{1/2}$ , i.e., gain is directly proportional to the square root of dc emitter current  $I_e$ . Although this can be confirmed in practice, variation of gain with  $I_e$  also can result from second-order effects, e.g., when one or more of assumptions 1, 3, or 4 above is not strictly valid, or when  $r_b'$  varies with  $I_e$ .<sup>14</sup>

#### Second-Order Effects

In view of the theoretical dependence of gain upon dc emitter current  $I_e$  for the distributed-model transistor, it might be of interest to remove several of the restrictions imposed above in order to calculate what might be called second-order correction terms. In particular, if the effect of emitter capacity is taken into account for low  $I_e$ , and

<sup>14</sup> See Pritchard and Coffey, reference 9, p. 93. Actually, this substitution is valid only for very small dc base current. When a substantial transverse base current exists, e.g., as at higher values of dc emitter current  $I_e$ , a *grown*-junction triode behaves like an internally biased tetrode transistor (*ibid.*, p. 95), and  $r_b'$  decreases with increasing  $I_e$ . However, even in this case, the value of  $3r_b'$  may be taken as a measure of the *effective* transverse base resistance.

<sup>15</sup> Actually, if the more complete expression (3) for  $p_m$  is considered for the theoretical model, as it should be when comparing experimental results for gain determined with a purely resistive generator impedance, the following results may be obtained:

If  $H_r$  and  $H_i$  terms are negligible, then  $p_m \doteq \sqrt{2}$ , and actual gain will be approximately 0.8 db less than that calculated by setting  $p_m = 1$ . If the  $H_i$  terms are not negligible, oscillations may be obtained; see reference 13.

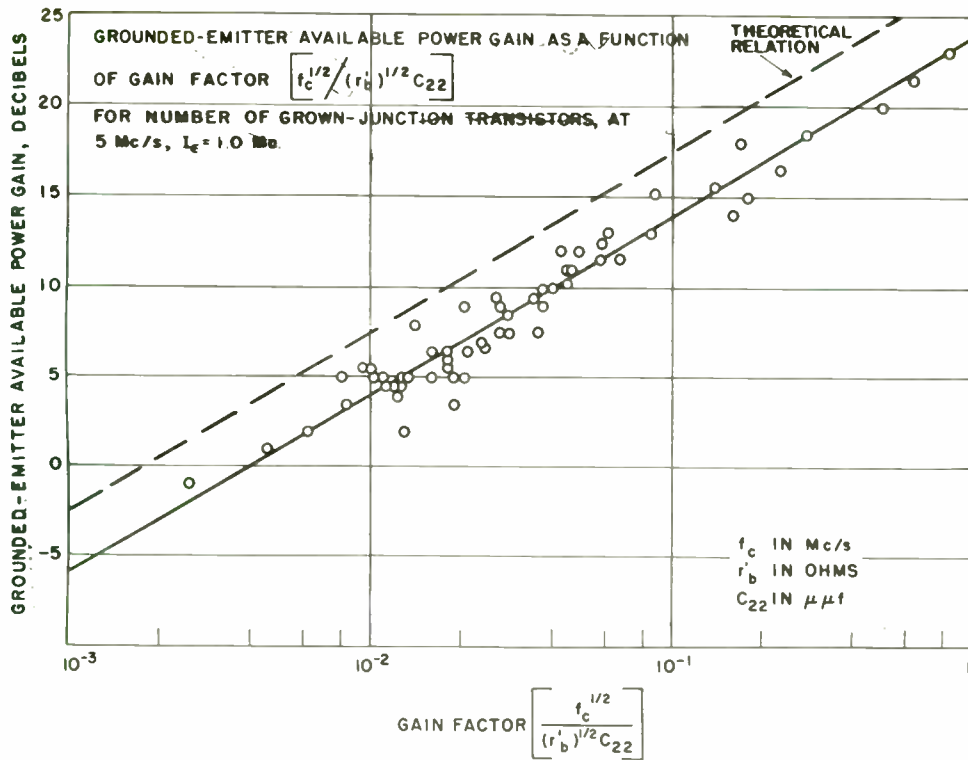

Fig. 3—Grounded-emitter maximum available power gain with resistive generator impedance as a function of gain factor  $[f_c^{1/2}/(r'_b)^{1/2}C_{22}]$ ; experimental results for a number of grown-junction transistors at 5 mc.

if the effect of collector-base diffusion admittance is taken into account at high emitter current density, the more complete expression for gain becomes

$$G \approx \frac{0.2}{\omega_c^{3/2}} \frac{\omega_c^{1/2}}{C_c(r'_b r'_e)^{1/2}} \frac{1}{(1 + C_d/C_c)} \frac{1}{\sqrt{1 + 0.8\omega_c r'_e C_T}} \quad (11)$$

In this equation,  $C_T \equiv (C_e + C_c)$  is the sum of emitter-base and collector-base barrier capacities, and  $C_d$  is the (frequency-independent) collector-base diffusion capacity, due to the effect of space-charge-layer widening and the charge stored in the base region by the dc emitter current  $I_e$ . In particular,  $C_d$  is directly proportional to  $I_e$  and to Early's space-charge-layer widening factor, which in turn is a function of the nature of the collector junction.<sup>16</sup> Furthermore, it should be noted that the ratio of  $C_d/C_c$  is an indication of injection level.<sup>17</sup> High-

<sup>16</sup> See R. L. Pritchard, "Collector-base impedance of a junction transistor," PROC. IRE, vol. 41, p. 1060; August, 1953; also R. L. Pritchard (reference 1); pp. 798-799. Explicitly,

$$C_d \approx (I_e w / D_b) (\partial w / \partial E_c),$$

where  $w$  is the base thickness,  $(\partial w / \partial E_c)$  is the rate of change of base thickness with collector voltage, and  $D_b$  is the diffusion constant for minority carriers in the base. Alternatively, that part of the output conductance  $g_{22}$  which is due to stored charge may be written as  $0.8 \omega_c C_d = g_{c\beta} / (1 - \beta_0)$ , where  $g_{c\beta}$  is that part of the Early collector-base conductance  $g_c$  due to the transport function  $\beta$ , and  $\beta_0$  is the low-frequency value of  $\beta$ . If emitter efficiency  $\gamma$  is completely negligible, as assumed here,  $g_{c\beta} / (1 - \beta_0) = g_c / (1 - \alpha_0)$ ; this value can be obtained easily from low-frequency parameter measurements. However, in a practical transistor, with  $\alpha_0$  close to unity,  $g_{c\beta} / (1 - \beta_0)$  may not equal  $g_c / (1 - \alpha_0)$ , even though  $\gamma$  is negligible at higher frequencies.

<sup>17</sup> R. L. Pritchard, reference 1, p. 799. Note, however, that high-level injection effects were discussed first by Webster (*op. cit.*).

level injection occurs when the injected minority-carrier charge density is comparable with the majority-carrier charge density normally present in the base. For  $C_d/C_c \approx 1$ , these two charge densities are approximately equal.

The expression given above is substantially complete except for the decrease of current gain at large values of dc emitter current, due to high-level injection effects. However, if it is assumed that the current gain is not adversely affected unless high-level injection is fairly substantial, then (11) will be valid up to approximately  $C_d/C_c \approx 1$ .<sup>18</sup> In this case, it might be noted that if the term involving  $C_T$  is negligible, a maximum power gain with respect to dc emitter current, with all other parameters held constant, occurs for  $C_d/C_c = 1$ .

### Experimental Results

In an attempt to check the validity of (10), power gain and small-signal parameter measurements were made for a large number of grown-junction transistors originating from a number of different sources. Results for a dc emitter current  $I_e = 1$  ma are shown in Fig. 3 in which each point corresponds to a different transistor. For each point, the ordinate value represents the maximum power gain available at a frequency of 5 mc from

<sup>18</sup> Note that if internal tetrode biasing occurs, as it will for large values of  $I_e$ , the active cross-section area of the transistor is reduced while  $C_c$  remains fixed. Hence, high-level injection may occur for values of  $(C_d/C_c)$  considerably less than unity.

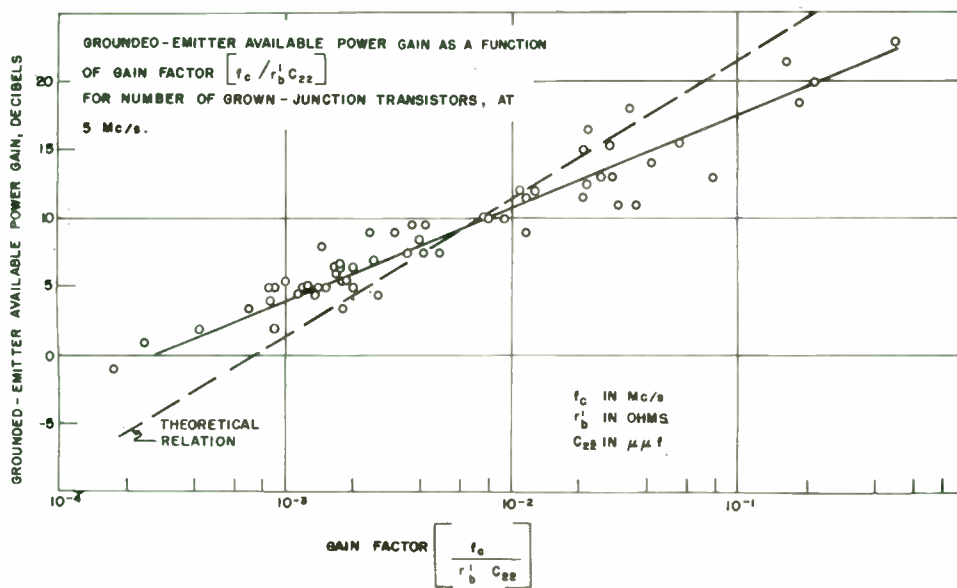

Fig. 4—Grounded-emitter maximum available power gain with resistive generator impedance as a function of gain factor  $[f_c/r_b' C_{22}]$ ; experimental results for a number of grown-junction transistors at 5 mc.

a particular transistor in a grounded-emitter configuration, driven by a generator having a variable but purely resistive internal impedance, while the value of the abscissa is calculated from measured values of  $f_c$ ,  $r_b'$  and  $C_{22}$  for that transistor. The solid line in Fig. 3 represents an "average curve" about which the experimental points appear to group themselves.

An arbitrary selection of transistors was employed for these measurements, although certain types of units specifically were excluded. The latter included transistors having poor low-frequency characteristics, transistors having alpha-cutoff frequencies  $< 2.5$  mc [in view of the 5 mc measuring frequency and of the restriction on (10)], transistors with emitter efficiencies  $\gamma$  appreciably different from unity at high frequencies ("slow-drool" type of alpha-frequency behavior),<sup>19</sup> and transistors having a large emitter-base overlap capacity.<sup>20</sup>

The dotted line shown in Fig. 3 represents the theoretical result calculated from (10) for  $I_e = 1$  ma ( $r_e' = 25$ ). Note that the solid line drawn through the experimental results lies about 3.5 db below the dotted line. Also note that no single point approaches the theoretical dotted curve more closely than about 1 db.<sup>15</sup>

The same experimental results also have been plotted as a function of the older parameter  $(f_c/r_b' C_{22})$  derived for transistors having constant base-spreading resistance, as shown in Fig. 4. Although there definitely is a correlation between  $G_{av}$  and this parameter, as indicated

by the solid line, the relationship is *not* according to theory, as shown by the dotted line calculated from (8). Also note that a large number of experimental points lie above dotted curve in Fig. 4, i.e., for a large number of transistors (mostly those having lower gain) measured gain exceeded theoretical gain as calculated from equation (8).

Variation of available power gain also has been measured as a function of frequency, of dc emitter current, and of dc collector voltage for a smaller number of transistors. In general, the experimental results are in agreement with the theory. For example,  $G$  varied as  $\omega^{-1.5}$  to  $\omega^{-1.7}$ . Also, gain increased with increasing emitter current at first and attained a maximum with respect to  $I_e$  at a moderate value of  $I_e$  (of the order of 1–10 ma for the transistors measured). Finally,  $G$  increased with increasing collector voltage until collector-breakdown voltage was approached.<sup>21</sup>

DESIGN CRITERIA FOR DISTRIBUTED MODEL

Since the high-frequency power gain of a distributed model (grown-junction) transistor depends upon the same circuit parameters as does the constant- $r_b'$  model (fused-junction) transistor, the same general design criteria that have been described previously<sup>22</sup> also may be applied to the grown-junction transistor. However, since the nature of the dependences is different for the two types of models, a few remarks together with numerical examples concerning optimum design for high-frequency performance may be of some interest.

<sup>21</sup> The increase of  $G$  with increasing collector voltage is due to an increase in  $f_c$  as base width is reduced by space-charge-layer widening and to a decrease in  $C_e$ .

<sup>22</sup> See, for example, Early, reference 2.

<sup>19</sup> R. L. Pritchard, reference 1, p. 788.

<sup>20</sup> In such cases,  $\alpha$ -cutoff frequency would be quite dependent upon dc emitter current, and the short-circuit input impedance would be largely capacitive-reactive in nature. See R. L. Pritchard, "Effect of base-contact overlap and parasitic capacities on small-signal parameters of junction transistors," Proc. IRE, vol. 43, p. 39; January, 1955.



In addition to the different manner in which base spreading resistance influences gain in the grown-junction transistor [cf. (10) and (8)], this type of transistor also may have a graded collector-base junction, resulting in potentially lower collector-base capacitance than in the fused-junction transistor. (Generally a rather abrupt emitter-base junction is preferred in order to yield good high-frequency emitter efficiency.) The value of the collector-junction gradient represents one additional parameter for the design of high-frequency grown-junction transistors. In general, however, the gradient will be a function of majority-carrier concentration in the base, i.e., of base resistivity. For example, in one case which has been considered for computation and has been termed *proportionately graded*, the majority-carrier concentration ( $N_a - N_d$ ) is assumed to vary with position  $x$  through the base region as shown in Fig. 5. Consequently, the concentration gradient  $A = 2N_b/w_0$ , where  $N_b$  is the maximum value of ( $N_a - N_d$ ) in the base, and  $w_0$  would be the base width in the *absence* of a collector depletion layer.

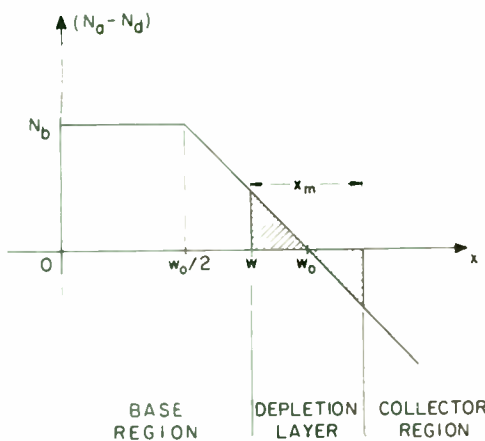

Fig. 5—Variation of majority-carrier concentration through base region of an  $n-p-n$  transistor having proportionately graded collector junction and abrupt emitter junction.

In order to calculate theoretical gain for a physical model of a grown-junction transistor, the circuit parameters of (10) may be related to the various physical parameters such as base dimensions, base resistivity, etc. All of these calculations are straightforward and will not be repeated here because of space limitations. If this is done, the following expression results for the first-order gain of a theoretical distributed-model transistor having substantially constant majority-carrier concentration  $N_b$  in the base:

$$G_{av} \cong \left( \frac{0.5q_e^{1/2}/\epsilon_0\epsilon_r}{\omega^{3/2}} \right) \left[ \frac{(d/h)^{1/2} I_e^{1/2}}{S} \right] \cdot \left[ \frac{(\mu_n\mu_p N_b)^{1/2} x_m}{2\omega^{1/2}} \right] \quad (12)$$

A corresponding expression for the constant- $r_b'$ -model transistor could be obtained from (8) rather than (10). Such a result already has been given by Giacoletto.<sup>23</sup> In (12),  $q_e$  is the electronic charge,  $\epsilon_0$  is the free-space dielectric constant ( $8.85 \times 10^{-12}$  fd/meter),  $\epsilon_r$  is the relative dielectric constant of the semiconductor (e.g.,  $\epsilon_r = 16$  for  $Ge$ ),  $d$  is the base depth,  $h$  is the transverse height of the base (for a tetrode transistor,  $h$  would be the base-base dimension),  $S$  is the base cross-section area ( $S = dh$ ),  $\mu_n$  and  $\mu_p$  are respectively the mobilities of electrons and holes in the  $p$ -type base region (which are functions of  $N_b$ ),<sup>24</sup> and  $x_m$  is the width of the collector-base-junction depletion layer.<sup>25</sup>

With the help of (12), plus consideration of second-order effects, the variation of theoretical gain with each of the physical parameters for the distributed-model transistor could be discussed in detail. A few of the more pertinent results are as follows:

1. For a fixed bias and fixed cross-section geometry (of conventional values), the theoretical gain is essentially independent of base width and base resistivity (within suitable limitations) and is essentially constant to within 3–6 db, depending upon the nature of the collector-base junction.

2. For a fixed cross-section area  $S$ , theoretical gain is directly proportional to the square root of the ratio  $d/h$  of base depth to base height. Hence, for maximum gain, a long thin cross-section geometry should be employed with a line-type of base contact on the long side (dimension  $d$ ) of the base. However, in practice, in order to obtain a good line contact,  $d/h$  probably would be limited to a moderate value, e.g., 2–5.

3. As cross-section area is reduced, first-order gain is increased directly. However, the second-order term  $C_d/C_c$  increases owing to an increased current density in the base region, while the second-order term involving  $\omega_c C_T r_e'$  decreases owing to a decrease in total barrier capacity. *Reduction in cross-section area represents the most significant method of increasing gain over any appreciable range.*

<sup>23</sup> L. J. Giacoletto, "Comparative high-frequency operation of junction transistors made of different semiconductor materials," *RC.A Rev.*, vol. 16, p. 37, Eq. (2); March, 1955. Note that because of the differences between this equation and (12) above, Giacoletto's semiconductor figure of merit ( $\mu_n\mu_p/\epsilon_r^{2/3}$ ) is not directly applicable to the case of high-frequency grown-junction transistors. The corresponding figure of merit for a high-frequency grown-junction transistor having a line-type of base contact, with a linearly graded collector junction is  $[(\mu_n\mu_p)^{1/2}/\epsilon_r^{2/3}]$ . Note that in this case the comparison between silicon and germanium is much less unfavorable than in the case of the fused-junction transistor. (Ratio of figure of merit of germanium to that of silicon is 2.9 for case of grown-junction and is 10.7 for case of fused-junction.)

<sup>24</sup> See, for example, M. B. Prince, "Drift mobilities in semiconductors, I. Germanium," *Phys. Rev.*, vol. 92, pp. 681–687; November 1, 1953; Part II. Silicon, *Phys. Rev.*, vol. 93, pp. 1204–1206; March 15, 1954.

<sup>25</sup> For an essentially abrupt collector-base junction with collector resistivity very much less than the base resistivity,  $x_m = (2\epsilon_0\epsilon_r E_c / q_e N_b)^{1/2}$ , just as in the case of the fused-junction transistor. For the proportionately graded junction shown in Fig. 5,  $x_m = (6\epsilon_0\epsilon_r E_c w_0 / q_e N_b)^{1/3}$ .

A few numerical values of gain which have been calculated for various physical parameters<sup>26</sup> are shown below in Table I. Values of gain are quoted at 5 mc, but

TABLE I  
THEORETICAL POWER GAIN, DISTRIBUTED-MODEL TRANSISTOR  
 $E_c = 4.5$  v;  $f = 5$  mc.

| $c-b$ junction | $\rho_b$ ohm-cm | $w_0$ mils ( $10^{-3}$ inches) | $d$ inches | $h$ inches | $I_c$ ma | First-order gain db | Second-order gain db |
|----------------|-----------------|--------------------------------|------------|------------|----------|---------------------|----------------------|
| prop. gr.      | 1               | 0.39                           | 10         | 10         | 1        | 18.9                | 18.2                 |
| prop. gr.      | 8               | 0.39                           | 10         | 10         | 1        | 18.7                | 17.7                 |
| abrupt         | 1               | 0.39                           | 10         | 10         | 1        | 14.5                | 14.0                 |
| prop. gr.      | 1               | 0.39                           | 10         | 2.5        | 1        | 27.9                | 26.9                 |
| prop. gr.      | 1               | 0.39                           | 10         | 2.5        | 4        | 30.9                | 28.1                 |
| abrupt         | 1               | 0.39                           | 10         | 2.5        | 4        | 26.5                | 25.0                 |
| prop. gr.      | 1               | 0.2                            | 10         | 2.5        | 4        | 31.8                | 30.7                 |

gain at other frequencies may be calculated from these values by adding or subtracting 4.5 db per octave change in frequency. Note, however, that the results are valid at high frequencies only if  $(\omega/\omega_c) < 2$ . Also, it should be emphasized that these numerical values were calculated for a conventional grown-junction triode, as distinguished from a *p-n-i-p* or *n-p-i-n* transistor<sup>2</sup> or from a "drift transistor."<sup>27</sup>

CONCLUSIONS

The subject of maximum gain available from a junction transistor at high frequencies has been discussed briefly. A theoretical expression has been presented for calculating maximum gain available from a transistor driven by a generator having a purely resistive internal impedance in terms of the four-pole small-signal parameters of the transistor. Under certain conditions, this expression reduces to that given by Linvill for the maximum possible gain available from a transistor.

The four-pole parameters of a theoretical model of a junction transistor then were substituted in this expression to obtain a simple concise result for evaluating high-frequency power gain in terms of three fundamental transistor parameters, viz.,  $\alpha$ -cutoff frequency, medium-frequency base spreading resistance, and collector-base capacity. Two different expressions are given, one for the fused-junction type of transistor, for which a constant base spreading resistance is valid, and one for the grown-junction type of transistor, for which base spreading resistance becomes complex and frequency-dependent at high frequencies. Experimental results given for approximately 60 grown-junction transistors tend to confirm the validity of this second result, which is new.

<sup>26</sup> In these calculations, dc base current is assumed to be negligible so that no internal tetrode biasing exists (see reference 14). Also for calculation of emitter-base barrier capacitance, a fixed value of total emitter-base potential (built-in potential plus applied voltage) of 0.25 v was assumed. Actually, this potential depends upon injection level and upon emitter resistivity, but the dependence is slight, e.g., see Early, reference 1, p. 1286.

<sup>27</sup> H. Krömer, "Zur Theorie des Diffusions- und des Drifttransistors," *Arch. elekt. Übertragung*, vol. 8, pp. 223-228, 363-369, 449-504; May-August, November, 1954.

By further relating the three fundamental high-frequency transistor parameters to physical parameters, such as base resistivity and geometry, an expression has been presented for calculating typical available power gains for the grown-junction type of transistor. It has been emphasized that the most significant method of increasing high-frequency power gain over any appreciable range is to employ a rectangular cross section with small transverse dimension and to reduce total cross-section area. For square cross-section area of 100 mil<sup>2</sup>, gains of the order of 15-18 db should be available at 5 mc. Gain at other frequencies can be calculated by addition or subtraction of 4.5 db per octave frequency change. By reducing cross-section area to, say, 25 mil<sup>2</sup> and by employing rectangular cross section with a line type of contact along the longer cross section dimension, 30 db of gain should be available at 5 mc, and it should be possible to obtain oscillations from such triode transistors up to several hundred mc.

APPENDIX A

CALCULATION OF MAXIMUM AVAILABLE POWER GAIN

Available power gain for a quadripole in a circuit as shown in Fig. 1 in general is given by the equation<sup>28</sup>

$$G_{av} = \frac{4R_o G_L |h_{21}|^2}{|(h_{11} + Z_o)(h_{22} + Y_L) - h_{12}h_{21}|^2}, \quad (13)$$

where  $R_o$  and  $G_L$  are the real components of the generator and load immittances  $Z_o$  and  $Y_L$  respectively. (For this calculation,  $Z_o \equiv R_o$ .) By separating the complex four-pole parameters  $h_{ij}$  into real and imaginary parts,

$$h_{11} \equiv r_{11} + jx_{11}, \quad h_{22} \equiv g_{22} + jb_{22}$$

$$h_{12}h_{21} \equiv II_r + jII_i, \quad Y_L \equiv G_L + jB_L,$$

and by defining dimensionless variables

$$x \equiv 1 + (R_o/r_{11}), \quad y \equiv 1 + (G_L/g_{22}), \quad z \equiv 1 + (B_L/b_{22}),$$

$$A \equiv r_{11}g_{22}, \quad B \equiv x_{11}b_{22}, \quad C \equiv x_{11}g_{22}, \quad D \equiv r_{11}b_{22}.$$

Eq. (13) may be written in the form

$$G_{av} = \frac{4A |h_{21}|^2 (x-1)(y-1)}{X^2 + Y^2}, \quad (14)$$

where  $X \equiv (Axy - Bz - II_r)$  and  $Y \equiv (Cy + Dxz - II_i)$ .

In order to maximize available power gain, (14) may be differentiated with respect to each of the three variables  $x, y, z$ , corresponding to varying  $R_o, G_L$ , and  $B_L$  respectively, and the results may be set equal to zero. This yields the following three equations:

$$\left. \begin{aligned} 2(x-1)[AXy + DYz] &= X^2 + Y^2, \\ 2(y-1)[AXx + CY] &= X^2 + Y^2, \\ BX &= DYx. \end{aligned} \right\} \quad (15)$$

A solution to the last two equations of (15) is

$$X = 2(y-1)Ax, \quad Y = 2(y-1)C, \quad (16)$$

<sup>28</sup> For example, R. L. Pritchard, "Small-signal parameters for transistors," *Elec. Engrg.*, vol. 73, p. 903; October, 1954.

valid for any  $x$ , i.e., for any  $R_o$ . Physically, the conditions expressed by (16) correspond to setting the load admittance equal to the complex conjugate of the transistor output admittance, for any arbitrary  $R_o$ , i.e.,

$$\left. \begin{aligned} (G_L/g_{22}) &= (y - 1) = 1 - \frac{AII_r x + CHI_i}{A^2 x^2 + C^2} \\ -(B_L/b_{22}) &= (1 - z) = 1 - \frac{DII_i x - BII_r}{D^2 x^2 + B^2} \end{aligned} \right\} \quad (17)$$

Substituting (16) and (17) in the first part of (15), then yields a fourth-degree equation in  $x$  which can be factored into two quadratic equations. One of these yields no real solution for  $x$ ; the other is

$$A^2 x^2 - 2A^2 x + AII_r - C^2 + CHI_i = 0. \quad (18)$$

Alternatively, (16) and (17) may be substituted directly back into (14) to obtain an expression for  $G_{av}$  as a function of  $x$  alone. This expression then may be maximized with respect to  $x$ . This is a far simpler procedure and leads to the same result (18). Eq. (18) may be solved for

$$(x-1)^2 = (R_o/r_{11})^2 = 1 - (II_r/A) + (C/A)^2 + (CHI_i/A^2), \quad (19)$$

which is (3) in slightly different form.

Then, substitution of (16) and the first part of (17) back into (14), plus manipulation of the result with the help of (16), yields

$$G_{av} = |h_{21}|^2 / (2Ax - H_r),$$

where  $x$  is given by (19). This is (1) in slightly different form.

APPENDIX B

*h*-PARAMETER REPRESENTATION OF JUNCTION TRANSISTOR IN GROUNDED-EMITTER CONFIGURATION

The grounded-emitter  $h^{(e)}$  parameters for an ideal one-dimensional transistor may be calculated by conventional transformation from the grounded-emitter admittance or  $y^{(e)}$  parameters. The latter parameters can be calculated in terms of the grounded-base  $y$  parameters<sup>1</sup> from the relation

$$[y^{(e)}] = \begin{bmatrix} y_{\Sigma} & -(y_{12} + y_{22}) \\ -(y_{21} + y_{22}) & y_{22} \end{bmatrix}, \quad (20)$$

where

$$y_{\Sigma} \equiv (y_{11} + y_{12} + y_{21} + y_{22}).$$

Then,<sup>29</sup>

$$[h^{(e)}] = \begin{bmatrix} 1/y_{\Sigma} & (y_{12} + y_{22})/y_{\Sigma} \\ -(y_{21} + y_{22})/y_{\Sigma} & (y_{11}y_{22} - y_{12}y_{21})/y_{\Sigma} \end{bmatrix}. \quad (21)$$

It should be noted that emitter-base and collector-base barrier capacities  $C_e, C_c$  are included here in  $y_{11}$  and  $y_{22}$ , respectively.

<sup>29</sup> See for example, J. S. Brown and F. D. Bennett, "The application of matrices to vacuum-tube circuits," *PROC. IRE*, vol. 36, p. 852; July, 1948.

R. L. Pritchard, reference 28, p. 905.

Each  $h^{(e)}$  parameter can be calculated in terms of base thickness, diffusion constants, etc., if desired. However, it may be of more practical interest here to express each  $h^{(e)}$  parameter in terms of appropriate low-frequency parameters and a single frequency variable, namely,  $\omega/\omega_c$ , or (radian) frequency  $\omega$  relative to  $\alpha$ -cutoff frequency  $\omega_c$ . Thus, for the special case of unity emitter efficiency  $\gamma$ ,<sup>10</sup> the current-amplification factor  $\alpha = \beta$ , where

$$\beta = \beta_0 \operatorname{sech} (j\omega\tau_D)^{1/2}, \quad (22)$$

is the transport factor. In (22),  $\beta_0$  is the low-frequency value of  $\beta$ , and

$$\tau_D = 2.43/\omega_c, \quad (23)$$

where  $\omega_c/2\pi$  is the  $\alpha$ -cutoff frequency. In this special case,<sup>30</sup>

$$y_{\Sigma} = y_e'(1 - \beta)(1 + \mu_{ec}) + j\omega(C_e + C_c), \quad (24)$$

where

$$y_e' \equiv (1/r_e') [(j\omega\tau_D)^{1/2} \coth (j\omega\tau_D)^{1/2}] \quad (25)$$

is the emitter-base diffusion admittance, and  $r_e' = (kT/q_e I_e)$  is the Shockley, *et al*, emitter resistance;  $\mu_{ec}$  is the voltage-feedback factor described by Early,<sup>31</sup> and  $C_e, C_c$  are, respectively, emitter-base and collector-base barrier capacities. Similarly,<sup>31</sup>

$$\left. \begin{aligned} (y_{12} + y_{22}) &= \mu_{ec} y_e'(1 - \beta) + j\omega C_c \\ -(y_{21} + y_{22}) &= y_e'(\beta - \mu_{ec}) - j\omega C_c \\ (y_{11}y_{22} - y_{12}y_{21}) &= y_e' \left\{ j\omega(C_c + \mu_{ec}C_e) \right. \\ &\quad \left. + \frac{g_{c\beta}}{2(1 - \beta_0)} [(y_e' r_e')(1 - \beta^2)] \right\} \end{aligned} \right\}, \quad (26)$$

where  $g_{c\beta}$  is the low-frequency collector-base Early conductance (for  $\gamma = 1$ ).

In general,  $\mu_{ec}$  is very small and may be neglected relative to unity and to  $\beta$ . In this case, expressions for the  $h^{(e)}$  parameters of the ideal transistor may be obtained as follows:

$$h_{11}^{(e)} = \{ y_e'(1 - \beta)[1 + \epsilon] \}^{-1}, \quad (27)$$

$$h_{12}^{(e)} = [\mu_{ec} + j\omega C_c / y_e'(1 - \beta)] / [1 + \epsilon], \quad (28)$$

$$h_{21}^{(e)} = [\beta / (1 - \beta)] [1 - j\omega C_c / y_e' \beta] / [1 + \epsilon], \quad (29)$$

$$h_{22}^{(e)} = \left[ \frac{j\omega C_c}{(1 - \beta)} + \frac{g_{c\beta}}{2(1 - \beta_0)} (y_e' r_e')(1 + \beta) \right] / [1 + \epsilon] \quad (30)$$

<sup>30</sup> If emitter efficiency is not unity, a diffusion admittance term of the form  $g(1 + j\omega\tau_e)^{1/2}$  described by Shockley must be added to the right-hand side of (24) and to  $y_{11}$  in calculating  $h^{(e)}$ . See W. Shockley, "The theory of  $p$ - $n$  junctions in semiconductors and  $p$ - $n$  junction transistors," *Bell Sys. Tech. Jour.*, vol. 28, pp. 449-450; July, 1949.

<sup>31</sup> In deriving the third of these results, use was made of the identity  $\tanh Z = \coth Z(1 - \operatorname{sech}^2 Z)$ .

where

$$[1 + \epsilon] \equiv [1 + j\omega(C_c + C_e)/y_e'(1 - \beta)]. \quad (31)$$

Alternatively, for  $h_{22}^{(e)}$  at high frequencies it is useful to express the second term involving the space-charge-layer widening factor in terms of the collector-base diffusion capacitance  $C_d$  due to charge stored in the base by dc emitter current.<sup>16</sup> The relation for the *theoretical* model is simply

$$g_{c\beta}/(1 - \beta_0) = (\omega_c C_d/1.2). \quad (32)$$

However, it should be pointed out that for a *practical* transistor, the factors  $g_{c\beta}$  and  $\beta_0$  in general will *not* correspond to measured collector-base conductance  $g_c$  and current-amplification factor  $\alpha_0$  respectively.<sup>11,16</sup> The difference arises from the fact that although emitter efficiency  $\gamma$  may be *essentially* equal to unity without modifying the high-frequency behavior of the transistor, if  $\beta_0$  is close to unity,  $(1 - \gamma_0) \neq 0$  may be comparable with  $(1 - \beta_0)$ . In this case, in (30) for  $h_{22}^{(e)}$ ,  $g_{c\beta}/(1 - \beta_0)$  should be replaced by  $g_c/(1 - \alpha_0)$  for *low frequencies*; however, at high frequencies, (30) as given is correct. Since in general it is not easy to differentiate between  $g_{c\beta}$  and  $g_c$ , use of (32) is recommended for high frequencies. (It might be pointed out that if  $C_d \ll C_c$ , then at high frequencies the second term in (30) for  $h_{22}^{(e)}$  will be negligible compared to the term involving  $C_c$ .)

It is especially important to note that *all* of the  $h^{(e)}$  parameters for the *ideal transistor* can be calculated completely in terms of four low-frequency parameters  $r_e'$ ,  $\mu_{ec}$ ,  $g_{c\beta}$ ,  $\beta_0$ , plus two barrier capacitances  $C_c$ ,  $C_e$ , and two normalized functions of frequency,  $y_e'r_e'$  and  $(\beta/\beta_0)$ . Each of the latter two functions depends only upon the  $\beta$ -cutoff frequency  $\omega_c/2\pi$ . Curves of these two normalized functions of frequency have been presented earlier for a fairly wide range of frequencies.<sup>1,32</sup> At low frequencies, each of the hyperbolic functions may be represented approximately by series expansions. Thus,

$$(\beta/\beta_0) \approx [(1 - x^2/4) - j1.2x]/(1 + x^2), \quad (33)$$

$$y_e'r_e' \approx [(1 + x^2/4) + j0.8x]/[1 + 0.06x^2], \quad (34)$$

where

$$x \equiv \omega/\omega_c$$

is the ratio of frequency to  $\alpha$ -cutoff frequency. These expansions are accurate to order  $x^2$  and are valid up to approximately  $x = 2$ , to an accuracy of approximately 10–20 per cent. (Somewhat less accurate series expansions have been given by Early.<sup>1</sup>)

With the help of these series expansions, approximate expressions may be obtained for each  $h_{ij}^{(e)}$  parameter in a straightforward manner. For example, if low-frequency effects are neglected, so that  $(1 - \beta_0) \approx 0$ , particularly simple results are obtained:

$$h_{11}^{(e)} \approx [(r_e'/6) + (\omega_c r_e'/j1.2\omega)]/[1 + \epsilon], \quad (35)$$

$$h_{12}^{(e)} \approx [\mu_{ec} + 0.8\omega_c C_c r_e'(1 + jx/6)]/[1 + \epsilon], \quad (36)$$

$$h_{21}^{(e)} \approx [-1/6 + (1/j1.2x) - 0.8\omega_c C_c r_e'(1 + jx/6)]/[1 + \epsilon], \quad (37)$$

$$h_{22}^{(e)} \approx [0.8\omega_c C_c(1 + jx) + 0.8\omega_c C_d(1 + j(0.2x))]/[1 + \epsilon], \quad (38)$$

$$[1 + \epsilon] \approx [1 + 0.8\omega_c(C_c + C_e)r_e'(1 + jx/6)]. \quad (39)$$

From these equations, together with the matrix (5), the parameters required for calculating  $G_{av}$  according to (1) and (3) can be evaluated readily. For example, for  $g_{22} = \text{Re}(h_{22}^{(e)})$ , from (38), to the first approximation, [see assumptions 1–4 following (5)]  $g_{22} \approx 0.8 \omega_c C_c$ , whereas to the second approximation,

$$g_{22} \approx [0.8\omega_c(C_c + C_d)]/[1 + 0.8\omega_c(C_c + C_e)r_e'].$$

Alternatively, the theoretical transistor can be represented by an equivalent circuit if desired. The basic circuit for  $h$ -parameter representation is shown in Fig. 6(a).<sup>33</sup> This two-generator circuit also can be converted to a one-generator circuit by incorporating either shunt or series feedback. An approximate circuit employing shunt feedback, which is valid if  $|h_{12}| \ll 1$  and if  $|h_{12}| \ll |h_{21}|$ , is shown in Fig. 6(b).

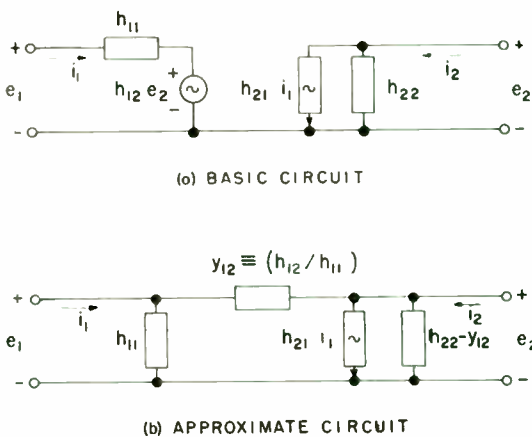

Fig. 6—Equivalent circuits for representation of a network by small-signal series-parallel  $h$  parameters; (a) Basic two-generator circuit, (b) Approximate one-generator circuit.

For grounded-emitter operation of the transistor, the elements of the approximate equivalent circuit shown in Fig. 6(b) assure reasonable and well-behaved values. For example, for frequencies less than approximately twice  $\omega_c$ , relatively simple two-terminal networks for each of the elements can be constructed from the expressions given above for  $h_{ij}^{(e)}$  in (35) to (38). These networks can be simplified further and reduced to simple components by neglecting certain terms with a loss of accuracy of approximately 20 per cent. Further simplification also results if it is assumed that  $\mu_{ec}$  is negligible at high frequencies. The resulting circuit for *high*

<sup>32</sup> R. L. Pritchard, "Frequency variations of current-amplification factor for junction transistors," *PROC. IRE*, vol. 40, p. 1480; November, 1952.

<sup>33</sup> The equivalent circuits described here also have been given by the writer in "Frequency response of theoretical models of junction transistors," *TRANS. IRE*, vol. CT-2, No. 2, pp. 183–191; June, 1955.

frequencies is shown in Fig. 7; the base impedance  $z_b'$  also has been included in accordance with the model shown in Fig. 2(b).<sup>34</sup> In this circuit, the frequency variation of the current-generator constant  $h_{21}^{(e)}$  has been taken into account by employing a simple *pi* network in the output circuit and by replacing  $h_{21}^{(e)}$  by a constant  $\alpha_0/(1-\alpha_0)$  (low-frequency value of  $h_{21}^{(e)}$ ), independent of frequency. As a consequence of this modification, the limiting low-frequency representation of  $h_{22}^{(e)}$  also can be obtained from this circuit. To obtain the low-frequency representation for  $h_{11}$  and  $h_{12}$ , additional resistances  $r_e'/(1-\alpha_0)$  and  $r_e'/\mu_{ec}(1-\alpha_0)$  should be shunted across the input capacitance  $1.2/\omega_c r_e'$  and across  $C_c$ , respectively.

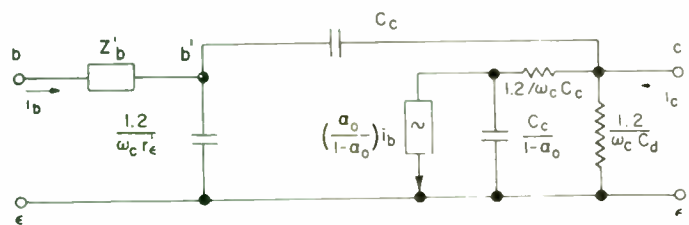

Fig. 7—Approximate high-frequency equivalent circuit for theoretical model of junction transistor; grounded-emitter operation.

On the other hand, for grounded-base operation, use of the shunt-feedback circuit shown in Fig. 6(b) leads to negative values for the admittance ( $h_{22} - y_{12}$ ); this is not especially desirable. A series feedback circuit could be employed (e.g., see that given by Early<sup>11</sup> for low frequencies). However, for high frequencies in grounded-base operation, feedback is predominantly due to the effect of the base impedance, and  $h_{12}$  of the inherent transistor is negligible. Consequently, the basic circuit

<sup>34</sup> Note the similarity between this circuit of Fig. 7 and the hybrid-*pi* equivalent circuit of Giacoletto-Johnson. (See for example, Giacoletto, reference 2, or C. W. Mueller, and J. I. Pankove, "A *p-n-p* triode alloy junction transistor for radio frequency amplification," *RCA Rev.*, vol. 14, p. 594; December, 1953, also *Proc. IRE*, vol. 42, p. 389; February, 1954.) The principal difference is that in the equivalent circuit above, the current generator in the output circuit is proportional to the actual input current to the over-all transistor, whereas in the Giacoletto-Johnson circuit, the current generator is proportional to a voltage at a point ( $b'$ ) inside the equivalent circuit which is not accessible in practice. Also, in the latter circuit, the current generator is shown to be independent of frequency, whereas in theory, the output current should lag the  $b'-\epsilon$  voltage by an appreciable phase angle, e.g., 22 degrees at the  $\alpha$ -cutoff frequency.

[Fig. 6(a)] may be employed directly for the ideal transistor, and at high frequencies,  $h_{12}e_2$  simply may be neglected.

By combining the circuit of Fig. 6(a), sans voltage generator, with the model shown in Fig. 2(a), and by substituting appropriate low-frequency expansions for the grounded-base  $h_{ij}$  parameters of the ideal transistor, the circuit shown in Fig. 8 has been synthesized.<sup>35</sup> In this circuit, as in Fig. 7, a simple *pi* network has been used in the output circuit. However, in this case, although the resulting current-generator "constant" can be made independent of frequency with respect to amplitude, it is necessary to include a frequency-dependent phase shift, i.e., a constant time delay, between the input current and current applied in the *pi* network. To complete the circuit for low frequencies, the voltage generator  $\mu_{ec}e_2$  and a collector-base conductance  $g_c$  must be added.<sup>11</sup>

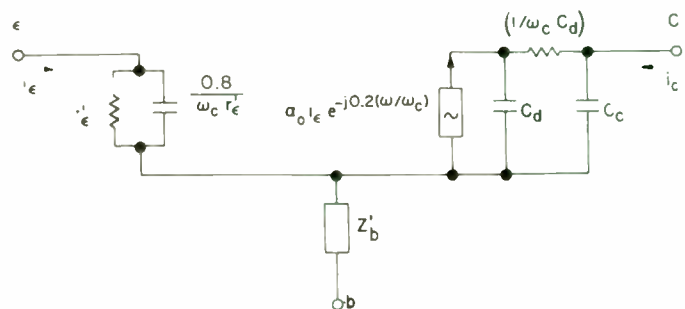

Fig. 8—Approximate high-frequency equivalent circuit for theoretical model of junction transistor; grounded-base operation.

ACKNOWLEDGMENT

The writer is grateful to J. Lawrence for his help in obtaining experimental data reported here and to R. N. Hall and W. N. Coffey for helpful discussions.

<sup>35</sup> Note the simplicity of this approximate circuit relative to the more exact circuits employing RC transmission lines (Pritchard, reference 16, Fig. 1; reference 1, Fig. 13, 16. Also, J. Zawels, "Physical theory of new circuit representation for junction transistors," *Jour. Appl. Phys.*, vol. 25, p. 978; August, 1954). A simplified equivalent circuit incorporating a time delay (delay line) between input and impressed-output currents also was presented by W. F. Chow and J. J. Suran, "Transient analysis of junction transistor amplifiers," *Proc. IRE*, vol. 41, pp. 1126-1127; September, 1953.



# IRE Standards on Radio Receivers: Method of Testing Receivers Employing Ferrite Core Loop Antennas, 1955\*

## COMMITTEE PERSONNEL

### Subcommittee on Loop Receivers, 1954-55

L. E. CLOSSON, *Chairman*

V. Beck  
R. A. Bell  
R. J. Farber

W. R. Koch  
J. R. Locke  
C. G. Seright

### Committee on Radio Receivers 1953-55

J. AVINS, *Chairman*, 1953-55

J. D. REID, *Vice-Chairman*, 1953-54

D. E. HARNETT, *Vice-Chairman*,  
1954-55

K. A. Chittick  
L. E. Closson  
D. E. Harnett  
D. J. Healey III

K. W. Jarvis  
J. K. Johnson  
W. R. Koch  
C. O. Marsh  
W. O. Swinyard

I. J. Melman  
G. Mountjoy  
F. R. Norton  
J. D. Reid

F. B. Uphoff

L. Riebman  
L. M. Rodgers  
S. W. Seeley  
R. F. Shea

R. S. Yoder

### Standards Committee, 1955-56

E. WEBER, *Chairman*

M. W. BALDWIN, JR., *Vice-Chairman*

L. G. CUMMING, *Vice-Chairman*

R. F. SHEA, *Vice-Chairman*

J. Avins  
W. R. Bennett  
J. G. Brainerd  
P. S. Carter  
P. S. Christaldi  
A. G. Clavier  
J. E. Eiselein  
A. W. Friend

V. M. Graham  
R. A. Hackbusch  
H. C. Hardy  
P. J. Herbst  
Hans Jaffe  
Henry Jasik  
A. G. Jensen  
J. L. Jones

J. G. Kreer, Jr.  
E. A. Laport  
A. A. Macdonald  
Wayne Mason  
D. E. Maxwell  
K. R. McConnell  
H. R. Mimno  
M. G. Morgan

W. T. Wintringham

G. A. Morton  
H. L. Owens  
C. H. Page  
P. A. Redhead  
R. Serrell  
R. M. Showers  
H. R. Terhune  
J. E. Ward

### Measurements Co-ordinator

R. F. SHEA

**1.00. Introduction.** The technique for introduction of a test signal into a loop antenna (see "Standards on Radio Receivers—Methods of Testing Amplitude-Modulation Broadcast Receivers—1948," Section 4.01.03, for example) has long been employed with receivers using air-core loop antennas. These antennas are normally of a more or less flat or "pancake" construction and, in general, lend themselves to the method described in the standard without ambiguity. When this method is extended to loop antennas wound on cores of high permeability in which the length-to-diameter ratio is high, it tends to break down. When the test loop and this type of antenna are coaxial, it is usually not feasible to

assign a spacing between these two for calibration purposes. Moreover, the use of the induction field to simulate the actual radiation field received by the loop is a satisfactory procedure only if the loop is immersed in a reasonably uniform field. This is substantially the situation with flat air core loops using the aforementioned technique but is not approximated satisfactorily when the relatively long ferrite core loop antenna is employed. This present standard describes a modification of the existing techniques which allows for the measurement of a receiver employing a ferrite-core loop antenna with the same precision as that obtained in the measurement of air-core loop antennas.

\* Reprints of this Standard, 55 IRE 17.S1, may be purchased while available from the Institute of Radio Engineers, 1 East 79 Street, New York 21, N. Y., at \$0.50 per copy. A 20 per cent discount will be allowed for 100 or more copies mailed to one address.

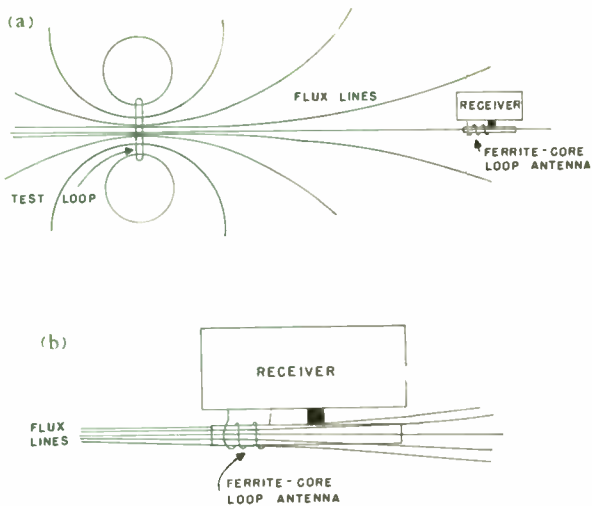

Fig. 1—Field configuration when air loop practice is followed with ferrite core loop antenna.

## 2.00. Apparatus Required.

**2.01. Radiating Test Loop.** The test loop employed can be identical to the one described in "Standards on Radio Receivers—Methods of Testing Amplitude-Modulation Broadcast Receivers—1948," Section 5.00. It should be observed, however, that the calibration relations of that section and Section 4.01.03.01 of the same standard refer to the field directed along the axis of the loop. Although this is not the field that is to be employed in this standard, the same loop design is implied.

**2.02. Shielded Room (Screen Room).** The relations presented for the field due to the loop assume free space conditions. Measurements generally are made in a screen room, and the precaution of Section 5.02 of the "Standards on Radio Receivers—Methods of Testing Amplitude-Modulation Broadcast Receivers—1948" applies. If there is any doubt concerning the validity of the measurements due to the proximity of fixed large metal objects, the field within the screen room can be compared with the field at the same distance in free space and a suitable correction factor applied to the screen room field. This correction is explained more fully in Section 3.03.

**2.03. Other Equipment.** The standard signal generators and receiver output measuring devices required for any particular test should have the characteristics specified in Section 3.00 of "Standards on Radio Receivers—Methods of Testing Amplitude-Modulation Broadcast Receivers—1948."

**3.00. Method of Measurement.** This new standard describes a method of introducing a known signal into a ferrite-core loop antenna and therefore replaces Section 4.01.03 of "Standards on Radio Receivers—Methods of Testing Amplitude-Modulation Broadcast Receivers—1948," when a receiver employing such an antenna is being measured. The remainder of the test procedures specified in Section 4.00 of that standard still apply.

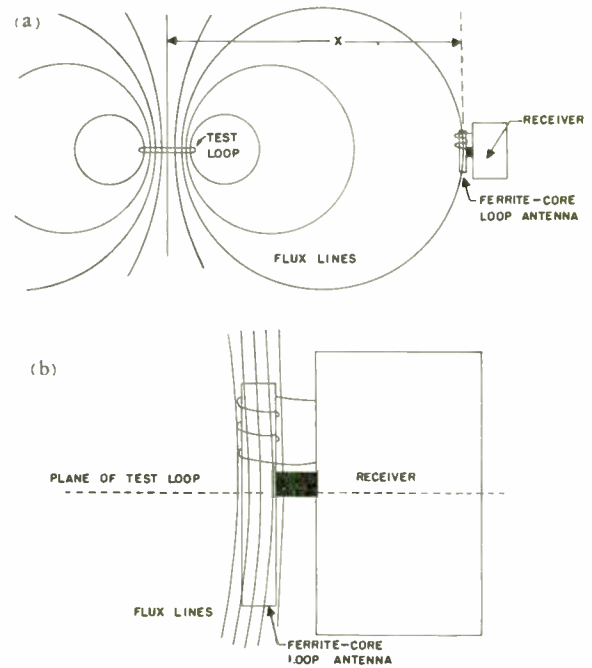

Fig. 2—Field configuration suitable for ferrite core loop antennas.

**3.01. Orientation of Radiating Loop and Receiver under Test.** Fig. 1 shows the magnetic field that would exist at a ferrite-core loop antenna if the orientation of radiating loop and receiver loop normally used with receivers employing air loop antennas were used (this figure and subsequent ones do not demonstrate the effect on the magnetic field configuration of the presence of the high-permeability ferrite rod). Notice that the field is not constant over the length of the rod; and since the length of the ferrite rod is generally significant compared to the spacing between radiating loop and rod, it is difficult, in general, to assign a value to the effective field at the antenna.

The recommended orientation is as shown in Fig. 2. The axis of the ferrite rod is placed normal to the plane of the test loop with the center of the rod in the plane of the test loop. The antenna rod is now located in a substantially constant field to which an effective value can be assigned.

**3.02. Calibration of Effective Field.** The significant component of field near the radiating test loop is a magnetic field that varies inversely as the cube of the distance from the loop. The receiving loop is essentially responsive to a magnetic field, and the magnitude of the field can be calculated in terms of the test loop parameters, the current in the test loop, and the spacing between the radiating and receiving loops. This can also be expressed in terms of the equivalent electric radiation field in volts per meter that would be accompanied by a magnetic field of the calculated value. The relation between the observed current in the coil and the equivalent electric field intensity is, to a close approximation, given by the formula:

$$E = \frac{30\pi n_1 a_1^2}{x^3} I_1,$$

where  $E$  = equivalent electric field intensity in volts per meter at the receiving loop antenna,  $n_1$  = number of turns of radiating loop  $L$ ,  $a_1$  = radius of radiating loop  $L$  in meters,  $x$  = distance in meters between the center of radiating loop  $L$  and the axis of the ferrite rod receiving loop,  $I_1$  = current in radiating loop  $L$  in amperes. If the loop is constructed as described in Section 5.01 of the "Standards on Radio Receivers—Methods of Testing Amplitude-Modulation Broadcast Receivers—1948," and a spacing of 24 inches ( $x$ ) between the axes of the radiating test and receiving loops is employed, the above equation can be reduced to a simple relationship between the indicated output voltage of the signal generator ( $V$ ) and the effective electric field strength in volts per meter as follows:

$$E = 0.05V.$$

In other words, the field in db below one volt per meter is 26 db below the signal generator output in db below one volt.<sup>1</sup>

<sup>1</sup> This relation is approximate in that it assumes the loop is a point source. For greater accuracy nonuniformity of field over length of ferrite rod must be taken into account. The 26-db value appears to be sufficiently accurate for normal measurement purposes.

**3.03. Effect of Screen Room.** The equation relating effective electric field intensity to signal generator output is derived assuming that the induction field of the radiating loop varies inversely as the cube of the distance from the loop as occurs in free space. If the screen room is not sufficiently large, reflections from its walls will tend to modify the field from its ideal value. It is useful to set up a receiver, radiating loop, and signal generator in "free space" (as far from large metal objects as possible) in the manner prescribed in this standard, and adjusted to a frequency that can be used outside the screen room without undue interference. The signal generator output required to produce a suitable reference output from the receiver is recorded. The entire set-up is then transferred to the screen room, and the signal generator output readjusted, if necessary, to produce the same reference output from the receiver. This change in signal generator output is a measure of the distortion of the field configuration due to the screen room. The correction should be used to modify the relation between effective field strength and signal generator output given in Section 3.02. Since the calibration in general is not independent of frequency, it should be made at or near the frequency of interest. If the locations of the instruments within the screen room are modified, a new calibration may be required.

## A Microwave Phase Contour Plotter\*

J. S. AJIOKA†

**Summary**—A simple, easily built rf phase contour plotting device is described. This phase plotter differs from the conventional plotter in that two field-sampling probes are used instead of one. Instead of a fixed reference signal taken directly from the source, a phase reference is taken from the field itself. This technique offers several practical advantages over conventional methods.

THE MEASUREMENT of phase in the field of microwave radiators is important in the design of antenna components and in the study of the effects of objects placed in the field. The determination of equiphase contours and the location of phase centers of feeds for reflectors and lenses are of much value in the design of such antennas. Phase measurements are also important in the study of the effects of weatherizing covers and radomes.

This paper describes a simple, inexpensive, easily made device for manual phase contour plotting, with primary application to locating the phase centers of

primary radiators. It has some advantages over the conventional phase contour plotting apparatus and is comparable in accuracy. This device is not intended to replace some of the rather complex and expensive automatic phase plotters<sup>1</sup> now in existence, but rather to afford a design for a simple inexpensive phase plotter that can be built in a relatively short time.

In the conventional method for measuring phase, a sample of energy from the field is picked up by a probe and compared in phase with a reference signal which comes directly from the source.<sup>2</sup> The phase of one signal is varied with respect to the other to produce an interference resulting in a maximum or minimum. The amount of phase shift is a measure of the difference in phase between the field sample and the reference. A slotted line with the reference signal inserted through the traveling probe is often used as the phase shifter and mixer.

\* Original manuscript received by the IRE, January 25, 1955; revised manuscript received, June 6, 1955. This work was performed at the U. S. Navy Electronics Lab., San Diego 52, Calif.

† Hughes Res. Labs., Hughes Aircraft Co., Culver City, Calif.

<sup>1</sup> R. M. Barrett and M. H. Barnes, "Automatic antenna wave-front plotter," *Electronics*, vol. 25, pp. 120-125; January, 1952.

<sup>2</sup> S. Silver, "Microwave Antenna Theory and Design," McGraw-Hill Book Co., Inc., New York, N.Y., ch. 15, 1949.



The conventional phase measuring apparatus has several practical disadvantages which are as follows:

1. The necessary rf rotating joints or flexible cables complicate the rf plumbing; and unless much care is taken, may cause phase shift with movement.
2. If there is a wide variation in the amplitude of the field whose phase is to be measured, the minima readings in the mixer cannot all be made sharp by a simple interference procedure.<sup>3</sup>
3. All components in the rf system must be well matched or false minima can occur.<sup>2</sup>
4. Phase contour plot, usually not direct, must be plotted from data taken from phase shifter readings.
5. The accuracy is impaired by small changes in frequency during the time for making a complete plot.<sup>2</sup>

A method using two field-sampling probes instead of one eliminates the above disadvantages. Instead of a fixed reference directly from source, a phase reference is taken from the field itself. Fig. 1 is a photograph of this phase plotter. The stand in the background is an instrument for projecting the horn onto plotting paper.



Fig. 1—Phase contour plotter in operation.

The device (See Fig. 2) is described as follows:

Two probes spaced a fixed distance apart are connected respectively to the *E* and *H* arms of a magic tee where their signals are mixed. A detector is placed on one of the remaining arms and a matched load is placed on the other. The connection is such that in-phase sig-

<sup>3</sup> With somewhat more complication, this difficulty can be eliminated. See F. L. Vernon, Jr., "Application of the microwave homodyne," *TRANS. IRE*, vol. AP-4, pp. 110-116; December, 1952 and J. Bacon, "An automatic X-baud phase plotter," *Proc. NEC*, Chicago, Ill.; October, 1954.

nals from the probes will destructively interfere at the detector to give a minimum. Since the probes are close enough together so that they are usually in a field of approximately the same strength, the minimum is sharp. Since the magic tee with the detector is an integral part of the two-probe combination, there is only an audio cable that need be flexible.

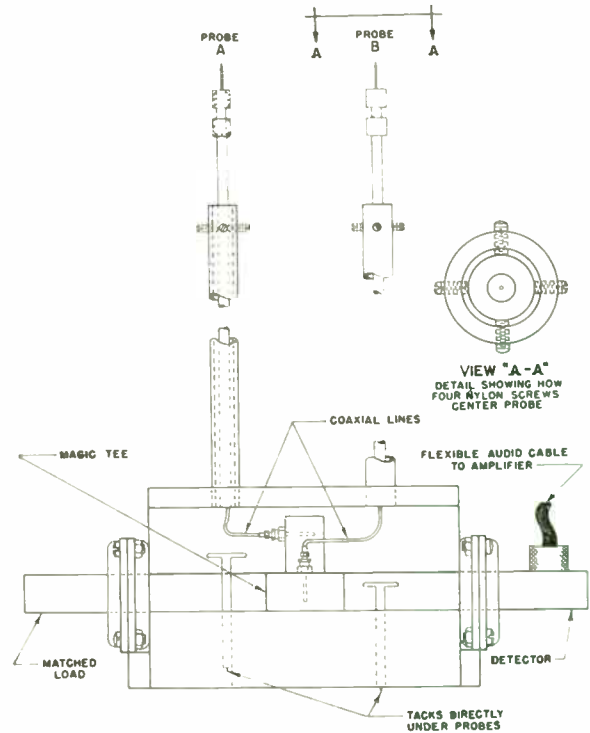

Fig. 2—Sketch of phase contour plotter.

To plot equiphase contours, the probe assembly is placed in the field of the radiator whose phase fronts are to be plotted. The probe assembly is placed over a flat surface on which the phase contour is plotted. The flat surface is  $\frac{1}{2}$  inch plate glass covered with heavy paper.

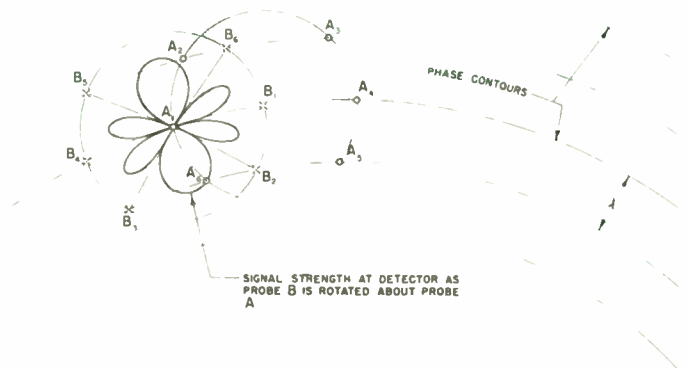

Fig. 3—Diagram illustrating the procedure of plotting phase contours.

(See Fig. 3). The tack under probe *A* is pushed into the surface (paper) and the probe assembly is rotated about probe *A* and the positions of minimum readings are

marked by pushing tack "B" into the paper. These  $B$ -tack points (marked by  $x$ 's) are points of equal phase. The tack is lifted from point  $A$  and the probe assembly is rotated about one of the  $B$ -tack points. Since the center of phase is somewhere in the region of the aperture of the radiating element under test, there will, in general, be no ambiguity as to which of the  $B$ -points are on the same phase contour as point  $A$ . Of course, there would be no ambiguity if the probe spacing were less than a wavelength but the sensitivity would be decreased. These  $B$ -points are labeled  $B_1$  and  $B_4$  in the figure. As the assembly is rotated about point  $A_1$ , the null-points  $B_1$  and  $B_4$  only are considered and the center of rotation is then moved to either  $B_1$  or  $B_4$  (say  $B_1$ ) and point  $A_4$  on the same phase front as  $A_1$  is found. This process of alternately rotating about probe  $A$  (circles) and probe  $B$  ( $x$ 's) is repeated to plot a complete equiphase contour.

If the electrical line length from probe  $A$  to the detector is equal to that from probe  $B$  to the detector as was intended, the  $A$  and  $B$  points will be in phase. Otherwise, the points  $A$  (circles) and the points  $B$  ( $x$ 's) are two different sets of equiphase points. If curves are drawn through points  $A$  and through points  $B$ , the normal separation between the curves will be the difference in electrical lengths of the lines from the two probes. This difference in line lengths can be calibrated by picking a fixed point in the field, rotating about probe  $A$  and establishing a null-point for probe  $B$ . Then place probe  $B$  at fixed point, rotate about probe  $B$  and establish a null-point for probe  $A$ . Distance between these null-points will be twice the difference in line lengths.

Since the path lengths from the probes to the detector are made to be as nearly identical as possible, the phase front plotter is quite insensitive to variations of frequency.

If the phase fronts are smooth, there is no ambiguity as to which points are on the same contour; but if there is a sudden phase change as would occur over a minimum in the amplitude pattern of the radiator under test, care must be taken so that a true phase contour would be followed. For this reason, amplitude patterns are also taken with a single probe with a center of rotation about the approximate center of phase of the radiating element. A deep minimum in the amplitude pattern will give warning that a sudden change in phase is to be expected. A typical amplitude and phase plot of such a situation is given in Fig. 4. Fig. 4 is an amplitude (dashed lines) and phase (solid lines) plot of an  $E$ -plane horn with a septum. This horn was chosen as an example because of the deep minima in its amplitude pattern. If the minimum were infinitely deep, the phase change would be a sudden step of 180 degrees. In general, the

minima are not infinitely deep and the phase contour is like that of Fig. 4. To plot points about the region of rapid phase change, a partial curve is drawn in the smooth phase region and points on this curve are used as reference points for establishing points closer than the probe spacing. Thus, we creep up to the region near the amplitude minimum and finally we span the amplitude minimum to establish points on the phase contour on the other side of the amplitude minimum. With a little more complexity a probe assembly could be made so that the probe spacing could be varied. Once the probe spacing is changed, it is kept unvaried during a set of measurements. This eliminates the difficulty of the above procedure. Such a variable spacing probe assembly has not been made but a fixed spacing of approximately one and one-half wavelengths was chosen to give sharp minima readings. The probes for each polarization were of conventional design.

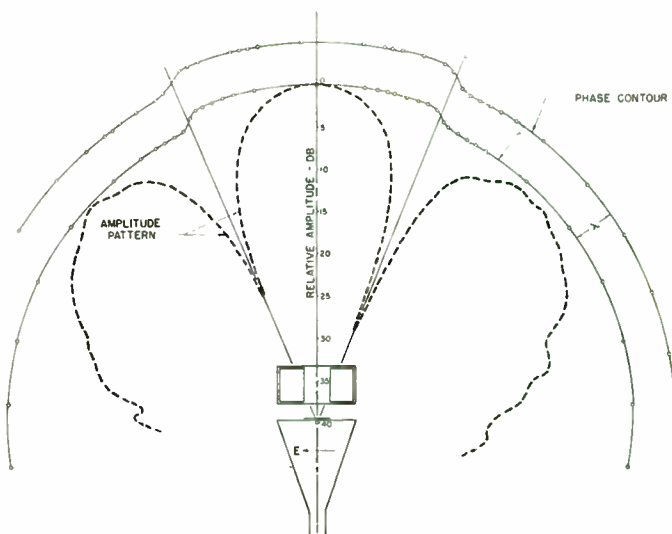
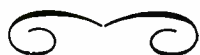

Fig. 4—Phase and amplitude plot of horn with septum.

One obvious disadvantage of the above procedure is the possibility of cumulative errors, but in the application to locating the phase centers of primary feeds, this is not serious because only groups of three points on the phase contour are necessary for location of the phase center. However, the simplicity, inexpensiveness, and ease of operation make this phase plotter a practical laboratory tool.

#### ACKNOWLEDGMENT

The author gratefully acknowledges the encouragement given by all members of the Microwave Antenna Section at NEL headed by J. J. Thomas and formerly headed by E. K. Abbey. The author also wishes to thank J. H. Jensen who built the first models.



# The Application of Dielectric Tuning to Panoramic Receiver Design\*

T. W. BUTLER, JR.†, ASSOCIATE, IRE, W. J. LINDSAY†, ASSOCIATE, IRE, AND  
L. W. ORR†, ASSOCIATE, IRE

**Summary**—This paper describes a method of utilizing the voltage tuning characteristics of ferroelectric capacitors in a wide range, superheterodyne, dielectric-tuned, panoramic receiver. Continuous tuning over a 2:1 frequency band is obtained in frequency ranges up to 110 mc. Some of the problems encountered in this application are described, and a method of optimizing the parameters of specific materials is discussed. No detailed technical discussion is presented. The application of these capacitors to various types of circuitry is briefly indicated.

## INTRODUCTION

**F**ERROELECTRIC tuning techniques utilize the nonlinear electrical characteristics of certain types of ferroelectric materials. Barium-strontium titanate materials constitute the major class of dielectrics that are presently being applied to ferroelectric tuning devices. The use of capacitors constructed from these materials as the basic tuning elements in panoramic receiver front ends is the subject of this paper.

It should be noted, however, that ferroelectric tuning techniques are being applied to sweep generators, spectrum analyzers, search receivers, and other equipments where wide-range, rapid-scan devices are useful.

This paper describes a method of utilizing the voltage tuning characteristics of ferroelectric capacitors in a wide-range superheterodyne, dielectric-tuned, panoramic receiver. This receiver employs titanate ceramic capacitors as tuning elements in the rf, mixer, and local oscillator tank circuits. The capacity of the tuning elements is varied by changing the electric field applied to the capacitor.

The receiver described is incorporated in a rather complete laboratory test unit which was designed specifically for testing dielectric-tuned receiver front end assemblies. This unit consists of an assemblage of power supplies, a display oscilloscope, and control panels. The essential components of this test unit are indicated in the block diagram of Fig. 1. The receiver front-end assemblies are plug-in units containing the electrical electrically tunable stages, i.e., the rf, mixer and local oscillator stages.

## CHARACTERISTICS OF CAPACITORS

The ceramic capacitors used as the tuning elements in the front end assemblies are of the barium-strontium titanate class. These were developed in the Department

\* Original manuscript received by the IRE, April 25, 1955; revised manuscript received, June 8, 1955. This work was sponsored by the U. S. Army Signal Corps under Contract No. DA-36-039 sc-63203.

† Electronic Defense group, Engrg. Res. Inst., Univ. of Mich., Ann Arbor, Mich.

of Electrical Engineering Laboratories at the University of Michigan. A commercially made body material is used, but methods of plating, connecting, and potting capacitors are still laboratory processes.

To obtain the maximum tuning range with good receiver stability and sensitivity, the capacitor body material should have the following characteristics:

1. A large change in dielectric constant,  $\epsilon$ , with applied field,
2. A small temperature coefficient of  $\epsilon$  over a wide temperature range, and
3. Low loss over the desired frequency range.

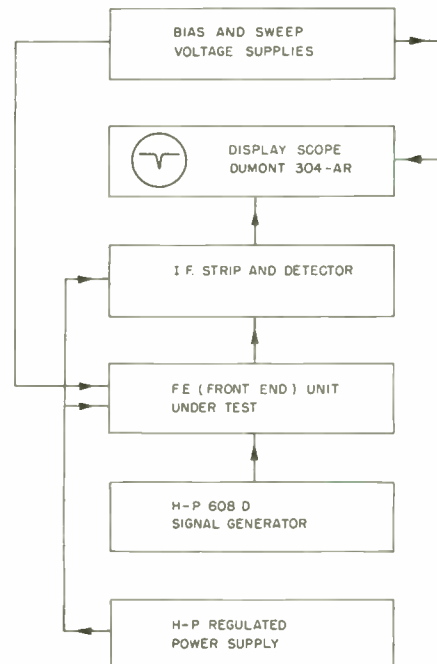
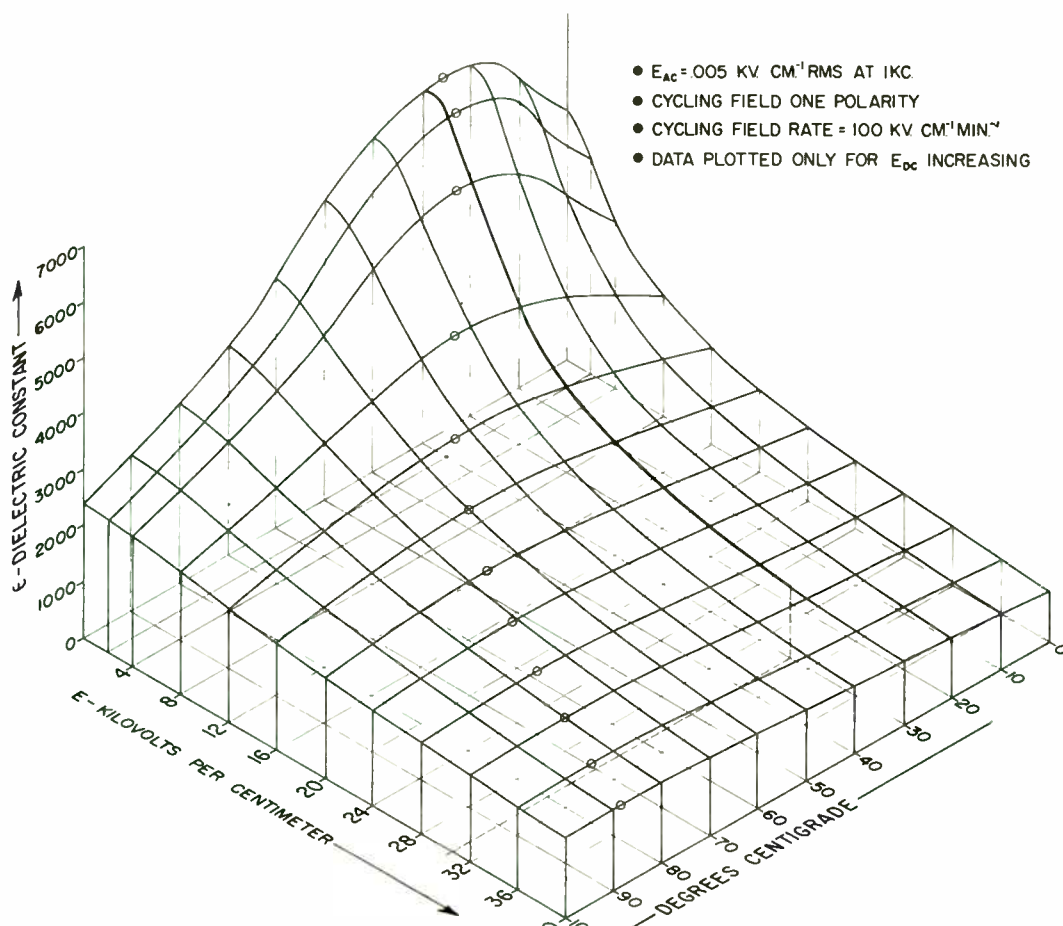

Fig. 1—Block diagram of wide-range dielectric tuned panoramic receiver.

Materials which exhibit large changes in dielectric constant with applied field also exhibit large changes in dielectric constant with changes in temperature. Conversely, materials which have a small temperature coefficient of dielectric constant over a wide temperature range generally lack field sensitivity and are not suitable for dielectric tuning. It has not been possible to obtain body material for the capacitors which possess all three of the desirable characteristics.

Fig. 2 (next page) shows an  $\epsilon$ - $T$ - $E$  surface for a typical ferroelectric ceramic material of rather high dielectric constant. Ordinate of surface gives the dielectric con-

Fig. 2— $\epsilon$ - $T$ - $E$  surface for aerovox Hi-Q 41.

stant, with abscissae of temperature and dc electric field. Small circles indicate points of zero temperature coefficient. Surface representation gives a very clear display of the characteristics of the material, and its use in the design of the tuning elements is illustrated by the following numerical example.

Consider the design of the rf amplifier tank circuit which is to be tunable from 50 to 100 mc. Assuming a value of  $160 \mu\mu\text{f}$  for the total tank capacitance at 50 mc, gives  $40 \mu\mu\text{f}$  for the total capacitance at 100 mc. If the fixed shunt capacitance representing the tube, wiring and strays is  $10 \mu\mu\text{f}$ , the tunable element must vary from  $150 \mu\mu\text{f}$  to  $30 \mu\mu\text{f}$ . This element will be a pair of ceramic capacitors connected in series, each having a value of  $300 \mu\mu\text{f}$  at zero applied field.

The capacitance variation as the electric field is applied may be obtained from the contour curves of Fig. 2. Consider the curve for 30 degrees C. It is noted that a 5:1 variation in dielectric constant is obtained when the applied field varies from zero to 30.5 kv/cm. If the material is 0.05 cm thick, the required field is furnished by an applied voltage of 1,525 volts.

Effect of a temperature change on tuning may be calculated by noting dielectric constant at 20 degrees C. is almost identical with that at 30 degrees C. with zero applied field. Therefore, lower frequency will still be 50 mc. At a field of 30.5 kv/cm, dielectric constant is lowered about 4 per cent below its value at 30 degrees C. The minimum capacitance value at 20 degrees C. will

therefore be  $28.8 \mu\mu\text{f}$ , giving an upper frequency of

$$f_2 = \left\{ \frac{30 + 10}{28.8 + 10} \right\}^{1/2} \cdot 100 = 101.5 \text{ mc.}$$

This does not imply a tracking error of 1.5 mc since the oscillator circuit will also experience a similar temperature-induced change. It does, however, represent an increase in the tuning range of 3 per cent, so that as the equipment warms up from 20 degrees C. to 30 degrees C., the tuning range will shrink by this amount.

The effect of capacitor tolerance may be disposed of by noting that an increase of 10 per cent in the zero field capacitance due to a larger electrode area is accompanied by an increase of 10 per cent in the capacitance at all fields, and can therefore be compensated throughout the tuning range by an appropriate decrease (9.1 per cent) in the tuning inductance. To insure that all capacitors of the receiver have approximately the same tuning characteristic, i.e., the same  $\epsilon$ - $T$ - $E$  surface, they may all be cut from the same wafer of ceramic material. The ceramic materials now available are sufficiently homogeneous that variations in tuning characteristic are less than 1 per cent between samples cut from the same wafer of the material.

$\epsilon$ - $T$ - $E$  surfaces have been obtained for a number of materials suitable for electric tuning. A survey of these surfaces is of great assistance in selecting the best available material for a particular set of conditions.

Low loss is an important factor in electric tuning, and tests show that this is not entirely a property of the ceramic material. The type and quality of metal used for electrodes, and its thickness and uniformity, all have important effects on the loss. Capacitors for the tuning units were made with 0.020-inch cubes of ceramic having one mil thick electrode plating extending to the edges of the ceramic faces. Fig. 3 shows typical capacitors made in this manner. A plastic coating over the dielectric seals out moisture, preventing excessive losses and possible electrical breakdown.

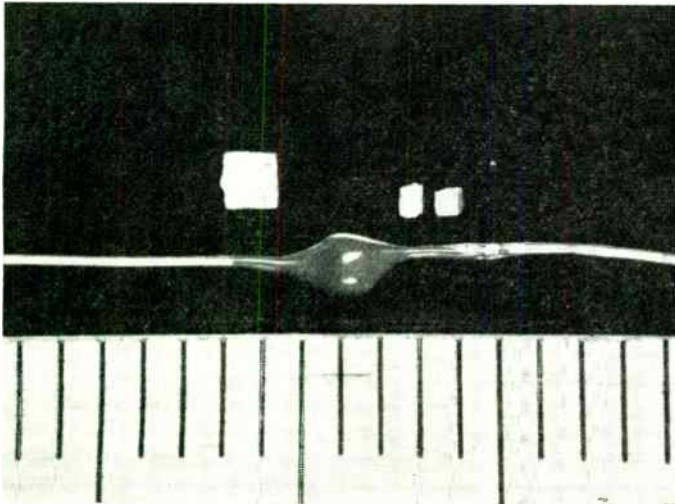

Fig. 3—Typical subminiature ferroelectric capacitor.

circuits in the front-end unit are tuned by changing the dc bias voltage on the tuning capacitors. The receiver is swept by applying a superimposed 60 cps alternating voltage to the tuning capacitors. The dc bias voltage may be varied from 0 to 1,000 volts, and the ac sweep voltage may be varied from 0 to 1,000 volts rms. No power is absorbed from the dc bias supply in sweeping the receiver over the maximum range. The reactive power absorbed from the ac sweep voltage supply is generally less than 0.1 volt-amperes. The three tuned circuits are tracked by suitable adjustments of the dc bias and the ac sweep voltages. The IF strip is of the synchronous-tuned type<sup>1</sup> with a 3 db bandwidth of approximately 100 kc. The output of the crystal detector feeds the vertical input of the DuMont 304-AR oscilloscope. The horizontal input of the scope is fed a sample of the 60 cycle sweep voltage applied to the oscillator. This results in a panoramic display on the oscilloscope.

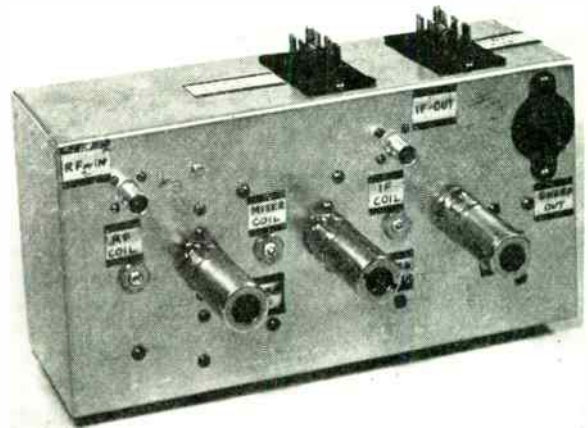

Fig. 5—Exterior view of a front-end unit.

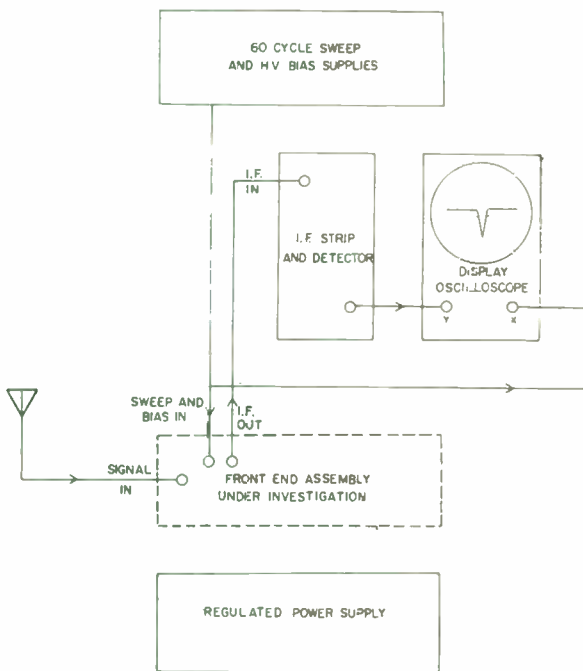

Fig. 4—Block diagram of receiver.

### RECEIVER DESIGN

The receiver is a single conversion superheterodyne type with a tuned rf stage, tuned mixer, and local oscillator in the tunable front end unit, and a 20 mc IF strip driving a crystal detector (Fig. 4). The three tuned

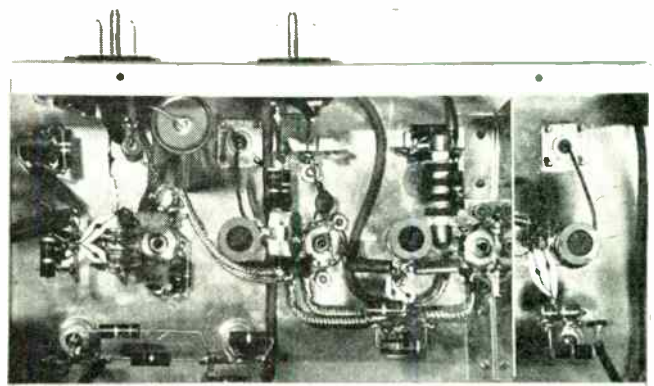
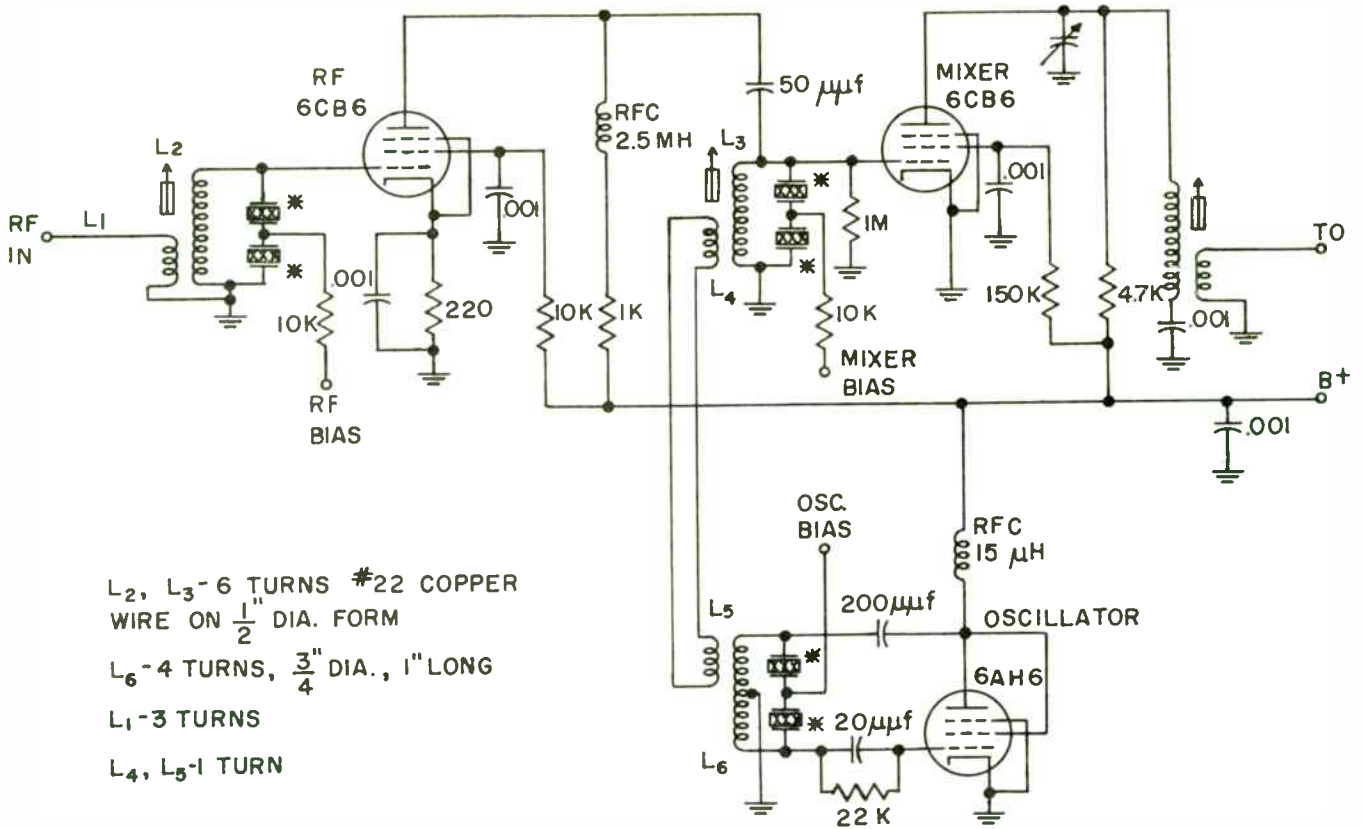

Fig. 6—Interior view of a front-end unit.

### FRONT-END UNITS

Exterior and interior views of one of the early FE (Front-End) units are shown in Figs. 5 and 6. The three sets of tuning capacitors can be seen in Fig. 6. A sche-

<sup>1</sup> The individual stages of a synchronous-tuned IF strip are single tuned and all stages are tuned to the same frequency.



L<sub>2</sub>, L<sub>3</sub>-6 TURNS #22 COPPER WIRE ON 1/2" DIA. FORM  
 L<sub>6</sub>-4 TURNS, 3/4" DIA., 1" LONG  
 L<sub>1</sub>-3 TURNS  
 L<sub>4</sub>, L<sub>5</sub>-1 TURN

\* ALL FERROELECTRIC CAPACITORS APPROXIMATELY 100μμf

Fig. 7—Schematic of receiver front-end unit.

matic of one of the later FE units is shown in Fig. 7. The circuit design is conventional in some respects, but requires some precautions. The principal points of difference in circuitry occur in the tuned circuits and in the method of connecting the bias and sweep voltages. Capacitances to ground are kept as low as possible to reduce the effect of shunt circuit capacitance on the tuning range. This also dictates use of tubes with low shunt capacitance. The 6CB6 tube has good noise characteristics, and has performed very well in the frequency ranges considered.

A pentode mixer is used to keep the circuitry simple, and still provide good signal-to-noise ratio. Link coupling is used to obtain oscillator injection. This method of injection reduces the possibility of spurious responses due to oscillator harmonics.

The *Q* of the tank circuits used is lower than ordinarily encountered in receiver design. This is due to the relatively low *Q* of the capacitors. High *g<sub>m</sub>* tubes must be used to obtain satisfactory results. The oscillator circuit is quite critical with respect to the *g<sub>m</sub>* of the tube, requiring at least 7,000 to 8,000 μmhos to oscillate satisfactorily. The triode-connected 6AH6 has given good results as the oscillator tube. The 6J4 triode has also performed satisfactorily.

The bias and sweep voltages are decoupled from the

rf circuits to avoid increases in rf loading and stray capacitance. Pairs of series-connected capacitors are used in all the tank circuits. This affords smaller minimum capacitance and at the same time supplies a convenient dc block for the bias voltage. The rf ground end of the rf and mixer coils, and the feedback point of the oscillator coil, are connected to the chassis. This permits a single connection to be used for the bias and sweep voltages, which aids in keeping stray capacitances to a minimum.

It was pointed out in an earlier section that it is desirable to use titanate materials which have a small temperature coefficient of dielectric constant over a wide temperature range. If the receiver is to be used over an extended temperature range, methods of temperature compensation will be required to maintain receiver tuning range and sensitivity. It has been found that for laboratory operation temperature compensation was not necessary.

RESULTS

To date, two working units, Models FE-2 and FE-3 have been built and tested. FE-2 tunes from 28 to 60 mc, while FE-3 tunes from 55 to 110 mc.

The sensitivity of the units may be defined as that signal level at the input of the receiver which will pro-

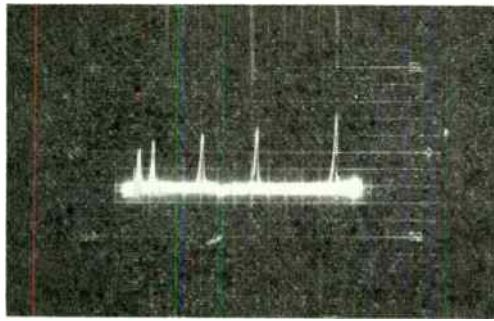

(a) Marker signals at 28, 30, 40, 50, and 60 mc.

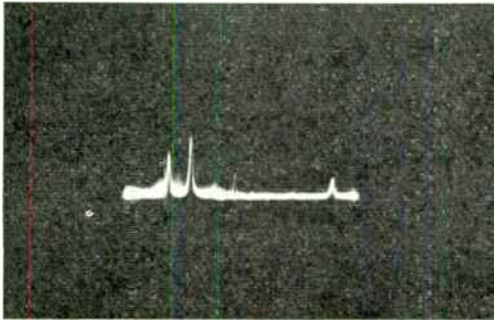

(b) Local spectrum using short wire antenna.

Fig. 8—Oscillograms showing response of FE-2.

duce a "pip" on the scope twice the apparent average height of the internal noise of the receiver.<sup>2</sup> The sensitivity of both units under the swept conditions listed is  $5(\pm 1)$  microvolts into 50 ohms. When tuned to a fixed frequency, the sensitivity goes up to approximately 1.5 microvolts. The internal noise generated in the receiver is a function of the sweep width, and of other factors, the exact nature of which are not yet known. The overall bandwidth of this system is approximately that of the IF strip, or approximately 100 kc. The half-power point resolution of the receiver is approximately 150 kc. The reliability of the receiver depends primarily upon the reliability of the tuning capacitors. Recently, excellent results have been obtained in this respect. Improvements in the methods of manufacturing the capacitors from the commercially available body materials have resulted in capacitors that are expected to give continuous operation over long periods<sup>3</sup> with few failures.

Fig. 8 shows two oscillograms taken with FE-2 in operation. In the upper picture, marker signals of 20 microvolts at 28, 30, 40, 40 and 60 mc indicate the frequency spectrum. The lower picture shows the local strong signal spectrum with a short piece of wire used as an antenna. Fig. 9 shows a similar display for FE-3.

<sup>2</sup> J. B. L. Foot, "Wideband VHF panoramic receiver," *Wireless World*, vol. 59, p. 392; September, 1953.

<sup>3</sup> At this writing the reliable life of capacitors under operating conditions cannot be evaluated since life-test results are incomplete.

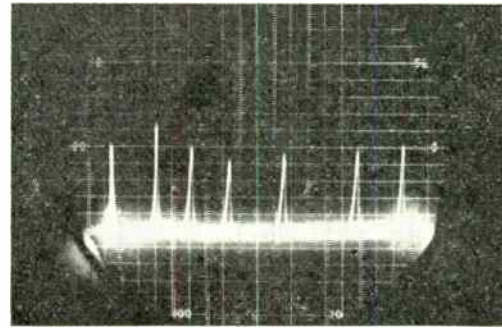

(a) Marker signals at 55, 65, 75, 85, 95, 105, and 110 mc.

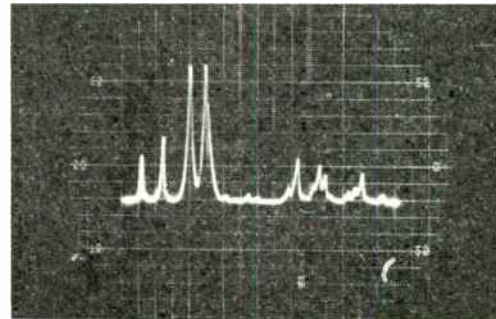

(b) Local spectrum (Detroit) with high gain disccone antenna.

Fig. 9—Oscillograms showing response of FE-3.

The upper picture contains markers at 55, 65, 75, 85, 95, 105, 110 mc. The lower picture was made with a high-gain antenna oriented toward two TV stations, 30 miles distant. At the lower end of the spectrum are the audio and video signals of the two TV channels, while in the higher regions numerous FM radio stations may be observed. The frequency scale distortion noted in the upper picture is due to the nonlinear characteristic of the tuning capacitors.

Work is presently being done to extend the tuning range to higher frequencies. Preliminary tests on a higher frequency FE unit indicate that attaining the 200 mc region is feasible. This requires different types of circuits than those used in FE-2 and FE-3. At frequencies much above 100 mc the most satisfactory oscillator circuit is the ultra-audion.<sup>4</sup> Oscillators of this type have been built and tested up through 400 mc with tuning ratios of 1.5:1. There are two major problems in connection with extension of the frequency range.

1. It is difficult to manufacture capacitors with capacitances low enough to be useful in high-frequency circuits.

2. Rf losses in the dielectric increase with frequency, resulting in lowered  $Q$  of the tuned circuits.

Although the receiver described in this paper uses a relatively slow scan rate (60 cps), these are applications for which a faster scan rate may be desirable. Faster

<sup>4</sup> J. F. Reintjes and G. T. Coate, "Principles of Radar," 3rd ed., McGraw-Hill Book Co., Inc., N. Y., N. Y., p. 706; 1952.

scan rates are readily obtainable with dielectric tuned oscillators and have been reported up to 500 kc for small deviations.<sup>5</sup> To judge from the relaxation measurements on several samples of titanate ceramics, the upper practical limit of sweeping in a panoramic receiver appears at present to be about 100 kc.

### CONCLUSION

There are many applications in the field of instrumentation in which dielectric tuned tank circuits could

<sup>5</sup> M. Apstein and H. H. Wieder, "Capacitor-modulated wide range FM system," *Electronics*, vol. 26, p. 190; October, 1953.

be used to advantage, i.e., sweep generators and spectrum analyzers. Dielectric-tuned, wide-range, vhf swept oscillators which may be suitable for use in the instrumentation field are under development at the present time.

The results achieved to date are very good considering the characteristics of the capacitor body material being used in the tuning elements. It is possible that the present difficulty of dielectric tuning—i.e., obtaining a large tuning ratio while maintaining a small temperature coefficient—may be considerably reduced through the development of new materials and manufacturing techniques.

## Note on the Design of Wide-Band Low-Noise Amplifiers\*

D. WEIGHTON†

**Summary**—The case is considered of a grounded cathode amplifier fed from a finite source impedance in which the requirements of minimum noise factor conflict with those of adequate bandwidth. Equalization, either by feedback or by the use of complementary networks, provides one means of dealing with this problem, and involves modification of some circuit parameters for minimum noise factor. Design criteria are developed for amplifiers based on this procedure, including equalization of both input and tube coupling circuits. Some measurements on an experimental amplifier are reported.

### INTRODUCTION

THE PRINCIPLES of design of low-noise amplifiers in which bandwidth is not a limiting factor are well-known as a result of the early work of a number of authors, notably North<sup>1</sup> and Herold.<sup>2</sup> In the case where the requirements of minimum noise factor conflict with those of adequate bandwidth there is, however, no clearly established procedure, although a number of devices to increase bandwidth have been discussed by Herold,<sup>2</sup> Lebenbaum<sup>3</sup> and others. In the narrow-band case, the input circuit of a grounded cathode amplifier is normally designed for minimum noise factor by choice of the optimum transformation of source impedance as described, for example, by Wallman<sup>4</sup> or Houlding.<sup>5</sup> The value of this optimum source

impedance depends only on the circuit losses, the transit time damping and the equivalent noise resistance of the tube, and the maximum bandwidth available in these conditions is therefore fixed by the tube input and stray capacitances. If a greater bandwidth is required there are a number of alternatives open to the designer, but in most cases some sacrifice in noise factor is involved. A detailed discussion of these alternatives is to be found in Twiss and Beers.<sup>6</sup>

The use of feedback affords one of the most attractive solutions to this problem largely for incidental reasons. It allows some freedom in modifying the input impedance of the amplifier without appreciably degrading the noise factor and tends to minimize the effect of variations in source impedance. The effect of feedback on single frequency noise factor has been dealt with by Harris<sup>7</sup> and more recently by Beers,<sup>8</sup> who also discusses specific cases based on the work of Macnee. These authors show that, provided the feedback network does not itself significantly load the input circuit, the effect on single-frequency noise factor is small. The effect on the average noise factor over a wide pass band may, however, be large, since the spectral distribution of noise is changed, and a new value of optimum source impedance has to be found. The problem is similar to that of an amplifier in which the restricted bandwidth of the input circuit is corrected by an equalizing network inserted at some later stage. The latter arrangement has received some attention in relation to video amplifiers fed from a

\* Original manuscript received by the IRE, January 7, 1955; revised manuscript received, June 17, 1955.

† Pye, Ltd. Radio Works, Cambridge, England.

<sup>1</sup> B. J. Thompson, D. O. North, and W. A. Harris, "Fluctuations in space-charge-limited currents at moderately high frequencies," *RCA Rev.*, vols. 4 and 5, pp. 269-285; January, 1940-July, 1941.

<sup>2</sup> E. W. Herold, "An analysis of the signal-to-noise ratio of ultra high frequency receivers," *RCA Rev.*, vol. 6, pp. 302-331, 1942.

<sup>3</sup> M. T. Lebenbaum, "Design factors in low noise figure input circuits," *PROC. IRE*, vol. 38, pp. 75-80; January, 1950.

<sup>4</sup> H. Wallman, A. B. Macnee, and C. P. Gadsden, "A low-noise amplifier," *PROC. IRE*, vol. 36, pp. 700-708; June, 1948.

<sup>5</sup> N. Houlding, "Noise factor of conventional V.H.F. amplifiers," *Wireless Eng.*, vol. 30, pp. 281-306; November, December, 1953.

<sup>6</sup> R. Q. Twiss and Y. Beers, "Vacuum Tube Amplifiers," M.I.T. Rad. Lab. Ser., No. 18, McGraw-Hill Book Co., Inc., New York, N. Y., ch. 13; 1948.

<sup>7</sup> W. A. Harris, "Fluctuations in vacuum-tube amplifiers and input systems," *RCA Rev.*, vol. 6, pp. 114-124; July, 1941.

<sup>8</sup> Y. Beers, "Microwave Receivers," M.I.T. Rad. Lab. Ser., No. 23, McGraw-Hill Book Co., New York, N. Y., p. 88; 1948.



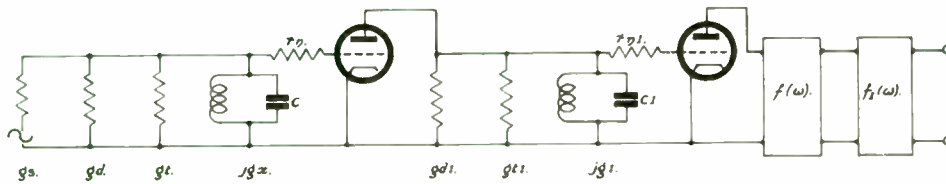

Fig. 1

constant current source (see, for example, Barco<sup>9</sup>) but as far as the author is aware it has not received quantitative treatment for the case of a source of constant available power.

The purpose of the present note is to develop design criteria and performance data for minimum-noise equalized amplifiers and to present the results in a form directly useful to the engineer. The discussion is limited to the grounded cathode circuit fed from a source of finite impedance, but applies equally to pentodes or triodes which may be either neutralized or cascode stabilized.

INPUT CIRCUIT

The simplest arrangement of input circuit for a band-pass amplifier is shown in Fig. 1, where the total capacitance to ground is tuned by a shunt inductor. Writing  $g_s$  the source conductance,  $g_d$  the conductance representing circuit losses,  $g_t$  the transit time conductance, and  $g_x$  the total shunt susceptance, then the transfer function of the input circuit is of the form

$$g_s / (g_s + g_d + g_t + jg_x),$$

and the correcting network must therefore have the form

$$f(\omega) = (g_s + g_d + g_t) + jg_x, \tag{1}$$

if the amplifier is to be distortionless.

It is shown in Appendix A that the noise factor of the first stage of an amplifier which is followed by a correcting network of this form is given by

$$N = 1 + \left\{ K g_t + g_d + \frac{4}{3} r_n \pi^2 B^2 C^2 \right\} / g_s + r_n (g_s + g_t + g_d)^2 / g_s, \tag{2}$$

where  $K$  is the excess noise temperature assigned to the transit time loading,  $B$  is the over-all noise bandwidth of the amplifier in cycles per second and  $r_n$  is the equivalent noise resistance of the first tube. Eq. (2) will be recognized as the expression for single-frequency noise factor at band center with an additional term in the first bracket. It follows that the bandwidth limitation may be taken into account by supposing an additional noise source equal to that of a conductance  $4/3 r_n \pi^2 B^2 C^2$  to be in shunt with the input circuit.

In a wide-band amplifier  $g_d$  and  $g_t$  will generally be small compared with  $g_s$ , and the expression for noise factor may be approximated

<sup>9</sup> A. A. Barco, "An iconoscope preamplifier," *RC:A Rev.*, vol. 4, pp. 89-107; July, 1939.

$$N = 1 + \left( K g_t + \frac{4}{3} r_n \pi^2 B^2 C^2 \right) / g_s + r_n g_s. \tag{3}$$

In video amplifiers or intermediate frequency amplifiers in which the center frequency is sufficiently low, the bandwidth term predominates over the induced grid noise and the expression may be further approximated

$$N = 1 + 4 r_n \pi^2 B^2 C^2 / 3 g_s + r_n g_s, \tag{4}$$

from which the optimum source impedance is seen to be

$$r_s \text{ optimum} = \sqrt{3/2 \pi B C}, \tag{5}$$

and the minimum noise factor,

$$N \text{ minimum} = 1 + 2.32 r_n \pi B C. \tag{6}$$

It will be observed that under these conditions the optimum source impedance is independent of the equivalent noise resistance of the tube. Substituting from (5) into the transfer function of the input circuit, we obtain the result that the response falls by a factor of 2 at the edge of the band. The best noise factor is therefore obtained when the coupling of the source is adjusted to give an input circuit response which falls by 6 db at the edges of the desired band.

It is interesting to compare the performance of an amplifier designed on this basis with that of one in which the input circuit is damped by the source to a point where it is substantially flat over the desired band so that no compensation or feedback is necessary. For the sake of comparison substantially flat may be interpreted as dropping by 1 db at the limits of the over-all noise bandwidth. In this condition,  $\pi B C r_s = .255$ .

Rearranging (4),

$$N = 1 + r_n \cdot \pi B C \cdot \left\{ \frac{g_s}{\pi B C} + \frac{4 \pi B C}{3 g_s} \right\},$$

$$N = 1 + 4.35 \pi B C r_n.$$

Comparing this result with (6), it is seen that the incremental noise is improved by a factor of nearly 2 by the use of the correct source impedance combined with compensation. When the induced grid noise is not negligible as when the bandwidth is smaller or the center frequency higher, the improvement effected in noise factor will be less.

TUBE COUPLING CIRCUITS

The discussion has so far neglected the noise sources associated with the second and subsequent stages. The contributions to the total noise from these sources be-

come of increasing importance as the bandwidth is made wider, and for minimum noise factor it is evidently desirable to achieve the greatest possible gain—bandwidth product for each stage. The noise relations in double-tuned circuits have been studied in this connection by Herold.<sup>2</sup> For optimum performance multiple circuit couplings tend to become critical of adjustment and difficult to handle in practice, and the case of an undamped circuit compensated by feedback is worthy of attention on the score of simplicity. The arrangement corresponds closely to the video amplifier described by Barco,<sup>9</sup> but the equations differ when the amplifier contains more than one circuit to be compensated. Integration of the noise over the band then involves cross products and the equations tend to become too complex to be useful to the designer. In most cases, however, the noise sources in the first two stages are the only ones of importance and the solution in this instance is derived in Appendix A.

Inspection of the expressions for noise factor given by (19) and (20) shows that the damping on the circuits  $g_d$  and  $g_{d1}$  should be as small as possible for the best noise factor. In the wide-band case an approximation may be made similar to that discussed above for the input circuit and (19) then simplifies to

$$N = 1 + r_n \left\{ K g_t + \frac{4}{3} \pi^2 B^2 C^2 R_z \right\} + g_s R_y, \quad (7)$$

where

$$R_z = r_n + \frac{1}{g^2} \left\{ K g_{t1} + \frac{12}{5} r_{n1} \pi^2 B^2 C_1^2 \right\}$$

and

$$R_y = r_n + \frac{1}{g^2} \left\{ K g_{t1} + \frac{4}{3} r_{n1} \pi^2 B^2 C_1^2 \right\}.$$

The contribution from the second tube appears in terms in both  $g_s$  and  $1/g_s$  and will in general modify the optimum value of source impedance. However, the effect will be small unless the stage gain is very low, and the source impedance given by (5) may usually be used with negligible rise in noise factor. Substituting for  $g_s$  from (5) in (7), and neglecting the induced grid noise terms, we obtain

$$N = 1 + \frac{4\pi BC}{\sqrt{3}} \left\{ r_n + \left( \frac{\pi BC_1}{.73g} \right)^2 r_{n1} \right\}. \quad (8)$$

Comparing this with (6), it appears that for the purposes of calculating noise the effective voltage gain of the first stage is

$$\frac{.73g}{\pi BC_1}. \quad (9)$$

When the input circuit is not equalized but is made sufficiently flat over the required frequency band by reducing the source impedance, then the term in  $1/g_s$  in

(7) will be small compared with the term in  $g_s$ . The effective voltage gain of the first stage is then obtained from the coefficient of  $r_{n1}$  in the term in  $g_s$  and will be

$$\frac{.87g}{\pi BC_1}. \quad (10)$$

Comparing (9) and (10), it appears that the effective stage gain does not vary greatly for widely varying values of source impedance. The expressions are in a form permitting direct comparison with the performance of other types of coupling circuit,<sup>10,11</sup> for example, they compare favorably with the corresponding formula for a two-circuit coupler having unequal  $Q$ s.

Eq. (8) illustrates a feature of wide-band amplifiers which has not been emphasized in the literature. The criterion for low-noise factor in the first tube is a low value of the product  $r_n C$ , whereas in the second stage the contribution to the noise depends on  $r_{n1} C_1^2$ . This may have an important bearing on the selection of suitable tubes for these positions in a low-noise amplifier.

#### MATCHING TO THE SOURCE

In narrow-band amplifiers the optimum source impedance is generally lower than the input impedance of the amplifier if the latter is largely determined by transit time damping. In the wide-band case the discrepancy will be greater, but the use of a feedback network to equalize the response of the input circuit suggests the possibility of also obtaining a match by this means. To satisfy the matching requirement and at the same time equalize with sufficient accuracy over the desired band it would theoretically be necessary to provide a rather complex feedback network. In the simplest case of a resistor connected back to the input circuit from a point in the amplifier where the gain is sufficiently high there are two parameters at the disposal of the designer, the feedback factor at band center and the group time delay round the loop. If the first of these is chosen to match the input impedance to the source, the second may be adjusted for a first-order equalization, but the frequency band over which such equalization is adequate will then be fixed. The result is, however, reasonably good for a source impedance chosen in accordance with (5), and it is shown in Appendix B that a maximally flat condition may then be obtained in which the response falls by  $\frac{1}{2}$  db at the limits of the design bandwidth. If the induced grid noise is significant so that the circuit to be equalized falls by less than 6 db at the band limits, then the matching condition may evidently be satisfied with an even better over-all response.

#### PRACTICAL ASPECTS

The construction of wide-band amplifiers in accordance with the above principles presents two major

<sup>10</sup> H. A. Wheeler, "Wide-band amplifiers for television," Proc. IRE, vol. 27, pp. 429-438; July, 1939.

<sup>11</sup> D. Weighton, "Performance of coupled and staggered circuits in wide band amplifiers," *Wireless Eng.*, vol. 21, pp. 468; October, 1944.

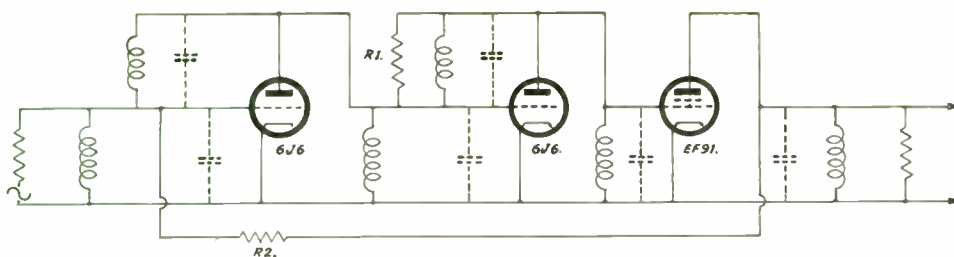

Fig. 2—Experimental amplifier showing ac connections only.

practical difficulties. The first is the familiar one of avoiding the effects of anode-grid capacitance in a grounded cathode triode, and the second the design of practical networks for compensation of the input and tube coupling circuits. An experimental amplifier has been constructed which offers one approach to the solution of these two problems. Compensation is by feedback rather than by complementary networks, since the response is then less critically dependent on the source impedance. In order to avoid appreciable damping on the input circuit by the feedback network itself, it is desirable that this should be taken from a point in the amplifier where the voltage gain is high. A similar remark applies to the circuit coupling the first and second tubes. However, since a compromise has to be effected and the input circuit is evidently the more important from the noise point of view, the arrangement in Fig. 2 (above) was tried and found to be reasonably satisfactory. Feedback for compensation of the second circuit is over only one stage via the resistor  $R_1$  in shunt with a resonant circuit of which the plate-grid capacitance of the tube forms the major portion of the tuning capacitance. The arrangement can readily be adjusted for a maximally flat response without the addition of damping across the circuit. Feedback for the input circuit is over three stages allowing the resistor  $R_2$  to be large compared with the source impedance. In one example for a bandwidth of 16 mc the optimum source impedance was found to be about 500 ohms and  $R_2$  was 18,000 ohms having no measurable effect on the single-frequency noise factor.

Inductive neutralization is employed throughout, since it affords the simplest circuit arrangement. The ease of neutralization in the first stage is greatly helped by the low voltage gain between grid and plate of the first tube. Since the feedback resistor  $R_1$  is generally small compared with the plate impedance of the second tube, the input impedance of this stage at band center approximates to the reciprocal of the slope of the tube, and the voltage gain of the first stage is therefore one when the slopes of the two tubes are equal. In this respect the arrangement resembles the cascode. It differs in that the gain of the first stage rises on either side of band center. It is, however, sufficiently low at all times to ensure stability, and neutralization has been found to be very noncritical.

## EXPERIMENTAL RESULTS

No detailed experimental investigation has been undertaken, but the noise factor of one amplifier of the kind described above has been measured for a range of source impedance, adjusting the feedback in each case to maintain a flat response, and the results are shown in Fig. 3. The first two tubes were 6J6s with the two halves operated in parallel and the main parameters as follows:

|   |                   |
|---|-------------------|
| Total shunt capacitance of input circuit    | 25 pF.            |
| Total shunt capacitance of coupling circuit | 15 pF.            |
| Slope of the first tube                     | 10,000 micromhos. |
| Equivalent noise resistance                 | 300 ohms.         |
| Transit time damping                        | 20,000 ohms.      |
| Total noise bandwidth                       | 15 mc.            |
| Band center frequency                       | 35 mc.            |

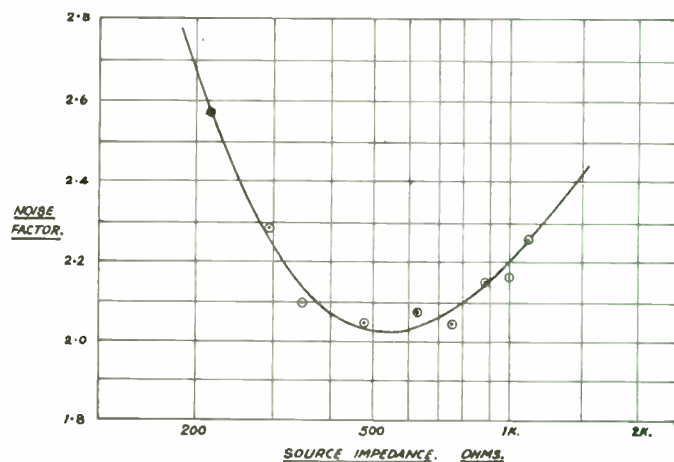

Fig. 3

Calculation of the anticipated performance illustrates the use of the equations and provides a check on the experimental results. The effective voltage gain of the first stage is first estimated from (9) and yields a figure of 10.3 times. The noise contribution from the second stage may therefore be neglected and the optimum source impedance derived from (3). Allowing a noise temperature ratio of 5 for the induced grid noise, the terms are

$$1/kg_t = 4,000 \text{ ohms,}$$

and

$$3/4r_n\pi^2B^2C^2 = 1,800 \text{ ohms,}$$

giving a total shunt resistance of 1,240 ohms. The optimum source impedance is therefore the geometric mean

of 1,240 ohms and the equivalent noise resistance 300 ohms, i.e., 610 ohms, and the corresponding noise factor

$$N = 1 + 2 \times \frac{300}{610}$$

$$N = 1.98.$$

The measured values show reasonably good agreement with these calculated figures.

CONCLUSIONS

Consideration of the noise relationships in grounded cathode wide-band amplifiers in which the input and tube coupling circuits are equalized by feedback reveals two points of interest to the design engineer.

1. The optimum source resistance may be selected by considering the usual narrow-band equation for noise factor with the addition of a hypothetical noise source equivalent to a conductance  $4 r_n \pi^2 B^2 C^2 / 3$  in shunt with the input. In the case of very large bandwidth or low mean frequency where this hypothetical source predominates over induced grid noise, the optimum condition is one in which the circuit falls by 6 db at the edges of the desired frequency band.

2. The equalized tube coupling circuit has an effective gain-bandwidth for noise calculations which compares favorably with that of multiple circuit networks.

There appears to be no major practical difficulty in constructing amplifiers of this kind which approximate closely to the theoretical limits at least for bandwidths up to about 20 mc.

APPENDIX A

Fig. 1 shows the essential features of an amplifier in which the input and first stage coupling circuits are followed by their appropriate correcting networks. From the transfer functions of the two circuits it is readily shown that the correcting networks have the form

$$f(\omega) = (g_s + g_d + g_t) + jg_x$$

$$f_1(\omega) = (g_{d1} + g_{t1}) + jg_{x1}. \tag{11}$$

Neglecting any correlation between induced grid noise and shot noise, the equivalent mean-square noise voltage per cycle at the grid of the first tube is found to be

$$v^2 = 4kT(g_s + g_d + Kg_t) / \{ (g_t + g_d + g_s)^2 + g_x^2 \}$$

$$+ 4kTr_n, \tag{12}$$

where  $KT$  is the noise temperature assigned to the transit time conductance, and  $r_n$  is the equivalent noise resistance of the tube.

The mean square noise voltage per cycle at the grid of the second tube due to the sources in the second circuit is given by

$$v_1^2 = 4kT(g_{d1} + Kg_{t1}) / \{ (g_{t1} + g_{d1})^2 + g_{x1}^2 \} + 4kTr_{n1}. \tag{13}$$

Now the mean noise power per cycle at the output of the amplifier is proportional to

$$g^2 v^2 |f(\omega)|^2 + v_1^2 |f(\omega)|^2 \cdot |f_1(\omega)|^2, \tag{14}$$

where  $g$  is the transconductance of the first tube. Substituting for  $v^2$  and  $v_1^2$  from (12) and (13), this expression becomes

$$4kT [g^2(g_s + g_d + Kg_t) + (r_n g^2 + g_{d1} + Kg_{t1}) \cdot |f(\omega)|^2 + r_{n1} \cdot |f(\omega)|^2 \cdot |f_1(\omega)|^2]. \tag{15}$$

Substituting for  $f(\omega)$  and  $f_1(\omega)$  from (1) and (13) yields an expression containing terms in  $g_x^2$ ,  $g_{x1}^2$ ,  $g_x^2 g_{x1}^2$  and terms independent of frequency. To find the total noise this function must be integrated over the band accepted by the remainder of the amplifier, and the integrand should properly be modified in those regions where the over-all amplitude response is not flat. In practice it is usually sufficient to estimate the noise bandwidth and to integrate within these limits assuming a flat response.

If  $\omega_0$  is the angular frequency at the band center, then

$$g_x^2 = \omega_0^2 C^2 \left( \frac{\omega}{\omega_0} - \frac{\omega_0}{\omega} \right)^2,$$

and writing

$$p = (\omega_1 - \omega_2) / 2\omega_0$$

where  $\omega_1$  and  $\omega_2$  define the limits of the noise bandwidth

$$\int_{\omega_1}^{\omega_2} g_x^2 \cdot d\omega = (\omega_2 - \omega_1) \omega_0^2 C^2 p^2 (4 - p^2) / 3(1 - p^2).$$

Provided  $p$  is less than about 0.25, a very good approximation is given by

$$\int_{\omega_1}^{\omega_2} g_x^2 \cdot d\omega = (\omega_2 - \omega_1) \cdot \frac{4}{3} p^2 \omega_0^2 C^2$$

$$= (\omega_2 - \omega_1) \cdot \frac{4}{3} \pi^2 B^2 C^2 \tag{16}$$

where  $B$  is the noise bandwidth.

The remaining terms may be integrated in a similar manner, giving

$$\int_{\omega_1}^{\omega_2} g_{x1}^2 \cdot d\omega = (\omega_2 - \omega_1) \cdot \frac{4}{3} \pi^2 B^2 C_1^2 \tag{17}$$

$$\int_{\omega_1}^{\omega_2} g_x^2 \cdot g_{x1}^2 \cdot d\omega = (\omega_2 - \omega_1) \cdot \frac{16}{5} \pi^4 B^4 C^2 C_1^2. \tag{18}$$

Using these relations in the integration of (15) and dividing by the noise originating in the source gives the noise factor:

$$N = 1 + r_n \left( g_d + Kg_t + \frac{4}{3} \pi^2 B^2 C^2 R_s \right)$$

$$+ r_s (g_s + g_d + g_t)^2 R_v, \tag{19}$$

where

$$R_x = r_n + \frac{1}{g^2} \left[ g_{d1} + K g_{t1} + r_{n1} \left\{ (g_{d1} + g_{t1})^2 + \frac{12}{5} \pi^2 B^2 C_1^2 \right\} \right]$$

$$R_y = r_n + \frac{1}{g^2} \left[ g_{d1} + K g_{t1} + r_{n1} \left\{ (g_{d1} + g_{t1})^2 + \frac{4}{3} \pi^2 B^2 C_1^2 \right\} \right]. \tag{20}$$

When the noise sources in the second stage are omitted,

$$R_x = R_y = r_n,$$

and inserting these values in (19) gives the noise factor of the first stage alone.

APPENDIX B

Fig. 4 shows an input circuit with current feedback via a resistor  $R$ ; the amplifier having a gain of  $-A$  and a time delay  $T$ . The analysis is carried out for the low-pass case but applies equally to a band-pass amplifier if  $T$  is the group delay.

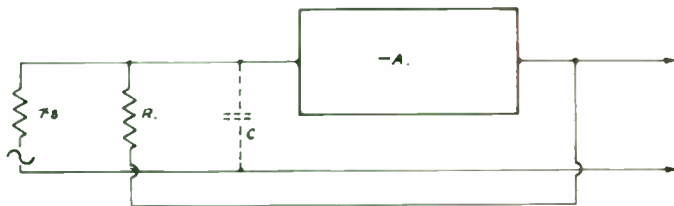

Fig. 4

The effective admittance due to feedback is of the form

$$\frac{1}{R} (1 + A e^{-j\omega T}),$$

and the total admittance of the circuit is therefore

$$Y = \frac{1}{r_s} + j\omega C + \frac{1}{R} (1 + A e^{-j\omega T}).$$

When the matching condition is satisfied and  $R$  is large compared with  $r_s$ ,

$$Y = j\omega C + \frac{1}{r_s} (1 + e^{-j\omega T}).$$

Separating real and imaginary terms and taking the modulus gives

$$|Y|^2 r_s^2 = 2(1 + \cos \omega T) + \omega^2 C^2 r_s^2 \left( 1 - \frac{2 \sin \omega T}{\omega C r_s} \right).$$

Expanding in powers of  $\omega$  and equating the coefficient of  $\omega^2$  to zero, we obtain

$$T = (\sqrt{2} - 1) C r_s.$$

This is the condition for first-order equalization. If  $r_s$  is chosen in accordance with criterion (5), then

$$\omega C r_s = \sqrt{3}$$

at the limits of the band and hence

$$\begin{aligned} \omega T &= \sqrt{3}(\sqrt{2} - 1) \\ &= .715 \text{ or } 41^\circ. \end{aligned}$$

Substituting these values in the expression for transfer admittance, we obtain

$$|Y|^2 r_s^2 = 4.23.$$

When  $\omega = 0$ ,  $|Y|^2 r_s^2 = 4$ , and the response at the edge of the band is therefore down in the ratio  $\sqrt{4/4.23} = .945$ , or about  $\frac{1}{2}$  db.

ACKNOWLEDGMENT

The author is indebted to J. Blades for many useful discussions and to the Directors of Messrs. Pye Limited for permission to publish this paper.

CORRECTION

H. A Haus and F. N. H. Robinson, authors of the paper, "The Minimum Noise Figure of Microwave Beam Amplifiers," which appeared on pages 981-991 of the August, 1955 issue of the PROCEEDINGS OF THE IRE, have brought the following corrections to the attention of the editors.

1. Eq. 3 should read

$$q = (q_1 e^{j\beta_p z} + q_2 e^{-j\beta_p z}) e^{-j\beta_e z}.$$

2. Paragraph above Eq. 27 should read

The determinant of  $P$  is  $\det P = \pm 1$  and so (25) . . .

3. Delete this sentence, which follows Eq. 54:

The equality sign applies when  $M_{44} = 0$ , which will be the case if the amplifier presents a match to the output transmission line.

4. Eq. 61 should read

$$G(z) = G e^{-2\beta_e \sigma x_1 z}.$$

where  $\beta_e C$  and  $x_1$  have their usual meaning.<sup>1</sup>

5. The integral expression below Eq. 61 should read

$$\int_0^l e^{-2\beta_e C \tau_{1z} \lambda dz}.$$

6. Immediately below this integral expression, change lower case  $c$  to capital  $C$ .

7. In Eq. 76 insert an equality sign between closed paren. and  $E_z$ .

8. Two lines below Eq. 84,  $\epsilon_2 = \epsilon_2^*$  should read  $\epsilon_1 = \epsilon_2^*$ .

# Wide-Range Electronic Tuning of Microwave Cavities\*

F. R. ARAMS†, SENIOR MEMBER, IRE, AND H. K. JENNY†, SENIOR MEMBER, IRE

**Summary**—Methods for electronically tuning microwave cavities using the principles of space-charge tuning and of spiral-beam electronic tuning in the presence of a low-pressure gas are described. The use of a low-pressure gas permits tuning over frequency ranges several times larger than those obtainable in vacuum.

An S-band cavity was tuned over a frequency range from 3,280 to 4,350 mc, and from 3,280 to 2,540 mc, or  $\pm 30$  per cent. An X-band cavity was tuned over a frequency range from 9,170 to 10,800 mc, or 18 per cent. These values are compared to measurements made in vacuum.

A semi-quantitative theory for electronic tuning in gas atmospheres is presented. Limitations of the method are given.

## INTRODUCTION

ELECTRONIC tuning of microwave resonant elements is necessary for many applications in which frequency must be varied rapidly. For example, frequency-modulated oscillators may use electronically tuned microwave resonant cavities. Although earlier electronic-tuning techniques limited the tuning range of microwave cavities to a few per cent, the use of a low-pressure gas atmosphere has been found to permit the tuning of microwave cavities over frequency ranges several times larger than those obtainable when corresponding techniques are used in vacuum.

Two principal methods are used for the electronic tuning of microwave cavities in vacuum. The first method, spiral-beam tuning,<sup>1,2</sup> involves the projection of an electron beam into the resonant structure in a direction perpendicular to the oscillating electric field and parallel to a constant magnetic field, as in Fig. 1(a). The second method, space-charge tuning,<sup>3-5</sup> involves rotation of a cloud of electrons in a plane perpendicular to a constant magnetic field and in the same plane as the oscillating electric field, as in Fig. 1(b).

Both methods of tuning involve the interaction of rotating electrons with the radio-frequency electric field. Although this article describes the effects of this interaction in terms of changes in resonant frequency, the process is fundamentally an electronic means for changing capacitance. The various tuning methods described, therefore, are applicable not only to resonant elements but also to any other microwave network involving electric fields, i.e., capacitances. This paper discusses theo-

retical aspects and experimental results for spiral-beam tuning and space-charge tuning in gas atmospheres and compares these results to those obtained when the same tuning methods are used in vacuum.

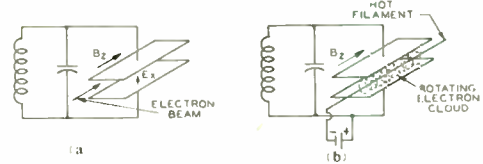

Fig. 1—(a) Schematic representation of resonant cavity using spiral-beam tuning. (b) Schematic representation of resonant cavity using space-charge tuning.

## THEORETICAL ASPECTS

### Spiral-Beam Tuning

In spiral-beam tuning, an electron beam is introduced into the concentrated electric-field region of a cavity, as shown schematically in Fig. 1(a). The magnetic field, which is parallel to the electron stream, causes the electrons to precess, i.e. to describe helical orbits. The electrons, therefore, exchange energy with the radio-frequency electric field,  $E_x$ , inducing a reactive current in the cavity walls and thereby having a tuning effect on the cavity. The period of rotation of the electrons is determined by the magnetic field in accordance with the formula  $\omega_c = (|e|/m)B_z$ , where  $\omega_c$  is the angular frequency of rotation in radians per second,  $|e|$  and  $m$  are the charge and mass, respectively, of an electron, and  $B_z$  is the magnetic-field density in webers per square meter. Depending on the value of  $\omega_c$  and the combination of angular frequency,  $\omega$ , of the rf field, geometry, and electron entrance velocity,  $v_0$ , the electron beam behaves as an electronically variable admittance, with or without a dissipative component. This admittance is either inductive or capacitive, i.e., can either raise or lower the resonant frequency of the circuit electronically. This relation has been analyzed by Smith and Shulman<sup>1</sup> and by Baños and Saxon.<sup>2</sup>

Smith and Shulman begin their analysis with the electronic equations of motion:

$$m\ddot{x} = -E_0 |e| e^{i\omega t} - B_z |e| \dot{y} \quad (1)$$

$$m\ddot{y} = +B_z |e| \dot{x} \quad (2)$$

$$m\ddot{z} = 0 \quad (3)$$

where  $x$ ,  $y$ , and  $z$  are the three Cartesian co-ordinates,  $t$  is time in seconds,  $E_0 e^{i\omega t}$  represents the electric-field intensity varying at an angular radio frequency  $\omega (= 2\pi f)$ ,  $B_z$  is the constant magnetic-field density, and the dots above the symbols  $x$ ,  $y$ , and  $z$ , denote first and second derivatives with respect to time. In this paper, a distinction is made between  $\omega$ , the resonant angular frequency of the tuned cavity, and  $\omega_0$ , the resonant angular frequency of the untuned cavity, such that  $\omega = \omega_0 + \Delta\omega$ .

\* Original manuscript received by the IRE, February 2, 1955; revised manuscript received, June 6, 1955.

† Radio Corporation of America, Tube Division, Harrison, N. J.

<sup>1</sup> L. P. Smith and C. Shulman, "Frequency modulation and control by electron beams," *Proc. IRE*, vol. 35, pp. 644-657; July, 1947.

<sup>2</sup> A. Baños, Jr., and D. S. Saxon, "An Electronic Modulator for CW Magnetrons," *M.I.T. Rad. Lab. Rep. 748*; June 26, 1945.

<sup>3</sup> J. P. Blewett and S. Ramo, "High frequency behavior of a space charge rotating in a magnetic field," *Phys. Rev.*, vol. 57, pp. 635-641; 1940; and *Jour. Appl. Phys.*, vol. 12, pp. 856-859; 1941.

<sup>4</sup> W. E. Lamb, Jr., and M. Phillips, "Space-charge frequency dependence of a magnetron cavity," *Jour. Appl. Phys.*, vol. 18, pp. 230-238; February, 1947.

<sup>5</sup> H. W. Welch, Jr., G. R. Black, G. R. Brewer, and G. Hok, Final Report, "Theoretical Study, Design and Construction of CW Magnetrons for Frequency Modulation," Contract W-36-039-SC-32245, Univ. of Michigan, Engng. Res. Inst., May 27, 1949.

For the initial conditions, Smith and Shulman assumed that when  $t=t_0$ ,  $x=z=0$ ,  $\dot{x}=v_x=\dot{y}=0$ , and  $\dot{z}=v_0$ . Thus, they obtained for the  $x$ -component of velocity:

$$v_x = -E_0 \frac{|e|}{m} \frac{i\omega}{\omega^2 - \omega_c^2} \left\{ \left( \frac{\omega_c + \omega}{2\omega_c} \right) e^{i(\omega_c - \omega)(t-t_0)} + \left( \frac{\omega_c - \omega}{2\omega_c} \right) e^{-i(\omega + \omega_c)(t-t_0)} - 1 \right\} e^{i\omega t} \quad (4)$$

If the frequency change is restricted so that the fraction  $(\omega_c - \omega)/\omega$  is considerably less than unity, an expression for electron admittance as a function of the transit angle,  $\theta$ , is obtained, as shown in Fig. 2. The

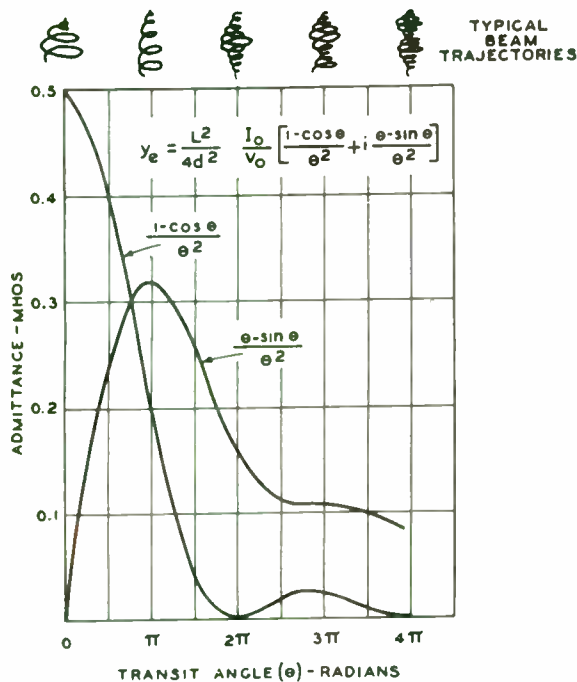

Fig. 2—Electronic admittance as a function of transit angle,  $\theta$ .

transit angle,  $\theta$ , in radians, is equal to  $(\omega_c - \omega_0)\tau$ , where  $\tau$  is the electron transit time in seconds. Typical electron trajectories appear in Fig. 2 for several values of  $\theta$ , when cavity is excited in the  $TE_{111}$  mode. When the electron enters the rf-field region, it is accelerated by the rf field toward one ridge (Fig. 7) and then begins to describe a circular path due to influence of the dc magnetic field. The length of time required for an electron to describe a complete circle is independent of the rf field, and is a function of the magnetic field only. Angular velocity of the electron,  $\omega_c$ , is a constant equal to  $B_z |e| / m$ . If the angular frequency,  $\omega$ , of the rf field is somewhat greater than  $\omega_c$ , the time of one complete revolution is somewhat more than the time of one rf cycle so that the electron will lag somewhat behind the field. At the end of each succeeding revolution, the electron has gained more energy and has increased its radius of rotation, but it continues to fall further behind the rf field until its rotation is in quadrature with the field. Beyond this point, as the electron continues to rotate, it begins to give up some of its rotational energy to the rf field, and its radius of rotation decreases.

If the electron leaves the interaction space when its radius of rotation is zero ( $\theta = 2\pi n$ ;  $n = 1, 2, 3, \dots$ ), the electron beam can be represented by a pure susceptance; this condition represents frequency modulation. If the electron leaves the interaction space at any other point ( $\theta \neq 2\pi n$ ), the beam has rotational energy (which is dissipated as heat) and can be represented by a susceptance plus a dissipative component; this condition represents a combination of amplitude and frequency modulation. In the special case where  $\omega = \omega_c$ , the electron rotation is in phase with the rf field; as a result, the radius of rotation will increase without limit until the electron strikes the ridge; this condition represents amplitude modulation.

Even though the susceptance decreases with increasing transit angle,  $\theta$ , (for  $\theta > \pi$ ) as shown in Fig. 2, it is not inversely proportional to transit time,  $\tau$ , because  $\tau$  is a variable dependent on the electron entrance velocity  $v_0$ . Since

$$V_0 = \frac{1}{2} \frac{m}{|e|} \frac{L^2}{\tau^2},$$

by substituting for  $V_0$  in the expression for electronic admittance shown in Fig. 2, the curves shown in Fig. 3, in a three-dimensional plot, are obtained. These curves indicate that for a given value of magnetic field the electronic susceptance increases continuously with transit time.

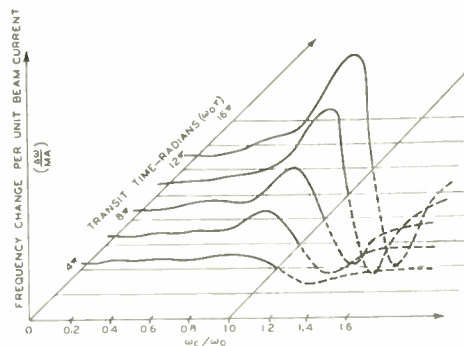

Fig. 3—Three-dimensional plot of theoretical frequency shift in spiral-beam tuning as a function of magnetic-field parameter,  $\omega_c/\omega_0$ , and transit time,  $\omega_0\tau$ .

In the experimental work described in this article, the experimental frequency shifts were large enough so that the restriction of frequency change  $\omega_c - \omega \ll \omega$  was no longer valid. Therefore, new expressions for electronic admittance are shown in (7) and (8).

### Spiral-Beam Tuning in a Gas Atmosphere

The electron is shot into the tuning cavity with a kinetic energy  $v_0$ , which is several times the ionization potential of the gas (15.7 volts for argon  $A^+$ ). After traveling a mean free path which can be calculated statistically, the electron experiences inelastic collisions with gas molecules, thereby producing ionization electrons. These then begin to spiral in phase with the rf field (as the primary electrons did when they entered the cavity), and thereby contribute to the electronic susceptance. Because the primary electrons are slowed

down by the collisions and the ionization electrons have very low drift velocity, the time during which the electrons interact with the rf field is substantially increased. Therefore, we can expect an increase in electronic reactance, over that obtainable with spiral-beam tuning in vacuum, due to two factors: (1) more electrons, and (2) increased interaction time, i.e., transit time.

*More Electrons.* An electron having an entrance velocity of 100 volts can produce as many as six ionization electrons in argon. The probability of an electron colliding with a gas molecule in a given distance in the  $z$ -direction is substantially increased by the magnetic field because of the spiral-beam helical motion of electrons in the (transverse)  $xy$  plane. Hence, a given mean free path may be divided by a factor,  $K$ , to obtain an equivalent mean free path which allows for increased path length due to the transverse helical electron motion. The value of the factor  $K$  is derived as follows:

The length,  $S$ , of the helical path of the electron in spiral-beam tuning for one spiral may be expressed as

$$S = 2 \int_0^{1/2(f_c-f)} \sqrt{\left(\frac{2|e|E_0\omega}{m(\omega_c^2-\omega^2)}\right)^2 \sin^2 \frac{1}{2}(\omega_c-\omega)t + v_0^2} dt \quad (5)$$

If the electron moves in the (transverse)  $xy$ -plane in a spiral path without motion in the (axial)  $z$ -direction, i.e.,  $v_0$  is taken to be zero, (5) can be easily integrated and the length of the path between adjacent points of minimum radius obtained:

$$S = 8 \frac{|e|E_0}{m\omega^2} \left[ \frac{1}{\left(\frac{\omega_c}{\omega}\right)^2 - 1} \right] \left[ \frac{1}{\left(\frac{\omega_c}{\omega}\right) - 1} \right] \quad (6)$$

The axial distance,  $l$ , for one complete helical path, is given by

$$l = v_0 t = \frac{v_0}{f_c - f}$$

The value of the factor  $K$  is approximately equal to the sum of the two path lengths (added linearly) divided by  $l$ :

$$K \approx \frac{S + l}{l}$$

The equivalent mean free path, therefore, is a function of both the rf electric field and the electron-beam velocity.

Fig. 4 shows  $K$  as a function of beam voltage,  $V_0$ , for an S-band cavity fed from a local oscillator having an output of 50 milliwatts and for an X-band cavity fed from a 200-watt source. For the X-band cavity,  $K$  is about 10 for a 10-volt electron beam; therefore, for this case the helical electron motion increases the probability of ionizing collisions approximately tenfold.

*Increased Interaction Time.* The decrease in axial drift velocity, i.e., increase in transit time, of the entire

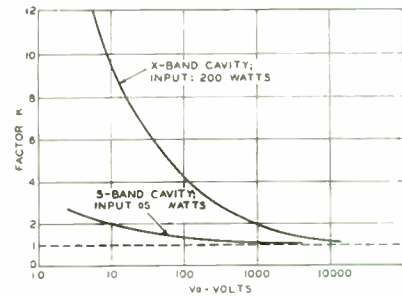

Fig. 4—Factor  $K$  as a function of beam voltage,  $V_0$ .

spiraling electron cloud due to collisions and the low axial drift velocity of the ionization electrons cause an increase in interaction time. The equation given by Smith and Shulman for the electronic admittance of the spiraling electron cloud may be solved in terms of transit time,  $\tau$ , for the electronic conductance

$$G_e = \frac{|e|}{m} \frac{I_0}{2d^2} \left\{ \frac{1}{(\omega_c - \omega)^2} [1 - \cos(\omega_c - \omega)\tau] + \frac{1}{(\omega_c + \omega)^2} [1 - \cos(\omega_c + \omega)\tau] \right\} \quad (7)$$

and for the electronic susceptance

$$B_e = \frac{|e|}{m} \frac{I_0}{2d^2} \left\{ \frac{1}{(\omega_c - \omega)^2} [(\omega_c - \omega)\tau - \sin(\omega_c - \omega)\tau] - \frac{1}{(\omega_c + \omega)^2} [(\omega_c + \omega)\tau - \sin(\omega_c + \omega)\tau] \right\} \quad (8)$$

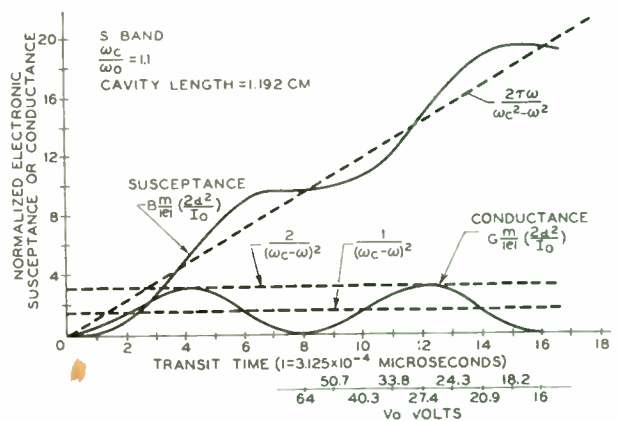

Fig. 5—Electronic admittance of spiral beam as a function of transit time.

Eqs. (7) and (8) are plotted in Fig. 5 in terms of normalized expressions

$$G \frac{m}{|e|} \frac{2d^2}{I_0}$$

and

$$B \frac{m}{|e|} \frac{2d^2}{I_0}$$

for a frequency of 4,000 megacycles per second and a ratio of  $\omega_c/\omega_0$  equal to 1.1. The second term of (4), which is neglected by Smith and Shulman, is not neglected in these expressions.



As shown in Fig. 5, the susceptance increases in an essentially linear manner with transit time while the conductance oscillates about a mean value. Therefore, even if a *slow-moving* electron does leave the interaction space with some rotational energy, the dissipative effect (AM) is very small in comparison to the reactive effect (FM). Thus, for a given frequency change, it becomes less and less important to maintain the transit angle,  $\theta$ , equal to  $2\pi n$  as the value of  $\tau$  increases.

EXPERIMENTAL RESULTS

Test Cavities

All tests reported in this article were made in ridge-waveguide resonant cavities having a length equal to one-half the guide wavelength. Fig. 6 shows the important dimensions of the cavities used for the S- and X-band tests.

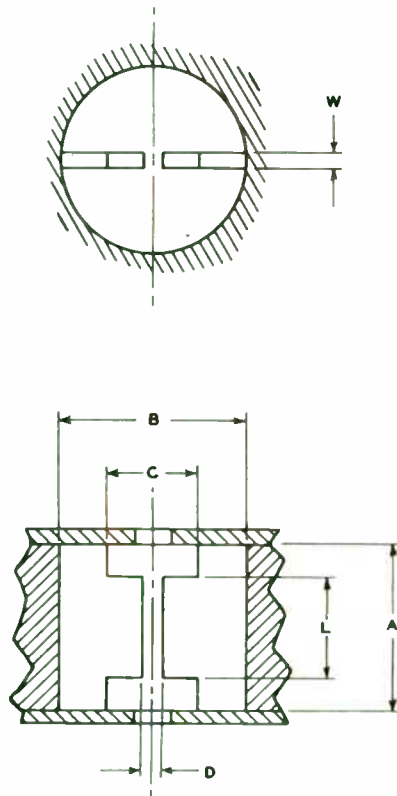

CAVITY DIMENSIONS IN INCHES

|   | S-BAND | X-BAND |
|---|--------|--------|
| A | 1.300  | .660   |
| B | 1.500  | .835   |
| C | .700   |        |
| D | 1.130  | .100   |
| L | .800   | .660   |
| W | .100   | 200    |

Fig. 6—Ridge-waveguide resonant cavity used for S- and X-band tests.

In the S-band cavity, two coaxial feed lines which are coupled into the cavity by means of inductive loops allow both transmission-type and reaction-type measurements. The X-band spiral-beam cavity is shown in Fig. 7. The gun consists of a tetrode having 0.200-inch by 0.050-inch rectangular apertures. The indirectly heated oxide cathode operates at a temperature of 830 degrees C. and a heater voltage and current of 6.3 volts and 2 amperes, respectively.

The X-band cavity, which is coupled to 1-inch by 1/2-inch waveguide through slots, has the following electrical values in the absence of the electron beam:  $f_0=9,600$  mc;  $Q_0=1,760$ ;  $Q_L=380$ . Vacuum-tight ceramic windows and mica windows are used in the waveguide to separate the cavity from the atmosphere.

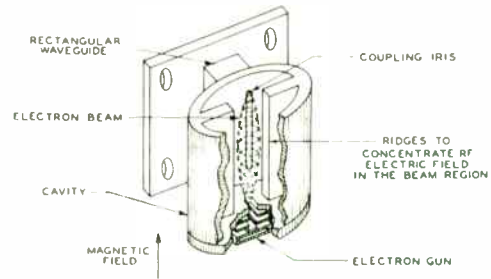

Fig. 7—X-band cavity using spiral-beam tuning.

Test Arrangements

Fig. 8 illustrates the setup used at low power levels to measure frequency changes in the X-band cavity by the reaction method. For the work at S-band, a simpler, transmission-type arrangement was used. An arrangement similar to that shown in Fig. 9 was used for tuning measurements at high power levels and for gas-break-down tests.

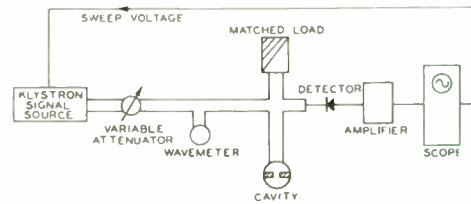

Fig. 8—Test setup used to measure frequency changes at low power levels in the X-band cavity.

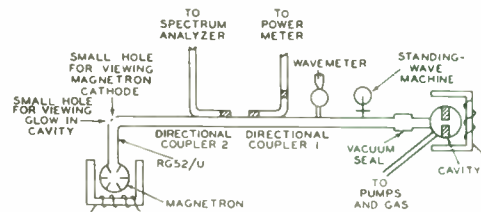

Fig. 9—Test setup used at high power levels and for gas-break-down tests.

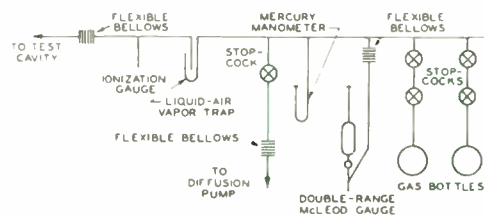

Fig. 10—Glass system used for exhaust and for gas-pressure measurements.

A special glass system, shown schematically in Fig. 10, provided the facilities required for exhaust, for filling the test cavities with gas, and for measuring the gas pressure over a wide range. The double-range McLeod gauge is designed and constructed to measure pressure continuously from 5 mm to about 0.2 microns of Hg.

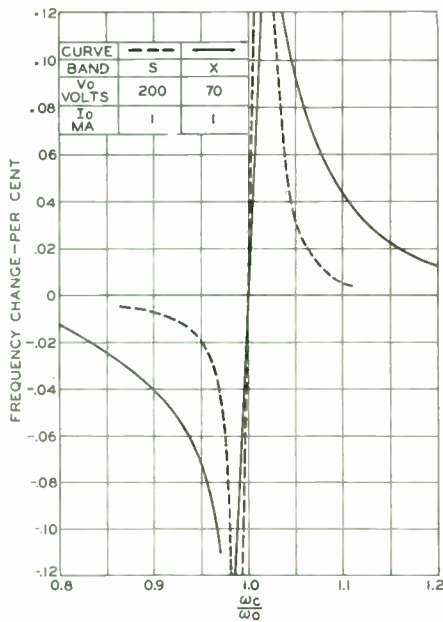

Fig. 11—Frequency change as a function of magnetic-field parameter for spiral-beam tuning in vacuum.

*Spiral-Beam Tuning in Vacuum*

Fig. 11 shows the frequency change as a function of magnetic-field density with electron-beam current held constant for both S-band and X-band cavities using spiral-beam tuning in vacuum. At S-band (3,250 mc), a maximum frequency change of  $\pm 30$  mc ( $\pm 0.9$  per cent) was obtained with a beam current of 2 milliamperes. (The plus and minus signs refer to settings of magnetic field for  $\omega_c/\omega_0 < 1$  and  $> 1$ , respectively.) The tuning rate was 15 mc/ma at 2 ma.

For a special test in the S-band cavity, a second electron gun was installed opposite the gun shown in Fig. 7, and two electron beams were shot into the cavity from opposite directions. As expected, the frequency deviation obtained was the same when each of the two guns was operated at one-half the current of the single gun used in the initial test. A maximum frequency change of  $\pm 175$  mc ( $\pm 5.5$  per cent) was obtained with a total beam current of 20 milliamperes. This frequency change represents a tuning rate of 8.8 mc/ma at 20 ma.

At X-band (10,000 mc), a maximum frequency change of  $\pm 500$  mc ( $\pm 5$  per cent) was obtained with a beam current of 14 ma. The tuning rate was 35 mc/ma at 14 ma. Although higher values of deviation can be obtained by the use of higher beam currents, the tuning rate decreases with increasing beam current, as shown in Fig. 12.

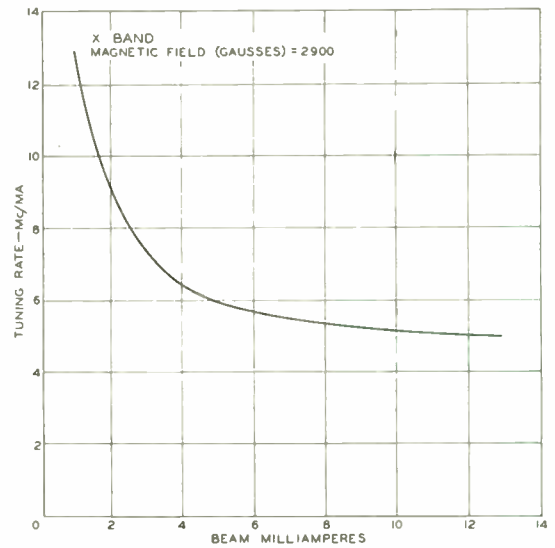

Fig. 12—Tuning rate as a function of beam current for spiral-beam tuning in vacuum.

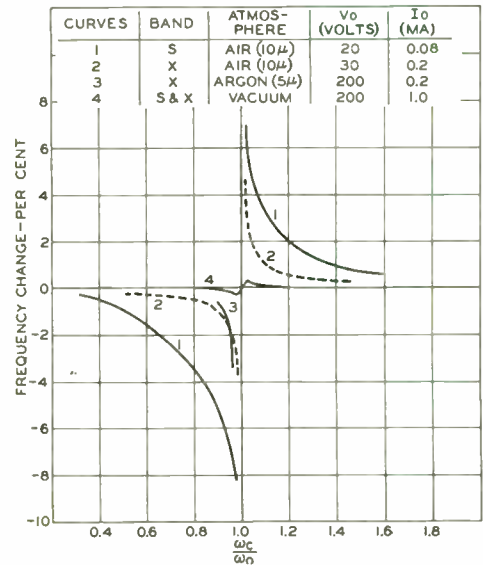

Fig. 13—Frequency change as a function of magnetic-field density for spiral-beam tuning in gas atmospheres, and comparison to results with vacuum.

values of beam current and a probable air pressure of about 10 microns of Hg (not measured). In general, the curves obtained in air are similar to those obtained in vacuum, although there is some beam loading at magnetic-field values at which no loading would exist in vacuum.

Fig. 14 shows curves of wavelength versus beam current obtained in a spiral-beam S-band cavity filled with argon at various pressures. Two values of magnetic field were used:  $\omega_c/\omega_0 = 0.86$  for the two upper curves, and  $\omega_c/\omega_0 = 1/0.86 = 1.16$  for the lower curves. At a pressure of argon equal to 46 microns Hg and with a gun-cathode current of less than 1 milliampere, the frequency change was almost  $-30$  per cent when the magnetic field was set for  $\omega_c/\omega_0 = 0.86$  and  $+30$  per cent for  $\omega_c/\omega_0 = 1.16$ . The cavity was actually tuned from 2,540 to 4,350 megacycles per second. It should be noted that the curves obtained for values of  $\omega_c/\omega_0$  equal to 0.86 and

*Spiral-Beam Tuning in Gas Atmosphere*

Tests made in S-band and X-band cavities filled with low-pressure air showed that substantially larger frequency deviations could be obtained in low-pressure air than in vacuum. Fig. 13 shows the frequency deviation as a function of magnetic field for extremely low

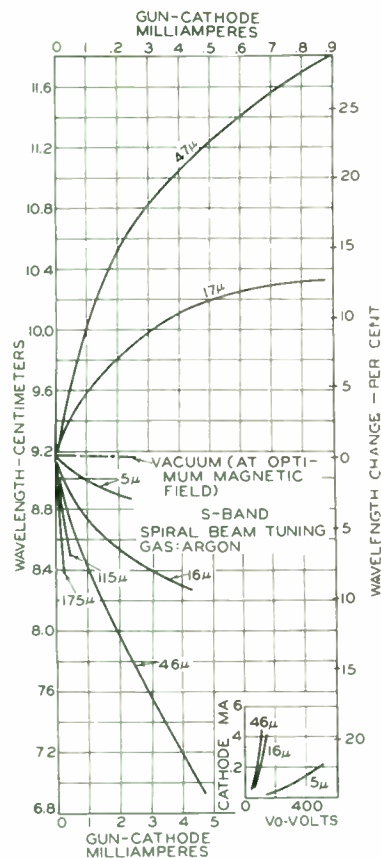

Fig. 14—Frequency as a function of gun-cathode current for a spiral-beam S-band cavity filled with argon at various pressures for two fixed values of magnetic field.

1.16 are symmetrical. Although no measurements were made of the dissipative component, qualitatively it was found to be approximately proportional to pressure and low at pressures up to 46 microns of Hg. The tuning rate at a pressure of 46 microns of Hg is 760 mc/ma at 1 ma and 2,850 mc/ma at 0.1 ma. The tuning rate is shown in Fig. 15 as a function of beam current. A similar curve for spiral-beam tuning in vacuum is also shown for comparison.

The frequency change in an X-band cavity filled with argon is shown in curve 3 of Fig. 13 as a function of magnetic field for a constant beam current. Fig. 16 shows the frequency change at X-band as a function of the beam current for different values of pressure and fixed magnetic field ( $\omega_c/\omega_0 = 0.86$ ). In all tests in which the cavities were filled with low-pressure air or argon, the limit on the frequency range obtained was determined by the test equipment rather than the test cavity. Therefore, frequency changes larger than those measured are obtainable.

The data shown in Figs. 11 through 16 were measured using a low-power tunable klystron oscillator having a power output of only a few hundred milliwatts as a signal source.

COMPARISON OF THEORY AND EXPERIMENT FOR SPIRAL-BEAM TUNING IN GAS

In order to compare theory and experiment, we need

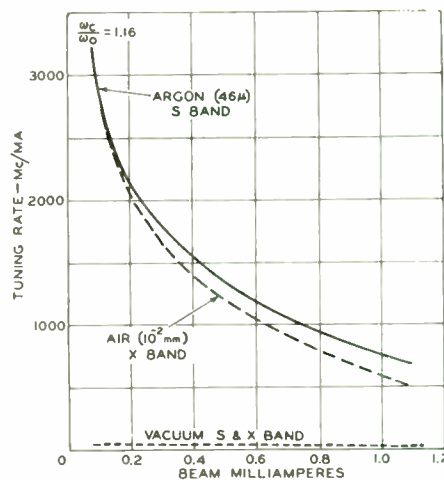

Fig. 15—Tuning rate as a function of beam current for spiral-beam tuning in gas atmospheres.

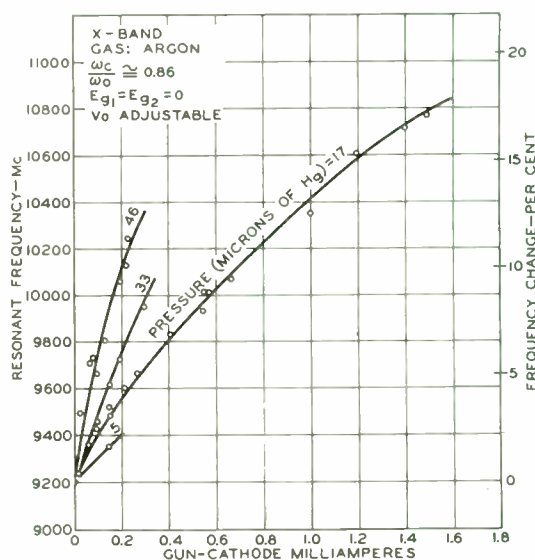

Fig. 16—Frequency change as a function of gun-cathode current for different values of pressure and fixed magnetic field.

to derive an expression for frequency change that is usable with the large values of frequency deviation observed with spiral-beam tuning in gas atmospheres. Eq. (8) for electronic susceptance, can be approximated by the first term, so that

$$B_e \cong \frac{|e|}{m} \frac{I_0}{2d^2} \left( \frac{\tau}{\omega_c - \omega} \right) \tag{9}$$

The resonant frequency may be determined by the application of the condition  $\Sigma B = B_e + B_c = 0$ , and by the use of the expression  $B_c \cong 2C_0\Delta\omega$  for circuit susceptance. Then, since  $\omega = \omega_0 + \Delta\omega$ ,

$$\Delta\omega = \frac{(\omega_c - \omega_0) \pm \sqrt{(\omega_c - \omega_0)^2 + \frac{|e|}{m} \frac{I_0}{d^2} \frac{\tau}{C_0}}}{2} \tag{10}$$

The positive sign may be eliminated by substitution of the condition  $\Delta\omega = 0$  when  $\tau = 0$ , so that the fractional frequency change becomes

$$\frac{\Delta\omega}{\omega_0} = \frac{1 - \omega_c/\omega_0}{2} \left[ \sqrt{1 + \frac{1}{(1 - \omega_c/\omega_0)^2} \frac{|e|}{m} \frac{I_0\tau}{\omega_0^2 d^2 C_0}} - 1 \right]. \quad (11)$$

This expression is usable for large values of  $\Delta\omega$ , and reduces, for the case of small frequency deviations, to

$$\frac{\Delta\omega}{\omega_0} = \frac{1}{1 - \omega_c/\omega_0} \frac{|e|}{m} \frac{I_0\tau}{4\omega_0^2 d^2 C_0}. \quad (12)$$

Curves of frequency change versus transit time are shown in Fig. 17 for values of  $\omega_c/\omega_0$  equal to 1.1 and 0.9. The dashed lines in Fig. 17 represent (12). The error introduced by this approximation is appreciable for the physical conditions chosen even at a deviation of 10 per cent.

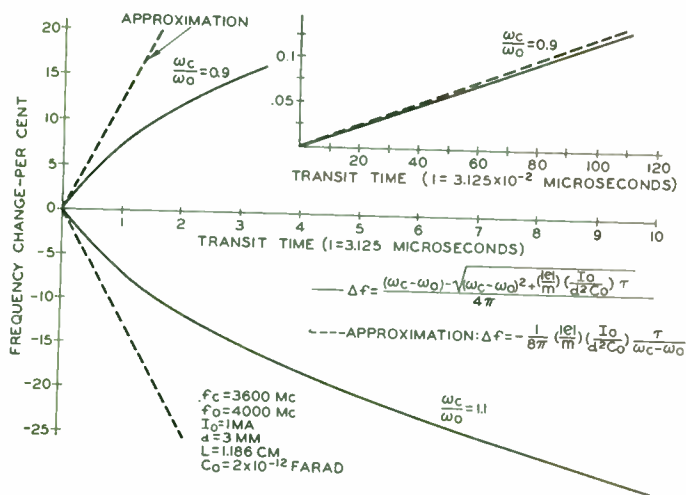

Fig. 17—Theoretically calculated frequency change as a function of transit time for spiral-beam tuning. Dashed lines represent the approximation  $\Delta\omega \ll \omega$ .

When physical constants and dimensions for the S-band cavity are substituted in (11), and a value of 0.86 is used for  $\omega_c/\omega_0$ ,

$$\frac{\Delta\omega}{\omega_0} = 0.07 \left[ \sqrt{1 + 333 \frac{I_0}{\sqrt{V_0}}} - 1 \right]. \quad (13)$$

For a typical value of  $I_0/\sqrt{V_0}$  equal to  $10 \times 10^{-6}$  (for example,  $I_0 = 100$  microamperes;  $V_0 = 100$  volts), the calculated frequency change,  $\Delta\omega/\omega_0$  is 0.0117 per cent. This value is representative of the frequency deviation obtainable in vacuum for this current and voltage, but does not agree with the measured  $\Delta\omega$  for gas-filled cavities because the measured value of cavity current,  $I_0$ , substituted in (13) is essentially a measure of primary electron flow alone. Eq. (13), therefore, should be rewritten with an additional term as follows:

$$\frac{\Delta\omega}{\omega_0} = 0.07 \left[ \sqrt{1 + 333 \left( \frac{I_0}{\sqrt{V_0}} + \frac{nI_0}{\sqrt{V_2}} \right)} - 1 \right], \quad (14)$$

where  $V_0$  is used as a measure of the average transit time

of the primary electrons,  $n$  is the number of ionization electrons produced per primary electron (and is a function of  $V_0$ ) and  $V_2$  is used as a measure of the average transit time of the ionization electrons.

Because the ionization electrons have very low initial velocities and there are more of them than primary electrons, the term in (14) involving  $V_0$  is much smaller than the term involving  $V_2$  and can be neglected.

For an S-band spiral-beam cavity filled with argon at a pressure of 46 microns of Hg, the frequency change for a beam current,  $I_0$ , of 100 microamperes is calculated as follows: The curves in Fig. 14 indicate that the measured value of beam voltage,  $V_0$ , for a beam current of 100 microamperes and a pressure of 46 microns of Hg is approximately 55 volts. Because about 10 ions/cm/mm Hg are created in argon for each primary electron having a velocity from 50 to 100 volts,<sup>6</sup> at a pressure of 46 microns of Hg approximately one ion is created for two centimeters traversed by a primary electron. This value must be multiplied by the factor  $K$  to allow for the decrease in mean free path due to the spiral motion of the primary electron. For a value of  $K$  equal to 2 (from Fig. 4) and a cavity length,  $L$ , of about 2 centimeters, the number of created ionization electrons,  $n$ , for each primary electron is approximately 2. If it is assumed that the ionization electrons are at room temperature, their thermal velocity,  $V_2 = \sqrt{2KT/|e|}$  is equal to 0.013 volt. By substitution in (12) a frequency deviation of 1.6 per cent is obtained. Although this value does not agree with the measured value of 8 per cent, it comes much closer than the value of 0.0117 per cent originally calculated.

### Space-Charge Tuning

Phase shifts in a coaxial line using a rotating space charge in vacuum have been measured by Blewett and Ramo.<sup>3</sup> The problem of a rotating space charge in a nonoscillating magnetron has been investigated by Lamb and Phillips<sup>4</sup> and by Welch, *et al.*<sup>5</sup>

In the method of space-charge tuning shown in Fig. 1(b), a thin heated filament is placed between the two ridges parallel to a constant magnetic field, and a dc voltage is applied between the filament (which serves as the cathode) and the ridges (which serve as the anode). Space-charge tuning can be considered as closely analogous to spiral-beam tuning, particularly when the cathode is extremely small. In space-charge tuning, however, two modifications are: (1)  $v_0 = 0$ , and (2) a dc field is superimposed on the interaction space.

The dissipative component can be expected to be greater for space-charge tuning than for spiral beam tuning because the dc field attracts the electrons to the anode and sweeps them out of the interaction space while they possess rotational energy originating from the rf field. One therefore would not expect that there

<sup>6</sup> A. Von Engel and M. Steenbeck, "Elektrische Gasentladungen," J. Springer, Berlin, Germany; 1932.

exists a condition for zero dissipative component (pure FM) as in spiral beam tuning.

The test cavity used in the measurement of space-charge tuning was similar to the spiral-beam cavity shown in Fig. 7 except that a fine tungsten wire, mounted midway between the ridges, is substituted for the electron gun. The external dc magnetic field is parallel to the filament. All measurements were made at frequencies near 4,000 megacycles.

Curves 1 and 2 in Fig. 18 show the change in frequency obtained in a space-charge cavity in vacuum as a function of anode current for two values of  $\omega_c/\omega_0$ . A maximum deviation of +130 mc (+4 per cent) at 3,280 mc was measured. The dissipative component was found to increase rapidly in proportion to frequency deviation. Curves 3 and 4 show frequency change for space-charge tuning in argon as a function of anode current for two values of  $\omega_c/\omega_0$ . In argon frequency deviations of the order of +12 per cent were obtained. Curves 3 and 3a in Fig. 18 taken with different values of heater power show that space-charge tuning is very sensitive to filament temperature.

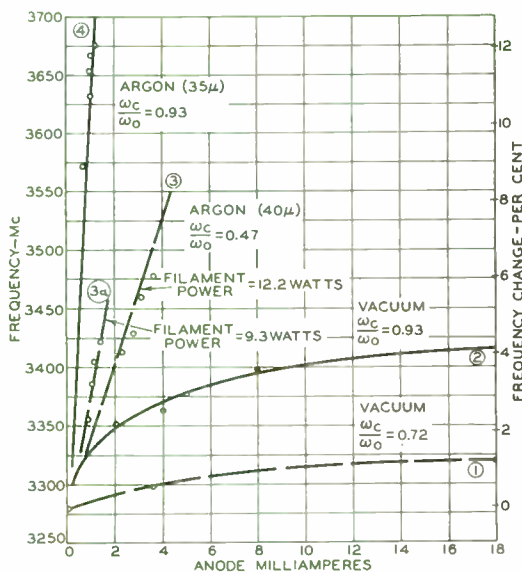

Fig. 18—Frequency change as a function of anode current for space-charge tuning for vacuum and gas atmosphere.

In space-charge tuning, rf absorption increases rapidly in proportion to frequency deviation. Electrons absorb energy from the rf and dc electric fields, spiral in increasingly larger orbits, and finally strike the anode, thereby dissipating energy in the anode in the form of heat. This loading and the sensitivity to filament temperature mentioned above are serious disadvantages of the space-charge tuning method both in vacuum and in gas. The use of an interaction space which is free of electrostatic fields and the separation of the electron-emitting means from the microwave portion of the device combine to make the spiral-beam tuning technique superior to the space-charge tuning method for both vacuum and gas atmosphere.

## LIMITATIONS

Any tuning method which employs a gas atmosphere is subject to limitation by gas *breakdown*.<sup>7</sup> The breakdown point is that point at which cumulative ionization is initiated by the rf energy stored in the cavity. Beyond this point, the dc voltages have no control over the cavity frequency. The operating rf power level, therefore, must be kept below the power level necessary for initiating breakdown.

The presence of the magnetic field enhances breakdown. As  $\omega_c$  approaches  $\omega_0$ , the angular momentum of the electron continues to increase and the rotational energy becomes greater than the ionization potential for the gas used. For example, if the electronic maximum rotational energy,  $V_\omega$ , is given by

$$V_\omega = \frac{1}{2} \frac{m}{|e|} \omega_c^2 r_{\max}^2, \quad (15)$$

and the maximum radius,  $r_{\max}$  of the spiral beam is

$$r_{\max} = 2 \frac{E_0 |e|}{m \omega^2} \left\{ \frac{1}{\left(\frac{\omega_c}{\omega_0}\right)^2 - 1} \right\} \quad (16)$$

then for the conditions  $f = 3,000$  mc,  $\omega_c/\omega_0 = 1.1$ , and  $E_0 = 300$  volts/centimeter (corresponding to 50 milliwatts input power to the cavity from the signal generator), a value of  $V_\omega$  equal to 20.6 volts is obtained. This value exceeds the ionization potential of argon. It must be concluded from this and from other tests that gas tuning can be used only in applications where the power level is of the order of one watt or less.

The magnitude of the *conductance component* was not measured during the frequency-deviation measurements. However, it has been observed qualitatively that the loading is not severe for spiral-beam tuning at gas pressures up to about 47 microns of Hg.

*Gas pressure* can be expected to decrease with the life of the tube. This decrease in pressure can be reduced to some extent by inclusion of a large glass bulb in the tube to serve as a gas reservoir, or by the use of hydrogen reservoir or a metallic vapor.

Modulation due to *plasma oscillations* or *noise* was not investigated.

## CONCLUSIONS

The energy interaction of electrons and radio-frequency electric fields in resonant structures, such as microwave cavities, provides a means for producing electronically-controlled amplitude modulation and/or frequency modulation (tuning).<sup>8</sup>

Spiral-beam tuning in vacuum has been successfully applied to obtain cavity-tuned magnetron frequency

<sup>7</sup> B. Lax, W. P. Allis, and S. C. Brown, "Effect of magnetic field on the breakdown of gases at microwave frequencies," *Jour. Appl. Phys.*, vol. 21, pp. 1297-1304; December, 1950.

<sup>8</sup> F. Arams, "Microwave applications of gas discharges," *Electronics*, vol. 27, pp. 168-172; November, 1954.

changes of the order of 1 per cent.<sup>9,10</sup> No indication has been observed that this value can be substantially exceeded in vacuum in self-excited oscillators where a substantial fraction (such as 50 per cent) of the total energy is stored in the tuning cavity. However, it can be expected that more tuning range is obtainable in amplifier-type devices where a smaller fraction of the energy would be stored in the tuning cavity.

When a gas atmosphere is used with spiral-beam tuning, frequency deviations of one or two orders of magnitude larger can be obtained with beam currents (driving power) one or two orders of magnitude smaller than those used in vacuum. The reasons for the improvement in tuning in a gas atmosphere are that one beam electron frees several ionization electrons as a result of ionizing collisions and that the ionization electrons interact with the electric field for a longer time due to their very low drift velocity.

Frequency changes of  $\pm 30$  per cent have been measured in gas atmospheres. These values did not necessarily represent maximum or optimum values, but rather limitations in test equipment. Fig. 19 shows gas pressure and beam current required for a given frequency deviation at both S- and X-band for the operating point  $\omega_c/\omega_0 = 0.86$ .

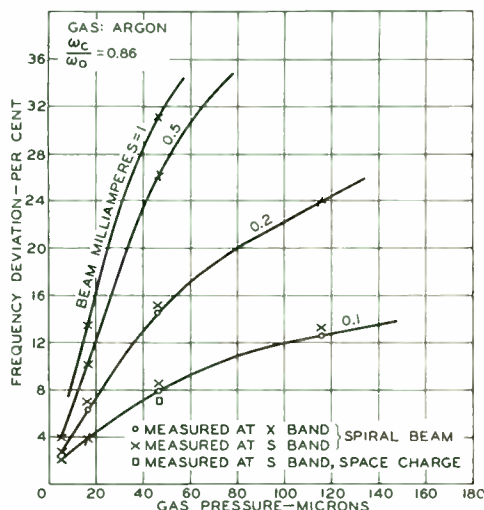

Fig. 19—Summary of results of frequency change as a function of gas pressure.

Space-charge tuning produces a tuning characteristic similar to that of spiral-beam tuning. Frequency deviations for both vacuum and gas atmosphere are in the same order of magnitude as those obtained with spiral-beam tuning. However, loading is far greater and the tuning is sensitive to filament temperature. In addition, as in all microwave tubes, the device in which the cathode is not in the interaction space has certain advantages. The spiral-beam modulation technique, therefore, is superior.

<sup>9</sup> H. K. Jenny, "A 7000 mc developmental magnetron for frequency modulation," *RCA Rev.*, vol. 13, pp. 202-223; June, 1952.

<sup>10</sup> J. S. Donal, Jr., "Modulation of continuous-wave magnetrons," *Advances in Electronics*, vol. 4. Academic Press, New York, N. Y., pp. 188-256; 1952.

LIST OF SYMBOLS

- $B_c$  = circuit susceptance in mhos
- $B_e$  = electronic susceptance of spiraling electron cloud in mhos
- $B_z$  = magnetic field density in webers per square meter in z-direction
- $C_0$  = dc ridge capacitance in farads
- $d$  = separation of ridges in meters
- $|e|$  = electronic charge in coulombs
- $E_x$  = rf electric field intensity in volts per meter =  $E_0 e^{i\omega t}$
- $G_e$  = electronic conductance of spiraling electron cloud in mhos
- $i = \sqrt{-1}$
- $I_0$  = beam current in amperes
- $K$  = factor by which mean free path is reduced due to spiraling motion of electrons.
- $l$  = axial distance for one complete helical path in meters
- $L$  = cavity length in meters
- $m$  = electronic mass in kilograms
- $n$  = number of secondary electrons produced per primary electron
- $Q_L$  = loaded cavity  $Q$
- $Q_0$  = internal cavity  $Q$
- $r_{max}$  = maximum radius of spiral beam in meters
- $s$  = length of helical path of electron in spiral-beam tuning in meters
- $t$  = time in seconds
- $T$  = temperature in degrees Kelvin
- $v_0$  = electron entrance velocity in meters per second ( $= \sqrt{2kV_0/m}$ )
- $v_x$  = x-component of velocity
- $V_e$  = electronic maximum rotational energy expressed in volts
- $V_0$  = beam voltage in volts
- $x$  )
- $y$  ) = Cartesian co-ordinates
- $z$  )
- $\theta$  = electron transit angle in radians
- $\tau$  = electron transit time in seconds
- $\omega$  = angular frequency of rf field in radians per second ( $= 2\pi f$ )
- $\omega_c$  = angular frequency of rotation of electron in radians per second ( $= 2\pi f_c$ )
- $\omega_0$  = resonant angular frequency of untuned cavity in radians per second ( $= 2\pi f_0$ )
- $\omega_c/\omega_0$  = magnetic-field parameter
- $\dot{\phantom{x}}$  = first derivative with respect to time
- $\ddot{\phantom{x}}$  = second derivative with respect to time

ACKNOWLEDGMENT

Work reported in this paper was sponsored by the Navy under contract N0bsr-39312. The authors wish to thank Dr. B. B. Brown and the Microwave Development Laboratory of the RCA Tube Division for their help, and Dr. T. S. Chen for his work on some of the theoretical calculations.

# The Resolution of Signals in White, Gaussian Noise\*

C. W. HELSTROM†

**Summary**—The resolution of two signals of known shapes  $F_1(t)$  and  $F_2(t)$  in white Gaussian noise is treated as a problem in statistical decision theory. The observer must decide which of the signals is present with a minimum probability of error. The optimum system for this decision is specified in terms of filters matched to the two signals, the outputs of which are compared. The error probability is exhibited as a function of the cross-correlation of the two signals and of the signal-to-noise ratio. If the phases of the two signals are unknown, as in radar, and if the signals are of equal strength and equal *a priori* probability, the optimum system consists of filters matched to each of the signals, each followed by a detector. The observer then bases his decision upon which of the detectors has the larger output. The probability of error is computed for this case also.

## I. INTRODUCTION

THE PROBLEM of resolution can be considered from two points of view. The first is that of, for example, astronomy, in which one studies the ability of a particular instrument to produce a response which the observer can identify as the result of two sources of a certain nature rather than of one such source. Thus the resolving power of a telescope is defined in terms of the smallest angular separation of two stars, the image of which can be identified as that of two stars rather than one. Similarly, considering a conventional A-scope presentation in radar, one can ask how close two targets can be in range before their echo pips so blend as to appear to be one.

From the second point of view one studies the nature of the phenomenon rather than the instrument used to observe it. One imagines a situation in which one of two (or more) similar sources is present, and one asks an observer to identify which of them it is, permitting him to use the best system which he can design for the purpose. His observations will in general suffer interference of a statistical nature which prevents an unambiguous selection. The optimum instrument for this purpose will thus depend on the characteristics of the sources as well as on the statistical properties of the interference.

It is from the latter standpoint that we wish to study narrow-band, pulsed electrical signals such as those encountered in radar or in communications. The interference will be taken as white Gaussian noise of power  $N$  per unit of frequency. The problem will be treated by the methods of statistical decision theory by imagining that one of a class of signals is presented immersed in noise, the observer being asked to identify which member of the class it is. The observer will make this decision by picking that member of the class having

the largest *a posteriori* probability calculated on the basis of the received signal  $x(t)$ .

In order best to understand the influence of the noise, we shall assume that one of two signals,  $F_1(t)$  and  $F_2(t)$ , is present, the form of each being known exactly. The optimum system for deciding between the two will be derived, and the probability of error  $P_e$  per decision will be calculated. The probability of error can be used as a measure of the ambiguity of the signals; that is, it measures the extent to which the similarity of two signals causes one to be mistaken for the other when they are observed in the presence of noise.

The resolution of narrow-band, pulsed signals has been discussed by Woodward,<sup>1</sup> who considered the problem of determining simultaneously the range and velocity of a radar target by measuring the delay in time and the Doppler shift in frequency of a returning echo. One asks how close two such signals can be in frequency and in time of arrival before it becomes difficult to tell them apart. Woodward pointed out that their ambiguity depends on the quantity  $\lambda$  given by

$$\begin{aligned}\lambda &= B/E \\ E &= \frac{1}{2} \int_0^T |u_1(t)|^2 dt = \frac{1}{2} \int_0^T |u_2(t)|^2 dt \\ B &= \frac{1}{2} \left| \int_0^T u_1(t) u_2^*(t) e^{-i\omega t} dt \right|,\end{aligned}\quad (1)$$

where  $u_1(t)$ ,  $u_2(t)$  are the complex envelopes of the signals,  $\omega$  is the difference in the carrier frequencies  $\Omega_1$  and  $\Omega_2$  of the two signals (resulting e.g. from a Doppler shift), and  $T$  is the time of observation. That is, the signals are taken as

$$\begin{aligned}F_1(t) &= Rl u_1(t) e^{i\Omega_1 t} \\ F_2(t) &= Rl u_2(t) e^{i\Omega_2 t}\end{aligned}\quad (2)$$

and they are assumed to be of equal energies (proportional to  $E$ ) and of small bandwidth compared with the carrier frequencies. The quantity  $\lambda$  may be called the relative cross-correlation of the two signals. Woodward<sup>1</sup> asserts that if the quantity  $\lambda$  is small, the signals can be easily distinguished, while if  $\lambda$  is close to unity it will be difficult to distinguish them. He discusses the form of  $\lambda$  for various types of signals, such as trains of pulses, frequency-modulated signals, etc.

Clearly, if there were no noise present, one could distinguish two such signals, let them differ by ever so

\* Original manuscript received by the IRE, April 2, 1955; revised manuscript received, June 9, 1955.

† Westinghouse Res. Labs., East Pittsburgh, Pa.

<sup>1</sup> P. M. Woodward, "Probability and Information Theory, with Application to Radar," McGraw-Hill Book Co., Inc., New York, N. Y., p. 115; 1953.

little, by passing the input through two parallel filters, one matched to  $F_1(t)$  and the other matched to  $F_2(t)$ . The filter giving the larger output would then determine which of the two signals had been received. (By a filter matched to a given signal we mean that filter which gives the maximum output for this signal among the class of all signals having the same energy  $E$ . Its admittance is proportional to the complex conjugate of the Fourier transform of the given signal.<sup>2</sup>)

The effect of noise on the ambiguity of two such signals will be evaluated by the decision-theoretic approach mentioned above. In Section II it will be assumed that each of the signals  $F_1(t)$  and  $F_2(t)$  is known exactly. Then it turns out that the decision between them can be based on the output of a single filter, which is matched to the difference of the signals,  $F_2(t) - F_1(t)$ . In Section III the phases of the received signals are assumed to be completely unknown, as for instance in radar. Then one compares the outputs of detectors following parallel filters, one matched to  $F_1(t)$ , the other matched to  $F_2(t)$ . The probability of error  $P_e$ , which we define as a measure of the ambiguity of the signals, is calculated in each section under the assumption that the signals are of equal energy  $E$  and equal *a priori* probability.  $P_e$  turns out to be a function of the relative cross-correlation  $\lambda$  and of the signal-to-noise ratio  $\rho = E/2N$ . The ambiguity of signals of random phase is a minimum when  $\lambda = 0$ , i.e., when each pair is orthogonal in the sense that the integral of their product taken over the observation interval vanishes. Thus the advantage of coding into a set of orthogonal signals in communication is indicated.

The application of decision-theoretic methods to this type of situation is not, of course, restricted to the simple cases treated here. One could imagine that the signal amplitudes are unknown, so that one is asked to distinguish between two classes of signals of the forms  $A_1 f_1(t)$  and  $A_2 f_2(t)$ , in which  $f_1(t)$  and  $f_2(t)$  are known (except perhaps for a random phase), but in which the amplitudes are described by *a priori* probability distributions  $P(A_1)$  and  $P(A_2)$ . In this case these *a priori* distributions would be used in computing, on the basis of the received signal  $x(t)$ , the *a posteriori* probability distributions of the two classes of signals, and the optimum decision procedure would be accordingly modified. In another situation, the observer may have to decide among the possibilities that either one, both, or neither of the two signals is present, the *a priori* probabilities of these alternatives being given. The optimum system would then consist of two parallel filters, each matched to one of the signals (and each followed by a linear detector if the signal phases are unknown). The output of each filter would be provided with a bias level appropriately chosen in terms of the *a priori* probabilities, and the decision would be made

by comparing the two outputs with their respective bias levels. Choices among larger numbers of signals can be similarly systematized by statistical decision theory.<sup>3</sup>

## II. AMBIGUITY OF SIGNALS OF KNOWN SHAPE

One of two signals of known waveforms  $F_1(t)$  and  $F_2(t)$  is received in white Gaussian noise  $n(t)$ , the power of which is  $N$  per unit of frequency over an input band of width  $W$  which includes and is much larger than the signal bandwidth. (If  $F_1$ ,  $F_2$ , and  $n$  are taken as voltages then the quantities of power and energy are determined with respect to dissipation in a resistance of 1 ohm.) The *a priori* probabilities that  $F_1$  and  $F_2$  are sent are  $\zeta$  and  $(1 - \zeta)$  respectively. The signals are observed over a period of time  $0 < t < T$  long enough to contain them in their entirety. Let  $x(t)$  be the received signal, including the noise. Then the observer must decide between case I:  $x(t) = F_1(t) + n(t)$  and case II:  $x(t) = F_2(t) + n(t)$ . He will pick that case for which he computes the larger *a posteriori* probability.

Let the *a posteriori* probabilities of cases I and II be  $p_1$  and  $p_2$  respectively. Since  $T \gg 1/W$ , these will be given<sup>1</sup>

$$p_1 = K\zeta \exp - \frac{1}{N} \int_0^T [x(t) - F_1(t)]^2 dt$$

$$p_2 = K(1 - \zeta) \exp - \frac{1}{N} \int_0^T [x(t) - F_2(t)]^2 dt, \quad (3)$$

where  $K$  is that number which makes  $p_1 + p_2 = 1$ . The observer decides for case I if  $p_1 > p_2$ , and for case II if  $p_1 < p_2$ . This decision can as well be based on the *a posteriori* likelihood ratio, given by

$$\Lambda = p_2/p_1 = \frac{1 - \zeta}{\zeta} \exp \frac{2}{N} \int_0^T [F_2(t) - F_1(t)] x(t) dt$$

$$\cdot \exp - \frac{1}{N} \int_0^T \{ [F_2(t)]^2 - [F_1(t)]^2 \} dt. \quad (4)$$

All the factors in this expression are given except the first exponential, which is a monotonic function of its argument. Hence the decision can be based on a measurement of the quantity  $G$  given by

$$G = \int_0^T x(t) [F_2(t) - F_1(t)] dt. \quad (5)$$

This is the cross-correlation of the received signal  $x(t)$  with the difference of the two signals in question. The observer picks case I or case II accordingly as  $G$  is less than or greater than a  $G_0$  given by

$$G_0 = \frac{N}{2} \ln \frac{\zeta}{1 - \zeta} + \frac{1}{2} \int_0^T \{ [F_2(t)]^2 - [F_1(t)]^2 \} dt. \quad (6)$$

The quantity  $G$  is the output at time  $T$  of a filter having an impulse response  $K(\tau)$  given by

<sup>2</sup> J. H. Van Vleck and D. Middleton, "A theoretical comparison of the visual, aural, and meter reception of pulsed signals in the presence of noise," *Jour. Appl. Phys.*, vol. 17, p. 940; November, 1946.

<sup>3</sup> D. Middleton, "Modern statistical approaches to reception in communication theory," *TRANS. IRE*, vol. PGIT-4, p. 119; September, 1954.



$$K(\tau) = F_2(T - \tau) - F_1(T - \tau), \quad 0 < \tau < T$$

$$K(\tau) = 0, \quad \tau < 0, \quad \tau > T, \quad (7)$$

since neither of the signals is assumed to last more than  $T$  seconds. The admittance  $Y(\omega)$  of this filter is given by

$$Y(\omega) = \int_0^\infty K(\tau)e^{-i\omega\tau}d\tau = e^{-i\omega T}[\Phi_2^*(\omega) - \Phi_1^*(\omega)], \quad (8)$$

where  $\Phi_1(\omega)$  and  $\Phi_2(\omega)$  are Fourier transforms of  $F_1(t)$  and  $F_2(t)$  respectively.

Since the noise  $n(t)$  is Gaussian, the quantity  $G$  is also Gaussian distributed, for it is the result of a linear operation on  $x(t)$ . Thus one can easily calculate the probability of error. In case I it is just the probability that  $G > G_0$  when  $x(t)$  is  $F_1(t) + n(t)$ . The average error probability is then obtained by weighting the error probabilities in the two cases in accordance with the *a priori* probabilities  $\zeta$  and  $(1 - \zeta)$ .

Let us assume that the two signals are of equal *a priori* probabilities and equal energies  $E$ , where

$$E = \int_0^T [F_1(t)]^2 dt = \int_0^T [F_2(t)]^2 dt. \quad (9)$$

Then  $G_0 = 0$ , and the error probabilities are equal in both cases. Hence the average probability of error  $P_e$  is just the probability  $G > 0$  when  $x(t) = F_1(t) + n(t)$ . In this case mean  $G$  and variance  $\sigma^2$  of  $G$  are given by<sup>4</sup>

$$\bar{G} = \int_0^T [F_2(t) - F_1(t)]\overline{x(t)}dt$$

$$= \int_0^T [F_2(t) - F_1(t)]F_1(t)dt = -(E - B)$$

$$\sigma^2 = \int_0^T \int_0^T [F_2(t) - F_1(t)][F_2(s) - F_1(s)]\overline{n(t)n(s)}dtds$$

$$= \frac{N}{2} \int_0^T [F_2(t) - F_1(t)]^2 dt = N(E - B), \quad (10)$$

where

$$B = \int_0^T F_1(t)F_2(t)dt \quad (11)$$

is the cross-correlation of the two signals. (10) used

$$\overline{n(t)n(s)} = \frac{N}{2} \delta(t - s) \quad (12)$$

as the autocorrelation function of the noise, since this corresponds to the assumption of wideband white noise of power  $N$  per unit of frequency in the limit  $W \gg 1/T$ . The probability that  $G > 0$  is then given by

$$P_e = (2\pi\sigma^2)^{-1/2} \int_0^\infty \exp - \frac{(G - \bar{G})^2}{2\sigma^2} dG$$

$$= \frac{1}{2} [1 - \Phi(\sqrt{\rho(1 - \lambda)})], \quad (13)$$

<sup>4</sup> The bar in  $\overline{x(t)}$  refers to an ensemble average rather than to a time average, so that  $\overline{x(t)} = F_1(t)$  is a function of time.

where  $\Phi(x)$  is the standard error-function integral, defined by

$$\Phi(x) = \frac{2}{\sqrt{\pi}} \int_0^x e^{-t^2} dt, \quad \Phi(\infty) = 1, \quad (14)$$

and  $\lambda$  and  $\rho$  are given by

$$\lambda = B/E, \quad \rho = E/2N. \quad (15)$$

In Fig. 1 we have plotted the error probability  $P_e$  as a function of  $\lambda$  for various values of the "signal-to-noise ratio"  $\rho$ . The ambiguity of two such signals can be defined by means of the error probability  $P_e$ . For fixed ambiguity one obtains a curve of the signal-to-noise ratio  $\rho$  versus the relative cross-correlation  $\lambda$

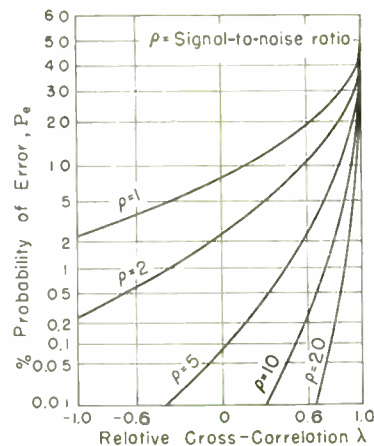

Fig. 1—Ambiguity of known signals.

which describes the effect of noise on the ambiguity of the signals. Such curves are in Fig. 2 (on following page) for error probabilities of 1, 5, and 10 per cent. One can show by means of the Schwarz inequality that  $|\lambda| \leq 1$ , so that the minimum ambiguity occurs when  $\lambda = -1$ , i.e., when  $F_2(t) = -F_1(t)$  and the two signals are 180 degrees out of phase.

### III. NARROW-BAND SIGNALS OF UNKNOWN PHASE

In radar systems in which the ranges of the targets are unknown *a priori* and in which no attempt is made to make successively transmitted pulses coherent, information regarding the carrier (radio-frequency) phase is lost, and one may assume it to be a uniformly distributed random variable. The same may be true in many communication systems in which coherent detection cannot be used. It is of interest to determine the ambiguity of signals in such situations.

Let us assume that the signals  $F_1(t)$ ,  $F_2(t)$  can be written as

$$F_i(t) = f_i(t) \cos [\Omega_i t + \psi_i(t) - \phi_i], \quad i = 1, 2, \quad (16)$$

where the  $\Omega_i$  are the carrier frequencies and the  $f_i(t)$  and  $\psi_i(t)$  are the amplitude and phase modulations respectively, both the latter being of bandwidth small compared with the  $\Omega_i$ .  $\Omega_2 - \Omega_1 = \omega \ll \Omega_i$ . The carrier phases  $\phi_i$  are random variables distributed uniformly over their

ranges 0 to  $2\pi$ . The noise is assumed to be Gaussian of power  $N$  per unit bandwidth over a range of frequencies containing both signals. Again the observer is asked to choose between two cases: (I)  $x(t) = F_1(t) + n(t)$  and (II)  $x(t) = F_2(t) + n(t)$ ; his choice is to be made in accordance with the *a posteriori* probabilities of the two cases.

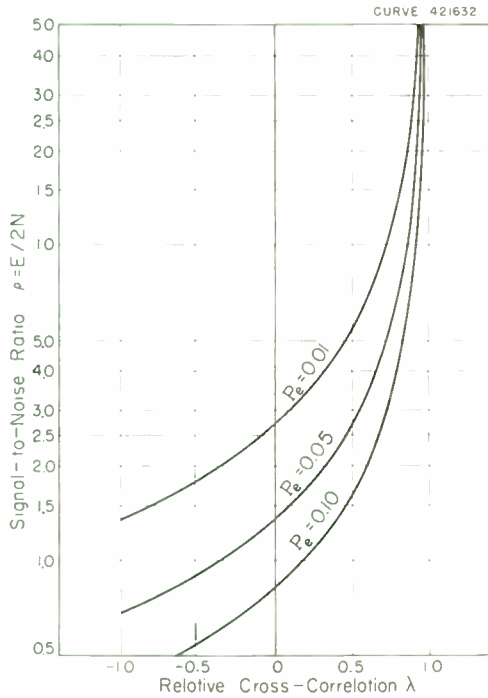

Fig. 2—Ambiguity of known signals: fixed error probability.

If the phases  $\phi_1, \phi_2$  were known, the *a posteriori* probabilities would be given by (3). But since these phases are unknown, we must average the exponential factors over the distribution of the phases. This has been done by Peterson, Birdsall, and Fox<sup>5</sup> using a representation in terms of a sampling plan, but one can simply substitute (16) into (3), multiply by  $d\phi_i/2\pi$  and integrate over  $0 < \phi_i < 2\pi, i = 1, 2$ , using the narrow-band character of the signals to discard all but the video-frequency parts of the terms in the exponential. The *a posteriori* likelihood ratio upon which the decision is to be based then becomes

$$\Lambda = p_2/p_1 = \frac{1 - \zeta}{\zeta} \exp\left(\frac{E_1 - E_2}{N}\right) \frac{I_0(2R_2/N)}{I_0(2R_1/N)}, \quad (17)$$

where ( $i = 1, 2$ )

$$E_i = \frac{1}{2} \int_0^T [f_i(t)]^2 dt \quad (18)$$

and

$$R_i^2 = X_i^2 + Y_i^2 \quad (19)$$

with

<sup>5</sup> W. W. Peterson, T. G. Birdsall, and W. C. Fox, "The theory of signal detectability," *TRANS. IRE*, vol. PGIT-4, p. 171; September, 1954. See Section 4.5.

$$X_i = \int_0^T x(t) f_i(t) \cos [\Omega_i t + \psi_i(t)] dt$$

$$Y_i = \int_0^T x(t) f_i(t) \sin [\Omega_i t + \psi_i(t)] dt. \quad (20)$$

$I_0(x)$  is the modified Bessel function of order zero.

The observer picks case I if  $\Lambda < 1$  and case II if  $\Lambda > 1$ . He could as well use the logarithm of the likelihood ratio, basing the decision on the quantity  $G'$  given by

$$G' = \ln I_0(2R_2/N) - \ln I_0(2R_1/N). \quad (21)$$

It can be shown<sup>6</sup> that  $R_1$  is the output at time  $T$  of a linear detector following a filter having the impulse response  $K_1(\tau)$  given by

$$K_1(\tau) = f_1(T - \tau) \cos [\Omega_1(T - \tau) + \psi_1(T - \tau)], \quad 0 < \tau < T$$

$$K_1(\tau) = 0, \quad \tau < 0, \quad \tau > T. \quad (22)$$

A filter similarly matched to  $F_2(t)$  will yield, when followed by a linear detector, the quantity  $R_2$ . By using detectors having the characteristic  $\ln I_0(2R/N)$ , the receiver can form the quantity  $G'$  of (21). There is then a quantity  $G_0'$  depending on  $E_1, E_2$ , and  $\zeta$  with which  $G'$  is compared for purposes of making a decision. Of course the detector characteristic required here is identical with that for optimum detection of pulsed signals in noise.<sup>6</sup>

If, however, the signals are of equal *a priori* probabilities and equal energies  $E_1 = E_2 = E$ , as we shall assume henceforth, one sees from (17) that one can simply use a linear detector (or any detector having a characteristic monotonic in  $R$ ) at the output of each matched filter. One then will decide for case I if  $R_1 > R_2$  and for case II if  $R_2 > R_1$ . Again the ambiguity of the two signals in noise will depend on the probability  $P_e$  of making an error in such a decision. We shall now calculate this probability as a function of the quantities  $\lambda$  and  $\rho$  defined in (1) and (15). The error probability  $P_e$  is the probability, given  $x(t) = F_1(t) + n(t)$ , that  $R_2 > R_1$ , that is

$$P_e = \int_0^\infty dR_1 \int_{R_1}^\infty p(R_1, R_2) dR_2, \quad (23)$$

where  $p(R_1, R_2)$  is the joint probability density for measuring  $R_1$  at the output of the first and  $R_2$  at the output of the second filter-detector combination, when the input to both is  $x(t) = F_1(t) + n(t)$ .

To determine the joint probability density function  $p(R_1, R_2)$  one fixes the phase of  $F_1(t)$  at  $\phi_1 = \phi$ , obtaining the conditional density function  $p(R_1, R_2; \phi)$ . This will turn out to be independent of  $\phi$ , so that it equals  $p(R_1, R_2)$ , since  $\phi$  is completely random. The quantities

<sup>6</sup> D. Middleton, "Statistical criteria for the detection of pulsed carriers in noise," *Jour. Appl. Phys.*, vol. 24, p. 371; April, 1953.

$X_i, Y_i$  of (20) are Gaussian distributed, since they are linear combinations of Gaussian variables. The means, variances, and cross-correlations of these variables are given in the following equations. For simplicity of writing it has been assumed that there is amplitude modulation only, though the same derivation could be carried through for the general case by replacing  $\Omega_i t$  by  $\Omega_i t + \psi_i(t)$  everywhere.

$$\begin{aligned} \bar{X}_1 &= \int_0^T [f_1(t)]^2 \cos \Omega_1 t \cos (\Omega_1 t - \phi) dt = E \cos \phi \\ \bar{Y}_1 &= \int_0^T [f_1(t)]^2 \sin \Omega_1 t \cos (\Omega_1 t - \phi) dt = E \sin \phi \\ \bar{X}_2 &= \int_0^T f_1(t) f_2(t) \cos \Omega_2 t \cos (\Omega_1 t - \phi) dt \\ &= \frac{1}{2} \int_0^T f_1(t) f_2(t) \cos [(\Omega_2 - \Omega_1)t + \phi] dt \\ &= c_1 \cos \phi - c_2 \sin \phi = B \cos (\phi + \psi) \\ \bar{Y}_2 &= \int_0^T f_1(t) f_2(t) \sin \Omega_2 t \cos (\Omega_1 t - \phi) dt \\ &= \frac{1}{2} \int_0^T f_1(t) f_2(t) \sin [(\Omega_2 - \Omega_1)t + \phi] dt \\ &= c_1 \sin \phi + c_2 \cos \phi = B \sin (\phi + \psi), \end{aligned} \tag{24}$$

where

$$\begin{aligned} c_1 &= \frac{1}{2} \int_0^T f_1(t) f_2(t) \cos (\Omega_2 - \Omega_1)t dt = B \cos \psi \\ c_2 &= \frac{1}{2} \int_0^T f_1(t) f_2(t) \sin (\Omega_2 - \Omega_1)t dt = B \sin \psi \\ B^2 &= c_1^2 + c_2^2. \end{aligned} \tag{25}$$

The fact that the signals are of narrow bandwidths compared with the carrier frequencies has enabled us to simplify the above integrals by keeping only the slowly varying parts of the integrands.

Because the signal energies are equal, the variances of the  $X_i$  and  $Y_i$  are all equal to  $\sigma^2$ , which is given by

$$\begin{aligned} \sigma^2 &= \int_0^T \int_0^T \overline{n(t)n(s)} f_1(t) f_1(s) \cos \Omega_1 t \cos \Omega_1 s dt ds \\ &= \frac{N}{2} \int_0^T [f_1(t)]^2 \cos^2 \Omega_1 t dt = NE/2, \end{aligned} \tag{26}$$

where we have used (12). The cross-correlations are

$$\begin{aligned} \overline{(X_1 - \bar{X}_1)(Y_1 - \bar{Y}_1)} &= \overline{(X_2 - \bar{X}_2)(Y_2 - \bar{Y}_2)} = 0 \tag{27} \\ \overline{(X_1 - \bar{X}_1)(X_2 - \bar{X}_2)} &= \overline{(Y_1 - \bar{Y}_1)(Y_2 - \bar{Y}_2)} \\ &= \int_0^T \int_0^T \overline{n(t)n(s)} f_1(t) f_2(s) \cos \Omega_1 t \cos \Omega_2 s dt ds \\ &= \frac{N}{2} \int_0^T f_1(t) f_2(t) \cos \Omega_1 t \cos \Omega_2 t dt = Nc_1/2 = k_1, \end{aligned} \tag{28}$$

$$\begin{aligned} \overline{(X_1 - \bar{X}_1)(Y_2 - \bar{Y}_2)} &= -\overline{(X_2 - \bar{X}_2)(Y_1 - \bar{Y}_1)} \\ &= \int_0^T \int_0^T \overline{n(t)n(s)} f_1(t) f_2(s) \cos \Omega_1 t \sin \Omega_2 s dt ds \\ &= \frac{N}{2} \int_0^T f_1(t) f_2(t) \cos \Omega_1 t \sin \Omega_2 t dt = Nc_2/2 = k_2. \end{aligned} \tag{29}$$

The joint distribution of the  $X_1, Y_1, X_2, Y_2$  is now the exponential of a quadratic form, the coefficients of the terms of which form a matrix which is the inverse of the correlation matrix of the four variables.<sup>7</sup> Taking the variables in the above order, the correlation matrix  $\|\phi_{ij}\|$  and its inverse  $\|\mu_{ij}\|$  are

$$\begin{aligned} \|\phi_{ij}\| &= \begin{bmatrix} \sigma^2 & 0 & k_1 & k_2 \\ 0 & \sigma^2 & -k_2 & k_1 \\ k_1 - k_2 & \sigma^2 & 0 & 0 \\ k_2 & k_1 & 0 & \sigma^2 \end{bmatrix}, \\ \|\mu_{ij}\| &= \frac{1}{A} \begin{bmatrix} \sigma^2 & 0 & -k_1 & -k_2 \\ 0 & \sigma^2 & k_2 & -k_1 \\ -k_1 & k_2 & \sigma^2 & 0 \\ -k_2 & -k_1 & 0 & \sigma^2 \end{bmatrix}, \end{aligned} \tag{30}$$

where  $A = \sigma^4 - k_1^2 - k_2^2$ . Thus the joint probability may be written

$$\begin{aligned} p(X_1, Y_1, X_2, Y_2) &= (4\pi^2 A)^{-1} \exp - (2A)^{-1} \{ \sigma^2 [(X_1 - \bar{X}_1)^2 \\ &+ (Y_1 - \bar{Y}_1)^2 + (X_2 - \bar{X}_2)^2 + (Y_2 - \bar{Y}_2)^2] \\ &- 2k_1 [(X_1 - \bar{X}_1)(X_2 - \bar{X}_2) + (Y_1 - \bar{Y}_1)(Y_2 - \bar{Y}_2)] \\ &- 2k_2 [(X_1 - \bar{X}_1)(Y_2 - \bar{Y}_2) - (X_2 - \bar{X}_2)(Y_1 - \bar{Y}_1)] \}. \end{aligned} \tag{31}$$

If one now uses the above expressions for the means, making the substitutions

$$\begin{aligned} X_1 &= R_1 \cos \theta_1, & Y_1 &= R_1 \sin \theta_1, \\ X_2 &= R_2 \cos \theta_2, & Y_2 &= R_2 \sin \theta_2, \\ \theta_1' &= \theta_1 - \phi, & \theta_2' &= \theta_2 - \phi - \psi, \\ k_1 &= \mu \cos \psi, & k_2 &= \mu \sin \psi, & \mu &= NB/2, \end{aligned} \tag{32}$$

one finds the joint probability of the new variables  $R_1, R_2, \theta_1', \theta_2'$  to be<sup>8</sup>

$$\begin{aligned} p(R_1, R_2, \theta_1', \theta_2'; \phi) &= \frac{R_1 R_2}{4\pi^2 A} e^{-E/N} \exp \left\{ -\frac{\sigma^2}{2A} (R_1^2 + R_2^2) \right. \\ &\quad \left. + \frac{\mu R_1 R_2}{A} \cos (\theta_2' - \theta_1') + \frac{2R_1}{N} \cos \theta_1' \right\}, \end{aligned} \tag{33}$$

where the factor  $R_1 R_2$  comes from the Jacobian of the

<sup>7</sup> S. O. Rice, "The mathematical analysis of random noise," *Bell Sys. Tech. Jour.*, vol. 23, p. 282; July, 1944; and vol. 24, p. 46; January, 1945.

<sup>8</sup> This derivation is formally similar to one given by D. Middleton for a different problem, "Some general results in the theory of noise through non-linear devices," *Quart. Appl. Math.*, vol. 5, p. 445; January, 1948, section 5. His eq. (5.12) can be reduced to our (33) by making the proper identification of symbols.

transformation to the new variables. Note that this expression is independent of  $\phi$ . In order to find the joint distribution of the magnitudes  $R_1$  and  $R_2$ , we integrate  $\theta_1'$  and  $\theta_2'$  over their ranges 0 to  $2\pi$ . The result is

$$p(R_1, R_2) = \frac{R_1 R_2}{A} e^{-E/2N} \exp \left[ -\frac{\sigma^2}{2A} (R_1^2 + R_2^2) \right] \cdot I_0(\mu R_1 R_2 / A) I_0(2R_1 / N). \quad (34)$$

The error probability  $P_e$  is the probability that  $R_2 > R_1$ , i.e., (23):

$$P_e = (1 - \lambda^2) e^{-2\rho} \int_0^\infty dx \int_x^\infty dy xy e^{-(x^2+y^2)/2} I_0(2x\sqrt{\rho(1-\lambda^2)}) I_0(\lambda xy), \quad (35)$$

where we have introduced the notation

$$\lambda = B/E, \quad \rho = E/2N, \quad x^2 = \sigma^2 R_1^2 / A, \quad y^2 = \sigma^2 R_2^2 / A \quad (36)$$

and changed variables in the double integral. In carrying out the derivation with the inclusion of the phase modulations  $\psi_i(t)$  one finds that the quantities  $B$ ,  $E$ , and  $\lambda$  are just those given by (1), with  $u_i(t) = f_i(t) \exp i\psi_i(t)$ . The integral can be reduced by transformations outlined in the Appendix. The result is

$$P_e = Q(\sqrt{\rho(1 - \sqrt{1 - \lambda^2})}, \sqrt{\rho(1 + \sqrt{1 - \lambda^2})}) - \frac{1}{2} e^{-\rho} I_0(\rho\lambda), \quad (37)$$

where the function  $Q(\alpha, \beta)$  is given by

$$Q(\alpha, \beta) = \int_\beta^\infty t e^{-(\alpha+t)^2/2} I_0(\alpha t) dt. \quad (38)$$

It has been tabulated by Marcum.<sup>9</sup>

If both  $\lambda$  and  $\rho\lambda$  are small, it is convenient to use the series expansion

$$P_e = \frac{1}{2} e^{-\rho} \left[ I_0(\rho\lambda) + 2 \sum_{n=1}^\infty \left( \frac{1 - \sqrt{1 - \lambda^2}}{\lambda} \right)^n I_n(\rho\lambda) \right]. \quad (39)$$

For large signal-to-noise ratios,  $\rho \gg 1$ , and for  $1 - \lambda \ll 1$ , (37) reduces to (13), so that in this region the loss of phase information introduces only a very small increase in the probability of error. [See Appendix, (62).] In Fig. 3 we have plotted  $P_e$  versus  $\lambda$  for a number of values of  $\rho$ , while in Fig. 4 are given curves of  $\rho$  versus  $\lambda$  for various values of  $P_e$ . By comparing these curves with those of Figs. 1 and 2 one can assess the increase in ambiguity arising when the carrier phases become uncertain. Thus it is the quantity  $\lambda$ , along with the signal-to-noise ratio  $\rho$ , which again determines the ambiguity of the signals, so that Woodward's contention<sup>1</sup> that the ambiguity of narrow-band signals depends on the relative cross-correlation  $\lambda$  is borne out, provided one takes account of the noise as we have done here.

<sup>9</sup> J. I. Marcum, "Table of Q Functions," Rand Corporation Report RM-339; January 1, 1950.

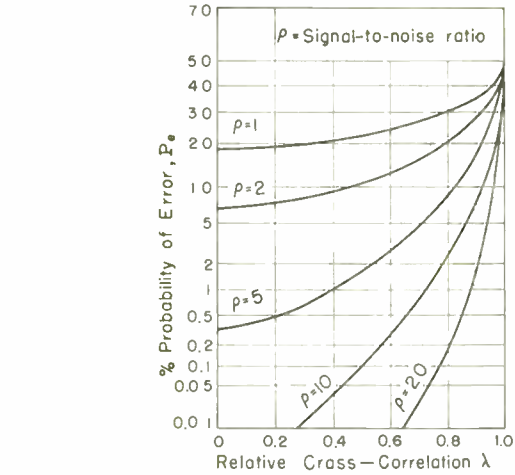

Fig. 3—Ambiguity of signals of unknown phase.

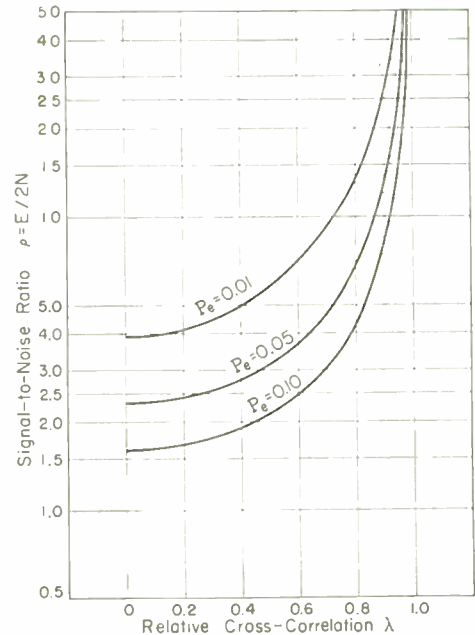

Fig. 4—Ambiguity of signals of unknown phase: fixed error probability,  $P_e$ .

IV. CONCLUSION

The probability of error in deciding which of two signals,  $F_1(t)$  or  $F_2(t)$ , was sent has been computed as a function of the signal-to-noise ratio  $\rho = E/2N$  and of the relative cross-correlation  $\lambda$  of the signals, where  $\lambda$  is given by (1). It has been shown that as  $\lambda$  approaches unity, an ever higher signal-to-noise ratio is required to keep the error probability to a pre-assigned value  $< 0.5$ .

These results have a bearing upon the accuracy with which parameters of a received signal, such as its carrier frequency or its time of arrival, can be measured when noise is present.<sup>10</sup> Consider for example the measurement of frequency. This could be accomplished by use of a large number of filters of amplitude characteristic

<sup>10</sup> Cf. D. Slepian, "Estimation of signal parameters in the presence of noise," TRANS. IRE, vol. PGIT-3, p. 68; March, 1954.

matching the pulse envelope, the pass-frequencies  $\Omega_i$  spaced more or less uniformly over the band of expected signal carrier frequencies. That filter yielding the maximum output would determine the signal frequency to an accuracy given by the frequency spacing between adjacent filters. Now there would be little point to placing the filters so close together that the noise would introduce a large probability of error in the decision as to which filter output was the largest. If one considers the filters pairwise, the results of this paper enable one to determine the probability that an adjacent filter, of pass frequency  $\Omega_{i+1}$ , say, will have a larger output than that of pass frequency  $\Omega_i$ , when the frequency of the signal was really  $\Omega_i$ . By setting a limit to this probability  $P_e$  one can determine the overlap  $\lambda$  as a function of the expected signal-to-noise ratio  $\rho$ , using the curves of Figs. 2 or 4.

Suppose for example that one expects pulses of Gaussian envelope  $u(t)$  given by

$$u(t) = A \exp \left[ -\frac{1}{2}\alpha^2(t - \frac{1}{2}T)^2 \right], \quad (40)$$

where  $\alpha$  is roughly the bandwidth of the pulse. If we assume that the observation time is long compared with  $\alpha^{-1}$ , the relative cross-correlation  $\lambda$  is given by (1) to be

$$\lambda = e^{-\omega / 4\alpha} \quad (41)$$

when the time of arrival of the pulses is the same, but when the frequency separation (corresponding to the difference of the pass frequencies of adjacent matched filters) is  $\Omega_{i+1} - \Omega_i = \omega$ . If we use for simplicity the results of Section II, which assume the signals completely known, we find that the dependence of signal-to-noise ratio upon  $\lambda$  for fixed error probability  $P_e$  is given by

$$\rho(1 - \lambda) = k^2, \quad (42)$$

where  $k$  is a constant such that

$$P_e = \frac{1}{2} [1 - \Phi(k)]. \quad (43)$$

Now for  $\lambda$  near unity, (41) is, approximately,

$$\omega = 2\alpha\sqrt{-\ln \lambda} \cong 2\alpha\sqrt{1 - \lambda} \quad (44)$$

so that

$$\omega \cong 2k\alpha/\sqrt{\rho}. \quad (45)$$

This implies that the minimum resolvable frequency difference, i.e., the minimum reasonable difference between the pass frequencies of adjacent filters, is proportional to the signal bandwidth and inversely proportional to the square root of the signal-to-noise ratio. This essentially is the limitation upon the accuracy with which the frequency of such a signal can be determined. Of course, to make better use of such a system one should use the outputs of all the filters of the array, computing from them the *a posteriori* probability distribution of the input signal frequency. The width of this

distribution would indicate the expected error in a frequency determination by this means.

APPENDIX

In order to evaluate the integral of (35), we start with the definition (38) of the function  $Q(\alpha, \beta)$ . By integration by parts<sup>11</sup> one can show, for  $\alpha < \beta$ ,

$$Q(\alpha, \beta) = e^{-(\alpha + \beta)/2} \sum_{n=0}^{\infty} (\alpha/\beta)^n I_n(\alpha\beta). \quad (46)$$

Now we use the integral representation of the modified Bessel functions  $I_n(x)$ :

$$I_n(x) = \frac{1}{2\pi} \int_0^{2\pi} \cos n\theta e^{x \cos \theta} d\theta. \quad (47)$$

Substituting into (46) and interchanging the order of summation and integration we get

$$\begin{aligned} Q(\alpha, \beta) &= \frac{1}{2\pi} e^{-(\alpha + \beta)/2} \int_0^{2\pi} e^{\alpha\beta \cos \theta} \sum_{n=0}^{\infty} (\alpha/\beta)^n \cos n\theta d\theta \\ &= \frac{1}{2\pi} e^{-(\alpha^2 + \beta^2)/2} \\ &\quad \cdot \int_0^{2\pi} \frac{1 - (\alpha/\beta) \cos \theta}{1 - 2(\alpha/\beta) \cos \theta + (\alpha/\beta)^2} e^{\alpha\beta \cos \theta} d\theta \end{aligned} \quad (\alpha < \beta). \quad (48)$$

Now (35) can be written using (38) as

$$P_e = (1 - \lambda^2)e^{-2\rho} \cdot \int_0^{\infty} x e^{-x^2(1-\lambda^2)/2} I_0(2x\sqrt{\rho(1-\lambda^2)}) Q(\lambda x, x) dx. \quad (49)$$

Substituting from (48) for  $Q(\lambda x, x)$ , we get

$$\begin{aligned} P_e &= \frac{(1 - \lambda^2)e^{-2\rho}}{2\pi} \int_0^{2\pi} \frac{1 - \lambda \cos \theta}{1 - 2\lambda \cos \theta + \lambda^2} d\theta \\ &\quad \cdot \int_0^{\infty} x e^{-x^2(1-\lambda \cos \theta)/2} I_0(2x\sqrt{\rho(1-\lambda^2)}) dx. \end{aligned} \quad (50)$$

Now we use the formula

$$\int_0^{\infty} x e^{-a^2 x} I_0(bx) dx = \frac{e^{b^2/4a^2}}{2a^2} \quad (51)$$

(from which one can show that  $Q(\alpha, 0) = 1$ ). (50) then becomes, with  $a^2 = 1 - \lambda \cos \theta$ ,  $b = 2\sqrt{\rho(1-\lambda^2)}$ ,

$$\begin{aligned} P_e &= \frac{(1 - \lambda^2)e^{-2\rho}}{4\pi} \int_0^{2\pi} \frac{d\theta}{1 - 2\lambda \cos \theta + \lambda^2} \\ &\quad \cdot \exp \left[ \frac{\rho(1-\lambda^2)}{1 - \lambda \cos \theta} \right]. \end{aligned} \quad (52)$$

We now make the change of variable given by

<sup>11</sup> J. I. Marcum, *A Statistical Theory of Target Detection by Pulsed Radar*, Math. App., Rand Corp. Report RM-753; 1948.

$$\cos \theta = \frac{\lambda + \cos \phi}{1 + \lambda \cos \phi}, \tag{53}$$

where the range  $0 < \theta < 2\pi$  corresponds to  $0 < \phi < 2\pi$ , obtaining after some labor

$$P_e = \frac{\sqrt{1 - \lambda^2} e^{-\rho}}{4\pi} \int_0^{2\pi} \frac{e^{\rho\lambda \cos \phi} d\phi}{1 - \lambda \cos \phi}. \tag{54}$$

Now in (48) let us put  $\alpha/\beta = \mu$ , whereupon we can break up the integral as follows:

$$\begin{aligned} Q(\alpha, \beta) &= \frac{1}{4\pi} e^{-(\alpha + \beta^2)/2} \int_0^{2\pi} e^{\alpha\beta \cos \theta} d\theta \left[ 1 + \frac{1 - \mu^2}{1 - 2\mu \cos \theta + \mu^2} \right] \\ &= \frac{1}{2} e^{-(\alpha + \beta^2)/2} \left[ I_0(\alpha\beta) \right. \\ &\quad \left. + \frac{1 - \mu^2}{2\pi} \int_0^{2\pi} \frac{e^{\alpha\beta \cos \theta} d\theta}{1 - 2\mu \cos \theta + \mu^2} \right] \end{aligned} \tag{55}$$

so that

$$\begin{aligned} \frac{1}{2\pi} \int_0^{2\pi} \frac{e^{\alpha\beta \cos \theta} d\theta}{1 - 2\mu \cos \theta + \mu^2} \\ = (1 - \mu^2)^{-1} [2Q(\alpha, \beta) e^{(\alpha + \beta^2)/2} - I_0(\alpha\beta)]. \end{aligned} \tag{56}$$

Thus we can evaluate (54) by putting

$$\begin{aligned} \lambda &= \frac{2\mu}{1 + \mu^2}, \quad \mu = \frac{1 - \sqrt{1 - \lambda^2}}{\lambda}, \quad \sqrt{1 - \lambda^2} = \frac{1 - \mu^2}{1 + \mu^2} \\ \alpha &= \sqrt{\rho\lambda\mu} = \sqrt{\rho(1 - \sqrt{1 - \lambda^2})}, \\ \beta &= \sqrt{\rho\lambda/\mu} = \sqrt{\rho(1 + \sqrt{1 - \lambda^2})}, \end{aligned} \tag{57}$$

whereupon (54) becomes

$$\begin{aligned} P_e &= \frac{(1 - \mu^2)e^{-\rho}}{4\pi} \int_0^{2\pi} \frac{(e^{\rho\lambda}) \cos \theta d\theta}{1 - 2\mu \cos \theta + \mu^2} \\ &= \frac{1}{2} e^{-\rho} [2Q(\alpha, \beta) e^{(\alpha + \beta^2)/2} - I_0(\alpha\beta)] \\ &= Q(\alpha, \beta) - \frac{1}{2} e^{-\rho} I_0(\rho\lambda) \end{aligned} \tag{58}$$

which was to be proved. The series expansion of (39) comes directly from (46).

When  $\alpha$  and  $\beta$  are large, one can obtain an asymptotic evaluation of  $Q(\alpha, \beta)$  by using the asymptotic form of the function  $I_0(x)$ :<sup>10</sup>

$$I_0(x) \cong \frac{e^x}{\sqrt{2\pi x}}. \tag{59}$$

Putting this into the integral (38), and noticing that most of the contribution to the integral comes from the region in which  $y \sim \alpha$ , one obtains

$$\begin{aligned} Q(\alpha, \beta) &\cong \int_{\beta}^{\infty} \frac{y}{\sqrt{2\pi\alpha y}} e^{-(y-\alpha)^2/2} dy \\ &\sim \frac{1}{2\pi} \int_{\beta}^{\infty} e^{-(y-\alpha)^2/2} dy \\ &= \frac{1}{2} \left[ 1 - \Phi\left(\frac{\beta - \alpha}{\sqrt{2}}\right) \right]. \end{aligned} \tag{60}$$

Now for  $1 - \lambda \ll 1$ , one can write  $\alpha$  and  $\beta$  approximately as

$$\alpha \doteq \sqrt{\rho}(1 - \sqrt{(1 - \lambda)/2}), \quad \beta \doteq \sqrt{\rho}(1 + \sqrt{(1 - \lambda)/2}). \tag{61}$$

In addition, the second term of (58) becomes negligible, so that one finally obtains the approximate result

$$P_e \cong \frac{1}{2} [1 - \Phi(\sqrt{\rho}(1 - \lambda))]. \tag{62}$$

Comparison of the curves of Figs. 1 and 3 shows that this is a good approximation when  $\rho \geq 10, \lambda \geq 0.5$ .

ACKNOWLEDGMENT

I wish to thank Professor R. Fano of the Massachusetts Institute of Technology and Dr. W. Siebert of Lincoln Laboratory, Massachusetts Institute of Technology, for an introductory discussion of the problem of signal resolution. I am indebted to Dr. W. Altar of Westinghouse Research Laboratories for helpful criticism of the manuscript.



# Automatic Gain Control of Transistor Amplifiers\*

W. F. CHOW†, SENIOR MEMBER, IRE, AND A. P. STERN†, ASSOCIATE, IRE

**Summary**—Since transistor small signal parameters are functions of the dc emitter current ( $I_e$ ) and of the dc collector voltage ( $V_c$ ), gain control can be achieved by varying either  $I_e$  or  $V_c$ . The gain decreases with decreasing  $I_e$  or  $V_c$ .

Using the series-parallel representation, the parameter most sensitive to  $I_e$ -variations is  $h_{11}$ , whereas  $V_c$ -variations affect  $h_{12}$  and  $h_{22}$  considerably. In common emitter configuration changes of  $h_{21}$  are also important. A study of the dependance of the  $h_{ij}$  on the dc operating point explains the nature of gain variations with  $I_e$  and  $V_c$ .

Satisfactory AGC circuits have been built using either  $I_e$ - or  $V_c$ -control. The control power required is very small if  $I_e$  or  $V_c$  are controlled indirectly by varying the base current. Since  $I_e$  or  $V_c$  are decreased considerably in the presence of strong input signals, the problem of distortion must be given serious consideration. Due to the variation of transistor driving point impedances, AGC may result in changes of the bandpass characteristic of tuned amplifiers.

The gain of transistor converters and oscillator-converters can be controlled by conventional or special techniques.

## I. INTRODUCTION

THE POSSIBILITY of controlling the gain of amplifiers is very important in many electronic systems. Methods achieving gain control in vacuum tube amplifier circuits are well-known. These methods are based on the fact that the transconductance, and consequently, the amplification of a vacuum tube are functions of its grid bias.

Automatic gain control circuits using transistors have been described by Blecher,<sup>1</sup> Barton,<sup>2</sup> Stern and Raper.<sup>3,4</sup> Blecher discusses circuits using the common base configuration. The other papers describe broadcast receivers employing AGC.

The purpose of this paper is to review the theoretical aspects of transistor gain control and some of the principles useful in the design of transistor AGC circuits. The investigations leading to this paper were mainly concerned with the gain control of amplifiers designed to operate in the 100 kc to 2 mc frequency range, but it is believed that the conclusions can be considered valid for amplifiers designed for different frequencies.

\* Original manuscript received by the IRE, March 23, 1955; revised manuscript received, June 15, 1955. The first part of this paper has been presented as "Principles of Automatic Gain Control of Transistor Amplifiers," at the IRE-AIEE-UP Conference on Transistor Circuits, Philadelphia, February 17, 1955; the second part has been presented as "Automatic Gain Control of Transistor Amplifiers," at the Radio Fall Meeting of the RETMA, Syracuse, October 18, 1954. Parts of this paper will be incorporated in a thesis being prepared for presentation to the Elec. Engrg. Dept., Syracuse University.

† Electronics Lab., General Electric Co., Syracuse, N. Y.

<sup>1</sup> F. H. Blecher, "Automatic gain control of junction transistor amplifiers," *Proc. NEC*, vol. 9, pp. 731-737; 1953.

<sup>2</sup> L. E. Barton, "An experimental transistor personal broadcast receiver," *Proc. IRE*, vol. 42, pp. 1062-1066; July, 1954.

<sup>3</sup> A. P. Stern and J. A. A. Raper, "Transistor AM broadcast receivers," *1954 IRE Convention Record*, part 7, "Broadcasting and Television," pp. 8-14.

<sup>4</sup> A. P. Stern and J. A. A. Raper, "Transistor broadcast receivers," *Elec. Eng.*, vol. 73, pp. 1107-1112; December, 1954.

## II. TRANSISTOR BEHAVIOR AND DC OPERATING POINT

### Small Signal Parameters and Gain

Using the series-parallel representation, the behavior of the transistor is described by:

$$\begin{aligned} E_1 &= h_{11}I_1 + h_{12}E_2 \\ I_1 &= h_{21}I_1 + h_{22}E_2. \end{aligned} \quad (1)$$

The small signal parameters  $h_{ij}$  vary with the frequency<sup>5,6</sup> and are, of course, different for the three transistor configurations (common base, emitter and collector). If the transistor (Fig. 1) is terminated by a



Fig. 1—Schematic representation of a transistor amplifier.

source impedance  $Z_G$  ( $Z_G = R_G + jX_G$ ) and a load admittance  $Y_L$  ( $Y_L = G_L + jB_L$ ), the transducer gain  $G$  of the transistor can be expressed as:

$$G = \frac{4R_G G_L |h_{21}|^2}{|(h_{11} + Z_G)(h_{22} + Y_L) - h_{12}h_{21}|^2}. \quad (2)$$

The gain  $G$  of (2) is defined as the ratio of the power delivered to the load to the available power of the source connected to the input terminals of the transistor.

Gain control of the transistor is possible because, as will be shown in the following discussion, the parameters  $h_{ij}$  depend on the dc operating point, i.e., on the dc emitter current ( $I_e$ ) and the dc collector-voltage ( $V_c$ ). Therefore, there are two basic methods of transistor gain control:

1. Emitter current or  $I_e$ -control
2. Collector voltage or  $V_c$ -control.

The two methods apply in different regions of the collector plane:  $I_e$ -control applies at "normal" values of  $V_c$  (several volts) and small values of  $I_e$ , whereas  $V_c$ -control involves "normal" values of  $I_e$  (order of milliampere) and small values of  $V_c$ .

The  $h_{ij}$  being frequency dependent and complex and the functions  $h_{ij} = F(I_e, V_c)$  rather involved, an exact analytic treatment of the gain as a function of the dc operating point using (2) is hardly practical, especially

<sup>5</sup> J. M. Early, "Design theory of junction transistors," *Bell Sys. Tech. Jour.*, vol. 32, pp. 1271-1312; November, 1953.

<sup>6</sup> R. L. Pritchard, "Frequency variation of junction transistor parameters," *Proc. IRE*, vol. 42, pp. 786-799; May, 1954.

at higher frequencies. The effect of  $I_e$  and  $V_e$  on gain and other performance characteristics of transistor amplifiers can, however, be described qualitatively by analyzing the theoretical properties and observing the experimental behavior of the  $h_{ij}$  as functions of  $I_e$  and  $V_e$ .

In the following discussion,  $h_{ij,b}$  designate the  $h$ -parameters of the common base transistor configuration whereas  $h_{ij,e}$  refer to the common emitter circuit. Wherever it is necessary to distinguish between collector-to-base and collector-to-emitter voltages, the former is designated by  $V_{cb}$  and the latter by  $V_{ce}$ .

*Common Base Parameters: Theory*

The common base small signal admittance parameters of the transistor have been calculated by Early<sup>6</sup> in terms of the physical properties of the device. Early has solved the one-dimensional diffusion equation approximately valid for an "ideal" transistor and has added to the ideal model several circuit elements representing the deviation of a "real" transistor from the ideal one.

In the case of gain controlled amplifiers  $I_e$  may be reduced to a few microamperes and  $V_{cb}$  to a few millivolts ( $V_{cb}$  may change sign). Consequently,  $I_e$  may be of the order of magnitude of the emitter or collector reverse currents and  $V_{cb}$  is not necessarily larger than  $kT/q$ . Early's solution of the diffusion equation can be written to include terms which may be of importance at small values of  $I_e$  and  $V_{cb}$ . The resulting admittance parameters are transformed into series-parallel parameters  $h_{ij}'$ , yielding an equivalent circuit of the "ideal" transistor. The ideal model is assumed to have unity emitter efficiency and collector multiplication and can be completed by adding the "base spreading impedance"  $z_b'$  and collector barrier capacitance  $C_b$  (Fig. 2). (Pritchard and Coffey<sup>7</sup> have shown that the base spreading "resistance" is complex for rate grown  $n$ - $p$ - $n$  transistors.)

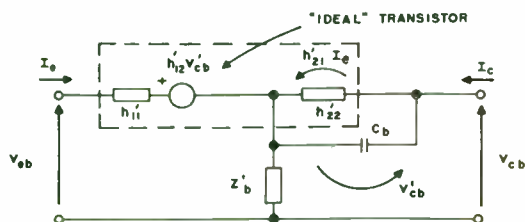

Fig. 2—"Real" transistor.

The collector-to-base leakage resistance is negligible at medium and high frequencies under consideration.

At higher frequencies  $h_{12}'$  is small as compared to the feedback due to  $z_b'$  and the parameters  $h_{ij,b}$  of the common base transistor are related to those of the "ideal" transistor  $h_{ij}'$  by the following approximate relations:

<sup>7</sup> R. L. Pritchard and W. N. Coffey, "Small signal parameters of grown-junction transistors at high frequencies," 1954 IRE Convention Record, part 3, "Electron Devices and Component Parts," pp. 89-98.

$$h_{11,b} = h_{11}' + z_b'(1 + h_{21}') \tag{3}$$

$$h_{12,b} = (h_{22}' + j\omega C_b)z_b' \tag{4}$$

$$h_{21,b} = -\alpha = h_{21}' \tag{5}$$

$$h_{22,b} = h_{22}' + j\omega C_b \tag{6}$$

Writing out the  $h_{ij}'$  explicitly, the  $h_{ij,b}$  can be written as functions of  $I_e$  and  $V_{cb}$ :

$$h_{11,b} = \frac{\tanh sw/L}{as \tanh w/L} \frac{1}{I_e + I_{e0}} + z_b' \left( 1 - \frac{1}{\cosh sw/L} \right) \tag{7}$$

$$h_{12,b} = \left\{ \left[ aI' + \frac{1}{L} \frac{\partial w}{\partial V_{cb}} \left( \frac{1}{\cosh w/L} I_e + I_{e0} \right) \right] s \cdot \tanh sw/L + j\omega C_b \right\} z_b' \tag{8}$$

$$h_{21,b} = -\frac{1}{\cosh sw/L} \tag{9}$$

$$h_{22,b} = \left[ aI' + \frac{1}{L} \frac{\partial w}{\partial V_{cb}} \left( \frac{1}{\cosh w/L} I_e + I_{e0} \right) \right] s \cdot \tanh sw/L + j\omega C_b \tag{10}$$

$I_{e0}$  is the emitter reverse current, the collector being biased at  $V_{cb}$ ;  $I_{e0}$  is the collector reverse current with open emitter and  $I'$  is a quantity having the dimension of a current. For  $p$ - $n$ - $p$  transistors:

$$I_{e0} = \frac{qD_p p_n}{L \sinh w/L} (e^{aV_{cb}} - 1 + \cosh w/L) \tag{11}$$

$$I_{e0} = \frac{qD_p p_n}{L} (1 - e^{aV_{cb}}) \tanh w/L \tag{12}$$

$$I' = \frac{qD_p p_n}{L} e^{aV_{cb}} \tag{13}$$

The symbols used in (7) to (13) are those of Early and have the following significance:

- $a = q/kT$  (approximately 40 at room temperature);
- $D_p$  = diffusion constant for holes;
- $p_n$  = equilibrium concentration of holes in  $n$ -type base region;
- $L$  = diffusion length of holes;
- $w$  = base-layer thickness;
- $s = (1 + j\omega\tau)^{1/2}$ ,  $\tau$  being the lifetime of holes in the base region.

Eq. (7) shows that  $h_{11,b}$  has a component which is inversely proportional to  $(I_e + I_{e0})$  and a component proportional to  $(1 + h_{21,b})$ . Due to the decrease of  $\alpha = -h_{21,b}$  with decreasing  $I_e$  at low values of  $I_e$ ,  $(1 + h_{21,b})$  increases under the same conditions. Consequently, with decreasing  $I_e$ ,  $h_{11,b}$  increases.  $h_{11,b}$  is, however, hardly affected by changes in  $V_{cb}$ .

According to (8) and (10), the dependence of  $h_{12,b}$  and  $h_{22,b}$  on the dc parameters is rather complicated.



Both  $h_{12,b}$  and  $h_{22,b}$  have a component varying linearly with  $I_e$  and all components are sensitive to variations  $V_{cb}$ , due to the fact that both  $\partial w/\partial V_{cb}$  and  $C_b$  increase with decreasing  $V_{cb}$ . The major portion of  $h_{12,b}$  and  $h_{22,b}$  in practical transistors is due to  $C_b$  and,  $C_b$  being independent of  $I_e$ ; the variation of these parameters with  $I_e$  is not as strong as their variation with  $V_{cb}$ .

In (9)  $h_{21,b}$  is independent of  $I_e$  and  $V_{cb}$ , but it is well known that  $h_{21,b} = -\alpha$  does decrease at low values of  $I_e$ <sup>8</sup> and in the neighborhood of zero  $V_{cb}$ .

In the case of transistors with small base layer thickness the dependence of  $h_{ij,b}$  on  $V_{cb}$  is particularly complicated because of the nonnegligible variation of the base layer thickness with  $V_{cb}$ .<sup>9</sup>

The variation of the  $h$ -parameters with  $I_e$  can be summarized schematically by the following qualitative relationships:

$$h_{11,b} \cong A_1 \frac{1}{I_e + I_{e0}} + z_b'(1 - \alpha) \quad (14)$$

$$h_{12,b} \cong [A_2(\alpha_0 I_e + I_{e0}) + A_3]z_b' \quad (15)$$

$$h_{21,b} = -\alpha \quad (16)$$

$$h_{22,b} \cong A_2(\alpha_0 I_e + I_{e0}) + A_3 \quad (17)$$

The  $A_i$  are complex constants and  $\alpha_0$  is the low frequency value of  $\alpha$ .  $A_3$  is usually the prevailing term in (15) and (17) and consequently, the parameter most sensitive to  $I_e$  variations is  $h_{11,b}$ . Therefore, one can state that, in terms of small signal parameter variations, emitter current type gain control is due principally to variations of  $h_{11,b}$ .

In the case of varying  $V_{cb}$ , both  $\partial w/\partial V_{cb}$  and  $C_b$  are functions of  $V_{cb}$ .<sup>5,10</sup> In general:

$$\frac{\partial w}{\partial V_{cb}} = k_1 V_{cb}^{-m} \quad (18)$$

$$C_b = k_2 V_{cb}^{-n} \quad (19)$$

The magnitude of the exponents  $m$  and  $n$  depends on the nature of the collector junction. For graded junctions  $m = \frac{2}{3}$  and  $n = \frac{1}{3}$ , whereas for step junctions  $m = n = \frac{1}{2}$ . Both cases are idealized: in practice the exponents will be close to  $\frac{1}{2}$ .

The  $h$ -parameters for varying  $V_{cb}$  can be written in first approximation as:

$$h_{11,b} \cong B_1 + z_b'(1 - \alpha) \quad (20)$$

$$h_{12,b} \cong [B_2 e^{\alpha V_{cb}} + B_3 V_{cb}^{-m} + B_4 V_{cb}^{-n}]z_b' \quad (21)$$

$$h_{21,b} = -\alpha \quad (22)$$

$$h_{22,b} \cong B_2 e^{\alpha V_{cb}} + B_3 V_{cb}^{-m} + B_4 V_{cb}^{-n} \quad (23)$$

<sup>8</sup> W. M. Webster, "On the variation of junction-transistor current-amplification factor with emitter current," PROC. IRE, vol. 42, pp. 914-920; June, 1954.

<sup>9</sup> D. Haneman, "Expression for the  $\alpha$ -cut-off frequency in junction-transistors," PROC. IRE, vol. 42, pp. 1808-1809; December, 1954.

<sup>10</sup> J. M. Early, "Effects of space-charge layer widening in junction-transistors," PROC. IRE, vol. 40, pp. 1401-1406; November, 1952.

These expressions show that  $h_{12,b}$  and  $h_{22,b}$  are the parameters most sensitive to variations of  $V_{cb}$ . Therefore, in terms of small signal parameter variation, collector voltage type gain control is due principally to variations of  $h_{12,b}$  and  $h_{22,b}$ .

Common Base Parameters: Experimental Results

The common base  $h$ -parameters of a typical General Electric rate grown  $n$ - $p$ - $n$  transistor (Type 2N78) were measured as functions of  $I_e$  and  $V_{cb}$  at one megacycle.

$h_{11,b}$  is considered as the parallel connection of a resistance  $r_{11,b}$  and a (negative) capacitance  $C_{11,b}$  (Fig. 3). Both resistive and reactive components of  $h_{11,b}$  increase if  $I_e$  is decreasing. The phase angle of  $h_{11,b}$  decreases as  $I_e$  is decreasing and reverses itself ( $C_{11,b}$  becomes positive) at a small value of  $I_e$  (this part of the curve is not shown in Fig. 3). The phase reversal is due to the fact that at low values of  $I_e$ , the first component of  $h_{11,b}$  in (7) is prevailing and this component is capacitive.  $h_{11,b}$  depends only to a very moderate extent on  $V_{cb}$ .

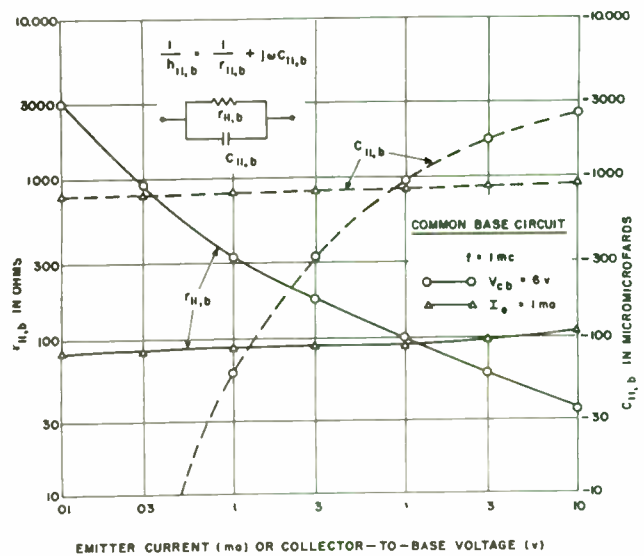

Fig. 3—Components of  $h_{11,b}$  as functions of emitter current and collector-to-base voltage.

$h_{12,b}$  (Fig. 4, next page) does not vary strongly with  $I_e$ , small measured variation due mainly to  $I_e$ -dependence of  $z_b'$ . The variation of  $h_{12,b}$  with  $V_{cb}$  is considerable, as can be expected.  $h_{12,b}$  increases if  $V_{cb}$  is decreasing but its phase remains unaffected,  $z_b'$  being independent of  $V_{cb}$ .<sup>11</sup>

Variation of  $h_{22,b}$  (Fig. 5, next page) with  $I_e$  and  $V_{cb}$  is analogous to  $h_{12,b}$  as can be expected from the similarity of (8) and (10). Effect of  $I_e$  is small, whereas that of  $V_{cb}$  is considerable. Both components of  $h_{22,b}$  ( $g_{22,b}$  and  $C_{22,b}$ ) increase if  $V_{cb}$  is decreasing. The slope  $C_{22,b}$  versus  $V_{cb}$  is comparable to that of  $h_{12,b}$  versus  $V_{cb}$  and is close to  $(-1/2)$ .

<sup>11</sup> Measurements of the phases of  $h_{12,b}$  and  $h_{12,b}$  involved considerable errors and the corresponding curves may not be representative.

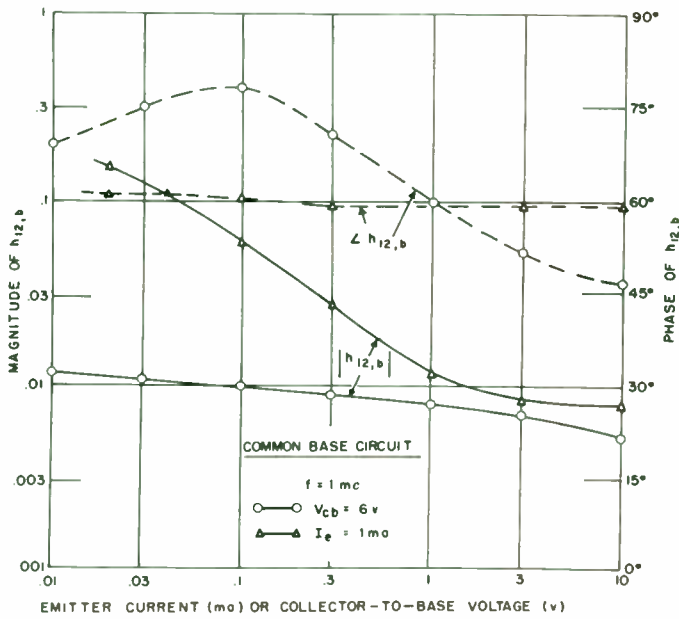

Fig. 4— $h_{12,b}$  as a function of emitter current and collector-to-base voltage.

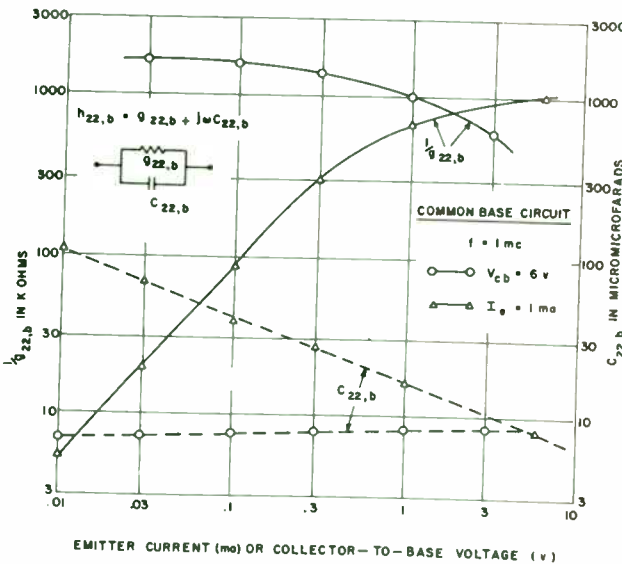

Fig. 5—Components of  $h_{22,b}$  as functions of emitter current and collector-to-base voltage.

The magnitude of  $h_{21,b} = -\alpha$  decreases with decreasing  $I_e$  (Fig. 6) in the region of small values of  $I_e$  ( $I_e < 0.3$  ma).  $h_{21,b}$  also decreases slightly with decreasing  $V_{cb}$ .

The reduction of  $h_{21,b}$  at 1 mc with decreasing  $I_e$  or  $V_{cb}$  is due both to the decrease of the low frequency value of  $h_{21,b}$  as well as to the decrease of the  $h_{21,b}$ —(or  $\alpha$ —) cutoff frequency. The latter manifests itself in the notable increase of the phase angle of  $h_{21,b}$ .

Common Emitter Parameters

The approximate relationships between common emitter parameters  $h_{ij,e}$  and common base parameters  $h_{ij,b}$  are:

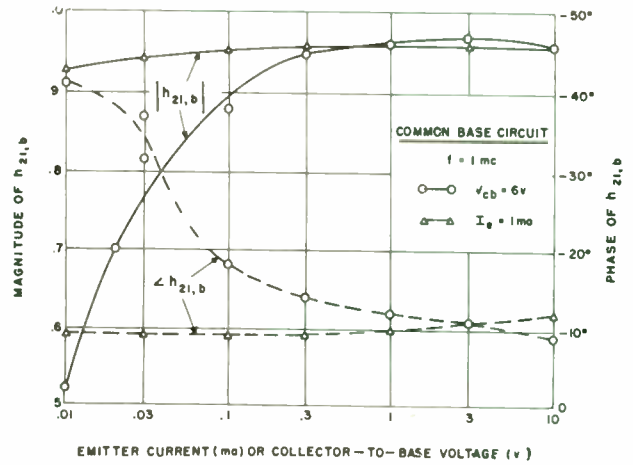

Fig. 6— $h_{21,b}$  as function of emitter current and collector-to-base voltage.

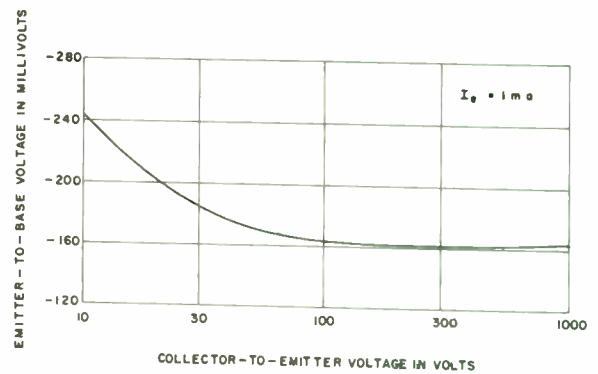

Fig. 7—Emitter-to-base versus collector-to-emitter voltage at constant emitter current.

$$h_{11,b} \cong h_{11,b} / (1 + h_{21,b}) \tag{24}$$

$$h_{12,e} \cong h_{11,b} h_{22,b} / (1 + h_{21,b}) - h_{12,b} \tag{25}$$

$$h_{21,b} \cong -h_{21,b} / (1 + h_{21,b}) \tag{26}$$

$$h_{22,e} \cong h_{22,b} / (1 + h_{21,b}). \tag{27}$$

With exception of  $h_{12,e}$

$$|h_{ij,e}| \cong |h_{ij,b} / (1 - \alpha)|, \tag{28}$$

where  $1/(1 - \alpha)$  decreases strongly with decreasing  $I_e$  or  $V_{ce}$ .

In Figs. 8 to 11, the  $h_{ij,e}$  are plotted as functions of  $I_e$  and  $V_{ce}$ .  $V_{ce}$  has been chosen as independent variable rather than  $V_{cb}$  for the common emitter case. By subtracting the emitter-to-base voltage from  $V_{ce}$  one obtains  $V_{cb}$  (Fig. 7).

Both resistive and reactive components of  $h_{11,e}$  increase as  $I_e$  is decreasing (Fig. 8). The effect of  $V_{ce}$  variation is negligible until  $V_{ce}$  reaches values of approximately 100 mv. In this region, the collector diode is forward biased and  $h_{11,e}$  decreases as  $V_{ce}$  is decreased.

$h_{12,e}$  increases if  $I_e$  is decreasing (Fig. 9) due to the increase of  $h_{11,b}$  in (25).  $h_{12,e}$  also increases with  $V_{ce}$ , the variation being largest in the region of forward biased collector junction.

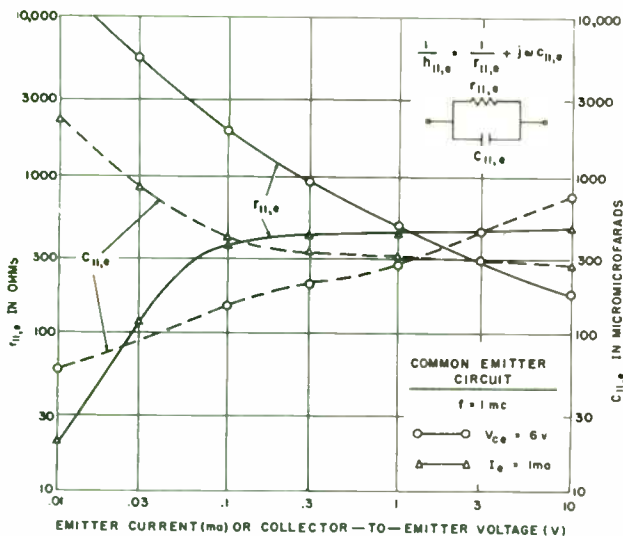

Fig. 8—Components of  $h_{11,e}$  as functions of emitter current and collector-to-emitter voltage.

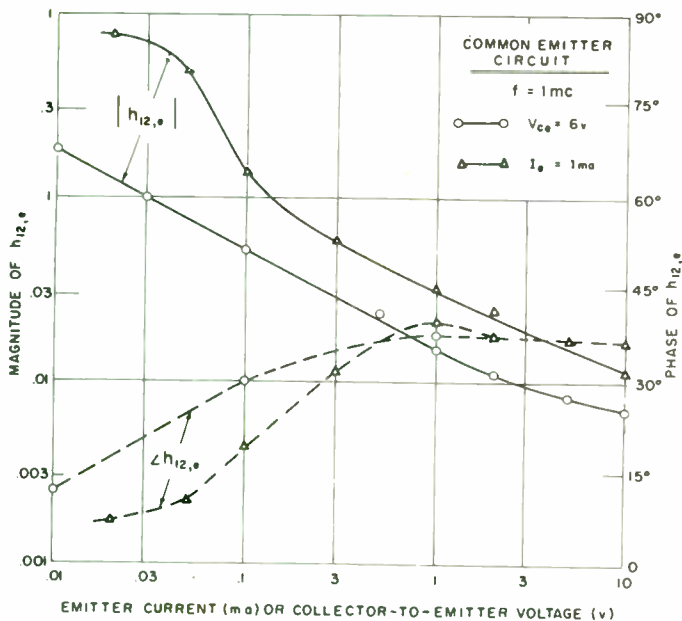

Fig. 9— $h_{12,e}$  as a function of emitter current and collector-to-emitter voltage.

$h_{21,e} \cong \alpha / (1 - \alpha)$  is, of course, more sensitive to variations of  $I_e$  and  $V_c$  than  $h_{21,b} = -\alpha$  (Fig. 10). The variation of  $h_{22,e}$  is qualitatively similar to  $h_{22,b}$  (Fig. 11).

The measured curves show that in common emitter configuration, just as in the case of the common base stage, emitter current type gain control is achieved by varying  $h_{11,e}$ , whereas if collector voltage type gain control is used,  $h_{12,e}$  and  $h_{22,e}$  are mainly responsible for gain variation. In common emitter configuration, however, the variation of  $h_{21,e}$ , which is in the numerator of (2), helps the gain control process considerably.

*The Gain as Function of  $I_e$  and  $V_c$ .*

Considering (2) for the gain and the dependence of the

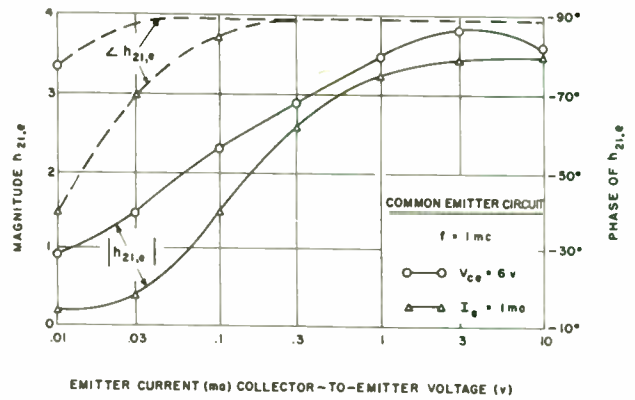

Fig. 10— $h_{21,e}$  as function of emitter current and collector-to-emitter voltage.

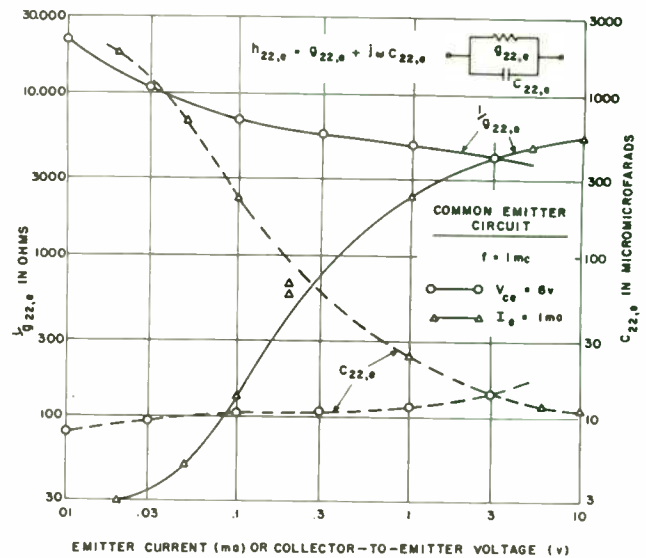

Fig. 11—Components of  $h_{22,e}$  as functions of emitter current and collector-to-emitter voltage.

$h$ -parameters on  $I_e$ , it is easy to see that in the case of  $I_e$ -control, at small values of  $I_e$ , the gain is approximately proportional to  $1/|h_{11}|^2$ . Due to the nature of the variation of  $h_{11}$  with  $I_e$  this means that the gain will be reduced by almost 20 db per decade decrease of  $I_e$ .

In the case of  $V_c$ -control the variation of  $h_{12}$  and  $h_{22}$  is most important. The exponent  $(-\frac{1}{2})$  leads to a gain variation of approximately 10 db per decade variation of  $V_c$  at low values of  $V_c$ .

The actual dependence of the transducer gain of a General Electric rate grown  $n-p-n$  transistor on  $I_e$  and  $V_c$  has been measured at 500 kc (Figs. 12 and 13). The terminations were resistive:  $R_G = 500\Omega$  and  $R_L = 5,000\Omega$ . The curves show that considerable control action occurs in the region of small values of  $I_e$  and  $V_c$ . (By reducing  $I_e$  and  $V_c$  beyond the values shown on the diagram, gain reductions exceeding 35 db per stage can be achieved.) The agreement with the theoretical gain variation is satisfactory: gain decrease of 15 to 18 db per decade decrease in  $I_e$  is measured in the case of  $I_e$ -control,

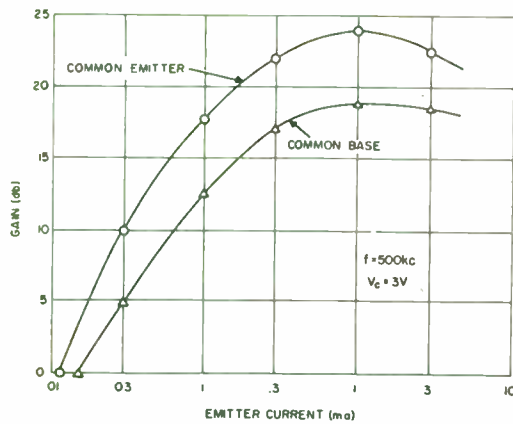

Fig. 12—Transistor gain as a function of the emitter current.

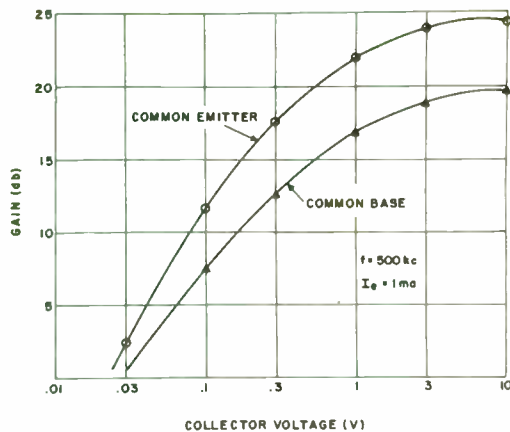

Fig. 13—Transistor gain as a function of the collector voltage.

whereas for  $V_c$ -control the gain decrease per decade of  $V_c$  is 12 to 15 db. The higher value applies to the common emitter circuit, due to the previously mentioned fact that  $h_{21,a}$  is more sensitive to  $I_e$  and  $V_c$  variations than  $h_{21,b}$ .

The gain does not vary appreciably at values of  $I_e$  exceeding 500  $\mu a$  and at values of  $V_c$  exceeding 1 v. This enables the design of amplifiers with "delayed" AGC. By selecting an appropriate "no signal" operating point, reasonable delay characteristics can be obtained using either gain control principle.

Although the characteristics discussed were those of a General Electric rate-grown transistor, other transistor types exhibit similar gain control properties.

### III. CIRCUIT CONSIDERATIONS

#### Methods of Gain Control

In practical AGC circuits the variation of  $I_e$  or  $V_c$  must be performed economically, with a minimum expenditure of control power. The following consideration illustrates the problem. Figs. 12 and 13 show that for adequate gain in the presence of small signals,  $I_e$  must be of the order of 500  $\mu a$  and  $V_c$  at least 1 v. With increasing signal level, in the case of  $I_e$ -control,  $I_e$  must

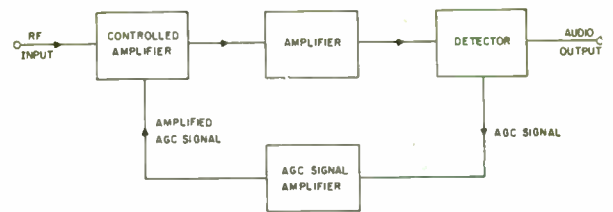
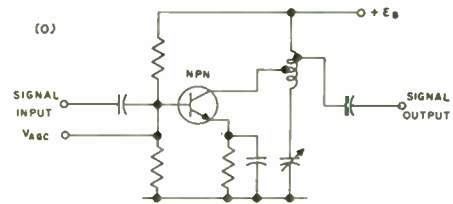

Fig. 14—AGC system with additional amplifier in feedback loop.



I. Control of tuned amplifier with AGC voltage applied to base.

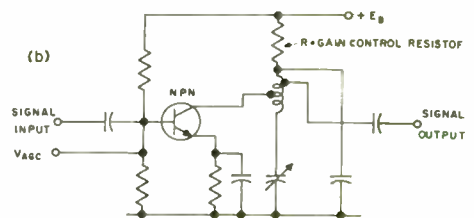

Fig. 15—Indirect  $V_c$ -control of tuned amplifier with AGC voltage applied to base.

be decreased to 20  $\mu a$  or less, whereas if  $V_c$ -control is used,  $V_c$  must be reduced to 30 mv or less. If  $I_e$  or  $V_c$  are controlled *directly*, the dc control power required to achieve this reduction of  $I_e$  or  $V_c$  is considerable.

The necessary dc power for direct control is not always available from detectors or other sources of AGC power and, consequently, in some cases (especially with a diode detector), if direct control of  $I_e$  or  $V_c$  is desired, an additional dc amplifier must be inserted in the feedback loop to deliver this control power (Fig. 14) unless detection is performed at very high level.

Control power can, however, be saved and the control power requirements on the detector (or any other control source) reduced by using the controlled transistor amplifier simultaneously as a dc amplifier of the control signal.

An example for the case of  $I_e$ -control is shown in Fig. 15(a).  $I_e$  is varied indirectly by applying an appropriate control potential to the base. The transistor shown is *n-p-n* and, consequently, with increasing signal level, a decreasing positive voltage is required as AGC signal. This will result in a decrease of  $I_e$ . (For a *p-n-p* transistor, a decreasing negative voltage is needed.) The transistor amplifies the dc control signal and moderate variations of the base current will result in appreciable variations of  $I_e$ .

A similar procedure can be applied in case of  $V_c$ -control (Fig. 15(b)). The AGC voltage is applied to the base.

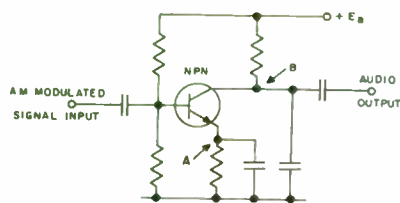

Fig. 16—Transistor detector circuit.

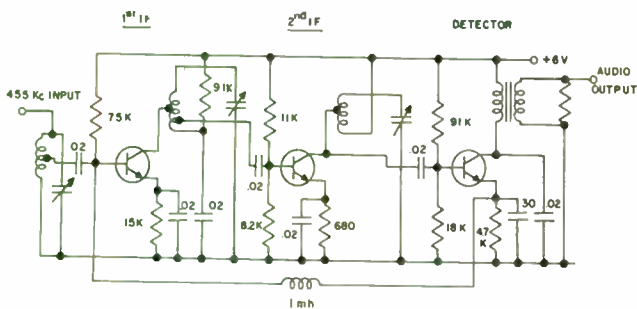

Fig. 17—Two stage IF amplifier followed by detector with  $V_c$  type AGC.

With increasing signal level, the AGC voltage acts to increase the emitter current  $I_e$  and the collector current  $I_c$  of the controlled stage. Due to the increased voltage drop developed by  $I_e$  across the resistor  $R$  inserted in the collector lead,  $V_c$  decreases and results in a reduction of gain. The controlled stage being  $n-p-n$ , an increasing positive control voltage is needed to reduce the gain (increasing negative for  $p-n-p$  transistor).

The necessary control power is often smaller in the case of  $V_c$ - than in the case of  $I_e$ -control, since very small variations of  $I_e$  will cause large variations of  $V_c$ , provided the gain control resistance  $R$  is sufficiently high.

Detector

The control voltage (with required polarity and sense of variation) can be obtained in many ways. Diode detectors produce positive or negative control voltages increasing with increasing signal level and by using appropriate biasing arrangements control voltages decreasing with increasing signal level can be easily produced.

In many cases (e.g., in broadcast receivers), transistor detectors delivering ample control power can be used. A possible arrangement is shown in Fig. 16. A positive voltage increasing with increasing signal level will appear at  $A$ . The potential at  $B$  will be decreasing with increasing signal level. Both points can be used as control signal sources. (With  $p-n-p$  detectors, the control voltage will be negative.)

AGC Circuits

Making use of the principles described in the previous paragraphs many, more or less different, AGC circuits can be designed. Blecher<sup>1</sup> and Barton<sup>2</sup> have described circuits based on  $I_e$ -control. Stern and Raper<sup>3,4</sup> use  $V_c$ -control in a broadcast receiver.

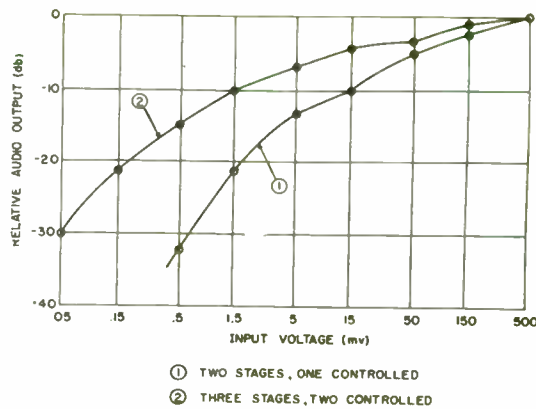

Fig. 18—AGC characteristics of IF amplifiers.

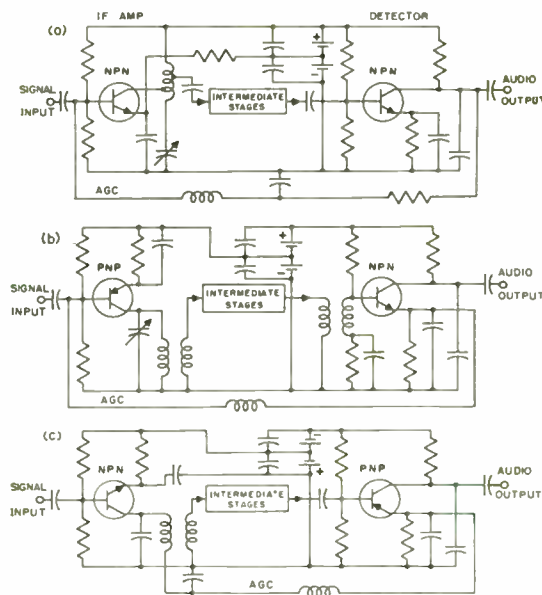

Fig. 19—AGC circuits.

A  $V_c$ -controlled circuit is shown in Fig. 17. The diagram represents a two-stage IF amplifier followed by a transistor detector. The first IF stage is  $V_c$ -controlled. The gain control characteristic of this amplifier is shown in Fig. 18.

Fig. 19 shows other possible circuits. Fig. 19(a) represents an  $I_e$ -controlled system, the performance of which is comparable to the one of Fig. 17. The circuit of Fig. 19(b) operates in a similar manner, but uses a  $p-n-p$  amplifier and a  $n-p-n$  detector. In the arrangement of Fig. 19(c), the collector voltage of the amplifier stage is controlled directly by the AGC voltage. Obviously, many other variations are possible.

The methods described can be applied to control the gain of several stages simultaneously. Desirable differential delays between the AGC action of different stages can be achieved, by either operating the controlled stages at different quiescent ("no signal") operating points or by designing different feedback networks for the controlled stages, or by deriving the control signal

for one controlled stage from another controlled stage.

Fig. 18 also shows the gain characteristic of a  $V_c$ -controlled IF amplifier two stages of which were controlled. The circuit was that of Fig. 17 with an additional controlled IF stage preceding the IF amplifier.

*Distortion*

Both principles of gain control ( $I_e$  and  $V_c$ ) involve the reduction of the signal handling capability of the controlled stage at high signal levels (i.e., at reduced gain).  $I_e$ -control is achieved by decreasing  $I_e$  in presence of strong signals and, therefore, at small values of  $I_e$ , the permissible input current swing is reduced. If, on the other hand, the gain is decreased in the presence of strong signals by reducing  $V_c$ , the output voltage swing of the controlled stage is strongly limited.

In other words, the AGC performance of most transistors can be compared to that of sharp-cutoff vacuum tubes. Some transistors do, however, exhibit an  $\alpha$  which starts to decrease at relatively large values of  $I_e$  or  $V_c$ . With such transistors, in common emitter configuration, the distortion problem is less serious.

In amplitude modulated systems, the controlled stages must be low-level stages to prevent distortion (or, even worse, the suppression) of the modulation envelope. (This does not apply, of course, to frequency-modulated systems.) In broadcast receivers, for instance, this limitation implies that AGC must not be applied to the last IF stage, and if more than one stage is controlled, suitable staggering of delays will be necessary. Controlled stages should be designed to handle only a fraction of a microwatt signal power. By careful design, adequate performance with tolerable distortion can be obtained.  $I_e$ -controlled stages can handle somewhat more signal power than  $V_c$ -controlled stages.

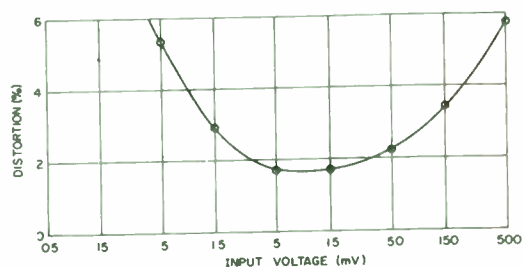

Fig. 20—Harmonic distortion as a function of input voltage.

Fig. 20 shows the distortion measured at the detector output of the amplifier of Fig. 17. High distortion at very low input signal levels is due to detector nonlinearity. The distortion is minimum at intermediate input levels and increases at high input levels as a result of AGC.

*Bandwidth and Tuning*

It has been seen that from the point of view of AGC the variation of  $h_{11}$  and  $h_{22}$ , and consequently that of in-

put and output impedances is very important. The driving point impedances of a gain controlled stage vary with the signal level. This implies changes in the band-pass characteristics of tuned amplifiers:

1. Variation of the resistive component of the driving point impedances means variable damping of the interstage tuned circuits and consequently variation of bandwidth and selectivity.
2. Variation of the reactive component of the driving point impedances means detuning, i.e., a shift of the center frequency of the tuned amplifier.

In the case of emitter current control, resistive component of input impedance rises with decreasing  $I_e$ . Variation of the output impedance is less pronounced, but it also increases. If a parallel-parallel interstage tuning arrangement is used (Fig. 21(a)), with increasing signal level, that is with decreasing  $I_e$ , the bandwidth will decrease. The parallel-series tuning arrangement (Fig. 21(b)) is more desirable. The parallel output impedance of the first stage tends to decrease the bandwidth in the presence of large signals, but this is overcome by the increasing input impedance of the second stage which is in series with the tuned circuit. The combined effect is a moderate increase in bandwidth.

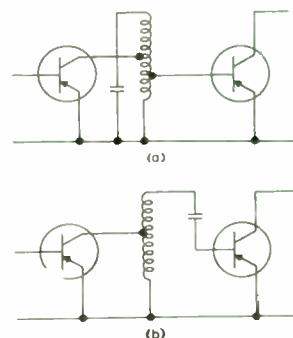

Fig. 21(a)—Parallel-parallel coupling circuit. (b) Parallel-series coupling circuit. (The circuits are drawn ac-wise.)

The situation is different in the case of collector voltage control. The input impedance is hardly at all affected by variations of  $V_c$  and the output impedance decreases if  $V_c$  is reduced. Consequently, the parallel arrangement leads to increasing bandwidth in the presence of strong signals. Fig. 22 (opposite page) shows the audio response of a  $V_c$ -controlled receiver as a function of the input signal. The increasing bandwidth at strong signal levels results in an "automatic tone control" feature, permitting taking advantage of the radiated spectrum of local transmitters.

In cases where it is desired to keep the bandwidth rigorously constant, it is necessary to place the desired selectivity into tuned circuits not adjoining controlled stages. Keeping the bandwidth of variable center frequency amplifiers constant is a particularly difficult

problem, and can often be achieved only by using stabilizing resistors and thereby sacrificing gain.

In the case of the  $I_e$ -controlled common emitter stage both input and output capacitances decrease in the presence of strong signals and result in an upward shift of the center frequency. The common base circuit usually shifts in the downward direction, because its input impedance is inductive and the inductive component increases with decreasing  $I_e$ .

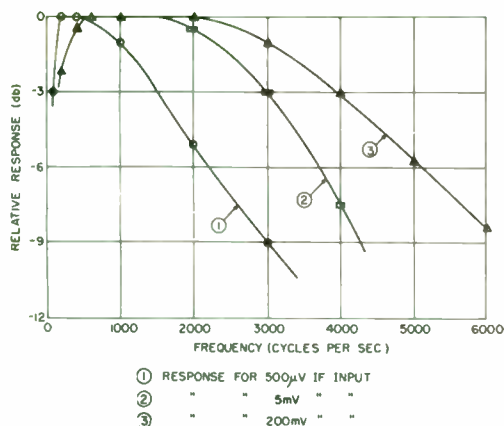

Fig. 22—Audio response of controlled IF amplifier-detector.

In the case of  $V_c$ -control the variation of the output capacitance is important; it increases with decreasing collector voltage and results in a downward shift of the center frequency.

An obvious method of center frequency stabilization is the use of a large external tuning capacitance, thereby reducing the effect of transistor reactances as tuning elements. If this is unsatisfactory, stabilizing resistances can be used; an uneconomical solution because of the loss in gain. In some cases it is advantageous to design the controlled stages as wideband amplifiers and to provide the selectivity by tuned circuits which are not associated with controlled stages.

### Gain Control of Converters

Converter stages have special properties distinguishing them from linear amplifiers and special techniques can be used to control their gain.

Conventional  $I_e$ - or  $V_c$ -control will also be effective in the case of converters. The gain of converters<sup>12</sup> having a maximum at a certain value of  $I_e$  (Fig. 23), the gain can be reduced not only by decreasing  $I_e$ , but also by increasing it beyond the maximum. A further possibility of gain control exists due to the dependence of the converter gain on the injected oscillator voltage.

It is possible to perform with a single junction transistor both functions of oscillation and conversion simultaneously (Fig. 24). Such a circuit has optimum gain at

<sup>12</sup> J. Zawels, "The transistor as a mixer," *Proc. IRE*, vol. 42, pp. 542-548; March, 1954.

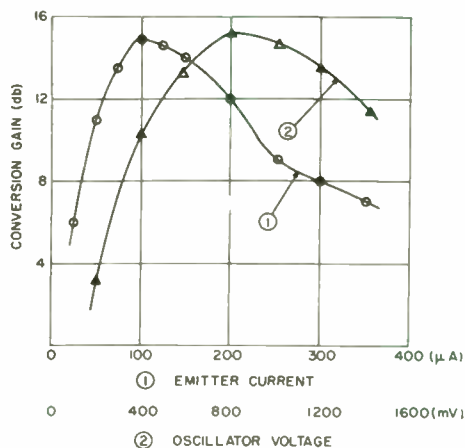

Fig. 23—Conversion gain as a function of emitter current and oscillator voltage.

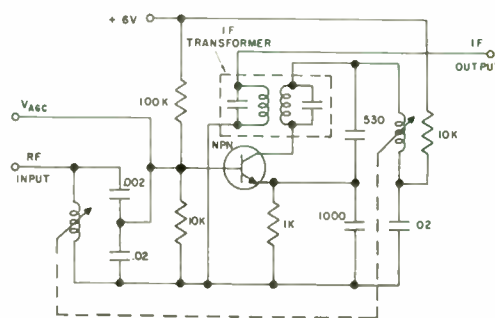

Fig. 24—Single transistor oscillator-converter with inductive tuning and AGC.

a certain value of  $I_e$ . Increasing or decreasing of  $I_e$  will result in reduction of gain and both methods can be used to obtain efficient automatic gain control.

### IV. CONCLUSION

Automatic gain control of transistor amplifiers is possible due to the dependence of the gain on the dc operating point. AGC circuits with satisfactory performance have been built using either collector voltage or emitter current control. Efficient use can be made of the available control power if the controlled transistor is operated as a dc amplifier of the control signal.

No transistors are as yet available which have been designed specifically for AGC use. With present transistors, AGC involves problems of distortion, bandwidth and center frequency variation. In many applications these problems can be solved by appropriate design.

### ACKNOWLEDGMENT

The authors are pleased to express their gratitude to J. A. A. Raper, who has designed part of the circuits and has done part of the experimental work leading to this paper. The helpful advice of R. L. Pritchard and the extensive measurements of C. D. Aiken are also gratefully acknowledged.

# Two Network Theorems for Analytical Determination of Optimum-Response Physically Realizable Network Characteristics\*

S. S. L. CHANG†, SENIOR MEMBER, IRE

**Summary**—By a technique combining variational methods, contour integration, and the concept of analytic extension, two network theorems are derived which form the basis of a procedure for determining the physically realizable network characteristic which is the best compromise between conflicting requirements in the sense of least mean-square error or some other criterion of approximation selected by the designer and written into the variational problem. Both the specifications and the criterion for compromise may include functions which are given as curves versus frequency rather than explicit functions of frequency.

The Wiener-Kolmogoroff theory of smoothing and prediction and the vestigial sideband filter with linear phase shift are included as illustrative application problems. For the former an alternative derivation in the frequency domain as well as a simpler procedure for numerical computations are given. For the latter a criterion for selecting the constant slope of the phase characteristic is derived in addition to providing the procedure for computing the optimum response filter.

## I. INTRODUCTION

IN RECENT years, the primary emphasis of network synthesis appears to have been on the assembling of circuit elements to meet or approximate prescribed, physically-realizable attenuation and phase characteristic as functions of frequency. One may ask a rather basic question: "Are the prescribed characteristics best suited to the job for which the network is assigned?" If the answer to the above question is uncertain, then it would appear rather meaningless to try to fit the prescribed characteristics to one-tenth of a decibel or one degree. Many present-day problems contain conflicting requirements so that a network characteristic selected by qualitative judgment alone, even at its best, belongs to the uncertain category.

This paper describes an analytical method for obtaining a physically realizable network characteristic which is the best compromise towards meeting various desired but conflicting requirements. The "best" compromise may be based on a root-mean-square error criterion or other criterion of approximation as selected by the designer and introduced in the formulation of the minimization problem. The procedure is based on two network theorems which will be stated and proved in this paper.

One noteworthy point about this procedure is that while the derived network characteristic is physically realizable, it is in general not of the minimum phase

type.<sup>1</sup> In other words, in selecting the best characteristic, the possibilities of using phase corrective networks are already taken into account. Thus the solution arrived at by this procedure gives the best final result including the phase corrective networks. One obvious by-product of this procedure is that the proper phase corrective networks to be used are already prescribed in the specification of network characteristics and no laborious trial and error procedure is required.

Two examples are given to illustrate the mechanics of this method:

### 1. Wiener's Prediction Network<sup>2,3</sup>

The problem of predicting the instantaneous value with least mean-square error is shown to be analytically equivalent to designing for a nonrealizable network function which is simultaneously  $e^{j\omega t}$  for the signal and zero for the noise. Wiener's prediction filter emerges as the best compromise.

Besides giving an alternative derivation, the present procedure also provides a simpler method for numerical computations of the prediction filter network function from arbitrary signal and noise power spectra. The new method does not require transforming back and forth between the frequency and time domains.

### 2. Vestigial Sideband Filter

In some cases of vestigial sideband transmission, notably television, the over-all (transmitter and receiver) filter response is required to have linear phase shift characteristic besides conforming to certain amplitude characteristic. (See Fig. 1, page 1130, for example.) It does not matter if the slope of the phase characteristic is larger or smaller. In terms of time delay, a constant time delay is not objectionable, but deviation from the constant time delay is to be minimized.

The above problem can be formulated into a weighted mean-square error minimization problem in which a designer may assign arbitrary weights to frequency ranges which he wishes to emphasize or de-emphasize. Such emphasis may be due to signal power spectrum or

<sup>1</sup> H. W. Bode, "Network Analysis and Feedback Amplifier Design," D. Van Nostrand Co., Inc., New York, N. Y., pp. 301-336; 1945.

<sup>2</sup> Norbert Wiener, "The Extrapolation, Interpolation and Smoothing of Stationary Time Series," John Wiley & Sons, New York, N. Y.; 1949.

<sup>3</sup> H. W. Bode and C. E. Shannon, "A simplified derivation of linear least square smoothing and prediction theory," PROC. IRE, vol. 38, pp. 417-425; April, 1950.

\* Original manuscript received by the IRE, March 16, 1955; revised manuscript received, June 6, 1955.

† Dept. of Elec. Engrg., New York University, New York 23, N. Y.



other considerations. The designer may select any slope for the phase characteristic. However, as a guide to such selection, it will be proven in general that the over-all error of the optimum filter decreases with increasing value of the assigned slope of the phase characteristic. This error reduction consideration is to be balanced against the increased complexity of the filters when a larger slope of the phase characteristic is used.

Once the minimization problem is formulated, a designer may follow a definite procedure to calculate the optimum response network function. An equation for the over-all error is also given which allows a designer to determine the error before the calculation of the optimum response network function is completed.

## II. DEFINITION OF TERMS

To describe the same terminal pairs of the same network, two entirely different network functions may be used. One may define the network function as the ratio of the input to the output, or as the logarithm of this ratio, or as the ratio of output to the input. The latter definition will be used throughout this paper. For passive as well as stable active linear networks, all the poles of the network function are in the left-half  $p$ -plane ( $p = \sigma + j\omega$ ), excluding the imaginary axis. The above condition will be the basis for the analysis. While it may appear to be more restrictive than Bode's definition of physically realizable network functions, the restriction is due to a more definite definition rather than on the type of networks to be analyzed.

Some of the functions involved in the two theorems are defined only along the positive half of the real frequency axis. For instance, the desired phase and amplitude characteristics and the weighting factors may be given as curves versus frequency, rather than explicit expressions of frequency. As the required numerical computations of the design procedure being proposed in this paper are done entirely along the real frequency axis, specifications of the above type are entirely adequate for actual design work. However, in the theorems and derivations these functions are considered as defined over the entire complex plane and are analytic except at isolated singularities. The implied extension follows from a well-known mathematical theorem which states that if an analytic function is defined for the entire imaginary axis, then that function is completely determined over the complex plane. In theory at least, its value can be calculated for any arbitrary complex value of  $p$  by means of analytic extension.

Some explanatory remarks are due here on the choice of notations. In the literature the network function  $G(j\omega)$  is usually expressed as a function of  $p$  or  $j\omega$  along the real frequency axis while the spectral densities  $S(\omega)$  and  $N(\omega)$  are usually given as curves or real functions of  $\omega$ . It appears desirable to the writer to comply with the conventional usage in both cases so that practically inclined readers will not find the design procedure confusing.

The independent variable  $p = \sigma + j\omega$  is used outside the real frequency axis and the functions  $G(j\omega)$ ,  $S(\omega)$ , and  $N(\omega)$  etc., become  $G(p)$ ,  $S(-jp)$ , and  $N(-jp)$  etc., respectively. One should note that  $S(-jp)$  and  $N(-jp)$  etc., are actually even and real functions of  $p$  since  $S(\omega)$  and  $N(\omega)$  are even functions of  $\omega$ .

Throughout LHP and RHP denote interior of the left-half  $p$ -plane and right-half  $p$ -plane, respectively.

In the following sections examples of application will be taken up first to illustrate the nature of the problems and the manner in which the two theorems will be applied. The derivations of the two theorems will follow the examples. This sequence is probably preferred by practically inclined readers. Theoretically inclined readers may find it more convenient to read Sections V and VI ahead of Sections III and IV.

## III. THE PREDICTION PROBLEM IN PRESENCE OF NOISE

A filter is to be designed such that when a desired signal  $s(t)$  plus a disturbing signal  $n(t)$  is the input, the output  $s_0(t) + n_0(t)$  is closest to  $s(t + \tau)$  in the least mean-square error sense. The spectral densities of  $s(t)$  and  $n(t)$  are known and  $s(t)$  and  $n(t)$  are not correlated. The time interval  $\tau$  is the forecast time.

The problem is simply to minimize the following integral, which represents the averaged value of the instantaneous error squared:

$$I = \lim_{T \rightarrow \infty} \frac{1}{2T} \int_{-T}^T [s_0(t) + n_0(t) - s(t + \tau)]^2 dt. \quad (1)$$

Since  $n(t)$  is not correlated with  $s(t)$ ,  $n_0(t)$  is not correlated with both  $s_0(t)$  and  $s(t + \tau)$ , and (1) becomes:

$$I = \lim_{T \rightarrow \infty} \frac{1}{2T} \int_{-T}^T \{ [s_0(t) - s(t + \tau)]^2 + n_0(t)^2 \} dt. \quad (2)$$

By a method similar to that used by Phillips,<sup>4</sup> (2) can be written in terms of frequency functions, as

$$I = \frac{1}{2\pi} \int_0^{\infty} \{ |G(j\omega) - e^{j\omega\tau}|^2 S(\omega) + |G(j\omega)|^2 N(\omega) \} d\omega. \quad (3)$$

In (3),  $G(j\omega)$  is the response function of the filter;  $S(\omega)$  and  $N(\omega)$  are spectral densities of the desired signal and disturbing signal respectively.

To apply the minimization theorem, the integrand may be written as:

$$F_0 = \frac{S(\omega)}{2\pi} [G(j\omega) - e^{j\omega\tau}][G(-j\omega) - e^{-j\omega\tau}] + \frac{N(\omega)}{2\pi} G(j\omega)G(-j\omega). \quad (4)$$

Let  $C(p)$  be defined as the following function:<sup>5</sup>

<sup>4</sup> H. M. James, N. B. Nichols, and R. S. Phillips, "Theory of Servomechanisms," McGraw-Hill Book Co., Inc., New York, N. Y., pp. 278-279; 1947.

<sup>5</sup> In general,  $C(j\omega)$  is defined as the functional derivative  $\partial F_0 / \partial G(-j\omega)$ .

$$C(p) = \frac{S(-jp)}{2\pi} [G(p) - e^{p\tau}] + \frac{N(-jp)}{2\pi} G(p). \quad (5)$$

The Minimization Theorem which will be derived later states that if a network function  $G_m(p)$  minimizes the integral of (3), the corresponding  $C(p)$  will not have any poles in the LHP including the imaginary axis, and vice versa. This condition can be used to determine  $G_m(p)$  completely. Let  $Y_+(p)$  and  $Y_-(p)$  be defined such that  $Y_+(p) \cdot Y_-(p) = S(-jp) + N(-jp)$  and all the poles and zeros of  $Y_+(p)$  are in the LHP, and all the poles and zeros of  $Y_-(p)$  are in the RHP.

Dividing (5) by  $Y_-(p)$ , there results

$$\frac{2\pi C(p)}{Y_-(p)} + \frac{S(-jp)e^{p\tau}}{Y_-(p)} = G_m(p)Y_+(p). \quad (6)$$

Let

$$\phi(p) \equiv \frac{S(-jp)e^{p\tau}}{Y_-(p)}.$$

In general,  $\phi(p)$  has poles in both the LHP and RHP. It will be shown later that  $\phi(p)$  can be expressed as the sum of two components  $\phi_1(p)$  and  $\phi_2(p)$  such that all the poles of  $\phi_1(p)$  are in the LHP and all the poles of  $\phi_2(p)$  are in the RHP. Since all the poles of  $C(p)/Y_-(p)$  are in the RHP and all the poles of  $G_m(p)Y_+(p)$  are in the LHP it follows from (6) that

$$G_m(p) = \frac{\phi_1(p)}{Y_+(p)}. \quad (7)$$

If  $S(\omega)$  and  $N(\omega)$  are given as explicit functions of  $\omega$ ,  $\phi_1(p)$  can be determined by writing  $\phi(p)$  into partial fraction form and retaining only the terms with poles in the LHP. However, in most actual cases,  $S(\omega)$  and  $N(\omega)$  are given as curves versus  $\omega$  for real values of  $\omega$  only. Then the gain and phase of the optimum response network function for real values of  $\omega$  can be calculated as follows: Let  $\alpha(\omega)$  and  $\beta(\omega)$  be the gain and phase respectively of  $Y_+(j\omega)$ . As both  $S(\omega)$  and  $N(\omega)$  are positive and are even functions of  $\omega$ , it follows that  $-\beta(\omega)$  is the phase of  $Y_-(j\omega)$  and that  $|Y_+(j\omega)| = |Y_-(j\omega)| = \sqrt{S(\omega) + N(\omega)}$ . The gain  $\alpha(\omega)$  can be calculated as:

$$\alpha(\omega) = \frac{1}{2} \log_e [S(\omega) + N(\omega)]. \quad (8)$$

Since all the poles and zeros of  $Y_+(j\omega)$  are in the LHP,  $\beta(\omega)$  can be determined from  $\alpha(\omega)$  by the well-known Bode's equations. Let  $\beta(\omega_c)$  be the phase at an arbitrary frequency  $\omega_c$ . It can be calculated as

$$\beta(\omega_c) = \frac{1}{\pi} \int_{-\infty}^{\infty} \frac{d\alpha}{du} \log \coth \frac{|u|}{2} du. \quad (9)$$

In (9) and subsequent equations,  $u = \log(\omega/\omega_c)$ . From (8) and (9)  $\phi(j\omega)$  can be calculated. The real component of  $\phi(j\omega)$  is

$$A(\omega) = \frac{S(\omega)}{\sqrt{S(\omega) + N(\omega)}} \cos [\omega\tau + \beta(\omega)]. \quad (10)$$

The imaginary component of  $\phi(j\omega)$  is:

$$B(\omega) = \frac{S(\omega)}{\sqrt{S(\omega) + N(\omega)}} \sin [\omega\tau + \beta(\omega)]. \quad (11)$$

Presently one has only a set of numerical values of the real and imaginary components of  $\phi(j\omega)$  instead of an explicit expression of  $\phi(j\omega)$  in terms of  $\omega$ . Apparently  $\phi_1(j\omega)$  cannot be determined by the partial fraction method. It will be shown later in the Separation Theorem that the real and imaginary components of  $\phi_1(j\omega)$  can be calculated as below: Let  $A^1(\omega_c)$  and  $B^1(\omega_c)$  for any arbitrary frequency  $\omega_c$  be defined by the following equations.

$$A^1(\omega_c) = -\frac{1}{\pi\omega_c} \int_{-\infty}^{\infty} \frac{d[\omega B(\omega)]}{du} \log \coth \frac{|u|}{2} du \quad (12)$$

$$B^1(\omega_c) = \frac{1}{\pi} \int_{-\infty}^{\infty} \frac{dA(\omega)}{du} \log \coth \frac{|u|}{2} du, \quad (13)$$

then:

$$\phi_1(j\omega) = \frac{1}{2} [A^1(\omega) + A(\omega)] + \frac{j}{2} [B^1(\omega) + B(\omega)]. \quad (14)$$

Let  $\alpha_1$  and  $\beta_1$  be the gain and phase of  $\phi_1(j\omega)$  in nepers and radians respectively as calculated from the values of  $\phi_1(j\omega)$  obtained by (14). From (7) the gain and phase of  $G_m(j\omega)$  are  $\alpha_1 - \alpha$  and  $\beta_1 - \beta$  respectively.

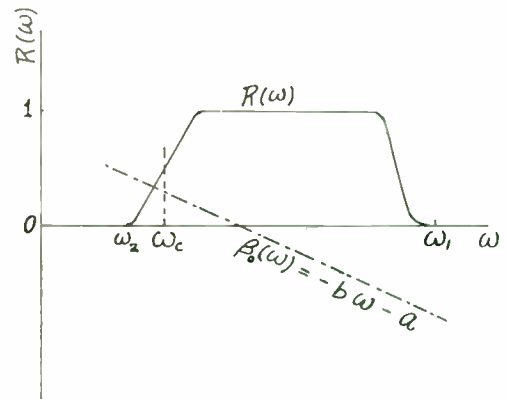

Fig. 1—Idealized response.

#### IV. THE VESTIGIAL SIDEBAND FILTER PROBLEM

The vestigial sideband filter is designed for a given amplitude response characteristic and a linear phase characteristic as shown in Fig. 1. However, as this is not strictly realizable, the vector difference between the actual network response  $G(j\omega)$  and the desired response is  $G(j\omega) - R(\omega)e^{-j(b\omega+a)}$ . From various engineering considerations, it is desirable to minimize a more general weighted square error integral

$$I = \int_0^{\infty} W(\omega) [G(j\omega) - R(\omega)e^{-j(b\omega+a)}] \cdot [G(-j\omega) - R(\omega)e^{j(b\omega+a)}] d\omega \quad (15)$$

instead of a straight square error integral which will be obtained by setting  $W(\omega) = 1$ . The function  $W(\omega)$  will be called the spectral emphasis function. It is even and real and is determined by the following considerations: In the passband  $W(\omega)$  may be the product of the signal spectral density and a weighting factor to take into account, for instance, that the picture detail may be considered more important than slow variations in luminous level in a television. While  $W(\omega)$  at high frequencies is still smaller than  $W(\omega)$  at low frequencies, it is not reduced to the same ratio as the spectral density. In the attenuation band,  $W(\omega)$  determines the attenuation to a large extent. The larger  $W(\omega)$  is, the larger will be the minimum value of the attenuation.

The optimum response network function  $G_m(p)$  can be obtained by an analysis which is exactly parallel to that of the preceding section. From the Minimization Theorem,

$$G_m(p) = \frac{\phi_1(p)}{Y_+(p)}, \tag{16}$$

where  $Y_+(p)Y_-(p) = W(-jp)$ , and  $\phi(p) = \phi_1(p) + \phi_2(p) = Y_+(p)f(p)$ . All the poles and zeros of  $Y_+(p)$  are in the LHP, and all the poles of  $\phi_1(p)$  are in the LHP. The function  $f(p)$  is the analytic extension of  $f(j\omega)$  which is defined as follows:

$$\begin{aligned} f(j\omega) &= R(\omega)e^{-j(b\omega+a)} && \text{for } \omega > 0 \\ f(j\omega) &= R(\omega)e^{j(b|\omega|+a)} && \text{for } \omega < 0 \end{aligned}$$

and either  $R(\omega)$  is assumed to vanish at  $\omega=0$  or  $a=0$ , so that there is no discontinuity at  $\omega=0$ . In case  $R(\omega)$  is known only numerically, following the same reasoning as in the prediction filter case, a similar procedure for determining  $G_m(j\omega)$  is obtained:

1. Calculate  $\alpha$  and  $\beta$  as in (8) and (9), with the function  $S(\omega) + N(\omega)$  replaced by  $W(\omega)$ .
2. Calculate  $A(\omega)$  and  $B(\omega)$  as follows:

$$A(\omega) = \sqrt{W(\omega)}R(\omega) \cos(\beta(\omega) - b\omega - a) \tag{17}$$

$$B(\omega) = \sqrt{W(\omega)}R(\omega) \sin(\beta(\omega) - b\omega - a). \tag{18}$$

The remaining steps are the same as (12), (13) and (14) etc., of the prediction filter case.

As  $G_m(j\omega)$  is not expected to be appreciably affected by minor variations of  $W(\omega)$ ,  $W(\omega)$  may be written as a real algebraic function of  $\omega^2$ , or  $Y_+(j\omega)$  may be written as an algebraic function of  $j\omega$  directly. The first step of the numerical computations will be saved in this case.

It is usually desirable to be able to calculate the minimum value of mean-square error before the optimum response network function is completely determined, and to know in advance what effect of change in the specified phase slope  $b$  would have on the minimum value of mean-square error. The following equations will be derived in Appendix I:

$$I_{\min} = \frac{1}{2} \int_0^\infty [A(\omega) - A^1(\omega)]^2 d\omega$$

$$= \frac{1}{2} \int_0^\infty [B^1(\omega) - B(\omega)]^2 d\omega \tag{19}$$

$$\begin{aligned} \frac{\partial I_{\min}}{\partial b} &= -\frac{1}{\pi} \left[ \int_0^\infty A(\omega) d\omega \right]^2 \\ &= -\frac{1}{\pi} \left[ \int_0^\infty \sqrt{W(\omega)}R(\omega) \cos(\beta(\omega) - b\omega - a) d\omega \right]^2. \end{aligned} \tag{20}$$

In (19) two alternatives for calculating  $I_{\min}$  are given.  $A^1(\omega)$  and  $B^1(\omega)$  are calculated from (12) and (13). Since  $B^1(\omega)$  is the simpler one to calculate, the latter form is recommended. Eq. (20) gives a valuable criterion for choosing  $b$ , as values of  $A(\omega)$  can be readily calculated from the given functions. It means the following:

1. The approximation improves with increasing value of the phase slope  $b$ .
2. As a larger value of  $b$  means a more complicated filter construction, it is not desirable to make  $b$  unduly large. Eq. (20) predicts a case of "diminishing returns" as follows: With a small value of  $b$ , the argument of the cosine factor varies over a relatively small angle as  $\omega$  varies over the range  $\omega_2$  to  $\omega_1$  for which  $R(\omega)$  has substantial value. Therefore,  $A(\omega)$  is of substantially the same sign and the magnitude of  $\int_0^\infty A(\omega) d\omega$  is large. An increase in  $b$  tends to reduce  $I_{\min}$  substantially. For a large value of  $b$ , the argument of the cosine factor increases many times  $2\pi$  radians as  $\omega$  increases from  $\omega_2$  to  $\omega_1$ . Therefore,  $A(\omega)$  has many sign reversals and the magnitude of  $\int_0^\infty A(\omega) d\omega$  is small. A further increase in  $b$  will have very little effect in reducing  $I_{\min}$ . As a good compromise the value of  $b$  should be such that in addition to overcoming the upward phase slope of  $Y_+(j\omega)$ , adequate amount of downward slope is provided to cause a few sign reversals of  $A(\omega)$ , depending on the degree of approximation required.

#### V. DERIVATION OF THE MINIMIZATION THEOREM FOR THE TWO SPECIAL CASES

It will be shown rigorously that for the two illustrative cases, the previous procedure leads to network functions for which the respective error integrals have absolute minimum values. For both cases the error integrals can be written as:

$$\begin{aligned} I &= \int_0^\infty \{ W_1(\omega) [G(j\omega) - f(j\omega)] [G(-j\omega) - f(-j\omega)] \\ &\quad + W_2(\omega) G(j\omega) G(-j\omega) \} d\omega \end{aligned} \tag{21}$$

where  $W_1(\omega)$  and  $W_2(\omega)$  are positive real for real values of  $\omega$ , and are even functions of  $\omega$ . Let  $\omega^{2n}$  and  $\omega^{2m}$  be the leading terms of  $W_1(\omega)$  and  $W_2(\omega)$  respectively at the vicinity of  $\omega \rightarrow \infty$ , where  $n$  and  $m$  may be positive or negative integers.

For the prediction filter case, if  $n$  is 0 or positive, and  $G(j\omega)$  is restricted to physically realizable functions, the

integral  $I$  does not converge at all. In other words, if the signal power does not diminish as frequency approaches infinity, no prediction is possible. If  $n$  is a minus integer, and  $k$  is the larger one (or the less negative one) of  $m$  and  $n$ ,  $I$  converges if the leading term of  $G(j\omega)$  is  $(1/\omega)^{k+1}$  or higher power of  $1/\omega$ .  $I$  does not converge otherwise.

For the vestigial sideband filter case  $W_2(\omega) = 0$ , and  $f(j\omega)$  vanishes for  $\omega$  larger than  $\omega_1$ . The necessary and sufficient condition for  $I$  to converge is simply that the leading term of  $G(j\omega)$  is  $(1/\omega)^{n+1}$  or higher power of  $1/\omega$  in the vicinity of  $\omega \rightarrow \infty$ . For both cases, only the network functions for which  $I$  is convergent need to be considered, and these are the admissible ones in the sense of condition  $c$  of the more general theorem. (See Appendix II.)

Let  $G_m(j\omega)$  be the network function which minimizes  $I$ , and  $G(j\omega)$  be any other admissible network function. The difference function  $II(j\omega)$  is defined by the following equation:

$$G(j\omega) = G_m(j\omega) + II(j\omega). \quad (22)$$

Substituting (22) into (21) there results:

$$\begin{aligned} I = & \int_0^\infty \{W_1(\omega) |G_m(j\omega) - f(j\omega)|^2 + W_2(\omega) |G_m(j\omega)|^2\} d\omega \\ & + \int_0^\infty (W_1(\omega) + W_2(\omega)) |II(j\omega)|^2 d\omega \\ & + \int_0^\infty \{[W_1(\omega) + W_2(\omega)]G_m(j\omega) \\ & - W_1(\omega)f(j\omega)\} II(-j\omega) d\omega \\ & + \int_0^\infty \{[W_1(\omega) + W_2(\omega)]G_m(-j\omega) \\ & - W_1(\omega)f(-j\omega)\} II(j\omega) d\omega. \end{aligned}$$

Since the second integral is positive definite, it follows that the necessary and sufficient condition for  $G_m(j\omega)$  to be the minimizing network function is that the sum of the last two integrals vanish. Combining these two terms, and using  $p$  as the independent variable, there results

$$\int_{-j\infty}^{j\infty} \{[W_1(-jp) + W_2(-jp)]G_m(p) - W_1(-jp)f(p)\} II(-p) dp = 0. \quad (23)$$

Since both  $G_m(p)$  and  $G(p)$  are of the order  $(1/p)^{k+1}$  as  $p \rightarrow \infty$ ,  $II(p)$  is also of the order  $(1/p)^{k+1}$  as a result of (22). The convergence at  $\omega = \pm \infty$ , and the vanishing of the integral along the large semicircle on LHP can be verified easily. The path of integration of (23) may be extended from  $+j\infty$  through a large semicircle to  $-j\infty$ , enclosing the LHP, and there results:

$$\int_{\text{LHP}} \{[W_1(-jp) + W_2(-jp)]G_m(p) - W_1(-jp)f(p)\} II(-p) dp = 0. \quad (24)$$

Let  $C(p)$  denote the expression inside the curved bracket in (24):

$$C(p) = [W_1(-jp) + W_2(-jp)]G_m(p) - W_1(-jp)f(p). \quad (25)$$

Since  $II(p)$  does not have any poles in the RHP including the imaginary axis, it follows that  $II(-p)$  does not have any poles in the LHP including the imaginary axis. A sufficient condition for satisfying (24) is that  $C$  does not have any poles in the LHP including the imaginary axis. This is also the necessary condition due to the arbitrariness of  $II(-p)$ . If  $C(p)$  has poles in the LHP, a function  $II(-p)$  can be found such that the sum of residues does not vanish, and the condition embodied in (24) will be violated.

## VI. SEPARATION THEOREM

In carrying out the minimization calculations, usually there is required the separation of a function  $\phi(j\omega)$  into two portions

$$\phi(j\omega) = \phi_1(j\omega) + \phi_2(j\omega), \quad (26)$$

such that all the poles of  $\phi_1(p)$  are in the LHP, and all the poles of  $\phi_2(p)$  are in the RHP.  $\phi(p)$  does not have any poles on the imaginary axis.

In most problems  $\phi(j\omega)$  is not expressed as an explicit function of  $\omega$ , but with its amplitude and phase specified as curves versus  $\omega$  for real positive values of  $\omega$ . One well-known method of separation is by means of the Fourier transform. Let  $\Psi(t)$  be the inverse transform of  $\phi(j\omega)$ . Generally  $\Psi(t)$  does not vanish for  $t < 0$ . Let  $\Psi(t)$  be cut into two halves,  $\Psi_1(t)$  and  $\Psi_2(t)$ , such that for  $t < 0$ :  $\Psi_1(t) = 0$  and  $\Psi_2(t) = \Psi(t)$ ; and for  $t > 0$ :  $\Psi_1(t) = \Psi(t)$  and  $\Psi_2(t) = 0$ . Then  $\phi_1(j\omega)$  and  $\phi_2(j\omega)$  are obtained as Fourier transforms of  $\Psi_1(t)$  and  $\Psi_2(t)$ . The disadvantage of this method is that  $\Psi(t)$  is rather insensitive to  $\phi(j\omega)$ . Within reasonably expected accuracies of numerical computations, the result is not likely to be accurate enough for filter design work.

The separation theorem is an extension of Bode's relationships between real and imaginary components of physically realizable network functions. It may be stated as follows:

"If a function  $\phi(j\omega)$  is bounded and is of the order of  $1/\omega$  as  $\omega$  approaches  $\infty$ , and

$$\phi(-j\omega) = \phi^*(j\omega) \quad (27)$$

where  $\phi^*$  denotes the complex conjugate value of  $\phi$ , then two functions  $\phi_1(j\omega)$  and  $\phi_2(j\omega)$  can be found such that  $\phi(j\omega) = \phi_1(j\omega) + \phi_2(j\omega)$ , and that both  $\phi_1(j\omega)$  and  $\phi_2(j\omega)$  satisfy the same conditions as  $\phi(j\omega)$  for real values of  $\omega$ , and that all the poles of  $\phi_1(p)$  are in the LHP and all the poles of  $\phi_2(p)$  are in the RHP.  $\phi_1(j\omega)$  and  $\phi_2(j\omega)$  can be calculated as:

$$\phi_1(j\omega) = \frac{1}{2}[\phi(j\omega) + \phi^1(j\omega)] \quad (28)$$

$$\phi_2(j\omega) = \frac{1}{2}[\phi(j\omega) - \phi^1(j\omega)], \quad (29)$$

where the 'complementary function'  $\phi^1(j\omega)$  is defined such that along the real frequency axis its real and

imaginary components  $A^1(\omega)$  and  $B^1(\omega)$  are related to the real and imaginary components  $A(\omega)$  and  $B(\omega)$  of the function  $\phi(j\omega)$  by the following equations:

$$A^1(\omega_c) = -\frac{1}{\pi\omega_c} \int_{-\infty}^{\infty} \frac{d(\omega B)}{du} \log \coth \frac{|u|}{2} du \quad (30)$$

$$B^1(\omega_c) = \frac{1}{\pi} \int_{-\infty}^{\infty} \frac{dA}{du} \log \coth \frac{|u|}{2} du \quad (31)$$

where  $u = \log_e (\omega/\omega_c)$ .

The proof of the existence part of the theorem is simple. If  $\phi_1(p)$  is defined as having the same poles and residues as  $\phi(p)$  in the LIHP, but none whatsoever in the RHP, and  $\phi_2(p)$  is defined as having the same poles and residues as  $\phi(p)$  in the RIHP but none whatsoever in the LHP, then all the conditions of the first sentence of the theorem are satisfied.

To prove (28) to (31), let real functions  $A_1(\omega)$ ,  $A_2(\omega)$ ,  $A^1(\omega)$ ,  $B_1(\omega)$ ,  $B_2(\omega)$  and  $B^1(\omega)$  be defined by the following equations:

$$\phi_1(j\omega) = A_1(\omega) + jB_1(\omega) \quad (32)$$

$$\phi_2(j\omega) = A_2(\omega) - jB_2(\omega) \quad (33)$$

$$A^1(\omega) = A_1(\omega) - A_2(\omega) \quad (34)$$

$$B^1(\omega) = B_1(\omega) + B_2(\omega). \quad (35)$$

By definition, from (26), (32), and (33)

$$A(\omega) = A_1(\omega) + A_2(\omega) \quad (36)$$

$$B(\omega) = B_1(\omega) - B_2(\omega). \quad (37)$$

Solving for  $A_1$ ,  $A_2$ ,  $B_1$  and  $B_2$  from (34) to (37) leads to (28) and (29) directly. To prove (30) and (31), let the functions  $\phi_3(j\omega)$  and  $\phi_4(j\omega)$  be defined such that

$$\phi_3(j\omega) \equiv \phi_1(j\omega) + \phi_2(-j\omega) = A(\omega) + jB^1(\omega) \quad (38)$$

$$\phi_4(j\omega) \equiv \phi_1(j\omega) - \phi_2(-j\omega) = A^1(\omega) + jB(\omega). \quad (39)$$

The second equality signs in (38) and (39) follow from (32) to (37). As all the poles of  $\phi_1(p)$  and  $\phi_2(-p)$  are in the LIHP, it follows that all the poles of  $\phi_3(p)$  and  $\phi_4(p)$  are in the LHP. By means of contour integration enclosing the RHP, one can easily prove that  $A^1(\omega)$  and  $B(\omega)$  are related by Bode equations, and that  $A(\omega)$  and  $B^1(\omega)$  are related by Bode equations. There is no limitation on the zero locations since  $A(\omega)$  and  $B^1(\omega)$  are real and imaginary components of the function  $\phi_3(j\omega)$  itself rather than of the logarithm of  $\phi_3(j\omega)$ .

The following corollaries are easily verified:

1. "The complementary function of the complementary function is the function itself, provided that the function has no poles on the imaginary axis."
2. "If all the poles of a network function are in the LHP, excluding the imaginary axis, then the function is self-complementary."

#### CONCLUSION

A method for determining the optimum-response network function from conflicting requirements has

been shown and illustrated by application to two actual examples: the prediction filter and the vestigial sideband filter with linear phase shift. The method is also applicable to cases where the desired performance is given as curves rather than explicit functions of  $\omega$ , and the actual calculations involve evaluation of real integrals only along the real frequency axis.

The network theorems are proved rigorously for the special cases and are also stated in terms much more general than the two illustrative cases require, and can be expected to have wider applications (see Appendix II). Exact mathematical requirements such as continuity, etc., on the minimization function  $F$  has not been determined for the general case, but as most actual physical functions are continuous and have continuous derivatives, the problem rarely arises in application. However, such conditions as location of poles, convergence at infinity, etc., which are pertinent to engineering problems have been explicitly stated.

#### APPENDIX I

##### DERIVATION OF FORMULAS RELATING TO THE MINIMUM VALUE OF ERROR FOR THE VESTIGIAL SIDEBAND FILTER PROBLEM

##### Minimum Value of the Error Integral

From (16) and the definition of  $\phi(p)$  one obtains:

$$G_m(j\omega) - f(j\omega) = \frac{\phi_1(i\omega)}{Y_+(j\omega)} - \frac{\phi(j\omega)}{Y_+(j\omega)} = -\frac{\phi_2(j\omega)}{Y_+(j\omega)}. \quad (40)$$

The complex conjugate of the above equation is:

$$G_m(-j\omega) - f(-j\omega) = -\frac{\phi_2(-i\omega)}{Y_+(-j\omega)} = -\frac{\phi_2(-j\omega)}{Y_-(j\omega)}. \quad (40a)$$

Substituting (40) and (40a) in (15), there results:

$$I_{\min} = \int_0^{\infty} \phi_2(j\omega)\phi_2(-j\omega)d\omega. \quad (41)$$

From (18), (41) can be written as

$$I_{\min} = \int_0^{\infty} [A_2^2(\omega) + B_2^2(\omega)]d\omega. \quad (42)$$

Eq. (42) can be further simplified. Let the integral  $J$  be defined as:

$$J = \int_{-\infty}^{\infty} \phi_2^2(j\omega)d\omega. \quad (43)$$

Since  $\phi_2(-j\omega) = \phi_2^*(j\omega)$ ,  $J$  can be written as

$$\begin{aligned} J &= \int_0^{\infty} [\phi_2^2(j\omega) + \phi_2^{*2}(j\omega)]d\omega \\ &= 2 \int_0^{\infty} A_2^2(\omega)d\omega - 2 \int_0^{\infty} B_2^2(\omega)d\omega. \quad (44) \end{aligned}$$

As all the poles of  $\phi_2(p)$  are in the RIHP, and  $\phi_2(p)$  is of the order of  $1/p$  as  $p$  approaches infinity, it can be

easily shown that  $J=0$  as a result of contour integration. Combining (42) and (44), there results

$$I_{\min} = 2 \int_0^{\infty} A_2^2(\omega) d\omega = 2 \int_0^{\infty} B_2^2(\omega) d\omega. \quad (45)$$

*Effect of Time Delay or Slope of Phase Characteristics on Minimum Error*

Differentiating (15), one obtains

$$\frac{\partial I}{\partial b} = 2 \int_0^{\infty} W(\omega) \{ R(\omega) e^{-j(\omega b+a)} [G(-j\omega) - R(\omega) e^{j(\omega b+a)}] - R(\omega) e^{j(\omega b+a)} [G(j\omega) - R(\omega) e^{-j(\omega b+a)}] \} (j\omega) d\omega. \quad (46)$$

Substituting (40) and (40a) in (46), the latter becomes

$$\frac{\partial I_{\min}}{\partial b} = \int_0^{\infty} [\phi_1(-j\omega)\phi_2(j\omega) - \phi_1(j\omega)\phi_2(-j\omega)] (j\omega) d\omega. \quad (47)$$

Eq. (47) can be rewritten into the following form:

$$\frac{\partial I_{\min}}{\partial b} = - \int_{-\infty}^{\infty} \phi_1(j\omega)\phi_2(-j\omega)(j\omega) d\omega. \quad (48)$$

The integrand of (48) is analytic and without singularities in the RHP. However, the integration over the large semicircular path does not vanish. In general, the amplitude of the desired response  $R(\omega)$  is nonvanishing only in the limited range of  $\omega$ . Therefore both  $A(\omega)$  and  $B(\omega)$  are nonvanishing in the same range only. From Bode's equation, one obtains, as  $\omega_c \rightarrow \infty$ .

$$B^1(\omega_c) = \frac{2\omega_c}{\pi} \int_0^{\infty} \frac{A}{\omega^2 - \omega_c^2} d\omega = \frac{B_{\infty}}{\omega_c} \quad (49)$$

$$A^1(\omega_c) = 0 \left( \frac{1}{\omega_c^2} \right) \quad (50)$$

$$B_{\infty} = - \frac{2}{\pi} \int_0^{\infty} A(\omega) d\omega. \quad (51)$$

The real constant  $B_{\infty}$  is defined in (49). From (28) and (29), the limits of  $\phi_1(j\omega)$  and  $\phi_2(j\omega)$  are found to be  $jB_{\infty}/2\omega$  and  $-(jB_{\infty}/2\omega)$  respectively as  $\omega$  approaches infinity along the real frequency axis. Since  $\phi_1$  and  $\phi_2$  are analytic, the results hold true for all large values of  $p$ . Therefore, by contour integration:

$$\int_{-\infty}^{\infty} \phi_1(j\omega)\phi_2(-j\omega)(j\omega) d\omega - \frac{\pi}{4} B_{\infty}^2 = 0. \quad (52)$$

From (48) and (52), one obtains (20).

APPENDIX II

GENERAL FORMULATION OF THE MINIMIZATION THEOREM

While in most applications the minimization formulation is quite simple, it may be desirable to state the theorem in a relatively general form. It is:

If the integral along the real frequency axis (or the imaginary  $p$ -axis)

$$I = \int_0^{\infty} F_0(\omega, G_1, G_2 \cdots G_n, G_1^*, G_2^*, \cdots G_n^*) d\omega \quad (53)$$

is stationary with respect to infinitesimal variations of  $G_1(p), G_2(p) \cdots$  etc., and correlated infinitesimal variations of  $G_1^*, G_2^* \cdots$  etc., under the following conditions, where  $G_L^*$  is the shorthand notation for  $G_L(-p)$ : (1) the integrals along the real frequency axis

$$I_i = \int_0^{\infty} F_i(\omega, G_1, G_2 \cdots G_1^*, G_2^* \cdots) d\omega = K_i \quad (54)$$

$i = 1, 2, 3, \cdots m$

are fixed in value, that is,  $K_i$ 's are constants; (2)  $G_1(p), G_2(p) \cdots$  etc., are physically realizable network functions in the sense that they are real functions of  $p$  with all the poles in the left  $p$ -plane excluding the imaginary axis; (3) only sets of  $G_1(p), G_2(p) \cdots$  etc. for which the integrals  $I_0, I_1 \cdots$  converge and exist are admissible for comparison, and the functions  $F_0, F_1 \cdots$  etc. are well behaved so that for the admissible  $G_L(p)$ 's differentiation under the integral sign is allowed;

$$(4) \quad \left. \frac{\partial F_i}{\partial G_L} \right|_{p=j\omega_1} = \left. \frac{\partial F_i}{\partial G_L^*} \right|_{p=-j\omega_1} \quad (55)$$

$i = 0, 1, 2, \cdots m; L = 1, 2, \cdots n$

then the linear combinations of the functional derivatives

$$C_L(p) = \sum_{i=0}^m \lambda_i \frac{\partial F_i}{\partial G_L^*} \quad (56)$$

do not have any pole in the LHP including the imaginary axis, where  $\lambda_0=1$  and  $\lambda_1, \lambda_2, \cdots \lambda_m$  are determined by  $K_1, K_2, \cdots K_m$  or vice versa. The reverse statement is also true. That is, if  $C_L(p)$  do not have any pole in the LHP inclusive, and given the conditions (1), (2), (3) and (4), then the integral  $I$  is stationary.

The proof of the theorem is as follows:

Let  $EH_L(p)$ 's be an arbitrary set of infinitesimal difference functions where  $E$  is an infinitesimal constant and  $H_L(p)$ 's are finite. Since the admissible  $G_L(p)$ 's must meet the condition of physical realizability, the difference functions  $EH_L(p)$ 's between two sets of admissible  $G_L(p)$ 's meet the same conditions. Making use of Lagrange multipliers, the first order variations are:

$$E \sum_{i=0}^m \lambda_i \int_0^{\infty} \sum_{L=1}^n \left[ \frac{\partial F_i}{\partial G_L} H_L(p) + \frac{\partial F_i}{\partial G_L^*} H_L(-p) \right] d\omega = 0. \quad (57)$$

Since  $H_L(j\omega)$ 's are independent of each other, (57) is equivalent to

$$\int_0^\infty \sum_{i=0}^m \lambda_i \frac{\partial F_i}{\partial G_L} H_L(p) d\omega + \int_0^\infty \sum_{i=0}^m \lambda_i \frac{\partial F_i}{\partial G_L^*} H_L(-p) d\omega = 0 \quad (58)$$

$L = 1, 2, \dots, n.$  (58)

From (55):

$$\int_0^\infty \sum_{i=0}^m \lambda_i \frac{\partial F_i}{\partial G_L} H_L(p) d\omega = \int_{-\infty}^0 \sum_{i=0}^m \lambda_i \frac{\partial F_i}{\partial G_L^*} H_L(-p) d\omega. \quad (59)$$

Substituting (59) into (58), and using  $p$  as an independent variable, there results

$$\int_{-j\infty}^{j\infty} \left( \sum_{i=0}^m \lambda_i \frac{\partial F_i}{\partial G_L^*} \right) H_L(-p) d(p) = 0. \quad (60)$$

As a result of condition (3), the integral on the left-hand side of (60) converges at  $\omega = \infty$ . Either the integrand is oscillatory and does not have a definite value at  $\omega = \infty$ , or the following equation must hold:

$$\lim_{p \rightarrow \infty} p \left( \sum_{i=0}^m \lambda_i \frac{\partial F_i}{\partial G_L^*} \right) H_L(-p) = 0. \quad (61)$$

In the latter case, the path of integration of (8) may be extended from  $+j\infty$  through a large semicircle to  $-j\infty$ , enclosing the entire LHP, and there results

$$\oint_{\text{LHP}} \left[ \sum_{i=0}^m \lambda_i \frac{\partial F_i}{\partial G_L^*} \right] H_L(-p) d(p) = \oint_{\text{LHP}} C_L(p) H_L(-p) d(p) = 0 \quad (62)$$

$L = 1, 2, \dots, n.$

In a strictly physical problem, the functions  $F_i$  can always be formulated so that the integrand is nonoscillatory as the frequency approaches  $\infty$ , since the frequency range of interest is always limited. However, the integrand may become oscillatory in some oversimplifying mathematical formulations and in such cases, it would be necessary to check if the integration over the large arc does vanish before applying the minimization theorem.

Since  $H_L(p)$  does not have any poles in the RHP including the imaginary axis, it follows that  $H_L(p)$  does not have any poles in the LHP including the imaginary axis. A sufficient condition for satisfying (62) is that the functions  $C_L(p)$ 's do not have any poles in the LHP, including the imaginary axis. This is also the necessary condition due to the arbitrariness of  $H_L(-p)$ . If any of the functions  $C_L(p)$  has poles in the LHP, a function  $H_L(-p)$  can be found such that the sum of residues does not vanish, and the condition embodied in (62) will be violated.

ACKNOWLEDGMENT

The writer is indebted to Professor J. H. Mulligan, Jr., of the Department of Electrical Engineering of New York University for his many valuable suggestions.



# Correspondence

## VHF and UHF Signals in Central Canada\*

Since the spring of 1953, the Radio Physics Laboratory of the Defence Research Board has carried out measurements on the amplitudes of vhf and uhf signals beyond the optical horizon. These signals have been propagated over rolling terrain between antennas whose height above ground was less than one hundred feet, but greater than one wavelength. Although the duration of the individual measurements was between one day and three weeks, the experiments were carried out over several different paths in central Canada during the winter and summer.

Fig. 1 shows the median signal power at 49, 91, 173 and 495 mc as measured at ranges between 20 and 235 miles. The reference axis (0 db) corresponds to the theoretical signal for diffraction around a smooth, spherical earth.<sup>1</sup> Here, the modified earth's radius factor was taken as 1.4 for summer propagation and 1.3 for winter propagation, according to Bean.<sup>2</sup> The signals at 21, 27 and 41 miles were measured over frozen muskeg in the sub-Arctic during January, while the signals at 30 and 49 miles were measured over Lake Ontario in October. The remaining signals at 29 and 50 miles and at greater ranges were measured between Ottawa and Sudbury. It will be seen that the diffraction theory predicts the median signal within a few decibels at ranges up to 30 or 40 miles. Beyond this range, the signals deviate widely from this theory. At ranges beyond 80 miles, the deviation from smooth-earth diffraction theory generally increases with increasing signal frequency. It should be mentioned that the measurements on different signal frequencies at ranges beyond 80 miles were made simultaneously at each location.

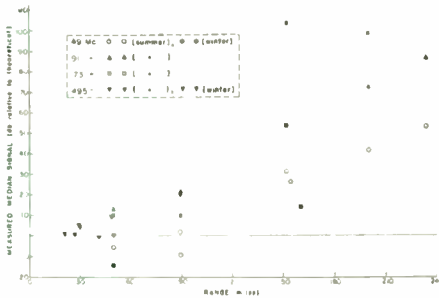

Fig. 1—Comparison between median measured signals and theoretical signals for diffraction around smooth spherical earth with atmosphere.

If it is assumed that the signals beyond 80 miles are propagated by scatter from atmospheric turbulence, the summer measurements indicate that the intensity of atmospheric turbulence varies inversely as the first power of height above ground. Fig. 2 shows the median of the random component of the signals at ranges beyond 80 miles, de-

rived from the measured medians by removing the small steady diffraction component.<sup>3</sup> Examination of the data shows that the signal power (relative to free space level) varies approximately as the inverse cubed power of distance from the transmitter. According to the scatter formula recently proposed by Gordon,<sup>4</sup> this attenuation rate requires the distribution in atmospheric turbulence stated above. It is of interest to note also that the median measured signals lie well below the Bullington mean curve, which was fitted to radio measurements obtained during the past several years in the United States and the United Kingdom.<sup>5</sup>

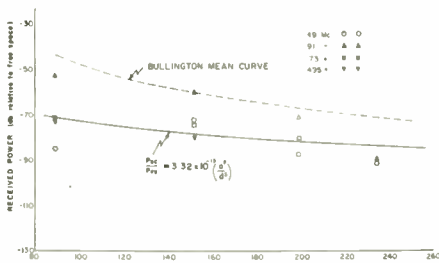

Fig. 2—Comparison between summer measurements and Gordon theory.

Further details on the measurements reported here are given in project reports of the Radio Physics Laboratory.

D. R. HAY AND R. C. LANGILLE  
Radio Physics Lab.  
Defence Research Board  
Ottawa, Canada

\* A. P. Barsis, J. W. Herbstreit, and K. O. Hornberg, "Cheyenne Mountain tropospheric propagation experiments," Nat. Bureau of Standards Circular 554, p. 34; January 3, 1955.

<sup>1</sup> W. E. Gordon, "Radio scattering in the troposphere," Proc. IRE, vol. 43, pp. 23-28; January, 1955.

<sup>2</sup> K. Bullington, "Radio transmission beyond the horizon in the 40- to 4000 mc band," Proc. IRE, vol. 41, p. 135; January, 1953.

## On Reciprocal Inductance\*

Mr. Stockman's objection<sup>1</sup> to "inertance"<sup>2</sup>—that most engineers would associate it with inductance rather than reciprocal inductance—is worthwhile, but answerable.

Clearly, with analogies based largely on arbitrary interpretation of coefficients and variables involved in basic differential equations, several models of analogous mechanical and electrical systems are possible and, in many circumstances, rather useful. Consequently, it is easy to make  $C$ , rather than  $1/C$ , correspond to the elastic constant of a spring, and so qualify for the name "elastance." In fact, the necessary argument would hinge upon electrical quantities that are the *duals* of the corresponding quantities in the argument that would make  $L$  correspond to inertia.

However, to arrive at analogies that are physically more satisfying, one would go back to the rudiments, and talk, not in terms of currents and voltages, but in terms of the more fundamental concepts of electric flux in a capacitor corresponding to the rest-

ing charge on it, and magnetic flux in a coil corresponding to the rate of moving charge through it. If the electric displacement is then associated with the length by which a spring is stretched, and the magnetic flux with the velocity of a moving mass, an elegant physical correspondence will be established between static and dynamic concepts. One consequence of this is that current and momentum become direct analogs—which does not lack in physical appeal. Also the analogies will be found to parallel electrically dual quantities. More important at the moment is the fact that  $1/C$  will be found to deserve the name "elastance," and  $1/L$ , "inertance."

Would Mr. Stockman prefer our "newtance" to his "yrneh" for the unit of inertance—or even "newt"?

E. J. BAGHDADY  
Res. Lab. of Elect.  
Mass. Inst. Tech.  
Cambridge, Mass.

## Rebuttal<sup>3</sup>

Reading E. J. Baghdady's letter, I receive the impression that it serves as a derivation of his originally given formulas and statements, which are all correct. No statement to the contrary was implied in my correspondence item. As Baghdady points out, several models of analogous mechanical and electrical systems are possible, and one of these models will no doubt be selected as a future basis for terminology considerations. As stated, I feel most engineers would associate inertance with inductance rather than reciprocal inductance. In view of the rapid progress of generalized field concepts, perhaps ten years from today most engineers would feel the opposite way!

It is not easy to formulate and define useful quantities and units, which are fundamentally correct, and one of the stumbling blocks is the fact that each generation inherits from the previous one a maze of nomenclature; to a great extent inadequate and erroneous. Mr. Baghdady deserves credit for having brought up for discussion in the correspondence section such fundamentals as the basic inductance concept, and perhaps the viewpoints he brings out illuminate the fact that many improvements would result, if other basic concepts were also brought out in open discussions. In fact, a correspondence page in every issue of the PROCEEDINGS OF THE IRE, reserved for new thoughts on symbols, terms, units, and definitions would, I am sure, be received with great interest by all readers, and would supply much fresh thought material for the various IRE symbols and standards committees. Actually, this sort of arrangement has already been successfully tried by two leading European scientific journals.

With regards to "yrneh," this term is not my "invention" any more. Somebody else invented it long before I did.<sup>4</sup> Probably, there have been many inventors since then.

HARRY STOCKMAN  
Scientific Specialties Corp.  
Boston 35, Mass.

\* Received by the IRE, May 5, 1955.  
<sup>1</sup> K. Bullington, "Radio propagation at frequencies above 30 megacycles," Proc. IRE, vol. 35, pp. 1122-1136; October, 1947.  
<sup>2</sup> B. R. Bean, "The geographical and height distribution of the gradient of refractive index," Proc. IRE, vol. 41, pp. 549-550; April, 1953.

\* Received by the IRE, April 25, 1955.  
<sup>1</sup> H. Stockman, "On reciprocal inductance," Proc. IRE, vol. 43, p. 341; March, 1955.  
<sup>2</sup> E. J. Baghdady, "On reciprocal inductance," Proc. IRE, vol. 42, p. 180; December, 1954.

<sup>3</sup> Received by the IRE, May 6, 1955.  
<sup>4</sup> H. Stockman, "yrneh," Proc. IRE, vol. 43, p. 879; July, 1955.



## Empirical Relationships with the Munsell Value Scale

In color television development and control activities, it is sometimes desirable to use or consider a gray scale which presents equal visual lightness steps. The Munsell value (renotation) scale is widely used for this purpose. Munsell value is defined as the lightness of the colors of a series of standards, varying in reflectance from zero to unity, in such a way that all visual intervals are uniform when viewed on a middle gray background by a light-adapted eye.<sup>1</sup>

The Weber-Fechner law has sometimes been applied to establish a visual scale linear with reflection density. However, it applies only to the dark-adapted eye; hence it is of limited practical utility. The Munsell value scale applies to the light-adapted eye; hence it is of more general use.

We have had occasion to consider scales of equal brightness differences for presentation on color picture tubes. A single visual scale can produce a scale of equal brightness differences on all color picture tubes only if the viewing conditions are standardized. "A visual scale is applicable only under the conditions of calibration or when the departures from these conditions have been found to make no difference."<sup>2</sup> The manner in which the conditions of observation influence brightness sensation is described and illustrated by Evans.<sup>3</sup>

It is granted that neither the Munsell value scale nor any other visual scale can be used "blindly" as a scale of equal brightness differences to be reproduced on color picture tubes, even if the color television system gives exact tone reproduction. Nevertheless, the Munsell value scale is an established equi-spaced visual scale for achromatic colors from black to white.

The utility of the Munsell value scale would be extended if there were a simple analytical relationship between Munsell renotation value ( $V$ ) and per cent reflectance ( $R$ ). This would facilitate conversion from physical to psychophysical units and vice versa. This relationship is now defined<sup>4</sup> by the empirical equation:

$$R = 1.2219 V - 0.23111 V^2 + 0.23951 V^3 - 0.021009 V^4 + 0.0008404 V^5.$$

A more simple relationship between Munsell value and reflectance would be desirable.

In an attempt to find such a relationship, six equations were assumed, each of the form  $V = a + b \cdot f(R)$ . The empirical constants in each equation were found by the method of least squares. The goodness-of-fit for each equation is stated in parenthesis for the range of Munsell values from 1.0 to 9.0. These equations were calculated from the table of reference 4 using 0.10 value increments.

1.  $V = -1.324 + 2.217 R^{0.3520}$  ( $\sigma_{\text{max}} = \pm 0.018$ )
2.  $V = -1.636 + 2.468 R^{1/3}$  ( $\sigma_{\text{max}} = \pm 0.029$ )
3.  $V = -3.598 + 4.146 R^{1/4}$  ( $\sigma_{\text{max}} = \pm 0.12$ )
4.  $V = 0.336 + 1.010 R^{1/2}$  ( $\sigma_{\text{max}} = \pm 0.17$ )
5.  $V = -0.388 + 4.505 \log_{10} R$  ( $\sigma_{\text{max}} = \pm 0.43$ )
6.  $V = 2.381 + 0.09834 R$  ( $\sigma_{\text{max}} = \pm 0.66$ ).

For large ranges of value and for smaller ranges of value, these six empirical equations forms maintain approximately the same relative merit. The assumed linear relationship between reflectance and value (eq. 6) is very poor. The logarithmic relationship (eq. 5) is nearly as bad. The square-root and the fourth-root relationships (eqs. 3 and 4) are both somewhat better than the linear and logarithmic relationships. The cube-root of  $R$  (eq. 2) gives an excellent linear fit to value. The empirically-found 0.3520-power of  $R$  relationship (eq. 1) gives the best fit for a simple equation of the six forms tried.

In Fig. 1 we have compared the failure of the logarithmic equation with the failure of the simple cube-root of reflectance expression and the 0.3520-power of reflectance expression. A perfect fit would be represented by a horizontal line through the origin. The figure illustrates graphically the inadequacy of the logarithmic expression.

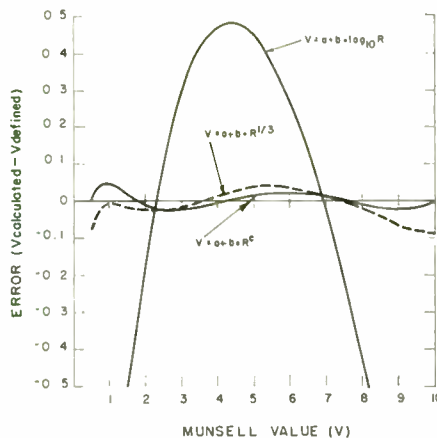

Fig. 1—Error graph for three assumed empirical equations relating per cent reflectance ( $R$ ) to Munsell renotation value ( $V$ ). The zero-error axis represents the defining equation relating reflectance to Munsell value. The equations involving  $R^{1/3}$  and  $R^0$  both give better fits than does the equation involving  $\log_{10} R$ .

The equation relating Munsell renotation value with cube-root of per cent reflectance may be of particular interest. This simple equation may be used instead of the defining quintic equation for many purposes. The cube-root of  $R$  equation has the important advantage that it may be used to compute  $V$  from  $R$  or  $R$  from  $V$ . The defining quintic equation will not easily compute  $V$  from  $R$ .

J. H. LADD and J. E. PINNEY  
Color Tech. Div., Eastman Kodak Co.  
Rochester 4, New York

## Effects of Impurities on Resonator Properties of Quartz\*

During recent studies conducted at the Signal Corps Engineering Laboratories on fundamental properties of natural and synthetic quartz, it was found that piezoelectric resonators fabricated from synthetic quartz

crystals<sup>1</sup> containing impurities introduced during the quartz growth cycle have different frequency-temperature characteristics from those made from natural quartz.

Measurements of frequency-temperature characteristics of fifth overtone, 29 mc AT-cut resonators prepared from aluminum-doped synthetic quartz show higher inflection temperature and orientation angles than those of natural quartz having similar frequency-temperature characteristics. This is graphically illustrated by the frequency-temperature curves of Fig. 1. In this figure

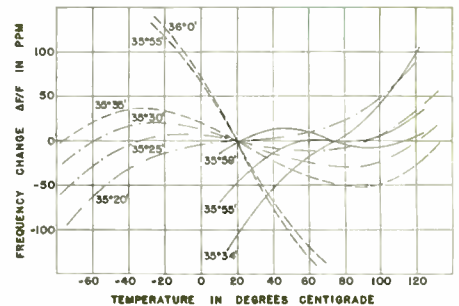

Fig. 1—Frequency-temperature characteristics of AT-cut crystals with different  $ZZ'$  angles fabricated from natural and aluminum-doped synthetic quartz. The solid curves are the characteristics for aluminum-doped crystals; the dashed curves for natural quartz having same  $ZZ'$  angles; and dot-dashed curves for natural quartz having similar frequency-temperature characteristics.

the solid line is used to represent aluminum-doped synthetic quartz resonators; the broken line represents the natural quartz resonators which have approximately the same orientation angles as the "doped" units; and the dot-dash line represents the natural quartz resonators which have the same frequency-temperature characteristics as those of the "doped" units. Angle given at ends of each curve is  $ZZ'$  orientation angle of particular AT-cut resonator.

The inflection temperature is defined as the temperature at which  $d^2F/dT^2 = 0$ . As Fig. 1 shows, the inflection temperature of the aluminum doped synthetic quartz resonators is at 75 degrees C., whereas that of natural quartz is at 20 degrees C. For similar frequency-temperature characteristics, the  $ZZ'$  orientation angle of aluminum doped synthetic quartz resonators is roughly 30 minutes higher than that of natural quartz.

The spectrochemical analysis of the aluminum-doped synthetic quartz shows that the following impurities (in parts per million by weight) are present: Al—100, Ge—50, Mg—10, Mn—10, Ca—5. Other impurity-doped synthetic quartz crystals have been grown and tested. In the case of germanium-doped quartz (Ge—1,000, Al—100, Fe—10, Ag—10, Mg—5, Ca—5), there is an upward shift of the inflection temperature of approximately 25 degrees, and an upward shift of the orientation angle of approximately 15 minutes. The investigation is being continued in an effort to determine the effects of various other impurities on resonator properties.

A. R. CHI, D. L. HAMMOND, and  
E. A. GERBER  
Frequency Control Branch  
Components Division  
Ft. Monmouth, N. J.

\* Received by the IRE May 23, 1955.

<sup>1</sup> A paper on synthesis of impurity doped quartz is in preparation by J. Stanley and S. Theokritoff.

<sup>1</sup> A. E. O. Munsell, L. L. Sloan, and I. H. Godlove, "Neutral value scales. I. Munsell neutral value scale," *Jour. Opt. Soc. Amer.*, vol. 23, pp. 394-411; November, 1933.

<sup>2</sup> Committee on Colorimetry, Opt. Soc. Amer., "The Science of Color," Thomas Y. Crowell Co., New York, N. Y., p. 134; 1953.

<sup>3</sup> R. M. Evans, "An Introduction to Color," John Wiley and Sons, New York, N. Y., pp. 124-129, 157-172; 1948.

<sup>4</sup> S. M. Newhall, D. Nickerson, and D. B. Judd, "Final report of the O.S.A. subcommittee on the spacing of the Munsell colors," *Jour. Opt. Soc. Amer.*, vol. 33, pp. 385-418; July, 1943.

# Contributors

J. S. Ajioka (S'49) was born at Rexburg, Idaho, on August 9, 1923. He received his early college education at the University of California at Los Angeles. During World War II he served with the 442nd Infantry Regiment in southern Europe.



J. S. AJIOKA

At the close of the war, Mr. Ajioka entered the University of Utah, where he received the B.S. degree in 1949 and the M.S. degree in 1951. Since graduation, he has been employed in the U. S. Navy Electronics Laboratory at San Diego, working on microwave antenna design and development, and in the Hughes Research Laboratories, Hughes Aircraft Co., Culver City, working on certain analytical phases of the radome design problem.



F. R. Arams (S'44-A'49-SM'55) was born on October 18, 1925, in the Free City of Danzig. He received a B.S.E. in electrical engineering and a



F. R. ARAMS

B.S.E. in mathematics from the University of Michigan in 1947, a M.S. degree in applied physics from Harvard University in 1948, and a M.S. degree in business management from Stevens Institute of Technology in 1953. He is presently studying for a doctorate in electrical engineering at the Polytechnic Institute of Brooklyn. During World War II he served as Communications Chief in charge of Radio Receiver Station WXH, Ketchikan, Alaska.

Mr. Arams joined the Radio Corporation of America in 1948 as a specialized trainee, and subsequently joined the Microwave Engineering laboratory of the RCA Tube Division, first at Lancaster, Pa. and now at Harrison, N. J. From 1948 to 1950, he was engaged in advanced development problems on microwave gaseous phenomena. From 1950 to 1953, he was project engineer on various magnetron and traveling-wave-tube design programs. From 1953 until early 1955, he served as assistant to the manager of Microwave Engineering, and at present he is in charge of Application Engineering on Microwave Tubes at RCA Tube Division.

Mr. Arams was a 1944 Donovan Scholar at the University of Michigan, and is a member of Eta Kappa Nu and Tau Beta Pi.

T. W. Butler, Jr. (A'53) was born in Niagara Falls, N. Y., on October 9, 1922. He received the B.S.E.E. and M.S. in physics from the University of Michigan in 1950 and 1953, respectively.



T. W. BUTLER, JR.

From 1950 to 1951 he was employed as an assistant design engineer with Consumers Power Company, Jackson, Mich. From 1951 to the present time, Mr. Butler has been employed by the Engineering Research Institute, at the University of Michigan as an associate research engineer. He is currently engaged in both component and systems research programs and is working toward the Ph.D. degree in electrical engineering.

He is a member of Gamma Alpha and Sigma Xi.



S. S. L. Chang (SM'53) was born in Peiping, China, in 1920. He received the M.S. in physics from Tsinghua University in China, in 1944 and the Ph.D. in electrical engineering from Purdue University in 1947. From 1947 to 1948, he taught at Purdue University.



S. S. L. CHANG

He has been associated with Robbins and Myers, Inc., Springfield, Ohio since 1946. He joined the faculty of New York University in 1952 and is now Associate Professor of Electrical Engineering.

Dr. Chang is a member of the AIEE, ASEE, American Physical Society, Eta Kappa Nu, and Sigma Xi.



For a photograph and biography of W. F. Chow, see page 881 of the July, 1955 issue of the PROCEEDINGS OF THE IRE.



C. W. Helstrom was born on February 22, 1925, in Easton, Pa. From 1944 to 1946, he served as a radio technician in the United States Navy.

In 1947 he received the B.S. degree in engineering physics from Lehigh University, and in 1951 the Ph.D. in physics from the California Institute of Technology. Since 1951, he has been employed in the Electronics and Nuclear Physics Department of the Westinghouse Research Labs., in East Pittsburgh, Pa.



C. W. HELSTROM

Dr. Helstrom is a member of the American Physical Society.



H. K. Jenny (A'45-M'47-SM'50) was born on September 14, 1919, in Glarus, Switzerland. He received the M.S. degree in electrical engineering from the Swiss Federal Institute of Technology in Zurich, Switzerland in 1943. He remained there from 1943 to 1945, as assistant to Dr. F. Tank, head of the Institute of High Frequency.



H. K. JENNY

In 1946 he joined the Tube Division of the Radio Corporation of America in Lancaster, Pa., and has since been engaged in the development of microwave tubes. At present, Mr. Jenny is manager of the Microwave Tube Engineering Activity in Harrison, N. J.



F. D. Lewis (S'36-A'38-A'39-SM'50) was born in Liberty, Mo., on July 2, 1911. He received the A.B. degree at Central College, Fayette, Mo., in 1933, and the B.S. and M.S. degrees from Massachusetts Institute of Technology in 1937 and 1940.



F. D. LEWIS

From 1937 to 1940 he was engaged in experimental work on uhf receivers and electromagnetic horn radiators at M.I.T. During the summer of 1940 he worked on Doppler-effect radar at Loomis Laboratory, subsequently going to the M.I.T. Radiation Laboratory when it opened in November, 1940.

In 1941 he went to England as scientific liaison officer for the NDRC-OSRD. Returning in 1942, he became an expert con-

sultant in the Office of the Secretary of War on radar countermeasures and allied problems. He has been with the General Radio Co. since 1945, and has been working on frequency measurement since 1949.

Mr. Lewis holds the President's Certificate of Merit. He is a member of Sigma Xi and the AAAS.



W. J. Lindsay (A'55) was born in Miles, Texas, on October 28, 1925. He received his B.S. degree from Texas A. and M. College



W. J. LINDSAY

in 1948 and the M.S. degree in 1954. From August, 1948, to May, 1951, he was employed by the Humble Oil and Refining Company in Houston, Texas as an assistant engineer. From May, 1951 to August, 1952, Mr. Lindsay was employed in the EWS Research Laboratory of the Halliburton Oil Well Cementing Company of Houston as project engineer. From 1952 to 1954 he was engineer in charge of a network analyzer project, at the Texas A. and M. Research Foundation.

Mr. Lindsay joined the staff of the Electronic Defense Group, Engineering Re-

search Institute, at the University of Michigan in August, 1954 as research associate. He is currently working toward the Ph.D. degree in electrical engineering.

He is a member of Tau Beta Pi.



L. W. Orr (A'52) was born in 1915 in Hamilton, Canada. He received the B.A.Sc. degree in electrical engineering in 1943 from



L. W. ORR

the University of Toronto, and the M.S. and Ph.D. degrees in electrical engineering in 1946 and 1949 from the University of Michigan. During World War II, he was an officer in the Signals Branch of the Royal Canadian Air Force.

From 1950 to 1951, Dr. Orr was in charge of the research and development of magnetic devices at the Burroughs Research Division, Philadelphia, Pa. From 1949 to 1950, and from 1951 to the present time, he has been a research engineer in the Engineering Research Institute, at the University of Michigan. He is presently engaged in a component research program in the Electronic Defense Group.

For a photograph and biography of R. L. Pritchard, see page 105 of the January, 1955 issue of the PROCEEDINGS OF THE IRE.



For a photograph and biography of A. P. Stern, see page 882 of the July, 1955 issue of the PROCEEDINGS OF THE IRE.



D. Weighton was born on June 26, 1913, in Kingston-upon-Hull, England. He received the M.A. degree from Cambridge University in 1935. From 1936 to 1938, he served as Education Officer in the Royal Air Force.



D. WEIGHTON

In 1938 Mr. Weighton joined the research staff of Pye Limited, Cambridge, Eng. and from 1948 has headed the research division of that company.

Mr. Weighton is an associate member of the British Institution of Electrical Engineers.

## IRE News and Radio Notes

### PG ON BROADCAST TRANSMISSION SYSTEMS WILL HOLD SYMPOSIUM

"New Perspectives in the Field of Broadcasting" will be the theme of the Fifth Annual Fall Symposium of the Professional Group on Broadcast Transmission Systems. The meeting is scheduled for September 23 and 24 at the Hamilton Hotel in Washington, D. C. Registration will open at 9:00 A.M., September 23. Advance registration and reservations may be sent to PGBTS, Seventh Floor, 1735 DeSales Street, N.W., Washington 6, D. C.

The Friday morning session of the symposium will be devoted to 32 new television broadcasting equipment and facilities. Papers will include *Multiple Antenna System with Antennas of Equal Height* by L. J. Wolf of RCA, *Studio Switching Problems with Color Signals* by H. W. Morse of General Electric, and *A Fifty Kilowatt Transmitter* by John Ruston of DuMont. Philip B. Laeser, Technical Director of WTMJ in Milwaukee, will speak on *Integrating Color Equipment with Monochrome Facilities at your Television Station*.

The Friday afternoon session will be devoted to measurements, including propagation factors, in television. A paper, made available by Edward W. Allen, Jr., of the FCC and including work directed by William

C. Boese and Harry Fine, *Present Knowledge of Propagation in VHF and UHF Television Bands*, will be delivered. Edward W. Chapin, Chief of the Laurel, Maryland Laboratory Division of the Federal Communications Commission will deliver a paper summarizing field intensity measurements which have been made on various UHF stations.

The Saturday morning session will include papers on new broadcast operation techniques and equipment arrangements. R. A. Isberg, of the Ampex Corporation, will deliver a paper on *Using New Tape and Film Techniques to Increase Broadcast Operation Efficiency*. A. C. Goodnow, Westinghouse Broadcasting Company, will speak on *Experimental Experience with Remote Control of High Power and Directional Antenna Broadcast Transmitter Operations*. A *Novel Television Slide Sequencing Arrangement* will be presented by Roger E. Peterson of WNBC, Binghamton, New York. Edgar F. Vandivere, Jr. of Vandivere, Cohen and Wearn will present a paper on *Some Techniques in Automatic Programming*.

Moderators for the sessions will be Ralph N. Harmon, Westinghouse Broadcasting Company; Stuart L. Bailey, Jansky and Bailey, Incorporated, and George C. Davis, consulting engineer.

A Friday evening cocktail hour will begin at 6:00 P.M. and will be followed by a

banquet. Arrangements have also been made with Edgar T. Martin, Chief Engineer of the Voice of America for conducted tours there on Saturday afternoon.

Steering Committee includes Oscar Reed, Jr., General Chairman; Ralph N. Harmon, Technical Program Committee; Harold Dorschug, Public Relations and Publicity; C. M. Brown, Finance; Lewis Winner, Papers Review; and Irma B. Galane, Local Arrangements Committee.

### W. C. WHITE CONTRIBUTES TO BROWDER THOMPSON FUND

Friends of W. C. White recently presented him with several gifts upon his retirement from the General Electric Company. Mr. White has generously donated those gifts that were in cash to the Browder J. Thompson Fund. The money is to be used in six annual installments to augment the Browder J. Thompson Memorial Prize, which is given annually to an author, less than 30 years old, who has published the most outstanding paper in an IRE publication.

Mr. White has been active in IRE affairs for more than twenty-five years, serving as Treasurer in 1946 and Director from 1943 to 1947.

### Calendar of Coming Events

- IRE-ISA Tenth Annual Instrument Conference, Shrine Auditorium, Los Angeles, Calif., Sept. 12-16
- Association for Computing Machinery. Annual Meeting, Moore School of Electrical Engineering, U. of Pa., Sept. 14-16
- IRE Professional Group on Nuclear Science—Second Annual Meeting, Oak Ridge National Labs., Oak Ridge, Tenn., Sept. 14-17
- IRE Cedar Rapids Section Symposium on Automation, Cedar Rapids, Ia., Sept. 17
- PGBTS Fifth Annual Fall Symposium, Hamilton Hotel, Washington, D. C., Sept. 23-24
- Symposium on Physiologic and Pathologic Effects of Microwaves, Mayo Clinic, Rochester, Minn., Sept. 23-24
- RETMA Automation Symposium, U. of Pennsylvania, Philadelphia, Pa., Sept. 26-27
- PG on Vehicular Communications, Sixth Annual Meeting, Multnomah Hotel, Portland, Ore., Sept. 26-27
- IMSA Annual Convention, Hotel Seneca, Rochester, N. Y., Sept. 26-29
- International Analogy Computation Meeting, Société Belge des Ingénieurs des Télécommunications et d'Electronique, Brussels, Belgium, Sept. 27-Oct. 1.
- IRE-AIEE Conference on Industrial Electronics, Rackham Memorial Building, Detroit, Michigan, Sept. 28-29
- National Electronics Conference, Hotel Sherman, Chicago, Ill., October 3-5
- Audio Engineering Society Convention, Hotel New Yorker, New York City, Oct. 12-15
- IRE-RETMA Radio Fall Meeting, Hotel Syracuse, Syracuse, N. Y., Oct. 17-19
- Conference On Electrical Insulation, Pocono, Pa., Oct. 17-19
- Eighth Annual Gaseous Electronics Conference, General Electric Res. Lab., Schenectady, N. Y., Oct. 20-22
- PG on Electron Devices Annual Technical Meeting, Shoreham Hotel, Washington, D. C., Oct. 24-25
- GAMM and NTG-VDE International Conference on Electronic Digital Computers, and Data Processing, Darmstadt, Germany, Oct. 25-27
- IRE East Coast Conference on Aeronautical and Navigational Electronics, Lord Baltimore Hotel, Baltimore, Md., Oct. 31-Nov. 1.
- Symposium on Applied Solar Energy, Westward Ho Hotel, Phoenix, Ariz., Nov. 1-5
- Kansas City Section Electronics Conference, Kansas City, Kansas, Nov. 3-4
- IRE-AIEE-ACM Eastern Joint Computer Conference, Hotel Statler, Boston, Nov. 7-9
- IRE-AIEE-ISA Electrical Techniques in Medicine and Biology, Shoreham Hotel, Washington, D. C., Nov. 14-16
- IRE-PGCS Symposium on Aeronautical Communications—Civil and Military; Utica, New York, Nov. 21-22
- PGI and Atlanta Section Data Processing Symposium, Hotel Biltmore, Atlanta, Ga., Nov. 28-30

### SYMPOSIUM ON RELIABILITY AND QUALITY CONTROL.



Victor Wouk (left), Chairman of PG on Reliability and Quality Control, is Publicity Chairman for Symposium.

The PG on Reliability and Quality Control will sponsor a Symposium on Reliability and Quality Control in Electronics. The symposium will be held January 9 and 10, 1956 at the Hotel Statler in Washington.

A preliminary schedule for the symposium has been published.

*First Session:* "Quality Control and Automation," "Reliability of Complex Commercial Equipment," "Reliability of Weapons Systems."

*Second Session:* "The Control Chart Applied to Field Failure Data," "An Ap-

proach to the Study of System Reliability," "The Relation of Life Tests to Failure Rates." The panel discussions will include: "High Reliability vs Cost of Equipment and Parts," "System Testing vs In-process Control," "The Problem of Field Failure Reporting (including new Air Force plans)."

*Third Session:* "Advances in Tube Reliability," "Reliable Connectors Through Quality Control," "Controlling Relay Characteristics," "Reliable Capacitors," "Parts Reliability Research by the Services."

*Fourth Session:* "Quality Requirements and Acceptance Procedures."

### SYMPOSIUM ON MICROWAVE TECHNIQUES TO MEET IN FEBRUARY IN PHILADELPHIA

Jointly sponsored by the PG on Microwave Theory and Techniques, the PG on Antennas and Propagation, and the Philadelphia Section, a national symposium on Microwave Techniques will be held at the University of Pennsylvania in Philadelphia, February 2 and 3, 1956.

Sessions are planned to include the following topics:

*Radiating Systems:* radomes, techniques of antenna gain and pattern measurement, the use of near field measurements, problems associated with paraboloid antennas of 20 feet or more diameter.

*Panel Session on Guided Microwave Transmission:* rectangular guide, ridge guide, round guide, dielectric guide, single wire guide.

*Components:* filters, converters, duplexers, directional couplers, non-reciprocal components.

*Propagation:* scatter.

*Measurements:* power spurious emission, spurious modulation, emission bandwidth, gain standards.

Those interested in presenting papers on one of these subjects should submit 250 word abstracts no later than October 15. The abstracts, in duplicate, may be sent to D. R. Crosby, RCA, Bldg. 10-1, Camden 2, N.J.

### NOVEMBER 4 IRE CONVEN- TION PAPERS DEADLINE

November 4 is the deadline for submission of 1956 IRE National Convention papers. Information needed, to be included in triplicate: a 100-word abstract with title of paper, name, and address; a 500-word summary, with title of paper, name, and address. One of the following fields in which the paper falls should be indicated. Aeronautical and Navigational Electronics, Antennas and Propagation, Audio, Automatic Control, Broadcast and Television Receivers, Broadcast Transmission Systems, Circuit Theory, Communications Systems, Component Parts, Electron Devices, Electronic Computers, Engineering Management, Industrial Electronics, Information Theory, Instrumentation, Medical Electronics, Microwave Theory and Techniques, Nuclear Science, Production Techniques, Reliability and Quality Control, Telemetry and Remote Control, Ultrasonics Engineering, Vehicular Communications.

Send material to Russell R. Law, 1956 Technical Program Committee, IRE, 1 East 79 St., N. Y. 21, N. Y.

# ANNUAL MEETING OF THE DALLAS-FORT WORTH SECTION

Seen at right are two participants at the Dallas-Fort Worth Section Annual Meeting. Bernard Brister (left), public relations counselor for the Section, was honored with membership in the Institute of Radio Engineers. Making the presentation is Dr. Gordon K. Teal of Texas Instruments, Inc., new Dallas-Fort Worth Vice-Chairman.



(Above) Mark Bullock, Continental Electronics Manufacturing Co., is caught in an informal shot during the banquet which was held in conjunction with the meeting. He will be the new chairman of the Section.



Shown above is John A. Green, outgoing Chairman of the Section. He was honored at the meeting for the services to IRE during the past year.



Shown at left are the new contributing editors who were elected recently at the Annual Meeting. (From left to right) Kenneth P. Dowell, of the Texas Instruments, Inc., Dallas, and James M. Weldon of the Collins Radio Company, Cedar Rapids, Iowa, look over an issue of *Direction* with T. A. Wright, Jr., of A. Earl Cullum, Jr., and Associates, Dallas, John K. Godbey, and Theil Sharp, both of Collins Radio Company.

## FEBRUARY TO BE DATE FOR WESTERN COMPUTER CONFERENCE

The Western Computer Conference will be held in San Francisco February 8-10, 1956. It will be sponsored jointly by the IRE, AIEE, and ACM.

Papers on all phases of the computer field are now being solicited. In addition to paper title, authors are asked to submit an abstract of approximately 200 words, suitable for reproduction in the program, and either the complete manuscript or sufficient additional information to permit evaluation by the Technical Program Committee. Early submission of papers is desired, the final deadline being November 15. This is the latest date that is feasible and papers received thereafter cannot be considered.

Authors should indicate any plans for publication and should state what facilities, such as slide or movie projectors, power sources, etc. are required. For uniformity of handling, it is requested that all papers be directed to: Byron J. Bennett, Chairman,

Technical Program Committee, Stanford Research Institute, Menlo Park, California.

## SEVERAL PROCEEDINGS AVAILABLE

The 1954 *Eastern Joint Computer Conference Proceedings* are now available at \$3.00 per copy. These are the complete papers that were presented in Philadelphia December 8-10, 1954. Also available at \$3.50 per copy are the 1955 *National Telemetering Conference Proceedings*. These represent the complete papers delivered at Chicago May 18-20. Both volumes may be obtained through IRE Headquarters, 1 E. 79 St., N. Y. 21, N. Y.

The *Proceedings of the 1955 Electronic Components Conference* held in Los Angeles are now available. The publication contains more than forty-eight papers on electronics which will not be duplicated in other publications. Checks for \$4.50 per copy should be made payable to the 1955 Electronic Components Conference, 8820 Bellanca, Los Angeles, California.

## NATIONAL SIMULATION CONFERENCE WILL MEET IN DALLAS

The Dallas-Fort Worth Chapter of the PG on Electronic Computers will sponsor a National Simulation Conference in Dallas, Texas, January 19-21, 1956. The conference will be devoted to simulation and associated computing techniques, and will include topics in general simulation (mathematical, physical, logistic, etc.); advances in computer design, techniques, and applications; and methods of determining and improving the accuracy of analog solutions.

Papers for the conference are now being solicited. Although it is expected that most of the papers will deal with analog computers, papers on the use of digital computers in simulation will be strongly encouraged. Prospective authors should submit in duplicate by September 10, a 100 word abstract together with either a 500 word summary or the complete paper itself to: J. R. Forester, 2104 Huntington, Arlington, Texas.

## FORMER IRE PRESIDENT ELECTED HEAD OF RADIO PIONEERS CLUB

Raymond F. Guy recently has been elected president of the Radio Pioneers Club. He is Director of Radio Frequency Engineering for the National Broadcasting Company. Mr. Guy was on the original staff, composed of only a few persons, at WJZ when it was opened by the Westinghouse Company in Newark, N. J., in 1921 as the world's second broadcasting station. At that time the audience consisted of only a few amateurs. Commercial broadcasting was unknown and practically all operating methods and techniques had to be originated by trial and error. In the last 36 years, Mr. Guy has played a part in developing network broadcasting, short-wave broadcasting to foreign countries, frequency modulation and the evolution and development of television.



Raymond F. Guy, new President of Radio Pioneers

During World War II, he participated in projects of the Office of Strategic Services, the Co-ordinator of Inter-American Affairs, and the Office of War Information, one of which took him abroad. Since the war he has participated in international radio conferences in Havana, Mexico City, and Montreal.

A fellow of the Radio Club of America, a charter member of the Radio Pioneers Club, a life member of the Veteran Wireless Operators Association, and a member of the Society of Professional Engineers, he was admitted to practice as a professional engineer in New York and New Jersey in 1937. He has also served on the Radio Technical Planning Board and represented the IRE in the activities of the American Standards Association.

Mr. Guy became an IRE Associate Member in 1925, a Member in 1931 and a Fellow in 1939. He was President in 1950. In 1944, he was elected to the Board of Directors and served through 1948, including one term as Treasurer. He has served on a number of IRE committees, functioning as chairman of the standards, public relations, founders, transmitters, membership and office practices committees, and vice chairman of the building fund and executive committees.

## TRANSACTIONS OF THE IRE PROFESSIONAL GROUPS

The following issues of TRANSACTIONS are available from The Institute of Radio Engineers, Inc., 1 East 79 Street, New York 21, N. Y., at the prices listed below:

| Sponsoring Group   | Publications   | Group Members   | IRE Members | Non-* Members |
|--|--|---|-------------|---------------|
| Aeronautical & Navigational Electronics  | PGAE-5: A dynamic Aircraft Simulator for Study of Human Response Characteristics (6 pages)                 | \$ .30  | \$ .45      | \$ .90        |
|  | PGAE-6: Ground-to-Air Cochannel Interference at 2900 NC (10 pages)   | .30   | .45         | .90           |
|  | PGAE-8: June 1953 (23 pages)   | .65   | .95         | 1.95          |
|  | PGAE-9: September 1953 (27 pages)  | .70   | 1.05        | 2.10          |
|  | Vol. ANE-1, No. 1, March 1954 (51 pages)   | 1.00  | 1.50        | 3.00          |
|  | Vol. ANE-1, No. 2, June 1954 (22 pages)  | .95   | 1.40        | 2.85          |
|  | Vol. ANE-1, No. 3, September 1954 (27 pages)   | 1.00  | 1.50        | 3.00          |
|  | Vol. ANE-1, No. 4, December 1954 (27 pages)  | 1.00  | 1.50        | 3.00          |
|  | Vol. ANE-2, No. 1, March 1955 (41 pages)   | 1.40  | 2.10        | 4.20          |
|  | Antennas and Propagation   | PGAP-4: IRE Western Convention, August 1952 (136 pages)         | 2.20        | 3.30          |
| Vol. AP-1, No. 1, July 1953 (30 pages)   |  | 1.20  | 1.80        | 3.60          |
| Vol. AP-1, No. 2, October 1953 (31 pages)  |  | 1.20  | 1.80        | 3.60          |
| Vol. AP-2, No. 1, January 1954 (39 pages)  |  | 1.35  | 2.00        | 4.05          |
| Vol. AP-2, No. 2, April 1954 (41 pages)  |  | 2.00  | 3.00        | 6.00          |
| Vol. AP-2, No. 3, July 1954 (36 pages)   |  | 1.50  | 2.25        | 4.50          |
| Vol. AP-3, No. 4, October 1954 (36 pages)  |  | 1.50  | 2.25        | 4.50          |
| Vol. AP-3, No. 1, January 1955 (43 pages)  |  | 1.60  | 2.40        | 4.80          |
| Vol. AP-3, No. 2, April 1955 (47 pages)  |  | 1.60  | 2.40        | 4.80          |
| Audio  |  | PGA-7: Editorials, Technical Papers & News, May 1952 (47 pages) | .90         | 1.35          |
|  | PGA-10: November-December 1952 (27 pages)  | .70   | 1.05        | 2.10          |
|  | Vol. AU-1, No. 1, January-February 1953 (24 pages)   | .60   | .90         | 1.80          |
|  | Vol. AU-1, No. 2, March-April 1953 (34 pages)  | .80   | 1.20        | 2.40          |
|  | Vol. AU-1, No. 3, May-June 1953 (34 pages)   | .80   | 1.20        | 2.40          |
|  | Vol. AU-1, No. 4, July-August 1953 (19 pages)  | .70   | 1.05        | 2.10          |
|  | Vol. AU-1, No. 5, September-October 1953 (11 pages)  | .50   | .75         | 1.50          |
|  | Vol. AU-1, No. 6, November-December 1953 (27 pages)  | .90   | 1.35        | 2.70          |
|  | Vol. AU-2, No. 1, January-February 1954 (38 pages)   | 1.20  | 1.80        | 3.60          |
|  | Vol. AU-2, No. 2, March-April 1954 (31 pages)  | .95   | 1.40        | 2.85          |
|  | Vol. AU-2, No. 3, May-June 1954 (27 pages)   | .95   | 1.40        | 2.85          |
|  | Vol. AU-2, No. 4, July-August 1954 (27 pages)  | .95   | 1.40        | 2.85          |
|  | Vol. AU-2, No. 5, September-October 1954 (22 pages)  | .95   | 1.40        | 2.85          |
|  | Vol. AU-2, No. 6, November-December 1954 (24 pages)  | .80   | 1.20        | 2.40          |
|  | Vol. AU-3, No. 1, January-February 1955 (20 pages)   | .60   | .90         | 1.80          |
| Vol. AU-3, No. 2, March-April 1955 (51 pages)  | .95  | 1.40  | 2.85        |               |
| Vol. AU-3, No. 3, May-June 1955 (85 pages)   | .85  | 1.25  | 2.55        |               |
| Broadcast Transmission Systems   | PGBTS-1: March 1955 (102 pages)  | 2.50  | 3.75        | 7.50          |
| Broadcast and Television Receivers   | PGBTR-1: Round-Table Discussion on UHF TV Receiver Considerations, 1952 IRE National Convention (12 pages) | .50   | .75         | 1.50          |
|  | PGBTR-3: June 1953 (67 pages)  | 1.40  | 2.10        | 4.20          |
|  | PGBTR-5: January 1954 (96 pages)   | 1.80  | 2.70        | 5.40          |
|  | PGBTR-6: April 1954 (119 pages)  | 2.35  | 3.50        | 7.00          |
|  | PGBTR-7: July 1954 (58 pages)  | 1.15  | 1.70        | 3.45          |
|  | PGBTR-8: October 1954 (20 pages)   | .90   | 1.35        | 2.70          |
|  | Vol. BTR-1, No. 1, January 1955—Papers presented at the Radio Fall Meeting, 1954 (68 pages)                | 1.25  | 1.85        | 3.75          |
|  | Circuit Theory   | PGCT-1: IRE Western Convention, August 1952 (100 pages)         | 1.60        | 2.40          |
| PGCT-2: Papers presented at the Circuit Theory Sessions of the Western Electronic Show & Convention, San Francisco, Calif., August 19-21, 1953 (106 pages) |  | 1.95  | 2.90        | 5.85          |
| Vol. CT-1, No. 1, March 1954 (80 pages)  |  | 1.30  | 1.95        | 3.90          |
| Vol. CT-1, No. 2, June 1954 (39 pages)   |  | 1.00  | 1.50        | 3.00          |
| Vol. CT-1, No. 3, September 1954 (73 pages)  |  | 1.00  | 1.50        | 3.00          |
| Vol. CT-1, No. 4, December 1954 (42 pages)   |  | 1.00  | 1.50        | 3.00          |

\* Public Libraries, Colleges and Subscription Agencies may purchase at IRE Member rate.

(Continued)

## TRANSACTIONS OF IRE PROFESSIONAL GROUPS

| Sponsoring Group              | Publications  | Group Mem- bers | IRE Mem- bers | Non-* Mem- bers |
|-------------------------------|---|-----------------|---------------|-----------------|
|                               | Vol. CT-2, No. 1, March 1955 (106 pages)  | \$2.70          | \$4.05        | \$8.10          |
| Communica- tions Systems      | Vol. CS-2, No. 1, January 1954 (83 pages)   | 1.65            | 2.50          | 4.95            |
|                               | Vol. CS-2, No. 3, November 1954: IRE Symposium on Global Communications, June 23-25, 1954, Washington, D. C. & IRE-AIEE Symposium on Military Communications, April 28, 1954, New York, N. Y. (181 pages) | 3.00            | 4.50          | 9.00            |
|                               | Vol. CS-3, No. 1, March 1955: Papers presented at the Symposium on Marine Communications & Navigation, October 13-15, 1954, Boston, Mass. (72 pages)  | 1.00            | 1.50          | 3.00            |
| Component Parts               | PGCP-1: March 1954 Issue (46 pages)   | 1.20            | 1.80          | 3.60            |
|                               | PGCP-2: September 1954: Papers presented at the Component Parts Sessions at the 1954 Western Electronic Show & Convention, Los Angeles, Calif. (118 pages)  | 2.25            | 3.35          | 6.75            |
|                               | PGCP-3: April 1955 (44 pages)   | 1.00            | 1.50          | 3.00            |
| Electronic Computers          | Vol. EC-2, No. 2, June 1953 (27 pages)  | .90             | 1.35          | 2.70            |
|                               | Vol. EC-2, No. 3, September 1953 (27 pages)   | .75             | 1.10          | 2.25            |
|                               | Vol. EC-2, No. 4, December 1953 (47 pages)  | 1.25            | 1.85          | 3.75            |
|                               | Vol. EC-3, No. 1, March 1954 (39 pages)   | 1.10            | 1.65          | 3.30            |
|                               | Vol. EC-3, No. 2, June 1954 (65 pages)  | 1.65            | 2.45          | 4.95            |
|                               | Vol. EC-3, No. 3, September 1954 (54 pages)   | 1.80            | 2.70          | 5.40            |
|                               | Vol. EC-3, No. 4, December 1954 (46 pages)  | 1.10            | 1.65          | 3.30            |
|                               | Vol. EC-4, No. 1, March 1955 (48 pages)   | 1.10            | 1.65          | 3.30            |
| Electron Devices              | Vol. EC-4, No. 2, June 1955 (86 pages)  | .90             | 1.35          | 2.70            |
|                               | PGED-4: December 1953 (62 pages)  | 1.30            | 1.95          | 3.90            |
|                               | Vol. ED-1, No. 1, February 1954 (72 pages)  | 1.40            | 2.10          | 4.20            |
|                               | Vol. ED-1, No. 2, April 1954 (75 pages)   | 1.40            | 2.10          | 4.20            |
|                               | Vol. ED-1, No. 3, August 1954 (77 pages)  | 1.40            | 2.10          | 4.20            |
|                               | Vol. ED-1, No. 4, December 1954—Papers presented at the 1954 Symposium on Fluctuation Phenomena in Microwave Sources, November 18-19, 1954, New York, N. Y. (280 pages)                                   | 3.20            | 4.80          | 9.60            |
|                               | Vol. ED-2, No. 2, April 1955 (53 pages)   | 2.10            | 3.15          | 6.30            |
| Engineering Management        | PGEM-1: February 1954 (55 pages)  | 1.15            | 1.70          | 3.45            |
|                               | PGEM-2: November 1954 (67 pages)  | 1.30            | 1.95          | 3.90            |
|                               | PGEM-3: March 1955 (52 pages)   | 1.00            | 1.50          | 3.00            |
| Industrial Electronics        | PGIE-1: August 1953 (40 pages)  | 1.00            | 1.50          | 3.00            |
|                               | PGIE-2: March 1955 (81 pages)   | 1.90            | 2.85          | 5.70            |
| Information Theory            | PGIT-2: A Bibliography of Information Theory (Communication Theory-Cybernetics)—(60 pages)  | 1.25            | 1.85          | 3.75            |
|                               | PGIT-3: March 1954 (159 pages)  | 2.60            | 3.90          | 7.80            |
|                               | PGIT-4: September 1954 (234 pages)  | 3.35            | 5.00          | 10.00           |
|                               | Vol. IT-1, No. 1, March 1955 (76 pages)   | 2.40            | 3.60          | 7.20            |
| Instrumentation               | PGI-2: Data Handling Systems Symposium: IRE Western Electronic Show & Convention, Long Beach, Calif., August 27-29, 1952 (111 pages)  | 1.65            | 2.45          | 4.95            |
|                               | PGI-3: April 1954 (55 pages)  | 1.05            | 1.55          | 3.15            |
| Microwave Theory & Techniques | Vol. MTT-1, No. 2, November 1953 (44 pages)   | .90             | 1.35          | 2.70            |
|                               | Vol. MTT-2, No. 2, July 1954 (67 pages)   | 1.25            | 1.85          | 3.75            |
|                               | Vol. MTT-2, No. 3, September 1954: Papers presented at the Joint IRE Professional Group—URSI meeting, Washington, D. C., May 5, 1954 (54 pages)   | 1.10            | 1.65          | 3.30            |
|                               | Vol. MTT-3, No. 1, January 1955 (47 pages)  | 1.50            | 2.25          | 4.50            |
|                               | Vol. MTT-3, No. 2, March 1955—Symposium on Microwave Strip Circuits, October 11-12, 1954, Tufts College, Medford, Mass. (182 pages)   | 2.70            | 4.05          | 8.10            |
| Nuclear Science               | Vol. MTT-3, No. 3, April 1955 (44 pages)  | 1.40            | 2.10          | 4.20            |
|                               | Vol. NS-1, No. 1, September 1954 (42 pages)   | .70             | 1.00          | 2.00            |
| Reliability & Quality Control | Vol. NS-2, No. 1, June 1955 (15 pages)  | .55             | .85           | 1.65            |
|                               | PGQC-2: March 1953 (51 pages)   | 1.30            | 1.95          | 3.90            |
|                               | PGQC-3: February 1954 (39 pages)  | 1.15            | 1.70          | 3.45            |
|                               | PGQC-4: December 1954 (56 pages)  | 1.20            | 1.80          | 3.60            |
|                               | PGQC-5: April 1955 (56 pages)   | 1.15            | 1.75          | 3.45            |

\* Public Libraries, Colleges and Subscription Agencies may purchase at IRE Member rate.

(Continued)

RADIO PIONEERS—  
ATTENTION!

This notice, from the Radio Pioneers Club, is for the information of members of the IRE who are qualified and wish to join the Radio Pioneers but who lack information concerning it. Originally formed in 1942 as the Twenty Year Club, the purposes of the organization are:

"To establish a membership organization of persons who by their long years of service in the field of Radio desire to become associated for the purposes of friendship and education. The Club shall be a central clearing house for the exchange of information and historical data about the radio industry and shall record in form to be determined facts and data about the history of the radio industry and its traditions for use by this and future generations. It is felt that this organization with the resultant exchange of information would make a valuable contribution to the public interest."

As outlined in the constitution, the purposes are broad enough to enable the Radio Pioneers to undertake almost any task which the club may desire for the furtherance of the radio industry.

1950 marked the establishment of a Radio Hall of Fame in which the memories of men and women whose contribution have placed them among the immortals will be perpetuated. The first of such awards went to Thomas Alva Edison. Subsequent awards went to Marconi, Fessenden, Frank Conrad and Joseph Henry. All members are entitled to submit their choice which will be voted upon by the committee.

In 1950 the Radio Pioneers inaugurated the radio oral history project which has been undertaken by Columbia University's oral history project, under the direction of Allen Nevins. This vast project set up a source of material which will be available to all future historians of the industry, or to those writing books which dwell on some phases of radio. The plan consisted of obtaining recorded interviews of outstanding men and women who have pioneered in radio, engineers as well as those in other branches. It is felt that soon many of these will no longer be available for first-hand information. All members are encouraged to send in early anecdotes and "firsts" with which they were connected or concerned.

The requirements for membership are that a prospective member be in good standing, and have served the radio industry for 20 consecutive years or more at the time of making application for membership.

H. V. Kaltenborn, noted commentator and author, is the founder of the Pioneers; this came about when NBC gave him a dinner on April 4, 1942, to commemorate his 20th year in radio. The small original group has grown to more than 1000. Officers include Raymond F. Guy, formerly IRE President, President; John Patt (Station WJR Detroit) 1st Vice President; Lewis H. Avery (Avery-Knodel, Inc.) Vice-President; Victor Diehm (Station WAZL) Vice-President; and Merle Jones (Columbia Broadcasting System) Vice-President. Honorary Presidents

(Cont'd on page 1144)

## TRANSACTIONS OF IRE PROFESSIONAL GROUPS

(Continued)

| Sponsoring Group             | Publications   | Group Mem- bers | IRE Mem- bers | Non-* Mem- bers |
|------------------------------|--|-----------------|---------------|-----------------|
| Telemetry and Remote Control | PGRTRC-1: August 1954 (16 pages)   | \$ .85          | \$1.25        | \$2.55          |
|                              | PGRTRC-2: November 1954 (24 pages)   | .95             | 1.40          | 2.85            |
|                              | Vol. TRC-1, No. 1, February 1955 (24 pages)  | .95             | 1.40          | 2.85            |
| Ultrasonics Engineering      | PGUE-1: June 1954 (62 pages)   | 1.55            | 2.30          | 4.65            |
|                              | PGUE-2: November 1954 (43 pages)   | 1.05            | 1.55          | 3.15            |
|                              | PGUE-3: May 1955 (70 pages)  | 1.45            | 2.20          | 4.35            |
| Vehicular Communica- tions   | PGVC-3: Theme—Spectrum Conservation, Wash- ington, D. C., December 3-5, 1952 (140 pages)     | 3.00            | 4.50          | 9.00            |
|                              | PGVC-4: Design, Planning & Operation of Mobile Communications Systems (June 1954) (98 pages) | 2.40            | 3.60          | 7.20            |
|                              | PGVC-5: June 1955 (76 pages)   | 1.50            | 2.25          | 4.50            |
|                              |  |                 |               |                 |

\* Public Libraries, Colleges and Subscription Agencies may purchase at IRE Member rate.

## RADIO PIONEERS—ATTENTION!

(Cont'd from page 1143)

are Brig. Gen. David Sarnoff and Dr. Lee De Forest.

Active local chapters exist in New York and Honolulu and plans are made to form others to promote friendship and social intercourse among the pioneer radio fraternities. New members have an opportunity to participate actively in the formation of their local chapters.

Radio Pioneers issues a small magazine and whenever feasible an annual membership roster including short biographies of each member.

Radio Pioneers holds its annual election, meeting and banquet each year at the time

and place of the NARTB Convention and during the year a number of chapter meetings are held.

Membership dues in the Pioneers are \$10 annually. The initiation cost is \$15 each, \$10 for dues and \$5 for a Pioneers insignia pin.

The Radio Pioneers is the only association of its kind in that it is not confined to engineers, financial people, the legal fraternity, program people, or management personnel, but includes them all. The meetings provide an opportunity to create friendships and enjoy informal social affairs with fellow members representing all of the industry. The opportunity to meet and enjoy the companionship with pioneers in the non-engineering professions has been pleasant, stimulating and valuable.

Chapter meetings are highly informal

and normally include excellent entertainment following dinner. Members of the Institute who are eligible to join are invited to send for an application blank to Raymond F. Guy, President, c/o National Broadcasting Company, Inc., 30 Rockefeller Plaza, New York 20, New York.

## I.I.T. WILL SPONSOR CONFERENCE ON INDUSTRIAL HYDRAULICS

The use of electronic analog computers in the solution of hydraulic problems will be a feature of the eleventh annual National Conference on Industrial Hydraulics, October 27 and 28, at the La Salle Hotel, Chicago.

The conference will be sponsored by the Illinois Institute of Technology graduate school and Armour Research Foundation, in cooperation with engineering societies and nearly 100 industrial organizations.

## TWO HUNDRED ATTEND PHILADELPHIA STUDENT NIGHT

The Philadelphia Section last spring organized a Student Night which included a dinner and meeting at the Engineers Club in Philadelphia. Nearly 100 students from the University of Delaware, Drexel Institute, Lafayette College, Lehigh University, University of Pennsylvania, Swarthmore, and Villanova were guests of the Section. After the dinner, attended by 200, a Section meeting was held. John Ryder, IRE President, spoke to the group on "Automatic Electronic Production." Also addressing the meeting was Theodore Hunter, Editor of the *Student Quarterly*. Student Awards were presented to seven students by S. C. Spielman, Chairman of Philadelphia Section.

## Philadelphia Section Presents Student Awards to Members from Six Colleges



Winners of Student Awards at the Philadelphia Section meeting are (standing, left to right): L. A. Rubin, Pennsylvania; E. J. Taylor, Delaware; William Fryer, Lafayette; William Kilpatrick, Lafayette; C. F. Der, Drexel. Seated: T. S. Durand, Villanova; S. C. Spielman, Philadelphia Section Chairman; R. J. Fulmer, Lehigh.



## PROFESSIONAL GROUP NEWS

### NEW YORK CHAPTER OF PGANE WILL EXPAND WINTER PROGRAM

Now in its second full season, the New York Chapter of the Professional Group on Aeronautical and Navigational Electronics is scheduling an expanded program of six meetings. Functioning jointly for the New York, Long Island, and Northern New Jersey Sections, the chapter will cover topics in communications, control, navigation, and training aids.

The season will get under way on Thursday evening, October 20, with a session on "The Automatic Dead Reckoning Computer." Subsequent meetings and field trips will take place in November, January, February, April, and June.

Planning has been carried out by the Chapter Executive Committee, consisting of *Gordon P. McCouch*, Aircraft Radio Corp., Chairman; *Lester M. Glantz*, Telephonics Corp., Vice-Chairman; *William P. McNally*, W. L. Maxson Corp., Secretary; *Stamates I. Frangoulis*, Ford Instrument Co., Membership Committee Chairman; *Henry C. Nelson*, Polytechnic Research and Development Corp., Program Committee Chairman; and *Robert J. Bibbero*, Hillyer Instrument Co., Past Chairman. The Program Committee includes: *Thomas W. Winternitz*, Bell Telephone Labs.; *Robert A. Buckles*, Watson, Leavenworth, Kelton and Taggart; *Charles Cambridge*, N. Y. USAF Development Field Office; *Richard Meyers*, Federal Telecommunications Labs.; and *John Litsios*, W. L. Maxson Corp.

### FOUR NEW CHAPTERS ANNOUNCED

On May 4, the IRE Board of Directors approved the establishment of a new Section in Ontario, Canada, to be known as the Bay of Quinte Section.

At the same meeting, the Amarillo-Lubbock Subsection of the Dallas-Fort Worth Section was made a full Section, now called the Lubbock Section.

The Executive Committee, at its meeting on June 7, approved the following chapters: Central Florida Section, PG on Telemetry and Remote Control; Philadelphia Section, PG on Medical Electronics; Boston Section, PG on Automatic Control; Rome-Utica Section, PG on Communications Systems.

## OBITUARY

**James F. Pierce (A'30-VA'39)** died recently. Mr. Pierce, a patent attorney, received the bachelor's degree in civil engineering from the University of Michigan and the bachelor of laws degree from George Washington University. He was a World War I veteran and a member of the American Legion. He also held membership in the American Bar Association and the American Patent Law Association. He had been admitted to practice before the Supreme Court, and was a partner in the patent law firm of Pierce, Scheffler and Parker, Washington, D. C.

Mr. Pierce was an IRE Representative at the University of Pittsburgh in 1949 and 1950.

## Technical Committee Notes

The Antennas and Waveguides Committee met at IRE Headquarters on June 8 with Henry Jasik presiding. Mr. Jasik reported on the Standards Committee review of the Proposed Definitions of Waveguide Components. The work of the Waveguide and Waveguide Component Measurements Subcommittee (2.4) on Methods of Waveguide Measurement was reviewed. The sections on delay time and power handling capacity had no further change. The section on *Q* was discussed at length and amended.

This Proposed Standard will be discussed further at the next meeting.

W. R. Bennett presided at a joint meeting of the Circuits Committee and the Subcommittee on Linear Active Circuits Including Network with Feedback Servomechanism (4.7) on June 23 at IRE Headquarters. It was announced that S. J. Mason had resigned from the Circuits Committee because of the pressure of other work, and that W. A. Lynch would take his place as Vice-Chairman. The committee discussed, amended, and approved the feedback definitions for submission to the Standards Committee.

The Facsimile Committee met at the Times Building on June 17 with K. R. McConnell presiding. Mr. Lankes reported on the progress of the IRE Facsimile Standards Chart from a series of prepared notes. The committee decided to write down a short definition and use for each pattern of the chart. The committee discussed the facsimile definitions as sent to the Standards Committee.

Mr. J. E. Fiselein presided at a meeting of the Industrial Electronics Committee at IRE Headquarters on June 15. The chairman announced that the definitions on induction and dielectric heating were approved by the Standards Committee with some short added notes on the two words, decalescence and recalescence. The secretary was instructed to send a letter to R. R. Batcher, Chairman of the Professional Group on Production Techniques. The letter was to stipulate that those in the Industrial Electronics Committee had assumed work in the production techniques and automation fields and that they would appreciate it if the Production Techniques group worked with them. The letter also indicated a desire to have any interested members of this professional group as members of the Industrial Electronics Committee and a desire to have them recognize the group as their channel of expression. Mr. Cottle reported on the RETMA work on definitions. Definitions for

## Administrative Committee of PG on Microwave Theory and Techniques Meets at IRE



At a recent meeting of the Administrative Committee of the PG on Microwave Theory and Techniques A. C. Beck was elected Chairman of the Group. Pictured at IRE Headquarters are (seated left to right): H. F. Englemann, Vice-Chairman; A. C. Beck, Chairman; W. W. Mumford, former Chairman; G. C. Southworth, Chairman

of Awards Committee. Standing (left to right) are: K. Tomiyasu, Secretary-Treasurer; R. F. Schwartz, who organized the Philadelphia Chapter; S. D. Schreyer, Secretary of the Baltimore Chapter; T. S. Saad, Editor; and Henry Jasik, of the Papers Review Committee. The meeting was held early this summer.

automatic machinery, aspect ratio and automatic dip soldering, prepared by Mr. Eiselein, were discussed and some modifications suggested. For those terms containing "automatic" it was decided to accept the dictionary definition for automatic and define the rest of the terms separately. It was decided to appoint a small task group to work on definitions of other terms and present them for consideration at the next meeting.

The **Information Theory and Modulation Systems** Committee met at IRE Headquarters on June 1 with J. G. Kreer presiding. The committee discussed and amended the Information Theory Definitions now under consideration.

H. R. Minno presided at a meeting of the **Navigation Aids** Committee at IRE Headquarters on June 17. The committee continued its discussion of the proposed standard on "VHF Omni-Directional Radio Range (VOR)." Minor revisions and minor

editorial changes were noted. The committee noted, but did not settle, certain policy questions regarding the possible subdivision of the system into major components for measurement standardization purposes.

The **Standards Committee** met at IRE Headquarters on June 7 with Chairman E. Weber presiding. The following proposed standards were discussed, amended, and approved and will appear in *THE PROCEEDINGS* shortly: "Standards on Industrial Electronics: Definitions of Industrial Electronic Terms, 1955;" "Standards on Antennas and Waveguides: Definitions of Waveguide Components, 1955;" "Standards on Pulses: Methods of Measurement of Pulse Quantities, 1955;" "Standards on Radio Receivers: Method of Testing Receivers Employing Ferrite Core Loop Antennas, 1955;" and "Standards on Graphical and Letter Symbols for Feedback Control Systems, 1955." The proposed standard on "Terminology for Feedback Control Sys-

tems" was discussed and will be completed at the next meeting of the Standards Committee. It was unanimously approved on motion by Mr. Shea and seconded by Mr. Baldwin that the Standards Committee recommend to the Executive Committee that the title of the Semiconductor Devices Committee be changed to the Solid State Devices Committee and their scope be changed accordingly. Dr. Weber announced that the following appointments had been approved at the last meeting of the Executive Committee: upon resignation of Mr. Dodds, P. A. Redhead was appointed Chairman of the Electron Tubes Committee; L. E. Coffey, Telecommunication Division, Department of Transport, Ottawa, Canada was appointed as a non-IRE member to the Radio Frequency Interference Committee. P. A. Fleming, British Radio Valve Manufacturers, London, England, was appointed as a non-IRE member to the Electron Tubes Committee.

## Books

### **Analog Methods in Computation and Simulation** by Walter W. Soroka

Published (1954) by McGraw-Hill Book Co., Inc., 330 W. 42 St., N. Y. 36, N. Y. 380 pages +9 page index +xii pages. Illus. 9 1/2 X 6 1/2. \$7.50.

This book describes various electrical and mechanical components which (ideally) obey fundamental mathematical laws, and proceeds to demonstrate how computers and simulators may be constructed from these basic building blocks. The chapters are: "Mechanical Computing Elements;" "Electromechanical, Electrical, and Electronic Computing Elements;" "Machines for Simultaneous Linear Algebraic Equations;" "Analog Solution of Nonlinear Algebraic Equations;" "The Mechanical Differential Analyzer;" "Electronic Analog Computers (Electronic Differential Analyzers);" "Dynamical Analogies;" "Equivalent Circuits for Ordinary and Partial Differential Equations in Finite Differences;" and "Membrane and Conducting-sheet Analogies."

The analog computer has both a long history and a current vitality. The basic precepts may be quickly enumerated, but a feeling for the subject is developed only through acquaintance with a wide spectrum of examples, many in the "ingenious device" category. Prof. Soroka has provided these examples in profusion, yet without making the book a mere catalog of miscellany. He has done a good job of collecting and organizing material largely available heretofore only in isolated spots. The book is descriptive, but the author does not hesitate to "put the numbers in."

The problem of scaling receives adequate attention throughout the book, and the technical limitations of many of the computers described are indicated. A particu-

larly valuable addition would have been the expansion of the brief chapter on electronic analog computers to include checking procedures and error analysis techniques.

The author's preface indicates that the book is considered a textbook; however, no exercises for the student are included. Properly employed, it could form the basis for a course at perhaps a high undergraduate level, although appreciation of the fine points in certain chapters requires somewhat more advanced training. Laboratory work would be essential, and might well be modeled upon examples in the book.

The practicing engineer will find this a useful basic reference, but one which does not attempt to solve his practical problems of detail design to meet space and weight limitations or to ensure reliable operation under adverse environmental conditions. In this connection, the reader will be grateful that the book contains a wealth of basic references to the literature.

LOUIS B. WADEL  
Chance Vought Aircraft, Inc.  
Dallas, Texas

### **Servomechanisms and Regulating System Design: Volume II** by Harold Chestnut and Robert Mayer

Published (1955) by John Wiley and Sons, Inc., 440 Fourth Ave., New York 1, N. Y. 368 pages +8 page index +xii pages. Illustrated. 9 1/2 X 6. \$8.50.

An engineer who has had the experience of reducing a control system to practice soon recognizes the rather substantial gap between theory and practical design. Theory considers the broad and general fundamentals that describe the performance of the system. On the other hand, practical design

requires the translation of the control task into technical specifications and the specific means of implementation. Included in the latter are error-sensing circuits, actuators, transducers, amplifiers and other components. The designer must also recognize and minimize the effects of imperfections such as drift, backlash, noise, saturation, nonlinearities, and overheating which are present in the physical components he is compelled to use. While there are many books which deal with the theory of feedback control systems (such as volume one of this same work), there are very few which deal with practical design. For this reason, this book is a most valuable and welcome addition to the library of the control engineer.

The first part deals with the measurement techniques for obtaining transfer functions of components. The only criticism offered here is that this reviewer's experience has been that except for simple cases the accurate deduction of transfer functions from test data is not quite as direct and simple as the authors seem to imply. Following this, there is material on the setting of dynamic specifications of the system as influenced by the systematic inputs the system is required to follow and the noise it is required to reject. Selection of motors and actuators, network design, amplifier design and the handling of ac carrier servomechanisms round out the material on design. The authors restrict themselves largely to electrical and electronic systems, omitting other forms of implementation. It concludes with a substantial amount of material on nonlinearities such as saturation and backlash, on-off systems and the use of non-linear components for compensation.

Generally speaking, the book is well written and is replete with information of practical value to the engineer. The presentation, while analytical, is not too complex thus making the book easily readable by the practicing engineer and student. A comprehensive bibliography is available as an appendix so that the reader may broaden his coverage should he wish to do so. The lack of problems is one factor which lessens its value as a student textbook. On the other hand, it is recognized that meaningful problems in practical design are very difficult to devise and the lack of problems is quite understandable. This book is a very worthwhile addition to the list of texts dealing with feedback control and it is highly recommended to those engineers and students who have an interest in the practical design of servomechanisms.

JOHN R. RAGAZZINI  
Columbia University  
New York, N. Y.

### The Amplification and Distribution of Sound by A. E. Greenlees

Published (1954) by Chapman and Hall Ltd., 37 Essex St. W.C. 2, London, England. 295 pages + 5 page index + x pages. 114 Figs. 8½ × 5½. 35s.

The author of this third revised edition faithfully pursues the purpose stated in the preface—"to present a general survey of the principles of sound amplification and distribution, showing the practical considerations involved, together with sufficient technical detail to enable the reader to appreciate the fundamental principles." The book is a survey in that a wide variety of subjects is covered lightly, though not superficially. By reading this book a beginner in sound amplification covers the field rapidly without getting deeply involved in any one branch of the subject. The emphasis throughout is on practical consideration and, although many technical details are omitted, it is to the author's credit that technical correctness has not been sacrificed.

Chapters are included on amplifier components, typical amplifier circuits, amplifier performance factors; audio sources such as radio receivers, microphones, and records of various types; loudspeakers, installation acoustics, system layouts; operation and maintenance of equipment; and the preparation of sound equipment specifications. No attempt is made to assign specific values to circuit components or to describe the mechanical design of electroacoustic components in terms of actual dimensions. The numerous block diagrams, charts, and schematics are intended to be illustrative rather than specific.

Little, if any, mathematical background or prerequisite reading is required for the reader of this book. The reader would do well, however, to have as alternative background a modicum of experience with sound systems, and additional experience of this type is recommended as an accompaniment to the study program.

Although sound amplification systems cannot, as the author states, "improve the acoustics of the building," their proper design, installation, and use can go far to overcome an adverse acoustical environment. The book will be very useful to sound system dealers, service technicians, and operators,

as well as to architects and others in need of immediate direct information on sound amplification systems.

DANIEL W. MARTIN  
Baldwin Piano Company  
Cincinnati, Ohio

### An Outline of Atomic Physics by O. H. Blackwood, T. H. Osgood, and A. E. Ruark

Published (1955) by John Wiley and Sons, Inc., 440 Fourth Ave., New York 16, N. Y. 474 pages + 12 page index + x pages + 9 Appendixes. Illus. 9½ × 6. \$7.50.

This well-rounded exposition is the third edition of a text originally designed to provide college students with a thorough-going knowledge and understanding of the structure and behavior of atoms, molecules, and radiation. While the intended reader is expected to have completed a year's course in college physics, the book is written primarily for students aspiring to professions other than physics.

The contents of the book may be roughly divided into two classes. First nine chapters contain descriptions of the atomic nature of matter and of electricity, the forms and properties of radiant energy, atomic and molecular spectra, the duality of waves and particles, and a brief treatment of solids. The remaining six chapters may be roughly classed as nuclear physics, and include discussions of radioactivity, the elementary particles, nuclear transmutations, cosmic rays, and the theory of relativity.

The authors have avoided the use of calculus and higher mathematics throughout the text; nevertheless they make a determined (and generally highly successful) attempt to give the full story of the physics involved. They give to the reader not only the present-day physical theories but also the ideas which led to their formation. Where our knowledge is vague or contradictory this is pointed out, and the dilemmas of physics are discussed as freely as its successes.

Altogether, the radio engineer who is interested in getting an accurate and complete picture of the physics which interrelates the phenomena underlying his profession, and who wishes, as the authors state, "to go to the frontiers of physics and see for himself what manner of things must be done to take the next step forward" will find this book rewarding. The subject matter is not easy, and most readers will find that a considerable degree of concentration is required. The authors' presentation is, however, remarkable for its clarity, and those who expend the effort to absorb and retain this material will find unfolding a fascinating story of the triumphs of modern thought in unravelling some of the fundamental mysteries of nature.

JOHN W. COLTMAN  
Westinghouse Research Laboratories  
East Pittsburgh, Pennsylvania

### Servomechanism Practice by William R. Ahrendt

Published (1954) by McGraw-Hill Book Co., Inc., 330 W. 42 St., N. Y. 36, N. Y. 341 pages + 7 page index + vii pages. 283 figures. 9½ × 6½. \$7.00.

This book is ideal for a manufacturer of instrument servomechanisms. The solutions

which it gives to problems in fabrication, construction, component selection, circuitry, vibration, temperature variations, tolerances, and nonlinearities, are of considerable value to maintenance engineers and to manufacturers of all types of feedback control systems.

The writing is clear, simple, nonmathematical, easy to read, and accurate. It can be studied and mastered by a practicing engineer or an undergraduate student without the help of a teacher. Block diagrams are used effectively in the presentation by often appearing with the detailed circuit diagram.

There are a number of good examples of complete electric and hydraulic instrument servomechanisms with specifications, component characteristics, system analyses, and actual system performances. The book is excellent in its treatment of manufacturing techniques, nonlinearities in small components, and the observed effect of these nonlinearities on system performance. The selection of a prime mover and gear ratios is covered in detail.

In its limited scope, this work fulfills an important need, duplicating no other book. It has very little, however, on control theory, high power industrial control systems, analogs or function computers. It does not discuss process control servos, guidance of large objects, digitally or periodically controlled systems, on-off or relay systems, nonlinear predictor systems, tension, velocity, or fabrication controls. It has nothing on statistical disturbances, or the formulation of specifications. It does not cover graphical, electrolytic, or analog aids for the design steps.

This book unfortunately does not have a wide enough scope to serve as a laboratory text for engineers in training, but it is an excellent guide for the final design and production engineers who must bridge the gap between preliminary design and delivery.

OTTO J. M. SMITH  
Instituto Tecnológico de Aeronáutica,  
Sao Jose dos Campos, Est. Sao Paulo, Brasil

## RECENT BOOKS

*ASTM Standards on Electrical Insulating Materials.* Compiled by ASTM Committee D-9 on Electrical Insulating Materials. American Society for Testing Materials, 1916 Race St., Philadelphia 3, Pa. \$5.50.

Banner, E. H. W., *Electronic Measuring Instruments.* Chapman and Hall Ltd., 37 Essex St., W.C. 2, London, England. 45 S.

Duschinsky, W. J., *TV Stations: A Guide for Architects, Engineers, and Management.* Reinhold Publishing Corp., 430 Park Ave., N. Y. 30, N. Y. \$12.00.

Higdon, Archie, and Stiles, William B., *Engineering Mechanics.* Prentice-Hall, Inc., 70 Fifth Ave., N. Y. 11, N. Y. \$7.95.

Kiver, Milton S., *Introduction to UHF Circuits and Components.* D. Van Nostrand Co., Inc., 250 Fourth Ave., New York, N. Y. \$7.50.

*Proceedings of the Third Meeting of the Joint Commission on Radiometeorology.* U.R.S.I. 42 Rue des Minimes, Brussels, Belgium. \$5.00.

# Professional Groups

**Aeronautical & Navigational Electronics**—*Chairman*, Edgar A. Post, Navigational Aides, United Air Lines, Operations Base, Stapleton Field, Denver 7, Colo.

**Antennas & Propagation**—*Chairman*, Delmer C. Ports, Jansky & Bailey, 1339 Wisconsin Ave., N.W., Washington 7, D. C.

**Audio**—*Chairman*, W. E. Kock, Bell Tel. Labs., Murray Hill, N. J.

**Automatic Control**—*Chairman*, Robert B. Wilcox, Raytheon Manufacturing Co., 148 California St., Newton 58, Mass.

**Broadcast & Television Receivers**—*Chairman*, W. P. Boothroyd, Philco Corp., Philadelphia 34, Pa.

**Broadcast Transmission Systems**—*Chairman*, O. W. B. Reed, Jr., Jansky & Bailey, 1735 DeSales St., N.W., Washington, D. C.

**Circuit Theory**—*Chairman*, J. Carlin, Microwave Res. Inst., Polytechnic Inst. of Brooklyn, 55 Johnson St., Brooklyn 1, N. Y.

**Communications Systems**—*Chairman*, A. C.

Peterson, Jr., Bell Labs., 463 West St., New York 14, N. Y.

**Component Parts**—*Chairman*, Floyd A. Paul, Reliability Bendix Development Lab., 116 W. Olive Avenue, Burbank, Calif.

**Electron Devices**—*Chairman*, J. S. Saby, Electronics Laboratory, G.E. Co., Syracuse, N. Y.

**Electronic Computers**—*Chairman*, J. H. Felker, Bell Labs., Whippany, N. J.

**Engineering Management**—*Chairman*, C. J. Breitwieser, Lear, Inc., 3171 S. Bundy Drive, Los Angeles 34, Calif.

**Industrial Electronics**—*Chairman*, George P. Bosonworth, Engrg. Lab., Firestone Tire & Rubber Co., Akron 17, Ohio

**Information Theory**—*Chairman*, Louis A. DeRosa, Federal Telecommunications Lab., Inc., 500 Washington Avenue, Nutley, N. J.

**Instrumentation**—*Chairman*, F. G. Marble, Boonton Radio Corp., Intervale Rd., Boonton, N. J.

**Medical Electronics**—*Chairman*, Dr. Julia F. Herrick, Inst. of Experimental Medicine, Mayo Found, Rochester, Minn.

**Microwave Theory and Techniques**—*Chairman*, A. C. Beck, Bell Labs., 463 West St., New York 14, N. Y.

**Nuclear Science**—*Chairman*, M. A. Schultz, Westinghouse Automatic Power Division, Bettis Field, Pittsburgh 30, Pa.

**Reliability and Quality Control**—*Chairman*, Victor Wouk, Beta Electric Corp., 333 E. 103rd St., New York 29, N. Y.

**Production Techniques**—*Chairman*, R. R. Batcher, 240-02—42nd Ave., Douglaston, L. I., N. Y.

**Telemetry and Remote Control**—*Chairman*, C. H. Hoepfner, Stavid Engineering, Plainfield, N. J.

**Ultrasonics Engineering**—*Chairman*, M. D. Fagen, Bells Labs., Whippany, N. J.

**Vehicular Communications**—Newton Monk, Bell Telephone Labs., 463 West St., New York, N. Y.

## Sections\*

**Akron (4)**—H. L. Flowers, 2029 19 St., Cuyahoga Falls, Ohio; H. F. Lanier, 49 W. Lowell Ave., Akron, Ohio.

**Alberta (8)**—Officers to be elected.

**Albuquerque-Los Alamos (7)**—T. G. Banks, Jr., 1124 Monroe St., S.E., Albuquerque, N. M.; G. A. Fowler, 3333 49 Loop, Sandia Base, Albuquerque, N. M.

**Atlanta (3)**—D. L. Finn, School of Electrical Engineering, George Institute of Technology, Atlanta, Ga.; P. C. Toole, 605 Morningside Dr., Marietta, Ga.

**Baltimore (3)**—C. F. Miller, Johns Hopkins University, 307 Ames Hall, Baltimore 18, Md.; H. R. Hyder, III, Route 2, Owings Mills, Md.

**Bay of Quinte (8)**—J. C. R. Punchard, Elec. Division, Northern Elec. Company, Ltd., Sydney St., Belleville, Ont., Canada; M. J. Waller, R.R. 1, Foxboro, Ont., Canada.

**Beaumont-Port Arthur (6)**—W. W. Eckles, Jr., Sun Oil Company, Prod. Lab., 1096 Calder Ave., Beaumont, Tex.; E. D. Coburn, Box 793, Nederland, Tex.

**Binghamton (4)**—O. T. Ling, 100 Henry St., Binghamton, N. Y.; Arthur Hambrgen, 102 S. Nanticoke Ave., Endicott, N. Y.

**Boston (1)**—T. P. Cheatham, Jr., Hosmer St., Marlborough, Mass.; R. A. Waters, 4 Gordon St., Waltham 54, Mass.

**Buenos Aires**—J. M. Rubio, Ayachucho 1147, Buenos Aires, Argentina; J. L. Blon, Transradio Internacional, San Martin 379, Buenos Aires, Argentina.

**Buffalo-Niagara (1)**—D. P. Welch, 859 Highland Ave., Buffalo 23, N. Y.; W. S. Holmes, 1961 Ellicott Rd., West Falls, N. Y.

**Cedar Rapids (5)**—Ernest Pappenfus, 1101 30 St. Dr., S.E., Cedar Rapids, Iowa; E. L. Martin, 1119 23 St., S.E., Cedar Rapids, Iowa.

**Central Florida (3)**—Hans Scharla-Nielsen, Radiation Inc., P.O. Drawer "Q," Melbourne, Fla.; G. F. Anderson, Radiation Inc., P.O. Box "Q," Melbourne, Fla.

**Chicago (5)**—J. S. Brown, 9829 S. Hoyne Ave., Chicago 43, Ill.; D. G. Haines, 17 W. 121 Oak Lane, Bensenville, Ill.

**Cincinnati (4)**—D. W. Martin, The Baldwin Company, 1801 Gilbert, Cincinnati 2, Ohio; F. L. Wedig, Jr., 3819 Davenant Ave., Cincinnati 13, Ohio.

**Cleveland (4)**—R. H. DeLany, 5000 Euclid Ave., Cleveland 3, Ohio; J. F. Keithley, 22775 Douglas Rd., Shaker Heights 22, Ohio.

**Columbus (4)**—R. W. Masters, 1633 Essex Rd., Columbus 21, Ohio; R. L. Cosgriff, 2200 Homestead, Columbus, Ohio.

**Connecticut Valley (1)**—P. F. Ordung, Dunham Laboratory, Yale University, New Haven, Conn.; H. M. Lucal, Box U-37, University of Connecticut, Storrs, Conn.

**Dallas-Fort Worth (6)**—M. W. Bullock, 6805 Northwood Rd., Dallas 25, Tex.; C. F. Seay, Jr., Collins Radio Company, 1930 Hi-Line Dr., Dallas, Tex.

**Dayton (5)**—M. A. McLennan, 304 Schenck Ave., Dayton 9, Ohio; N. A. Nelson, 310 Lewiston Rd., Dayton 9, Ohio.

**Denver (6)**—J. W. Herbstreit, 2000 E. Ninth Ave., Boulder, Colo.; R. S. Kirby, 455 Hawthorne Ave., Boulder, Colo.

**Des Moines-Ames (5)**—A. A. Read, 511 Northwestern Ave., Ames, Iowa; W. L. Hughes, E.E. Department, Iowa State College, Ames, Iowa.

**Detroit (4)**—N. D. Saigeon, 1544 Grant, Lincoln Park 25, Mich.; A. L. Coates, 1022 E. Sixth St., Royal Oak, Mich.

**Elmira-Corning (1)**—J. L. Sheldon, 179 Dodge Ave., Corning, N. Y.; J. P. Hocker, Corning Glass Works, Corning, N. Y.

**El Paso (6)**—J. C. Nook, 1126 Cimarron St., El Paso, Tex.; J. H. Maury, 3519 Ft. Blvd., El Paso, Tex.

**Emporium (4)**—E. H. Boden, R.D. 1, Emporium, Pa.; H. S. Hench, Jr., R.D. 2, Emporium, Pa.

**Evansville-Owensboro (5)**—A. P. Haase, 2230 St. James Ct., Owensboro, Ky.; D. D. Mickey, Jr., Engineering Department, General Electric Company, Owensboro, Ky.

**Fort Wayne (5)**—C. L. Hardwick, 2905 Chestnut St., Fort Wayne 4, Ind.; Paul Rudnick, Farnsworth Electronics Company, Fort Wayne 1, Ind.

**Hamilton (8)**—G. F. Beaumont, 6 Tallman Ave., Burlington, Ont., Canada; C. N. Chapman, 40 Dundas St., Waterdown, Ont., Canada.

**Hawaii (7)**—H. E. Turner, 44-271 Mikiola Dr., Kaneohe, Hawaii; G. H. Hunter, Box 265, Lanikai, Oahu, T.H.

**Houston (6)**—L. W. Erath, 2831 Post Oak Rd., Houston, Tex.; J. M. Bricaud, Schlumberger Well Surveying Corporation, Box 2175, Houston 1, Tex.

**Huntsville (3)**—D. E. French, 1403 E. Clinton St., Huntsville, Ala.; T. L. Greenwood, 1709 La Grande St., Huntsville, Ala.

**Indianapolis (5)**—A. J. Schultz, 908 E. Michigan St., Indianapolis, Ind.; H. L. Wisner, 5418 Rosslyn Ave., Indianapolis 20, Ind.

**Inyokern (7)**—G. D. Warr, 213-A Wasp Rd., China Lake, Calif.; B. B. Jackson, 54-B Rowe St., China Lake, Calif.

**Israel**—Frauz Ollendorf, Box 910, Hebrew Institute of Technology, Haifa, Israel; J. H. Halberstein, P.O. Box 1, Kiriath Mozkin, Israel.

**Ithaca**—Benjamin Nichols, School of Electrical Engineering, Cornell University, Ithaca, N. Y.; Howard Heydt, General Electric Co., Advanced Electronics Center, Cornell University Airport, Ithaca, N. Y.

\* Numbers in parentheses following Section designate Region number, first name designate, Chairman, second name, Secretary.

(Cont'd on next page)

(Sections cont'd)

- Kansas City (6)**—K. V. Newton, Bendix Aviation Corporation, Box 1159, Kansas City 41, Mo.; Mrs. G. L. Curtis, Radio Industries, Inc., 1307 Central Ave., Kansas City 2, Kan.
- Little Rock (6)**—J. E. Wylie, 2701 N. Pierce, Little Rock, Ark.; J. C. Spilman, 34 Lakeshore Dr., Route 9, Little Rock, Ark.
- London (8)**—C. F. MacDonald, 328 St. James St., London, Ont., Canada; J. D. B. Moore, 27 McClary Ave., London, Ont., Canada.
- Long Island (2)**—P. G. Hansel, Addison Lane, Greenvale, L. I., N. Y.; J. Neidert, 9 Surrey Rd., New Hyde Park, L. I., N. Y.
- Los Angeles (7)**—B. S. Angwin, 3300 Colby Ave., Los Angeles 34, Calif.; C. E. Rutherford, 209 S. Oakhurst Dr., Beverly Hills, Calif.
- Louisville (5)**—R. W. Mills, 1017 Eastern Pkwy., Louisville 4, Ky.; L. A. Miller, 314 Republic Building, Louisville 2, Ky.
- Lubbock (6)**—H. A. Spuhler, F. E. Dept., Texas Tech. College, Lubbock, Tex.; J. W. Dean, 1903 49 St., Lubbock, Tex.
- Miami (3)**—C. S. Clemans, Station WSWN, Belle Glade, Fla.; H. F. Bernard, 1641 S.W. 82 Pl., Miami, Fla.
- Milwaukee (5)**—W. E. Watts, 2224 N. 70 St., Wauwatosa 13, Wis.; W. A. Van Zealand, 4510 N. 45 St., Milwaukee 16, Wis.
- Montreal (8)**—Sydney Bonneville, Room 1427, 1050 Beaver Hall Hill, Montreal, P. Q., Canada; R. E. Penton, 2090 Claremont Ave., Montreal, P. Q., Canada.
- New Orleans (6)**—J. A. Cronvich, Department of Electrical Engineering, Tulane Univ., New Orleans 18, La.; N. R. Landry, 620 Carol Dr., New Orleans 21, La.
- New York (2)**—A. B. Giordano, 85-99 Livingston St., Brooklyn, N. Y.; H. S. Renne, Radio-Electronic Engr., 366 Madison Ave., New York 17, N. Y.
- North Carolina-Virginia (3)**—J. C. Mace, 1616 Jefferson Park Ave., Charlottesville, Va.; A. L. Comstock, 1404 Hampton Dr., Newport News, Va.
- Northern New Jersey (2)**—W. R. Thurston, 923 Warren Pkwy., Teaneck, N. J.; R. J. Kircher, 145 Maple St., Summit, N. J.
- Northwest Florida (3)**—B. H. Overton, Box 115, Shalimar, Fla.; G. C. Fleming, 579 E. Gardner Dr., Fort Walton Beach, Fla.
- Oklahoma City (6)**—A. P. Challenner, University of Oklahoma, Norman, Okla.; Frank Herrmann, 1913 N.W. 21 St., Oklahoma City, Okla.
- Omaha-Lincoln (5)**—M. L. McGowan, 5544 Mason St., Omaha 6, Neb.; C. W. Rook, Department of Electrical Engineering, University of Nebraska, Lincoln 8, Neb.
- Ottawa (8)**—George Glinski, 14 Dunvegan Rd., Ottawa, Ont., Canada; C. F. Pattenson, 3 Braemar, Ottawa 2, Ont., Canada.
- Philadelphia (3)**—C. R. Kraus, Bell Telephone Company of Pennsylvania, 1835 Arch St., Philadelphia 3, Pa.; Nels Johnson, Philco Corporation, 4700 Wissahickon Ave., Philadelphia 44, Pa.
- Phoenix (7)**—W. R. Saxon, 641 E. Missouri, Phoenix, Ariz.; G. L. McClanathan, 509 E. San Juan Cove, Phoenix, Ariz.
- Pittsburgh (4)**—J. N. Grace, 112 Heather Dr., Pittsburgh 34, Pa.; J. B. Woodford, Jr., Box 369, Carnegie Tech. P.O., Pittsburgh 13, Pa.
- Portland (7)**—J. M. Roberts, 4325 N.E. 77, Portland 13, Ore.; D. C. Strain, 7325 S.W. 35 Ave., Portland 19, Ore.
- Princeton (2)**—G. C. Sziklai, Box 3, Princeton, N. J.; L. L. Burns, Jr., R.C.A. Laboratories, Princeton, N. J.
- Rochester (1)**—Allan Holstrom, 551 Spencer Rd., Rochester 9, N. Y.; W. F. Bellor, 186 Dorsey Rd., Rochester 16, N. Y.
- Rome-Utica (1)**—Harry Davis, 716 Cherry St., Rome, N. Y.; M. V. Ratynski, 205 W. Cedar St., Rome, N. Y.
- Sacramento (7)**—R. C. Bennett, 3401 Chenu Ave., Sacramento, Calif.; R. A. Poucher, Jr., 3021 Mountain View Ave., Sacramento 21, Calif.
- St. Louis (6)**—F. A. Fillmore, 5758 Itaska St., St. Louis 9, Mo.; Christopher Efthim, 1016 Louisville Ave., St. Louis 10, Mo.
- Salt Lake City (7)**—M. E. Van Valkenburg, Department of Electrical Engineering, University of Utah, Salt Lake City 1, Utah; A. L. Gunderson, 3906 Parkview Dr., Salt Lake City, Utah.
- San Antonio (6)**—C. M. Crain, Engineering Building 149, University of Texas, Austin 12, Tex.; W. H. Hartwig, Dept. E. E., University of Texas, Austin 12, Tex.
- San Diego (7)**—F. X. Byrnes, 1759 Beryl St., San Diego 9, Calif.; R. T. Silberman, 4274 Middlesex Dr., San Diego, Calif.
- San Francisco (7)**—B. M. Oliver, 395 Page Mill Rd., Palo Alto, Calif.; Wilson Pritchett, Div. of Electrical Engineering, University of California, Berkeley 4, Calif.
- Schenectady (1)**—C. C. Allen, 2064 Baker Ave., Schenectady 9, N. Y.; A. E. Rankin, 833 Whitney Dr., Schenectady, N. Y.
- Seattle (7)**—W. C. Galloway, 5215 Pritchard St., Seattle 6, Wash.; L. O. Nelson, 10303 13 Ave., N.W., Seattle 77, Wash.
- Syracuse (1)**—A. D. Arsem, G.E. Co., Electronics Park, Syracuse, N. Y.; G. M. Glasford, E. E. Dept., Syracuse Univ., Syracuse 10, N. Y.
- Toledo (4)**—L. R. Klopfenstein, Portage, Ohio; D. F. Cameron, 1619 Milburn Ave., Toledo 6, Ohio.
- Toronto (8)**—A. P. H. Barclay, 2 Pine Ridge Dr., Toronto 13, Ont., Canada; H. W. Jackson, 352 Laird Dr., Toronto 17, Ont., Canada.
- Tulsa (6)**—C. F. Hadley, 1356 E. 45 Pl., Tulsa 15, Okla.; L. H. Hooker, 4064 E. 22 Pl., Tulsa 5, Okla.
- Twin Cities (5)**—N. B. Coil, 1664 Thomas Ave., St. Paul 4, Minn.; A. W. Sear, 5801 York Ave., S., Minneapolis 10, Minn.
- Vancouver (8)**—J. E. Breeze, 5591 Toronto Rd., Vancouver 8, B. C., Canada; R. A. Marsh, 3873 W. 23 Ave., Vancouver, B. C., Canada.
- Washington (3)**—H. I. Metz, U. S. Government Department of Commerce, CAA, Room 2076, T-4 Building, Washington 25, D. C.; A. H. Schooley, 3940 First St., S.W., Washington 24, D. C.
- Williamsport (4)**—J. E. Snook, 1629 Warren Ave., Williamsport, Pa.; F. T. Henry, 1345 Pennsylvania Ave., Williamsport, Pa.
- Winnipeg (8)**—R. M. Simister, 179 Renfrew St., Winnipeg, Man., Canada; G. R. Wallace, 400 Smithfield Ave., Winnipeg, Man., Canada.

## Subsections

- Amarillo-Lubbock (6)**—R. B. Spear, 510 E. Hill St., Brownfield, Tex.; J. B. Joiner, 2621 30 St., Lubbock, Tex.
- Berkshire (1)**—Gilbert Devey, Sprague Elec. Co., Marshall St., Building 1, North Adams, Mass.; R. P. Shechan, Ballou Lane, Williamstown, Mass.
- Buenaventura (7)**—E. C. Sterneke, 320 Vista Del Mar, Camarillo, Calif.; Oliver La Plant, 325 N. "J" St., Oxnard, Calif.
- Centre County (4)**—W. L. Baker, 1184 Omeida St., State College, Pa.; W. J. Leiss, 1173 S. Atherton St., State College, Pa.
- Charleston (3)**—W. L. Schachte, 152 Grove St., Charleston 22, S. C.; Arthur Jonas, 21 Madden Dr., Dorchester Ter., Charleston Heights, S. C.
- East Bay (7)**—J. M. Rosenberg, 1134 Norwood Ave., Oakland 10, Calif.; C. W. Park, 6035 Chabolv Ter., Oakland 18, Calif.
- Erie (1)**—R. S. Page, 1224 Idaho Ave., Erie 10, Pa.; R. H. Tuznik, 905 E. 25 St., Erie, Pa.
- Fort Huachuca (7)**—R. O. Burns, Electronic Prov. Gd., Ft. Huachuca, Ariz.; J. H. Homsy, Gen. Del., Warren, Ariz.
- Lancaster (3)**—G. W. Scott, Jr., Armstrong Cork Co., Lancaster, Pa.; G. E. Mandell, 522 E. King St., Lancaster, Pa.
- Mid-Hudson (2)**—E. A. Keller, Red Oaks Mill Rd., R.D. 2, Poughkeepsie, N. Y.; P. A. Bunyar, 760 South Rd., Poughkeepsie, N. Y.
- Monmouth (2)**—G. F. Senn, 81 Garden Rd., Little Silver, N. J.; C. A. Borgeson, 82 Garden Rd., Little Silver, N. J.
- Northwest Florida (6)**—K. L. Huntley, Mary Esther, Fla.; G. C. Jones, 12 N. Okaloosa Rd., Fort Walton Beach, Fla.
- Orange Belt (7)**—M. V. Kiebert, Jr., 1937 Elaine St., Pomona, Calif.; W. F. Meggers, Jr., 6844 De Anza Ave., Riverside, Calif.
- Palo Alto (7)**—W. W. Harman, Electronic Res. Lab., Stanford Univ., Stanford, Calif.; W. G. Abraham, 611 Hansen Way, c/o Varian Associates, Palo Alto, Calif.
- Pasadena (7)**—Officers to be elected.
- Richland (7)**—R. G. Clark, 1732 Howell, Richland, Wash.; R. E. Connally, 515 Cottonwood Dr., Richland, Wash.
- Tucson (7)**—R. C. Eddy, 5211 E. 20 St., Tucson, Ariz. (Chairman).
- USAFIT (5)**—W. T. Jones, USAFIT, Box 3125, MCLI, Wright-Patterson AFB, Ohio; J. J. Gallagher, Box 3482, USAFIT, Wright-Patterson AFB, Ohio.
- Westchester County (2)**—Joseph Reed, 52 Hillcrest Ave., New Rochelle, N. Y.; D. S. Kellogg, 9 Colonial Dr., Chappaqua, N. Y.
- Wichita (6)**—M. E. Dunlap, 548 S. Lorraine Ave., Wichita 16, Kan.; English Piper, 1838 S. Parkwood Lane, Wichita, Kan.

# 1955 INDUSTRIAL ELECTRONICS CONFERENCE

SPONSORED BY DETROIT SECTION, PG ON INDUSTRIAL ELECTRONICS, AND MICHIGAN SECTION OF AIEE  
DETROIT, MICHIGAN, SEPTEMBER 28-29

The Industrial Electronics Conference will be held at the Rackham Memorial Auditorium in Detroit, Michigan, September 28-29. The meeting is sponsored jointly by the Michigan Section of the American Institute of Electrical Engineers, the Professional Group on Industrial Electronics of the Institute of Radio Engineers and the Detroit Section of the IRE. Sixteen papers have been scheduled for the four technical sessions which will discuss automation, industrial measurement problems and new control system applications. The tentative program for the two-day conference is as follows:

Conference Registration will be \$2.00 to members of the IRE and AIEE and \$3.00 to all others. The conference hotel will be the Park-Shelton and reservations should be made prior to September 10. Information concerning advance conference registration and hotel reservations may be obtained from Guido Ferrara, 8106 West Nine Mile Road, Oak Park 37, Michigan.

## Wednesday Morning

9:30—12:30

### SESSION I—ELECTRO-OPTICAL DEVICES AND APPLICATIONS

- "Miniature Strobelight System for a 60,000 rpm Bearing Tester," John Patraiko, Ford Motor Company.
- "An Instrument to Count and Size Particles in a Gas," E. S. Gordon, Armour Research Foundation.

"Industrial Applications of a High Speed Spectrum Analyzer," N. L. Duncan, Raytheon Manufacturing Company.

"How Can Industry Use Television," H. F. Schneider, Radio Corporation of America.

12:30—2:30 p.m.

Luncheon at the Engineering Society of Detroit—\$2.75 per person. Speaker: John R. Robertson, Chrysler Corporation.

2:30—5:30 p.m.

### SESSION II—MEASURING AND RECORDING INSTRUMENTS AND APPLICATIONS

"Capacitive Measurements of High Sensitivity and Their Applications to Industrial Testing and Control," George Revesz, Robertshaw Fulton Control Company.

"Some Applications of a Capacity Micrometer to High Speed, High Temperature Measurements," Ralph Condit, Ford Motor Company.

"Principles of Radioactive Gauging Applied to Measurements and Control in the Process Industry," D. C. Brunton, Isotope Products, Ltd.

"A Frequency-Modulated Magnetic Recorder," Walter Richter, Cutler-Hammer, Inc.

Thursday, September 29

9:30—12:30 p.m.

### SESSION III—PROCESS CONTROL AND SYSTEMS ANALYSIS

"Automatic and Semi-Automatic Steel Flow Control Systems," Robert D. Morrow, Morrow Products, Inc.

"Problems in the Control of Nuclear Reactor Steam-Electric Power Plants," William Kerr, University of Michigan.

"Ultrasonic Impact Grinder—Industrial Tool," Kenneth W. Henderson, Raytheon Manufacturing Company.

"Automatic Controlled Electrolytic Grinding," Eugene Mittelmann.

12:30—2:30 p.m.

Luncheon at the Engineering Society of Detroit—\$2.75 per person

2:30—5:30 p.m.

### SESSION IV—AUTOMATION AND MACHINE TOOL CONTROL

Title to be announced, Cleo Brunetti, General Mills, Inc.

"Automation Re-Examined," J. J. Graham, Radio Corporation of America.

"A Numerically-Controlled Cam Milling Machine," E. C. Johnson, Bendix Aviation Corporation.

"Two-Motion Duplicator for Machine Tool Control," A. J. Carr, Jr., Raytheon Manufacturing Company.

## RADIO FALL MEETING PROGRAM

HOTEL SYRACUSE,

SYRACUSE, N. Y.

OCTOBER 17-19

Monday, October 17

9:30 A.M.

*Report on the FCDA-RETMA Atomic Test of Commercial Equipment*, R. H. Williamson, General Electric Co.

Additional paper to be announced.

2:00 P.M.

Sponsored by the IRE Professional Group on Reliability and Quality Control  
*Session Chairman*, J. R. Steen, Sylvania Electric Co.

*Type Test to Assure TV Performance Reliability*, R. F. Rollman, C. Quirk, A. B. DuMont Laboratories.

*Influence of Production Quality Distributions on Production Engineering*, H. H. Mahuron, General Electric Co.

Two additional papers to be announced.

Tuesday, October 18

Sponsored by the IRE Professional Group on Broadcast and Television Receivers

9:00 A.M.

### TRANSISTORIZATION SESSION

*Session Chairman*, W. P. Boothroyd, Philco Corp.

*The Practical Application of Transistors in Monochrome Television Circuits*, Ken James, Emerson Radio and Phonograph Corp.

*Some Recent Advances in the Application of Transistors to R-F and I-F Radio Receiver Circuits*, J. Karew, F. Mural, J. Tellier, Philco Corp.

*Some Considerations of Transistor Video Amplifiers*, M. C. Kidd, RCA.

*A Discussion of the Design Problems Encountered in the Development of a Transistorized Radio Receiver*, J. A. Worcester, General Electric Co.

*Application of RCA Transistors to Battery-Powered Portable Receivers*, John W. England, RCA.

2:00 P.M.

Television Session

*Session Chairman*, L. R. Fink, General Electric Co.

*Methods of Measurement of Color Television Receiver Performance*, Stephen P. Ronzheimer, Hazeltine Research Inc. and Richard J. Farber, Hazeltine Corp.

*Generation of Television Sweep by Resonant Networks*, Kurt Schlesinger, Motorola, Inc.

*A Method of Measuring the Optical Sine-Wave Spectrum and Effective Bandwidth of TV Image Display Devices*, O. H. Schade, Sr., RCA.

*Design Considerations in the Reduction of Sweep Interference from Television Receivers*, Alexander M. Intrator, General Electric Co.

*Magnetic Field Effects on Color Receivers*, Olaf H. Fernald, Westinghouse Electric Corp.

8:00 P.M.

Radio Fall Meeting Banquet

Toastmaster, J. D. Ryder, IRE President.

Speaker—to be announced.  
Presentation of Radio Fall Meeting Plaque.

Wednesday, October 19  
9:00 A.M.

Sponsored by the IRE Professional Group on Electron Devices

Session Chairman, R. R. Law, CBS Hytron.

*High Frequency NPN Transistors*, A. P. Kordalewski, General Electric Co.

*Transistors for Portable Radios*, Author to be determined, Texas Instrument Co.

*Recent Improvements in the RCA-21AXP-22 Color Kinescope*, R. B. Janes, L. B. Headrick, J. Evans, RCA.

*22 Inch Rectangular CBS-Colortron*, N. F. Fyler, P. Hambleton, T. Hodge, CBS-Hytron.

2:00 P.M.

*Color and Brightness in Projected Pictures*, R. M. Evans, Eastman Kodak Co.

## SECOND ANNUAL MEETING OF PROFESSIONAL GROUP ON NUCLEAR SCIENCE

SPONSORED BY PG ON NUCLEAR SCIENCE

SEPTEMBER 14-16,  
OAK RIDGE, TENNESSEE

The Second Annual Meeting of the Professional Group on Nuclear Science will be held at the Center Theater in Oak Ridge, Tennessee, September 14-16. Registration fees for this meeting will be as follows: member PGNS—\$2.50; member IRE, not PGNS—\$4.00; non-member, \$5.00. Registration and technical sessions at the Center Theater. A copy of the transactions will be sent to all persons registering for the meeting.

Officers of the meeting committee are: Chairman, Harold E. Walchli; Vice-Chairman-Treasurer, D. J. Knowles; Papers Committee, H. E. Banta; Arrangements Committee, R. W. Schede; Publicity Committee, E. Fairstein; Ex-officio, D. H. Loughridge.

A complete program, including abstracts, may be obtained from D. J. Knowles, Oak Ridge National Laboratory, P.O. Box P, X-10, Oak Ridge, Tenn.

### TENTATIVE PROGRAM

Wednesday, September 14  
10:00 A.M.—12:15 P.M.

#### SESSION I—ACCELERATORS

*Welcoming Address*, R. W. Schede, Chairman, Oak Ridge Chapter PGNS.

*History and Aims of the PGNS*, M. A. Schultz, National PGNS Chairman.

*The Brookhaven Electron Analogue*, Ralph Kassner, Brookhaven National Laboratory.

*The Microtron, a Nuclear and Electronic Research Instrument*, H. F. Kaiser, Naval Research Laboratory.

*Proton Beam Studies in a Fixed Frequency Cyclotron*, Farno L. Green, Oak Ridge National Laboratory.

*An Approximate Method for Obtaining the FWHM on Cyclotron Dees*, R. M. Donaldson, Oak Ridge National Laboratory.

2:00 P.M.—5:00 P.M.

#### SESSION II—ELECTRONICS

*Phototube Voltage Regulators for Scintillation Counters*, O. R. Harris and Bruce d'E. Flagge, University of Virginia.

*Recent Advances in Modular Design of Electronics*, W. G. James, A.C.F. Industries, Inc.

*Multichannel Time Interval Analyzer*, J. H. Neiler, H. E. Banta, W. M. Good, and E. C. Smith, Oak Ridge National Laboratory.

*The 'Hard-Bottoming' Technique in Nuclear Instrumentation Circuit Design*, C. C. Harris, Oak Ridge National Laboratory.

*Four-Channel Counting System*, D. W. Scott, Oak Ridge National Laboratory.

8:00 P.M.

Social and Smoker sponsored by Carbide and Carbon Chemicals Company, operators of Oak Ridge National Laboratory.

Thursday, September 15  
9:00 A.M.—12:00 NOON

#### SESSION III—REACTOR CONTROLS AND PULSE HEIGHT ANALYZERS

*Electronic Analogue Devices for Design of Reactor Controls*, E. R. Mann, Oak Ridge National Laboratory.

*Control of a Two-Phase Reactor*, John MacPhee, American Machine and Foundry, Atomic Division.

*The Oak Ridge National Laboratory Serial Memory 120 Channel Pulse Height Analyzer*, T. L. Emmer, Oak Ridge National Laboratory.

*Circuits for Pulse Analysis*, G. G. Kelley, Oak Ridge National Laboratory.

2:00 P.M.—5:00 P.M.

#### SESSION IV—RADIATION DETECTION, MEDICAL INSTRUMENTATION AND HEALTH PHYSICS

*Medical Radiation Instrumentation with Scintillation Spectrometers*, P. R. Bell, Oak Ridge National Laboratory.

*Radiation Fall Out Measurements*, John Harley, AEC Operations New York.

*Present Status of Halogen Quenched FM Tubes Using Transparent, Non-metallic, Electrically Conducting Cathodes*—L. G. Clark, Sr., Naval Research Laboratory.

*A Direct Current Integrator*, F. M. Glass, Oak Ridge National Laboratory.

*Instrument Requirements for Routine Medical Radioisotope Techniques*, Theodore Fields, VA Hospital, Hines, Ill.

*A Dual Function Gamma Monitor*, R. E. Connally, General Electric Co., Hanford, Wash.

7:00 P.M.—10:00 P.M.

Banquet at the Oak Terrace, speaker to be announced.

#### Friday, September 16

Tour of unclassified facilities at Oak Ridge National Laboratory, Abbott Pharmaceutical Laboratory (radioactive drugs), and Museum of Atomic Energy.



# Abstracts of Transactions of the IRE

The following issues of "Transactions" have recently been published, and are now available from the Institute of Radio Engineers, Inc., 1 East 79th Street, New York 21, N. Y. at the following prices. The contents of each issue and, where available, abstracts of technical papers are given below.

| Sponsoring Group                   | Publication       | Group Members | IRE Members | Non-Members* |
|------------------------------------|-------------------|---------------|-------------|--------------|
| Broadcast and Television Receivers | Vol. BTR-1, No. 2 | \$ .95        | \$1.45      | \$2.85       |
| Broadcast and Television Receivers | Vol. BTR-1, No. 3 | \$ .95        | \$1.45      | \$2.85       |
| Circuit Theory                     | Vol. Ct-2, No. 2  | \$2.60        | \$3.90      | \$7.80       |
| Electron Devices                   | Vol. Ed-2, No. 2  | \$2.10        | \$3.15      | \$6.30       |

\* Public libraries and colleges may purchase copies at IRE Member rates.

## BROADCAST AND TELEVISION RECEIVERS

VOL. BTR-1, NO. 2, APRIL, 1955

**Automatic Gain Control of Transistor Amplifiers**—W. F. Chow and A. P. Stern

Due to the dependence of transistor small signal parameters on the dc operating point, the gain of a transistor amplifier is function of the emitter current  $I_e$  and of the collector voltage  $V_c$ . An analysis of the variation of the series-parallel transistor parameters  $h_{ij}$  with the operating point shows that the gain decreases with decreasing  $I_e$  or decreasing  $V_c$  in the region of small values of  $I_e$  and  $V_c$ . The appreciable control power necessary to vary  $I_e$  or  $V_c$  (of possibly several amplifying stages) can be obtained advantageously by operating the controlled stages as dc amplifiers of the control signal and employing transistor detectors. Automatic gain control systems applicable to linear amplifiers and converters using  $I_e$  and  $V_c$  control have been developed, and their performance is described in this paper. Some problems arising in transistor agc systems are distortion, detuning and bandwidth variation.

**Technical Requirements of the Australian Television System**—A. J. McKenzie

Following a brief discussion of the important aspects of television standards, those used by various countries are described. The history of the Australian standards is then outlined and specific aspects of these standards are dealt with in some detail. The effect of introducing color television is considered. After summarizing the frequency channels available for Australian television services, standards of allocation of frequency and power are discussed. Finally some conclusions from tentative frequency allocation plans are given.

**Preventing Fires from Electrical Causes in the Design and Manufacture of Radio and Television Receivers**—H. T. Heaton

**Minutes of the Meeting of the Administrative Committee of the IRE Professional Group on Broadcast and TV Receivers**

**Publication Committee Report**

**Notice for Papers for the Fall Meeting**

VOL. BTR-1, NO. 3, JULY, 1955

**Selectivity and Transient Response Synthesis**—R. W. Sonnenfeldt

The theory, design, and operation of a uni-

versal filter for the rapid synthesis of selectivity and transient responses are presented. This filter is useful in monochrome and color TV applications, and has the universality and ease of use normally associated with decade boxes. Like decade boxes, it enables the development engineer to design circuits that otherwise would require laborious and intricate calculations.

Low-pass, high-pass, band-pass, and band-stop characteristics, all at constant-time-delay, can be obtained in the basic operating range from 30 cps to 4.5 mc by throwing switches and adjustment of independent potentiometers. A simple theory, using elementary trigonometry, determines the settings. Transients can be synthesized by a series of small steps. This process produces the required phase and amplitude responses simultaneously. The settings in this case are determined by simple arithmetic. Experimental results are given for various selectivity curves and transients in the form of oscillograms and plotted curves.

**A Transistor Sub-Carrier Generator for Color Receivers**—L. J. Kabell and W. E. Evans

The era of transistorized television receivers on a commercial scale is still in the future. However, even at the present state of the art, laboratory tests on experimental transistorized color receivers have shown that certain of the circuit functions can be performed reliably enough with transistors to make them true competitors for vacuum tube circuits whenever the economic comparison becomes favorable. A representative circuit is the one used to generate the local 3.58 Mc sub-carrier.

A junction transistor circuit capable of performing the color synchronization function of a color television receiving system is described. The circuit employs a single high frequency junction transistor which serves as an oscillator-amplifier, phase detector, and current-controlled variable reactance in the generation of an accurately phased color reference carrier. A series mode quartz crystal filter in the feedback loop of the oscillator enables the circuit to perform well in the presence of noise interference up to a 1:1 signal-to-noise ratio.

The use of a transistor characteristic sometimes thought of as being objectionable illustrates the general principle of attempting to exploit those characteristics peculiar to transistors, rather than thinking of them as mere vacuum tube substitutes.

**Differential Phase and Gain Measurements in Color Television Systems**—H. P. Kelly

The presence of differential phase and gain distortion in systems used for the transmission of color television results in distortion of the colors being transmitted. A test set for measuring differential phase and gain is described. The set consists of two pieces of portable equipment, a transmitter and a receiver. Each has a self-contained power supply operated from 115 volt, 60-cycle power. The measurement is presented as a display on an oscilloscope. Scales of 0.5 db per inch differential gain and 2.5 degrees per inch differential phase are obtainable.

**Operational Tests for Color Television**—E. E. Gloystein

The advent of compatible color television has brought with it the need for several new types of test instruments to facilitate the adjustment of the specialized circuits required for generating, transmitting and receiving color television signals. This paper consists of descriptions of a selected group of test instruments which have been found particularly useful for routine operational tests in broadcasting plants and receiver service shops. Test generators which provide noise-free, artificial color signals are described, and techniques for using such signals for the adjustment of critical circuits in broadcast equipment and in home receivers are outlined briefly.

**Light Amplification**—P. E. Pashler

Three principal methods of light amplification are described. These are electron optical image tubes, contiguous layers of photoconductor and electroluminescent phosphor, and direct amplification of light in photoelectroluminescent film. Details of construction and relative merits of each are presented.

**The Composite Video Signal—Waveforms and Spectra**—J. B. Chatten, R. G. Clapp and D. G. Fink

Measured frequency spectra are given for the composite video signals of a variety of types of subject matter, in both color and monochrome. The subject matter includes colored flat fields, a bar chart and N.T.S.C. slides, as well as a monochrome flat field and resolution test chart. Data is presented in several forms, so as to show the relative amplitudes of all the main spectrum components, the general trends of energy distribution over the entire video frequency range, and the detailed fine structure showing the modulation sidebands on the individual spectrum components. The frequency interleaving of the luminance and chrominance components is clearly shown.

The waveforms resulting from scanning the various subjects are shown, including the synchronizing pulses and burst, and theoretical methods are discussed for predicting the resulting spectra.

The experimental methods which were employed are described.

This material will form part of a chapter of the forthcoming "Television Engineering Handbook," Donald G. Fink, Editor, to be published by McGraw-Hill.

**UHF Tuner Local Oscillator Radiation**—V. Mukai

Factors important to the design of a low radiation uhf television tuner have been empirically studied within the framework of the open field measuring technique specified by the FCC. Although there is some question as to the reliability of the open field method some significant results have been obtained. In particular it has been established that the magnitude of radiation is dependent on basic tuner circuitry as well as shielding and by-passing, namely on the type of oscillator, crystal circuit, and num-



ber of preselectors. An existing commercial model which employed a balanced oscillator and two preselectors was developed until radiation was below the proposed FCC limit of 500 uv/m. These developments were then successfully applied to a recently designed small package model. It was not necessary to make any sacrifice of overall tuner performance.

## CIRCUIT THEORY

VOL. CT-2, No. 2, JUNE, 1955

### A Note on the Scattering Matrix of an Active Linear Two-Terminal Pair Network—J. E. Knausenberger

By separating the scattering matrix into matrix factors, a cascade of partial two-terminal pair networks is obtained, which represents the general nonreciprocal two-terminal pair network. Using a matrix factor to represent a source, the active circuit properties are separated from the passive ones and it is demonstrated that this source, which is simply related to the determinant can be moved to the terminal ends of the total network, where it may be combined with an external source.

The derived equivalent circuits do not employ gyrators but contain, besides the source mentioned, 2 two-terminal circuit elements, which characterize loss as well as inherent stability, and 2 "ideal transformers" rendering measures of amplitude and phase transfer.

An application to the transistor results in a novel equivalent circuit for that device.

### Matrix Analysis of Oriented Graphs with Irreducible Feedback Loops—J. K. Percus

A generating function is obtained for the nonrepetitive closed loops of a network with unidirectional elements; from this is derived an analogous function for the irreducible loops. Criteria for the existence of loops are then established and the size of the smallest loop present determined; an asymptotic evaluation is made of the number of irreducible loops in a completely connected network. Further application of the generating function permits estimation of bounds for both irreducible and composite closed loops of a given order; less rigorous bounds are found by two perturbation techniques. The generating function is reformulated in terms of determinant-like quantities and application made to small networks.

Transformations preserving the irreducible loops of a system are discussed at length, following a delineation of the meaning of loop equivalence. Methods employed include elimination of branches, condensation of nodes, and decomposition of circuits, with criteria for their utilization being set forth. Finally, connection is made between the analysis of the present paper and those prevalent in more avowedly topological treatments.

### Matrix Factorization—H. A. Schulke, Jr. Minimum-Phase Transfer-Function Synthesis—R. H. Pantell

This paper presents a means for realizing a minimum-phase transfer-function  $H(p)$  to within a constant multiplier, provided that  $H(p)$  has no poles on the  $j\omega$ -axis including infinity. The network is in ladder form, without coupled coils, and every coil has an associated series resistance if  $H(j\omega) \neq 0$  for any finite  $\omega$ . Synthesis is illustrated for the specification of resistance termination at input and output, and for the specification of a resistor-capacitor termination at both ends. Regardless of the complexity of  $H(p)$ , the synthesis problem can always be reduced to the problem of synthesizing driving-point functions that are no more complicated than the ratio of quadratic polynomials in  $p$ . The method to be described is an extension of constant-resistance ladder network synthesis.

### Neutralization and Unilateralization—C. C. Cheng

The subject of neutralization and unilateralization is of great interest in the field of transistor design because of the inherent bilateral property of transistors. This paper presents a systematic study of unilateralization in terms of generalized network theory presented in matrix form. Results are listed in tabulated form for easy use in practical circuit design. Examples illustrating the adaptation of the general procedure to the design of transistor amplifiers and vacuum-tube amplifiers are also included.

### A General Matrix Factorization Method for Network Synthesis—E. C. Ho

This paper considers a new matrix factorization method for the synthesis of RLC two terminal-pair networks. Equivalent matrixes suitable for the synthesis of RLC ladder and parallel ladder networks are developed by linear transformations of matrix multiplication. The application of the method is demonstrated through the synthesis of a general minimum-phase transmission function as a ladder network and a general nonminimum-phase transmission function as a parallel ladder network. Ideal transformers are not required in the realized networks and superfluous elements in ladder networks are reduced considerably. Distribution of losses in reactive elements and arbitrary specification of resistive terminations are considered.

### A Matrix Method for the Design of Relay Circuits—F. E. Hohn

This paper reviews the matrix method of synthesis of combinational multiple-output relay circuits first given in reference 44. Further examples are provided and it is shown how the method may be applied to sequential circuits as well. The purpose of presenting this material in the present connection is to illustrate the use of unconventional techniques with unconventional types of matrixes in switching circuit design.

### Generalized Mesh and Mode Systems of Equations—M. B. Reed

Based on the obvious complexity of present-day problems to be solved and the increasing availability of computers, the broadest possible base for establishing the differential equations of an electrical network is an urgent need. This paper presents, on a topology, Laplace transform base, the differential equations and their solutions for any network describable in terms of linear differential equations with constant coefficients. These systems of equations by successive matrix partitioning and change of variable, lead to generalized "mesh" and "node" systems of unrestricted character.

### Use of Tchebycheff Functions in Dealing with Iterated Networks—H. L. Armstrong

Expressions for the transmission matrixes of four-terminal networks in terms of Tchebycheff functions have been given previously. Here, relations among these functions are used to give a convenient formula for the voltage gain of such networks; the transfer impedance etc., could be handled similarly. As an example, the low-pass network formed by cascading inductance-capacitance  $T$  sections is discussed.

### Regeneration Analysis of Junction Transistor Multivibrators—D. O. Pederson

The two-transistor, collector-coupled relaxation circuit is a prototype configuration from which various switching circuits such as monostable multivibrators and flip-flops can be derived. Although the operational possibilities derived from the basic configuration, e.g., astable, monostable, or bistable, may differ in the details of triggering and stable point operation, the circuits of this class will have in common the key factor of the regenerative switching behavior. In addition, the circuits will have similar transient behavior immediately following the regeneration, having to do with the

drive of one transistor off and the other into saturation.

The operation of the transistors for a complete cycle of operation can be divided into regions, each region of which can be characterized by an approximate linear equivalent circuit. Hence, a piece-wise linear analysis can be made of the operation of these circuits. In this paper, attention will be centered on the analysis of the regenerative switching mechanism which occurs when the transistors are in the active region. A major result of the analysis is the derivation of a simple formula for the switching time. The analysis also provides a fundamental inequality which must be satisfied in order to obtain regenerative switching. An extension of the results leads to an expression for the maximum repetition frequency.

In setting up the regeneration analysis, elementary design data are established. From this data, a minimum value for  $\alpha_0$  can be specified if sharp, rectangular output waveforms are desired.

### Predictions Based on Maximum Oscillator Frequency—P. R. Drouilhet, Jr.

Considerable difficulty is encountered in directly measuring the parameters of a transistor at very high frequencies. An approximate high-frequency equivalent circuit for a transistor is presented, and several techniques for measuring the alpha-cutoff frequency are discussed. An indirect technique is presented involving the measurement of the maximum frequency at which the transistor can oscillate, and it is shown that this leads to a simple and accurate determination of the alpha-cutoff frequency. This maximum frequency of oscillation can also be used to predict the approximate gain obtainable from a transistor at high frequencies, and the efficiency which may be realized from the transistor used as a high frequency oscillator.

### Frequency Response of Theoretical Models of Junction Transistors—R. L. Pritchard

For a grown-junction transistor, the concept of a constant base-spreading resistance may not be valid at high frequencies, owing to the distributed nature of the transistor parameters in the transverse direction of the base. However, results of a theoretical analysis of an appropriate two-dimensional model have shown that this type of transistor may be represented by the same type of model as that normally used for the fused-junction transistor, but with the constant base spreading resistance of the latter model replaced by a complex frequency-dependent base impedance. These two types of models represent limiting cases which should be useful for calculating circuit performance of practical junction transistors. In this paper, a method of comparing circuit performance of these two types of transistor models is described for both grounded-base and grounded-emitter configuration, using the series-parallel, or  $h$ , parameters. Under simplifying conditions, either type of transistor model in either configuration can be described by three normalized functions of frequency relative to  $\alpha$ -cutoff frequency plus three additional constants. Simple relations are shown to exist between grounded-base and grounded-emitter parameters. Polynomial representations are given for the  $h$  parameters for both grounded-base and grounded-emitter operation, and simplified equivalent circuits are presented. To illustrate this method of circuit analysis, numerical examples are given for power gain and input resistance for a one-stage amplifier terminated in a pure resistance. Finally, the subject of maximum available power gain also is discussed briefly.

### Constant-Resistance AGC Attenuator for Transistor Amplifiers—C. R. Hurtig

The gain of a wideband tuned transistor amplifier may be varied over a large range by an external control voltage, accompanied by

only slight changes in amplifier bandwidth or center frequency, by means of a unique constant-resistance *agc* attenuator. The control power required by this attenuator is in the milliwatt region. At audio frequencies this relatively simple attenuator may be used to obtain the arithmetic operations of multiplication and division.

#### Weighted Least-Squares Smoothing Filters

—L. A. U'ic

This paper differs from many others on least square filtering, in that no explicit note has been taken of the noise spectrum, at least no more than is taken when one fits a curve by least squares to a set of data. The concept of a least weighted error, not new in curve fitting, has, to the author's knowledge, never before been applied to a filter—other workers have uniformly weighted their signal over a fixed interval of length  $T$ , with the result that the filters so derived cannot be realized with lumped constants. If this artificial constraint is removed as it is here, lumped constant filters are possible. The expression for the filter weighting function is obtained with a bare minimum of elementary mathematics; a very slight generalization leads to an expression for a time-varying filter weighting function when this is required. The nonlinear least-square filter is considered but no general solution is given.

The paper is replete with examples and is directed to the average engineer. Although some original material is presented, a large part of the paper may be considered tutorial.

#### Note on a Logarithmic Approximation for Use with Singularity Plots—H. E. Tompkins

The analysis or synthesis of band-pass networks using plots of the singularities of their transfer functions can often be shortened and simplified by using a suitable logarithmic transformation of the complex-frequency  $s$ -plane which permits a simple approximate calculation of the transfer function. This approximation is good for over-all-bandwidth ratios of 2 to 1 or less as compared with a usable bandwidth ratio of 1.2 to 1 for the conventional narrow-band approximation. This transformation is not intended for use with an electrolytic tank, for which better methods have been described in the literature. It does not have the power of certain conformal transformations, but is considerably simpler. Unlike the wide-band low-pass to band-pass transformation it is not limited to pole and zero patterns of particular symmetry. This approximation also has interesting properties as an aid in the factoring of network polynomials.

#### Circuits with Quantized Feedback—Rajko Tomovitch

The paper deals with a special class of feedback circuits in which the feedback path is closed at a discrete set of time instants that depend upon two arbitrary inputs  $g(t)$  and  $v(t)$ . Since the feedback signal is quantized in magnitude as well as in time, these circuits possess novel properties not found in ordinary linear feedback systems. The equations of such circuits are established and it is shown that these circuits may perform various mathematical operations, such as yielding inverse or reciprocal functions. Application to a communication method similar to delta modulation is described.

#### Reviews of Current Literature

"The Complete Specification of a Network by a Single Parameter"—M. S. Corrington, T. Murakami and R. W. Sonnerfeldt . . . Reviewed by A. D. Perry

"Extension de la méthode du diagramme de phase généralisé dans l'étude de la stabilité des systèmes linéaires"—P. Lefevre . . . Reviewed by V. Belevitch

"A New Method of Synthesis of Reactance Networks"—A. Talbot . . . Reviewed by H. J. Orchard

"Synthesis of Distributed Amplifiers for Prescribed Amplitude Response"—A. D. Moore . . . Reviewed by W. H. Kautz

#### Correspondence

Comment on B. J. Bennett's Paper, "Synthesis of Electric Filters with Arbitrary Phase Characteristics" . . . D. Helman

Reply to Mr. Helman's Letter . . . B. J. Bennett

"The Spelling of the Name Napier" . . . H. A. Wheeler

#### News

#### PGCT News

## ELECTRON DEVICES

VOL. ED-2, No. 2, APRIL, 1955

Plasma Frequency Reduction Factors in Electron Beams—G. M. Branch and T. G. Mihan

The electron plasma frequency reduction factor has proved to be a fundamental design parameter in all types of microwave tubes employing long electron beams. This factor is here calculated for a variety of beam shapes and drift-tube cross sections, and the results are presented in a series of graphs. One interesting result is that the reduction factor for an annular beam depends primarily on the width of the annulus and is relatively independent of the radius of curvature of the beam.

Noise in Traveling-Wave Tubes—A. G. Mungall

A number of experimental traveling-wave tubes have been built for operation in the 3.2 centimeter wavelength region, and series of noise measurements have been made on these tubes. The periodic dependence of noise figure on the separation between the electron gun and the circuit entrance of the traveling-wave tube has been investigated and various characteristics of these curves have been discussed. A modified noise theory has been suggested; comparisons between it and the experimental results show fair agreement. Noise figure reduction by the use of a triode gun has been investigated for two of the experimental tubes, and a method of analysis that should lead to theoretical justification is suggested.

Writing Speed and Tonal Range of Dark Trace Tubes—Seymour Nozick

The writing speed and tonal range properties of dark trace tubes are analyzed and figures of merit are outlined. Experimental results are presented. Writing speed of a dark trace tube varies linearly with the ratio of beam current to spot size. The information writing rate varies directly with the beam current and inversely with the square of the spot size. The tonal range

of dark trace tubes varies directly with the ratio of maximum contrast to spot size.

Suppression of Backward-Wave Oscillation by Filter Helix Methods—A. E. Siegman and H. R. Johnson

An experimental study has been made of the filter helix properties of a periodically loaded helix, using a special traveling-wave tube. The filter helix is shown to possess filter-like frequency pass bands and stop bands and a phase velocity characteristic such that forward- and backward-wave phase velocities are separated, making the filter helix a useful circuit for traveling-wave amplification at high  $ka$  (ratio of helix circumference to free space wavelength) without danger of backward-wave oscillation. Certain difficulties associated with backward-wave oscillation frequency pushing were found to arise in filter helices, but useful gain was obtained at  $ka$  greater than 0.5 using filter helix techniques.

A Wide-Band Square-Law Circuit Element—A. S. Soltes

A square-law circuit element with operating frequency range from zero into the vlf region is described. Its dynamic range and accuracy capabilities vary with the particular conditions under which it is operated; accuracies within less than one per cent of full scale and output dynamic ranges of over 100 db have been achieved. Frequency response limitations and possible sources of error are analyzed. Experimentally determined characteristics are presented and noise properties, dynamic range, and accuracy potentialities evaluated.

Low-Frequency Circuit Theory of the Double-Base Diode—J. J. Suran

The double-base diode is a single-junction semiconductor triode. When an electric potential is applied between the two ohmic contacts, a negative-resistance is obtained between the junction and one of the ohmic contacts. This negative resistance is bounded by two positive-resistance regions, one of considerably high magnitude which corresponds to the cut-off state and one of very low magnitude which corresponds to a saturating condition. The magnitude of the negative resistance is related to the ratio of majority-to-minority carrier mobilities. Small-signal low-frequency equivalent circuits are developed to approximate the double-base diode in each of the operating regions of the negative-resistance characteristic and equations for current and voltage amplification, input and output resistance and power gain are developed. The important circuit parameters are related to the physical constants of the device.

Space-Charge Conditions in a Reflected Flow of Electrons—J. T. Wallmark

Some characteristic features of a reflected flow of electrons are described, in particular variations of the virtual cathode and transit time with respect to current. This has been accomplished by finding new solutions to well-known basic equations treated earlier by Fay, Samuel, Shockley, Salzberg, Haef, and others. The results are applicable to problems where the current is varied while earlier solutions were considering the potential as variable. The theoretical results are found to be in agreement with experimental results obtained on reflex klystrons and space-charge deflection tubes.

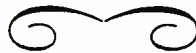

## 1955 STUDENT AWARDS

## THE INSTITUTE OF RADIO ENGINEERS, INC.

JANUARY 1—JULY 29, 1955

| STUDENT BRANCH   | RECIPIENT OF AWARD                              | IRE SECTION     | STUDENT BRANCH  | RECIPIENT OF AWARD        | IRE SECTION           |
|--|---|-----------------|---|---------------------------|-----------------------|
| University of Akron<br>Joint Student Branch                              | Floyd H. Jean                                   | Akron           | Mississippi State College<br>Student Branch               | Meek B. Graves            | Huntsville            |
| University of British Columbia<br>Joint Student Branch                   | Christopher John Goodman                        | Vancouver       | College of The City of New York<br>Student Branch         | Melvin L. Eisenstein      | New York              |
| Polytechnic Institute of Brooklyn<br>Joint Student Branch (Day Division) | Victor Wallace                                  | New York        | New York University<br>Student Branch (Day Division)      | Jack Silberlicht          | New York              |
| California Institute of Technology<br>Joint Student Branch               | Carl W. Johnson                                 | Los Angeles     | North Carolina State College<br>Student Branch            | James Benhard Tommerdahl  | No. Carolina-Virginia |
| California State Polytechnic College<br>Student Branch                   | Philip L. Rich                                  | Los Angeles     | Northwestern University<br>Joint Student Branch           | Robert K. Chen            | Chicago               |
| Carnegie Institute of Technology<br>Joint Student Branch                 | Dale Horelick                                   | Pittsburgh      | University of Notre Dame<br>Joint Student Branch          | Robert Lawrence Bolger    | Chicago               |
| Columbia University<br>Joint Student Branch                              | Alexander Proudfit                              | New York        | Ohio State University<br>Joint Student Branch             | John Robert Baechle       | Columbus              |
| The Cooper Union<br>Joint Student Branch                                 | Joseph Gala                                     | New York        | Ohio University<br>Joint Student Branch                   | Charles Husson            | Columbus              |
| Cornell University<br>Joint Student Branch                               | Kenneth R. Evans                                | Ithaca          | University of Pennsylvania<br>Joint Student Branch        | Llewellyn A. Rubin        | Philadelphia          |
| University of Dayton<br>Joint Student Branch                             | Wilbert H. K. Chang                             | Dayton          | University of Pittsburgh<br>Student Branch                | James R. Garnett          | Pittsburgh            |
| University of Delaware<br>Joint Student Branch                           | Edward J. Taylor                                | Philadelphia    | Pratt Institute<br>Joint Student Branch                   | Richard T. Coen           | New York              |
| University of Detroit<br>Joint Student Branch                            | Albert Vanschaemelhout                          | Detroit         | Princeton University<br>Joint Student Branch              | John L. Norton            | Princeton             |
| Drexel Institute of Technology<br>Joint Student Branch                   | Chuck F. Der                                    | Philadelphia    | Rutgers University<br>Joint Student Branch                | John C. Strole            | Princeton             |
| George Washington University<br>Joint Student Branch                     | Claire A. Kennedy, Jr.                          | Washington      | San Diego State College<br>Student Branch                 | Edward A. Starr           | San Diego             |
| Illinois Institute of Technology<br>Student Branch                       | Burton L. Hulland                               | Chicago         | Seattle University<br>Student Branch                      | Robert B. Martindale      | Seattle               |
| University of Illinois<br>Joint Student Branch                           | William Wayne Lichtenberger                     | Chicago         | University of Southern California<br>Joint Student Branch | Mark C. Biedebach         | Los Angeles           |
| Iowa State College<br>Joint Student Branch                               | Richard J. Reid                                 | Des Moines-Ames | Southern Methodist University<br>Joint Student Branch     | Lloyd Carleton Brandt     | Dallas-Fort Worth     |
| Kansas State College<br>Student Branch                                   | John R. Buck                                    | Kansas City     | Texas Technological College<br>Joint Student Branch       | George T. Baker           | Dallas-Fort Worth     |
| University of Kansas<br>Joint Student Branch                             | Philip T. Boling                                | Kansas City     | University of Toronto<br>Joint Student Branch             | John V. Hanson            | Toronto               |
| Lafayette College<br>Joint Student Branch                                | William T. Fryer                                | Philadelphia    | Tulane University<br>Joint Student Branch                 | Charles G. Battig         | New Orleans           |
| Lehigh University<br>Joint Student Branch                                | Robert J. Fulmer                                | Philadelphia    | Utah State Agricultural College<br>Student Branch         | Clair L. Wyatt            | Salt Lake City        |
| Manhattan College<br>Joint Student Branch                                | Harvey P. LeFevre                               | New York        | University of Utah<br>Joint Student Branch                | LeRoy H. Walker           | Salt Lake City        |
| University of Maryland<br>Joint Student Branch                           | Emile Joseph Daigle, Jr.                        | Washington      | University of Vermont<br>Joint Student Branch             | Paul R. Low               | Boston                |
| Michigan State University<br>Joint Student Branch                        | Clyde M. Hyde and Robert L. Grim (posthumously) | Detroit         | Villanova University<br>Joint Student Branch              | Tulvio S. Durand          | Philadelphia          |
| University of Michigan<br>Joint Student Branch                           | Gordon Alfred Roberts                           | Detroit         | Virginia Polytechnic Institute<br>Joint Student Branch    | John D. Hawks, III        | No. Carolina-Virginia |
|  |   |                 | University of Washington<br>Joint Student Branch          | Wallace H. Eckton, Jr.    | Seattle               |
|  |   |                 | Wayne University<br>Joint Student Branch                  | Charles Leonard Schreiber | Detroit               |
|  |   |                 | West Virginia University<br>Joint Student Branch          | Gordon R. Williams        | Pittsburgh            |



# Abstracts and References

Compiled by the Radio Research Organization of the Department of Scientific and Industrial Research, London, England, and Published by Arrangement with that Department and the *Wireless Engineer*, London, England

NOTE: The Institute of Radio Engineers does not have available copies of the publications mentioned in these pages, nor does it have reprints of the articles abstracted. Correspondence regarding these articles and requests for their procurement should be addressed to the individual publications, not to the IRE.

|   |      |
|---|------|
| Acoustics and Audio Frequencies . . . . .             | 1156 |
| Antennas and Transmission Lines . . . . .             | 1156 |
| Automatic Computers . . . . .                         | 1157 |
| Circuits and Circuit Elements . . . . .               | 1158 |
| General Physics . . . . .                             | 1159 |
| Geophysical and Extraterrestrial Phenomena . . . . .  | 1161 |
| Location and Aids to Navigation . . . . .             | 1162 |
| Materials and Subsidiary Techniques . . . . .         | 1162 |
| Mathematics . . . . .                                 | 1164 |
| Measurements and Test Gear . . . . .                  | 1164 |
| Other Applications of Radio and Electronics . . . . . | 1165 |
| Propagation of Waves . . . . .                        | 1165 |
| Reception . . . . .                                   | 1167 |
| Stations and Communication Systems . . . . .          | 1167 |
| Subsidiary Apparatus . . . . .                        | 1167 |
| Television and Phototelegraphy . . . . .              | 1168 |
| Transmission . . . . .                                | 1169 |
| Tubes and Thermionics . . . . .                       | 1169 |
| Miscellaneous . . . . .                               | 1170 |

The number in heavy type at the upper left of each Abstract is its Universal Decimal Classification number and is not to be confused with the Decimal Classification used by the United States National Bureau of Standards. The number in heavy type at the top right is the serial number of the Abstract. DC numbers marked with a dagger (†) must be regarded as provisional.

## ACOUSTICS AND AUDIO FREQUENCIES

543.2 2174

**The Propagation of Sound Pulses along Metal Bars**—W. Guth. (*Acustica*, vol. 5, no. 1, pp. 35–43; 1955. In German.) The stationary-phase method is applied in developing the theory of pulse propagation along a bar. Experiments using schlieren technique were made on cylindrical steel bars immersed in water, with an electric spark as pulse source. Agreement of results with theory was satisfactory. In the case of thick bars, a wave of higher order was observed, presumably the first-order skew-symmetric wave.

534.213 2175

**Sound Propagation in the Atmosphere and Audibility of Warning Signals in Ambient Noise**—P. Baron. (*Ann. Télécommun.*, vol. 9, pp. 258–274; October, 1954.) An account of experiments carried out in 1938–1939 in the Vals d'Yonne district and in Paris. Meteorological and sound-pressure measurements were made. Raising the sound source from ground level to 37 m produced a marked increase of received sound power for distances <1 km. A mean curve of propagation was derived from the experimental data. The directional effect of the wind makes it desirable to have several sound sources to cover a given area. The degree of audibility satisfactory in the presence of noise was determined in a series of laboratory experiments. Computation shows that two sources having a combined power equal to that of a single source have a greater range.

534.54:534.2 2176

**Tubes and Resonators. Computation and Measurement of Some Acoustic Resistances**—J. Guitard. (*Acustica*, vol. 5, no. 1, pp. 7–18; 1955. In French.) Assuming that the linear dimensions of the enclosed space are small compared with  $\lambda/4$ , where  $\lambda$  is the wavelength

The Index to the Abstracts and References published in the PROC. IRE from February, 1954 through January, 1955 is published by the PROC. IRE, April, 1955, Part II. It is also published by *Wireless Engineer* and included in the March, 1955 issue of that journal. Included with the Index is a selected list of journals scanned for abstracting with publishers' addresses.

of the sound, acoustic resistance is computed from elementary theory for a circular aperture in a thin wall, for a tube opening on to (a) a semi-infinite and (b) an infinite space, and for a discontinuity of tube cross section. Satisfactory agreement between theory and experiment is found.

534.78:621.39 2177

**The Effect of Severe Amplitude Limitation on Certain Types of Random Signal: a Clue to the Intelligibility of "Infinitely" Clipped Speech**—(See 2412.)

534.833 2178

**Subjective Assessment of Sound Insulation, using Electrical Simulation of Transmission-Loss Curves**—H. J. Rademacher. (*Acustica*, vol. 5, no. 1, pp. 19–27; 1955. In German.)

534.85 2179

**Frequency Irregularity in Rooms**—A. F. B. Nickson and R. W. Muncey. (*Acustica*, vol. 5, no. 1, pp. 44–47; 1955.) The sounds of the speaking or singing voice and of musical instruments are often modulated in frequency and/or contain transients. These are the sounds of real importance in assessing the acoustic characteristics of auditoria. Frequency irregularity measurements using only pure tones may therefore give misleading results. Experiments with tones modulated in frequency at 6 cps over a range of  $\pm 3$  per cent show that the frequency-irregularity curves for such tones are much smoother than the corresponding ones for pure tones.

534.86:621.396.712.3 2180

**On the Structural and Room Acoustics of the Multipurpose Studio Unit at Broadcasting House, Hamburg**—G. Venzke. (*Tech. Hausmitt. Nordw.Dtsch. Relfunks.*, vol. 6, nos. 11/12, pp. 229–236; 1954.) The two-story building contains two groups of studios designed principally for recording plays. These comprise two "dead" studios, two studios with normal reverberation time, two studios in which the reverberation time can be changed, and one underground reverberation room. Reverberation-time/frequency curves are shown and results of measurements of the sound insulation achieved by the double-leaf, floating-floor construction of the studios are noted.

621.395.6:621.372.5 2181

**Equivalent Quadripole Networks for Electromechanical Transducers: Part 1**—W. Reichardt and A. Leink. (*Acustica*, vol. 5, no. 1, pp. 1–6; 1955. In German.) Es, em and electrodynamic transducers are considered, with particular reference to the frequency-independent transformer or gyrator used as the coupling element between the electric and mechanical elements.

621.395.61+621.395.623.7].012.12 2182

**Directivity Characteristics of Electro-**

**acoustic Transducers**—A. C. Raes. (*Ann. Télécommun.*, vol. 9, pp. 313–314; November, 1954.) A method of obtaining the polar characteristics of loudspeakers and microphones is described which does not require the use of an anechoic chamber. The transducer under test and the recording instrument are arranged at distances from the reflecting wall such that the characteristic can be recorded during the period preceding the arrival of the reflected sound.

621.395.623.8 2183

**Sound System for Plenary Hall of United Nations General Assembly Building**—C. W. Goyder and L. L. Beranek. [*Proc. IRE, (Australia)*, vol. 16, pp. 38–44; February, 1955. *1953 IRE Convention Record*, part 3, pp. 26–34; 1953.] This specially designed sound-reinforcement system has a linear frequency response over the range 300 cps–6 kc. Time-delay systems are used to improve intelligibility. Measured performance characteristics are presented.

621.395.625.3:621.397.6:778.5 2184

**Methods of Picture-Synchronized Sound Recording in Television**—Gondesen. (See 2450.)

## ANTENNAS AND TRANSMISSION LINES

621.372.2 2185

**Theory of the Harms-Goubau Wire Waveguide at Metre Wavelengths**—G. Piefke. (*Arch. elekt. Übertragung*, vol. 9, pp. 81–93; February, 1955.) Whereas at centimeter and decimeter wavelengths thin dielectric layers provide adequate concentration of the wave energy, at meter wavelengths, and particularly for dealing with bends, thick dielectric layers are required. Theory is developed for this case, and is extended to include the use of a separate dielectric tube shielding the line from precipitation. Both the leakage attenuation and the resistive attenuation increase with rising frequency, the former increasing also as dielectric constant decreases. For a given degree of energy concentration, the attenuation has a minimum value for a particular value of wire radius, but this value may be unacceptable for economic reasons. Attenuation due to a coating of ice on the line is investigated. Neglecting icing effects, a relay section of length 15 km with a loss of 5n at 1 m  $\lambda$  is practicable.

621.372.2+621.372.54]:512.831 2186

**The Matrix Approach to Filters and Transmission Lines**—Fisher. (See 2231.)

621.372.21:621.396.67 2187

**The Behaviour of the Open End of a Coaxial Line**—V. Pürrmann. (*Arch. elekt. Übertragung*, vol. 9, pp. 8–12; January, 1955.) A theoretical study is made of the field pattern and variations at the junction of a coaxial line and a circular waveguide; the method of least squares is used. Particular cases treated are (a) frequency

below the cut-off value for the waveguide, and (b) radiation conditions, the waveguide being excited in the  $E_{01}$  mode.

621.372.221:621.395.97 2188

**Programme Circuits on Cable Pairs Loaded at 500-Yard Intervals**—J. L. W. Morgan and W. S. Ash (*P.O. Elec. Eng. Jour.*, vol. 47, part 4, pp. 193–196; January, 1955.) Cable links between telephone exchanges which will be suitable for normal traffic when not required for BBC program circuits for outside broadcasts are obtained by loading standard cable pairs with 22-mH coils at 500-yard nominal spacing. Sufficient tolerance on the spacing to permit existing jointing chambers to be used is achieved by artificially increasing the mutual capacitance of the circuits.

621.372.8 2189

**Propagation of a Signal in a Waveguide**—P. Poincelot. (*Ann. Télécommun.*, vol. 9, pp. 315–317; November, 1954.) An approximate formula is derived for the amplitude of the signal at a given time. Its application is illustrated by a numerical example for a guide of length 3 km and radius 3.825 cm. The duration of the initial transient state is found to be proportional to the square root of the length.

621.372.8 2190

**Stability of the  $H_{01}$  Mode in Circular Waveguides, and the Occurrence of Harmonic Modes on Deformation to an Elliptical Cylinder**—J. Kornfeld. (*Arch. elekt. Übertragung*, vol. 9, pp. 29–38; January, 1955.) Analysis involving use of Mathieu functions is presented. A numerical example indicates that a 10 per cent deformation gives rise to an  $H_{11}$  wave whose amplitude is about 0.15 that of the original  $H_{01}$  wave.

621.372.8:538.614 2191

**Propagation of Electromagnetic Waves in an Anisotropic Gyromagnetic Medium in a Rectangular Waveguide**—A. Chevalier, T. Kahan and E. Polacco. [*Compt. Rend. Acad. Sci. (Paris)*, vol. 240, pp. 1323–1324; March 21, 1955.] Analysis is presented for the case where the gyromagnetic medium is made anisotropic by application of a magnetic field perpendicular to the direction of propagation. General expressions are derived for the three electric-field components.

621.372.8:621.318.134 2192

**Temperature Dependence of the Microwave Properties of Ferrites in Waveguide**—B. J. Duncan and L. Swern. (*Proc. IRE*, vol. 43, pp. 623–624; May, 1955.) Report of an experimental investigation on a rod of ferrimic A-106 in a waveguide of internal diameter 0.937 inch, with a static magnetic field parallel to the direction of propagation. The results indicate that at some temperature between 23 degrees and 500 degrees C. the ferrite absorption loss for this specimen is practically independent of frequency.

621.396.67+621.397.62 2193

**New Television Receivers and Aerials [in Western Germany]**—W. W. Diefenbach. [*Funk-Technik (Berlin)*, vol. 10, pp. 88–91; February, 1955.] A brief survey of commercially available equipment.

621.396.67 2194

**Scattering of Electromagnetic Waves by Wires and Plates**—D. B. Brick and J. Weber. (*Proc. IRE*, vol. 43, p. 628; May, 1955.) Comment on 930 of May and author's reply.

621.396.67 2195

**Method of Measurement of Aerial Gain by Electrical Integration of the Characteristic Function**—J. Munier. [*Compt. Rend. Acad. Sci. (Paris)*, vol. 240, pp. 1411–1413; March 28, 1955.] An arrangement is described which operates in conjunction with a polar-diagram recorder with square-law receiver to give a

direct reading of the gain for antennas with rotationally symmetrical characteristics. The af output of the receiver is applied to the primary of a rotating transformer mechanically coupled to the rotating antenna support; the secondary voltage is detected by means of a rectifier whose time constant is large compared with the af period.

621.396.67:621.372.2 2196

**Gap Problem in Antenna Theory**—R. King. (*Jour. Appl. Phys.*, vol. 26, pp. 317–321; March, 1955.) Discussion indicates that the so-called gap problem [see e.g. 24 of 1948 (Infeld)] is more properly to be considered as a problem of the coupling between the transmission line and the antenna.

621.396.67:621.396.93 2197

**Aerials for Mobile Radio Services**—W. Stohr and D. Bassler. (*Frequenz*, vol. 8, pp. 357–368; December, 1954.) A survey covering wide-band antennas comprising full-wave dipoles, corner reflectors, collinear antennas, Yagi arrays, multichannel  $\lambda/4$  radiators and folded dipoles, all for meter wavelengths.

621.396.67.012 2198

**Wave Launching from a Conical Aerial**—V. Pfirrmann. (*Arch. elekt. Übertragung*, vol. 9, pp. 98–101; February, 1955.) The near field of a  $\lambda/4$  conical antenna is computed, and the wave-launching mechanism is illustrated by field patterns.

621.396.67.095.12 2199

**Elliptic Polarization of Electromagnetic Radiation**—M. Bouix. (*Ann. Télécommun.*, vol. 9, pp. 275–281, 298–304 and 345–351; October–December, 1954.) Fundamental formulas are developed in detail, and the general expressions of Kottler and Goudet are adapted for elliptic polarization. The results are used to obtain formulas for the gain and effective surface area of antenna systems.

621.396.674.1:621.318.134 2200

**Ferrite-Cored Antennae**—C. A. Grimmett. [*Proc. IRE (Australia)*, vol. 16, pp. 31–35; February, 1955. Discussion, pp. 36–37; 1954 *IRE Convention Record*, Part 7, pp. 3–7.] A survey of developments in the use of this type of antenna for reception of broadcast at 540 kc–1.6 mc. The influence of length, diameter, winding and core material on sensitivity is discussed; ferrite-cored and air-cored antennae are compared.

621.396.674.3:621.372 2201

**The Radiation of a Hertzian Dipole over a Coated Conductor**—D. B. Brick. (*Proc. IEE*, Part C, vol. 102, pp. 104–121; March, 1955; Digest, *ibid.*, Part B, vol. 102, pp. 392–395; May, 1955.) The study presented was undertaken in an effort to explain certain characteristics of an antenna field pattern measured over an aluminium ground screen presumed to have a thin coating of aluminium oxide. Analysis is given for the case where the dipole is (a) above the dielectric coating, (b) in the dielectric coating, and (c) lying in the conductor/dielectric interface. Values of the field potentials are obtained for both electric and magnetic dipoles. The power from the dipole is partly radiated and partly surface-guided; numerical values for the ratio between the two are derived for some particular cases.

621.396.676 2202

**Aircraft Antennas**—J. V. N. Granger and J. T. Bolljahn. (*Proc. IRE*, vol. 43, pp. 533–550; May, 1955.) A survey of antennas for communication and navigation on conventional aircraft.

621.396.677.45 2203

**Radiation Characteristics of a Conical Helix of Low Pitch Angle**—J. S. Chatterjee. (*Jour. Appl. Phys.*, vol. 26, pp. 331–335; March, 1955.) Experiments are reported on a

conical helix with a pitch angle much smaller than in the previous investigation (2899 of 1953) and with a larger ground plane. Mounted with the apex at the bottom and a short distance above the ground plane, the arrangement provided radiation in the axial direction over a frequency range of 100–500 mc. Radiation pattern and current distribution along the helix were determined experimentally; the radiation pattern is also determined by computation, assuming a linear current distribution.

621.396.677.85 2204

**Virtual Source Luneberg Lenses**—G. D. M. Peeler, K. S. Kelleher and H. P. Coleman. (*Trans. IRE*, vol. AP-2, pp. 94–99; July, 1954.) An investigation is made of lenses formed by portions of a spherical Luneberg lens bounded by a pair of plane reflectors intersecting along a diameter; wedge angles up to 180 degrees are considered. Multiple virtual sources corresponding to the reflections of the feed point can be obtained. Calculations are made of the positions of these virtual sources and the width of the corresponding beam. Methods of eliminating undesired beams include the placing of absorptive material at the edges of the lens. Data obtained experimentally on a two-dimensional lens with wedge angle of 180 degrees are in good agreement with calculated values.

#### AUTOMATIC COMPUTERS

681.142 2205

**Computer for Universal Application**—(*Elec. Times*, vol. 127, pp. 319–320; February 24, 1955.) Brief description of DEUCE, a commercially available computer developed from the ACE; it has punched-card input and output systems, mercury delay lines for short-term storage and a magnetic recording drum for long-term storage. The total floor space occupied by the equipment is 14 feet by 4 feet 6 inches.

681.142 2206

**An Outline of an Electronic Arithmetic Unit**—W. Woods-Mill. (*Electronic Eng.*, vol. 27, pp. 212–217; May, 1955.) Discussion of the design of a digital-computer unit capable of performing and checking the operations represented by  $A \times B \pm D = C$ .

681.142 2207

**Pulse-Switching Circuits using Magnetic Cores**—M. Karnaugh. (*Proc. IRE*, vol. 43, pp. 570–584; May, 1955.) Design theory is presented for nonstorage uses of cores with rectangular hysteresis loops in digital computers. To facilitate determination of the sense of the em processes a method of representation due to Mayer is used in which the magnetic-circuit elements are replaced by elements of a mirror system. Devices for eliminating output voltage on "shuttling" the core are discussed. Operating frequencies >100 kc are attainable. 31 references.

681.142 2208

**A Statistical Method for Solution of the Laplace Differential Equation using Electronic Computers**—H. Harmuth. (*Acta Phys. austriaca*, vol. 9, pp. 27–32; December, 1954.) An electrical analog of the Galton board is used in which the rolling balls are replaced by pulses and the pins by pulse-storage units.

681.142:621.37:535.32 2209

**Analogue Machine for Calculation of the Complex [refractive] Index of a Body from its Reflection Coefficient**—M. Hénon. [*Compt. Rend. Acad. Sci. (Paris)*, vol. 240, pp. 1305–1306; March 21, 1955.] A resistance network is discussed by means of which the phase shift of light reflected by a body can be calculated if the reflection coefficient is known for all wavelengths; the refractive index can hence be determined.

681.142:621.385.832 2210

**The Function of Basic Elements in Digital Systems**—C. B. Speedy. (*Proc. IEE*, Part C, vol. 102, pp. 49–56; March, 1955. Digest, *ibid.*, Part II, vol. 101, pp. 677–679; December, 1954.) The three basic elements of digital computers are (a) a bistable element for storing a digit, (b) a gate for controlling the passage of a digit, (c) a diode for controlling the direction of passage. A unit in the form of a beam deflection tube has been designed including a bistable element together with two gating elements. See also 2485 below.

## CIRCUITS AND CIRCUIT ELEMENTS

621.3.011.21.012 2211

**The Geometric Transformation of Impedance Diagrams**—A. Železnikar. (*Telefunken Ztg.*, vol. 27, pp. 252–253; December, 1954.) An extension of the work of Briner and Graffunder (2576 of 1953) to the general case. For a correction to the earlier paper see *ibid.*, vol. 27, p. 254; December, 1954.

621.3.042:621.396.822 2212

**Barkhausen Noise from a Cylindrical Core**—D. Haneman. (*Jour. Appl. Phys.*, vol. 26, pp. 355–356; March, 1955.) The method used by Krumhansl and Beyer for calculating Barkhausen noise (298 of 1950) is simplified by considering an exciting field with a sawtooth rather than a sinusoidal waveform.

621.3.066.6 2213

**The Variation with Current and Inductance of Metal Transfer between Platinum Contacts**—J. Riddlestone. (*Proc. IEE*, Part C, vol. 102, pp. 29–34; March, 1955.) Continuation of investigation described previously [3495 of 1953 (Warham)]. Curves of the net transfer are given for currents and inductances in the ranges 1.8–7.6 a and 0.06–117  $\mu$ h respectively. Four different types of transfer, termed “bridge,” “short arc,” “long arc,” and “reversed short arc,” may be involved. The results indicate that the life of Pt contacts could be improved by controlling the effective circuit inductance at break to about 0.6  $\mu$ h.

621.314.223 2214

**Analytical Approach to the Variable Turns-Ratio Autotransformers**—E. Mishkin. (*Trans. Amer. IEE*, Part III, *Power Apparatus and Systems*, vol. 72, pp. 669–673; August, 1953.)

621.314.7:621.375.4 2215

**High-Frequency Amplification using Transistors**—E. Kettel. (*Telefunken Ztg.*, vol. 27, pp. 245–251; December, 1954.) Measurements were made on transistors Type OC 601 and OC 602 in the grounded-base connection to assess them for use in narrow-band IF amplifiers. The voltage feedback effect may lead to instability, hence neutralization is essential. At the higher frequencies ( $\sim$ 500 kc) the stage gain is reduced mainly by the base resistance and the collector barrier capacitance.

621.314.7.012.8 2216

**Theory of Equivalent Circuits for Junction Transistors**—L. Oertel. (*Telefunken Ztg.*, vol. 27, pp. 230–237; December, 1954.) An equivalent circuit is discussed which differs from that of Pritchard (2537 of 1954) only in respect of the arrangement of the current and voltage sources. A simplified equivalent circuit including a triode tube is also presented.

621.314.7.012.8 2217

**The Frequency Dependence of [junction] Transistor Quadripole Parameters**—E. Kettel and G. Meyer-Brötz. (*Telefunken Ztg.*, vol. 27, pp. 237–245; December, 1954.) The grounded-base connection only is considered. Oertel's equivalent tube circuit (2216 above) is a satisfactory approximation up to a frequency about half that of  $\alpha$  cut off, but a proper description of rf performance requires the addition of a base resistance and leakage conductance to the basic equivalent circuit. Measurements on a

Type-OC 601 transistor show satisfactory agreement with theory.

621.318.4+621.314.2]:621.3.015.3 2218

**Field Theory of Wave Propagation along Coils**—H. Poritsky, P. A. Abetti and R. P. Jerrard. (*Trans. Amer. IEE*, Part III, *Power Apparatus and Systems*, vol. 72, pp. 930–938; October, 1953. Discussion, pp. 938–939.) Expressions are derived for phase and group velocities and surge impedance in air-cored and iron-cored coils and transformer windings. Theoretical and experimental data for frequencies up to 600 kc are compared.

621.318.42 2219

**The Design of Coils for the Production of High Magnetic Fields**—A. N. Ince. (*Proc. IEE*, Part C, vol. 102, pp. 25–28; March, 1955. Digest, *ibid.*, Part A, vol. 102, p. 100; February, 1955.) Design curves are presented for coils of rectangular cross section for producing intense transient magnetic fields, using energy obtained from a bank of charged capacitors.

621.318.57 2220

**A Reversible Binary Counter**—R. W. Fenimore. (*Elect. Eng.*, vol. 27, pp. 204–206; May, 1955.) A multivibrator-type counter performs addition or subtraction depending on application of a control signal to a two-gate system interposed between consecutive counter stages. The control signal may be obtained from a multivibrator circuit similar to the counter stages. Applications in digital-analog conversion and in an interpolator are discussed.

621.318.57:621.314.7 2221

**Transistor Choppers for Stable DC Amplifiers**—R. L. Bright and A. P. Kruper. (*Electronics*, vol. 28, pp. 135–137; April, 1955.) Two fused-junction transistors driven at power frequency are used in a switching circuit for converting weak dc input signals into proportional square wave ac signals.

621.318.57:621.38 2222

**Multi-electrode Counting Tubes**—K. Kan, diah and D. W. Chambers. (*Jour. Brit. IRE*, vol. 15, pp. 221–232; April, 1955. Discussion-p. 232.) Applications other than straightforward counting operations are discussed for decimal counting tubes of various types. The design of a pulse amplitude analyzer using trochotrons and dekatrons in a matrix system is outlined. The life of the tubes is comparable to that of ordinary tubes.

621.37.+621.396.621[049.75 2223

**Investigations of Laboratory Production of Printed Circuits for Communication Equipment**—W. Götze. (*Fernmeldetechn. Z.*, vol. 8, pp. 83–88; February, 1955.) A brief report is presented on the practical aspects of very-small-scale production of printed circuits, using the simplest tools only. The electrical and mechanical properties of 12 different chassis materials are tabulated as well as the properties and the treatments required by seven different conducting materials. Applications described include the production of components, an amplifier, an RC oscillator and a heterodyne receiver for the frequency band 500 kc–15 mc; this receiver contains no inductive components (see also 958 of 1953).

621.372.412 2224

**Piezoelectrically-Activated Low-Frequency Mechanical Resonators**—J. F. W. Bell. (*Jour. Sci. Instr.*, vol. 32, pp. 52–54; February, 1955.) Discussion of resonators comprising plates or bars carrying two relatively small piezoelectric crystals. The parameters of the equivalent electrical quadripole are determined for flexural modes of some circular Chladni's plate type resonators. Application to stabilization of sinusoidal oscillators is briefly described.

621.372.5 2225  
On the Physical Realizability of Linear

**Non-reciprocal Networks**—H. J. Carlin. (*PROC. IRE*, vol. 43, pp. 608–616; May, 1955.) “The necessary and sufficient conditions are given that a matrix with arbitrary complex number elements be the impedance, admittance or scattering matrix of a physical linear reciprocal or non-reciprocal network. A canonical form for non-reciprocal network synthesis is presented which applies to any linear  $n$ -terminal pair ( $n$ -port) system at any fixed frequency. If the network is passive the only circuit element required in addition to lossless inductors, capacitors, transformers and positive resistors is the gyrator. If the network is active, negative resistors and gyrators must be used in addition to conventional passive elements. Some discussion of matrices with frequency variable elements is also given.”

621.372.5 2226

**Transient Responses with Limited Overshoot**—A. J. O. Cruickshank. (*Wireless Eng.*, vol. 32, pp. 154–163; June, 1955.) “The problem is considered of designing a system transfer function such that, in the response to a step-function input, the overshoot shall be limited and consist largely of the principal mode of oscillation. A method is stated by which the size of any real term in the response may be calculated relative to the maximum value of the principal mode. Graphical conditions are given restricting the permissible pole and zero positions in certain cases when this ratio is specified. The procedure is illustrated by examples.”

621.372.5 2227

**Design of Parallel-T Resistance-Capacitance Networks**—Y. Oono. (*Proc. IRE*, vol. 43, pp. 617–619; May, 1955.) Formulas are derived for networks having a transfer characteristic symmetrical with respect to resonance frequency and a minimum loss for a prescribed frequency discrimination.

621.372.5 2228

**Symmetrical Quadripoles operated as [asymmetrical] Transformers**—A. Ruhrmann. (*Arch. Elektrotech.*, vol. 41, pp. 320–333; November 25, 1954.) A theoretical investigation is presented of the behavior of passive, linear quadripoles in asymmetrical operation. The analysis is based on introduction of the characteristic iterative impedance. Multisection bandpass filters with different output and input impedances are built up with sections which have similar frequency characteristics and phase constants, but geometrically graduated impedances. A numerical example is given of a  $30\Omega/60\Omega$  transformation for the 474–1,570-kc frequency band.

621.372.54 2229

**The Initial Transient Behaviour of Filters with Characteristic Amplitude Response**—H. H. Nissen and W. Händler. (*Arch. elekt. Übertragung*, vol. 9, pp. 74–80; February, 1955.) The distortion of a step-voltage input by Butterworth-type and Tchebycheff-type filters is analyzed. Calculations are made for all-pass equalizing networks for the former type.

621.372.54 2230

**A Note on Time Series and the use of Jump Functions in Approximate Analysis**—A. J. O. Cruickshank. (*Proc. IEE*, Part C, vol. 102, pp. 81–87; March, 1955. Digest, *ibid.*, Part II, vol. 101, p. 680; December, 1954.) The response of filters to jump-function inputs is investigated. Jump-transfer functions and serial operators for common types of filter are tabulated. The method is compared with that described by Tustin (*Jour. IEE*, Part IIA, vol. 94, p. 130; 1947.)

621.372.54+621.372.2]:512.831 2231

**The Matrix Approach to Filters and Transmission Lines**—M. E. Fisher. (*Electronic Eng.*, vol. 27, pp. 198–204 and 258–263; May and June, 1955.) Use of matrices provides a

direct and flexible method of treatment. A simple graphical procedure is indicated for investigating filter characteristics.

**621.372.54:519.241.1** 2232  
**A New Method of Determining Correlation Functions of Stationary Time Series—Lampard.** (See 2352.)

**621.372.54:621.3.015.3** 2233  
**The Transient Response of R.F. and I.F. Filters to a Wave Packet—A. W. Gent.** (*Proc. IEE*, Part C, vol. 102, pp. 1-2; March, 1955) Discussion on 963 of 1953.

**621.372.56:546.289:538.63** 2234  
**A Novel Microwave Attenuator using Germanium—J. B. Gunn and C. A. Hogarth.** (*Jour. Appl. Phys.*, vol. 26, pp. 353-354; March, 1955.) The device comprises a thin rectangular slab of Ge set obliquely across a waveguide, with current leads attached to the two ends and a magnetic field applied parallel to the face of the slab so as to control the concentration of current carriers as described by Weisshaar and Welker (3590 of 1954). Attenuation of 33 db was obtained with a pulsed control current of 60 ma.

**621.372.6** 2235  
**The Hybrid Ring—a Hybrid Circuit for Very High Frequencies—C. Colani.** (*Frequenz*, vol. 8, pp. 368-372; December, 1954) Input admittance and coupling attenuation are calculated as functions of frequency; good agreement with measured values is obtained. Methods of increasing bandwidth are discussed and a practical arrangement is described for the 4-kmc band, using a construction similar to microstrip.

**621.373** 2236  
**Suggestions on constructing Oscillators—J. Piesch.** (*Öst. Z. Telegr. Teleph. Funk Fernschtech.* vol. 9, pp. 10-19; January/February, 1955.) The operation of various tube and transistor oscillators is analyzed. Fixed and continuously tunable oscillators, pulse generators, and two-frequency oscillators for special applications are discussed.

**621.373.2.029.65** 2237  
**The Generation of Millimetre Waves—J. L. Farrands.** (*Proc. IEE*, Part C, vol. 102, pp. 98-103; March, 1955. Digest, *ibid.*, Part B, vol. 102, p. 264; March, 1955.) Theory is presented for spark generators; experimental evidence generally supports the theory. Useful results can only be obtained with sparks in oil.

**621.373.42.029.4** 2238  
**Ultra-low-Frequency Oscillator—M. D. Armitage.** (*Wireless Eng.* vol. 32, pp. 173-174; June, 1955.) A CR circuit using resistors and polystyrene capacitors of moderate values is described for obtaining oscillations at frequencies down to <1 cps. The effective value of the resistance is increased by use of the cathode-follower effect.

**621.373.421** 2239  
**Parallel-Network Oscillators—J. L. Stewart.** (*Proc. IRE*, vol. 43, pp. 589-595; May, 1955.) General principles are discussed of electronically tunable wide-band oscillators having two signal paths, with their outputs added, and a common feedback path; the tuning is performed by differentially controlling the gain in the two paths, e.g. by push-pull modulation. Particular arrangements described include a twin-triode circuit using an artificial-transmission-line network, giving a 2:1 tuning ratio, and a four-tube circuit with lead and lag networks, giving a frequency range nearly independent of center frequency. Amplitude constancy, stability, waveform and noise are examined.

**621.373.5:[621.314.7+621.372.412]** 2240  
**A Simple Quartz Crystal Oscillator driven by a Junction Transistor—H. G. Bassett.**

(*Electronic Eng.*, vol. 27, pp. 222-223; May, 1955.) The transistor is connected with grounded base and the quartz crystal is operated in its series mode. The frequency range is up to about 300 kc and the output power up to about 10 mw.

**621.374.4** 2241  
**Four-Decade Frequency Divider—G. K. Jensen and J. E. McGeogh.** (*Electronics*, vol. 28, pp. 154-158; April, 1955.) Division of any frequency from sub-audio to 450 kc by any whole number up to 10,999 is accomplished by a direct-reading divider using binary counter circuits.

**621.375.2:621.372.2** 2242  
**Design of Coaxial Cavities for Valves with Planar Electrodes—L. Grifone.** (*Alta Frequenza*, vol. 23, pp. 357-377; December, 1954.) The cavities form the double coaxial-line structure used in conjunction with a disk-seal-type tube for grounded-grid operation as amplifier or multiplier. A graphical method of design is presented, which involves only functions of the characteristic impedance, once the operating mode has been chosen. Criteria are explained for determining the diameters of the two cavities for optimum response. For higher-mode operation the response can be improved most easily by the introduction of a suitable discontinuity. Three types are considered. The occurrence of spurious resonances is also discussed.

**621.375.2:621.396.41** 2243  
**Design of H.F. and I.F. Amplifiers for Multichannel F. M. Links—R. Schienemann.** (*Telefunken Ztg.* vol. 24, pp. 157-162 and 211-219; September and December, 1954. Correction, *ibid.*, vol. 24, p. 254; December, 1954.) Bandwidth required is determined (a) from the side-band amplitudes for given modulation index and (b) from the permissible distortion. Expressions for (b) involve the derivatives of the amplifier response curves and are tabulated for single-stage circuits and two-stage bandpass filters. The computation for multi-stage circuits is shown to involve the same derivatives. Under ideal conditions, second-harmonic distortion would be eliminated by exact tuning to the central frequency, and third-harmonic distortion sufficiency reduced by using symmetrical filters with a coupling coefficient  $1/\sqrt{3}$ . In practice, tuning is not exact, but second-harmonic distortion can be kept at a tolerable level by adjustment of the pass-band response at the alignment stage. Tube capacitance variations are allowed for in the shunt circuit capacitance. Neutralization can practically eliminate the effects of feedback via grid-anode capacitance. Criteria for the choice of IF are explained.

**621.375.2.029.3** 2244  
**Circuit Design Factors for Audio Amplifiers—M. V. Kiebert, Jr.** (*Electronics*, vol. 28, pp. 166-171; April, 1955.) Close regulation of the anode supply of a cathode-follower driver stage in a power amplifier is achieved by using a regulator triode operated by a diode connected to the driven grid. Circuits discussed include improved versions of Williamson and "ultra-linear" amplifiers.

**621.375.2.029.3** 2245  
**Design for a 20-Watt High-Quality Amplifier: Part 2—W. A. Ferguson.** (*Wireless World*, vol. 61, pp. 279-282; June, 1955.) Details are given of the circuit, lay-out and performance of an amplifier with an output stage of two Type-EL34 high-slope pentodes in push-pull with partial screen-grid loading. Part 1: 1918 of August.

**621.375.227** 2246  
**A New Circuit for balancing the Characteristics of Pairs of Valves—R. E. Aitchison.** (*Electronic Eng.*, vol. 27, pp. 224-226; May,

1955.) A more detailed account of the work described previously (982 of May).

**621.375.23.029.64** 2247  
**X-Band Receiving Amplifier—K. Ishii.** (*Electronics*, vol. 28, pp. 202, 210; April, 1955.) A regenerative klystron amplifier is described, suitable for use in a microwave television receiver, having a gain 16 db at 9.76 kmc, with a bandwidth of 20 mc.

**621.375.3** 2248  
**Problems of Magnetic Pre-amplifiers—F. Kümmel.** (*Elektrotech. Z., Edn. A*, vol. 76, pp. 113-120; February 1, 1955.) The topics discussed include the quality, the effect of core shape on the magnetization characteristic, effect of characteristic of tube or semiconductor rectifier on amplification, and effects of incomplete magnetic decoupling of input circuit.

#### GENERAL PHYSICS

**53(083.7)** 2249  
**Representation of Physical Quantities in Formulae, Tables and Coordinate Systems—C. Glinz.** (*Tech. Mitt. schweiz. Telegr. Teleph-Verw.*, vol. 33, pp. 41-69; February 1, 1955. In German.) A comprehensive discussion covering both fundamental physical principles and typographical aspects.

**53.081.4** 2250  
**A New System of Logarithmic Units—J. B. Moore.** (*Proc. IRE*, vol. 43, p. 622; May, 1955.) Comment on 988 of May (Hartley).

**530.112** 2251  
**Proposal for a New Aether Drift Experiment—D. D. Crombie.** [*Nature (London)*, vol. 175, pp. 350-351; February 19, 1955.] A method of greater sensitivity than Essen's (2618 of 1954) uses a resonant cavity to produce a phase change in a signal from a fixed-frequency oscillator.

**530.145:538.3** 2252  
**Derivation of the Laws of Relativistic Electrodynamics for a Vacuum from the Energy-Quantum Model—H. Zuhrt.** (*Arch. elekt. Übertragung*, vol. 9, pp. 47-51; January, 1955.) Theory developed previously (1627 of July) is extended to include the case of systems in motion.

**530.145.6:621.385.833** 2253  
**Wave-Mechanics Theory of Electron-Optical Image Formation: Part I—W. Glaser and G. Braun.** (*Acta Phys. austriaca*, vol. 9, pp. 41-74; December, 1954.)

**537.21:621.3.013.78** 2254  
**Electrostatic Averaged Boundary Conditions for Wire Mesh—B. Ya. Moyzhes.** (*Zh. Tekh. Fiz.*, vol. 25, pp. 167-176; January, 1955.) A brief review is given of the existing methods for determining the screening effect of a mesh, and a general derivation is proposed of the boundary condition for a mesh by the method of averaging the field. The results obtained are applied to the determination of the screening effect of an earthed uniform spherical mesh with respect to a charge or a dipole placed at the center, and also to the determination of the effective potential in a triode. See also 2273 below.

**537.212:621.317.39.082.72** 2255  
**The Field due to an Infinite Dielectric Cylinder between two Parallel Conducting Planes—C. Mack.** (*Brit. Jour. Appl. Phys.*, vol. 6, pp. 59-62; February, 1955.) If the cylinder radius,  $b$ , is sufficiently small compared with the other dimensions involved, the change of capacitance due to its insertion between the plates can be made proportional to  $(K-1)b^2/(K+1)$ , where  $K$  is the dielectric constant of the cylinder. For a conducting cylinder,  $K$  is put equal to infinity. Applications include the measurement of the departure from uniformity of threads.

- 537.226:537.311.35 2256  
**The Ionic Conductivity of Dilute Potassium Chloride Solutions at Centimetric Wavelengths**—V. I. Little and V. Smith. (*Proc. Phys. Soc.*, vol. 68, pp. 65—74; February 1, 1955.) Measurements on solutions in the concentration range 0.005–1.0 normal, at a frequency of  $3 \times 10^9$  cps, indicate the existence of a strong dispersion region at concentrations below 0.5 normal, which may be explained in terms of the perturbations by the applied field of a shell of water molecules surrounding the ion at a mean distance of 6 Å.
- 537.226.2:546.212:621.317.335.3 2257  
**The Dielectric Constant of 'Free' and 'Bound' Water at Microwave Frequencies**—J. Baruch and W. Low. (*Bull. Res. Coun. Israel*, vol. 3, pp. 31–36; June–September, 1953.) An attempt is made to assess and summarize results obtained by the authors and by other workers on the dielectric dispersion of water, the water molecules in  $\text{CuSO}_4 \cdot 5\text{H}_2\text{O}$  in the temperature range from –70 degrees C. to 150 degrees C., water in hygroscopic salts, aqueous gels and thixotropic gels. Estimation of hydration is also considered. 39 references.
- 537.311.1:535.137 2258  
**The Theory of the Reflectivity of Metals**—R. Wolfe. (*Proc. Phys. Soc.*, vol. 68, pp. 121–127; February 1, 1955.) The reflectivity of an ideal metal for infrared radiation is calculated by quantum-mechanics. Results agree with those obtained by Dingle (2626 of 1954) using classical methods; the diffuse-reflection wave functions correspond more closely than the specular-reflection wave functions to the actual electronic wave functions as indicated by experimental results.
- 537.311.6:621.315.514 2259  
**Skin and Spiraling Effect in Stranded Conductors**—J. Zaborsky. (*Trans. Amer. IEE*, Part III, *Power Apparatus and Systems*, vol. 72, pp. 599–602; August, 1953. Discussion, pp. 602–603.) An analysis is made to determine the ac resistance and internal reactance of stranded conductors with or without a magnetic core, at power frequencies, assuming current density constant in individual strands. The spiraling of strands tends to reduce skin effect. Data calculated for standard copper conductors with parallel and spiralled strands are listed.
- 537.52:537.226 2260  
**Theory of Breakdown of Inhomogeneous Dielectrics**—Yu. M. Volokobinski. (*Zh. Tekh. Fiz.*, vol. 25, pp. 74–80; January, 1955.)
- 537.525 2261  
**Formative Time-Lag Studies with High-Frequency Discharges**—A. W. Bright and H. C. Huang. (*Proc. IEE*, Part C, vol. 102, pp. 42–45; March, 1955. Digest, *ibid.*, Part III, vol. 101, pp. 407–408; November, 1954.) Pulse techniques were used to study phenomena in coaxial-cylinder and parallel-wire systems, in the frequency range 1–15 mc, where the discharge changes from corona type to one which completely crosses the gap. The breakdown voltage drops by about 13 per cent above the critical frequency.
- 537.525 2262  
**Space-Charge Effects in a High-Frequency Discharge: Part 2**—M. Chenot. (*Jour. Phys. Radium*, vol. 16, pp. 101–107; February, 1955.) Further discussion of results of experiments previously reported (1945 of August). Cathode disintegration phenomena, various shapes of characteristic, and factors affecting the direction and magnitude of the emf are considered.
- 537.533 2263  
**Field-Emission and Surface Phenomena**—F. L. Jones. [*Nature (London)*, vol. 175, pp. 244–245; February 5, 1955.] Brief report of a symposium held at Pittsburg in November, 1954.
- 537.533 2264  
**Delayed Electron Emission from Metals**—K. Seeger. (*Naturwiss.*, vol. 42, p. 66; February, 1955.) Measurements were made on a foil substituted for the usual photocathode in a multiplier cell. Emission was excited by bombarding with 1-kev electrons and measurements were started 5 minutes after the bombardment, the foil being simultaneously heated at a controlled rate. The emission/temperature curve passed through a maximum between 130 degrees and 200 degrees C. Emission was eliminated by prolonged heating at 1,000 degrees C. but was restored by exposing the foil to the atmosphere at 100 degrees C. and abrading it. The results support theory advanced by Nassenstein (87 of February).
- 537.533 2265  
**Electron Emission from Metal Surfaces after Mechanical Working**—J. Lohff and H. Raether. (*Naturwiss.*, vol. 42, pp. 66–67; February, 1955.) Measurements were made on various metals in gas at a pressure of about  $2 \times 10^{-6}$  Torr, using an electron multiplier. The surfaces were abraded with a steel brush within the vessel. Emission/time curves are shown for Pb, Ca, Al and Na; the activity of the elements is correlated with their position in the periodic system. Oxidation may be the cause of the emission, but no explanation of the mechanism is yet available.
- 537.533.8 2266  
**On the Escape Mechanism of Secondary Electrons from Insulators**—A. J. Dekker. (*Physica*, vol. 21, pp. 29–38; January, 1955.) Starting from the Boltzmann transport equation, and with certain simplifying assumptions, theory is developed which takes into account the interaction of secondary electrons with lattice vibrations, traps and occupied donor levels. At high trap densities, the secondary yield for high primary energies is inversely proportional to the square root of the trap density, at low trap densities yield is independent of trap density. Expressions for the temperature effect for high primary energies are derived for polar and nonpolar insulators. Results for the first case have been confirmed by experiment.
- 538.11 2267  
**Antiferromagnetism**—G. W. Pratt, Jr. (*Phys. Rev.*, vol. 97, pp. 926–932; February 15, 1955.) The nature of the spin coupling in the antiferromagnetic oxide MnO is discussed on the basis of a simplified model. The coupling between magnetic ions whose charge densities interact with an intervening nonmagnetic ion but not directly with each other is described as the result of the polarization of the nonmagnetic ion.
- 538.56 2268  
**Representation of Electromagnetic Field by Retarded Potentials**—I. S. Arzhanykh. [*Compt. Rend. Acad. Sci. (URSS)*, vol. 100, pp. 1053–1056; February 21, 1955. In Russian.] Applications considered include a boundary problem and the equation of motion of electron gas in vacuo.
- 538.566+534.2 2269  
**Electromagnetic and Acoustic Scattering by a Semi-infinite Body of Revolution**—C. E. Schensted. (*Jour. Appl. Phys.*, vol. 26, pp. 306–308; March, 1955.) Theory developed by Kline (646 of 1952) is used to determine the scattering of a plane wave incident along the axis of a perfectly reflecting body. For the case of a paraboloid the solution of the em problem is obtained exactly in closed form. The results are compared with those obtained from consideration of current distribution, as in 2306 below.
- 538.566+534.2 2270  
**Electromagnetic and Acoustical Scattering from a Semi-infinite Cone**—K. M. Siegel, J. W. Crispin and C. E. Schensted. (*Jour. Appl. Phys.*, vol. 26, pp. 309–313; March, 1955.) Calculations of scattering cross section for em waves incident along the axis of the cone are made by the physical-optics method based on current distribution and by the exact method based on the appropriate field equations; the solutions are practically identical for cone semi-angles close to zero or  $\pi/2$ . The corresponding comparison is also made for acoustic waves.
- 538.566:535.42 2271  
**Studies of the Diffraction of Electromagnetic Waves by Circular Apertures and Complementary Obstacles: the Near-Zone Field**—M. J. Ehrlich, S. Silver and G. Held. (*Jour. Appl. Phys.*, vol. 26, pp. 336–345; March, 1955.) Measurements have been made of both magnetic and electric field strengths with diffracting apertures of diameter up to  $36\lambda$  and normally incident waves. Experimental techniques for illuminating the aperture and probing the field are described; wavelengths around 3 cm afford a satisfactory compromise between reasonable over-all dimensions on the one hand and reliability of measurements on the other. Results are shown graphically; the predicted uniformity of the tangential magnetic field in the aperture plane is confirmed.
- 538.566:537.5:523.72 2272  
**Nonlinear Theory of Space-Charge Wave in Moving, Interacting Electron Beams with Application to Solar Radio Noise**—H. K. Sen. (*Phys. Rev.*, vol. 97, pp. 849–855; February 15, 1955.) Consideration of the exact equations for interaction between two neutralized electron beams indicates that steady-state space-charge waves can be propagated in such a medium. The period of the wave depends on the amplitude and phase velocity. The oscillation is simple harmonic for small amplitudes but deviates progressively from this condition as the amplitude increases. Beyond a critical amplitude, whose value depends on the phase velocity, the oscillation waveform becomes discontinuous. The theory is used to estimate the relative intensity of the second-harmonic component in solar rf outbursts reported by Wild *et al.* (391 of 1954). Analysis based on theory of radiation from oscillating plasma leads to a value for the rf flux of the order of magnitude of that observed.
- 538.566:621.3.013.78 2273  
**Electrodynamic Averaged Boundary Conditions for Wire Mesh**—B. Ya Moyzhes. (*Zh. Tekh. Fiz.*, vol. 25, pp. 158–166; January, 1955.) Eqs. (29) and (30) are derived which form a system of boundary conditions relating the averaged tangential components of the electric and magnetic fields on the surface of the mesh to the averaged surface density of the current in the mesh. The results obtained are illustrated by calculating the reflection of a plane wave from a plane uniform mesh, and by determining the screening effect of a spherical mesh with respect to a small turn of wire carrying a current and located at the center of the sphere.
- 538.566.2:535.32:[546.212+546.332.26 2274  
**The Refractive Index of Water and Aqueous Solutions of Sodium Sulphate at Metre Wavelengths**—I. S. Frolov. (*Zh. Eksp. Teor. Fiz.*, vol. 27, pp. 477–486; October, 1954.) Using the first method of Drude, the determination of the dependence of the refractive index of water on wavelength and temperature was extended to meter wavelengths and a temperature range from 2 degrees to 32 degrees C. Similar investigations were also carried out to determine the dependence on concentration of the refractive index of aqueous solutions of  $\text{Na}_2\text{SO}_4$ . The main conclusions reached are: (a) the refractive index in both cases increases linearly with temperature; (b) there is no anomalous dispersion at meter wavelengths; (c) for a given temperature the refractive index of a solution increases with concentration.



- 538.569.4:029.64:535.338 2275  
**Application of Molecular Beams to Radio-spectroscopic Study of Rotation Spectra of Molecules**—N. G. Basov and A. M. Prokhorov. (*Zh. Eksp. Teor. Fiz.*, vol. 27, pp. 431-438; October, 1954.) Molecular beams may be used to obtain narrow spectral lines, of width about 7 kc, and the rotation spectra of materials in the solid state. Quantitative estimates are made of the possibility of detecting the rotation transition  $J=1 \rightarrow J=2$  in  $\text{CsI}^+$  molecules at a frequency of 17.7 kmc using a spectroscope with a waveguide absorption cell, and of the  $J=0 \rightarrow J=1$  transition using a cavity-resonator instrument [see also 100 of February (Gordon et al.).]
- 539.233/.234 2276  
**Growth of Thin Films**—G. Cario and J. H. Kallweit. (*Z. Phys.*, vol. 140, pp. 47-56; January 13, 1955.) An attempt is made to explain qualitatively the mechanism of growth on the basis of Frenkel's theory of adsorption. A summary is given of the most important parameters which may affect the structure of the film before, during, and after deposition.
- 548.0:53 2277  
**Investigation of the Natural Frequencies and Natural Oscillations of Imperfect Crystal Lattices**—E. Fues and H. Stumpf. (*Z. Naturf.*, vol. 9a, pp. 897-902; October, 1954.) A theoretical investigation.
- 538.3 2278  
**Electromagnetics [Book Review]**—J. D. Kraus. Publishers: McGraw-Hill, London, 1953, 604 pp., 76s.6d. [*Nature (London)*, vol. 175, pp. 358-359; February 26, 1955.] A treatment of Maxwell's theory and some of its applications; suitable as a reference book for research workers. Mathematical functions entering into the solution of wave equations are dealt with in an appendix.
- 538.569.4:535.33 2279  
**Microwave Spectroscopy [Book Review]**—W. Gordy, W. V. Smith and R. F. Trainbarulo. Publishers: J. Wiley & Sons, New York, and Chapman & Hall, London, 1953, 446 pp., 64s. [*Nature (London)*, vol. 175, p. 273; February 12, 1955.] Includes chapters on spectroscopy technique and design, on measurements on gases, liquids and solids, on nuclear properties, on molecular structure, and on further possible applications of microwaves.
- GEOPHYSICAL AND EXTRATERRESTRIAL PHENOMENA**
- 523.5 2280  
**The Diffusion of Ionized Meteor Trails in the Upper Atmosphere**—J. S. Greenhow and E. L. Neufeld. (*Jour. Atmos. Terr. Phys.*, vol. 6, pp. 133-140; March, 1955.) The variation with height of the duration of radio echoes from meteor trails is discussed. For the experimental conditions involved, echo duration decreases approximately exponentially with increased height, in agreement with diffusion theory. The diffusion coefficient is between  $10^4$  and  $10^5 \text{ cm}^2$ , in agreement with estimates based on rocket determinations of upper-air density.
- 523.5:537.564 2281  
**Collision Processes in Meteor Trails**—H. S. W. Massey and D. W. Sida. (*Phil. Mag.*, vol. 46, pp. 190-198; February, 1955.) Momentum-loss cross sections for impacts between meteor atoms and atmospheric molecules are calculated. The values of the ionization cross section derived from them are in agreement with those derived earlier by Bates and Massey (*Phil. Mag.*, vol. 45, pp. 111-122; February, 1954.) The diffusion of ionization in a meteor trail is also discussed in relation to known mobilities of positive ions in gases.
- 523.72:538.566:537.5 2282  
**Nonlinear Theory of Space-Charge Wave in Moving, Interacting Electron Beams with Application to Solar Radio Noise**—Sen. (See 2272.)
- 523.72:621.396.822.029.62 2283  
**Character of 200-Mc/s Solar Noise Observation Equipment installed at Hiraiso Radio Wave Observatory**—T. Takahashi, M. Onoue and K. Kawakami. [*Jour. Radio Res. Labs. (Japan)*, vol. 1, pp. 41-53; September, 1954.] Principles of measurement and accuracy of equipment installed in March, 1952 are discussed. Routine observations started in August, 1954. The path of the sun is followed by a beam antenna system rotated 2 degrees every eight minutes, with manual adjustment daily for change of declination. During one minute in every eight the receiver input is connected to a noise generator for calibration purposes. The double-superheterodyne receiver has a bandwidth of about 80 kc. Results are compared with data from other stations.
- 523.74+551.510.535]:537.311.37 2284  
**Solar Electrodynamics**—J. W. Dungey. (*Jour. Atmos. Terr. Phys.*, vol. 6, pp. 88-90; March, 1955.) The reduction in conductivity of an ionized gas by a magnetic field and the effect of a polarization electric field are discussed. The theory has a bearing on conditions in the solar atmosphere above sunspots and on tidal oscillations in the ionosphere.
- 523.75:[551.510.535+550.38 2285  
**Geophysical Aspects of Solar Flares**—V. C. A. Ferraro. [*Nature (London)*, vol. 175, pp. 242-244; February 5, 1955.] Report of a discussion held at the Royal Astronomical Society in November, 1954. Results of research on the geomagnetic and ionospheric effects of the flares were surveyed.
- 523.755:523.16:621.396.822:523.99 2286  
**The Irregular Structure of the Outer Regions of the Solar Corona**—A. Hewish. (*Proc. Roy. Soc. A*, vol. 228, pp. 238-251; February 22, 1955.) Records obtained in 1952 of the radiation from the radio star in Taurus [9 of 1953 (Machin and Smith)] and results of measurements made in June, 1953, using antennas of greater directivity, cannot be explained in terms of absorption or large-scale refraction effects in the solar corona, but are consistent with a scattering theory. An estimate is made of the size and the electron density of the coronal irregularities in the range of distance 5-15  $R_{\odot}$ , where  $R_{\odot}$  is the solar radius. The irregular structure may represent an extension of the visible coronal rays.
- 550.384 2287  
**Recent Progress in the Theory of the Main Geomagnetic Field**—S. K. Runcorn. (*Sci. Prog.*, vol. 43, pp. 13-27; January, 1955.)
- 550.386:523.75 2288  
**Particularly Large Chromospheric Eruptions and Geomagnetic Activity**—P. Simon. [*Compt. Rend. Acad. Sci. (Paris)*, vol. 240, pp. 1056-1058; March 7, 1955.] Further analysis of observations indicates that geomagnetic activity related to the appearance of certain eruptions can be distinguished from that related to the central meridional passage of certain sunspots (1973 of August).
- 551.510.5 2289  
**Ion Production Rate in an Atmosphere of Exponentially Rising Temperature with Height**—H. Kamiyama. (*Sci. Rep. Tohoku Univ., 5th Ser., Geophys.*, vol. 6, pp. 11-18; August, 1954.) An expression is derived for the height distribution of the ion production rate, assuming that temperature varies exponentially with height and also depends on the solar zenith distance. Results are similar to those of Chapman for heights up to about 100 km. In the  $F_2$  region the maximum rate of ion production and the height at which it occurs vary anomalously with solar zenith distance.
- 551.510.535 2290  
**Mechanism of Creation of Ionospheric Inhomogeneities**—B. N. Gershman and V. L. Ginzburg. [*Compt. Rend. Acad. Sci. (URSS)*, vol. 100, pp. 647-650; February 1, 1955. In Russian.] Results of approximate calculations indicate that a negative temperature gradient of about  $10^{-4}$  degrees per cm, or greater, at a height of about 400 km could result in thermal convection currents such as would produce inhomogeneities and high-velocity winds in the ionosphere. The temperature at 300-400 km is assumed to be about 1,000 degrees-3,000 degrees.
- 551.510.535 2291  
**Studies on the Sunrise Effect in Regions E and F**—S. S. Baral. (*Jour. Atmos. Terr. Phys.*, vol. 6, pp. 160-170; March, 1955.) To be effective in causing ionization in a night-time layer, solar radiation must pass above the day-time height of the layer. The observed delay in time of sunrise effect is due therefore to the difference between the night-time and day-time heights of the layer considered. Observations made at Calcutta over the period 1947-1952 are in reasonable agreement with the theory.
- 551.510.535 2292  
**Absence of Bifurcation in the E Layer**—J. C. Seddon and J. E. Jackson. (*Phys. Rev.*, vol. 97, pp. 1182-1183; February 15, 1955.) Results of rocket measurements of electron concentration [see e.g. 1033 of May (Seddon et al.)] are adduced as evidence of absence of the bifurcation reported by Lien et al. (1054 of 1954).
- 551.510.535 2293  
**Further Remarks on Bifurcation in the E Layer**—W. Pfister, J. C. Ulwick and R. J. Marcou. (*Phys. Rev.*, vol. 97, pp. 1183-1184; February 15, 1955.) Comment on 2292 above.
- 551.510.535 2294  
**Horizontal Movements of Ionization in the Equatorial F Region**—B. W. Osborne. (*Jour. Atmos. Terr. Phys.*, vol. 6, pp. 117-123; March, 1955.) Results of measurements at Singapore during the period September, 1953-April, 1954 show the existence of a regular semi-diurnal sinusoidal variation in the  $E-W$  velocity component at the equinoxes. Around the December solstice, during the mornings, the movements were irregular. No correlation with virtual height was found, nor any regular N-S movement.
- 551.510.535 2295  
**Origin of the  $F_1$  Layer**—E. Chvojková. (*Bull. Astr. Inst. Csl.*, vol. 4, pp. 101-109; September 1, 1953. In German.) The splitting of the  $F$  layer into the  $F_1$  and  $F_2$  layers is considered to be due to a thermal effect. The maximum temperature occurs in the region of maximum ion production, but since the density of gas in this region is a minimum, higher electron concentrations will occur above and below it. The region of maximum ionization lies in the lower half of the  $F$  layer and hence the  $F_1$  layer will be thinner than the  $F_2$  layer. The formula derived for the height distribution of the electron concentration shows that the thermal process could lead to splitting of an ionized layer and also explains the secondary nocturnal maximum of  $f^oF$ . The peculiarities of the equatorial layer described by Osborne (989 of 1952) are briefly discussed.
- 551.510.535:001.4 2296  
**Nomenclature and Conventions used in Analysis of Ionospheric Data**—K. Bibl, R. Busch, K. Rawer and K. Suchy. (*Jour. Atmos. Terr. Phys.*, vol. 6, pp. 69-87; March, 1955. In French.) It is proposed to classify the layers according to their thickness. A "critical thickness" is introduced to define the difference between normal layers, which are always thick, and abnormal thin layers, caused by transitory phenomena. The term "critical frequency" may

be used of thin layers if account is taken of the intensity of the echoes. Characteristics directly determined and those found by extrapolation should be distinguished. Revised lists of characteristic symbols and code letters are given in appendices.

**551.510.535:523.746** 2297  
**Relations between the Critical Frequency of the Ionosphere  $F_2$  Layer at Freiburg and Solar Activity Centres during the Years 1948-1951**—P. Simon. [*Compt. Rend. Acad. Sci. (Paris)*, vol. 240, pp. 1192-1193; March 14, 1955.] Analysis is made separately for night-time and daytime observations. No significant variation of  $F_2$ -layer critical frequency was associated with the passage of those sunspots giving no rf radiation. On passage of sunspots giving rf radiation, the night-time critical frequency suffered a significant reduction, while the daytime value was not significantly affected. This night-time effect is in concordance with observations of ionospheric absorption reported by Davies and Hagg (1765 of July).

**551.510.535:523.78** 2298  
**Ionospheric Behaviour at Khartoum during the Eclipse of 25th February 1952**—C. M. Minnis. (*Jour. Atmos. Terr. Phys.*, vol. 6, pp. 91-112; March, 1955.) Observations indicate that the  $E$  and  $F_1$  layers behave as Chapman layers having constant effective recombination coefficients  $\alpha'$  of  $1.5 \times 10^{-8} \text{ cm}^3 \text{ s}^{-1}$  and  $8 \times 10^{-9} \text{ cm}^3 \text{ s}^{-1}$  respectively, assuming a nonuniform distribution of the sources of ionizing radiation on the sun's disk. The positions and relative intensities of these sources and the frequency of the radiation are indicated. The  $F_2$ -layer records suggest the existence at the time of the eclipse of two component layers: a lower one corresponding to the normal post-sunrise  $F_2$  layer, having a high  $\alpha'$ , and an upper one which is a later development of the lower, having a low  $\alpha'$ . Changes in  $D$ -layer absorption confirm the asymmetrical distribution of sources of ionizing radiation. There is no evidence of an eclipse effect on  $E_s$  ionization, nor for a corpuscular eclipse in the  $F_2$  layer.

**551.510.535:621.317.39** 2299  
**An Apparatus for recording Time Delays between Radio Fading Characteristics**—G. J. Phillips. (*Jour. Atmos. Terr. Phys.*, vol. 6, pp. 124-128; March, 1955.) The equipment is designed for the study of ionospheric winds (1916 of 1952) and records time delays in the range 0.1 to 5s, with an instrumental accuracy of about 0.1s.

**551.510.535:621.396.11.029.62** 2300  
**Sporadic—E Propagation**—Gerson. (*See* 2409.)

**551.510.535:621.396.6:621.317.7** 2301  
**D.S.I.R. Ionospheric Absorption Measuring Equipment**—W. R. Piggott. (*Wireless Eng.*, vol. 32, pp. 164-169; June, 1955.) Main design features are described of pulse transmitting and receiving equipment used at Slough since 1941. Highly stable operation is essential. Pulse duration is variable between 50  $\mu\text{s}$  and 500  $\mu\text{s}$ ; the frequency range is 1-10 mc, and a peak power output of 0.5 kw is adequate for observer reception. Rhombic, delta and folded-dipole transmitting antennas have been used. The receiver is a superheterodyne with extra-high gain and dynamic range, and with provision for attenuation varying continuously up to about 160 db. Double-doublet and folded-dipole receiving antennas have been used. The display unit is a conventional cro.

**551.593** 2302  
**Collisional Deactivation and the Night Airglow**—D. R. Bates. (*Jour. Atmos. Terr. Phys.*, vol. 6, pp. 171-172; March, 1955.) A possible reaction of the oxygen is indicated to explain the observed spectrum of the night airglow.

**551.510.53** 2303  
**The Earth's Exterior Atmosphere and the Counterflow: The Counterflow as Related to Modern Geophysical Theories, with Seven Recent Russian Papers. Collected and translated by E. R. Hope [Book Review]**—Publishers: Defence Research Board, Ottawa, 2nd ed., 1954, 52 pp. [*Nature (London)*, vol. 175, p. 377; February 26, 1955.] Theory based on observations suggests that a gaseous tail resembling that of a comet stretches away from the earth in the direction away from the sun. A valuable contribution to the literature of upper-atmosphere research.

#### LOCATION AND AIDS TO NAVIGATION

**621.396.663:621.396.933.1** 2304  
**Qualitative and Quantitative Errors of an Automatic Radio Compass**—A. Troost and G. Ziehm. (*Fernmeldetechn. Z.*, vol. 8, pp. 65-70; February, 1955.) Three sources of bearing errors in a typical automatic radio compass are considered: (a) effect of "nondirectional" noise voltage in goniometer output, (b) effect of noise voltage and an error phase angle between the goniometer output voltage and the output voltage of the omnidirectional aerial, and (c) effect of inaccurate tuning.

**621.396.933:551.594.6** 2305  
**The Measurement of Low-Frequency Atmospheric Noise in Southern Africa**—(ICAO *Bull.*, vol. 9, pp. 7-8; October, 1954.) General account of work undertaken since 1946 for the development of radio navigational aids in South Africa. This includes the recording of atmospheric noise in aircraft and on the ground at 100 kc [438 of 1951 (Hogg)], and ground tests carried out by the Telecommunications Research Laboratory on Decca, radio-compass, consol and loran equipment installed at fixed sites; in these, atmospheric noise picked up by an antenna and measured on a recorder was fed to the equipment together with a signal to simulate actual operating conditions.

**621.396.96:538.566** 2306  
**Bistatic Radar Cross-Sections of Surfaces of Revolution**—K. M. Siegel, H. A. Alperin, R. R. Bonkowski, J. W. Crispin, A. L. Maffett, C. E. Schensted and I. V. Schensted. (*Jour. Appl. Phys.*, vol. 26, pp. 297-305; March, 1955.) The "bistatic" cross section  $\sigma(\beta)$  corresponds to an arrangement in which radar transmitter and receiver are separated,  $\beta$  being the angle subtended at the scatterer by the transmitter-receiver line. Simple geometrical configurations are considered in which the transmitter is located on the axis of symmetry of the scatterer. Formulas are derived, by considering current distribution, for scatterers of spheroidal, conical, ogive, paraboloidal, ellipsoidal and hyperboloidal form, with characteristic dimensions large compared with  $\lambda$ . *See* also 2269 above.

**621.396.96.089.6** 2307  
**Precision Calibrator checks Radar Beacons**—R. D. Sinish. (*Electronics*, vol. 28, pp. 150-153; April, 1955.) Description of portable transponder equipment which checks range accuracy within  $\pm 5$  yards.

#### MATERIALS AND SUBSIDIARY TECHNIQUES

**531.788.7** 2308  
**A Compensated Ionization Manometer for Measurement of Vacua with High Relative Accuracy**—J. W. Hiby and M. Pahl. (*Z. Naturf.*, vol. 9a, pp. 906-907; October, 1954.)

**535.37** 2309  
**Action of Ni and of Co on ZnS(Au) Phosphors. Displacement of the Fermi Level by Variation of the Concentration**—N. Arpiarian. [*Compt. Rend. Acad. Sci. (Paris)*, vol. 240, pp. 1333-1335; March 21, 1955.]

**537.226:546.212** 2310  
**The Dielectric Method of Studying the Ad-**

sorption of Water—J. Le Bot and S. Le Montagner. (*Jour. Phys. Radium*, vol. 16, pp. 163-164; February, 1955.) Continuation of experiments reported in 1998 of August using various types of gel and varying water content. Comparable results were obtained.

**537.226.2** 2311  
**Dielectric Mixture Chart**—E. Sion. (*Electronics*, vol. 28, p. 176; April, 1955.) Nomogram relating dielectric constants of mixtures of two dielectrics with the dielectric constants of the components and the composition of the mixture.

**537.227** 2312  
**X-Ray and Neutron Diffraction Study of Ferroelectric PbTiO<sub>3</sub>**—G. Shirane, R. Pepinsky and B. C. Frazer. (*Phys. Rev.*, vol. 97, pp. 1179-1180; February 15, 1955.)

**537.311.3+536.21** 2313  
**Thermal and Electrical Conductivities of Solids at Low Temperatures**—G. K. White and S. B. Woods. (*Canad. Jour. Phys.*, vol. 33, pp. 58-73; February, 1955.) Measurements were made over the range 2 degrees-300 degrees K on materials for which lattice conductivity is comparable to electronic conductivity. Results are presented for some dilute Cu alloys, Be, Bi and Ge.

**537.311.3:546.3-1** 2314  
**Semiconducting Properties of some High-Resistance Metallic Alloys**—A. I. Drabkin. (*Zh. Tekh. Fiz.*, vol. 25, pp. 81-84; January, 1955.) A table is given showing the properties of various types of manganin, constantan and NWB alloys (Ag and Mn with Sb or Ni).

**537.311.33+621.314.7** 2315  
**Semiconductors and the Transistor**—E. W. Herold. (*Jour. Frank. Inst.*, vol. 259, pp. 87-106; February, 1955.) A general survey with 33 references.

**537.311.33** 2316  
**Motion of Electrons and Holes in Perturbed Periodic Fields**—J. M. Luttinger and W. Kohn. (*Phys. Rev.*, vol. 97, pp. 869-883; February 15, 1955.) "A new method of developing an effective-mass" equation for electrons moving in a perturbed periodic structure is discussed. This method is particularly adapted to such problems as arise in connection with impurity states and cyclotron resonance in semiconductors such as Si and Ge. The resulting theory generalizes the usual effective-mass treatment to the case where a band minimum is not at the center of the Brillouin zone, and also to the case where the band is degenerate. The latter is particularly striking, the usual Wannier equation being replaced by a set of coupled differential equations."

**537.311.33** 2317  
**Scattering of Electrons by Charged Dislocations in Semiconductors**—W. T. Read, Jr. (*Phil. Mag.*, vol. 46, pp. 111-131; February, 1955.) Experiments [2124 of 1954 (Pearson et al.)] suggest that dislocations in Ge act as rows of closely spaced acceptor centers. In  $n$ -type material a dislocation accepts electrons and becomes a line of negative charge surrounded by a cylindrical region of fixed positive space charge. A theoretical investigation is made of drift and Hall mobilities for current flow normal to the dislocations, with a magnetic field (a) parallel to the dislocations, and (b) normal to them.

**537.311.33** 2318  
**Dielectric Properties of Transition Layers in Semiconductors**—B. M. Vul. (*Zh. Tekh. Fiz.*, vol. 25, pp. 3-10; January, 1955.) Formulas are derived for determining the capacitance, resistance and dielectric losses of the region in which the semiconductor changes from  $n$  to  $p$  type.

- 537.311.33:537.32** 2319  
**On the Thermoelectric Properties of the Impurity Semiconductors**—E. Laurila. (*Ann. Acad. Sci. Fenn.*, Ser. A, no. 178, 11 pp.; 1955.) Formulas for the Seebeck, Peltier and Thomson coefficients of impurity semiconductors are derived on the basis of statistical theory of conductivity as developed by Shockley (246 of 1951). For a Ge *p-n* junction at room temperature the thermoelectric power is found to be about 2 mv/degrees K.
- 537.311.33:546.28** 2320  
**Hyperfine Splitting of Donor States in Silicon**—W. Kohn and J. M. Luttinger. (*Phys. Rev.*, vol. 97, pp. 883-888; February 15, 1955.) Calculations are reported which support the view that spin resonances observed by Fletcher et al. (3254 of 1954 and 453 of February) are due to electrons in donor states.
- 537.311.33:546.28:548.0** 2321  
**Lamellar Defects in Single Crystals of Silicon**—J. Franks, G. A. Geach and A. T. Churchman. (*Proc. Phys. Soc.*, vol. 68, pp. 111-112; February 1, 1955.) "Otherwise perfect single crystals of silicon have been shown to contain lamellar defects lying on (111) and (123) planes. Similar lamellae may be introduced by plastic deformation."
- 537.311.33:546.289** 2322  
**Effective Carrier Mobility in Surface Space-Charge Layers**—J. R. Schrieffer. (*Phys. Rev.*, vol. 97, pp. 641-646; February 1, 1955.) "Carriers held to a region near the surface by the potential well of a space charge layer may have their mobility reduced by surface scattering, if the width of the well is of the order of a mean free path. An effective mobility, which may differ from the bulk mobility by as much as a factor of ten, has been obtained from a solution of the Boltzmann equation. Solutions have been carried out for two types of potential functions: (a) a linear potential corresponding to a constant space-charge field, and (b) a solution of Poisson's equation including an external bias applied normal to the surface. The results have been used to calculate changes in surface conductance of germanium with changes in surface potential and predict the 'field effect' and 'channel effect' mobilities."
- 537.311.33:546.289** 2323  
**Gold as an Acceptor in Germanium**—W. C. Dunlap, Jr. (*Phys. Rev.*, vol. 97, pp. 614-629; February 1, 1955.) Measurements are reported on wafers cut from single crystals grown from a Ge melt to which Au had been added. Acceptor levels are found at 0.15 ev above the valence band and at 0.2 ev below the conduction band. At 77 degrees K, specimens of *p*- or *n*-type, with either high or low resistivity can be obtained, depending on the amounts of other impurities present. Photoconductive response extends to a wavelength of about 8  $\mu$ . Trapping phenomena are discussed. Important applications of Au-doped Ge in research are indicated.
- 537.311.33:546.289** 2324  
**Properties of Germanium Doped with Cobalt**—W. W. Tyler, R. Newman and H. H. Woodbury. (*Phys. Rev.*, vol. 97, pp. 669-672; February 1, 1955.) "Measurements of the temperature dependence of electrical resistivity in *n*- and *p*-type cobalt-doped germanium crystals indicate that cobalt introduces acceptor levels in germanium at  $0.31 \pm 0.01$  eV from the conduction band and  $0.25 \pm 0.01$  eV from the valence band. Ionization energies deduced from infrared photoconductivity studies at 77° K are in good agreement with the values obtained from resistivity measurements. *N*-type samples show higher intrinsic photosensitivity than *p*-type samples and demonstrate quenching effects."
- 537.311.33:546.289** 2325  
**Sparked Hydrogen Treatment of Germanium Surfaces**—N. Holonyak, Jr., and H. Letaw, Jr. (*Jour. Appl. Phys.*, vol. 26, p. 355; March, 1955.) On subjecting Ge specimens to a discharge in hydrogen at low pressure, the surface recombination velocity was greatly increased while the magnitude and decay time of voltages produced by illuminating *p-n* junctions was reduced; hole-storage effects in junctions were also reduced, without greatly impairing the reverse *I/V* characteristics.
- 537.311.33:546.47.86** 2326  
**Diffusion of Sb and Sn in Semiconducting Compound SbZn**—B. I. Boltaks. [*Compt. Rend. Acad. Sci. (URSS)*, vol. 100, pp. 901-903; February 11, 1955. In Russian.] Report of an experimental investigation. A sharp change of slope of the log-*D*/(1/*T*) curve was observed at about 400 degrees C. This effect is briefly discussed.
- 537.311.33:546.472.21** 2327  
**Investigations on Zinc Sulphide Crystals**—J. Krumbiegel. (*Z. Naturf.*, vol. 9a, pp. 903-904; October, 1954.) Brief report of an investigation of the structure, luminescence and photoconductivity of single crystals grown from the vapor phase. Nonuniformities are observed particularly in the luminescence properties.
- 537.311.33:546.482.21** 2328  
**Significance of the Electrical Contact in Investigations on CdS Single Crystals**—W. M. Buttler and W. Muscheid. [*Ann. Phys (Leipzig)*, vol. 14, pp. 215-219; February 15, 1954, and vol. 15, pp. 82-111; November 15, 1954.] The properties of ohmic and of nonohmic CdS photoresistors were investigated experimentally. Separate models are suggested for the metal-to-semiconductor contact in the two cases, one based on the assumption of a perfect contact, the other assuming a dependence of the contact on adsorption layers and surface states. Both models deviate from the Schottky-Mott model.
- 537.311.33:546.623.86** 2329  
**Zone Melting of Aluminium Antimonide**—H. A. Schell. (*Z. Metallkde.*, vol. 46, pp. 58-61; January, 1955.) Experiments on the purification of AlSb were made using Pfann's technique. The method proved satisfactory for eliminating Cu, Fe, Mg, Si, Ca and Pb, and yielded material with improved electrical properties.
- 537.311.33:546.811-17** 2330  
**Measurements of Electrical Conductivity and Magnetoresistance of Gray Tin Filaments**—A. W. Ewald and E. E. Kohnke. (*Phys. Rev.*, vol. 97, pp. 607-613; February 1, 1955.) Measurements were made on filaments of pure material and of alloys containing Sb, As, In, Al or Zn prepared by the method described previously (*Phys. Rev.*, vol. 91, p. 244; July 1, 1953.) For 99.998 per cent pure Sn the activation energy is 0.082 ev and the conductivity at 0 degree C. is  $2,090 \Omega^{-1} \text{ cm}^{-1}$ . The activation energy is increased by addition of impurities. Differences in the temperature variation of conductivity produced by the different types of impurity are indicated.
- 537.311.33:548.0** 2331  
**Energy Levels of a Disordered Alloy**—R. H. Parmenter. (*Phys. Rev.*, vol. 97, pp. 587-598; February 1, 1955.) A study is made of the one-electron energy levels of a disordered alloy, using perturbation theory. The method is relevant to problems of semiconductor crystals with imperfections. Some experimental verification is reported for a predicted tailing off of the density-of-states curve into a forbidden band.
- 537.311.33:621.396.822** 2332  
**Current Noise in Semiconductors**—W. Baumgartner and H. U. Thoma. (*Z. angew. Math. Phys.*, vol. 6, pp. 66-68; January 25, 1955.) The observed inverse-frequency spectral distribution of noise is explained in terms of electron trapping.
- 538.22:546.3-1-47-46-26** 2333  
**The Structure and Properties of Some Ternary Alloys of Manganese, Zinc and Carbon**—R. G. Butters and H. P. Myers. (*Phil. Mag.*, vol. 46, pp. 132-143; February, 1955.) The single-phase alloys prepared have an ordered structure of the perovskite type and show spontaneous magnetization at room temperature. The observed magnetic properties are exceptional and indicate a new type of ferrimagnetic behavior postulated by Néel (3159 of 1949) but not hitherto observed. Measured characteristics are presented.
- 538.221** 2334  
**Possibility of the Observation of Exchange Resonance near a Ferrimagnetic Compensation Point**—R. K. Wangness. (*Phys. Rev.*, vol. 97, p. 831; February 1, 1955.) Theory for a system containing two sublattices indicates that resonance corresponding to the upper branch of the frequency curve should occur at a wavelength of the order of 0.1 mm. The possibility of observing such resonance is improved by working near the compensation point for angular momentum.
- 538.221** 2335  
**Observation of Exchange Resonance near a Ferrimagnetic Compensation Point**—T. R. McGuire. (*Phys. Rev.*, vol. 97, pp. 831-832; February 1, 1955.) Report of observations made under the conditions described by Wangness (2334 above).
- 538.221** 2336  
**Domains of Reverse Magnetization in Ferrromagnetic Metals**—T. G. Nilan and W. S. Paxton. (*Phys. Rev.*, vol. 97, pp. 834-835; February 1, 1955.) Calculations made by Goodenough (470 of March) are discussed in the light of studies of powder patterns in polycrystalline grain-oriented Si steels.
- 538.221** 2337  
**Spontaneous Magnetogalvanism and Magnetization in Irreversible Ferronickels**—A. L. Perrier and E. Ascher. [*Compt. Rend. Acad. Sci. (Paris)*, vol. 240, pp. 1066-1068; March 7, 1955.] Hall-effect and resistance measurements have been made on specimens containing about 70 per cent Fe and 30 per cent Ni, over a range of temperatures. Anomalies in the curves obtained are eliminated if, instead of the usual Hall emf, the current component normal to the longitudinal electric field and to the magnetic field or the magnetization is considered as the primary transverse effect.
- 538.221** 2338  
**Fundamental Processes in the Magnetization of Alnico Permanent-Magnet Alloys**—H. Fahlenbrach. (*Naturwiss.*, vol. 42, pp. 64-65; February, 1955.) Electron-microscope investigations of polycrystalline and single-crystal specimens of alnico-400 confirm the structural features observed by Nesbitt and Heidenreich (3456 of 1952) in heat-treated alloys.
- 538.221** 2339  
**Dependence of Coercive Force on Thickness of Laminae of Fe-Si Alloy**—Yu. P. Burdakova and V. V. Druzhinin. (*Zh. Tekh. Fiz.*, vol. 25, pp. 108-111; January, 1955.)
- 538.221:537.311.31:538.632** 2340  
**Band Model for Hall Effect, Magnetization, and Resistivity of Magnetic Metals**—E. M. Pugh. (*Phys. Rev.*, vol. 97, pp. 647-654; February 1, 1955.)
- 538.221:538.652** 2341  
**The [110] Magnetostriction of Some Single Crystals of Iron and Silicon Iron**—E. W. Lee. (*Proc. Phys. Soc.*, vol. 68, pp. 65-71; February 1, 1955.) The results of the previous investigation of magnetization curves (117 of 1954) are

used in magnetostriction calculations. The magnetostriction is found to depend on crystal width in a manner similar to that of the magnetization curves.

**539.234:546.23** 2342

**X-Ray Investigation of Selenium Films obtained by Evaporation in Vacuum**—D. N. Nasledov, V. A. Dorin and I. M. Dikina. (*Zh. Tekh. Fiz.*, vol. 25, pp. 29–38; January, 1955.) A detailed report is presented; one of the conclusions is that the electrical conductivity of the film depends on the temperature of the base during the evaporation process.

**549.514.51:621.93** 2343

**A Novel Type of Saw for the Economical Cutting of Quartz Crystals or Other Materials**—J. E. Thwaites and C. F. Sayers. (*P. O. Elect. Engr. Jour.*, vol. 47, part 4, pp. 233–235; January, 1955.)

**621.3-761** 2344

**New Solution Ceramic Coatings**—K. Rose. (*Materials and Methods*, vol. 41, pp. 107–108; February, 1955.) Heat- and corrosion-resistant films are formed on either metal or nonmetal surfaces by spraying on an aqueous solution of metallic salts. The surface is warmed sufficiently to drive off the water, leaving a tightly bonded oxide layer. Oxides of Zr and Cr are especially satisfactory; oxides of Ti, Ce and Mg and some phosphates, silicates, oxyhalides and metals have also been applied in this way. Such films may be useful for resistors and capacitors as well as for protective coatings.

**621.315.615:537.311.3** 2345

**A Note concerning the Conductivity of Liquid Dielectrics**—J. Hart and D. A. Simmonds. (*Canad. Jour. Phys.*, vol. 33, pp. 54–57; February, 1955.) "Experiments are described which show that it is not permissible to ignore electrode effects in the calculation of the mobilities of ions in liquid dielectrics."

**546.831** 2346

**Zirkonium—Seine Herstellung, Eigenschaften und Anwendungen in der Vakuumtechnik (Zirconium—its Production, Properties and Applications in Vacuum Technique)** [Book Review]—W. Espe. Publishers: Winter'sche Verlagshandlung, Fuessen/Bayern, 1953, 174 pp. (*Electronic Eng.*, vol. 27, p. 232; May, 1955.) A comprehensive survey including tables of properties and a bibliography; of particular interest in relation to gettering technique.

#### MATHEMATICS

**516** 2347

**Geometric Representation of the Gudermann Transformation**—R. Cazenave. (*Ann. Télécommun.*, vol. 9, pp. 330–333; December, 1954.)

**517.51** 2348

**The Theory of Generalized Functions**—G. Temple. (*Proc. Roy. Soc. A*, vol. 228, pp. 175–190; February 22, 1955.) An introductory account of the construction and properties of generalized functions of real variables, so defined that any generalized function  $f(x)$  possesses partial derivatives  $D^n f(x)$  of all orders, and that if the sequence  $f_n(x)$  converges to  $f(x)$ , then  $D^n f_n(x)$  converges to  $D^n f(x)$ . Delta functions of Dirac are included in the theory. The representation of generalized functions by Fourier series and integrals is illustrated. Applications in vector analysis, potential theory and wave theory will be dealt with subsequently.

**517.562** 2349

**Locus Diagrams of some Elementary Transcendental Functions**—H. Wahl. (*Frequenz*, vol. 8, pp. 372–378; December, 1954.) Continuation of paper abstracted in 1423 of June.

**517.65** 2350

**Method of Computation for Generalized**

**Lommel Integrals**—G. Coulmy. (*Ann. Télécommun.*, vol. 9, pp. 305–312; November, 1954.)

**517.65:621.396.11** 2351

**A Table of a Function used in Radio-Propagation Theory**—Horner. (*See* 2397.)

**519.241.1:621.372.54** 2352

**A New Method of Determining Correlation Functions of Stationary Time Series**—D. G. Lampard. (*Proc. IEE*, Part C, vol. 102, pp. 35–41; March, 1955. Digest, *ibid.*, Part III, vol. 101, pp. 343–346; September, 1954.) The method is based on an expansion of the correlation function in a suitable orthonormal system. The coefficients in the expansion are simply related to the convolution integrals which arise when the given time series are applied to linear filters whose impulse responses are members of this orthonormal system. A method of measuring these coefficients is proposed. Complex filters can be built up having an impulse response of the same form as the desired correlation function. Examples are presented of filters whose impulse responses are members of a Laguerre system. A practical autocorrelator based on such a filter is described and some results obtained with it are reported.

**519.241.5** 2353

**On the Averaging of Data**—S. S. Stevens. (*Science*, vol. 121, pp. 113–116; January 28, 1955.) A brief introductory discussion on when to use the mean, mode or median as measure of central tendency.

**517** 2354

**Higher Transcendental Functions [Book Review]**—Staff of the Bateman Project. Publishers: McGraw Hill, London, 1953, vol. 1, 302 pp., 52s., vol. 2, 396 pp., 60 s. [*Nature (London)*, vol. 175, p. 317; February 19, 1955.] The first two volumes of a series. Thousands of formulas are presented, usually with some indication of origin and often with suggestions as to methods of proof.

#### MEASUREMENTS AND TEST GEAR

**621.396.11.029.45:621.3.018.41(083.74)** 2355

**The Diurnal Carrier-Phase Variation of a 16-Kilocycle Transatlantic Signal**—Pierce. (*See* 2404.)

**621.317.3:621.314.632:546.289** 2356

**Recovery-Time Measurements on Point-Contact Germanium Diodes**—T. E. Firlie, M. E. McMahon and J. F. Roach. (*Proc. IRE*, vol. 43, pp. 603–607; May, 1955.) Discussion indicates the importance of using standard techniques and terminology.

**621.317.3.012.3** 2357

**Phase-Linearity Nomograph**—J. F. Sodaro. (*Electronics*, vol. 28, p. 178; April, 1955.) Nomogram relating delay time, phase shift and frequency for circuits of various types.

**621.317.32:621.385.2** 2358

**Use of Diodes for Measurement of R.M.S. Voltage with Good Independence of Waveform**—G. Bernardi. (*Ricerca Sci.*, vol. 25, pp. 34–48; January, 1955.) The important feature of the measurement circuit described is the inclusion of an improved voltage divider for supplying the diodes.

**621.317.329:621.373.413** 2359

**Measurement of the Distribution of the Electromagnetic Field in a Resonant Cavity**—A. Septier. (*Jour. Phys. Radium*, vol. 16, pp. 108–114; February, 1955.) See 1853 of 1954.

**621.317.335.2** 2360

**The Precise Measurement of Capacitance**—J. K. Webb and H. B. Wood. (*Proc. IEE*, Part C, vol. 102, pp. 3–12; March, 1955. Digest, *ibid.*, Part II, vol. 101, pp. 681–682; December, 1954.) The method described is designed to enable measurements to be made conveniently with a precision approaching that achieved by the National Physical Laboratory. A bridge

network is used with inductively coupled ratio arms which can be switched into the form of either a comparison or a Wien bridge. By combined use of the comparison bridge with a 2:1 ratio and the Wien bridge with a 1:1 ratio the unknown capacitance in one arm can be determined in terms of the resistance in the other arm at a given frequency.

**621.317.335.3.029.63/64** 2361

**Phase and Amplitude Balance Methods for Permittivity Measurements between 4 and 50 cm**—T. J. Buchanan and E. H. Grant. (*Brit. Jour. Appl. Phys.*, vol. 6, pp. 64–66; February, 1955.) The coaxial-line equipment described can be used to measure permittivities of liquids over a wide range of values; several alternative methods of procedure are given and two types of liquid cell are described. The apparatus is useful mainly for medium and high-loss liquids; for low-loss liquids cavity methods are preferred.

**621.317.353.2** 2362

**Measurements of a Fundamental by [periodic] Contacting without using a Fundamental Filter**—P. K. Hermann. (*Frequenz*, vol. 8, pp. 379–382; December, 1954.) Extension of the method in which harmonics are eliminated by appropriate choice of the contacting period,

**621.317.374** 2363

**Loss-Angle Standards [fixed and variable]**—H. Hoyer. (*Arch. Elektrotech.*, vol. 41, pp. 347–356; November 25, 1954.) Several types of fixed and variable capacitor-resistor loss-angle standards developed at the Physikalisch-Technische Bundesanstalt are described. The constructional details, method of use and experimental results are given. Standards for use at frequencies up to 10 kc are included.

**621.317.374.027.3** 2364

**A Recording Loss-Angle Meter for High Voltages**—K. B. Westendorf. (*Arch. Elektrotech.*, vol. 41, pp. 333–346; November 25, 1954.) A bridge-circuit instrument for use at voltages of the order of 10 kv at 50 cps is described.

**621.317.38.029.63** 2365

**A Note concerning Forces and Torques on Spheroidal Bodies in Cavities**—W. J. van de Lindt. (*Canad. Jour. Phys.*, vol. 33, pp. 113–117; February, 1955.) The method of determining microwave power from the force or torque on a ring in a cavity [1140 of 1954 (Kalra)] is modified by substitution of a metal sphere or spheroid for the ring. The forces acting on such a body are calculated from considerations of the energy in the cavity field.

**621.317.411:621.318.134:621.372.413** 2366

**Circularly Polarized Cavities for Measurement of Tensor Permeabilities**—E. G. Spencer, R. C. LeCraw and F. Reggia. (*Jour. Appl. Phys.*, vol. 26, pp. 354–355; March, 1955.) The determination of the tensor permeability of a ferrite by introducing a small sample into a cavity and observing the resonance characteristic is facilitated by exciting the cavity with a circularly rather than a linearly polarized wave.

**621.317.42** 2367

**A Probe for the Study of Magnetic Fields**—R. Birebent. [*Compt. Rend. Acad. Sci. (Paris)*, vol. 240, pp. 1064–1065; March 7, 1955.] The probe comprises a small coil fixed at one end of a tube and fed from an oscillator by leads passing through the tube, the other end of which carries a piezoelectric crystal. When the coil is exposed to a magnetic field, an alternating torsion is applied to the crystal, whose output is proportional to the field and to the coil current. Maximum sensitivity is obtained when the oscillator frequency is equal to the natural frequency of vibration of the probe, which was 1 kc in a particular model. The range of measurement is from a few oersteds to some thousands of oersteds.

- 621.317.7:621.3.018.75 2368  
**A Transient Pulse Width and Pulse Amplitude Meter**—F. Hart. (*Electronic Eng.*, vol. 27, pp. 192-197; May, 1955.) Two low-leakage capacitors are given charges proportional respectively to the amplitude and the duration of the pulse, and the voltages across the capacitors are measured with electrometer-type voltmeters before the charge leaks away. The particular instrument described was developed for observations on pulses originating from a mechanically vibrating tube.
- 621.317.7:621.385 2369  
**Circuit for the Determination of Contact Potentials and Electron Temperatures from Retarding Field Characteristics**—S. Friedman and L. N. Heynick. (*Rev. Sci. Instr.*, vol. 26, pp. 17-19; January, 1955.) The design of the circuit is based on the retarding-field equation for parallel-plane diodes; errors involved in applying it to measurements on other tubes are discussed.
- 621.317.729.1 2370  
**Probe Impedance in the Electrolytic Tank**—J. C. Burfoot. (*Brit. Jour. Appl. Phys.*, vol. 6, pp. 67-68; February, 1955.) The impedance is usually ascribed to capacitance or polarization effects, but in many cases the simple ionic conduction mechanism will give a useful estimate, so that the optimum size and shape may be calculated. Theoretical results are supported by measurements.
- 621.317.733:621.375.2 2371  
**A Tuned Detector-Amplifier for Power-Frequency Measurements**—W. K. Clothier and W. E. Smith. (*Jour. Sci. Instr.*, vol. 32, pp. 67-70; February, 1955.) A detector-amplifier for bridge measurements is tuned by means of a two-section LC filter, the inductors of which are varied simultaneously by dc in control windings on their mumetal cores. When used with suitable tuned input transformers it can detect power as low as  $10^{-10}$  w.
- 621.317.75:[621-526+621.372.5 2372  
**A Harmonic Response Plotter**—Z. Czajkowski. (*Electronic Eng.*, vol. 27, pp. 207-211; May, 1955.) The instrument described gives simultaneously the frequency response of a system and its first derived plot. It was designed for testing servo systems, but is useful for determining the characteristics of any network over the frequency range 0.2-104 cps. An electromechanical analog computer system is used incorporating six servomechanisms.
- 621.317.75:[621-526+621.372.5 2373  
**Servo Analyzer for Wide-Range Testing**—F. E. Dickey. (*Electronics*, vol. 28, pp. 172-175; April, 1955.) A phase-shift oscillator covering the range 0.25-300 cps provides a drive voltage for the servo unit under test and a variable two-phase output for analysis purposes. It may also be used to measure the characteristics of filters etc. The output can be modulated to supply a 60- or 400-cps suppressed-carrier AM signal.
- 621.317.75:621-526 2374  
**Transient Measurement of Feedback Control Systems**—F. H. Ferguson and C. H. Looney. (*Trans. Amer. IEE*, Part II, *Applications and Industry*, vol. 72, pp. 110-114; May, 1953.) Description of a transient-response indicator and recording system.
- 621.317.75:621.373.4.029.62 2375  
**Wobulator Adaptor for Band III**—G. H. Leonard. (*Wireless World*, vol. 61, pp. 283-287; June, 1955.) Full details are given of a circuit designed to operate with an existing band-I frequency-sweep oscillator for alignment of tuning units. Third harmonics of the 57-73-mc range are derived in a tripler stage and amplified, the response of the amplifier peaking somewhat below the center of the pass band to discriminate against fourth harmonics. An over-all flat response is achieved by an agc system based on detecting any modulation at the sweep frequency, 25 cps, in the rf output. Marker, attenuator and cro display systems are described.
- 621.317.755 2376  
**The Development and Design of Direct-Coupled Cathode-Ray Oscilloscopes for Industry and Research**—M. J. Goddard. (*Jour. Brit. IRE*, vol. 15, pp. 179-197; April, 1955.)
- 621.317.755 2377  
**Study and Realization of a Four-Beam Cathode-Ray Oscillograph for High-Voltage Operation**—J. Ollé. (*Rev. Gén. élec.*, vol. 64, pp. 104-108; February, 1955.) A fuller account of the oscillograph previously described by Fert et al. (1624 of 1954).
- 621.317.755:621.318.57 2378  
**Trigger Adapter for Transient Oscillograms**—L. Fleming. (*Electronics*, vol. 28 pp. 159-161; April, 1955.) An auxiliary unit operated by the transient to be displayed provides single sweep and unblanking of the cro beam. Sweep times of 2-5 ms are used.
- 621.317.755:621.385.029.6 2379  
**Velocity Spectrography of Electron Dynamics in a Traveling Field**—O. T. Purl and H. M. VonFoerster. (*Jour. Appl. Phys.*, vol. 26, pp. 351-353; March, 1955.) Velocity variations of electrons at a selected point along a beam are studied by means of a modification of an arrangement described by Bloom and VonFoerster (218 of February), one of the Lecher-wire deflection systems being replaced by a pair of curved deflection plates and the fluorescent screen being correspondingly offset. Use of this device for investigating the motion of electrons at the input of a traveling-wave tube is discussed.
- 621.317.772 2380  
**A Direct-Indicating Phase Meter**—A. van Weel. (*Jour. Brit. IRE*, vol. 15, pp. 143-152; March, 1955.) Description of a complete instrument based on principles discussed previously (3659 of 1953).
- 621.317.78.029.6 2381  
**A Microwave Microcalorimeter**—A. C. Macpherson and D. M. Kerns. (*Rev. Sci. Instr.*, vol. 26, pp. 27-33; January, 1955.) A bolometer instrument developed at the National Bureau of Standards measures microwave power accurately to within 1 per cent at milliwatt levels. The bolometer mount assembly serves as a matched waveguide termination.
- 621.373.421.13:621.3.018.41(083.74) 2382  
**A Simple Circuit for Frequency Standards employing Overtone Crystals**—E. P. Felch and J. O. Israel. (*Proc. IRE*, vol. 43, pp. 596-603; May, 1955.) An oscillator circuit with frequency stable to within one part in  $10^8$  over periods of several hours is obtained using a single-stage class-A amplifier with II-section feedback network and a quartz crystal operating at its fifth overtone, at 5 mc [see 3481 of 1952 (Warner)]. Undesired frequencies are suppressed by connecting a resistor in parallel with the crystal.
- 621.385.001.4:531.768 2383  
**Vibration Generator for Electron Tubes**—(*Elec. Jour.* vol. 154, p. 350; February 4, 1955.) Electrodynamical apparatus developed at the National Bureau of Standards for testing subminiature tubes uses a BaTiO<sub>3</sub> accelerometer capable of measuring vibration frequencies up to 20 kc at acceleration levels of 0.2-10,000 g.
- 621.385.833 2391  
**Electron Optics of Cylindrical Systems having a Plane of Symmetry: Part I—First-Order Approximation**—M. Laudet. (*Jour. Phys. Radium*, vol. 16, pp. 118-124; February, 1955.)
- 621.317.755:621.318.57 2384  
**Photoelectric Measurement of Weak Acoustic Birefringence**—J. Badoz. (*Compt. Rend. Acad. Sci. (Paris)*, vol. 240, pp. 1062-1064; March 7, 1955.) An ultrasonic beam modulated at low frequency is passed through a liquid, thus periodically producing birefringence. Polarized light passes through the liquid and is received by a photomultiplier, the intensity of the received light varying with the ultrasonic variations. The photomultiplier output is connected to a selective amplifier followed by a detector. Differences of optical path down to  $10^{-4}$  can thus be measured.
- 621.316.7 2385  
**A Design Philosophy for Man-Machine Control Systems**—M. Hoberman. (*Proc. IRE*, vol. 43, p. 623; May, 1955.) Comment on 822 of March (Birmingham and Taylor), suggesting that animals could replace humans as machine minders in some cases.
- 621.37[.38]786.2 2386  
**New Electronic Piano**—B. F. Miessner. (*Radio-Electronics*, vol. 26, pp. 64-66, 68; February, 1955.) Description of a keyboard instrument in which the strings are replaced by hammer-struck fixed-free reeds capacitively associated with fixed electrodes to control the frequency of an oscillator, producing a FM signal which is detected by a discriminator.
- 621.373.43:616-7 2387  
**Application of Pulse Circuits in Medicine**—I. Abrikosov. [*Radio (Moscow)*, no. 12, pp. 43-45; December, 1954.] Basic circuits are shown of apparatus for diagnosis and therapy. The pulse shapes and repetition rates most commonly used are indicated.
- 621.383.2:621.317.087:534.213-8 2388  
**A Method of Ultrasonoscopy using an Electron-Optical Image Converter**—M. von Ardenne. (*Nachr. Tech.*, vol. 5, pp. 49-51; February, 1955.) The ultrasonic-wave intensity distribution produced by a selectively absorbing test object is converted into a corresponding temperature distribution at an absorbing layer on the image converter photocathode. For maximum sensitivity the cathode work function should be low; a suggested material is [Ag]-Cs<sub>2</sub>O on a CsAg base, which has a work function of about 1 ev. The sketch of the suggested arrangement includes notes on materials and dimensions; the calculated threshold ultrasonic energy density, when using a photographic method of recording the image, is about 0.04 w/cm<sup>2</sup>. References to literature on the subject are tabulated, classified according to the method used, and the operation of the converters is outlined.
- 621.383.2:778.37 2389  
**Two New Image-Converter Tubes for Scientific Uses, "Valvo 18120" and "Valvo 18130"**—F. Cubasch. (*Elektronische Rundschau*, vol. 9, pp. 5-11; January, 1955.) A diode- and a triode-type image converter are described. Applications noted include use in a high-speed camera; a circuit diagram is given and results obtained are illustrated. Exposure times shorter than  $10^{-7}$  seconds are attainable. Methods of increasing the repetition rate to about 200,000 exposures/second are mentioned.
- 621.384.622 2390  
**Linear-Accelerator Issue**—(*Rev. Sci. Instr.*, vol. 26, pp. 111-231; February, 1955.) Detailed accounts are included of the Berkeley accelerator, which produces 31.5-Mev protons, and of the Stanford Mark-II and Mark-III traveling-wave electron accelerators.
- 621.385.833 2391  
**Electron Optics of Cylindrical Systems having a Plane of Symmetry: Part I—First-Order Approximation**—M. Laudet. (*Jour. Phys. Radium*, vol. 16, pp. 118-124; February, 1955.)

#### OTHER APPLICATIONS OF RADIO AND ELECTRONICS

- 534.222-8 2384  
**Photoelectric Measurement of Weak**

1955.) Expressions for the electron trajectories are derived, using Lagrange's method.

621.385.833:537.533 2392

**Use of Space Charge in Electron Optics**—E. A. Ash. (*Jour. Appl. Phys.*, vol. 26, pp. 327–330; March, 1955.) “The electron optical properties of a cylindrical space charge cloud are derived. The possibility of achieving a system free from either spherical or chromatic aberration by combining a space charge lens with a space charge free converging lens is examined. It is concluded that the achromatization of a thin electric or magnetic lens is possible only if the resultant action of the combination is divergent. The correction of the spherical aberration of a high quality lens, such as an electron microscope objective, is shown to be impossible on account of electron interaction effects.”

621.387.424 2393

**Geometric Efficiency of Cylindrical [G-M] Counters**—J. Goldemberg. (*Rev. Sci. Instr.*, vol. 26, pp. 41–44; January, 1955.)

621.387.424 2394

**Spontaneous Discharges of Thermionic Origin in Geiger Counters**—R. Meunier, M. Bonpas and J. P. Legrand. (*Jour. Phys. Radium*, vol. 16, pp. 145–148; February, 1955.)

621.387.424 2395

**Geiger Counters with  $\text{Tr}_2\text{O}$  Vapour Filling**—P. Meunier, M. Bonpas and J. P. Legrand. (*Jour. Phys. Radium*, vol. 16, pp. 148–151; February, 1955.)

621.397.3 2396

**Image Processing**—Kovácszay and Joseph. (See 2445.)

#### PROPAGATION OF WAVES

621.396.11:517.65 2397

**A Table of a Function used in Radio-Propagation Theory**—F. Horner. (*Proc. IRE*, Part C, vol. 102, pp. 134–137; March, 1955. Digest, *ibid.*, Part B, vol. 102, p. 400; May, 1955.) “Real and imaginary components of the complex integral  $1 + 2j\sqrt{\omega}\epsilon^{-\omega} \int_0^{\omega} \sqrt{\omega'} \epsilon^{-\omega'} dx$  are tabulated as a function of  $\omega$ . The Tables are prepared for real components of  $\omega$  in the range 0 to 10, associated with imaginary components in the range  $-10$  to  $0$ .”

621.396.11:537.56 2398

**Theory of Coupling of the Ordinary and Extraordinary Electromagnetic Waves in an Inhomogeneous Anisotropic Plasma and Conditions for Reflection. Applications to the Ionosphere**—R. Jancel and T. Kahan. (*Jour. Phys. Radium*, vol. 16, pp. 136–145; February, 1955.) Results of previous work [1030, 2196 and 2364 of 1954] are applied. Using the BKW approximation, expressions for the refractive index of the medium and the conditions for reflection both for longitudinal and transverse propagation are developed. Coupling is then considered, the four-sheeted Riemann surface representing the refractive-index equation giving the various forms of coupling between the ordinary and extraordinary rays. This surface is studied in detail for the particular conditions of the ionosphere.

621.396.11:551.510.52 2399

**Cheyenne Mountain Tropospheric Propagation Experiments**—A. P. Barsis, J. W. Herbstreit and K. O. Hornberg. (*NBS Circulars*, no. 554, 39 pp; January 3, 1955.) Experiments were started in 1950 on propagation over simulated air-to-ground communication paths, using cw transmitters on five frequencies in the range 92–1,046 mc, receivers continuously recording field strength at four locations within 226 miles of the mountain with additional provision for reception at distances of 393 and 617 miles, and an extensive meteorological

installation at Haswell, Colo. A detailed description is given of the transmitting and receiving equipment. Sample results lend support to Booker and Gordon's theory of scattering elaborated by Staras (804 of 1953). See also 2499 of 1954 (Bean) and 1955 *IRE Convention Record*, Part 2, pp. 85–93 (Herbstreit et al.).

621.396.11:551.510.535 2400

**An Ionospheric Attenuation Equivalence Theorem**—E. V. Appleton and W. J. G. Beynon. (*Jour. Atmos. Terr. Phys.*, vol. 6, pp. 141–148; March, 1955.) Partial reflection and scattering in the ionosphere may be important sources of attenuation of radio waves. For frequencies well above the equivalent critical frequency the following theorem relating oblique-incidence to  $f$  vertical-incidence phenomena is stated:  $[\rho]i_0 = \lambda[\rho]i_0' \cos i_0$  where  $\rho$  is the fractional attenuation,  $f$  the frequency and  $i_0$  the angle of incidence;  $\lambda = 1$  or  $\cos 2i_0$ , according as the electric vector is perpendicular to the plane of propagation or in the plane.

621.396.11:551.510.535 2401

**Radio Disturbance Warnings in Japan**—T. Obayashi. (*Jour. Radio. Res. Labs (Japan)*, vol. 1, pp. 55–61; September, 1954.) The system operated by the Hiraiso observatory is described. Short-term forecasts are broadcast on 4 mc and 8 mc from the standard-frequency station JJY. Weekly and monthly forecasts and special services for operators are provided.

621.396.11.029.45:551.510.535 2402

**The Numerical Solution of Differential Equations governing Reflexion of Long Radio Waves from the Ionosphere**—K. G. Budden. (*Proc. Roy. Soc. A*, vol. 227, pp. 516–537; February 8, 1955.) Two methods which have been used with the EDSAC are described. “In the first method the first-order simultaneous equations, derived from Maxwell's equations and the constitutive relations for the ionosphere, are integrated by a step-by-step process proceeding downwards. The integrations are started from properly chosen initial solutions. From the resulting field variables at the bottom of the ionosphere a reflexion coefficient matrix  $R$  is derived, whose elements include the familiar reflexion coefficients. Two integrations are needed for each derivation of the elements of  $R$ . For the second method, it is shown that the formulae for  $R$  for a level below the ionosphere can be applied also within the ionized medium, and define a more general matrix variable whose elements are the dependent variables in a new set of differential equations. These are integrated by a step-by-step process as in the first method. The solution obtained below the ionosphere gives the required set of reflexion coefficients without further calculation. Only one integration is required for each derivation. The equations are given in full for certain important special cases.”

621.396.11.029.45:551.510.535 2403

**The Ionospheric Propagation of Radio Waves of Frequency 16 kc/s over Short Distances**—T. W. Straker. (*Proc. IRE*, Part C, vol. 102, pp. 122–123; March, 1955. Digest, *ibid.*, Part B, vol. 102, pp. 396–399; May, 1955.) Report of experiments made during the period March, 1948–October, 1949, in continuation of the investigations described by Budden et al. (*Proc. Roy. Soc. A*, vol. 171, pp. 188–214; May 19, 1939) on signals transmitted from Rugby to Cambridge; amplitude and phase were measured separately. Conclusions reached previously concerning diurnal and seasonal variations of the reflection height are confirmed. Marked seasonal variation of the amplitude of the downcoming wave was observed, the variations being different for daytime and nighttime. During summer the amplitude was closely controlled by the sun, but was not related in any simple way to the zenith angle.

The sunrise effect for amplitude occurred about an hour earlier than for phase. Subsidiary variations observed are consistent with reflection taking place at two levels. Abnormal variations of reflection height occurred during and after magnetic storms.

621.396.11.029.45:621.3.018.41(083.74) 2404

**The Diurnal Carrier-Phase Variation of a 16-Kilocycle Transatlantic Signal**—J. A. Pierce. (*Proc. IRE*, vol. 43, pp. 584–588; May, 1955.) Measurements at Cambridge, Mass., on signals from GBR are reported. The diurnal variation in apparent transmission time is about  $40 \mu\text{s}$ ; this is presumed to be due to a variation of 10–12 km in  $h'p$ . The degree of phase stability of the received signal is such as to permit intercontinental comparison of frequencies with a precision of at least 1 part in  $10^{10}$ . On this basis, a radio navigation system could theoretically be accurate to within about a mile at a range of several thousand miles. The importance of such stability for narrow-band reception is discussed. See also 1425 of June (Pierce et al.).

621.396.11.029.6 2405

**Tropospheric Scatter Propagation**—(*Wireless World*, vol. 61, pp. 253–254; June, 1955.) Experiments carried out in America at frequencies in the lower ulf band, using 10-kw transmitters with antenna reflectors 60 feet in diameter, show that wide-band transmissions over a range of 200 miles are feasible. The system will probably be used to supplement the present radio-link system. Other experiments in progress at Syracuse are designed to determine the best modulation system and the diurnal and seasonal variation in reception. See also 2811 of 1951 (Straiton et al.).

621.396.11.029.6 2406

**Large Reduction of V.H.F. Transmission Loss and Fading by the Presence of a Mountain Obstacle in Beyond-Line-of-Sight Paths**—J. H. Crisdale; F. H. Dickson, J. J. Egli, J. W. Herbstreit and G. S. Wickizer. (*Proc. IRE*, vol. 43, pp. 627–628; May, 1955.) Comment on 3396 of 1953 and authors' reply.

621.396.11.029.62 2407

**V.H.F. Field Strength far beyond the Radio Horizon**—T. F. Rogers. (*Proc. IRE*, vol. 43, p. 623; May, 1955.) Measurements on a 220-mc pulsed signal are reported; an airborne receiver was used, at an altitude of 500 feet, at distances up to 420 miles. Differences from Megaw's results (973 of 1951) are noted. The results appear to be reasonably consistent with a  $d^{-7}$  law of variation of field strength.

621.396.11.029.62 2408

**Meteorological Consideration on the V.H.F. Propagation between Inubo and Hiraiso**—K. Hirao and H. Maruyama. (*Jour. Radio. Res. Labs (Japan)*, vol. 1, pp. 31–40; September, 1954.) Results of propagation tests during the period June–August, 1952 at 153 mc over a 78-km sea path are analyzed with reference to aerological data. A sudden 20-db increase of field strength lasting up to several hours occurred frequently during both late autumn and summer seasons. These increases are related to meteorological conditions giving rise to dry, warm air over the sea surface.

621.396.11.029.62:551.510.535 2409

**Sporadic-E Propagation**—N. C. Gerson (*Jour. Atmos. Terr. Phys.*, vol. 6, pp. 113–116; March, 1955.) Reports of two-way communication by amateurs during the period 1949–1952, mainly in summer, on a frequency of 50 mc, are analyzed. The results indicate that the modal station separation was 1,490 km, 2,800 km and about 4,200 km for single-, double- and triple-hop communication respectively. E<sub>s</sub> clouds having an effective diameter of about 925 km appeared to be fairly prevalent.

- 621.396.11.029.64:535.4 2410  
**The Reflection of Electromagnetic Waves from a Rough Surface**—H. Davies. (*Proc. IEE*, Part C, vol. 102, p. 148; March, 1955.) Discussion on 537 of March.
- 621.396.81.029.53 2411  
**Measurement of Loran Waves**—Y. Aono, T. Kobayashi, C. Ouchi and C. Nemoto. [*Jour. Radio Res. Labs (Japan)*], vol. 1, pp. 1-16; September, 1954.] In order to develop a reliable system for predicting field strength in the mf band, measurements were made at Hiraoso of the field strength of 1.85-mc and 1.95-mc loran transmissions from 12 stations in the western Pacific Ocean between 200 and 4,000 km away. Results are analyzed and characteristic curves are derived for diurnal variation factor  $\kappa$  and absorption factor  $\Gamma_m$ . These are used in constructing nomograms (a) relating  $\kappa$  to local time, month, and latitude of transmitting and receiving stations, and (b) relating  $\Gamma_2$  (deviative absorption factor), critical frequency, muf, operating frequency and distance.
- RECEPTION**
- 621.39:534.78 2412  
**The Effect of Severe Amplitude Limitation on Certain Types of Random Signal: a Clue to the Intelligibility of "Infinitely" Clipped Speech**—J. M. C. Dukes. (*Proc. IEE*, Part C, vol. 102, pp. 88-97; March, 1955. Digest, *ibid.*, Part B, vol. 102, pp. 261-263; March, 1955.) The energy spectrum of a random waveform is compared with that of the waveform after limiting and differentiation. With certain signals of common occurrence the average energy distribution is not much affected by the limiting, and the phase relation between the waveforms is highly coherent. This result explains the observed high intelligibility of clipped speech [1537 of 1948 (Licklider and Pollack)].
- 621.396.621+621.37]049.75 2413  
**Investigations of Laboratory Production of Printed Circuits for Communication Equipment**—Götze. (See 2223.)
- 621.396.621.57:621.314.7 2414  
**Crystal Valve Receivers**—A. Stead. (*RSGB Bull.*, vol. 30, pp. 378-380; February, 1955.) The design of simple "straight" receivers employing point-contact and junction-type transistors is described and complete circuit diagrams are given. The receivers worked satisfactorily at frequencies up to 2 mc.
- 621.396.822:621.396.62 2415  
**The Response of a Nonlinear System to Random Noise**—W. E. Thomson. (*Proc. IEE*, Part C, vol. 102, pp. 46-48; March, 1955. Digest, *ibid.*, Part III, vol. 101, p. 407; November, 1954.) A simplified form is derived of a formula obtained previously [see e.g. 3238 of 1948 (Middleton)] for the autocorrelation function of the output of a nonlinear system for the case where the output/input relation is expressed as a power series. The new formula emphasizes that intermodulation products of different orders are uncorrelated while contributions to the intermodulation product of a given order from different terms of the power series are completely correlated. If the output is expressed as a series of Hermite polynomial functions of the input, each term of the series gives rise to intermodulation products of one order only.
- 621.396.823 2416  
**High-Frequency Interference from Electric-Fence Equipment**—M. Haag. (*Elektrotech. Z., Edn. A*, vol. 76, pp. 120-124; February 1, 1955.) Electric fences considered are operated with voltage pulses of up to 5 kv, maximum pulse charge of 2.5 ma.s, pulse duration 0.1 second and pulse intervals of at least 0.75 second. Radio interference occurs mainly in the long-, medium- and short-wave bands; usw

interference has not so far been reported. Suitable measurement circuits and suppressors are discussed and both impedance/frequency and interference/frequency curves are shown.

- 621.396.823:537.523.3 2417  
**Radio Interference from Direct-Voltage Corona in a Coaxial Cylindrical Field**—H. Heindl. (*Arch. elektr. Übertragung*, vol. 9, pp. 93-98; February, 1955.) Report of a laboratory investigation intended as preliminary to a study of the effects produced by ac lines. The rf interference calculated from a consideration of the corona discharge mechanism is in good agreement with the observations. Comparison is made also with results obtained by other workers in various countries.

#### STATIONS AND COMMUNICATION SYSTEMS

- 621.39.001.11-20 2418  
**Extent of Redundancy in the Speech and its Importance in Long-Distance Telephony**—W. Endres. (*Fernmeldelech. Z.*, vol. 8, pp. 89-93; February, 1955.) According to communication theory, the time interval during which the frequency/time characteristic of a sound remains constant is considered to be redundant. Visible speech diagrams indicate that the redundancy in spoken English is about 50 per cent; a 2:1 time-compression should therefore be feasible.
- 621.395.44:621.315.052.63 2419  
**Telecommunication Equipment for Power Systems: Developments and Application in Sweden**—U. Hecht, S. Rodhe and H. J. B. Nevitt. (*Trans. Amer. IEE*, Part III, *Power Apparatus and Systems*, vol. 72, pp. 961-968; October, 1953. Discussion, pp. 968-969.) See also 1148 of May (Rathsmann et al.)
- 621.395.44:621.315.052.63:621.395.822 2420  
**A Study of Carrier-Frequency Noise on Power Lines: Part 3—Interpretation of Field Measurements**—J. D. Moynihan and B. J. Sparlin. (*Trans. Amer. IEE*, Part III, *Power Apparatus and Systems*, vol. 72, pp. 573-580; June, 1953. Discussion, pp. 580-581. Corrections for bandwidth and impedance differences to be considered in correlating test data are discussed. A standard reference bandwidth of 1 kc is suggested. Parts 1 and 2: 3705 of 1953 (Cheek and Moynihan).

- 621.395.741:621.3.018.78 2421  
**Law of Addition of Distortion Voltages in Long-Distance Communication Systems**—K. Steinbuch and H. Marko. (*Fernmeldelech. Z.*, vol. 8, pp. 71-78; February, 1955.) The law of addition of interference voltages due to thermal noise and to the nonlinear distortion in the amplifiers is derived for cascaded amplifiers with given phase characteristics. With sufficiently curved characteristics arithmetical addition is partly prevented, but the maximum obtainable gain is of the order of only 1.3  $n$ . Such a phase characteristic can be obtained by means of a suitable all-pass filter in the system.

- 621.396.4:621.376.222 2422  
**Study of the Balanced Valve Modulator for S.S.B. Radio Communication**—G. Bronzi. (*Alta Frequenza*, vol. 23, pp. 335-356; December, 1954.) Operation of conventional balanced bridge circuits is analyzed. If the amplitudes of the modulation and carrier signals, the static tube characteristics and the load are known, the maximum bridge output voltage can be determined graphically. Experiments confirm the validity of the method.

- 621.396.65:621.396.41 2423  
**Trieste-Venezia-Bologna-Verona-Milano Radio-Link Network**—L. Bernardi. (*Poste e Telecomun.* vol. 23, pp. 61-67; February, 1955.) Extensions to the Mestre-Trieste multi-channel microwave communication link (3109 of 1953) are described.

- 621.396.712.3:534.86 2424  
**On the Structural and Room Acoustics of the Multipurpose Studio Unit at Broadcasting House, Hamburg**—Venzke. (See 2180.)

- 621.396.97+621.397.74 2425  
**Present State of U.S.W. Sound and Television Broadcasting Coverage [in Germany]**—R. Gressmann. (*Funk-Technik*, vol. 10, pp. 31-34; January, 1955.)

#### SUBSIDIARY APPARATUS

- 621-526 2426  
**Asymmetrical Servomechanisms**—J. Loeb and J. D. Lebel. (*Ann. Télécommun.*, vol. 9, pp. 282-286; October, 1954.) Servomechanisms in which the nonlinear element has an input/output characteristic asymmetric with respect to the origin are considered. Even if the input signal is a pure sine wave, the output will have a dc component that cannot be filtered out by the linear element. The general feedback-loop equations are reformulated and the new conditions of stability considered. A temperature-control device is treated as an example.

- 621-526 2427  
**Feedback Control Systems**—(*Trans. Amer. IEE*, Part II, *Applications and Industry*, vol. 72; 1953.) The following papers are included: "Quick Methods for evaluating the Closed-Loop Poles of Feedback Control Systems,"—G. Biernson (pp. 53-68. Discussion, pp. 68-70). "Correlation Between Frequency and Transient Responses of Feedback Control Systems,"—Y. Chu (pp. 81-92). "Coulomb Friction in Feedback Control Systems,"—V. B. Haas, Jr. (pp. 119-123. Discussion, pp. 123-126). "Describing Function Method of Servomechanism Analysis applied to Most Commonly Encountered Nonlinearities,"—H. D. Greif (pp. 243-248). "Optimization of Nonlinear Control Systems by means of Nonlinear Feedbacks,"—R. S. Neiswander and R. H. MacNeal (pp. 262-270. Discussion, pp. 270-272). "A Relative Damping Criterion for Linear Systems,"—J. F. Koenig (pp. 291-294. Discussion, pp. 294-295). "Errors in Relay Servo Systems,"—L. F. Kazda (pp. 323-328. Discussion, p. 328). "Effects of Friction in an Optimum Relay Servomechanism,"—T. M. Stout (pp. 329-335. Discussion, pp. 335-336). "Backlash in a Velocity Lag Servomechanism,"—N. B. Nichols (pp. 462-467). "Determination of the Maximum Modulus, or of the Specified Gain, of a Servomechanism by Complex-Variable Differentiation,"—T. J. Higgins and C. M. Siegel (pp. 467-468. Discussion, pp. 468-469). Abstracts of other papers appear separately.

- 621-526 2428  
**Some Saturation Phenomena in Servomechanisms with Emphasis on the Tachometer Stabilized Systems**—E. Levinson. (*Trans. Amer. IEE*, Part II, *Applications and Industry*, vol. 72, pp. 1-9; March, 1953.) Analytical methods of dealing with frequency response and transient response are described and various saturation effects are explained.

- 621-526 2429  
**Relative Stability of Closed-Loop Systems**—M. J. Kirby and D. C. Beaumariage. (*Trans. Amer. IEE*, Part II, *Applications and Industry*, vol. 72, pp. 22-43; March, 1953.) The equivalence of a transfer-function plot and a plot of the Laplace transform of transient response is illustrated and the application of transform plots in the analysis of linear systems is described.

- 621-526 2430  
**A Differential-Analyzer Study of Certain**

**Nonlinearly Damped Servomechanisms**—R. R. Caldwell and V. C. Rideout. (*Trans. Amer. IEE*, Part II, *Applications and Industry*, vol. 72, pp. 165-169; July, 1953. Discussion, pp. 169-170.) Advantages of the system described by Lewis (1186 of 1954) over corresponding linear systems are illustrated and modifications to improve its operation are suggested.

**621-526** 2431  
**Limiting in Feedback Control Systems**—R. J. Kochenburger. (*Trans. Amer. IEE*, Part II, *Applications and Industry*, vol. 72, pp. 180-192; July, 1953. Discussion, pp. 192-194.) Study of the effect of limiting on system performance in terms of the frequency response.

**621-526** 2432  
**Open-Loop Frequency Response Method for Nonlinear Servomechanisms**—R. L. Cosgriff. (*Trans. Amer. IEE*, Part II, *Applications and Industry*, vol. 72, pp. 222-225; September, 1953.) A graphical representation similar to a Nyquist diagram is developed for indicating frequency response characteristics and for the synthesis of linear filters.

**621-526** 2433  
**The Synthesis of "Optimum" Transient Response: Criteria and Standard Forms**—D. Graham and R. C. Lathrop. (*Trans. Amer. IEE*, Part II, *Applications and Industry*, vol. 72, pp. 273-286; November, 1953. Discussion, pp. 286-288.) "Eight mathematical criteria for optimum transient responses are critically examined, and the clear superiority of the minimum integral of time-multiplied absolute-value of error is demonstrated. The application of this criterion results in the selection of standard forms, which are presented in tables." See also 268 of February.

**621-526** 2434  
**Approximation of Transient Response from Frequency Response Data**—C. H. Dawson. (*Trans. Amer. IEE*, Part II, *Applications and Industry*, vol. 72, pp. 289-291; November, 1953.) A relatively short method is described involving an 18-point graphical integration which gives accurate results for linear feedback systems with a closed-loop transfer function of fifth order or below.

**621-526:016** 2435  
**Bibliography on Feedback Control**—(*Trans. Amer. IEE*, Part II, *Applications and Industry*, vol. 72, pp. 430-462; January, 1954.) A classified list of references up to 1952 relating to the theory and application of feedback systems. A list of relevant periodicals is also given.

**621-526:621.3.066.6** 2436  
**Control of Metal Build-up in Minimum Pressure Sensitive Contact Systems [for servomechanisms]**—J. P. Dallas and T. R. Stuelpnagel. (*Trans. Amer. IEE*, Part II, *Applications and Industry*, vol. 72, pp. 398-403; January, 1954.) A review of designs aimed at reducing spire-type metal transfer on contacts with gaps of 0.001-0.005 inch and operating on pressures down to 0.01 g.

**621.311.6:621.373.4** 2437  
**Highly Regulated R.F. Voltage Supply**—L. G. Sloan, R. W. Raible and M. K. Testerman. (*Electronics*, vol. 28, pp. 192-200; April, 1955.) A rf output voltage of 5 v rms maximum, with low harmonic content, is obtained by using a crystal-controlled pentode oscillator at the fundamental frequency, with positive feedback. Regulation of the output is achieved by means of a negative-feedback loop incorporating a high-gain dc amplifier which supplies the oscillator screen-grid voltage.

**621.314.63:546.28** 2438  
**Silicon Power Rectifiers for AC Line Operation**—G. Rudenberg. (*Electronics*, vol. 28, pp. 146-149; April, 1955.) Used as half-wave recti-

fiers, with capacitor-input filters, typical alloy-junction units rated for 135-v maximum rms input give 150 ma output at 125 degrees C. A typical full-wave rectifier with choke-input filter will deliver 800 ma at 125 degrees C. or 1.5 a at room temperature. Heat-dissipating mountings are discussed.

**621.314.67:621.372.54** 2439  
**Rectifier-Filter Characteristics**—F. G. Heymann. (*Wireless Eng.*, vol. 32, pp. 147-154; June, 1955.) Approximate calculations are described for the design of half-wave rectifiers with capacitor-input filters and of full-wave rectifiers with capacitor-choke-input filters. The method gives results within about 5 per cent of measured values.

**621.316.7.012** 2440  
**Determination of Frequency Characteristics of Automatic Control Systems using Mikhailov's Curves**—O. P. Denichenko. [*Compt. Rend. Acad. Sci. URSS*, vol. 100, pp. 693-696; February 1, 1955. In Russian.]

**621.316.93:621.396.933** 2441  
**Aircraft Protection from Thunderstorm Discharges to Antennas**—J. M. Bryant, M. M. Newman and J. D. Robb. (*Trans. Amer. IEE*, Part II, *Applications and Industry*, vol. 72, pp. 248-252; September, 1953. Discussion, pp. 253-254.) See 1586 of 1954.

**621.316.993.08** 2442  
**The Effect of Reactive Components in the Measurement of Grounding Circuits**—L. H. Harrison. (*Trans. Amer. IEE*, Part II, *Applications and Industry*, vol. 72, pp. 340-343; November, 1953. Discussion, pp. 343-345.) Discussion of results of measurements of earth resistance using ac in the range 30 cps-200 kc, and dc.

## TELEVISION AND PHOTOTELEGRAPHY

**621.397.2:621.397.8** 2443  
**Some Typical Characteristics of Frequency-Modulated Television Transmissions**—G. Brühl. (*Arch. elekt. Übertragung*, vol. 9, pp. 63-68; February, 1955.) Control of picture quality in the course of international television exchanges is considered. The distortion of the video signal by multiple reflections in hf and IF cables is discussed; the frequency swing is the determining factor. Methods of specifying the permissible deterioration and of measuring the relevant system transmission properties are indicated.

**621.397.24** 2444  
**The London-South Wales Television Link**—J. C. D. Bell (*GEC Telecommun.*, no. 18, pp. 4-13; December, 1953.) Simultaneous two-way transmission is provided on the 165-mile London-Wenvoe coaxial link. The over-all gain/frequency characteristic is flat within  $\pm 0.65$  db and the delay/frequency characteristic is flat within  $\pm 0.075$   $\mu$ s over the range 500 kc-3.8 mc. The rms noise level is 58 db below carrier level for the London-Bristol section.

**621.397.3** 2445  
**Image Processing**—L. S. G. Kovásznyai and H. M. Joseph. (*Proc. IRE*, vol. 43, pp. 560-570; May, 1955.) Mathematical theory is presented and extensions and applications are discussed of the techniques described previously (1541 of 1954).

**621.397.335.001.4** 2446  
**Aligning TV Receivers by Pulse-Cross Display**—H. E. Thomas. (*Electronics*, vol. 28, pp. 184-192; April, 1955.) Synchronization faults in a television system may be analyzed by presentation on the picture tube screen of the synchronizing and blanking portions of the signal, by simple adjustment of the receiver controls. See also 1125 of 1952 (Lauer).

**621.397.5** 2447  
**Television and Modern Information Theory**—F. Schröter. (*Arch. elekt. Übertragung*, vol. 9, pp. 1-7; January, 1955.) See 556 of March.

**621.397.5(083.7)** 2448  
**I.R.E. Standards on Television: Definitions of Television Signal Measurement Terms, 1955**—(*Proc. IRE*, vol. 43, pp. 619-622; Standard 55 IRE 23 S1.)

**621.397.6** 2449  
**Possible Methods of Equalization in Vestigial Sideband Transmission in Television**—H. J. Griese. (*Fernmeldetech. Z.*, vol. 8, pp. 94-103; February, 1955.) A survey with particular reference to the method of improving transient response described by Ruston (3253 of 1952). Results of an experimental investigation of transient response on two types of receiver are presented graphically and a standard television-receiver response is proposed, combined with the application of group delay pre-emphasis at the transmitter.

**621.397.6:778.5:621.395.625.3** 2450  
**Methods of Picture-Synchronized Sound Recording in Television**—K. E. Condens. (*Tech. Hausmit. NordwDtsch. Rdfunk*, vol. 6, nos. 11/12, pp. 237-242; 1954.) 16-mm film with magnetic sound track is preferred. The principles of the single-stripe method and three variants of the double-stripe method, (a) with perforated film, (b) with a pilot frequency and (c) without special synchronization, are outlined. The equipment and operation of these methods are described and applications of these and photoelectric recording techniques are tabulated. See also 1802 of July (Lauer and Schulze).

**621.397.611.2** 2451  
**Properties and Applications of Television Camera Tubes with Photoconductive Targets**—W. Heimann. (*Arch. elekt. Übertragung*, vol. 9, pp. 13-19; January, 1955.) The construction and operation of vidicon-type tubes are discussed with particular reference to the development of a German tube, the resistron. A method is described for measuring the time delay of the target response in normal operation, in which a vertical bar pattern is scanned horizontally across the target. The picture quality attained is illustrated by photographs.

**621.397.62+621.396.67** 2452  
**New Television Receivers and Aerials [in Western Germany]**—W. W. Diefenbach. [*Funk-Technik (Berlin)*, vol. 10, pp. 88-91; February, 1955.] A brief survey of commercially available equipment.

**621.397.62:535.88** 2453  
**M.E.P. 55 Projector**—A. V. J. Martin. (*Télévision*, no. 51, pp. 45-51; February, 1955.) Illustrated description of a television receiver using a classical objective system for projecting pictures of linear dimensions variable from about 25 cm to 3 m. The equipment is no larger than a standard receiver with 36-cm screen.

**621.397.621.2:535.623** 2454  
**Convergence in the CBS-Colortron "205"**—J. Giuffrida. (*Radio-Electronic Eng.*, vol. 24, pp. 12-13, 27; February, 1955.) Accurate superposition of the three beams in the center of the screen of this color-television tube is achieved by using radial-deflection correcting coils or permanent magnets on all three guns and a lateral-deflection adjustment on one of them. Convergence of the beams when deflected requires further magnetic fields which vary as complex circular functions of the scanning angle. Circuit arrangements for deriving the required magnetic-field waveforms from the deflection system are indicated.



621.397.7:628.9 2455  
Some Problems in Television Lighting—W. C. Pafford. (*Wireless World*, vol. 61, pp. 288–290; June, 1955.) Discussion of scene illumination and camera arrangements.

621.397.74+621.396.97 2456  
Present State of U.S.W. Sound and Television Broadcasting Coverage [in Germany]—R. Gressmann. (*Funk-Technik*, vol. 10, pp. 31–34; January, 1955.)

#### TRANSMISSION

621.376.223 2457  
Unbalance Effects in Modulators—D. G. Tucker. (*Jour. Brit. IRE*, vol. 15, pp. 199–207; April, 1955.) Rectifier modulators of (a) shunt ("Cowan") and (b) ring types are considered. With type (a) only one balance control is needed and only one unbalance component can in general be brought to a real minimum by a particular adjustment. With type (b) two independent balance controls can be provided and two unbalance components can be simultaneously brought to a minimum. The effect of the signal voltage on the magnitude of unbalance components is zero in a modulator which is perfectly balanced in the absence of signal, and is noticeable only near the overload point even when initial unbalance exists.

621.396.61:621.3.018.78 2458  
The Problem of Distortion in Anode-Voltage-Modulated Transmitters—W. T. Runge. (*Telefunken Ztg.*, vol. 27, p. 254; December, 1954.) Correction to paper abstracted in 262 of 1953.

621.396.61:621.375.2 2459  
Progress in the Construction of Modulation Amplifiers for Anode-Modulated Broadcasting Transmitters—H. Müller. (*Telefunken Ztg.*, vol. 27, pp. 204–210; December, 1954.) Development work was aimed at reducing the amount of equipment and the power dissipation. The essential features of the present circuit arrangement are (a) operation of the driver valve with grid current, (b) dc negative feedback on the driver, and (c) a substantial reduction in the anode currents of the output valves with no signal applied. Because of the higher efficiency resulting from grid-current operation, smaller tubes with lower anode voltage can be used. Measurements on amplifiers for 20-kw and 150-kw transmitters confirmed the saving in equipment and power dissipation.

#### TUBES AND THERMIONICS

621.314.632:546.289 2460  
The Barrier Height of Point-Contact Germanium Diodes Inferred from Measurements of the Voltage Dependence of Capacitance—F. F. Roberts and J. R. Tillman. (*Proc. Phys. Soc.*, vol. 68, pp. 113–115; February 1, 1955.) Results of measurements on several types of diode are presented graphically, using a  $\log C/\log(V+\phi)$  presentation so as to give equal prominence to large and small values of the capacitance  $C$  and reverse voltage  $V$ , the constant  $\phi$  being chosen for each unit so that the curves are nearly straight lines. The value of  $n$ , the reciprocal of the slope, is about 2 for most types and about 3 for some others; the interpretation of these values is discussed in terms of the distribution of impurities. It is inferred that for the cases where  $n \sim 2$  the barrier height for electrons approaching the semiconductor from the metal is less than or barely equal to half the forbidden energy gap for Ge. Attention is drawn to the discrepancy between this low value of barrier height and the much greater values to be inferred from measurements of injection ratio [e.g. 2536 of 1954 (Swanson)].

621.314.632:546.289:621.317.3 2461  
Recovery Time Measurements on Point-

Contact Germanium Diodes—Firle, McMahon and Roach. (See 2356.)

621.314.7+537.311.33 2462  
Semiconductors and the Transistor—E. W. Herold. (*Jour. Frank. Inst.*, vol. 259, pp. 87–106; February, 1955.) A general survey with 33 references.

621.314.7 2463  
Some Aspects of the Design of Power Transistors—N. H. Fletcher. (*Proc. IRE*, vol. 43, pp. 551–559; May, 1955.) Design of alloyed-junction transistors for af operation with output  $>1$  w is considered. Special electrical problems are involved since the injected carrier density cannot be considered as a linear perturbation. Mechanical design problems relate mainly to cooling and shock resistance. The effect of reduction of emitter bias due to transverse current flow in the base region is examined. Transistors with class-A output ratings  $>50$  w have been obtained.

621.314.7.002.2 2464  
The Transistor: Part 4—the making of Transistors—H. Yemm and J. L. Carasso. (*P.O. Elec. Eng. Jour.*, vol. 47, Part 4, pp. 217–221; January, 1955.) Part 3: 1070 of May (Speight and Carasso).

621.314.7.012.8 2465  
Theory of Equivalent Circuits for Junction Transistors—Oertel. (See 2216.)

621.314.7.012.8 2466  
The Frequency Dependence of [junction-] Transistor Quadripole Parameters—Kettel and Meyer-Brötz. (See 2217.)

621.383.2 2467  
Energy Distributions of Photoelectrons from Au and Ge in the Far Ultraviolet—W. C. Walker and G. L. Weissler. (*Phys. Rev.*, vol. 97, pp. 1178–1179; February 15, 1955.)

621.383.2 2468  
Evolution and Conservation of the Photoelectric Effect of an Sb-Cs Layer deposited in Vacuum—A. Lallemand and M. Duchesne. [*Compt. Rend. Acad. Sci. (Paris)*, vol. 240, pp. 1329–1331; March 21, 1955.] Experiments are described in which a sealed tube containing an Sb-Cs photocathode is introduced into an evacuated enclosure. After evaporating Ba onto the enclosure wall, the inner tube is broken and the time variation of the photoelectric emission is observed. Photosensitivity is retained longer by those cathodes which are richer in Cs. When the cathode is placed on a support cooled to about  $-55$  degrees C. the photosensitivity is not appreciably reduced after several hours, while the dark emission is considerably reduced.

621.383.27 2469  
Theory of Operation of the Final Stage of a Photomultiplier—P. Leuba. (*Jour. Phys. Radium*, vol. 16, pp. 161–162; February, 1955.) Under specified operating conditions, the voltage variation on the collector electrode is expressed approximately by  $du/dt + u/RC = q(t)/C$ , where  $RC$  is the time constant of the equivalent capacitor, and  $q(t)$  the charge transferred from the penultimate electrode to the collector. When  $RC/T \gg 1$ ,  $T$  being the period of charge transfer, operation is linear. When  $RC/T < 100$ , experiment shows that  $q(t)$  is approximately an inverse exponential function.

621.383.4/.5:546.289 2470  
Germanium Junction Photodiodes—Zh. I. Alferov, B. M. Konovalenko, S. M. Ryvkin, V. M. Tuchkevich and A. I. Uvarov. (*Zh. Tekh. Fiz.*, vol. 25, pp. 11–17; January, 1955.) In the photocell proposed by Shive (2825 of 1953) the direction of the beam of light is parallel to the plane of the  $n-p$  junction. In the cell

used in the present investigation the light beam is perpendicular to the plane of the junction and passes through a thin layer of  $n$ - or  $p$ -type Ge. Experiments were carried out to determine the voltage/current characteristics, dependence of current on intensity of illumination, distribution of sensitivity over the surface, spectral distribution of sensitivity, inertia and temperature effect.

621.383.4/.5:546.289 2471  
Sensitivity of Germanium Photodiodes to X Rays—B. M. Konovalenko, S. M. Ryvkin and V. M. Tuchkevich. (*Zh. Tekh. Fiz.*, vol. 25, pp. 18–20; January, 1955.) Measurements indicate that Ge photodiodes are much more sensitive to X rays than silver sulphide or selenium photocells. They also possess the advantage of a linear current/irradiation characteristic.

621.383.4/.5:546.289 2472  
Mechanism of Operation of Germanium Photodiodes—S. M. Ryvkin. (*Zh. Tekh. Fiz.*, vol. 25, pp. 21–28; January, 1955.) Theory of the operation of an  $n-p$  Ge diode as a photocell is given; the fundamental relations are established between the photo-emf, short-circuit photocurrent and saturation current for the case of operation as a barrier-layer photocell. A general equation suitable for any operating conditions is also derived. Results are given of experiments made to verify the relations obtained, and the efficiency of the diodes used as barrier-layer photocells is discussed.

621.385:621.317.7 2473  
Circuit for the Determination of Contact Potentials and Electron Temperatures from Retarding Field Characteristics—Friedman and Heynick. (See 2369.)

621.385:621.396.822 2474  
Fluctuations of Cathode Emission in Electron Valves—A. Blanc-Lapierre, G. Goudet and P. Lapostolle. [*Compt. Rend. Acad. Sci. (Paris)*, vol. 240, pp. 1409–1411; March 28, 1955.] Noise due to fluctuations of electron velocity and of current density is discussed. Separate consideration is given to the cases where (a) electrons are emitted at regular intervals, and (b) electrons are emitted at irregular intervals. In case (a) there is no noise contribution from current fluctuation; expressions are given for the current-fluctuation contribution in case (b) and for the velocity-fluctuation contribution, which is twice as great in case (b) as in case (a). Values derived for the anode-current fluctuations of a space-charge-controlled diode, using the case (a) formula, are in good agreement with those obtained by direct calculation and in fairly good agreement with values obtained experimentally, indicating that the electron emission is regulated by the virtual cathode.

621.385.029.6 2475  
Space-Charge Waves in Ion-Free Electron Beams—J. Labus and K. Pöschl. (*Arch. elekt. Übertragung*, vol. 9, pp. 39–46; January, 1955.) In a previous analysis by Labus (2182 of 1953) the rf variations of the beam boundary were neglected; on taking these into account, the theoretical results are in satisfactory agreement with measurements made at the Massachusetts Institute of Technology. See also 2807 of 1954.

621.385.029.6 2476  
The Design of Travelling-Wave Output Valves for Microwave Relay Stations—W. Klein. (*Arch. elekt. Übertragung*, vol. 9, pp. 55–62; February, 1955.) The operation of helix-type valves capable of giving outputs of the order of 5 w is discussed on the basis of the relation between gain and power level. To obtain the required output it is necessary to use electron guns providing strong beam con-

centration, or alternatively to use cathodes giving high current density; the requirements become more difficult to satisfy as the wavelength decreases. With high-gain valves very good matching is required between the localized attenuation section and the rest of the helix. Typical values of efficiency are 10–15 per cent. See also 1526 of June (Klein and Friz).

621.385.029.6:621.317.755 2477

**Velocity Spectrography of Electron Dynamics in a Travelling Field**—Purl and VonFoerster. (See 2379.)

621.385.032.2:537.533 2478

**New Approach to the Design of Electron Guns for Cylindrical Beams with High Space Charge**—M. Müller. (*Arch. elekt. Übertragung*, vol. 9, pp. 20–28; January, 1955.) Discrepancies between the predicted and observed characteristics of guns with spherically curved electrodes (Pierce type) are studied. The influence of the anode aperture is evaluated by electrolyte-trough measurements, using specially shaped anode and control electrodes. Design details are given for simple electrode shapes and arrangements, and an indication is given of the corrections for high perveance values. Effects due to thermal velocity distribution are discussed.

621.385.032.21 2479

**The Platinum-Cored Oxide-Cathode Repeater Valve**—G. H. Metson. (*P.O. Elec. Eng. Jour.*, vol. 47, part 4, pp. 208–211; January, 1955.) The reactions of cathodes with pure platinum and nickel cores to oxygen attack are compared. Complete recovery from heavy oxygen contamination occurs in the case of platinum, whereas the nickel-cored cathode is completely destroyed.

621.385.032.213 2480

**Deviation from the Boguslavski-Langmuir Law when a Tungsten Cathode of a Thermionic Valve is Heated by a High-Density Current Pulse**—S. V. Lebedev. (*Zh. Eksp. Teor. Fiz.*, vol. 27, pp. 487–500; October, 1954.) Experiments were made to find the cause of the abnormal increase in the anode current when a tube filament is heated by a high-density current pulse. A detailed report is presented including photographs of oscillograms recorded. The main conclusion reached is that the current increase is due to a change in the state of the tungsten, and is not related to the neutralization of the space charge by ions.

621.385.032.216 2481

**Electron-Optical Study of Non-stationary Emission from an Oxide Cathode in Vacuum and in a Gas**—I. N. Prilezhaeva, V. V. Livshits and G. V. Spivak. (*Zh. Tekh. Fiz.*, vol. 25, pp. 97–107; January, 1955.) The emission from a pulsed cathode was studied. Electron-optical images were obtained showing the disturbances caused by sparking and cathode poisoning. Oscillograms of discharge currents corresponding to these images are also given.

621.385.032.216 2482

**Growth of the Barium Orthosilicate Interface of Oxide-Coated Cathodes**—M. G. Harwood and N. Fry. (*Brit. Jour. Appl. Phys.*, vol. 6, pp. 62–64; February, 1955.) The core/coating interface of oxide cathodes with Ni-alloy cores containing (a) 0.048 per cent and (b) 0.17 per cent Si was examined. In addition to barium orthosilicate a layer of nearly pure strontium oxide was found. Results of an investigation of the barium orthosilicate layer during heating at 765 degrees C. for up to 2,000 hours indicate that the growth continues until all the available Si is used up, in case (a), but a limitation of the growth is apparent in case (b), possibly due to diffusion of Si.

621.385.832 2483

**Optical Distortion of Magnetic Deflecting Coils**—E. Cambi. (*Alta Frequenza*, vol. 23, pp. 292–334; December, 1954.) First-order approximations are made for three distinct causes of distortion considered separately. These are (a) finite length and axial nonuniformity of the field, (b) curvature of the screen, and (c) transverse nonuniformity of the field. (a) is substantially independent of the direction of deflection, and may be partly compensated by (b) provided the screen is rotationally symmetric and concave. (c) is considered in terms of percentage of field harmonics present, i.e. in terms of design parameters of the coil. Conditions under which the geometric and third-harmonic distortion due to (c) can cancel out in an axial direction are established. All formulas are expressed in terms of design parameters of a cr tube.

621.385.832 2484

**A Revolutionary Television Tube**—(*Radio and Telev. News*, vol. 53, p. 44; April, 1955.) Brief description of a very-short-length picture tube comprising a phosphor screen sandwiched between glass plates. An electron beam is directed along an edge, adjacent to a row of deflection plates; by applying a control voltage to a selected deflection plate the beam is bent at right angles, remaining parallel to the plane of the screen. A second set of deflection plates is used to bend the beam so as to strike the screen normally.

621.385.832:535.37 2485

**Reduction of Cathodoluminescence of ZnS:Ag by Irradiation with 16-kV Electrons**—K. H. J. Rottgardt and W. Berthold. (*Naturwiss.*, vol. 42, p. 67; February, 1955.) Experiments were made using ordinary 43-cm television tubes with Al-coated screens. Comparison of the results with those obtained previously for bombardment with 4-kv electrons [3420 of 1954 (Rottgardt)] confirms that the reduction of luminescence depends only on the number of incident electrons and is independent of electron energy over the range 2–16 kv.

621.385.832:681.142 2486

**A Beam-Deflection Valve for use in Digital Computing Circuits**—M. W. Allen. (*Proc.*

*IEE*, Part C, vol. 102, pp. 57–61; March, 1955. Digest, *ibid.*, Part II, vol. 101, pp. 682–684; December, 1954.) The properties required in a universal computing element are discussed in terms of the analogy with the nervous system. A description is given of a ribbon-beam-deflection tube consisting of two interconnected elements each having the desired properties; this enables binary addition and other operations of interest to be performed in a single tube with a 12-pin base.

621.387 2487

**Restoration of Control in Ionic Apparatus**—V. I. Drozdov and A. F. Smirnov. (*Zh. Tekh. Fiz.*, vol. 25, pp. 85–96; January, 1955.) The time necessary for the restoration of control in devices such as thyratrons, mercury rectifiers etc. after the cessation of the current is considered; various definitions are discussed. An elementary theory of the restoration process is proposed and two experimental methods are described for determining the "electric-strength"/time build-up characteristic which indicates the ability to block the anode voltage. Some experimental results are given.

621.387.032.216 2488

**Peak Current of Oxide Cathodes in Arc Discharges**—H. J. Vogt. (*Elektrotech. Z., Edn A*, vol. 76, pp. 192–195; March 1, 1955.) An oscillographic pulse-method for determining the permissible peak current is described. At this value of current, when the emission from the cathode just becomes nonuniform, both the anode voltage and the emission current traces show sharp "spikes." This condition was also observed spectroscopically. A circuit diagram of the experimental setup is given.

## MISCELLANEOUS

601.4:[621.317.7+621.38 2489

**Physical Society's Exhibition [1955]**—(*Wireless World*, vol. 61, pp. 271–278; June, 1955. Correction, *ibid.*, vol. 61, p. 324; July, 1955.) An illustrated review of exhibits, including instruments and tubes shown also at the RECMF exhibition (2490 below). See also *Wireless Eng.*, vol. 32, pp. 169–172; June, 1955.

601.4:621.396.6 2490

**Components Exhibition**—(*Wireless World*, vol. 61, pp. 258–264; June, 1955.) Detailed review of components and accessories at the RECMF exhibition held in London, April, 1955. See also 2489 above.

621.19:621.37/.38].004.4 2491

**Mould Growth in Electronic Apparatus**—E. Ganz and O. Walchli. (*Bull. schweiz. elektrotech. Ver.*, vol. 46, pp. 233–239; March 19, 1955. In French.) The IEC-recommended methods for testing equipment and components for resistance to mold growths are discussed and modified test specifications are proposed based on experimental results. Spraying or painting with a suitable varnish should give adequate protection.

## Tailored Engineering Creates Unique Accelerometer System

The new Glennite® self-recording accelerometer system is an outstanding example of how the practice of "tailored engineering" is brought to bear by Gulton Industries upon the specific need of industry.

The accelerometer, Model KAT-1, can reliably measure accelerations up to  $\pm 60g$  in moving devices without the use of direct cable or wireless connections, and is particularly applicable in guided missiles, air, sea, and land vehicles, underwater devices, and ordnance equipment where remote or relatively inaccessible mounting of the accelerometer is required.

The accelerometer, completely self-contained and self-recording, provides an instantaneous 30-second permanent tape recording of shock and vibration phenomena. These measurements are then reproduced in a special playback unit and can be read through any standard recording device such as a galvanometer, oscilloscope, meter, or direct-writing recorder.

From the seismic transducer and tape transport mechanism of the recorder to the demodulator of the playback unit, the Glennite KAT-1 system has been engineered and designed with new techniques and developments never before found in an instrument of this kind. A new phase modulation system provides

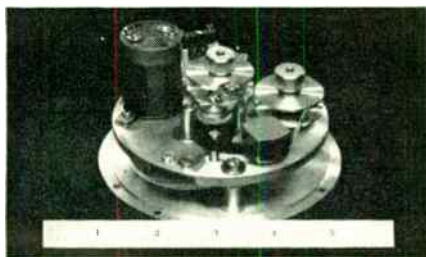

### SPECIFICATIONS:

|                            |  |
|----------------------------|--|
| Range:                     | 0 — $\pm 60g$                              |
| Frequency Range:           | 0 — 300 cps                                |
| Seismic Element Resonance: | above 500 cps                              |
| Recording Speed:           | 15"/sec.                                   |
| Recording Time:            | 30 seconds (500 inches using 2.5 mil tape) |
| Channels:                  | 1  |
| Size:                      | 4½" diameter by 3" high                    |
| Weight:                    | 3 pounds                                   |

Instantaneous start by pull of wire or electric relay; automatic stop when tape recording is completed.

©Trade mark registered

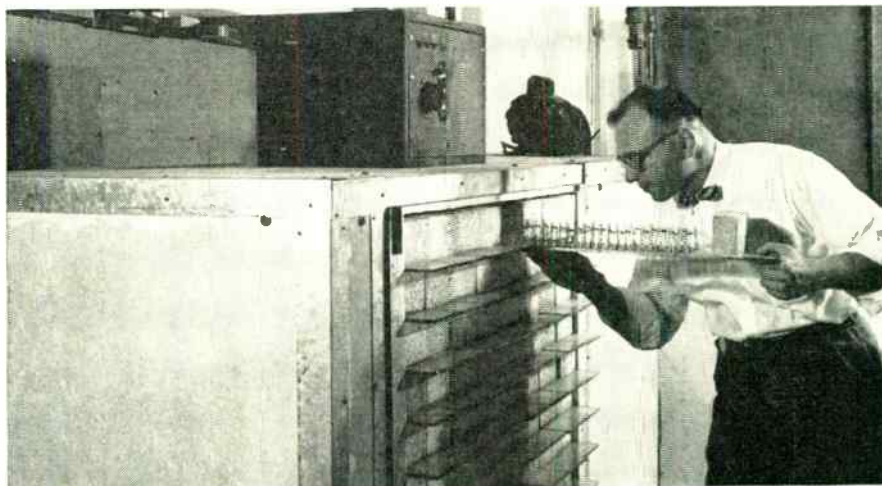

Each high-reliability capacitor which leaves the Glenco plant is first tested in this special temperature-controlled oven which performs accelerated life tests on 2400 units simultaneously.

## Combine Hi-Reliability and Hi-K in New Subminiature Capacitors

The continually growing commercial and military need for high-reliability components can now be met in your industry by using Glennite® MINIPLATE ceramic capacitors.

Through constant research and development, the normally undesirable feature of sacrificing high-reliability for high-K in subminiature capacitors has been eliminated.

And now of prime importance, where space and weight are prime factors and when varied circuitry demands super-reliable performance—such as in computers or in complex aircraft equipment upon which a human life may depend—these capacitors are available to insure against even virtual negligible failure in field use.

Quality controlled and inspected from the initial processing of the raw material through final assembly, Glennite capacitors are produced in one plant under one roof to insure consistent standards of high-reliability and superior characteristics.

The patented thin sheet process of automatic manufacture, unique testing methods—including a rugged 24-hour life and screening procedure—and new coating techniques have been combined to produce a product with increased reliability and unusual flexibility of size and shape to conform to your specifications.

Your inquiry is invited. For more information about MINIPLATE capacitors (high-reliability and high-K), write on your company letterhead to:

an amplitude accuracy comparable to an FM tape system yet overcomes the typical FM system errors normally caused by tape speed variations. A completely transistorized electronic circuit has been developed to minimize size, weight, and battery power consumption and, in addition, provides instantaneous starting. Simple adjustment of phase sensitivity can provide various acceleration ranges within the same instrument, and overall phase characteristics have been made independent of oscillator stability, temperature, and battery condition to provide greater accuracy.

Meanwhile, extensive development work is in progress to extend the application of the accelerometer to include multi-channel operation and other uses in the fields of pressure and temperature measurements.

Perhaps the Glennite KAT-1 tape-recording accelerometer system can help your shock and vibration measurements. You are urged to write about your problem on your company letterhead to:

**Gulton Mfg. Corp.**  
Metuchen, New Jersey

**Glenco Corporation**  
Metuchen, New Jersey

# FIRST REPORT

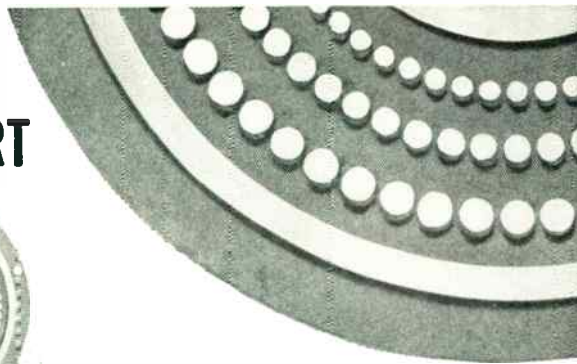

## MYCALEX® TELEMETERING TESTS

**1660 hours**  
of high quality switching at **600 rpm**

March 29, 1955:  
After 1660 hours of operation, the new Mycalex Model TM-55 Series Commutator Switch continues to function with a perfect and unchanging signal. This initial continuous test run was halted only to permit a simple brush cleaning—and the life test resumed. Test goal—**10,000 hours!**

**170 hours**  
of uniform operation at **1,800 rpm**

A second test—running concurrently—and using the new Mycalex Model TM-55 Series brush construction provided a clean signal for 170 hours at 1,800 rpm! Once again, operation was halted only to permit brush cleaning—and the test resumed.

### Mycalex 410 provides:

- absolute dimensional and age stability
- imperviousness to moisture
- precision dimensional tolerance control
- temperature endurance to 650°F.

### Write today:

Mycalex Electronics Corporation  
Dept. 111  
P. O. Box 311  
Clifton, N. J.

## MYCALEX ELECTRONICS CORPORATION



Under exclusive license  
of the Mycalex Corporation  
of America

Executive Offices  
30 Rockefeller Plaza  
New York 20, N. Y.



(Continued from page 91A)

- Newman, M. M., Lighting & Transients Research Inst., Minneapolis 2, Minn.  
Newmeyer, D. R., 2025 Rittenhouse St., Philadelphia 38, Pa.  
Nicholides, E. C., 116 Pinehurst Ave., New York 33, N. Y.  
Nielsen, G., Jr., Bell Tel. Labs., Inc., Murray Hill, N. J.  
Nielsen, H. V., 11 E. 31 St., New York 16, N. Y.  
Niemi, L. T., Navcicoffscol, Naval Air Station, Glenview, Ill.  
Nierstheimer, P. H., 1974 Shaftsbury Rd., Dayton 6, Ohio  
Niewenhaus, J. H., 54 Colonial Dr., Farmingdale, L. I., N. Y.  
Nighthenheler, L. W., R.R. 1, Arcadia, Ind.  
Nitsche, J. E., Corning Glass Works, Corning, N. Y.  
Nittoli, A. J., Pond Acre, Rt. 25-A, R.F.D. Syosset, L. I., N. Y.  
Noon, J. R., 1542 E. Rancho Dr., Phoenix, Ariz.  
Norby, H. A., 10746 Crank Rd., Culver City, Calif.  
Nordseth, M. P., Navy Ord. Lab., Corona, Calif.  
Nordyke, H. W., Jr., Merry Hill, Titusville Rd., Poughkeepsie, N. Y.  
Normando, N. J., 133 Locust Ave., Dumont, N. J.  
Norris, R. M., 1323 Fern Ave., Torrance, Calif.  
Northrop, P. A., 52 Grove St., Lexington 73, Mass.  
Notthoff, A. P., Jr., 19 Nancy Way, Menlo Park, Calif.  
Novak, W. D., Gipsy Trail Club, Carmel, N. Y.  
Novick, G., 96 Queens Dr., S., Little Silver, N. J.  
Novick, R., 74-22—263 St., Floral Park, L. I., N. Y.  
Nunan, J. K., 1775 Mt. Read Blvd., Rochester 3, N. Y.  
Nuut, A., 1330 Cordova Ave., Glendale 7, Calif.  
Nyland, F. S., 1004 A Kern Blvd., El Paso, Tex.  
Nymberg, R. J., Jr., 21644 Pembroke, Detroit 19, Mich.  
Nyswander, R. E., 7012 N. 8 Ave., Phoenix, Ariz.  
Oates, T. L., 616—27 St., Sacramento 16, Calif.  
O'Brien, J. A., 1109 Elm Ave., W. Collingswood 6, N. J.  
O'Brien, T. H., 63 Aster Dr., New Hyde Park, L. I., N. Y.  
Obsharsky, P., 131 Hudson Ave., Red Bank, N. J.  
Oeko, R., 868 Lancaster Ave., Syracuse 10, N. Y.  
O'Day, M. D., 642 Pleasant St., Belmont 78, Mass.  
Ogram, R. L., 1325 Trieste Dr., San Diego 7, Calif.  
Ohler, A. E., 514 Holmestead Ave., Haddonfield, N. J.  
Ohlsson, R. L., Willow Run Research Center, Ypsilanti, Mich.  
Olha, W. R., 51 Westville Ave., Danbury, Conn.  
Olsen, E. U., 22 Hawthorne Ave., Glen Ridge, N. J.  
Oman, N. J., 6529 Rogers Ave., Merchantville 8, N. J.  
O'Meara, T. J., 21 Lace Lane, Westbury, L. I., N. Y.  
O'Meara, W. J., Montgomery Ave., Ambler, Pa.  
O'Reilly, J. P., 538 Sherwood Pkwy., Westfield, N. J.  
Ornstein, E., 3339 10 Pl., S.E., Washington, D. C.  
Osborn, W. O., Westinghouse Elec. Corp., E. Pittsburgh, Pa.  
Osborn, P. H., 546 Sunset Ave., Haworth, N. J.  
Osborn, R. L., 8652 Kedvale Ave., Skokie, Ill.  
Ostrolenk, S., 10 E. 40 St., New York 16, N. Y.  
Ould, R. S., Box 27, Washington 4, D. C.  
Pachuta, J. R., 3824 Milan Dr., Alexandria, Va.  
(Continued on page 100A)

**CHATHAM** advance-designed yesterday

- in  
industry-wide  
use today!

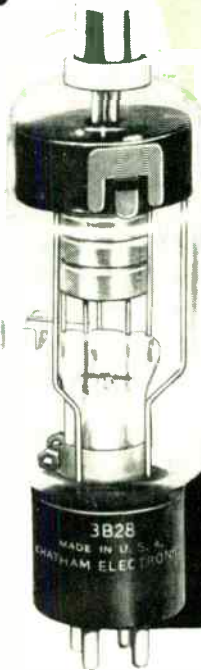

AMPLIFIERS • REGULATORS • INERT GAS  
AND MERCURY RECTIFIERS • MERCURY,  
INERT GAS AND HYDROGEN THYRATRONS

# CHATHAM SPECIAL-PURPOSE TUBES



5R4WGB



VC-1258



5651-WA

STANDARD TYPES DIRECT FROM STOCK  
PLUS SPECIAL DESIGNS BUILT TO REQUIREMENTS

Chatham specializes in the development of general and special purpose tubes for both electronic and industrial applications. Many of the tubes originally developed by Chatham to fill a specialized need, now number among the most widely used tubes in the industry. For complete information on Chatham tubes — either stock items or types built to your requirements — call or write today.

● **3B28 RECTIFIER**

Rugged half-wave Xenon filled rectifier. Operates in any position. Ambient temperature range  $-75^{\circ}$  to  $+90^{\circ}$ C. Inverse peak anode voltage 10,000, average current .25 amps. Filament 2.5v., 5 amp.

● **4832 RECTIFIER**

Ruggedly built, half-wave Xenon filled rectifier. Ambient temperature range  $-75^{\circ}$  to  $+90^{\circ}$ C. Inverse peak anode voltage 10,000, average anode current 1.25 amp. Filament 5v., 7.5 amp.

● **VC-1258 MINIATURE HYDROGEN THYRATRON**

for pulse generation. Handles 10 kw peak pulse power.

● **6336 TWIN TRIODE**

for voltage regulation. Features high plate dissipation, hard glass envelope.

● **5R4WGB RECTIFIER**

Full wave rectifier manufactured to MIL-E-1B reliable tube specifications.

● **5651-WA VOLTAGE REFERENCE TUBE**

Stable, rugged. Available in both commercial or reliable tube MIL types.



**CHATHAM ELECTRONICS**  
Division of Gera Corporation LIVINGSTON, NEW JERSEY

# FERROXCUBE SHIELDING BEADS

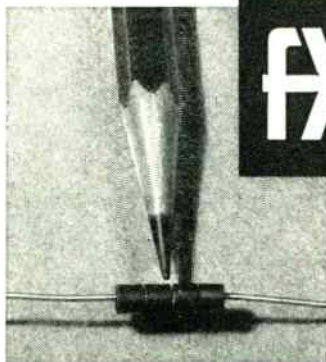

**EFFECTIVELY  
PREVENT  
PARASITIC  
RESONANCES**

Ferroxcube shielding beads on input leads provide simple, efficient decoupling so that h-f, i-f and pulse signals from output stages will not be picked up by input wiring. High-permeability Ferroxcube material increases inductance so that lead acts as h-f choke while i-f, h-f and pulse oscillations are damped by high losses that occur in Ferroxcube 3B at frequencies over 0.5 mc.

Ferroxcube shielding beads also increase the h-f effectiveness of button-type ceramic feed-thru capacitors.

SEND FOR BULLETIN FC 5112

## FERROXCUBE CORP. OF AMERICA

A Joint Affiliate of Sprague Electric Co., and Philips Industries,  
Managed by Sprague

235 East Bridge Street • Saugerties, New York



**Membership**

(Continued from page 98A)

- Palik, F., Fed. Comm. Com., New Post Office Bldg., Washington 25, D. C.
- Palm, H. A., Jr., 5250 N. Spaulding Ave., Chicago 25, Ill.
- Palm, K. E., R.D. 1, Box 61, Moorestown, N. J.
- Palmer, F. J., 49 Stow St., So. Acton, Mass.
- Palmer, O. M., Jr., 1131 Tulane St., Houston 8, Tex.
- Palmquist, C. A., 150 Kelburne Ave., N. Tarrytown, N. Y.
- Pardee, O. O'M., Syracuse Univ., Syracuse 10, N. Y.
- Parke, H. G., 138-71 St., Brooklyn 9, N. Y.
- Parker, A. P., 33 Ivanhoe Ave., Dayton 9, Ohio
- Parker, E. O., Jr., 427 Huron Ave., Cambridge 38, Mass.
- Parker, J. R., 8 Lippincott Ave., Haddon Heights, N. J.
- Parker, R. O., 2045 San Diego Ave., San Diego 1, Calif.
- Parker, R. H., 2831 Post Oak Rd., Houston 19, Tex.
- Parker, S. E., 854 Bangor St., San Diego 6, Calif.
- Parsons, B. L., 109 Center St., Williston Park, L. I., N. Y.
- Partin, M. E., 5009 Boudinot St., Philadelphia 20, Pa.
- Parsons, J. R., 1709 S. Keeler, Bartlesville, Okla.
- Paskin, M., 2301 Sedgwick Ave., New York 68, N. Y.
- Paslay, L. C., 4815 Shadywood Lane, Dallas 9, Tex.
- Pataki, E., 343 E. 8 St., New York 9, N. Y.
- Paul, G. S., 60 Hudson St., New York 13, N. Y.
- Pauls, G. C., 1108 Pembroke Dr., Webster Groves 19, Mo.
- Pearson, H. A., Sonotone Corp., Elmsford, N. Y.
- Pearson, S. S., 2585 Rosewood Ave., Roslyn, Pa.
- Peckham, H. A., 130 S. Fairview Ave., Upper Darby, Pa.
- Pelzman, L., 225 W. 25 St., New York 1, N. Y.
- Penwell, G. N., Box 691, Bozeman, Mont.
- Perch, D. F., 1009 Dixie Hwy., Rossford, Ohio
- Perkins, E. G., Supreme Instr. Co., Greenwood, Miss.
- Perlman, L., 2251-81 St., Brooklyn, N. Y.
- Pernick, H. L., 521 E. 14 St., New York 9, N. Y.
- Perry, J. S., Box 351, Pennington Dr., Huntington, L. I., N. Y.
- Perry, J. T., 1365 Milan Pl., Monterey Park, Calif.
- Perry, V. G., 2921 Mansfield Ave., S.E., Cedar Rapids, Iowa
- Petersen, M. E., 142 Langdon Ave., Watertown, Mass.
- Petersen, R. L., Guerrero 14, Esq. Patton, Park Blvd., Santurce, P. R.
- Peterson, C. D., 11115 Edlbrooke Ave., Chicago 28, Ill.
- Peterson, E. H., Jr., 11 Oakdale Ct., Mains Ave., Syracuse 7, N. Y.
- Peterson, F. V., 3920 Wellington Rd., Los Angeles 8, Calif.
- Peterson, L. E., R.C.A. Comm., Rocky Point, L. I., N. Y.
- Peterson, R. M., 6 Joseph Ave., Bethpage, L. I., N. Y.
- Peterson, W. E., 3111 Carnation St., Ft. Worth 11, Tex.
- Petes, J., 1058 Ruatan, St., Silver Spring, Md.
- Petit, F. W., N. Woodbury, Conn.
- Petkofsky, L., 10 Francis St., Shrewsbury, N. J.
- Pfaff, R. W., 96 E. 219 St., Euclid 23, Ohio
- Phillips, W. E., Box 87, Deerfield, Ill.
- Pickens, G. O., U.S. Navy Electronics Lab., San Diego 52, Calif.
- Pickert, C. E., 115 Pinehurst Pl., Sebeneclady 4, N. Y.
- Pierce, E. R., Box 87, Petersburg, Alaska

(Continued on page 102A)

## AN/APR-4 LABORATORY RECEIVERS

Complete with all five Tuning Units, covering the range 38 to 4,000 Mc.; wideband discone and other antennas, wavetraps, mobile accessories, 100 page technical manual, etc. Versatile, accurate, compact—the aristocrat of lab receivers in this range. Write for data sheet and quotations.

We have a large variety of other hard-to-get equipment, including microwave, aircraft, communications, radar; and laboratory electronics of all kinds. Quality standards maintained. Get our quotations!

NEW TS-13/AP X-BAND SIGNAL GENERATORS, with manual, \$575.00 . . . T-47A/ART-13 Transmitters, \$450.00 . . . H-P, Boonton, G-R, Measurements, and other standard items in stock; also nucleonic equipment.



## ENGINEERING ASSOCIATES

434 PATTERSON ROAD

DAYTON 9, OHIO

## TRANSCONDUCTANCE ANALYZER AND CIRCUIT SIMULATOR

MODEL 901

This direct-reading meter measures transconductance under all operating conditions. It has directly calibrated voltage controls and means for connecting components to simulate the circuitry in which a tube will operate. Facilities are provided for measuring both static and dynamic tube characteristics.

Transconductance Range: 0-100, 0-500, 0-1,000, 0-5,000, 0-10,000, 0-50,000 micromhos. Accuracy of measurement:  $\pm$  5%.

Write for Catalog



**NEW LONDON  
INSTRUMENT**

*Company INC.*

82 Union Street  
New London 4, Conn.

# the first NEW DESIGN of selenium rectifiers IN OVER 20 YEARS

*Kool-Sel*<sup>®</sup>  
Pat. pend.  
by PYRAMID

No center mounting  
Full air ventilation between plates  
Light contact and constant assembly pressure  
No center hot spots  
Lightest weight per unit of output power  
Lower initial forward resistance—better voltage regulation  
Smaller overall size for each rating—cost no more  
Better for all electrical and electronic equipment because of

- Improved convection cooling
- Simpler mounting
- Longer life and minimum aging
- Designed for more rugged service and rated for use in high ambient temperatures

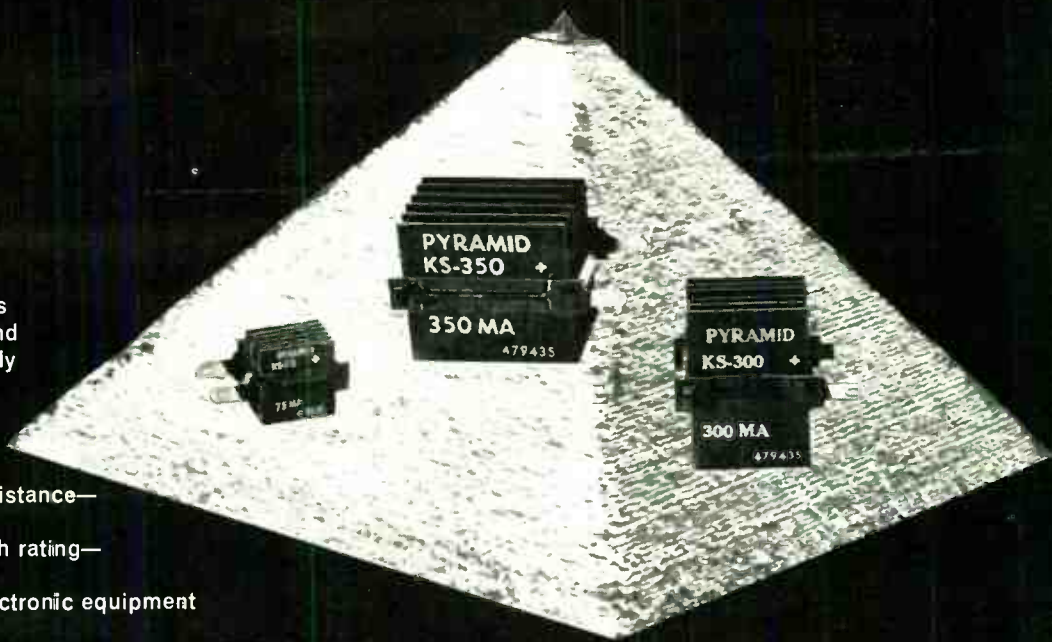

*Kool-Sel*<sup>®</sup> **Important** is the rectifier most readily adaptable to printed circuit applications.

Because of the fixed edge mount yoke, assembly requires only one whistler die, one hole fixed, one hole variable to three dimensions. For complete information write

RECTIFIER DIVISION



**PYRAMID ELECTRIC COMPANY** North Bergen, N. J.

World Radio History

# How SECON Fine Wire is used in critical Government end-use items

Secon's highly engineered fine wire is being used to meet critical specifications by manufacturers of important defense and military end-use items.

## Precision Wire-Wound Potentiometers

In supplying precious metal alloy wire for these, Secon not only conforms to the physical and electrical characteristics on the manufacturer's specifications, but also winds a prototype potentiometer from each melt, which is tested for life, noise, and other characteristics which cannot be specified on the wire. Roundness of so small a magnitude that it cannot be measured is a carefully controlled characteristic which receives Secon's continuous attention.

## Direct-Heated Cathodes in Electronic Vacuum Tubes

Wire and ribbon for use here are individually prepared for each manufacturer to insure satisfactory operation. Secon sets aside the melts until the manufacturer has ascertained the emission and life characteristics of the melt. Approved Secon melts are then used exclusively to supply the manufacturer who made the tests.

## Electro-Plated Grid Wire for Electronic Vacuum Tubes

Precious metals used for these are carefully selected for purity. Only high purity gold, rhodium, silver and others are employed.

## Strain Gauge Wires

These are most carefully selected, in both precious and base metals. Samples of Secon melts are tested by the manufacturer of the strain gauge for temperature coefficient of resistance, gauge factor, and other important characteristics. To insure uniformity, Secon sets aside approved melts for the exclusive use of the manufacturer who made the tests.

## New Wire Products for Semi-Conductors, Transistors, Diodes, Crystals

Developed through special research for application in these fields, the new products include:



**Gold:** fine gold in purities up to 99.99%; and doped gold alloys.

**Aluminum:** fine aluminum wire in four grades: (1) 2S aluminum, 99% pure; (2) EC grade aluminum, 99.4% pure; (3) 99.97% pure aluminum; (4) special high purity aluminum, 99.99% pure.

**Whisker Wires:** in base metals as well as hard platinum alloys, with close tolerances on straightness and hardness in all types.

**Lead-in Wires** of a great variety such as tinned copper wire or ribbon.

Secon specializes in the development, research and production of special alloys and pure metals, processed to very small diameter wire—in all shapes—round, oval, flat, ribbon, grooved—for highly engineered applications in electronics, instrumentation, ordnance, aviation, nuclear physics, atomic energy, guided missiles, automotive industry, and other fields.

Close tolerances and controlled specifications can be held on many important characteristics such as: resistance, tensile strength, elongation, surface appearance, special spooling, purity, torque, linearity, composition, cross section, weight per unit length, uniform plating, dependable insulation, temperature coefficient of expansion and resistance, and strain sensitivity.

## Secon end-products include:

- Fine Wire drawn to 0.0003" diameter
- Ribbon rolled to 0.0001" in thickness
- Electro-Plated Wire and Ribbon
- Special Solder
- Enameled and Insulated Wire
- Pirani Gauge Wire
- Electric Primer Ignition Wire
- Galvanometer Suspension Strip
- Etched Wire
- Precision Potentiometer Wire
- Transistor Wire Components
- Electronic Vacuum Tube Wire Components
- Experimental Melts

Secon invites you to discuss your metallurgical problems with its Research and Development Department.

Write for Pamphlet P-9.

## SECON METALS CORPORATION

7 Intervale Street, White Plains, N.Y.  
White Plains 9-4757



(Continued from page 100A)

- Pierce, J. L., General Elec. Co., 100 Woodlawn Ave., Pittsfield, Mass.
- Pierson, I. S., 185 Avis Ave., St. Marys, Pa.
- Piety, E. A., Box 6394, Honolulu 18, T. H.
- Piller, S. E., 157-32-26 Ave., Whitestone, L. I., N. Y.
- Pino, J. P., 292 Catherine St., Albany, N. Y.
- Pitt, Calvin J., 765 S. Lemon St., El Cajon, Calif.
- Pittard, F. L., 509 S.W., Oak St., Portland 4, Ore.
- Place, J. F., 12 Amity Dr., Camillus, N. Y.
- Place, W. P., Farmers Eng. & Mfg. Co., Irwin, Pa.
- Plotkin, I., 10409 Barrie Ave., Silver Spring, Md.
- Plummer, C. H., 91 Harmon Ave., Springfield 8, Mass.
- Plutt, J. A., Jr., 3346 Delaware St., Pittsburgh 14, Pa.
- Poast, I. M., 2138-26 Ave., S., St. Petersburg, Fla.
- Poehler, H., 7 Manville Lane, Pleasantville, N. Y.
- Polking, U. H., Hughes Aircraft Co., Culver City, Calif.
- Pomerantz, M., 154-39-23 Ave., Whitestone, L. I., N. Y.
- Ponsolle, W. L., 67 Riverside Dr., New York 24, N. Y.
- Poritzky, S. B., 1033 Woodley Pl., Falls Church, Va.
- Porter, A. D., 126 Villa St., Waltham 54, Mass.
- Porter, T. J., Sycamore Mills Rd., R.D. 1, Media, Pa.
- Post, D. B., 451 Conger Ave., Collingswood, N. J.
- Postle, A. H., Colonial Blvd., Williamstown, Mass.
- Pouliot, J. A., Famous Players Corp. Ltd., Royal Bank Bldg., Toronto, Ont., Canada
- Poulson, W. A., P.O. Box 26, Rivera, Calif.
- Powell, C. S., 1507 W. Sherwin Ave., Chicago 26, Ill.
- Powers, D. M., 64 Oxbow Rd., Weston 93, Mass.
- Predmore, E. E., 2265 Sedgwick Ave., New York 68, N. Y.
- Preston, J. G., 640 Martense Ave., Teaneck, N. J.
- Preziosi, F. W., 2336 Hingston Ave., N. D. G., Montreal, Que., Canada
- Prichard, J. S., 294 W. Lena Ave., Freeport, L. I., N. Y.
- Proskauer, R., 350 Lakeville Rd., New Hyde Park, L. I., N. Y.
- Prunty, P. F., 268 Arlington St., Mineola, L. I., N. Y.
- Puca, Q. J., 4989 Kalamazoo, S.E., Grand Rapids, Mich.
- Pughe, E. W., Jr., 36 Bradford Rd., Natick, Mass.
- Purvis, W. J., Nat'l Res. Council, Montreal Rd., Ottawa, Ont., Canada
- Putnam, R. E. A., 416 N. Union Ave., Havre De Grace, Md.
- Putz, H. R., 18 Carmichael Ave., Toronto, Ont., Canada
- Pyle, H., 1546 W. Jefferson Rd., Kokomo, Ind.
- Quarfoot, H. B., 242-A, Rt. 1, Kelseyville, Calif.
- Quate, C. F., 15 Pine Grove Rd., Berkeley 11, N. J.
- Quayle, G., 80 Southwell Rd., Wethersfield, Conn.
- Queen, J. L., 9622 Fernwood Rd., Bethesda, Md.
- Quinn, F. S., Jr., P.O. Box 322, Isle of Palms, S. Car.
- Quinn, J. L., Jr., 209 E. Roseville Rd., Lancaster, Pa.
- Quinn, J. M., 435 Breck St., Scranton 5, Pa.
- Quinn, R. L., Barber Hill, R.D. 3, Knoxville, Tenn.
- Radgowski, S. P., 79 New St., Staten Island, N. Y.

(Continued on page 104A)



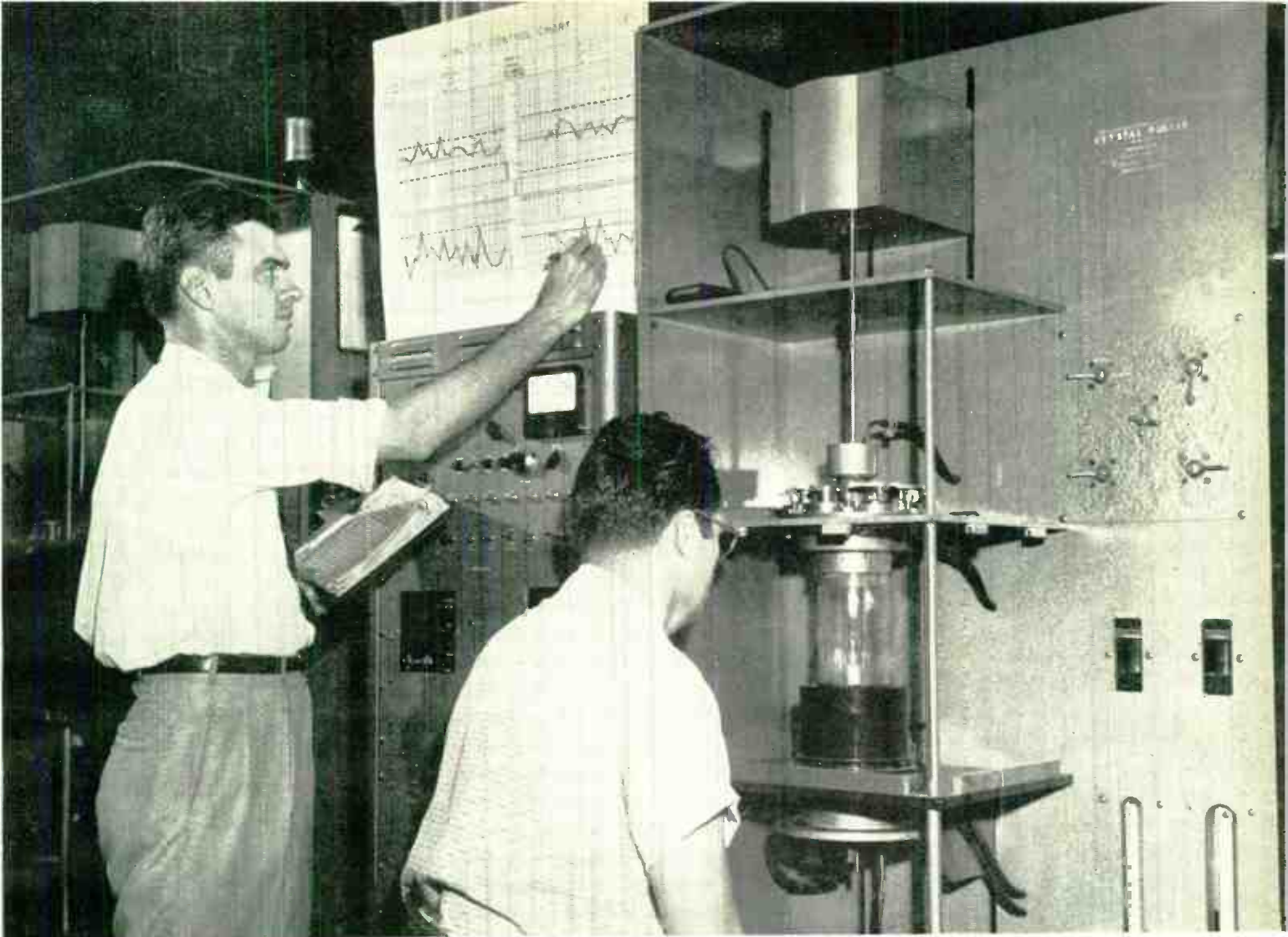

**CLOSE PARAMETER CONTROL MEANS**

## **TI transistors standardize your production circuits!**

You can now design transistorized circuits to standard device specifications. Texas Instruments *controlled parameter* semiconductor devices fit your specific applications without additional testing and selection. Parameter tolerances are closely held and accurately described in new comprehensive design data. All TI germanium and silicon transistors are manufactured and 100 per cent tested for exacting design characteristics.

This close parameter control has enabled Texas Instruments to pace the industry in transistor development and application. Newest TI germanium devices are n-p-n high speed switching transistors. An important step toward complete transistorization of computers, these grown junction units have beta spreads of two-to-one and are 100 per cent tested for switching characteristics. TI was also first to produce silicon transistors commercially, and *only* TI manufactures germanium transistors for *all* three transistorized pocket radios now on the consumer market. For radio, general purpose, and many specific applications, Texas Instruments manufactures both p-n-p alloyed junction and n-p-n grown junction germanium types.

For your own transistorized product development, specify the exact devices you need from TI's wide range of semiconductor products — germanium and silicon; p-n-p or n-p-n types; diodes, triodes, tetrodes. Write for new descriptive data and curves that will help simplify your production problems.

**TEXAS INSTRUMENTS**  
INCORPORATED  
6000 LEMMON AVENUE DALLAS 9, TEXAS



World Radio History

**SEND THE COUPON FOR DETAILS**

Please send comprehensive data and curves describing the semiconductor products checked below:

**GERMANIUM**

- Radio transistors, p-n-p and n-p-n types
- High speed switching transistors
- P-N-P alloyed junction general purpose transistors
- N-P-N grown junction general purpose transistors
- Phototransistors
- Grown junction tetrodes

**SILICON**

- General purpose transistors
- Power transistors
- Junction diodes
- Voltage reference diodes

Name \_\_\_\_\_

Company \_\_\_\_\_

Address \_\_\_\_\_

## Where to get transformers for atomic submarines

Like General Dynamics' Stromberg-Carlson Division, you may at times need transformers that operate in a new circuit design under unusual and rugged conditions.

The shipboard announcing equipment Stromberg designed for the U.S.S. Nautilus, for example, must be 100% trouble-free because of the sub's ability to remain submerged indefinitely. It must also be able to withstand the terrific shock of depth bombs during battle.

Stromberg asked us to design and produce transformers that fit the system's advanced circuitry. The transformers we supplied them meet all the high standards of both Stromberg and the US Navy. They are now operating on the Nautilus and the second atomic sub, the U.S.S. Sea Wolf.

*Just off the press! 16-page, illustrated brochure describing Caledonia's services and facilities for custom-designing and manufacturing transformers.*

### CALEDONIA

ELECTRONICS AND TRANSFORMER CORPORATION

Dept. PI-9, Caledonia, New York

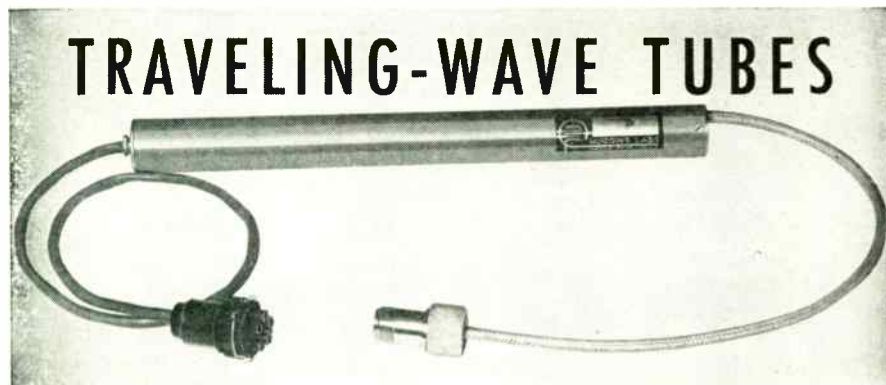

## TRAVELING-WAVE TUBES

### Backward-Wave Oscillators

| TYPE  | FREQUENCY               | MINIMUM POWER                             | HELIX VOLTAGE RANGE |
|-------|-------------------------|---|---------------------|
| HO-1A | 2.0—4.0 kmc<br>S-Band   | 20 dbm 2.5—4.0 kmc<br>10 dbm 2.0—4.0 kmc  | 300—3400            |
| HO-3A | 3.75—7.0 kmc<br>C-Band  | 20 dbm 4.3—7.0 kmc<br>10 dbm 3.75—8.0 kmc | 300—3400            |
| HO-2B | 7.0—14.0 kmc<br>X-Band  | 10 dbm 7.6—13.7 kmc<br>4 dbm 7.0—14.0 kmc | 300—3400            |
| HO-4B | 12.4—18.0 kmc<br>P-Band | 10 dbm 12.4—18.0 kmc                      | 450—2000            |

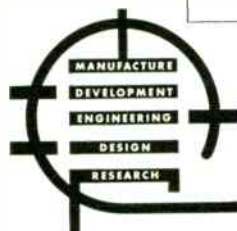

DELIVERY: 4 TO 6 WEEKS

## HUGGINS LABORATORIES

MENLO PARK 2

CALIFORNIA



(Continued from page 102A)

- Ramakrishnan, P. R., Radha Krishna Mills, Coimbatore, Madras, India
- Ramsay, William R., 307 Robert Ave., Oxnard, Calif.
- Randall, H. L., 16841—19 Ave., S.W., Seattle 66, Wash.
- Ranks, J. E., 1270 Leonard Ave., Pasadena 8, Calif.
- Rappaport, M. B., 52 Clearwater Rd., Brookline, Mass.
- Rappaport, R. B., 1514 S. Orange Grove Ave., Los Angeles 19, Calif.
- Rasmussen, C. F., 8239 Noren St., Downey, Calif.
- Rathje, E., 412 Haven Lane, Clarks Summit, Pa.
- Ratner, M., 1253 Barberry Rd., Wantagh, L. I., N. Y.
- Rawls, L. E., 5 White Bridge Rd., Nashville 5, Tenn.
- Rawson, H. B., 55 Manor Dr., Newark 6, N. J.
- Read, G. W., 360 W. Broadway, Glendale 4, Calif.
- Reader, M., 2514 E. Seventh St., Brooklyn 35, N. Y.
- Redelings, J. T., 3935 Del Mar Ave., San Diego 7, Calif.
- Redhead, P. A., Nat'l Research Council, Radio & Elec. Engr. Div., Ottawa, Ont., Canada
- Reed, E. D., R.D. 2, James St., Morristown, N. J.
- Reed, F. C., Jr., 9 Sylvia St., Glen Head, L. I., N. Y.
- Reed, J. F., Jr., 369 Parker Dr., Pittsburgh 16, Pa.
- Reed, W. O., 6517 Foster Ave., Chicago 31, Ill.
- Reedy, J. P., 2856 Exposition Blvd., Santa Monica, Calif.
- Reenstra, W. A., 450 Riverside Terr., Rutherford, N. J.
- Reese, J. S., 572 Fletcher St., Tonawanda, N. Y.
- Regis, R. J., 5358 N. 56 St., Milwaukee 16, Wis.
- Regnier, L. A., 206 W. Parkwood Dr., Dayton 5, Ohio
- Rehberg, C. F., 25-28—84 St., Jackson Hghts., L. I., N. Y.
- Rehler, K. M., 515 Montana Ave., Santa Monica, Calif.
- Reich, A. L., 219 Rodney Cir., Bryn Mawr, Pa.
- Reichert, H. A., 136 Central Ave., N. Hills, Pa.
- Reickord, A. W., 46 Revere Rd., Apt. 3, Drexel Hill, Pa.
- Reid, D. G., 145 Farnborough Rd., Farborough, Hants., England
- Reifel, H., 11 Neighbors Lane, Waltham 54, Mass.
- Reilly, R. R., 7117 N. Rosemead Blvd., San Gabriel, Calif.
- Reimer, R. N., 7811 Agnew Ave., Los Angeles 45, Calif.
- Reiner, S., 210 Pelham Rd., New Rochelle, N. Y.
- Reinsch, F. J., 445 W. 118 St., Los Angeles 61, Calif.
- Reintjes, I. C., 89-03 Matthew Ave., N.E., Albuquerque, N. Mex.
- Reisman, E., 2201 Dickinson Ave., Camp Hill, Pa.
- Renner, Darwin S., 1314 Cedar Hill Ave., Dallas, Tex.
- Reno, H., 2303 W. 46 Ave., Denver, Colo.
- Retherford, R. C., Univ. of Wis., Madison, Wis.
- Rett, H. C., 14 W. Elm St., Chicago 10, Ill.
- Reyling, G. F., 240 Los Trancos Woods, Menlo Park, Calif.
- Reynolds, D. J., 272 Deverill St., Ludlow, Ky.
- Reynolds, F. M., G. E. Co., Electronics Pk., Syracuse, N. Y.
- Reynolds, V. F., 1380 Warner Rd., Meadowbrook, Pa.
- Rhodelamel, A. J. W., R.D. 3, Doyle Rd., Baldwinville, N. Y.

(Continued on page 106A)

# new!

a solid-dielectric molded paper tubular capacitor

with flat capacitance-temperature characteristics

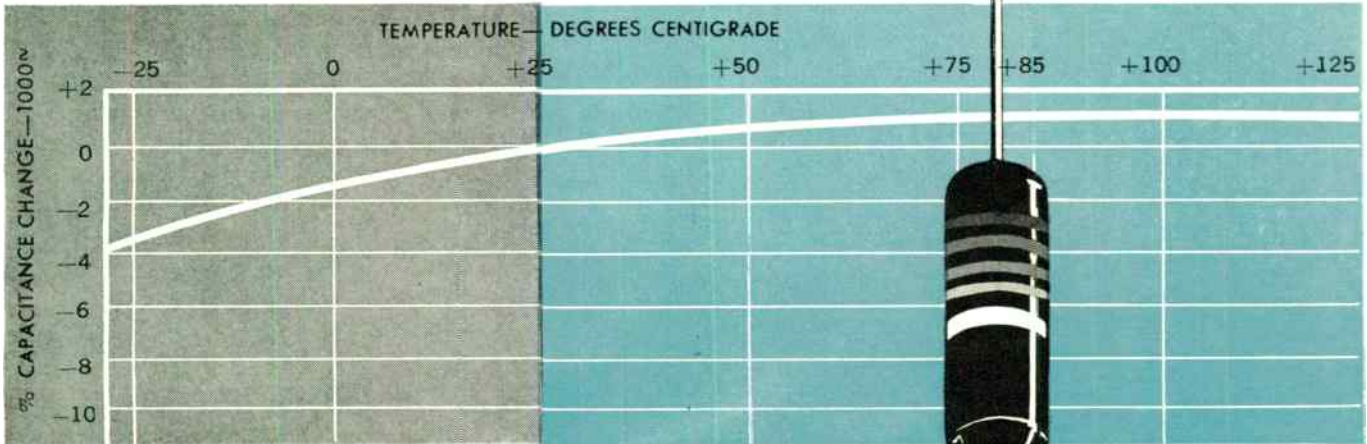

**HCX\*—impregnated Black Beauty® capacitors**

**offer improved circuit performance**

*Sprague, on request, will provide you with complete application engineering service for optimum results in the use of molded paper tubular capacitors.*

SPRAGUE'S NEW TYPE 109P CAPACITORS use a unique new impregnant identified by the trademark HCX. Developed in the Sprague research laboratories in the search for a better material than the polyesters customarily used for impregnating solid dielectric paper tubulars, HCX is a hydrocarbon which polymerizes after the rolled section has been vacuum impregnated. Its salient electrical characteristic of insulation resistance, power factor, and capacitance change with temperature are superior to those of the ordinary polyester units on the market today.

Type 109P Black Beauty Telecaps are molded in non-flammable phenolic and are mechanically rugged. They make an ideal capacitor for all TV and auto radio operations and are well suited for automation assembly by machine since the lead concentricity is closely fixed and there is no outer wax dip to jam inserting heads or magazines.

Complete performance data covering the wide range of sizes and ratings are in Engineering Bulletin 223, available on letterhead request to the Technical Literature Section, Sprague Electric Company, 235 Marshall Street, North Adams, Massachusetts.

\* Trademark

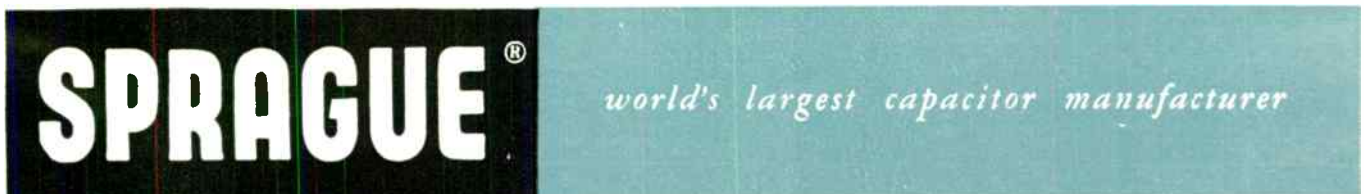

Export for the Americas: Sprague Electric International Ltd., North Adams, Massachusetts. CABLE: SPREXINT.

# High Dielectric Bobbins

## For High "Q" Coils

# PRECISION

**MADE TO YOUR EXACT SPECIFICATIONS  
IN ANY SIZE • SHAPE • QUANTITY**

Precision coil bobbins are fabricated from high dielectric materials and quality controlled to the most minute tolerances . . . Yet, because they are made on special high production equipment, they're available to you for prompt delivery at low unit cost.

Cores are spirally wound dielectric kraft, fish paper, acetate, phenol impregnated or combinations. Flanges are cut to any specification for all types of mountings.

Request illustrated bulletin. Send specifications for samples.

### High Strength Low Cost Paper Tubes

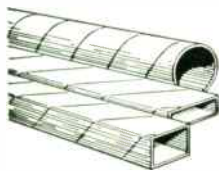

Accurately fabricated in any size, shape, ID or OD. Spirally wound from select dielectric materials. Crush resistant, with excellent dimensional stability. Subject to rigid control and inspection for tolerance and uniformity.

**Ask for samples and Arbor List of over 2000 sizes.  
Sales Representatives in:**

**New England:** Framingham, Massachusetts, Trinity 3-7091  
**Metropolitan New York, New Jersey:**  
 Jersey City, New Jersey, Journal Square 4-3574  
**Upstate New York:** Syracuse, New York, Syracuse 4-2141  
**Northern Ohio, Western Penn.:** Cleveland, Ohio, Atlantic 1-1060  
**Indiana, Southern Ohio:** Logansport, Indiana, Logansport 2555  
**California:** Pasadena, California, Sycamore 8-3919  
**Canada:** Montreal, Quebec, Canada, Walnut 0337



## PRECISION PAPER TUBE CO.

2051 W. CHARLESTON ST. CHICAGO 47, ILL.  
 Plant No. 2: 79 Chapel St., Hartford, Conn.



**Membership**

(Continued from page 104A)

- Rhodes, R. N., 53 Garden Lane, Levittown, Pa.  
 Riblet, H. J., 220 Grove St., Waltham, Mass.  
 Risner, M., 1129 Oakwood Ave., Columbus 6, Ohio  
 Richards, G. A., 216 Brookdale Ave., Toronto 12, Ont., Canada  
 Richardson, L. D., 328 Rantoul St., Beverly, Mass.  
 Richardson, M. S., 721 W. Montclair Ave., Milwaukee 17, Wis.  
 Richmond, M. R., 135 Princeton Rd., Nashua, N. H.  
 Richter, E., 361 Lincoln St., Waltham, Mass.  
 Rickert, H. H., 1084 Washington Ave., Westbury, L. I., N. Y.  
 Rigdon, C. A., 14 Biltmore Blvd., Massapequa, L. I., N. Y.  
 Rines, D., 10 P.O. S.W., Rm. 1318, Boston 9, Mass.  
 Ringer, H. N., 1303 Highland Ave., Palmyra, N. J.  
 Ripnitz, A., 10 Liberty St., Nashua, N. H.  
 Riser, H. N., 3889 Gaspar Dr., Dallas 9, Tex.  
 Risteen, H. C., Meadowlands Dr., City View, Via Ottawa, Ont., Canada  
 Robb, E. J., Box U-37, Univ. of Connecticut, Storrs, Conn.  
 Robbins, D., 555 S. Los Robles, Pasadena, Calif.  
 Robbins, N. P., 515 Lyndale Dr., Vestal, N. Y.  
 Roberts, B. J., 3246 Portage Bay Pl., Seattle 2, Wash.  
 Roberts, G. T., 85 Main St., Concord, Mass.  
 Robertson, J. P., 7345 Cherokee Dr., Kansas City 13, Mo.  
 Robillard, P. A., 174 Bord De L'Eau, Longueuil, Montreal 23, Que., Canada  
 Robinson, A. S., 330 Haven Ave., New York, N. Y.  
 Robinson, D., III, Box 71, Alplaus, N. Y.  
 Robinson, G. D., R. 1, Pullman, Mich.  
 Robinson, R. B., 1235 E. 103 St., Seattle Wash.  
 Robinson, W. C., 3 Russ St., Caribou, Me.  
 Rockwell, W. S., 365 Van Buren Ave., Los Altos, Calif.  
 Roddy, V. S., 8005 Westover Rd., Bethesda, Md.  
 Roedel, J., 829-173 Pl., Hammond, Ind.  
 Roediger, F. E., R.D. 2, Webster Village, Havre De Grace, Md.  
 Roel, E. L., Hillcrest Lane, Huntington, L. I., N. Y.  
 Rogers, E. J., 2022 N. Gantenbein Ave., Portland 12, Ore.  
 Rogers, J. A., 1528 W. Pratt Blvd., Chicago, Ill.  
 Rogers, M. D., R.D. 1, Stratford Rd., Vestal, N. Y.  
 Romanofsky, N. K., 7641 Woodcrest Ave., Philadelphia 31, Pa.  
 Romoser, P. E., 1118 Eighth St., Lorain, Ohio  
 Rosa, Gilbert N., 2945 Manning Ave., Los Angeles 64, Calif.  
 Rose, A., 134-136 Lewisham Way, New Cross, London S.E. 14, England  
 Rose, F. C., 5 Roosevelt Pl., Apt. 3-C Montclair, N. J.  
 Rose, J. K., 6047 N. Francisco Ave., Chicago 45, Ill.  
 Rosenberg, M., 715-18 St., Santa Monica, Calif.  
 Rosenberg, S. L., 119 Wooley Lane, Great Neck, L. I., N. Y.  
 Rosenman, L., 1351 Carmen Ave., Chicago 40, Ill.  
 Rosenthal, D., 8421 Temple Rd., Philadelphia, Pa.  
 Rosman, A. S., 4647 Alveo Dr., La Canada, Calif.  
 Ross, A. T., 5535 Beaucourt Ave., Apt. 16, Montreal, Que., Canada  
 Ross, H. D., Jr., 7 Hemlock Rd., Poughkeepsie, N. Y.  
 Ross, H. H., Jr., 1630 Shamwood St., West Covina, Calif.  
 Ross, J. D., H.M.T.S. Monarch GPO, London, England

(Continued on page 108A)

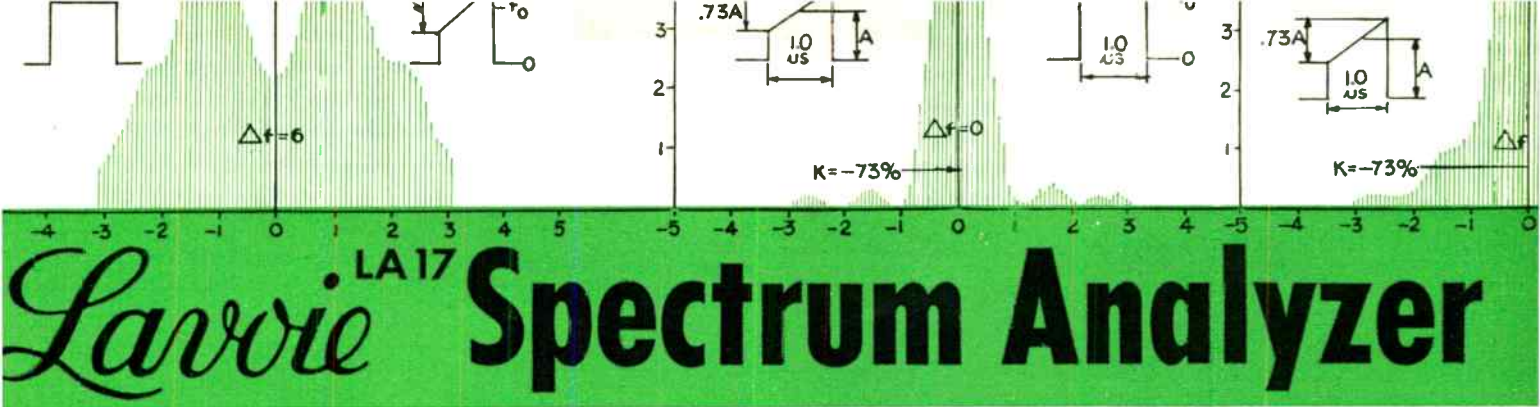

# Lavoie LA17 Spectrum Analyzer

- ★ Finer Resolution . . . 10 Kilocycles
- ★ Complete in one unit . . . no extra tuning heads required
- ★ Single Dial tuning . . . Use of stable triode oscillators eliminates klystrons
- ★ Smooth tuning without backlash
- ★ Ruggedized to military specifications
- ★ Simplicity of operation permits use by production line personnel
- ★ Usable to 34,000 megacycles

## SPECIFICATIONS

### DIMENSIONS

25-7/16" high by 20 1/8" wide by 19 1/4" deep.

### WEIGHT

150 pounds

### PRESENTATION

5CPIA 5" cathode-ray tube (other persistences available).

### SENSITIVITY

At signal to noise ratio 2:1, and spectrum width 25 megacycles:  
 - 75 dbm at 10 mc to  
 - 50 dbm at 16,000 mc

### RANGE

10 megacycles to 16,000 megacycles calibrated. Usable 1 to 34,000 megacycles.

### ACCURACY

Dial accuracy  $\pm 1.0\%$  at the operating frequency of the local oscillator.

### SPECTRUM WIDTH

0.5 to 25 megacycles

### RESOLUTION

10 kilocycles

### TEMPERATURE RANGE

Operating - 40 to + 130° F

### HUMIDITY

90% RH.

### SHOCK

(Non-operating in transit case.) One 12G impact, 10 msec duration on each face. One 37G impact, 10 msec duration on each face.

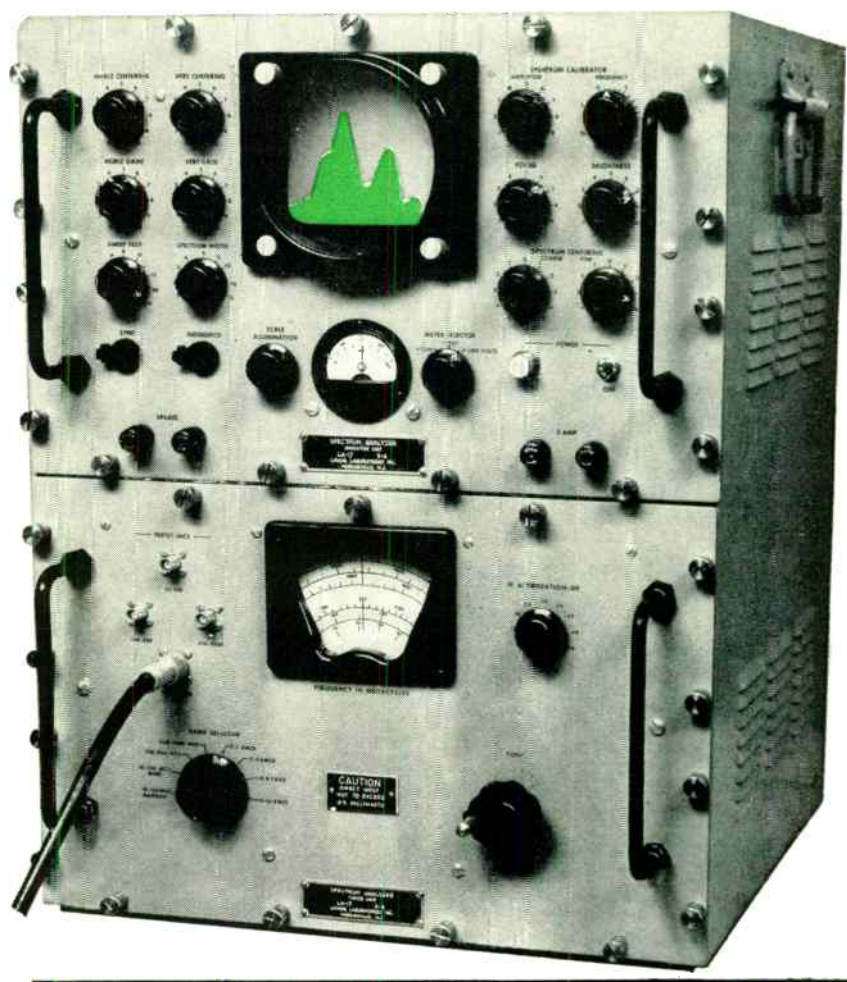

## Lavoie Laboratories, Inc.

MORGANVILLE, NEW JERSEY

Call The Lavoie Representative nearest you for complete information on The LA 17 Spectrum Analyzer and other Lavoie equipment.

- |   |   |
|---|---|
| <p><b>Albany, New York</b><br/>         I. A. Reagon Co.<br/>         51 Summit Avenue<br/>         Phone: 4-7676</p> <p><b>Atlanta, Georgia</b><br/>         Southeastern Industrial Instruments<br/>         374 Hascoll Road, N.W.<br/>         Phone: Exchange 7801</p> <p><b>Baltimore, Maryland</b><br/>         Thomas L. Taylor<br/>         2100 St. Paul Street<br/>         Phone: Belmont 5-9126</p> <p><b>Chicago, Illinois</b><br/>         R. Edward Stemm<br/>         5681 West Lake Street<br/>         Phone: Columbus 1-2227</p> <p><b>Denver, Colorado</b><br/>         Allen I. Williams Company<br/>         124 West 12th Ave.<br/>         Phone: Main 3-0343</p> <p><b>Flint, Michigan</b><br/>         Sam Robbins, Inc.<br/>         230 East First Street<br/>         Phone: Cedar 6-7310</p> | <p><b>Fort Worth, Texas</b><br/>         Mitchell Speoircs Co.<br/>         P.O. Box 11033<br/>         1929 Chotburn Court<br/>         Phone: Webster 8811<br/>         Sunset 3784</p> <p><b>Hartford, Conn.</b><br/>         M. S. Coldwell<br/>         289 Fairfield Avenue<br/>         Phone: Jackson 2-5832</p> <p><b>Los Angeles, California</b><br/>         T. Louis Snitzer<br/>         5777 West Pico Boulevard<br/>         Phone Webster 1-5566</p> <p><b>Montclair, New Jersey</b><br/>         Louis A. Garten &amp; Associates<br/>         25 Valley Road<br/>         Phone Montclair 3-0257</p> <p><b>San Mateo, California</b><br/>         R. L. Pflieger Co.<br/>         126 25th Avenue<br/>         Phone: Fireside 5-1134</p> <p><b>St. Louis, Missouri</b><br/>         Edwin H. Murty<br/>         3505 Ridgedale Avenue<br/>         Phone: Evergreen 5-7728</p> |
|---|---|

World Radio Phone: Cedar 6-7310

**Wet...  
but not  
worried!**



**Stoddart NM-10A Radio Interference and Field Intensity Meter,\***  
covering the frequency range of 14 kc to 250 kc.

**CHANCES ARE YOU'LL NEVER SUBJECT YOUR  
NM-10A TO THIS KIND OF TREATMENT...**

**BUT IT'S NICE TO KNOW THAT IT CAN TAKE IT IF IT HAS TO!**

We turned the hose on the AN/URM-6B — the Navy equivalent of the Stoddart NM-10A — in accordance with Navy specifications. Immediately afterward it was disassembled and found to be dry as a bone inside. And much to our satisfaction, the Navy inspector smiled!

Whether you use this fine, rugged instrument for field intensity measurements of carrier current systems, Navy, maritime or other services... or for surveys of conducted or radiated interference, you'll find that the NM-10A CAN TAKE IT... whether in the lab or in the field.

A complete selection of accessories is available, expanding the utility of the NM-10A to make it one of the most versatile instruments you have ever used.

Write today for further information. Learn about the excellent sensitivity... the "hand calibrated" accuracy... the sturdy, dripproof construction, enabling use in driving rain or snow... the A.C. power supply that permits operation from 105 to 125 volts or 210 to 250 volts A.C., 50 to 160 cps.

The NM-10A is the identical instrument we supply to the Navy as the AN/URM-6B, a Class One instrument, as shown in MIL-I-16910 (SHIPS). It was designed and is manufactured exclusively by Stoddart Aircraft Radio Co., Inc. When you buy the NM-10A you're getting a quality instrument that meets the rugged requirements of the U. S. Navy!



**\*Stoddart RI-FI Meters Cover the Frequency Range of 14 kc to 1000 mc**

**NM-20B — HF**

15 kc to 25 mc. Commercial equivalent of AN/PRM-1A. Self-contained batteries. A.C. supply optional includes standard broadcast band, radio range, WWW and communications frequencies. Has BFO.

**NM-30A — VHF**

20 mc to 400 mc. Commercial equivalent of AN/URM-47. Frequency range includes FM and TV bands.

**NM-50A — UHF**

375 mc to 1000 mc. Commercial equivalent of AN/URM-17. Frequency range includes Citizens band and UHF TV band.

**STODDART AIRCRAFT RADIO Co., Inc.**  
6644-C Santa Monica Blvd., Hollywood 38, California • Hollywood 4-9294



(Continued from page 100A)

- Rosselot, G. A., Bendix Prods. Div., 400 S. Beiger St., Mishawaka, Ind.  
 Rosznick, M., 28 Metropolitan Oval, New York 62, N. Y.  
 Rothbart, A., 98 Van Courtlandt, Park South, Bronx 63, N. Y.  
 Rothrock, H. B., 5413 Lynette Dr., Fountain City 18, Tenn.  
 Rozas, Felix, White Horse Pike & Dartmouth Ave., R.F.D., Haddonfield, N. J.  
 Rubel, J. H., Hughes Aircraft Co., Culver City, Calif.  
 Ruderman, M., 13145 Lake St., Los Angeles 66, Calif.  
 Rudich, I., Five Basket Lane, Hicksville, L. I., N. Y.  
 Rueda, J. V., El Rastreador C24, Buenos Aires, Argentina  
 Ruggi, A. G., 2807 Natta Blvd., Bellmore, L. I., N. Y.  
 Rummel, E. C., 5507 New Haven Court, Austin, Tex.  
 Runkle, E. G., Jr., 13788 W. Outer Dr., Detroit 28, Mich.  
 Rupke, E., 1830 Independence Blvd., Ann Arbor, Mich.  
 Rusinow, K., 336 W. 95 St., New York 25, N. Y.  
 Rusnak, W., 91 Wallace Ave., Buffalo 14, N. Y.  
 Russ, J. A., Federal Communications Comm., Washington 25, D. C.  
 Russell, J. A., 111, 27 Preston St., Huntington, L. I., N. Y.  
 Ryan, E. H., 3118 Snyder Ave., Brooklyn 26, N. Y.  
 Ryan, W. E., Diamond Ordnance Fuze Labs., Washington 25, D. C.  
 Ryan, W. J., 4215 N. Western Pkwy., Louisville 12, Ky.  
 Rypstra, B., Jr., 801 W. Lawrence, Charlotte, Mich.  
 Sabol, R. W., 485 Sumatra Ave., Akron 5, Ohio  
 Sackler, A. A., Cons. Diesel Elec., Corp., Ludlow & Canal St., Stamford, Conn.  
 Sahn, E. J., 193 Richard Ave., Merrick, L. I., N. Y.  
 Sail, A. H., 513 Syracuse Ave., Massapequa, L. I., N. Y.  
 St. John, I. S., Rt. 2, Bx 385, Bothell, Wash.  
 Sale, P. A., 226 Ledbury Ave., Toronto 12, Ont., Canada  
 Salem, J., 105 Demarest Pl., Maywood, N. J.  
 Salisbury, D. L., 3838 Alberan Ave., Long Beach 8, Calif.  
 Saltsburg, S. S., 97-11—134th Rd., Ozone Park, L. I., N. Y.  
 Samsel, R. W., 106 Birch Lane, Scotia 2, N. Y.  
 Sanson, R. L., 15 Colonial Dr., Wyckoff, N. J.  
 Samuelian, B., 1692 Washington Ave., Bronx 57, N. Y.  
 Samuelson, W. H. E., R.D. 5, Carlisle, Pa.  
 Sander, H. F., Bell Telephone Co., 416 Seventh Ave., Pittsburgh 19, Pa.  
 Sanders, L., Jr., 2200 Robles Ave., San Marino, Calif.  
 Santa, M. M., 6 Howland St., Cambridge, Mass.  
 Satterthwaite, W. F., 630 N. Chester Rd., Swarthmore, Pa.  
 Satullo, A. R., 4512 North Woodward Ave., Royal Oak, Mich.  
 Saunders, C. L., 83-30 Kew Gardens Rd., Kew Gardens 15, L. I., N. Y.  
 Saunders, H. M., Western Union Telegraph Co., 60 Hudson St., New York 13, N. Y.  
 Savadelis, I. C., 1910 E. Highland St., Allen town, Pa.  
 Sawyer, W. G., 2401 Gulf Bldg., Houston 2, Tex.  
 Sayles, P. W., General Electric Co., Schenectady, N. Y.  
 Scarborough, A. D., 595 W. Washington St., Pasadena 6, Calif.

(Continued on page 110A)

# New MALLORY FP Capacitors

*with snap-in mounting  
for printed circuits*

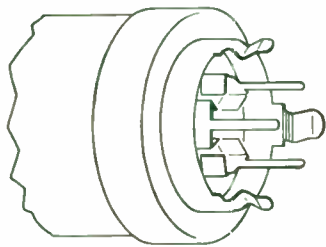
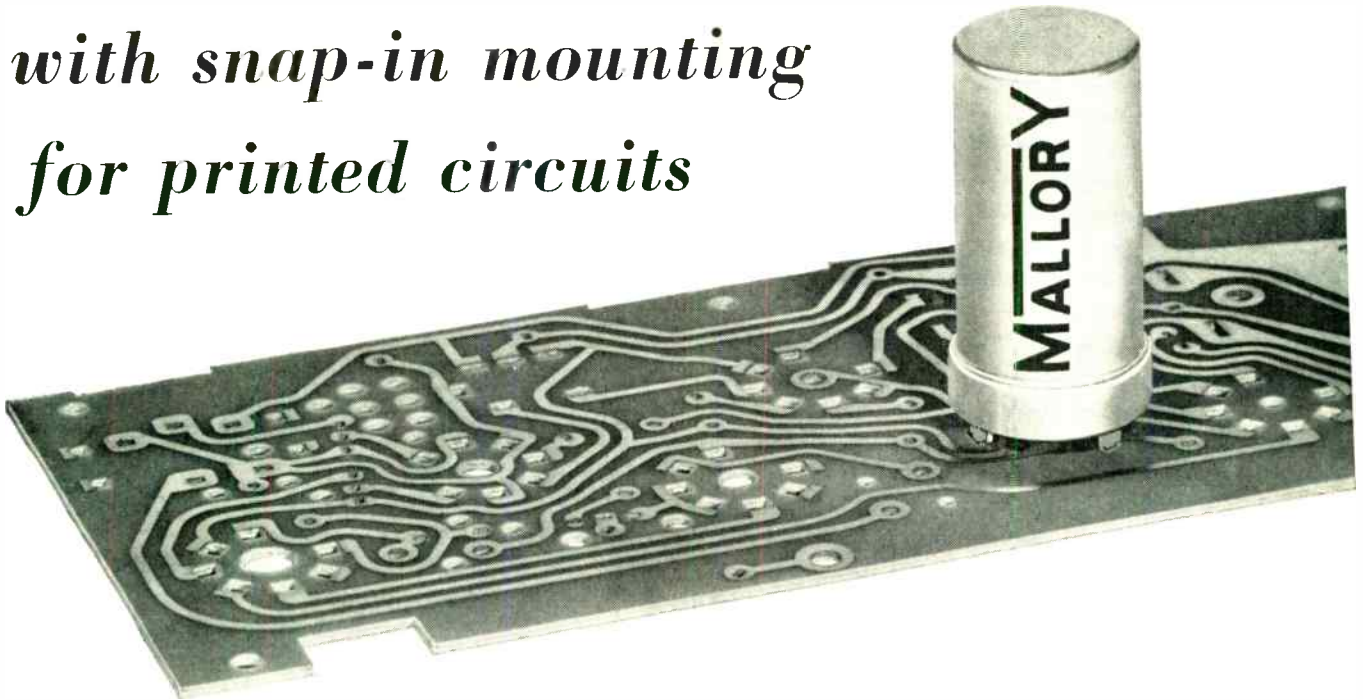

**SNAP-IN  
MOUNTING TABS**

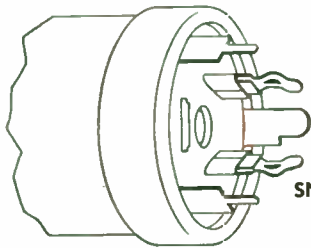

**SNAP-IN TERMINALS**



**MALLORY**  
Metal Tubular Electrolytics  
for Printed Circuits

In addition to the FP line of capacitors, Mallory produces a special series of metal tubular electrolytics for printed circuits. One terminal is a bare wire, and the other a flat tab for orientation. Write or call for technical data and available ratings.

If you are using printed circuits, Mallory can supply electrolytic capacitors with the terminal construction you need. During nearly two years of developing and manufacturing capacitors especially for printed circuit use, Mallory has created a diversified group of designs that cover most applications.

The latest additions to the line of FP Capacitors for printed circuits are designed for snap-in mounting. Just push the capacitor into its slots in the circuit panel, and spring-formed tabs hold it in place, ready for soldering.

You have a choice of either snap-in mounting tabs or snap-in terminals. In addition, you can select models with straight tabs and terminals. All are available in six-slot or eight-slot terminal configurations.

*Keyed tabs* make mounting foolproof.

*Circuits can be printed on both sides.* Shoulders on the mounting tabs hold the capacitor case clear of the printed sheet. Clearance ranges up to .137".

*Positive soldering.* Possibility of aluminum contamination is eliminated because the connections from the foil stop well short of the solder area.

Added to these time-saving design features are the superior electrical characteristics and long life at high temperatures which have made Mallory FP Capacitors the standard of performance throughout the industry. Write or call us today for technical data, and for an analysis of your circuit requirements by a Mallory capacitor engineer.

**Serving Industry with These Products:**

**Electromechanical**—Resistors • Switches • Television Tuners • Vibrators  
**Electrochemical**—Capacitors • Rectifiers • Mercury Batteries  
**Metallurgical**—Contacts • Special Metals and Ceramics • Welding Materials

*Expect more . . . Get more from*





# Generating enthusiasm

## NEW AM-FM SIGNAL GENERATOR

MODEL 995A/1

Our enthusiasm will be shared by you when you use this superbly designed instrument.

Model 995A/1 is designed to cover both IF and Carrier Frequencies. This new Marconi generator together with the Marconi Deviation Meter Model 934/2 are the basic instruments for developing and maintaining FM systems.

Make no mistake, specify Marconi . . . for Bridges, Audio & RF Power Meters, VTVM's, Deviation Meters, etc. Write to:

**MARCONI**  
Since 1897



MODEL 995A/1

- Frequency Range 1.5-220Mc
- Crystal Standardized to 0.02 %
- Leakage: below 0.1μV
- Deviation Ranges: 0-25kc, 0-75kc, and up to 600kc
- Deviation Accuracy: ± 5% of f.s.d.
- Tubes: 6AK6, 6AK5, 6AU6, 12AT7, 5Z4G, OA2
- Compact and Portable
- Price: \$850.00 Immediate Delivery

**MARCONI Instruments** 44 New Street, New York 4, N. Y.  
HANOVER 2-0197-8

designed  
for the  
user



**Other Shasta Quality Instruments**  
Expanded Scale Frequency Meters and Voltmeters • Log Scale Voltmeters • Audio Oscillators Square Wave Generators • Power Supplies • Wide Band Amplifiers Bridges • WWV Receivers • Decade Inductors.

S-9

by **Shasta** division



### ARGA MODEL 401 EXPANDED SCALE FREQUENCY METER

*description:*

Originally designed for production checking of frequency regulation on motor and engine-driven generator sets, ARGA Expanded Scale Frequency Meters offer fast, accurate monitoring of frequency on many applications.

*features:*

- ★ Accuracy of ± ½ cycle
- ★ 1 ma recorder connection provided
- ★ Expanded scale for easy, error-free reading

*brief specifications*

Base Frequency: 400 cps\*  
Span: ± 25 cycles  
Accuracy: ± ½ cycle  
Price: \$305.00 f.o.b. factory  
\*Also available in 60 cps model

Write today for Technical Bulletin A401; please address Dept. Sa-9.

**Shasta** division  
**BECKMAN INSTRUMENTS INC.**

P.O. BOX 296, STATION A • RICHMOND, CALIFORNIA  
TELEPHONE LANDSCAPE 6-7730



(Continued from page 108A)

- Schabbehar, E. A., 190 Clock Blvd., Amityville, L. I., N. Y.  
Schachter, J., 1907 Coney Island Ave., Brooklyn 30, N. Y.  
Scharling, R. M., 5943 S. Green St., Chicago 21, Ill.  
Scharf, E., 236 Broadway, Massapequa Park, L. I., N. Y.  
Scheets, D. F., 2800 Wiseman Rd., Silver Spring, Md.  
Scheffel, A. G., 2814-75 Ave., Elmwood Park 35, Ill.  
Scheiner, M. L., 541 E. 20 St., New York 10, N. Y.  
Scheldorf, R. D., 79 Manor Ave., Oaklyn 6, N. J.  
Schiller, J., 903 Capouse Ave., Scranton, Pa.  
Schindler, R. W., 6813 Charles Ave., Parma 29, Ohio  
Schlecht, M. F., 302 Merrell Rd., Syracuse, N. Y.  
Schlesinger, W. A., 4815 W. Division St., Chicago 51, Ill.  
Schleter, G. C., 4633 Davenport St., N.W., Washington 16, D. C.  
Schmidt, R. A., 717 N. Cayuga St., Ithaca, N. Y.  
Schneble, A. D., Michael St., Menlo Park, N. J.  
Schneider, R. E., 10 Waggon Ave., Malverne, L. I., N. Y.  
Schnipper, A., 79 W. 45 St., Bayonne, N. J.  
Schoenfeld, K., Broadway & Sanders St., Greenlawn, L. I., N. Y.  
Schrader, L. W., Jr., Airbourne Instruments Co., 160 Old Country Rd., Mineola, L. I., N. Y.  
Schreiner, 5 Bayview Ave., Port Washington, L. I., N. Y.  
Schreiner, K. E., Watson Scien., Comp., Lab., I.B.M. 2929 Broadway, New York 25, N. Y.  
Schreiner, W. A., Newton-Buckingham Pike, Pineville, Pa.  
Schultz, J. J., K. Q. V., Chamber of Commerce Bldg., Pittsburgh 19, Pa.  
Schure, Dr. A., 274B-141 St., Belle Harbor, L. I., N. Y.  
Schwartz, A. J., Wallworth Apts., Haddonfield, N. J.  
Schwartz, E. I., 18-31 Jordan Rd., Fairlawn, N. J.  
Schwartz, E., 147-25-71 Rd., Kew Gardens, L. I., N. Y.  
Schwartz, H. T., 150 E. Third St., New York 9, N. Y.  
Schwarz, H. F., The Decca Record Co., Ltd., 1-3 Brixton Rd., London S.W. 9, England  
Schwarzenbach, E. E., 8302 Osceola Ave., Chicago 31, Ill.  
Schwarzkopf, J., 29-7 Garden Cir., Waltham 54, Mass.  
Schwennesen, D., 4125 Grove St., Skokie, Ill.  
Scott, R. M., 1419 Alger Rd., Falls Church, Va.  
Seewald, E. C., 136 Osborn Rd., Aberdeen, Md.  
Sefton, W. E., 3645 Shadow Grove Rd., Pasadena 8, Calif.  
Sehnert, P. J., Box 250, Thousand Oaks, Calif.  
Seid, E., 3927 W. Jefferson Blvd., Los Angeles 16, Calif.  
Seid, H. R., 113 Colvin St., Mobile, Ala.  
Seidel, H., 46 C Leland Gardens, Plainfield, N. J.  
Seidman, S. M., 3638 Glencairn Rd., Shaker Heights 22, Ohio  
Seidner, O. R., 1705 W. Peilley Dr., Alhambra, Calif.  
Seisler, M., 136-19-222 St., Laurelton 13, L. I., N. Y.  
Selbmann, R. W., 180-48 Aberdeen Rd., Jamaica Estates 3, L. I., N. Y.  
Selby, E. O., 214 Fern Ave., Collingswood, N. J.  
(Continued on page 112A)



*Custom Electronic Components*

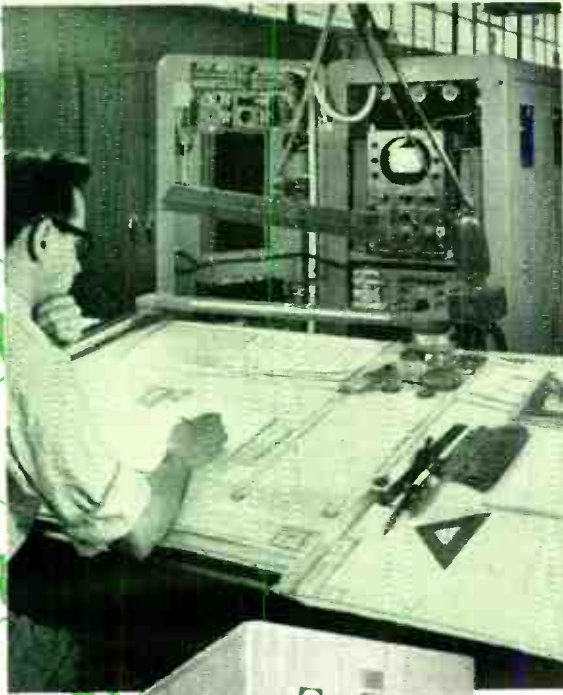

## MODULATORS for MAGNETRONS and KLYSTRONS

When industry and experimental laboratories need special instruments, designed and built to the highest standards of precision performance and at lowest cost, they turn to FXR for proved dependability. A good example of close integration between FXR engineering design and production, typified in the illustration, shows an electromechanical engineer working on a design change to accommodate a customer's special requirements. Got a design problem? Try FXR first!

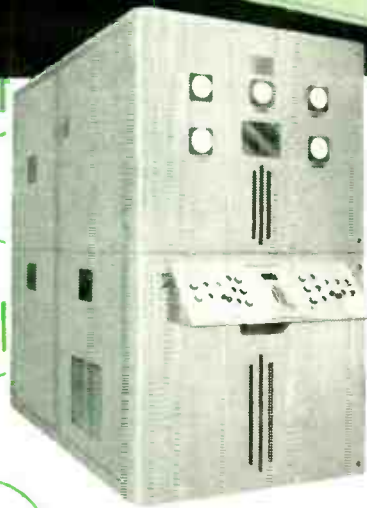

14  
MEGAWATT  
UNIT  
Type Z821A



ONE  
MEGAWATT  
UNIT  
Type Z820A



625  
KILOWATT  
UNIT  
Type Z824A

BASIC DESIGNS NOW AVAILABLE

| High Power Modulator Type No. | Power (peak megawatts) | Voltage (peak kilovolts) | Current (peak plate-amperes) | Impedance (output-ohms) | Duty Cycle (maximum) | Pulse Shape (μsec/pps)         | Input 60 CPS (Ø/volts) | Size (HxWxD, ft.) | Weight (lbs.) | Tubes Operated             |
|-------------------------------|------------------------|--------------------------|------------------------------|-------------------------|----------------------|--------------------------------|------------------------|-------------------|---------------|----------------------------|
| Z820A                         | 1.0                    | 33                       | 33                           | 1,000                   | .001                 | 0.5/2000<br>2.5/400            | 1/190-250              | 6x2x3             | 1400          | 4J50, QK-349<br>RK-6249    |
| Z821A                         | 14.0                   | 90                       | 160                          | 560                     | .001                 | 2.0/200-500                    | 3/440-550              | 7x4x7             | 6800          | QK-338                     |
| Z822A                         | 0.2                    | 20                       | 10                           | 3,330                   | .018                 | 10/1200-1800                   | 3/440                  | 6x3x4             | 3330          | SAL 39<br>(GL-6625)        |
| Z823A                         | 0.042                  | 12.7                     | 3.3                          | 3,330                   | .064                 | coded/300                      | 3/440                  | 6x4x4             | 3200          | SAL 39                     |
| Z824A                         | 0.625                  | 25                       | 25                           | 1,000                   | .001 at<br>0.5/2000  | 1.0/1000<br>2.0/250<br>5.0/100 | 1/190-250              | 6x2x3             | 2500          | QK-349<br>at reduced power |
| Z825A                         | 1.6                    | 40                       | 40                           | 1,000                   | .001 at<br>0.5/2000  | 1.0/1000<br>2.5/400            | 1/190-250              | 6x2x3             | 2500          | WE-5780                    |

Modulator Loads and Exhaust Ovens are also available.

Data subject to change without notice. Prices on application.



FIRST BY FAR

*Electronics & X-Ray Division*

F-R MACHINE WORKS, Inc.

26-12 BOROUGH PLACE, WOODSIDE 77, N. Y. • ASTORIA 8-2800

**ALLIED  
CONTROL**  
starts with  
the finest . . . . .



**GARFIELD  
WIRE**

# Garfield Wire

When you specify Allied Control, you're asking for the best. For example, take the relay shown here. It's the finest there is — in split-second response, unflinching accuracy, rugged dependability.

Design — construction — materials — all have to be the best for Allied . . . and the heart of this relay is wound with Garfield Enamelled Magnet Wire.

You'll start with the finest in wire, too, when you specify Garfield. Our modern drawing and enameling equipment, our rigid production control and our stringent inspection system are geared to produce only top-quality wire with tolerances closer than NEMA specifications.

Write for price lists and specification chart on Garfield bare wire, plain and heavy enamel additions today.



**GARFIELD WIRE DIVISION**  
*of The Overlake Corporation*  
142 Monroe Street, Garfield, N. J., GRegory 2-3661-2



**Membership**

(Continued from page 110A)

- Slender, H., 738 Howard Ave., Brooklyn 12, N. Y.
- Sell, R. L., 7233 Vincent Ave. So., Minneapolis 10, Minn.
- Setaro, J. E., 2426 -108 Ave., S.E., Bellevue, Wash.
- Sferrazza, P. J., 1494 Wagner St., Wantagh, L. I., N. Y.
- Shade, R. R., 8221 Buhman, Rivera, Calif.
- Shalleross, G. P., 4713 Pensacola Ave., Chicago 41, Ill.
- Shanahan, W. J., 23-19—31 Ave., Long Island City 2, L. I., N. Y.
- Sharp, J. M., R.F.D. 1, Box 217, Santa Paula, Calif.
- Shattuck, J. C., 1045 Bonita Ave., Coconut Grove, Miami 33, Fla.
- Shaw, B., 321 Ave. "C", New York 9, N. Y.
- Shaw, D., 3445 Holland Ave., Bronx 67, N. Y.
- Shawhan, E. N., Goshen Rd., & Butler Dr., Newtown Square, Pa.
- Sheker, E. B., 22 Aldwyn Lane, Villanova, Pa.
- Shellabarger, J. N., 725 Pennsylvania Ave., San Diego 3, Calif.
- Shepard, F. H., Jr., 480 Morris Ave., Summit, N. J.
- Shepard, W. H., Box 94, Rock Stream, N. Y.
- Sherertz, P. C., 151 Elmira St., S.W., Washington 24, D. C.
- Sherman, J. H., Jr., 220 Allen St., E. Syracuse, N. Y.
- Sherron, R. J., Jr., Box 107, Hempstead, Tex.
- Sherry, R. S., 146 Robby Lane, New Hyde Park, L. I., N. Y.
- Sherwood, E. M., 6 Battelle Memorial Inst., 505 King Ave., Columbus 1, Ohio
- Shetler, R. L., 2203 S. Geddes St., Syracuse, N. Y.
- Shiely, A. R., Jr., 14 Circle Dr., Hicksville, L. I., N. Y.
- Shiely, E. D., Asst. Dir., Oak Ridge Nat'l. Lab., Oak Ridge, Tenn.
- Shively, E. H., 250 C Haddon Hills Apts., Haddonfield, N. J.
- Shook, E. M., 227 W. Woodin Blvd., Dallas 16, Tex.
- Shure, S. N., Shure Bros. Inc., 225 W. Huron St., Chicago, Ill.
- Siebert, W. M., 5 Martha's Point Rd., Concord, Mass.
- Siefken, R. M., 104 Buckworth Dr., Kokomo, Ind.
- Sielski, A. T., 225 Mahwah Rd., Mahwah, N. J.
- Silberg, W. F., 122 Mohawk Dr., Clarendon Hills, Ill.
- Silberman, A., 81 W. 172 St., Bronx 52, N. Y.
- Sills, M. M., 468 Poplar Lane, East Meadow, L. I., N. Y.
- Silva, W., 9513—11 Ave., Inglewood 4, Calif.
- Silver, J. F., 122 Clinton Ave., Park Ridge, Ill.
- Silver, M., 21-11 Greenwood Dr., Radburn, N. J.
- Silver, S. H., 1441 Somerset Pl., N.W., Washington 11, D. C.
- Simmons, E., Jr., 455 S. Oakland Ave., Pasadena 5, Calif.
- Simonds, F. W., 3722 Richmond Ave., Houston 6, Tex.
- Simpson, W. F., 245 W. Passaic Ave., Rutherford, N. J.
- Sims, W. H., Jr., 7326 Yorktowne Dr., Towson 4, Md.
- Singer, E. M., 430 Deal Lake Dr., Asbury Park, N. J.
- Sixbey, S. R., 132 Washington Ave., Amityville, L. I., N. Y.
- Skaggs, E. R., 824 Elspeth Way, Covina, Calif.
- Skalnik, J. G., Dunham Lab., Yale University, New Haven, Conn.
- Skene, R. A., Douglas Aircraft Co. Engr., Dept., C-250, Long Beach 1, Calif.
- Skilneski, C. E., 25 W. 39 St., Bayonne, N. J.

(Continued on page 114A)

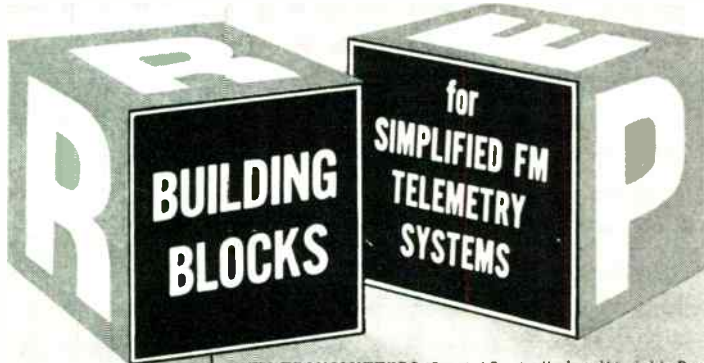

Assembly of these rugged building blocks into an integrated system is a simple and easy process. Analyze your telemetry requirements, sketch your block diagram, and select the required units from RREP's full line of FM transmitting equipment. You've then got the finest airborne system available.

Technical Bulletins giving complete information on these units are available on request.



- FM TRANSMITTERS.** Crystal Controlled and Variable Reactance
- RF AMPLIFIERS** for boosting R.F. signal strength
- SUBCARRIER OSCILLATORS.** Voltage Controlled, Bridge Activated, and Variable Reactance
- COMMUTATORS AND DYNAMOTOR-COMMUTATOR GATING UNITS** for expansion of system capacity by subcarrier commutation
- UNIVERSAL MOUNTING ASSEMBLY:**  
UNERAC (Universal Regulator, Amplifier and Calibrator) and **UNIVERSAL MOUNTING UNITS** for mounting all RREP Oscillators
- DYNAMOTORS** for high voltage supplies

**RAYMOND ROSEN  
ENGINEERING PRODUCTS, INC.**  
32nd and Walnut Streets, Philadelphia 4, Pennsylvania  
Western Regional Office: 15166 Ventura Blvd.,  
Sherman Oaks, Los Angeles, California

# YEARS AHEAD of the industry...



**Type 105 Model 6**

**New!**

## Northern Radio FREQUENCY SHIFT KEYER

**New!** Highest Stability achieved  
by any Frequency Shift Keyer

**New!** Increased Frequency Range  
1.0 to 7.0 mc

**New!** Pre-selection of Proper  
Frequency Shift for any  
particular transmitter fre-  
quency multiplication

**New!** Permits use with  
external oscillator  
without need of adapters

**New!** Improved  
Accessibility —  
for even easier  
maintenance

The new Northern Radio Frequency Shift Keyer Type 105 Model 6, is a very high stability RF oscillator which provides a means for shifting an RF carrier in accordance with the intelligence. This exciter replaces the crystal oscillator in a transmitter and produces "Mark" and "Space" carrier shift for transmission of teleprinter or telegraph signals, or a linear carrier shift for transmission of FM telephone, facsimile or telephoto. In addition to the technical advancements mentioned above, this new Keyer continues to embody the following performance-proven features:

- Direct-reading frequency calibration of shift from 0 to 1000 cps.
- Frequency shift dial adjusts "Mark" and "Space" frequencies equally above and below the carrier position, which remains fixed.
- Simplified frequency setting makes only the upper sideband tuning indication visible on the meter over substantially all of the tuning range.
- Direct-reading frequency calibration of mixer and output tuning dials from 1.0 to 7.0 mc.
- Direct-reading calibration of output frequency vernier  $\pm 600$  cps.
- Pulse-shaping circuit to permit operation within assigned bandwidth with no adjacent channel radiation.
- Highly stable temperature-controlled oven with control of  $\pm 0.1^\circ\text{C}$ . at  $60^\circ$
- Linear carrier shift up to 1400 cps for Fax operations.
- Component ratings according to JAN specs for greater assurance of trouble-free operation.



Pace-Setters in Quality Communication Equipment

### NORTHERN RADIO COMPANY, inc.

147 WEST 22<sup>nd</sup> ST., NEW YORK 11, NEW YORK

In Canada: Northern Radio Mfg. Co., Ltd., 1950 Bank St., Billings Bridge, Ottawa, Ontario.

Write for Catalog P-9

# WESGO... for the best vacuum tube ceramic



## WESGO AL-300 a very high alumina ceramic

Non-gassing at elevated temperatures • Extremely high strength • Very low loss at all frequencies • Vacuum tight • Very high bond strength to a "moly-manganese" metallized coating • Can be supplied in most shapes to precise dimensional tolerances.

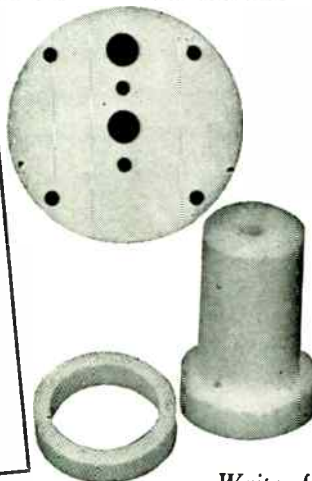

Write for additional information

## WESTERN GOLD & PLATINUM WORKS

589 BRYANT

SAN FRANCISCO 7, CALIF.

the ONLY instrument in the field that offers ALL these features at



**NO  
EXTRA  
COST!**

the new  
**DS-6100-T**  
**FREQUENCY-PERIOD**  
electronic counter

A compact frequency-period counter designed for direct measurement of any mechanical, electrical or optical phenomena which can be converted to a varying voltage. Read-out in direct digital form. Ideal for use by skilled or unskilled personnel. Price \$700.00.

Write for complete catalog data **TODAY!**

- **FREQUENCY** Measurement
- **1 and 10 SECOND** Time Base
- **PERIOD** Measurement
- **1 and 10 CYCLE** Gate Time
- **PRECISION ACCURACY** Over 1-100,000 cps range

- **EASILY PORTABLE** Only 28 Pounds
- **SMALL SIZE** 14 1/4" W x 7 1/2" H x 13 1/2" D

**NEW**  
*Improved  
Sensitivity*



Representatives in all major areas.  
**COMPUTER-MEASUREMENT CORP.**

5457 Cleon Avenue, Dept. 86-J  
North Hollywood, California

0-111



Membership

(Continued from page 112A)

- Skinner, R. L., 333 High St., Woodbury, N. J.  
Skrobisch, A., Technical Advisory Assoc., 30 Broad St., New York 4, N. Y.  
Slade, M. G., 17 Holden Wood Rd., Concord, Mass.  
Slate, M. W., 435 Ft. Washington Ave., New York 33, N. Y.  
Slawek, J. E., 4202 Manayunk Ave., Philadelphia 28, Pa.  
Slotow, H. G., 1303 W. University Ave., Champaign, Ill.  
Snalts, F. W., 225 S. Lecato Ave., Audubon, N. J.  
Smart, M. E., 990 San Ramon Way, Sacramento 21, Calif.  
Smith, C. H., Jr., Lockheed Aircraft Corp., Missiles Research Labs., 7701 Woolley Ave., Van Nuys, Calif.  
Smith, E. L., Jr., 3010 Severth St., N. Arlington 7, Va.  
Smith, E. L., Jr., 5129 Frederick Ave., Baltimore 29, Md.  
Smith, G. M., Box 1142, Church St., Station, New York 8, N. Y.  
Smith, G. H., 1 Elm St., Nassau, N. Y.  
Smith, G. S., Rd-2 Turkey Hill Rd., Ithaca, N. Y.  
Smith, G. E., University of Kentucky, Elect. Engr., Dept., Lexington, Ky.  
Smith, H. A., Civil Aeronautics Admin., Sect., 6-556, 5651 W. Manchester Ave., Los Angeles 45, Calif.  
Smith, H. R., 111 Morningside Dr., Verona, N. J.  
Smith, H. G., 236 Valley Rd., Ithaca, N. Y.  
Smith, J. C., 15359 Cohasset St., Van Nuys, Calif.  
Smith, K. A. H., 4714 Edgefield Rd., Bethesda, Md.  
Smith, L. R., 5130 W. 72 Terr., Prairie Village 15, Kan.  
Smith, R. A., 1243 E. Shamwood St., West Covina, Calif.  
Smith, W. E., 617 Derstine Ave., Lansdale, Pa.  
Smith, W. B., 744-36 St., Manhattan Beach, Calif.  
Smith, W. M., 2500 Hudson Blvd., Jersey City 4, N. J.  
Snefsky, E. A., 2046 Brookfield Rd., Pittsburgh, Pa.  
Snow, H. A., 30 Old Salem Rd., West Orange, N. J.  
Snowden, J., 6 Rediffusion, P.O. Box 608, Singapore  
Snyder, G. H., Hq. AMFE APO, 633, New York, N. Y.  
Solzberg, S., 49-67 Fresh Meadows Lane, Flushing, L. I., N. Y.  
Somers, B. A., Westover Rd., Simsbury, Conn.  
Somerville, J. R., Jr., 723 Griffith Ave., Owensboro, Ky.  
Sonthimer, C. G., 350 Flax Hill Rd., South Norwalk, Conn.  
Soorin, A. J., Box 211, R.F.D. 1, Medway, Ohio  
Sorensen, R. L., Civil Aeronautics Adm., W-356, Washington, D. C.  
Sorkin, S. A., 6738 Norway Rd., Dallas, Tex.  
Sowerby, J. M., 74 Marston Gardens, Luton, Beds., England  
Spagnoletti, P. H., Kolster-Brandes, Ltd., Footscray, Sidcup, Kent, England  
Spandorfer, L. M., Res. Div., Moore School of Elec. Engrs., 20th So. 33rd St., Philadelphia, Pa.  
Spear, L. P., 2534 N. Granada St., Arlington, Va.  
Spencer, H. H., Bldg., 10-2 RCA Victor Div., Camden, N. J.  
Spencer, M. C., 105 Park Ave., East Orange, N. J.

(Continued on page 116A)

**YOU FURNISH THE PRINT, WE'LL FURNISH THE PART**

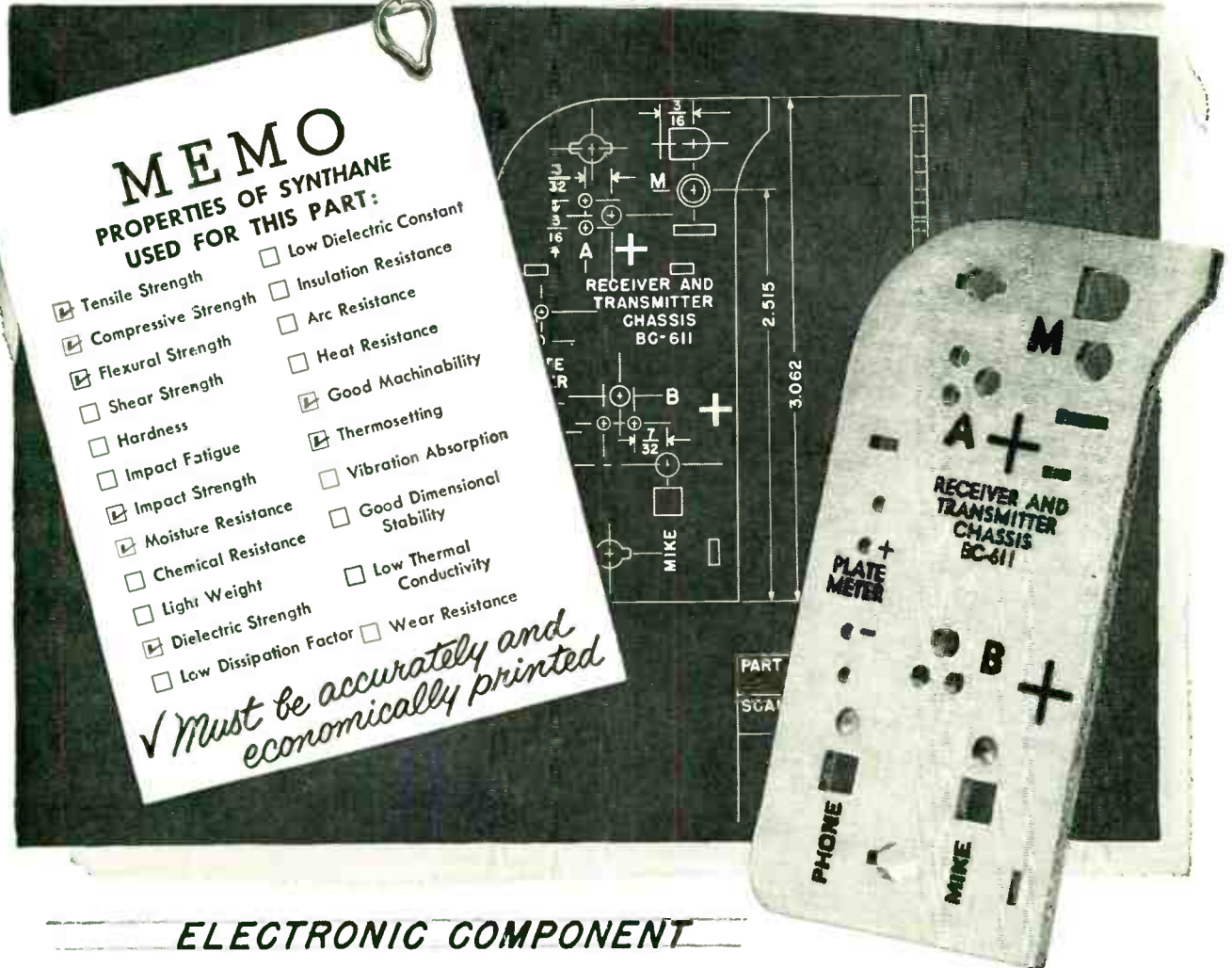

**MEMO**  
**PROPERTIES OF SYNTHANE**  
**USED FOR THIS PART:**

- Tensile Strength
- Compressive Strength
- Flexural Strength
- Shear Strength
- Hardness
- Impact Fatigue
- Impact Strength
- Moisture Resistance
- Chemical Resistance
- Light Weight
- Dielectric Strength
- Low Dissipation Factor
- Low Dielectric Constant
- Insulation Resistance
- Arc Resistance
- Heat Resistance
- Good Machinability
- Thermosetting
- Vibration Absorption
- Good Dimensional Stability
- Low Thermal Conductivity
- Wear Resistance

*Must be accurately and economically printed*

**ELECTRONIC COMPONENT**

**OF SYNTHANE HAS DURABILITY, DIMENSIONAL STABILITY,**

**DIELECTRIC STRENGTH**

Although this sturdy end plate will fit into the palm of your hand, it has in combination all the dielectric strength, the physical properties, and the printability the customer requires. It's made of *Synthane*, a laminated plastic, the same material used in hundreds of other electrical, mechanical, and chemical applications.

The blue print for this part calls for accurate machining, the punching of twenty holes of various shapes and sizes, and printing or engraving in three different colors. *Synthane* delivers finished parts exactly as specified, ready for the production line. The customer gets them promptly without problems of tooling up, waste, or rejects.

If you need components with many properties in combination, you will want to know more about *Synthane* laminates and the *Synthane* fabricating service. Send in the coupon for the full story.

**SYNTHANE CORPORATION, 8 River Road, Oaks, Pa.**  
 Please send my copy of the Synthane catalog.

Name \_\_\_\_\_  
 Title \_\_\_\_\_  
 Company \_\_\_\_\_  
 Address \_\_\_\_\_  
 City \_\_\_\_\_ Zone \_\_\_\_\_ State \_\_\_\_\_



**SYNTHANE CORPORATION • OAKS, PENNSYLVANIA**

Where  
accuracy is

**VITAL!**

**You Can  
Depend On ARC  
Test Equipment**



The Type H-14A Signal Generator has two uses: (1) It provides a sure and simple means of checking omnirange and localizer receivers in aircraft on the field, by sending out a continuous test identifying signal on hangar antenna. Tuned to this signal, individual pilots or whole squadrons can test their own equipment. The instrument permits voice transmission simultaneous with radio signal. (2) It is widely used for making quantitative measurements on the bench during receiver equipment maintenance.

The H-16 Standard Course Checker measures the accuracy of the indicated omni course in ARC's H-14A or other omni signal generator to better than 1/2 degree. It has a built-in method of checking its own precision.

Type H-12 Signal Generator (900-2100 mc) is equal to military TS-419/U, and provides a reliable source of CW or pulsed rf. Internal circuits provide for control of width, rate and delay of internally-generated pulses. Complete specifications furnished on request.



Type H-14A  
Signal Generator



Type H-16  
Standard Course Checker



Type H-12  
UHF Signal Generator

Dependable Airborne Electronic Equipment Since 1928

# Aircraft Radio Corporation

BOONTON, NEW JERSEY

Omni Receivers • 900-2100 Mc Signal Generators • UHF and VHF  
Receivers and Transmitters • 8-Watt Audio Amplifiers • 10-Channel  
Isolation Amplifiers • LF Receivers and Loop Direction Finders



Membership

(Continued from page 111A)

- Spergel, J., 412 Third Ave., Asbury Park, N. J.  
Spieker, L. J., 6000 Lemmon Ave., Dallas 9, Tex.  
Spielberg, A. M., 267 Crystal Terr., Haddonfield, N. J.  
Spinks, A. W., 4216 Knowles Ave., Kensington, Md.  
Spinner, L. N., 3867 Maywood Court, Cheviot 11, Ohio  
Spoor, T. A., Phillips Mexicana S. A., Calle Norte 44, No. 3612, Col Nochimanca-Atzacapotzalco, Mexico 16, D. F. Mexico  
Sprague, R. M., 76 Annawan Rd., Waban 68, Mass.  
Sprague, V. G., 31 Brunswick Rd., Montclair, N. J.  
Sproul, S., R.F.D. 1, Cato, N. Y.  
Sprunger, R. W., 809 S. Grove Ave., Oak Park, Ill.  
Squibb, W. F., 3910 Alicia Dr., San Diego 7, Calif.  
Squitieri, A., 70 Crest Rd., Merrick, L. I., N. Y.  
Sreb, J. H., 203 Elmira St., S.W., Washington 24, D. C.  
Stahl, M. D., Hoover Co., North Canton, Ohio  
Stahmann, J. R., 1827 Carl St., St. Paul 8, Minn.  
Stambaugh, D. W., 1528-28 St., Columbus, Ind.  
Stanton, G. V., 1257 Punta Way, Monterey Park, Calif.  
Stanton, R. S., 10747 Rochester Ave., Los Angeles 24, Calif.  
Stanton, S. W., Halsey Rd., East, Box 383, Parsippany, N. J.  
Stanwick, C. A., 131 Rynda Rd., South Orange, N. J.  
Starek, R. A., 412 Highview Ave., Elmhurst, Ill.  
Starks, W. H., 7203 Leonard St., Philadelphia 49, Pa.  
Starner, C. J., 314 Elm Avenue, Haddonfield, N. J.  
Staschover, L., 211-01-75 Ave., Bayside 64, L. I., N. Y.  
Stavitski, L. N., 3705-64 St., Woodside, L. I., N. Y.  
Steeb, E. C., Jr., 15 Groveland Ave., Buffalo 14, N. Y.  
Steele, E. R., 55 Harding Ave., Hathoro, Pa.  
Stein, E., 31-07 Garrison Terr., Fairlawn, N. J.  
Stein, S., 90 Day St., Clifton, N. J.  
Steinberg, W. A., 3756 Libby Lane, Levittown, L. I., N. Y.  
Steinhammer, H. T., 55 E. 93 St., New York, N. Y.  
Stensgaard, C. P., Jr., 240 S. Michigan Ave., Pasadena 5, Calif.  
Stephanz, G. H., 8 Lake Dr., Darien, Conn.  
Stephenson, J. O., 127 Dunbarton Rd., Baltimore, Md.  
Sterk, A. A., 198 Seminary Ave., Yonkers, N. Y.  
Stern, J. L., C.B.S. Engr., Dept., 485 Madison Ave., New York 22, N. Y.  
Sternick, L., 3451 Giles Pl., New York 63, N. Y.  
Stetson, H. T., 541 Lido Dr., Ft. Lauderdale, Fla.  
Stevens, W. J., 253 Governors Ave., Medford 55, Mass.  
Stewart, B. L., Insp. of Naval Material, 2300 Eleventh Ave., S.W., Seattle 4, Wash.  
Stewart, J. A., 23 Drake, Mount Kisco, N. Y.  
Stewart, W. A., 5816 Trojan Ave., San Diego 15, Calif.  
Stiles, M. G., 789 Prospect St., Maplewood, N. J.  
Stimmel, R. G., 141 Foxridge Dr., Dayton 9, Ohio  
Stoll, J. L., 1031 N. Lake St., Madera, Calif.  
Stoltz, G. F., 808 S.E., Riverside Dr., Evansville 13, Ind.  
Stone, W. R., 21 Horn Lane, Levittown, L. I., N. Y.  
Stonevic, V. R., 1342 Argyle, Chicago 40, Ill.

(Continued on page 118A)

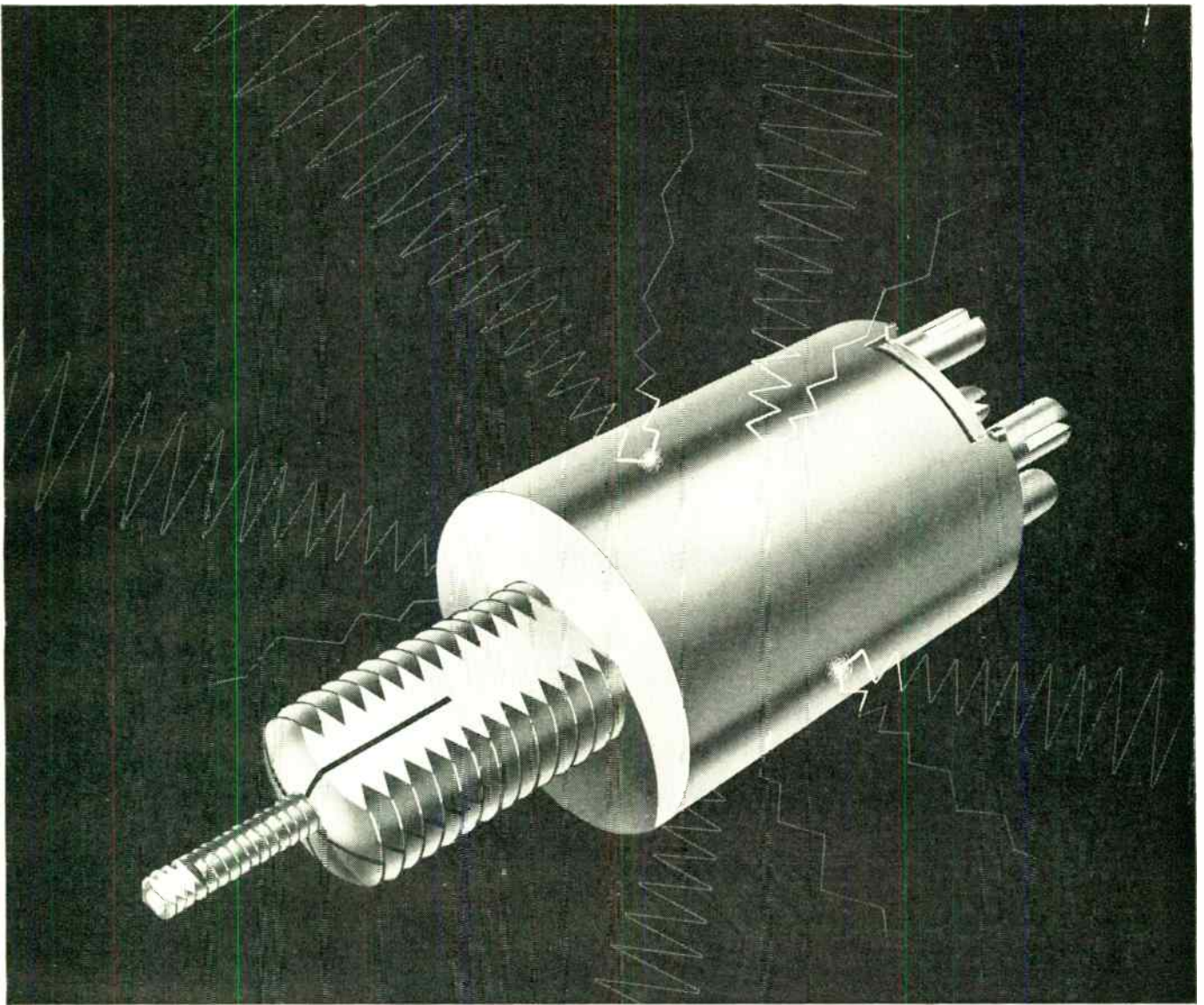

## Built for close "combat" in tight spots

Into the construction of this coil form goes C.T.C.'s rigid *quality control* to highest production standards.

The result is another C.T.C. *first* — a miniaturized coil form ( $\frac{1}{16}$ " diameter by  $\frac{1}{2}$ " high when mounted) that is shock-resistant and exceptionally rugged — shielded against radiation, electrically, and therefore ideal for "close quarter" use in I.F. strips and numerous designs where adjacent mounting is necessary.

C.T.C.'s policy of continuous step-by-step quality control in the manufacture of every component means guaranteed performance. Already certified materials are doubly checked before manufacture.

Whatever your component need — let C.T.C. solve your problem — with either custom or standard designs of *quality-controlled, guaranteed* components — including insulated terminals, coil forms, coils, swagers, terminal boards, diode clips, capacitors and a wide variety of hardware items.

Put your component problem up to

C.T.C. now. For samples, specifications and prices — write today to Sales Engineering Dept., Cambridge Thermionic Corporation, 456 Concord Ave., Cambridge, Mass. On West Coast, contact E. V. Roberts, 5068 West Washington Blvd., Los Angeles 16 or 988 Market St., San Francisco, California.

*Coil Form Data:* C.T.C.'s 1.3-9 coil form has a brass shell enclosing a powdered-iron cup-core, tuning slug, phenolic coil form and silicone fibreglas terminal board. Three terminal boards are available with choice of two, three or four terminal layout. Forms, unassembled, may be had *without windings . . . or wound and assembled to your specifications.*



*Capacitor:* New CST-50 variable ceramic capacitor surpasses range of capacitors many times its size. Stands only  $1\frac{1}{2}$ " high when mounted, is less than  $\frac{1}{4}$ " in diameter and has an 8-32 thread mounting stud. A tunable element of unusual design practically eliminates losses due to air dielectric giving large minimum to maximum capacity range (1.5 to 12MMFD).

**C T C**

**CAMBRIDGE THERMIONIC CORPORATION**

*makers of guaranteed electronic components,  
custom or standard*



# Best Way TO KEEP 6080 SIZE TUBES



**i. e. r. c.'s**  
**T-12**

Tube Shield Designed for Use in Severe Heat and Vibratory Environments greatly extends life of the larger, expensive tubes under all conditions! Effective cooling of bulb (up to 50%) makes the T-12 shield ideal for use in all equipment.

TECHNICAL BULLETIN T-12 is available by writing: Sales Dept., I. E. R. C., 177 W. Magnolia Blvd., Burbank, Calif.

## International



electronic research corporation

**PROVEN**  
*in missiles-*

**NOW**  
*in production*

*to meet*

*demands*

*for every*

*application!*



(Continued from page 116A)

- Storner, W. J., 2800--51 Ave., S.E., Washington 27, D. C.
- Stotz, C. C., 180 Pine St., Rockville Centre, L. I., N. Y.
- Stouse, L. E., Jr., 4233 E. Second St., Long Beach 3, Calif.
- Stout, E. R., 620 Clarendon Ave., Arlington Heights, Ill.
- Stovall, H. E., 3909 First Ave., N.E., Seattle, Wash.
- Stover, E. B., Jr., 2301 S. Florence Pl., Tulsa 5, Okla.
- Strain, C. E., 1298 Niles Ave., N.W., Atlanta, Ga.
- Strain, M., 61 Hickory St. Dumont, N. J.
- Strand, J., 3051 Geddes Ave., Ann Arbor, Mich.
- Straney, K. O., 20 Pearl St., Ext., Beverly, Mass.
- Streater, A. J., 120 Sylvan Dr., Broomall, Pa.
- Streich, R. J., Box 121, Inverness, Calif.
- Streifus, C. A., 2 Rector St., Rm., 930, New York 6, N. Y.
- Stribling, J. L., Jr., 2003 Columbus, Ft. Worth, Tex.
- Striker, R. G., 58 South Dr., Plandome, L. I., N. Y.
- Strobach, F., 106 Myrtle St., Suite 9, Boston 14, Mass.
- Stroble, R. R., 4715 Chestnut St., Bethesda 14, Md.
- Stroman, C. F., Officers Mail Sect., 814 Opns. Sq., Fairchild Air Force Base, Fairchild, Wash.
- Strother, J. E., Hq. AMC, Box 4195, Wright Patterson AFB, Ohio
- Strothers, H., 4111 33 St., S., Arlington, Va.
- Stroud, S. G., 3501 McBain Ave., Redondo Beach, Calif.
- Strull, G., 819 College Ave., Pittsburg 32, Pa.
- Stuart, R. M., 270 Ocean Ave., Marblehead, Mass.
- Stuber, Dr. R., Schlosslistr. 29, Zurich 14, Switzerland
- Stubner, J. W., 2116 Grove St., Glenview, Ill.
- Suarez-Flamerich, O., Qta. Mariaemma Ave., Valle Arriba, Caracas, Venezuela
- Subramaniam, C. R., Ass't Supt. Development, Techn. Devel. Estab., Sunderwala Camp, Dehra Dun, U.P., India
- Sukup, J. P., 4317 W. 99 Pl., Oak Lawn, Ill.
- Summers, G. C., 1447 Fleming Ave., Dallas 16, Tex.
- Summers, W. P., 1549 Glenwood Rd., Vestal, N. Y.
- Sunder, J. E., 320 Duckpond Dr., South Waukegan, L. I., N. Y.
- Sundquist, A., El. Engr., Stenkullavagen 45, Stora Essingen, Stockholm K. Sweden
- Sutton, G. L., Box 313 Griffiss AFB, Rome, N. Y.
- Sutton, J. G., Jr., 1524 E. Oak St., Phoenix, Ariz.
- Svedlow, J. D., 102-1121 Patrick Henry Dr., Falls Church, Va.
- Svihel, B. T., 940 Wyoming Ave., Croydon, Pa.
- Swain, R. R., 2324 General Bradley N.E., Albuquerque, N. M.
- Sweeney, W. R., 32 Wyatt Rd., Garden City, L. I., N. Y.
- Swindall, P. M., P.O. Box 682, Huntsville, Ala.
- Swire, B. E., 78 Arabella St., Longueville, N.S.W., Australia
- Synnamon, J. H., 255 Eberly Ave., Bowling Green, Ohio
- Taber, J. E., 2804 W. 163 St., Gardena, Calif.
- Tanck, H., 197 Wicks Lane, Malverne, L. I., N. Y.
- Tanigawa, G., Telechron Inc., Gen. Elec. Co., Ashland, Mass.
- Tanner, W. E., Bell Aircraft Corp., Buffalo 5, N. Y.

(Continued on page 120A)



## Our "In-Plant" Testing Facilities Can Save You Time and Money!

Our test equipment and services, set up to meet MIL-T-27, assure you of prompt approval and minimum delivery time.

We also have an experienced staff, an extensive research and measurement laboratory, and complete pulse magnetron test equipment. Thus, we can offer you top-quality transformers and expert assistance with your design problems.

Write for free literature

**ATLANTIC TRANSFORMER DIVISION**  
OF NEW LONDON INSTRUMENT COMPANY, INC.  
30 Hynes Ave., Groton 4, Conn.

Pioneer in Radio Engineering Instruction Since 1927

Accredited  
Technical  
Institute  
Curricula



# CAPITOL RADIO ENGINEERING INSTITUTE

Advanced Home Study and Residence  
Courses in Practical Radio-Electronics  
and Television Engineering

Request your free Home Study or  
Resident School Catalog by writing to Dept. 26 B9.

3224 16th St., N. W. Washington 10, D. C.

Approved for Veteran Training



# Styroflex Coaxial Cable

**CHOSEN FOR**

**WFMY-TV TRANSMISSION LINE!**



Station WFMY-TV in Greensboro, N. C., went on the air January 2, 1955, with a feed system consisting of two 3 $\frac{1}{8}$ " Styroflex cables. These cables are installed from the 25,000-watt transmitter, located approximately 200 feet from the footing of the tower, to the base of the antenna 658 feet above ground. The installation is an unusual one, as this photo shows.

Mr. William E. Neill, Chief Engineer of WFMY-TV, reports that the Styroflex cables are operating satisfactorily and are holding air pressure to the point where use of a dehydrator has not been necessary. The cables' performance, according to Mr. Neill, measures up to every expectation both electrically and mechanically.



***PHELPS DODGE COPPER PRODUCTS***  
**CORPORATION**

40 WALL STREET, NEW YORK 5, N. Y.

Designed for



Application



**The No. 90901  
One Inch  
Instrumentation Oscilloscope**

Miniaturized, packaged panel mounting cathode ray oscilloscope designed for use in instrumentation in place of the conventional "pointer type" moving coil meters uses the 1" ICPI tube. Panel bezel matches in size and type the standard 2" square meters. Magnitude, phase displacement, wave shape, etc. are constantly visible on scope screen.

**JAMES MILLEN  
MFG. CO., INC.**

MAIN OFFICE AND FACTORY  
**MALDEN  
MASSACHUSETTS**



**Membership**

(Continued from page 118A)

- Taris, C. M., 11 Adams Ave., Cranford, N. J.  
 Tasker, R., 7000 Lasane Ave., Van Nuys, Calif.  
 Taylor, E. R., Bell Tel. Labs., Murray Hill, N. J.  
 Taylor, E. S., Hedge Apple Lane, Wilmington, Del., RFD 1  
 Taylor, H. M., Jr., 411 W. Holmes, Huntsville, Ala.  
 Taylor, K. A., Bell Tel., 416 Seventh Ave., Pittsburgh 19, Pa.  
 Taylor, Malcolm, 6705 Sherwood Rd., Baltimore 12, Md.  
 Taylor, P. H., 224 Washington Ave., Chatham, N. J.  
 Temple, D. L., 600 Pelham Rd., Bldg. B., New Rochelle, N. Y.  
 Tenenbaum, E., 55 Plymouth Rd., Great Neck, L. I., N. Y.  
 Tennant, M. J., 2159 Five Mile Line Rd., Penfield, N. Y.  
 Teske, J. A., 115 Sheffield St., Silver Spring, Md.  
 Teslik, J. A., 3854 W. Van Buren, Chicago 14, Ill.  
 Thaxton, Herbert A., 4029 S. Acoma, Englewood, Colo.  
 Theobald, D. J., 5450 Linda Rosa, La Jolla, Calif.  
 Theofil, D. V., 637 Fifth St., Ann Arbor, Mich.  
 Thille, R. W., 1 Wood St., Apt. 7, San Francisco 18, Calif.  
 Thomas, E. R., 245 Maple St., Englewood, N. J.  
 Thomas, M. E., 575 'P' St., Idaho Falls, Idaho  
 Thomas, R. R., Jr., Radio Sta. W.O.A.Y., Oak Hill, W. Va.  
 Thomas, T. R., 14834 Coyle Ave., Detroit 27, Mich.  
 Thomson, B., Jr., 814 1/2 N. Madison, Pasadena 6, Calif.  
 Thompson, D. C., 30 Cleveland Rd., Waltham 54, Mass.  
 Thompson, G. L., 7104 Flight Ave., Los Angeles 45, Calif.  
 Thompson, J. F., 27 N. Fernwood Dr., Rockledge, Fla.  
 Thompson, J. E., 1140 W. 17 St., Chicago 9, Ill.  
 Thomson, E. C., 55 Livingston Rd., Wellesley 82, Mass.  
 Thurensen, R., 11420 Bolas St., Los Angeles 49, Calif.  
 Thrasher, P. M., Jr., 1612 Eastman Dr., Falls Church, Va.  
 Thunen, G. W., Box 182, Orinda, Calif.  
 Thurston, E. G., 2433 N. Belvoir Blvd., Cleveland 21, Ohio  
 Tibbetts, G. C., Colcord Ave., Camden, Maine  
 Tillotson, J. G., 2532 Place De Monceau, Apt. 5, Silley P.Q., Canada  
 Tilton, D. S., 27 Pennacook St., Manchester, N. H.  
 Timineri, A. A., 318 Lenox Dr., Dayton 9, Ohio  
 Tingley, E. M., Jr., 383 Elm St., Glen Ellyn, Ill.  
 Tipton, C. D., Rt. 3, Box 26912, Austin, Texas  
 Tittle, H. C., 81 Rose Hill Way, Waltham 54, Mass.  
 Tobin, M. W., 58 02-251 St., Little Neck, L. I., N. Y.  
 Tobler, C. R., 20 Sutton Pl., Verona, N. J.  
 Tongue, B. H., 526-536 N. Ave., Westfield, N. J.  
 Torian, J. T., 88-11-34 Ave., Jackson Heights, L. I., N. Y.  
 Tourshon, S., 1716 Spring Garden St., Philadelphia 30, Pa.  
 Trachtenberg, R., 401 Graisbury Ave., Haddonfield, N. J.  
 Trapp, R. R., 320 W. Franklin St., Taylorville, Ill.

(Continued on page 121A)

AMERICAN TELEVISION & RADIO CO. ST. PAUL, MINN.

introduces the  
**new**

**ATR TV**

Full Door Console  
Receiving Sets

UNSURPASSED  
IN BEAUTY

UNEQUALLED  
IN PERFORMANCE

UNMATCHED IN  
QUALITY  
CONSTRUCTION

exclusive  
profitable  
dealer  
franchises  
now available



designed  
with the  
Serviceman  
in mind  
... easy to  
get at



WRITE TODAY FOR COLORFUL  
BROCHURE SHOWING THE  
NEW LINE OF ATR TV SETS

ALSO MANUFACTURERS OF DC-AC INVERTERS,  
"A" BATTERY ELIMINATORS, AUTO RADIO VIBRATORS

**ATR** AMERICAN TELEVISION & RADIO CO.  
Quality Products Since 1931  
SAINT PAUL 1, MINNESOTA-U. S. A.



## Membership

(Continued from page 120A)

- Trinter, V. E., 2808 Echdale Ave., Baltimore 14, Md.
- Trotter, B. E., 3110 First St., N., Arlington, Va.
- Truscott, D. N., 58 Oxford Rd., Birmingham 13, England
- Tuckerman, L. S., 317 E. 87 St., New York 28, N. Y.
- Tunncliffe, W. W., 11 Orient St., Winchester, Mass.
- Turner, A. H., 202 Burrwood Ave., Collingswood 7, N. J.
- Turner, A., 160 Gaylor Rd., Scarsdale, N. Y.
- Tuttle, L., 1131 Ashburton St., Baltimore 16, Md.
- Tutty, J. E., 56 Jefferson St., Belleville, N. J.
- Tykulsky, A., 551 Wales Ave., New York 55, N. Y.
- Ulmer, R. M., 2207 Campus Rd., Beachwood 21, Ohio
- Umbach, L., Jr., 21 Olive St., Youngstown 1, Ohio
- Urey, G. M., 934 N. Orlando Ave., Hollywood 46, Calif.
- Vacca, L. N., 7 Meadowbrook Lane, Vestal, N. Y.
- Valera, M. F., 14 Ben Oaks Dr., W., Millersville, Md.
- Vallarino, A. R., E. Saddle River Rd., Allendale, N. J.
- Vallarino, A. D., Casilla 1753, Santiago De Chile
- Vanacore, T., 151 Tulane Rd., Kenmore 17, N. Y.
- Vance, D. H., RD 1, Crooked Lane, Moorestown, N. J.
- Van Doeren, C. A., Peace Haven Rd., Winston-Salem, N. Car.
- Van Every, A., 1017 S. California, Albuquerque, N. Mex.
- Van Meter, J. L., 4298 Highview Ave., Baltimore 29, Md.
- Van Name, J. M., 1506 E. Walnut Lane, Philadelphia, Pa.
- Vasilevskis, H. S., Tioga & C Sts., Philadelphia 34, Pa.
- Vaughan, V., 3836 Pukalani Pl., Honolulu, T. H.
- Veazie, E. A., Bell Tel. Labs., Murray Hill, N. J.
- Vehling, R. H., 60 Hudson St., New York 13, N. Y.
- Vendeland, R. N., 610 Fourth St., Riverton, N. J.
- Verkeley, Bernard M., 3768 Hubble Rd., Cincinnati 24, Ohio
- Vetter, William F., 43 Sprucewood Dr., Levittown, L. I., N. Y.
- Viales, Lionel O., 2332 Cedar St., Berkeley 8, Calif.
- Vilas, Edward T., Box 491, Silver Spring, Md.
- Vogel, H. O., U.S.S. Rehoboth, c/o F.P.O., New York, N. Y.
- Vogel, W. H., Jr., 59 Crane St., Caldwell, N. J.
- Von Dohlen, H. W., 1701 Preston Rd., Alexandria, Va.
- Vore, M. P., c/o Westinghouse Elec. Corp., Baltimore 3, Md.
- Vulliet, P. O., Rt. 2, Box 870, Bremerton, Wash.
- Waer, R. R., 49 Daily St., Nutley, N. J.
- Wagner, F. C., 16219 Tonkaway Rd., Wayzata, Minn.
- Walden, G. R., 3804 Fulton St., N.W., Washington 7, D. C.
- Wales, R. O., 301 Vierling Dr., Silver Spring, Md.
- Walkup, L. A., 4904-14 Ave., S., Minneapolis 17, Minn.
- Wall, V. W., 10058 Lesterford Ave., Downey, Calif.
- Wallace, Bert E., Jr., 7509 Far Hills Dr., Towson 4, Md.
- Wallace, Don C., Bendix Bldg., 1206 Maple Ave., Los Angeles 15, Calif.

(Continued on page 122A)

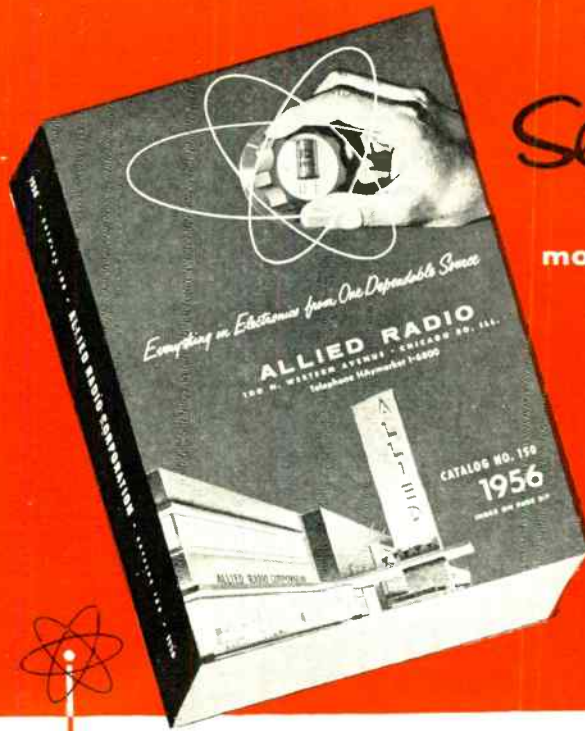

Send for the

most widely used

Electronic  
Supply  
Guide

**free**  
on request

## ALLIED'S 1956 324-PAGE CATALOG

World's largest Stocks OF

**ELECTRONIC SUPPLIES FOR INDUSTRY**

Here's how to simplify and speed the purchasing of *all* your electronic supplies and equipment: send your orders to ALLIED—the reliable one-supply-source for all your electronic needs. We make fastest shipment from the world's largest stocks of electron tubes (all types and makes), transistors, test instruments, audio equipment, electronic parts (transformers, capacitors, controls, etc.) and accessories—*everything* for industrial and communications application, for research, development, maintenance and production. Our expert Industrial supply service saves you time, effort and money. Send today for your FREE copy of the 1956 ALLIED Catalog—the *complete* Buying Guide to the world's largest stocks of quality Electronic Supplies for Industrial and Broadcast use.

ultra-modern facilities  
for the fastest service  
in Electronic Supply



one complete  
dependable source for  
everything in electronics

## ALLIED RADIO

100 N. Western Ave., Dept. 35-7-5 Chicago 80, Illinois



## MODERN WAVE ANALYZER

MODEL 21

A step forward in Wave Analyzer design. Identifies and evaluates harmonic or other components of input signal voltages. New design offers wide frequency range from 30 to 50,000 cps and full scale voltage readings of 160 microvolts to 500 volts. Amplitudes of subsidiary components are indicated directly as percentages of the component with highest level — \$445.

# ADVANCED INSTRUMENTATION



## WOW AND FLUTTER METER

MODEL 28

An all new instrument for measuring phenomena that can be expressed as frequency or phase modulation of an audio frequency. Completely portable. Meets all applicable requirements of the IRE, SMPTE and ASA — \$295.

# DONNER SCIENTIFIC COMPANY

2829 7th Street, Berkeley 10, California  
all prices f.o.b. Berkeley, California

Write for specification sheets on the above instruments and  
the complete Donner line of advanced instrumentation



(Continued from page 121A)

- Wallace, Robert M., 2921 Cherrywood, Dallas 19, Tex.
- Wallenstein, J. P., 89 Shephard Ave., Newark 8, N. J.
- Walsh, J. V., 501 E. 234 St., Apt. 4E, New York 66, N. Y.
- Walter, G. W., 4425 Main St., Kansas City, Mo.
- Walters, Andrew W., National Bur. of Standards, Corona, Calif.
- Wamboldt, H., 601 Meyer Ave., Dayton 3, Ohio
- Wang, C. S., 1205 Eudora St., Denver 20, Colo.
- Ward, D. M., 2926 Balboa Ave., San Diego 9, Calif.
- Warnick, A., 12752 Memorial, Detroit 27, Mich.
- Warren, M., Jr., Box 465, Alcoa, Tenn.
- Washburn, C. A., Andria Lane, Thornwood, N. Y.
- Waserman, J., 760 Bronx River Rd., Bronxville, N. Y.
- Wasson, I., 8 Scooter Lane, Hicksville, L. I., N. Y.
- Waterman, P., Naval Research Lab., Anacostia Sta., Washington 25, D. C.
- Watson, R. H., 3741 Narragansett, San Diego 7, Calif.
- Watterberg, J., 1227 Garcia, N.E., Albuquerque, N. Mex.
- Wayer, C. F., Jr., Star Rt., Box 2805, Spenard, Alaska
- Weaver, A., 463 W. St., New York 14, N. Y.
- Webb, R. H., c/o Sperry Products Co., Shelter Rock Rd., Danbury, Conn.
- Weber, J. W., 8819 1/2 Belford Ave., Los Angeles 45, Calif.
- Weber, M. E., 1933 Santa Rose, Houston 23, Tex.
- Weeks, G. E., Bell Tel. Labs., Inc., Whippany, N. J.
- Wehner, G. L., Olive Rd., Box 385, RR 10, Dayton, Ohio
- Weidemann, H. K., 26 Chesapeake St., N.W., Apt. 5, Washington 24, D. C.
- Weidknecht, C. J., Jr., 1611 Rounfort Rd., Philadelphia 19, Pa.
- Weiler, G., 1429 E. Monroe, South Bend, Ind.
- Weill, A. E., 1229 Blanchan Ave., La Grange Park, Ill.
- Weinberg, D., 7087 E. Glenmeadow Lane, Cincinnati 37, Ohio
- Weingarten, J., 114 Farnham St., Belmont 78, Mass.
- Weinstein, A., Box 478, RFD 5, Alexandria, Va.
- Weinstein, G., 5251 Pullman Ave., Seattle 58, Wash.
- Weinstein, M. S., 1408 Langley Way, Hyattsville, Md.
- Weise, D., WTTW-TV, 38 S. Dearborn St., Chicago 3, Ill.
- Weiss, L. M., 857 Crotona Pk., N., Bronx 60, N. Y.
- Welan, I., Hillside Ave., Spring Valley, N. Y.
- Welch, H. E., 3301 Kensington Way, Stockton, Calif.
- Welker, John J., 2553 N. Mason Ave., Chicago, Ill.
- Wellman, B., Box 88, Lincoln, Mass.
- Wells, W. M., 3222 Ibsen St., San Diego 6, Calif.
- Wells, W. S., 1207 Ryan Ave., St. Paul 13, Minn.
- Wendt, R. H., 624 Garret Pl., Evanston, Ill.
- Wengryn, M., 248-11-87 Dr., Bellerose, L. I., N. Y.
- Werman, H. M., 1014 E. 24 St. Brooklyn 10, N. Y.
- West, J. L., 7 Edwards St., Binghamton, N. Y.
- Westbom, A. C., Jr., 16 Circuit Rd., Westwood, Mass.
- Westenhaver, J. L., Hughes Aircraft Co., Florence & Teale Sts., Culver City, Calif.

(Continued on page 124A)

# MEASURES IN NUMBERS

## ...NOT VOLTS!

### For FM/FM Telemetry and Multiplexing Systems

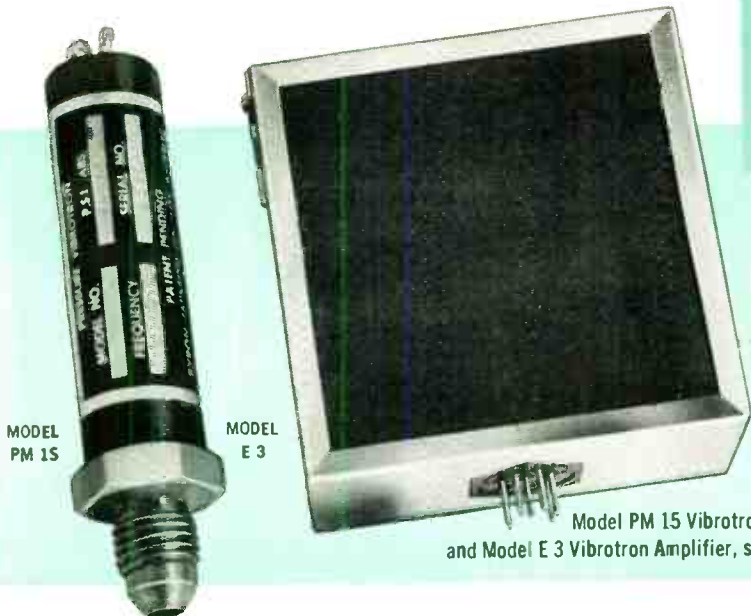
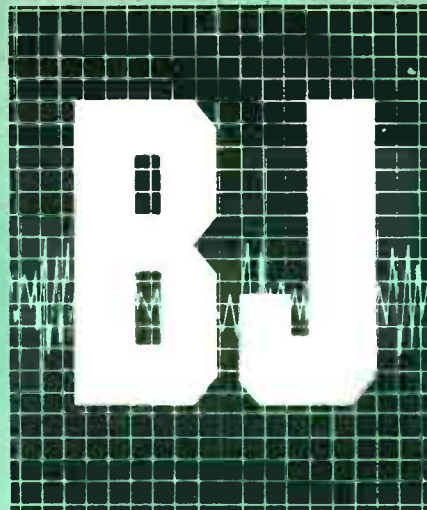

# vibrottron

## DIGITAL PRESSURE GAGE

Model PM 15 Vibrotron Pressure Gage  
and Model E 3 Vibrotron Amplifier, shown actual size

Accurate enough to fit into any telemetry system that requires precise measurement of static or dynamic pressure... and small enough to fit into the palm of your hand... Byron Jackson's new Vibrotron Pressure Gage sets a new standard of accuracy by measuring in numbers, not volts!

**ACCURATE AND RELIABLE** Standard Vibrotron Gages provide accuracies to .1% under the temperature and pressure conditions encountered from sea level to 75,000'.

**DIRECT AND SIMPLE** Utilization of the vibrating wire principle which directly produces a subcarrier frequency eliminates subcarrier oscillators and consequent drift and inaccuracy. The direct digital information is easily handled by tape recording and data handling systems.

**VERSATILE AND STABLE** For altitude measurements, the standard Vibrotron Gages will resolve 60' at sea level. Special gages that cover 0-1 psi absolute ranges or less are also available for better resolution. For air speed measurements, a variety of differential gages have been developed to measure the wide ranges of speeds needed for aircraft and missile work. For pressure measurements, corrosion-resistant gages are being supplied to measure static or dynamic pressure of virtually any medium including fuming acids.

Available in eight pressure ranges from 0-3 psi to 0-2000 psi and in the following RDB Channels.

| CHANNEL | CPS   | % DEVIATION    |
|---------|-------|----------------|
| 8       | 3000  | ±7½%           |
| 9       | 3900  | ±7½%           |
| 10      | 5400  | ±7½%           |
| 11      | 7350  | ±7½%           |
| 12      | 10500 | ±7½%           |
| 13      | 14500 | ±7½%           |
| 14      | 22000 | ±7½%<br>or 15% |
|         | 40000 | ±15%           |
|         | 70000 | ±15%           |



# Byron Jackson Co.

ELECTRONIC DIVISION

492 EAST UNION STREET • PASADENA 1, CALIF. • RYAN 1-5166

PACEMAKER IN PRECISION ELECTRONICS

**WRITE TODAY** for complete specifications and information on how Byron Jackson engineers can work with you on (1) application of standard Vibrotron models to your measurement problems; (2) special Vibrotron development; and (3) design of complete systems.

70 mm.

for  
one

millivolt

yet drift-free



TYPE M

## THE OFFNER DYNOGRAPH

0.001 volt input d-c gives 70 mm. deflection with this high-speed direct writing oscillograph, many times that for competitive units. The Dynograph with one amplifier is used for all types of inputs for measuring speed, temperature, position, vibration, and other variables. Patented, chopper amplifier design makes it sensitive, stable, and versatile. Available in both 6 channel console model and single and dual channel portable models. Get bulletin L742—compare the Dynograph with all competitive models—it combines sensitivity with absolute stability.



Get bulletin L742—compare the Dynograph with all competitive models—it combines sensitivity with absolute stability.

**OFFNER  
ELECTRONICS INC.**

5328 N. Kedzie Avenue  
Chicago 25, U.S.A.



(Continued from page 122A)

- Westman, H. P., Jr., 55 Arleigh Dr., Albertson, L. I., N. Y.
- Whannel, R. L., R.F.D. 1, Oakdale, Conn.
- Wheat, Wilson M., Box 266, MPO, Springfield, Mo.
- Wheeler, Randolph B., 130 La Rue Dr., Huntington, L. I., N. Y.
- White, A. D., Woodridge Rd., Wayland, Mass.
- White, E. A., 1204 Delta Blvd., Ft. Wayne 3, Ind.
- White, J. A., Box 1230, Williamstown, Mass.
- White, J. R., 33 Hidden Lane, Westbury, L. I., N. Y.
- Whiting, Webster K., 604 Woodlawn Ave., Falls Church, Va.
- Whitney, D. J., 41 Gabb Rd., Bloomfield, Conn.
- Whittaker, H. F., Jr., 32 Essex St., Lynn, Mass.
- Widenor, M. D., 19 Greely Sq., Glen Head, L. I., N. Y.
- Widmann, F. W., 15 Roberts Ave., Haddonfield, N. J.
- Wier, J. M., 904 S. Wabash, Urbana, Ill.
- Wiesner, L., 118—65 Metropolitan Ave., Kew Gardens, L. I., N. Y.
- Wild, J. H., 1224 Ransom St., Sandusky, Ohio
- Wild, J. J., 7 Overhill Lane, Roslyn, L. I., N. Y.
- Wilkinson, D. A., 777—14 St., N. W., Washington, D. C.
- Willard, J. M., 5205 Eight Rd., So., Arlington 4, Va.
- Willard, R. S., Jr., 40 Kaihola Pl., Lanikai, Oahu, T. H.
- Willett, E., 447 Tenth Ave., New York 1, N. Y.
- Williams, C. E., 1517 Piedmont Ave., Austin, Tex.
- Williams, C. H., 2031—34 St., S.E., Washington 20, D. C.
- Williams, C. S., 5010 Kimball, Kansas City 4, Kan.
- Williams, J. T., 145 Calbin Ave., Evanston, Ill.
- Williams, R. J., 111, Greene Rd., Berwyn, Pa.
- Williams, R. W., 4800 Oak Grove Dr., Pasadena, Calif.
- Williams, S. B., 4847 N. 41 St., Milwaukee 9, Wis.
- Williamson, C. R., 85 E. Columbus Ave., White Plains, N. Y.
- Williamson, J. C., 205 Brow St., Liverpool, N. Y.
- Williamson, R. J., 136 Esperanza Ave., Sierra Madre, Calif.
- Willis, F. H., Bell Tel. Labs., New York 14, N. Y.
- Willner, P., 499 Fort Washington Ave., New York, N. Y.
- Willson, F. E., 463 West St., New York 14, N. Y.
- Wilmot, R. D., Kirk's Ferry, Ottawa, P.Q., Canada
- Wilson, C. A., 1612 Cody Dr., Silver Spring, Md.
- Wilson, H. R., 236 S. Lynnwood Ave., Glenside, Pa.
- Wilson, R. E., Radio Corp. of America, Camden, N. J.
- Wilts, J. R., 447 Mesa Way, La Jolla, Calif.
- Winchester, D. S., Box 89, Baldwinsville, N. Y.
- Wingate, Sidney A., 8 Gray St., Cambridge, Mass.
- Winget, William F., 2342 Commonwealth Ave., St. Paul 8, Minn.
- Winkle, La Verne, 1270 Prospect Pl., Cincinnati 31, Ohio
- Winkler, M. R., 5225 N. 20 St., Phoenix, Ariz.
- Winter, Harold F., Mountain Ave., Murray Hill, N. J.
- Withrow, W. E., 4803 Ravenswood Rd., Riverdale, Md.
- Wittenberg, R. C., 136 Pine St., New Hyde Pk., L. I., N. Y.
- Wittig, William L., 2519 S. Walter Reed Dr., Arlington 6, Va.

(Continued on page 125A)

## VHS\* RELAY

(\*Very High Sensitivity)



### Model 266

Sample specs. are:  
0.2 micro-ampers, (12,000 ohms coil) or, 0.1 millivolts, (5 ohms.)



• The VHS is a balanced armature, Alnico magnet type relay. It is internally shock-mounted and resistant to vibration. The screw-on cover is gasket sealed. It can be opened and resealed.

Connections: 9 pin octal style. Dimensions: 1 1/4" diameter x 2 1/4" long. Weight: 4 ounces. Sensitivity: Infinite variations from 0.2 Ua. to 10 Amp. or 0.1 Mv. to 500 volts, self contained. Higher volts or amps with external multipliers. A.C. rectifier types. Trip point accuracies to 1%. Differential 1%. The degree of resistance to shock and vibration primarily depends upon sensitivity and type of action wanted. In general, the relays will not be permanently damaged by shocks of 100 G's and vibrations up to 2,000 cps at 4 G's. The most sensitive relays may close their contacts under these conditions.

Contacts: SPST or SPDT, 5-25 Ma. D.C. Other ratings to 1/2 Amp. A.C. A locking coil gives high pressure and chatter free contact under shock and vibration.

Prices: \$20 - \$80.

Delivery 4 to 6 weeks.

Assembly Products, Inc.,

Chesterland 2, Ohio.

Booth A-150, Instrument Show,

Sept. 12-16, Los Angeles

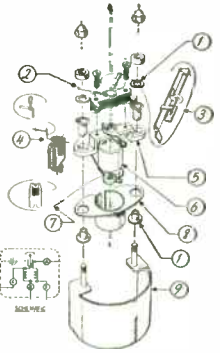

Write for explanation of symbols

Designers  
Manufacturers  
Of

**PLASTIC LIGHTING  
PANELS and DIALS**

Specialists  
In The  
**INTEGRAL LIGHTING  
OF INSTRUMENTS**

Authorized  
**LIGHT TESTING  
Facility of Bu-Air**

**BODNAR INDUSTRIES**  
238 Huguenot St.  
New Rochelle, N.Y.

(Continued from page 124A)

- Wohl, C. J., 44-21 Macnisi St., Elmhurst 73, L. I., N. Y.
- Wolf, A. A., 7131 Cedar Park Ave., Philadelphia 38, Pa.
- Wolf, E. W., 19 Robinson Rd., Lexington, Mass.
- Wolf, F. E., Jr., 161-03-65 Ave., Flushing, L. I., N. Y.
- Wolfe, D., 905 Manor Rd., Falls Church, Va.
- Wolfe, C. M., 820 E. Bennett, Glendora, Calif.
- Wolken, I. L., 6307 N. Francisco Ave., Chicago 45, Ill.
- Wong, G. W., 66 University Rd., Brookline 46, Mass.
- Wood, Frederick B., 1152 Hedding St., San Jose, Calif.
- Wood, R. M., Jr., 13 Gibson Rd., Hampton, Va.
- Wood, R. F., Bear Rd., N. Syracuse, N. Y.
- Woodruff, A. E., 312 N. Parkside, Chicago, Ill.
- Woodruff, R. L., 86 Concord St., San Francisco 12, Calif.
- Woods, O. R., 301 Henrietta St., Kalamazoo, Mich.
- Woods, W. A., 255 Waterview St., Playa Del Rey, Calif.
- Woodward, W. E., 5002 S.E., 122 St., Portland 66, Ore.
- Woodyard, J. R., University of California, Berkeley, Calif.
- Worthen, G. B., 2630 Kingsbridge Terr., Bronx, N. Y.
- Wrathall, G. R., Rt. 2, Box 260, Aptos, Calif.
- Wright, C. R., 207 St. L., Mishawaka, Ind.
- Wright, D., 1420 Opechee Way, Glendale 8, Calif.
- Wright, D. S., 86 Brook Rd., Red Bank, N. J.
- Wright, J. W., 5504 Grove St., Chevy Chase, Md.
- Wright, R. B., 4607 Connecticut Ave., N.W., Washington, D. C.
- Wright, T. A., Highland Pk., Village, Dallas, Tex.
- Wurman, G., 318 E. Walnut St., Long Beach, L. I., N. Y.
- Wycoff, K. H., Rt. 1, Overton, Nebr.
- Wyeth, F. H., 4901 Stenton Ave., Philadelphia 44, Pa.
- Yang, T., Remington Rand Inc., Philadelphia, Pa.
- Yaplee, B. S., 4219-Fourth St., S.E., Washington 20, D. C.
- Yarbrough, A. D., 3513 Stanford St., Dallas 5, Tex.
- Yeager, J. R., Queens Village, L. I., N. Y.
- York, E., Jr., 1094 S. King St., San Gabriel, Calif.
- Young, A. F., Rt. 2, Box 474-A, Severna Pk., Md.
- Young, J. W., Box 407, Fort Amador, Balboa, Canal Zone
- Young, M. F., Box 1142, Honolulu, T. H.
- Young, W. E., Hq. Fifth Air Force, Box 544, APO 710, c/o P.M., San Francisco, Calif.
- Youngblood, W. A., M.I.T., Cambridge 39, Mass
- Younger, U. E., 3202 E. Foothill Blvd., Pasadena 8, Calif.
- Youngstrom, N. C., Seven E. Cedar Lane, Maplewood, N. J.
- Youtz, P., 211 Massachusetts Ave., Cambridge 39, Mass.
- Yu, Y. P., 451 Highland Ave., Passaic, N. J.
- Zablocki, H. S., 30 Grove Terr., Irvington, N. J.
- Zancanata, H. W., R.F.D. 2, Aberdeen, Md.
- Zayac, F. R., Rockaway Dr., R.D. 2, Boonton, N. J.
- Zebrowitz, S., 2220 Pine St., Philadelphia 3, Pa.
- Zeiger, L. B., 4515-12 Ave., Brooklyn 19, N. Y.
- Zenon, Z., 27 Lincoln Dr., Box 363, N. Syracuse, N. Y.
- Zern, R. T., 2972 Second St., Norristown, Pa.

(Continued on page 126A)

# Don't DO IT YOURSELF...

let **ERIE** TRADE MARK

## BUILD YOUR ELECTRONIC AND MECHANICAL CUSTOM ASSEMBLIES

ERIE has the unique combination of facilities for producing electronic components, molded plastic parts, metal stampings and embossed wiring boards, for Electronic and Mechanical Custom Assemblies. Such assemblies are essential in the design of Computers, Business Machines, Automatic Industrial Controls, Electronic Organs, Communication Equipment, Guided Missiles and Ordnance Materiel.

A definite trend has been toward unitized assemblies that help speed production and insure a minimum of down time on end use equipment. Through research, design and actual production of component packaging for a number of years, ERIE has kept pace with this fast growing industry. By subcontracting certain basic assemblies to ERIE, you, the manufacturers, can devote more of your engineering time to the design of new equipments and development of end use systems, and save on your final unit costs.

The Electro-Mechanical Division of Erie Resistor will welcome the opportunity to consult with you on the possible economies to be gained through the use of ERIE assemblies.

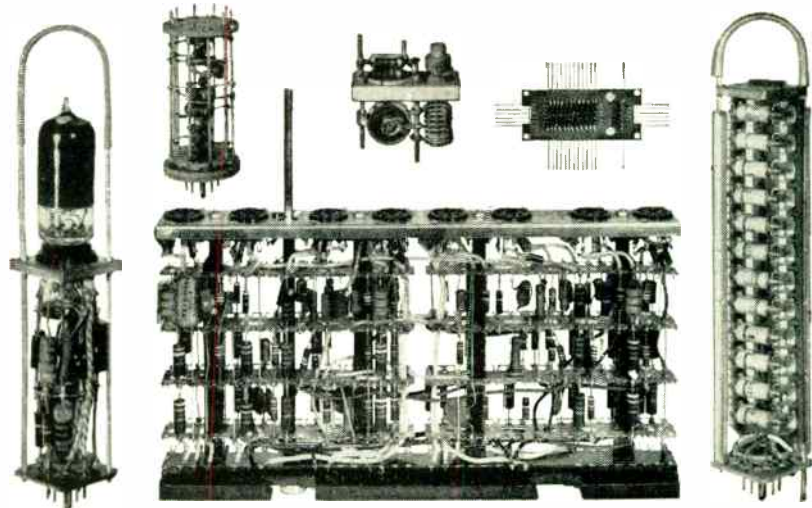

### Typical ERIE Electronic and Mechanical Assemblies

- Pluggable and Modular Units
- Unitized Multiple Component Networks
- Transistorized Assemblies and Assemblies for Military Use
- Memory Matrix Devices
- Panel Wiring and Cabling



**ERIE ELECTRO-MECHANICAL DIVISION**  
**ERIE RESISTOR CORPORATION**  
 Main Offices: ERIE, PA.  
 Factories: ERIE, PA. • LONDON, ENGLAND • TRENTON, ONTARIO

FOR SCIENCE and INDUSTRY

# Electro-Pulse PRECISION PULSE GENERATORS

- 10 CPS to 100 KC
- Calibrated Duration and Delay
- Block Unitized Construction

FAST RISE TIME

...LOW IMPEDANCE



Model 2120A

An extremely versatile instrument for the generation of accurately controlled test pulses—also provides gate pulses, neg. triangles, and five sync. pulses in each cycle. Ideally suited for: Computer Development...Radar Test...Fuse and Relay Research...Pulse Modulation...Transient Response Studies... General Pulse Circuit Development.

- 10 CPS to 100 KC Rep. Rate • 0 to 10,000  $\mu$ s Delay
- .1 to 1,000  $\mu$ s Pulse Width • 80 V Amplitude (open circuit) • 93 Ohms Internal Impedance • .02  $\mu$ s Rise Time
- Twin Pulse or Advanced Pulse Connection

Write for Complete Data: Our Bulletin 2120A/1



Model 1310A LONG TIME DELAY GENERATOR

The Model 2120A Pulse Generator is one of a series of Electro-Pulse precision instruments. Others: Analog and Digital Time Delay Generators, Pulse Oscillators, Magnetic Core Testing Equipment, and Variable Pulse Generators.

Representatives in Major Cities

**EP** Electro-Pulse, Inc.

11861 TEALE STREET, CULVER CITY, CALIFORNIA  
Telephones: EXmont 8-6764 and TExas 0-8006



(Continued from page 125A)

- Zieman, C. M., 2293 Hazelton Ave., Dayton 3, Ohio  
Zilis, G. S., 6742 S. Artesian Ave., Chicago 29, Ill.  
Zimmerman, C. W., 3526 E. Haskell Pl., Tulsa, Okla.  
Zimmerman, L., 1950 N. River Rd., Melrose Pk., Ill.  
Zimmerman, R. L., 17122 Osborne, Northridge, Calif.  
Zuckerberg, H., 67-30 Dartmouth St., Forest Hills, L. I., N. Y.  
Zuckerbraun, J., 2260 Olinville Ave., New York, N. Y.

### Admission to Member

- Adams, J. E., Box 138, North Bay, N. Y.  
Adams, R., Suite 1, 38 Home, Winnipeg 10, Man., Canada  
Baron, J., 3 Rue J. R. Bloch, Sartrouville (S&O) France  
Barre, W. E., Sylvania Electric Products, Inc., 12 Second Ave., Warren Pa.  
Bateman, F. E., 2500 Morton St., Charlotte, N. C.  
Bly, J. R., 4831 Angeles Crest Hwy., La Canada, Calif.  
Bower, C. M., Air Associates, Inc., 511 Joyce St., Orange, N. J.  
Callahan, A. L., U.S. Embassy, APO 928, c/o P.M., San Francisco, Calif.  
Chaudhuri, D., 500 Riverside Dr., New York 27, N. Y.  
Chu, Y., 9402 Allen Rd., Allert Park 10, Mich.  
Cleveland, A. R., 11413 Lanewood Cir., Dallas, Tex.  
Cook, M. E., 534 Baeder Rd., Jenkintown, Pa.  
Cory, W. E., 254 Shrine, San Antonio, Tex.  
Durage, A. H., 70 Wootton Rd., Essex Falls, N. J.  
Farrell, J. W., 1536 San Saba Dr., Dallas 15, Tex.  
Gerrish, C. R., 8008 W. Davis St., Dallas Tex  
Gladstone, H., 152 W. 58 St., New York 19, N. Y.  
Goris, E. N., 212 N. Viches St., Los Angeles 54, Calif.  
Graves, C. J., 2865 Thornhill Dr., Mobile, Ala  
Halstead, W. R., Southern Technical Institute, Chamblee, Ga.  
Herrick, T. A., Jr., 3615 Brayton Ave., Long Beach 7, Calif.  
Hogan, J. C., Electrical Engineering Dept., University of Missouri, Columbia, Mo.  
Horelick, D., 1508 S. Negley Ave., Pittsburgh, Pa.  
Howe, P. R., 65 Kendall Rd., Colchester, Essex, England  
Jaffe, H., 239 Newman St., Metuchen, N. J.  
Johns, S. E., Jr., c/o Bird Well Surveys, 21 Holley Ave., Bradford, Pa.  
Kim, B., Box 530, 3337 Tech. Tag Sq., Scott A.F.B., Ill.  
Kozak, W. S., Box 75, Cumberland, Ont., Canada  
Leblond, A. F., 23 Rue de Maroc, Paris 19, France  
Madsen, J. F., AC/S Materiel Hq., 12th Air Force, APO 12, New York, N. Y.  
Mahoney, D. F., 3101 Lerwick Rd., Sacramento, Calif.  
Matzen, W. T., Electrical Engineering Dept., A & M College of Texas, College Station, Tex.  
McGinley, G. W., 6927 Hamilton Ave., Pittsburgh 8, Pa.  
McGovern, M. J., 111-58 -3 Ave., Flushing, L. I., N. Y.  
McMullin, T. J., 900 Dragon, Dallas, Tex.  
Olson, A. J., c/o Keafott Co., Inc., 253 N. Vinelo, Pasadena, Calif.

(Continued on page 128.)



**CUT CORES  
TOROIDAL  
SQUARE  
RECTANGULAR**

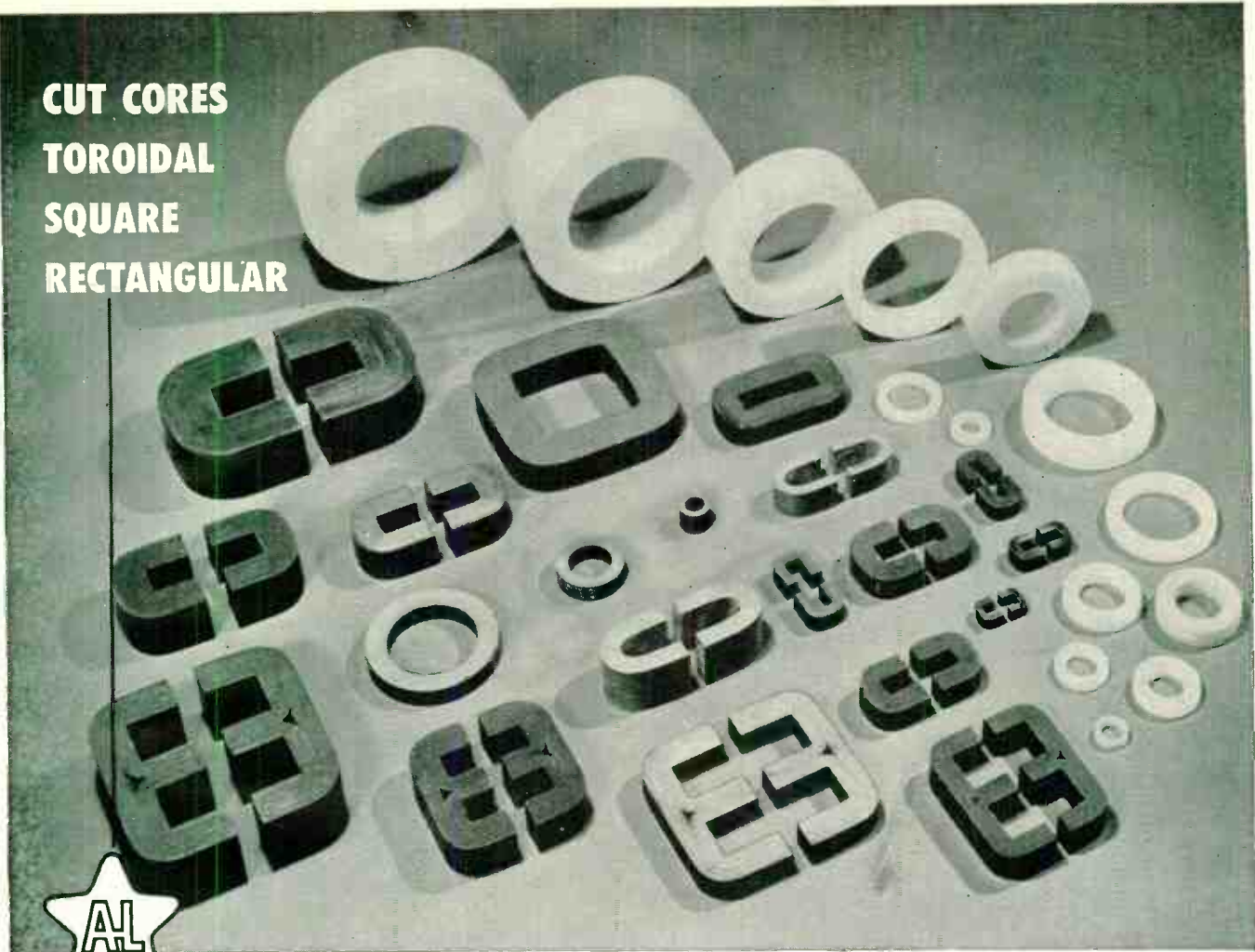

# *Anything You May Need in* **TAPE-WOUND CORES**

## **RANGE OF MATERIALS**

Depending upon the specific properties required by the application, Arnold Tape-Wound Cores are available made of DELTAMAX . . . 4-79 MO-PERMALLOY . . . SUPERMALLOY . . . MUMETAL . . . 4750 ELECTRICAL METAL . . . and SILECTRON.

## **RANGE OF SIZES**

Practically any size Tape-Wound Core can be supplied, from a fraction of a gram to several hundred pounds in weight. Toroidal cores are made in twenty-seven standard sizes with protective nylon cases. Special sizes of toroidal cores—and all cut cores, square or rectangular cores—are manufactured to meet your individual requirements.

## **RANGE OF TYPES**

In most of the magnetic materials named, Arnold Tape-Wound Cores are produced in the following standard tape thicknesses: .012", .004", .002", .001", .0005", or .00025", as required.

*For complete details, write for Bulletins TC-101A and SC-107.*

## *Applications*

Let us help with your core problems for Pulse and Power Transformers, 3-Phase Transformers, Magnetic Amplifiers, Current Transformers, Wide-Band Transformers, Non-Linear Retard Coils, Reactors, etc.

**ADDRESS DEPT. P-59**

WAD 5485

## **THE ARNOLD ENGINEERING COMPANY**

SUBSIDIARY OF ALLEGHENY LUDLUM STEEL CORPORATION

General Office & Plant: Marengo, Illinois

DISTRICT SALES OFFICES . . . New York: 350 Fifth Ave.

Los Angeles: 3450 Wilshire Blvd.

Boston: 200 Berkeley St.



# 6444 MAGNETRON for 9.8-10 kmc/s fixed-tuned operation



## CHECK THIS LIST OF SUPERIOR FEATURES

- ✓ **Light weight** — only 8 ounces
- ✓ **Over 10% efficient** — 1 watt CW output . . . uses 450-500 volt receiver power supply
- ✓ **Compact** — smaller than 6L6 receiving tube
- ✓ **Rugged** — Cathode supported at both ends to minimize microphonics

The 6444 Magnetron is fixed-tuned for 9800 to 10,000 mc/s operation, incorporates the long-life Philips dispenser-type cathode . . . delivers 1 watt CW energy into a coax output. Mounts in standard klystron octal socket. Extremely rugged, 6444 Magnetron is exceptionally suited for Doppler-type radar and other field and laboratory use.

| Tube Type     | Frequency (mcs) | Nominal Output (watts) | Anode Voltage | Anode Current (ma) | Pulling Factor (max, mc) | Initial Heater Voltage (v) | Current (a) |
|---------------|-----------------|------------------------|---------------|--------------------|--------------------------|----------------------------|-------------|
| 6444 (ESM-48) | 9800-10000      | 1.0                    | 450-500       | 15                 | 10                       | 6.0                        | 0.4-0.5     |

Available from stock for immediate delivery

ATR - TR - AND MAGNETRON TUBES  
WAVEGUIDE COMPONENTS AND  
TEST EQUIPMENT - SILICON DIODES



22 CUMMINGTON STREET  
BOSTON 15, MASSACHUSETTS  
COPLEY 7-7577

## Send for this Free SAMPLE FOLDER...

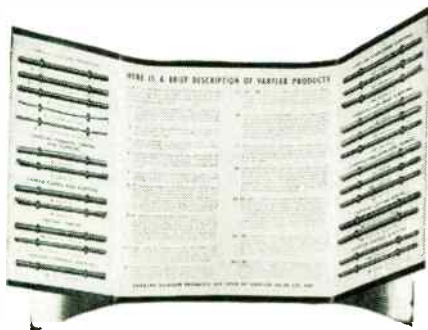

### Contains 25 different test samples of high dielectric Insulating Tubing & Sleeving

Includes samples and descriptions of:  
Varglas Silicone • Permafil-Impregnated Varglas Tubing • Varglas Tubing and Sleeving • Varglas Non-Fray Sleeving • Varflo Tubing and Sleeving • Varflex Cotton Tubing and Sleeving • Syntholvar Extruded Tubing

Write today!

VARFLEX CORP., 518 W. COURT ST., ROME, N.Y.



(Continued from page 126A)

- Pixley, N. S., Jr., 13585 Bromwich St., Picoima, Calif.  
Polan, M., 816 Howard Ave., Brooklyn 12, N. Y.  
Roberts, A. N., 3246 Portage Bay Pl., Seattle 2, Wash.  
Simmonds, C. W., 153 Second Ave., Apt. 3, Salt Lake City, Utah  
Smith, E. C., 903 Summit St., Findlay, Ohio  
Stehn, J. W., W. L. Maxson Corp., 460 W. 34 St., New York 1, N. Y.  
Thompson, A. J., 273 April Way, Campbell, Calif.  
Uhland, J. C., 359 Garden Ave., Camden, N. J.  
Vandervoort, Q. D., 12 Riverside St., Rochester 13, N. Y.  
Wamboldt, G. L., 217 Bleecker Ave., Belleville, Ont., Canada  
Warner, G., 3840 Linton Ave., Apt. 4, Montreal, Que., Canada  
Waters, W. E., Jr., 3208 Edgewood Rd., Kensington, Md.  
Wood, L. A., ANP Division, General Electric Co., Cincinnati 15, Ohio

### The following elections to the Associate grade were approved and are now effective

- Abel, W. G., 7 Aerial St., Arlington 74, Mass.  
Ali, F. I., Egyptian State Broadcasting, 4, Shara Sherifein, Cairo, Egypt  
Ambos, R. G., 28 Gales Dr., New Providence, N. J.  
Amer, S., Egyptian State Broadcasting, 4, Sherifein, Cairo, Egypt  
Andrews, F. E., 2275 Gladys St., Beaumont, Tex.  
Andrikan, C. P., 6228 N. Dak. Ave., N.W., Washington, D. C.  
Arndt, L. A., 14328 Gilmore, Van Nuys, Calif.  
Awaad, A. K., Egyptian State Broadcasting, 4 Sherifein St., Cairo, Egypt  
Bailey, J. J., CMR Box 2, APO 994, San Francisco, Calif.  
Bernstein, E., c/o Bel Fuse, Inc., 311 Mountain Rd., Union City, N. J.  
Bishop, W. M., 463 West St., New York 14, N. Y.  
Boyd, J. E., 1451 Vista Trail, N.E., Atlanta, Ga.  
Burke, T. J., 105 Virginia Ave., Westmont, N. J.  
Burrows, D. E., 6966 Ramona, Cucamonga, Calif.  
Byrne, J. J., Jr., 1002 Garrison Ave., New York 59, N. Y.  
Canese, O. R., Guemes 5557 (Carapachay) Munro, FCNG. Belgr., Peia de Buenos Aires, Argentina  
Canning, T. B., 8 W. Erie, Chicago 10, Ill.  
Care, W. G., 4113 E. 21 Pl., Tulsa 14, Okla.  
Carpenter, J. L., 319 Pioneer Dr., Glendale 3, Calif.  
Churlin, E., 7112 Blvd., E., North Bergen, N. J.  
Clark, C. C., Star Rt., Castle Creek, N. Y.  
Coats, R. P., 6158 Llano, Dallas 14, Tex.  
Coawette, R. T., 2154 Williams St., St. Paul 10, Minn.  
Cote, J. A., King St., Bathurst, N.B., Canada  
Daabis, G. A. H., No. 6 St., El-Toran, Damanhour, Egypt  
Dangeti, S. M., Physics Department, Andhra University, Waltair, Visakhanatam 3, Andhra, India  
Deering, C. S., 1853 Grand, Fort Worth, Tex.  
de Haro, F. O., Yermal 2663, Buenos Aires, Argentina  
Dessouki, M. I., Egyptian State Broadcasting, 4 Sherifein St., Cairo, Egypt  
Dunham, K. D., 1432 Riverside Dr., Titusville, Fla.  
Elabd, I. H. A., Faculty of Engineering, Alexandria University, Alexandria, Egypt  
Elkashlan, E. I., Egyptian State Broadcasting, Cairo, Egypt

(Continued on page 130A)

**The  
Greatest Names  
in British  
Electronics use**

**Mullard  
TUBES**

**Mullard**  
Electronic Tubes

*used throughout the world*

British equipment manufacturers are making a vital contribution to the development of electronics in all fields of application. Their products are being exported to every corner of the world, earning a universal reputation for advanced techniques and excellent performance.

The majority of these electronic equipment manufacturers consistently use Mullard tubes. This choice is decided upon because they prefer the greater assurance of efficiency and dependability, and because the vast manufacturing resources of the Mullard organisation guarantee ready availability of Mullard tubes wherever they are needed.

Write to the undermentioned distributors for full details of Mullard tubes:—

**In the U.S.A.** International Electronics Corporation,  
Department P.9,  
81, Spring Street, N. Y. 12, New York, U.S.A.

**In Canada** Rogers Majestic Electronics Limited,  
Department K.A  
11-19 Brentcliffe Road, Toronto 17, Ontario, Canada.

MULLARD OVERSEAS LTD., CENTURY HOUSE, SHAFTESBURY AVENUE, LONDON, ENGLAND

*Mullard is the Trade Mark of  
Mullard Ltd., and is registered in most of the principal countries of the world.*



## FREQUENCY-SHIFT V-F CARRIER-TELEGRAPH SYSTEM

Provides one, two, or three frequency-shift teletype channels above the voice on a 3400-cycle telephone circuit



A send and a receive panel require 5 1/4" of mounting space on a standard 19" rack

This system provides an economical trouble-free method of obtaining up to three full-duplex 100 wpm telegraph channels at the upper end of a broad-band telephone channel, and still retain a 2950-cycle voice circuit. Mid-channel carrier frequencies of 3120, 3240 and 3360 cycles are employed. The mark frequencies are 30 cycles below and the space frequencies are 30 cycles above the mid-band frequencies. The three telegraph channels are transmitted in the band 3080 to 3400 cycles, leaving the band below 2950 cycles for the voice channel.

Fault-free teletype circuits are obtained,

even where the telephone circuit on which they are superimposed suffers from noise or abrupt level variations which may be so great as to render on-off keyed signals unintelligible. Frequency-shift signals do not suffer deterioration from non-linear transmission, such as is caused by overloading in voice-frequency, carrier or radio equipment. Under most circumstances a signal-to-noise ratio per channel as low as 20 db is satisfactory, and under some conditions even lower ratios result in fault-free operation. This equipment meets the requirements of current MIL specifications wherever applicable.

## RADIO ENGINEERING PRODUCTS

1080 UNIVERSITY STREET, MONTREAL 3, CANADA

Telephone: UNiversity 6-6887

Cable Address: Radenpro, Montreal

MANUFACTURERS OF CARRIER-TELEGRAPH, CARRIER-TELEPHONE AND BROAD-BAND RADIO SYSTEMS

# YOKE SPECIALISTS



- Military or special yokes and focus coils designed to your specifications.
- Production yokes for TV sets.

For your answer to yoke problems write Dr. Henry Marcy today.

*syntronic*

**INSTRUMENTS, INC.**

100 Industrial Road • Addison, Ill. • Phone: Terrace 4-6103



Membership

(Continued from page 128A)

- Elliott, R., 561 W. Briar Pl., Chicago, Ill.  
 Espina, H. E., 4058 Belerano, Mar Del Plata, Pcia, Buenos Aires, Argentina  
 Fahny, A. I., Egyptian State Broadcasting Stations, ABU-ZAABAL, Cairo, Egypt  
 Faitouri, A. M., Egyptian State Broadcasting, 4 Sherifein, Cairo, Egypt  
 Fattah, A. F. A., 16 Farascour, Cairo, Heliopolis, Egypt  
 Fouts, D. F., HQ AACS, Andrews AFB, Washington 25, D. C.  
 Fujimoto, M., 5600 Imperial Hiwy., South Gate, Calif.  
 Gharbawi, I. S., 14 Sakhaa St., Apt. 8, Heliopolis, Cairo, Egypt  
 Giordano, N. J., 1170 E. 29 St., Brooklyn 10, N. Y.  
 Green, P. J., 49 E. Mountain Ave., South Wilhamsport, Pa.  
 Hager, D. N., Hqs. Squad. Sec., 3380 Technical Training Group, Box 277, Keesler AFB, Miss.  
 Hall, J. E., 2686 Filmore, Salt Lake City, Utah  
 Hall, R. D., 15918 Morrison St., Encino, Calif.  
 Hann, G. W., R.F.D. 2, Kennesaw, Ga.  
 Hansell, G. E., 25 Friendly Rd., Norwalk, Conn.  
 Harroun, M. S., Radar & Wireless Work Shops, Almaza, Cairo, Egypt  
 Hassan, M. I., Radar & Wireless Work Shops, Almaza, Cairo, Egypt  
 Hayes, M. E., 3115 Oaklyn Ave., Muncie, Ind.  
 Helmer, R. J., 799 Sixth St., Apt. 21, Los Alamos, N. M.  
 Helmy, A. M., 96 Abd El-Daker Taha, Cairo, Egypt  
 Hendrix, C. E., 211-B Byrnes St., China Lake, Calif.  
 Hermann, F. C., 3431 W. 227 Pl., Torrance, Calif.  
 Herrera, H., 3337 Tech. Tng. Sqn., Box 244, Scott AFB, Ill.  
 Hodges, G. W., 107 Birch La., Scotia 2, N. Y.  
 Holmbeck, J. D., 434 Wilmot Ave., Burlington, Wis.  
 Hyde, P. L., Box 122, Watertown, N. Y.  
 Ibrahim, F. B., Egyptian State Broadcasting, 4 Sherifein St., Cairo, Egypt  
 Issa, E. E. M., Egyptian State Broadcasting, 4 Sherifein St., Cairo, Egypt  
 Iverson, K. E., Harvard Computation Laboratory, 33 Oxford St., Cambridge 38, Mass.  
 Jongberg, J. B., 452 E. 29 St., Brooklyn 26, N. Y.  
 Jonkman, J. Y., 2022-32 St., S.W., Calgary, Alta., Canada  
 Jung, D. H., R.F.D. 1, New Bremen, Ohio  
 Kanton, L. B., 8735 Bay Pkwy., Brooklyn 14, N. Y.  
 Kelly, D. R., U.S.S. Carronade, 1Fsl, c/o FPO, San Francisco, Calif.  
 Kheireldin, A. E. M., Alexandria University, Faculty of Engineering, Alexandria, Egypt  
 Kistner, R. L., 3812-43 St., Sioux City, Iowa  
 Kurma, V. R., c/o Sri. K. V. Gopalaswamy, Registrar, Andhra University, Waltair, Visachapatnam 3, Andhra, India  
 Laignelet, H., 3337 Tech. Tng. Squ., Box 244, Scott AFB, Ill.  
 Larsen, R. R., 2019 Lincoln Cir., Salt Lake City, Utah  
 Lignon, J. R., Instituto Tecnológico de Aeronautica, Sao Jose Dos Campos, Est., Sao Paulo, Brazil  
 Lowdenslager, J. R., 1023 Hulls Hwy., Southport, Conn.  
 Ludwig, D. E., 729 Gayley Ave., Los Angeles 24, Calif.  
 Maass, C. A. J., 1775 Fremont Ave., S., Minneapolis 5, Minn.  
 MacCrone, C. R., 5308 Knowlton St., Los Angeles 45, Calif.

(Continued on page 132A)

**NOW...**

*you can* **DIP-SOLDER**  
*resistor connections*  
*with the NEW SPEER*  
**SOLDER-BATH RESISTOR**

**Found:** the answer to automatic soldering of resistors to printed circuit terminals. Speer's new solder-bath resistor assures secure dip-soldered connections . . .

**without flux**  
**without re-tinning**

Here's a resistor specifically made for efficient dip-soldering on modern assembly lines. The *high solderability* of its specially tinned leads gives a firmer joint—closer to the body of the resistor.

Perhaps you are employing or developing automatic production of electronic components—based on printed circuitry. Now's the time to get all the details on a resistor designed for automatic dip-soldering: the Speer solder-bath resistor!

*Send coupon for complete information.*



**SPEER RESISTOR DIVISION**  
**SPEER CARBON COMPANY**  
Bradford, Pennsylvania  
Other Divisions: Jeffers Electronics  
International Graphite & Electrode

**SPEER RESISTOR DIVISION**  
Speer Carbon Company  
Bradford, Pennsylvania

Please send me the full story on your  
solder-bath resistor.

Name \_\_\_\_\_

Title \_\_\_\_\_

Company \_\_\_\_\_

Address \_\_\_\_\_



(Continued from page 130A)

- Malcolm, A., 266 N. Fulton Ave., Mount Vernon, N. Y.
- Mansfield, L., Pathe Laboratory, 105 E. 106 St., New York 29, N. Y.
- Marshall, D. E., Jr., 835 Westview St., Philadelphia 19, Pa.
- Matsumara, K., Electrical Communication Laboratory, Kichijoji 1551, Musashino, Tokyo, Japan
- McDaniel, G., 63 Wall, New York 5, N. Y.
- McDowell, D. E., 821 Neil Ave., Apt. A-2, Columbus 8, Ohio
- McKeown, F. J., 205 Sterling St., Brooklyn 25, N. Y.
- Michael, R. A. M., 9 Dekerness, Apt. 14, Heliopolis, Cairo, Egypt
- Mill, A. F., 1145 N. 11 St., Reading, Pa.
- Miller, R. S., 241-02—86 Rd., Bellerose 26, L. I., N. Y.
- Mirchandani, I. T., Box 687, Bombay 1, India
- Moharram, A., Radar & Wireless Work Shops, Almaza, Cairo, Egypt
- Mondreti, S. R., Padmaraju Quarters, Waltair, Visakhapatnam 3, Andhra, India
- Morsy, S. H., Radar & Wireless Work Shops, Almaza, Cairo, Egypt
- Nasr, T., Egyptian State Broadcasting, 4 Sherifein, Cairo, Egypt
- Norris, V. L., 24 Delrey Ave., Baltimore 28, Md.
- Parker, J. F., 3102 Montgomery Dr., Santa Rosa, Calif.
- Payne, G. W., 830 Cavilier, San Antonio, Tex.
- Peirano, A., Av. Eva Peron #2216, Olivos, FENGBM, Argentina
- Perfilio, L. M., Maure 2180, Buenos Aires, Argentina
- Rashwan, H. M., Egyptian State Broadcasting, 4 Sherifein St., Cairo, Egypt
- Redden, E. T., 212 N. Spruce Dr., Anaheim, Calif.
- Rodgers, J. W., Jr., 4013 S. Rockwell St., Chicago 32, Ill.
- Rosser, B. M., 280 Branchbrook Dr., Belleville 9, N. J.
- Rubin, M. M., 11 Sinai Ave., Aluza Haifa, Israel
- Selfridge, J. J., 13 Genetti St., Bedford, Mass.
- Shaltout, M. H., 34 Mostafa Kamel St., Sidi Gaber, Alexandria, Egypt
- Shaw, L. A., 2 Castine, Schenectady 9, N. Y.
- Shirvis, R. A., 5125 N. Kenmore, Chicago 40, Ill.
- Sinclair, R. R., 216 W. Second St., Biloxi, Miss.
- Sklon, G. M., 8912 Forest View Dr., North Riverside, Ill.
- Smith, R. E., 858 Ensenada Ave., Berkeley 7, Calif.
- Stapf, M. R., Jr., 405 E. 15 Ave., Columbus 1, Ohio
- Steinbrenner, E. W., 4821 S. Union Ave., Chicago 9, Ill.
- Sterrett, J. E., 438 Liberty St., Grove City, Pa.
- Stewart, A. C., 185 Barley Dr., Toronto 16, Ont., Canada
- Sundberg, G. A., 17 River Rd., Philadelphia 28, Pa.
- Sundheimer, D. M., 505 W. Maumee St., Angola, Ind.
- Tallon, W. J., 529 Second St., Manhattan Beach, Calif.
- Turner, H. C., 13576 Corrent, Pacoima, Calif.
- Vina, F. A., Griveo 2798, Buenos Aires, Argentina
- Volder, J. E., 708 Burton Hill Rd., Fort Worth 14, Tex.
- Wascavage, J. A., 517 Amberly Rd., Glen Burnie, Md.
- Westervelt, G. J., 4543 Bannock St., San Diego 17, Calif.
- Weytze, D. W., 6580—38 Ave., 5, Rosemount, Montreal, Que., Canada
- Whan, D. F., 51 Belle Haven, Manhattan, Kans.
- Wong, E., 5602 E. 17 St., Oakland 21, Calif.
- Young, R. H., 320 Ninth St., Sunbury, Pa.

**PRINT BY SILK SCREEN →**

**ELECTRONIC CIRCUITS AUTOMATICALLY**

**GENERAL DECORATOR PRESSES-SERIES B**

The Silk Screen method is being widely accepted for preparing copper laminated plastic panels prior to etching printed circuits. General Decorator Presses put printed circuits on an automatic, high production basis. Bowed panels are held flat by vacuum. Line contact impression and accurate register give clean, sharp reproduction of fine lines. Controlled inking lays down a thick, uniform layer of resist.

|              |              |              |              |
|--------------|--------------|--------------|--------------|
| Model No.    | B1224        | B1824        | B1836        |
| Sheet Size   | 13x25"       | 19x25"       | 19x37"       |
| Speeds Up To | 1500 per hr. | 1500 per hr. | 1500 per hr. |

**ThermoJet DRYER** Utilizes a new system for high speed drying of inks, resists and coatings by greatly accelerated evaporation of solvents.



Write for complete information  
**RESEARCH AND SUPPLY COMPANY**  
 572 S. Division Avenue  
 Grand Rapids 3, Michigan

# Teflon<sup>\*</sup>...

**INQUIRIES INVITED ON TAPE • SHEET • ROD • TUBES**

*Molded and Machined Parts*

**O. J. Maigne Co.**

321 PEARL STREET • NEW YORK 38, N. Y. • WORTH 2-1165

**BERYLLIUM COPPER**  
Silvercote®

**titanium**

**phosphor bronze**

**ALUMINUM**

**OTHER NON-FERROUS**

Send for descriptive folder.

**LFA**

**LITTLE FALLS ALLOYS Inc.**  
191 Caldwell Ave., Paterson 1, N. J.

*Special Purpose* **WIRE**

Consider WIRE and the importance of its function in your product. Whether a highly engineered application or a simple stapling purpose, your choice of the proper alloy or composition, temper and type of wire could mean success or failure during crucial test.

round • flat — square ■ half-round ▲

Precision gauges from 1/8 to .002.

**SPRING WIRE — WIRE FOR INSTRUMENTS — ELECTRONICS. STRAND FOR WIRE ROPE AND BRAIDED APPLICATIONS — MANDREL WIRE — WIRE FOR FORMS — RIVETS — STAPLING**



# Save Time in Circuit Design

Get advance information...in graphic form...  
on vacuum-tube behavior in new circuitry —  
with the **Type 570 Characteristic-Curve Tracer**

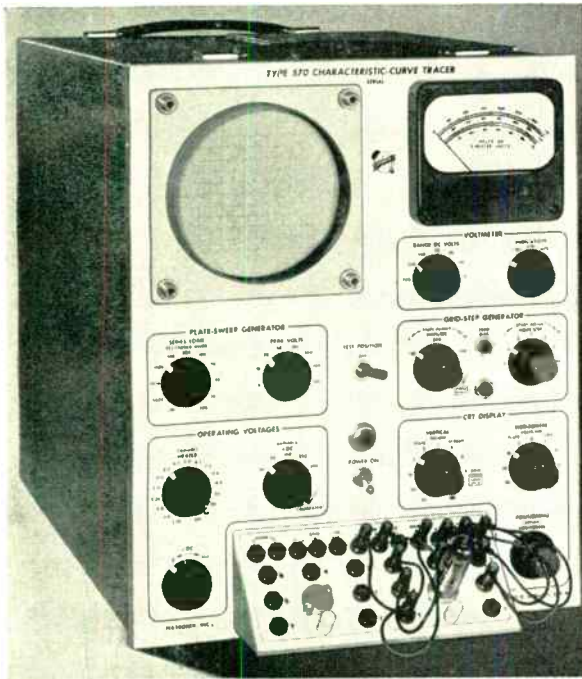

The **Tektronix Type 570 Characteristic-Curve Tracer** can save you many hours in circuit-development work by providing quick, accurate pictures of vacuum-tube characteristics. You have complete control of the operating-condition setup, permitting a realistic approach to actual circuit conditions, whatever they may be. You get curves that can be very important in a particular circuit problem; but are rarely, if ever, published in handbooks.

The Type 570 can also be used for rapid preselection of vacuum tubes, either by comparison with another vacuum tube, or with curves outlined on a crt mask.

**Please call your Tektronix Field Engineer or Representative or write direct for new booklet, Type 570 Technical Description.**

### Displays Families of Curves on CRT Screen

Choice of four to twelve characteristic curves per family—with as many as 8 positive-bias curves per family.

### Plots All Important Characteristics

Plate current against plate voltage.  
Plate current against grid voltage.  
Screen current against plate voltage.  
Screen current against grid voltage.  
Grid current against plate voltage.  
Grid current against grid voltage.

### Calibrated Controls

Accurate current and voltage readings directly from the crt screen.

### Wide Display Range

11 current ranges from 0.02 ma/div to 50 ma/div.  
9 voltage ranges from 0.1 v/div to 50 v/div.  
11 series-load resistors from 300 ohms to 1 megohm.  
7 grid-step values from 0.1 v/step to 10 v/step.

**Price — \$925**

f.a.b. Portland (Beavertan), Oregon

See and try the Type 570 at the National Electronic Conference in Chicago, Booths 133 and 134.

# Tektronix, Inc.

P. O. Box 831, Portland 7, Oregon

CYpress 2-2611

Cable: TEKTRONIX

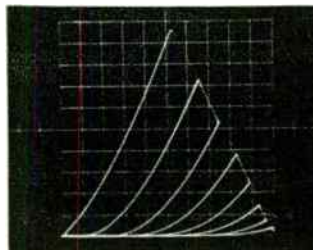

**Fig. 1** — Plate current plotted against plate voltage for one triode section of a 12AU7. Plate load is 5 k, peak plate-supply voltage is 500 v. Grid voltage is changed 5 v between curves, from -35 v to zero. Vertical sensitivity is 5 ma/div, horizontal sensitivity 50 v/div. Calibrated controls permit accurate current and voltage readings directly from the screen.

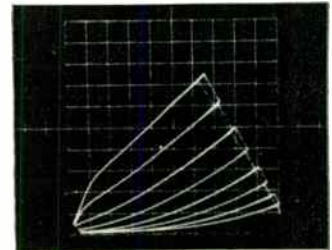

**Fig. 2** — Same triode section of 12AU7 with only 20-v peak plate supply and sensitivities increased to 0.2 ma/div vertical and 2 v/div horizontal. Grid voltage is changed 2 v between curves, from -14 v to zero. This is essentially a 25-times magnification of the lower left portion of Fig. 1, showing the operating characteristics at low plate-supply voltage.

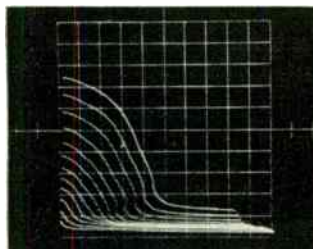

**Fig. 3** — Screen current plotted against plate voltage with positive grid bias on a 6AQ5. Plate load is 300 ohms, peak plate voltage is 100 v, screen-grid voltage is 100 v, with grid voltage changing 2 v/step from +16 v to below zero. Vertical scale is 10 ma/div, horizontal scale 10 v/div.

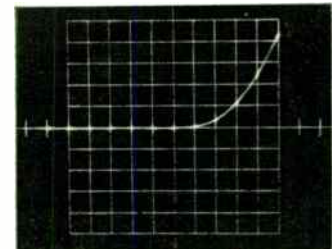

**Fig. 4** — Typical Germanium Diode curve. Inherent flexibility of the Type 570 permits accurate evaluation of diode characteristics and detailed examination of any part of the curve. Calibrated scales above are 0.2 v/div horizontal, 0.5 ma/div vertical, with zero points at center of screen.

# The NEW American Beauty

## Bantams

ELECTRIC  
SOLDERING  
IRONS WORTH  
"Crowing"  
ABOUT!



Cat. No. 3120  $\frac{3}{16}$ " Tip Diameter 30 Watts



Cat. No. 3120-SCP  $\frac{3}{16}$ " Tip Diameter 30 Watts

Not just another "bantam"—but a true American Beauty "Bantam" backed by the most famous name in electric soldering for over 60 years.

### American Beauty "Bantams" feature:

- Indestructible stainless steel casing that insures against undue loss of heat and keeps handle cool.
- Highest quality nickel-chromium heating element with genuine mica insulation.
- Tapered spool nose for maximum visibility and projection-free casing to assure easy access to hard-to-get-at places.
- Available in  $\frac{1}{8}$ " and  $\frac{3}{16}$ " tip diameters with either pencil type handle or standard handle and with long or short casing. Diamond point tip is standard—chisel type if specified.

For the finest quality in ALL TYPES of Electric Soldering Irons—Check with American Beauty first.

AMERICAN ELECTRICAL HEATER COMPANY



DETROIT 2, MICHIGAN

14B-H



Industrial Engineering Notes

\*

### FCC ACTIONS

The Federal Communications Commission has issued a request to set manufacturers that they supply information relating to the current status of UHF television receivers. The request was contained in a notice of proposed rule making which looks toward increasing the maximum power limits for UHF stations to five million watts. In other actions the commission issued rules authorizing the construction of low-power TV stations, without regard to city size, and amended the chain broadcast rules to prevent territorial exclusivity clauses in TV station contracts with networks.

### MOBILIZATION

The Office of Naval Material has made a report available in which it showed that 509 manufacturers of electronic end equipment and major components had sales of nearly \$6.6 billion in 1954. These firms employed over 458,000 persons in connection with their electronic end equipment production and have a maximum annual production potential, on a one-shift basis, of over \$9.6 billion.

### RETMA

Dorman D. Israel of Emerson Radio & Phonograph Corp. has been named Chairman of the Joint Technical Advisory Committee for a one-year period starting July 1. The appointment was made by W. R. G. Baker, Director of the RETMA Engineering Department. Ernst Weber of the Polytechnic Institute of Brooklyn has been appointed Vice-Chairman for the same period by the Board of Directors of the Institute of Radio Engineers. The other members of JTAC for the coming year are R. N. Harmon, Westinghouse Broadcasting Co., Inc.; I. J. Kaar, Gen. Elec. Co.; A. V. Loughren, Hazeltine Electronics Corp.; Ralph Bown, Bell Telephone Labs.; John V. L. Hogan, Hogan Laboratories, Inc., and Philip F. Siling, Radio Corp. of America. L. G. Cumming, Technical Secretary of the IRE, will continue to serve as Secretary. . . . W. R. G. Baker, Director of the RETMA Engineering Department, has been elected to the grade of Fellow in the Standards Engineering Society. The award will be made at an awards luncheon Sept. 30 during the group's national convention at the Hotel Statler in Hartford, Conn.

### STANDARDIZATION

The Radio Technical Commission for Aeronautics has released a report setting forth minimum performance standards for airborne radio communication receiving

(Continued on page 136A)

\* The data on which these NOTES are based were selected by permission from *Industry Reports*, issues of June 13, and 26, July 4, and 11, published by the Radio-Electronics-Television Manufacturers Association, whose helpfulness is gratefully acknowledged.



Radio  
Receptor's  
**NEW**  
money saving  
rectifier  
mounting!

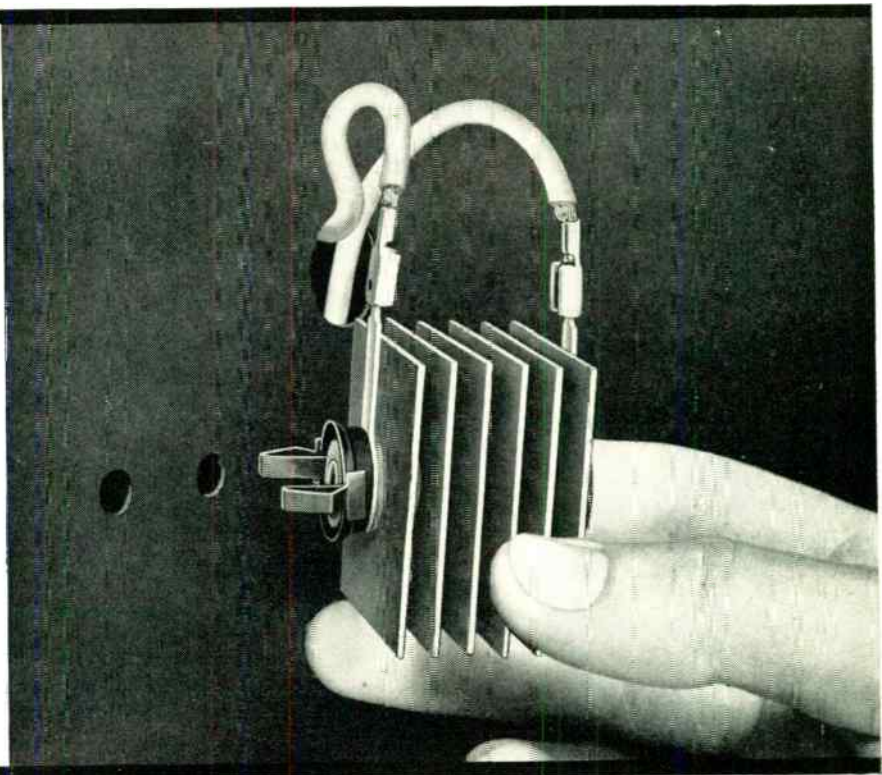

**"QUI-KLIP"** *snap-in type*  
**SELENIUM RECTIFIERS**

**QUICK MOUNTING! QUICK REMOVAL!**

Spring steel clips with safe edges snap into two round, large tolerance holes in chassis (approx  $\frac{3}{16}$ " dia.,  $\frac{1}{16}$ " c. to c.). Solderless connectors as shown, when used, simplify servicing.

Radio Receptor's unique QUI-KLIP rectifiers will soon make their debut in TV sets produced by one of the country's leading manufacturers, saving them countless dollars in production costs.

QUI-KLIP requires no tools or sockets for mounting. There are no studs to break or threads to strip and the locating tab is now unnecessary. QUI-KLIP provides a positive seat for the rectifier — no rocking. Yet any serviceman can remove the stack quickly by squeezing the QUI-KLIP prongs with his fingers and removing the solderless connectors.

Let us show you how to put the cost saving QUI-KLIP selenium rectifiers to work in *your* production . . . Available in most popular sizes with cells from 1" square to 2" square, for radio, TV and other electronic circuits. For detailed information, write Dept. P-6

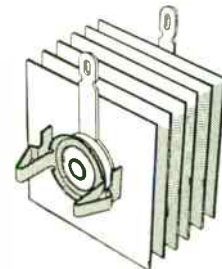

- Speeds assembly time.
- Slashes production costs.
- Simplifies assembly.
- Eliminates stud rejects  
(No studs or nuts needed.)
- Permits easier replacement  
in the field.



Semiconductor Division  
**RADIO RECEPTOR COMPANY, INC.**  
*In Radio and Electronics Since 1922*

SALES OFFICES: 251 WEST 19TH ST., NEW YORK 11, N. Y., WAtkins 4-3633 • Factories in Brooklyn, N. Y.

# NEW

**PANORAMIC SPECTRUM ANALYZER SPA-1**



**now 50 mc to 4000 mc**

### WITH TWO TUNING HEADS

#### Check these outstanding features:

- Low noise input, less than 0.5 micro-volt across 50 ohms, for high usable sensitivity
- 10 MC maximum sweepwidth, continuously reducible to 0 MC
- Continuously variable differential markers,  $\pm 50$  kc to  $\pm 5$  mc
- Continuously variable resolution (I.F. bandwidth) 9 kc to 100 kc
- 1 cps to 60 cps sweep rate, continuously variable with single control.
- DC coupled video amplifier for analysis of CW signals.
- Three selectable amplitude scales, 40 db log, 20 db linear and square law.
- Low frequency swept oscillator provides high inherent stability.
- Excellent construction and design make the equipment unparalleled for minimum down time.
- Optional bezels and CRTs for visual examination or camera use.
- Low cost.

#### Tuning Heads

RF-2 50 mc - 250 mc  
RF-3 220 mc - 4000 mc in five ranges

Inquiries invited on Panoramic Spectrum Analyzers for special problems. Write today for descriptive literature.



12 South Second Avenue, Mount Vernon, N.Y.  
Mount Vernon 4-3970

- Makers of
- Panadaptor
- Analyzer
- Panoramic
- Sonic
- Analyzer
- Panoramic
- Ultrasonic
- Analyzer



## Industrial Engineering Notes

(Continued from page 134A)

equipment operating in the 118-132 meg-band. Compliance with the standards is recommended by RTCA as a means of assuring "that the equipment will satisfactorily perform its intended function under all conditions normally encountered in routine aeronautical operations." In addition to setting forth minimum performance standards, the report also outlines standard test conditions and methods of test to be used in measuring performance characteristics. "Minimum Performance Standards—Airborne Radio Communication Receiving Equipment Operating Within the Radio-Frequency Range of 118-132 Megacycles" is available at 30 cents per copy from the RTCA Secretariat, Room 2036, Building T-5, Washington 25, D. C.

### TECHNICAL

A summary of the ideas and experiences of researchers in the field of automatic programming for digital computers, compiled by the Office of Naval Research, is contained in a report made available to industry by the Office of Technical Services, Commerce Department. The volume consists of papers relative to differentiators, compilers, generators, interpretative routines and universal automatic codes. The report, PB 111607, "Symposium on Automatic Programming for Digital Computers," may be obtained from OTS, Commerce Department, Washington 25, D. C., for \$4. Also, OTS has made available "A survey of High-Speed Printers for Digital-Computer Output," prepared in August 1952 by the Office of Naval Research. The code number of this report is PB 111615, and the price is 50 cents. . . .

An improved sphere generator for precision contouring of round quartz crystals on a mass production basis, developed by Bausch and Lomb under an Army Signal Corps contract, is described in a report just released to industry by the Office of Technical Services, Commerce Department. The report notes that the contouring machine grinds spherical bevels on one or more flat round crystals at a time, with a range of curves from 29 mm to 350 mm. Curves even shorter can be generated with slight modifications in the machine and its auxiliary equipment, the OTS report states. The report, "Contouring Equipment for Round Crystals," is the final report on the subject, and can be ordered by number—PB 111609—from OTS, Commerce Department, Washington 25, D. C., for \$1.50 each, which includes drawings and design data. . . . The Radio Technical Commission for Aeronautics recently released two reports relative to airborne radio communication equipment. The first report sets forth minimum performance standards for airborne radio communication transmitting equipment operating within the radio-frequency range of 118-132 mc. A similar report dealing with receiving equipment in this band was released previously (RETMA Industry Report, Vol. 11, No. 24). The RTC report, "Minimum Per-

(Continued on page 138A)



**WHAT HAPPENED ?**



**SCHEDULE MAINTENANCE STUDY PRODUCTIVITY**

Glass-to-metal sealed ELAPSED TIME indicators. Compact, low cost, tamper-proof. Standard ASA-MIL dimensions, 2½" and 3½" sizes. Easy to read standard size counter registers 1/10 hour steps to 9999.9 or hour steps to 99999. Hermetically sealed. Shielded. Starts, operates continuously from -55° C. to +85° C. For 110-125 or 220-250 volt 50 or 60 cycle A.C.



marion electrical instrument co.  
Grenier Field, Manchester, N.H., U.S.A.

Manufacturers of Ruggedized and "Regular" Panel Instruments and Related Products.

copyright 1956 M.E.I. Co.

## marion meters



research  
design  
engineering  
manufacturing

of outstanding quality  
**CONNECTORS • CABLE ASSEMBLIES**

including

**PRINTED CIRCUIT**

**AN Types • RF**

**RACK and PANEL**

(Standard and Special)

for America's  
**Electronic Industry**

Catalog—Literature Available

**H. H. BUGGIE, Inc.**  
**BOX 817 • TOLEDO 1, OHIO**

# Eimac Amplifier Klystrons and Circuit Components

—the easy, economical approach to high power,  
UHF/microwave transmitters

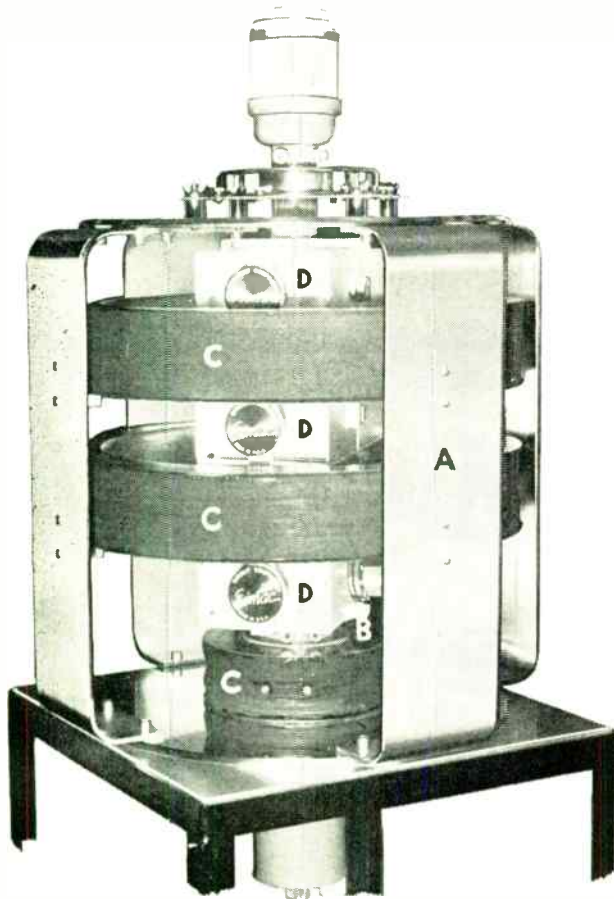

Design and construction of a high power UHF/microwave transmitter for beyond-the-horizon communication and other microwave applications is simple and straight-forward with an Eimac amplifier klystron and circuit components. In fact, it's easier to build than a low frequency Class C amplifier. Eimac high power amplifier klystrons, plus Eimac circuit components consisting of A) Magnetic framework B) RF output load coupler C) Magnetic beam-control coils and D) Convenient tuning wide range RF resonant cavities comprise the essential elements of a final amplifier package. By adding conventional power supplies, control circuits, driver and cabinets to the Eimac klystron-circuit component package, high power at UHF is easily obtained. Eimac developed klystron and circuit components provide equipment manufacturers with the easy economical approach to high power microwave transmitters. In many cases, existing low power equipment can be used as a driver for the higher powered amplifier.

Radio Frequency circuitry is completed outside the vacuum system of Eimac klystrons through circuit components. This allows unmatched economy by eliminating repurchase of costly RF circuitry with each tube replacement.

The reliability and performance of Eimac klystrons is proven, as they were employed extensively in established microwave scatter-type communication systems.

For an easy and economical approach to reliable high power microwave transmitting equipment, investigate the incomparable capabilities of performance-proved Eimac developed klystrons and klystron circuit components.



**A**  
Magnetic frame work



**B**  
Output load coupler



**C**  
Magnetic beam-control coils

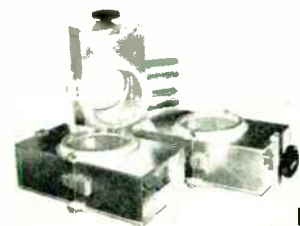

**D**  
Resonant cavities

## EIMAC AMPLIFIER KLYSTRONS

| FREQUENCY RANGE—MC |         | CW POWER | FREQUENCY RANGE—MC |         | CW POWER | FREQUENCY RANGE—MC |          | CW POWER |
|--------------------|---------|----------|--------------------|---------|----------|--------------------|----------|----------|
| 3K3000LA           | 400-600 | 2000w    | 3K20,000LF         | 580-720 | 5000w    | 3K50,000LF         | 580-720  | 10,000w  |
| 3K3000LQ           | 760-980 | 2000w    | 3K20,000LK         | 720-890 | 5000w    | 3K50,000LK         | 720-890  | 10,000w  |
| 3K20,000LA         | 470-580 | 5000w    | 3K50,000LA         | 470-580 | 10,000w  | 3K50,000LQ         | 850-1000 | 10,000w  |
|                    |         |          |                    |         |          | 4K50,000LQ         | 750-1000 | 10,000w  |

For further information write our technical service department.





**EITEL-McCULLOUGH, INC.**  
SAN BRUNO • CALIFORNIA

World's Largest Manufacturer of Transmitting Tubes

**BE Sure** with **CORNISH**  
*Electronic* **WIRES and CABLES**

**MICROPHONE CABLES**   
 Designed for low capacitance, high insulation resistance, low attenuation—in plastic or rubber insulation to stand severe service

**T-V LEAD-IN CABLES**   
 Furnished only in pure virgin polyethylene to insure best electrical properties and long life under severe operating conditions

**T-V LEAD-IN CABLES**   
 Made hollow, of pure virgin polyethylene, for maximum efficiency in receiving Ultra High Frequency signals

**INTERCOMMUNICATION CABLES**   
 These quality cables are made in various constructions, utilizing plastic insulation for both conductors and jacket

**SHIELDED INTERCOMMUNICATION**   
 When installation conditions dictate, shielded cables are recommended. Made with internal or external shield—2 and 3 conductors

“MADE BY ENGINEERS FOR ENGINEERS”

**CORNISH WIRE COMPANY, INC.**  
 50 Church Street New York 7, N. Y.

(Continued from page 136A)

formance Standards; Airborne Radio Communication Transmitting Equipment Operating Within the Radio-Frequency Range 118-132 Megacycles.” is available at 30 cents a copy from: the RTCA Secretariat, Room 2036, Building T-5, Washington 25, D. C. Compliance with the standards, the report stated, is recommended as a means of assuring that the equipment “will satisfactorily perform its intended function under all conditions normally encountered in routine aeronautical operations.” The second RTCA report issued, “Re-Evaluation of VOR Airway Lateral Separation Criteria” discusses the problems of VOR stations and receivers and describes methods of procedure for solving the problems. The procedures described are those relating to service and laboratory tests. The text also contains a statistical analysis of VHF omni-range navigation receiver errors and an analysis of VHF omni-bearing system errors. The report is available at 75 cents a copy from the RTCA Secretariat. . . .

**Two manuals designed to assist manufacturers of electronics equipment for the Armed Forces were just issued by the Office of Technical Services, Department of Commerce.** One manual is designed to help the manufacturer meet the requirements of radio-interference specifications and the other is concerned with the application of electron tubes. “Radio Interference Suppression Techniques” contains information on approved suppression components and systems and their application. In addition, it explains the procedures recommended for obtaining approvals, requesting tests by the Signal Corps, and in getting assistance from the Signal Corps in solving special problems. Some of the individual sources of radio-interference dealt with are rotating machinery, ignition systems, switches and contactors, electronic devices, fluorescent lamps and instruments. The manual is available from the OTS, Commerce Department, Washington 25, D. C., for \$6.75 and should be ordered by number—PB 111611. “Techniques for Application of Electron Tubes in Military Equipment” presents tube information from the point of view of the electronic design engineer, and is organized under three sections: numerical data and special design considerations for specific tube types; tube properties according to ratings, characteristics essential in circuit operation and properties detrimental to circuit operation; and tube properties in circuit design including a check list for the use of the circuit designer to insure coverage of all important design factors. The concepts of specification control, operation within ratings, and tolerance characteristic are emphasized throughout the report, available from the OTS, Commerce Department, for \$2.50. The report should be ordered by number—PB 111644. . . . **The Office of Technical Services, Commerce Department, has announced studies in the field of electronics in its “U. S. Govern-**

(Continued on page 142A)

**NEW MANUAL X-Y PLOTTER KEYBOARD**

**IMPROVED PERFORMANCE IN SUPPLYING INPUT SIGNALS FOR AUTOMATIC POINT PLOTTERS**

A major innovation in this new Librascope manually operated decimal keyboard eliminates sticking switch contacts and high contact resistance. Self-wiping slide-type contacts eliminate necessity for any switch and contact adjustments. Resistance potentiometers are simulated by two voltage dividers—one each for the X and Y axes. All keys are released automatically after point is plotted. A variety of contact configurations available for manual feeding of decimal or binary coded decimal inputs to computer or other systems.

*Write for catalog information.*

**FEATURES**

- DIMENSIONS—8½" wide; 11" deep; 16" high.
- WEIGHT—12 pounds.
- POWER—Energized by voltage from recorder. No external source required.





Computers and Controls  
**LIBRASCOPE**  
MEMBER OF GENERAL ELECTRIC CORPORATION

**LIBRASCOPE INCORPORATED** 1607 FLOWER ST. • GLENDALE, CALIF.

# FOR YOUR AUTOMATION PROGRAM

## VARIABLE RESISTORS FOR PRINTED CIRCUITS



**Type UPM-45**

For TV preset control applications. Control mounts directly on printed circuit panel with no shaft extension through panel. Recessed screwdriver slot in front of control and 3/8" knurled shaft extension out back of control for finger adjustment. Terminals extend perpendicularly 7/32" from control's mounting surface.



**Type U70 (Miniaturized)**

Threaded bushing mounting. Terminals extend perpendicularly 5/32" from control's mounting surface.

**Type GC-U45**  
Threaded bushing mounting. Terminals extend perpendicularly 7/32" from control's mounting surface. Available with or without associated switches.



**Type YGC-B45**

Self-supporting snap-in bracket mounted control. Shaft center spaced 29/32" above printed circuit panel. Terminals extend 1-1/32" from control center.

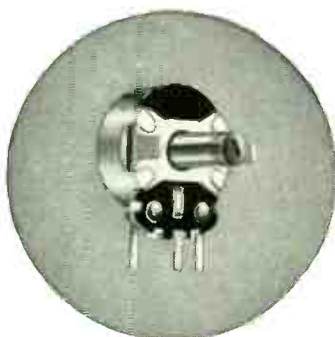

**Type XP-45**

For TV preset control applications. Control mounts on chassis or supporting bracket by twisting two ears. Available in numerous shaft lengths and types.

**Type XGC-45**

For applications using a mounting chassis to support printed circuit panel. Threaded bushing mounting.



## VARIABLE RESISTORS FOR SOLDERLESS "WIRE-WRAP" CONNECTIONS



**Type WGC-45**

Designed for solderless wire-wrapped connections with the use of present wire-wrapping tools. Available with or without switch and in single or dual construction.

The controls illustrated are typical constructions. CTS' years of engineering and technical experience makes available many other types for your automation needs.



**CHICAGO TELEPHONE SUPPLY Corporation**

ELKHART • INDIANA  
FOUNDED 1896

**EAST COAST OFFICE**  
Henry E. Sanders  
130 North Broadway  
Camden 2, New Jersey  
Phone: Woodlawn 6-1686  
TWX No. Camden NJ 380  
P.O. Phone: Market 7-3129

**SOUTHWESTERN U.S.A.**  
John A. Green Company  
6815 Oriole Drive  
P.O. Box 7224  
Dallas 9, Texas  
Phone: Dixon 9515

**SOUTH AMERICA**  
Jose Luis Fontet  
Buenos Aires, Argentina  
Montevideo, Uruguay  
Rio de Janeiro, Brazil  
Sao Paulo, Brazil

**WEST COAST OFFICE**  
Robert A. Stockhouse  
966 S. Robertson Blvd.,  
Los Angeles 35, Calif.  
Phone: Century 4-9931  
TWX No. BIEV H 3636

**CANADIAN DIVISION**  
C. C. Meredith & Co., Ltd.  
Sudburyville, Ontario  
Phone: 310

**OTHER EXPORT**  
Sylvia Gimbury  
4 West 44th Street  
New York 36, New York  
Phone: Pennay 6-1133

*The Exclusive Specialists in Precision Mass Production of Variable Resistors*

# 23 Fields of Special Interest -

The 23 Professional Groups are listed below, together with a brief definition of each, the name of

## ACTIVITIES

The IRE Professional Group has the responsibility of providing the individual with the advantages of a small, select society in the field of his specialization, with its own magazine, just as IRE provides him with the advantages of a large, general society. The advantages of the small society relate primarily to meetings and to publications. Specialized symposia may be arranged either to coincide with IRE Conventions or to occur where there are places of large activity in the field of interest.

The Group is concerned with the advancement of scientific engineering leading to increased professional standing in its field and serves to aid in promoting close cooperation and exchange of technical information among its members. It provides a forum for discussion and presentation of papers on subjects of mutual interest, and provides smaller, more compact Groups who may meet on the common basis of professional interests.



## ORGANIZATION

The IRE Professional Group is established under a constitution within the framework of the IRE. The constitution defines the technical field of interest of the Group, establishes committee structures, describes broadly its functions and procedures, and fixes a minimum level of activity. The management of an IRE Professional Group is in the hands of its Administrative Committee, the officers and members of which are elected annually. The IRE provides financial assistance to the Groups in accordance with their activity and current needs.

## PUBLICATIONS

Every Group publishes a magazine which is called TRANSACTIONS of the Professional Group, generally on a regular quarterly schedule. The TRANSACTIONS serve to preserve and disseminate the body of knowledge that constitutes the fields of interest of the Groups. All editions are distributed without additional cost to members who have paid the annual assessment.

The CONVENTION RECORD covering the sessions presented at the IRE National Convention is furnished without further charge to the members of Groups who have paid assessments.

## MEMBERSHIP

IRE members of any grade are eligible for membership in the IRE Professional Groups and will receive all Group publications upon payment of the prescribed assessments. An IRE member may join as many Professional Groups as serve his interests and wishes.

To join IRE Professional Groups, indicate on the application coupon in the lower right-hand corner of the opposite page the Group or Groups you wish to join. Detach completed coupon and mail with your check for assessment to The Institute of Radio Engineers, 1 East 79th Street, New York 21, N.Y.

### Aeronautical and Navigational Electronics

*The application of electronics to operation and traffic control of aircraft and to navigation of all craft.*

Mr. Edgar A. Post, Chairman, United Air Lines, Operations Base, Stapleton Field, Denver 7, Colo.

Fee \$2. 14 Transactions, 4 Newsletters, \*5, \*6, \*8, & \*9, and \*Vol. ANE-1, Nos. 1, 2, 3 and 4. Vol. 2, No. 1.

### Antennas and Propagation

*Technical advances in antennas and wave propagation theory and the utilization of techniques or products of this field.*

Mr. Delmer C. Ports, Chairman, Jansky & Bailey, 1339 Wisconsin Ave., N.W., Washington 7, D.C.

Fee \$4. 12 Transactions, 1 Newsletter, \*4, \*Vol. AP-1, Nos. 1, 2; \*Vol. AP-2, Nos. 1-4; AP-3, No. 1-3.

### Audio

*Technology of communication at audio frequencies and of the audio portion of radio frequency systems, including acoustic terminations, recording and reproduction.*

Mr. Winston E. Kock, Chairman, Bell Telephone Laboratories, Inc., Murray Hill, N.J.

Fee \$2. 25 Transactions, 4 Newsletters, \*5, \*7, \*10. \*Vol. AU-1, Nos. 1-6; \*Vol. AU-2, Nos. 1-6; Vol. AU-3, Nos. 1-3.

### Automatic Control

*The theory and application of automatic control techniques including feedback control systems.*

Mr. Robert B. Wilcox, Chairman, Raytheon Mfg. Co., 148 California St., Newton 58, Mass.

Fee \$2.

### Broadcast & Television Receivers

*The design and manufacture of broadcast and television receivers and components and activities related thereto.*

Mr. Wilson P. Boothroyd, Chairman Philco Corporation, Tioga and "C" Sts. Philadelphia 32, Pa.

Fee \$2. 10 Transactions. \*1, \*2, \*3, \*5, \*6, \*7, \*8; BTR-1, No. 1-2.

### Broadcast Transmission Systems

*Broadcast transmission systems engineering, including the design and utilization of broadcast equipment.*

Mr. Oscar W. B. Reed, Jr., Chairman, Jansky & Bailey, 1735 DeSales St., N.W., Washington, D.C.

Fee \$2. 1 Transaction, No. 1.

### Circuit Theory

*Design and theory of operation of circuits for use in radio and electronic equipment.*

Dr. Herbert J. Carlin, Chairman, Microwave Research Institute, Polytechnic Institute of Brooklyn, 55 Johnson St., Brooklyn 1, N.Y.

Fee \$2. 8 Transactions. \*1, \*2, \*Vol. CT-1, Nos. 1-4; CT-2, No. 1-2.

### Communications Systems

*Radio and wire telephone, telegraph and facsimile in marine, aeronautical, radio-relay, coaxial cable and fixed station services.*

Mr. Arthur C. Peterson, Jr., Chairman, Bell Telephone Laboratories, 463 West Street, New York 14, N.Y.

Fee \$2. 4 Transactions. 5 Newsletters. \*Vol. CS-1, No. 1; \*Vol. CS-2, Nos. 1-2; CS-3, No. 1.

### Component Parts

*The characteristics, limitation, applications, development, performance and reliability of component parts.*

Mr. A. W. Rogers, Chairman, Chief, Components & Materials Branch, Squier Signal Lab., Fort Monmouth, N.J.

Fee \$2. 3 Transactions. \*PGCP-1-2-3.

### Electron Devices

*Electron devices, including particularly electron tubes and solid state devices.*

Dr. John S. Saby, Chairman, Electronics Laboratory, General Electric Company, Syracuse, New York

Fee \$2. 10 Transactions, 3 Newsletters, 2 Technical Bulletins. \*1, \*2, \*4, \*Vol. ED-1, Nos. 1-4; ED-2, No. 1-2.

# THE INSTITUTE OF RADIO

# - IRE's 23 Professional Groups

the group chairman, and publications to date.

\* Indicates publications still available.

|   |  |  |
|---|--|--|
| <p align="center"><b>Electronic Computers</b></p> <p><i>Design and operation of electronic computers.</i></p> <p>Mr. Jean H. Felker, Chairman, Bell Telephone Laboratories, Whippany, N.J.</p> <p>Fee \$2. 14 Transactions, 5 Newsletters. *Vol. EC-2, Nos. 2-4; *Vol. EC-3, Nos. 1-4; EC-4, No. 1-2.</p>   | <p align="center"><b>Engineering Management</b></p> <p><i>Engineering management and administration as applied to technical, industrial and educational activities in the field of electronics.</i></p> <p>Mr. Max C. Batsel, Chairman, Engineering Products Dept., RCA Victor Div., Bldg. 10-7, Camden, N.J.</p> <p>Fee \$1. 3 Transactions, 8 Newsletters. *1, *2-3.</p>   | <p align="center"><b>Industrial Electronics</b></p> <p><i>Electronics pertaining to control, treatment and measurement, specifically in industrial processes.</i></p> <p>Mr. George P. Bosomworth, Chairman, Firestone Tire and Rubber Co., Akron 17, Ohio.</p> <p>Fee \$2. 2 Transactions, *PGIE-1-2.</p>   |
| <p align="center"><b>Information Theory</b></p> <p><i>Information theory and its application in radio circuitry and systems.</i></p> <p>Mr. Louis A. DeRosa, Chairman, Federal Telecommunications Lab., Inc., 500 Washington Ave., Nutley, N.J.</p> <p>Fee \$2. 5 Transactions, 1 Newsletter. *2, *3, 4. IT-1, No. 1.</p>   | <p align="center"><b>Instrumentation</b></p> <p><i>Measurements and instrumentation utilizing electronic techniques.</i></p> <p>Mr. F. G. Marble, Chairman, Boonton Radio Corp., Intervale Road, Boonton, N.J.</p> <p>Fee \$1. 3 Transactions. *2, *3.</p>   | <p align="center"><b>Medical Electronics</b></p> <p><i>The application of electronics engineering to the problems of the medical profession.</i></p> <p>Dr. Vladimir K. Zworykin, Chairman, RCA Laboratories, Princeton, N.J.</p> <p>Fee \$1. 1 Transaction. 3 Newsletters. *1.</p>  |
| <p align="center"><b>Microwave Theory and Techniques</b></p> <p><i>Microwave theory, microwave circuitry and techniques, microwave measurements and the generation and amplification of microwaves.</i></p> <p>Mr. Alfred C. Beck, Chairman, Bell Telephone Laboratories, 463 West Street, New York 14, N.Y.</p> <p>Fee \$2. 9 Transactions. *Vol. MTT-1, No. 2; *Vol. MTT-2, Nos. 1-3; MTT-3, No. 1-4.</p> | <p align="center"><b>Nuclear Science</b></p> <p><i>Application of electronic techniques and devices to the nuclear field.</i></p> <p>Dr. Mortimer A. Schultz, Chairman, Westinghouse Automatic Power Div., Bettis Field, Pittsburgh 30, Pa.</p> <p>Fee \$2. 2 Transactions, 3 Newsletters. NS-1, No. 1; NS-2, No. 1.</p>   | <p align="center"><b>Production Techniques</b></p> <p><i>New advances and materials applications for the improvement of production techniques, including automation techniques.</i></p> <p>Mr. R. R. Batcher, Chairman, 240-02 42nd Ave., Douglaston, L.I., N.Y.</p> <p>Fee \$1.</p>   |
| <p align="center"><b>Reliability and Quality Control</b></p> <p><i>Techniques of determining and controlling the quality of electronic parts and equipment during their manufacture.</i></p> <p>Dr. Victor Wouk, Chairman, Beta Electric Corp., 333 E. 103rd St., New York 29, N.Y.</p> <p>Fee \$2. 5 Transactions, 1 Newsletter. *1, *2, *3, 4-5.</p>  | <p align="center"><b>Telemetry and Remote Control</b></p> <p><i>The control of devices and the measurement and recording of data from a remote point by radio.</i></p> <p>Mr. Conrad H. Hoepfner, Chairman, Stavid Engineering, Plainfield, N.J.</p> <p>Fee \$1. 4 Transactions, Newsletter. 1-2. TRC-1, No. 1-2.</p>  | <p align="center"><b>Ultrasonics Engineering</b></p> <p><i>Ultrasonic measurements and communications, including underwater sound, ultrasonic delay lines, and various chemical and industrial ultrasonic devices.</i></p> <p>Mr. Morton D. Fagen, Chairman, Bell Telephone Laboratories, Whippany, N.J.</p> <p>Fee \$2. 3 Transactions, 4 Newsletters. *1, 2-3.</p> |
| <p align="center"><b>Vehicular Communications</b></p> <p><i>Communications problems in the field of land and mobile radio services, such as public safety, public utilities, railroads, commercial and transportation, etc.</i></p> <p>Mr. Newton Monk, Chairman, Bell Telephone Labs., 463 West St., New York 14, N.Y.</p> <p>Fee \$2. 5 Transactions, 2 Newsletters. *2, *3, *4, 5.</p>                   | <p align="center"><b>USE THIS COUPON</b></p> <p>Miss Emily Sirjane<br/>IRE—1 East 79th St., New York 21, N.Y. <span style="float:right">PG-9-55</span></p> <p>Please enroll me for these IRE Professional Groups</p> <p>..... \$ .....</p> <p>..... \$ .....</p> <p>Name .....</p> <p>Address .....</p> <p>Place .....</p> <p>Please enclose remittance with this order.</p> |  |

# ENGINEERS



1 East 79th Street, New York 21, N.Y.

# NEW "PARAFORMED" PAPER TUBES

MAKE YOUR COIL WINDING  
EASIER! FASTER! BETTER!

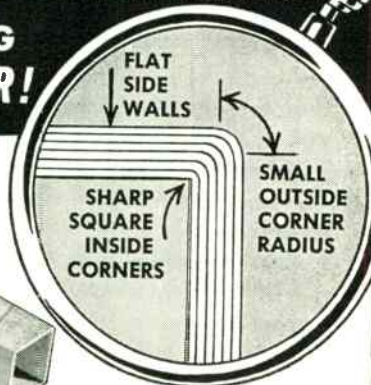

**SPIRAL WOUND**  
NOT DIE FORMED

## ANY SIZE—SQUARE OR RECTANGULAR

Entirely new technique in tube making developed and perfected by PARAMOUNT now for the first time solves many coil winding problems, *yet costs you no more!* Hi-Dielectric. Hi-Strength. Kraft, Fish Paper, Acetate, Red Rope or any combination wound on automatic machines. Produced from stock arbors or special sizes engineered for you.

Write on Company letterhead for Stock Arbor List of over 2000 sizes

- No sharp outside edges to cut wire
- Has full rigidity and physical strength
- Permits winding coils to closer tolerances
- No need for wedges to tighten wire
- Allows faster stacking of wound coils

## PARAMOUNT PAPER TUBE CORP.

618 LAFAYETTE STREET, FORT WAYNE 2, INDIANA  
Manufacturers of Paper Tubing for the Electrical Industry Since 1931

**SWITCHCRAFT**  
INC.

## "TELEVER SWITCH"

*The Rugged  
Telephone Type Switch  
of "T-Beam"  
Construction*



2 and 3 Position Types

**A Unique Design That Has Been  
Universally Accepted By Today's Design Engineers**

Use this Telephone Type Lever Switch for dependable switching. Exceptionally light, rugged construction for long life.

Proved in thousands of installations during the past 4 years. Send for bulletin S-52 or outline your problem.

**SWITCHCRAFT**  
INC.

1332 N. Halsted Street

Chicago 22, Illinois

Canadian Representative: Atlas Radio Corp., Ltd., 50 Wingold Avenue, Toronto, Canada.

**AVAILABLE AT ALL LEADING RADIO PARTS JOBBERS •**



## Industrial Engineering Notes

(Continued from page 138A)

ment Research Reports." The following reports can be purchased from the Photoduplication Section, Library of Congress, Washington 25, D. C., for the reported price: "Analysis of a Cyclotron Type Tube," PB 116027; microfilm, \$3; photocopy, \$7.75. "Circular Waveguide Coupling for Laboratory Use," PB 116623; microfilm, \$1.50; photocopy, \$1.50. "Coaxial Line Step Discontinuity Admittances," PB 116547; microfilm, \$2; photocopy, \$2.75. "Accelerated Life Program," PB 116407 (quarterly progress report No. 1) and PB 116409 (quarterly progress report No. 3); microfilm, \$2.25; photocopy, \$4. "Radio Interference Suppressors. Final Report Under Contract No. AF 33 (038)-9353," PB 116519; microfilm, \$4.75; photocopy, \$14. "Flush-mounted Cardioid-Pattern Antennas," PB 116070; microfilm, \$2.50; photocopy, \$5.25. "Integral Equation Governing Electromagnetic Waves," PB 116389; microfilm, \$2; photocopy, \$2.75. "Presentation on Automatic Production of Electronic Equipment," PB 116381; microfilm, \$3; photocopy, \$7.75. "Measurement of Pulse Time Jitter," PB 116561; microfilm, \$2.25; photocopy, \$4. "On the Cylindrical Antenna," PB 116304; microfilm, \$2.25; photocopy, \$4. "Shielded Two-Wire Hybrid Junction," PB 116292; microfilm, \$2.25; photocopy, \$5.25. "Semi-Flush-Mounted Cardioid-Pattern Antenna for the 225-400 mc Band," PB 116071; microfilm, \$2; photocopy, \$2.75. "State of the Art of Electronic Subminiaturization," PB 116555; microfilm, \$6.75; photocopy, \$22.75. "Transmission-Line Tubes," PB 116537; microfilm, \$2.25; enlargement print, \$6.50.

## TELEVISION

"Approximately 50,000 color television sets will be produced this year and it will be six or seven years before color set production catches up with black-and-white." Board Chairman Max F. Balcom estimated during a speech at the Canadian RETMA Convention in Niagara Falls, June 2-3. Mr. Balcom discussed "The Status of Color Television in the U. S." and told the Canadians that "by the end of the decade it is likely that 7.4 million sets will be sold, at a factory price total of \$1.5 billion." He pointed out that a number of factors are involved in the growth of color TV and "it is not simply a case of designing a color set and rushing it out to the market and handing it to some eager customer who will pay anything he has to pay to get it" and "... at this stage of the game, color television is filled with unpredictable and uncontrollables. . . . As far as some specific estimates about color production and sales are concerned" he said, "our latest thinking is that some 50,000 sets will be produced this year in the U. S. and that something less than 35,000 will probably be sold at the retail level. You will recall that last year some 25,000 sets were produced but indications are that not more than 10,000 of them were sold to the

(Continued on page 154A)



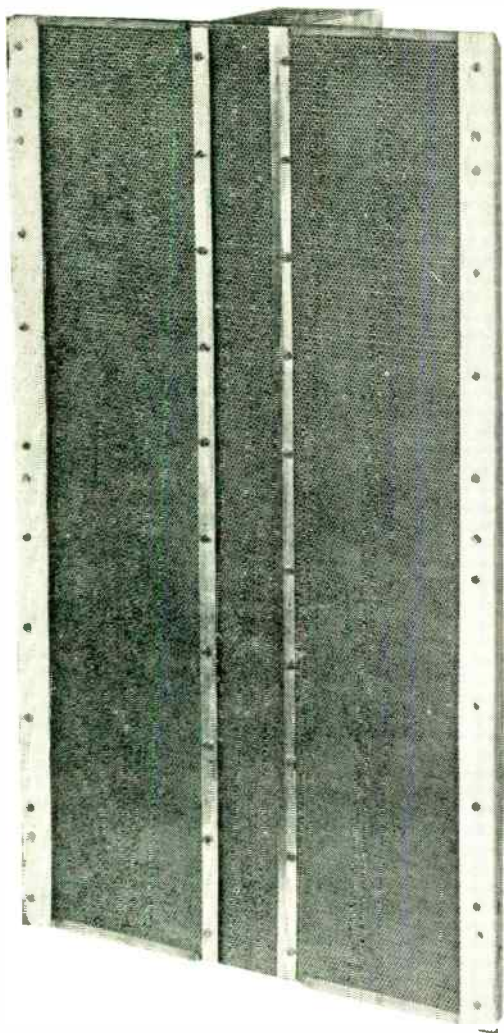

## What is this ?

*New wide-range linear electrostatic loudspeaker 40 c/s—20 kc/s.*

*Featured in May 1955 Wireless World. High fidelity reproduction is covered by frequent articles.*

## Up-to-date news of every British development

### Wireless World

Britain's chief technical magazine in the general field of radio, television and electronics. Founded 45 years ago, it provides a complete and accurate survey of the newest British techniques in design and manufacture. Articles of a high standard cover every phase of radio and allied technical practice, with news items on the wider aspects of international radio. Theoretical articles by recognised experts deal with new developments, while design data and circuits for every application are published. WIRELESS WORLD is indispensable to technicians of all grades and is read in all parts of the world.

*Monthly: \$4.50 a year. Three years \$9.00*

**Recent editorial features:** *Wide Range Electrostatic Loudspeakers — Principles of design for operation with negligible distortion at low as well as high frequencies; V.H.F. and U.H.F. Propagation; Transistor Equivalent Circuits; Non-Linearity Distortion; Developments in Sound Reproduction.*

### Wireless Engineer

Journal of radio research and progress, produced for research engineers, designers and students in the fields of radio, television and electronics. Its editorial policy is to publish only original work, and its highly specialized content is accepted as the authoritative source of information for advanced workers everywhere. The journal's Editorial Advisory Board includes representatives of the Department of Scientific and Industrial Research, the British Broadcasting Corporation, and the British Post Office.

*Monthly: \$7.50 a year. Three years \$15.00 (including annual Index to Abstracts & References).*

**Recent editorial features:** *Pulse Response of Signal Rectifiers; Junction Transistor Trigger Circuits; Waveguide Phase Changer; Visual Impedance-Matching Equipment; Ferromagnetic Loop Aerials; Differential-Amplifier Design; Waveguides and Waveguide Junctions.*

### MAIL THIS ORDER TODAY

To: ILIFFE & SONS LTD., DORSET HOUSE, STAMFORD STREET, LONDON, S.E.1., ENGLAND

Please forward.....for 12 months/36 months. Payment is being made\*.....

NAME.....

ADDRESS.....

CITY..... ZONE..... STATE.....

\*Payment can be made by Banker's draft or International Money Order.

PRO I.R.E.

# ENGINEERS & PHYSICISTS

. . . Are invited to investigate the opportunities created by the growth of our research and development program

---

As a member of our staff you will enjoy the advantages of outstanding personnel policies, job security, and an environment of a progressive and creative nature . . . Broad coverage group insurance benefits are offered together with liberal vacation and sick leave policies . . . Facilities of an extensive technical library allow investigation of the latest developments in many fields . . . Periodic wage reviews assure you of a salary commensurate with your contributions . . . You will be encouraged and given financial assistance in supplementing your formal education at the world-famous colleges and universities of the Greater Boston Area.

---

We have openings for persons experienced in:

- System Design
- Logical Design
- Radar Circuits
- Systems Testing
- Component Testing
- General Circuitry
- Magnetic Recording
- Transformer Design
- Transistor Circuits
- Digital Systems Design
- Magnetic Core Circuits
- Digital Techniques Development

We sincerely feel that your investigation of these openings will be worthwhile and assure you of our prompt reply to all inquiries. For further details you may forward a resume to Personnel Administrator or Tel. RI 2-3200 for appointment.



**LABORATORY for ELECTRONICS, INC.**  
**75 PITTS ST. BOSTON 14. MASS.**



## Positions Wanted

### By Armed Forces Veterans

In order to give a reasonably equal opportunity to all applicants and to avoid overcrowding of the corresponding column, the following rules have been adopted:

The IRE publishes free of charge notices of positions wanted by IRE members who are now in the Service or have received an honorable discharge. Such notices should not have more than five lines. They may be inserted only after a lapse of one month or more following a previous insertion and the maximum number of insertions is three per year. The IRE necessarily reserves the right to decline any announcement without assignment of reason.

Address replies to box number indicated, c/o IRE, 1 East 79th St., New York 21, N.Y.

#### ENGINEER

BSEE 1951, I.I.T. Eta Kappa Nu. Age 25. 2 years experience in adapting power system analysis to digital computers. 2 years experience at White Sands in programming and in troubleshooting a large scale digital computer. Desires position involving logical design of computers. Box 838 W.

#### ELECTRONIC ENGINEER

BEE 1953. Age 25. 5 years electronic experience, including 2 years shop and testing, 1 year assistant project engineer on classified Navy project. 2 years as radio officer USAF. Desires responsible position in production or development. Box 839 W.

#### INSTRUCTOR

BSEE, MSEE. Age 29, married, 1 child. Graduate work in advanced electron tube circuits, network analysis and synthesis, and feedback systems. Mathematics minor. Licensed radio amateur. 1 year communications (R.F.) design and development; 1 year analogue computer circuit research and design; 3 years applied transistor research. Excellent references. Desires a full time teaching position in an institution that has an E.E. graduate school (Ph.D.) with privilege of engaging in six semester hours per semester of graduate study. Available Sept. 1, 1955. Box 840 W.

#### ENGINEER

Age 28, married. BS in EE, working on MS. 2 years ETM 2/c in WW II; 5 years experience in VHF-UHF tuner design; precision radar receiver circuit design, some video and pulse work. Desires challenging position with medium size company. \$7,000 minimum. Prefer east. Box 853 W.

#### SENIOR ELECTRONIC DEVELOPMENT ENGINEER

BS 1950. Age 25, married. 3 years video, pulse and ultrasonic systems development, project level. (patents) some guided missile system development, 2 years Army electronics instructor. Desires responsible R & D position. Box 854 W.

#### ELECTRONIC ENGINEER

BSEE January 1951. Age 27, married, 2 children. 3½ years experience in circuit development, instrument and communications systems planning, and ordnance testing. 1 year administrative and supervisory experience. Desires position offering responsibility and advancement in San Francisco area. Box 855 W.

(Continued on page 146A)

## TO THE FINE ENGINEERING MIND SEEKING THE CHALLENGING PROJECTS IN



### TEST EQUIPMENT

**TEST EQUIPMENT ENGINEERS** (Senior Electronic Engineers and Electronic Engineers) are urgently needed for design and development of test equipment for aircraft and missile application at Convair. Unusual career opportunities are here now for engineers qualified in these fields: *telemeter equipment; auto pilot; rocket propulsion; system engineering; electronic packaging and cabling; electrical, hydraulic and pneumatic power distribution; data reduction systems, radar beacon, remote control systems, specification writers, test procedures, component test, inertial guidance.*

**CONVAIR** offers you an imaginative, explorative, energetic engineering department to challenge your mind, your skills, and your abilities in solving the complex problems of vital, new, immediate and long-range programs. You will find salaries, facilities, engineering policies, educational opportunities and personal advantages excellent.

Generous travel allowances to engineers who are accepted. Write at once enclosing full resume to:

H. T. Brooks, Engineering Personnel, Dept. 809

# CONVAIR

*A Division of General Dynamics Corporation*

3302 PACIFIC HIGHWAY

SAN DIEGO, CALIFORNIA

**SMOG-FREE SAN DIEGO**, lovely city on the coast of Southern California, offers you and your family a wonderful new way of life... a way of life judged by most as the Nation's finest for climate, natural beauty and easy (indoor-outdoor) living.

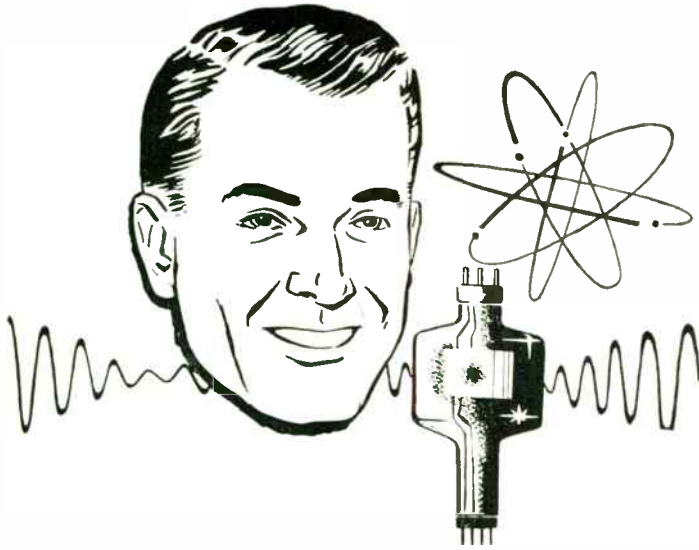

**BELL AIRCRAFT CORPORATION**  
 has  
 Immediate Openings  
 for  
**ELECTRONICS ENGINEERS**

Electronics at Bell Aircraft includes the broad field of radio communication, wide-band amplifiers, pulse circuitry, computers, coders, decoders, subminiature components, special electronic indicators, remote-control systems, telemetry and instrumentation systems.

● **RESEARCH and DEVELOPMENT ENGINEERS**

Electronic guidance, control, checkout and instrumentation systems for guided missiles and remotely controlled aircraft. Systems engineering.

● **MICROWAVE ENGINEER**

Research and development work on antennas and complex components.

● **ELECTRONIC STANDARDS ENGINEER**

Evaluation of electronic component parts for guided missiles.

● **TRANSFORMER ENGINEER**

Design of special transformers and reactors.

*Send complete resume to: Manager, Engineering Personnel*



**POST OFFICE BOX 1**

**BUFFALO 5, N. Y.**



**Positions Wanted**

**By Armed Forces Veterans**

*(Continued from page 145A)*

**ENGINEERING PHYSICIST**

BS Physics, MSEE. 4 years experience in industrial electro-mechanical, electronic instrumentation. 2 years instrumentation experience as assistant project engineer in nucleonics branch of Signal Corps on A.E.C. project. Employer going west. Desires eastern area position. Excellent record and references. Box 856 W.

**REGISTERED PROFESSIONAL ENGINEER**

Senior Member IRE seeks position where unique combination of technical and administrative ability and experience can be put to good use as director of engineering, technical manager, technical sales director, or similar position. Age 39. Broadly experienced in most aspects of electronics, radio and TV stations, networks, general management. Known in industry for books and articles on TV. Taught at 2 universities. Specialized in TV and films for TV. Prefer connection with broadcast organization or similar. Box 857 W.

**PATENT ENGINEER**

Electrical engineer with patent experience in mechanical, electrical and nuclear arts. Member of Illinois and Fed. bars. Registered patent lawyer. At present available in midwest on part time basis or as independent. Box 859 W.

**ENGINEER  
 WASHINGTON REPRESENTATIVE**

Government engineer. Age 34. Nearing the Government ceiling wants to grow. Has been Project Engineer or Supervisor at NBS, NOL, BuOrl, BuShips, and Army. Knows elec for missiles, fuzes, ships, air defense and nuclear sciences; Government contract law and patents. Best schools and references. Box 860 W.

**ELECTRONIC ENGINEER**

BSEE 1950, MSEE 1951, Tau Beta Pi, 27, married, one child. 2½ years experience as unit head on classified Navy project. 1½ years experience involving logical design and design of electronic circuitry of large scale digital computer. Desires position in research or development with possibility of advancement. Box 867 W.

**MANAGEMENT ENGINEER**

14 years experience working with top-ranking executives of some of the country's best known corporations. Heavy technical background, organizational and analytical ability. Teaching experience especially valuable to executives who delegate responsibilities. Desires position not involving military contracts. Box 868 W.

**BROADCAST ENGINEER**

RCA graduate, EE 2 years. Age 23, married 1st phone license with Radar. 2 years experience Radar and UHF. Desires position in broadcasting or in broadcast equipment lab. Prefers New York City area. Box 869 W.

**ELECTRONIC ENGINEER**

B.A. (Physics), M.A. (Math.). Age 29, married, 2 children. Graduate work in E.E. and Math. 3 years naval electronics, 4½ years circuit development and design. Teaching experience. Will relocate. Box 870 W.

**RESEARCH ENGINEER**

B.S.E.E. (communications option) Illinois Institute of Technology. Prof. Eng-in-Training license State of Illinois. 3 years as Radio Officer. U.S. Navy, 8 years amateur radio. Desire research or development position with opportunity to enter management in northeastern Illinois. Box 871 W.

*(Continued on page 148A)*

# EXPAND YOUR HORIZON!

ELECTRONIC ENGINEERS  
ELECTRONIC PHYSICISTS

*Bendix Radio has new,  
exceptional opportunities for advancement  
while working on:*

**RADAR  
MISSILE GUIDANCE  
AIRBORNE COMMUNICATIONS  
MOBILE COMMUNICATIONS  
AUTO RADIO**

Expand the horizon of your future with Bendix Radio—a leader & pioneer in the electronics field, one that has the knowledge, strength and resources to stay out front during the competitive days ahead! Your part is EASY! Wire, phone, write . . . or send us a post card. Simply state your name, address and phone number, your education and experience. We'll carry the ball from there! All replies held in strictest confidence, and we guarantee speedy action!

Address: Mr. L. H. Noggle  
Dept. M  
Bendix Radio  
Baltimore 4, Md.  
Phone: VALley 3-2200

# Bendix Radio

DIVISION OF  
BENDIX AVIATION  
CORPORATION

Baltimore 4, Maryland

## ELECTRONIC ENGINEERS:

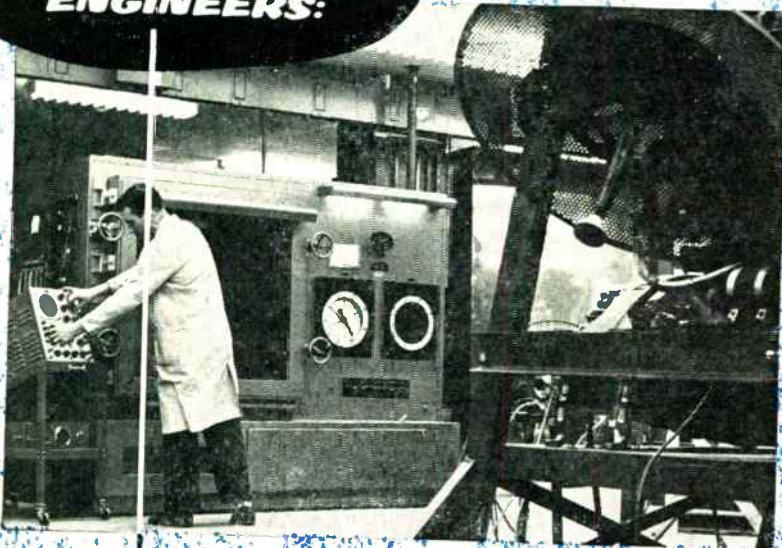

# READ WHAT HAPPENED WHEN WE PUT OURSELVES IN THE WESTINGHOUSE TEST CHAMBER

Both the Electronics and the Air Arm Divisions of the Westinghouse Electric Corporation are expanding. We need experienced electronic engineers for advanced design and development work . . . so we put ourselves in the "environmental test chamber" to see just what we have to offer the people we need.

We found that we have a professional atmosphere that is ideal for the engineer. We offer advanced study at company expense and merit promotions that assure a good future.

Our income and benefit advantages scored high on this test, too. Finally, there were many "extras," like the Westinghouse Patent Award Program, that make investigation of the current openings worthwhile for all electronic engineers.

**APPLY NOW-**

Openings exist in the fields of—

|                               |                   |
|-------------------------------|-------------------|
| COMMUNICATIONS<br>(Microwave) | BOMBER DEFENSE    |
| FIRE CONTROL                  | MISSILE GUIDANCE  |
| RADAR                         | FIELD ENGINEERING |
| COMPUTERS                     | TECHNICAL WRITING |
| INDUSTRIAL INDUCTION HEATING  | TEST EQUIPMENT    |

Send resume outlining education and experience to:

Technical Director  
Dept. 242  
Westinghouse Electric Corporation  
2519 Wilkens Avenue  
Baltimore 3, Md.

**TO APPLY-**

**ILLUSTRATED BROCHURE  
WILL BE SENT TO  
ALL APPLICANTS.**



**Positions Wanted**

### By Armed Forces Veterans

(Continued from page 146A)

#### COMPUTER ENGINEER

Digital Computer Application Engineer. BSFE 1950. EIT, IRE, Project and supervisory experience. Interested in development, test or field engineering. 3 years World War II. Military experience in airborne radar and communications. Box 872 W.

#### ENGINEERING PHYSICIST

B.S. Physics, graduate school, age 27, married and children. 3 1/2 years experience in selenium rectifier R & D. Vacuum deposition of selenium and other materials, high current density and high temperature selenium rectifier development. Supervisory experience. Desires position with aggressive rectifier manufacturer. Box 873 W.

#### ELECTRONIC ENGINEER

B.E.E., M.S., P.E. 13 years experience in general electronics including facsimile, radar, oscilloscope design, pulse circuits, magnetic recording, analog computers, servo-mechanisms, mathematical analysis, instrumentation, teaching. Desires employment on part time or consulting basis. Good bench man. Metropolitan New York and Northern New Jersey. Box 874 W.

#### PHYSICIST, TWO ELECTRICAL ENGINEERS, SALES ENGINEER

Small technical group available for work in solid state photoelectricity (cadmium sulfide, lead sulfide, phototransistors, etc.) and applications. Wide and varied experience. Will relocate. Box 875 W.

#### PATENT ENGINEER

B.Aero. E. 1948, B.E.E. 1950, 2 years toward L.L.B. on New York State Veterans Scholarship. 6 years diversified electronics experience, including transistor circuitry design and servo systems. Several patent credits. 1 year as M.E. on radar. Interested in patent field. Prefer New York City area. Box 877 W.

#### ELECTRONIC ENGINEER

BSEE, with honors, BS Commerce, 5 years design, development, and operations on guided missile guidance, control and instrumentation including 2 years experience on computers, primarily analog, but with some digital background. 15 hours graduate work in feedback control theory and practice. Interested in automation, controls, and computers either this country or abroad. Box 876 W.



**Positions Open**

The following positions of interest to IRE members have been reported as open. Apply in writing, addressing reply to company mentioned or to Box No. . . .

The IRE reserves the right to refuse any announcement without giving a reason for the refusal.

#### PROCEEDINGS of the IRE

1 East 79th St., New York 21, N.Y.

#### SALES ENGINEER

Sales Engineer needed with BEE degree in metropolitan New York area. Write in detail. Box 820.

#### SEMICONDUCTOR ENGINEERS

Responsible positions are available with one of the leading and fastest growing manufacturers of semiconductors. Outstanding opportunities for engineers and physicists in research.

(Continued on page 150A)

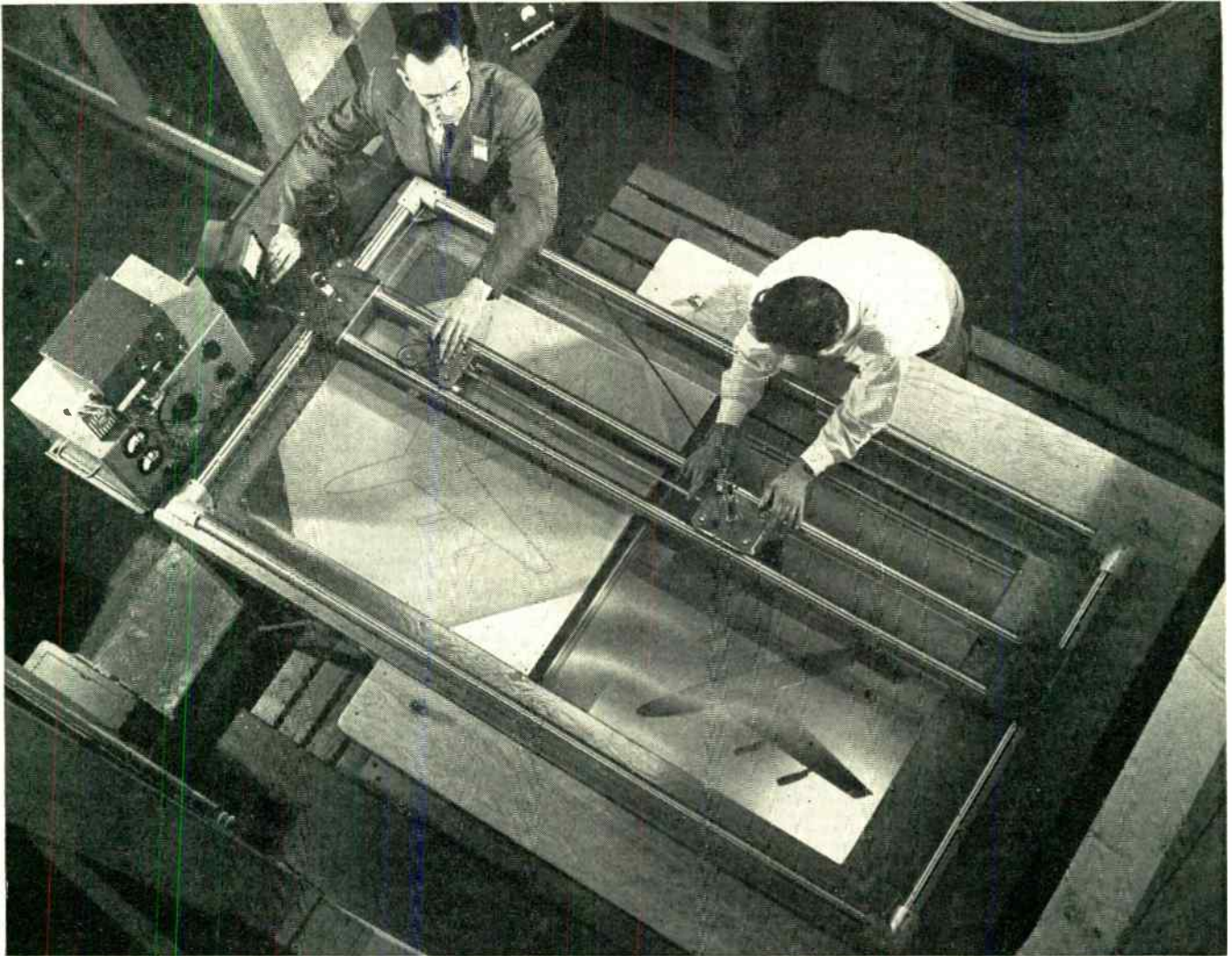

## Boeing "E.E.'s" are kept free for creative assignments

Thanks to draftsmen and engineering aides, Boeing electrical engineers are free to handle stimulating projects like this: determining optimum antenna performance and placement in an electrolytic tank. The findings of these electronics experts will influence the configuration of Boeing airplanes and guided missiles for years to come.

At Boeing, electrical engineers have the same relationship to draftsmen and engineering aides that doctors have to technicians and laboratory assistants. The skills of a Boeing electrical engineer are fully utilized. He finds scope for really creative engineering in instrumentation, radar systems design, guided missile con-

trol, miniaturization, sonic testing, and much more.

This electrolytic tank is one example of the superb equipment at Boeing engineers' disposal. Other facilities include the world's most versatile privately owned wind tunnel, a new tunnel under construction, capable of velocities up to Mach 4, the latest electronic computers, and splendidly equipped laboratory and test equipment in the new multi-million-dollar Flight Test Center.

Achievements of each Boeing engineer are recognized by regular, individual merit reviews, and by promotions from within the organization. Boeing offers exceptional career stability and growth:

this soundly expanding company now employs more than twice as many engineers as at the peak of World War II.

Do you want a chance to "spread your wings" in a truly creative job? There may be a place for you on one of Boeing's engineering teams in design, research or production.

- JOHN C. SANDERS, Staff Engineer—Personnel
- Boeing Airplane Co., Dept. G-43, Seattle 14, Wash.
- Please send further information for my analysis.
- I am interested in the advantages of a career with Boeing.

• Name \_\_\_\_\_  
 • University or \_\_\_\_\_  
 • college(s) \_\_\_\_\_ Degree(s) \_\_\_\_\_ Year(s) \_\_\_\_\_  
 • Address \_\_\_\_\_  
 • City \_\_\_\_\_ Zone \_\_\_\_\_ State \_\_\_\_\_

# **BOEING**

Aviation leadership since 1916

SEATTLE, WASHINGTON WICHITA, KANSAS

# ENGINEERS

## Creative Opportunities with Republic Aviation

Research

### Senior Power Plant Engineer

Three to eight years aircraft power plant experience. Capable conducting power plant testing in conjunction with jet engine and induction system analysis. B.S. in M.E. or A.E.

### Antenna Engineer

To conduct pattern studies, design prototype antennas and supervise flight tests of new antenna installations. College graduate in Physics, Math or E.E.

### Electronic Instrumentation Engineer

Three to five years aircraft instrumentation experience required. Knowledge of transducers, amplifiers and recording equipment used in experimental research testing of hi-speed jet aircraft is essential. Knowledge of servo loop theory as applied to aircraft systems coupled with ability to properly instrument, record and analyze is desirable. Graduate with E.E. degree preferred.

### Electronics Engineer

Familiar with airborne electronic equipment (communications, navigation I.F.F., Radar and Autopilots), preferably with 2 to 4 years aircraft experience. Should be a college graduate. Duties will include system investigations, establishing test procedures and conducting environmental tests on airborne electronic equipment and components.

### Computer Engineer

To supervise maintenance and to design special circuitry for computers. Experience with either analogue or digital computers required. College graduate preferred.

#### NEW ALL-EXPENSE-PAID RELOCATION PLAN

For those living outside the New York City and Long Island area, Republic offers an unusual plan which relieves you of all financial worries. This plan offers these no-cost-to-you benefits: Interview expenses paid for qualified candidates; Educational Refund Plan pays up to  $\frac{2}{3}$  of tuition and laboratory fees; life, health and accident insurance—up to \$20,000 company-paid; plus hospital-surgical benefits for the whole family. And of course you'll live and work on fabulous Long Island, playground of the east coast.

- Please address complete resume, outlining details of your technical background, to:
- Assistant Chief Engineer
- Administration
- Mr. R. L. Bortner



**REPUBLIC AVIATION**  
FARMINGDALE, LONG ISLAND, NEW YORK



Positions Open

(Continued from page 148A)

development, and production of advanced germanium and silicon diodes and transistors. Experience in semiconductor or other components such as tubes or capacitors is desirable. Positions are available for physicists, metallurgists, device engineers, sales engineers and production engineers. Send resume or call: Transitron Electronic Corp., 407 Main St., Melrose, Mass. ME1rose 4-9600

### COIL ENGINEER

Coil engineer needed. Must be experienced in design of deflection yokes. Send resume of education and experience to Box 821.

### ENGINEERS

The U.S. Naval Ordnance Test Station, China Lake, California, is urgently in need of Electronic Engineers and Electronic Technicians. Salaries range from \$4035 to \$7040 per annum. Write or send application form 57 to Personnel Officer, U.S. Naval Ordnance Test Station, China Lake, California.

### COMPONENTS ENGINEER

A progressive manufacturer, with AAA-1 financial rating and well diversified product line, needs a Senior Engineer with experience in the pulse-transformer and inductor fields. This man will be responsible for developing new product lines, devising test facilities for determining performance with industrial and military specifications and establishing production process specifications on new products. Pleasant living conditions in one of the foremost educational and cultural centers of the southeastern U.S. Send full details including salary requirements to Box 822.

### INSTRUCTORS

California State Polytechnic College plans additions to its staff in the Electronic Engineering Department to teach (1) courses in fields, waves and antennas, and (2) intermediate level courses in circuits. For information, write to: Harold P. Hayes, Dean of Engineering, San Luis Obispo, California.

### RESEARCH ENGINEERS AND PHYSICISTS

1. MICROWAVE PHYSICIST for research project on application of Ferrites at Microwave frequencies and other microwave projects. Ph.D. with experience.

2. INSTRUMENTATION ENGINEER. Electronic and mechanical experience for design of x-ray spectrographic instruments. BS or MS with 3 to 5 years experience.

TUBE DESIGN ENGINEER to head project on x-ray tube design. BS or MS with 3 to 5 years tube design and development experience.

Ideal working conditions in suburban research laboratory. All retirement, insurance and other fringe benefits. Interviews with prospective applicants may be arranged by calling New York L.Orraine 2-8703 or Irvington 9-5100.

### ELECTRONICS ENGINEER

Small engineering organization needs competent engineers with initiative. Experience in guided missile field desirable, but not necessary; must have a broad background in electronics as well as a working knowledge of the many aspects of the current state of the art including the latest developments in circuits, components and production techniques. The positions also require experience in the specialized fields of radar, infrared, flight stabilization and control systems, and instrumentation. Eligibility for security clearance required. Positions are open at GS-11 through 14 levels. Salaries \$5,940 to \$9,600. Send resume or form 57 to Officer in Charge, U.S. Naval Ordnance Experimental Unit, c/o National Bureau of Standards, Washington 25, D.C.

(Continued on page 153A)



# SPERRY ENGINEERS

... nearly half a century of engineering history

... now pointing to a new era of engineering opportunities

|                          |   |   |
|--------------------------|---|---|
| <b>1911</b>              | First gyro-compass installation in battleship USS Delaware—the Company's first product                      |    |
| <b>1914</b>              | First gyro-stabilized automatic flight (demonstrated by Lawrence Sperry)                                    |    |
| <b>1916</b>              | Revolutionary high-intensity searchlight  |    |
| <b>1918</b>              | First radio-controlled "guided missile"   |    |
| <b>1924</b>              | First marine automatic pilot (installed on the LEVIATHAN)   |   |
| <b>1929</b>              | First gyro horizon and directional gyro used in blind takeoff and landing by Doolittle                      |  |
| <b>1933</b>              | First Gyropilot installed in the WINNIE MAE in time for record around the world flight                      |  |
| <b>1937</b>              | Sperry enters the field of klystron tube development and improvement  |  |
| <b>WORLD WAR II</b>      | First automatic computing sights for flexible guns and turrets  |  |
|                          | First electronic automatic pilot for aircraft installed in the famous B-24                                  |  |
|                          | First to manufacture anti-submarine X-band airborne radar   |  |
| <b>POST WORLD WAR II</b> | First successful instrument combining all essential flight information on a single instrument (Zero Reader) |  |
|                          | First large caliber automatic anti-aircraft artillery weapon — the Skysweeper                               |  |
|                          | First automatic computing gunsight  |  |
|                          | First radio-controlled pilotless jet  |  |
|                          | First mortar locator — automatically computes position of enemy mortars in a few minutes                    |  |
|                          | First sub launched missile  |  |

From the memorable day in 1911 when the first gyro-compass went aboard the USS Delaware to modern electronic "miracles", Sperry Engineers have pioneered the way. Their achievements have made Sperry an institution possessing a broad base of engineering "know how" for ventures into new and diverse fields. Over 1500 employees have been with Sperry more than fifteen years! Here is a monument to sound management... founded an foresight... looking to the future with confidence born of the past. Above all, Sperry is dynamic. This is an organization constantly growing... expanding... progressing.

## We invite you to investigate ENGINEERING OPPORTUNITIES AVAILABLE AT SPERRY

These openings offer unusual possibilities for professional development and recognition

**ELECTRICAL ENGINEERS**—Servo-Mechanisms • Circuits and Components • Radio and Radar Systems • Telemetering • Digital and Analog Computers • Synchros, Resolvers, Motor Design • Systems Planning and Analysis • Klystron and Traveling Wave Tubes, Solid State Devices

**MECHANICAL ENGINEERS**—Small Mechanical Assembly Design • Packaging of Airborne Electro-Mechanical Equipment • Heat Flow • Vibration Analysis • Airborne Antennas Design • Gyros • Accelerometers

**AERONAUTICAL ENGINEERS**—Aerodynamics • Stability and Control • Navigation and Guidance • Aircraft Performance and Flight Testing

RELOCATION ALLOWANCES • LIBERAL EMPLOYEE BENEFITS  
ADEQUATE HOUSING in Beautiful Suburban Country Type Area  
TUITION REFUND PROGRAM (9 graduate schools in area of plant)  
MODERN PLANT with Latest Technical Facilities  
ASSOCIATION WITH OUTSTANDING PROFESSIONAL PERSONNEL

Please submit resume to

**J. W. DWYER**

Engineering Employment Supervisor

Phone **Fieldstone 7-3600 Ext. 2605 or 8238**  
for interview appointment.

(Interviews arranged for Sat. or Wed. Eve.)

# SPERRY

**GYROSCOPE COMPANY**

Division of Sperry Rand Corp.

**GREAT NECK, LONG ISLAND, NEW YORK**



has a future for **ELECTRONIC ENGINEERS**

## in these specialized fields

### MISSILES

Research, systems analysis, development, and design in guidance and control systems, systems component equipment, and systems operational test equipment.

### TEST EQUIPMENT

Research, development, and design in Guided Missile operational test equipment systems and systems component equipment.

### MICROWAVES

Systems analysis, development, and design in microwave circuitry and components for missile guidance systems, radar systems, and systems test equipment.

### RADAR

Study, analysis, development, and design in highly advanced radar techniques, and electronic countermeasures.

### ANTENNAS

Research, development, and design of airborne antennas in low-frequency, UHF, and microwave regions for missiles, radar, and countermeasures equipment.

### PACKAGING

Encapsulation and subminiaturization design for reliability and produceability in missile guidance and control equipment systems, airborne radar systems, operational systems test equipment, closed-loop TV systems, etc.

Career-minded men with several years specialized experience, and preferably with advanced degrees, are invited to join our rapidly expanding programs in industrial and military electronics.

Address inquiries to:

Technical Employment Manager

**FARNSWORTH ELECTRONICS CO.,**  
**Fort Wayne, Indiana**  
A division of International Telephone and Telegraph Corp.

## ENGINEERS

### Find Out About GPL's INTEGRATED APPROACH To Research Engineering

A continuous flow of stimulating and varied projects are laid before the staff of General Precision Laboratory, Incorporated.

Sometimes research and development engineers work together as a cooperative, specialized professional team. Often one or two devote all their energies to a long-range basic problem. All are engaged in challenging work which encourages them to broaden their interests beyond their immediate fields of concentration. There is particular opportunity for components application engineers of several types.

Your family will enjoy your career at GPL as much as you, for you'll make your home in beautiful Westchester, noted for its high standard of living. Only an hour away is New York City, with all its famous cultural and educational advantages.

### GENERAL PRECISION LABORATORY INC.

A subsidiary of General Precision Equipment Corporation  
63 Bedford Road  
Pleasantville, New York

### WHAT GOES ON IN THE GP LAB:

#### RESEARCH & DEVELOPMENT WORK IN:

Electronics

Television

Aircraft & Missile Guidance, Control, Simulation

Radar, Microwave, Ultrasonics

Systems Engineering: (aeronautical, naval, industrial)

Precision Mechanics, Ceramics, Optical Devices

Instruments, Servos, Controls: (hydraulic, pneumatic, magnetic, electronic)

Expenses will be paid for qualified applicants who come for interview. We regret we can consider only U.S. citizens. Please write complete details to Mr. H. F. Ware

## ENGINEERS

THE APPLIED PHYSICS LABORATORY OF THE JOHNS HOPKINS UNIVERSITY offers an exceptional opportunity for professional advancement in a well-established Laboratory with a reputation for the encouragement of individual responsibility and self-direction.

Our program of

### GUIDED MISSILE RESEARCH and DEVELOPMENT

provides such an opportunity for men qualified in:

- DESIGN AND ANALYSIS OF PULSE CIRCUITS
- RESEARCH AND DEVELOPMENT IN RADAR AND MICROWAVES
- ELECTRONIC PACKAGING
- DEVELOPMENT OF TELEMETERING, DATA PROCESSING, AND SPECIAL SWITCHING EQUIPMENT
- MAGNETIC AMPLIFIER DESIGN AND ANALYSIS
- DEVELOPMENT AND APPLICATION OF PRINTED CIRCUITS
- SERVOMECHANISMS AND CONTROL-SYSTEM ANALYSIS

Please send your resume to Professional Staff Appointments

APPLIED PHYSICS LABORATORY  
THE JOHNS HOPKINS UNIVERSITY  
8603 Georgia Avenue  
Silver Spring, Maryland



(Continued from page 150A)

**CHEMISTS, ENGINEERS, PHYSICISTS,  
PATENT AGENTS**

Florida firm with Manhattan office has several positions available for research and development on radioactive batteries. Vacuum evaporation experience is helpful but not essential. Radiation Research Corp., 140 Cedar St., New York 6, N.Y.

**ENGINEERS**

We want experience in magnetic amplifiers, analog computers, servomechanisms and electronic systems. Juniors to \$120.00 per week. Intermediates to \$140.00 per week. Box 825.

**PATENT RESEARCH ENGINEER**

Engineering Degree, Electrical or Electronics major preferred for opening involving technical research and report preparation based on aeronautic applications. Opportunity for an engineering graduate interested in entering the patent field. Liberal salary commensurate with experience and educational qualifications. Pension plan. Nationally known organization located in New York City. Box 826.

**MISSILES SYSTEMS ENGINEERS**

For work on radar indicator circuits, digital computers, systems analysis, missile planning. Submit inquiries to Engineering Personnel Division, Sperry Gyroscope Co., Great Neck, L.I., N.Y.

**ASSISTANT OR ASSOCIATE PROFESSOR**

Ph.D. preferred to teach undergraduate and evening graduate courses. Specialist in Communication or Computers preferred. Salary on 9 month basis competitive, with opportunity for local summer employment for right man. High altitude, dry climate. Write Chairman, Elect. Engr. Department, University of New Mexico, Albuquerque.

**TECHNICAL SALES ENGINEER**

A medium-sized southern New England manufacturer of technical papers used by the electronics industry has a challenging position for an electrical engineer under 35. Some selling or administrative experience is desirable. He must have a strong persuasive personality and be capable of working with both technical and non-technical people. Salary open. Include resume of personal history, education, and experience with introductory letter to Box 827.

**ELECTRONIC ENGINEERS**

Must have 2 to 6 years experience in the design of I.F., V.H.F., and/or U.H.F. broad band systems. Progressive L.I. firm; many benefits. Send resume or phone for appointment: Mr. G. W. Fellendorf, Pioneer 2-5300, Instruments for Industry, Inc., 150 Glen Cove Road, Mineola, N.Y.

**ASSISTANT PROFESSOR**

Assistant professor of Electrical Engineering, University of North Dakota, Grand Forks, North Dakota. Duties: teaching electronic and communications courses to undergraduate students. An advanced degree plus some teaching or industrial experience preferred. Submit resume of education and experience to Head, Electrical Engineering Dept.

**ELECTRONICS ENGINEERS**

Degrees in electrical or electronic engineering with at least 2 years related experience, to conduct and supervise junior engineers and technicians on qualification testing and evaluation of electronic components. Analyze test programs and instrumentation, design test methods, evaluate completed data and prepare final reports. Age: 25 to 40. U. S. Testing Company, Inc., 1415 Park Avenue, Hoboken, N.J.

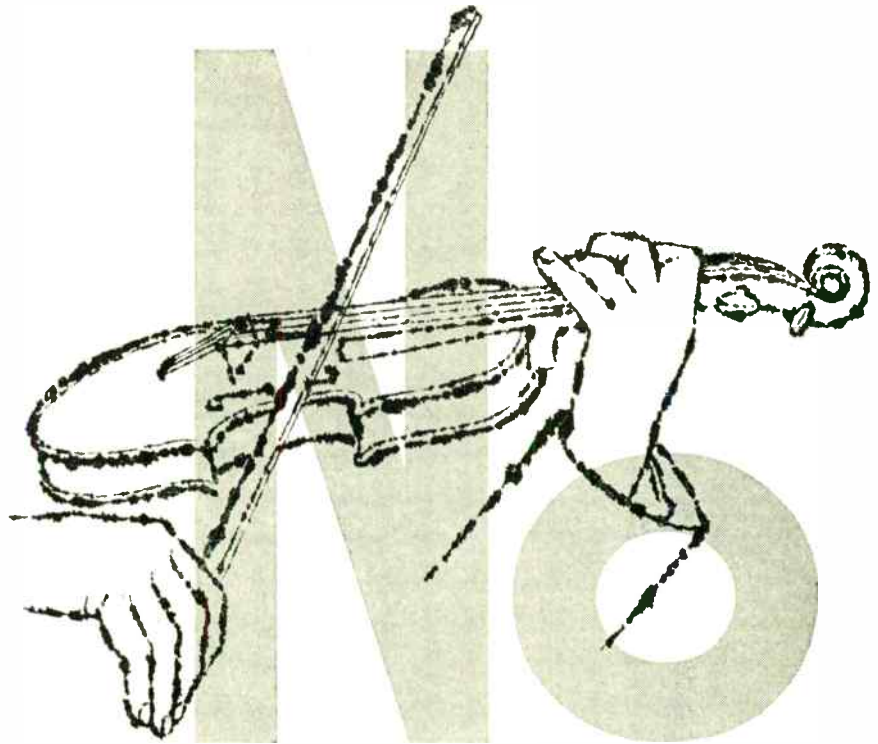

**violin music**

The demand exceeds the supply. It's that simple!

With 3 engineering jobs available for every 2 engineers, some 5,000 companies are bidding for you with offers, inducements and background music. But don't be mistaken! Most of today's "opportunities" are *jobs*, not futures.

We, too, want engineers. But we're offering no violin music—only the opportunity for intelligent and careful evaluation—you of us and we of you—with the possibility of your joining one of the finest team operations in the whole new world of flight systems development.

Most of the people on that team are young, and moving ahead fast. They weren't lured here. They found out—and figured out—for themselves. We hope you'll do that too.

Write to J. M. Hollyday, Dept. P-9, The Glenn L. Martin Company, Baltimore 3, Maryland.



**MARTIN**  
BALTIMORE · MARYLAND



**mri** •

*needs competent men in:*

Instrumentation and Control  
Electro-mechanics  
Servo Mechanisms  
Applied Mechanics  
Ballistics

Structural Analysis  
Aerodynamics  
Fluid Mechanics  
Electronics and Communications  
Design

**Do You Want To:**

- solve some of industry's toughest technical problems—
- work on projects assigned by the nation's most progressive corporations—
- work on area-wide regional research problems—
- work in a completely new 80,000 sq. ft. research center—
- have a real personal sense of professional accomplishment—

Midwest Research Institute is one of the country's largest independent research and development organizations created to meet the requirements of the rapidly increasing industrial expansion of the midwest. In its first ten years it has completed a multitude of assignments for numerous sponsoring organizations. It has a well oriented staff of scientists and engineers representing 61 different universities in this country and abroad. It has a tremendous record of productive research, as evidenced by its repeat projects in which we take modest pride.

*If you would like to become a part of this plan and learn more about the MRI story*

Write to:

F. N. Stephens, Manager  
Engineering Division  
Midwest Research Institute  
425 Volker Blvd.  
Kansas City 10, Missouri

**MIDWEST RESEARCH INSTITUTE**  
KANSAS CITY, MISSOURI

**positions  
available  
at KOLLSMAN**

These are permanent positions with Kollsman, designers of America's finest aircraft instruments... a progressive, growing organization in which the atmosphere is friendly, the facilities of the best, and the employee benefit program liberal.

Please submit complete resumes, preliminary to confidential interview, to the Employment Manager.



**kollsman** INSTRUMENT CORPORATION

80-08 45th AVENUE, ELMHURST, NEW YORK • SUBSIDIARY OF *Standard* COIL PRODUCTS CO. INC.

**UHF RECEIVING EQUIPMENT ENGINEER** Capable of creative work on advanced UHF amplifiers and oscillator circuits.

**VIDEO CIRCUITS ENGINEER** For creative work with multi-vibrator, gate and pulse circuits.

**SENIOR ELECTRONIC ENGINEERS** For development of component systems and test equipment associated with aircraft navigational equipment.

**DESIGNERS**

**Electronic, Electro-Mechanical, Mechanical**

1. Electronic or electrical packaging. Knowledge of sub-miniaturized techniques. Work is associated with servos, amplifiers and components.
2. Mechanical or electro-mechanical packaging of precision flight instruments.



**Industrial Engineering Notes**

(Continued from page 142A)

public, since they were really developmental and prototype models. Making any predictions about next year is really not advisable until we can get a more definite measure of this year, but today's commonly accepted figure is that some 150,000 sets will be made in 1956. Several years from now, and on into 1960 or so, it is probable that about one-third of all sets produced will be color sets, and that color will be nearing two-thirds of all sets in nine or ten years. In other words, it will be six or seven years before color set production catches up with black-and-white." . . . A committee of engineers appointed by the Senate Interstate and Foreign Commerce Committee to study the present allocation of the spectrum and other engineering matters related to TV (RETMA Industry Report, Vol. 11, No. 25) held its first meeting and named Professor Edward Bowles of the Massachusetts Institute of Technology as permanent Chairman. Donald Fink, of Philco Corp., representing RETMA, was named Secretary. In addition to Edward Bowles and Donald Fink, other members of the engineering committee are: Allen B. DuMont and Robert Wakeman of Allen B. DuMont Laboratories, Inc.; radio engineering consultants C. M. Jansky and S. Bailey; William Duttera, National Broadcasting Co.; Frank Marx, American Broadcasting Co.; William Lodge, Columbia Broadcasting System; Ralph Harmon, Westinghouse Broadcasting Co., Inc.; Haraden Pratt, Institute of Radio Engineers; Curtis Plummer, Federal Communications Commission, and engineering consultant T.A.M. Craven.



**IRE People**

Consolidated Engineering Corporation has appointed R. B. Hurley (S'44-A'47), a transistor specialist, to its Research Division as a senior research engineer.

Prior to his appointment by Consolidated, Mr. Hurley spent three years as senior electronics engineer with Convair, Pomona. Earlier, he was an engineer with Aerojet-General Corporation, Azusa, California; U. S. Electrical Motors, Los Angeles, and General Electric Company, Schenectady, New York. He is also a part-time lecturer in engineering at the University of California in Los Angeles.



R. B. HURLEY

He is author of two articles on transistor amplifiers which appeared recently and "Predictable Design of Transistor Ampli-

(Continued on page 156A)



If you are interested in guided missiles this book will interest you. Here is one of the most complete guides to job opportunities in the guided missile field yet published. In this book, you will find not only a complete outline of the objectives and accomplishments of the Bendix Guided Missile Section, but also a detailed background of the functions of the various engineering groups such as system analysis, guidance, telemetering, steering intelligence, component evaluation, missile testing, environmental testing, test equipment design, reliability, propulsion, and other important engineering operations. Send for your free copy today.

# 23 challenging opportunities in the newest and fastest growing branch of the aviation industry are now open

Bendix job opportunities in guided missiles range from top senior engineers to assistant engineers, junior engineers, technicians, and a score of other assignments.

Qualified men are given real job responsibility with Bendix and grow with the development of what is not only the nation's most important weapon system, but a project that will undoubtedly lead to new and important long-range commercial applications.

And at Bendix you will be associated with top missile authorities and have at your command unexcelled engineering and manufacturing facilities.

If you are interested in a future in guided missiles, the first step is to fill out the coupon and mail it to us today.

Missile Section, Employment Department M  
Bendix Products Division, Bendix Aviation Corporation  
401 North Bendix Drive, South Bend, Indiana

Please send me a copy of the book  
"Your Future in Guided Missiles."

Name \_\_\_\_\_

Address \_\_\_\_\_

City \_\_\_\_\_

State \_\_\_\_\_

# ENGINEERS



Fulfill professional and personal objectives . . . with an outstanding firm in its field.

Challenging openings for experienced engineers with degrees or equivalent experience in:

- ELECTRICAL
- ELECTRONIC
- MECHANICAL

Research, Development, Design & Field Engineering on:

- Countermeasures
- Navigation Systems
- Guidance Systems
- Fire Control Radar Systems
- Beacons
- Electronic Installation
- Underwater Sound Systems
- Flight Simulators
- Antennas
- Magnetic Amplifiers
- Radar & Sonar Trainers
- Telemetering
- Communications Equipment
- Circuit Design

- DEVELOPMENT ENGINEERS  
Junior & Senior
- FIELD ENGINEERS  
(Local & Field Assignments)

## WHAT STAVID OFFERS YOU

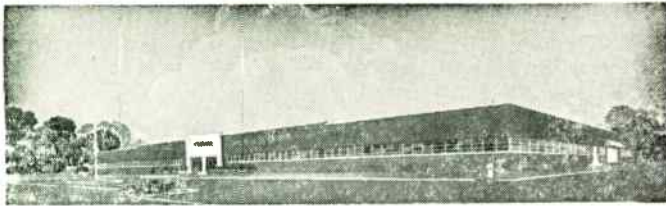

### LOCATION:

On U.S. Highway 22, thirty miles (45 minutes) from New York City, near the beautiful Watchung Mountains, and within one hour's drive to the seashore. Enjoy all the advantages of the city, the mountains, and the seashore, as well as excellent schools, homes, churches and shopping facilities all conveniently located.

### ENVIRONMENT:

One of the finest plants of its kind . . . spacious, modern, air-conditioned. Conducive to bringing out the best of your abilities!

### ABOUT THE COMPANY:

Organized in 1945. Engaged in research, design and development for the Armed Services. The company has steadily progressed and grown since its inception, and now employs over 400. Positions are permanent, with opportunities for your development matching our own constant expansion.

### ITS BENEFITS:

- Pension Plan
- Paid Vacations
- Group Life Insurance
- Education & Tuition Assistance
- Paid Holidays
- Other Group Insurances
- Paid Sick Leave
- Recreational programs: golf, softball, bowling, picnics, dances.

Interviews in Your Community by Appointment

*Send resume, write or call for additional information.*



## STAVID ENGINEERING, INC.

U.S. Highway 22, Watchung, P.O. Plainfield, N.J. Plainfield 7-1600



(Continued from page 154A)

fiere," will appear this fall in Tele-Tech & Electronic Industries.

Holder of the M.S. degree in electrical engineering from the University of Southern California, Mr. Hurley is a member of Phi Beta Kappa, Eta Kappa Nu, Sigma Xi, Tau Beta Pi, American Institute of Electrical Engineers, and the Scientific Research Society of America.



The appointment of T. R. Kennedy Jr. (SM'48), to the public relations staff of Allen B. Du Mont Laboratories, Inc., has been announced.

For twenty-five years Mr. Kennedy was a member of the radio-television news and editorial staff of The New York Times. He began newspaper work in 1925 at the Pittsburgh Post & Sun, being radio editor and radio advertising manager. A year later he joined the Philadelphia Evening Ledger as technical radio editor.

Mr. Kennedy studied electrical engineering at Carnegie Institute of Technology, Pittsburgh, and joined the U. S. Navy at the beginning of World War I. He attended the Navy Radio School at Harvard University, received a commission, and was transferred to the Boston Navy Yard, where he helped design, construct, and install the radio compass.

Mr. Kennedy is a member of the Audio Engineering Society, a fellow of the Radio Club of America, and a member of the Radio Pioneers.



Lester M. Field (M'48-F'52) has been appointed Head of the Electron Tube Laboratory, Hughes Aircraft Company Culver City, California. He comes to Hughes with a background in tube research and development acquired at the Bell Telephone Laboratories and as head of tube research projects at both Stanford University and the California Institute of Technology. He will continue to be associated with the faculty at the California Institute of Technology to help maintain the research program in progress there.

Dr. Field's honors include one of the Eta Kappa Nu Outstanding Young Electrical Engineer Awards for 1949, and election to Fellow of the Institute of Radio Engineers. He is also a member of Tau Beta Pi, Sigma Xi, the American Association of University Professors, and the American Physical Society.



J. W. Thatcher (SM'46), formerly an engineering executive at Western Electric Company, has been appointed Customer Service Manager of Pasadena's Electro-Data Corporation.

Mr. Thatcher will head a department of computer engineers and technicians,

(Continued on page 161A)

# PROGRESS REPORT

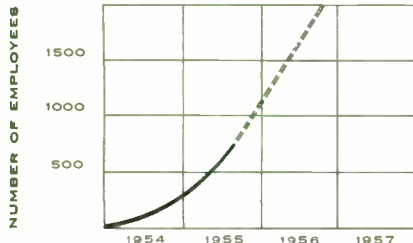

## PROJECTS

Our eight current military contracts support a broad range of advanced development work in the fields of modern communications, digital computing and data-processing, fire-control, and guided missiles. This work is supplemented by non-military activities in the fields of operations research, automation, and data-processing.

## FINANCES

In 1954, our first full year of operation, we showed a good profit. Of greater importance, however, are the arrangements recently completed with Thompson Products, Inc., our corporate associate, whereby we are assured additional funds up to \$20,000,000 to finance our expansion requirements of the next few years, and insure the long-range stability of the company.

## The Future

Our first year and a half of corporate history encourages us in the belief that our future will be one of expanding productivity. But whether we remain a small company or grow large, we plan not to lose sight of the fact that the continued success of The Ramo-Wooldridge Corporation depends on our maintaining an organizational pattern, a professional environment, and methods of operating the company that are unusually well suited to the very technical, very special needs of modern systems development and manufacturing.

# After Twenty-One Months...

## RESEARCH AND DEVELOPMENT PERSONNEL

Total population figures, such as those displayed in the curve, tell only a limited story. Personnel quality factors are most important, in our kind of business. We believe we are doing well in this respect. Of the 90 Ph.D.'s, 65 M.S.'s and 75 B.S.'s or B.A.'s who today make up our professional staff, a gratifyingly high percentage are men of broad experience and, occasionally, national reputation in their fields.

## FACILITIES

By mid-1956 our Los Angeles facility will consist of seven buildings totalling 300,000 square feet of modern research and development space. Two of the three buildings now complete and occupied are shown at bottom of this page; a fourth and fifth are presently under construction, the others are in the design stage.



## MANUFACTURING

We are somewhat ahead of the usual systems development schedule, with some of our projects having arrived at the field and flight-test stages. We are now planning a facility for quantity production of electronic systems. Construction on the initial unit of 160,000 square feet (shown above) is expected to start in late 1955, with manufacturing planned for late 1956.

# The Ramo-Wooldridge Corporation

8820 BELLANCA AVE., LOS ANGELES 45 CALIFORNIA.

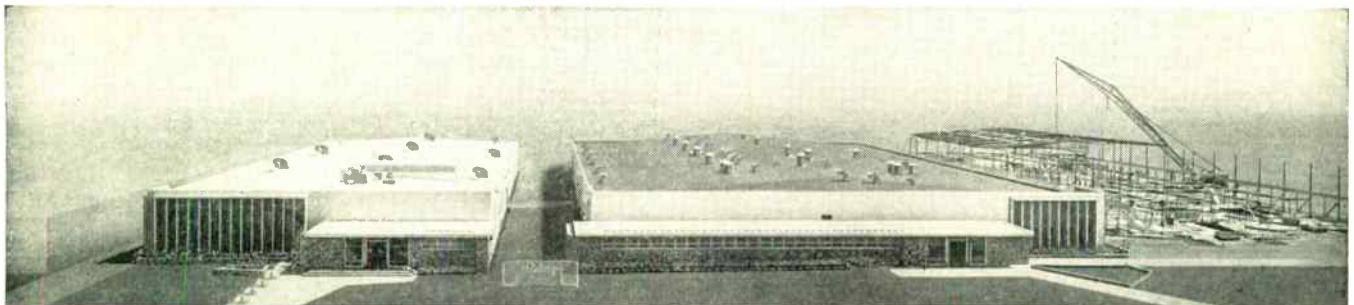

Take a look at the record.

**WITHIN THE LAST YEAR,  
MORE THAN 500  
EXPERIENCED ENGINEERS AND SCIENTISTS\*  
CHOSE DESIGN AND DEVELOPMENT CAREERS  
WITH RCA!**



Today... RCA opens  
new opportunities for you to join  
these progressive, creative engineers in...

**NEW EXTENDED  
SYSTEMS  
ENGINEERING  
CONCEPTS**

**NEW,  
MOST ADVANCED  
ELECTRONIC DATA  
PROCESSING  
SYSTEMS**

**AN ENTIRELY  
NEW PROGRAM  
IN  
GUIDED MISSILE  
ELECTRONICS**

**NEW CHALLENGES  
IN  
AVIATION  
ELECTRONICS**

**NEW FIELDS  
IN  
ELECTRON TUBE  
DEVELOPMENT**

RCA advancement creates opportunities with a future... openings which are available today for engineers and scientists who can move ahead professionally with the world leader in electronics. At the RCA engineering locations listed in the chart, you'll find the kind of living and working conditions you and your family consider most attractive.

RCA offers you... facilities unsurpassed in the electronics industry... everyday association with top engineers and scientists. Plus RCA benefits that include: tuition refund plan, a company-paid insurance program for you and the family, modern retirement plan, relocation assistance. A carefully-planned advancement program helps you move ahead financially and professionally!

\* RCA was also chosen by several hundred recent engineering graduates, field service engineers and other categories of experienced professional engineers or scientists.



... with your future in mind

Check the chart below for  
positions which interest you most...

| FIELDS OF ENGINEERING ACTIVITY  | TYPE OF DEGREE AND YEARS OF EXPERIENCE PREFERRED |                  |                  |                      |                  |                  |                  |                  |                  |   |     |    |
|---|--|------------------|------------------|----------------------|------------------|------------------|------------------|------------------|------------------|---|-----|----|
|   | Electrical Engineers                             |                  |                  | Mechanical Engineers |                  |                  | Physical Science |                  |                  | Chemistry<br>Ceramics<br>Glass Technology<br>Metallurgy |     |    |
|   | 1-2  | 2-3              | 4+               | 1-2                  | 2-3              | 4+               | 1-2              | 2-3              | 4+               | 1-2   | 2-3 | 4+ |
| <b>SYSTEMS</b><br><i>(Integration of theory, equipments, and environment to create and optimize major electronic concepts.)</i>   |  |                  |                  |                      |                  |                  |                  |                  |                  |   |     |    |
| <b>AIRBORNE FIRE CONTROL</b>  |  |                  | W                |                      |                  |                  |                  |                  | W                |   |     |    |
| <b>DIGITAL DATA HANDLING DEVICES</b>  |  |                  | C                |                      |                  | C                |                  |                  | C                |   |     |    |
| <b>MISSILE AND RADAR</b>  |  |                  | M                |                      |                  | M                |                  |                  | M                |   |     |    |
| <b>INERTIAL NAVIGATION</b>  |  |                  | M                |                      |                  | M                |                  |                  | M                |   |     |    |
| <b>COMMUNICATIONS</b>   |  |                  | C<br>I           |                      |                  |                  |                  |                  | C<br>I           |   |     |    |
| <b>DESIGN • DEVELOPMENT</b>   |  |                  |                  |                      |                  |                  |                  |                  |                  |   |     |    |
| <b>COLOR TV TUBES</b> —Electron Optics—Instrumental Analysis—Solid States (Phosphors, High Temperature Phenomena, Photo Sensitive Materials and Glass to Metal Sealing)                               | L  | L                | L                | L                    | L                | L                | L                | L                | L                | L   | L   | L  |
| <b>RECEIVING TUBES</b> —Circuitry—Life Test and Rating—Tube Testing—Thermionic Emission   | H  | H                | H                |                      | H                | H                |                  | H                | H                |   | H   | H  |
| <b>SEMI-CONDUCTORS</b> —Transistors—Semi-Conductor Devices  | H  | H                | H                |                      |                  |                  | H                | H                | H                |   |     |    |
| <b>MICROWAVE TUBES</b> —Tube Development and Manufacture (Traveling Wave—Backward Wave)   |  | H                | H                |                      | H                | H                |                  | H                | H                |   | H   | H  |
| <b>GAS, POWER AND PHOTO TUBES</b> —Photo Sensitive Devices—Glass to Metal Sealing   | L  | L                | L                | L                    | L                | L                | L                | L                | L                | L   | L   | L  |
| <b>AVIATION ELECTRONICS</b> —Radar—Computers—Servo Mechanisms—Shock and Vibration—Circuitry—Remote Control—Heat Transfer—Sub-Miniaturization—Automatic Flight—Design for Automation—Transistorization | C<br>X   | C<br>F<br>X      | M<br>C<br>F<br>X | C<br>X               | C<br>F<br>X      | M<br>C<br>F<br>X | C<br>X           | C<br>F<br>X      | M<br>C<br>F<br>X |   |     |    |
| <b>RADAR</b> —Circuitry—Antenna Design—Servo Systems—Gear Trains—Intricate Mechanisms—Fire Control  | C<br>X   | M<br>C<br>F<br>X | M<br>C<br>F<br>X | C<br>X               | M<br>C<br>F<br>X | M<br>C<br>F<br>X | C<br>X           | M<br>C<br>F<br>X | M<br>C<br>F<br>X |   |     |    |
| <b>COMPUTERS</b> —Systems—Advanced Development—Circuitry—Assembly Design—Mechanisms—Programming   | C  | C<br>F<br>X      | M<br>C<br>F<br>X | C                    | C<br>F           | M<br>C<br>F<br>X | C                | C<br>F           | M<br>C<br>F      |   |     |    |
| <b>COMMUNICATIONS</b> —Microwave—Aviation—Specialized Military Systems  | C  | C<br>F           | M<br>C<br>F      |                      | C<br>F           | M<br>C<br>F      |                  | C<br>F           | M<br>C<br>F      |   |     |    |
| <b>RADIO SYSTEMS</b> —HF-VHF—Microwave—Propagation Analysis—Telephone, Telegraph Terminal Equipment   |  | I<br>F           | I<br>F           |                      | I<br>F           | J<br>F           |                  | I<br>F           | I<br>F           |   |     |    |
| <b>MISSILE GUIDANCE</b> —Systems Planning and Design—Radar—Fire Control—Shock Problems—Servo Mechanisms   |  | M<br>F           | M<br>F           |                      | M<br>F           | M<br>F           |                  | M<br>F           | M<br>F           |   |     |    |
| <b>COMPONENTS</b> —Transformers—Coils—TV Deflection Yokes (Color or Monochrome)—Resistors   | C  | Z<br>C<br>X      | Z<br>C<br>X      | C                    | Z<br>C           | Z<br>C           | C                | C<br>C           | C                |   | Z   | Z  |
| <b>MACHINE DESIGN</b><br>Mech. and Elec.—Automatic or Semi-Automatic Machines   |  | L                | L                |                      | L                | L                |                  | L                | L                |   |     |    |

**Location Code**

- C—Camden, N. J.—in Greater Philadelphia near many suburban communities.
- F—Florida—on east central coast
- H—Harrison, N. J.—just 18 minutes from downtown New York.
- I—International Div.—New York City and Overseas.

- L—Lancaster, Pa.—about an hour's drive west of Philadelphia.
- M—Moorestown, N. J.—quiet, attractive community close to Phila.
- W—Waltham, Mass.—near the cultural center of Boston.
- X—Los Angeles, Calif.—west coast electronics center.
- Z—Findlay, Ohio—pleasant, small midwestern town.

Please send resume of education and experience, with location preferred, to:

**Mr. John R. Weld, Employment Manager**  
Dept. A-13J, Radio Corporation of America  
30 Rockefeller Plaza  
New York 20, N.Y.



**RADIO CORPORATION of AMERICA**

Copyright 1955 Radio Corporation of America

# ENGINEERS

for immediate placement

## ENGINEERING AT NCR:

1. Immediate, permanent positions in Mechanical and Electrical Engineering Divisions.
2. Engineering project work in Adding Machines, Cash Registers, Accounting Machines, Computers, and related Data Processing Equipment in Dayton, Los Angeles, and Ithaca, New York.
3. Work involving design, development, and production engineering of mechanical, electronic, and electromechanical devices.
4. Some experience in development, design, and application of high-speed, light-weight mechanisms of the intermittent motion type is desirable, but not essential.
5. Ample training and indoctrination is available to all employees.

**ACT AT ONCE**—Send resume of your education and experience to: **EMPLOYMENT DEPARTMENT, TECHNICAL PROCUREMENT SECTION**

## THE NATIONAL CASH REGISTER COMPANY

Dayton 9, Ohio

ELECTRICAL ENGINEERS  
MECHANICAL ENGINEERS  
ELECTRONIC ENGINEERS  
MECHANICAL DRAFTSMEN

**AS AN NCR ENGINEER** you, with your family, will enjoy:

1. **UNLIMITED OPPORTUNITY** in the broad, ever-expanding field of Business Machine Engineering.
2. **AN EXCELLENT SALARY**, plus exceptional benefits of lifetime value for you and your family.
3. **A RECREATIONAL PROGRAM** for year-round enjoyment of the entire family including a new Country Club with 36 holes of golf, and a 166-acre park for outings with swimming, boating, and supervised play for the children.
4. **LIVING IN DAYTON . . .** considered one of the cleanest and most attractive cities in the Midwest with outstanding school facilities.
5. **YOUR WORK AT NCR** with its friendly, family atmosphere, with its employee morale at a very high level, and with people who, like yourself, have decided to build their professional future with NCR.

**ENGINEERS**  
DESIGNERS-DRAFTSMEN  
Electronic Mechanical

**Keep Your  
Eye  
on the  
Ball**

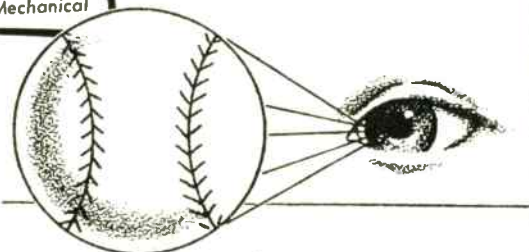

In your career, as in successful baseball, golf or tennis, it pays to keep your eye on the ball. Keep your eye on the advantages only a young, yet securely established company can offer. Melpar is young enough to welcome new ideas, to recognize and award achievement, yet big enough to offer stability and growth to those who look to the future.

Superb new laboratory facilities just completed this year; an engineering staff of the highest calibre; long-range military and industrial research programs; and an ideal family environment in pleasant Fairfax County in northern Virginia . . . these are just some of the many benefits you'll find as a member of the Melpar staff.

Keep your eye on a career with Melpar, leader in electronic research and development.

For personal interview send resume to  
Technical Personnel Representative,



**melpar, inc.**

Subsidiary of Westinghouse Air Brake Co.

3000 Arlington Blvd., Dept. IRE-20, Falls Church, Virginia or 11 Galen St., Watertown, Mass.

- Network Theory
- Systems Evaluation
- Automation
- Microwave Technique
- UHF, VHF or SHF Receivers
- Analog Computers
- Digital Computers
- Magnetic Tape Handling Equipment
- Radar & Countermeasures
- Packaging Electronic Equipment
- Pulse Circuitry
- Microwave Filters
- Flight Simulators
- Servomechanisms
- Subminiaturization
- Electro-Mechanical Design
- Quality Control & Test Engineers

**ELECTRONIC DESIGN ENGINEERS**  
capable of  
**ASSUMING RESPONSIBILITY**

To perform basic design and direct experimental laboratory work in the development of new equipment.

The desire and ability to progress with an expanding engineering and production organization will yield ample opportunity for advancement.

The position affords excellent working conditions, modern equipment, and usual fringe benefits.

Salary will be commensurate with background and ability.

**BELL SOUND SYSTEMS**

Electronics Division of

**THOMPSON PRODUCTS, INC.**

555 Marian Road, Columbus, Ohio



(Continued from page 156A)

responsible for nationwide installation and maintenance of "DATATRON" high-speed electronic data processing machines.

During 26 years with Western Electric, Mr. Thatcher has held a variety of posts, most recent of which was the west coast managership of field engineering service for electronic equipment purchased by the Air Force. Previously he was west coast representative of the Nike contract manager. He has served also as manager of the Wesco Field Modification Shop and general manager of Sound Services, Inc., a Western Electric subsidiary.

He is a graduate of the California Institute of Technology.



The election of **Richard Hodgson** (M'47-SM'51) as a Vice-President of Fairchild Camera and Instrument Corporation has been announced. At the same time, Mr. Hodgson was promoted from the position of Trend Planning Director to that of General Manager of the Company's Reconnaissance Systems Division.

Mr. Hodgson was one of the organizers of Chromatic Television Laboratories, Inc., which pioneered in the development of manufacture of color television picture tubes based on the invention of Dr. E. O. Lawrence. He was president of the firm when he joined Fairchild, and continues to serve on the board of directors.

His association with the military dates back to 1942 when he was a research staff member of M.I.T.'s Radiation Laboratory working on microwave radar developments. His work included liaison with Air Force Laboratories at Wright Field on airborne radar developments and operational applications. In 1944 he was given leave and assigned to the office of the Secretary of War as an expert consultant on radar. During this period he also served as civilian radar advisor to General Hoyt B. Vandenburg, then Commanding General of the 9th Air Force.

He also served as a consultant to the Department of the Air Force in 1952 and 1953, advising on the organization of the research and development program as part of a three-man advisory group headed by Lt. General James H. Doolittle. This work led to the establishment of the Air Research and Development Command.

He also has been Director of Television Development for Paramount Pictures Corporation; Assistant Treasurer of Allen B. DuMont Laboratories, Inc.; head of the Engineering Management Division of Brookhaven National Laboratory, A.E.C.; a senior change board engineer for Lockheed Aircraft Corp. and a manufacturing and process economic analyst for Standard Oil Company of California.

He is a member of the Society of Motion Picture and Television Engineers and has served on many industry committees of the Radio-Electronics-Television Manufacturers Association.

(Continued on page 162A)

# transistor and digital computer techniques

APPLIED TO THE DESIGN, DEVELOPMENT AND APPLICATION OF

*AUTOMATIC RADAR DATA PROCESSING,  
TRANSMISSION AND CORRELATION  
IN LARGE GROUND NETWORKS*

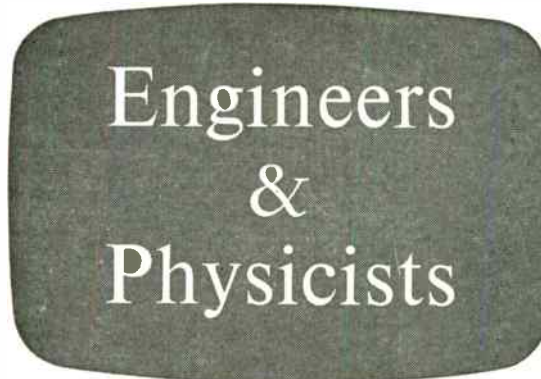

## Engineers & Physicists

*Digital computers similar to successful Hughes airborne fire control computers are being applied by the Ground Systems Department to the information processing and computing functions of large ground radar weapons control systems.*

The application of digital and transistor techniques to the problems of large ground radar networks has created new positions at all levels in the Ground Systems Department. Engineers and physicists with experience in the fields listed, or with exceptional ability, are invited to consider joining us.



- TRANSISTOR CIRCUITS • DIGITAL COMPUTING NETS •
- MAGNETIC DRUM AND CORE MEMORY • LOGICAL DESIGN •
- PROGRAMMING • VERY HIGH POWER MODULATORS AND
- TRANSMITTERS • INPUT AND OUTPUT DEVICES •
- SPECIAL DISPLAYS • MICROWAVE CIRCUITS

*Scientific and Engineering Staff*

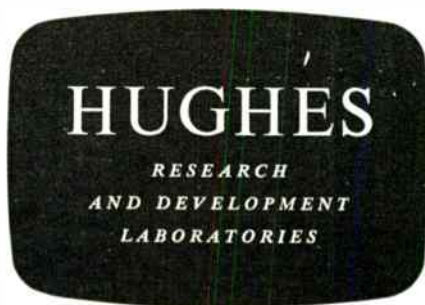

## HUGHES

RESEARCH  
AND DEVELOPMENT  
LABORATORIES

Culver City, Los Angeles County, California

## Electronic and Electro-Mechanical Engineers

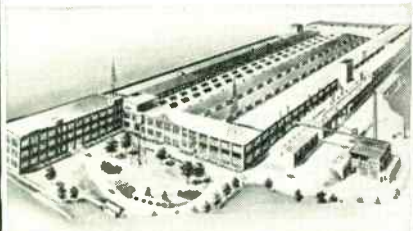

**Sparton can use your  
professional talents—  
Here's the place to  
GROW GROW GROW**

**Vital military electronics  
program—long range  
research and development**

- Television—  
Military and Domestic
- Under-water Acoustics
- Airborne  
Communications
- Guided Missiles
- Air and Sea Rescue  
Beacons
- Transistor Circuit  
Development
- Automation and  
Printed Circuit  
Development
- Electronic  
Counter-measures
- Servo Mechanisms
- Miniaturization

**You and your family will enjoy  
living in the Jackson area—  
in Michigan's Vacationland**  
Opportunities for graduate study nearby.



**Send resume of education  
and experience today to:**

Frank Norton, Director of Engineering  
Sparks-Withington Co., Jackson, Mich.  
Interview and relocation expenses paid for qualified applicants.



(Continued from page 161A)

The new Technical Products Division of Allen B. DuMont Laboratories, Inc. will be headed by P. S. Christaldi (S'35-A'40-SM'44-F'52) and will manufacture and sell the products formerly handled by the company's Instrument Division and Communication Products Division. It is initiating a program of expansion and diversification with especial emphasis on elements and systems for automation of industrial processes.



P. S. CHRISTALDI

Products manufactured by the new division include television station broadcasting and studio equipment, industrial television systems, cathode-ray and other electronic instruments, automotive test equipment, industrial electronics, components and systems, guided missiles test equipment, military electronic and electro-mechanical devices, and the newly developed complement of mobile radio equipment.

Dr. Christaldi has been associated with Allen B. DuMont Laboratories since 1938. His first duties were in the field of cathode-ray tube and cathode-ray oscillograph development, being expanded to include television receiving and transmitting operations when he was appointed Chief Engineer of the company in 1941. In 1947 he became Engineering Manager of the Instrument Division. He was made Assistant Manager of the division in 1952 and Manager in 1953. He is a member of Sigma Xi, the American Radio Relay League, the American Rocket Society, a Fellow of the Radio Club of America, and a fellow of the Institute of Radio Engineers. Dr. Christaldi is a member of the IRE Standards Committee, Chairman of the IRE Committee on Measurement and Instrumentation, a member of the IRE Subcommittee on Oscillography, chairman of the RETMA Committee on Oscillography, and IRE Delegate to the American Standards Association, Section C-39.



Franklin S. Cooper (A'46) research scientist and physicist, has been elected President and Director of Research of Haskins Laboratories Inc. of New York to succeed Caryl P. Haskins who has resigned to accept the presidency of the Carnegie Institution of Washington. Mrs. Anne Hinchey Gallagher was elected to serve as Treasurer and Assistant Secretary.

Franklin Cooper was born in Robinson, Illinois in 1908 and graduated from the University of Illinois. He received the

(Continued on page 165A)

## ENGINEERS PHYSICISTS METALLURGISTS

If you can see a limit to your job . . . then it's not big enough!  
Consider the future in

### MICROWAVE & POWER TUBES

and all that goes with it:

- making new ideas work
- designing manufacturable tubes
- an accelerating rate of growth
- fundamental training
- company sponsored courses
- long-term personal benefits
- an invitation to advance that has your name written on it

Come and look us over at our expense

Just drop a line to

Mr. A. A. Root  
POWER TUBE DEPARTMENT

**GENERAL ELECTRIC**  
Schenectady, N.Y.

## Is YOUR FUTURE as promising as the ATOM'S?

If you're not satisfied with your own answer to this question, you should investigate the opportunities at TRACERLAB, foremost company in the field of NUCLEAR APPLICATIONS.  
TRACERLAB needs . . .

**NUCLEAR ENGINEERS  
ELECTRONIC ENGINEERS  
ELECTRICAL ENGINEERS  
MECHANICAL ENGINEERS  
PHYSICISTS**

to work in research, development and applications of nuclear instrumentation. Openings are of a permanent and non-military nature, and offer outstanding opportunities for advancement. We would be pleased to have you consider the possibility of joining our successful and forward looking team.

Write in confidence to

**Tracerlab**  
130 HIGH ST., BOSTON 10, MASS.

# Now Republic Greatly Expands its Development and Experimental Activities



## Adding 425,000 sq. ft. of Floor Space

Republic Aviation has undertaken a vital and huge expansion program for its development and experimental activities. Many new opportunities at all levels of professional experience are open to scientists and engineers. If you seek a position where your abilities alone are the key to success, and where *company growth facilitates your advancement*, you owe it to your future to investigate these positions with Republic.

The large, modern building pictured above with 425,000 square feet adjoining Republic's Farmingdale plants has just been added. A corps of pioneer thinkers is working with minds unfettered by material restrictions of any kind, unhampered by hidebound tradition. New ideas being developed will be as record-setting as Republic's many past achievements in aircraft design.

The fast-broadening scope of these operations has created a large number of positions for men with a bent toward development work. *Why not make today a landmark in your career*, by checking into the opportunities open with our staff of development engineers and scientists? Republic's benefit program for its professional staff is unsurpassed; the pay scale is a model for the industry. Relocation expenses are paid.

### CHECK THESE NO-COST-TO-YOU REPUBLIC BENEFITS

- ✓ INTERVIEW EXPENSES paid for qualified candidates
- ✓ EDUCATIONAL REFUND PLAN pays up to 3% of tuition and laboratory fees
- ✓ LIFE, HEALTH & ACCIDENT INSURANCE—up to \$20,000 company-paid; plus hospital-surgical benefits for the whole family

### POSITIONS ARE OPEN AT ALL LEVELS IN THE FIELDS OF:

physics  
mathematics  
physical chemistry

operational analysis  
electronics  
servo-mechanisms  
fire control

missile armament  
aerodynamics  
thermodynamics  
stress analysis

vibration & flutter  
structural and  
mechanical design

*Convenient interviews will be arranged.*

Please forward complete resume to:  
Mr. R. L. Bortner, Dept. C  
Assistant Chief Engineer  
Administration



**REPUBLIC AVIATION**  
FARMINGDALE, L. I., N. Y.

# MISSILE SYSTEMS

## *Research and Development*

Broad interests and exceptional abilities are required of scientists participating in the technology of guided missiles. Physicists and engineers at Lockheed Missile Systems Division are pursuing advanced work in virtually every scientific field.

■ ■ ■

Below: Missile Systems scientists and engineers discuss future scientific exploration on an advanced systems concept with Vice President and General Manager Elwood R. Quesada. From left to right: Dr. Eric Durand, nuclear physicist, systems research laboratory; Ralph H. Miner (standing), staff division engineer; Dr. Montgomery H. Johnson, director, nuclear research laboratory; Elwood R. Quesada; Dr. Louis N. Ridenour (standing), director, program development; Willis M. Hawkins (standing), chief engineer; Dr. Joseph V. Charyk (standing), director, physics and chemistry research laboratory; Dr. Ernst H. Krause, director, research laboratories.

■ ■ ■

Scientific advances are creating new areas of interest for those capable of significant contribution to the technology of guided missiles.

*Lockheed* **MISSILE SYSTEMS DIVISION**

*research and engineering staff*

LOCKHEED AIRCRAFT CORPORATION • VAN NUYS, CALIF.



# NATIONAL ELECTRONICS CONFERENCE

Chicago, Oct. 3-5

# FALL MEETING AMERICAN INSTITUTE OF ELECTRICAL ENGINEERS

Chicago, Oct. 3-7

C. T. Petrie, A. A. Daush  
and senior members of  
the technical staff will be  
available for consultation  
at the Sherman Hotel,  
FRanklin 2-2100.

*Lockheed*

MISSILE SYSTEMS DIVISION



(Continued from page 162A)

Ph.D. degree in 1936 from the Massachusetts Institute of Technology. He was with the Research Laboratory of the General Electric Company until he joined Haskins Laboratories in 1939 where he has been Associate Director of Research.

Dr. Cooper was Senior Liaison Officer of the Office of Scientific Research and Development during the war, in charge of the exchange of scientific information with the Allies. He has served as consultant to the Secretary of Defense and to the Atomic Energy Commission of the United Nations. He is a member of various scientific and professional societies and of advisory committees of the Massachusetts Institute of Technology and New York University, and is Adjunct Professor of acoustic phonetics at Columbia University.



The appointment of W. Evan-Jones (A'54) to the Canadian Westinghouse Company Ltd., Electronics Division in Hamilton, Ontario has been announced. Mr. Evan-Jones will be responsible for the Sales Engineering promotion of the company's communication products across Canada.

Prior to joining the Canadian Westinghouse Company, Mr. Evan-Jones was with the Canadian Marconi Company as Assistant Sales Supervisor, Commercial Products Division Montreal; The Communications Group, Hydro Electric Power Commission of Ontario; and the Northern Electric Co. Ltd.

He has been actively engaged in communication engineering for the past fifteen years and is an Associate Member of the American Institute of Electrical Engineers.



Airborne Instruments Laboratory, Inc., Mineola, New York, announces the promotion of J. G. Stephenson (A'45-M'47-SM'50) to the position of assistant



J. G. STEPHENSON

Supervising Engineer of the Applied Electronics Section of the Research and Engineering Division.

In the ten years of his employment with Airborne Instruments Laboratory, he has been associated with major developments in the fields of UHF receivers, stable oscillators, and data-processing equipment.

Prior to his employment with Airborne Instruments Laboratory in 1945, Mr. Stephenson was a Research Associate at the Radio Research Laboratory of Harvard University, where he worked on

(Continued on page 166A)

## THE NORDEN LABORATORIES

Offers Unusual  
Opportunities For  
Competent Engineers

**ELECTRONIC  
ELECTRO-  
MECHANICAL**

For Research and  
Development work on

Radar  
Servo Mechanisms  
Microwave Equipment  
Antennas  
Infrared Equipment  
Communications Equipment  
Computers, Digital and  
Analog  
Gyroscopes  
Television

- Liberal Employee Benefits
- Merit Salary Reviews
- Excellent Working Conditions
- Ideally located in Westchester County

Please telephone or send  
resume and salary requirements  
to the Personnel Department.  
All inquiries will be handled  
in confidence.

## THE NORDEN LABORATORIES

121 Westmoreland Avenue  
White Plains, New York  
WHite Plains 6-4300

A division of

**NORDEN-KETAY  
CORPORATION**

## To the ENGINEER of high ability

AiResearch is looking for your kind of engineer. Through the efforts of engineers like yourself our company has become a leader in many outstanding aircraft accessory fields. Among them are: air-conditioning and pressurization, heat transfer, pneumatic valves and controls, electric and electronic controls, and the rapidly expanding field of small turbomachinery.

AiResearch is also applying this engineering skill to the vitally important missile accessory field.

Our engineers work on the very frontiers of present day scientific knowledge. We need your creative talents and offer you the opportunity to progress by making full use of your scientific ability.

Positions are now open for aerodynamicists... mechanical engineers... physicists... specialists in engineering mechanics... electrical engineers... electronics engineers.

For further information write today to Mr. Wayne Clifford, THE GARRETT CORPORATION, 9851 S. Sepulveda Blvd., Los Angeles 45, California. Indicate your preference as to location between Los Angeles and Phoenix.

**THE GARRETT CORPORATION**

AiResearch  
Manufacturing  
Divisions



(Continued from page 165A)

radar countermeasures. He also served with the American British Laboratory in England and was a Technical Observer in the Mediterranean Area.

Mr. Stephenson graduated from Yale University with the B.E. degree in 1939 and from Stanford University in 1941 with the Engineer degree. He is a member of the AIEE, Sigma Xi, and Tau Beta Pi.



Edward H. Weitzen, president of the Gruen Watch Company, has announced the appointment of **Gerald C. Schutz** (M'46 SM'50) as Director of Electronics.

Mr. Schutz was formerly associated with the Gibbs Manufacturing and Research Corporation as Director of Electronics. During his five years with the Gibbs Organization, he was responsible for the initiation of a number of development programs in the airborne radar navigation and countermeasures field.

Previously, Mr. Schutz was in charge of Airborne Radar Techniques development for the U. S. Air Force at Wright Field, Dayton, Ohio. With the Air Force from 1942 to 1950, he was concerned with the development of many radar test instruments including radar missile guidance and bombing systems.

Mr. Schutz is a graduate of the University of Illinois with the Bachelor of Science degree in electrical engineering. He is a member of Tau Beta Pi.



G. C. SCHUTZ



**P. J. Schenk** (A'43 SM'52), former executive officer to the Technical Assistant to the Secretary of the Air Force, has been appointed manager of marketing for the General Electric Light Military Electronic Equipment Department.



P. J. SCHENK

His new duties will include direction of the department's product planning, sales, contract negotiation, and product and field service activities.

Mr. Schenk for the past year has been manager of market research and product planning for the G. E. Heavy Military Electronic Equipment Department, Syracuse, N. Y.

Mr. Schenk, a Lieutenant Colonel in the USAF Reserve, joined G. E. in early 1954 following his Air Force assignments

(Continued on page 167A)

## Electronics Engineer

(MAGNETIC AMPLIFIER  
EXPERIENCE)

THE APPLIED PHYSICS LABORATORY OF THE JOHNS HOPKINS UNIVERSITY has open a Senior-Staff position in the theory and design of magnetic amplifiers and related devices for guided-missile controls. Applicants should have five years' electronic circuit experience, including one or more years in the magnetic-amplifier field.

### THE LABORATORY OFFERS—

A creative professional atmosphere, progressive wage policy, and excellent benefits with regard to vacation, pension, advanced education, etc.

Please send resume to:  
Professional Staff Appointments

### THE JOHNS HOPKINS UNIVERSITY APPLIED PHYSICS LABORATORY

8603 Georgia Avenue  
Silver Spring, Maryland

## WANTED ELECTRONIC ENGINEERS

Experienced in  
Power Supply Design  
for Military Applications

One of the country's oldest and largest manufacturers of electronic equipment requires the services of several competent electronic engineers familiar with military specifications and requirements for power supplies. Working environment and surroundings are congenial and stimulating. The company plant is situated in Long Island City.

Our employees are aware of this advertisement. Please furnish written resume and state salary required.

Box #828

Institute of Radio Engineers  
1 E. 79th St., New York 21, N.Y.



(Continued from page 166A)

as executive officer to Lt. Gen. James H. Doolittle, technical assistant to the Secretary of the Air Force; assistant military director of the Air Force Scientific Advisory Board; and executive officer to the Chief Scientist, USAF.

From mid-1951 to December, 1952, he served successively as deputy for research and as vice commander of the Air Force Cambridge Research Center, Cambridge, Mass. Previously, he served for two years on the Research and Development Planning Team of the office of the Deputy Chief of Staff, Development, USAF. From 1946 to 1949 he was chief, Aircraft Control and Warning Branch, Headquarters, USAF, and from 1943 to 1946 he was technical inspector and deputy signal officer of the 26th Fighter Command in Panama. He entered active duty with the Signal Corps in 1941, and for two years instructed and organized in the radio and radar school at Ft. Dix, N. J. He has a mobilization assignment to the Scientific Advisory Board, Office of the Chief of Staff, Headquarters, USAF.

A native of Vienna, Austria, Mr. Schenk came to this country with his parents at the age of 12 and settled in New York City. He won a four-year regional competitive scholarship to Lafayette College, Easton, Pa., and was graduated in 1941 with honors.



Administration of technical product sales for Allen B. DuMont Laboratories, Inc., will be handled by **G. Robert Mezger**, (A'37-V'A'39-SM'54), who has been named General Sales Manager of the Technical Products Division.



G. R. MEZGER

Mr. Mezger will supervise the Television Transmitter Sales Department, the Mobile Communications Sales Department, and the Technical Sales Department. He will be responsible for over-all sales planning, administration, and sales promotion for DuMont electronic and cathode-ray instruments, television transmitting and studio apparatus, mobile radio equipment, industrial cathode-ray tubes, and multiplier phototubes, electronic control apparatus, and industrial electronic devices.

Immediately prior to his new appointment, Mr. Mezger was Assistant Manager of the Instrument Division.

He first joined the DuMont organization in 1936, following his graduation from Rensselaer Polytechnic Institute. From 1936 to 1939 he was active in the engineering and development of cathode-ray instruments and was technical sales manager from 1939 until 1941, when he was assigned to active duty by the United States Navy. With the Navy he participated in instrument development work at the David

(Continued on page 169A)



# ENGINEERING OPPORTUNITIES

*for you!*

CONVAIR-Pomona is engaged in development, engineering and production of electronic equipment and complex weapons systems. The Convair-Pomona engineering facility is one of the newest and best equipped laboratories in the country. The work in progress, backed by Convair's outstanding record of achievement, offers excellent opportunities for recent graduates and experienced engineers in the following fields:

- ELECTRONICS**
- DYNAMICS**
- AERODYNAMICS**
- THERMODYNAMICS**
- OPERATIONS RESEARCH**
- HYDRAULICS**
- MECHANICAL DESIGN**
- LABORATORY TEST ENGINEERING**

Generous travel allowance to engineers who are accepted.

\*For further information on Convair and its fields of interest, write at once, enclosing a complete resume to:  
Employment Department 3-E

\*ENGINEERING BROCHURE TO QUALIFIED APPLICANTS



# CONVAIR

A DIVISION OF GENERAL DYNAMICS CORPORATION  
POMONA, CALIFORNIA

# ENGINEERS and DESIGNERS NEEDED

for:

MISSILE GUIDANCE SYSTEMS

BOMBING NAVIGATIONAL COMPUTER SYSTEMS

NEW CIVIL AVIATION PRODUCTS

JET AND TURBO-PROP ENGINE CONTROLS

AIRBORNE FIRE CONTROLS

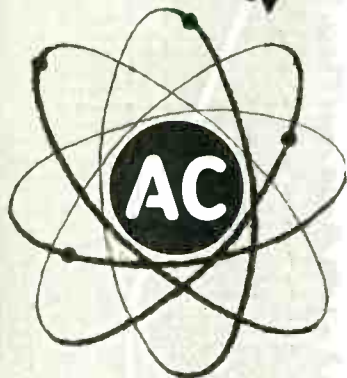

## GM CAREER OPPORTUNITIES IN

Systems Engineering and Analysis  
Experimental Engineering  
Development Engineering  
Project Coordination

Design Engineering  
Product Engineering  
Product Evaluation  
Field Engineering

## AND WE ALSO NEED:

## DESIGNERS • CHECKERS • LAYOUT MEN

Positions Are Permanent

Excellent Advancement Opportunities

Every inquiry treated confidentially and given immediate attention and personal reply.

## WRITE TODAY FOR EMPLOYMENT APPLICATION

Mr. Louis R. Berks  
Supervisor of Employment

AC SPARK PLUG DIVISION  
Precision Instrument Plant

**GENERAL MOTORS CORPORATION**  
Milwaukee 2, Wisconsin

## ELECTRONIC DEVELOPMENT ENGINEERS

### CHALLENGING DESIGN & DEVELOPMENT POSITIONS FOR CREATIVE ENGINEERS

These positions are tailor-made for highly imaginative engineers who enjoy problems of more than ordinary difficulty—problems that require a maximum of individual electronic creativity. Men selected will be entrusted with the complete electronic or electromechanical design and development tasks (initial circuits, systems, components, or product design) entailed in carrying a prototype project from original conception to its completion.

REQUIREMENTS: Senior and Intermediate engineers with degrees and 4 to 8 years' experience; Junior engineers with degrees and 1 to 3 years' experience, capable of growing with our long-range, electronic design and development program in the following fields:

- |                          |                     |
|--------------------------|---------------------|
| (1) ANALOG COMPUTER      | (4) ELECTRO-OPTICS  |
| (2) RADAR BEACONS        | (5) MISSILE SYSTEMS |
| (3) MAGNETIC AMPLIFIERS  | (6) SERVOS          |
| (7) FIRE CONTROL SYSTEMS |                     |

Interviews will be arranged at convenient locations.

Send resume to:

**AVION DIVISION**  
OF ACF INDUSTRIES INCORPORATED  
Route 17, Paramus, N.J.                      COlfax 1-4100

## SENIOR ELECTRONICS ENGINEERS

EE degree or equivalent experience. Background in communications and navigation desirable. Permanent positions in design and development. Citizenship required. Position at Rochester, New York. Excellent living and recreational conditions in this area.

ADDRESS:

Chief Electronics Engineer  
Stromberg-Carlson Company  
Rochester 3, New York



(Continued from page 167A)

Taylor Model Basin in Washington, D.C. and in the design of naval radar equipment. Mr. Mezger held the rank of Commander. He rejoined DuMont after World War II where he served successively as technical sales manager, engineering manager, and assistant division manager—all for the Instrument Division.

He is a member of the American Institute of Electrical Engineers and the Institute of Radio Engineers.



**M. J. Kelly** (M'25-F'38), president of Bell Telephone Laboratories, New York, has been named to the Board of Trustees of Stevens Institute of Technology, Hoboken, N. J.

Dr. Kelly has served as chairman of the U. S. Air Force's Scientific Advisory Board, and as advisor to the Secretary of the Air Force, the Atomic Energy Commission and other defense agencies.



M. J. KELLY

An alumnus of the Missouri School of Mines, he received the master's degree from the University of Kentucky and the Ph.D. from the University of Chicago.

He is a Fellow of the American Physical Society, the Acoustical Society of America, and the American Institute of Electrical Engineers; and a member of the National Academy of Sciences, the American Philosophical Society, and Tau Beta Pi, Eta Kappa Nu, and Sigma Xi.



The appointment of **Peter Janis** (SM'47) as Chief Engineer of Ampere Electronic Corporation, Hicksville, L.I., New York has been announced.



PETER JANIS

Mr. Janis came to Ampere from Sylvania Electric Products, Inc., where he was active in the development of klystrons, hydrogen thyratrons, magnetrons and photo-sensitive devices. Later, he was put in charge of the

microwave and special purpose tube development activities of the Product Development Laboratories, and more recently was involved in the design, development, and production of traveling-wave tubes.

Prior to his work at Sylvania, he was engaged at R.C.A., Victor Division in development of special purpose tubes. He has also taught theory and design of monochrome and color television, AM and FM receivers.

Born in New York, Mr. Janis received  
(Continued on page 170A)



**D**iversification at ADMIRAL is making itself felt in more and better engineering careers.

Real ability and originality can find new challenge and opportunity with a leader in electronic development and manufacturing.

Positions available for engineers with the following backgrounds:

### ★ MICROWAVE ENGINEERS

Experienced in UHF and SHF circuitry and components, with understanding of wave guides, cavities, and duplexers.

### ★ ELECTRONIC ENGINEERS

Junior and Senior engineers for television receiver circuit design. Experienced men also needed for V.H.F. and U.H.F. tuner work.

### ★ RADIO ENGINEERS

Duties involve designing household and portable radio receivers. FM and AM experience preferred.

### ★ MECHANICAL ENGINEERS

Electro-Mechanical designers. Assignments involve the design and layout of small mechanical devices at the development level.

### ★ COMMUNICATIONS ENGINEERS (MILITARY)

Applied development and design of radar and other specialized military systems.

### ★ AUTOMATION ENGINEERS

A special opportunity exists in the field of applying automation and printed circuit techniques in the above categories. Your imagination and engineering talents can be used in furthering this development.

Good starting salaries and working conditions with complete program of employee benefits. Opportunity for professional development with excellent facilities in Chicago area to carry on University graduate work while working full time.

• Send complete resume to Mr. Walter Wecker, Personnel Department, to get more information on these opportunities.

**Admiral Corporation**

3800 W. Cortland St.  
Chicago 47, Illinois

# UNIVAC

The FIRST Name

in Complete Electronic Computing Systems

As the UNIVAC takes its place in more and more industries, REMINGTON RAND has greatly expanded its research and development work in order to continue its leadership in electronic computing equipment.

There are many positions recently opened at all levels in all phases of research, design, development, and application of computing and allied equipment. Even though your training and experience may not be connected with computers, we are willing in many cases to provide the necessary training. Individual cases can be evaluated during interview.

- System Studies
- Logical Design
- New Components
- Solid State Physics
- Semi-conductors
- Magnetic Materials
- Storage Techniques
- Circuit Design
- Pulse Techniques
- Input-Output Devices
- Product Design
- Test Equipment Design
- Computer Development and Design
- High Speed Electro-Mechanical Devices
- System Test and Maintenance

The rapidly expanding engineering program has created many permanent positions paying excellent salaries. These positions offer personal challenges as well as outstanding opportunities for professional development. The possibilities for graduate study in this area are excellent and the company has a liberal plan for reimbursement of tuition expenses. Other company benefits include retirement and group insurance.

Replies Kept Strictly Confidential

FOR INTERVIEW, WRITE TO

***Remington Rand***

Division of

**SPERRY RAND CORPORATION**

2300 West Allegheny Ave.

Philadelphia 29, Pa.



(Continued from page 169A)

the E.E. degree from Cooper Union School of Engineering, and attended Columbia University and New York University. He is a recipient of the War Production Merit Award, has several patents and disclosures on electronic devices, and has written articles and papers on wide band oscillators, amplifiers and microwave devices.



ALBUQUERQUE-LOS ALAMOS

"A Transistorized Digital Computer — TRADIC," by J. H. Felker, Bell Telephone Labs.; July 14, 1955.

ATLANTA

"Radio Location by Phase Comparison," by E. J. Crossland, Seismograph Corp.; June 24, 1955.

(Continued on page 172A)

USE YOUR  
IRE DIRECTORY  
IT'S VALUABLE!

★ ————— ★  
●  
**ELECTRONIC  
ENGINEER**

for work on  
**Civilian Products**

in the fields of  
**ACOUSTICS and  
ELECTROMECHANICS**

Salary commensurate with  
background

●  
**DYNA-EMPIRE  
INC.**

1075 Stewart Avenue  
Garden City, L.I., N.Y.



## What Opportunities in Electronics are on the Horizon at GENERAL ELECTRIC?



Huge antenna used with new radar height-finder needs a room all its own above the control center in the radome building erected in Arctic climates. Air pressure supports the rubberized glass fabric radome "balloon." Entrance to the radome is through an air lock chamber.

Advances in electronics are so rapid at General Electric that today's predictions appear tomorrow as equipment bearing the GE symbol.

The opportunities created by the scope and pace of the field are increased at General Electric by the facilities and range of professional advantages which GE engineers enjoy.

This means that GE electronics engineers have incentives, satisfactions and rewards that lead to accelerated personal development and advancement in the company.

### ENGINEERS • PHYSICISTS

*Positions available in the following fields:*

Advanced Development, Design, Field Service and Technical Writing in connection with:

**MILITARY RADIO & RADAR • MULTIPLEX MICROWAVE  
MOBILE COMMUNICATION • SEMICONDUCTORS • ELECTRONIC COMPONENTS • TELEVISION, TUBES & ANTENNAS**

*Bachelor's or advanced degree in Electrical or Mechanical Engineering, physics, and experience in electronics industry necessary.*

*Please send resume to:  
Dept. 9-5-P—Technical Personnel*

# GENERAL ELECTRIC

ELECTRONICS PARK, SYRACUSE, N. Y.

### A MAJOR CANADIAN COMPANY requires a SENIOR ELECTRONICS ENGINEER

To direct the equipping and operation of an electronic laboratory involved in the development and testing of complex assemblies.

Applicants must have an electrical engineering degree (or equivalent) preferably with honours or specialization in electronics or telecommunications, and at least 6 to 8 years experience with some years in a senior capacity in a development type facility and be qualified to direct the efforts of engineers and technicians.

An excellent salary will be paid to the right man together with liberal relocation assistance.

Write: Box No. 930

**INSTITUTE OF RADIO ENGINEERS**  
1 East 79th St.  
New York 21, N.Y.

## COMMUNICATIONS and ELECTRONICS

are but two of the many scientific disciplines in which the Operations Research Office of The Johns Hopkins University offers most unusual and challenging opportunities to the experienced researcher. Salaries are commensurate with experience. Inquiries are invited. Address:

W. P. Champlain, Research Personnel Officer  
Operations Research Office, 7100 Connecticut Ave.  
Chevy Chase 15, Maryland

# LET'S FACE IT...

HERE'S  
WHY  
YOU  
SHOULD  
COMPARE

there are thousands of  
engineering positions  
open today... *but*—

## CROSLEY

DIVISION



✓ New engineering groups being established offering unusual opportunities *NOW* . . . "on the ground floor."

✓ Greater advancement opportunities assured by the continued expansion of this young, vibrant engineering organization.

### PRESENT REQUIREMENTS\*

Electronics and Mechanical Engineers, Physicists and Mathematicians:

- Advanced Research
- Research
- Project
- Advanced Design
- Senior Design
- Design
- Junior

CROSLEY ENGINEERING GROWTH IN PERSONNEL

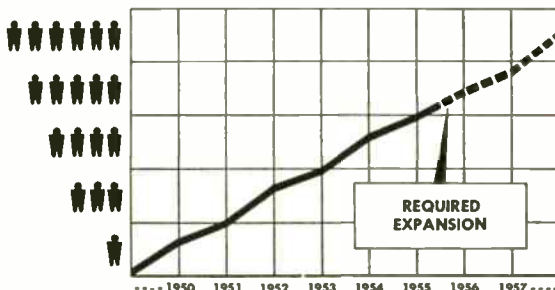

### SOME OF THE FIELDS OF INTEREST TO CROSLEY:

Radar — Servo-mechanisms — Fire Control — Digital Circuitry  
— Navigation — Communications — Countermeasures — Missile  
Guidance — Microwave Design — Telemetry

### SUBSTANTIAL BENEFITS AVAILABLE TO YOU:

Excellent salaries, fully equipped modern laboratories, paid vacations and holidays, subsidized university educational program, group insurance program for you and your family, retirement plan and adequate housing in desirable residential areas.

Investigate these opportunities  
by sending resume to:

\*U. S. Citizenship required

**DIRECTOR OF ENGINEERING**  
**Government Products — Crosley Division,**  
**AVCO Manufacturing Corporation**  
**Cincinnati 15, Ohio**



(Continued from page 170A)

#### BALTIMORE

"Ferrites in Duplexers," by T. N. Anderson, Airttron, Inc.; June 8, 1955.

#### BEAUMONT-PORT ARTHUR

"The IRE," by D. J. Tucker, Director, Region 6; June 21, 1955.

#### CEDAR RAPIDS

"Basic Considerations and More Interesting Problems in the Development of the Iowa Electronic Test Processing Equipment," by John A. Brady; "The Future of the Peaceful Atom," by Aristidis Ratermanis; and "Matrix Analysis of Communication Networks and Power Systems," by D. R. Wilson; May 18, 1955.

"Elements of Music and an Electronic Music Synthesizer," by Dr. H. F. Olson, RCA Labs.; June 15, 1955.

#### CINCINNATI

"Jest about Jets," by N. R. Thomas, General Electric Company; June 21, 1955.

#### DENVER

Business meeting, and inspection trip to TV transmitter sites of KLZ TV, KBTV and KOA-TV; June 7, 1955.

#### DETROIT

Student papers contest: "Putting the Rainbow on the Air," by R. P. Farbolin, Wayne University; "Semi-Conductors and Point Contact Transistors," by Elliot Rappaport, Wayne University; "Magnetic Amplifiers Using Square Loop Core Materials," by J. W. Rood, Michigan State University; May 20, 1955.

#### EL PASO

"Electronics in Law Enforcement," by Lt. Art Clatfelter, El Paso Police; June 30, 1955.

#### FORT WAYNE

"Galactic Radio Waves," by Dr. J. P. Hagen, U. S. Naval Research Lab; June 2, 1955.

#### HAWAII

"1955 IRE Convention Report," by J. R. Sanders, Matson Navigation Co.; July 13, 1955.

#### HUNTSVILLE

"Radio Astronomy," by H. W. Wells, Carnegie Institute and Director, Region 3; June 23, 1955.

#### INDIANAPOLIS

"Radar Systems, All Types and Their Characteristics," by C. J. Marshall, Wright Patterson AFB; June 9, 1955.

#### INYOKERN

"Modern Radar Components and Applications," by George Dexter, Hoffman Labs.; July 11, 1955.

#### OKLAHOMA CITY

Tour of the International Crystal Company Plant; April 20, 1955.

Student papers: "Electrical Pipeline Pumping," by Bob McAlpine; "The Economical Replacement of Machinery," by Jess Jackson; "Power Plant Location," by Bob Marshall; and "Something for Nothing," by Ted Hart; May 4, 1955.

#### PITTSBURGH

"Numerical Control," by H. P. Grossimon, Massachusetts Institute of Technology; June 13, 1955.

#### SACRAMENTO

Business and social meeting, with talk by J. H. Cowan, former member of the F.B.I.; June 17, 1955.

(Continued on page 174A)

**ENGINEERS . . .  
NOW— A COMPLETE  
ELECTRONIC PLACEMENT  
SERVICE COVERING  
THE COUNTRY.**

Just tell us where you would like to relocate. We will handle everything for you at no cost or obligation.

**PARTIAL LISTINGS**

- CHIEF RADAR ENGR. . . . \$18,000
- NUCLEONIC ENGRS. . . \$10-12,000
- ELECTRONIC MFG. . . . To \$11,500
- ELECTRONIC CABLE ENG. To \$10,000
- TRANSISTOR ENGRS. . . To \$14,000

We need 90 Engineers with 2-4 years' experience for a computer Company with salaries from \$6-8000.

**(A Free Service to You)**

Mail 3 resumes in confidence to:  
HARRY L. BRISK  
Member I.R.E.

**ACCREDITED PERSONNEL SERVICE**

Since 1937  
Suite 936, 12 S. 12th St., Phila. 7, Pa.

**Engineers**

with experience in

- computers
- microwave
- pulse techniques
- servo-mechanisms
- related circuit design

leading designers and manufacturers of electronic instrumentation offer outstanding opportunity, top pay, moving allowance, benefits, plus the charm of san francisco living.

please send resume.

**Berkeley** *division*  
BECKMAN INSTRUMENTS INC.  
2200 WRIGHT AVE., RICHMOND 3, CALIF.

Sandia Corporation operates Sandia Laboratory under contract with the Atomic Energy Commission. Sandia engineers and scientists work in the forefront of a new field — the design and development of atomic weapons vital to the nation's defense. Graduate engineers and scientists will find excellent professional opportunities in these specific fields:



**ENGINEERS** — Mechanical, electrical, electronic; with BS or higher degree. Design, development, and preparation for production of electro-mechanical systems and components, electronic devices and test sets, antennae, test and design evaluation of electrical and mechanical components.

**PHYSICISTS AND ENGINEERING PHYSICISTS** — with MS or PhD degrees. Openings for classical theorists, experimentalists, in the fields of weapon systems analysis, blast wave propagation and diffraction, evaluation of present weapon designs, recommendations for new weapons.

**MATHEMATICIANS** — PhD level, in field of applied mathematics, probability studies, fluid dynamics, statistics, weapon systems analysis.

**AERODYNAMICISTS** — PhD, MS, or BS with at least 5 years experience. To perform analytical or experimental aero studies.

**QUALITY CONTROL, TEST & EVALUATION ENGINEERS** — Set up and perform electro-mechanical tests, environmental testing, evaluate results, devise new test methods, statistical quality control. Appropriate college degrees required.

Sandia Laboratory is located in Albuquerque — a modern, cosmopolitan city of 160,000, rich in cultural and recreational attractions and famous for its delightful year-around climate. Working conditions are excellent. Employee benefits include liberal paid vacation, free group life insurance, sickness benefits, and a generous contributory retirement plan. Compensation is competitive with that offered in other industry, and there are many opportunities for advancement. Housing is readily obtained, and accepted applicants receive a generous moving allowance. Personal interviews will be arranged for qualified applicants. For additional information, or to apply for employment, please write:

PROFESSIONAL EMPLOYMENT DIVISION 554

**SANDIA**

*Corporation*

**SANDIA BASE ALBUQUERQUE, NEW MEXICO**

# E

is for

# Emerson

and

# Electronics

and

# Expansion

Vital words that spell a promising career for qualified engineers! EMERSON, looking back on 40 years of scientific development, now looks ahead to even greater expansion. And EMERSON is looking for engineers to grow with it. Applicants should understand that EMERSON is offering careers—not merely positions. In addition to the stability of long-term Government contracts EMERSON provides the basic stability of its constantly expanding civilian engineering activities in Television, Radio and Air-conditioning. Openings exist at all levels for young-minded engineers (some of EMERSON'S top engineers are not college graduates) with vision, imagination and creativeness to fill responsible

### Electronics and Mechanical Engineering Assignments

in any of the following fields:

- Radar
- Antennas
- Fire Control
- Network Theory
- Servo-Amplifiers
- Pulse Techniques
- Analog Computers
- Magnetic Amplifiers
- Microwave Techniques
- Electronic Counter-measures

Offices and Laboratories Fully Air-Conditioned

Interview expenses paid to qualified candidates. Generous moving allowance and other fully paid benefits.



SUBMIT RESUME (according to location preferred) TO:  
Mr. Richard Hoffman  
Engineering Personnel Manager

## EMERSON

RADIO & PHONOGRAPH CORP.  
14th & Coles Sts., Jersey City 2, N.J.

OR

Dr. Ray Wilson

## EMERSON

Research Laboratories  
701 Lamont St., N.W.,  
Washington 10, D.C.



### Section Meetings

(Continued from page 172A)

#### SAN ANTONIO

"Instrumentation for Uranium Prospecting," by Dr. J. C. Cook, Southwestern Research Institute; April 27, 1955.

Upgrading party; May 27, 1955.

"Telemetry Highlights of 1955," by John Ohman, Southwest Research Institute; June 3, 1955.

#### SAN FRANCISCO

"The Engineer in Society," by J. W. McRae, Sandia Corporation; June 17, 1955.

#### SEATTLE

Student paper contest: "Amplifiers," by Phil Beaudoin; "An Investigation of the Two-Charge Theory of Electrets," by R. B. Kiebertz; and "Dielectric Potentiometers," by A. T. Simmons, all of University of Washington; April 12, 1955.

"Automatic Electronics," by J. D. Ryder, President, IRE; April 21, 1955.

"Instrumentation at the Hanford Operation," by R. G. Clark, and "A Gamma Scintillation Spectrometer," by R. E. Connally, both of Hanford Works; May 19, 1955.

Election of officers; June 3, 1955.

#### TOLEDO

"Police Radar, Speed Control," by Manfred Rosencrantz, Toledo Police Dept.; April 14, 1955.

Technical Tour of Television Facilities at WSPD-TV, conducted by W. M. Stringfellow; May 12, 1955.

Election of officers; June 9, 1955.

#### VANCOUVER

"Automatic Electronic Production," by J. D. Ryder, President, IRE; April 20, 1955.

"Atomic Energy—The New Frontier," by Dr. G. M. Shrum, U.B.C.; May 19, 1955.

### SUBSECTIONS

#### BUENAVENTURA

"The Present and Future of Airborne Fire Control," by Dr. R. M. Ashby, North American Aviation, Inc.; June 9, 1955.

#### TUCSON

"Applied Communication Theory," by Dr. Eberhardt Rehtin, California Institute of Technology; April 22, 1955.

"Automation and Mechanization," by G. O. Haglund, General Mills; May 26, 1955.

#### WICHITA

"Boolean Algebra and Its Circuit Application," by P. I. Miller, Boeing Airplane Co.; June 2, 1955.

Election of officers; June 17, 1955.  
Kay Lab. Industrial TV Demonstration in Mobile Trailer, by Mr. O'Neal and Bob Bacon, Both of Kay Lab.; June 23, 1955.



### Professional Group Meetings

### AERONAUTICAL AND NAVIGATION-ELECTRONICS

Dallas-Ft. Worth Chapter—May 24

"Modern Aircraft Transmitter Design" by Ryan B. Seals, Collins Radio Company.

## CONTROL SYSTEMS ENGINEERS

ELECTRONIC ENGINEER or PHYSICIST required for  
CONTROL SYSTEMS DESIGN  
and  
APPLICATIONS ENGINEERING

involving pressure and level sensing devices, data transmission, automatic controlling, and instrumentation (monitoring—recording—and supervision)

SEND RESUME IN STRICT CONFIDENCE TO

G. J. Miller

**AUTOMATIC CONTROL COMPANY**

995 University Avenue

St. Paul 4, Minnesota





## Professional Group Meetings

New York Chapter—May 19

"Distance Measuring Equipment" by William J. Flynn, Hazeltine Electronics Corporation.

"Automatic Test Equipment for DME" by Sherman Rinkle, Polytechnic Research and Development Company, Inc.

Election of Officers: Chairman—Gordon P. McCouch, Vice-Chairman—Lester M. Glantz, Secretary—William P. McNally.

### ANTENNAS AND PROPAGATION

Albuquerque-Los Alamos Chapter—May 4

"Theoretical Analysis of a Dipole Antenna" by S. H. Dike, Sandia Corporation.

Chicago Chapter—April 15

"Ionospheric Propagation" by Howard J. Goldman, Armour Research Foundation.

Chicago Chapter—May 20

"A Color Film Entitled 'The Antenna is the Payoff'" by The Channel Master Corporation of Ellenville, New York.

### AUDIO

Boston Chapter—June 2

"Man, a Somewhat Neglected Component of Hi-Fi Systems" by Walter A. Rosenblith, MIT.

Chicago Chapter—January 19

"Calibration of Test Records by Interference Patterns" by Ben Bauer, Shure Brothers, Inc.

Chicago Chapter—April 15

"The Circulator Amplifier" by John Overly and Lloyd Loring, Electro-Voice.

Cincinnati Chapter—October 19

"Audio Systems Home Demonstration" by C. G. Haehnle, A. B. Bereskin, F. M. Livezey, J. P. Goode, R. A. Jenkins, J. P. Quitter, W. W. Gulden.

Cincinnati Chapter—November 16

"What and How You Hear" by Warren E. Johnson, Cincinnati Speech and Hearing Center.

Cincinnati Chapter—January 18

"A Twin Lever Ceramic Cartridge" by B. B. Bauer, Shure Brothers, Inc.

Cincinnati Chapter—April 26

"How Many Dollars Can You Hear?" by Harvey B. Glatstein, Customcrafters Audio, Inc.

Cincinnati Chapter—May 17

"Binaural Audio Demonstration" by C. G. Haehnle, E. D. Kay, and R. A. Jenkins, Jr.,

Syracuse Chapter—April 13

"Performance of the 'Distributed Port' Loudspeaker Enclosure" by A. F. Petrie, Gen. Elec. Co.

(Continued on page 176A)

# COMPUTER ENGINEERS

## Can you fill these key positions?



### Link Aviation, Inc. needs top level

## electronics engineers

If you are experienced in computer engineering—and have the ability to direct others in important projects, then Link Aviation Inc. has a top level position for you in its expanding research and development program.

These permanent, key positions are for:

**SENIOR DIGITAL COMPUTER ENGINEERS**—Must be capable of supervising a small group of engineers designing special-purpose digital computers. Should have extensive knowledge of latest digital computer logic and circuit design techniques. Familiarity with transistor pulse circuits, magnetic functional elements, magnetic tape and drum read-write systems and analog digital conversion methods is highly desirable. The position will require complete responsibility for computer project from system design through prototype construction.

**SENIOR ELECTRONICS ENGINEERS**—Qualified to design complex feedback amplifiers, precision regulated power supplies, specialized electronic instruments and advanced systems which require unusual creative and analytical ability. Familiarity with vacuum-tube circuit design, transistor circuits, application of magnetic amplifiers, photo-conductor and photo-transistor circuitry is desirable. Should be capable of directing a small group of engineers engaged in systems and component design in the above fields.

Link's broad scope of activities—including design and development of flight and radar simulators, computer-actuated training devices, electronic instruments and special-purpose computers—presents engineers of executive calibre with an outstanding opportunity for personal advancement in a growing organization.

In addition to these advantages, Link offers an unusually attractive "fringe benefit" program including profit sharing, retirement and liberal vacation and holiday policies. Link is located in Binghamton near the heart of upstate New York's recreationland. Only 180 miles from New York City, Binghamton provides "hometown" comfort with big-city conveniences.



Write full details to Mr. John M. Hunt  
Director of Research



BINGHAMTON, NEW YORK

A SUBSIDIARY OF  
GENERAL PRECISION EQUIPMENT CORPORATION



••• for those  
who qualify



offers  
**ELECTRONIC  
ENGINEERS**

**Security**

- HEAVY BACKLOGS
- SOUND FINANCING
- TOP BENEFITS

**Understanding**

- MANAGEMENT BY ENGINEERS
- EDUCATIONAL AID
- MINIMIZED RED-TAPE

**Know how**

- VARIED SPECIALIZATION
- FLEXIBLE ORGANIZATION
- VERSATILE PERSONNEL

Send resume to R. F. Lander  
Electronic Engineering Company  
of California  
180 SOUTH ALVARADO STREET  
LOS ANGELES, 57, CALIFORNIA



**Professional Group Meetings**

(Continued from page 175A)

**BROADCAST AND TELEVISION  
RECEIVERS**

Chicago Chapter—April 15  
"A New High Efficiency Parallax Mask Color TV Tube" by Mark Amdursky, Rauland Corp.

Chicago Chapter—May 20  
"Theory and Design of Vertical and Horizontal Deflection Circuits" by Kurt Schlesinger, Motorola, Inc.

**BROADCAST TRANSMISSION  
SYSTEMS**

Houston Chapter—May 30  
"Color TV Demonstration of 'The Petrified Forest'."

**CIRCUIT THEORY**

Albuquerque-Los Alamos Chapter—  
May 25  
"Physics of Transistors" by Walter E. Brown, Sandia Corporation.

Election of Officers: Chairman—Norman J. Elliott, Vice Chairman—George Webber, Secretary—John McLay.

Chicago Chapter—April 15  
"Effects of Impedance in Cathode and Plate of Vacuum Tube Amplifiers" by Bernard S. Parmet, Motorola, Inc.

Los Angeles Chapter—May 13  
"Color Television Circuitry" by Dr. E. L. Michaels, Packard-Bell Corp.

"Color Television Studio Equipment, Staging Practices, and Techniques" by W. H. Copeland, CBS.

Election of Officers: Chairman—J. E. Jacobs, Secretary-Treasurer—H. Low, Program Committee—J. Heilfron, R. M. W. Johnson, Dick Towle.

Urbana Chapter—February 10  
"Formulation of Kirchhoff Voltage and Current Postulates" by M. B. Reed and E. W. Schwarz, Univ. of Illinois.

Urbana Chapter—February 24  
"The Differential Equation Postulates for Circuit Theory" by M. B. Reed and E. W. Schwarz, Univ. of Illinois.

Urbana Chapter—March 10  
"Mathematical Aspects of Switching" by F. E. Hohn, Univ. of Illinois.

Urbana Chapter—March 24  
"The Differential" by M. E. Munroe, Univ. of Illinois.

Urbana Chapter—April 14  
"The Stieltje's Integral" by F. E. Hohn, Univ. of Illinois.

Urbana Chapter—April 28  
"The Laplace-Stieltje's Transform" by S. Seshu, Univ. of Illinois.

Urbana Chapter—May 12  
"Time Domain Analysis" by C. L. Coates, Univ. of Illinois.

(Continued on page 178A)

World Radio History

**DU MONT**  
**Technical Products**  
**Division**

needs additional high  
calibre engineers for

Electronic Instrumentation  
Missile Work  
Test Equipment  
Timing and Pulse Circuits  
Video Circuits  
Electro-Mechanical Devices  
Recording Systems  
Communications Equipment  
Television Development

for both commercial and  
government output

Contact

Mr. William Papaestor  
Employment Manager

**ALLEN B. DU MONT  
LABORATORIES, INC.**

35 Market Street  
East Paterson, New Jersey  
or at  
11845 Olympic Blvd.  
Los Angeles, California

ELECTRONIC TUBE  
DIVISION  
OF  
WESTINGHOUSE  
ELECTRIC  
CORPORATION  
IN  
ELMIRA, NEW YORK

OPPORTUNITIES  
IN  
TUBE DESIGN, DEVELOP-  
MENT & APPLICATION.

MICROWAVE TUBE  
DESIGN

MANUFACTURING EQUIP.  
DESIGN - ELECTRICAL  
& MECHANICAL

MANUFACTURING  
ENGINEERING

INDUSTRIAL  
ENGINEERING  
FOR  
MFG. COST CONTROL

OPPORTUNITIES  
FOR  
BETTER LIVING  
&  
PROFESSIONAL  
IMPROVEMENT

Interviews your area, or  
expenses paid for Elmira  
interviews send resume to:  
R. M. Jarrett  
Westinghouse Elec. Corp.  
P.O. Box 284, Elmira, N.Y.

the Key  
to your  
future...

ELECTRONIC **ENGINEERS** MECHANICAL

opportunities better than ever at  
*Remington Rand*  
ENGINEERING RESEARCH ASSOCIATES DIVISION

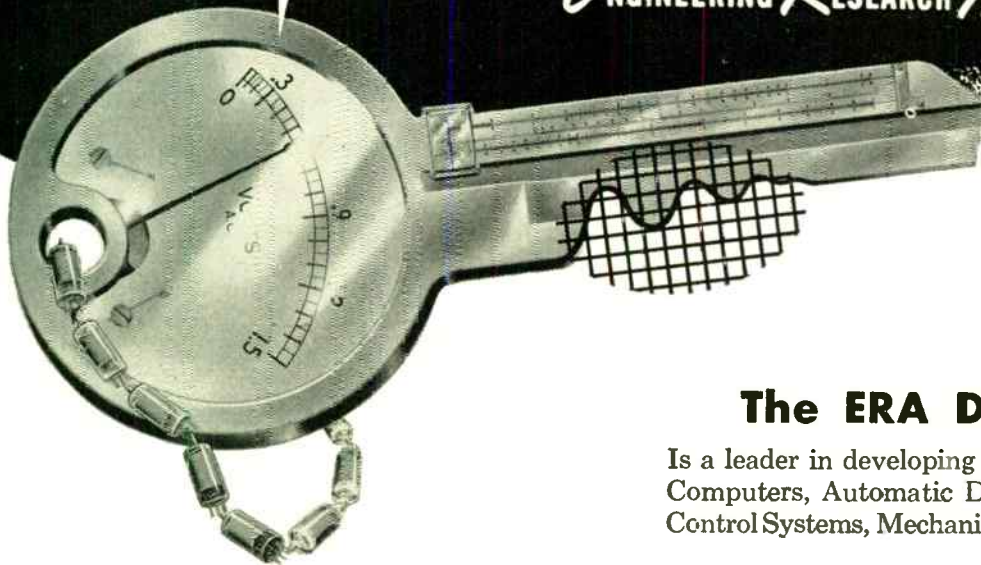

## The ERA Division

Is a leader in developing Electronic Digital Computers, Automatic Data-Handling and Control Systems, Mechanisms, and Weapons.

# Everything you want in a job—

### Stimulating Work

Most of our engineers are having the time of their lives doing creative research and development on important new applications in mechanical and electronic engineering. Men work as project teams, and each man learns all aspects of his project. Pulse circuits, magnetic cores, transistors, printed wiring, miniaturization, and precise mechanisms are used in designing computers, automatic data-handling and control systems, mechanisms, and special weapons. Other excellent engineering jobs are available in production, testing, specifications, quality control, contract administration, and technical writing.

### Advancement

ERA plans to *triple* its staff. Opportunities for promotion are sure to come rapidly for years.

### Good Pay from the Start

We offer the highest starting salary possible considering your qualifications for the job. Experience need not be in computers.

### Good Living

Most ERA engineers own their homes. Within 15 minutes they can drive to work, to downtown shopping, or to the country. The University of Minnesota offers evening courses and Big Ten sports. Minneapolis Symphony concerts are a vital force in the community. Minnesota's forests are dotted with 10,000 cool lakes, many nearby. Hunting, fishing, swimming, and boating are excellent. You will enjoy living in Minnesota's vacation land.

Send an outline of your training and experience to Dept. S-5:



ENGINEERING RESEARCH ASSOCIATES DIVISION

1902 W. Minnehaha Avenue  
Saint Paul W4, Minnesota

# WANTED:

## Electronic and Mechanical Engineers at **Bendix-Pacific**

This is the new Engineering Center at Bendix-Pacific now nearing completion. With 100,000 square feet of area, it represents the latest and one of the most complete engineering facilities in the nation.

You are invited to consider becoming a member of this vital engineering group—with a forward looking company in Southern California.

Unusual engineering positions in electrical and mechanical design of radar, sonar and telemetering are available. These positions, which are directly associated with our long-range projects for industry and for defense, are available at all levels.

Please fill in the coupon or write us for complete information.



W. C. Walker, Engineering Employment Mgr.  
Pacific Division, Bendix Aviation Corp.  
Sherman Way, North Hollywood, Calif.  
11019

Please send information.

I am a graduate engineer with \_\_\_\_\_ degree.

I am not a graduate engineer but have \_\_\_\_\_ years experience.

Name \_\_\_\_\_

Address \_\_\_\_\_

City \_\_\_\_\_ Zone \_\_\_\_\_ State \_\_\_\_\_



## Professional Group Meetings

(Continued from page 176A)

Urbana Chapter—May 26

"Purpose of Symbolic Logic" by H. E. Vaughan, Univ. of Illinois.

### ELECTRONIC COMPUTERS

Boston Chapter—May 26

"Pulse Circuits Near Absolute" by Dudley A. Buck, M.I.T.

Dallas-Ft. Worth Chapter—March 22

"Introduction to Control Systems Application" by John F. Nolan, M.I.T.

"Development of a Magnetic Memory" by Harlan E. Anderson, M.I.T.

New York Chapter—April 26

"Fundamental Theory and Operation of a Typical but Elementary Computer (Digital Differential Analyzer)" by J. A. Githens, Bell Labs.

"Design Features of the ETT-100 Computer (Stevens D.D.A.)" by S. M. Shockell, Stevens Institute.

New York Chapter—May 24

"The Type 650 Magnetic Drum Data Processing Machine" by R. W. Avery, IBM Corp.

### ELECTRONIC DEVICES

Los Angeles Chapter—May 2

"How Should a Transistor be Characterized?"—Panel Discussion.

Philadelphia Chapter—May 17

"Transistors Today" by Harry L. Owens, Signal Corps Engineering Labs.

Election of Officers: Chairman—Bernard T. Svihel, Vice Chairman—Werner Hasenberg, Secretary—Gordon R. Spencer.

Washington, D. C. Chapter—May 23

"P-N-I-P Transistors" by J. M. Early, Bell Labs.

Election of Officers: Chairman—Henry D. Arnett, Vice Chairman—Robert W. Grantham, Secretary—Harold J. Peake.

## CORNELL AERONAUTICAL LABORATORY, INC. of Cornell University

is seeking

### ELECTRONIC ENGINEERS

for positions in all levels of  
experience above Junior  
Engineer

Communications  
Dynamic Control Systems  
Aircraft Instrumentation  
Radar  
Computers  
Electrical Measurements  
Varied Electronic Circuits  
Servo-Mechanisms  
Missile Guidance  
Microwave

If you have a B.S. degree and  
experience, imagination and  
potential, we invite you to  
communicate with our Em-  
ployment Manager

Box 235 Buffalo 21, N.Y.

### ENGINEERING MANAGEMENT

Los Angeles Chapter—May 18

"A Technique for Interviewing" by Dick S. Barlow, Hughes Aircraft Co.

Philadelphia Chapter—May 26

"Research and Development Organization and Planning for a Dynamic Field" by J. W. Forrester, Lincoln Computer Labs., also Director, Digital Computer Lab., MIT.

Syracuse Chapter—May 12

"Planning Meeting for Engineering Management Course" by Harlan Perrins, Cornell Univ.

### MICROWAVE COMMUNICATIONS ENGINEER

Leading independent manufacturer of carrier telephone and multi-channel radio equipment is expanding transmission engineering services to customers. An opportunity exists for an experienced communications engineer familiar with the problems of multi-channel transmission and common-carrier grade reliability requirements. This job involves working with microwave systems and circuit design engineers on requirements for new systems, as well as solution of field problems. Some work on tropospheric scatter and higher microwave frequencies can be expected in the near future. A minimum of five years' experience in development or operation and familiarity with common carrier techniques is required. Salary open. Send complete résumé to Ind. Rel. Div., Lenkurt Electric Co., San Carlos, California.

**INDUSTRIAL ELECTRONICS**

Chicago Chapter—April 15

“Automation in the Electronics Industry” by V. C. Lafferty, Armour Research Found.

Cleveland Chapter—April 21

“Radio Noise Measurements and Control Problems” by Leonard Thomas, Bureau of Ships, Navy Dept.

Election of Officers: Chairman—Ruben Kozarian.

**INFORMATION THEORY**

Albuquerque-Los Alamos Chapter—  
May 11

Business Meeting

Election of Officers: Chairman—Walter E. Brown, Vice-Chairman—Leo V. Skinner, Secretary—Charles H. Bidwell.

Los Angeles Chapter—May 26

“Linear Programming Applied to Bid Analysis” by Leon Gainen, Hughes Aircraft Co.

**INSTRUMENTATION**

Houston Chapter—May 24

“Nuclear Batteries” by Edward A. DeCrosta, Tracerlab, Inc.

**MEDICAL ELECTRONICS**

Los Angeles Chapter—January 26

“Medical and Electronic Cooperation” by J. Phillip Sampson, L. A. County Medical Assoc.

“Instrumentation Problems” by Marcel Verzeano, UCLA.

Los Angeles Chapter—March 16

“Heart Microphone” by John Hilliard, Altec Lansing.

“X-Ray Microscope” by Curtis G. Smith, UCLA.

Los Angeles Chapter—April 19

“Hearing Correction” by Helen Kennedy, City College.

“Electric Potentials in Tissue” by Robert Tschirgi, UCLA, “Electrosurgery” by Ralph Gunter, UCLA, “Physiological Monitoring” by John Dillon, UCLA.

Los Angeles Chapter—May 10

“Acoustical Resonance in Microorganisms” by Robert Woods, College of Med. Evang.

“Localization of Nerve Blocks” by Robert Pearson, College of Med. Evang.

San Francisco Chapter—May 26

“Electronic Instrumentation in Otolology and Audiology” by Francis Sooy, Univ. of Cal., and R. E. Allison, Allison Labs.

**MICROWAVE THEORY AND TECHNIQUES**

Boston Chapter—May 12

“Broadband Microwave Crystals” by Eugene J. Feldman, Sylvania Elec. Products Inc.

*(Continued on page 180A)*

**CHALLENGING CAREERS AT RAYTHEON**

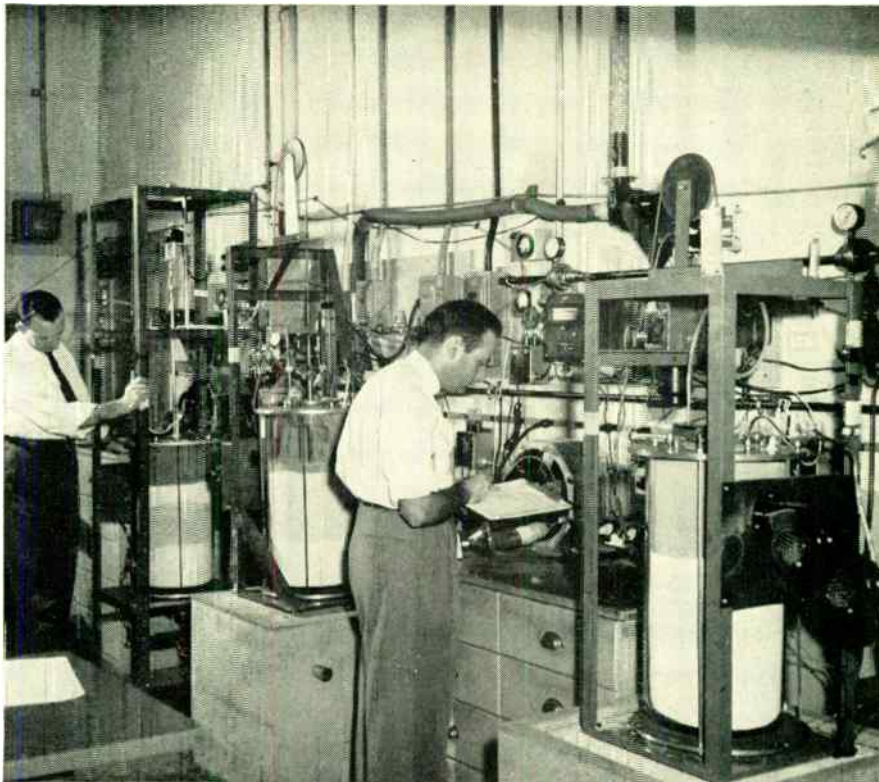

Checking on a process in one of Raytheon Research Division's "furnace" rooms. Single crystals of silicon (melting point near 1400°C) are grown in these furnaces.

**Ready to move UP in electronics?**

In Raytheon's extensive research program, a variety of special furnaces and equipment is used for the preparation, purification and study of semiconductor materials. This research is fundamental to the continuing pre-eminence of Raytheon in the field of transistors and diodes. Today there are more Raytheon transistors in use than all other makes combined.

When you join Raytheon you work in an atmosphere of progress. University graduate study is encouraged through a tuition refund plan. Openings now for engineers, scientists in many areas including:

- microwave tubes • special purpose tubes • guided missiles
- transistors • diodes • receiving tubes • TV receivers • radar
- metallurgy • ceramics • communications • cathode ray tubes
- sonar • servomechanisms • solid state physics • field engineering

Join a team where performance pays off. Please address inquiries to L. B. Landall, Professional Personnel Section.



**RAYTHEON MANUFACTURING COMPANY**

190 Willow St., Waltham 54, Mass.

Plants also located in California and Illinois

Developers  
of the  
Corporal  
Guided  
Missile.



## JET PROPULSION LABORATORY

CALIFORNIA  
INSTITUTE OF  
TECHNOLOGY

*Active in all phases  
of electronics and physics  
related to guided missiles  
and jet propulsion.*

The nation's foremost guided-missile research and development facility, established in 1940, offers exceptional opportunity for engineers and research scientists in the fields of guidance and control, information theory, computers, electro-mechanical devices, instrumentation, and related aspects of electronic research. The Laboratory offers an ideal blend of academic and industrial environments and maintains a high level of technical competence. Attractive salaries are offered.

*A brochure describing  
opportunities and activities  
at the Laboratory will be  
sent upon request.*

JPL  
JET PROPULSION LABORATORY

California Institute of Technology  
4800 OAK GROVE DR.,  
PASADENA 3, CALIFORNIA



## Professional Group Meetings

(Continued from page 179A)

Chicago Chapter—April 15

"Latest Developments in Microwave Test Equipment Featuring the Reflectometer" by John E. Stiles and Frank Waterfall, Alfred Crossley Associates, Inc.

### NUCLEAR SCIENCE

Albuquerque-Los Alamos Chapter—May 3

Nomination of Officers for coming year: Chairman—Alan S. Rawcliffe, Vice-Chairman—Leo Grant, Secretary—Richard Hiebert.

Albuquerque-Los Alamos Chapter—  
May 18

"The Racetrack Synchrotron" by G. P. Kenfield, Sandia Corp.

Boston Chapter—April 14

"Dynamic Analysis and Control of Nuclear Power Plants" by J. N. Grace, Westinghouse Atomic Power Div.

Election of Officers: Chairman—John C. Simons, Vice-Chairman and Program Chairman—A. B. Van Rennes, Secretary—William M. Trenholme.

Chicago Chapter—April 15

"Methods of Particle Acceleration" by John J. Livingood, Argonne National Lab.

Chicago Chapter—May 20

"Pioneering in Nuclear Research" by Hal Fredrich Fruth, Hal Fruth Associates.

Connecticut Valley Chapter—May 31

"The Atomic Energy Industry" by F. H. Warren, Gen. Dynamics Corp.

Election of Officers: Chairman—Nelson A. Merritt, Vice Chairman #1—Francis A. Fanelli, Vice Chairman #2—John E. Bassett, Secretary-Financial Officers—Henry A. Sardelli.

Oak Ridge Chapter—May 18

"Organization and Programming for Magnetic Drum Calculators" by J. P. Kelly, K-25 Plant, Oak Ridge.

### PRODUCTION TECHNIQUES

Washington, D. C. Chapter—April 14

"The Autofab Assembly System" by Donald Melton, General Mills.

### RELIABILITY AND QUALITY CONTROL

Chicago Chapter—May 20

"Reliability of Transformers" by Martin Wolff, Chicago Transformer Corp.

### TELEMETRY AND REMOTE CON- TROL COMMUNICATIONS SYSTEMS

Chicago Chapter—April 15

"A New Data Transmission System for Pipeline Applications" by George E. Foster, Metrotyne Corp.

Chicago Chapter—May 20

"The Role of Magnetic Tape in Data Recording, Processing and Analysis" by Gomer L. Davies, The Davies Lab.

(Continued on page 181A)

# ENGINEERS

## ELECTRONIC and MECHANICAL

The Radio and Television Department of General Electric, situated in beautiful Electronics Park, is expanding its staff of development and product design engineers.

Those graduate engineers who qualify for current openings will find excellent opportunities for professional development through association with the outstanding engineers and scientists concentrating on research, development and design in all branches of the electronics industry.

Electronics Park is headquarters for the Electronics Division of GE, including the Electronics Laboratory, Radio and Television Department, Semiconductor Products, Communications Equipment, Broadcast Equipment, Cathode Ray Tube Department, Components Department and Government Equipment Department.

Salary scales for engineers are strictly competitive, and based on individual ability and experience. And, in addition to its comprehensive system of benefits, General Electric is noted for its stability.

Current openings include:

**ELECTRONICS ENGINEERS  
ENGINEERING SUPERVISORS  
MECHANICAL ENGINEERS**

VHF and UHF Head-End Design  
Audio and High-Fidelity Products  
Advanced Development  
Deflection Component Design  
Deflection Systems  
Color Television  
Transistor Circuits  
Metal-forming and Plastics

Please send  
complete resume to:  
MR. JAMES STARK

**GENERAL ELECTRIC**

Electronics Park  
Syracuse, N.Y.



## Professional Group Meetings

(Continued from page 180A)

Los Angeles Chapter—May 17

“Linear Voltage-Controlled Frequency Modulation of the Hartley Oscillator” by W. F. Link, Bendix Aviation Corp. (Presented by W. G. Coe, Bendix Aviation Corporation).

“High Measurement Accuracy via FM/FM Telemetry” by D. W. Blancher, Bendix Aviation Corp.

## VEHICULAR COMMUNICATIONS

Chicago Chapter—April 15

“Transistorized Auto Receiver” by Thomas O. Stanley, RCA Labs.



## News-New Products

These manufacturers have invited PROCEEDINGS readers to write for literature and further technical information. Please mention your IRE affiliation.

(Continued from page 16A)

## TV Camera Dolly

A new, lightweight, remarkably maneuverable television camera pedestal is introduced by **Houston Fearless Div., Color Corp. of America**, 11831 W. Olympic Blvd., Los Angeles 64, Calif. Designated the PD-7, it is particularly adapted to the small studio, or is suitable as an auxiliary camera mount for larger studios.



Outstanding feature of the Houston Fearless PD-7 Pedestal is its unusually light weight: 140 lbs. It rolls smoothly on rubber-tired ball bearing wheels and will pass through a 34 inch or, if necessary, a 30 inch door.

Its maneuverability is made possible by two types of steering: For rolling dolly shots, “parallel steering” is used wherein the three

(Continued on page 183A)

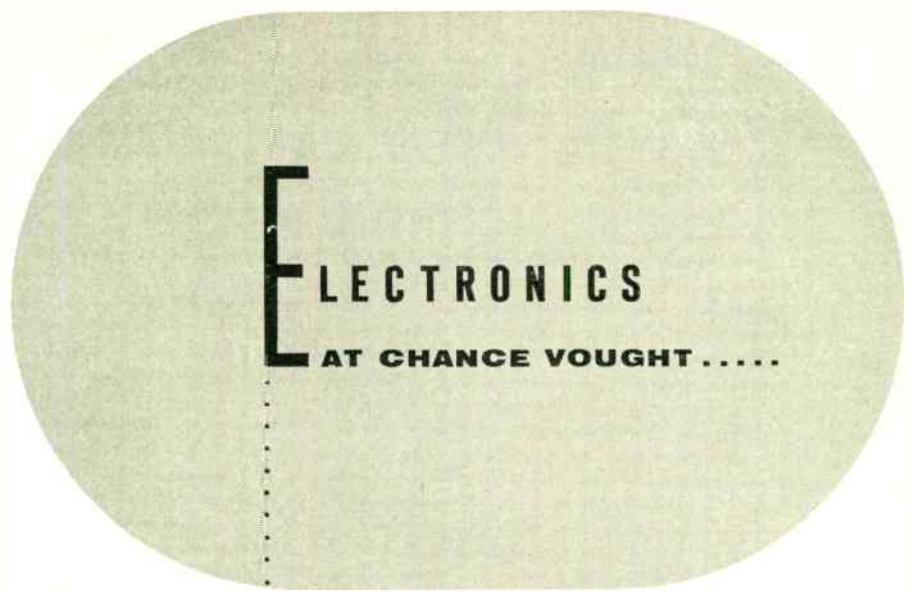

• Chance Vought Aircraft is continuing to expand its activities in the area of Electronics Systems utilization. • Already a recognized leader in the development of surface to surface missiles, Chance Vought is currently undertaking the development of practical electronic systems to further the potential functions of the Regulus Missile projects and the supersonic XF8U-1 Day Fighter. • Exceptional opportunities are available in the following fields:

• **SERVOMECHANISMS** . . . Design, develop and test of Stabilization Control Systems. Analysis and design of Inertial Guidance Systems.

• **RADIATION** . . . Aircraft antenna design and development. Model studies. Wave guide component design. Radome measurements and qualifications.

• **LABORATORIES & DESIGN** . . . Packing design of assemblies for manufacturing. Test analysis and definition of components for the environments.

• **INSTRUMENTATION** . . . Systems planning and installation; transducer design and transistor application to telemetering equipment.

• **SYSTEMS** . . . Coordinate installation, modification, acceptance tests of radar fire control, navigation and communication systems.

• **GUIDANCE** . . . Radar, beacon, computer design for missiles and surface and sub-surface vessel application.

• **RELIABILITY** . . . Test and analyze environmental effects on aircraft components and systems; define reliability criteria.

THE SCOPE of the comprehensive electronics design programs under way at Chance Vought assures the qualified engineer of the opportunity for recognition of his unique abilities and superior performance.

These outstanding career opportunities now exist at all levels in electronics research, design and development.

Engineers interested in a personal interview for discussion of these openings should contact:

SUPERVISOR — ENGINEERING PERSONNEL

**CHANCE VOUGHT AIRCRAFT**  
INCORPORATED

P. O. BOX 5907 — DALLAS, TEXAS

DESIGNERS AND BUILDERS OF HIGH PERFORMANCE MILITARY AIRCRAFT SINCE 1917

## EXPERIMENTAL PHYSICISTS

For the expansion of a small group of competent physicists and engineers who are concerned with the development of new devices and with the solution of advanced instrumentation and measurement problems. This group is responsible for devising methods for the solution of special problems and for the experimental verification of these methods. The final engineering and packaging is normally carried out by other groups in the organization. The varied nature\* of this work requires both recent graduates and experienced people capable of accepting primary responsibility for the solution of problems of varying degrees of complexity.

Excellent opportunities for advancement and advanced study. Salary commensurate with experience and education level.

\* Some of the current investigations are in the fields of mass spectrometry, electron multipliers, electron and ion optics, fast pulse techniques, ultrasonics, radiography, and wide-band sensors for the measurement of pressure, temperature, and flow.

For further information please contact:

PERSONNEL DIRECTOR

**BENDIX AVIATION CORPORATION**

Research Laboratories Division

4855 Fourth Avenue, Detroit 1, Michigan



## ENGINEERS:

Take it from  
RALPH S. HAWKINS,  
B.S.E.E., Cornell  
University '39

**No  
frustrations  
at National**

Mr. Hawkins started with National in 1940 testing equipment and writing instruction books. He advanced to Project Engineer on teletype and facsimile equipment development, then to chief engineer of the Communications Receiver Department, and most recently became Staff Engineer. One reason for his steady and rapid progress is the combination of diversified opportunities and the cooperation of superiors that exists at National. It's a combination, says Mr. Hawkins, that makes an engineer's association with National a pleasant and profitable one.

Opportunities at National Now for . . .

PROJECT ENGINEERS  
SENIOR ENGINEERS

SEND YOUR RESUME TODAY TO Mr. John A. Bigelow

**National**



**NATIONAL COMPANY, INC.**  
60 Sherman St. Malden, Mass.

## ELECTRONIC ENGINEERS

DEVELOPMENT ENGINEER-  
ING OPENINGS EXIST IN THE  
FOLLOWING FIELDS:

### SERVO-SYSTEMS . . .

SERVO AMPLIFIERS . . . REMOTE  
POSITIONERS . . . INSTRUMENT  
DEVELOPMENT.

### PULSE CIRCUITS . . .

RADAR APPLICATIONS . . .  
DIGITAL DEVICES.

### ANALOGUE CIRCUITS . . .

TRANSISTOR-MAGNETIC  
AMPLIFIER DEVELOPMENT.

A background in computer or radar systems work is desirable. Openings also exist in the above fields for Junior Engineers.

The efforts of a relatively small but select staff are being applied on projects requiring engineering ingenuity essential to advancing the art of control.

For a Confidential  
Personal Interview  
during the National  
Electronics Conference  
Call Vernon Vogel

at the Bismark Hotel.

Telephone: Central 6-0123

Appointments may be made in advance by contacting Mr. Vogel, Electronics Laboratory Director, in Anaheim.

AERONAUTICAL DIVISION

### ROBERTSHAW-FULTON

CONTROLS COMPANY  
SANTA ANA FREEWAY AT  
EUCLID AVENUE  
ANAHEIM, CALIFORNIA  
Telephone: MUtual 5144 or  
KEystone 5-8151

## ELECTRONICS for Medical Research

E.E. or Physics Major with work experience in electronic instrumentation. Interesting & challenging opportunity to develop equipment in connection with medical & biological research problems. Superior employee benefits & working conditions. Nationally known research organization located N.Y. area. Send detailed resume including salary requirements.

Box #829, Institute of Radio  
Engineers

1 East 79th St., New York 21,  
N.Y.

## PHYSICISTS RESEARCH ENGINEERS

The Radiation Laboratory of The Johns Hopkins University provides unusual opportunities in a long range research and development program for senior engineers and physicists. The men we seek are experts in fields of:

INFRARED TECHNIQUES  
SYSTEMS  
MICROWAVES  
CIRCUITRY

The Laboratory offers challenging work in an atmosphere of scientific progress, encourages professional advancement and provides opportunity for advanced study in the University graduate schools. Congenial surroundings, excellent laboratory facilities, stimulating associations and, of course, liberal employee benefits.

Address inquiries to:  
Radiation Laboratory  
The Johns Hopkins University  
Homewood Campus  
Baltimore 18, Maryland





## News-New Products

These manufacturers have invited PROCEEDINGS readers to write for literature and further technical information. Please mention your IRE affiliation.

(Continued from page 181A)

wheels are locked in parallel and turn together in any direction. For sharp turning or rotating "tricycle steering" is employed wherein all steering is done with the rear wheel while the front wheels are locked in parallel. Changing from one type of steering to the other is done simply by lifting the steering wheel.

### RF Signal Generator

**EICO ELECTRONIC INSTRUMENT CO., INC.**, 84 Withers St., Brooklyn 11, N. Y., has just released details on its new Model 324 Signal Generator. It can be used for IF-rf alignment; signal tracing, and trouble shooting of AM, FM and TV receivers (all on fundamentals); as a marker generator for alignment of new high-frequency as well as older low frequency TV IF's; for 400 cps sine wave audio testing, and laboratory and experimental work.



Its frequency range is 150 kc to 145 mc on fundamentals in 6 bands; and 111 mc to 435 mc on calibrated harmonics. Accuracy of dial calibration is  $\pm 1-5$  per cent with 6-1 vernier tuning knob and good spread at most important frequencies.

Colpitts rf oscillator, directly plate-modulated by a cathode follower for improved modulation. Turret-mounted, slug tuned coils for individual calibration of each band. Variable depth of internal modulation from 0 to 50 per cent by the 400 cps Colpitts oscillator. Variable gain external modulation amplifier requires audio input of only 0.8 volts for 30 per cent modulation. Fine and Coarse (3 step) attenuators—50 ohms output impedance. The unit is supplied complete or in kit form. Request catalog Z-1.

(Continued on page 184A)

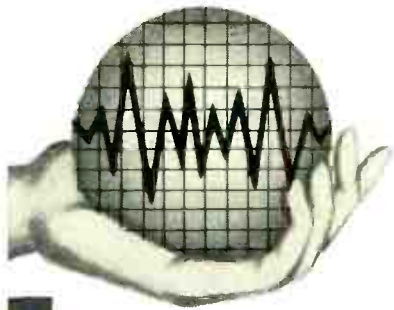

## ENGINEERS

# How Realistic Are You About Your Future In Electronics?

As the electronics industry grows from \$9 billion to \$20 billion in the next 10 years, will you be growing with it?

In answering, consider the extent to which your personal progress is dependent on the progress of the company you are with...and the following facts about Sylvania:

- Sylvania has expanded to 45 plants and 16 laboratories in 11 states
- In 6 years, the electronics industry grew 24%; Sylvania grew 32%
- Since 1949, Sylvania has doubled its engineering staff and tripled its sales

Sylvania's success story is the story of its creative engineers. These men of talent are given wide latitude to experiment... every facility to test original designs... and are rapidly advanced in the company as is shown by the fact that the average age of high level officials at Sylvania is only 45.

If you are realistic about your future, look into the opportunity now open to join Sylvania...and be high in your profession 10 years from now.

### WALTHAM Engineering

Majors in E.E., M.E., Math, Physics. Research & Development experience in—

- Countermeasures
- Systems Analysis
- Transistor Applications
- Noise Studies
- Antenna Res. & Dev.
- Systems Development
- Mechanical Design
- Miniaturization
- Digital Computer Circuits & Systems
- Circuit Design
- Shock & Vibration
- Technical Writing
- Missile Analysis

### Missile Systems Laboratory

- Radar Research & Development
- Missile Guidance & Ground Equipment Analysis
- Systems Evaluation Operations Research

### BUFFALO Engineering

Majors in E.E., M.E., or Physics. Experience in Product Design and Advanced Development in—

- Circuit Design
- Systems Development
- Pulse Techniques
- F.M. Techniques
- Equipment Specifications
- Components
- Microwave Applications
- Servo Mechanisms
- Subminiaturization
- Mechanical Design
- Shock & Vibration
- Heat Transfer

**INTERVIEW & RELOCATION EXPENSES WILL BE PAID BY SYLVANIA**

Sylvania provides financial support for advanced education as well as liberal insurance, pension and medical programs.

Please forward resume to: Professional Placement Supervisor

### SYLVANIA ELECTRIC PRODUCTS INC.

Thomas A. Tierney  
100 First St.  
Waltham, Mass.

Randall A. Kenyon  
175 Great Arrow Ave.  
Buffalo 7, N. Y.

**SYLVANIA**  
SYLVANIA ELECTRIC PRODUCTS INC.

Your inquiries will be answered within 2 weeks

# Electrically Conductive Cloth

**A New Engineering Material for Many Applications in Electronics**

SUGGESTED USES:

RF SHIELDING  
RADAR REFLECTION  
MICROWAVE GASKETING  
WARNING SYSTEMS  
ATTENUATORS  
STATIC DISCHARGE

Buy it by the yard and sew it to shape on any sewing machine. Or, have us sew it for you.

WRITE OR PHONE

# Swift

INDUSTRIES, INC.  
10 Love Lane, Hartford 1, Conn.  
Hartford 2-1181



These manufacturers have invited PROCEEDINGS readers to write for literature and further technical information. Please mention your IRE affiliation.

(Continued from page 183A)

## Master TV Amplifier with AGC

High power single channel TV amplifiers with automatic gain control are now available from **Blonder-Tongue Laboratories, Inc.**, 526-536 North Ave., Westfield, N. J. These model MCS units are used to amplify, mix and equalize individual VHF channels at the antenna site, or in TV distribution lines.

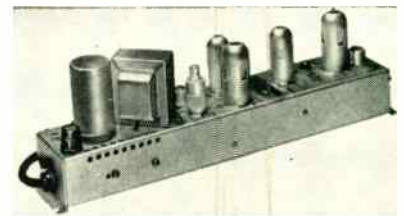

The new "Masterline" amplifiers deliver a maximum constant output of 0.7 volts RMS on each channel. Gain ranges from 32 to 36 db and response is flat within  $\pm 1$  db. Side channel rejection is high. Any number of units may be mixed without loss and channels may be cascaded for increased gain. Model MCS can be added to any existing amplifier system.

Each MCS has a built-in power supply and an ac receptacle to receive the power cord of the next unit. Power rating is 28 Watts at 0.28 amperes from a standard 117 volt source. Tube complement includes (2) 6CB6, (1) 6BK7A and (1) 6AM8. All input and output cables are handled by 75 ohm coax fittings. In outdoor installations, amplifiers may be enclosed and shielded in B-T's Model MRH Radiation-Proof Housing. List price for each MCS unit is \$109.50.

## Current Probe

A new device for the measurement of rf current and interference in conductors has been announced by the **Stoddart Aircraft Radio Co., Inc.**, 6644 Santa Monica Blvd., Hollywood 38, Calif.

The probe does not require direct connection to the conductor under measurement. It is a special-

(Continued on page 186A)

## CONTINUOUS, DIRECT-READING X-BAND VSWR MEASUREMENT



better than  
**2% overall accuracy!**

For speedy and accurate VSWR measurements in laboratory or production use, the CTI Model 110B Measuring System reads directly, is continuously tunable from 8,500 to 9,600 mc.

### SPECIFICATIONS

|                                   |                                 |
|-----------------------------------|---------------------------------|
| Two VSWR Ranges:                  | 1.02 to 1.2; 1.2 to 2.5         |
| Attenuation Scale:                | 0 to $\infty$ ; 1.5 db midscale |
| Waveguide Fitting                 | UG-39/U                         |
| Directional Couplers, directivity | over 40 db                      |

**COLOR TELEVISION INCORPORATED**

SAN CARLOS 2, CALIFORNIA



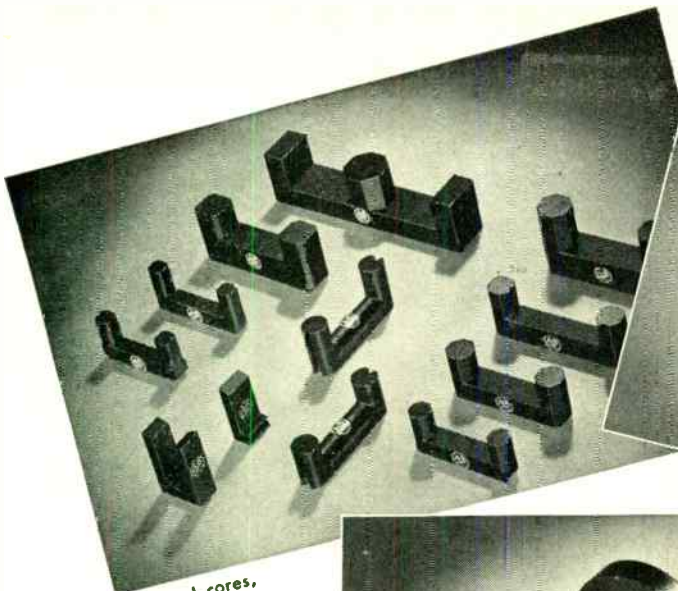

E-cores, L-cores,  
and U-cores

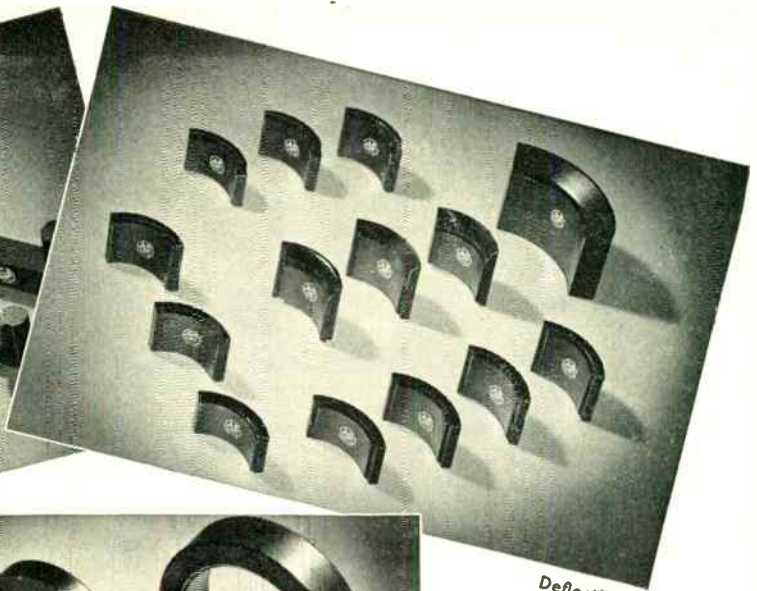

Deflection  
yoke cores  
Quarter-section

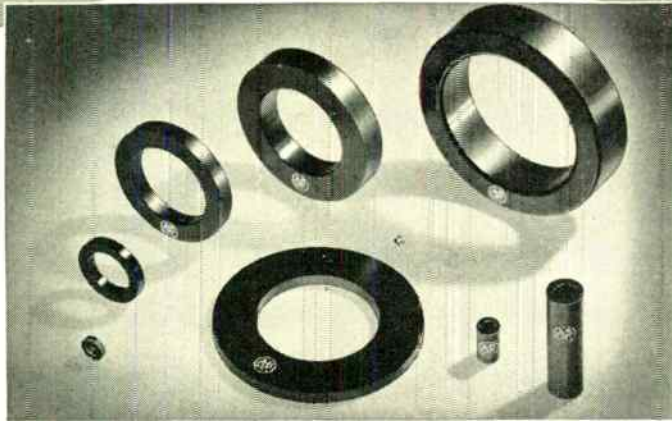

Toroid, cylindrical,  
and ring cores

## FERRITE COMPONENTS of HIGH EFFICIENCY for COLOR TV CIRCUITS

A greatly broadened line of Allen-Bradley Quality ferrite parts is now available to electronic and television set manufacturers. Some standard pieces are shown above.

Three performance standards—WO-1, WO-2, and WO-3 have been established for the electrical and magnetic characteristics of Allen-Bradley ferrite component parts:

WO-1 and WO-3 are somewhat more efficient but still interchangeable with other makes of ferrite parts.

WO-2 parts have much lower losses and higher

permeability with greater flux density at maximum operating temperatures. Their higher magnetic efficiency permits reduction in size of these ferrites and the use of less copper. A lower over-all cost is often the result. In some color television circuits, the use of Allen-Bradley WO-2 ferrites has eliminated two tubes and related parts.

Allen-Bradley has grown rapidly as a dependable producer of Quality ferrite parts. It will pay you to investigate the performance of Allen-Bradley ferrites in your electronic circuits.

Allen-Bradley Co.  
114 W. Greenfield Ave., Milwaukee 4, Wis.

In Canada—  
Allen-Bradley Canada Ltd., Galt, Ont.

### OTHER QUALITY COMPONENTS FOR RADIO, TV & ELECTRONIC APPLICATIONS



NEW — Allen-Bradley  
Ferrite Beads for in-  
creasing the inductance of  
lead wires.

ALLEN-BRADLEY FERRITE BEADS



Ferri-Cap Feed-thru Filters are capacitors in combination with ferrite material to provide "T" filter performance.

ALLEN-BRADLEY FERRI-CAP FILTERS

# ALLEN-BRADLEY

## RADIO, ELECTRONIC AND TELEVISION COMPONENTS



## 360-440 CPS BENCH TYPE

### VARIABLE FREQUENCY POWER SUPPLY "THE STANDARD OF THE INDUSTRY"

Operating from standard 115v 60 cps power, the Model 1460 provides 400 cps 100-130 volt supply at any bench position. Utilization of units of this type allows testing at 400 cps  $\pm 10\%$  at any individual position without interference with any other test position. Catalogue "M" describing this unit as well as other CML generators in the power range of from 50 VA to 80 KVA and frequency range of 20 cps to 60 KC is available for the asking.



MODEL 1460

**OUTPUT—100 V.A.**  
**DISTORTION—2%**  
**STABILITY— $\pm 1$  CPS**  
**REGULATION— $\pm 1\%$ .**

## COMMUNICATION MEASUREMENTS LABORATORY, INC.

350 LELAND AVE., PLAINFIELD, N.J.



### News-New Products

These manufacturers have invited PROCEEDINGS readers to write for literature and further technical information. Please mention your IRE affiliation.

(Continued from page 184A)

ly-designed radio-frequency current transformer of the inserted-primary type and has a nominal output impedance of 50 ohms. The probe consists of two semi-circular insulated windings on a hypersil core. These are hinged, and by opening the probe the conductors may be placed in its center. A locking arrangement holds the probe closed.



The probe is useable from 20 cps to 25 mc and is especially designed for use with the Stoddart NM-10A and NM-20B Radio Interference-Field Intensity Measuring equipments.

Interference measurements may be made on single and multi-conductor cables, on ground and bonding straps, and on the external surfaces of shielding conduits and coaxial cables. Radio frequency currents, modulated or unmodulated, can also be measured by suitable operation of the NM-10A or NM-20B.

### Precision Variable Delay Line

This delay line, designed by Advance Electronics Co., Inc., 451 Highland Ave., Passaic, N. J., consists of 60 sections of LC m-derived networks and one 60 position rotary switch. The LC m-derived networks are especially designed for fast rise time, and negligible overshoot. The rotary switch is used to change the amount of time delay between the input and output by connecting the output terminal to any one of the 60 sections of LC networks. The input impedance of the delay line is equal to the characteristic impedance. The output terminal should be connected to a high-impedance load (approximately 20 times or more the characteristic impedance of the line), such as the

(Continued on page 188A)

### DIRECT TEMPERATURE MEASUREMENTS

UP TO **3700° F.**

**IRIDIUM vs. RHODIUM IRIDIUM  
THERMOCOUPLE WIRE**

The only thermocouple material which may be used at these very high temperatures in an oxidizing atmosphere.

Ductile wire made possible by high purity and our advanced melting and drawing techniques.

Output: Over 10 millivolts at **3700° F.**

UNIFORM • REPRODUCIBLE

Write for List of Products

Since 1901



## SIGMUND COHN CORP.

Metallurgists and Producers of Small Wire

121 SOUTH COLUMBUS AVE., MOUNT VERNON, N. Y.

Specialists in the  
*Unusual*



# Buss Fuses give you..

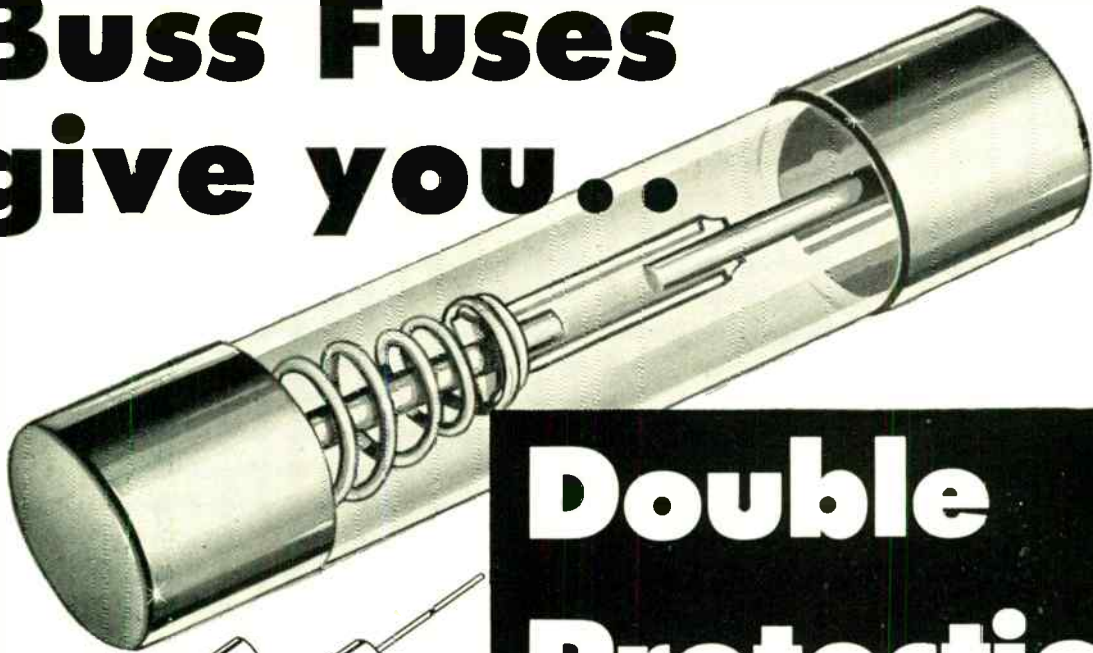

## Double Protection

### .. Against loss of Customer Satisfaction

To make sure of proper operation under all service conditions — every BUSS fuse normally used by the Electronic Industries is tested in a sensitive electronic device. Any fuse not correctly calibrated, properly constructed and right in all physical dimensions is automatically rejected.

That's why BUSS fuses won't blow when trouble doesn't exist. Useless shutdowns caused by poor quality fuses blowing needlessly are not only irritating to customers — but customers' confidence in your product or service could be jolted.

However, when there is an electrical fault BUSS fuses open to prevent further damage to equipment — saving users the expense of replacing needlessly damaged parts.

When you standardize on BUSS fuses, you are doubly safe.

MAKERS OF A COMPLETE LINE OF FUSES FOR  
HOME, FARM, COMMERCIAL, ELECTRONIC,  
AUTOMOTIVE AND INDUSTRIAL USE.

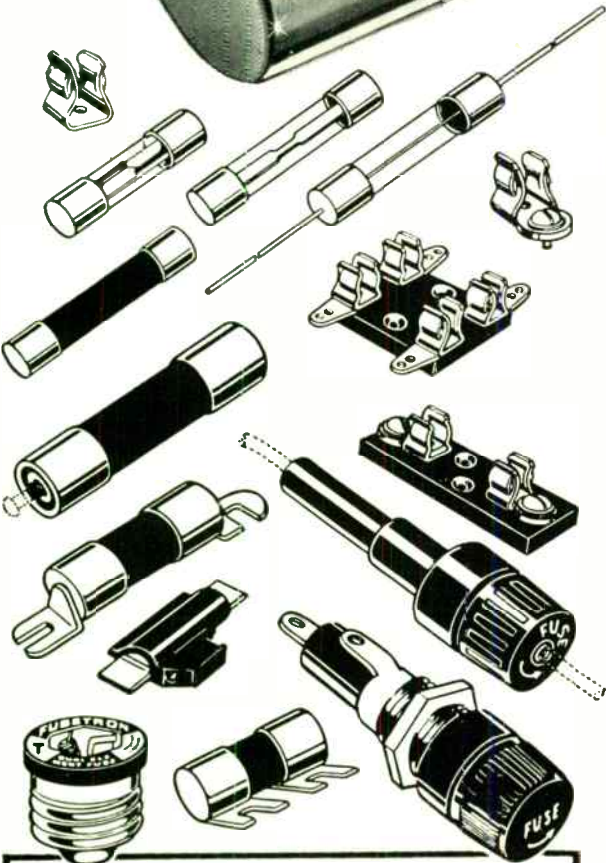

#### SAVE ENGINEERING TIME ON ELECTRICAL PROTECTION PROBLEMS

The BUSS fuse research laboratory and its staff of engineers are at your service to help you with problems involving electrical protection. Submit description or sketch and tell us your requirements.

Whenever possible, the fuse or fuse mounting selected will be available in local wholesalers' stocks, so that your device can easily be serviced.

Be sure to get the latest information on BUSS and FUSETRON small dimension fuses and fuse-holders . . . Write for bulletin SFB.

**BUSSMANN MFG. CO.**



Div. McGraw Electric Co.

University at Jefferson

St. Louis 7, Mo.

# CRITICAL QUALITY CONTROL

Means the Finest in Frequency Control in

## Midland CRYSTALS

Midland makes more frequency control crystals than anybody else. Millions are used in two-way communications throuout the world.

Only a product of the highest quality rates that kind of demand. That's why you know your Midland crystal will do a completely dependable job for you.

The quality of Midland crystals is assured by exacting tests and controls through every step of processing. It's quality you can stake your life on — as our men in the armed forces and law enforcement do every day.



Whatever your crystal need — conventional or highly specialized... when it has to be exactly right, contact

**Midland Manufacturing Co., Inc.**  
3155 Fiberglas Road • Kansas City, Kansas  
**WORLD'S LARGEST PRODUCER OF QUARTZ CRYSTALS**



These manufacturers have invited PROCEEDINGS readers to write for literature and further technical information. Please mention your IRE affiliation.

(Continued from page 186A)

grid circuit of the amplifier. The end of the delay line has been terminated by a resistor equal to the characteristic impedance internally.



Both the m-derived networks and the rotary switches can be moved from the cabinet and incorporated into any equipment where various time delay is needed. The accuracy of time delay can be as high as  $\pm 0.5$  per cent of the time delay at any point.

There are five different types available. Type 605a has a maximum time delay of  $0.6 \mu s$  in step of  $0.01 \mu s$ , 75 ohms impedance, 32 megacycles bandwidth, and  $0.01 \mu s$  rise time. Type 605b has a maximum time delay of  $1.5 \mu s$  in step of  $0.35 \mu s$ , 95 ohms impedance, 12.4 mc bandwidth, and  $0.025 \mu s$  rise time. There are three more types available with total time delay up to  $12 \mu s$ . All of them have 60 steps and impedance ranging from 75 ohms to 300 ohms.

### Miniature Toroid Coils

A line of toroid coils for use with transistors in both subminiature and printed circuits is announced by the Forrest Mfg. Co., 5962 Smiley Dr., Culver City, Calif. These coils are designed for insertion through transistor terminal boards, the windings are terminated in lugs, or solid wire leads. Leads can be tinned for dip soldering, or brought to any pin arrangement. Major applications for the toroids include uses in

(Continued on page 190A)

## NEMS-CLARKE INCORPORATED 167 SERIES RECEIVERS



for **UNEQUALED PERFORMANCE** in

- TELEMETERING
- GUIDED-MISSILE MONITORING
- RADIOSONDE RECEPTION

Frequency coverage of 55 to 260 megacycles, AM and FM, without band changing. The 167 series of Special Purpose Receivers are designed for optimum performance in telemetering, guided-missile monitoring, radiosonde reception, television sound rebroadcasting and many other applications calling for superior performance. The superheterodyne circuit assures lowest noise figure possible with an input tube of reasonable cost, ready availability, and reliable performance. Particular care has been exercised to provide for extreme sensitivity and linearity of response, and the 500 ohm impedance of the output circuit permits bridging of many high-impedance devices. Only the finest components are used in their construction. All meters, transformers and chokes are hermetically sealed; all components are operated well within their safe design limits; and the entire assembly is treated to reduce the effect of moisture and fungus. Rigidly inspected and aligned, the Model 167 Receivers reflect the high standards characteristic of the products of this company which for 45 years has been engaged in manufacturing radio-communications equipment and electronic instruments for the rigid requirements of military service.

**NEMS-CLARKE**  
Incorporated



PRECISION ELECTRONIC INSTRUMENTS

WRITE FOR FULL SPECIFICATIONS DEPT. NO. G

SILVER SPRING MARYLAND

# The most valuable reference work in the world

- for the electronics engineer
- for buyers of component parts
- for users of electronic equipment
- for anyone who must

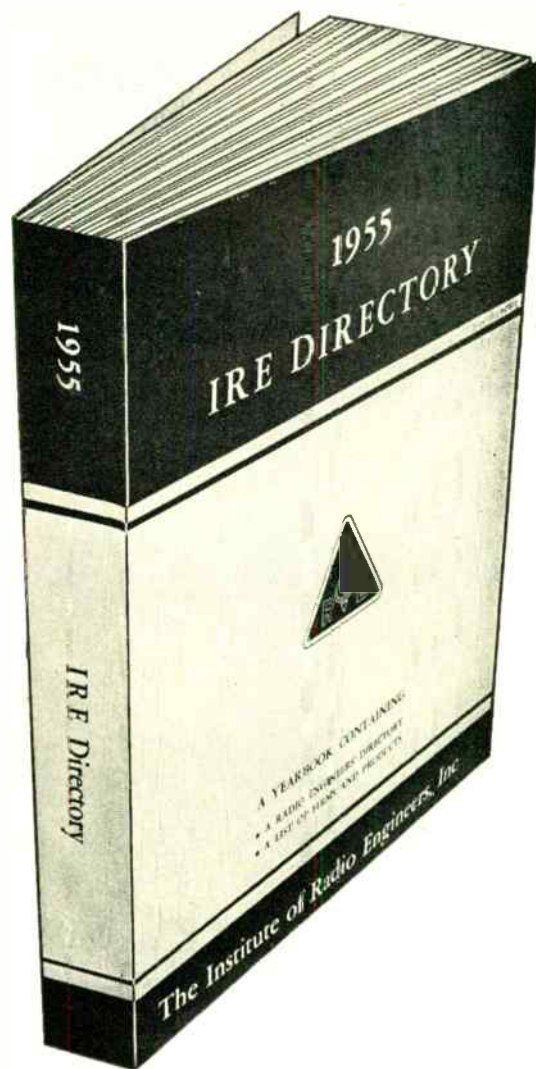

## FIND FACTS FAST

The IRE Directory contains full information on 3000 firms manufacturing products or furnishing services in the radio-electronic field, brought up-to-date every year.

Arranged efficiently and logically, the way an engineer thinks, for simple location of any product or service—

675 specific products and services, arranged under  
99 major headings in  
4 great groups

- Communications
- Components
- Controls and Instruments
- Materials and Services

USE YOUR IRE DIRECTORY . . . IT'S VALUABLE  
1955 edition coming September 15.



### THE INSTITUTE OF RADIO ENGINEERS

1 East 79th Street, New York 21, N.Y.

SERVICING KITS · TAPE RECORDERS · ANTENNA ROTATOR · CONTROL CABLES

When You Need



# Coated fabrics...



Fabric-covering problems vary with the size and shape and function of the carrying case. Here's the cue for APEX specialists! For fast-colored, durable fabrics to make your units SELL faster and LAST longer... ask men who KNOW.



It will cost you nothing to let APEX specialists consider your problems.

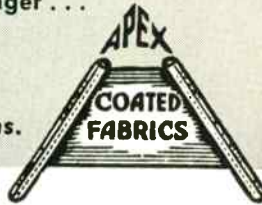

For 29 years "THE HOUSE of SERVICE"

## APEX COATED FABRICS Co., Inc.

12-16 East 22nd St., N. Y. City 10  
Spring 7-3140



### News-New Products

These manufacturers have invited PROCEEDINGS readers to write for literature and further technical information. Please mention your IRE affiliation.

(Continued from page 188A)

super-selective IF, rf and audio transformers, pulse transformers, high Q filter reactors, magnetic amplifiers, low-level modulators, tuneable reactors, and voltage regulators.

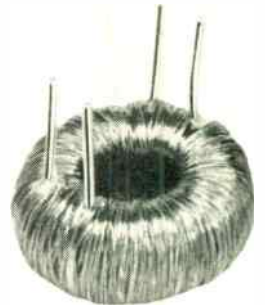

Sizes range from  $\frac{5}{8}$  OD  $\times$   $\frac{1}{4}$  to  $\frac{7}{8}$  OD  $\times$   $\frac{3}{8}$  inches. Inductance values up to 2 henries. Types for use with reactors provide as high as 150 Q in the  $\frac{5}{8}$  inch size illustrated, with rising Q values as coil sizes increase. Types for use in magnetic amplifiers, modulators and voltage regulators absorb up to 130 V, 400 cps in units with an OD of 0.94 inch. Manufacturer states that windings with low capacity and rf resistance can be provided. Units are finished with hard-setting epoxy resin, or are sealed in cans to meet Mil specifications. Maker will wind coils to special sizes and inductance values. Details on the line will be sent on request.

### Color TV Tuboscope

The Color TV Tuboscope, manufactured by Edmund Scientific Corp., 101 E. Gloucester Pike, Barrington 3, N. J., is a microscope designed to assist and simplify alignment of the dot pattern on the picture tube during manufacture and on regular field service calls. Specifically, it checks the accuracy and concentricity of the pattern where unaided vision is unsatisfactory.

The instrument consists of two parts, a main chrome plated optical body housing a cemented achromatic objective lens with the eyepiece, and the outer black

(Continued on page 192A)

# Cosmic

CONDENSER SPECIALISTS SINCE 1923  
ELECTROLYTIC & PAPER TUBULAR  
**CONDENSERS**  
For A.C., D.C. Sets - Phonographs etc.

**COSMIC CONDENSER CO.**  
853 WHITTIER ST., BRONX  
N. Y.

for

**performance**

**quality**

**price**

Phone — LU 9-3360

## VHF-UHF Noise Source

Long-Lived, Low Cost Tubes  
No Balun Requirements  
No Tuning Required

This simplified noise source operates between 50 and 900 mc. It's fast and accurate, ideal for testing television tuners and receivers in the laboratory and on the production line.

Noise Figure: 0 to 19 db; Accuracy:  $\pm 1$  db max. at 900 mc with equipment having an input impedance of 300 ohms.  $\pm 0.5$  db below 400 mc regardless of input impedance.

Write for Catalog



**NEW LONDON  
INSTRUMENT**

*Company* INC.

82 Union Street  
New London 4, Conn.



**DESIGNED**  
**...DELIVERED**  
*in operation\**!

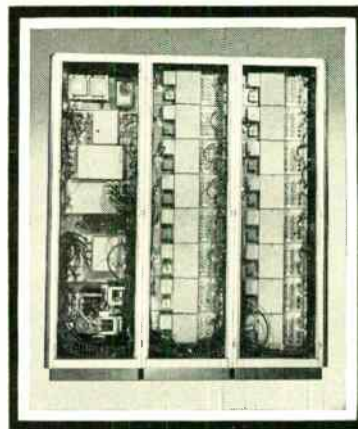

# datex digital data recording systems

\*NAMES ON REQUEST

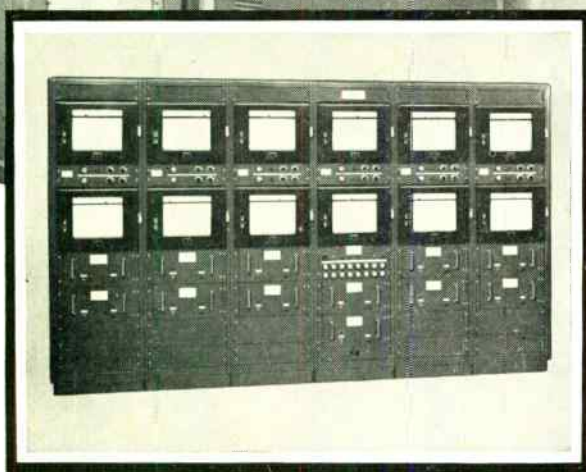

Designed by using *Standard* Giannini DATEX modular units, systems, such as those illustrated, facilitate automatic data handling, logging, recording and indicating. Giannini DATEX standard modular units are engineered so that they can be readily combined into complete data recording systems controlled by a single contact closure.

The inherent simplicity of the DATEX Building Block concept, which utilizes standard major elements to make either small or large multi-channel systems, allows expansion by the addition of other modular elements. Various input or output arrangements are possible by using standard switching or sequencing techniques. Combinations of outputs (punch cards, typewritten tabulation, visual light bank, printed tape or punched tape) are readily obtained by the addition of proper modular units. Basically electro-mechanical in design, DATEX systems use simple tested components of proven reliability to give superior performance.



**REGIONAL SALES OFFICES:**

EMPIRE STATE BLDG., NEW YORK 1, N.Y. • CHICKERING 4-4700  
 8 SO. MICHIGAN AVE., CHICAGO, ILL. • ANDOVER 3-5272  
 1307 SO. MYRTLE AVE., MONROVIA, CALIF. • ELLIOTT 9-5381

**G. M. GIANNINI & CO., INC. • PASADENA 1, CALIFORNIA**



Here are your  
**CANNON CONNECTORS**  
for PRINTED CIRCUITS

- Available in 5 Sizes
1. DX-1052. Length 2-13/32". 10 contacts, spaced 5/32". For cards 0.057" to 0.067" thick.
  2. DX-1852. Length 3-21/32". 18 contacts, spaced 5/32". For boards 0.060" to 0.071" thick.
  3. DX-2252. Length 4-9/32". 22 contacts, spaced 5/32". For boards 0.060" to 0.071" thick.
  4. DX-2842. Length 4-9/32". 28 contacts, spaced 1/8". For boards 0.060" to 0.071" thick.
  5. DY-4453. Length 4-9/32". Double row, total of 44 contacts, spaced 5/32". For printed circuit boards 0.062" to 0.100" thick.



**Nylon plastic shells... gold plated contacts**

DX contacts of phosphor bronze; DY of beryllium copper. All contacts "grip" the board, which enters to a depth of approximately 11/32". Each rated at 5-amp. Polarization studs provided. Flashovers 2000 and 2500 v. 60 cps ac rms.

Single-row types for boards printed on one side only, or both sides common. Double-row type for boards printed both sides having different circuits, not common.

Please refer to Dept. 377

**CANNON PLUGS**

40th YEAR 1911-1951

CANNON ELECTRIC CO., 3209 Humboldt St., Los Angeles 31, California. Representatives and distributors in all principal cities



**News-New Products**

These manufacturers have invited PROCEEDINGS readers to write for literature and further technical information. Please mention your IRE affiliation.  
(Continued from page 190A)

anodized felt lined aluminum barrel for focusing. A working distance of 4 1/4 inches is ample to view the periphery of the tube, and



makes it unnecessary to remove the safety glass shield thereby protecting technicians from the high potential on the tube.

Five different eyepieces are available and can be easily interchanged to give powers from 10X to 33X. The instrument is 7 1/4 inches long with outside diameter of 1 1/2 inches.

**Ohmmeter**

A new low-resistance ohmmeter featuring low test current is announced by Industrial Instruments, Inc., Cedar Grove, N. J., manufacturers of electrical test equipment. The new meter, Model LRO, is especially adaptable to measurement of relay contact resistance, fuse resistance, bonding and ground wire resistance and any other application requiring low resistance measurements with minimum test current.

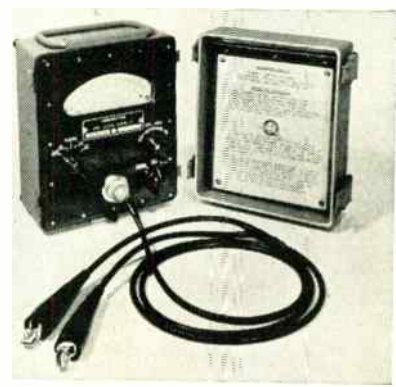

The Model LRO has an accuracy of ±1 per cent of full scale reading. Ranges include full-scale  
(Continued on page 194A)

**BE SAFE WITH**

# Q-max

**A-27**

**LOW-LOSS LACQUER & CEMENT**

- Q-Max is widely accepted as the standard for R-F circuit components because it is chemically engineered for this sole purpose.
- Q-Max provides a clear, practically loss-free covering, penetrates deeply, seals out moisture, imparts rigidity and promotes electrical stability.
- Q-Max is easy to apply, dries quickly and adheres to practically all materials. It is useful over a wide temperature range and serves as a mild flux on tinned surfaces.
- Q-Max is an ideal impregnant for "high" Q coils. Coil "Q" remains nearly constant from wet application to dry finish. In 1, 5 and 55 gallon containers.

*Communication Products Company, Inc.*

MARLBORO, NEW JERSEY (MONMOUTH COUNTY)  
Telephone: Freehold 8-1880

**52-ohm LINE STRETCHERS**

*Coaxial, constant impedance type, has low VSWR*

Rugged, reliable and handles substantial RF power.

Model 3701 extends 8 inches.  
Model 3702 extends 14 inches.

Both can be fitted with Types N, HN, or other connectors.

Write for Bulletin R-454

ANTENNA SYSTEMS - COMPONENTS  
AIR NAVIGATION AIDS - INSTRUMENTS

**ALFORD**  
Manufacturing Co., Inc.  
299 ATLANTIC AVE., BOSTON, MASS.

# new

## 1 1/4" P.M. MOTOR

smaller · more efficient  
minimum radio noise

MEETS MIL-M-8609 SPECS

# Oster®

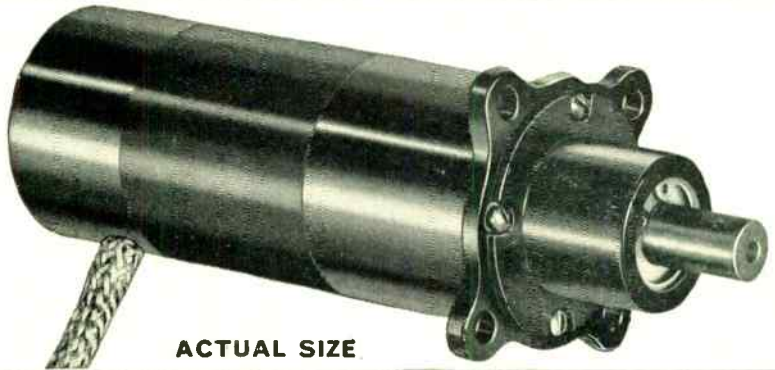

ACTUAL SIZE

### *a complete new line of 1 1/4" P.M. Motors*

- **Smaller:** 5 oz. weight, 2.14" L, 1.25" OD. (A typical example—Type AM-210).
  - **Exceptionally High Torque** due to unique, simpler magnet design.
  - **Radio Noise Minimized.**
  - -55° C to +71° C temperature range.
  - 6000 to 20,000 RPM motor speed range. Speeds controllable to ±1% over a voltage range from 24V to 29V by using a governor.
  - Altitude-Treated Brushes have exceptionally long life.
  - Specially Designed Metal Brush Holders avoid sticking in environmental tests and do not protrude into outside housing, permitting full design freedom.
  - Available with gear train, governor, brake or any combination thereof. For gear train ratios, see chart.
  - Applications: radio, radar, actuators, drive mechanisms, antenna tilt-motors, tuning devices, blowers, cameras and many others.
- Write for further details today.

#### PERMANENT MAGNET MOTOR GEAR TRAIN DATA

Motor can be designed for speeds from 6000 RPM to 20,000 RPM.

Length of motor will vary according to power.

Length of gear train will vary according to gear ratio required—

| TORQUE AT OUTPUT SHAFT<br>OZ. IN. | GEAR RATIO OF GEAR TRAIN |
|-----------------------------------|--------------------------|
| 25                                | 15:1 to 33,000:1         |
| 100                               | 15:1 to 33,000:1         |
| 300                               | 15:1 to 33,000:1         |
| 400                               | 15:1 to 5,500:1          |
| 600                               | 15:1 to 5,500:1          |

|                    |          |
|--------------------|----------|
| 1000:1 to 33,000:1 | 6 stages |
| 300:1 to 5,900:1   | 5 stages |
| 100:1 to 1,000:1   | 4 stages |
| 40:1 to 183:1      | 3 stages |
| 15:1 to 32:1       | 2 stages |

Other products include Actuators, AC Drive Motors, DC Motors, Fast Response Resolvers, Servo Torque Units, Servo Motors, Synchros, Reference Generators, Tachometer Generators and Motor Driven Blower and Fan Assemblies.

# John Oster

## MANUFACTURING CO.

Your Rotating Equipment Specialist

avionic division

RACINE, WISCONSIN



## News-New Products

These manufacturers have invited PROCEEDINGS readers to write for literature and further technical information. Please mention your IRE affiliation.

(Continued from page 192A)

readings of 0.1 ohm, 1 ohm and 10 ohms. The scale is divided into 1100 divisions, that is, one scale division on the 0.1 range therefore being 0.001 ohm.

With the Model LRO Ohmmeter current passing through test piece never exceeds 110 milliamperes on any range. Protection for the meter is incorporated in the event resistance being measured is outside range of instrument or open. Connection to resistance to be measured is made by special test lead supplied with the instrument which provides four terminal measurement for increased accuracy in the low resistance ranges.

Instrument is entirely self-contained. Power is supplied by standard flashlight battery of 1½ volts.

### Variable Inductors

Available both shielded and unshielded, then ew Style A Type 1 Variable Inductors designed by Levinthal Electronic Products, Inc., 2979 Fair Oakes Ave., Redwood City, Calif. are supplied in ten standard values from 56 µh to 1.8 µh and up to a maximum of 25 µg in special units. They feature an inductance variation range of 2:1; Q's of approximately 200; operating temperature range from -50°C to +100°C; and temperature coefficients of inductance less than 50 ppm/°C.

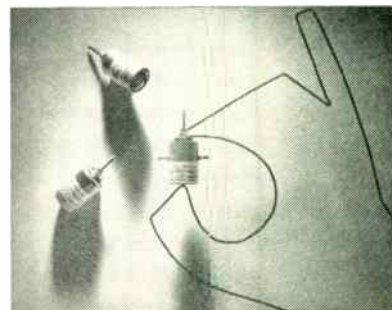

Imbedment of the entire powdered carbonyl-iron cup core and coil assembly in epoxy resin gives these variable inductors high resistance against the effects of large-amplitude vibration or shock, as well as providing good protection against moisture and chemical attack. Type 1 core formula gives unusually constant

(Continued on page 196A)

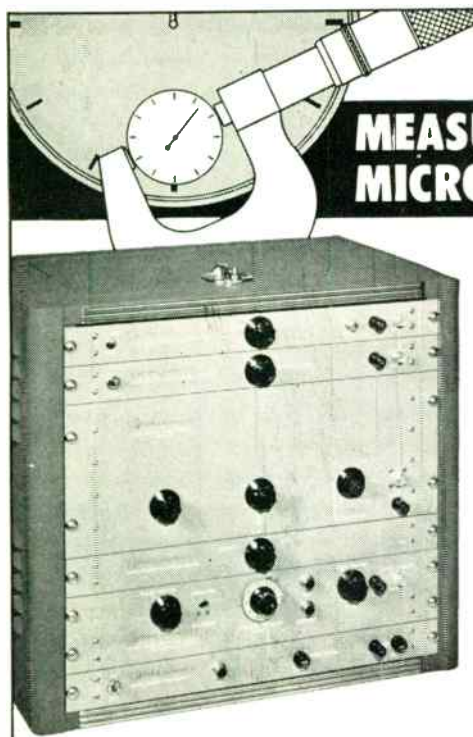

## MEASURE TIME WITH MICROMETER ACCURACY

### MODEL B-4 TIME MEASURING SYSTEM

Direct reading for simple, fast, accurate operation

Measures time intervals to an accuracy of ±2 millimicroseconds

Provides marker signals of .1 µs and 1 µs spacing on synchroscope

Incremental control calibrated to ±1 millimicrosecond

Complete self-contained integrated system

WE ALSO MAKE PRECISION WIDE-RANGE PULSE and TIME DELAY GENERATORS—DATA SHEETS AVAILABLE

Write for complete data: our Bulletin I-B-4

**Rutherford ELECTRONICS CO.** 3707 S. ROBERTSON BLVD. CULVER CITY, CALIFORNIA

## BETTER IMPREGNATING EQUIPMENT MEANS BETTER PRODUCTION

.... and

# NYECO has the Best!

Whether you impregnate electrical windings, transformers, castings, paper tubes, etc.—with NYECO's *better* equipment, you will get *better* impregnation and *more* production.

The New York Engineering Company manufactures complete systems for vacuum-pressure impregnating. Tank sizes range from 24" diameter to 12' 6" diameter . . . depth to suit applications.

For prompt, reliable data and quotations

WRITE, PHONE or WIRE

**NEW YORK ENGINEERING CO.**  
75 West Street • New York 6, N. Y. Dept. 1

**NYECO** where progress is a habit

PHONE: WHitehall 4-5380

CABLE: NYECO, New York

# COMMUNICATIONS EQUIPMENT CO.

## MICROWAVE COMPONENTS

### 10 CM.—RG48/U Waveguide

- POWER SPLITTER** for use with type 726 or any 10 CM. Shephard Klystron. Energy is fed from Klystron antenna through dual pick-up system to 2 type "N" connectors \$12.50
- LHTR. LIGHTHOUSE ASSEMBLY.** Parts of RT29 APG 5 & APG 15. Receiver and Trans. Cavities w/assoc. Tr. Cavity and Type N CPWG. To Recv. Uses 2C10, 2C48, 1B27. Tunable APX 2400-2700 MGS. Silver Plated. \$15.00
- BEACON LIGHTHOUSE** cavity p/w CPN 2 Beacon 19 cm. Mtg. Bernard Rice, each \$27.50
- MAGNETRON TO WAVEGUIDE** Coupler with 721-A Diplexer Cavity, gold plated \$51.50
- 721A TR BOX** complete with tube and tuning plugs \$12.50
- McNALLY KLYSTRON CAVITIES** for 707B or 2K28, 2700-2900 MC \$4.00
- HOLMDELL-TO-TYPE "N"** Male Adapters, W. E. 210167284 \$22.75
- BEACON ANTENNA** AS831/APN-7 in Lucite Ball. Type "N" Feed \$22.50
- ANTENNA, AT19A/APR:** Broadband Conical, 200-3300 MC Type "N" Feed \$12.50
- "E" PLANE BENDS,** 90 deg. less flanges \$7.50
- R-Band, X-Band** Eqp. Available. Send for List

### X BAND—1" x 1/2" WAVEGUIDE

- PARABOLOID DISH,** 18" diam. Spun Aluminum, 8" Focus. For AN/APN 6 \$4.95
- 3 CM. DIPOLE** and Feed Assembly. (May be used with above dish.) 8 inch long \$3.00
- FLEXIBLE SECTION** 9 in. long. Cover to Cover \$5.50
- ROTARY JOINT** (A1S 6) Sperry PT 2658275, 180 deg. rotation, choke to choke. Has "Built-in" Di Coupler, 20 DB, with "N" Takeoff \$22.50
- 3CM. DIPOLE FEED,** 1 1/2" L. for A1S-15 \$14.50
- MITRED ELBOW,** Cast aluminum, 1 1/4" x 9/16" W.C. W/E. Flanges, "E" Flanged \$3.50
- 3 CM ANTENNA ASSEMBLY:** Uses 17" paraboloid dish, operating from 24 vdc motor. Beam pattern: 5 deg. in both Azimuth and elevation. Sector Scan: over 160 deg. at 35 scans per minute. Elevation Scan, over 2 deg. Tilt. Over 24 deg. \$35.00
- Cross-Guide Directional Coupler,** UG-40 output flange. Main Guide is 6" Long, with UG 39/40 output flange, at one end, and is fitted with Std. UG 39/40 40 flanges. Coupling figure: 20 db Nominal \$22.50
- RG52/U Waveguide** in 5' lengths, fitted with UG 39 flanges to UG40. Silver plated \$5.00 per length
- Rotating Joints** supplied either with or without deck mountings. With UG40 flanges \$17.50
- Bulkhead Feed-Off Assembly** \$15.00
- Pressure Gauge Section** with 1 1/2" gauge \$10.00
- Directional Coupler,** UG-40 U Take off 20db \$17.50
- MAGNET AND STABILIZER CAVITY** For 2141 Magnetron \$24.50
- 90 degree elbows,** "E" or "H" Plane 2 1/2" radius \$8.50
- ADAPTER,** waveguide to type "N". UG 81-U 1/2" TS-12 TS-13. Etc. \$7.50
- ADAPTER,** UG-165/U round cover to special BTL. Flange for TS-45, etc. \$2.50 ea.

### COAXIAL R.F. FILTERS

- F-29/SPR-2,** Hi-Pass, with 1000 mc. Cut-off. Type "N" input and output. 50 Ohms Z \$9.50
- F-41/SPR-1,** Hi-Pass, with 300 mc cut-off. Type "N" input and output. 50 Ohms Z \$10.50

## MICROWAVE ANTENNAS

- 3 cm. Horn,** 1" x 1/4", with twist and 180 deg. bend. With dielectric window \$22.50
- AT49/APR—Broadband** Conical, 200-3300 MC. Type N Feed \$8.95
- Discone Antenna,** AS 125 APR, 1000-3200 mc. Stub supported with type "N" Connector \$14.50
- AS14/AP,** 10 CM pick up dipole assy. complete w/length of coax and "N" connectors \$14.50
- AS16A/APG-4** Yagi Antenna, 5 element array \$22.50
- 30" Paraboloid Reflector** Spun Aluminum dish \$4.85
- AN/APA-12** Sector Scan adaptor for APS-2 radar. Complete Kit \$37.50
- TPS-3,** 10 Ft. Dish, "Chicken Wire" Paraboloid. Extremely lightweight, portable \$125.00
- AN-154** 3 vertical dipoles working against a rectangular mesh approx. 3'x4'. Freq. 140-200 mc. with lobeing switch (115v, 60 cy) and portable started crate. Extremely rugged \$27.95
- LP-24** Alford loop, for use with glide-path transmitters (MRN-1, etc.) 100-108 mc. \$32.50

## THERMISTORS

- D-164699** Bead Type DCR 1.25-50 Ohms @ 75 Deg. F. Coefficient 2% Per Deg. Fahr. Max. Current 25 MA AC/DC \$1.00
- D-167332** Bead Type DCR is 2525-2550 Ohms. Rated 25 MA at 825-1175 MW \$1.00
- D-167613** Disk Type DCR: 355 Ohms @ 75 Deg. F. 1.2 W. 2.5 % 1 Watt \$1.00
- D-166228** Disk Type 7120 Ohms @ 60° F. 4220 Ohms @ 80° F. 2500 Ohms @ 100° F. 1640 Ohms @ 120° F. \$1.00

## VACUUM TUBES

|           |        |           |         |         |         |
|-----------|--------|-----------|---------|---------|---------|
| 1N21      | \$ .28 | 5J33      | \$ 4.75 | 700D    | \$ 8.75 |
| 1P56GT    | .45    | 5J50      | 14.50   | 700A    | 1.50    |
| 1P50      | 1.10   | 6C51/5C30 | 1.10    | 704A    | .95     |
| 2C21      | .35    | 6C3/3C21  | 4.50    | 705A    | .75     |
| 2C22/7193 | .07    | 7C4/1205A | .18     | 706A    | 9.75    |
| 2C26A     | .08    | 9C1P7     | 3.45    | 706D    | 14.75   |
| 2C27A     | 2.25   | 10Y       | 1.10    | 706EV   | 9.75    |
| 2C22      | 2.50   | 15R       | .15     | 706VY   | 9.75    |
| 2C26      | 2.50   | 39/44     | .08     | 708A    | 2.10    |
| 2C27      | 3.00   | QK39      | 39.50   | 709A    | 2.45    |
| 2C29      | 18.50  | QK60      | 35      | 713A    | .85     |
| 2C31      | 13.95  | QK61      | 50.00   | C-722A  | .90     |
| 2C32      | 14.50  | QK62      | 54.00   | 725A    | write   |
| 2C37      | 9.50   | QK67Z     | .59     | 730A    | 8.50    |
| 2C38      | 9.00   | ML-100    | 69.50   | 800     | .65     |
| 2C39      | 8.25   | ML 111B   | .25     | 801     | .25     |
| 2C48      | 22.50  | 227A      | 2.50    | 837     | .85     |
| 2C56      | 48.50  | 268A      | 2.25    | 843     | .19     |
| 2C62      | 6.75   | 316A      | .50     | 861     | 12.00   |
| 3E1P      | 1.75   | 355A      | 12.50   | 864     | .19     |
| 3F1P      | 1.10   | 356B      | 10.50   | 876     | .75     |
| 4J4       | 22.50  | 393A      | 4.50    | 884     | 1.10    |
| 4J58      | 85.00  | 417A      | 6.10    | CK91005 | .35     |
| 4J12      | 47.50  | GL47A     | 2.10    | CK91006 | .20     |
| 5F1P7     | 1.10   | ML551     | 2.75    | 1419    | .15     |
| 5G1P      | 4.50   | 592/1142Z | 1.10    | 1426    | .19     |
| 5H1P4     | 3.50   | GL559     | .75     | 1629    | .10     |
| 5J23      | .40    |           | .75     | 8412    | 1.75    |

## POWER TRANSFORMERS

### COMBINATION—115V/60 INPUT

|        |   |        |
|--------|---|--------|
| CT-15  | 150-C-150V/65MA. 6.3V/2.5A. 6.3V/0.6A               | \$1.79 |
| CT-127 | 900V/25MA PK. 5V/2A, 2V/7.5A                        | 2.79   |
| CT-006 | 350-0-350/120MA. 5VCT/3A, 2.5VCT/12.5A, 2.5VCT/3.5A | 4.39   |
| CT-965 | 78V/0.6A, 6.3V/2A                                   | 1.95   |
| CT-034 | 350-0-350V/90MA, 5VCT/3A, 2.5VCT/12.5A              | 4.60   |
| CT-002 | 350-0350V/50MA, 5VCT/2A, 2.5VCT/7.5A                | 3.65   |
| CT-479 | 700V/0.18V, 2.5V/5A/17,800 V. Test                  | 22.50  |
| CT-083 | 450-0450V @ 200MA, 10V/1.5A, 2.5, 3.5A, 5V/3A       | 4.35   |
| CT-403 | 350VCT .026A 5V/3A                                  | 2.75   |
| CT-931 | 585VCT .086A 5V/3A, 6.3V/6A                         | 4.25   |
| CT-929 | 4200V/.001A, 2.5V/2A, 6.3VCT/.6A                    | 5.35   |

### PLATE—115V/60~INPUT

|         |  |        |
|---------|--|--------|
| PT-07   | 400VCT/4.0 AMPS For RA43   | 17.50  |
| PT 034  | 125V/45MA (For Preamp)   | 1.15   |
| PT 157  | 660-0-660VAC (500VDC) or 550-0-550 VAC (400VDC) at 250 MADC          | 8.70   |
| PT 167  | 1400-0-1400 VAC (300MADC) or 1175-0-1175 VAC (1000VDC) at 300 MA O.C | 22.50  |
| PT 168  | 2100-0-2100 VAC (1750VDC) or 1800-0-1800 VAC (1500 VDC) at 300 MADC  | 33.00  |
| PT 371  | 210-0-210V at 2.12 Amp.  | 9.45   |
| PT 133  | 3140/1570V. 2.36kVA  | 85.00  |
| PT 201  | 22,000V/234 MA., 5.35 KVA  | 115.00 |
| PT 521  | 7500V/.06A. Half Wave  | 59.50  |
| PT 913  | 2500V/12 MA H'SLD  | 4.95   |
| PT 24   | 280VCT/2A  | 2.95   |
| PT-38-2 | 37.5/40V AT 750 MA   | 2.15   |

### FILAMENT—115V/60~INPUT

|         |                                      |       |
|---------|--------------------------------------|-------|
| FT-157  | 4V/16A, 2.5V/2.75A                   | 2.95  |
| FT-101  | 6V/.25A                              | .79   |
| FT-924  | 5.25A/21A, 2x7.75V/6.5A              | 14.95 |
| FT-423  | 6.4V/2A                              | 8.95  |
| FT-463  | 6.3VCT/1A, 5VCT/3A, 5VCT/3A          | 5.49  |
| FT-55-2 | 7.2V/21.5A, 6.5V/6.85A, 5V/6A, 5V/3A | 8.95  |
| FT-38A  | 6.3V/2.5A, 2x2.5V/7A 51V TEST        | 2.79  |
| FT-650  | 2.5V/10A-3KV TEST LO-CAP             | 7.50  |
| FT-025  | 2.5VCT/10A, 10KV TEST                | 6.95  |

## FILTER CHOKES

| Stock   | Description                        | Price   |
|---------|------------------------------------|---------|
| CH-914  | 12HY/250 MA 2500 V. Test           | \$3.25  |
| CH-CEC  | 117: 9-60H/.05-400 MA, 10 KV Test  | \$14.95 |
| CH-113  | 2.5H/700 MA, 2.5 KV Test 18 Ohms   | 5.75    |
| CG-044  | 8.5H/350 MA, 3.5 KV Test 50 Ohms   | 6.35    |
| CH-291  | 0.1H/12 A. DCR: 0.3 Ohms           | 12.50   |
| CH-322  | .35H/350 MA—10 Ohms DCR            | 2.75    |
| CH-141  | Dual 7H/75 MA, 11H/60 MA           | 4.69    |
| CH-69-1 | Dual 120H/17 MA                    | 2.35    |
| CH-8-35 | 2x.5H/380 MA/25 Ohms               | 1.79    |
| CH-776  | 1.28H/130 MA/75 Ohms               | 2.25    |
| CH-344  | 1.5H/145MA/1200V Test              | 2.35    |
| CH-43A  | 1.08H/15 MA—850 Ohms DCR           | 1.75    |
| CH-366  | 20H/300 MA                         | 6.95    |
| CH-999  | 15HY/15 MA—400 Ohms DCR            | 1.95    |
| CH-445  | 0.5HY/300 MA, 32.2 Ohms, 3000 V.T. | 1.39    |
| CH-170  | 2.0x.3H/280 MA, 25 Ohms            | 2.79    |
| CH-533  | 13.5H, 1.0 AMP DC, 13.5 KVINS      | 29.95   |

## I. F. AMPLIFIER STRIPS

Model 15: 30 Mc center frequency. Bandwidth 2.5 Mc. gain figure: 65 db. Uses 6 stages of 6AC7's. Has D. C. Restorer and Video Detector. A.F.C. Strip included. Input impedance: 50 Ohms. Less tubes \$17.50

60 Mc. Miniature IF strip, using 6AK5's 60 Mc center Freq. Gain: 95 db at Bandwidth of 2.7 Mc. New. Complete with tubes. \$15.00

## PULSE TRANSFORMERS

- 4P37:** Primary, 50 Ohms 750V, .001 Duty. Sec. 15KV, 1000 Ohms Impedance, Bifilar 12.6V/2.5A \$32.50
- RAYTHEON WX 4298E:** Primary 4KV, 1.0 USEC. SEC. 16KV-16 AMP DUTY RATIO: 001 400 Cycles. FILE. PLANS. "BUILT-IN" \$42.50
- WECO:** D 168247 For Modulator of SCR 720 \$22.50
- GE 2K-2449A**  
 Primary: 9.33 KV, 50 ohms Imp.  
 Secondary: 28 KV, 150 ohms  
 Pulse length: 1.05/5 usec @ 635/120 PPS, PK Power Out: 1.740 KW  
 Bifilar: 1.5 amps (ns shown) \$62.50
- GE 2K-2748-A,** 0.5 usec @ 2000 PPS, PK. Power out is 32 KV Impedance 40-100 ohm output. Pri. volts 2.3 KV Pk. Sec. volts 11.5 KV Pk. Bifilar rated at 1.3 Amp. Fitted with magnetron wlt \$24.50
- K-2745** Primary: 3.1/2.8 KV, 50 ohms Z. Secondary: 11/12.6 KV 1025 ohms Z. Pulse Length: 0.25/1.0 usec @ 600/600 PPS, PK. Power 200/130 KW. Bifilar: 1.3 Amp. Has "built-in" magnetron wlt \$32.50
- K-2461-A,** Primary: 3.1/2.6 KV, 50 ohms (Hm). Secondary: 14/11.5 KV (1000 ohms Z. Pulse Length: 1 usec @ 600 PPS, PK. Power Out: 200/130 KW. Bifilar: 1.3 Amp. Fitted with magnetron wlt \$29.50
- K35145—Pulse Inversion:** PRI: 5 KV PK. Pulse Negative. Sec: Pos. Pulse, 4 KV; 1 usec. and 001 DUTY RATIO
- 54J308-A,** Wdgs. Ratio: 1:1:1, 1.10 in. /wdg. 2.5 ohms DCR \$3.50
- UTAH X-151T-1:** Dual Transformer, 2 Wdgs. per section 1:1 Ratio per sec 13 MH inductance 50 ohms DCR \$5.00
- UTAH X-150T-1:** Two sections, 3 Wdgs. per section 1:1:1 Ratio, 3 MH, 6 ohms DCR per Wdg. \$5.00
- 66711:** Ratio: 4:1 n: 200V, Sec. 53V, 1.0 usec Imp. \$4.50
- TR1049** Ratio 2:1 Pri. 220 MH, 50 Ohms, sec. 0.75 H. DCR 100 Ohms \$6.75
- K-904695-501:** Ratio 1:1, Pri. Imp. 40 Ohm. Sec. Imp. 40 Ohms. Passes pulse 0.6 usec. with 0.05 usec rise \$8.95
- RAYTHEON, UX-7350, UX-7307** \$5. ea.

## PULSE NETWORKS

- 7-5E3-1-200-67P, 7.5 KV** Circuit 1 microsec. 200 PPS. 67 ohms Impedance 4 sections \$7.50
- 7-5E4-16-60, 67P, 7.5 KV** Circuit 4 sections 16 microsec. 60 PPS. 67 ohms Impedance \$15.00
- 7-5E3-3-200-67P, 7.5 KV, "E"** Circuit, 3 microsec. 200 PPS. ohms Imp. 3 sections \$12.50
- H-616 10KV, 2.2 usec., 375 PPS, 50 ohms Imp.** \$27.50
- H-615 10KV, 0.85 usec., 750 PPS, 50 ohms Imp.** \$27.50
- KS8865 CHARGING CHOKE:** 115-150 H @ .02A, 32 40H @ .08A, 21 KV Test \$37.50
- G.E. 25E5-1-350-50-2P, "E"** CKT 1 Microsec. Pulse @ 350 PPS, 50 OHMS Impedance \$69.50
- KS9623 CHARGING CHOKE:** 16H @ 75 MA, 380 Ohms DCR, 9000 Vac Test \$14.95
- H-605 25KV, "E"** CKT, 1.5 usec, 400 PPS, 50 Ohms Impedance, 5 sections \$62.50

## PULSE MODULATORS

- MIT, MOD. 3 HARD TUBE PULSER:** Output Pulse Power 141 KW (12 KV at 12 AMP.) Duty Ratio: .001 max. Pulse duration: 5, 1.0, 2.0 microsec. Input voltage: 115 v. 400 to 2400 cps. Uses: 1-71B, 4-89 B, 3-72's, 1-73. New \$135
- ASD Modulator-Units,** mfd. by Sherry. Hard tube pulser delivers PK. pulse of 144 kv. Similar to Mod 3 unit. Brand new. Less tubes \$85.00
- Airborne RF head, model A1A,** delivers 50 kw peak output at 9000 mc. at .001 duty. Complete with pulser unit and all tubes \$185.00

## DELAY NETWORKS

- D-168184:** 0.5 usec. up to 2000 PPS, 1800 Ohms \$4.00
- D-170499:** 0.25/.5/.75usec. 8 KV, 50 Ohms \$8.50
- D-165997** Delay 1.25 usec. \$5.00
- RCA 2255686-502:** 1.7 usec. 1400 ohm Impedance \$2.00
- D-162311:** Delay of 0.5 usec. 72 ohms with 1 MC. Bandwidth \$4.75
- 4-172578,** 416 ohms Imp. 0.22 usec. Delay \$4.75
- D-150979:** Oscillating network. Oscillates at 81,955 kc. When normal current of 10ma. is interrupted. Has built-in temperature control for stability. Assembled in shielded can 4" L x 4" Diam. \$4.55

## DYNAMOTORS

| TYPE     | INPUT |      | OUTPUT |      | Price                    |
|----------|-------|------|--------|------|--------------------------|
|          | VOLTS | AMPS | VOLTS  | AMPS |                          |
| 35X-059  | 19    | 3.8  | 405    | .095 | \$4.35                   |
| PO5X-15  | 14    | 2.8  | 220    | .08  | 8.95                     |
| DA-7A    | 28    | 2.7  | 1100   | .400 | 15.00                    |
| DM 33A   | 28    | 7    | 540    | .250 | 3.95                     |
| 23350    | 27    | 1.75 | 285    | .075 | 3.95                     |
| B-19     | 12    | 9.4  | 275    | .110 | 6.95                     |
|          |       |      | 500    | .050 |                          |
| DA-3A*   | 28    | 10   | 300    | .260 | 6.95                     |
|          |       |      | 150    | .010 |                          |
|          |       |      | 14.5   | 5.   |                          |
| PE 73 CM | 28    | 19   | 1000   | .350 | 17.50                    |
| BD 82E   | 14    | 2.8  | 220    | .08  | 8.95                     |
| DAG-33A  | 18    | 3.2  | 450    | .06  | 2.50                     |
| DM 251   | 12    | 2.3  | 250    | .05  | 6.95                     |
| BDAR 93  | 28    | 3.25 | 375    | .150 | 6.95                     |
|          |       |      |        |      | * Replacement for PE 94. |
|          |       |      |        |      | † Used, Excellent.       |
|          |       |      |        |      | PE 94-, Brand New \$5.95 |

## INVERTERS

- 800-1B** Input 24 vdc. 62 A. Output: 115 V, 800 cy. 7A. 1 phase. Use. excellent \$18.75
- PE-218H:** Inout: 25/28 vdc, 92 amp. Output: 115V 500/500 cy 1500 Vt-ampere. New \$32.50

MAIL ORDERS PROMPTLY FILLED. ALL PRICES F.O.B. NEW YORK CITY. SEND M.O. OR CHECK. ONLY SHIPPING SENT C.O.D. RATED CONCERNS SEND P.O. PARCELS IN EXCESS OF 20 POUNDS WILL BE SHIPPED VIA CHEAPEST TRUCK OR RAILEX.

131 Liberty St., New York 7, N. Y. Dept. I-9 Chas. Rosen Phone: Dlgby 9-4124

# PROFESSIONAL SERVICES

## ALFRED. W. BARBER LABORATORIES

Specializing in the Communications Field and  
in Laboratory Equipment  
Offices, Laboratory and Model Shop at:  
32-44 Francis Lewis Blvd., Flushing, L.I., N.Y.  
Telephone: Independence 3-3306

## BERGEN LABORATORIES

MAX HOBERMAN, P.E., Chief Engineer  
Automation of Electronic Equipment  
Relay Logic Control Circuits  
Automatic Meter Range Switching  
Step Servomechanisms  
265 Elm St., East Paterson, N.J., FAirlawn 4-1736

## Edward J. Content, P.E. and Staff INTERNATIONAL RADIO CONSULTANTS

Pan American Radio Tangier Int'l Zone  
Bldg., 16 Rue Delacroix Morocco  
Specialized in the design, construction,  
foreign. Electronic, projects, and advising  
governments at Int'l Telecommunications  
Union.

## CROSBY LABORATORIES, INC.

MURRAY G. CROSBY & STAFF  
RADIO-ELECTRONIC RESEARCH  
DEVELOPMENT & ENGINEERING  
COMMUNICATIONS, FM & TV  
ROBBINS LANE  
HICKSVILLE, NEW YORK  
HICKSVILLE 3-3191

## ELK ELECTRONIC LABORATORIES, INC.

Jack Rosenbaum  
Specializing in design and development of  
Test Equipment for the communications,  
radar and allied fields.  
333 West 52nd St., New York 19, PL-7-0520

## FREDERICK RESEARCH CORPORATION

Carl L. Frederick, D.Sc., President  
Bethesda 14, Maryland • OLiver 4-5897  
Engineering Research and Development, Eval-  
uation, Technical Writing and Publishing—Elec-  
tronic and Electro-mechanical Systems, Test  
Equipment, Radio Interference, Instrumenta-  
tion, Controls.

## HIGHLAND ENGINEERING CO.

William R. Spittal & Staff  
Specialize in Design and Development of  
Transformers, Chokes, etc.  
for the  
Electronic, Industrial and Allied Fields.  
Westbury L.I., N.Y. EDgewood 3-2933

## HOGAN LABORATORIES, INC.

John V. L. Hogan, Pres.  
APPLIED RESEARCH, DEVELOPMENT,  
ENGINEERING  
Est. 1929. Electronics, Optics, Mechanisms,  
Facsimile Communication, Digital Computers,  
Electro-sensitive recording media, Instrumenta-  
tion.  
155 Perry Street, New York 14 CHelsea 2-7855

## INTERFERENCE TESTING AND RESEARCH LABORATORY, INC.

Rexford Daniels E. T. Buxton P. B. Wilson  
150 Causeway Street, Boston 14, Mass.  
Lafayette 3-7826  
Specializing in the design and testing of  
equipment to meet Military and FCC specifica-  
tions for radio interference.

## LEONARD R. KAHN

Consultant in Communications and Electronics  
Single-Sideband and Frequency-Shift Systems  
Diversity Reception - Modulation Theory  
Television Systems  
Elizabeth Bldg., 22 Pine St., Freeport, L.I., N.Y.  
Freeport 9-8800

## George W. Baker, Pres. KIP ELECTRONICS CORPORATION

Electron tube consulting and design.  
Research and development and preparation of  
prototype electron tubes.  
29 Holly Place,  
Stamford, Connecticut  
DAvis 3-5116

## ARNOLD S. J. LEE - KENNETH B. MORRIS

Consultants in Control Engineering, Electro-  
mechanical Devices, Medical-Physical In-  
struments.  
Development of New Devices and Pre-Production  
Models—Building of Developmental De-  
vices.  
P.O. Box 301 MUTual 1-4525 BELMAR, N.J.

## LEONARD J. LYONS

Consulting Mechanical Engineer  
Heat Transfer and Thermodynamics  
Packaging-Rating Charts-Miniaturization.  
Analysis of heat flow, temperature rise,  
and cooling system characteristics.  
5817 Alviso Ave., Los Angeles 43, Calif.  
Phone: AXminster 1-5446

Harry W. Houck Martial A. Honnell  
John M. van Beuren

## RESEARCH ENGINEERS

Specialists in the Design and  
Development of Electronic Test Instruments  
c/o MEASUREMENTS CORP.  
BOONTON, N.J.

L. J. CASTRIOTA M. WIND  
S. W. ROSENTHAL P. G. MARIOTTI

## Microwave Consultants

Radio Frequency and Microwave Components  
Cable—Waveguide—Coax  
Dielectric Evaluation  
Telephone G.P.O. Box 844  
BOulevard 3-2096 Brooklyn 1. N.Y.



## News-New Products

(Continued from page 194A)

inductance, free from non-linear effects.

Capable of dissipating 2.5 watts with a temperature rise of 20°C, the units have voltage ratings of 400 volts maximum, dimensions of  $1\frac{1}{8}$  inches long by  $\frac{3}{4}$  inches diameter, weigh approximately one ounce. The same range of inductance values and other corresponding characteristics can be provided with approximately 10 per cent higher Q's when mounted in slightly larger cans. Style A Type 1 Variable Inductors are also available in the form of complete sealed tuned circuits with shunt capacitors included to customer's specifications.

## HOWARD J. MURRAY, JR

ELECTRONIC  
PATENT CASES  
EXCLUSIVELY  
1824 Lakeshore Ave. Telephone  
Oakland 6, Calif. TEmplebar 5-3268

## Olympic Radio & Television, Inc.

Radio—Electronics  
Consulting—Research—Development  
Environmental Tests Performed  
for the Industry  
B. Parzen — E. Bradburn  
Olympic Building, Long Island City 1, N.Y.  
EXeter 2-5200

## EVERT M. OSTLUND Consulting Radio Engineer

Radio—Microwave  
Communication—Control  
Systems and Equipment  
Planning, Research, Development  
ANDOVER, NEW JERSEY  
Tel.: Lake Mohawk 8635

## PENN-EAST ENGINEERING CORPORATION

(Formerly—Atlantic Electronics Corp.  
of Port Washington, N.Y.)  
Designers of Industrial Controls  
Gerold L. Tawney, Robert R. Sparacino,  
Warren M. Janes, Richard C. Tawney  
P.O. Box 240, Telephone Kutztown 2675

## PICKARD AND BURNS, INC.

Consulting Electronic Engineers  
Analysis and Evaluation of Radio Systems  
Research, Development, Design and Production  
of Special Electronic Equipment and Antennas.  
240 Highland Ave. Needham 94, Mass.

## SIDNEY PICKLES

Consulting Radio Engineer  
Antennas & Transmission Lines  
Phone: Post Office Box 643  
Monterey 5-3379 MONTEREY, CALIFORNIA

## Paul Rosenberg Associates

Consulting Physicists  
100 STEVENS AVE. • MOUNT VERNON, NEW YORK  
CABLE: PHYSICIST MOUNT VERNON 7-8040

## M. D. Ercolino and Associates ANTENNA CONSULTANTS

Research and Development  
Communication Arrays  
Commercial and Amateur  
FM and TV  
c/o TELREX, INC. ASBURY PARK, N.J.  
Phone Prospect 5-7252

## WHEELER LABORATORIES, INC.

Radio and Electronics  
Consulting — Research — Development  
R-F Circuits — Lines — Antennas  
Microwave Components—Test Equipment  
Harold A. Wheeler and Engineering Staff  
Great Neck, N.Y. HUnter 2-7876



5 MC  
Band-  
Width

10 MV  
per  
inch

**PRECISION**  
PRESENTS  
THE NEW MODEL **ES-550**  
High Sensitivity, Wide Band  
**5" OSCILLOSCOPE**

For laboratory, industrial and technician. A rugged, dependable instrument for broad coverage of modern electronic oscillograph applications, INCLUDING COLOR TV. High sensitivity PLUS single, overall wide-band frequency response, and many other special performance features — at most sensible price.

- ★ Push-Pull, Wide-Band Vertical Amplifier: 10 MV/inch sensitivity. 2 Megohms, 22 mmfd. One DB from 10 cps. to 3.5 MC—3 DB at 5 MC.
- ★ Direct Reading, Peak to Peak Voltage Calibrator
- ★ Vertical Pattern Reversal Switching Facility
- ★ Push-Pull, Wide-Range Horizontal Amplifier: 100 MV/inch sensitivity. 2 Megohms, 25 mmfd. One DB from 10 cps. to 1.0 MC—3DB at 2 MC.
- ★ Linear, Multi-vibrator Sweep Circuit: 10 cycles to 100 KC. Amplified sweep retrace blanking.
- ★ Amplified Auto-Sync Circuit
- ★ Four Way Sync. Selector Switch provides for internal Negative, Internal Positive, External and Line Synchronization.
- ★ "Z" Axis Input for blanking, timing, marking.
- ★ Built-in 60 cps Phasing and Blanking Controls.
- ★ All 4 Deflection Plates Available directly (at rear), with full beam centering facilities.
- ★ Tube Complement: 12AV7 "V" Cathode Follower-Ampl. 6U8 "V" Ampl.-Phase Splitter. Two 6CL6 Push-Pull "V" Drivers. 6U8 "H" Cathode Follower-Ampl. 6C4 "H" Phase Splitter. Two 12BH7 Push-Pull "H" Drivers. 12AV7 Linear-Sweep. 6BH6 Auto-Sync. Ampl. 12AU7 Sweep Retrace Blanking Ampl. OA2 Voltage Regulator. 5V4 Low Voltage Rect. Two 1V2 High Voltage Rect. 5CP1/A CR Tube.
- ★ High Contrast, Filter Type, Calibrating Screen
- ★ Fully Licensed under AT&T and RCA patents.

Model ES-550 Deluxe: (Illustrated) in custom-styled, blue-grey ripple finished steel cabinet; 2 color satin-brushed aluminum panel and contrasting dark blue control knobs. Case Dimensions 8 1/4 x 14 1/2 x 18 1/2 inches. Complete with all tubes, including 5CP1/A CR tube. Comprehensive Instruction Manual.  
Net Price \$215.00

Model ES-550 Standard: Electrically identical to above but in standard black cabinet with black anodized aluminum panel. Case Dimensions 8 1/4 x 14 1/2 x 18 1/2 inches. Complete as above.  
Net Price: \$210.00

*PRECISION Test Equipment is available and on display at leading electronic parts distributors. Write directly to factory for new 1955 catalog.*

**PRECISION** Apparatus Company, Inc.  
70-31 84th Street, Glendale 27, L. I., N. Y.  
Export: 458 Broadway, New York 13, U. S. A.  
Canada: Atlas Radio Corp., Ltd., 50 Wingold Ave., Toronto 10

**INDEX AND DISPLAY ADVERTISERS**

|   |      |
|---|------|
| Meetings with Exhibits                    | 4A   |
| News—New Products                         | 14A  |
| Membership                                | 32A  |
| Industrial Engineering Notes              | 134A |
| Positions Wanted by Armed Forces Veterans | 145A |
| Positions Open                            | 148A |
| IRE People                                | 154A |
| Section Meetings                          | 170A |
| Professional Group Meetings               | 174A |

**DISPLAY ADVERTISERS**

|  |      |
|--|------|
| Accredited Personnel Service (Empl.)                       | 173A |
| Admiral Corporation (Empl.)                                | 169A |
| Advance Electronics Co., Inc.                              | 197A |
| Aerovox Corporation  | 56A  |
| Airborne Instruments Lab., Inc.                            | 18A  |
| Aircraft Radio Corp.                                       | 116A |
| Airtron, Inc.  | 72A  |
| Alford Mfg. Co., Inc.                                      | 192A |
| Allen-Bradley Company                                      | 185A |
| Allied Radio Corp.   | 121A |
| Alpha Metals, Inc.   | 86A  |
| American Electrical Heater Co.                             | 134A |
| American Lava Corporation                                  | 39A  |
| American Phenolic Corp.                                    | 48A  |
| American Television & Radio Co.                            | 120A |
| American Time Products, Inc.                               | 92A  |
| Amperex Electronic Corp.                                   | 67A  |
| Ampex Corporation  | 95A  |
| Andrew Corporation   | 53A  |
| Apex Coated Fabrics Co., Inc.                              | 190A |
| Arnold Engineering Co.                                     | 127A |
| Assembly Products, Inc.                                    | 124A |
| Atlantic Transformer Corp., Div. New London Instrument Co. | 118A |
| Automatic Control Co. (Empl.)                              | 174A |
| Automatic Manufacturing Corp.                              | 24A  |
| Avion Div. of ACF Industries, Inc. (Empl.)                 | 168A |

|   |      |
|---|------|
| Ballantine Laboratories, Inc.                             | 6A   |
| Barber Laboratories, Alfred W.                            | 196A |
| Bell Aircraft Corporation                                 | 146A |
| Bell Sound Systems, Inc. (Empl.)                          | 160A |
| Bell Telephone Laboratories                               | 2A   |
| Bendix Aviation Corp., Eclipse-Pioneer Div.               | 38A  |
| Bendix Aviation Corp., Guided Missile Section (Empl.)     | 155A |
| Bendix Aviation Corp., Pacific Div. (Empl.)               | 178A |
| Bendix Aviation Corp., Radio Communication Div. (Empl.)   | 147A |
| Bendix Aviation Corp., Research Laboratories Div. (Empl.) | 182A |
| Bendix Aviation Corp., Scintilla Div.                     | 93A  |
| Bergen Laboratories                                       | 196A |
| Berkeley Div., Beckman Instruments, Inc.                  | 42A  |
| Berkeley Div., Beckman Instruments, Inc. (Empl.)          | 173A |
| Bodnar Industries   | 124A |
| Boeing Airplane Co. (Empl.)                               | 149A |
| Boesch Mfg. Co., Inc.                                     | 56A  |
| Boonton Radio Corp.                                       | 82A  |
| Ruckbee Mears Co.   | 90A  |
| Ruggie, Inc., H. H.                                       | 136A |
| Burroughs Corporation                                     | 76A  |
| Bussmann Mfg. Co.   | 187A |
| Byron Jackson Company                                     | 123A |

|   |      |
|---|------|
| Caledonia Electronics & Transformer Corp.                   | 104A |
| Calif. Institute of Technology, Jet Propulsion Lab. (Empl.) | 180A |
| Cambridge Thermionic Corp.                                  | 117A |
| Cannon Electric Company                                     | 192A |
| Capitol Radio Engineering Institute                         | 118A |
| Chance-Vought Aircraft (Empl.)                              | 181A |

**PRECISION PHASE METER**



TYPE 405

- 0.3-120 V, 8 CPS-100 KC
- NO AMBIGUITY AT ZERO DEGREE
- 0.25° RELATIVE ACCURACY
- PHASE READING INDEPENDENT OF SIGNAL AMPLITUDES—PRICE: \$485

**PRECISION PHASE MEASURING INSTRUMENTS**

.0001 CPS to 500 MC  
ACCURACY ± 0.1 DEGREE

**NEW PRECISION PHASE DETECTOR**

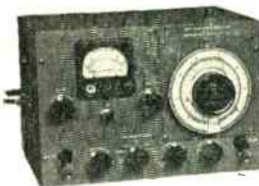

TYPE 205

- MEASURES TIME DELAY WITH 1% ACCURACY
- MEASURES PHASE DELAY WITH 0.1° ACCURACY
- 10 KC to 15 MEGACYCLES. 0.01 VOLT SENSITIVITY

PRICE: \$445

**H-F PHASE and VECTOR VOLTAGE METER—TYPE 213**

10 kc to 500 mc, ± 5% accuracy. PRICE: \$228

**VECTORLYZER, TYPE 202**

Vector sum or difference of two voltages. Phase angle between voltages. PRICE: \$445

**PHASE ANGLE COUNTER**

TYPE 1011-2-8-0 CPS to 1000 CPS. Accuracy ±1 count per 100,000. PRICE: \$918

WRITE FOR DATA!



**ADVANCE ELECTRONICS CO., INC.**  
451 HIGHLAND AVE. • PASSAIC, N.J.

**pulse transformer kit  
simplifies  
circuit design**

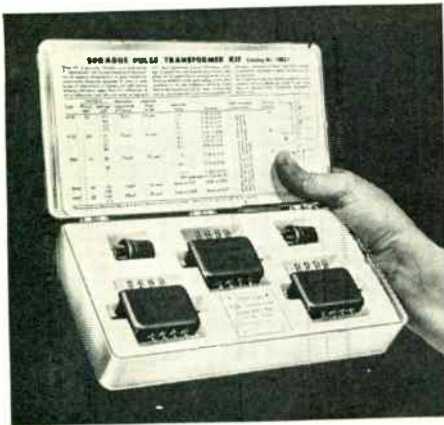

Sprague's new Type 100Z1 Pulse Transformer Kit contains five multiple winding transformers, each chosen for its wide range of practical application. Complete technical data on each of the transformers is included in the instruction card in each kit so that the circuit designer may readily select the required windings to give transformer characteristics best suited for his applications, whether it be push-pull driver, blocking oscillator, pulse gating, pulse amplifier, or impedance matching. Electrical characteristics of the transformers in the kit have been designed so they may be matched by standard Sprague subminiature hermetically-sealed pulse transformers shown in engineering bulletin 502B.

For complete information on this kit, as well as the extensive line of Sprague pulse transformers, write to the Technical Literature Section, Sprague Electric Company, 235 Marshall Street, North Adams, Massachusetts.

**CHARACTERISTICS OF KIT TRANSFORMERS**

| Type | Induct. Pri. ( $\mu$ H) | Leakage ( $\mu$ H) | Dist. Cap. of Pri. ( $\mu$ F) | Max. Nom. P.W. Range ( $\mu$ sec) | Avail. Ratios. |
|------|-------------------------|--------------------|-------------------------------|-----------------------------------|----------------|
| 4122 | 0.5                     | 2.5                | 5                             | 0.5                               | 1:1            |
|      |                         | 4.0                |                               |                                   | 2:1            |
|      |                         | 4.5                |                               |                                   | 3:1            |
|      |                         | 7.0                |                               |                                   | 5:1            |
| 4123 | 5.0                     | 13                 | 15                            | 6                                 | 1:1            |
|      |                         | 15                 |                               |                                   | 2:1            |
|      |                         | 25                 |                               |                                   | 3:1            |
|      |                         | 30                 |                               |                                   | 5:1            |
| 2027 | 10                      | 20                 | 12                            | 12                                | 1:1            |
|      |                         | 40                 |                               |                                   | 8:1            |
| 2028 | 20                      | 50                 | 15                            | 25                                | 1:1:1          |
|      |                         | 150                |                               |                                   | 8:8:1          |
| 2029 | 50                      | 150                | 20                            | 50                                | same as 2027   |
|      |                         | 210                |                               |                                   | same as 2027   |

**SPRAGUE**  
*the mark of reliability*

**DISPLAY ADVERTISERS**

- Chatham Electronics Div. of Gera Corp. .... 99A
- Chicago Standard Transformer Corp. .... 84A
- Chicago Telephone Supply Corp. .... 139A
- Clare & Company, C. P. .... 87A
- Cohn Corporation, Sigmund .... 186A
- Collins Radio Company .... 33A
- Color Television, Inc. .... 184A
- Communication Measurements Lab., Inc. .... 186A
- Communication Products Co. .... 192A
- Communications Equipment Co. .... 195A
- Content, Edward J. .... 196A
- Convair, Div. General Dynamics Corp. (Empl.) .... 145A, 167A
- Cornell Aeronautical Lab., Inc. (Empl.) .... 178A
- Cornell-Dubilier Electric Co. .... Cover 3
- Cornish Wire Co., Inc. .... 138A
- Cosmic Condenser Co. .... 190A
- Crosby Laboratories, Inc. .... 196A
- Crosley Div. of Avco Mfg. Corp. (Empl.) .... 172A
- Crucible Steel Co. of America .... 49A
- Daven Company .... 15A
- Daystrom Instrument Div. .... 89A
- Detectron Corporation .... 114A
- Donner Scientific Co. .... 122A
- DuMont Laboratories, Allen B. .... 26A
- DuMont Laboratories, Allen B. (Empl.) .... 176A
- Dyna-Empire, Inc. .... 170A
- ESC Corporation .... 34A
- Eitel-McCullough, Inc. .... 137A
- Electrical Industries .... 13A
- Electro-Impulse Laboratory .... 70A
- Electro-Motive Mfg. Co., Inc. .... 41A
- Electro-Pulse, Inc. .... 126A
- Electronic Engineering Co. of Calif. (Empl.) .... 176A
- Elk Electronic Laboratories, Inc. .... 196A
- Emerson Research Laboratories (Empl.) .... 174A
- Empire Devices Products Corp. .... 52A
- Engineering Associates .... 100A
- Engineering Research Associates, Div. Remington Rand, Inc. (Empl.) .... 177A
- Erie Resistor Corporation .... 125A
- F-R Machine Works, Inc. .... 111A
- Farnsworth Electronics Co. .... 29A
- Farnsworth Electronics Co. (Empl.) .... 152A
- Fast & Company, John E. .... 34A
- Federal Telephone & Radio Co. .... 11A
- Ferroxcube Corp. of America .... 100A
- Ford Instrument Co., Div. of Sperry Rand Corp. .... 80A
- Frederick Research Corporation .... 196A
- Freed Transformer Co., Inc. .... 47A
- Garfield Wire Div., The Overlakes Corp. .... 112A
- Garrett Corporation, AiResearch Mfg. Co. Division (Empl.) .... 166A
- General Aniline & Film Corporation, Antara Chemicals Div. .... 85A
- General Ceramics Corporation .... 3A
- General Electric Co., Capacitor Sales Div. .... 19A
- General Electric Co. (Empl.) .... 162A, 171A, 180A
- General Electric Co., Tube Dept. .... 74A-75A
- General Motors Corp., A C Spark Plug Div. .... 168A
- General Precision Laboratory, Inc. (Empl.) .... 152A
- General Radio Co. .... Cover 4
- General Research & Supply Co. .... 132A
- Giannini & Co., Inc., G. M. .... 191A
- Gulton Industries, Inc. .... 97A
- Hammarlund Mfg. Co., Inc. .... 51A
- Heath Company .... 78A
- Heliport Corporation .... 25A
- Heppner Mfg. Co. .... 199A
- Hewlett-Packard Company .... 9A, 45A
- Highland Engineering Co. .... 196A
- Hoffman Laboratories, Inc. .... 65A
- Hogan Laboratories, Inc. .... 196A
- Huggins Laboratories .... 104A
- Hughes Aircraft Company .... 57A
- Hughes Research & Development Labs. (Empl.) .... 161A
- Hycon Eastern, Inc. .... 62A
- Hycon Mfg. Co., Inc. .... 16A
- Hycor Company, Inc. .... 90A
- Iiffe & Sons, Ltd. .... 143A
- Institute of Radio Engineers, Inc. .... 140-141A, 189A

**ENGINEERED**

**. . . through  
EXPERIENCE  
to Fit Your Needs**

Station WOAY-TV is an example of how TOWER'S engineering and experience can solve your unusual tower problems. This 600 ft. tower supports an 83 ft. TV antenna, an FM antenna, an 8 ft. x 12 ft. Microwave Passive Reflector, and serves as an AM radiator. From coast to coast you'll find installations where TOWER'S "know how" has paid off.

**MICROWAVE  
TOWERS  
and REFLECTORS**



Pioneers in Microwave towers and reflectors, TOWER Microwave Passive Reflectors are used by the U. S. Government, Bell Telephone System and leading manufacturers. For strength, dependability and service . . . you can count on TOWER.

*Tower Fabricators  
And Constructors  
The World Over*

**TOWER**  
**Construction Co.**  
SIOUX CITY, IOWA



## DISPLAY ADVERTISERS

|  |      |
|--|------|
| Instruments for Industry, Inc.             | 86A  |
| Interference Testing & Research Lab., Inc. | 196A |
| International Automation Exposition        | 88A  |
| International Electronic Research Corp.    | 118A |
| International Rectifier Corp.              | 63A  |

|  |            |
|--|------------|
| Johns Hopkins University, Applied Physics Lab. (Empl.)       | 152A, 166A |
| Johns Hopkins University, Operations Research Office (Empl.) | 171A       |
| Johns Hopkins University, Radiation Lab. (Empl.)             | 182A       |
| Jones Div., Howard B., Cinch Mfg. Corp.                      | 78A        |

|                                       |      |
|---------------------------------------|------|
| Kahn, Leonard R.                      | 196A |
| Kay Electric Company                  | 5A   |
| Kearfott Co., Inc.                    | 94A  |
| Kearfott Co., Inc., Western Mfg. Div. | 32A  |
| Kennedy & Co., D. S.                  | 54A  |
| Kip Electronic Corp.                  | 196A |
| Kollsman Instrument Corp.             | 43A  |
| Kollsman Instrument Corp. (Empl.)     | 151A |

|  |           |
|--|-----------|
| Laboratory for Electronics (Empl.)     | 144A      |
| Lapp Insulator Co., Inc.               | 30A       |
| Lavoie Laboratories, Inc.              | 107A      |
| Lee, Arnold S. J. & Morris, Kenneth B. | 196A      |
| Lenkurt Electric Co., Inc. (Empl.)     | 178A      |
| Librascope, Inc.                       | 138A      |
| Link Aviation, Inc. (Empl.)            | 175A      |
| Little Falls Alloys, Inc.              | 132A      |
| Lockheed Aircraft Corp. (Empl.)        | 164A-165A |
| Lyons, Leonard J.                      | 196A      |

|   |           |
|---|-----------|
| Magnetics, Inc.   | 10A       |
| Maigne Co., O. J.   | 132A      |
| Mallory & Co., Inc., P. R.                                | 8A, 109A  |
| Marconi Instruments, Ltd.                                 | 110A      |
| Marion Electrical Instrument Co.                          | 88A, 136A |
| Martin Co., Glenn L. (Empl.)                              | 153A      |
| Measurements Corporation                                  | 40A, 196A |
| Melpar, Inc. (Empl.)                                      | 160A      |
| Microdot Division, Felts Corp.                            | 88A       |
| Microwave Associates, Inc.                                | 128A      |
| Microwave Consultants                                     | 196A      |
| Mid-Century Instrumental Corp.                            | 12A       |
| Midland Mfg. Co., Inc.                                    | 183A      |
| Midwest Research Institute (Empl.)                        | 154A      |
| Millen Mfg. Co., Inc., James                              | 120A      |
| Model Engineering & Mfg. Co., Inc., Tru-Ohm Products Div. | 61A       |
| Mullard Overseas Limited                                  | 129A      |
| Murray, Jr., Howard J.                                    | 196A      |
| Mycalex Corporation of America                            | 98A       |

|                                    |                       |
|------------------------------------|-----------------------|
| N.R.K. Mfg. & Eng. Co.             | 88A                   |
| National Cash Register Co. (Empl.) | 160A                  |
| National Company (Empl.)           | 182A                  |
| Nems-Clarke, Inc.                  | 188A                  |
| New London Instrument Co.          | 70A, 100A, 118A, 190A |
| New York Engineering Co.           | 194A                  |
| Norden-Ketay Corporation (Empl.)   | 165A                  |
| North Electric Mfg. Co.            | 68A                   |
| Northern Radio Company, Inc.       | 113A                  |

|                                  |      |
|----------------------------------|------|
| Offner Electronics, Inc.         | 124A |
| Ohmite Mfg. Co.                  | 71A  |
| Olympic Radio & Television, Inc. | 196A |
| Oster Mfg. Co., John             | 193A |
| Ostlund, Evert M.                | 196A |

|                                    |      |
|------------------------------------|------|
| Panoramic Radio Products, Inc.     | 136A |
| Paramount Paper Tube Corp.         | 142A |
| Penn-East Engineering Corp.        | 196A |
| Perkin Engineering Corp.           | 4A   |
| Phelps Dodge Copper Products Corp. | 119A |

world's largest Ion Trap maker  
offers lowest priced Ion Trap  
on the market

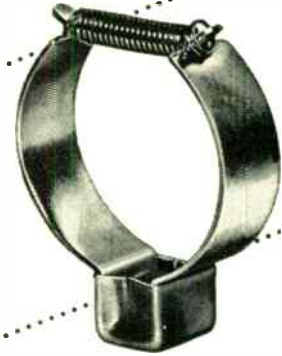

NEW SIMPLIFIED CONSTRUCTION

**MODEL T-312.** The new simplified steel construction lowers manufacturing costs by fully utilizing, for the first time, the Alnico permanent magnet's maximum efficiency. This makes Model T-312 the lowest priced ion trap on the market. Installs in only 2-3 seconds—just slip on.

### FEATURES OF BOTH MODELS

**STAYS PUT**—No wobble; no shift during shipment; no realignment necessary when your TV set is installed in the home.

**EASILY ADJUSTED**—Slides more uniformly over tube's neck due to metal-to-glass contact.

**STABILIZED AND TESTED** on special equipment designed and used only by Heppner, each individual Heppner Ion Trap is guaranteed to meet your working requirements.

**UNUSUALLY FAST DELIVERY.**

**LIGHTWEIGHT**—Snap-On Model weighs only 1/2 ounce; Slip-On Model only 3/5 ounce. Will not harm tube's neck.

**ALNICO P.M. USED**—Retains magnetism indefinitely.

### SNAP-ON ION TRAP

installs instantly—just snap on—stays put

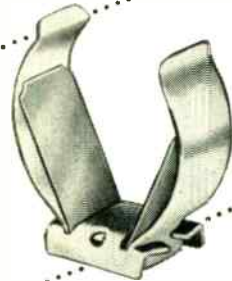

**MODEL E-437.** Saves you expensive production manhours with EXCLUSIVE instant snap-on feature. Reduces your parts costs because priced below competition. Clamp-type construction of Hardened Spring Steel.

Heppner has built over 15,000,000  
ion traps to date

Write today for further information on better ion traps at lower prices.

# HEPPNER

MANUFACTURING COMPANY

Round Lake, Illinois (50 Miles Northwest of Chicago)  
Phone: 6-2161

SPECIALISTS IN ELECTRO-MAGNETIC DEVICES

Representatives: William I. Duncan, Jr.  
3451 N. 10th St. Philadelphia 40,  
Penn.  
Ralph Haffey  
R.R. 1, U. S. 27, Coldwater Rd., Ft.  
Wayne 8, Indiana  
Irv. M. Cochrane Co.,  
408 S. Alvarado St., Los Angeles,  
Calif.  
John J. Koppie  
60 E. 42nd St., New York 17, N.Y.  
Ben H. Tollefson  
144 Collingworth Drive, Rochester 10,  
N.Y.

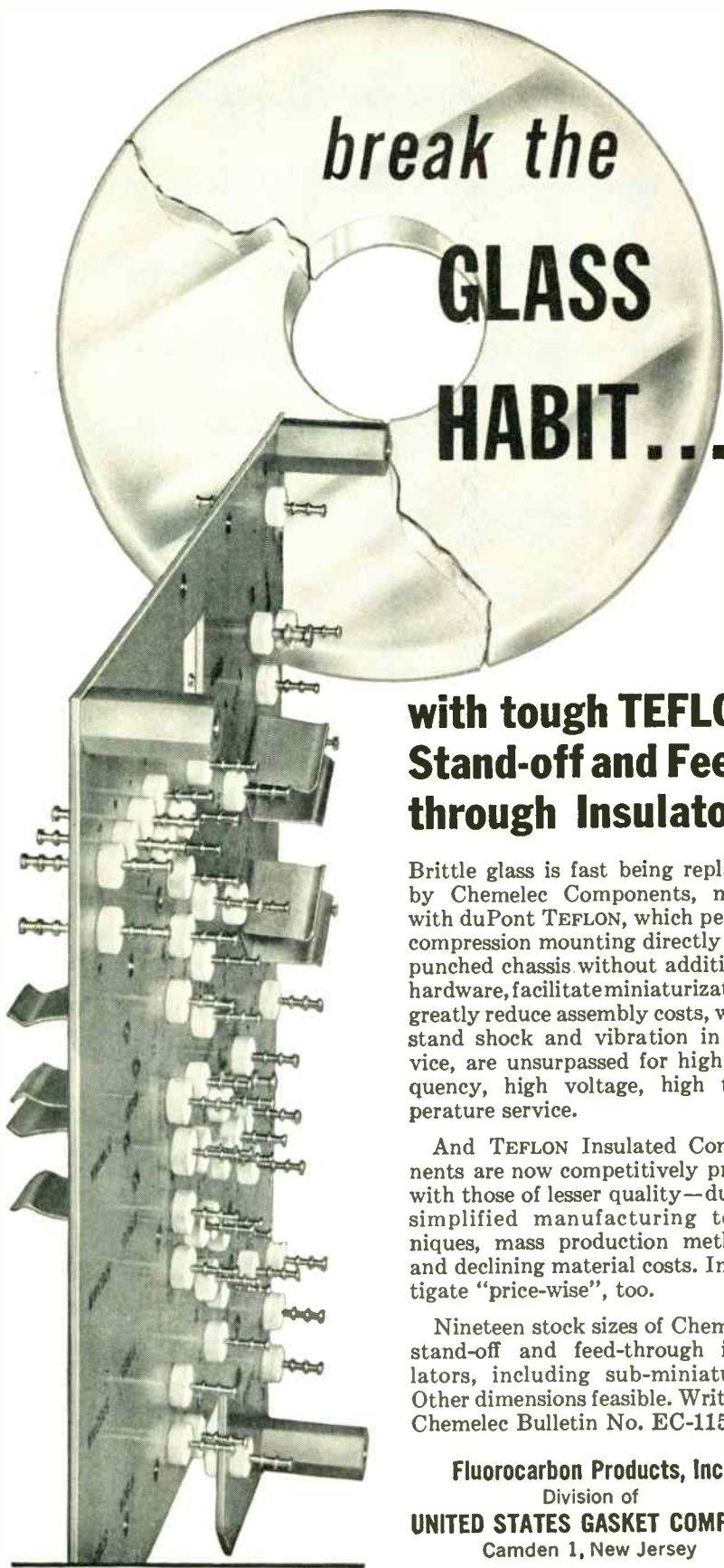

break the  
**GLASS**  
HABIT...

**with tough TEFLON  
Stand-off and Feed-  
through Insulators**

Brittle glass is fast being replaced by Chemelec Components, made with duPont TEFLON, which permit compression mounting directly into punched chassis without additional hardware, facilitate miniaturization, greatly reduce assembly costs, withstand shock and vibration in service, are unsurpassed for high frequency, high voltage, high temperature service.

And TEFLON Insulated Components are now competitively priced with those of lesser quality—due to simplified manufacturing techniques, mass production methods and declining material costs. Investigate “price-wise”, too.

Nineteen stock sizes of Chemelec stand-off and feed-through insulators, including sub-miniatures. Other dimensions feasible. Write for Chemelec Bulletin No. EC-1153.

**Fluorocarbon Products, Inc.**  
Division of  
**UNITED STATES GASKET COMPANY**  
Camden 1, New Jersey

**USG**

**FABRICATORS OF  
FLUOROCARBONS & OTHER PLASTICS**  
Representatives in principal  
cities throughout the world



**DISPLAY ADVERTISERS**

|   |                |
|---|----------------|
| Pickard & Burns, Inc. ....                                    | 196A           |
| Pickles, Sidney .....   | 196A           |
| Polarad Electronics Corp. ....                                | 6A-7A, 81A     |
| Polytechnic Research & Dev. Co., Inc. ....                    | 36A            |
| Precision Apparatus Co., Inc. ....                            | 197A           |
| Precision Paper Tube Co. ....                                 | 106A           |
| Pyramid Electric Co. ....                                     | 101A           |
| Radio Corp. of America (Empl.) .....                          | 158-159A       |
| Radio Corp. of America, Tube Dept. ....                       | 96A            |
| Radio Engineering Products Limited .....                      | 130A           |
| Radio Materials Corporation .....                             | 69A            |
| Radio Receptor Co., Inc. ....                                 | 135A           |
| Ramo-Wooldridge Corp. (Empl.) .....                           | 157A           |
| Raytheon Mfg. Co. (Empl.) .....                               | 179A           |
| Raytheon Mfg. Co., Equipment Marketing Div. ....              | 77A            |
| Raytheon Mfg. Co., Power Tube Div. ....                       | 17A            |
| Raytheon Mfg. Co., Special Purpose Tube Div. ....             | 22A-23A, 27A   |
| Remington Rand, Inc., Div. of Sperry Rand Corp. ....          | 20A            |
| Remington Rand, Inc., Div. of Sperry Rand Corp. (Empl.) ..... | 170A           |
| Republic Aviation Corp. (Empl.) .....                         | 150A, 163A     |
| Revere Copper & Brass Incorporated .....                      | 59A            |
| Robertshaw-Fulton Controls Co. ....                           | 182A           |
| Rosen Eng. Products, Inc., Raymond .....                      | 112A           |
| Rosenberg Associates, Paul .....                              | 196A           |
| Rutherford Electronics Co. ....                               | 194A           |
| Sanborn Company .....   | 91A            |
| Sandia Corporation (Empl.) .....                              | 173A           |
| Sangamo Electric Co. ....                                     | 56A            |
| Secon Metals Corporation .....                                | 102A           |
| Shallcross Mfg. Co. ....                                      | 66A            |
| Shasta Division, Beckman Instruments, Inc. ....               | 110A           |
| Sierra Electronics Corporation .....                          | 58A            |
| Sorensen & Company .....                                      | 50A            |
| Sparton Radio & TV Div., Sparks Withington Co. (Empl.) .....  | 162A           |
| Speer Carbon Co., Speer Resistor Div. ....                    | 131A           |
| Spencer-Kennedy Laboratories, Inc. ....                       | 46A            |
| Sperry Gyroscope Co., Div. of Sperry Rand Corp. (Empl.) ..... | 151A           |
| Sprague Electric Co. ....                                     | 1A, 105A, 198A |
| Stackpole Carbon Co. ....                                     | 73A            |
| Stavid Engineering, Inc. (Empl.) .....                        | 156A           |
| Stearns .....   | 37A            |
| Stoddard Aircraft Radio Co., Inc. ....                        | 44A, 108A      |
| Stromberg-Carlson Co. (Empl.) .....                           | 168A           |
| Stupakoff Ceramic & Mfg. Co. ....                             | 60A            |
| Superex Electronics Corp. ....                                | 70A            |
| Superior Tube Company .....                                   | 28A            |
| Swift Industries, Inc. ....                                   | 184A           |
| Switchcraft, Inc. ....  | 142A           |
| Sylvania Electric Products Inc. ....                          | 31A            |
| Sylvania Electric Products Inc. (Empl.) .....                 | 183A           |
| Synthane Corporation .....                                    | 115A           |
| Syntronic Instruments, Inc. ....                              | 130A           |
| Tektronix, Inc. ....  | 133A           |
| Telrex, Inc. ....   | 196A           |
| Texas Instruments Incorporated .....                          | 35A, 103A      |
| Thomas & Skinner, Inc. ....                                   | 64A            |
| Tower Construction Co. ....                                   | 198A           |
| Tracerlab, Inc. ....  | 162A           |
| Transitron Electronic Corp. ....                              | 79A            |
| Transradio, Ltd. ....   | 46A            |
| Tru-Ohm Products Div., Model Eng. & Mfg. Co. ....             | 61A            |
| United Electronics .....                                      | 55A            |
| United States Gasket Co. ....                                 | 200A           |
| United Transformer Co. ....                                   | Cover 2        |
| Varflex Corporation .....                                     | 128A           |
| Varian Associates .....                                       | 21A            |
| Vectron, Inc. ....  | 30A            |
| Waterman Products Co., Inc. ....                              | 83A            |
| Western Gold & Platinum Works .....                           | 114A           |
| Westinghouse Electric Corp. (Empl.) .....                     | 148A, 176A     |
| Wheeler Laboratories, Inc. ....                               | 196A           |
| Wickes Engineering & Construction Co. ....                    | 86A            |

# ONLY THE LEADER

always  
sets  
the  
course

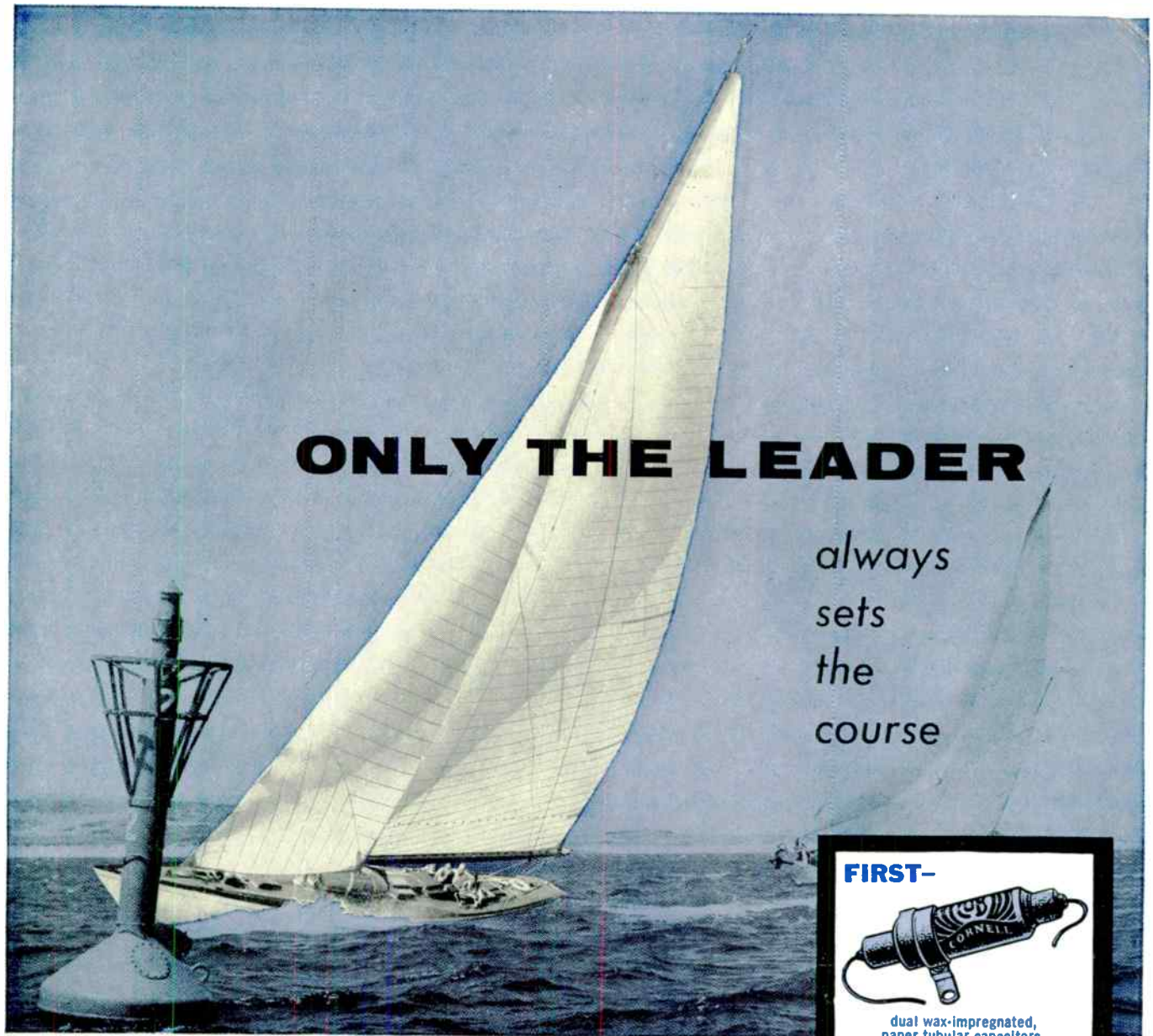

**FIRST-**



dual wax-impregnated,  
paper tubular capacitors.

**FIRST-**



low voltage dry  
electrolytic capacitors.

## C·D...45 YEARS OF FAMOUS FIRSTS

Typical of these "famous firsts" are the three examples shown here . . . proof that whatever your capacitor requirements may be, your needs can be filled by C-D. Write to Cornell-Dubilier Electric Corp., Dept. M-95, South Plainfield, N. J.

**FIRST-**



capacitor used in proximity fuse.

CONSISTENTLY DEPENDABLE  
**CORNELL-DUBILIER CAPACITORS**



PLANTS IN SO. PLAINFIELD, N. J.; NEW BEDFORD, WORCESTER AND CAMBRIDGE, MASS.; PROVIDENCE AND HOPE VALLEY, R. I.; INDIANAPOLIS, IND.; SANFORD AND FURQUAY SPRINGS, N. C.; SUBSIDIARY, RADIARTY CORP., CLEVELAND, OHIO.

THERE ARE MORE C-D CAPACITORS IN USE TODAY THAN ANY OTHER MAKE

# NEW!

## Universal Z-Y Bridge

Measures Impedance . . .

- ✓ from 0 to  $\infty$  ohms
- ✓ balanced or grounded
- ✓ positive or negative
- ✓ at any phase angle
- ✓ over 20-cps to 20-kc range

The Type 1603-A Z-Y Bridge is the latest addition to the G-R line of precision impedance-measuring apparatus.

This Universal Z-Y Bridge will measure any impedance — from short circuit to open circuit, at small or large phase angle, and with a basic accuracy of 1% over most of this very wide range. Quadrature components of impedance, R & X or G & B, are measured directly at calibrated 100c, 1kc and 10kc bridge positions. Measurements at other frequencies over the 20 to 20,000 cycle range are made simply by multiplying reactance X or susceptance B readings by a factor which takes into account the difference between operating frequency and frequency setting of the Bridge selector switch.

The ability to measure impedances of any magnitude and with good accuracy with the same instrument can be an extremely valuable asset in many measurement situations. The Z-Y Bridge can be used by chemists for measuring conductivity of liquids in dielectric cells as readily as it can be used for ordinary R-L-C component measurements in the laboratory or production-test department. It will measure . . . open-and short-circuit transformer parameters . . . impedances of batteries and electrolytic capacitors . . . characteristics of audio-transmission networks . . . motional impedance of electro-acoustic transducers . . . Q and resonant frequency of chokes . . . and impedances of feedback loops, since negative real parameters are directly measured.

The Bridge also can be used to determine cable-fault locations and circular-arc plots of liquids or solids having lossy polarizations in the audio-frequency range. These are but a few of the countless applications for this unique and versatile device. *You name it — this Z-Y Bridge can probably measure it!*

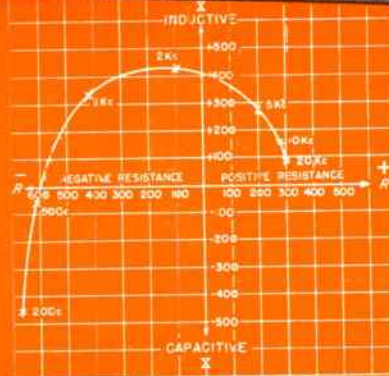

Plot of Impedance  $Z_1$  of Feedback Circuit . . .

illustrates ability of the Z-Y Bridge to measure any impedance; quadrature components may be positive or negative, real or imaginary.

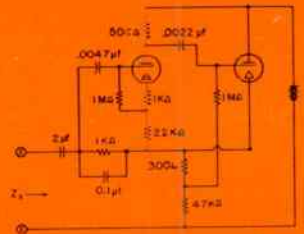

### SPECIFICATIONS

**Frequency Range** — 20 cycles to 20 kc

**Impedance and Admittance Range** —

R:  $\pm 1000$  ohms      G:  $\pm 1000$   $\mu$ mhos  
 X:  $\pm 1000$  ohms      B:  $\pm 1000$   $\mu$ mhos

**Accuracy** —

R or G:  $\pm (1\% + [1 \text{ ohm or } 1 \mu\text{mho}])$   
 X or B:  $\pm (1\% + [f_0 \text{ ohm or } f \mu\text{mho}])$

f is operating frequency,  $f_0$  is frequency setting of panel selector switch

Impedances of less than 100  $\Omega$  (or 100  $\mu$ mhos) can be measured on "Initial Balance" dials with considerably greater accuracy —

R or G:  $\pm (1\% + [0.2 \frac{f_0}{f} \text{ ohm or } 0.2 \frac{f}{f_0} \mu\text{mho}])$

X or B:  $\pm (1\% + [0.2 \frac{f_0}{f} \text{ ohm or } 0.2 \frac{f}{f_0} \mu\text{mho}])$

**Maximum Applied Voltage** — 150 volts, rms

**Accessories Recommended** —

Type 1210-B Unit R-C Oscillator and  
 Type 1212-A Unit Null Detector

**Accessories Supplied** —

2 Shielded Cables for generator and detector

**Dimensions** — 12½" x 13½" x 8½"

**Net Weight** — 21½ lbs.

**Type 1603-A Z-Y Bridge** — \$335.00

## GENERAL RADIO Company

275 Massachusetts Avenue, Cambridge 39, Massachusetts, U. S. A.

90 West Street NEW YORK 6  
 8055 13th St., Silver Spring, Md. WASHINGTON, D. C.  
 1150 York Road, Abington, Pa. PHILADELPHIA  
 320 S. Michigan Ave. CHICAGO 5  
 1000 N. Seward St. LOS ANGELES 38



1915-1955

40 Years of Pioneering

in Electronics

World Radio History

**WE SELL DIRECT**  
 Prices are net, FOB Cambridge  
 or West Concord, Mass.