

AUGUST · 1954

Proceedings



of the I · R · E

A Journal of Communications and Electronic Engineering

TELEVISION MICROSCOPY

Balkan

Volume 42

Number 8

IN THIS ISSUE

Very High Power Broadcasting Station
Transistor Audio Oscillator Circuits
A New Electron Tube: The Strophotron
Microwave SSB Modulator Using Ferrites
Developmental Germanium Power Transistors
Charts for Laminated Coaxial Cables
Reflection Coefficients of Irregular Terrain
On the Design of Arrays
Reciprocity Relations in 3-Terminal Elements
HF Compensation of RC Amplifiers
IRE Standards on Electron Devices
Filter Problem of the Power-Spectrum Analyzer
Nondestructive Read-Out of Magnetic Cores
False Echoes in Line-Type Pulsers
Frequency Stable LC Oscillators
Precision Quartz Resonator Frequency Standards
High-Accuracy Logarithmic Receiver
Coaxial Line with Helical Inner Conductor
Transactions Abstracts
Abstracts and References

TABLE OF CONTENTS INDICATED BY BLACK-AND-WHITE MARGIN, FOLLOWS PAGE 94A

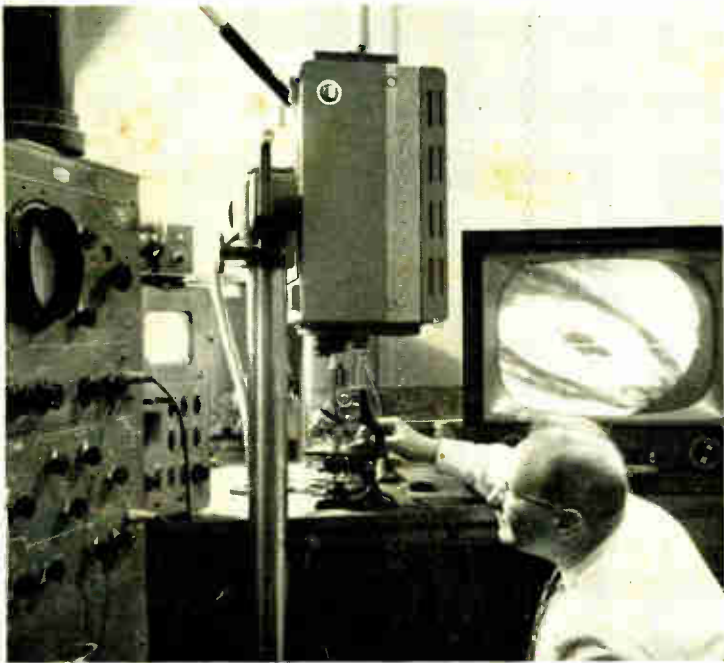

Allen B. Du Mont Laboratories

A television camera is employed to view the structure of a cell through a microscope. The magnified image is displayed on the screen of the monitor at the right, where variations in the light pattern provide a measure of the constituents of the cell.

IRE Standards on Electron Devices: Definitions of Terms Related to Phototubes appear in this issue.

The Institute of Radio Engineers



PRECISION IN PRODUCTION

Many people realize and take advantage of the fact that "the tough ones go to UTC." Many of these "tough ones," while requiring laboratory precision, are actually production in quantity. To take care of such special requirements, the UTC Laboratories have a special section which develops and produces production test equipment of laboratory accuracy. The few illustrations below indicate some of these tests as applied to a group of units used by one of our customers in one production item of equipment:



The component being checked here is a dual saturable reactor where the test and adjusting conditions necessitate uniformity of the complete slope of the saturation curve. The precision of this equipment permits measuring five widely separated points on the saturation curve with saturating DC controllable to .5% and inductance to .5%.

Servomechanisms and similar apparatus depend, to a considerable degree, on phase angle operation. The transformer adjusted in this operation requires an accuracy of .05 degrees phase angle calibration under the resonant condition of application. With wide change in voltage and temperature range from -40 to +85 degrees C., the phase angle deviation cannot exceed .2 degree. To effect this type of stability, specific temperature cycling and aging methods have been developed so that permanent stability is effected.



This test position involves two practical problems in a precision inductor. The unit shown is adjusted to an inductance accuracy of .3%, with precise (high) Q limits. It is then oriented in its case, using a test setup which simulates the actual final equipment so that minimum inductive coupling will result when installed in the final equipment.



The hermetic sealing of transformers involves considerable precision in manufacturing processes and materials. To assure consistent performance, continuous sampling of production is run through fully automatic temperature and humidity cycling apparatus. It is this type of continual production check that brings the bulk of hermetic sealed transformers to UTC.



United Transformer Co.

150 VARICK STREET NEW YORK 13, N. Y.
EXPORT DIVISION: 13 EAST 40th STREET, NEW YORK 16, N. Y. CABLES: "ARLAB"
World Radio History



1954 WESCON SHOW—Pan Pacific Auditorium—August 25-26-27



SPONSOR

WESCON (Western Electronic Show and Convention) is co-sponsored by WCEMA (West Coast Electronic Manufacturers' Association) and the Los Angeles and San Francisco Sections of the IRE (Institute of Radio Engineers), alternating annually between San Francisco and Los Angeles.



SPONSOR

The 1954 WESCON Show, scheduled for the Pan Pacific Auditorium, will feature 520 exhibits displaying the products of more than 600 electronic manufacturers. WESCON Convention activities will be headquartered at the Ambassador Hotel and will be highlighted by an outstanding technical program consisting of twenty-eight sessions and over 100 advanced technical papers.

WESCON, second only to the National IRE Convention in scope and stature, reflects the interests and progress of the industry and assures unequalled attendance in keeping with the continual expansion of electronics in the West.

Plan on attending; join some 20,000 executives, engineers and key industry personnel in a preview of the latest electronic development and production.

*Mark Your Calendar Now! --
Plan to Attend the Second --*

CONFERENCE ON COMMUNICATIONS

CEDAR RAPIDS, IOWA

Roosevelt Hotel

SEPTEMBER 17-18

Sponsored by the



Cedar Rapids Section

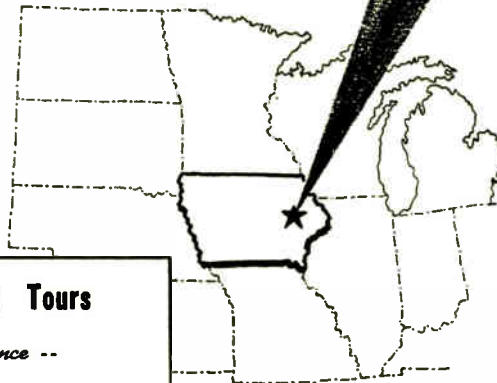

Exhibits : Speakers : Banquet : Tours

A Continuation of the Inaugural 1952 Conference --

FOR INFORMATION ON:

REGISTRATION

HOUSING

EXHIBITS

WRITE TO:

Robert L. Olson

Warren B. Bruene

Vernon R. Hudek

Address:

"Conference on Communications"

P.O. Box 1625

Cedar Rapids, Iowa

PROCEEDINGS OF THE I.R.E. August, 1954, Vol. 42, No. 8. Published monthly by the Institute of Radio Engineers, Inc., at 1 East 79 Street, New York 21, N.Y. Price per copy: members of the Institute of Radio Engineers \$1.50; non-members \$2.25. Yearly subscription price: to members \$9.00; to non-members in United States, Canada and U.S. Possessions \$18.00; to non-members in foreign countries \$19.00. Entered as second class matter, October 26, 1927, at the post office at Menasha, Wisconsin, under the act of March 3, 1879. Acceptance for mailing at a special rate of postage is provided for in the act of February 28, 1925, embodied in Paragraph 4, Section 412, P. L. and R., authorized October 26, 1927.

Table of Contents will be found following page 64A

A VERY WIDE RANGE SWEEPING OSCILLATOR PROVEN BY YEARS OF APPLICATION. VALUED & RECOMMENDED BY ENGINEERS IN MANY FIELDS

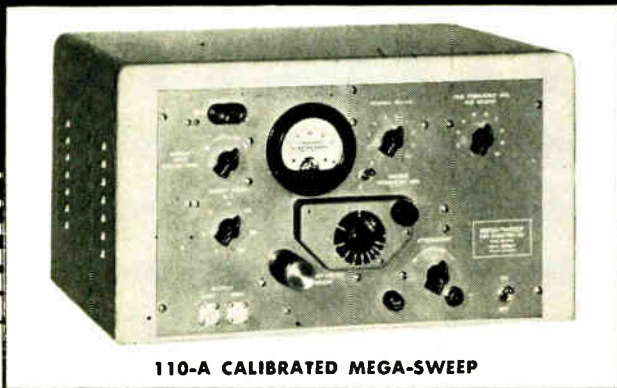

110-A CALIBRATED MEGA-SWEEP

FEATURES — Model 110A

- Wide Range—from 50 kc to 950 mc.
- Single Dial Tuning
- Wide Sweep Width Adjustable to 30 mc (wider on special order).
- Very Flat Amplitude vs. Frequency Response.
- Precision Micrometer-controlled Wavemeter.
- High Stability, Negligible Distortion.
- Sawtooth Sweep Voltage Available for Deflecting Oscilloscope.
- Electronically Regulated Power Supply.

SPECIFICATIONS:

- FREQUENCY RANGE:** 50 kc to 950 mc.
- SWEEP WIDTH:** Variable to 30 mc.
Note: Frequency sweeps up to 60 mc in width may be obtained with slight sacrifice in constancy of signal output while sweeping.
- R.F. OUTPUT VOLTAGE:** High output, approx. 50 mv max. into 50 ohm load.
Low output, approx. 2.5 mv max. into 50 ohm load.
- R.F. OUTPUT CONTROL:** Uncalibrated microwave attenuator continuously variable to 26 db. Attenuation characteristic flat over frequency range.
- FREQUENCY MEASUREMENTS:** Approx. output center frequency indicated by a calibrated dial accurate to about 10%. In addition, center frequency of sweep may be pre-set or frequency indicated at any point an oscilloscope display within ± 5 mc by use of the precision micrometer-controlled wavemeter.
- AMPLITUDE MODULATION:** Control of output signal amplitude by fixed frequency klystron produces an amplitude variation while sweeping of less than 0.1 db per mc.
- CATALOG No. 110-A.
- PRICE: \$495.00 f.o.b. factory.

ALSO THREE OTHER MODELS . . .

MEGA-SWEEP

Same as Calibrated Mega-Sweep, except:

1. Center frequency control not calibrated.
2. Variable klystron repeller voltage peaking controlled manually instead of automatically.
3. Frequency range: 50 kc to 1000 mc.

CATALOG No. 100-A.

PRICE: \$465.00 f.o.b. factory.

III-A MEGA-SWEEP

Same as Calibrated Mega-Sweep, plus:

1. Much higher output
2. Wider Sweep Width (to 40 mc)
3. Zero Level Baseline.

EXCEPT:

Frequency Range	Output Impedance	Output Voltage (into 70 ohm load)
1. 10 mc to 950 mc	70 ohms unbalanced	0.15 volts
2. 450 mc to 900 mc	300 ohms balanced	0.3 volts

CATALOG No. 111-A

PRICE: \$575.00 f.o.b. factory, including Ultra-Former.

112-A MEGA-SWEEP

Same as 111-A Mega-Sweep, except frequency range is 800 mc to 1200 mc

KAY ELECTRIC COMPANY

14 Maple Avenue

Pine Brook, New Jersey

Meetings with Exhibits

● As a service both to Members and the industry, we will endeavor to record in this column each month those meetings of IRE, its sections and professional groups which include exhibits.

▲

August 25, 26 & 27, 1954

Western Electronic Show & Convention, Pan-Pacific Auditorium, Los Angeles, Calif.

Business Manager: Mr. Mal Mobley, Jr., 344 North La Brea Ave., Los Angeles, Calif.

September 13-22, 1954

First International Instrument Congress & Exposition, Commercial Museum and Convention Hall, Philadelphia, Pa.

Exhibits: Mr. Richard Rimbach, Instrument Society of America, 921 Ridge Ave., Pittsburgh 12, Pa.

September 17 & 18, 1954

Conference on Communications, Cedar Rapids Section, Roosevelt Hotel, First Ave. at Second St. N.E., Cedar Rapids, Iowa.

Exhibits: Mr. Vernon R. Hudek, c/o Collins Radio Co., Cedar Rapids.

September 30, October 1, 1954

Fifth Annual Meeting of The Professional Group on Vehicular Communications, Rice Hotel, Houston, Texas.

Exhibits: Mr. McKinley Rhodes, Tennessee Gas Transmission Co., 1401 Rice Avenue, Bellaire, Texas.

October 4, 5, 6, 1954

National Electronics Conference, Sherman Hotel, Chicago, Ill.

Exhibits: Mr. George H. Wise, c/ DeVry Technical Institute, 41 Belmont Ave., Chicago 41, Ill.

November 4 & 5, 1954

East Coast Conference on Airborne and Navigational Electronics, Sheraton-Belvedere Hotel, Baltimore, Md.

Exhibits: Mr. C. E. McClellan, Air Arm Division, Westinghouse Electric Corp., Friendship Airport, Baltimore, Md.

November 18 and 19, 1954

Sixth Annual Electronics Conference, Hotel President, Kansas City.

Exhibits: Mr. Robert W. Butler, P.O. Box 8857, Kansas City, Mo.

February 10, 11, 12, 1955

Seventh IRE Conference, Baker Hotel, Dallas, Texas

Exhibits: T. W. Sharpe, Collins Radio Co., 1930 Hi-Line Drive, Dallas 2.

March 21-24, 1955

Radio Engineering Show and I.R.E. National Convention, Kingsbridge Armory, N.Y.C.

Exhibits: Mr. William C. Copp, Institute of Radio Engineers, 1475 Broadway, New York 36, N.Y.

Note on Professional Group Meetings: Some of the Professional Groups conduct meetings at which there are exhibits. Working committeemen on these groups are asked to send advance data to this column for publicity information. You may address these notices to the Advertising Department, and of course listings are free to IRE Professional Groups.

NEW!

NEW!

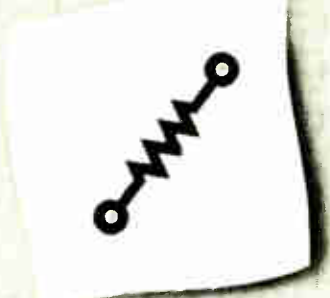

for convenient point-to-point wiring...

MINIATURIZED 5 AND 10 WATT WIRE-WOUND RESISTORS!

Blue AXIAL LEAD Jacket[®]

PHOTOGRAPHS ACTUAL SIZE ▶



Here are two *truly miniaturized* self-mounting wire-wound power resistors to simplify your TV and industrial electronic production where space is a factor. They're ideal for point-to-point wiring, terminal board mounting, and processed wiring boards, where they fit in admirably in dip-soldered subassemblies.

Axial lead Blue Jackets are rugged vitreous enamel power resistors built to withstand the severest humidity performance requirements. As for *economy*, these newest members of the Sprague Blue Jacket family are low in cost... eliminate need for extra hardware... save time and labor in mounting!

You can get these outstanding new Blue Jacket Resistors without delay in any quantity you require. Sprague Engineering Bulletin 111 gives full data on these and all other commercial Blue Jacket Resistors. Send for your copy.

SPRAGUE ELECTRIC COMPANY
235 Marshall Street, North Adams, Mass.

SPRAGUE TYPE NO.	WATTAGE RATING	DIMENSIONS L (inches) D		MAXIMUM RESISTANCE
27E	5	1 1/8	3/16	17,500 Ω
28E	10	1 1/8	3/16	35,000 Ω

Standard Resistance Tolerance: ±5%

SPRAGUE

PIONEERS IN ELECTRIC AND ELECTRONIC DEVELOPMENT

NORTH ADAMS, MASSACHUSETTS

EXPORT FOR THE AMERICAS: SPRAGUE ELECTRIC INTERNATIONAL LTD., NORTH ADAMS, MASS.

CABLE: SPREXINT

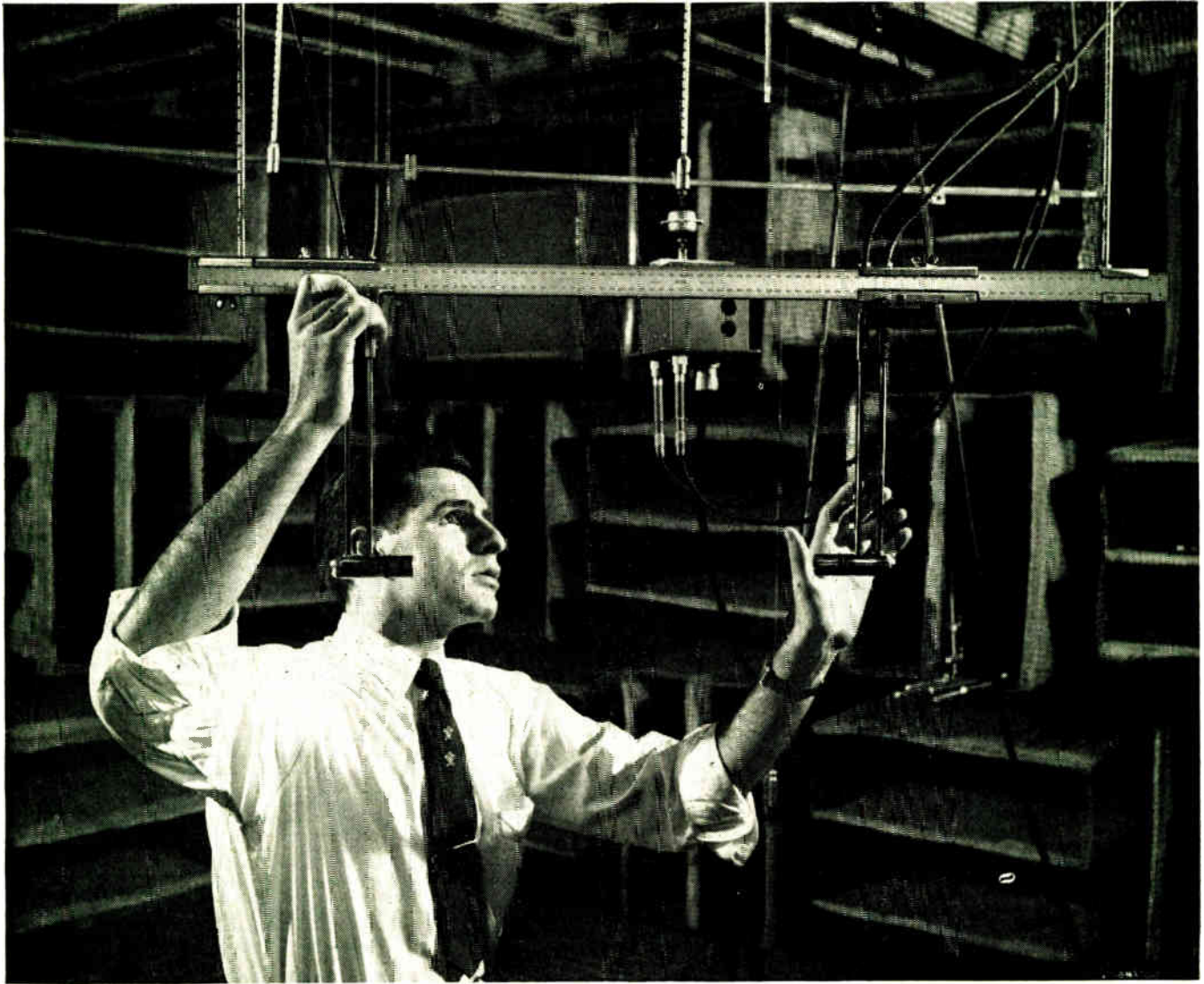

In a quiet room at Bell Laboratories an engineer scales off the distance between two condenser microphones during a calibrating test. Able to measure air pressure variations of a few billionths of an atmosphere, such microphones play a crucial role in the scientific study of telephone instruments.

SOUND STEPS ON THE SCALES

Those small cylinders facing each other are condenser microphones—measuring tools that play a vital part in making your telephone easier to hear and talk through.

They are being calibrated by an engineer at Bell Telephone Laboratories to give extremely accurate information on the kind of sound your telephone company handles. Armed with these vital fundamental data on what sound *is*, Bell Laboratories scientists

devise the instruments and equipment that transmit it best.

At Western Electric, manufacturing unit of the Bell System, a condenser microphone “listens” as your ear would listen to every telephone before it goes into service. The condenser microphone is but one of many precise tools that Laboratories scientists have developed to make telephone service better and more economical.

BELL TELEPHONE LABORATORIES

Improving America's telephone service offers careers for creative men in scientific and technical fields.





GERMANIUM AND SILICON JUNCTION DIODES

precision produced to RAYTHEON standards of stability and uniform excellence of performance

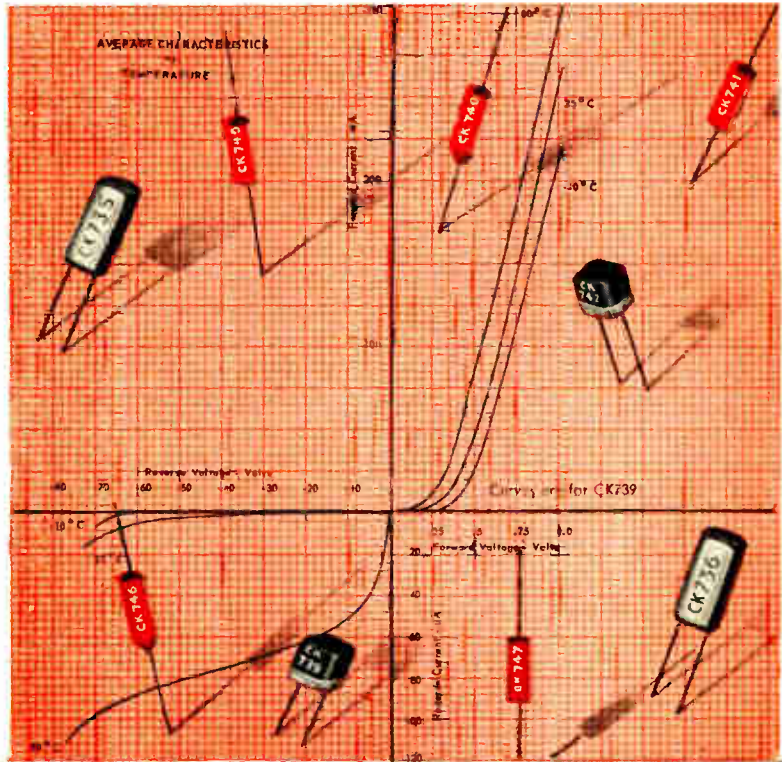

RAYTHEON JUNCTION SILICON DIODES

providing extreme stability, wide temperature range, high back resistance (100 megohms or more), and high ratio of back to forward resistance.

Type	Minimum Forward Current at +1 Volt (ma.)	Maximum Reverse Current			Maximum Avg. Rectified Current (ma.)	Maximum Peak Rectified Current (ma.)	Peak Inverse Voltage (volts)	Max. Avg. Power Dissipation (mw.)
		at -10 Volts (μa.)	at Voltage Shown: μa. volts					
CK735	5	0.01	—	—	30	150	15	125
CK736	3	0.1	.5	-50	20	150	70	100
CK738	1	0.1	1.0	-100	20	150	125	100
CK746	2**	2.0	50	-50	15	125	60	100

RAYTHEON JUNCTION GERMANIUM DIODES

providing extreme stability, fast switching (CK741 and CK747), high forward current and high ratio of back to forward resistance.

Type	Minimum Forward Current at +1 Volt (ma.)	Maximum Reverse Current			Maximum Avg. Rectified Current (ma.)	Maximum Peak Rectified Current (ma.)	Peak Inverse Voltage (volts)	Max. Avg. Power Dissipation (mw.)
		at -10 Volts (μa.)	at Voltage Shown: μa. volts					
CK739	100*	2	20	-50	125	300	60	125
CK740	100*	2	—	—	150	300	15	150
CK741	300	—	500	-8	100	350	8	50
CK742	100	5	20	-100	50	300	125	50
CK745	15	20 at -20 volts	100	-100	40	100	125	40
CK747	100	—	100	-20	100	300	40	100



*Measured at 0.8 volt maximum. **Measured at 1.5 volts maximum. All of the above ratings are at 25°C

RAYTHEON MANUFACTURING COMPANY

Excellence in Electronics

Resistor Tube Division — Home Office: 53 Chapel St., Newton 28, Mass.

For Application Information Call Boston, Mylow 4-7300 • Chicago, National 7-2770 • New York, Plaza 9-2900 • Los Angeles, Richmond 7-4325

RAYTHEON MAKES ALL THESE:

RELIABLE SUBMINIATURE AND MINIATURE TUBES • SEMICONDUCTOR DIODES AND TRANSISTORS • NUCLEAR TUBES • MICROWAVE TUBES • RECEIVING AND PICTURE TUBES

NEW HUDSON CATALOG

... a complete guide
to a dependable
source of
supply!

STANDARD CASES AND COVERS

— prompt shipment
in large quantities
from stock!

SPECIAL SHAPES AND FEATURES

— fast service
on specification
metal stampings!

PRECISION DRAWN
CLOSURES
AND QUALITY METAL
STAMPINGS
FOR ELECTRONICS

GEARED TODAY TO THE ELECTRONICS FUTURE — When you make Hudson your headquarters for cases and covers, you can schedule your production with confidence. Hundreds of special shapes and sizes, with many optional features available, are carried in stock at Hudson. Ample stocks assure prompt delivery and standardized production provides precision workmanship at economical prices. From simple closures to intricate, multi-operation shapes and sub-assemblies, you can depend on Hudson to meet your specifications.

CALL OR WRITE
FOR NEW CATALOG
OR QUOTATIONS,
TODAY!



HUDSON TOOL and DIE COMPANY • Inc
118-122 SO. FOURTEENTH ST., NEWARK 7, NEW JERSEY

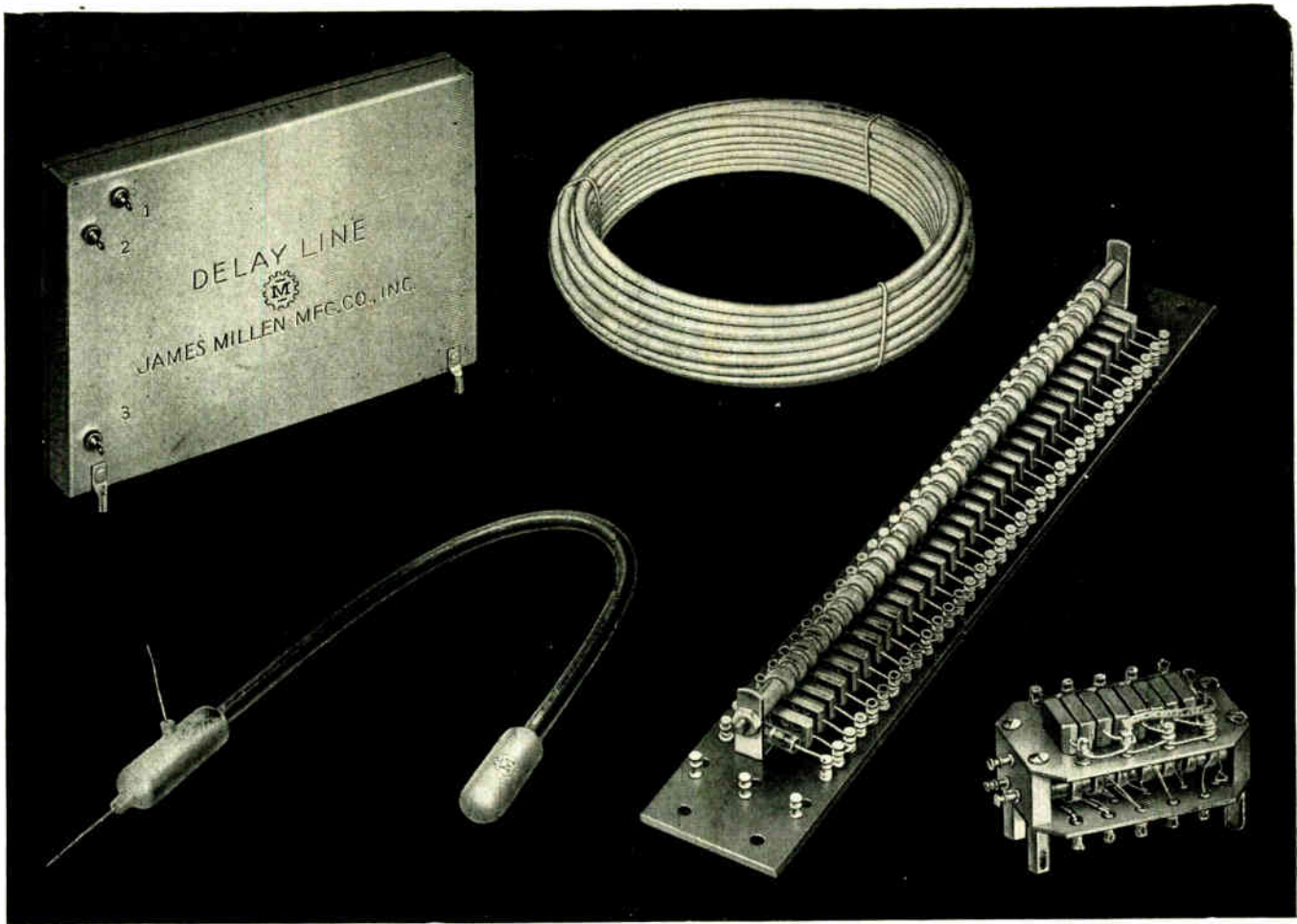

"Designed for Application"

Delay Lines and Networks

The James Millen Mfg. Co., Inc. has been producing continuous delay lines and lump constant delay networks since the origination of the demand for these components in pulse formation and other circuits requiring time delay. The most modern of these is the distributed constant delay line designed to comply with the most stringent electrical and mechanical requirements for military, commercial and laboratory equipment.

Millen distributed constant line is available as bulk line for laboratory use and in either flexible or metallic hermetically sealed units adjusted to exact time delay for use in production equipment. Lump constant delay networks may be preferred for some specialized applications and can be furnished in open or hermetically sealed construction. The above illustrates several typical lines of both types. Our engineers are available to assist you in your delay line problems.

JAMES MILLEN



MFG. CO., INC.

MAIN OFFICE

AND FACTORY

MALDEN, MASSACHUSETTS, U. S. A.

Allen B. DuMont
 Laboratories, Inc.,
 cordially invites you to examine the
 superb operating characteristics,
 high precision, and
 unique convenience of the new
 DuMont Type 329
 Cathode-ray Oscilloscope
 at your own laboratory
 under your own conditions.

R.S.V.P.*

Do you believe your own eyes? Accept our invitation to see the new Type 329, right in your own lab.

Operate it yourself. See how easily you can stabilize a hard-to-sync signal on the screen for measurement. Give it a "tough" signal like a short pulse of low repetition-rate or a long, slowly-rising wavefront and watch the Type 329 perform. Compare the Type 329 with any cathode-ray oscilloscope in your lab, with any signal you have to offer.

When you have put the Type 329 through its paces on your own terms, you'll undoubtedly agree with us that this is the best general-purpose cathode-ray oscilloscope available.

Some specific reasons why . . .

- The DuMont Type 5ATP- Cathode-ray Tube used is the most precise, distortion-free cathode-ray tube ever used.
- High-level, linear sweeps permit accurate front-panel-reading time calibration.
- Revolutionary new Notch expansion permits a ten times, calibrated expansion of any 5% of the sweep, leaving the remaining signal unexpanded.
- The linear wideband amplifier extends with full response to d.c. and 3db down at 10mc, a response commensurate with a seven-decade sweep rate of 1 second to 0.1 usec/major division.
- Accurate, direct, amplitude calibration makes the Type 329 a precise cathode-ray voltmeter, with eleven full-scale ranges of 0.2 to 400 volts.
- Use of printed wiring throughout assures product uniformity, ease of access, and neat appearance.

*For your demonstration or for more complete information on the Type 329 send postcard to Technical Sales Department, 760-11 Bloomfield Ave., Clifton, New Jersey. Or, better still, phone MULberry 4-7400, Clifton, N. J., for a prompt demonstration.



DU MONT®

See the DuMont exhibit at Booth 536-537 at the WESCON Show

NEW! PORTABLE DIRECT READING SPECTRUM ANALYZER



- 10 TO 22,000 MCS
- ONLY 3 R. F. HEADS
- SINGLE DIAL TUNING



Model No.	Equipment
Model TSA.....	Spectrum Display and Power Supply
Model STU-1...	R-F Tuning Unit 10-1,000 mc.
Model STU-2...	R-F Tuning Unit 910-4,560 mc.
Model STU-3...	R-F Tuning Unit 4,370-22,000 mc.

SPECIFICATIONS:

Frequency Range: 10 mc to 22,000 mc
 Frequency Accuracy: 1%
 Resolution: 20 kc
 Frequency Dispersion: Electronically controlled, continuously adjustable from 50 kc/in. to 7 mc/in.
 Input Impedance: 50 ohms
 Over-all Gain: 120 db
 Attenuation: RF...Internal: 120 db continuously variable
 IF...60 db continuously variable
 Input Power: 400 watts

Now, a new Polarad spectrum analyzer only 21 inches high that covers the entire frequency range 10 to 22,000 mcs with but 3 interchangeable R-F tuning heads. The model TSA operates simply—single dial frequency control—with utmost frequency stability. It provides highest accuracy, and reliability for observation and true evaluation of performance over the entire R-F spectrum—saving engineering manhours.

This instrument is designed for maximum utility and versatility in the laboratory and on the production line providing an easy-to-read 5 inch CRT display of the R-F spectrum.

The model TSA Spectrum Analyzer has these exclusive Polarad design and operating features:

- Single frequency control with direct reading dial. No klystron modes to set. Tuning dial accuracy 1%.
- Only three interchangeable R-F tuning units for the entire frequency range 10 to 22,000 mcs.
- Temperature compensation of Klystron Oscillator.
- Swept IF provides 250 kc to 25 mc display independent of R-F frequency setting.
- Internal R-F attenuator.
- Frequency marker for measuring frequency differences from 100 kc to 25 mc.

Write today to your nearest Polarad representative, or directly to the factory for complete information.



ELECTRONICS CORPORATION

100 METROPOLITAN AVENUE, BROOKLYN 11, NEW YORK

REPRESENTATIVES • Albuquerque • Atlanta • Boston • Chicago • Cleveland • Fort Worth • Kansas City • Los Angeles • New York
 Philadelphia • San Francisco • Seattle • St. Paul • Syracuse • Washington, D.C. • Canada, Arnprior — Export: Rocke International Corporation

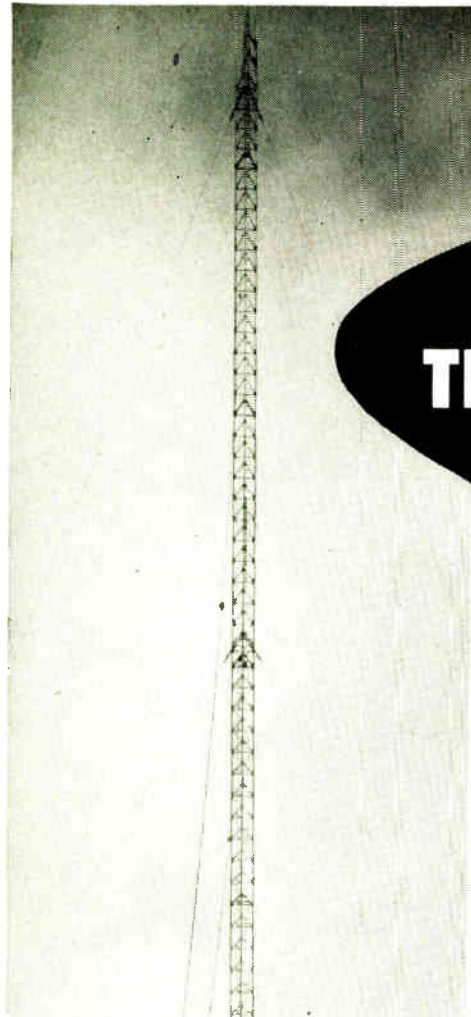

ANOTHER TRUSCON THOUSAND FOOTER GOES ON THE AIR

● Truscon builds them tall! Latest Truscon tower of strength to lift an antenna over the thousand foot mark now is on the air for WFMJ-TV in Youngstown. This Truscon triangular uniform guyed tower mounts an RCA antenna.

Your own tower requirements will be in well-qualified hands when you call on Truscon. Truscon knows towers. Truscon has engineered and constructed many hundreds of towers that now stand strong and tall in all parts of the world, in all kinds of wind and weather.

Truscon will build your towers tall or small . . . guyed or self-supporting . . . tapered or uniform in cross section . . . for AM, FM, TV, and Microwave transmission. Your phone call or letter to any Truscon district office or to "tower headquarters" in Youngstown will get your tower program started without delay.



TRUSCON®



TRUSCON STEEL DIVISION

REPUBLIC STEEL CORPORATION

1072 Albert Street • Youngstown 1, Ohio
Export Dept.: Chrysler Bldg., New York 17, N. Y.

a name you can build on



New, wide band thermistor and bolometer mounts require no tuning, speed microwave measuring



-hp- 420A Crystal Detector

Employs a silicon crystal to detect rf signals in a coaxial line employing Type N fittings. Covers frequencies 10 mc to 12.5 kmc. Frequency response flat within ± 3 db full range, excellent conversion efficiency. No tuning. Uses modified 1N21 crystal. \$50.00.

-hp- X421A Crystal Detector



X-Band Crystal Detector for use in waveguide systems at frequencies 8.2 to 12.4 kmc. Frequency response is flat within ± 2 db. No tuning. Detector has square law characteristic within ± 1 db over a 40 db dynamic range. \$75.00.



-hp- 477A Thermistor Mount

For coaxial measurements. Provides complete coverage of all frequencies 10 mc to 10 kmc. VSWR is less than 1.5. Operates with -hp- 430B Power Meter for direct power readings. No tuning. Not subject to burnout. Input connector is Type N; output is Type BNC. \$75.00.



-hp- 487A Thermistor Mount

For fast, accurate waveguide measurements. Each mount covers full range of its waveguide frequency. Available for all frequencies 3.95 through 12.4 kmc. No tuning required, VSWR less than 1.5. Not subject to burnout. Operates with -hp- 430B Power Meter for direct power readings. \$75.00 to \$95.00.

Here are four new wide band thermistor and bolometer mounts for use with coaxial or waveguide equipment at frequencies between 10 mc and 12.5 kmc. These new instruments are extremely simple to use, require no tuning, have low VSWR, and may be used with a power meter such as -hp- 430B to provide direct reading measurements.

Brief descriptions of new -hp- 420A and X421A Detector Mounts and -hp- 477A and 487A Fixed Tuned Thermistor Mounts appear at left. The broad complete coverage -hp- line of detectors and mounts is listed below. For details, see your local -hp- sales engineer, or write direct for Technical Bulletin, specifying instrument model number.

Complete Coverage—All Frequencies!

Model	Instrument	Frequency	Element	Price
420A	Detector Mount	10 mc to 12.5 kmc	1N21 Crystal	\$ 50.00
X421A	Detector Mount	8.2 kmc to 12.4 kmc	1N26 Crystal, mod.	75.00
440A	Detector Mount	2.4 kmc to 12.4 kmc	Crystal, Bolometer	85.00*
442B	Broad Band Probe	2.4 kmc to 18.0 kmc	—	35.00
444A	Broad Band Probe	2.6 kmc to 18.0 kmc	—	50.00
475B	Tunable Bolometer Mount	1.0 kmc to 4.0 kmc	Barretter, Thermistor, Fuse	200.00
476A	Universal Bolometer Mount	10 mc to 1.0 kmc	1/100 amp. fuses	85.00
477A	Thermistor Mount	10 mc to 10 kmc	Thermistor	75.00
S485A	Detector Mount	2.6 kmc to 3.95 kmc	Bolometer	125.00*
G485B	Detector Mount	3.95 kmc to 5.85 kmc	Bolometer, Crystal	95.00*
J485B	Detector Mount	5.85 kmc to 8.2 kmc	Bolometer, Crystal	90.00*
H485B	Detector Mount	7.05 kmc to 10.0 kmc	Bolometer, Crystal	85.00*
X485B	Detector Mount	8.2 kmc to 12.4 kmc	Bolometer, Crystal	75.00*
P485C	Detector Mount	12.4 kmc to 18.0 kmc	Thermistor	110.00
G487A	Thermistor Mount	3.95 kmc to 5.85 kmc	Thermistor	95.00
J487A	Thermistor Mount	5.85 kmc to 8.2 kmc	Thermistor	90.00
H487A	Thermistor Mount	7.05 kmc to 10.0 kmc	Thermistor	80.00
X487A	Thermistor Mount	8.2 kmc to 12.4 kmc	Thermistor	75.00

All mounts contain element unless marked (*).

Data subject to change without notice. Prices f.o.b. factory.



INSTRUMENTS FOR COMPLETE COVERAGE

HEWLETT-PACKARD COMPANY

3149D Page Mill Road • Palo Alto, California, U. S. A.

Sales and service engineers in all principal areas.

Export Division: 275 Page Mill Rd., Palo Alto, Calif.
Cable "HEWPACK"

WESCON Booths 552, 553

SEE, OPERATE NEW
-hp- INSTRUMENTS

PAN PACIFIC AUDITORIUM
LOS ANGELES—AUG. 25-26-27



Up-to-date news of every British development

WIRELESS WORLD, founded in 1911, was the first radio journal in the world. Today, it is still far ahead, and is the chief source of technical information for all who are interested in the design and manufacture of British radio, television and electronic products. Articles of a high standard cover every phase of radio and allied technical practice, and its news items embrace the wider aspects of international radio. Theoretical treatises written by experts deal with all new developments, and design data and circuits for every application are published regularly.

Published monthly \$4.50 per year

WIRELESS ENGINEER—the journal of radio research and progress—is produced for research engineers, designers and students in radio, television and electronics. It publishes only original work, and its Editorial Advisory Board contains representatives of the National Physical Laboratory, the B.B.C., and British Post Office. Keep in touch with the latest advances in Britain . . . read these important journals every month. Mail the order blank today.

Published monthly \$7.50 per year

(Including Annual Index to Abstracts and References formerly published separately)

RECENT EDITORIAL CONTENTS

Diagnosis of Distortion—The “Difference Diagram” and its Interpretation. Electronic Film-making. Remote Display of Radar Pictures—Centimetric Radio Link. Stereoscopic Television—Is it Practicable for Broadcasting? Spectrum Equalization—Use of Differentiating and Integrating Circuits. Automatic Ionospheric Height Recorder—Frequency Range 0.65 to 25 Mc/s. Squirrel-Cage Filament Structures—Equivalent Cathode Diameter. Design of Series Peaking Transformers. Distributed Amplifiers—Mutual-Inductance-Coupled Type.

MAIL THIS ORDER TODAY

To ILIFFE & SONS LIMITED, DORSET HOUSE, STAMFORD STREET, LONDON, S.E.1, ENGLAND

Please forward for 12 months. Payment is being made*

NAME

ADDRESS

CITY ZONE STATE

** Payment can be made by Bankers' Draft or International Money Order.*

Bomac

REFERENCE CAVITIES

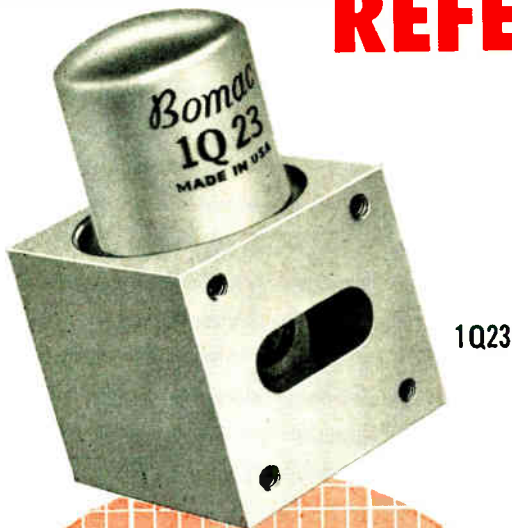

1Q23

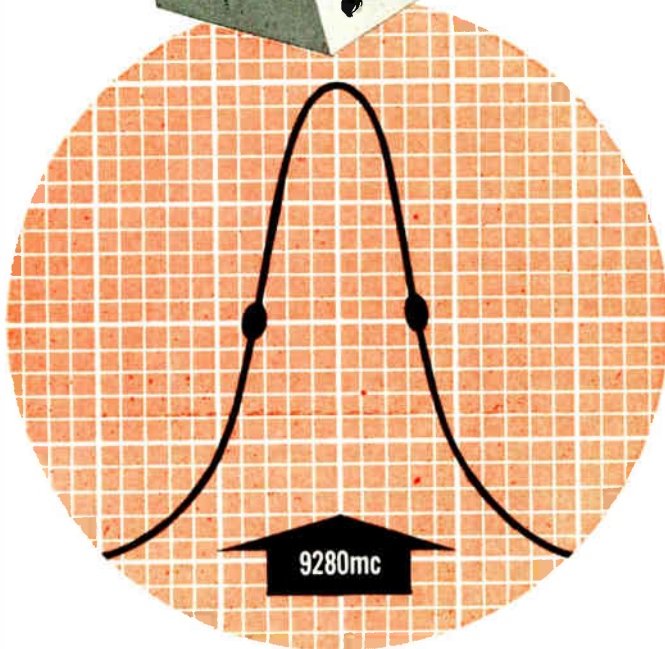

Bomac has developed a line of high-precision Reference Cavities covering six different frequencies. Essentially, Bomac cavities are fixed-frequency, vacuum-sealed, transmission-type tubes. They are used primarily as frequency determining references, and frequency stabilizers in radar beacon applications. The performance and stability of Bomac Reference Cavities over a wide range of temperatures is far superior to many other commercial cavities. Stability of the resonant frequency is maintained under severe conditions of shock and vibration by a unique cushioning arrangement that prevents excessive movement of the tube within the block.

CHARACTERISTICS AND RATINGS OF 1Q23 RESONANT CAVITY

RESONANT FREQUENCY (mc)	9280 ± 0.5 mc
VIBRATION 10 G's	± 0.1 mc
SHOCK 50 G's	± 0.1 mc
AVERAGE Q	2100
INSERTION LOSS	4.0 db — 6.0 db
TEMPERATURE COMPENSATION	
Room Temp. to 100°C	± 0.3 mc
Room Temp. to 0°C	± 0.3 mc
Room Temp. to -55°C	± 1.0 mc
ATMOSPHERIC PRESSURE	
To 45 psi (abs.)	± 0.15 mc
To 5 in. hg. (abs.)	± 0.15 mc
ALTITUDE RATING	50,000 ft. (max.)

CAVITIES FOR OTHER FREQUENCIES

1Q22 — 9250 mc	6040 — 9308 mc
1Q24 — 9310 mc	6041 — 9312 mc
5846 — 9280 mc	

MATCHED CAVITIES — For special applications, matched cavities are now available. We invite your inquiries regarding special applications for our reference cavities.

We invite your inquiries regarding

- ENGINEERING
- DEVELOPMENT
- PRODUCTION

Bomac Laboratories, Inc.

BEVERLY, MASSACHUSETTS

GAS SWITCHING TUBES · DIODES · HYDROGEN TETRATRONS · DUPLEXERS · MAGNETRONS · MODULATORS

Catalog on request. Write (on your company letterhead) Dept. T-8 BOMAC Laboratories, Inc. Beverly, Mass.

Frequency Meters

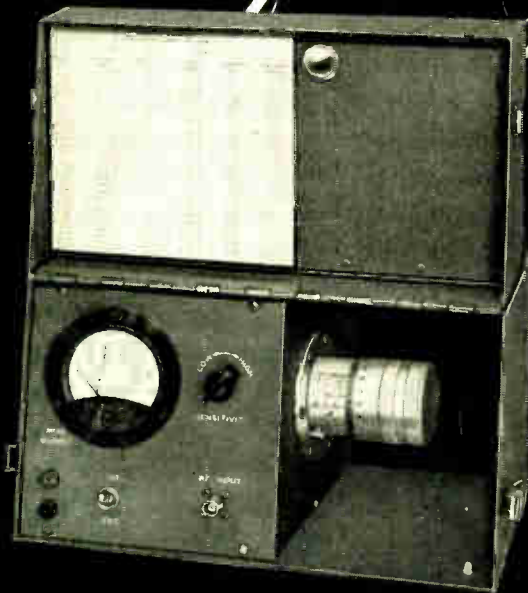

COMPLETELY
SELF-CONTAINED
FIELD TEST INSTRUMENTS

by

FREQUENCY STANDARDS

These precision-built field test instruments were designed by Frequency Standards to provide rapid and accurate means of frequency measurement in the field. Frequency is determined by means of a micrometer dial. This reading is translated to frequency by accurate individual calibration charts or curves. Transducers, fittings, and cables can be supplied to meet the requirements of customers and convenient storage space for these items is provided in the lid of the instruments.



MODEL	FREQUENCY RANGE	ACCURACY
912-4	900-1200 MC	.01%
1217-4	1200-1700 MC	.02%
1723-4	1700-2300 MC	.02%
2335-4	2300-3500 MC	.02%
3545-4	3500-4500 MC	.01%
4458-4	4400-5800 MC	.01%
5882-4	5800-8200 MC	.01%

ILLUSTRATED
BULLETINS
SENT ON
REQUEST

Frequency Standards
ASBURY PARK, NEW JERSEY

Address inquiries to
BOX 504



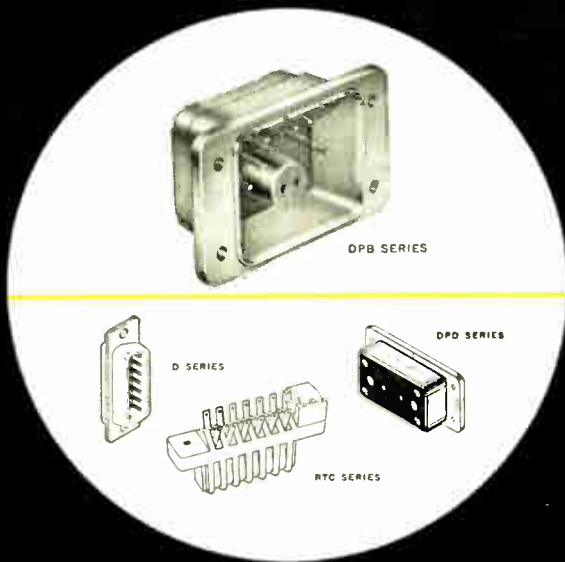

*for rapid disconnect
use cannon
"unit plug-in"
connectors*

speed up inspection...testing...maintenance! facilitate interchangeability!

You can connect, disconnect, interchange, replace, test, and inspect instruments, assemblies, and sub-assemblies easily and rapidly when you use Cannon "Unit Plug-In" multi-contact electric connectors.

You'll find some with shells . . . some without. Shell style units . . . in a wide variety of designs . . . are ruggedly constructed to take the many "in" and "out" operations of rack, panel, chassis, and sub-assembly applications. Varied, simple, but always rigid mounting facilities provided on each connector half. Standard, miniature, sub-miniature sizes.

Either connector half may be made into a plug by use of an end bell. Up to 156 contacts. And . . . an amazing number of combinations of contacts for control, audio, thermocouple, co-ax, twin-ax, as well as pneumatic connections. In single- or double-gang. Special moisture-proofed types. Standby units feature gold-plated contacts to withstand deterioration and corrosion.

Write for full information. Write TODAY!



first in connectors

CANNON PLUGS

Please refer to Dept. 377

CANNON ELECTRIC COMPANY, 3209 Humboldt Street, Los Angeles 31, California. Factories in Los Angeles; East Haven; Toronto, Canada; London, England. Contact representatives and distributors in all principal cities.



DIASTEC



August 1954

Flow Pickup

Waugh Engineering Co., 15306 Dickens St., Sherman Oaks, Calif., has a new series "FL" flow pickups which form a complete line of turbine type sensing elements, covering flow rates from 0.3 to 3,000 gpm. They are applicable to rocket and turbojet engine testing, and to many difficult industrial flow measurements.

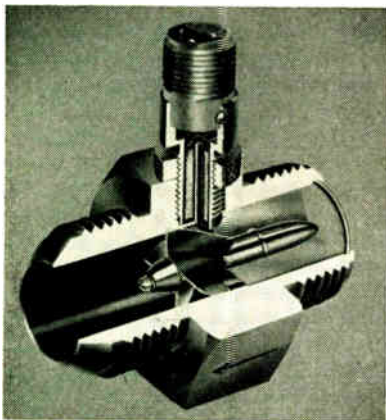

Fluid flow drives a freely spinning turbine wheel, which generates pulses in an externally-mounted magnetic coil. Pulse frequency is used as a measure of flow rate, while the total number of pulses measures total volume of fluid.

To indicate, record, or totalize fluid flow, either electronic counters or dc instruments may be used, the latter in conjunction with the Waugh pulse rate converter.

Simplified, rugged design permits accuracies of 0.5 per cent at pressures up to 3,500 psi, temperatures from -300°F to $+800^{\circ}\text{F}$, and under severe shock and vibration. Transient response up to 100 cps is available.

Range between maximum and minimum flow varies from 6 to 1 for the $\frac{3}{8}$ pickup, to 40 to 1 in the larger sizes.

Magnetic Amplifier

A new compact, lightweight magnetic amplifier is now being manufactured by Kollman Instrument Corp., 80-08 45th Ave., Elmhurst, N. Y., wholly-owned subsidiary of Standard Coil Products Co., Inc. This amplifier, Type 2063-01, is designed for use in meteorological sensing systems, in aircraft, navigational, gun-fire and other precision automatic controls.



These manufacturers have invited PROCEEDINGS readers to write for literature and further technical information. Please mention your I.R.E. affiliation.

The amplifier is entirely self-contained in a hermetically sealed case, $1\frac{1}{8} \times 3\frac{1}{2} \times 3\frac{1}{2}$ inches. The unit weighs 15.5 ounces. Consisting of two stages of vacuum-tube pre-amplification and a magnetic-power output stage, the amplifier operates from a 115-volt, 400 cps source and requires approximately 14 volt-amperes at a power factor of 0.7. Input impedance is 5,000 ohms and the maximum time delay is $1/400$ of a second. Inquiries for additional information should be directed to Girard S. Toombs, Manager of Motor Div.

Hermetic Seal For Subminiature Switches

The Model 5030 Hexseal has recently been added to the line of toggle-switch boots for high pressure service manufactured by Automatic & Precision Mfg. Co., 252 Hawthorne Ave., Yonkers 5, N. Y. When installed on the exterior of a panel in place of a conventional lock-nut, this device affords both hermetic sealing and fastening in one unit. The design incorporates a gasket rib, molded as an integral part of the boot, which seats against any panel surface to keep out moisture, dust, or combustible vapors.

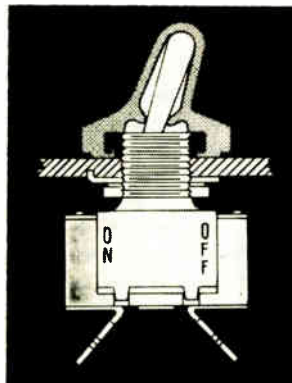

Hexseals are made of silicone rubber, chemically bonded to a threaded insert. They meet the vibration and weather requirements of MIL Spec E-5272A and surpass the requirements of MIL Spec B-5423. Operating temperature range is from -80° to 500°F . Dimensions are: $\frac{1}{2}$ inch high over all, $\frac{1}{16}$ inch between flats. It accommodates a toggle bat $\frac{3}{8}$ inch high, and mounting thread is $\frac{1}{4}$ -40.

Additional information and descriptive literature may be obtained from Automatic & Precision Mfg. Co.

General Instrument Promotes Klabin



Robert L. Klabin has been named Vice President and General Manager of the newly-created Elizabeth Div., General Instrument Corp., Elizabeth, N. J., major producer of television, radio and electronics components, it was announced recently by Monte Cohen, President of the corporation.

1954 WESCON Exhibitors Announced

Mr. Mal Mobley, Business Manager of the 1954 Western Electronic Show and Convention, to be held in the Pan-Pacific Auditorium in Los Angeles on August 25, 26 & 27, has announced that the following firms will exhibit:

EXHIBITOR	Booth No.
Abbott Instrument & Engineering Co.	206-207
Acc Engineering & Machine Co., Inc.	760
Advance Electric & Relay Co.	308
Aerovox Corporation	546-547
Air Associates, Inc.	1218
Air-Marine Motors, Inc.	639
Aircraft-Marine Products, Inc.	444-445
Airpax Products Co.	750
Airtron, Inc.	463
Allied Chemical & Dye Corporation	1201
Altec Lansing Corporation	550-551
American Electric Motors, Inc.	265
American Lava Corporation	245
American Microphone Co.	326
American Phenolic Corporation	523-524
Ampex Corporation	112
Andrew Corporation	532
Harry Appleton Co., Inc.	667
L. H. Appleman	742
Applied Science Corporation of Princeton	647

(Continued on page 18A)

DAVEN

advanced design brings you

“PLUG-IN”

ATTENUATION NETWORKS

Combining a wide range of attenuation with a “plug-in” feature for adjusting input and output impedance.

On Daven Series 690 Attenuation Networks, the exclusive “plug-in” feature permits input or output impedance to be changed to any value by substituting “plug-in” pads of the particular impedance desired.

These networks are intended for use in general laboratory and production testing. They are extremely rugged, flexible and reliable. They are available in either “T” or “Balanced H” circuits. A range of either 110 DB in 1 DB steps can be obtained on the 2-dial series, or a range of 111 DB in 0.1 DB steps on the 3-dial series. A special card type, non-inductive winding is used, giving a frequency range of from zero to 50 KC. These units may be used above 50 KC with only a slight decrease in accuracy. Resistor units are calibrated to $\pm 1.0\%$ accuracy and operate at a +20 DB (0.6 watt) maximum input level.

To insure low contact resistance and uniform contact pressure Daven patented “knee-action” switch rotors are used. Silver alloy rotors, slip-rings and contacts insure finest electrical performance. Daven’s exclusive “plug-in” impedance Matching Networks are available in a wide range of impedance and loss.

Write for complete catalog data.

THE **DAVEN** co. 195 Central Ave., Newark 4, N. J.



Series 690

WORLD'S LARGEST MANUFACTURER OF ATTENUATORS

1954 Wescon Exhibitors

(Continued from page 16A)

EXHIBITOR Booth No.

Arco Electronics, Inc.....	816
Aremac Associates.....	630
Arga Division, Beckman Instruments, Inc.....	1114
The Arnold Engineering Co.....	320-321
Assembly Products, Inc.....	233
Audio Devices, Inc.....	409
Audio Products Corporation.....	138
Automatic Electric Sales Corporation.....	345
Avery Adhesive Label Corp.....	221-222
Ballantine Laboratories, Inc.....	814
Barron-Jur Company.....	900A
Barry Corporation.....	364
Herb Becker Company.....	154
Belden Manufacturing Co.....	636
Bendix Aviation Corporation	
Computer Division.....	745-746
Eclipse-Pioneer Division.....	711-712
Pacific Division.....	719-720
Radio Division.....	743-744
Red Bank Division.....	716-717
Scintilla Division.....	650-651
Bennett Products Mfg. Co.....	606
Benson-Lehner Corporation.....	722-723
Berkeley Scientific Corporation.....	243-244
Div. of Beckman Instruments	
Jack Berman Company.....	502-503
Beta Electric Corporation.....	363
Bird Electronic Corporation.....	510
Bliley Electric Company.....	158
Bodnar Industries, Inc.....	1211
Boesch Manufacturing Co., Inc.....	702
Bogue Electric Manufacturing Co.....	110
Bomac Laboratories, Inc.....	461-462
Boonton Radio Corporation.....	507-508
Bourns Laboratories Instrument Sales Corp.....	640
Browning Laboratories, Inc.....	1301
Brubaker Manufacturing Co., Inc.....	123
Brush Electronics Company.....	330
Burgess Battery Co.....	128
Burlington Instrument Co.....	115
Burnell & Company.....	427A
Burroughs Corporation.....	1303
Bussmann Manufacturing Co.....	136
Calidyne Company.....	304-341
California Computer Products.....	700F
California Magnetic Control Corp.....	109
Cal-Tronics Corporation.....	201-202
Cambridge Thermionic Corporation.....	362
Camloc Fastener Corporation.....	900B
Cannon Electric Company.....	134
Carad Corporation.....	726
Allen D. Cardwell Mfg. Co.....	113
Cargo Packers, Inc.....	753
Carruthers & Fernandez, Inc.....	701
Carstedt Research Laboratory.....	721
Carter Motor Company.....	211
Cascade Research Corporation.....	141
CBS-Hytron Div. CBS, Inc.....	226-227
CEC Instruments, Inc.....	130-131
(Sub. of Consolidated Eng. Corp.)	
Centralab Division.....	718
Div. Glove-Union, Inc.	
Century Geophysical Corporation.....	609-610
Chicago Standards Transformer Corp.....	541
Cinch Manufacturing Corp.....	906-907
Howard B. Jones Div.	
Cinema Engineering Co.....	548
Clarostat Manufacturing Company.....	213
Clary Multiplier Corporation.....	255
Clear Beam Antenna Corporation.....	543
Irv M. Cochrane Co.....	258
Coil Winding Equipment Co.....	301
Collins Radio Company.....	911-912
Coleman Engineering Co., Inc.....	104
Color Television, Inc.....	231
Communication Accessories Co.....	608
Communication Products Co., Inc.....	1206
Condenser Products Co.....	566

(Continued on page 20A)



AEROVOX

high-temperature

metallized-paper CAPACITORS



Aerolene* does it! This Aerovox-exclusive solid impregnant accounts for the higher temperature ratings and longer life of Aerovox metallized-paper capacitors. The accompanying curve (Operating Voltage vs. Temperature) tells the story. Further gains from permanently-embedded sections in solid Aerolene impregnant are: maximum immunity to vibration and rough handling. And of course minimum size and maximum convenience. Install them—forget them!

Available in a wide variety of case styles including modified molded tubular, and all types of metal-cased hermetically-sealed construction with capacitance ratings from .0005 mfd. to 100. mfd. at voltages up to 600 VDC.

Get the FACTS!

*Trade Mark

Ask for literature on Aerovox metallized-paper capacitors in both standard and special types. Our metallized-paper specialists will gladly collaborate on your extra-compact-capacitor needs.



AEROVOX CORPORATION
NEW BEDFORD, MASS.

Hi-Q
DIVISION
OLEAN, N. Y.

ACME
ELECTRONICS, INC.
MONROVIA, CALIF.

CINEMA
ENGINEERING CO.
BURBANK, CALIF.

In Canada: AEROVOX CANADA LTD., Hamilton, Ont.

COMPRESSING TIME

In any security program *time* is the one irreplaceable element. Making the most of time is particularly vital in guided missiles projects. Fairchild's Guided Missiles Division has demonstrated its ability to "spend" time effectively. Its completely integrated engineering and production organization can, in effect, *compress time*.

With a balanced engineering team and an experienced production staff housed together in a facility built specifically for the development and manufacture of missiles, Fairchild can cut down lags in moving a missile project from the design and development phase into the production phase.

It has done so.

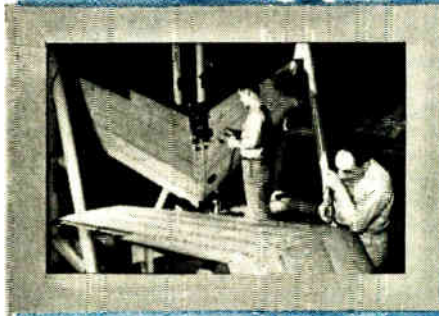
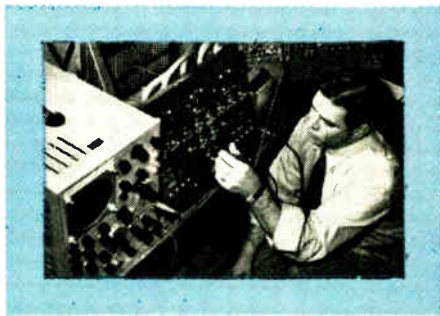
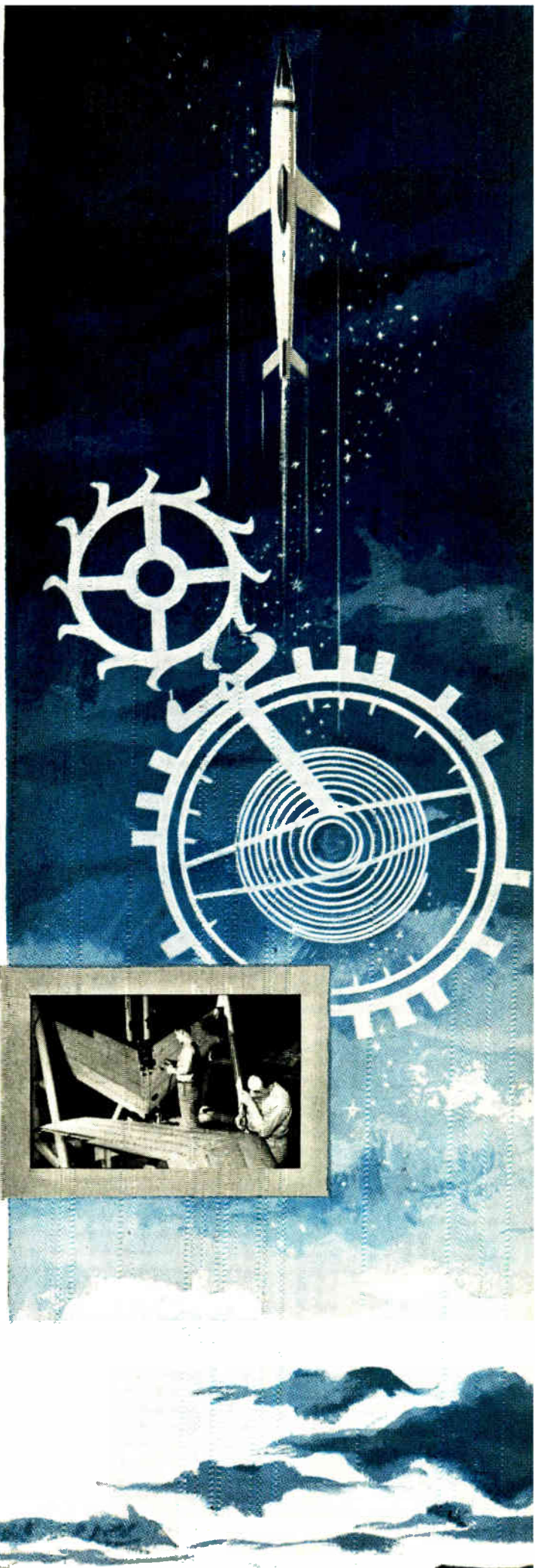

ENGINE AND AIRPLANE CORPORATION
FAIRCHILD

Guided Missiles Division

WYANDANCH, N. Y.

Aircraft Division, Hagerstown, Maryland • American Helicopter Division,
Manhattan Beach, Calif. • Engine Division, Farmingdale, N.Y. • Speed
Control Division, Wickliffe, Ohio • Stratos Division, Bay Shore, N.Y.

News—New Products

1954 Wescon Exhibitors

(Continued from page 18A)



DEPEND on

Six Wattage Ranges



DC-2 — 2 Watt
DC-1 — 1 Watt
DC-1/2 — 1/2 Watt
DC-1/4 — 1/4 Watt
*DC-1/8 — 1/8 Watt
*DC-1/16 — 1/16 Watt
*For Miniature Installations

DALOHM
Deposited Carbon Resistors
for
ACCURACY and STABILITY!

Dalohm deposited carbon resistors are manufactured under rigid controls to deliver matchless performance and economy in any high-low resistance range.

Dalohm resistors are sealed against moisture with special silicone coating having high di-electric strength, excellent thermal conductivity, and high resistance to abrasion.

From 1 Ohm to 200 Megohms, depending on type.

Temperature coefficient 200 PPM per degree C for lower resistance ranges up to 500 PPM per degree C for higher ranges.

1% accuracy. 2%, 5%, and 10% tolerances also available.

Meet MIL-10509-A Specifications

DALE PRODUCTS, INC. Columbus, Nebraska, U.S.A.
In Canada — Telatronics Corp., Ltd., Toronto and Montreal

Write, Wire or Call
1302 28th Ave. Phone 2139

EXHIBITOR Booth No.

Connecticut Telephone & Electric Corporation	638
Conrac, Inc.	127
Conrad, Inc.	705
L. L. Constantin & Co.	900C
Control Products, Inc.	529
Cornell Dubilier Electric Corp.	228-229
Corning Glass Works	142-143
R. W. Cramer Co., Inc.	204
Crucible Steel Co. of America	107-108
Cubic Corporation	903
Dage Electronics Corporation	1219
Dale Products, Inc.	601-602
The Daven Company	209
Joe Davidson & Associates	266-267
George Davis Sales Co.	614-615
De Jur Amsco Corporation	754
Digital Instrument Co., Inc.	427B
Doelcam Corporation	1205
The Robert Dollar Co.	807
Donner Scientific Company	737
Dressen-Barnes Corporation	567-568
Allen B. DuMont Laboratories, Inc.	536-537
Duncan-Rohne & Co.	700G
Ealy & Hastings	802
EBY Sales Co. of New York	1208
Jackson Edwards & Co.	260
Eitel-McCullough, Inc.	150-151
Elastic Stop Nut Corp. of America	700E
Elco Corporation	542
Electra Manufacturing Co.	530
Electro-Data Corporation	1214
Electro Engineering Works	317
Electro-Measurements, Inc.	560
Electro-Mechanical Specialties Co., Inc.	165
Electro-Pulse, Inc.	662
Electronic Associates, Inc.	253
Electronic Engineering Associates, Ltd.	254
Electronic Engineering Company of California	459-460
Electronic Products Corporation	1209
Electronic Specialty Co.	629
Elgin Metallformers Corp.	1108-1109
Frank A. Emmet Co.	162
Empire Devices Products Corp.	623
Endevco Corporation	324
Enright Engineering Co.	1217
Erie Resistor Corporation	544
Essex Wire Corporation	528
R-B-M Div.	
Fairchild Camera & Instrument Corp.	220
Potentiometer Div.	
Federal Telephone & Radio Co.	900D-900E
Felts Corporation	1207
Microdot Div.	
Fenton Company	628
Filtron Company, Inc.	428-429
T. R. Finn & Company, Inc.	1111
F-R Machine Works, Inc.	1105
Furane Plastics, Inc.	700D
Fusite Corporation	620
Gabriel Company, Electronics Div.	643
The Gamewell Company	1104
Garrard Sales Corporation	114
Gates Radio Company	1119
General Ceramics & Steatite Corp.	358
General Electric Company	
Apparatus Sales Division	811-812
Electronics Division	616-617
General Radio Company	251-252
Genisco, Incorporated	663-664
Gertsch Products, Inc.	511-512
M. B. Gilbert Co., Inc.	642

(Continued on page 36A)

plan your
production
with
KAHLE
machinery

built specifically for your operation...

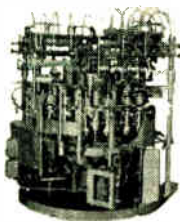

Industry leaders in electronics, glass, and allied fields have continuously keyed their operations to KAHLE Machines for over a quarter of a century. Your production rate, your specifications, your requirements—are "planned-in" KAHLE Machines.

**Call KAHLE for
"machines
that think for you!"**

Kahle
ENGINEERING
COMPANY

1314 SEVENTH STREET
NORTH BERGEN, N. J.

Selenium Rectifiers

**INTERNATIONAL
RECTIFIER
CORPORATION**



EL SEGUNDO
CALIFORNIA

**Largest
Range in the
Industry**

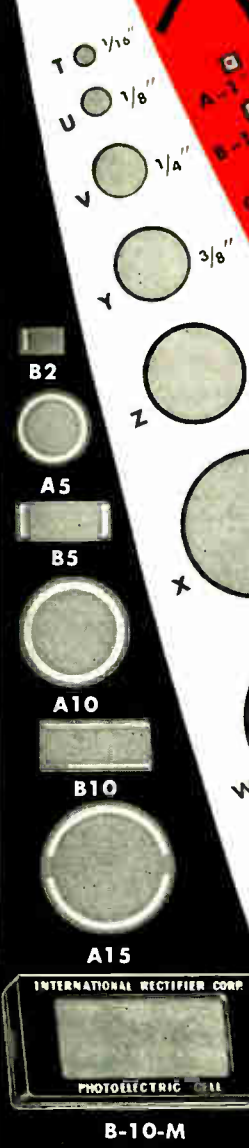

PHOTOELECTRIC CELLS
Send for Bulletin PC-649

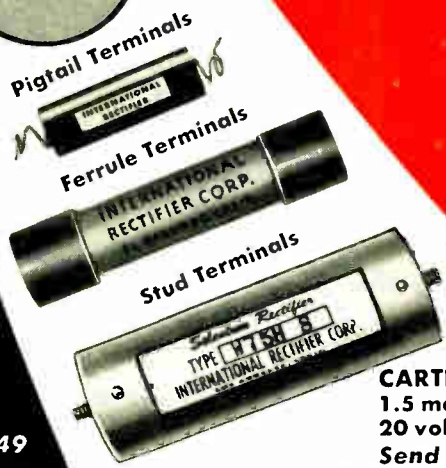
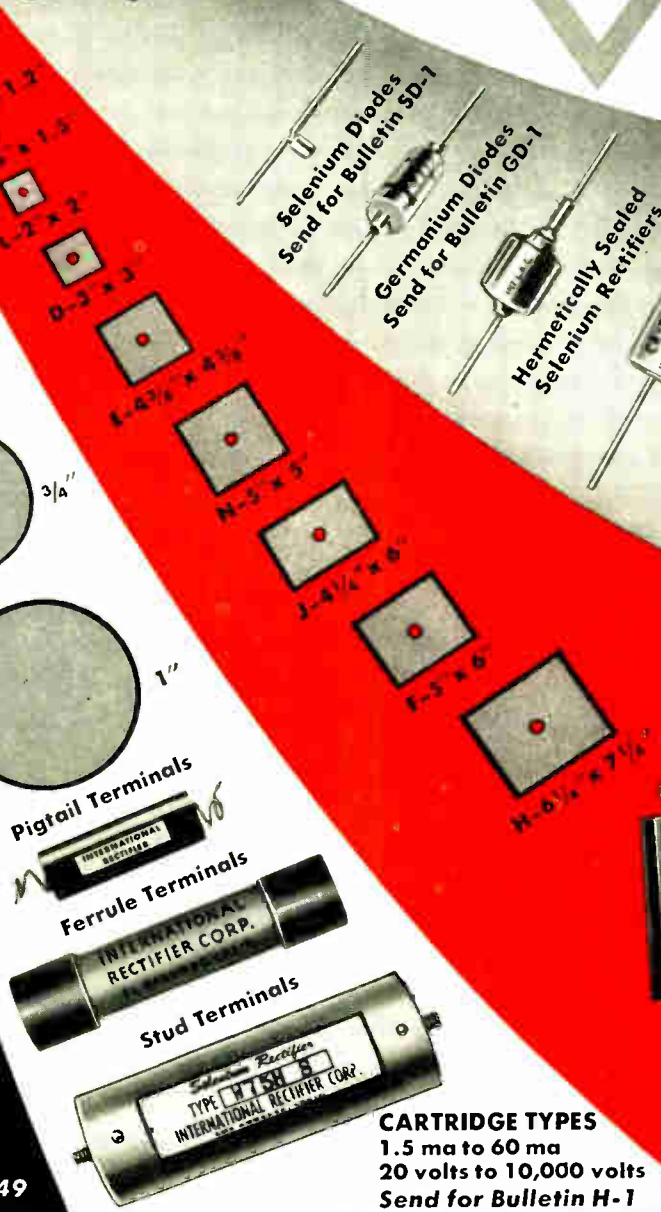

CARTRIDGE TYPES
1.5 ma to 60 ma
20 volts to 10,000 volts
Send for Bulletin H-1

Selenium Diodes
Send for Bulletin SD-1

Germanium Diodes
Send for Bulletin GD-1

Hermetically Sealed
Selenium Rectifiers

Metal Enclosed
Selenium Rectifiers

Encapsulated
Selenium Rectifiers



POWER RECTIFIERS
Single Stack Ratings:
125 ma to 2300 Amperes
Single Plate Ratings:
22 volts to 40 volts rms
Send for Bulletin C-349

I N T E R N A T I O N A L R E C T I F I E R

C O R P O R A T I O N
1521 E. GRAND AVE. EL SEGUNDO, CALIFORNIA, PHONE: OREGON 8-3778
CHICAGO: 205 W. WACKER DRIVE, PHONE: FRANKLIN 2-3889
NEW YORK: 501 MADISON AVENUE, PHONE: PLAZA 5-8665

ON DISPLAY AT WESCON EXHIBIT, AUGUST 25-27

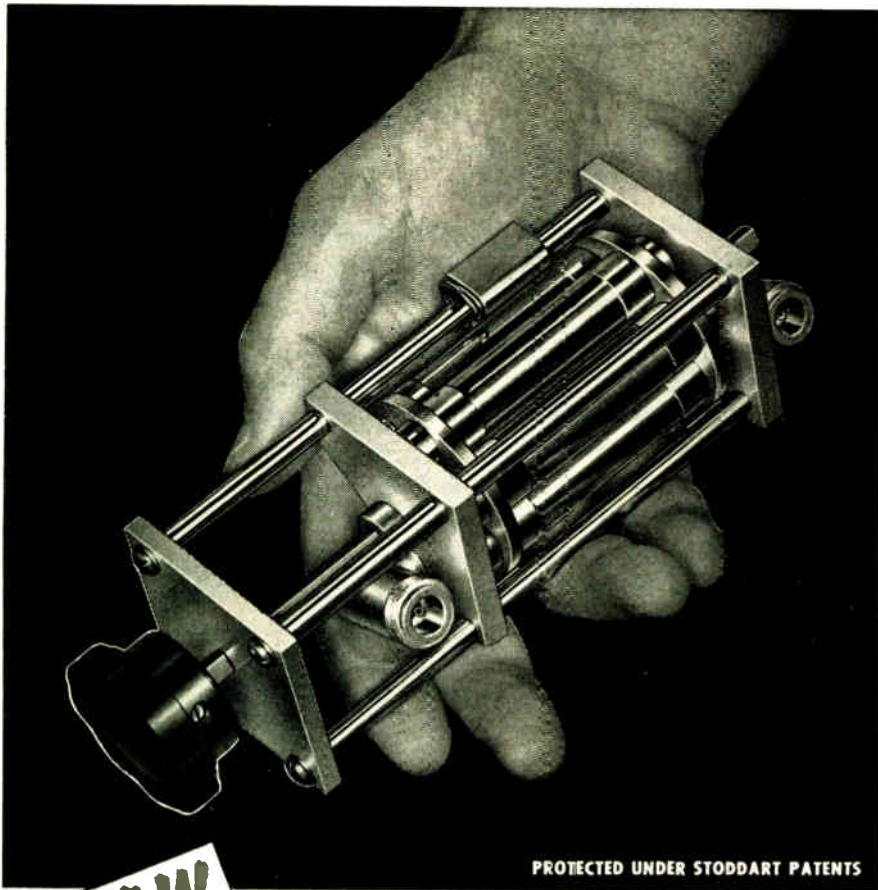

PROTECTED UNDER STODDART PATENTS

NOW

Precision Attenuation to 3000 mc!

TURRET ATTENUATOR featuring "PULL-TURN-PUSH" action



SINGLE "IN-THE-LINE" ATTENUATOR PADS and 50 ohm COAXIAL TERMINATION

FREQUENCY RANGE:
dc to 3000 mc.
CHARACTERISTIC IMPEDANCE:
50 ohms
CONNECTORS:
Type "N" Coaxial female fittings each end
AVAILABLE ATTENUATION:
Any value from .1 db to 60 db
VSWR:
<1.2, dc to 3000 mc., for all values from 10 to 60 db
<1.5, dc to 3000 mc., for values from .1 to 9 db
ACCURACY:
±0.5 db
POWER RATING:
One watt sine wave power dissipation

Send for free bulletin entitled "Measurement of RF Attenuation"

Inquiries invited concerning pads or turrets with different connector styles

STODDART AIRCRAFT RADIO Co., Inc.

6644-C Santa Monica Blvd., Hollywood 38, California • Hollywood 4-9294



Type **531**

SAVES ENGINEERING TIME

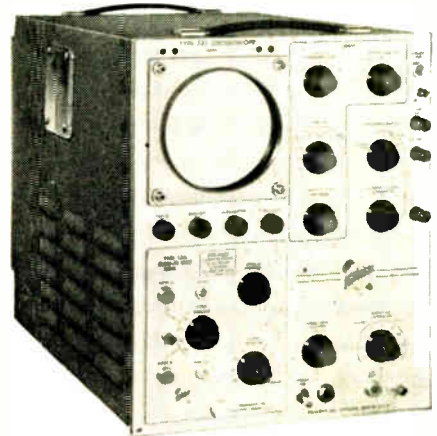

The Type 531 Oscilloscope saves engineering time two ways. It provides you with an extremely wide range of facilities. It eliminates the need to hunt for another oscilloscope when your requirements change—say from "high-gain" to "wide-band", or to "dual-trace".

Plug-in preamplifiers are used for maximum flexibility in signal handling. Sweep-speed range is 600 million to one—the widest you can get in a single oscilloscope. Accelerating potential is high enough to permit photographing a single sweep... even at the fastest sweep speed.

Direct-Reading in Time and Amplitude. You can read time and amplitude with accuracies comparable to indicating meters.

Sweep Range—0.02 μ sec/cm to 12 sec/cm.

10KV Accelerating Potential

Versatile Triggering Circuitry

Price—\$995 plus price of desired plug-in units

PLUG-IN UNITS

TYPE 53A—DC to 10 mc, 0.05 v/cm to 50 v/cm\$85

TYPE 53B—Some as 53A with additional ac-sensitivity to 5 mv/cm\$125

TYPE 53C—Dual-trace unit. Two identical amplifier channels, dc to 9 mc, 0.05 v/cm to 50 v/cm. Electronic switching triggered by oscilloscope sweep, or free-running at about 100 kc.\$275

TYPE 53D—Differential input. DC to 350 kc at 1 mv/cm—passband increasing to 2 mc at 50 mv/cm. Full range—1 mv/cm to 125 v/cm.\$145
Prices f.a.b. Portland (Beaverton) Oregon

See the Type 531 at Booths 556 and 557 at the 1954 WESCON



Tektronix, Inc.

P. O. Box 8318
Portland 7, Oregon
Phone: CYpress 2-2611
Cable: TEKTRONIX

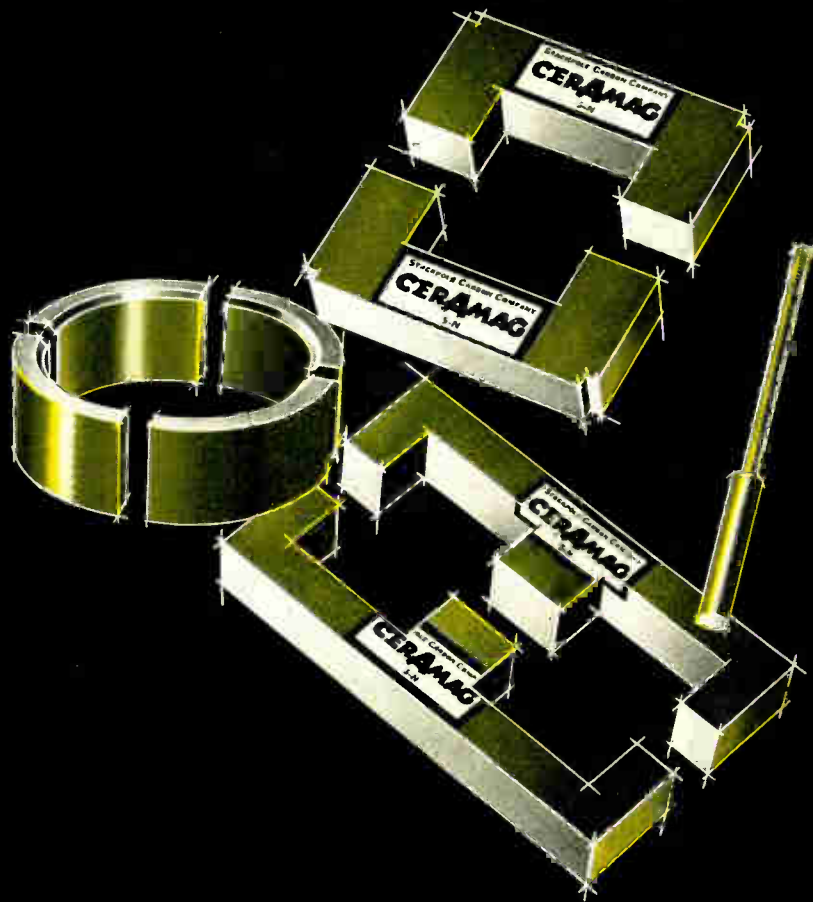

**THE PRODUCTION UNIT
IS LIKE THE SAMPLE . . . AND
EACH PRODUCTION UNIT IS LIKE THE
OTHER . . . ELECTRICALLY AND
MECHANICALLY!**

STACKPOLE
Ceramag[®]
FERRITE CORES

Electronic Components Division, STACKPOLE CARBON COMPANY, St. Marys, Pa.

3 ϕ to 2 ϕ
@ 380-1500 cycles

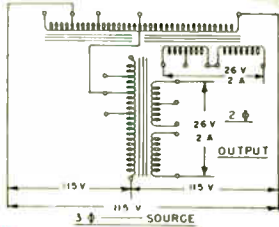

with 2
TRIAD HS-442's

Aircraft electronic equipment designers, with this one stock type of transformer, can supply needs for a 3-phase to 2-phase conversion or for single phase filament power. This limits the necessity for special transformers, necessarily of high cost because of small quantities.

This universal, compact, MIL-T-27 style transformer, with 2 units Scott-connected, supplies at the secondary 2-phase 26 or 13 volt power for resolvers, computers, remote indicators and control devices. One transformer, single phase, will supply 26 volts C. T. at 2 amperes, 12.6 volts C. T. at 4 amperes, or two 12.6 volt, 2 ampere windings, one center tapped.

All this in a MIL-T-27 case only 1 $\frac{1}{8}$ " x 1 $\frac{1}{8}$ " x 2 $\frac{3}{4}$ " high, with the proved-in-service Triad Hermetic Seal Terminal and permanently affixed schematic decal.

Type No.	List Price	Primary Volts	Secondary	
			Volts	Amperes
HS-442	22.50	54.5-96-115-120 Single phase.	12.6 C.T. 12.6	2 2

Two HS-442's can be used, 115 volt 3 phase to 26 volt 2 phase, Scott-connected.

Write for Catalog TR-54H

4055 Redwood Ave., Venice, Calif.

Lapp

**STAND-OFF
 INSULATORS**

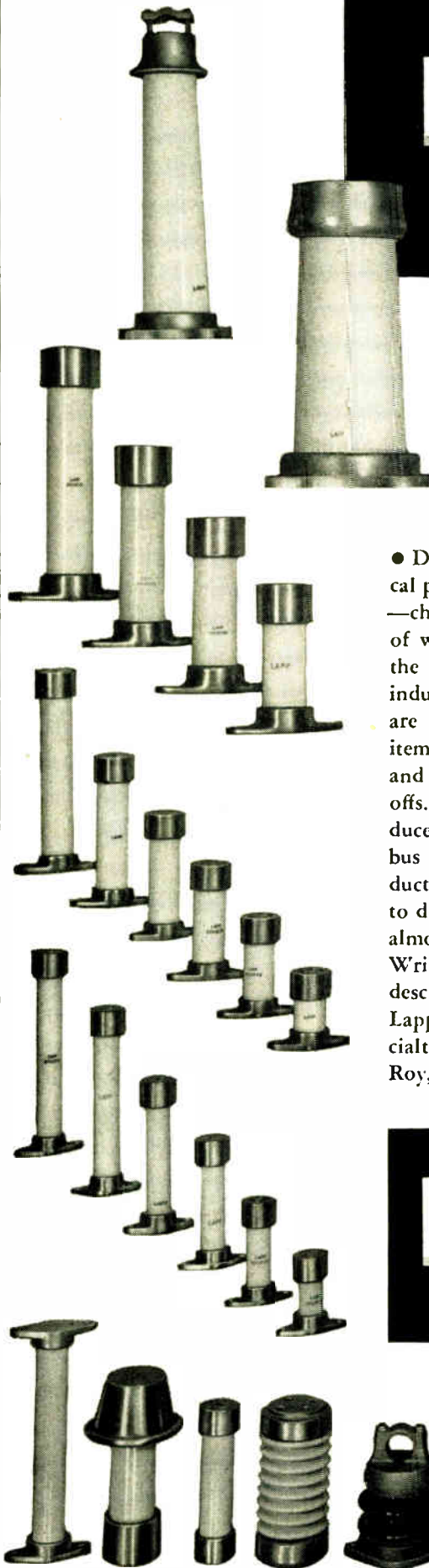

• Dependable mechanical and electrical performance—and trim good looks—characterize these standoff insulators, of which Lapp is a major supplier to the radio, television and electronics industry. Included in this illustration are representative units of catalog items—usually available from stock—and certain examples of special stand-offs. Hundreds of types have been produced for support of equipment and bus runs. Lapp engineering and production facilities are eminently suited to design and manufacture of units to almost any performance specification. Write for Bulletin 301 with complete description and specification data. Lapp Insulator Co., Inc., Radio Specialties Division, 216 Sumner St., Le Roy, N. Y.

Lapp

G.E. CONTINUES INDUSTRY LEAD WITH NEW GOLD BONDED GERMANIUM DIODES

- High Forward Current Characteristics
- High Peak Inverse Voltage
- High Back To Forward Resistance Ratio
- High Frequency Response

EXACTING military specifications provided the impetus for G-E's design of these new gold bonded germanium diodes. But, their application is certainly not limited to government use. Each superior characteristic points up a potentially broad market in commercial equipment.

Here, then, you have an indication of General Electric's planned program to supply *high quality germanium products for every conceivable user requirement.* It will benefit you to examine not only these new units but to become familiar with all of the many diodes, rectifiers and transistors G.E. manufactures. Call us or mail the coupon below for detailed information.



Germanium Products

TRANSISTORS • DIODES • RECTIFIERS

G-E Type Number	1N139	1N140	1N141	1N142	1N143
Forward Cur. (a) +1v (MA)	20	40	20	5	40
Maximum Reverse Cur. (a) -50v (μ a)	1500	300	50	—	—
(a) -100v (μ a)	—	—	—	100	100
Peak Inverse Voltage (Volts)	50	85	85	125	125
Cont. Reverse Voltage (Volts)	40	70	70	100	100
Cont. DC Forward Current (ma)	70	85	70	60	85
Peak Oper. Cur. (ma)	250	350	250	200	350
Surge Cur. for 1 Second (ma)	500	750	500	400	750
Ambient Temperature Range	-50°C to +80°C				
Derating above 25°C	10mw/10°C				
Average Shunt Capacitance	0.9 μ fd				
Average 100mc Rect. Eff.	46%				



DIMENSIONS:

CASE: Diameter .220 \pm .005 by 1/2 inch maximum length.
LEADS: 1 inch minimum with .020 diameter.
PINS: 1/8 inch length with .079 \pm .001 diameter.

General Electric Company, Section X5284
 Electronics Park, Syracuse, New York
 Please send me complete specifications on the new G-E Gold Bonded Diodes.

NAME.....
 ADDRESS.....
 CITY..... STATE.....

GENERAL ELECTRIC

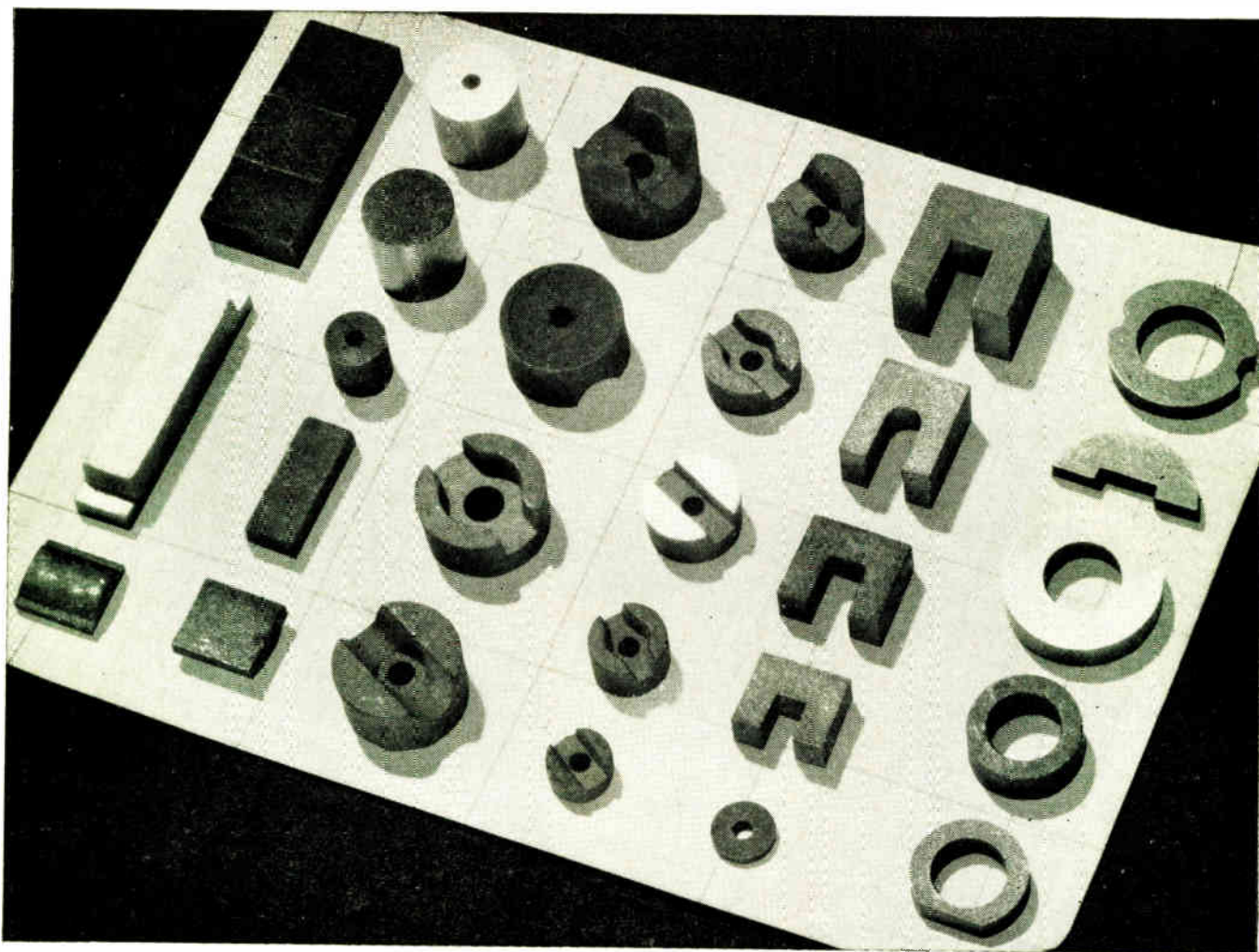

Page-full of ideas for you

on *Sintered Magnets*



"MAGNETIC MATERIALS CATALOG"
Write for your copy
 Contains handy data on various types of Alnico Magnets, partial lists of stock items, and information on other permanent magnet materials. Also includes valuable technical data on Arnold tape-wound cores, powder cores, and types "C" and "E" split cores in various tape gauges and core sizes.
ADDRESS DEPT. P-8

**"OFF-THE-SHELF" ITEMS or
 SPECIAL SHAPES to suit your needs**

Magnets of sintered Alnico offer endless opportunities to designers who need their useful combination of self-contained power and small bulk. A wide range of sintered Alnico shapes are carried in stock for quick shipment. Special shapes to meet an individual design need can be developed, where the quantity required is large enough to justify the tooling costs. Arnold sintered permanent magnets are fully quality-controlled and accurately held to specified tolerances. ● *We'll welcome your inquiries.*

W 43 5240

THE ARNOLD ENGINEERING COMPANY
 SUBSIDIARY OF ALLEGHENY LUDLUM STEEL CORPORATION
 General Office & Plant: Marengo, Illinois
 DISTRICT SALES OFFICES . . . New York: 350 Fifth Ave.
 Los Angeles: 3450 Wilshire Blvd. Boston: 200 Berkeley St.





When it comes to

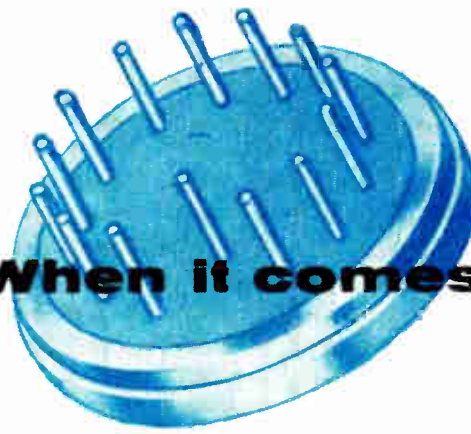

hermetic seals, consult E-I



for standard type



terminals to fit

standard closures...E-I



E-I HERMETICALLY-SEALED
TERMINALS
AND
CLOSURES

can save you



E-I... Headers for Hermetically-sealed Multiple Headers, Octal Plug-ins, Terminals, Color-coded Terminals, End Seals



time and money! Write

for catalogs and samples

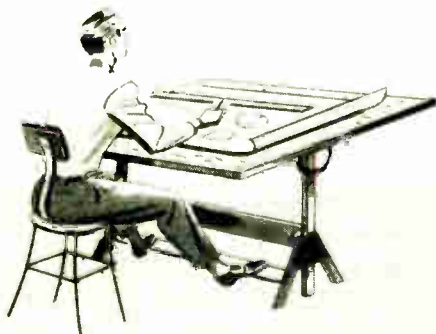

DIVISION OF AMPEREX
ELECTRONICS CORPORATION

ELECTRICAL INDUSTRIES

44 SUMMER AVENUE, NEWARK 4, NEW JERSEY

PATENT PENDING ALL RIGHTS RESERVED

**Where
in Hades
can I use
them!**



Synchro Control Transformer (1/4 Size)



Geared Servo Motor (1/4 Size)



Servo Motor Tachometer Generator (1/4 Size)



KEARFOTT COMPONENTS INCLUDE:

Gyros, Servo Motors, Synchros, Miniaturized Servo and Magnetic Amplifiers, Tachometer Generators, Hermetic Rotary Seals, Aircraft Navigational Systems, and other high accuracy mechanical, electrical and electronic components.

Visit the Kearfott display at the Western Electronic Show and Convention, August 25-27 at the Pan-Pacific Auditorium, Los Angeles, Calif., and the first International Instrument Congress & Exposition, September 13-24, Philadelphia, Pa.

Kearfott now offers Servo Motors, Synchros, and Servo-Motor Generators able to operate continuously in temperatures up to 185 degrees C. They are the same size and weight, and have the same characteristics as standard Kearfott Motors, and may be operated with them interchangeably. Besides the use of a new high-temperature insulating material, the stainless steel bearings, laminations and housings enable them to resist corrosion accelerated by high temperature operation.

Complete technical information on these and other Kearfott Components is available in bulletin form. Write today.



KEARFOTT COMPANY, INC., LITTLE FALLS, N. J.

Sales and Engineering Offices: 1378 Main Avenue, Clifton, N. J.
Midwest Office: 188 W. Randolph Street, Chicago, Ill. South Central Office: 6115 Denton Drive, Dallas, Texas
West Coast Office: 253 N. Vineta Avenue, Pasadena, Calif.

A GENERAL PRECISION EQUIPMENT CORPORATION SUBSIDIARY



HYCOR

TELEMETERING FILTERS



FEATURES . . .

- Hycor telemetering filters have excellent characteristics due to the use of high "Q" toroid inductor elements. The filters may be used in low level circuits with negligible hum pickup resulting.
- In addition, only the finest capacitors are employed to assure stability.
- Available in standard RDB frequencies.

GENERAL SPECIFICATIONS
Impedance 500/500

TYPE	BANDWIDTH	ATTENUATION	FREQUENCY RANGE
1500	+7 1/2%	-3 db or less	400 cps to 14.5 kc
	+20%	-30 db or more	
4300	+7 1/2%	-3 db or less	400 cps to 960 cps 1300 cps to 14.5 kc
	+20%	-40 db or more	
4000	+7 1/2%	-3 db or less	400 cps to 960 cps 1300 cps to 14.5 kc
	+15%	-45 db or more	
	+28%	-3 db or less	
	+28%	-45 db or more	22 kc to 70 kc

Other frequencies and impedances available on request.

REPRESENTATIVES

Hycor Sales Co. of California
11423 Vanowen St., No. Hollywood, Calif.
Beebe Associates
1155 Waukegan Rd., Glenview, Illinois
Burlingame Associates
103 Lafayette St., New York City
Harrison J. Blind, 1616 Cord St.
Indianapolis 24, Indiana
G. M. Howard & Assoc.
734 Bryant St., San Francisco 7, Calif.

EXPORT DIVISION

Morhan Exporting Corporation
458 Broadway, New York 13, N.Y., U. S. A.
Cable: "MORHANEX"



DECADE SCALERS

by



NOW
0-10 MC!

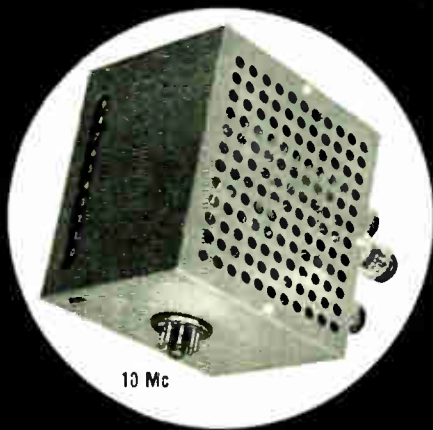

10 Mc

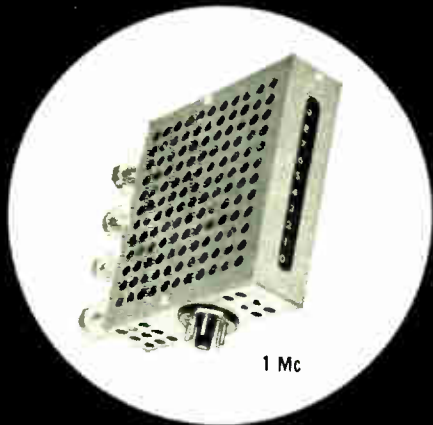

1 Mc

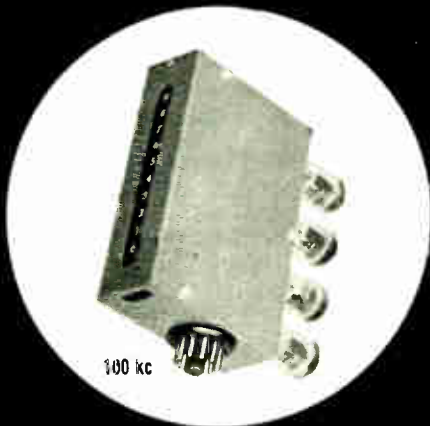

100 kc

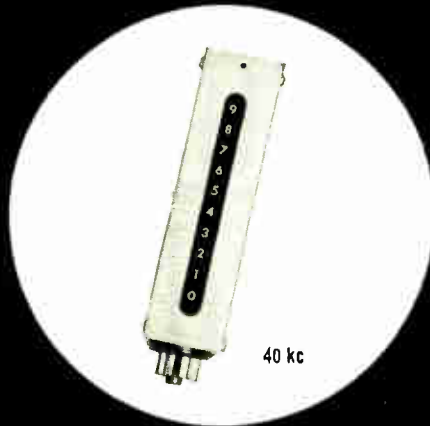

40 kc

- 0 to 10 Mc covered in four ranges, 40 kc, 100 kc, 1 Mc and 10 Mc Max.
- Direct Decimal Display throughout, including 10 Mc.
- Light in Weight.
- Plug-In Construction for all 4 ranges:
 - Decode Output with 8 pin base*
 - Individual Stage Outputs for remote readout with 11 pin base optional on 40 kc, 100 kc and 1 Mc models.*
- Zero Reset; "9" Reset optional on 40 kc and 100 kc models.
- Reliabilized Tubes.
- Low Power Consumption.
- Wide operating voltage Range:
 - approximately $\pm 30\%$ on 40 kc and 100 kc Models*
 - $\pm 20\%$ on 1 Mc Model*
 - $\pm 5\%$ on 10 Mc Model*

Dimensions, approx. ^o	40 kc	100 kc	1 Mc	10 Mc
Width	1 3/8"	1 3/8"	1 3/8"	4"
Height	5 1/4"	5 1/4"	5 1/4"	5 1/4"
Depth (including tubes)	5 1/4"	5 1/4"	6 5/8"	6 5/8"
Weight	10 oz.	10 oz.	13 oz.	24 oz.
Nominal Current	9 Ma.	14 Ma.	75 Ma.	125 Ma.
Nominal Voltage	300 V.	300 V.	300 V.	200 V.
Tube Complement	4-5963	4-5963	4-5965 (or 12Av7)	45 Ma. 275 V. 6-5687



LABORATORY FOR ELECTRONICS

75 PITTS STREET, BOSTON 14, MASS.

11,000 WAYS

to

QUALITY



The quality of any product depends upon the quality of its parts—particularly in electronics where precision is a must and all component parts are interdependent. At AMPHENOL the design and manufacture of electronic components to high quality standards has been carried on for over twenty years, and today the specification of AMPHENOL cables and connectors is your best guarantee of the final quality of your product.

There are over 11,000 separate AMPHENOL components that show the way to quality. Besides the standard AN and RF connectors, and RG cable, there are many special AMPHENOL components that will prove of value to you. These include the famous Blue RIBBON connectors, miniature AN-type 165 series connectors, field-serviceable audio and power plugs and receptacles, new 172 series Hermetic Seal receptacles (which mate with standard AN plugs), new QWIK microphone connectors and many others.

Write to the Product Sales Department at AMPHENOL for information about any of the above components.



AMERICAN PHENOLIC CORPORATION • Chicago 50, Illinois



MEASURE HIGH-FREQUENCY VOLTAGES

with the Heterodyne Voltmeter Model BL-2002

This selective vacuum tube voltmeter is particularly useful in radio, radar and television circuit measurements, signal generator control, and monitoring of coaxial carrier frequency systems. It is designed for the measurement of high-frequency voltages and has very high sensitivity for measuring extremely small R. F. voltages.

All measurements are made through a test probe. The input voltage is indicated on one meter, and the degree of amplitude modulation of the signal on a second meter. Normal sensitivity is in the microvolt and millivolt range; however, by using an external attenuator this range can be extended to a maximum of 10 volts.

For specifications on the Model BL-2002 Heterodyne Voltmeter and information on the complete line of Bruel & Kjaer Instruments, write Brush Electronics Company, Dept. F-8, 3405 Perkins Avenue, Cleveland 14, Ohio. Outside U.S.A. and Canada, address Bruel & Kjaer, Naerum, Denmark.

ACOUSTIC AND TEST INSTRUMENTS

Bruel & Kjaer instruments, world famous for their precision and workmanship, are distributed exclusively in the United States and Canada by Brush Electronics Company.

- BL-1012 Beat Frequency Oscillator
- BL-1502 Deviation Test Bridge
- BL-1604 Integration Network for Vibration Pickup BL-4304
- BL-4304 Vibration Pickup
- BL-2105 Frequency Analyzer
- BL-2109 Audio Frequency Spectrometer
- BL-2304 Level Recorder
- BL-2423 Megohmmeter and D. C. Voltmeter
- BL-3423 Megohmmeter High Tension Accessory
- BL-4002 Standing Wave Apparatus
- BL-4111 Condenser Microphone
- BL-4120 Microphone Calibration Apparatus and Accessory
- BL-4708 Automatic Frequency Response Tracer

BRUSH ELECTRONICS COMPANY

formerly
The Brush Development Company.
Brush Electronics Company
is an operating unit of
Clevite Corporation.



Eimac Klystron Report

Ruggedized X Band local oscillator reflex klystrons

1K015XA • coaxial output

1K015XG • waveguide output

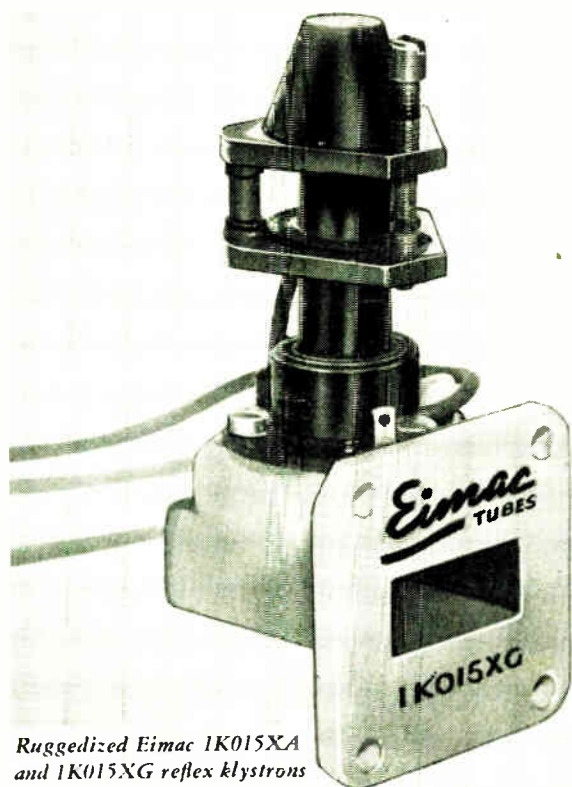

Ruggedized Eimac 1K015XA and 1K015XG reflex klystrons

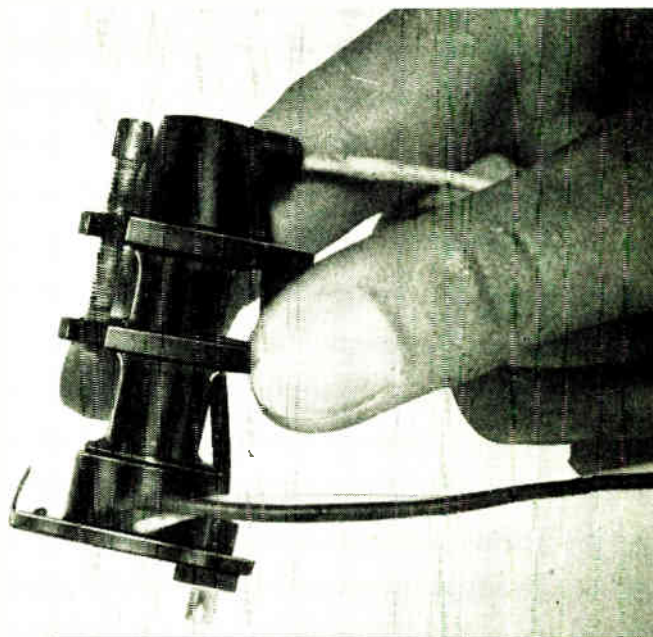

TYPICAL OPERATION (with flat load)

1K015XA and 1K015XG KLYSTRONS

MODE	7 3/4	5 3/4
D-C Resonator Voltage	250	300
D-C Cathode Current	36	47
D-C Repeller Voltage	-65	-170
Power Output	30	100
Frequency	9000	9000
Electronic Tuning Range	55	40

Reliable X band performance through the **VAST*** punishment of airborne environment plus the features of single adjustment tuning and rapid production are offered only in Eimac 1K015XA and 1K015XG local oscillator reflex klystrons.

- ***VIBRATION**—withstands 10G's of continuous vibration.
- ***ALTITUDE**—arc-guard protection of leads eliminates possibility of flash-over at extremely high altitudes.
- ***SHOCK**—withstands 100G's of impact shock.
- ***TEMPERATURE**—maintains frequency stability through a temperature variation of -20° to 80°C .

RAPID PRODUCTION—simplified design permits rapid, low cost production.

RELIABLE PERFORMANCE—25 to 100 milliwatts power output from 8400 to 9600mc with low power consumption—plus assurance of uncompromising Eimac quality proved through 20 years of electron-power tube design and manufacture.

SINGLE TUNING—one-adjustment tuning without the use of lock nuts.

● For further information about the 1K015XA, 1K015XG or any of the complete line of Eimac klystrons, including high power UHF-TV amplifiers, contact our Technical Services department.

EITEL-McCULLOUGH, INC.
SAN BRUNO • CALIFORNIA

Eimac
THE WORLD'S
LARGEST MANUFACTURER OF
TRANSMITTING TUBES

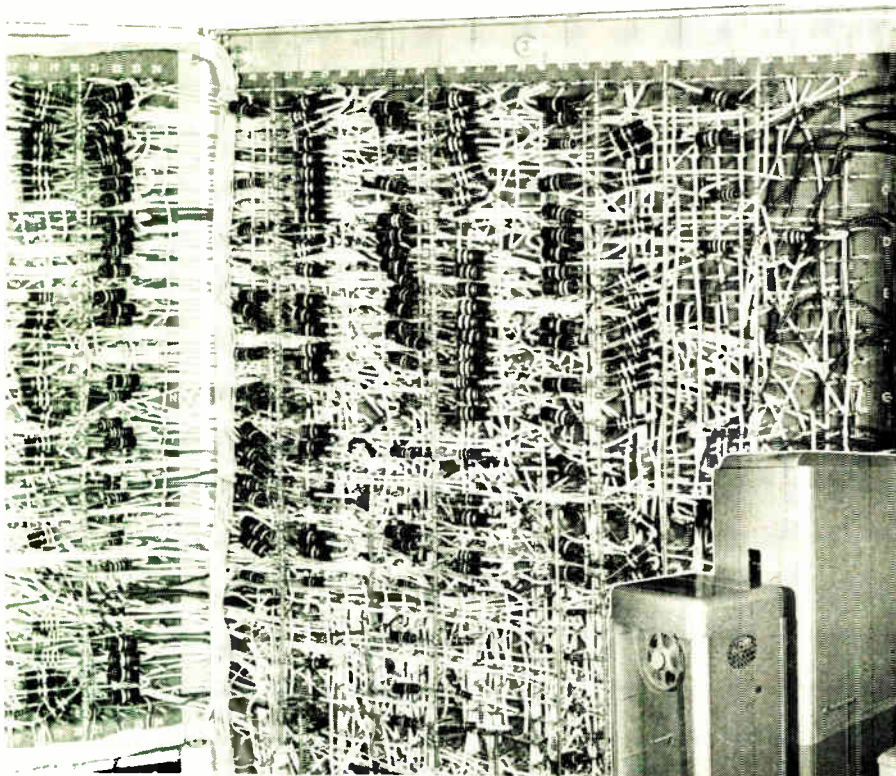

**BACK OF DIODE BOARD
showing Bradleyunit Resistors**

At the left is a rear view of a portion of the complex circuitry of the diode board in the CRC 102A general purpose computer. Several hundred Allen-Bradley Bradleyunits are visible. Their dependable characteristics are necessary for the continuous accuracy of this computer.

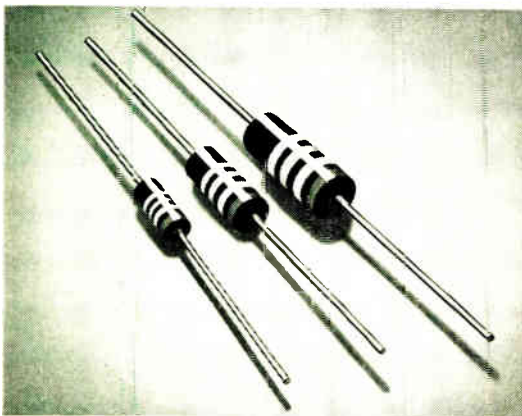
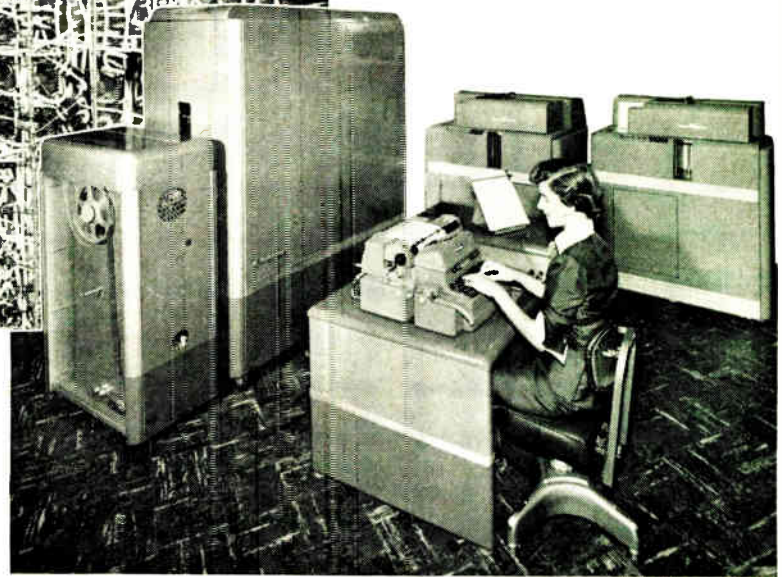

High Quality Fixed Resistors

Bradleyunits are rated at an ambient temperature of 70C . . . not at 40C . . . giving them an ultra-conservative rating. No other molded fixed resistors have such a margin of safety.

**CRC HIGH RELIABILITY COMPUTER
relies on Bradleyunit Fixed Resistors**

The CRC 102A general purpose computer, made by the Computer Research Corporation of Hawthorne, California, is a versatile digital computer consisting of a computing unit and a control console which may be used with a variety of input-output equipment. It can perform 25 different arithmetic and logical commands in less than 15 milliseconds. As many as 80 complete 3-address commands can be executed per second. Such performance demands precision and dependability of all components.

5 per cent resistance change, because they are rated at 70C . . . not 40C. They withstand heat and humidity, and have high mechanical strength.

Bradleyunits are solid molded with their leads imbedded in the densely compacted body of the resistor. No wax impregnation is needed to pass salt water immersion tests. The differential tempering of the leads prevents sharp bends near the resistor. They are made in all standard R. E. T. M. A. values in the 1/2 watt and 2 watt ratings from 10 ohms to 22 megohms, and the 1 watt rating from 2.7 ohms to 22 megohms.

Bradleyunit fixed resistors are standard equipment on the CRC 102A, and many other computers, because they are so conservatively rated. They will operate at full rating for 1,000 hours with less than

Let us send you a complete Allen-Bradley resistor chart.

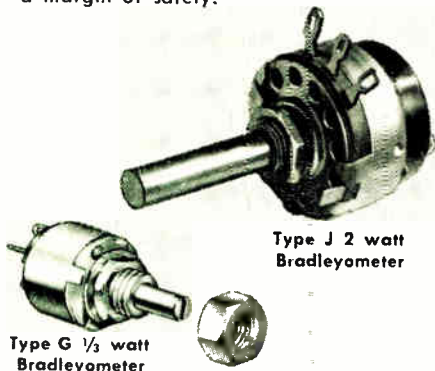

Type G 1/3 watt
Bradleyometer

Type J 2 watt
Bradleyometer

High Quality Adjustable Resistors

Bradleyometers incorporate a composition resistor molded to the resistance-rotation curve that is specified. They are unaffected by temperature or humidity.

Allen-Bradley Co., 114 W. Greenfield Ave., Milwaukee 4, Wis.

ALLEN-BRADLEY
RADIO & TELEVISION COMPONENTS



PROCEEDINGS OF THE I.R.E. August, 1954



ML-200 Series
Crystals for color television are available to your specific calibration for either the ringing or oscillator circuit. This new design provides hermetic seal at an economical cost.

NOW IN PRODUCTION . . .
Newly-Designed CRYSTALS for COLOR TELEVISION

MIDLAND is ready *now* to supply you in quantity with color TV crystals to your exact specifications . . . and to advise with you on any phase of this subject.

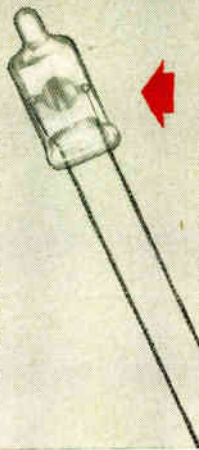

MIDLAND MINIATURES

Midland has developed, and is expanding, a new series of crystal units which will comprise the MIDLAND MINIATURE line. Their small glass enclosures insure true hermetic seal and long-term stability.



Type ML-6 Range
1.0 mc.—100 mc. Supplied per mil Type CR-18, CR-19, CR-23, CR-27, CR-28, CR-32, CR-33, CR-35, CR-36, CR-48 when specified. Hermetically sealed metal holder with glass and metal base. Height of can is $\frac{3}{8}$ in. Pins are .050" dia., spaced .486".

Type ML-6A
Identical to Type ML-6 except provided with .093" diameter pins.

Type ML-6S Range
5.0 mc.—100 mc. for those applications in which long-term stability is the paramount requisite.

Type ML-6W Range
3.0—15.0 mc. This unit is same as Type ML-6 except wire leads are provided, eliminating need for crystal socket.

Midland
PAY OFF IN PERFORMANCE

CRYSTALS

The quality of Midland Crystals—which is another way of saying the completely dependable job they will do for you—is assured by exacting tests and controls through every step of processing. The finest precision equipment and most advanced techniques known to the industry are used by Midland from selection of raw quartz to final sealing of the crystal.

That's a big reason why Midland has climbed to its present position as the world's largest producer of quartz crystals for use in 2-way communications and other electronic devices.

Midland's engineering staff is ready to help in any project involving the use of crystals.

SEE US AT WESCON!

BOOTH 212, Western Electronic Show & Convention, August 25-26-27, Pan-Pacific Auditorium, Los Angeles



MANUFACTURING CO., INC.
3155 Fiberglas Road Kansas City, Kansas



Type ML-4 Range
1.0 - 10.0 mc. Supplied per mil Type CR-5, CR-6, CR-8, CR-10 when specified. Holder is phenolic, gasket sealed. Holder size is $1\frac{1}{8} \times \frac{1}{8} \times \frac{1}{8}$ with .093" diameter pins $\frac{1}{2}$ " long spaced .486".



Type ML-13
Units of this type are currently undergoing tests on experimental basis. The unit is hermetically sealed. Pin dimensions are the same as our Type ML-6. Height of can is $1\frac{1}{2}$ -inch.



Type ML-1A Range
2.0 - 15.0 mc. Supplied per mil Type CR-1A when specified. Holder is phenolic, gasket sealed. Holder size is $1\frac{1}{4} \times 1\frac{1}{8} \times \frac{27}{64}$ with .125" diameter pins $\frac{3}{8}$ " long, spaced at .500".



Type ML-10 Range
15.0 - 50.0 mc. Supplied per mil Type CR-24 when specified. Over-all length is 1.055". Pin contacts, .062" diameter.

WORLD'S LARGEST PRODUCER OF QUARTZ CRYSTALS

TUNG-SOL TUBES FOR



2AF4
(Prototype—6AF4)
Heater Volts 2.35
Heater Current 0.6 A



3AL5
(Prototype—6AL5)
Heater Volts 3.15
Heater Current 0.6 A



3AU6
(Prototype—6AU6)
Heater Volts 3.15
Heater Current 0.6 A



3AV6
(Prototype—6AV6)
Heater Volts 3.15
Heater Current 0.6 A



3BC5
(Prototype—6BC5)
Heater Volts 3.15
Heater Current 0.6 A



3BE6
(Prototype—6BE6)
Heater Volts 3.15
Heater Current 0.6 A



3CB6
(Prototype—6CB6)
Heater Volts 3.15
Heater Current 0.6 A

4BQ7A
(Prototype—6BQ7A)
Heater Volts 4.2
Heater Current 0.6 A



4BZ7
(Prototype—6BZ7)
Heater Volts 4.2
Heater Current 0.6 A

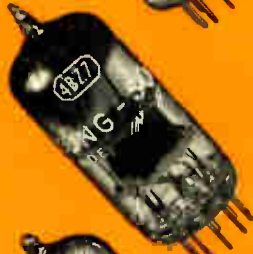

5AN8
(Prototype—6AN8)
Heater Volts 4.7
Heater Current 0.6 A



5AS8
(Prototype—6AS8)
Heater Volts 4.7
Heater Current 0.6 A



5T8
(Prototype—6T8)
Heater Volts 4.7
Heater Current 0.6 A



5U8
(Prototype—6U8)
Heater Volts 4.7
Heater Current 0.6 A



*Using heaters parallel connected

... designed and engineered to highest performance requirements

These are the new Tung-Sol Receiving Tubes for television sets having all of the heaters series-connected across the power line. Thermal characteristics of all the heaters are controlled so that heater voltage surges during the warm-up cycle are minimized, provided of course, that these tubes are used with other types similarly controlled.

Heater ratings are based on 600 milliamperes of current with the heater voltage adjusted for the same power as in the prototype. All other characteristics and ratings are identical to those of the prototype. Use of these tubes provides completely satisfactory receiver characteristics during warm-up.

All of the statistical quality control methods which make the performance of Tung-Sol tubes so outstanding, are utilized in the manufacture of these new types. In performance, uniformity and dependability they will be found fully reliable. For more detailed information, write Commercial Engineering Department, Tung-Sol Electric Inc., Newark 4, New Jersey.

Sales Offices: Atlanta, Chicago, Columbus, Culver City (Los Angeles), Dallas, Denver, Detroit, Newark, Philadelphia, Seattle.



Tung-Sol All-Glass Sealed Beam Lamps, Miniature Lamps, Signal Flashers, Picture Tubes, Radio, TV and Special Purpose Electron Tubes and Semiconductor Products.

SERIES STRING TV SETS

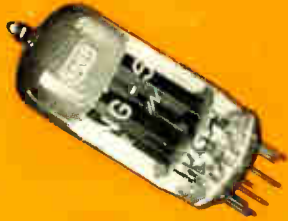

6AU7
(Prototype—12AU7)
Heater Volts 3.15*
Heater Current 0.6 A



6AX7
(Prototype—12AX7)
Heater Volts 3.15*
Heater Current 0.6 A

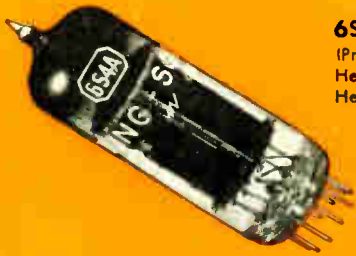

6S4A
(Prototype—6S4)
Heater Volts 6.3
Heater Current 0.6 A

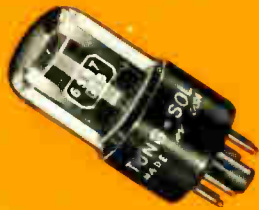

6SN7GTB
(Prototype—6SN7GTA)
Heater Volts 6.3
Heater Current 0.6 A



12AX4GTA
(Prototype—12AX4GT)
Heater Volts 12.6
Heater Current 0.6 A

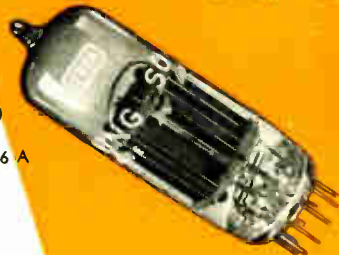

12B4A
(Prototype—12B4)
Heater Volts 6.3*
Heater Current 0.6 A



25CD6GA
(Prototype—25CD6G)
Heater Volts 25
Heater Current 0.6 A

12BQ6GT
(Prototype—6BQ6GT)
Heater Volts 12.6
Heater Current 0.6 A



12BH7A
(Prototype—12BH7)
Heater Volts 6.3*
Heater Current 0.6 A



12L6GT
(Prototype—25L6GT)
Heater Volts 12.6
Heater Current 0.6 A



12BY7A
(Prototype—12BY7)
Heater Volts 6.3*
Heater Current 0.6 A



12W6GT
(Prototype—6W6GT)
Heater Volts 12.6
Heater Current 0.6 A



19AU4
(Prototype—6AU4GT)
Heater Volts 18.9
Heater Current 0.6 A

*Using heaters parallel connected

TUNG-SOL RADIO AND TV TUBES, DIAL LAMPS

1954 Wescon Exhibitors

(Continued from page 20A)

EXHIBITOR	Booth No.
Girard-Hopkins	426
Glass Solder Engineering	730
Globe Industries, Inc.	264
Goodyear Aircraft Corp.	1117-1118
Gonset Company	161
Gramer Transformer Corporation	1203
Graphik Circuits, Inc.	709
Gremar Manufacturing Co., Inc.	728
The Gudeman Company	404
Hammarlund Manufacturing Co., Inc.	504
W. S. Harmon Company	749
Heinemann Electric Co.	166
Helipot Corporation	246-247
Hermetic Seal Products Co.	905
Carl W. Herrmann	805
Hetherington, Inc.	208
Hewlett-Packard Co.	552-553
Hickok Electrical Instrument Co.	1001
Hi-G Inc.	1002
J. T. Hill Sales Co.	538-539
Hoffman Radio Corporation	118-119
Huggins Laboratories, Inc.	505
Hughes Aircraft Company	564-565
Hycon Manufacturing Company	160
Hycor Company, Inc.	901
I E. Manufacturing Co.	230
Indiana Steel Products Co.	425
Induction Motors Corporation	655A
Industrial Laboratories Publishing Company	1113
Institute of Radio Engineers	145
Instruments Publishing Co.	263
Insulation & Wires, Inc.	533-534
International Electronic Research Corporation	909
International Rectified Corporation	412
International Resistance Co.	527
Iron Fireman Manufacturing Co.	1102
Jennings Radio Manufacturing Corp.	248
Kaar Engineering Corporation	446
Karp Metal Products Co.	618-619
Kay Electric Company	342
KAY-LAB (Kalbfell Laboratories, Inc.)	562-563
Kearfott Company, Inc.	752
Kepeco Laboratories	223-224
Robert J. Kerr Chemicals, Inc.	1103
Ketay Manufacturing Corp.	105-106
Kings Electronics Co., Inc.	715
Kittleson Company	467-468
The James Knights Co.	441
W. Bert Knight Co.	241-242
Krengel Manufacturing Co., Inc.	703
Kulka Electric Mfg. Co., Inc.	638
Laboratory for Electronics, Inc.	464
Lambda-Pacific Engineering, Inc.	1115
James B. Lansing Sound, Inc.	327
Harry A. Lasure Company	116-117
Lavoie Laboratories, Inc.	632
Leach Corporation	713-714
G. H. Leland, Inc.	103
Lenkurt Electric Co., Inc.	346
Lenz Electric Manufacturing Co.	163B
Librascope, Inc.	561
Litton Industries	611
Lowell Manufacturing Co.	659
Lynn Electronic Research Co.	435
McColpin-Christie Corporation	755
McCoy Electronics Co.	817
McGraw-Hill Publishing Co., Inc.	648
McKenna Laboratories	1305B
Machlett Laboratories, Inc.	747
Magnavox Company	1112
Magnecord, Inc.	328
Magnecraft Electric Co.	653
Magnetic Research Corporation	645
Magnetics, Inc.	236-237
D. E. Makepeace Co. Div.	
Union Plate & Wire Co.	725
P. R. Mallory & Co., Inc.	634
Marion Electrical Instrument Co.	361

(Continued on page 42A)

Join the Centralab parade to greater profits

Centralab

BC HI-KAPS®



make by-pass coupling easier... more dependable

- Impervious to moisture (.007% or less).
- Lighter in weight per capacity value.
- Small size (down to .200" x .400").
- High capacity (to .013 MF.).
- Special insulation (CRL developed).
- Convenient leads (radial — no bending).
- Low power factor (.3 to 2.0%).
- High leakage resistance (5,000 megohms).
- Maximum dependability (guaranteed).
- 100% factory tested for voltage and capacity.
- End your field troubles.

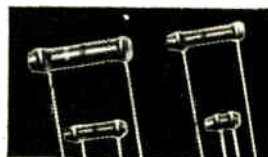

BC HI-Kaps are color-coded to RETMA specifications

So write for bulletin 42-3 right now.

Centralab

A Division of Globe-Union Inc.
920-H E. Keefe Avenue • Milwaukee 1, Wisconsin
In Canada: 804 Mt. Pleasant Road, Toronto, Ontario

VARIABLE RESISTORS SWITCHES CERAMIC CAPACITORS PRINTED ELECTRONIC CIRCUITS CERAMIC INSULATORS

Industry's greatest source of standard and special electronic components



Technology Instrument Corp., has pioneered in the development of PHASE MEASURING and STANDARDIZING EQUIPMENT and will continue its contributions in this critical and important field.



TYPE 320A PHASE METER
Phase Range: 0-360° without ambiguity
Frequency Range: 20 cycles to 100,000 cycles
Absolute Accuracy: 1% of full scale
Incremental Accuracy: As close as meter scale can be read.
Meter Scales: 0-36°, 0-90°, 0-180°, 0-360°



TYPE 322A PRECISION PHASE METER
Phase Range: 0-360° without ambiguity
Frequency Range: 20 cycles to 1 Mc.
Absolute Accuracy: ±1° up to 20,000 cycles, slightly decreasing accuracy 20,000 cycles to 1 Mc.
Incremental Accuracy: ±0.1° up to 20 Kc.
Meter Scales: 0-360°, 0-30° (any 30° segment 0-360°)



TYPE 324A VIDEO PHASE METER
Phase Range: 0-360° without ambiguity
Frequency Range: 20,000 cycles to 4.5 Mc.
Absolute Accuracy: ±4° over entire range
Incremental Accuracy: ±0.25° over entire range
Meter Scales: 0-360°, 0-90° (any 90° segment 0-360°)



TYPE 704A SECONDARY PHASE STANDARD
Range of Generated Phase Shift: 0-360°, variable
Available for any one of the following standard frequencies: 60, 400, 1000, 20,000 cycles . . . or
Available for any one specific frequency between 60 and 20,000 cycles
Absolute Accuracy of Phase Shift: Within 2°
Incremental Accuracy of Phase Shift: Within 0.1°

- for Measurement
- for Comparison
- for Calibration

These instruments have been designed for sustained, consistent performance. They are as simple and rapid in operation as possible. Full details are available upon request.

Phase measurement and phase reference are the keys to:

- SERVO SYSTEM OPERATION
- RADIO NAVIGATION PROBLEMS
- POWER FACTOR MEASUREMENTS
- TRANSMISSION NETWORK ANALYSIS
- PRECISE ELECTRICAL CONTROL
- INVESTIGATION OF FEEDBACK SYSTEMS
- PHASE DETECTOR FUNCTIONS
- PHASE NULL DETERMINATION IN BRIDGE CIRCUITS
- VIDEO PERFORMANCE
- DATA TRANSMISSION SYSTEMS
- VECTOR ANALYSIS
- IMPEDANCE DETERMINATION
- SYNCHRONOUS OPERATIONS
- HIGH ACCURACY TIMING
- MAGNETIC STUDIES
- CORRELATION STUDIES

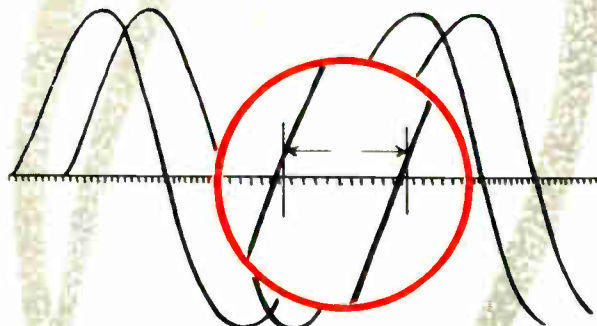

AMPLITUDE

For many years the industry has been well supplied with fine tools from many sources, for the measurement and control of amplitude and frequency. Well trodden paths of experimental procedure, based upon accurate instrumentation, have built up a tremendous body of know-how and familiarity with problems in this area of development.

FREQUENCY

PHASE It has remained for Technology Instrument Corp., to provide superb tools designed exclusively for attack on less familiar problems in the field of PHASE MEASUREMENT. The advance in electronics technology has, more and more, exploited PHASE relationships and control. Familiarity and understanding of this field, together with techniques based upon measurement devices of greater accuracy, make available a Third Dimension in electronic mastery.



TYPE 706-A ULTRASONIC PHASE STANDARD
Range of Generated Phase Shift: 0-360°, variable
Available in Standard Model for 82 Kc. or
Available in Special Models for any single frequency between 20,000 cycles and 200 kilocycles
Accuracy of Phase Shift: Within 0.1°



TYPE 7000-A PRIMARY PHASE STANDARD
Range of Generated Phase Shift: 0-360°, variable
Available for any single frequency between 60 cycles and 20,000 cycles
Absolute Accuracy of Phase Shift: At least 0.05°, multiples of 1° established to at least 0.02°

AMPLIFIERS

As adjuncts to the phase measuring and generating instruments described on these pages, an extensive line of amplifiers is available. These amplifiers have inherently low phase shift which is definitely known and which may be controlled to an accurately fixed value.

CONSULTATION ON PHASE PROBLEMS:

Technology Instrument Corp., as the leader in phase measurement techniques, will welcome the opportunity to assist in any problem in this field. A hand-picked engineering staff is ready at any time to consult with you on your phase problems. This staff has available the finest phase laboratory to be found and its services may be sought for any problem, large or small.

TECHNOLOGY INSTRUMENT CORP.

535 Main St., Acton, Mass. Colonial 3-7711

West Coast Eng'g. Facility, 731 No. LaBrea Ave., Hollywood, Calif., WHitney 0108

MORE PROOF that engineers rate Lambda power supplies

BEST...

REGARDLESS OF PRICE!

**TWO NEW, INDEPENDENT SURVEYS
SHOW WIDE PREFERENCE FOR LAMBDA**

Stock models
which have been
modified to customers'
requirements.

Bench Model 41
Unregulated
0-500 VDC @ 0-200 MA
\$149.50

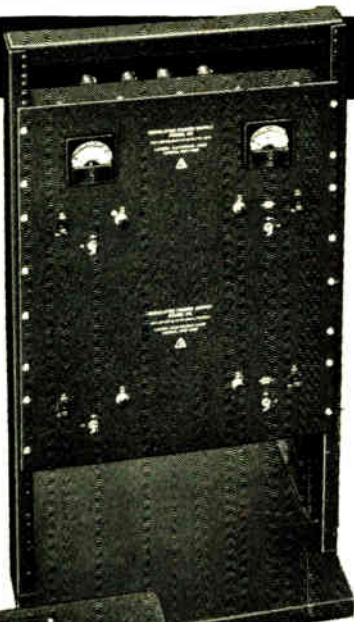

Bench Model 50
0-500 VDC @ 0-500 MA
\$415.00

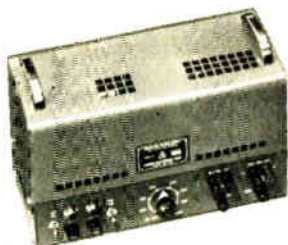

Bench Model 25
200-325 VDC
@ 0-100 MA
\$64.50



Rock Model 28
200-325 VDC @ 0-100 MA
\$57.50

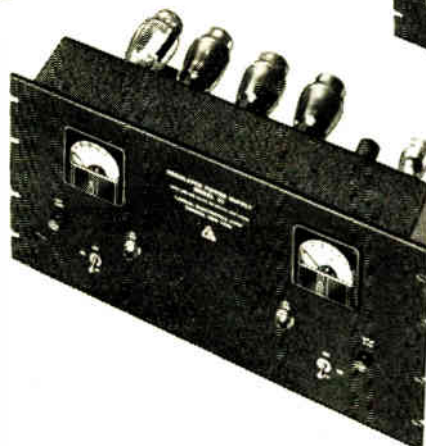

Rock Model 32
200-325 VDC @ 0-300 MA
\$129.50

Rock Model 32M
200-325 VDC @ 0-300 MA
\$159.50

LAMBDA POWER SUPPLIES ARE RANKED FIRST — 50 per cent ahead of the next identified manufacturer — by engineers who participated in a comprehensive survey of buying practices and preferences just released by one of the leading electronics publications.

Another independently conducted survey, also recently

concluded, places Lambda in the same position of leadership.

The reasons for this preference for Lambda by men who know power supplies intimately are simple: Lambda power supplies are *precision* equipment — dependable, and attractively priced. Lambda is a pioneer in the development of power supplies and a specialist in this field only.

Send for new *Lambda Power Supplies Catalog 11*

LAMBDA  **ELECTRONICS CORP.**
THE FIRST NAME IN POWER SUPPLIES

103-02 NORTHERN BOULEVARD • CORONA 68, NEW YORK

PIPELINE TO PRECISION



MODEL WWVR

A receiver of the instrument class which is setting a new standard for the reception and presentation of the world's finest standards of time and frequency as broadcast by the National Bureau of Standards from WWV and WWVH.

The fundamental use of this receiver is in the calibration of local equipment to the accuracy of these primary time and frequency standards.

This time saving instrument incorporates all the latest techniques for clear reception. A glance at the front panel will at once show the ease of operation and instant availability of the desired Radio and Audio frequencies.

Model WWVR allows the operator full use of the world's finest primary standards of frequency and time. All frequencies broadcast from WWV (or WWVH) are accurate to one part in fifty million. This instrument in your laboratory will truly give you a...

PRIVATE PIPELINE TO PRECISION.

Send for complete specifications, prices and delivery schedule.

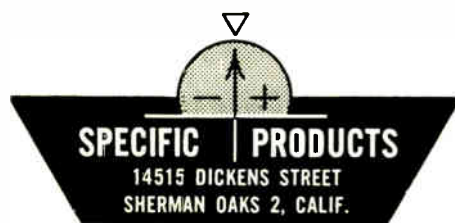

Quick, dependable carrier measurements—3 to 500 kc



New Model 104 Carrier Frequency Voltmeter—5 to 150 kc

Four Frequency-Selective Voltmeters

Four precision frequency-selective voltmeters for carrier system measurements are now offered by Sierra. Including the new Model 104, these instruments cover all frequencies 3 to 500 kc. They provide a fast, accurate means of measuring voltages in telephone, telegraph, telemetering and control circuits. They also make possible quick, dependable tracing of circuit faults. All four instru-

ments have direct reading meters calibrated in dbm from -20 to $+2$ dbm on the meter and -50 to $+40$ dbm on the range changing attenuator. All contain a built-in calibration oscillator and a VTVM for swift, simple calibration. **For details, request Bulletin 107.** (For wave analysis and harmonic studies 15 to 500 kc, Sierra offers Model 121 Wave Analyzer. Request Bulletin 103).

SPECIFICATIONS

Model No.	Frequency Range—kc	Input Level Range—dbm	Selectivity		Direct Reading in dbm	
			Down 3 db	Down 45 db	Balanced	Unbalanced
101A	20—500	-80 to +42	± 750 cps	± 6000 cps	*	600 ohms
103A†	3—40	-80 to +42	± 400 cps	± 3000 cps	**	600 ohms
104	5—150	-80 to +42	± 300 cps	± 1500 cps	**	600 ohms
108A	15—500	-80 to +42	± 600 cps	± 3000 cps	135 ohms*	600 ohms

*May be converted for 135, 500 or 600 ohm balanced line measurements with Sierra 122 Line-Bridging Transformer. (Low cost, plug-in unit). **Same as 101A except uses Model 155 Transformer. †Contains carrier re-insertion oscillator for monitoring single side band suppressed carrier systems. Data subject to change without notice.

Sierra Electronic Corporation San Carlos 2, California, U. S. A.

Sales representatives in major cities
Manufacturers of Carrier Frequency Voltmeters, Wave Analyzers, Line Fault Analyzers, Directional Couplers, Wideband RF Transformers, Custom Radio Transmitters, VHI-UHF Detectors, Variable Impedance Wattmeters, Reflection Coefficient Meters.



AMPEX

MAGNETIC RECORDERS

The most complete line of data tape recorders

AMPEX has applied magnetic tape recording to more varied problems in research, testing and control than any other manufacturer of tape equipment. To meet specific demands for broad frequency response, precise timing, extreme tape stability, high shock resistance and reliable transient accuracy, Ampex has built machines of a wide variety of designs. And from this experience has come this line of proven magnetic recorders:

F-M CARRIER TYPE RECORDER - MODEL 306

Explosions, shock waves, geophysical data and other highly transient phenomena can be recorded on the Model 306 with excellent "instantaneous" accuracy. Because the machine uses an fm carrier to modulate the signal, the accuracy of the recording is unaffected by minor tape imperfections.

Also, the Model 306 is able to record the vast majority of all mechanical occurrence, since it covers the extremely useful frequency range from 5000 cycles/sec. down to zero (D.C.).

OPTIONS: One to 14 tracks
Rack, console or combination mounting
Record and playback, record only or playback only

WIDE RANGE DIRECT RECORDER - MODEL 307

With a frequency response from 100 to 100,000 cycles per second, the Model 307 is particularly suited to steady state data occurring over a wide range of frequencies. The 307 has had extensive application in fm-fm telemetering, sharing this field with the Model 500 described below.

OPTIONS: Same as Model 306

PULSE WIDTH RECORDER - MODEL 303

This model can record any type of phenomena that lends itself to pulse width coding. Pulses can range from 60 to 1000 microseconds and will be accurate in duration to closer than 2 microseconds. Since each track on the machine may record commutated data consisting of many channels, it is possible to record hundreds of parallel data channels on one tape on a Model 303 machine.

OPTIONS: Same as Model 306

COMBINATION RECORDERS - MODELS 309, 311, etc.

Special Ampex Data Recorders can incorporate combinations of the heads and electronic circuitry of the 303, 306 and 307. Thus the parallel tracks on the same combination recorder might have the widely differing characteristics of each of those models. For example, on its parallel channels such a recorder might have an overall frequency response of 0 to 100,000 cycles/sec.

OPTIONS: Same as Model 306 (but 2 or more tracks)

"LOW FLUTTER" WIDE RANGE RECORDER - MODEL 500

The Model 500 is a four-track, two-speed magnetic tape recorder designed to achieve extreme stability of tape motion while recording information in the frequency range between 100 and 100,000 cycles. Thus it is able to record fm-fm telemetering data without introducing any objectionable data error from small variations in tape speed. It has the lowest known flutter and wow characteristics of any tape recorder—less than 0.1% peak-to-peak by RDB standards.

Console mounting only
Four tracks only



Series 300 data recorder in rack mounting.



Series 300 data recorder in console mounting. Rack mounting of portions of the electronic components may be necessary on multi-track console mounted recorders.



Ampex Model 500 Recorder

AMPEX CORPORATION
934 Charter St., Redwood City, California

BRANCH OFFICES:
New York, Chicago, Atlanta, San Francisco
and College Park, Maryland (Washington,
D. C., area)

DISTRIBUTORS:
Radio Shack, Boston; Bing Crosby Enterprises,
Los Angeles; Southwestern Engineering & Equipment,
Dallas and Houston; Canadian General Electric Company in
Canada.

AMPEX

MAGNETIC RECORDERS

For specifications and other information, write Dept. G-1535A

**select your
semiconductor devices
from TI's wide range**

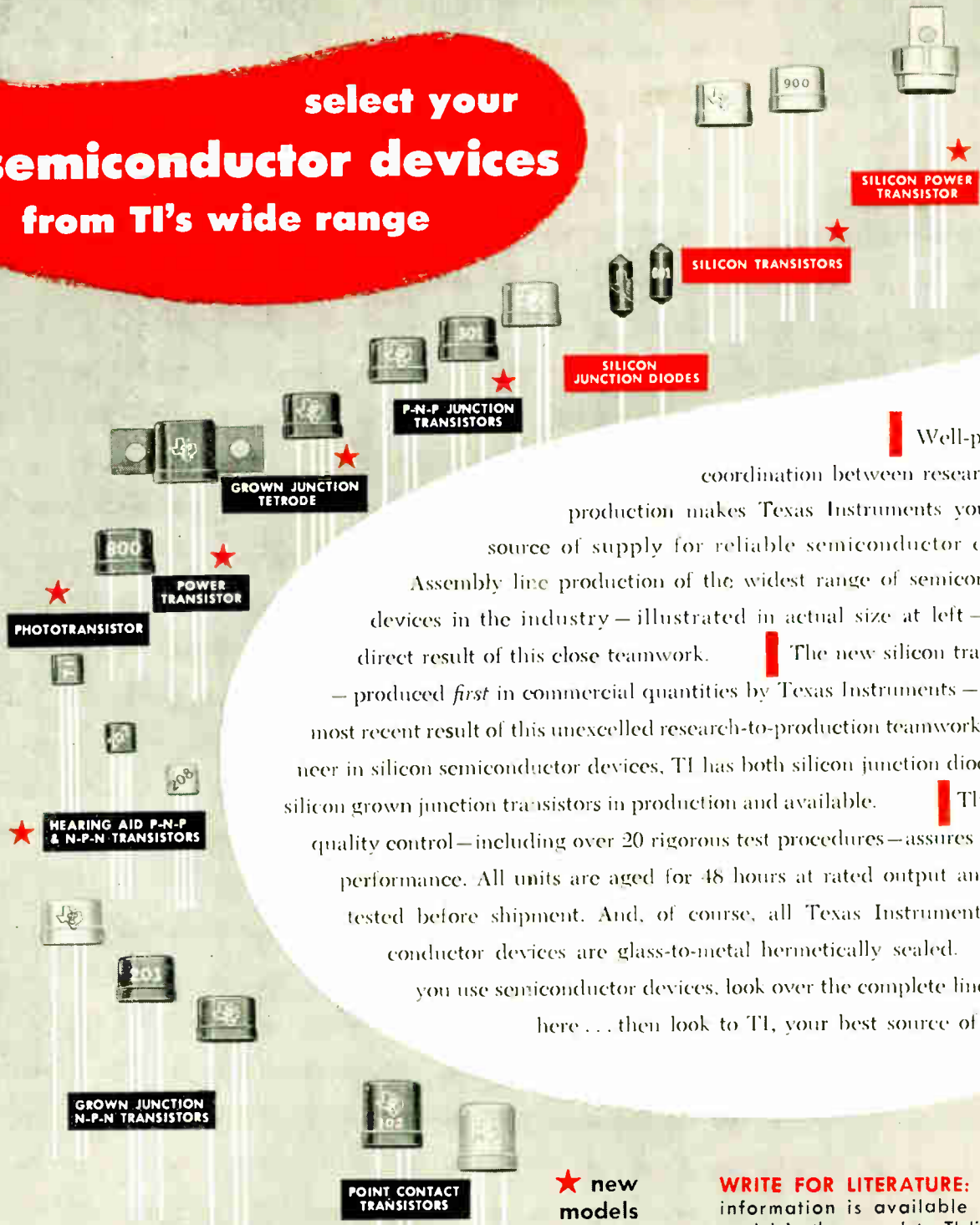

Well-planned coordination between research and production makes Texas Instruments your best source of supply for reliable semiconductor devices. Assembly line production of the widest range of semiconductor devices in the industry — illustrated in actual size at left — is one direct result of this close teamwork. The new silicon transistors — produced *first* in commercial quantities by Texas Instruments — are the most recent result of this unexcelled research-to-production teamwork. A pioneer in silicon semiconductor devices, TI has both silicon junction diodes and silicon grown junction transistors in production and available. Thorough quality control—including over 20 rigorous test procedures—assures reliable performance. All units are aged for 48 hours at rated output and again tested before shipment. And, of course, all Texas Instruments semiconductor devices are glass-to-metal hermetically sealed. If you use semiconductor devices, look over the complete line shown here . . . then look to TI, your best source of supply.

★ new models

WRITE FOR LITERATURE: Detailed information is available on every model in the complete TI line shown above. Write!

TEXAS INSTRUMENTS
INCORPORATED
6000 LEMMON AVENUE DALLAS 9, TEXAS



SEE OUR EXHIBIT AT THE WESCON SHOW

TANTALUM CAPACITORS



- Greater Stability
- Higher Capacity Rating
- Wider Temperature Range
- Less Space per Mfd.
- Longer Shelf Life

Fansteel TANTALUM CAPACITORS

Electrically proven in every way, and over a twenty year period, there's really nothing "new" about tantalum capacitors except in the significantly increased demand for them, and the continually expanding list of their applications.

Incorporating a porous tantalum anode assembly, tantalum capacitors derive their unusual stability from the characteristics inherent in tantalum itself—the most stable of *all* anodic film forming metals. It has been observed consistently that no important changes of characteristics occur in long periods of operation; there is no shelf aging. Large capacity in extremely small size is also an important advantage.

The growing demand for Tantalum Capacitors is being adequately met by Fansteel and other leading manufacturers. Write for current technical bulletins.

**NEW...
Power Factor Slide Rule**
All plastic, 8" circular rule gives power factor of capacitors from 0.06 to 10,000 mfd., at a glance.



Send a dollar bill with your letterhead to cover partial cost of rule, postage and handling. No C.O.D.s or charges, please.

FANSTEEL METALLURGICAL CORPORATION

NORTH CHICAGO, ILLINOIS, U. S. A.

Tantalum Capacitors... Dependable Since 1930



32504C

News—New Products

1954 Wescon Exhibitors

(Continued from page 36A)

EXHIBITOR	Booth No.
J. W. Marsh Company	102
G. S. Marshall Co.	430-431
Marshank Sales Co.	525-526
Master Mobile Mounts, Inc.	219
Meridian Metalcraft, Inc.	132
Merit Coil & Transformer Corp.	157
Claude Michael Agency	625
Midland Manufacturing Company	212
Midwestern Geophysical Laboratory	323
Gerald B. Miller Co.	337-338
J. W. Miller Co.	808
William Miller Instruments, Inc.	144A
Miller Dial & Name Plate Co.	734
Milwaukee Transformer Co.	666
Minneapolis-Honeywell Regulator Co.	1213
Mission-Western Engineers, Inc.	603-604
Monitor Products Co.	758
F. L. Moseley Co.	438
Mosley Electronics Inc.	401
G. E. Moxon Sales	612
Mycalex Corporation of America	129
Nassau Research and Development Associates, Inc.	1302
National Carbon Co.	649
Div., Union Carbide & Carbon Corp.	
National Company, Inc.	152-153
National Electric Products Corp.	159
Neely Enterprises	554-555
Neomatic, Inc.	405-406
Newcomb Audio Products Co.	314-315
New Hermes Engraving Machine Corporation	727
New London Instrument Co.	704
The J. M. Ney Co.	806
North American Instruments, Inc.	1116
North Electric Manufacturing Co.	434
North Shore Research Corporation	655B
Northwest Lead Company	1005
N. R. K. Manufacturing & Engineering Co.	751
Oak Manufacturing Co.	259
Offner Electronics, Inc.	729
Ohmite Manufacturing Co.	115
Optical Coating Laboratory, Inc.	706
Oregon Electronics Mfg. Co.	700A
John Oster Manufacturing Co.	1216
Lee H. Owens Company	305
Panoramic Radio Products, Inc.	1202
The Ralph M. Parsons Company	1004
PCA Electronics, Inc.	913
Penta Laboratories, Inc.	433
Perkin Engineering Corporation	111
Perlmuth-Colman & Associates	214-215
Permoflux Corporation	148
Phaotron Company	164
Phillips Control Corporation	1212
Photo Chemical Products of California, Inc.	661
Photocircuits Corporation	232
Photocon Research Products	1220
Plastic Capacitors, Inc.	654
Pioneer Electronics Corporation	733
Polarad Electronics Corporation	403
Polytechnic Research & Development Co., Inc.	312
Potter & Brumfield	133
Potter Instrument Co., Inc.	325
Premier Metal Products Co.	660
Presto Recording Corporation	304
Pyramid Electric Company	501
Radell Corporation	902
Radio Corporation of America Engineering Products Dept.	120-121
Tube Department	146-147
Radio Receptor Co., Inc.	739
Radio & Television News	343
Radio Magazines, Inc.	635
Ram Electronics	637
Raytheon Manufacturing Co.	216-217
Rea Magnet Wire Co., Inc.	163A

(Continued on page 46A)

JUST A MATTER OF CONTROL



LORD ENGINEERING CONTROLS VIBRATION

... anywhere!

Your continuing effort to improve your products and reduce their maintenance cost may be entirely A Matter Of Control . . . the control of destructive vibration and shock. To help you to accomplish your objectives, Lord Engineering recommends the correct design, selects the most suitable elastomer and metal, and uses precision manufacturing for all Vibration Control Mountings and Bonded Rubber Parts. Your vibration and shock control problems are our business. We welcome the opportunity of placing our wide experience in many diversified industries at your disposal.

*Over 27,000 designs and their variations from
which to choose.*

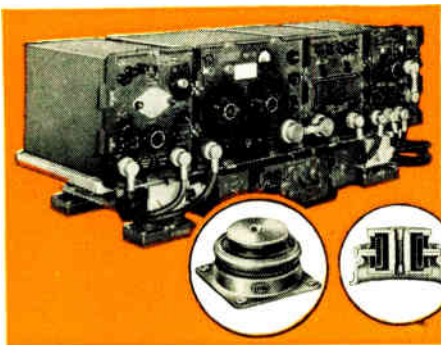

The sensitivity of many commercial and military radio transmitters is protected . . . their accuracy is insured against vibration and shock damage by Lord Vibration Control Mountings. Ask for complete details.

LOS ANGELES 28, CALIFORNIA 7046 Hollywood Blvd.	DALLAS, TEXAS 313 Fidelity Union Life Building	PHILADELPHIA 7, PENNSYLVANIA 725 Widener Building	DAYTON 2, OHIO 410 West First Street
DETROIT 2, MICHIGAN 311 Curtis Building	NEW YORK 16, NEW YORK 280 Madison Avenue	CHICAGO 11, ILLINOIS 520 N. Michigan Ave.	CLEVELAND 15, OHIO 811 Hanna Building

LORD MANUFACTURING COMPANY • ERIE, PA.



Headquarters for
VIBRATION CONTROL
FOR 30 YEARS

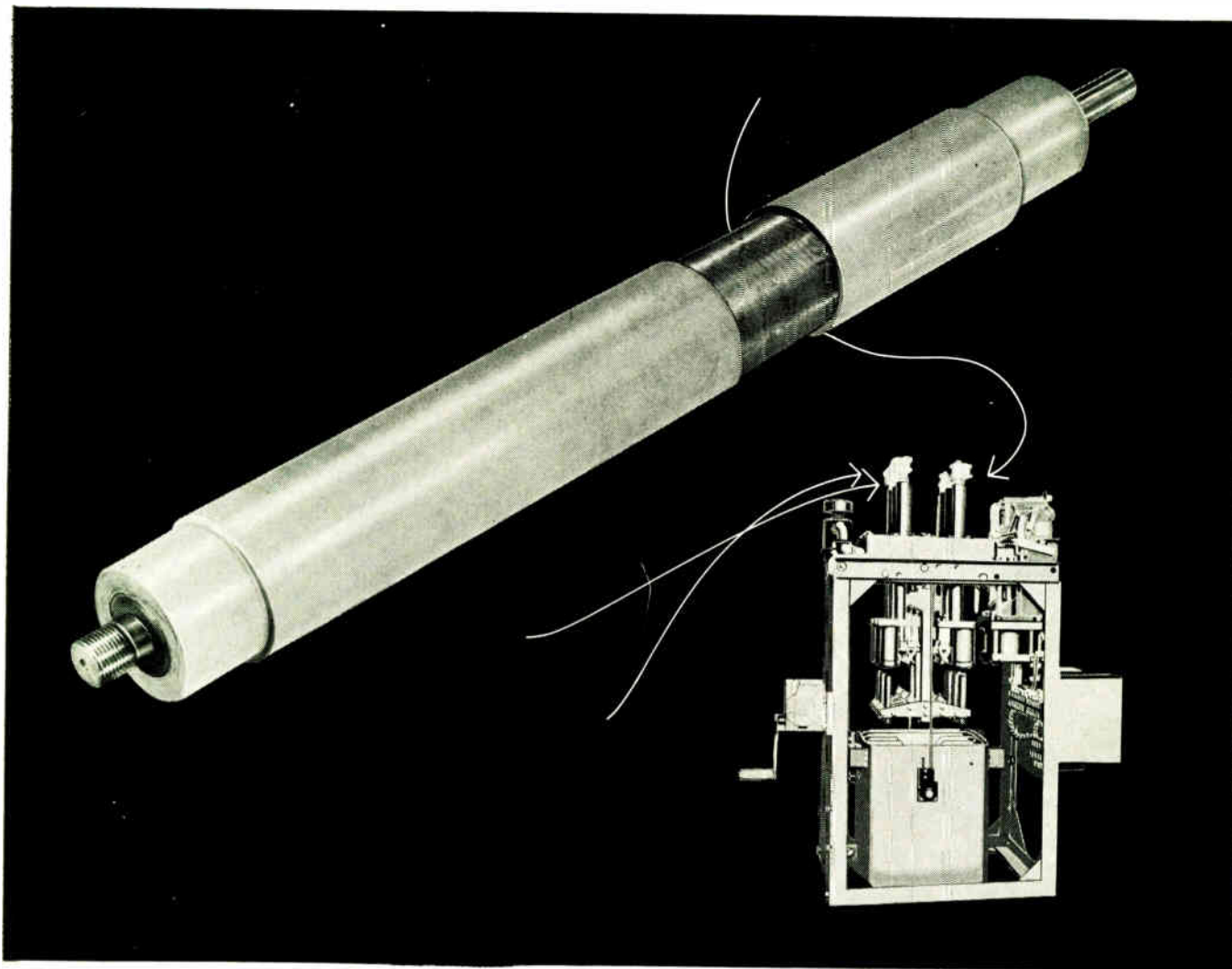

Where two materials are better than one

Properties of Synthane

Among the outstanding properties of Synthane are:



1. **Mechanical strength.** Synthane exhibits excellent strength under tension, compression, impact, vibration and mild shock loads. It will not delaminate.

2. **Dielectric strength.** Synthane is widely used as an insulating material in many different applications.

3. **Low moisture absorption.** Most grades of Synthane are highly moisture resistant. Special grades are available for applications where absorption must be at a minimum.

4. **Dimensionally stable.** Synthane is a thermosetting plastic with a minimum cold flow. It holds its shape under normal conditions and at elevated temperatures.

5. **Availability.** In addition to more than 33 grades of sheets, Synthane is also supplied in many grades of rods and tubes. Molded, laminated and milled-macerated parts are also manufactured. A complete fabricating service is available.

● This circuit breaker bushing is a most unusual application for *Synthane* laminated plastics combined with another material. Basically it's a conductor and an insulator—a solid copper bar—to which is bonded a thick insulating shield of *Synthane* laminated plastic.

There is one little joker in the design: each bushing contains a thin copper grid, only .003" thick, buried in the insulating plastic. It is positioned concentric to the copper core as the *Synthane* is being wound before curing. After curing, the bushing goes to our fabricating department. Here precision machinists turn off the *Synthane*

over the grid until the delicate grid is fully exposed—yet unharmed.

Synthane—the material—was chosen for this job because of its combination of high dielectric strength, toughness and machinability. *Synthane*, the company, was selected because of its ability to handle a tough job. Our fabricating department is especially equipped to work with laminated plastics.

Look into the advantages of *Synthane* laminated plastics and *Synthane* fabricating service. Write for a free catalog detailing both. Synthane Corporation, 8 River Road, Oaks, Pennsylvania.

Our 25th Year
SYNTHANE CORPORATION, OAKS, PA.

SYNTHANE
LAMINATED **S** PLASTICS

A Hi-Temperature Tested Germanium Diode

The new Hughes type 1N198

Temperatures inside operating equipment usually climb well above the equipment ambient temperature. At these elevated temperatures, you need components with *known* characteristics. Most germanium diodes are tested at room temperature and, as operating temperatures rise, their performance deteriorates. But the new Hughes Type 1N198 is a *realistic* germanium point-contact diode.

That's because this diode is tested 100% at 75°C—which is just about as hot as most electronic equipment gets in operation. In addition, samples of the 1N198 are regularly subjected to all standard tests at 25°C. This means that you can use these hi-temperature tested diodes with confidence, can design equipment to take full advantage of the fact that electrical characteristics at the higher temperatures are specified.

ACTUAL DIMENSIONS
DIODE BODY:
0.265 by 0.130 inches (maximum)



Type
1N198
Electrical
Characteristics

at 75°C

Forward Current at 1V dc 5 mA (Min.)

Reverse Current at -10V dc 0.075 mA (Max.)

Reverse Current at -50V dc 0.250 mA (Max.)

at 25°C

Forward Current at 1V dc 4 mA (Min.)

Reverse Current at -10V dc 0.010 mA (Max.)

Reverse Current at -50V dc 0.050 mA (Max.)

Like all Hughes Diodes, the hi-temperature tested 1N198 is fusion-sealed in a one-piece, gas-tight glass envelope which is impervious to moisture or other external contaminating agents. The complete Hughes line of fusion-sealed germanium diodes comprises standard RETMA, JAN, and many special types. We'd like to send our Bulletin SP-2A, which lists and describes these diodes, to you. Just send for your copy, or for additional details concerning the new Type 1N198.

Hughes

SEMICONDUCTOR SALES DEPARTMENT

Aircraft Company, Culver City, Calif.



New York Chicago

News—New Products

1954 Wescon Exhibitors

(Continued from page 42A)

EXHIBITOR	Booth No.
Reed and Reese, Inc.	700C
Reeves Instrument Corporation	439-440
Reeves Soundcraft Corporation	329
Remler Company, Ltd.	549
Resin Industries	626
The Rex Corporation	665
Al J. Rissi	621-622
E. V. Roberts & Associates	359-360
Robinson Aviation, Inc.	646
Rohn Manufacturing Co.	735
Raymond Rosen Engineering Products, Inc.	904
Rotron Manufacturing Co.	736
Rutherford Electronics Co.	613
Sanborn Company	262
San Fernando Electric Mfg. Co.	432
Sangamo Electric Company	156
Howard M. Saul & Associates	732
Sealectro Corporation	657B
Sensitive Research Instrument Corp.	506
Sequoia Process Corporation	256
Servo Corporation of America	466
Servomechanisms, Inc.	310-311
Shallcross Manufacturing Co.	365
Shasta Div.	
Beckman Instruments, Inc.	225
Samuel Siegel Co.	238
Sierra Electronic Corporation	509
Sigma Instruments, Inc.	366
Simpson Electric Co.	313
Div. American Gage & Machine Co.	
Claude C. Slate & Associates	738
Herman H. Smith, Inc.	657A
L. J. Smith Company	1003
T. Louis Snitzer	633
Sola Electric Co.	139-140
Sorensen & Co., Inc.	335-336
South River Metal Products Co.	815
Southern Electronics Co.	644
Southwestern Industrial Electronics Co.	125-126
Sperry Gyroscope Company	357
Spencer-Kennedy Laboratories, Inc.	465
Sprague Electric Company	318-319
Standard Wire & Cable Co.	756-757
Standard Coil Products Co.	908
Sterling Engineering Co.	437
George Stevens Manufacturing Co.	707
Stewart Stamping Co.	531
M. A. Stolaroff Co.	205
Conrad R. Strassner Co.	656
Superior Electric Co.	
Powerstat Division	809-810
Regulator Division	367-368
Suprenant Manufacturing Co.	316
Switchcraft, Inc.	261
Sylvania Electric Products, Inc.	249-250
Synthane Corporation	668
Taylor Fibre Company	1110
Tech Laboratories, Inc.	813
Technology Instrument Corp.	339
Tektronix, Inc.	556-557
Telecomputing Corporation	910
Tele-Tech & Electronic Industries	1305A
Teletronics Laboratory, Inc.	1304
Tensolite Insulated Wire Co.	442
Thermador Electrical Mfg Co.	545
Thomas & Skinner Steel Products Co.	331
Thompson Products, Inc.	203
Transformer Engineers	144B
Transistor Products, Inc.	332
Transitron Electronic Corporation	1210
Triad Transformer Corporation	149
Triplett Electrical Instrument Co.	731
Tri-State Supply Corporation	302
Trutone Electronics, Inc.	303
Tung-Sol Sales Corporation	309
Tur-Bo Jet Products	307
UM&F Manufacturing Corp.	803-804
Ungar Electric Tools, Inc.	122

(Continued on page 48A)

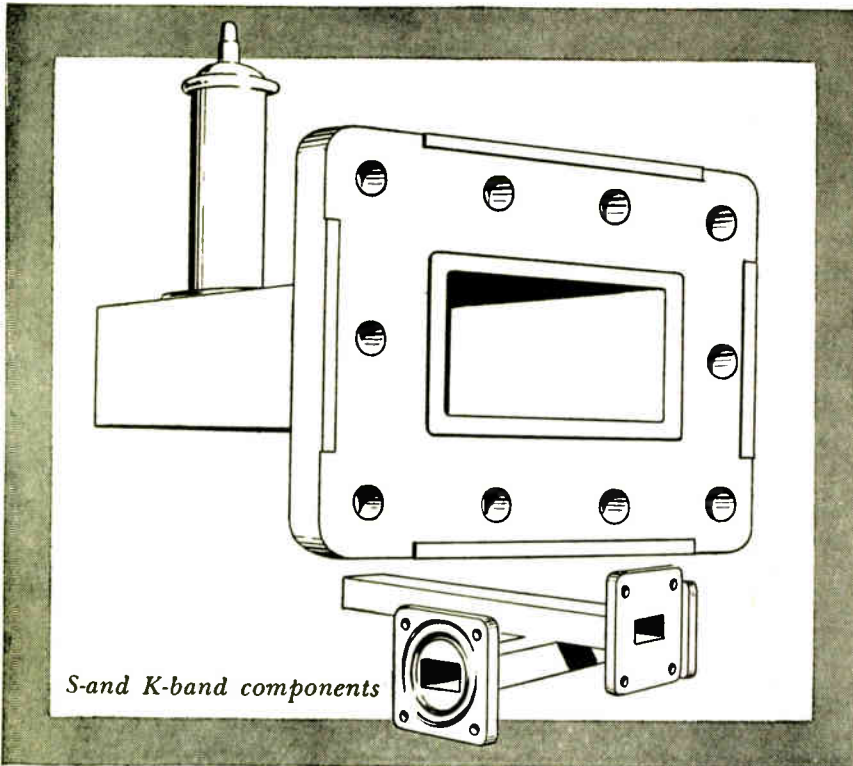

S-and K-band components

how
small
can a
wave
guide
get?

Well, alongside some of the stuff we're working with now, the radar plumbing we used during World War II gets to look like air-conditioning duct. What's more, some of our boys here seem to regard anything below S-band as practically pure D.C. Naturally, we're up to our hips as usual in work on military equipment. However, we do occasionally have some extra creative capacity available, so if you have a problem involving something special in wave guide components (real small ones, too) and like that, maybe we can help. Drop us a line.



L. H. TERPENING COMPANY

DESIGN • RESEARCH • PRODUCTION

Microwave Transmission Lines and Associated Components

16 West 61st St. • New York 23, N. Y. • Circle 6-4760

News—New Products

1954 Wescon Exhibitors

(Continued from page 46A)

EXHIBITOR Booth No.

Union Switch and Signal.....	1221-1222
Unitek Catalog Publishers.....	124
Universal Electronics Company.....	1215
U. S. Engineering Co., Inc. (USECO).....	218
U. S. Naval Ordnance Laboratory.....	801
United States Radium Corporation.....	748
United States Time Corporation.....	759
United Transformer Co.....	652
United Corporation.....	210
Van Cleef Bros, Inc.....	306
Van Groos Co.....	1106B-1107
Varian Associates.....	558-559
Vector Electronic Co.....	135
Vectron, Inc.....	535
Victoreen Instrument Co.....	641
Victory Engineering Corp.....	627
Viking Electric.....	257
Vitramon, Inc.....	436
V-M Corporation.....	101
Waldes, Kohinoor, Inc.....	410-411
The Walkirt Company.....	443
Don C. Wallace & William H. Wallace.....	740-741
Walsco Electronics Corporation.....	423-424
Ward Leonard Electric Co.....	239-240
Ward-Products Corporation, Division of The Gabriel Co.....	624
Waters Manufacturing, Inc.....	540
Waveline, Inc.....	710
Weightman & Associates.....	234-235
Western Control Equipment Co.....	724
Western Electronics News.....	1106A
Western Lithograph Co.....	900F
Westinghouse Electric Corp.....	457-458
Weston Electrical Instrument Corp.....	333-334
S. S. White Dental Mfg. Co.....	631
Wiancko Engineering Co.....	708
Winchester Electronics, Inc.....	605
Ash M. Wood Co.....	407-408
Wright Engineering Co.....	322
Wycro Metal Products.....	607
Xcelite Incorporated.....	344

SECON

- round •
- oval
- flat —
- grooved
- ribbon—

precision small wire

bare •
insulated
plated •

for highly engineered applications

all metals
all alloys

Round Wire to 0.00015" diameter. Ribbon rolled to 0.0001" in thickness. Close tolerances held on all specifications.



development and production metallurgists
SECON METALS CORPORATION
7 Intervale Street, White Plains, New York
WHite Plains 9-4757

Write for Pamphlet P

TELEMETER RECEIVING SET — 32 CHANNELS

Carrier frequency:
FM, 215-235 MC/S

Subcarriers: 6
5, FM continuous information
1, FM commutated information, 27 sub-channels

- Automatic Data Separation
- All Electronic
- High Degree of Accuracy and Reliability

For precision equipment in the fields of

RADIO CONTROL & TELEMETERING

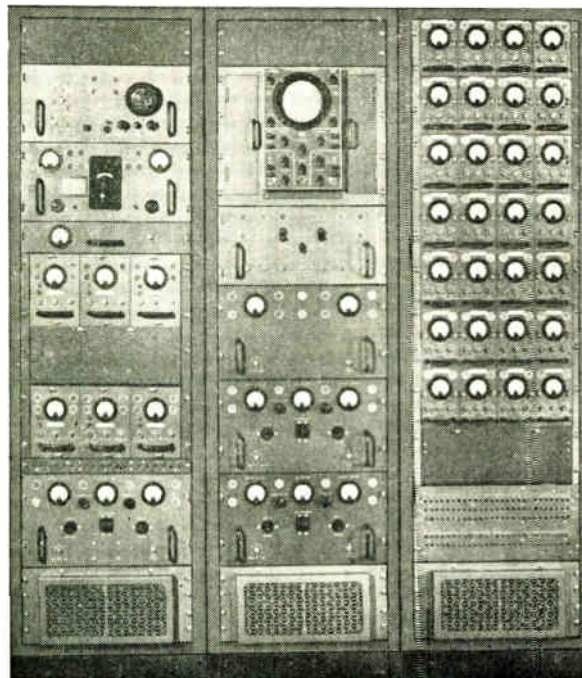

RAYMOND ROSEN ENGINEERING PRODUCTS, Inc.
32nd & Walnut Streets • Philadelphia 4, Pa.

High Temperature Servo Motors

New high temperature servo motors, which can operate in regions of 160°C (320°F) are now available from American Electronic Mfg., Inc., 9503 W. Jefferson Blvd., Culver City, Calif. These include BuOrd Mark VII and Mark VIII, as well as fifteen other variations available with a



wide choice of plain or pinion shafts. These high torque to inertia ratio units have been qualified to meet all military humidity, saltspray and fungus requirements. Delivery is within 30 to 45 days, Culver City, freight allowed.

(Continued on page 126A)

bill
of
particulars...

KEYSTONE PRODUCTS COMPANY
UNION CITY 2, N. J. UNION 6-5400

TRANSFORMER REPLY SHEET
KEYSTONE has made a specialty of meeting unusually difficult standards and specifications... and that experience can be put to work for you. We will be happy to make recommendations to answer your needs based on the information outlined here.

Company _____
Address _____
City _____ Zone _____ State _____

TRANSFORMER REQUIREMENTS

Type _____ Class _____
Input _____ Volts _____
Max. impedance _____
Applicable specs _____
C.S. Duty cycle _____
Load VA _____
Max. weight _____

OUTPUT	1	2	3	4
voltage				
vol. tolerance				
current				
load pf				
regulation				
vol. breakdown				

Ambient temp _____
Mounting preferred _____
Altitude (feet) _____
Type _____
Max. operating temp for:
Class A 105°C
Class B 130°C
Class F > 155°C

Please include schematic diagrams and additional remarks on reverse side.

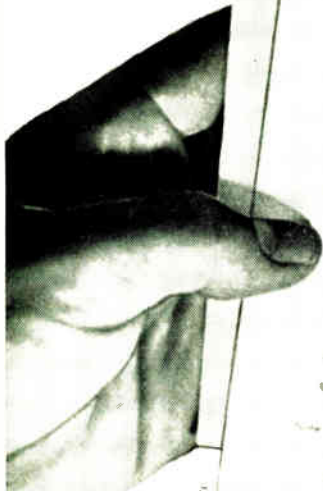

Consumer demands shape manufacturers' requirements...to fail to measure up is to lose the sale...incorrectness in one component often makes the difference...because of this,KEYSTONE custom-engineers each transformer it produces for the individual requirements of each manufacturer...KEYSTONE'S unique system of evaluating data supplied by manufacturers on the new reply sheet, enables KEYSTONE engineers to specify the correct transformer type for all operating conditions...this func-

tional fitting increases consumer acceptance and sales...proving over the years that confidence placed in KEYSTONE is well placed. For free information about how the KEYSTONE transformer reply sheet can help you, write box ... P-8 ... today!

keystone PRODUCTS COMPANY
904 23RD STREET UNION CITY 2, N. J.

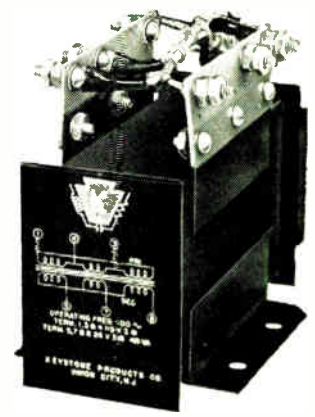

THE *S. White*

**"AIRBRASIVE" UNIT
WORKS WHERE OTHER
METHODS FAIL**

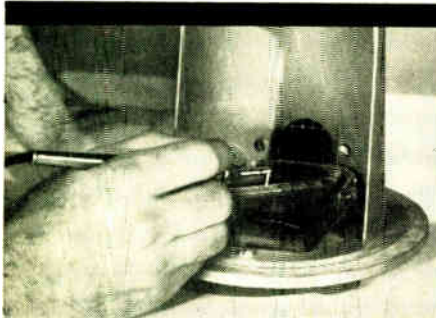
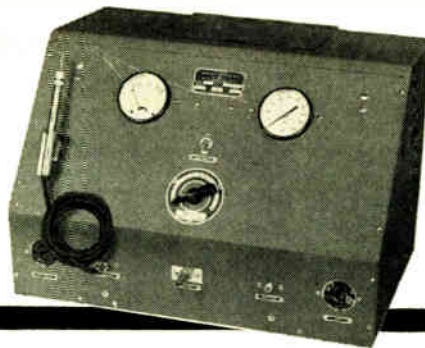

**...for cutting
hard, brittle
materials**

**for controlled
removal of
deposited
surface coatings...**

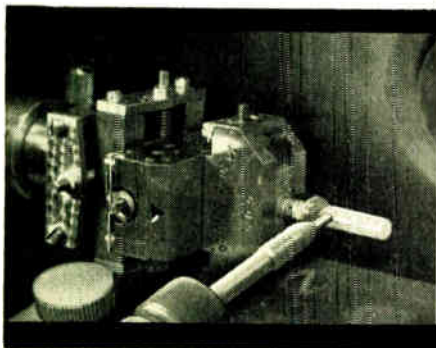
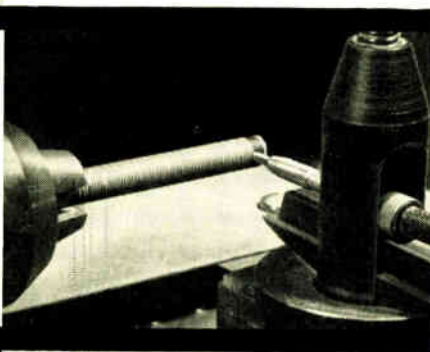

**...for shaping
fragile
crystals**

The "Airbrasive" method is an entirely new concept of cutting hard, brittle materials by the impingement of an ultra high speed stream of gas-propelled abrasive particles.

Its action is cool, shockless and rapid. It can be used for many operations involving cutting, drilling, surface film removal, light etching and scribing.

If you'll send us samples of your own work, we'll be glad to conduct tests and advise you as to the suitability of the process to your needs.

BULLETIN 5307 has full details. Send for a copy.



**AT THE WEST COAST IRE SHOW—LOS ANGELES, CALIF.
PAN PACIFIC AUDITORIUM—AUG. 25 to 27**

See the "Airbrasive" Unit in action. If you plan to attend, bring along work samples for a demonstration. **Booth 631.**

THE *S. White* **INDUSTRIAL DIVISION**
DENTAL MFG. CO.



Dept. GA, 10 East 40th St.
NEW YORK 16, N. Y.

Western District Office • Times Building, Long Beach, California

Contributors

H. Alfvén was appointed professor at the Royal Institute of Technology in Stockholm in 1940. His paper appears on page 1239 of this issue.



H. ALFVÉN

He was born in Norrköping, Sweden in 1908. He graduated from the University of Uppsala, and received the Ph.D. degree in physics there in 1934. He was a Research Fellow in physics at Uppsala and also at the Nobel Institute for Physics in Stockholm from 1934 to 1940.

He has published papers on electron physics, electron tubes (e.g. trochotrons), and cosmical physics. He is the author of "Cosmical Electrodynamics," Oxford University Press, 1950, and "On the Origin of the Solar System," Oxford, 1954.

He is an honorary member of Sigma Pi Sigma.



R. E. Buck joined the research staff at the Minneapolis-Honeywell Regulator Company in 1952, where he has been engaged in research pertinent to semiconductor devices. His paper appears on page 1247 of this issue.



R. E. BUCK

He was born in Ellwood City, Pa., November 26, 1921. He received the degree of Bachelor of Physics from the University of Minnesota Institute of Technology in 1949. He has been active since the thirties in the field of electronics. During World War II Mr. Buck served with the United States Navy as a radio and radar technician.

From 1949 to 1952 Mr. Buck was employed in commercial applications of electronics and engineering with a Minneapolis firm.



K. Bullington (A'45-SM'53) whose paper appears on page 1258 of this issue, joined the technical staff of Bell Telephone Laboratories after his graduation. First, he was engaged primarily with wire transmission problems connected with voice frequency and carrier telephone systems. Later, he began working on the engineering of mobile telephone and microwave relay systems. An in-



K. BULLINGTON

(Continued on page 52A)

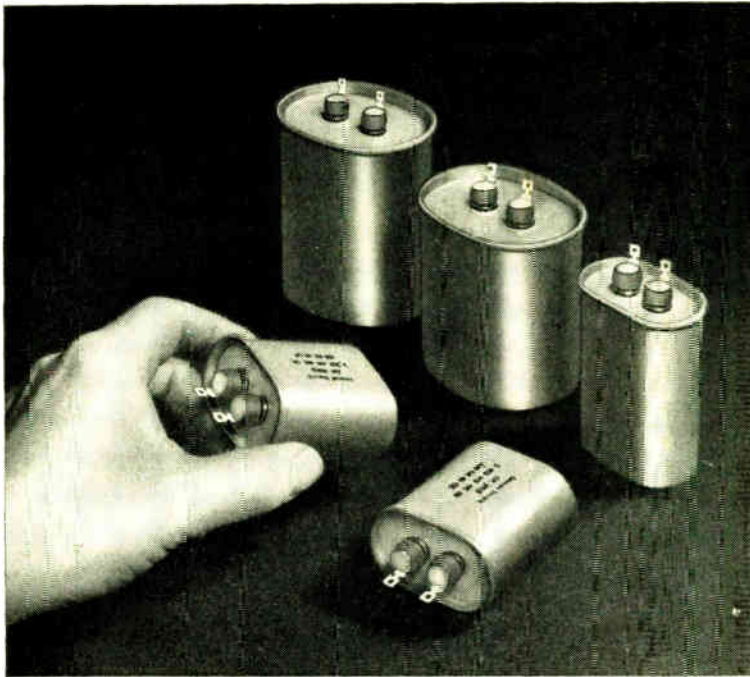

RATINGS of G-E drawn-oval capacitors range from 1 to 10 uf, 600 to 1500 volts d-c, and 330 to 660 volts a-c.

Versatile G-E drawn-oval capacitor saves space, costs less

If you use fixed paper dielectric capacitors, G-E drawn-ovals offer you an opportunity to save up to 20% on weight, and as much as 10% to 20% on cost. The oval-shaped container, developed by General Electric, offers more capacitance per dollar than similarly rated rectangular capacitors. And, by conforming to the natural shape of the winding, it results in a smaller, lighter unit, too. They're available in ratings from 1 to 10 uf, 600 to 1500 volts d-c, or 330 to 660 volts a-c, 60 cycles.

G-E drawn-ovals feature: A double-rolled seam, between case and cover that makes a mechanically strong, hermetic seal which stays leak-proof even under severe operating conditions; a choice of eyelet, fork-type, or quick-connect (solderless) terminals; silicone bushings between terminal and cover, that effectively maintain a high insulation resistance despite long operation and wide temperature variation.

General Electric drawn-oval capacitors are being used in room air conditioners, business machines, fluorescent lighting ballasts, and industrial and military control systems. If you would like specific application assistance, contact your local General Electric Apparatus Sales Office. General Electric Company, Schenectady 5, New York.

Progress Is Our Most Important Product

GENERAL  ELECTRIC

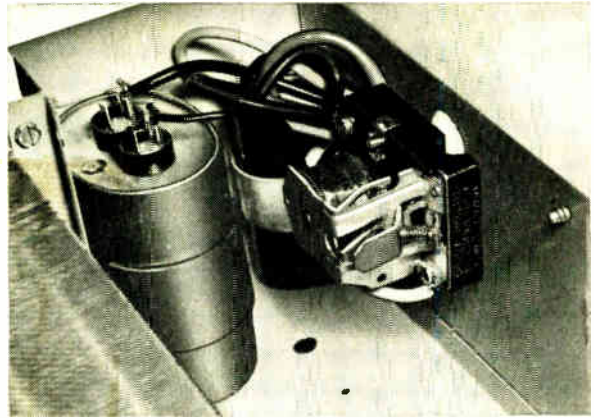

IN ROOM AIR-CONDITIONERS G-E drawn-oval improves power factor and reduces running current.

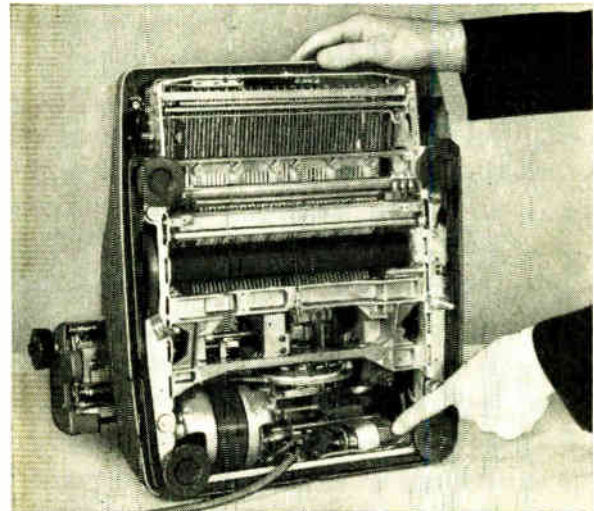

IN ELECTRIC TYPEWRITERS AND BUSINESS MACHINES, the compact G-E drawn-oval is used with split-phase capacitor-run motors.

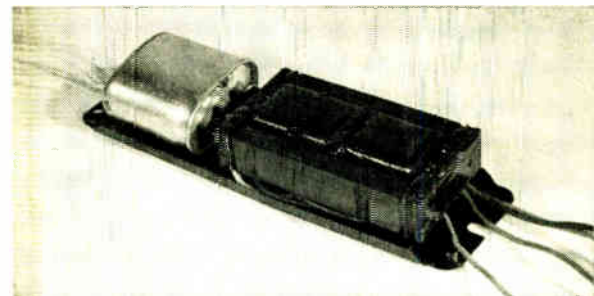

IN FLUORESCENT LAMP BALLASTS, G-E drawn-ovals (left) improve power factor.

CAN YOU USE THIS VERSATILE CAPACITOR?

General Electric Co.
Section A442-19
Schenectady 5, New York

Please send me Bulletin GEA-5777.

Name

Position

Company

City Zone State

THE NEW ELECTRONIC CHOPPER

by **AVION**

all electrical!
no moving parts!

- LIFE—3000 HOURS MINIMUM
- CASE SIZE— $\frac{7}{8} \times \frac{7}{8} \times 2$
- WEIGHS ONLY 1.6 OUNCES
- HIGH INPUT IMPEDANCE



The completely new design of this Avion Chopper provides for 100% electronic operation . . . achieved by modulation of D.C. voltages by alternate illumination at line frequency . . . of the photoconductive element in a voltage divider.

Compact, light, and durable, this unit is ideal for conversion of D.C. and A.C. in the fields of servomechanisms, computing devices; D.C. null measurement circuits, and other electronic control systems.

Send for complete data on this new Avion product

OTHER AVION PRODUCTS

Altitude & Air Speed Control Units • Electronic Invertors • Frequency Converters
Magnetic Memory Systems • Miniature Plug-In Amplifier Units • Power Supplies
Voltage Regulators • Replaceable Subminiature Amplifier Assemblies • Signal Generators



AVION
INSTRUMENT CORP.

Division of American Car and Foundry Company

299 Highway No. 17 • Paramus, New Jersey

X-Y PLOTTER AND RECORDER

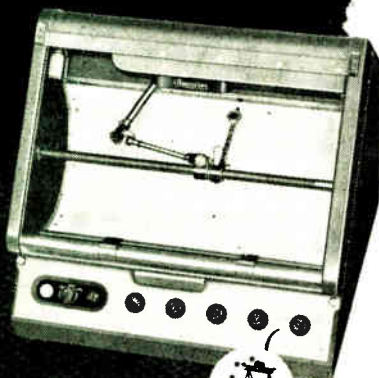

RECORDS TWO INDEPENDENT VARIABLES FROM ANALOG OR DIGITAL INPUTS

A compact, desk-size unit designed for general purpose graphic recording from analog or digital inputs with standard Librascope converters or special modifications engineered to customer requirements. Unique pen travel, fast and dependable. Full chart visibility allowing curve generation to be observed at all times. Write for detailed catalog information.

Mechanical and electrical
analog computers, digital
computers, input-output
devices and components.

Computers and Controls

LIBRASCOPE
A SUBSIDIARY OF GENERAL PRECISION EQUIPMENT CORPORATION

1607 FLOWER ST., GLENDALE, CALIF.

LIBRASCOPE, INCORPORATED

Contributors

(Continued from page 50A)

portant aspect of his work has been in the field of radio propagation.

He was born in Guthrie, Oklahoma on January 11, 1913. He attended the University of New Mexico, receiving the B.S. degree in electrical engineering in 1936. He received the M.S. degree in 1937 from the Massachusetts Institute of Technology.

He is a member of the Professional Groups on Antennas and Propagation and on Communication Systems.



J. C. Cacheris (M'48) joined the staff of the Ordnance Development Division of the National Bureau of Standards, Washington, D. C., in 1949,



J. C. CACHERIS

where he engaged in microwave antenna and diffraction studies, and in investigations of the microwave properties of ferrites. He is continuing the latter investigations as a member of the Diamond Ordnance Fuze Laboratories, Department of the

Army, to which the functions and staff of the Ordnance Development Division were transferred on September 28, 1953. His paper appears on page 1242 of this issue.

He was born on May 18, 1916, in Chicago, Ill. He graduated from the Capitol Radio Engineering Institute in 1941; received the B.S. degree in electrical engineering from Carnegie Institute of Technology in 1946; and the M.S. degree from Maryland University in 1953.

From 1941 to 1946 Mr. Cacheris was employed as a radio engineer in the Test Department of the Radio Division of the Westinghouse Electric Corporation, Baltimore, Md. From 1946 until 1949, as an electronic scientist with the Naval Ordnance Laboratory in White Oak, Md., he designed circuits and instruments for ultra high and microwave frequency ranges.

Mr. Cacheris is a member of the American Physical Society and Eta Kappa Nu, and is a registered professional engineer in the District of Columbia.



T. H. Chambers is a Registered Professional Engineer in the District of Columbia. He is also head of the Receiving Systems Section of the Search Radar Branch at the Naval Research Laboratory, Washington, D. C. His paper appears on page 1307 of this issue.



T. H. CHAMBERS

He was born at Ardmore, Pennsylvania on June 11, 1919. From Haverford College he received the B.S. de-

(Continued on page 56A)

Under overload conditions...

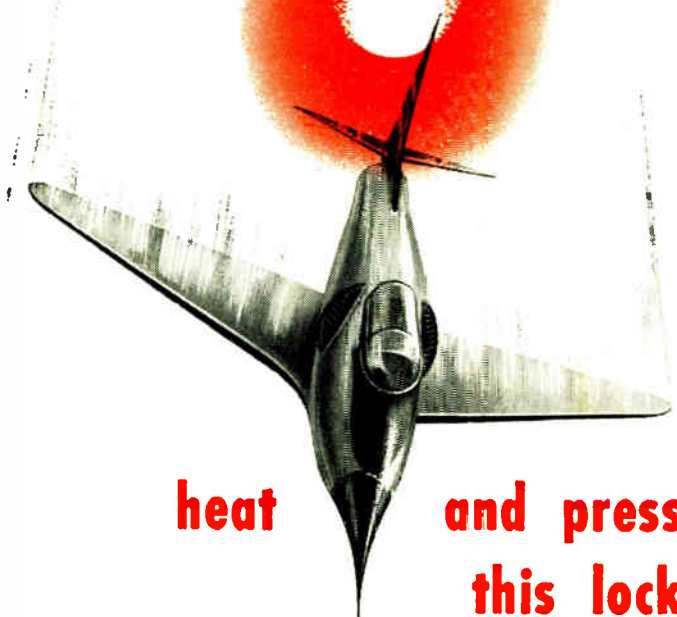

heat and pressure can't affect this lock-ring's grip—

HERMETIC'S new lock-ring for mounting hermetically sealed headers gives maximum mechanical security at lower cost!

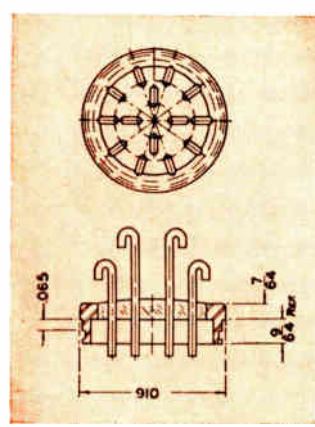

A simple hole is all you need to mount this VAC-TITE* glass-metal bonded header. Hermetic's new lock-ring design assures mechanical security without requiring shaped recesses. The ring will hold against internal pressures far in excess of any which can be encountered in service, and all the advantages and flexibility of round headers are retained.

Stripping and re-use of headers is facilitated by the lock-ring and by the intrinsic nature of the VAC-TITE* seal.

In co-operation with the Armed Services, Hermetic has developed a variety of other header and plug types which do not depend on solder alone for mechanical security of headers.

*VAC-TITE is HERMETIC's new, vacuum-proof, compression-construction, glass to metal seal. In addition to special shapes, many standard sizes such as .800 O.D. and .900 O.D. multi-terminal headers and a large variety of individual terminals are available in VAC-TITE Compression Seals.

Write to Hermetic for assistance and samples to meet your problems.

Hermetic Seal Products Co.

29 South Sixth St., Newark 7, New Jersey



See Us at the Western Electronic Show and Convention in Los Angeles — Booth 905.

F I R S T A N D F O R E M O S T I N M I N I A T U R I Z A T I O N

BALLANTINE Sensitive, Wide Band Electronic Voltmeter

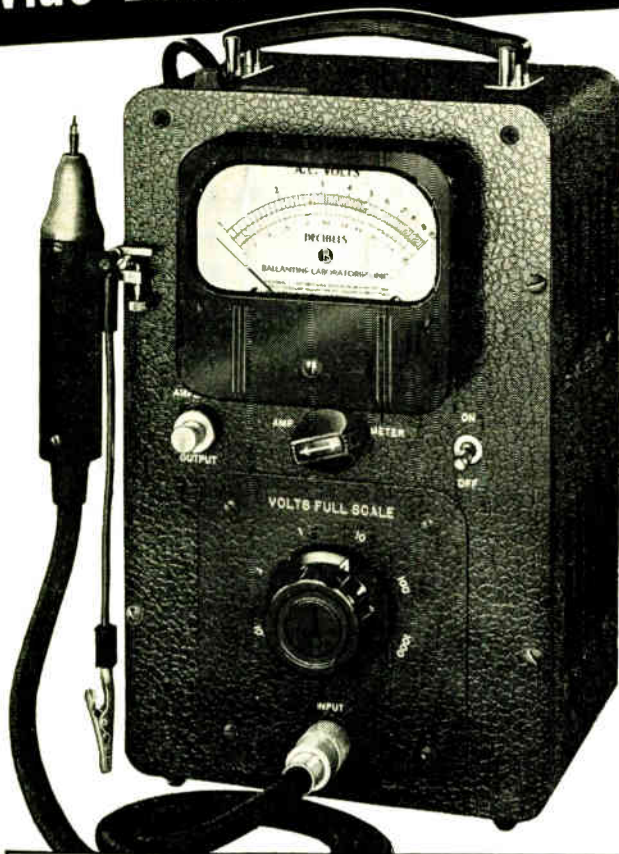

MODEL 314
Price \$285

To measure 1 millivolt to 1000 volts
from 15 cycles to 6 megacycles
with accuracy of 3% to 3 mc; 5% above
with input impedance 7.5 mmfds shunted by 11 megs

When used without probe, sensitivity is increased to 100 MICRO-VOLTS but impedance is reduced to 25 mmfds and 1 megohm

Featuring customary Ballantine

SENSITIVITY — ACCURACY — STABILITY

- Same accuracy at ALL points on a logarithmic voltage scale and uniform DB scale.
- Only ONE voltage scale to read with decade range switching.
- No "turnover" discrepancy on unsymmetrical waves.
- Easy-to-use probe with self-holding connector tip and unique supporting clamp.
- Low impedance ground return provided by supporting clamp.
- Stabilized by generous use of negative feedback.
- Can be used as 60 DB high fidelity video pre-amplifier.

Write for catalog for more information about this and other BALLANTINE voltmeters, amplifiers, and accessories.

BALLANTINE LABORATORIES, INC.

102 Fanny Road, Boonton, N.J.



YOURS for the asking



packed with the
latest and most
complete information
on

performance guaranteed

TAPE WOUND CORES

- 12 Pages of Performance Curves
- Tables of Guaranteed Performance
- Description of Core Matching Service
- Applications — Constructions

plus much additional information

For your copy of the "Performance-Guaranteed" Tape Wound Core Catalog

write on your letterhead

BOX I-1

MAGNETICS, inc.

Specializing in High Permeability Magnetics
BUTLER, PA.

Collins

MECHANICAL FILTERS PROVIDE A MORE DEPENDABLE SIGNAL FOR LORAC RECEIVERS

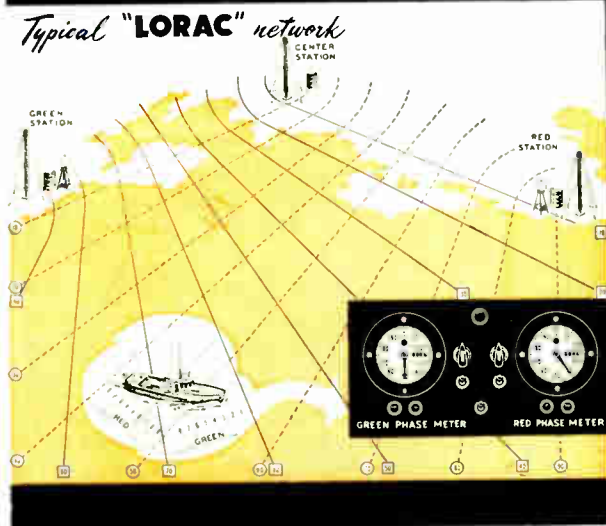
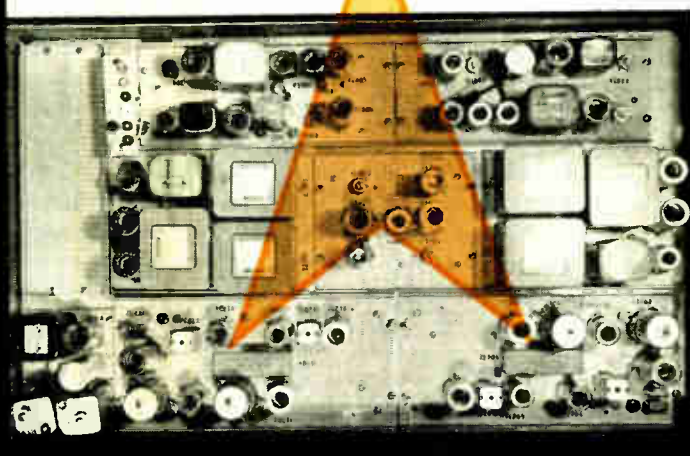
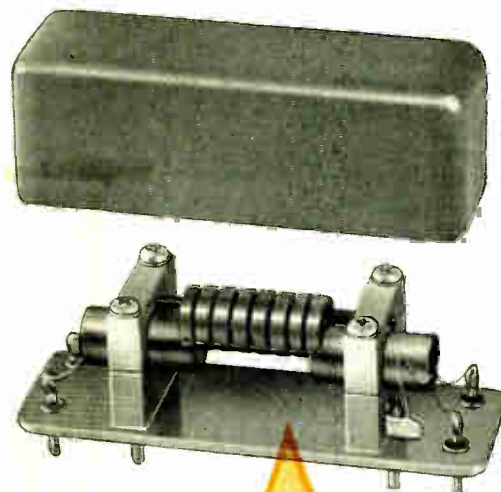

The Seismograph Service Corporation of Tulsa utilizes Mechanical Filters to narrow the I. F. pass band of their receivers and produce a better signal-to-noise ratio. Two Collins Mechanical Filters are now used in each marine mobile Lorac receiver.

During recent years the oil industry has displayed great interest in the Continental Shelf Area of the Gulf of Mexico. Increased geophysical activity in this area demanded a more accurate determination of the geographic position at which geophysical observations are made. As a result, Seismograph's Lorac radiolocation system, unhampered by poor visibility and line-of-sight limitations, was designed. Today the better signal-to-noise ratio provided by Collins Mechanical Filters in their Lorac receivers aids in providing position information as accurate as $\pm 2\frac{1}{2}$ feet.

Here is only one use of this compact, permanently tuned I. F. bandpass Filter. It is very probable that the Collins Mechanical Filter will provide the ideal selectivity and better signal-to-noise ratio you require. Collins Engineering Staff is available to assist in your particular application. Ask us today about the many types of standard Mechanical Filters now available for your use.

COLLINS RADIO COMPANY

Cedar Rapids, Iowa

261 Madison Ave., NEW YORK 16

1930 Hi-Line Dr., DALLAS 2

2700 W. Olive Ave., BURBANK

Collins Radio Company of Canada, Ltd., 74 Sparks Street, OTTAWA, ONTARIO



RESINITE

EMBOSSED COIL FORMS

*... can
increase
efficiency
of your
iron core
insertion
production
by 20%*

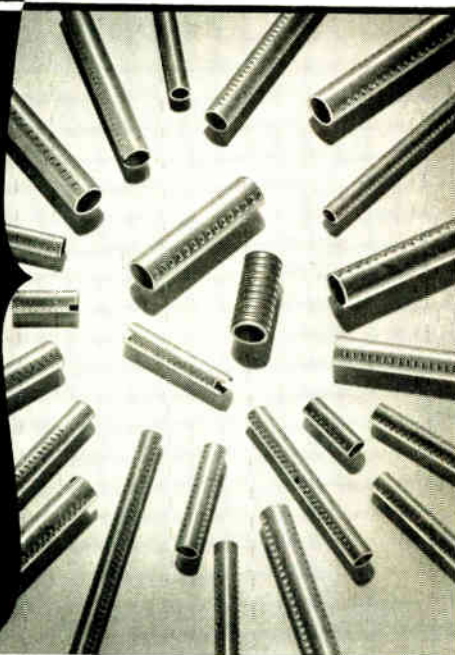

Special embossed construction eliminates torque control problems and stripping . . . prevents breakage or freezing of cores due to cross threading or improper starts.

Custom fabrication to your exact specification assures correct dimensions to within the most critical tolerances, plus uniformity throughout.

Threads are positioned in accordance with your requirement — full thread, each end, one end, center only.

We will furnish—without charge—a pilot production run of custom-made embossed forms to fit your particular application. We will also send a winding mandrel made to the specifications you supply.

Contact us now for full details about this special offer. Request technical bulletin, *Use of Threaded Tubes, Threaded Iron Cores VS. Torque Control.*

**RESINITE
CORPORATION**

New England:
Framingham, Massachusetts, Framingham 7091
Metropolitan New York, New Jersey:
Jersey City, New Jersey, Journal Square 4-3574
Upstate New York:
Syracuse, New York, Syracuse 76-8056
Northern Ohio, Western Pennsylvania:
Cleveland, Ohio, Atlantic 1-1060
Indiana, Southern Ohio:
Logansport, Indiana, Logansport 2555

Missouri, Southern Illinois, Iowa:
St. Louis, Missouri, Sterling 2318
Maryland:
Baltimore, Maryland, Plaza 2-3211
Philadelphia, Camden:
Philadelphia, Pa., Chestnut Hill 8-0282
California:
Pasadena, California, Sycamore 8-3919
Canada:
Montreal, Quebec, Canada, Walnut 2715

Sales Representatives in:



PRECISION PAPER TUBE COMPANY

2035G W. CHARLESTON ST. • CHICAGO 47, ILLINOIS

Contributors

(Continued from page 52A)

gree in 1941, graduating with honors in both physics and electrical engineering. He received his M.S. degree in 1950 from the University of Maryland.

From June to December, 1941, he was with the Columbia Broadcasting System doing research work on color television. In December, 1941, he accepted a position at the Naval Research Laboratory doing research work on receivers for search radar systems.

In October, 1945, Mr. Chambers was awarded the Meritorious Civilian Service award for his wartime work on anti-jamming receivers.



S. S. L. Chang (SM'53) has been associated with Robbins and Myers, Inc., Springfield, Ohio since 1946. He joined the



S. S. L. CHANG

Faculty of New York University in 1952 and is now Associate Professor of Electrical Engineering. His paper appears on page 1278 of this issue.

He was born in Peiping, China, in 1920. He received the M.S. in physics from Tsinghua University, China, in 1944, and the Ph.D. in Electrical Engineering from Purdue University in 1947. He taught at Purdue University from 1947 to 1948.

Dr. Chang is a member of A.I.E.E., American Physical Society, A.S.E.E., Eta Kappa Nu, and Sigma Xi.



J. K. Clapp (A'24-M'28-F'33), whose paper appears on page 1295 of this issue, has been with the engineering department



J. K. CLAPP

of General Radio Company, Cambridge, Mass., since 1928 to date, working on frequency standards and measurements. He was born on December 30, 1897 in Denver, Colorado.

Mr. Clapp received the B.S. degree from the Massachusetts Institute of Technology in 1923. He was an instructor in electrical engineering at M.I.T. from 1923 to 1928, obtaining the M.S. degree in 1926.

On graduating, Mr. Clapp became an amateur radio telegraph operator, from 1909 to 1928, and a commercial operator with Marconi Wireless Telegraph Company, from 1914 to 1916. He was in the United States Navy from 1917 to 1919, serving two years with the Expeditionary Forces in Europe. He was associated in 1920 with the Marine Division of the Radio Corporation of America.

(Continued on page 60A)

first of its kind

X-BAND SWEEP OSCILLATOR



wide band--8500 to 9600 mc;
output constant within one db;
for dynamic testing of microwave
components and systems

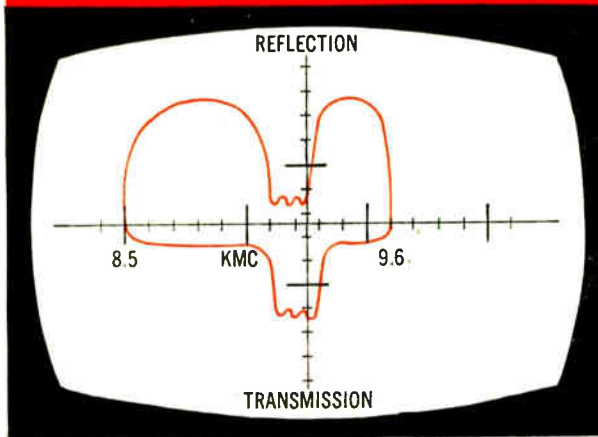
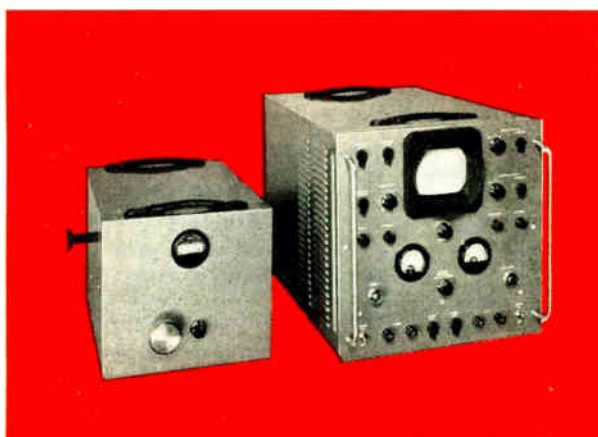

Now, for the first time, an instantaneous graphic display of the entire frequency range 8500 to 9600 MCS. This new Polarad X-Band Sweep Oscillator makes possible rapid, dynamic testing of microwave components such as TR tubes, antennas, crystal mounts, even complete microwave systems over a 1100 MC sweep at X-band. Eliminates laborious point-by-point testing methods. A unique display unit shows both reflection and transmission characteristics simultaneously, since two deflection amplifiers are utilized.

The X-Band Sweep Oscillator is an important instrument for laboratory and production line application. It gives one quick answer where formerly hours of checking were necessary. For further information, write to your nearest Polarad representative or the factory.

A Typical Scope Display (at left) Shows transmission and reflection characteristics of a double tuned cavity under test. This is an example of how the dynamic display reduces time required to test X-band components and systems. As a design tool in the laboratory, the effects of electronic or mechanical changes may be evaluated instantaneously. As a production tool, "go" and "no go" limits may be checked visually.

SPECIFICATIONS	
Frequency Range:	8.5 to 9.6 KMC
Output:	+ 12 dbm minimum into matched load
Output Variation:	± 1 db maximum
Sweeper Rate:	12 cycles per second
Operating Voltage:	115 V ± 10%
Input Power:	400 watts
Type of Output Connector:	UG-52A/U
Size of Control and Display Unit:	15 1/2" wide x 20" deep x 16 1/2" high
Size of Sweeper Oscillator:	12" wide x 16 1/4" deep x 12" high
Approx. Wt. of Control and Display Unit:	135 lbs.
Approx. Wt. of Sweeper Oscillator:	55 lbs.

Polarad ELECTRONICS CORPORATION 100 METROPOLITAN AVENUE, BROOKLYN 11, NEW YORK

REPRESENTATIVES Albuquerque • Arnprior, Canada • Atlanta • Boston • Chicago • Cleveland • Fort Worth • Kansas City • Los Angeles • New York • Philadelphia • San Francisco • Seattle • St. Paul • Syracuse • Washington, D. C.

PROCEEDINGS OF THE I.R.E. August, 1954

57A

MINIATURIZING YOUR EQUIPMENT?



Specify SIMPLEST, MOST COMPACT

AMPERITE THERMOSTATIC DELAY RELAYS

MOST ECONOMICAL, HERMETICALLY SEALED



STANDARD



MINIATURE

Provide delays ranging from 2 to 120 seconds.

- Actuated by a heater, they operate on A.C., D.C., or Pulsating Current.

- Hermetically sealed. Not affected by altitude, moisture, or other climate changes.
- Circuits: SPST only—normally open or normally closed.

Amperite Thermostatic Delay Relays are compensated for ambient temperature changes from -55° to $+70^{\circ}$ C. Heaters consume approximately 2 W. and may be operated continuously. The units are most compact, rugged, explosion-proof, long-lived, and — inexpensive!

TYPES: Standard Radio Octal, and 9-Pin Miniature.

PROBLEM? Send for Bulletin No. TR-81

BALLAST-REGULATORS

- Amperite Regulators are designed to keep the current in a circuit *automatically regulated* at a definite value (for example, 0.5 amp).
- For currents of 60 ma. to 5 amps. Operates on A.C., D.C., Pulsating Current.
- Hermetically sealed, light, compact, and most inexpensive.

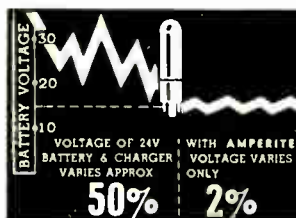
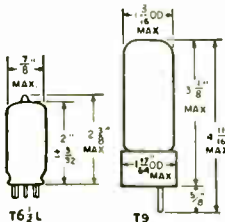

T9 BULB

Maximum Wattage Dissipation: T6 1/2 L—5W. T9—10W.

Amperite Regulators are the simplest, most effective method for obtaining *automatic regulation* of current or voltage. Hermetically sealed, they are not affected by changes in altitude, ambient temperature (-55° to $+90^{\circ}$ C), or humidity. Rugged; no moving parts; changed as easily as a radio tube.

Write for 4-page Technical Bulletin No. AB-51



AMPERITE CO. Inc., 561 Broadway, New York 12, N. Y.

In Canada: Atlas Radio Corp., Ltd., 560 King St. W., Toronto 2B

- Low noise level
- Precision
- Stability

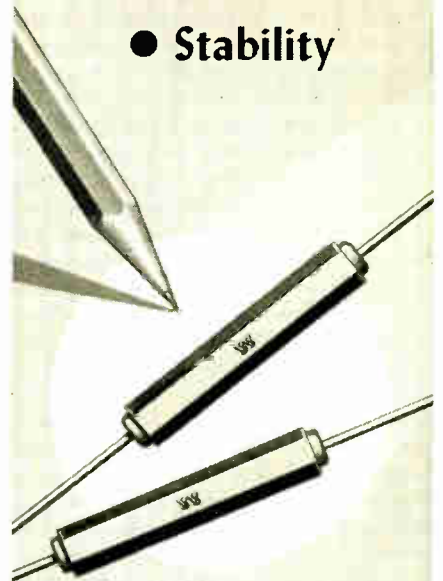

S.S. White 65X MOLDED RESISTORS

RATING—1 watt.

TEMPERATURE COEFFICIENT—From approx. $+0.1\%/^{\circ}$ F for 5000 ohm values to approx. $-0.2\%/^{\circ}$ F for 10 megohm values.

VOLTAGE COEFFICIENT—Rated at less than $0.02\%/$ Volt.

UPPER TEMP. LIMIT— 170° F for continuous operation.

NOISE LEVEL—Low noise level inherent, but at extra cost we can test and guarantee standard range resistors with "less noise than corresponds to a resistance change of 1 part in 1,000,000 for the complete audio frequency range."

VALUES

Standard Range — 1000 ohms to 9 megohms.

Extra High Value Range — Up to 10,000,000 megohms.

BULLETIN 4906

has full details. Send for a copy. Attention Dept. GR.



THE **S.S. White** INDUSTRIAL DIVISION

DENTAL MFG. CO.



10 EAST 40th ST.
NEW YORK 16, N. Y.

Western District Office • Times Building, Long Beach, Calif.

PERFORMANCE - WISE CERAMIC BUYERS

ASK
ABOUT

press facilities

ALSiMAG[®]

Invariably this question is brought up by seasoned buyers. Experience has taught them that no amount of good intentions can compensate for inadequate production machinery. To such practical and fore-sighted men, the following facts are presented for consideration:

To meet customer requirements for quality tested ALSiMag ceramics, American Lava Corporation maintains lineups of modern high speed presses which can produce *in one three-shift working day over 9,000,000 uniform, accurate ALSi-Mag pieces* (more than enough, laid end to end, to reach from Philadelphia, Pa., to Washington, D. C.)*

Why risk dole delivery when you can command ALSiMag production facilities ready to serve you?

* Based on an ALSiMag part 1" square. Our presses can produce pieces up to 14" x 14" and, of course, much smaller parts than the size mentioned.

53RD YEAR OF CERAMIC LEADERSHIP

AMERICAN LAVA CORPORATION

CHATTANOOGA 5, TENNESSEE

A SUBSIDIARY OF MINNESOTA MINING
AND MANUFACTURING COMPANY

OFFICES METROPOLITAN AREA: 671 Broad St., Newark, N. J., Mitchell 2-8159 • SYRACUSE, N. Y.: 647 S. Warren St., Phone 74-4889 and 74-4880 • CLEVELAND: 5012 Euclid Ave., Room 2007, Express 1-6585 • NEW ENGLAND: 1374 Mass. Ave., Cambridge, Mass., Kirkland 7-4498 • PHILADELPHIA: 1549 N. Broad St., Stevenson 4-2823 • ST. LOUIS: 1123 Washington Ave., Garfield 1-4959 • CHICAGO: 228 N. LaSalle St., Central 6-1721 • SOUTHWEST: John A. Green Co., 6815 Oriole Dr., Dallas 9, Dixon 9918 • LOS ANGELES: 5603 N. Huntington Dr., Capitol 1-9114 • SOUTH SAN FRANCISCO: 320 Shaw Rd., Plaza 6-0800
PITTSBURGH: 911 Plaza Bldg., Atlantic 1-2075

WAVEGUIDES FOR RADAR & MICROWAVE LINK SYSTEMS

We offer complete facilities for manufacturing Waveguide components from your drawings and specifications — or expert design and development to meet your needs.

- Precision Cast Waveguides
- Aluminum Dip Brazing & Heliarc Welding
- Broadband Waveguide Components
- Mixers • Duplexers
- Rotating Joints
- Hybrid Junctions
- Crystal Mounts
- Bends

Write for Illustrated Brochure

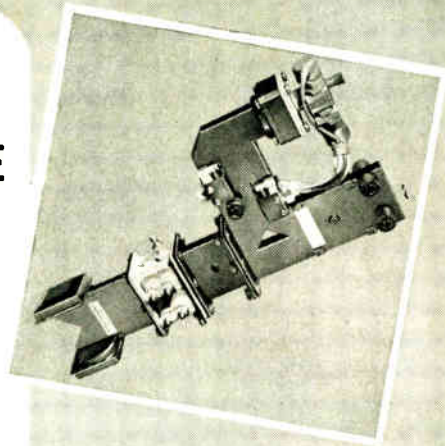

PREMIER INSTRUMENT CORP.

52 West Houston Street
New York 12, N. Y.

THE WAVEGUIDE HOUSE SINCE 1943

Contributors

(Continued from page 56A)

J. R. Hall (M'48-SM'54) is employed by Continental Electronics Mfg. Co., Dallas, Texas. His paper appears on page 1222 of this issue.



J. R. HALL

He was born in Boston, Mass., on December 4, 1915. He graduated with honors in electrical construction from Wentworth Institute at Boston in 1937.

After graduation he was employed as production engineer by Photoswitch

Inc., Lawrence, Mass. In 1940 he joined the engineering staff of the World Wide Broadcasting Corp. in Boston, and international short-wave stations WRUL-WRUW, where he was engaged in high-power transmitter design and construction.

From 1944 until 1946 Mr. Hall was employed by the U. S. Government, Office of War Information, as a radio engineer in London and Algiers.

From 1946 until 1953 he was employed by the U. S. Department of State and the U. S. Information Agency (Voice of America). During this period he was chief engineer in the relay stations at Algiers, and later engineer in charge of construction at the American Relay Base in Munich.

In 1949 he was appointed project engineer for the Voice of America and designed the short-wave relay facilities for Salonika, Greece. Later he was placed in charge of constructing the million-watt long wave transmitting plant at Munich. In 1953 Mr. Hall resigned from government service to enter television broadcasting as an engineer at WXEL, Cleveland, Ohio.



J. N. Hines (S'47-A'50) is presently employed as a research associate at the Antenna Laboratory of the Ohio State University, working on



J. N. HINES

the problems of traveling-wave slot antennas. He is also a member of the technical school staff of Franklin University, Columbus, Ohio. His paper appears on page 1262 of this issue.

He was born in Tientsin, China, on March 9, 1920. He received the B.S. degree in electrical engineering from the University of Connecticut in 1943 and entered the Armed Forces as a Radio Officer in the Signal Corps until the fall of 1946. Mr. Hines then enrolled in the graduate school of The Ohio State University where he was awarded the M.Sc. degree in electrical engineering in 1949.

Mr. Hines is a member of the AIEE.

(Continued on page 62A)

Metallurgists & Specialists in Small Wire
Serving Industry—FOR OVER 53 YEARS

BASE METAL WIRES . . . Very small diameter — for filaments, thermocouples, resistance units.

PRECIOUS METAL WIRES . . . Produced in Platinum, Gold, alloys and pure metals — small diameter . . . Platinum alloy resistance wires.

COATED WIRES . . . Comprising an extensive range of electroplated grid wires . . . Enamel insulated wires for precision resistors and potentiometers.

We invite your inquiry regarding unusual problems or specifications.
Write for latest List of Products.



Since
1901

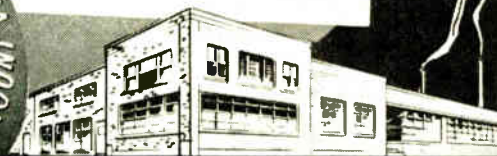

SIGMUND COHN MFG. CO. INC.

121 So. Columbus Avenue, Mt. Vernon, N. Y.



Greater STABILITY **Smaller SIZE** **Greater STRENGTH**

RMC[®] Temperature Compensating DISCAPS

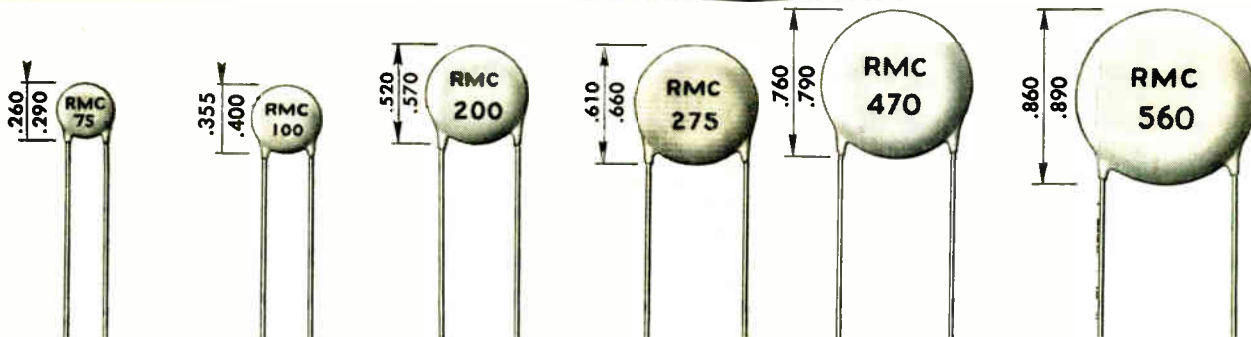

TC	1/4 Dia.	5/16 Dia.	1/2 Dia.	5/8 Dia.	3/4 Dia.	7/8 Dia.
P-100	1- 3 MMF	4- 9 MMF	10- 20 MMF	—	—	—
NPO	2- 12	13- 27	28- 47	48- 62 MMF	63-100 MMF	101-150 MMF
N- 33	2- 12	13- 27	28- 47	48- 62	63-100	101-150
N- 75	2- 15	16- 27	28- 56	57- 68	69-110	111-150
N- 150	2- 15	16- 30	31- 60	61- 75	76-140	141-150
N- 220	3- 15	16- 30	31- 75	76- 90	91-130	131-190
N- 330	3- 15	16- 30	31- 75	76-100	101-150	151-190
N- 470	3- 20	21- 40	41- 80	81-120	121-200	201-240
N- 750	5- 25	26- 56	57-150	151-180	181-300	301-350
N-1500	15- 50	51-100	101-200	201-250	251-330	331-560
N-2200	47- 75	76-120	121-200	201-275	276-470	471-560

Temperature coefficients up to N-5200 available on special order.

SPECIFICATIONS

POWER FACTOR: Over 10 MMF less than .1% at 1 megacycle. Under 10 MMF less than .2% at 1 megacycle.

WORKING VOLTAGE: 1000 V.D.C.

TEST VOLTAGE (FLASH): 1750 V.D.C.

CODING: Capacity, tolerance and TC stamped on disc

INSULATION: Durez phenolic-vacuum waxed

INITIAL LEAKAGE RESISTANCE: Guaranteed higher than 7500 megohms

AFTER HUMIDITY LEAKAGE RESISTANCE: Guaranteed higher than 1000 megohms

LEADS: No. 22 tinned copper (.026 dia.)

TOLERANCES: ±5% ±10% ±20%

The capacity of these condensers will not change under voltage.

These capacitors conform to the RTMA specification for Class 1 ceramic condensers.

RMC Type C temperature compensating DISCAPS are universally recognized as the ideal money-saving replacement for tubular ceramic and mica capacitors. Rated capacities will not change under voltage. **Smaller size** permits compact circuit designs. Greater mechanical strength assures rugged assemblies and lower costs in production line operations. Rated at 1000 working volts, Type C DISCAPS are available for a wide range of applications and cost no more than ordinary 600-volt capacitors.

Whatever your ceramic capacitor problem, standard or specialized, RMC engineers are prepared to solve it for you. Take advantage of a wealth of experience by writing today.



RADIO MATERIALS CORPORATION

GENERAL OFFICE: 3325 N. California Ave., Chicago 18, Ill.

FACTORIES AT CHICAGO, ILL. AND ATTICA, IND.

DISTRIBUTORS: Contact Jobbers Sales Co., P. O. Box 695, Fairlawn, N. J.

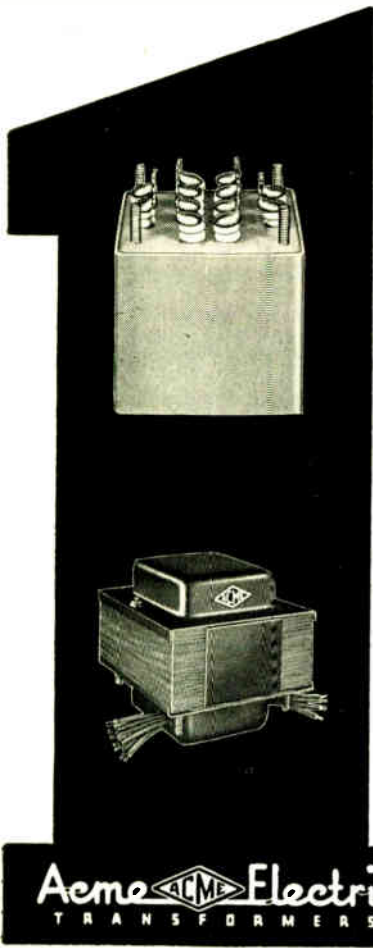

FIRST CHOICE FOR PRECISION MADE TRANSFORMERS

● Precision is two-fold in Acme Electric transformers. Exact mechanical dimensions facilitate installation in limited space. Unvarying electrical characteristics provide for dependable performance.

ACME ELECTRIC CORPORATION
448 WATER ST. • CUBA, N.Y.

West Coast Engineering Laboratories:
1375 W. Jefferson Blvd., Los Angeles, California
In Canada: Acme Electric Corp. Ltd.
50 Northline Road, Toronto, Ontario

Acme Electric
TRANSFORMERS

Contributors

(Continued from page 60A)

R. A. King (M'46) joined the Bell Telephone Laboratories in Murray Hill, N. J. in 1929, spending the next eight years in the systems drafting department. She transferred to the circuit research department and mathematical computing in 1937. Six years later, she joined a transmission development group concerned with pulse transmission systems for radio telephony. Her paper appears on page 1250 of this issue.



R. A. KING

In 1948 Mrs. King was assigned to local transmission research, with particular attention to problems in broadband-to-subscriber transmission. Recently she has been associated with experimental work on laminated conductors and currently is concerned with the transatlantic cable project.

She was born on July 17, 1911 in New York, N. Y. She received the B.A. degree in 1941 from the Brooklyn College of the College of the City of New York.

Mrs. King is a member of Pi Mu Epsilon.



R. Lee (A'32-SM'45-F'54) became associated with the Westinghouse Electric Corporation, first in the student course, followed in 1925 by work in the control engineering department, and in 1928 transferring to the radio-engineering department. First a design engineer in the Baltimore plant of Westinghouse, Mr. Lee is now an advisory engineer. His paper appears on page 1288 of this issue.



R. LEE

He was born on November 8, 1902, at Shirland, Derbyshire, England. He received the B.S. degree in electrical engineering from West Virginia University in 1924.

Mr. Lee is a member of Tau Beta Pi and the AIEE.

(Continued on page 66A)

BLOCK UNITIZED PULSE INSTRUMENTS

- EACH INSTRUMENT COMPLETE—AND EXPANDABLE. UNITS MAY BE ADDED TO EXTEND RANGE AND APPLICATION.

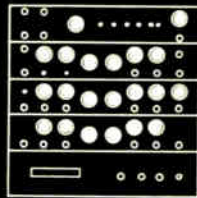

USE INDIVIDUALLY
OR IN MULTIPLE
COMBINATIONS

FUNCTION CHANGE EFFECTED BY SIMPLE SWITCH OF REAR PLUG-IN CABLE

TIME DELAY and GATE GENERATOR

Model 2210A

- Non-critical trigger requirements
- Pos. and neg. delayed output pulses
- Pos. and neg. variable width gate pulses
- Delays and gate widths to 10,000 μ S
- High accuracy, low jitter



Write for complete specifications: our Bulletin No. 2200-1/A and the Name of Our Representative in your area.



Electro-Pulse, Inc.

11811 MAJOR STREET, CULVER CITY, CALIF.

EXbrook 8-6764

New Towers in the Sky!

Research information readily exchanged between engineers and scientists has been the forerunner of every radio-electronic advance. This is the priceless service to all of "Proceedings of the I.R.E."

For "Trouble-Free" Electrical Protection

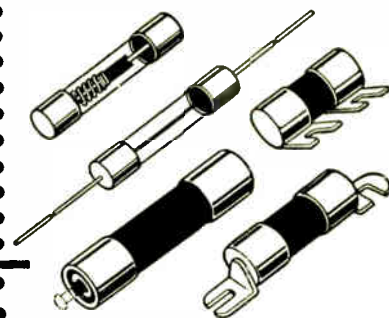

You can rely on BUSS FUSES!

Accuracy and dependability are built in every BUSS fuse at the factory and will be there no matter when the fuse is called upon to operate.

For every BUSS fuse normally used by the Electronic Industries is tested in a sensitive electronic device that rejects any fuse that is not properly constructed, correctly calibrated and right in all physical dimensions.

Proper construction prevents poor contact heating, correct calibration makes certain that the fuse will carry its rated current.

This insistence on perfection results in quality, 'trouble-free' fuses. That's why manufacturers and service organizations rely on BUSS fuses for dependable electrical protection under all service conditions.

If at any time you have an electrical protection problem, let BUSS save you engineering time. At your service are the facilities of the world's largest fuse research laboratory and its staff of engineers ready to help you select the right fuse or fuse mounting . . . and if possible, one already available from local wholesalers' stocks.

For More Information • Mail this Coupon ▶

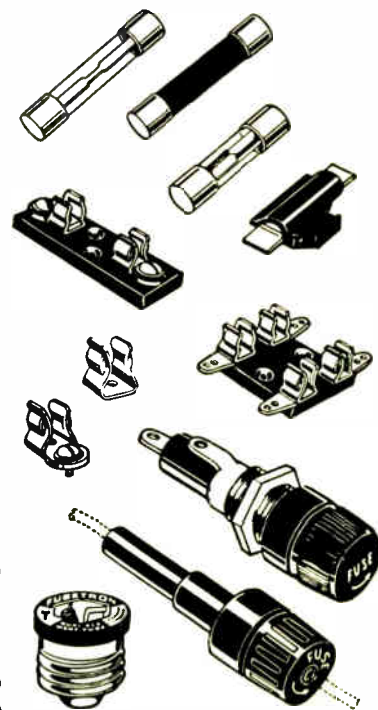

BUSSMANN Mfg. Co.
(Division of McGraw Electric Co.)
University at Jefferson, St. Louis 7, Mo.
Please send me bulletin SFB containing facts on
BUSS small dimension fuses and fuse holders.

Name _____

Title _____

Company _____

Address _____

City & Zone _____ State _____

854
IRE

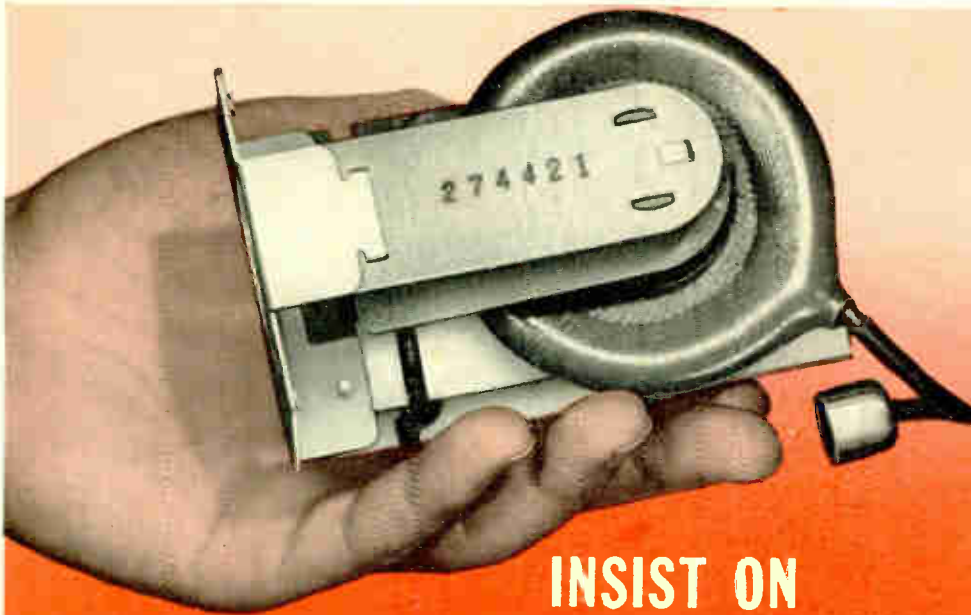

**INSIST ON
COMPONENTS WITH THE BEST PERFORMANCE
RECORD IN THE INDUSTRY!**

**SPECIFY
RCA**



Year after year, most of the successful TV receiver designs use deflection components made by RCA.

RCA deflection yokes and flyback transformers are first choice among leading circuit designers today because their outstanding quality and performance have been proved by satisfactory service in millions of receivers since they first made history in the famous "630" chassis.

The fact is, more yokes and flybacks produced by RCA are in use now than any other make. You'll consistently find them in the industry's "best-sellers".

For information on the latest RCA yokes and flybacks contact your RCA representative at the nearest district office.

(EAST)

Humboldt 5-3900.
415 S. Fifth Street,
Harrison, N. J.

(MIDWEST)

Whitehall 4-2900.
589 E. Illinois Street,
Chicago 11, Ill.

(WEST)

Madison 9-3671.
420 S. San Pedro Street,
Los Angeles 13, Cal.



RADIO CORPORATION of AMERICA
ELECTRONIC COMPONENTS
HARRISON, N. J.



Charles J. Marshall

DIRECTOR, 1954

Charles J. Marshall was born in San Antonio, Texas on March 27, 1912. His formal education was received in the Evening College of the University of Cincinnati where he received a Certificate in Radio Engineering in 1934 and a Bachelor of Science degree in Electrical Engineering in 1939. Subsequently, he received the degree of Electrical Engineer from the Engineering College in 1946.

He was employed by the Crosley Corporation in Cincinnati from 1929 to 1939 where he held positions as inspection foreman and radio engineer. His last position was concerned with the design and construction of W8XCT, the first television transmitting station in Cincinnati.

From 1939 to the present, he has held successively more responsible positions with the U.S. Army Signal Corps and with the U.S. Air Force at Wright-Patterson Air Force Base, Ohio. His technical responsibilities embraced a wide variety of airborne electronics such as communications, radio remote control, telemetering, television, infra red and radar. He holds several patents in

remote control. His duties required membership on numerous government committees co-ordinating research and development on radar and television. He is now Chief Scientist, Search Radar Branch, Aircraft Radiation Laboratory.

He joined the IRE as a Junior Member in 1931 and transferred to Associate in 1933. Since 1945 he has been a Senior Member. He has been active in the work of the Dayton Section since 1946 serving as Secretary-Treasurer, Vice-Chairman, and Chairman. He is a charter member of the Professional Group on Aeronautical and Navigational Electronics and served as President of the 1951 National Conference on Airborne Electronics. From 1950 to 1952 he was a member of the Region 5 Committee, and is now serving as Director of the IRE, Region 5, for the 1954-1955 term.

He is a Registered Engineer in Ohio and a member of the Ohio and National Societies of Professional Engineers. In addition, he holds memberships in Sigma Xi, Sigma Delta Gamma, and the Armed Forces Communications Association.

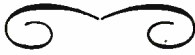

Why Transactions?

ERNST WEBER, FELLOW, I.R.E.

DIRECTOR, MICROWAVE RESEARCH INSTITUTE, POLYTECHNIC
INSTITUTE OF BROOKLYN, BROOKLYN, N.Y.



With the growth of professional organizations, the publications program becomes inevitably a serious problem. The IRE has been no exception in this respect and publication policies have been the center of many subjective and objective discussions. Subjectively, each member would like to see the main organ of IRE carry important news and readable articles covering fully his own particular field of interest. Objectively, the Editorial Department has endeavored to satisfy the necessarily widely divergent individual desires while also trying to maintain the very high standard of papers within rigidly confining space limits. It should be obvious that any ideal solution is unattainable through the PROCEEDINGS alone.

With the initiation of the professional group system, a solution of the difficult publication problem appears to be at hand in a most natural manner. Each professional group may publish in its TRANSACTIONS almost at a moment's notice any paper or group of papers of interest to its circles, without long, formal reviews, painful surgeries and unhappy feelings of authors. Moreover, TRANSACTIONS are destined to become the repository for outstanding papers in the particular field of each professional group, contributing collected papers on specific subject matter! Surely, it is now the responsibility of the professional groups to maintain the standard of the papers by effective use of their own editorial prerogatives. What was manifestly an impossible task for the PROCEEDINGS has become possible by delegation to 22 professional groups: a full, efficient, rapid, up-to-date reporting of scientific and technological developments to each interested sector of the IRE membership!

There might be a feeling on the part of some authors that the circulation of their contributions might be restricted by publication in the TRANSACTIONS as compared with publications in the PROCEEDINGS. This is not justified on at least two counts: unless the contribution is of such wide membership interest that it warrants full distribution to all members, it will not be published at all

in the PROCEEDINGS; and the PROCEEDINGS will carry abstracts of all TRANSACTIONS papers and, in addition, will include their authors and titles in the annual index. Actually, therefore, the TRANSACTIONS will constitute specialized "sections" of the over-all IRE publications and thus rank with the PROCEEDINGS from the professional point of view. Indeed, the PROCEEDINGS will now be able to concentrate upon a single objective, namely to publish matters of wide interest, and preferably of interest to most members of IRE.

Just what the division of subject matter between the PROCEEDINGS and that of the TRANSACTIONS of the Professional Groups might be—whether, indeed, a clear-cut division should be made—is yet an open question. Much will depend upon the use that Professional Groups will make of this unparalleled opportunity for self-expression. One possibility might be that the PROCEEDINGS include tutorial, informational, and basic scientific papers of high quality and of fundamental interest to a large majority of IRE members; granting the authors ample space for the full development of their ideas and thus making the papers valuable and lasting reference material. Most of the more specialized technical papers would then go automatically to the TRANSACTIONS which might, of course, also carry news of plans and activities of the particular Professional Group and its chapters.

Surely, a publication policy which can achieve satisfaction of the unifying membership interests in the PROCEEDINGS and of the divergent membership interests in the TRANSACTIONS of the Professional Groups is as close to an ideal solution of the intricate publication problem as we should hope for. Its success must, of course, depend upon the wholehearted support of each and every member of the IRE and particularly upon the hard work of the laboring authors and of the editorial staffs. "By their deeds ye shall know them"—I feel sure the proper deeds will be forthcoming in the interest of the members, who after all constitute the IRE, no more and no less.

Very High-Power Long-Wave Broadcasting Station*

C. E. SMITH†, SENIOR MEMBER, IRE, J. R. HALL‡, SENIOR MEMBER, IRE,
AND J. O. WELDON§, FELLOW, IRE

Summary—The most powerful radio broadcasting station in Europe began regular operation in August, 1953. The unique features include a 5.2 million watt complete diesel power station with fuel oil storage of 264,000 gallons. A "vapor phase system" cools the diesel engines. Transmitter metering, tuning, and power controls are centralized in a console type unit. The output of dual high powered transmitters are normally combined, but can be fed separately to the antenna system and dummy load. The over-all efficiency of the transmitter from power source to antenna is over 50 per cent and is unusually stable under extremely heavy modulation. The high-efficiency amplifier employs thoriated-tungsten filament triodes with a power gain of 33. The transmitter-output load has parallel-resonant symmetry. The 12-inch coaxial transmission line feeds an 837-foot top loaded tower optimized for maximum ground wave. The extensive ground system extends out 0.5 mile from the tower and consists of over 100 miles of no. 6 copper wire.

INTRODUCTION

IN 1948 the Voice of America (VOA) broadcasts to Iron Curtain countries began to be reduced in effectiveness by jamming. Methods instituted to overcome this damage and increase program coverage included using the clipper amplifier, operating on many frequencies, and moving VOA transmitters "next door," to Iron Curtain stations so that their jamming would affect their own broadcasts. A careful study of the prob-

lem by prominent scientists and engineers indicated that super-power transmitters would be one of the most effective methods. Government officials then agreed to a system known as the "Ring Plan" for super-power broadcasting stations encircling the Iron Curtain.

One of the super-power long-wave broadcasting stations known by the code name CAST was built in the American Zone of Germany to carry programs originating in Munich and by radio relay from New York. The CAST site is at Erching, Bavaria, about 15 miles north of Munich. The site was selected for good soil conductivity and its distance from the city to minimize the "blocking" of local radio receivers.

The long-wave band (150–285 kc) was selected, because of its good ground-wave propagation characteristics and its successful use in Europe where most of the receivers are equipped with this band. The transmitter, originally constructed for medium-wave was converted in the field for the 173 kc frequency assigned to CAST by using a conversion kit supplied by the manufacturer.

On April 28, 1952, after four months of planning, construction of the new plant began. With the help of 250 German contractual workmen on two shifts it was possible to proceed rapidly with roadway and building con-

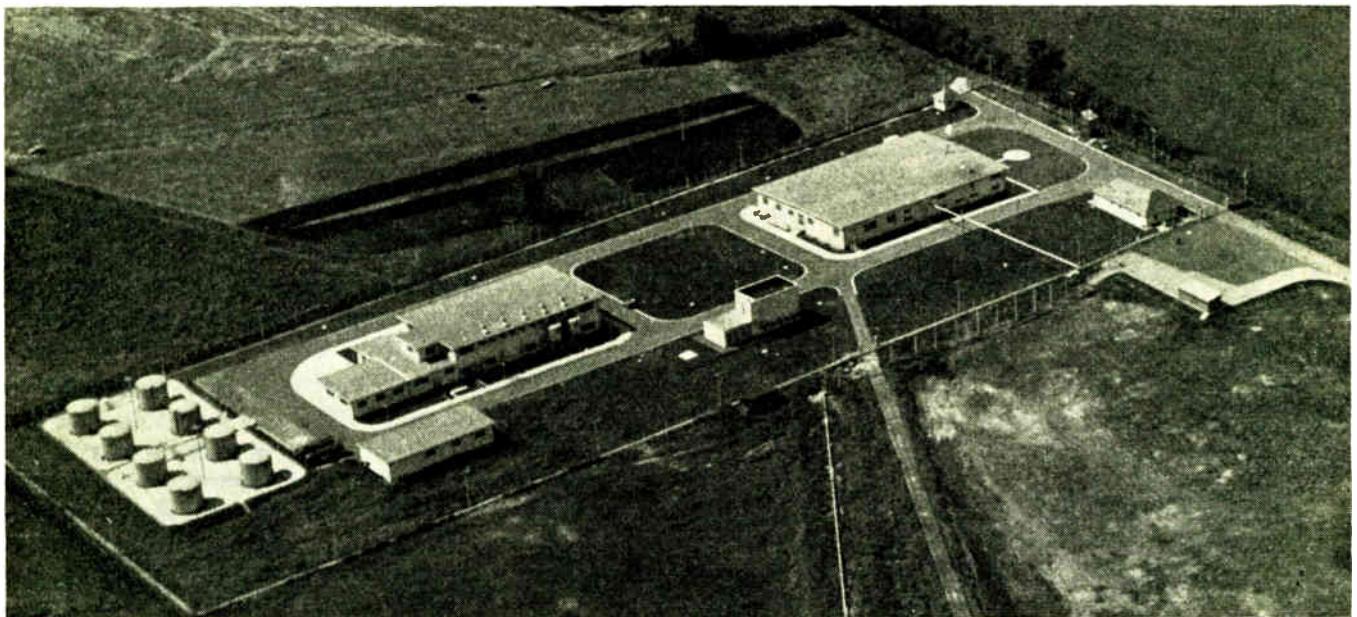

Fig. 1—View of transmitter building area from atop 837-foot antenna.

* Decimal classification: R620×R550. Original manuscript received by the IRE, November 27, 1953; revised manuscript received, March 17, 1954.

† Carl E. Smith Consulting Radio Engineers, Cleveland, Ohio.

‡ Formerly CAST Project Engineer, U. S. Information Agency, Munich, Germany; now with Continental Electronics Manufacturing Co., Dallas, Texas.

§ Continental Electronics Manufacturing Co., Dallas, Texas.

struction. Within three months it was possible to move in the transmitter and power plant components.

Except for the transmitter, diesel engines, generators, and switchboard, and the antenna tower, all equipment is of German manufacture. Probably one of the most important factors in speed of construction was very quick

delivery of such items as pumps, motors, copper, and iron. Another factor is the efficiency of German workmen supervised by their engineers and foremen.

The finished plant is indeed a complete "little city" with its own electric power, water and sewage systems, roads, sidewalks, telephone exchange, and fire alarm system. See Fig. 1. On August 31, 1953, just fifteen months after excavations on the Erching marshland began, the most powerful radio broadcasting station in Europe began its regular transmissions of the Voice of America.

DIESEL POWER PLANT AND COOLING TOWER

An investigation of local power availability revealed that the German power company could not guarantee continuity of service for the next five years, because their power plants, which are mostly hydroelectric, are already operating near full load. Furthermore, if power were to be bought from the local company the USIA would have to install a high-tension transmission line and substation and if diesel generators were installed for stand-by use the amount of their use would be limited by the power company regulations. Also, expensive high-capacity frequency changers would be required to change from 50 to 60 cycles per second.

With this information at hand it was decided to con-

struct a complete diesel-engine-driven electric plant. Five Worthington Pump and Machinery Corp. SDR-8 1320-horsepower diesels and one Chicago Pneumatic 298-horsepower diesel provide a total power of 5,200 kilowatts at 4,160 volts and 60 cps. See Fig. 2.

The diesel plant building which is 180×80 feet also houses the workshops, garage, and office. See Fig. 3. It is unique in design in as much as the engines are cooled by a "vapor-phase" system. The cooling water is kept at such a pressure that the temperature is maintained higher than 212 degrees F. It is circulated by the usual jacket water pumps and finally flashes into steam in the "vapor-phase unit" when the pressure head is released. The vapor-phase system results in higher efficiency of diesel operation and lower maintenance costs, and the steam generated is used to heat buildings and make distilled water. Excess steam is condensed by raw water which is pumped to the cooling tower.

The specially designed cooling tower of reinforced concrete construction is located conveniently for installing the 12-inch diameter raw water piping from it to the transmitter and the diesels. Nine hundred gallons of water per minute is pumped from the transmitter heat exchangers, and six hundred gallons per minute from the diesel heat exchangers, to be cooled in the

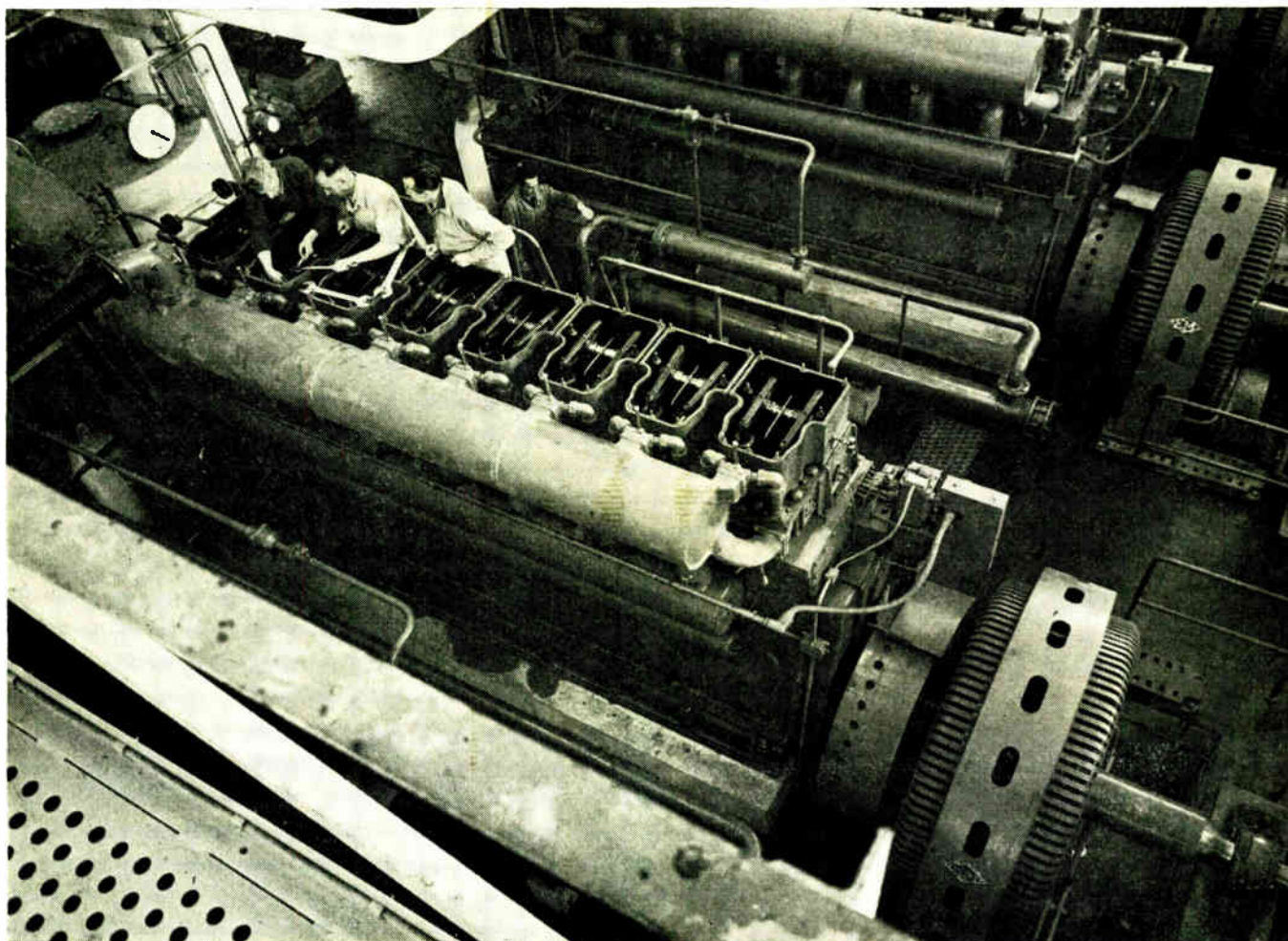

Fig. 2—View showing one of five diesel engines with the valve covers removed.

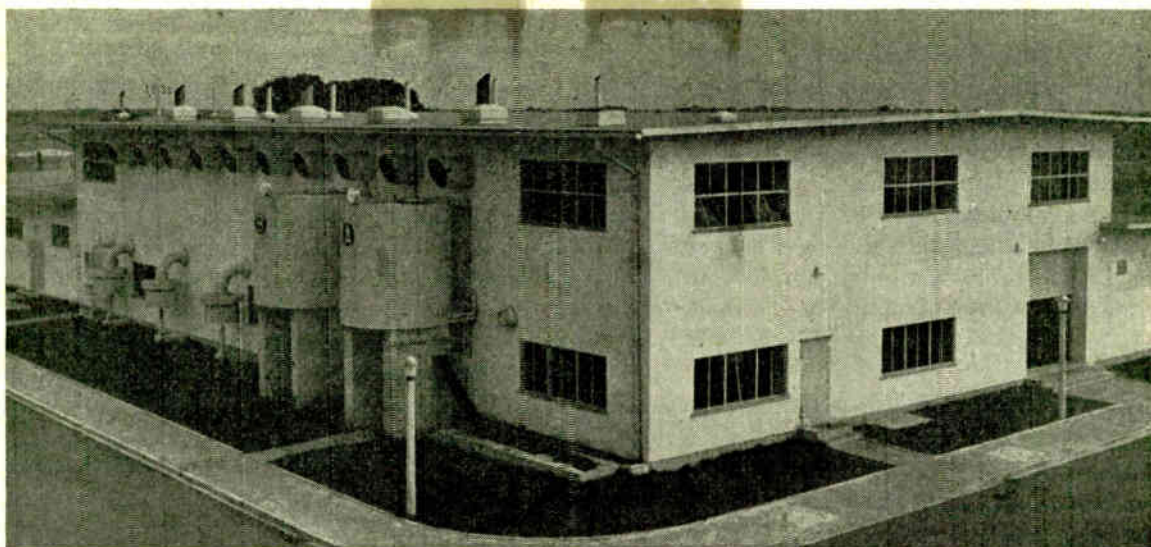

Fig. 3—Diesel power plant building.

tower by forced draft from ten four-foot diameter, five-horsepower electric blowers. The raw water is treated with acid and phosphate to “soften” it before its use in the heat exchangers. All controls and operation are automatic. See Fig. 4.

LONGWAVE-BAND AM-BROADCAST TRANSMITTER

The longwave transmitter used at the CAST Site is a modification of the Continental Electronics Type 105B Standard Broadcast AM transmitter built for operation on frequencies between 540 and 1,600 kilocycles with a carrier power of one million watts. A number of these transmitters have been delivered to the Government for use in the Voice of America program, one of them being shipped to the CAST location. See Fig. 5, page 1225.

In August, 1952, the design of a modification to change the frequency range of this transmitter to the European longwave band was authorized. This modification was designed, constructed, and power-tested, and shipped to the CAST Site in January, 1953, as a complete set of frequency conversion parts. The converted transmitter has been designated the Continental Electronics Type 105B-LW.

Except for the frequency-determining components, the standard band transmitter and the European longwave-band transmitter are identical, and a general description will apply to both. This will be followed by a short discussion of the changes made to permit operation in the longwave band.

Dual 500 Kilowatt Transmitters

The million-watt transmitter actually consists of two practically independent 500 kw transmitters, either of which may be operated separately, while the other unit is serviced or operated into a phantom antenna for test purposes. See Fig. 6. A network is used to combine the outputs of the two 500 kw transmitters and deliver the million-watt carrier power to a single transmission line. With combined operation, a single crystal oscillator is

used and a phase control network at the input of the “slave” transmitter is provided to bring the output of the two transmitters in phase.

Combining Network

The combining network utilizes a lumped component hybrid network, consisting of three 90-degree phase delay networks and one 90-degree phase advancing network connected in a continuous ring.¹ The location of this network is shown in Fig. 7, page 1226.

The result of using this network together with a suitable switching system and a phantom load makes it possible to feed both 500 kw transmitters combined to the antenna; one 500 kw transmitter to the antenna, and the other made inoperative for servicing, or to feed it into the phantom load for test purposes.

¹ W. A. Tyrrell, “Hybrid circuits for microwaves,” *PROC. I.R.E.*, vol. 35, pp. 1294-1306; November, 1947.

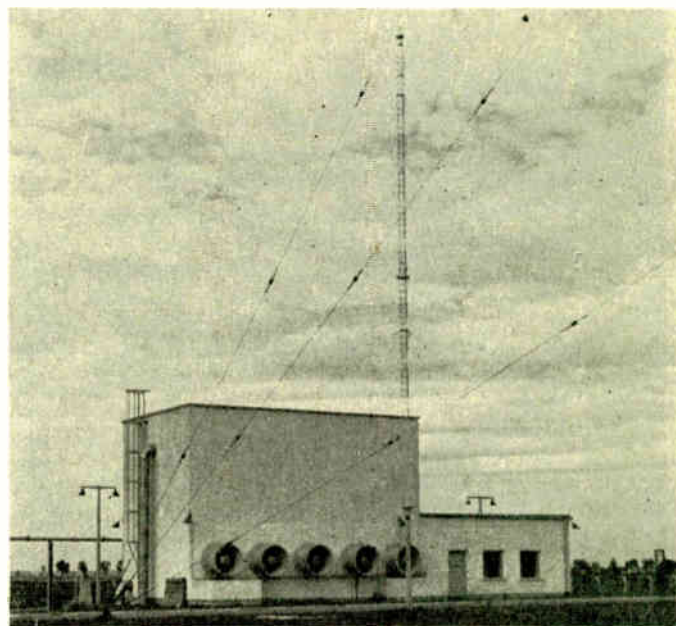

Fig. 4—Cooling tower capable of dissipating 20 million BTU per hour of heat from the transmitter and diesel engines.

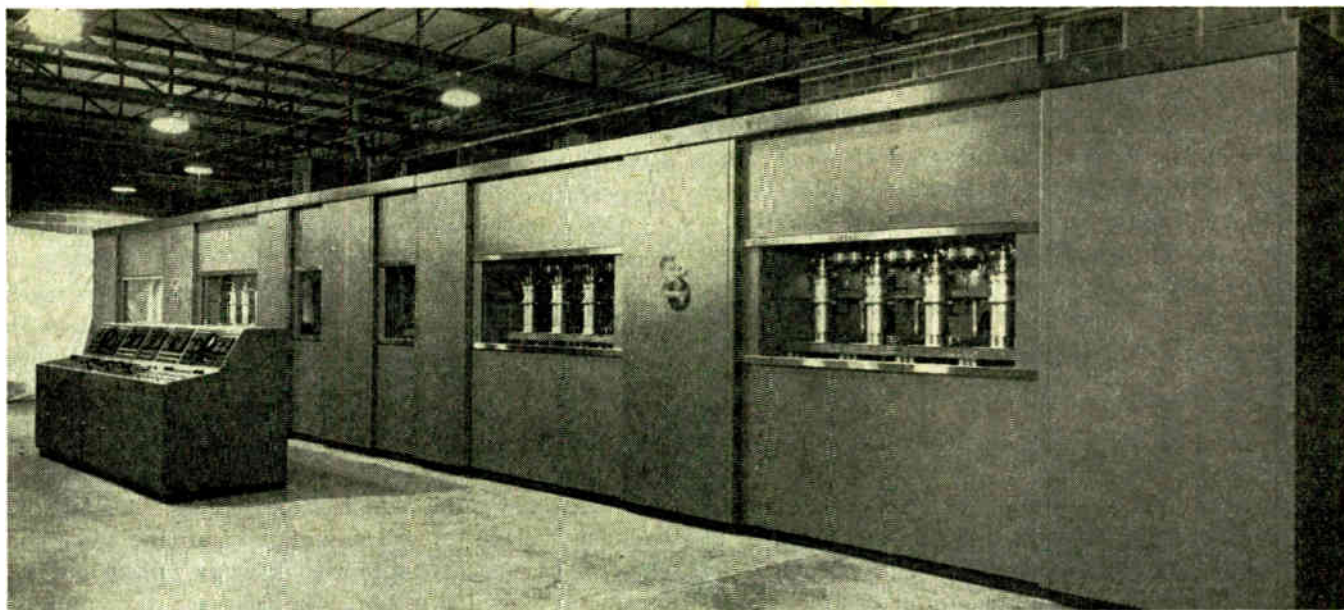

Fig. 5—Front view of million-watt transmitter and control console.

All of the transfer operations for single or combined transmitters are accomplished instantaneously by push-button control from the transmitter console.

Transmitter Circuit

Low-level modulation with a high-efficiency linear power amplifier² to raise the output level to 500 kilowatts is used in each of the two 500 kw transmitters. The selection of this circuit was based on: (1) The desirability of eliminating the heavy-modulation components which would be required for high-level modulation at this power level; (2) Reduced operating hazard for the high-power vacuum tubes; (3) The linear amplifying system makes possible the application of over-all feedback from the radio frequency output of the transmitter resulting in a simple system for reducing noise and distortion; (4) High over-all efficiency is obtainable, especially at high levels of modulation; (5) The circuit simplification resulting from the elimination of the high-powered audio system which would be required for high-level modulation.

The high-efficiency linear amplifier is driven by a single-tube, grid-bias modulated amplifier. Radio-frequency drive for the modulated amplifier is obtained from a push-pull amplifier using two Type ML-357B tubes with an output of approximately 1,800 watts. This stage is driven by a single 813, preceded by an 807 buffer stage which receives its excitation from the crystal oscillator tube.

The audio system consists of three voltage amplifiers using 807 tubes in the first two stages and an 845 in the third stage. This drives a cathode-follower modulator using four 845 tubes in parallel, which grid bias modulates the modulated amplifier.

The over-all efficiency of the entire transmitter from substation to antenna is slightly better than 50 per cent at the carrier condition and increases to approximately 54 per cent with 100 per cent tone modulation.

² W. H. Doherty, "A new high efficiency power amplifier for modulated waves," Proc. I.R.E., vol. 24, pp. 1163-1182; September, 1936.

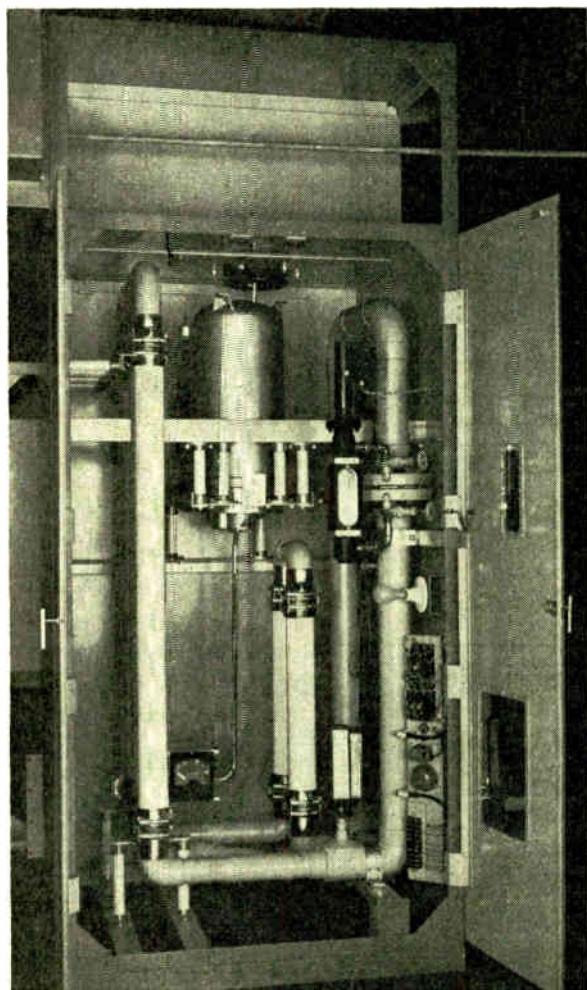

Fig. 6—Interior view of phantom antenna.

Power Tube

The tube selected for the 500-kw power amplifier is the Machlett ML-5682. This tube has a 100-kw plate dissipation rating and a nominal peak output rating of 250 kilowatts. The most important factors leading to the selection of this tube were: (1) Small size ($23\frac{1}{4}$ inches high); (2) Very high transconductance; (3) Low filament power consumption; (4) Ease of removal, requiring only a 45-degree turn in its bayonet-type socket; (5) Its light weight (approximately 50 pounds), making it removable by one man. The tube has a water-cooled anode and a small amount of air is blown on the filament seals. No cooling is required for the grid seal for use in frequencies of the standard broadcast band and lower. See Fig. 8, page 1228.

Eight of these tubes are used for a 500 kw amplifier, four in parallel being connected as the carrier tubes of the high-efficiency amplifier, with four more in parallel as the peak tubes. The modulated amplifier uses a single tube of the same type.

The use of these high-gain tubes in the 500 kw amplifier resulted in a power gain of 33 to 35, a fairly high figure for a linear amplifier using triodes.

Rectifiers

Each 500 kw transmitter has its own 15 kv plate rectifier, utilizing six General Electric Type GL-870A mercury-vapor rectifier tubes. Since each of these tubes is rated at an average current of 75 amperes, the six-tube rectifier is capable of delivering 225 amperes at 15,000 volts insofar as the tube complement is concerned.

A bias-rectifier unit provided for each 500 kw transmitter contains three bias rectifiers, supplying bias for the modulated amplifier, the peak tubes of the power amplifier, and the carrier tubes of the power amplifier.

Driver Unit

The driver units which supply audio- and radio-frequency drive for the modulated amplifiers are constructed as separate units with their own plate and bias rectifiers. The driver unit, the bias rectifier, and the 15 kv plate rectifier tube assembly for each transmitter are installed together as a complete assembly with the trans-view type of glass door cabinets as shown in Fig. 9, page 1228.

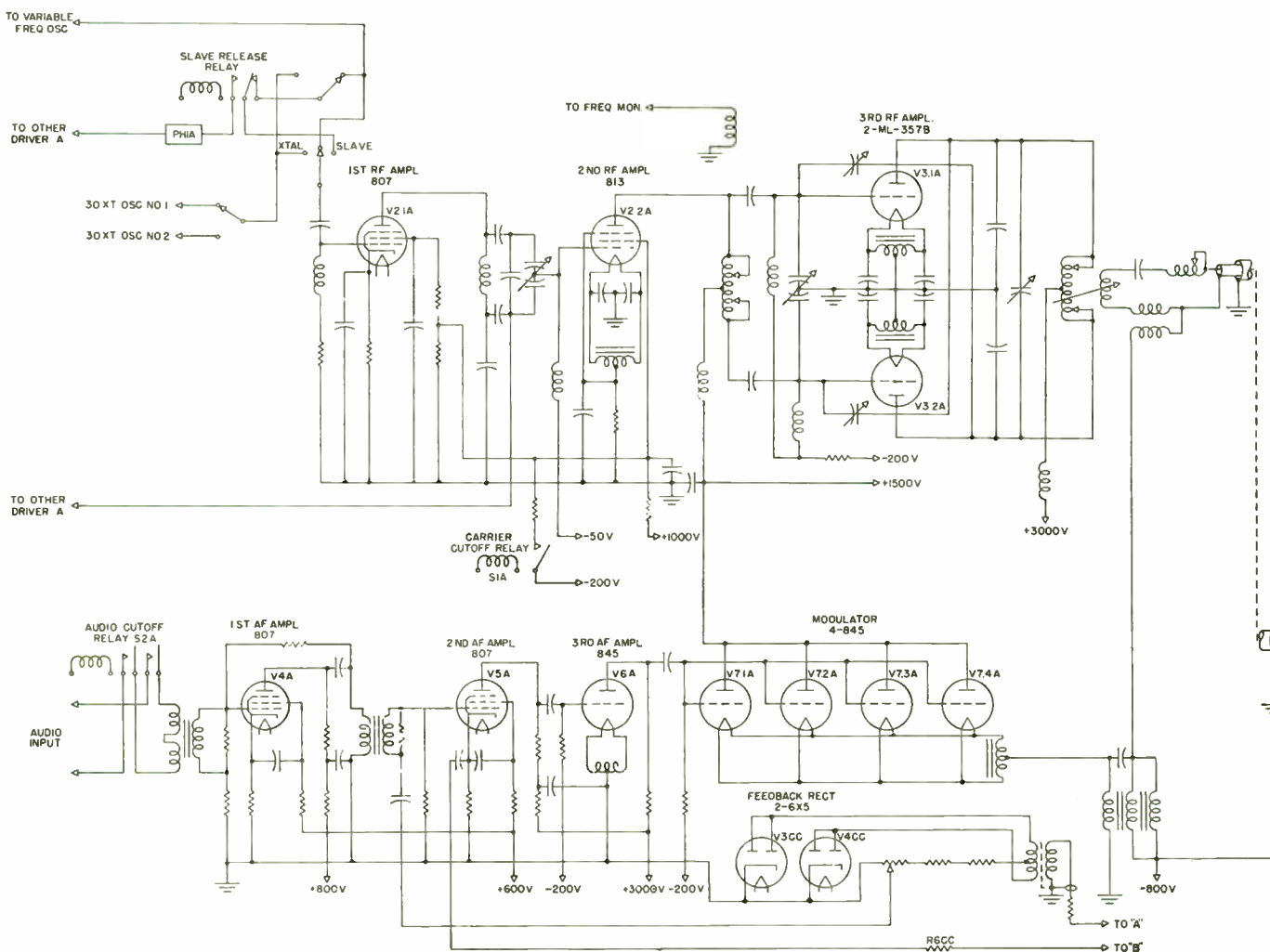

Fig. 7 (left half)—Type 105B transmitter fundamental rf and af circuits schematic.

Power Components

The power components for each transmitter are installed in separate vaults. These include the plate transformers for the 15 kv rectifier, the filter choke, filter capacitor bank which utilizes sixty 2 microfarad, 20 kv units, and a motor-operated, high-voltage grounding switch, the control of which is interlocked with door switches and electric door locks on the transmitter cubicles for the protection of personnel from dangerous voltages.

Physical Construction

The two 500 kw amplifiers with their associated modulated amplifier are built in mirror-image construction with the two modulated amplifiers side by side at the center of the assembly. The over-all length of the complete assembly is 62 feet. The combining network is located directly behind the two modulated amplifiers, between the output circuits of the two power amplifiers. The phantom antenna is constructed in a separate cubicle located about 4 feet behind the combining network cabinet.

A control and tuning console is provided for installation directly in front of this main transmitter assembly as shown in Fig. 10 on page 1229. This console contains

metering for all of the transmitter equipment except the drivers and bias rectifiers. Also located on the console are all-power control relays, switches, and individual tube protection over-load relays. The power controls are located at the center of the console assembly and on each side there is located a tuning console, one for transmitter No. 1 and the other for transmitter No. 2. These tuning consoles contain the individual cathode-current meters for the amplifier tubes and pushbutton control of motor-operated tuning devices in the amplifiers. Synchronous type indicators showing the setting of the tuning components are also located on the console panel. Each tuning console contains a feedback rectifier, an audio-monitor rectifier, and a rectifier tube associated with a protective circuit providing cutoff of the radio frequency excitation in case of arc-over in the output or antenna circuit.

Longwave Conversion

With the operating frequency in the longwave broadcasting band, the problem of sufficient bandwidth for modulation products becomes more formidable. However, good voice intelligibility and reasonably good musical quality can be obtained with a system passing no higher than 5,000 cps.

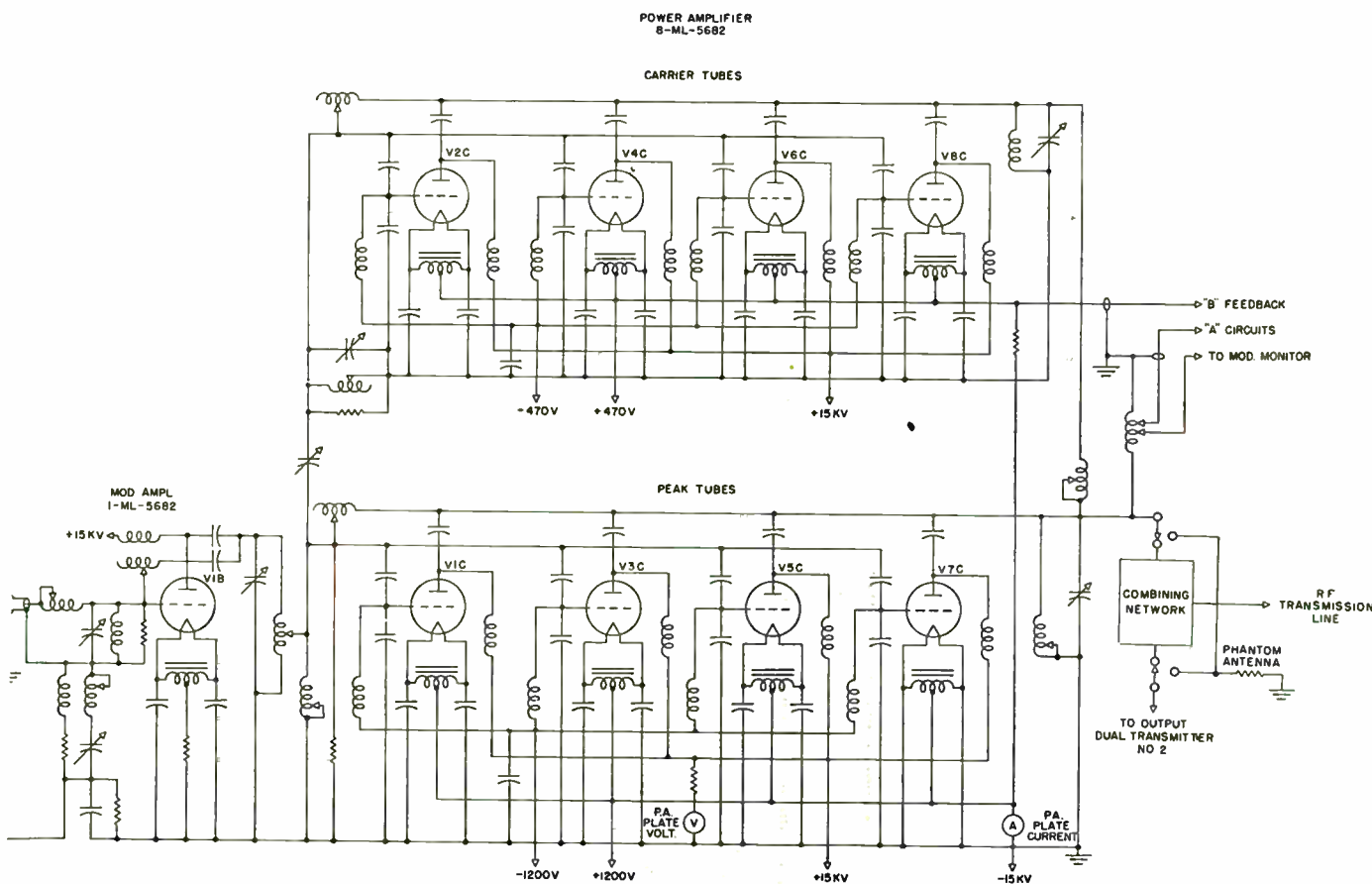

Fig. 7 (right half)—Type 105B transmitter fundamental rf and af circuits schematic.

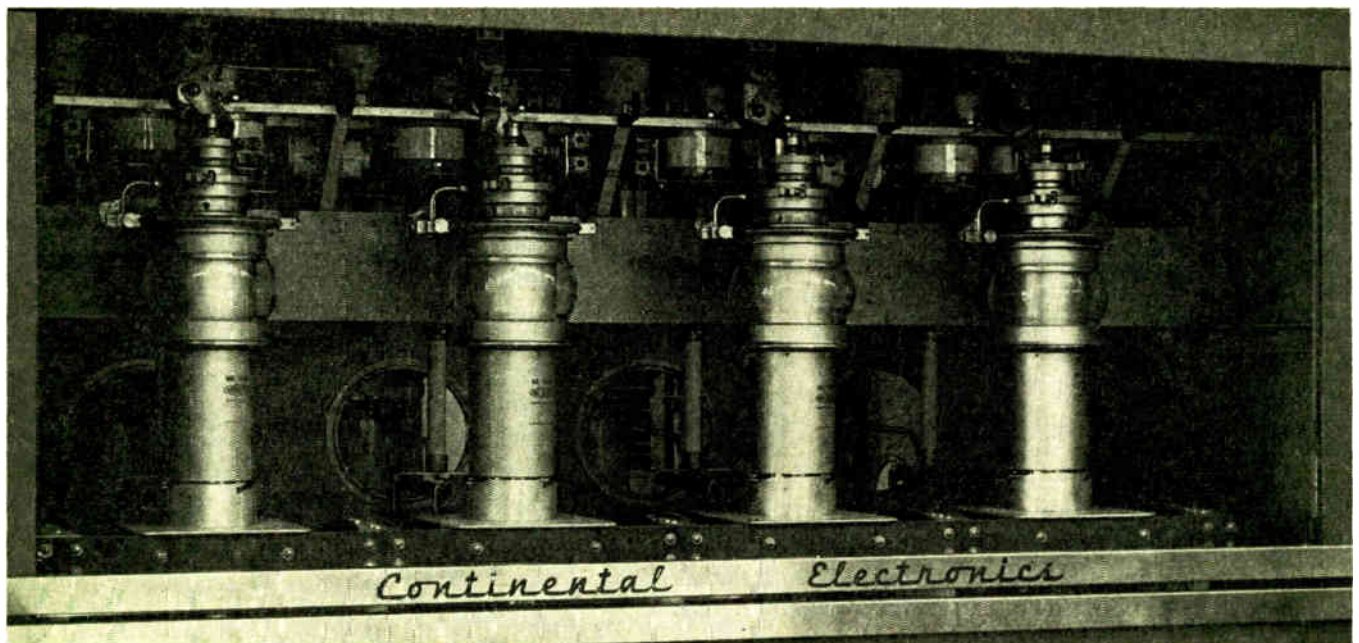

Fig. 8—View of 4 of the 18 high-power amplifier tubes.

By careful design of the audio system and over-all feedback circuits a large amount of feedback can be obtained with good stability.

In addition to the changes in the frequency determining components, it was necessary to increase the capacity of all blocking and bypass capacitors and increase the inductance of certain radio frequency chokes for the longwave operation. Multilayer bank wound coils were used in some positions.

The inductances required for low-frequency operation in the tuned circuits are not as large as might at first be expected. This is because of the relatively low impedances in the circuits of such a high-powered transmitter. For example, the plate-to-ground output impedance for the 500 kw amplifier is less than 40 ohms so that an output tank circuit designed for a kva/kw ratio of 3 requires an inductive reactance in the tank inductor of only 13 ohms. Another factor is that the conductor resistance reduces as the square root of the frequency and therefore some reduction in the conductor size used in the inductance is permissible. This allows an increase in inductance by reduction of the winding pitch, resulting in smaller over-all dimensions for the coil. All of the low frequency inductors followed conventional design with the exception of the output tank inductor shown in Fig. 11 on page 1230.

This position required an inductance of approximately 12 microhenrys capable of carrying 350 amperes. Because of losses anticipated in shielding the external field of such a coil, a design was selected which obtains the required inductance with practically no external field and with an extremely high "Q" factor.³ The winding takes the form of a toroid wound in two half coils so that the coil terminals are at either side of the toroid, placing the two half-coils in parallel. This arrangement makes the coil appear internally as two equal multi-turn coils aiding whereas externally it appears as two opposed half-turns with equal current. This results in a greater reduction of external field than in the ordinary toroid, and since the coil terminals are separated with the voltage gradient divided equally around the half coils, the inductor is applicable for high-voltage service.

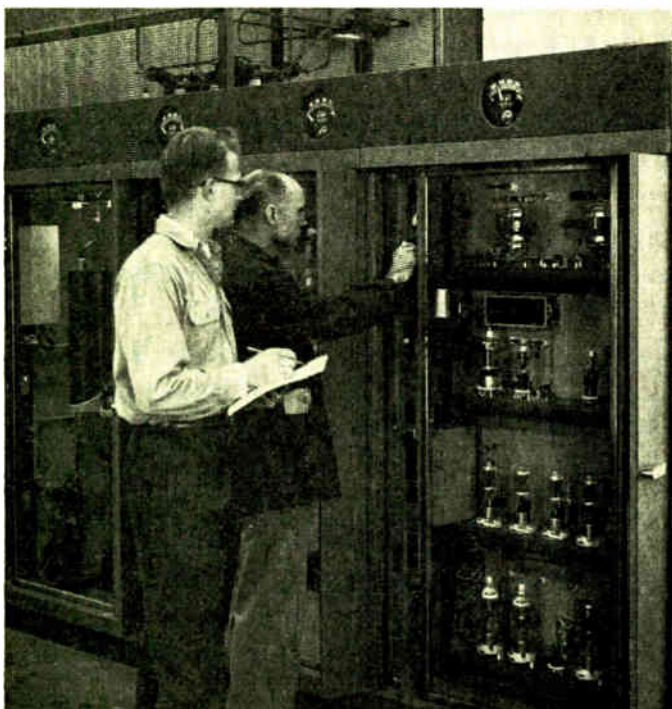

Fig. 9—T. G. Chadbourne and T. J. Copeland making adjustments on the exciter/driver unit.

³ R. Gunn, "The torusolenoid," *Proc. I.R.E.*, vol. 15, pp. 797-808; September, 1927.

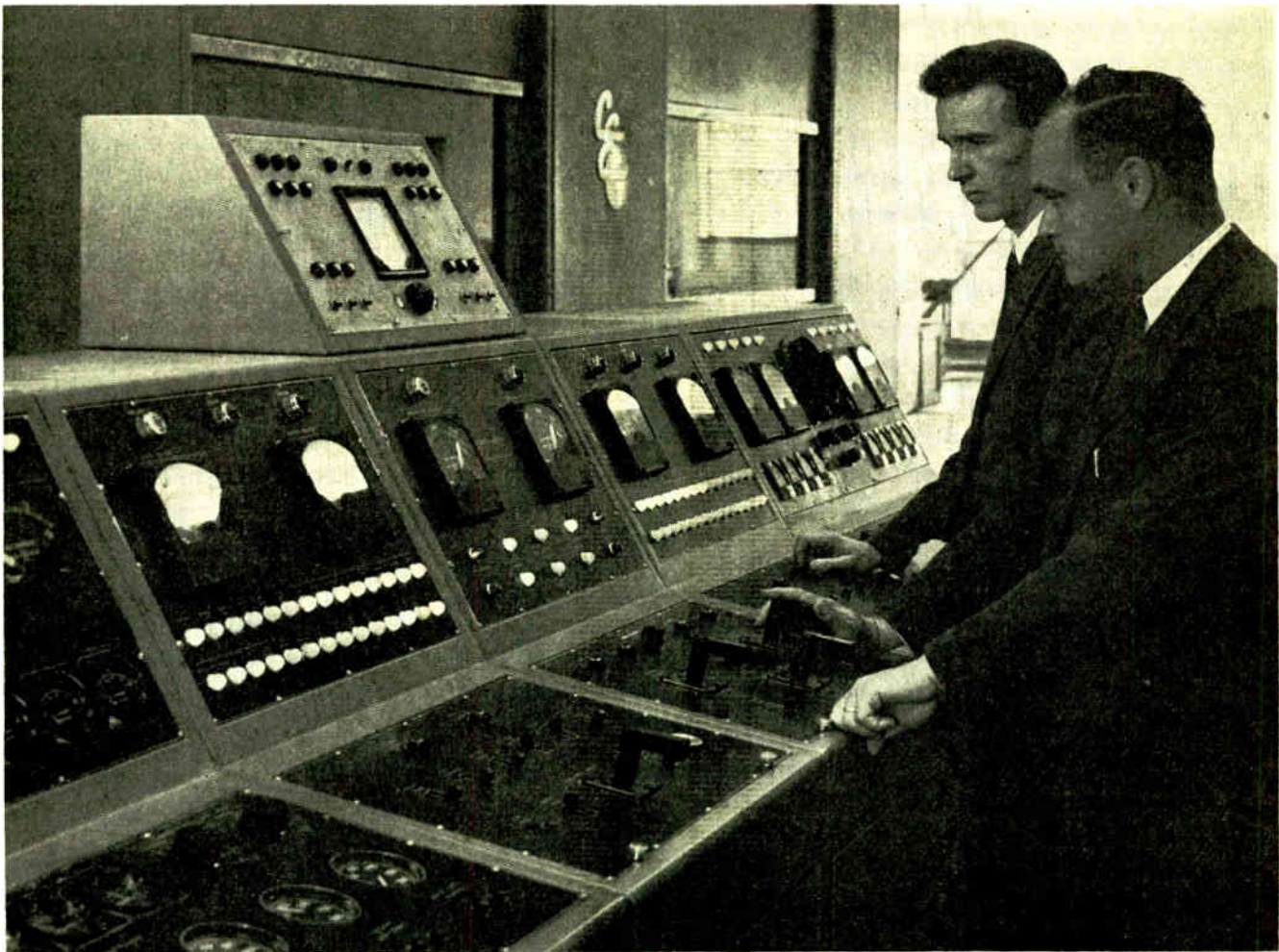

Fig. 10—In the foreground C. M. Finley, Construction Supervisor, is shown assisting J. R. Hall, Project Manager, making adjustments at the control and tuning console.

In the present application of this design, the turns of the coil are constructed of wide metal strips which almost completely enclose the internal area of the toroid, leaving only a small clearance between turns. This results in a much higher "Q" than in a similar wire-wound coil because all of the inner surface is utilized due to the fact that the magnetic flux lines produced in the coil are smooth and tangent to the conducting surface. It was found possible to use an inductance of this type approximately 3 feet high by 3 feet outside diameter with an inductance of 12 microhenrys carrying a current of about 350 amperes without water cooling.

In the standard band million-watt transmitter the capacitors used in the output tank circuit and in the matching networks are of standard gas-filled types.

A special line of oil-filled capacitors was developed to be installed in place of the gas-filled type. These specially designed capacitors satisfy the large capacity requirements for longwave operation and withstand the unusually high voltages and currents encountered. For example, currents in the order of 400–500 amperes, and voltages of 40 to 50 kilovolts per capacitor, with capacities ranging up to 100,000 micromicrofarads, are involved. See Fig. 12, page 1230.

Performance

Typical performance characteristics for one 500 kw unit operating into the phantom antenna on various frequencies in the standard broadcast band are shown in Fig. 13, page 1231.

The performance of the low-frequency transmitter showed only slightly higher distortion and a frequency-response flat within 0.5 db from 100 to 5,000 cps, and within 2 db from 50 to 10,000 cps. The noise level was 55 db below 100 per cent modulation. The carrier shift was –3 per cent at 90 per cent modulation, and –5 per cent at 100 per cent modulation.

FEEDER NETWORK AND CORONA PROBLEMS

The longwave antenna system feeder network consists of a π -section coupling network at the transmitter; a 60 ohm transmission line that is 12 inches in diameter, and a T-section coupling network at the base of the antenna. The coupling networks were selected so that the transmitter load was a parallel resonant point.⁴

⁴ W. H. Doherty, "Operation of AM broadcast transmitters into sharply tuned antenna systems," *Proc. I.R.E.*, vol. 37, pp. 729–734; July, 1949.

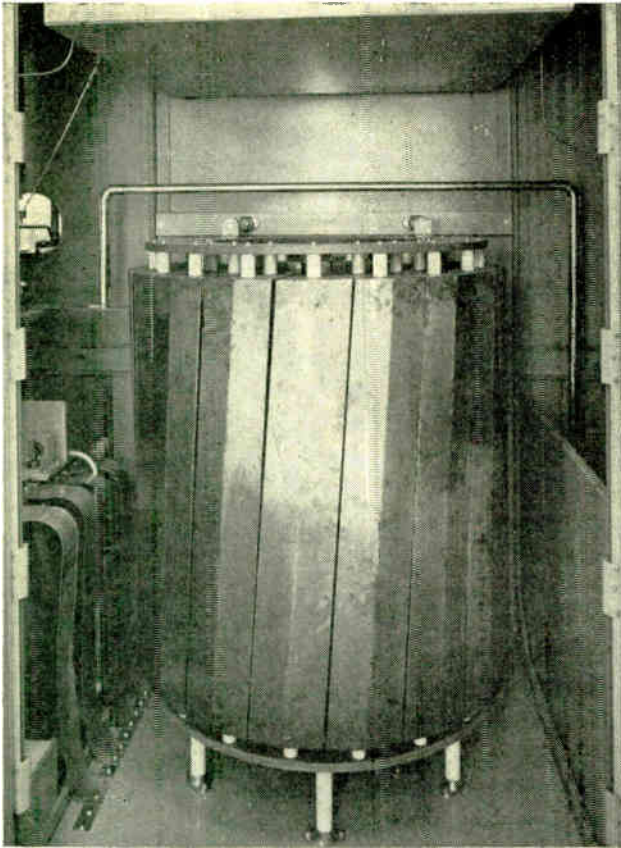

Fig. 11—Output tank inductor is high-current toroid.

The transmission line, manufactured by Telefunken Company, was specified to have an impedance of 60 ohms. Refined characteristic impedance measurements revealed $Z_0 = 60 - j 0.12$ ohm. A 90-degree mitered elbow and spacer-insulator construction is shown in Fig. 14. A vertical section and a horizontal length of the coaxial line is shown in Fig. 15. Note the earth embankment to protect the line. The concentric line is terminated in the tuning house as shown in Fig. 16 on page 1232, with provision made for several feet of expansion. The concentric line is pressurized enough to keep out moisture.

The transmission line is protected by a Telefunken protection device which also gives a continuous indication of standing-wave ratio and power radiated in megawatts. For instantaneous values of standing-wave ratio greater than 1.4 the transmitter is instantly turned off by this device.

When the transmitter was first fed into the antenna using high power, corona developed at several points. Corona rings had to be placed around the insulator plates covering the oil-filled capacitors in the transmitter proper and in the tuning house. With corona rings it was possible to take care of the difficulty.

In the tuning house it was not possible to obtain over 20 per cent modulation before corona streamers jumped from the antenna-capacitor case to the copper-covered

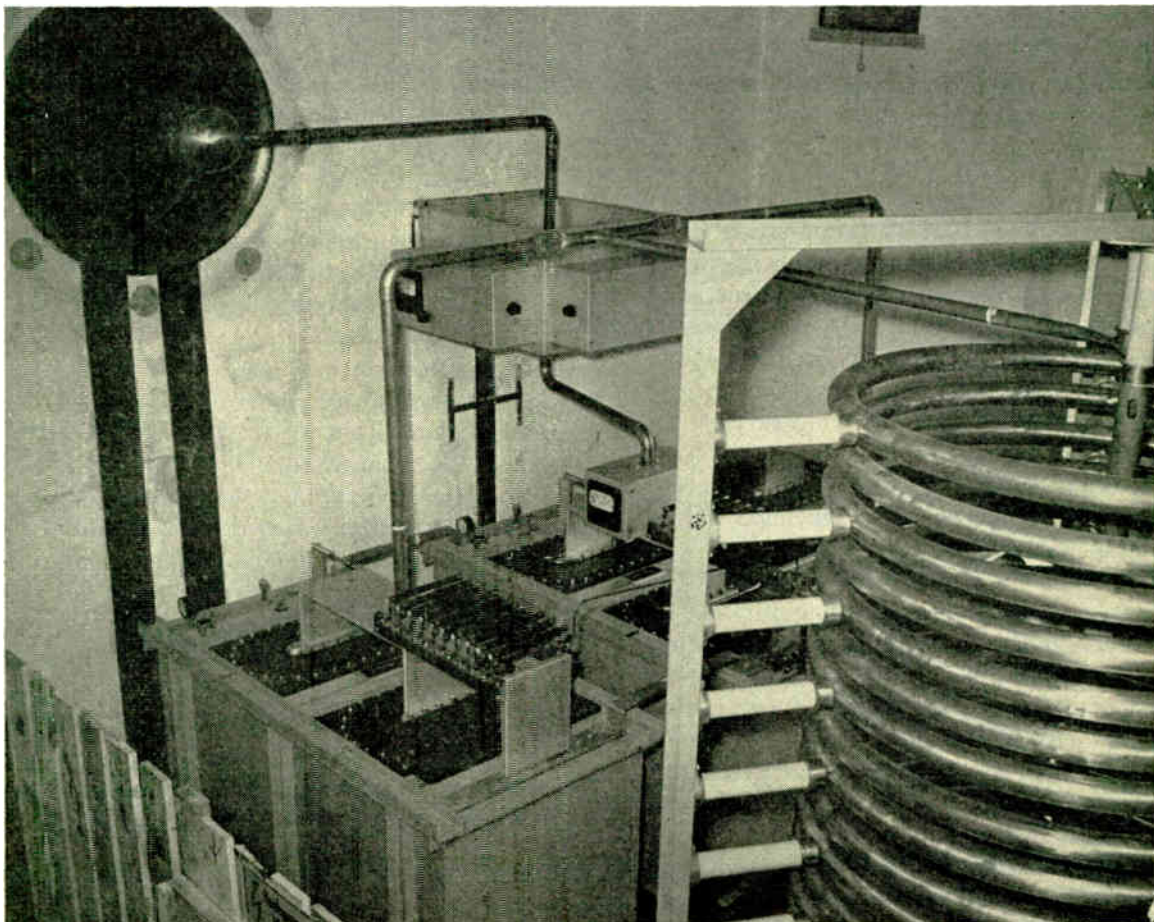
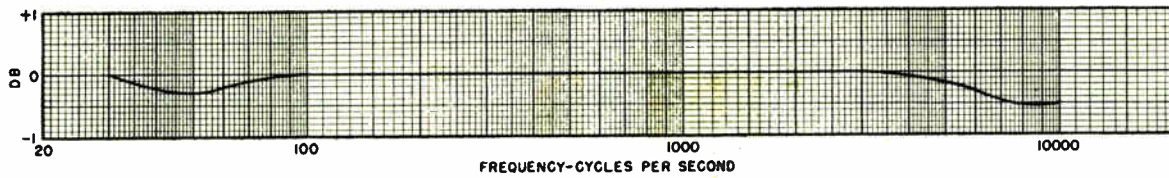
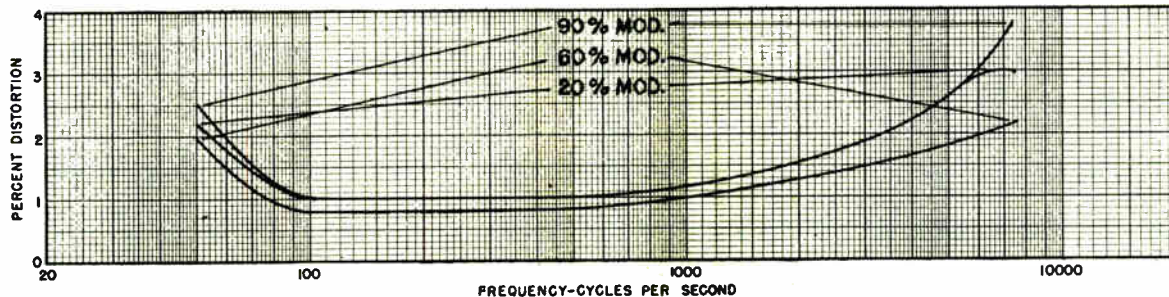

Fig. 12—View inside antenna tuning-house showing antenna-entrance lead, oil-filled capacitors, and large inductance coil.



AUDIO FREQUENCY RESPONSE



AUDIO FREQUENCY HARMONIC DISTORTION

NOISE: 61 DB BELOW 100% MODULATION
 CARRIER SHIFT FROM 0 TO 100% MODULATION: 0
 FINAL STAGE EFFICIENCY: 62%
 OVERALL EFFICIENCY: 50% AT CARRIER TO 54% AT 100%

Fig. 13—Transmitter-performance characteristics in standard broadcast band.

floor, and the Telefunken device operating on the transmission line standing-wave ratio would take the transmitter off the air. By using corona rings it was possible to increase the modulation to 60 per cent. And finally, by reversing the connections on the capacitor next to the antenna the case voltage to ground was reduced 11,000 peak volts and from then on it was possible to modulate the transmitter 100 per cent.

LONGWAVE ANTENNA SYSTEM

Although there is reasonably good information in the literature⁵ concerning the performance of short antennas

⁵ C. E. Smith and E. M. Johnson, "Performance of short antennas," PROC. I.R.E., vol. 35, pp. 1026-1038; October, 1947.



Fig. 14—90-degree mitered elbow- and spacer-insulator of 12-inch concentric line.

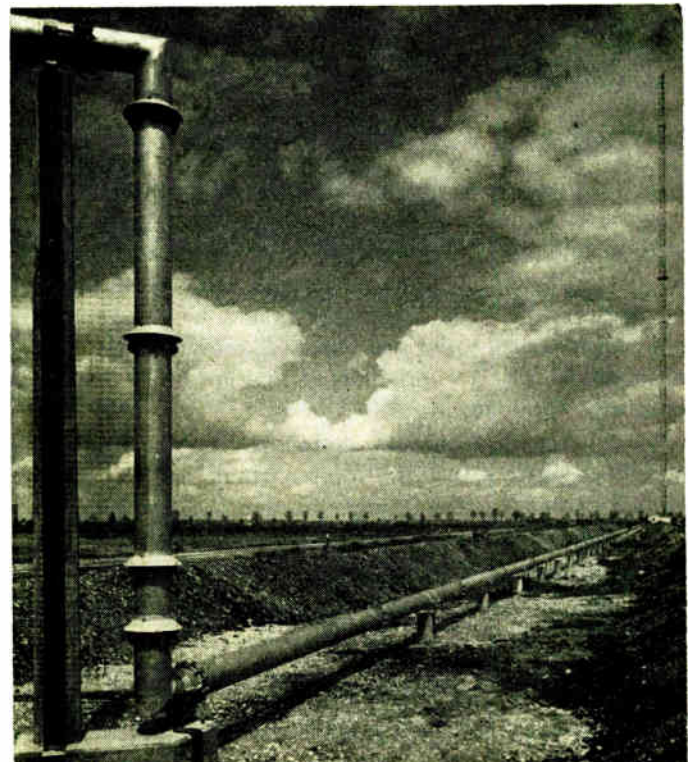

Fig. 15—Concentric line with 835-foot tower in background.

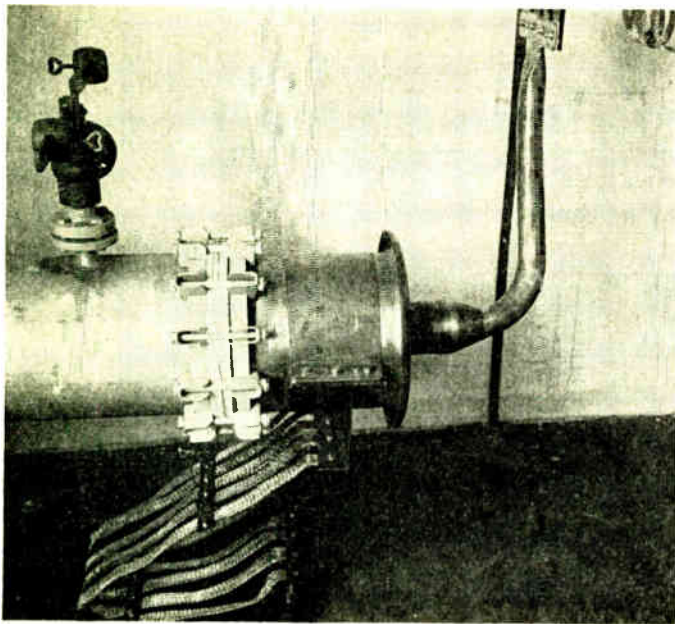

Fig. 16—Concentric-line termination in tuning-house.

240-Foot Scale Model Tower With 8 Umbrella Cables

Base impedance and field intensity measurements were made as a function of the top-loading umbrella angle β . These measurements made at 610 kc and plotted in Fig. 17 show that the base-resistance, base-reactance, and unattenuated field intensity, at one mile, all increase as the top-loading angle β increases.

A family of scale-model base-resistance measurements have been plotted in Fig. 18 for various angles of β as a function of antenna height, in degrees, thus making it relatively easy to estimate the base resistance for actual operating frequencies over the range of scale-model measurements. A similar set of curves for base reactance have been plotted in Fig. 19.

240-Foot Scale-Model Tower With 12 Umbrella Cables

Having determined that the top-loading angle $\beta = 50$ degrees was the largest practical angle that could be used on this project it was decided to increase the number of top-loading cables to 12 and vary their length for optimum results. Base-resistance, base-reactance, and unattenuated field intensity, at one mile, was measured at 610 kc and plotted in Fig. 20 for various lengths of top-loading cable.

A family of scale-model base-resistance measurements have been plotted in Fig. 21 for various lengths of top-loading cable as a function of antenna height. A similar set of curves for the base reactance are plotted in Fig. 22. For antenna heights above 85 or 90 degrees it is believed the curves are affected by the mutual impedance from other towers in the vicinity.

Scale-Model Tests on Guy-Cable Insulation

The main guy cables of the 837-foot tower were simulated and tests performed on the 240-foot scale-model

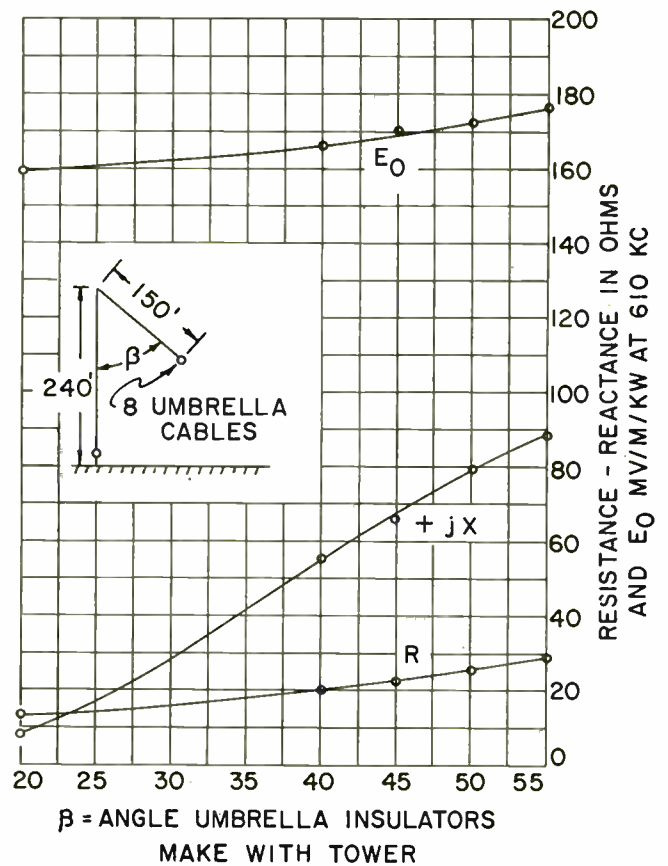

Fig. 17—Base impedance and unattenuated field intensity at one mile as a function of top-loading angle β for 8 umbrella cables.

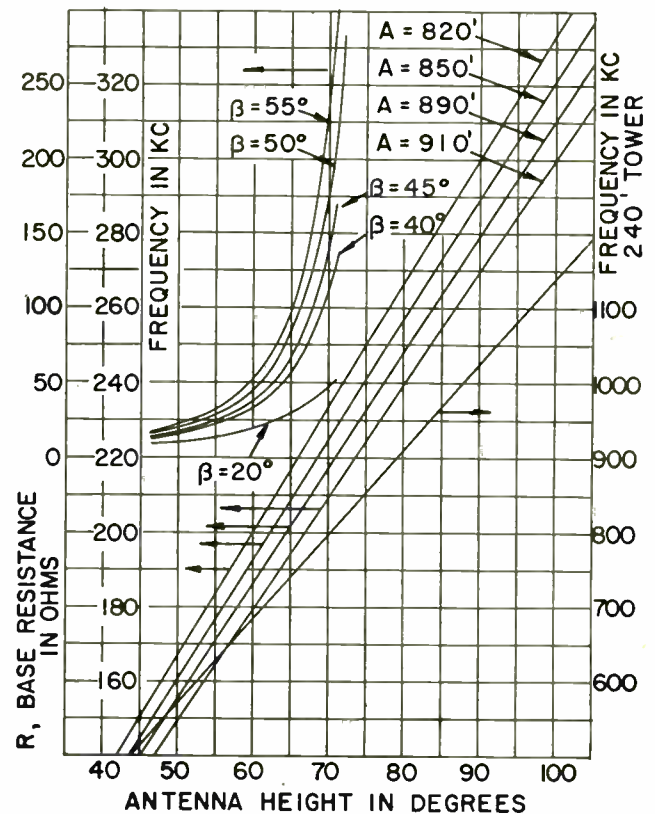

Fig. 18—Base resistance for various values of top-loading angle β for 8 umbrella cables.

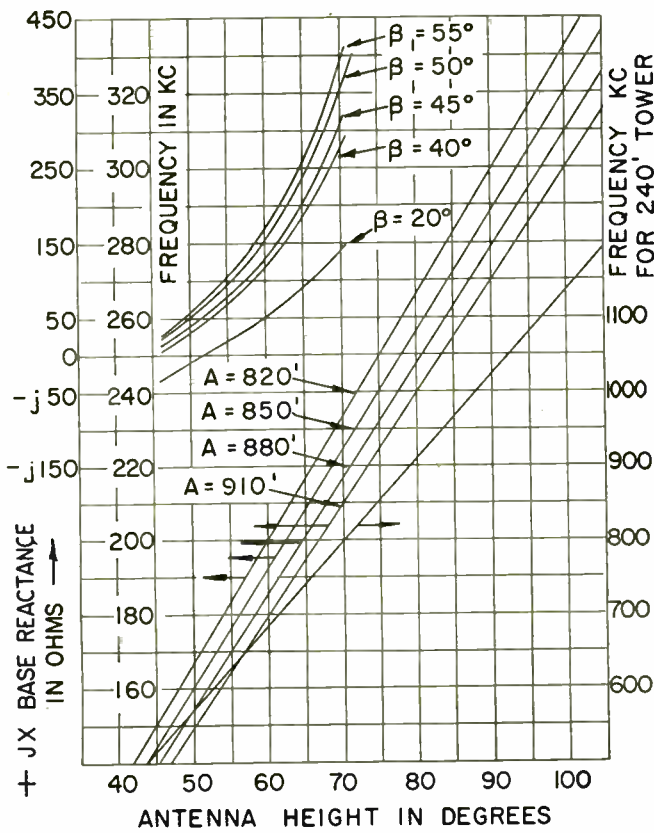

Fig. 19—Base reactance for various values of top-loading angle β for 8 umbrella cables.

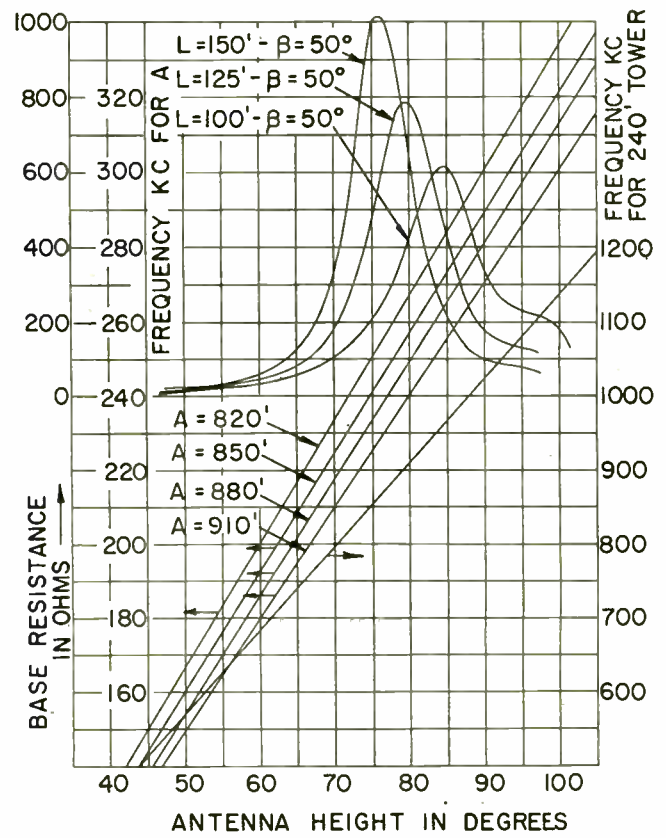

Fig. 21—Base resistance for various lengths of 12 top-loading cables in terms of antenna height.

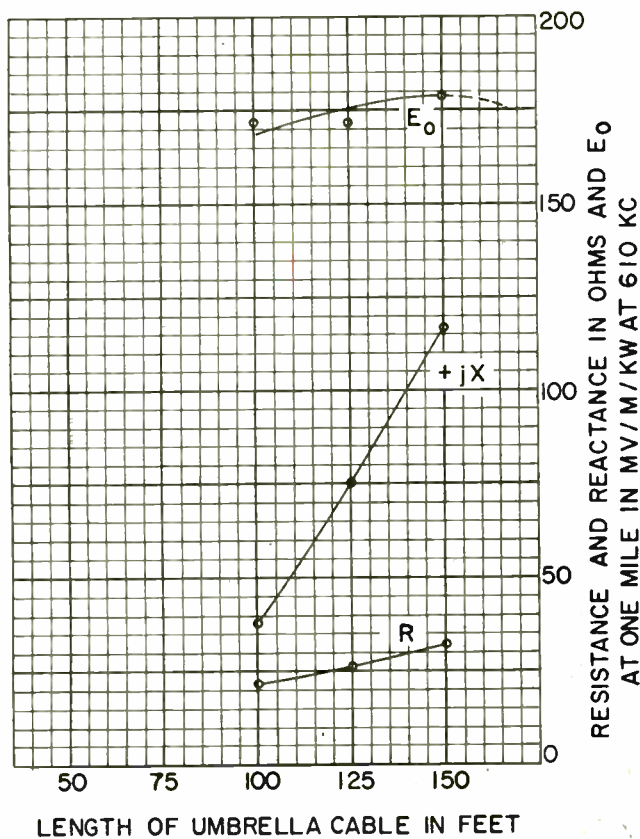

Fig. 20—Impedance and unattenuated field intensity as a function of umbrella cable length for 12 umbrella cables at angle $\beta = 50^\circ$.

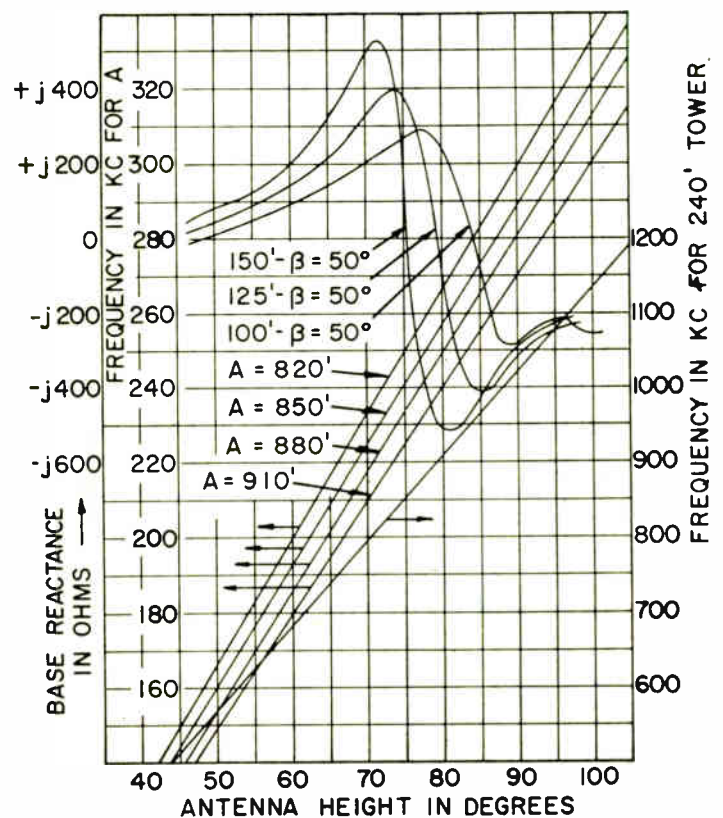

Fig. 22—Base reactance for various lengths of 12 top-loading cables in terms of antenna height.

tower. A crystal voltmeter was used across one of the simulated insulators. The voltmeter-insulator combination was moved to each guy-insulator location and a reading was taken by means of a telescope when the antenna was fed with power. The voltage measurements were first made for the normal condition of 40-foot guy-cable sections, and then for 20-foot guy-cable sections as shown in Fig. 23. It is interesting to note that the voltage across the insulators next to the tower is lower than across insulators out away from the tower. Also, when there is some cable between the tower and the first insulator the voltage across the first insulator increases as indicated in the figure.

The wet flash over voltage of the main guy insulators is about 30 kv. The final design for this tower holds the voltage to about 10 per cent of this value or 3,000 volts.

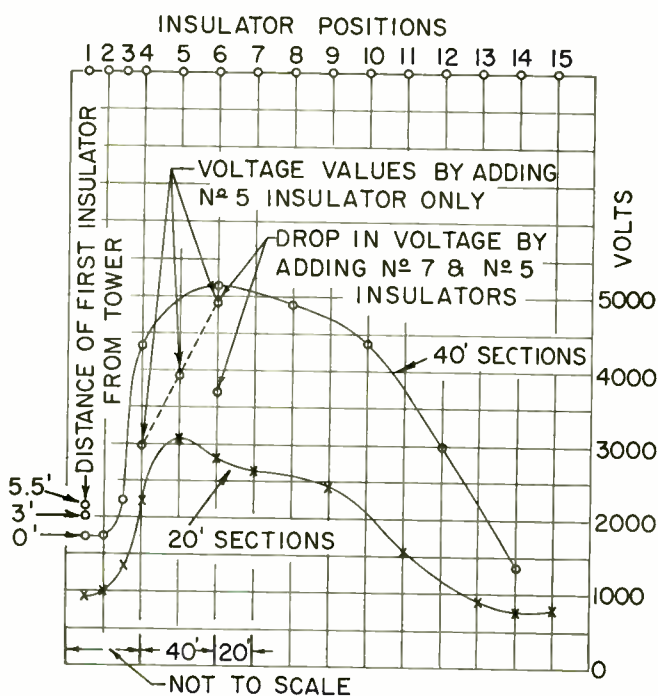

Fig. 23—Voltage values for 40-foot and 20-foot scale-model guy-cable lengths for one megawatt of power.

Top-Loading Cable Insulation

The highest electric potential on the antenna system is developed at the end of each of the 12 top-loading umbrella cables. At this point very low capacity, double rain-shield, oil-filled insulators were used. To make the design conservative, another set of similar insulators were inserted at the next insulator location in each support cable. The rest of the top-loading cable was insulated as shown in Fig. 24.

Structural Design of Antenna

It was necessary to remove 3 sections from the original 900-foot tower design in order to support the 12 top-loading cables. Then a new 15-foot top section was added to mount the flasher beacon and act as a corona shield.

Counterweight "A" frames were fabricated of steel to support each of the 12 top-loading cables. They are 20 feet high and under severe ice conditions will yield up to 39 feet of top-loading cable. See Fig. 25.

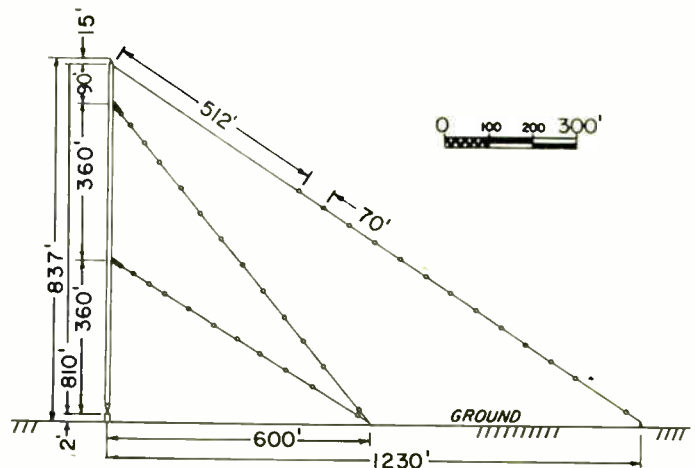

Fig. 24—Top-loading and guy-cable insulator locations.

The top-loading cables are steel-reinforced aluminum cable $\frac{3}{4}$ inch in diameter. The support cables are $\frac{7}{16}$ inch plow-steel galvanized hoist rope.

Tower-Base Insulation

The heavy-duty Austin oil-filled tower-base insulator is shown in Fig. 26. Also the Telefunken tuning-house feed through insulator and Austin tower-lighting transformer is shown in the figure. The weakest point in the system now appears to be the 8 inch spacing between primary and secondary of the tower-lighting transformer during heavy rain. If this causes trouble the transformer can be moved inside the tuning-house.

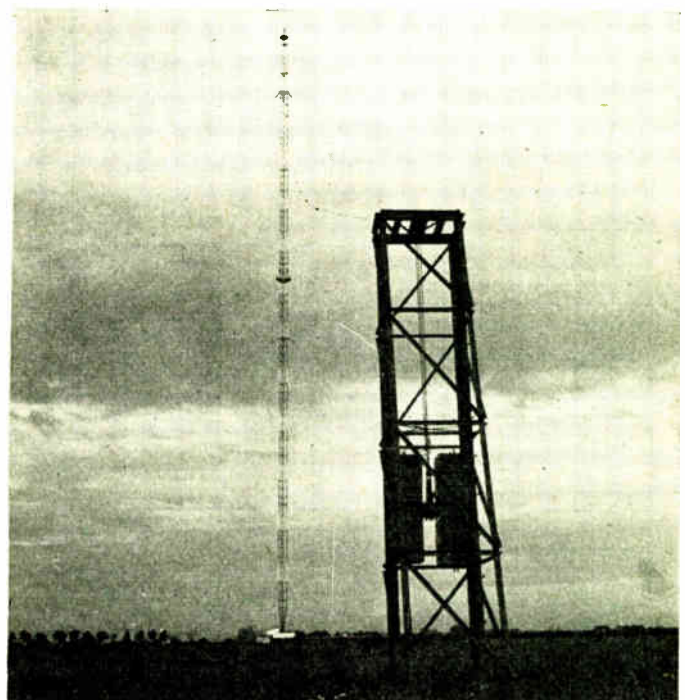

Fig. 25—Counterweight "A" frame to support top-loading cable.

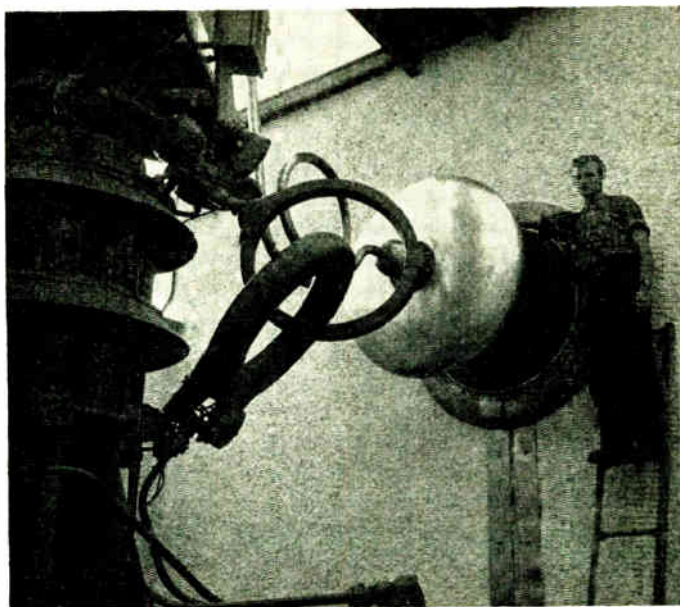

Fig. 26—Tower-base insulator, power transformer, and feed-through insulator.

Ground System

The ground system consists of an expanded copper mesh screen 96 feet in diameter around the antenna base, plus 12 radial-copper straps to carry the ground current out to the 360 No. 6 copper radials that extend out approximately 90 degrees to the edge of the prop-

erty. 180 of the radials extend out 180 degrees or 2,840 feet. All radials are terminated in a 5 foot copper-clad ground rod.

Predicted and Measured Performance

From model measurements it was predicted that the base impedance would be

$$Z_a = 28 + j101.5 \text{ ohms}$$

as compared to the measured value of

$$Z_a = 29.5 + j135 \text{ ohms.}$$

The scale-model bandwidth converted to the full-scale antenna was 35.6 kc as compared to 36.6 kc as measured on the full-scale antenna. The bandwidth was also determined more accurately in the field by computing the amount of power absorbed by the measured load over the necessary frequency range.

The measured antenna efficiency in terms of unattenuated field intensity at one mile was 5.66 volts per meter (178.9 mv/m for 1 kw at 1 mile) as compared to the scale model predicted value of 5.67 volts per meter (179.3 mv/m for 1 kw at 1 mile).

Using the equivalent distance method the field intensity was predicted to be 2 mv/m in Berlin, Germany. A field intensity measurement made in Berlin showed the field intensity to be 2.05 mv/m.

Analysis of Junction Transistor Audio Oscillator Circuits*

J. B. OAKES†, ASSOCIATE, IRE

Summary—Transistor oscillators, including Colpitts and Hartley types, have been analyzed using the low-frequency equivalent circuit for the transistor. Conditions for sustained oscillations and expressions for the frequency of oscillation and for the stability of this frequency with variation in transistor parameters have been derived for these circuits. In addition, reactance-stabilization conditions have been determined following the method which Llewellyn has applied to vacuum-tube oscillators.

INTRODUCTION

THIS PAPER is the outgrowth of a project having as a goal the transistorization of several audio-frequency oscillator circuits now employing vacuum tubes as the active elements. The following re-

quirements are met by these vacuum-tube oscillator circuits: (a) a high degree of frequency stability, (b) low distortion, and (c) in some cases, ability to be frequency modulated. The Hartley and Colpitts oscillator circuits were chosen as a starting point for this investigation because of their relative circuit simplicity. This paper discusses only these circuits, although the analytical method employed is certainly applicable to a number of other configurations. In the Colpitts- and Hartley-type oscillator circuits, two general conditions must be satisfied in order for oscillation to take place. The voltage fed back to the input must be of the correct phase to cause regeneration, and the amplitude of this voltage must be sufficient to sustain the oscillation. Since the feedback networks in both circuits have insertion loss, coupled with a phase shift of greater than ± 90 degrees, the active element must have voltage gain and a phase shift greater than ∓ 90 degrees in order to fulfill these conditions. Of the three useful

* Decimal classification: R355.914 X R282.12. Original manuscript received by the IRE, December 29, 1953; revised manuscript received March 16, 1954. Presented at the Symposium on "The Application of Transistors to Military Electronics Equipment," held at Yale University, September 3, 1953. This work was supported by the Bureau of Ordnance, Department of the Navy, under Contract NOrd 7386.

† The Johns Hopkins University, Applied Physics Laboratory, Silver Springs, Md.

transistor circuit configurations, only the common emitter, base input and the common base, emitter input have a voltage gain of greater than unity. In addition, the common-emitter circuit has a 180-degree phase shift between the base and the collector at low frequencies, whereas the common base has 0-degree phase shift. Therefore, unless a phase-inverting transformer is used, only the common-emitter, base-input circuit has the required properties.

The type of circuit to be considered, then, uses the common-emitter connection with the resonant circuit coupled to the transistor in such a way as to obtain either the Colpitts or Hartley configuration. The ac diagram for each of these circuits is indicated in Fig. 1 below.

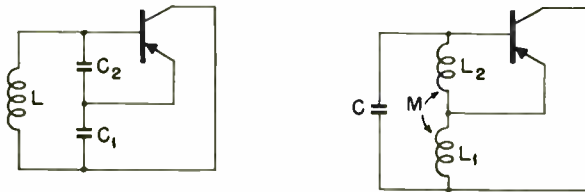

Fig. 1—Ac circuit diagram (a) Colpitts oscillator, and (b) Hartley oscillator.

ANALYSIS OF GENERALIZED OSCILLATOR CIRCUIT

The method of analysis to be applied here is similar to the one used by Llewellyn¹ in analyzing vacuum-tube oscillator circuits. Llewellyn devised a method for making the frequency of an oscillator independent of the vacuum-tube parameters, and thus also independent of changes in these parameters caused by variations in supply voltages. This was accomplished by the use of a stabilizing reactance in series with the grid circuit, or one in series with the plate circuit, or both. The generalized equivalent circuit to be used in the following analysis is shown below in Fig. 2. Z_b , Z_e , and Z_c are the impedances which will allow stabilization of the oscillator frequency with variation in the transistor parameters. The low-frequency small-signal equivalent circuit is used here, restricting the analysis to frequencies for which $\omega r_c C_c \ll 1$ (where C_c is the collector capacity of the transistor), and to signals which remain within the linear regions of the transistor characteristics. It is also assumed that the transistor parameters r_b , r_e , r_c , and r_m are purely resistive at these frequencies.

The three loop equations may now be written.

Loop 1:

$$0 = i_1[Z_b' + Z_e' + Z_2] + i_2[Z_e' - Z_m] - i_3[Z_2 + Z_m]$$

Loop 2:

$$0 = i_1[Z_e' - Z_m - r_m] + i_2[Z_c' + Z_e' + Z_1 - r_m] + i_3[Z_1 + Z_m]$$

Loop 3:

$$0 = -i_1[Z_2 + Z_m] + i_2[Z_1 + Z_m] + i_3[Z_1 + Z_2 + Z_3 + 2Z_m],$$

where

$$Z_b' = (r_b + R_b) + jX_b, \quad Z_c' = (r_c + R_c) + jX_c, \quad \text{and} \\ Z_e' = (r_e + R_e) + jX_e.$$

These three simultaneous equations have nontrivial solutions only when the determinant of the coefficients vanishes.² That is, for a solution,

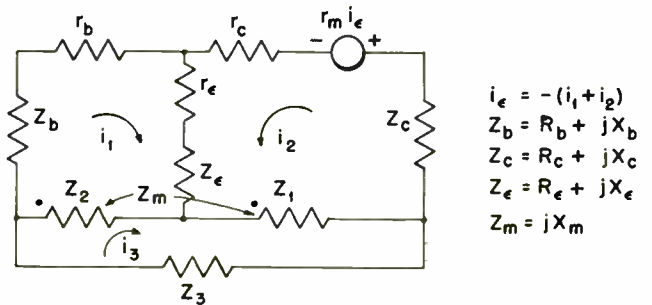

$$i_e = -(i_1 + i_2) \\ Z_b = R_b + jX_b \\ Z_c = R_c + jX_c \\ Z_e = R_e + jX_e \\ Z_m = jX_m$$

Fig. 2—Generalized equivalent circuit for the Hartley and Colpitts transistor oscillators.

$$\begin{vmatrix} (Z_b' + Z_e' + Z_2) & (Z_e' - Z_m) & -(Z_2 + Z_m) \\ (Z_e' - Z_m - r_m) & (Z_c' + Z_e' + Z_1 - r_m) & (Z_1 + Z_m) \\ -(Z_2 + Z_m) & (Z_1 + Z_m) & (Z_1 + Z_2 + Z_3 + 2Z_m) \end{vmatrix} = 0$$

This determinant may be expanded, the real and imaginary terms collected, and each set equal to zero. It will be assumed that the tank circuit has a high Q, and that Z_1 , Z_2 , and Z_3 are purely reactive. This assumption is valid for most stable oscillator designs. The results of this process are indicated below.

Imaginary terms:

$$\begin{aligned} & [X_1 + X_2 + X_3 + 2X_m][(R_b' R_c' + R_b' R_e' \\ & + R_e' R_c' - R_b' r_m) - (X_2 + X_b)(X_c + X_e + X_1) \\ & - X_e(X_1 + X_c) - X_m(2X_e - X_m)] \\ & + 2(X_e - X_m)(X_1 + X_m)(X_2 + X_m) \\ & + (X_2 + X_m)^2(X_c + X_e + X_1) \\ & + (X_1 + X_m)^2(X_b + X_e + X_2) = 0. \end{aligned} \tag{1}$$

Real terms:

$$\begin{aligned} & [X_1 + X_2 + X_3 + 2X_m][(X_2 + X_b)(R_c' + R_e' - r_m) \\ & + (X_c + X_e + X_1)(R_b' + R_c') + X_m(2R_e' - r_m)] \\ & + (2R_e' - r_m)(X_1 + X_m)(X_2 + X_m) \\ & + (X_1 + X_m)^2(R_b' + R_e') \\ & + (X_2 + X_m)^2(R_c' + R_e' - r_m) = 0, \end{aligned} \tag{2}$$

¹ F. B. Llewellyn, "Constant frequency oscillators," PROC. I.R.E., vol. 19, p. 2063; 1931.

² For proof, see M. Bocher, "Introduction to Higher Algebra," The Macmillan Company, New York, N. Y., chap. IV; 1907.

where

$$R_b' = r_b + R_b, \quad R_c' = r_c + R_c, \quad \text{and} \quad R_e' = r_e + R_e.$$

These are the two basic equations which will now be used to analyze a number of specific circuit configurations.

APPLICATION TO SPECIFIC CIRCUITS

Colpitts Oscillator

No Stabilization: The frequency of oscillation can be found by solving (1). For unstabilized Colpitts circuit,

$$X_m = Z_b = Z_c = Z_e = 0,$$

and

$$X_1 = -\frac{1}{\omega C_1}, \quad X_2 = -\frac{1}{\omega C_2}, \quad \text{and} \quad X_3 = \omega L.$$

If these values are substituted in (1), the following expression for ω may be obtained:

$$\omega = \sqrt{\frac{1}{LC_T} + \frac{1}{AC_1C_2}}, \quad (3)$$

where

$$C_T = \frac{C_1C_2}{C_1 + C_2},$$

and

$$A = [r_b r_c + r_b r_e + r_c r_e - r_b r_m].$$

Thus the circuit will oscillate at a frequency slightly higher than the resonant frequency of the tank circuit alone. Note that A contains the entire role of the transistor in this expression.

The tank-circuit constants for sustained oscillations may be determined by solving (2), using these same substitutions. The frequency of oscillation is very nearly equal to the resonant frequency of the tank circuit, so the term $(X_1 + X_2 + X_3)$ is approximately zero, and the equation of the real terms becomes

$$X_1^2(r_b + r_e) + X_1 X_2(2r_e - r_m) + X_2^2(r_c + r_e - r_m) \cong 0. \quad (4)$$

The solution of this equation is

$$\frac{X_1}{X_2} \cong \frac{(r_m - 2r_e) \pm \sqrt{(2r_e - r_m)^2 - 4(r_b + r_e)(r_c + r_e - r_m)}}{2(r_b + r_e)}.$$

Since

$$r_e \ll r_m,$$

and

$$4(r_b + r_e)(r_c + r_e - r_m) \ll (2r_e - r_m)^2$$

for an average transistor,

$$\frac{X_1}{X_2} = \frac{C_2}{C_1} \cong \frac{r_m}{r_b + r_e} \cong \frac{r_{21}}{r_{11}}. \quad (5)$$

Equation (5) is the condition for oscillations of constant amplitude. If

$$\frac{C_2}{C_1} > \frac{r_{21}}{r_{11}},$$

the amplitude will decrease and the oscillation will die out, whereas if

$$\frac{C_2}{C_1} < \frac{r_{21}}{r_{11}},$$

the amplitude of the oscillation will increase until limited by a circuit nonlinearity.

An expression for the frequency stability of this oscillator can be derived in the following manner. If it is assumed that L , C_1 , and C_2 have been chosen for good frequency-stability characteristics, the only parameter which can cause the frequency to vary is the term A in (3). The term A contains all the transistor parameters, and the problem to make ω as nearly independent of A as possible. A stability coefficient, k , can be defined as the ratio of a percentage change in frequency to a percentage change in A . That is,

$$k = \frac{d\omega/\omega}{dA/A} = \frac{d\omega}{dA} \cdot \frac{A}{\omega}.$$

Thus, the smaller k , the greater the frequency stability. If this operation is carried out, the result is

$$k = \frac{1}{\frac{2A}{L}(C_1 + C_2) + 2}. \quad (6)$$

Therefore, for a stable oscillator, A should be made large and $L/(C_1 + C_2)$ should be made small.

Colpitts Oscillator

Base Stabilization: Reference to (3) indicates that the sensitivity of frequency to changes in the transistor parameters is caused by the presence of the term $1/AC_1C_2$ in the expression. If some means can be found to cancel out this term, oscillator frequency stabilization will be achieved. In particular, if a pure reactance X_b is placed in series with the base lead of the transistor, a value can be found for this reactance which will force the circuit to oscillate at the series resonant frequency of the tank circuit, that is,

$$\omega = \sqrt{\frac{1}{LC_T}}.$$

If the substitutions $X_m = R_b = Z_c = Z_e = 0$ are made in (1), the value of X_b necessary to make the term $(X_1 + X_2 + X_3) = 0$ can be found. Equation (1) becomes

$$X_2^2 X_1 + X_1^2 (X_b + X_2) = 0.$$

Therefore,

$$X_b = -X_2 \left(1 + \frac{X_2}{X_1} \right). \quad (7)$$

Since X_2 is capacitive, X_b is inductive.

Colpitts Oscillator

Collector Stabilization: The same reasoning that was used in base stabilization applies here. If the substitutions $X_m = R_c = Z_b = Z_e = 0$ are made in (1), the expression for X_c is

$$X_c = -X_1 \left(1 + \frac{X_1}{X_2} \right). \quad (8)$$

Again, X_c is inductive since X_1 is capacitive.

The process carried out above for the Colpitts configuration can be extended to the transistor Hartley oscillator with suitable modifications of equations 1 and 2. The substitutions which should be made, and the results of such substitutions, are tabulated below.

Hartley Oscillator

No Stabilization: Substitutions—

$$Z_b = Z_c = Z_e = 0, \quad X_1 = \omega L_1, \quad X_2 = \omega L_2, \\ X_3 = -\frac{1}{\omega C},$$

and $X_m = \omega M$, in (1) and (2).

Results—

$$\text{a. } \omega = \frac{1}{\sqrt{C(L_1 + L_2 + 2M) - \left(\frac{L_1 L_2 - M^2}{A} \right)}} \\ \text{b. } \frac{L_1 + M}{L_2 + M} \cong \frac{r_{21}}{r_{11}}$$

for sustained oscillations of constant amplitude.

c. Stability coefficient k ;

$$k = \frac{-(L_1 L_2 - M^2)}{2[AC(L_1 + L_2 + 2M) - (L_1 L_2 - M^2)]}$$

Base Stabilization: Substitutions—

$$(X_1 + X_2 + X_3 + 2X_m) = 0 \text{ and } R_b = Z_e = Z_c = 0 \text{ in (1).}$$

Result:

$$X_b = \frac{X_2 + X_m}{X_1 + X_m} \left[2X_m - X_1 \left(\frac{X_2 + X_m}{X_1 + X_m} \right) \right] - X_2.$$

Collector Stabilization: Substitutions—

$$(X_1 + X_2 + X_3 + 2X_m) = 0, \text{ and } R_c = Z_b = Z_e = 0 \\ \text{in (1).}$$

Result:

$$X_c = \frac{X_1 + X_m}{X_2 + X_m} \left[2X_m - X_2 \left(\frac{X_1 + X_m}{X_2 + X_m} \right) \right] - X_1.$$

CONCLUSION

The method of analysis applied above has proved valuable for determining circuit values in the design of practical transistor audio oscillator circuits. A word of caution is necessary in applying the formulas derived for collector and base stabilization, however. The accuracy of the derivations depends on the assumption that the transistor equivalent-circuit parameters are purely resistive, an assumption which is valid only at low frequencies. This assumption, in fact, is necessary in order that the values of stabilizing reactance only depend on the external circuit parameters, so that stabilization may be achieved. A complete treatment of the implications of this assumption has been given by Llewellyn.

ACKNOWLEDGMENT

The author wishes to thank J. F. Jenkins, Jr. for his helpful suggestions concerning this work.



A New Electron Tube: The STROPHOTRON*

HANNES ALFVÉN† AND DAG ROMELL†

Summary—A new multitransit-electron tube is described, having high efficiency and an exceptionally wide electronic tuning range. An important feature of the tube is a trochoidal electron drift motion at right angles to the radio-frequency field, serving to remove electrons from the field at a favorable instant.

THE STROPHOTRON¹ is a developmental electron tube that holds promise for a variety of uses in vhf and uhf communication. It is a high-efficiency, wide-band device, easily frequency-modulated or electrically-tuned over an exceptionally wide range of frequencies. In fact, strophotrons may be operated, without mechanical tuning, over a frequency spectrum covering about an octave. The electrodes of a strophotron are few, of simple geometry, and do not require close tolerances.

The present paper will be limited to a general indication of the principle involved, the merits of the system, and some of the experimental results obtained with the tube operating as an oscillator. Development of the tube for amplification purposes is under way and will be reported in due course.

PRINCIPLE OF OPERATION

Basically, the strophotron may be regarded as a Barkhausen-Kurz oscillator or a multireflex klystron, in which some of the inherent drawbacks of these and similar tubes of the prior art, such as poor efficiency and low power, or narrow range of operating frequencies, have been eliminated. This is achieved by a combination of frequency-independent density modulation of the electron beam and a controllable drift velocity of the electrons in a direction perpendicular to the oscillatory motion, serving to remove them from the radio-frequency field at a favorable instant. This drift motion, obtained by means of crossed electric and magnetic fields or by an inhomogeneous magnetic field, is similar to that present in trochotrons.² The magnetic field at the same time serves to prevent the electron beam from striking the accelerator electrodes.

The principle of operation will be described with reference to Fig. 1, illustrating schematically a simple strophotron electrode system, in which A is the positive

accelerator electrode, R' and R'' are negative reflectors, K is the cathode, projecting through a slot in reflector R' , and C is the collector, having a potential roughly half that of the accelerator. A uniform magnetic field is indicated by arrows B . The mean path of favorable-phase electrons is indicated by the dashed lines. The mean distance between the reflectors in the region occupied by the electron beam is indicated by b .

The electrodes are shaped in such a fashion that the potential V in the plane $D-D$ of the electron beam obeys the relation $V \sim -z^2$. In such a field, of course, electrons will oscillate harmonically with a natural frequency of oscillation

$$f = \frac{1}{\pi} \cdot \sqrt{\frac{2e}{m}} \cdot \frac{1}{b} \cdot \sqrt{V} = 0.189 \cdot 10^6 \cdot \frac{\sqrt{V}}{b},$$

where V is the maximum potential in the beam.

If the reflectors are maintained at cathode potential and there is no radio-frequency field present, the electrons will oscillate with an amplitude equal to b and will graze the reflectors. If the reflectors are made negative with respect to the cathode, the electrons will oscillate with smaller amplitude, being reflected some distance in front of the reflector surfaces.

If a radio-frequency voltage of frequency f (and of sufficient amplitude) is applied between the reflector electrodes, half of the electrons will be accelerated and a major part of these will strike reflector R'' , being thus removed. The remaining half of the electrons will oscillate back and forth with decreasing amplitude, giving off energy to the radio-frequency field. (This is but one of several possible mechanisms of modulation.) If a suitable resonant circuit is connected between the reflectors, oscillations will be maintained.

In addition to the electric field components $\pm E_z$, parallel to the magnetic field, that govern the oscillatory motion of the electrons the electrostatic field of the electrode system (Fig. 1, page 1240) has a strong component E_y perpendicular to the magnetic field. This component, together with the magnetic field, causes the electrons to move in the x direction in a path, the projection of which in the xy plane is a trochoid. The mean trochoidal (drift) velocity of the electrons is $v_x = E_y/B$.

The tube is operated under "cut-off" conditions, meaning in this case that negligible current is drawn by the accelerator electrode. By adjusting the drift velocity v_x and the loading of the resonant circuit it is possible to cause a major part of the favorable-phase electrons to strike the collector electrode C and be removed when they have delivered most of their potential energy to the radio-frequency field.

* Decimal classification: R339.2. Original manuscript received by the IRE, October 1, 1953, revised manuscript received, February 16, 1954.

† Royal Institute of Technology, Stockholm, Sweden.

¹ The name is derived from the Greek $\sigma\tau\rho\omega\phi\alpha\omega$ = "turn to and fro" and refers to the shape of the mean electron path. A brief presentation of the strophotron was given by Dr. S. Tomner of L. M. Ericsson Telephone Co. in a paper read at the 11th Annual Conference on Electron Tube Research, Stanford University, June 18-20, 1953: "The Strophotron, a New Oscillator Tube for FM-Radio Links."

² H. Alfvén, L. Lindberg, K. G. Malmfors, T. Wallmark, and E. Åström, "Theory and Applications of Trochotrons," *Trans. Roy. Inst. Tech.*, Stockholm, Sweden, no. 22; 1948.

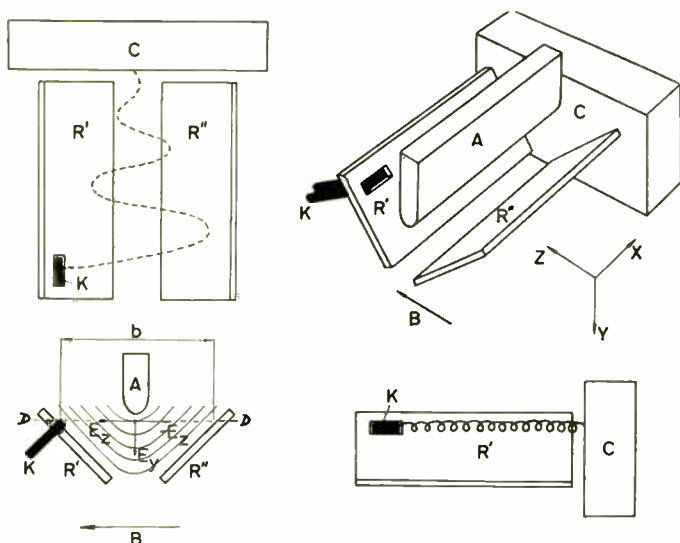

Fig. 1—The elements of a simple strophotron-electrode system shown in three projections and in perspective, with its associated uniform magnetic field, indicated by B , the trochoidal electron beam, and, indicated by dashed line, the mean path (neglecting trochoidal rotation) of favorable-phase electrons.

Two experimental strophotron tubes made by the L. M. Ericsson Telephone Co. are shown in Fig. 2. They have electrode systems very similar to the one described in Fig. 1. In one tube (Fig. 2(a)) the resonant circuit is a Lecher wire system connected between the reflectors (R' and R'' in Fig. 1) and in the other (Fig. 2(b)) it is a coaxial line, accelerator or anode (A in Fig. 1) being part of the center conductor, and reflectors (R' and R'') being parts of the outer conductor. This tube operates on the second harmonic of electron oscillation frequency.

SIGNIFICANT PROPERTIES AND SOME EXPERIMENTAL RESULTS

The useful properties of strophotrons are due to the following factors.

Simple Means of Frequency Modulation or Electrical Tuning

This is due to the fact that the natural frequency of oscillation of the electrons is determined by the electrostatic field within the electrode structure and is independent of the magnitude of the magnetic field. Hence, the frequency of operation of the tube may be altered by altering the accelerator potential, which is equivalent to a change in V in (1). As an alternative, the reflector potential may be altered. This may be regarded as equivalent to altering the magnitude of b in (1). In a typical case, by altering the accelerator voltage from 300 to 900 and the reflector voltage from -50 to -250 , the tube could be tuned from 800 to 1,700 mc (without mechanical tuning). If the reflector voltage was kept constant at -100 , the tube could be tuned from 1,000 to 1,500 mc by altering the accelerator voltage from 300 to 900. If the accelerator voltage was kept constant at 600, the tube could be tuned from 1,100 to 1,600 mc by altering the reflector voltage from -50 to -300 .

Within this tuning range, of course, the output power varies considerably. Width of the tuning range between points 3 db down was about 140 mc. These measurements were made on a simple electrode system where no efforts had been made to achieve a wide tuning range.

No hysteresis effects have been encountered. Absence of hysteresis phenomena may be due to the fact that conditions for oscillation are considerably less complicated in strophotrons than in, say, reflex klystrons.

Wide-band Characteristics

The favorable-phase electrons oscillate back and forth a number of times, usually of the order of ten times, before striking the collector. Consequently, the radio-frequency voltage across the resonant circuit for proper

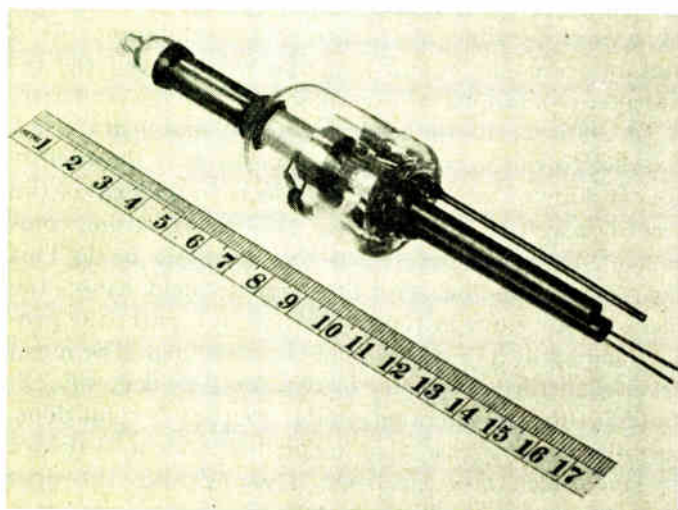

(a)

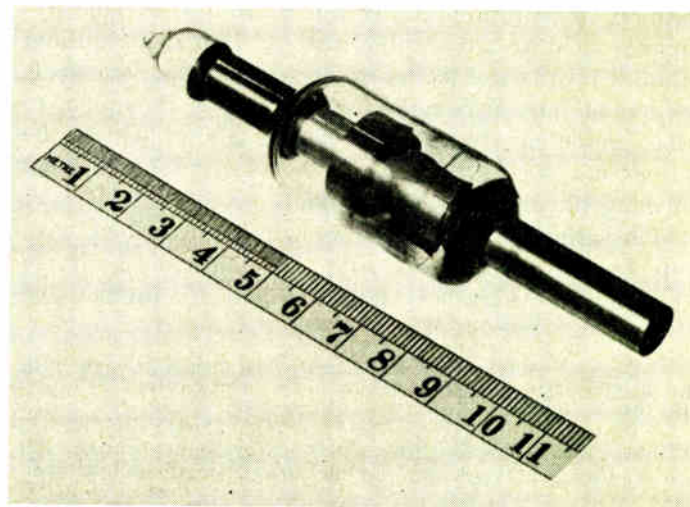

(b)

Fig. 2—Two experimental strophotron oscillator tubes (courtesy L. M. Ericsson Telephone Co.). The heavy electrodes visible to the left are the collectors. These tubes are mechanically tunable as well as electrically, the tube in Fig. 2 (a) by means of a Lecher wire system protruding through the bulb, and the tube in Fig. 2 (b) by means of a coaxial line. The frequencies of operation are about 1,000 mc for (a) and 2,000 mc for (b). Output power is about one watt for both types.

operation is only a small fraction of the dc voltage between the accelerator and reflectors. These factors combine to make the impedance presented by the oscillating electrons very low. The resonant circuit is heavily loaded, and will consequently be able to pass a wide band of frequencies. For extreme wide-band operation values of loaded Q as low as 2 to 5 have been used, while for high efficiency a value of about 30 is typical.

Another factor contributing to the wide-band characteristics is the method described above of density-modulating the electron beam by means of a sorting-out process, which is inherently independent of frequency.

High Efficiency

This is due to the fact that a majority of the favorable-phase electrons can be made to strike the collector with only a small fraction of their initial energy left (or having regained only negligible energy from the radio-frequency field). Measurements on a simple electrode system have yielded efficiencies of about 33 per cent. This figure can probably be improved.

USEFUL RANGES OF FREQUENCY AND POWER

In strophotrons, most of the power loss is dissipated as heat by the collector electrode. This electrode may be designed so that it will easily dissipate large amounts of heat, by radiation or convection cooling. The power input to a strophotron, therefore, may be large. However, there is another factor, which limits the useful power, as will be shown.

As mentioned previously, one condition for satisfactory operation is that the potential distribution in the electron beam be approximately $V \sim -z^2$. Now this requirement is easily met by suitably shaping the electrodes, provided there is no space charge. Space charge will disturb the field and, if the space-charge density exceeds a certain limit operation of the tube will be impossible or inefficient. It is possible to calculate, approximately, at which space-charge density this occurs, and the results obtained agree with experiment.

The limiting space-charge density, for practical purposes, may be more conveniently expressed in terms of the maximum current that may be passed through the system. This is of the order:³

$$I_{max} \approx \frac{b}{2} \cdot \frac{\epsilon_0 \cdot E_v^2}{B} \quad (2)$$

By decreasing the magnetic field density B this current could be increased, but B must also meet another requirement: it must be strong enough to prevent the electrons from reaching the accelerator electrode. As a consequence, there exists an optimum value of B . It is of the order³

$$B_{opt} \approx \sqrt{\frac{m}{e}} \cdot \frac{2}{b} \cdot \sqrt{V} \quad (3)$$

³ Neglecting a factor, usually of the order of unity, depending on the geometry of the particular system.

where V is the maximum potential in the electron beam.

If B is chosen equal to the optimum value, the maximum current may be expressed as³

$$I_{max} \approx \frac{\epsilon_0}{4} \cdot \sqrt{\frac{e}{2m}} \cdot V^{3/2} \quad (4)$$

The maximum power, available in the electron beam is of the order $V \cdot I_{max}$.

It turns out that these various characteristic quantities of a strophotron electrode system may be conveniently expressed in terms of λ and the dimensionless quantity b/λ , where λ is the wavelength corresponding to the frequency of oscillation, thus:

Maximum power input:³

$$P_{max} = \frac{\epsilon_0 \pi^5 c^5 m^2}{16 e^2} \cdot \left(\frac{b}{\lambda}\right)^5 = 1.33 \cdot 10^{10} \cdot \left(\frac{b}{\lambda}\right)^5 \text{ watts.} \quad (5)$$

Corresponding accelerating potential:

$$V = \frac{\pi^2 c^2 m}{2e} \cdot \left(\frac{b}{\lambda}\right)^2 = 2.52 \cdot 10^6 \cdot \left(\frac{b}{\lambda}\right)^2 \text{ volts.} \quad (6)$$

Optimum magnetic-field density:³

$$B_{opt} = \frac{\pi c m}{e} \cdot \frac{1}{b} \cdot \left(\frac{b}{\lambda}\right) = 0.536 \cdot 10^{-2} \cdot \left(\frac{1}{\lambda}\right) \frac{\text{volt seconds}}{(\text{meter})^2},$$

or

$$= 53.6 \cdot \left(\frac{1}{\lambda}\right) \text{ gauss.} \quad (7)$$

Symbols:

- c = velocity of light (in free space)
- $\epsilon_0 = \mu_0^{-1} \cdot c^{-2} = 8.85 \cdot 10^{-12}$
- $\mu_0 = 4\pi \cdot 10^{-7}$
- e = electronic charge
- m = electronic mass
- $\pi = 3.1415 \dots$
- b = distance between reflectors
- λ = wavelength corresponding to electron oscillation frequency

Good agreement has been obtained between the results predicted by these formulas and experimental results on tubes operating at about 1,000 mc with output powers of the order of one watt.

Definite conclusions as to the validity of the formulas for all ranges of frequency and power will be dependent on further experiments. However, it seems likely that high powers should be attainable.

Many other types of electrode structure are conceivable than the particular one described here, all employing the same method of conveying the electrons through the interaction space on to a collector. The trochoidal drift motion may be made use of also to convey electrons from one interaction space to another.

Microwave Single-Sideband Modulator Using Ferrites*

JOHN CACHERIS†, MEMBER, IRE

Summary—Two laboratory models of a single-sideband modulator are described. The frequency of a microwave signal is shifted by means of a rotating magnetic field transverse to a ferrite differential half-wave section. The first laboratory model, a *transmission* device, is inserted in a waveguide-transmission line. The second model, which is a *reflection* device, reflects signals from a source. Either modulator shifts the microwave-carrier frequency of 9,375 mc by plus or minus 20 kc. Differential half-wave sections are shown to be possible from Polder's explanation of double refraction of plane electromagnetic waves propagated in an infinitely large ferromagnetic medium magnetized transverse to the direction of propagation.

INTRODUCTION

FOR THE PAST few years, the microwave properties of ferrites with longitudinal dc fields have been of general interest. Ferrites with transverse fields also exhibit unusual properties. For example, differential phase shifts between two components of a linearly-polarized electromagnetic wave can be obtained by means of a ferrite inserted in circular waveguide and subjected to a dc magnetic field transverse to the direction of propagation.

In general, a ferrite is a polycrystalline substance of bivalent metallic oxides and ferric oxide. Ferrites are ferromagnetic dielectrics having a resistivity intermediate between that of the metallic alloys of iron and that of good insulating materials. Because of their high resistivity, ferrites propagate microwaves with relative ease. Their magnetic properties may be varied by an applied dc field. Ferrites may, therefore, be used in the design of microwave devices such as attenuators and phase shifters.

A single-sideband modulator is a device for generating the sum or difference of two frequencies. For low and very high carrier-frequency applications, mechanical devices are used as single-sideband modulators. In the intermediate frequency ranges, a wide variety of electronic systems are used. This paper describes an electronic single-sideband modulator for shifting the carrier frequency of a microwave signal by a fixed amount. The device is one of the first practical applications of the double-refraction properties of ferrites with transverse magnetic fields.

Frequency shifts of a few hundred cycles per second of a microwave carrier have been accomplished by means of a differential half-wave phase-shift section mechanically rotated between two stationary quarter-

wave sections of circular waveguide.¹ In the new modulator, the rotating section is replaced by a ferrite cylinder in circular waveguide with an applied transverse magnetic field so that the ferrite acts as a differential half-wave phase shifter. The applied field is electrically rotated by two pairs of coils at right angles to each other and excited 90 degrees out of phase. By this method, since moving parts are not required, much higher frequency shifts are possible.

The microwave single-sideband modulator consists of three waveguide sections as shown in Fig. 1. The quarter-wave plate of section I converts the incident linearly polarized waves into circularly polarized waves. The sense of rotation of the circularly polarized waves is reversed by section II which contains a ferrite cylinder with a rotating transverse magnetic field adjusted for 180-degree differential phase shift. The quarter-wave plate of section III reconverts the circularly polarized waves to linearly polarized waves.

Continuous rotation of the half-wave differential phase-shift section by means of the rotating magnetic field will cause a fixed increase or decrease in the frequency of the transmitted signal. The plane-polarized wave fed into section I emerges circularly polarized in, say, a clockwise direction. Hence, the E vector performs f rotations per second, f being the carrier frequency of the incoming energy. If an observer were located at the input of section II and rotating counterclockwise with the section, the observer will see a frequency $f+n$, n being the number of revolutions per second of section II. Due to the action of the half-wave plate, an observer at the output of section II will see $f+n$ counterclockwise rotations of the E vector. Since section II also rotates with respect to section III the E vector as seen by a stationary observer in section III rotates $f+2n$ times a second. Energy with a frequency $f+2n$, therefore, emerges from the device. If the device would be designed without the half-wave plate in section II, the observer would see $f+n$ rotations in this section. As seen in section III, however, $f+n-n$ rotations would be observed so that the incoming and outgoing frequencies would be identical.

THEORY OF THE FERRITE DIFFERENTIAL PHASE-SHIFT SECTION

The behavior of a saturated ferromagnetic material, such as a ferrite, magnetized in an arbitrary direction with respect to the direction of propagation has been

* Decimal classification: R310XR355.8. Original manuscript received by the IRE, December 31, 1953.

† Diamond Ordnance Fuze Labs., Dept. of the Army, Washington, D. C.

¹ A. G. Fox, "An adjustable waveguide phase changer," *Proc. I.R.E.*, vol. 35, pp. 1489-1498; December, 1947.

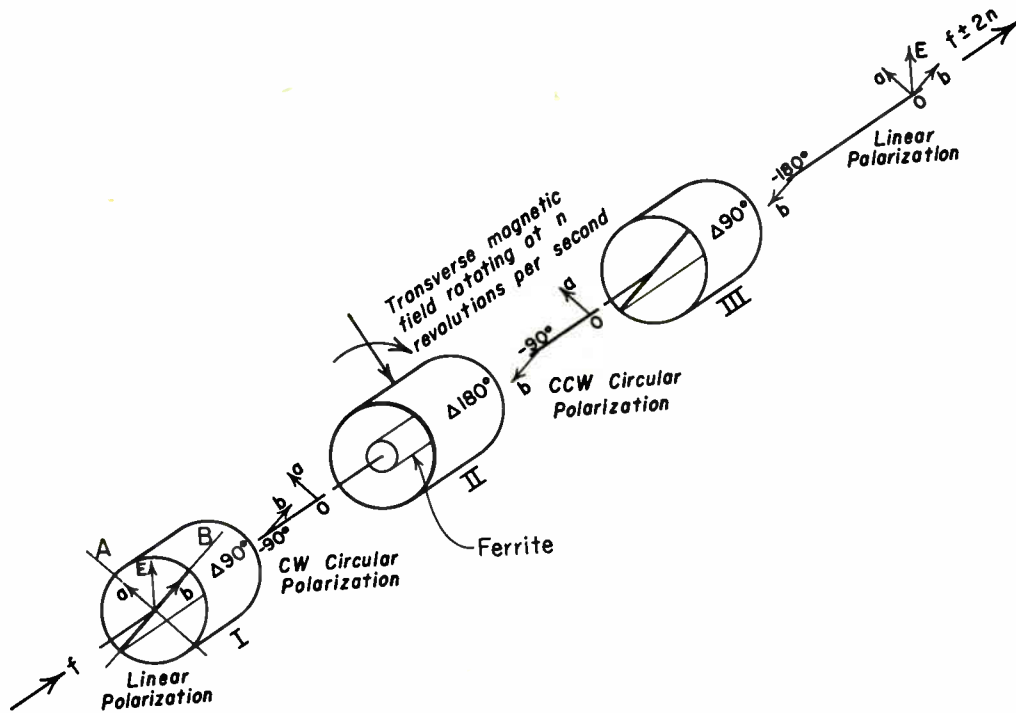

Fig. 1—Microwave single-sideband modulator.

analyzed by Polder.² He has shown that an infinitely large ferromagnetic medium which is homogeneously magnetized in the *Y*-direction becomes doubly refracting when plane electromagnetic waves are propagated in the *Z*-direction. For two linearly polarized waves with *H*-vectors respectively parallel and perpendicular to the applied dc magnetic field, the indices of refraction are given by

$$n_{\parallel}^2 = \epsilon$$

$$n_{\perp}^2 = \frac{\epsilon(\mu^2 - \alpha^2)}{\mu}$$

If ferromagnetic losses and crystal-anisotropy fields are ignored, μ and α are given by

$$\mu = \frac{\gamma^2 H_e B_e - \omega^2}{\gamma^2 H_e^2 - \omega^2}$$

and

$$\alpha = \frac{4\pi M\omega\gamma}{\gamma^2 H_e^2 - \omega^2}$$

Where

- ϵ is the dielectric constant of the medium
- γ is the gyromagnetic ratio of the electron
- B_e is the effective flux density ($B_e = H_e + 4\pi M$)
- H_e is the effective internal magnetic field
- M is the magnetization of the medium
- ω is the angular microwave frequency

² H. Polder, "On the theory of ferromagnetic resonance," *Phil. Mag.*, vol. 40, pp. 99-114; January, 1949.

$$n_{\parallel}^2 = \epsilon = \epsilon\mu_{\parallel}$$

$$n_{\perp}^2 = \epsilon \left[\frac{\gamma^2 B_e^2 - \omega^2}{\gamma^2 H_e B_e - \omega^2} \right] = \epsilon\mu_{\perp}$$

The effective permeability of the wave whose *H*-vector is parallel to the dc magnetic field H_a is unity, since $n^2 = \mu\epsilon$. It is independent of the magnitude of H_a . The effective permeability of the wave whose *H*-vector is perpendicular to the dc field is given by

$$\mu_{\perp} = \left[\frac{\gamma^2 B_e^2 - \omega^2}{\gamma^2 H_e B_e - \omega^2} \right]$$

The perpendicular permeability becomes infinite when $\omega^2 = \gamma^2 H_e B_e$, not when $\omega^2 = \gamma^2 H_e^2$ as for the medium magnetized in the direction of propagation. This agrees with the theory.²

Let $\mu_{\perp} = 1 + \Delta_{\perp}$

$$\Delta\mu_{\perp} = \left[\frac{\gamma^2 B_e^2 - \omega^2}{\gamma^2 H_e B_e - \omega^2} - 1 \right]$$

$$\Delta\mu_{\perp} = \left[\frac{\gamma^2 B_e^2 - \gamma^2 H_e B_e}{\gamma^2 H_e B_e - \omega^2} \right]$$

If $\gamma^2 H_e B_e$ is much smaller than ω^2 , the above equation can be simplified to

$$\Delta\mu_{\perp} = \frac{\gamma^2 H_e B_e - \gamma^2 B_e^2}{\omega^2}$$

and

$$\mu_{\perp} = \left[1 + \frac{\gamma^2 H_e B_e - \gamma^2 B_e^2}{\omega^2} \right]$$

The differential phase shift of the wave with its magnetic vector parallel to H_a , with respect to the wave whose magnetic vector is perpendicular to H_a , is given by

$$\Delta\phi = \omega l \frac{(\epsilon_r)^{1/2}}{c} [\mu_{\parallel}^{1/2} - \mu_{\perp}^{1/2}]$$

$$\Delta\phi \approx l \frac{(\epsilon_r)^{1/2}}{2c} \frac{[\gamma^2 B_e^2 - \gamma^2 H_e B_e]}{\omega}$$

This expression is similar to that obtained by Weiss and Fox³ of the Bell Telephone Laboratories. The results were obtained independently from different sets of Polder's equations. Although the theory has been derived for a saturated infinite medium with no losses it appears that the analysis approximates the waveguide case since double refraction has been observed experimentally.

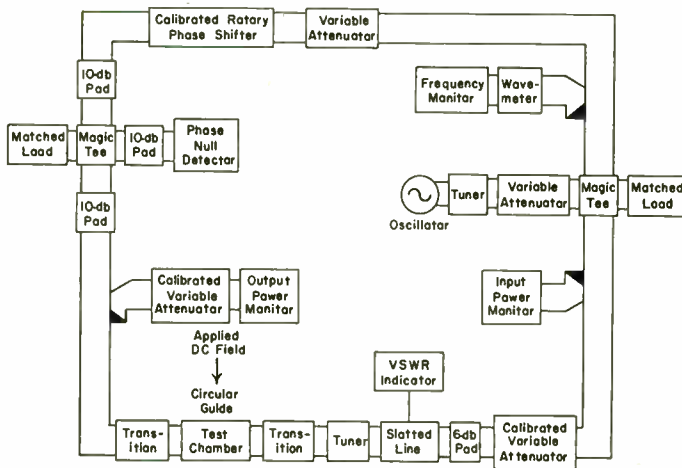

Fig. 2—Block diagram of the experimental setup.

DIFFERENTIAL PHASE-SHIFT MEASUREMENTS

Experiments were made at 9,375 mc to measure the differential phase shift of microwaves propagated through ferrites with the dc magnetic field first perpendicular and then parallel to the microwave H -vector. A block diagram of the experimental equipment is given in Fig. 2. At each end of the circular guide test chamber, the dominant TE_{10} mode in rectangular waveguide is transformed into the dominant TE_{11} mode in circular guide by smooth transitions. Resistance card absorbers in the circular section reduce cross-polarized reflections. The ferrite samples to be measured were placed in the test chamber and magnetized by applying the field transverse to the direction of propagation.

As can be seen in Fig. 2, all power levels as well as phase shift were measured. Measurements of insertion loss were made by determining the power transmitted

³ M. T. Weiss and A. G. Fox, "Magnetic double refraction at microwave frequencies," Letter to the Editor, *Phys. Rev.*, vol. 88, second series, no. 1; October 1, 1952.

with the sample removed. The absorbed power can be calculated by subtracting from the insertion loss the reflected power determined by the voltage standing wave ratio. The relative phase change due to the application of the dc magnetizing field was measured by comparison with a calibrated rotary phase shifter.

After initial changes, the microwave phase shift and insertion loss for the thin rod are essentially independent of the dc magnetic field applied parallel to the microwave H -vector. This is in agreement with Polder's theory. For the dc field perpendicular to the microwave H -vector, again as Polder has shown, the microwave phase shift and insertion loss are functions of the applied field. These curves indicate that gyromagnetic resonance occurs when the value of H_a is approximately 4,200 oersteds. The signal reflected by the rod was less than one per cent throughout the range of measurements.

The initial changes that are usually attributed to domain wall motions are not present. LeCraw of the National Bureau of Standards has also found that these initial changes are negligible for spherical samples of this material in microwave cavities, Fig. 3.

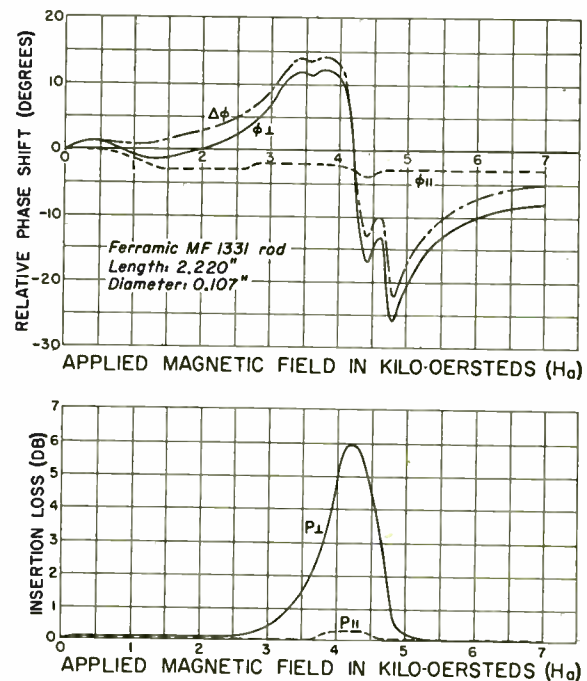

Fig. 3—Relative phase shift and insertion loss for microwaves propagated through a Ferramic MF 1331 rod as functions of applied magnetic field.

The data obtained in the measurements were used in designing the 180-degree differential phase-shift section of the single-sideband modulator. This section contains the ferrite and the dc field rotating transverse to the direction of propagation. The 180-degree differential phase shift should be obtained with a low applied field in order that the modulation power be small. The initial changes of the microwave phase shift and insertion-loss as the dc field is applied to the ferrite are im-

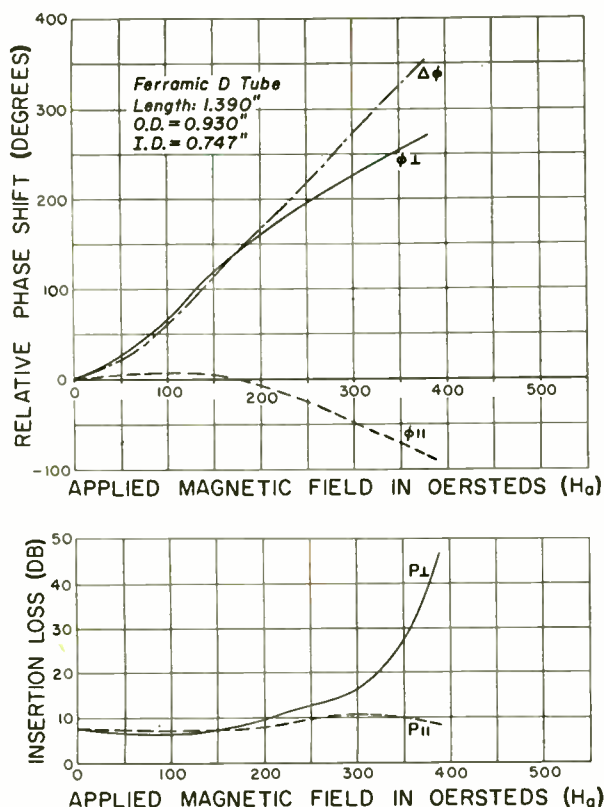

Fig. 4—Relative phase shift and insertion loss for microwaves propagated through a Ferramic *D* tube as functions of applied magnetic field.

portant. For a Ferramic *D* tube (Fig. 4) the field required to produce a 180-degree differential phase shift is approximately 200 oersteds. Since the parallel and perpendicular insertion losses are not equal, the output is an elliptically instead of circularly polarized wave. This increases the over-all insertion loss of the SSM. The elliptically polarized wave can be regarded

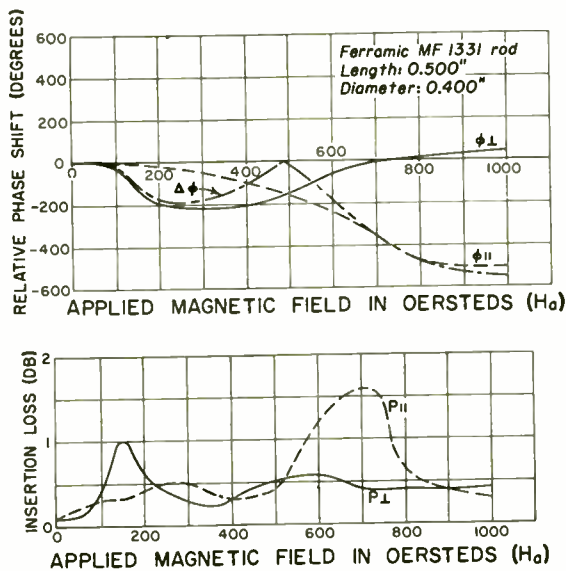

Fig. 5—Relative phase shift and insertion loss for microwaves reflected from a ferrite rod and short-circuiting plunger as functions of applied magnetic field.

as the resultant of two circularly polarized waves of unequal amplitudes rotating in opposite directions. Only one of these waves will be converted to linear polarization by section III, the other will be absorbed by the resistance card.

The signal reflected from a ferrite rod backed by a short-circuiting plunger is important in some applications. Measurements were made of the relative phase shift and insertion loss of microwaves reflected from this combination as functions of the applied magnetic field. For a Ferramic MF 1331 rod (Fig. 5) approximately 180 oersteds are required to produce a 180-degree differential phase shift between the two orthogonal components of the reflected signal.

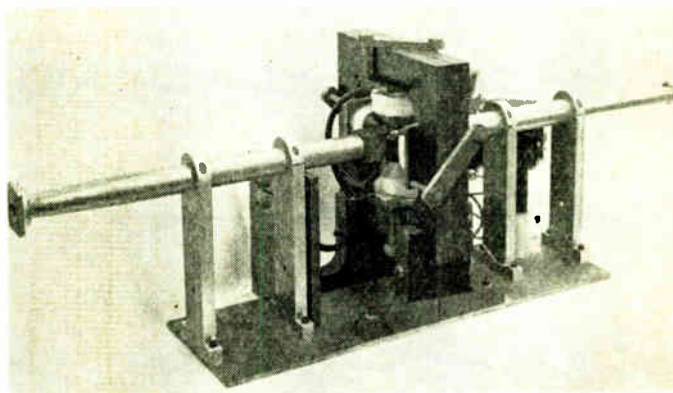

Fig. 6—Microwave single-sideband modulator (transmission type).

SIGNAL-SIDEBAND MODULATOR PERFORMANCE

Two X-band single-sideband modulators were constructed. The first shown in Fig. 6, a *transmission* system, is a device inserted in a waveguide transmission line to shift the microwave carrier frequency of 9,375 mc by plus or minus 20 kc. The rectangular-to-round waveguide transitions contain, in addition to quarter-wave dielectric plates, resistance cards to absorb cross-polarized reflections. The center section between the four coils contains the ferrite. Instead of metal waveguide, a linen bakelite form lined with silver paint is used so that the rotating field will not be attenuated by eddy currents. The applied field is adjusted so that the ferrite is a 180-degree differential phase-shift section. It is electrically rotated at 10 kc by exciting the vertical coils 90 degrees out of phase with respect to the horizontal coils. The 10 kc oscillator and power amplifiers are not shown. Fig. 7 (following page) shows the flux density in the air gap between the pole faces of the magnetic structure as a function of the modulation power.

The reflection type of SSM shown in Fig. 8 (following page) is similar to the previously described transmission system. In the reflection system, however, a short circuit is placed after the ferrite sample. Its position is adjusted so that the differential phase shift of the reflected signal is 180 degrees. The device reflects signals from an *X*-

band source but shifted in frequency by plus or minus 20 kc.

Microwave power in the X-band region was supplied to the device by a square-wave modulated klystron oscillator. The oscilloscope patterns of the rf envelope of the shifted signal are shown in Fig. 9(a) and 9(b). The residual ripple present is a measure of spurious frequency signals produced by the SSM. The 20 kc beat shown in Fig. 9(c) and 9(d) is produced by mixing the shifted signal with a small amount of the carrier signal. The data shown in Fig. 10 indicate that the microwave insertion loss is 1.5 db for 40 watts of modulation power per line. The undesired sideband suppression is approximately 47 db while the carrier suppression is 29 db. With 15 watts of modulation power per line, the microwave insertion loss is 4.5 db. Depending upon the application for which the device is to be used, a compromise may be made between microwave insertion loss

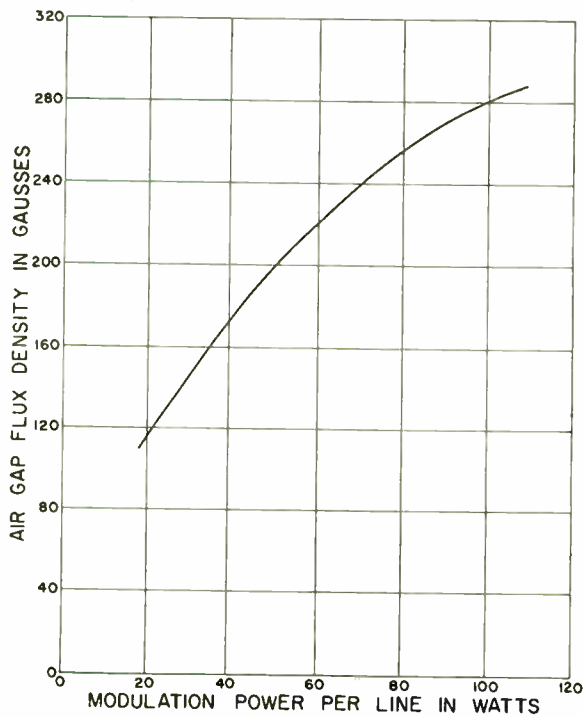

Fig. 7—SSM magnet characteristic.

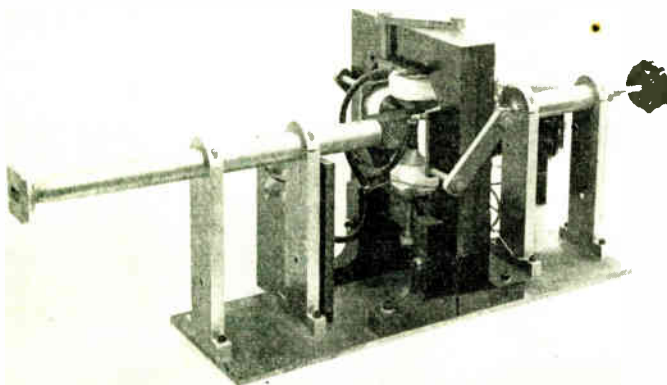
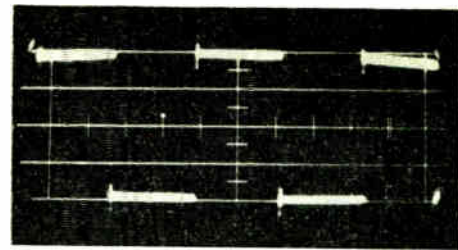
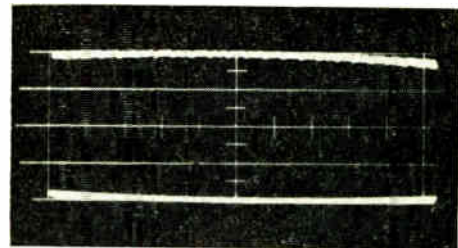

Fig. 8—Microwave single-sideband modulator (reflection type).



(a) Rf envelope of shifted signal (output of SSM).



(b) Rf envelope of shifted signal (expanded scale).

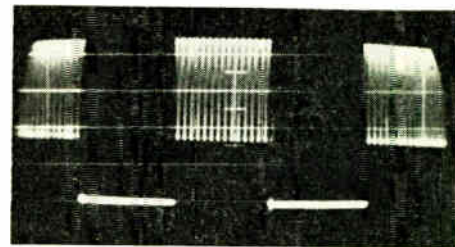

(c) Rf envelope of shifted signal mixed with a small amount of the carrier (input) signal.

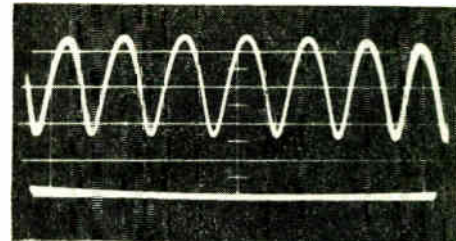

(d) Rf envelope of mixed signal (expanded scale).

Fig. 9—Rf envelopes of SSM output.

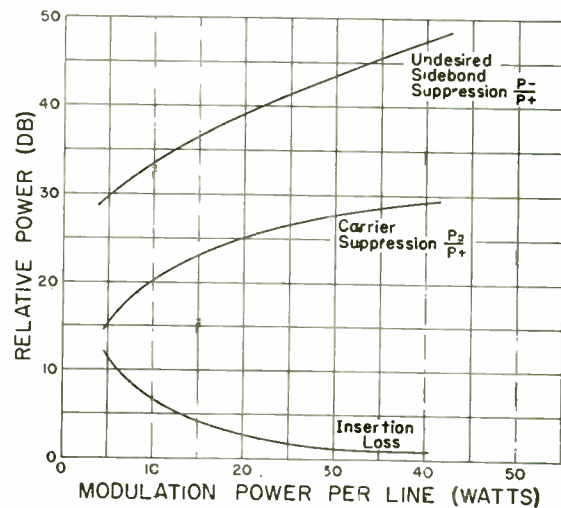

Fig. 10 SSM (reflection type) operating characteristics at 9,375 mc.

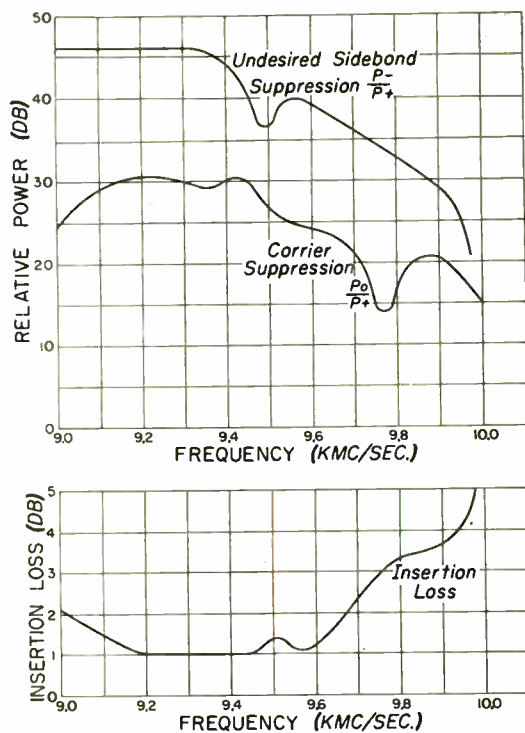

Fig. 11—Frequency characteristic of SSM (reflection type).

and modulation power. Fig. 11 shows that the undesired sideband and carrier suppression, and insertion loss are optimum at 9,300 mc.

CONCLUSIONS

Phase shift and insertion loss measurements for microwave energy propagated through ferrites with transverse dc magnetic fields indicate that devices such as phase shifters and attenuators can be designed. For the transverse field parallel to the microwave H -vector, the phase delay was different from that for the field perpendicular to the H -vector. Thus, differential phase shift sections are possible. Two single-sideband modulators employing ferrites as differential half-wave plates were designed for shifting the frequency of an X -band signal by plus or minus 20 kc.

ACKNOWLEDGMENTS

The author wishes to express appreciation for the assistance he received in performing the above work. He desires to thank H. Kalmus for his continued interest and helpful comments; R. C. LeCraw for many enlightening discussions; and L. Diehl and H. Dropkin for their many valuable ideas and assistance with the technical development.

Developmental Germanium Power Transistors*

E. G. ROKA†, ASSOCIATE MEMBER, IRE, R. E. BUCK‡, AND G. W. REILAND‡

Summary—A developmental germanium power transistor is described. The collector heat dissipation is 20 watts at room temperature when the transistor is properly mounted. The unit delivers a peak collector current in the order of 1 ampere and has a peak collector voltage of 60 volts. Problems concerning heat transfer and mounting are discussed. Electrical characteristics for 75 degrees F. and 175 degrees F. mounting base temperature are given.

THE POWER HANDLING ABILITY of germanium junction transistors is limited primarily by the maximum heat dissipation of the transistor, the maximum collector voltage, and the maximum collector current. The importance of heat dissipation is well known and presently is the basis for power classification of transistors. The collector voltage is limited by structural factors such as resistivity of the germanium and others. Experience indicates that at high tempera-

tures the germanium power transistors seem to give more satisfactory operation using lower collector voltage and high collector current. The collector current limitation is not sharp, and in many cases is a function of the particular application of the transistor. In the case of the power transistor, in which large collector currents exist, it is found that the power gain decreases with increasing collector current. The necessity of a given practical power gain limits the collector current and the maximum power output. For low power transistors in most cases the maximum heat dissipation is the controlling factor for power output. For high power units with good heat transfer, the maximum collector current and voltage or the requirement of a minimum power gain may limit the power output more severely, to a lower value, than that allowed by heat dissipation. The power transistor must have a junction large enough to carry high currents with a reasonable alpha. The power output can be limited in specific cases, of course, through other considerations such as the leakage current I_{c0} , mechanical design, and other factors.

* Decimal classification: R282.12. Original manuscript received by the IRE, January 4, 1954; revised manuscript received, March 22, 1954.

† Formerly Research Center, Minneapolis-Honeywell Regulator Co., Hopkins, Minn., now with Delco Radio Div. of General Motors Co., Kokomo, Ind.

‡ Research Center, Minneapolis-Honeywell Regulator Co., Hopkins, Minn.

The transistor which is described was developed to deliver a few watts of power output from room temperature up to 130 degrees F.

An outside and cross-sectional view of the transistor are shown in Figs. 1 and 2. The unit is a germanium, indium alloyed-junction $p-n-p$ transistor. The principles concerning alloyed-junction transistors are already described in other papers and need not be discussed here.¹⁻⁴ The transistor shown is hermetically sealed in a metal case to eliminate deteriorating effects of humidity. The collector is soldered directly to the copper base of the metal shell. The base and emitter leads are brought through the case by means of glass-to-metal seals.

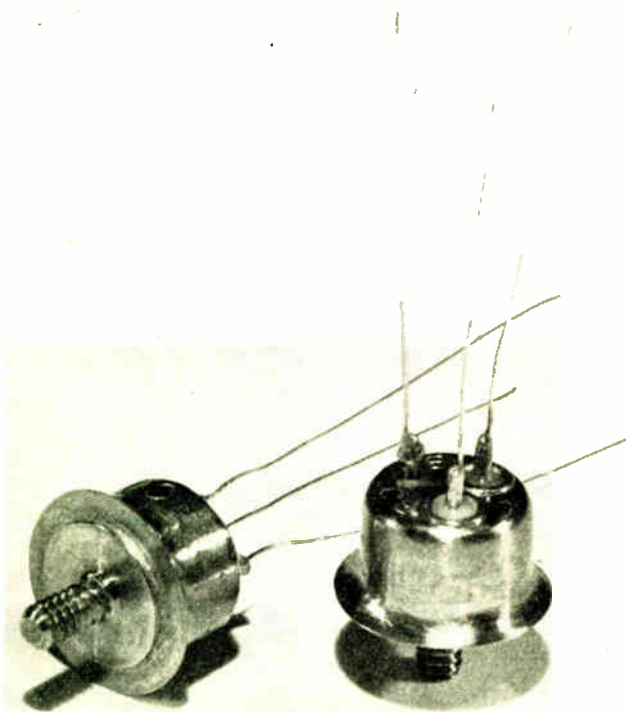

Fig. 1—The new power transistor.

The heat generated at the collector junction is conducted to the outside of the shell through the indium and the heat-transferring copper base of the shell. In order to assure adequate transfer of heat from the copper base, it is recommended that the transistor be mounted so the heat can be easily transferred from the copper base to an externally adaptable heat sink.

In many cases, it is necessary that the collector which is attached to the copper base remain electrically isolated from the heat sink. This can be accomplished by

inserting a 2 mil mica washer between the copper heat transfer base of the transistor shell and the chassis or heat sink as shown in Fig. 3. This provides good electrical insulation with a minimum of thermal insulation. It has been found that by applying a drop of silicone oil between the mica sheet and the metal surfaces the temperature drop across the mica insulator will be less than 2 degrees F. per watt of heat transfer.

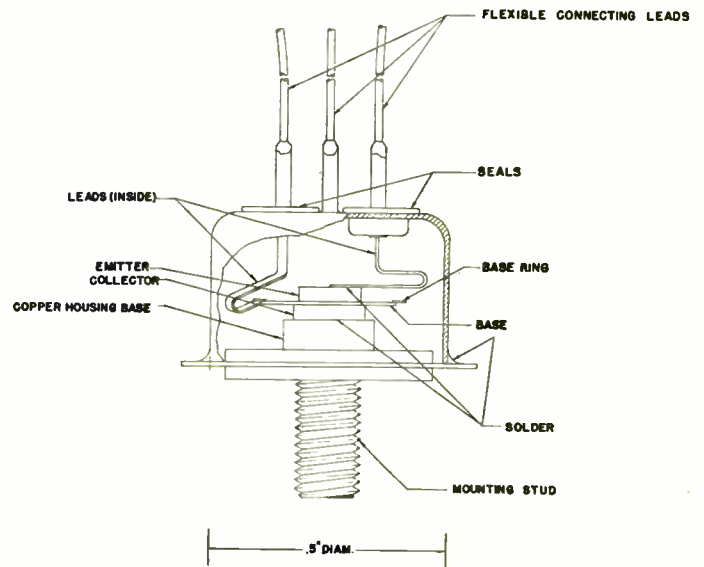

Fig. 2—Cross sectional view of the transistor.

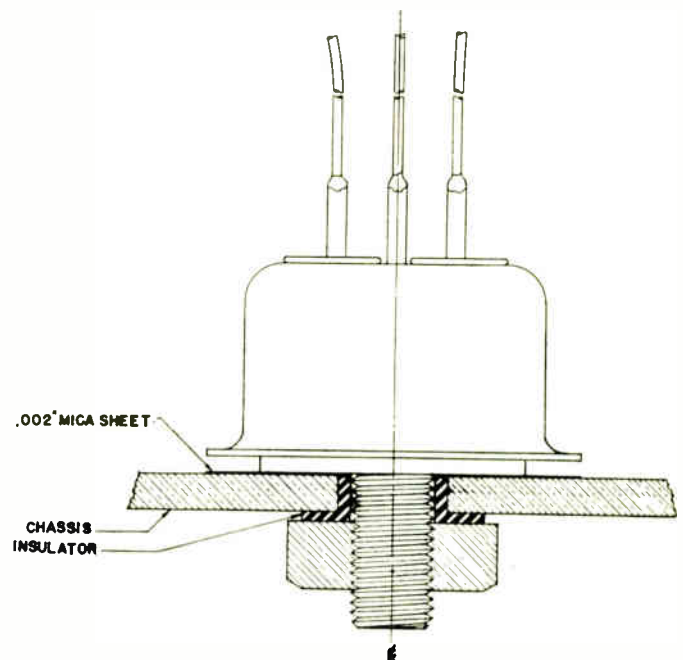

Fig. 3—A simple way of mounting transistor on chassis for effective heat transfer. A mica sheet, 2 mils thick, and a positioning ring insulate, electrically, transistor from chassis. Effective heat transfer is possible through the mica sheet to chassis.

The transfer of heat from the collector junction to the copper base of the transistor shell provides a flexible means of effectively cooling the transistor. For example, in many applications, there is sufficient chassis area to

¹ R. R. Law, C. W. Mueller, J. I. Pankove, and L. D. Armstrong, "A developmental germanium $p-n-p$ junction transistor," *Proc. I.R.E.*, vol. 40, p. 1352; November, 1952.

² R. N. Hall, "Power rectifiers and transistors," *Proc. I.R.E.*, vol. 40, p. 1512; November, 1952.

³ L. J. Giacoletto, "Power transistors," *Proc. of Transistor Short Course*, State College, Pa., p. XVII-1; 1953.

⁴ J. D. Fahnestock, "Production techniques in transistor manufacture," *Electronics*, vol. 26, p. 130; October, 1953.

provide adequate heat dissipation for the transistor. In other arrangements loudspeakers, transformers, or other metallic objects may be used as heat sinks. However, in applications where this is not possible the copper base temperature can be maintained by attaching colling fins.

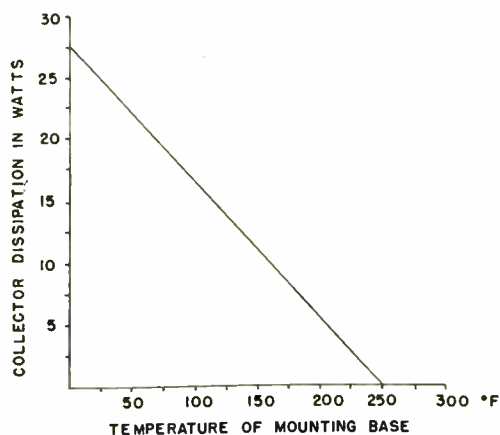

Fig. 4—The maximum collector heat dissipation of the transistor as a function of the base temperature of the transistor shell.

The size and shape of the fins can be arranged to best fit the space available. There are some applications in which the transistor may be hermetically sealed in a container with other components and in this case, it would be most desirable to attach the transistor directly to the hermetic can, and in turn provide a heat sink for

the can if necessary. This heat sink could be a part of the chassis or an attached radiator, whichever fits the design of the unit. It seems more practical to transfer the heat from the transistor to the container by direct conduction rather than to transfer the heat from the transistor to the container by less direct methods of convection or radiation.

The heat transfer from cooling fins or other heat sinks to the ambient air depends on a number of factors.⁵ A simple estimation shows³ that in the particular case when the fins are at 50 degrees C. above the ambient room temperature of 25 degrees C., about 2 square inches of cooling surface are necessary per watt of heat dissipation in the transistor allowing normal air circulation and radiation. The heat transfer parameters can vary considerably according to the individual circumstances.

Fig. 4 shows the maximum heat dissipation of the transistor as a function of the temperature of the copper base of the transistor shell. This temperature is, in the case of an "infinite" heat sink, about the same as the ambient temperature. If the base of the transistor is maintained at approximately 70 degrees F. it is possible to dissipate at least 20 watts of power in the collector, while at 175 degrees F. the power dissipated in the transistor is more than 8 watts. It has been found that the

⁵ W. H. McAdams, "Heat Transmission," McGraw-Hill Book Co., Inc., New York, N. Y.; 1942.

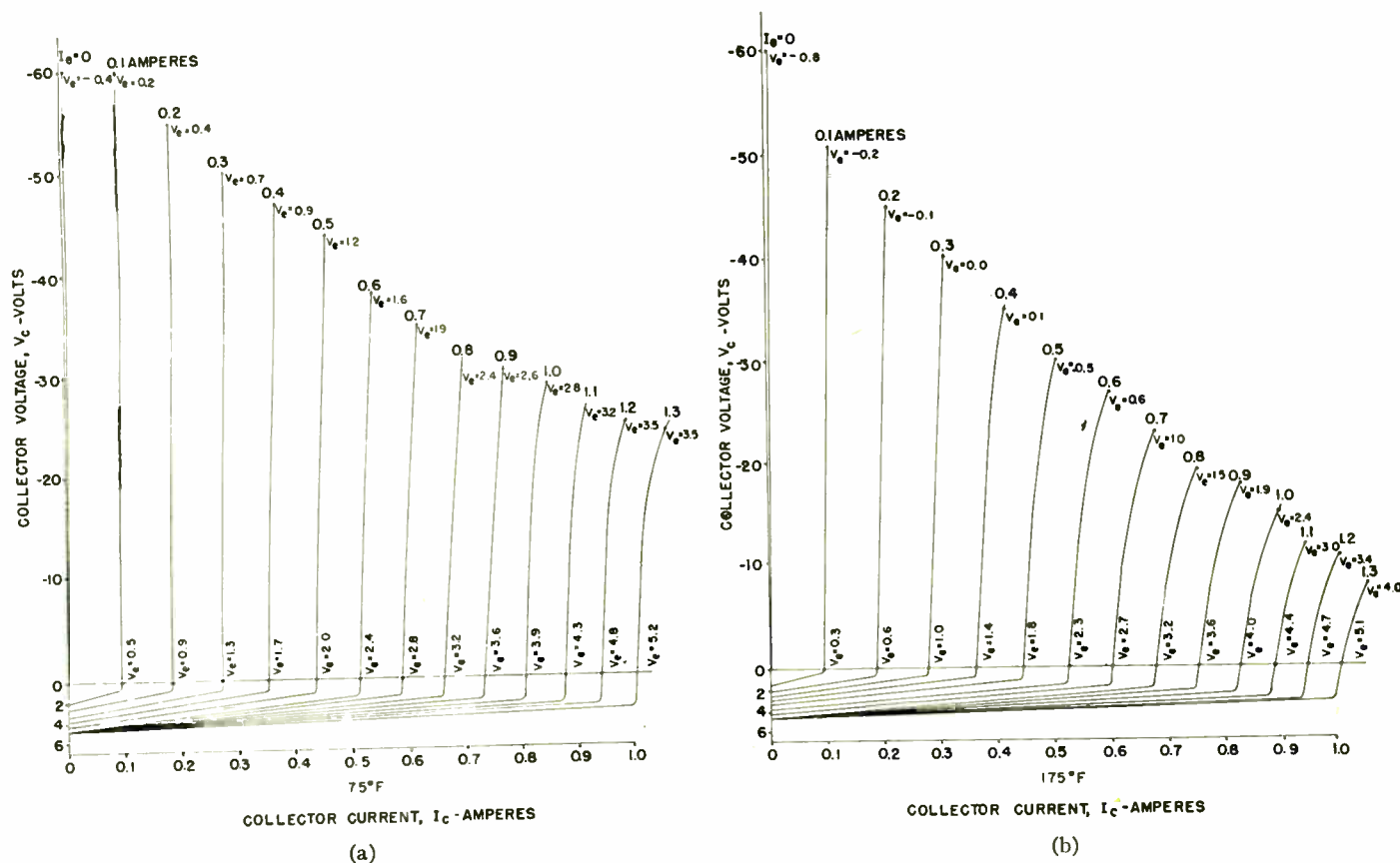

Fig. 5—Transistor characteristics for ambient temperatures of (a) 75 degrees F. and (b) 175 degrees F. with the mounting base connected to an "infinite" heat sink.

actual junction temperature increases about 9 degrees F. above the temperature of the copper base for each watt of collector-heat dissipation.

Figs. 5(a) and 5(b) (previous page) show the characteristics of this power transistor at ambient temperatures of 75 degrees F. and 175 degrees F. when properly connected to an "infinite" heat sink. The peak collector voltage in both cases is 60 volts. The curves in Fig. 5(b) show that satisfactory operation is possible at 175 degrees F. base temperature.

As far as the current amplification in grounded-emitter configuration is concerned the characteristics in Fig. 5 represent transistors in the upper third of our present units. However, the best units show considerably higher current gain. Emitter voltages, V_e , measured against the base are given at the selected points marked on the curve with dots.

The general small signal parameters such as r_e , r_b , and r_c and alpha are a function of the collector current for power transistors when the collector current is large.

From Fig. 5 it can be seen that a maximum power output up to 60 watts can be realized in dc switching applications. In ac applications the power output, of course, will be much less depending on the circuit and the desired power gain.

The transistor just described is a developmental unit, but experience indicates that it should be possible to develop transistors of this type with higher power handling abilities in the near future.

ACKNOWLEDGMENTS

The authors wish to acknowledge the help and manifold assistance of our co-workers and colleagues in the Honeywell Research Center.

Transmission Formulas and Charts for Laminated Coaxial Cables*

R. A. KING†, MEMBER, IRE AND S. P. MORGAN†

Summary—Theoretical formulas are given for the attenuation constants of Clogston laminated coaxial cables, together with illustrative numerical examples and charts in which the parameters are not too far outside the realm of present manufacturing possibility. In the first section the metal losses in a Clogston cable are discussed and compared with the losses in a conventional coaxial cable, and optimum proportions for the laminated cable are suggested. The second and third sections deal respectively with dielectric losses and the effects of nonuniformity in laminated cables.

INTRODUCTION

CLOGSTON¹ HAS PROPOSED a new type of coaxial cable in which the propagation space is partly or wholly filled with alternate thin layers of metal and insulation. He has shown that under proper conditions such a laminated cable should have lower attenuation than a conventional coaxial cable. Recent publications^{2,3} have dealt with the mathematical

analysis of laminated cables and the experimental verification of the theory, but so far no very complete set of numerical results has been published.⁴ This paper contains formulas and charts for the attenuation and bandwidth characteristics of Clogston cables with design parameters which are within or not too far outside the ranges of present manufacturing techniques and materials.

We shall consider only cables in which the entire propagation space is filled with laminations, since analysis has shown that, at least in the absence of magnetic loading, a completely laminated cable exhibits lower loss than one having laminated inner and outer conductors separated by a main dielectric.⁵ A schematic view of the cable is shown in Fig. 1. It consists of a laminated coaxial stack of alternate layers of metal and insulation, bounded internally by a cylindrical core and externally by a cylindrical sheath. Preferably the core and the sheath are insulators, or at least not such good conductors as the metal in the laminated stack.

* Decimal classification: R117.2. Original manuscript received by the IRE, October 29, 1953; revised manuscript received, March 18, 1954.

† Bell Telephone Laboratories, Murray Hill, N. J.

¹ A. M. Clogston, "Reduction of skin-effect losses by the use of laminated conductors," *Proc. I.R.E.*, vol. 39, pp. 767-782; 1951; also, *Bell Sys. Tech. Jour.*, vol. 30, pp. 491-529; July, 1951.

² S. P. Morgan, "Mathematical theory of laminated transmission lines," *Bell Sys. Tech. Jour.*, vol. 31, pp. 883-949 and 1121-1206; November, 1952.

³ H. S. Black, C. O. Mallinckrodt, and S. P. Morgan, "Experimental verification of the laminated conductors," *Proc. I.R.E.*, vol. 40, pp. 902-905; August, 1952.

⁴ E. F. Vaage, "Transmission properties of laminated Clogston type conductors," *Bell Sys. Tech. Jour.*, vol. 32, pp. 695-713; May, 1953, has given curves showing the metal losses, but only for the case in which the metal layers are twice as thick as the insulation.

⁵ In footnote reference 2 the completely laminated structure is called a Clogston 2 cable, and the partially laminated one a Clogston 1.

Theory and experiment show that if the metal layers are thin compared to the skin depth at the operating frequency, then the Clogston cable will propagate a transmission mode in which the current flows throughout the stack with a roughly sinusoidal distribution. In this mode the current flows in one direction in the inner layers and returns in the outer layers, with a null in the current density at some intermediate radius.⁶ The total volume of conducting material available to the current is thus higher than it would be in a conventional two-conductor cable with a well-developed skin effect, and the attenuation constant is therefore lower.

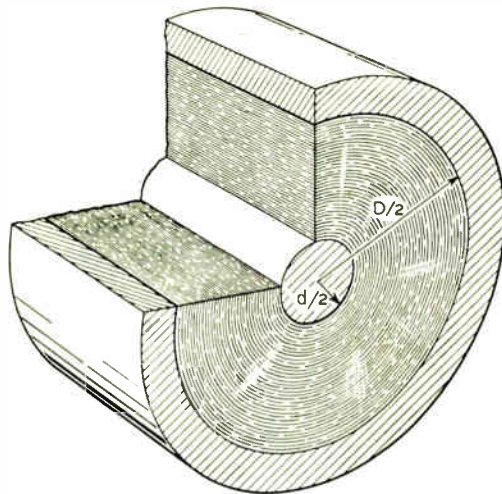

Fig. 1—Laminated Clogston coaxial cable.

There is in fact a range of frequencies, limited among other things by the thickness of the conducting layers, over which the attenuation constant of a Clogston cable is substantially independent of frequency. As is well known, the attenuation constant of a conventional coaxial cable is approximately proportional to the square root of frequency.

The general dependence of the attenuation constant of a Clogston cable on frequency has been discussed elsewhere⁷ and is shown schematically in Fig. 2 on a log-log scale. There are four distinct regions, which may be classified as very low, low, high, and very high frequencies. The limits of these various regions depend on the over-all dimensions of the cable and the thickness of the individual layers; they will be specified more precisely in the next section. For comparison it may be noted that the attenuation constant of an ordinary coaxial cable of comparable size is a straight line pro-

portional to the square root of frequency (except possibly at the very low end), lying above the Clogston curve in the middle range and below it at the ends. Engineering interest in the Clogston cable centers on the entire range called low, in which the attenuation constant is approximately independent of frequency, and the beginning of the range called high, in which the attenuation starts to vary as the square of the frequency. The very low range, in which the attenuation is proportional to the square root of frequency, is of somewhat less interest, and the very high range, in which the attenuation constant again varies as the square root of frequency, is not at present of any importance.

Although the thinness of the conducting layers is a major factor in determining the width of the frequency band over which a Clogston cable will have lower loss than a conventional coaxial cable of the same size, it is not the only such factor. Dielectric dissipation in the insulating layers may contribute appreciably to the total loss at the upper end of the frequency band. What is even more important, the average electrical properties of the laminated medium must be held extremely uniform from one side of the stack to the other, or else the current distribution in the propagating mode will be distorted and the attenuation constant correspondingly increased.

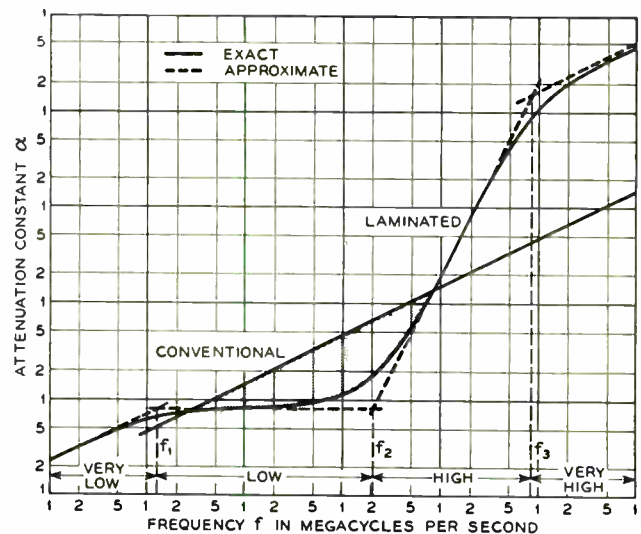

Fig. 2—Schematic plots of the attenuation constants of a laminated cable and a conventional air-filled coaxial cable of comparable size. Shading indicates the region in which the laminated cable has lower attenuation than the conventional cable.

⁶ It is shown in footnote references 1 and 2 that higher transmission modes can also exist, in which there is more than one current reversal across the stack. These modes have higher losses than the lowest or principal mode described above; they will not be considered here.

⁷ Morgan, *ibid.*, pp. 1163-1181.

In the following two sections formulas and curves are given for metal and dielectric losses. Under all ordinary conditions these two kinds of loss should be additive on a db basis. The last section contains a more qualitative discussion of the effects of nonuniformity.

METAL LOSSES

The following symbols will be used throughout the paper. Units are MKS except where English units are specified in particular formulas.

- C = a parameter related to the degree of nonuniformity in a laminated medium
- d = inner diameter of stack
- D = outer diameter of stack
- f = frequency in cycles/sec
- f_c = a characteristic frequency associated with a Clogston cable and defined by (11) below
- f_1 = transition frequency between very low and low frequency ranges
- f_2 = transition frequency between low and high frequency ranges
- f_3 = transition frequency between high and very high frequency ranges
- f_m = highest frequency in the operating band
- g = conductivity of conducting layers
- $\bar{g} = \theta g$; average conductivity of stack
- g_{cu} = conductivity of copper = 5.800×10^7 mhos/meter
- t_1 = thickness of a single conducting layer
- t_2 = thickness of a single insulating layer
- α = attenuation constant
- α_d = attenuation constant due to dielectric loss
- α_0 = low-frequency ("flat") attenuation constant of any Clogston cable
- α_{00} = minimum value of α_0 (obtained with $\theta = 2/3$ for nonmagnetic lines)
- $\delta = \sqrt{2/\omega\mu_v g}$; skin thickness in a solid conductor
- $\bar{\epsilon} = \epsilon_r \epsilon_v / (1 - \theta)$; average dielectric constant of stack
- ϵ_r = relative dielectric constant of insulation
- ϵ_v = dielectric constant of free space; 8.854×10^{-12} farad/meter
- $\theta = t_1 / (t_1 + t_2)$; fraction of conductor in stack
- θ_m = optimum value of θ as defined below
- θ_0 = average value of θ in a nonuniform stack
- μ_v = permeability of free space; $4\pi \times 10^{-7}$ henry/meter
- ω = angular frequency in radians/second
- $\tan \phi$ = loss tangent of insulating layers
- $F^2(d/D)$, $F^2(d/D)/(1-d/D)^2$ = numerical functions plotted against d/D in Fig. 3.

All permeabilities are set equal to μ_v , since we are not considering the use of magnetic materials. Furthermore, in the derivations of the formulas the total conduction and displacement currents in the core and the sheath have been neglected compared to the conduction currents in the laminated medium. If the laminations are applied to a conducting core and/or surrounded by a conducting sheath, the attenuation constant will be reduced, though probably not a great extent, at the lower end of the "flat" frequency band due to the shunting effect of the core and the sheath.

The attenuation constant of a cable of fixed outer

diameter D decreases as the core diameter d is decreased, and the lowest attenuation is theoretically obtained when $d = 0$. However, to achieve reasonable fabricating ease and strength of line the first layers will have to be laid on some semi-rigid rod or wire of finite diameter. When it is desirable to assign a numerical value to the core diameter, we shall rather arbitrarily choose the ratio $d/D = 0.1$. The "flat" attenuation constant of the cable is proportional to the function $F^2(d/D)/(1-d/D)^2$, which is plotted against d/D in Fig. 3. Reference to the figure shows that this function is substantially constant for d/D in range from 0 to 0.1.

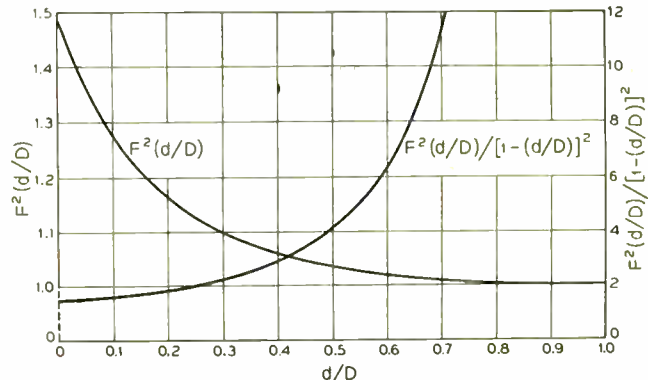

Fig. 3—The functions $F^2(d/D)$ and $F^2(d/D)/(1-d/D)^2$.

To get an idea of orders of magnitude, we shall first give the limits of the frequency ranges shown in Fig. 2. The transition frequencies $f_1, f_2,$ and f_3 are defined by the following equations:

$$f_1 = \frac{\pi F^2(d/D)}{\mu_v \bar{g} D^2 (1-d/D)^2},$$

$$f_2 = \frac{2\sqrt{3} F(d/D)}{\mu_v \bar{g} t_1 D (1-d/D)}, \tag{1}$$

$$f_3 = \left[\frac{36}{1-\theta} \right]^{1/3} \frac{1}{\pi \mu_v g t_1^2},$$

where $F(d/D)$ is a function of the ratio of core diameter to outer diameter of the cable and is of the order of magnitude of unity.⁸ $F^2(d/D)$ and $F^2(d/D)/(1-d/D)^2$ are plotted in Fig. 3. For subsequent numerical calculations note the values

$$F(0.1) = 1.129, \quad F^2(0.1) = 1.275. \tag{2}$$

Assuming that $d/D = 0.1$ and measuring the conductor thickness in mils and the cable diameter in inches, we find the following numerical formulas for the transition frequencies (in cycles/sec):

⁸ Morgan, *ibid.*, Part II, pp. 1127-1128. Actually

$$F(d/D) = (d-D)\chi/\pi,$$

where χ is the smallest root of the equation in Bessel functions,

$$J_1(\chi d)N_1(\chi D) - J_1(\chi D)N_1(\chi d) = 0.$$

The present χ is one-half the χ_1 of Morgan.

$$\begin{aligned}
 f_1 &= \frac{105.2}{\theta(g/g_{cu})D_{in}^2}, \\
 f_2 &= \frac{9.244 \times 10^4}{\theta(g/g_{cu})(t_1)_{mils}D_{in}}, \\
 f_3 &= \frac{2.235 \times 10^7}{(1-\theta)^{1/3}(g/g_{cu})(t_1)_{mils}^2}.
 \end{aligned} \quad (3)$$

Thus for a cable with copper conductors 0.1 mil thick and insulation 0.1 mil thick ($\theta = \frac{1}{2}$), and having an outside diameter $D = 0.1$ inch, the transition frequencies are $f_1 = 21.04$ kc, $f_2 = 18.49$ mc, and $f_3 = 2,816$ mc. For a cable of diameter 0.75 inch, we should have $f_1 = 374$ cps, $f_2 = 2.465$ mc, and $f_3 = 2,816$ mc.

The remainder of this section will be concerned with the low or "flat" frequency range, which extends approximately from f_1 to f_2 , and the high-frequency range, extending approximately from f_2 to f_3 . In the high range, only the part up to frequencies of two or three times f_2 is likely to be of much practical interest.

The low-frequency attenuation constant of a Clogston cable is⁹

$$\alpha = \frac{2\pi^2 F^2 (d/D)}{\sqrt{\mu_v/\bar{\epsilon}} \bar{g} D^2 (1-d/D)^2} \text{ nepers/meter.} \quad (4)$$

The way in which the attenuation constant increases with frequency due to the finite thickness of the conducting layers is given by¹⁰

$$\begin{aligned}
 \alpha &= \frac{2\pi^2 F^2 (d/D)}{\sqrt{\mu_v/\bar{\epsilon}} \bar{g} D^2 (1-d/D)^2} \\
 &+ \frac{\theta t^2 \pi^2 \mu_s^2 g^2 f^2}{6\sqrt{\mu_v/\bar{\epsilon}} \bar{g}} \text{ nepers/meter.}
 \end{aligned} \quad (5)$$

Eq. (5), which includes (4) as a special case for low enough frequencies or thin enough conductors, is valid over approximately the whole frequency range $f_1 < f < f_3$.

To put this equation in a convenient form for numerical computation take the value $d/D = 0.1$, and express the conductor thickness t_1 in mils, the cable diameter D in inches, the frequency f in megacycles, and the attenuation constant α in decibels/mile. The result is

$$\begin{aligned}
 \alpha &= \frac{3.082 \times 10^{-2} \sqrt{\epsilon_r}}{\theta(1-\theta)^{1/2}(g/g_{cu})D_{in}^2} \\
 &+ \frac{3.607\theta(t_1)_{mils}^2(g/g_{cu})f_{mc}^2 \sqrt{\epsilon_r}}{(1-\theta)^{1/2}} \text{ db/mile,}
 \end{aligned} \quad (6)$$

where ϵ_r is the relative dielectric constant of the insulation.

Several families of attenuation vs frequency curves calculated from (6) are plotted on log-log scales in

Fig. 4. These curves are for cables with copper conductors and with diameters of 0.1, 0.375, and 0.75 inch. For the sake of example we have chosen two values of θ , namely $\theta = 2/3$, which minimizes the low-frequency attenuation constant, and $\theta = 1/5$. In the former case the insulating layers are half as thick as the conducting layers, and in the latter case they are four times as thick. Each family of curves includes six thicknesses of conducting layers, from 0.05 mil to 0.5 mil. Also shown on each plot is the attenuation constant of an air-filled conventional coaxial cable of the same outside diameter and optimum proportions (ratio of conductor diameters equal to 3.59). The attenuation constant of the conventional cable is

$$\alpha = \frac{1.369(\epsilon_r f_{mc})^{1/2}}{(g/g_{cu})^{1/2} D_{in}} \text{ db/mile.} \quad (7)$$

It should be emphasized curves of Fig. 4, page 1254, were all calculated for $\epsilon_r = 1$, and so to get the attenuation constant of an actual laminated cable, the plotted values of attenuation must be multiplied by $\sqrt{\epsilon_r}$, where ϵ_r is the relative dielectric constant of the insulation. For example, with polyethylene insulation having $\epsilon_r = 2.26$, the multiplicative factor is 1.503. On the logarithmic scale this multiplication merely corresponds to a vertical translation of the whole family of curves. If one wishes to compare the Clogston cable with a dielectric-filled conventional coaxial cable, the straight line for the conventional cable is also shifted upward by an amount corresponding to $\sqrt{\epsilon_r}$.

In the low-frequency range and the first part of the high-frequency range, the phase velocity of a Clogston cable is given by the simple expression,

$$v = 1/\sqrt{\mu_v \bar{\epsilon}} = \frac{3 \times 10^8 \sqrt{1-\theta}}{\sqrt{\bar{\epsilon}_r}} \text{ meters/sec.} \quad (8)$$

The behavior of the phase velocity at very low and very high frequencies is of more or less academic interest and has been discussed elsewhere.¹¹

Next consider the question of optimum proportions for Clogston cables. It is easily shown that in the low-frequency range α is a minimum when $\theta = 2/3$, that is, when the conducting layers are twice as thick as the insulating layers. Call the minimum low-frequency attenuation constant α_{00} ; then putting $\theta = 2/3$ in (4) we have

$$\alpha_{00} = \frac{3\sqrt{3} \pi^2 \sqrt{\epsilon_r} F^2 (d/D)}{\sqrt{\mu_v/\epsilon_v} g D^2 (1-d/D)^2} \text{ nepers/meter,} \quad (9)$$

or, if $d/D = 0.1$,

$$\alpha_{00} = \frac{8.008 \times 10^{-2} \sqrt{\epsilon_r}}{(g/g_{cu})D_{in}^2} \text{ db/mile.} \quad (10)$$

⁹ *Ibid.*, p. 1127, eq. (295).

¹⁰ *Ibid.*, p. 1177, eq. (495).

¹¹ *Ibid.*, pp. 1167-1169.

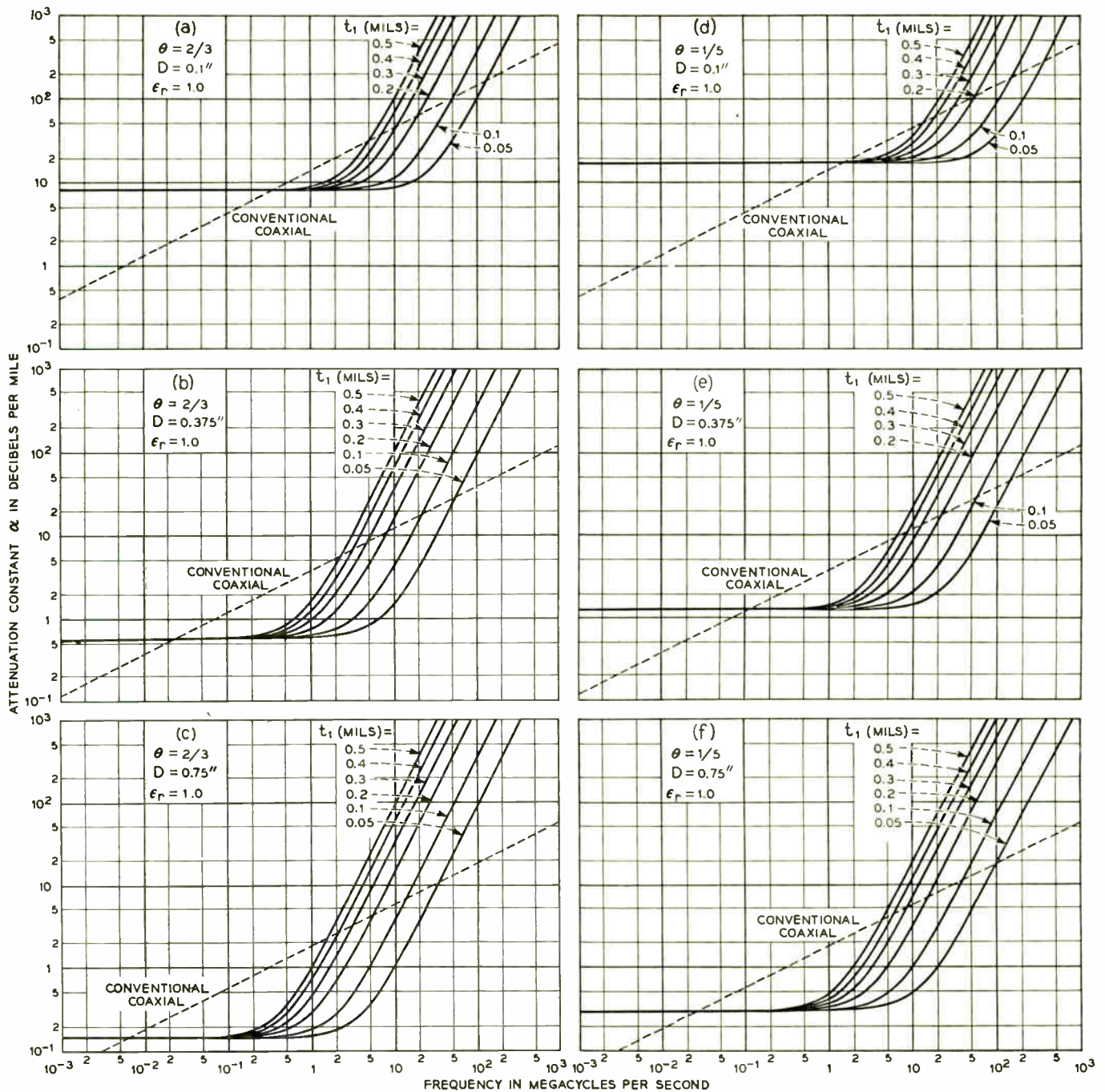

Fig. 4—Attenuation-frequency curves for Clogston cables of different sizes with copper conductors of various thicknesses. The dotted lines refer to conventional coaxials of the same diameter D .

In Fig. 5 are plotted curves showing the values of α_{00} obtainable with cables of different diameters having copper conductors and insulation whose relative dielectric constant ranges from 1 (for a hypothetical cable with air insulation) to 6.

A convenient reference parameter in the optimum design problem is the characteristic frequency f_c , at which the attenuation constant of a Clogston cable with $\theta = 2/3$ is double its low-frequency value α_{00} . From (5) we find

$$f_c = \frac{3\sqrt{3} F(d/D)}{\mu_0 g t_1 D (1 - d/D)} \text{ cps,} \tag{11}$$

or, if $d/D = 0.1$ and f_c is measured in mc,

$$(f_c)_{mc} = \frac{13.87 \times 10^{-2}}{(g/g_{cu})(t_1)_{mils} D_{in}} \text{ mc.} \tag{12}$$

The frequency f_c is plotted in Fig. 6 as a function of cable diameter, for cables with copper conductors of thickness from 0.05 mil to 0.5 mil.

It may be noted that the transition frequency f_2 of (1) and (3) is the frequency at which the attenuation constant of any Clogston cable is double its low-frequency value α_0 , and in general

$$f_c = (3\theta/2)f_2. \tag{13}$$

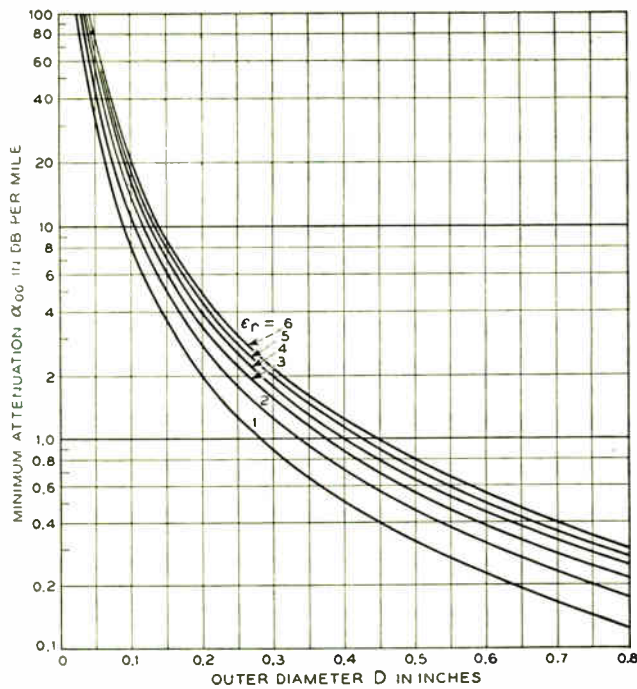

Fig. 5—Minimum attenuation constant α_{00} , for $\theta = \frac{2}{3}$, as a function of cable diameter and dielectric constant of insulation.

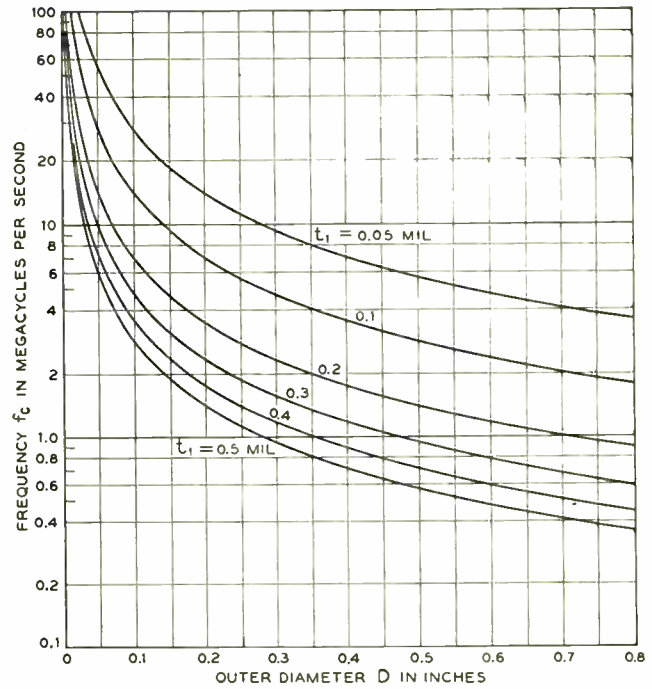

Fig. 6—Characteristic frequency f_c as a function of cable diameter and conductor thickness.

The characteristic frequency f_c is equal to f_2 if $\theta = 2/3$. We now write the general expression (5) for α in the form

$$\alpha = \frac{2\alpha_{00}}{3\sqrt{3}\theta(1-\theta)^{1/2}} \left[1 + \frac{9\theta^2 f^2}{4f_c^2} \right], \quad (14)$$

and pose one or the other of two questions: (a) What is the optimum value of θ which minimizes the attenuation constant at a preassigned top frequency f_m ? (b) What is the optimum value of θ which maximizes the frequency range over which α does not exceed a specified maximum value α_m ?

The value of θ which minimizes α at a given frequency f_m is the root θ_m , lying between zero and unity, of the cubic equation

$$9(f_m/f_c)^2[\theta^3 - 2\theta^2] - 12\theta + 8 = 0. \quad (15)$$

This root decreases from $2/3$ when $f_m/f_c = 0$ toward zero as f_m/f_c increases indefinitely.¹² θ_m is plotted as abscissa against f_m/f_c as ordinate in Fig. 7. Once the value of θ_m is known, the corresponding attenuation constant α_m at the top of the frequency band is obtained from (14) or from Fig. 8 (see following page), which shows the ratio α_m/α_{00} as a function of θ_m .

To maximize the frequency at which a given value α_m of the attenuation constant occurs, θ should satisfy the equation

$$\theta^4 - 4\theta^3 + 4\theta^2 + \frac{64\alpha_{00}^2}{27\alpha_m^2}(\theta - 1) = 0. \quad (16)$$

The root θ_m of this equation which lies between zero and

¹² Actually (14) is valid only down to the neighborhood of the transition frequency f_1 , as given by (1) or (3), but in practice f_m will always be at least a few times larger than f_1 .

unity decreases from $2/3$ when $\alpha_m/\alpha_{00} = 1$ toward zero as α_m/α_{00} increases indefinitely. The value of θ_m may be read from Fig. 8, and the corresponding top frequency f_m determined with a little algebra from (14), or read from Fig. 7.

The low-frequency attenuation constant α_0 of a Clogston cable with $\theta = \theta_m$ will be greater than α_{00} if θ_m

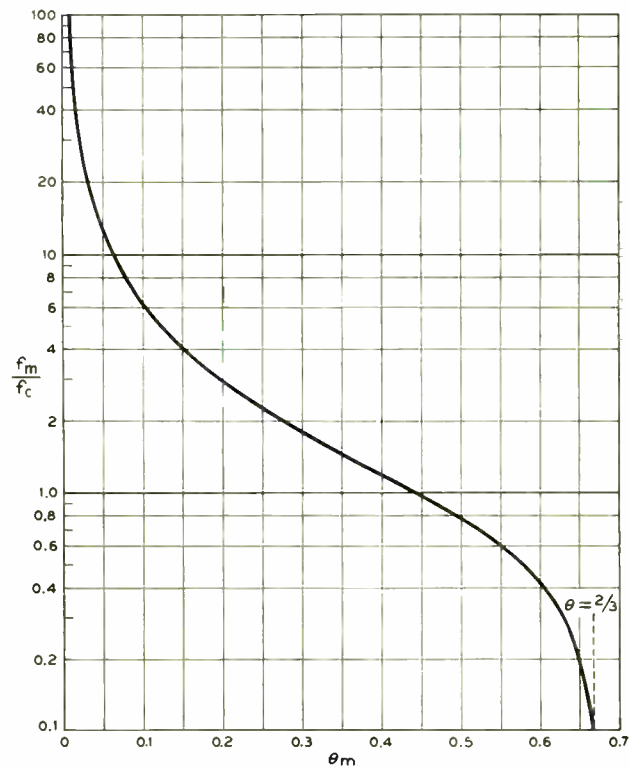

Fig. 7—Relation between the optimum fraction θ_m of conducting material in a Clogston cable and the highest operating frequency f_m in terms of the characteristic frequency f_c .

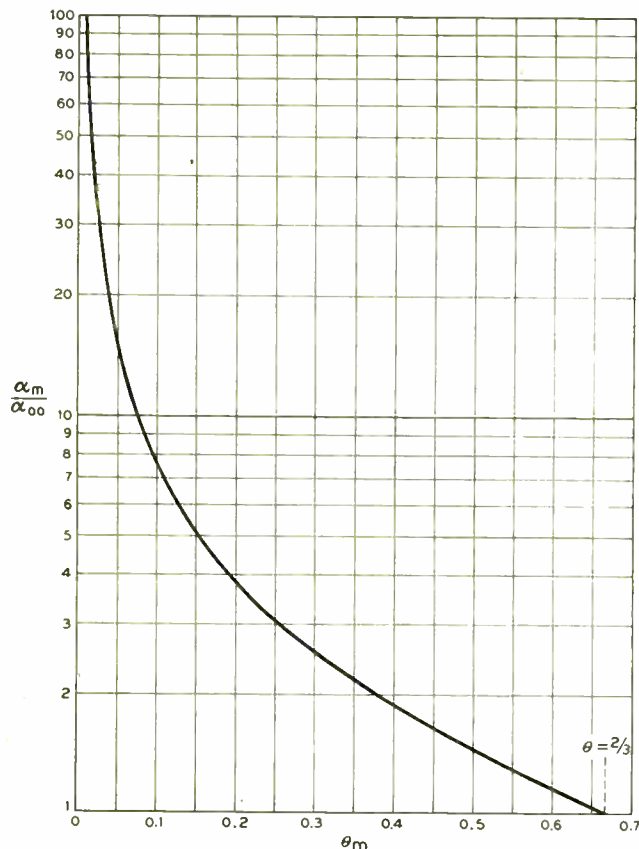

Fig. 8—Relation between the optimum fraction θ_m of conducting material in a Clogston cable and the attenuation constant α_m at the highest operating frequency, in terms of the reference attenuation constant α_{00} .

is not equal to $2/3$. This is not often a disadvantage, however, since usually we only wish to insure that $\alpha < \alpha_m$ over the operating band, and the nearer α approaches to α_m over the whole band the less serious will be the equalization problem. It may be shown that the ratio α_0/α_m decreases from unity toward one-half as α_m/α_{00} is increased indefinitely. Physically this means that the low-frequency attenuation constant of an optimum Clogston cable is always at least half as great as the attenuation constant at the upper end of the band.

As a numerical example, consider a cable of diameter one-half inch, with a core of diameter 0.05 inch, copper conductors of thickness 0.1 mil, and polystyrene insulation with $\epsilon_r = 2.56$. For this cable (10) and (12) give

$$\begin{aligned}\alpha_{00} &= 0.5125 \text{ db/mile,} \\ f_c &= 2.773 \text{ mc.}\end{aligned}\quad (17)$$

If we choose

$$\alpha_m = 2\alpha_{00} = 1.025 \text{ db/mile,} \quad (18)$$

then it turns out that

$$\theta_m = 0.3745, \quad (19)$$

so that the insulating layers should be 0.167 mil thick. The attenuation constant α_m is reached at the frequency

$$f_m = 3.625 \text{ mc,} \quad (20)$$

and the low-frequency attenuation constant for $\theta = \theta_m$ is

$$\alpha_0 = 1.300\alpha_{00} = 0.6660 \text{ db/mile.} \quad (21)$$

DIELECTRIC LOSSES

If the insulating layers in a Clogston cable are slightly dissipative, then the part of the attenuation constant due to dielectric loss is¹³

$$\alpha_d = \pi f \sqrt{\mu_0 \epsilon} \tan \phi \text{ nepers/meter,} \quad (22)$$

where $\tan \phi$ is the loss tangent of the insulation. A convenient numerical form is

$$\alpha_d = 146.5 f_{\text{mc}} \sqrt{\epsilon_r / (1 - \theta)} \tan \phi \text{ db/mile.} \quad (23)$$

As an example, for a cable with polystyrene insulation having $\epsilon_r = 2.56$, $\tan \phi = 0.0003$, and with $\theta = 2/3$, the dielectric loss at 1 mc amounts to 0.122 db/mile.

The metal losses and the dielectric losses in a Clogston cable may be regarded as additive, so long as the total attenuation per wavelength is small. The dielectric losses are directly proportional to frequency, provided that the loss tangent does not vary with frequency, but they are independent of the over-all dimensions of the cable.

EFFECT OF NONUNIFORMITY

All of the formulas and curves so far presented have assumed perfectly uniform laminations, with every conducting layer identical to every other conducting layer in thickness and in electrical properties, and all the insulating layers similarly identical to each other. Since this condition cannot be perfectly realized in practice, it is important to be able to estimate the effect of small nonuniformities on the transmission.

Some particular idealized cases of nonuniformity in a parallel-plane laminated transmission line have been previously studied.¹⁴ The principal conclusion was that in order to realize an attenuation constant which is a small fraction, say one-tenth, of the attenuation constant of a conventional line of the same dimensions, long-range variations in the average dielectric constant of the stack (as distinguished from short-range random fluctuations) must be controlled to within a few parts in 10,000. The price is less steep if the over-all improvement sought is less, but in all practical cases it appears that the average dielectric constant must be held against slow variations to within a fraction of a per cent.

We give here a somewhat briefer account of the effects of nonuniformity in a cylindrical laminated cable. The problem is idealized by the assumption of infinitesimally thin layers; physically this means metal layers very thin compared to the classical skin depth. Also for mathematical simplicity the average dielectric constant of the stack is assumed to vary only in the radial direction. Since $\bar{\epsilon} = \epsilon_r \epsilon_r / (1 - \theta)$, variations in $\bar{\epsilon}$ may result from variations in ϵ_r or variations in θ or both.

¹³ Morgan, *ibid.*, part II, p. 1202, eq. (590).

¹⁴ *Ibid.*, section XII, pp. 1181-1201.

Consider two cases. In the first case the average dielectric constant changes discontinuously from one constant value to another at the midpoint of the laminated stack; thus

$$\bar{\epsilon} = \begin{cases} \bar{\epsilon}_0 - \Delta\bar{\epsilon}/2, & \frac{1}{2}d \leq \rho < \frac{1}{4}(d + D), \\ \bar{\epsilon}_0 + \Delta\bar{\epsilon}/2, & \frac{1}{4}(d + D) < \rho \leq \frac{1}{2}D, \end{cases} \quad (24)$$

where ρ is the radial co-ordinate. In the second case, which is perhaps more realistic physically, $\bar{\epsilon}$ varies linearly from one boundary of the stack to the other, as follows:

$$\bar{\epsilon} = \bar{\epsilon}_0 + \frac{\rho - \frac{1}{4}(d + D)}{\frac{1}{2}(D - d)} \Delta\bar{\epsilon}. \quad (25)$$

In both of these equations $\bar{\epsilon}_0$ represents the mean value of $\bar{\epsilon}$ across the stack, and $\Delta\bar{\epsilon}$ is the difference between the maximum and minimum values.

It is convenient to express the effects of nonuniformity in terms of a dimensionless parameter C defined by

$$C = \pi\mu_0\theta_0g\left(\frac{D}{2}\right)f(\Delta\bar{\epsilon}/\bar{\epsilon}_0), \quad (26)$$

or

$$C = 3.693 \times 10^4 \theta_0(g/g_{cu})D_{in}^2f_{mc}(\Delta\bar{\epsilon}/\bar{\epsilon}_0), \quad (27)$$

where θ_0 is the average value of θ . C is thus directly proportional to $\Delta\bar{\epsilon}/\bar{\epsilon}_0$, and for a stack with a given value of $\Delta\bar{\epsilon}/\bar{\epsilon}_0$, it is directly proportional to frequency.

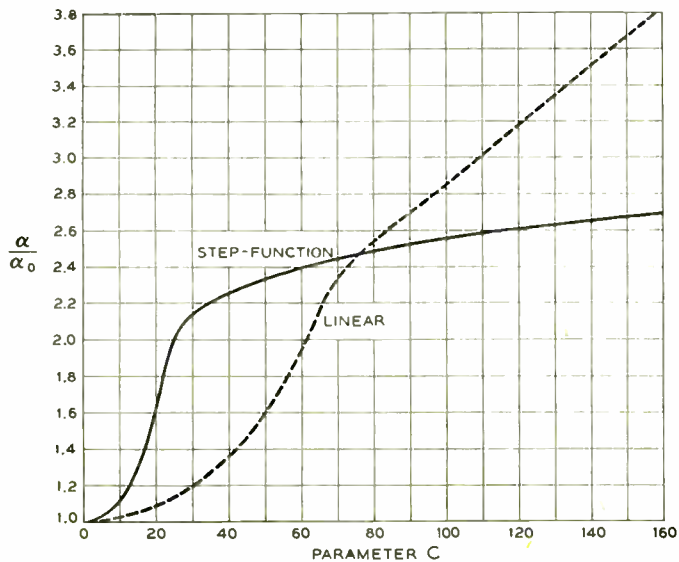

Fig. 9—Normalized attenuation α/α_0 of a Clogston cable vs nonuniformity parameter C for step-function and linear nonuniformity.

When $C=0$, the attenuation constant of the cable with infinitesimally thin layers is merely equal to the value, say α_0 , given by (4) or the first term of (5) or (6). When $C \neq 0$, however, because of a nonzero value of $\Delta\bar{\epsilon}/\bar{\epsilon}_0$, the attenuation constant α of the line is greater than α_0 , and as the frequency increases so does the attenuation constant, at a rate which depends on the nature and magnitude of the nonuniformity.

The ratio α/α_0 is plotted against C in Fig. 9, for both step-function and linear nonuniformity in a cable with $d/D=0.1$. The values were obtained by the procedure, described by Morgan, of solving a boundary-value problem on a general-purpose analog computer, the results then being refined on an IBM Card Programmed Calculator. The differential equation solved was the one appropriate to a cylindrical rather than a plane stack.

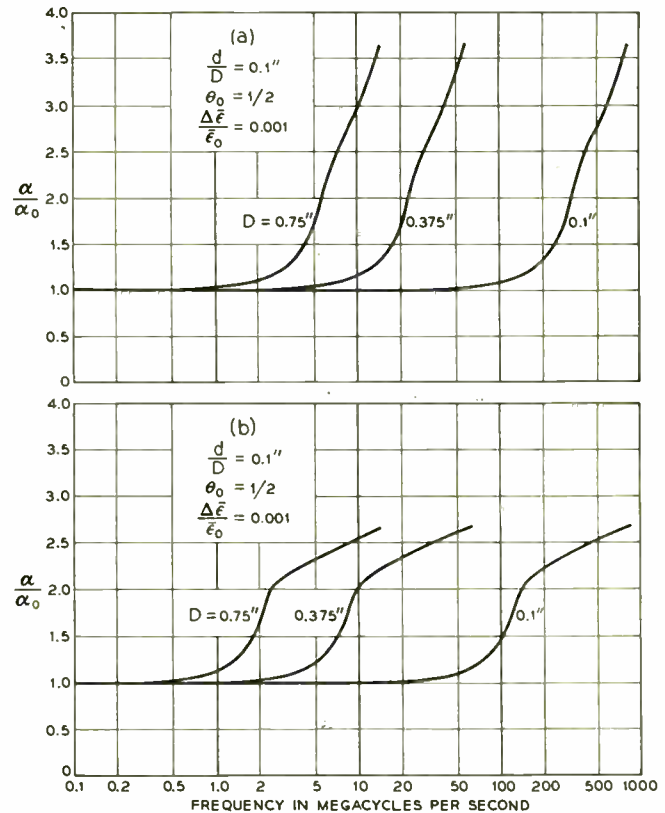

Fig. 10—Normalized attenuation of nonuniform Clogston cables of various diameters with 0.1 per cent total variation in $\bar{\epsilon}$: (a) linear variation, and (b) step-function variation.

It may be observed that for the step-function variation in $\bar{\epsilon}$, the ratio α/α_0 is asymptotic to 3.22 for very large C . This is connected with the existence, for large differences between the dielectric constants of the two parts of the stack, of two modes, one confined essentially to the outer part of the stack and the other to the inner part. In the present case the "outer" mode has somewhat lower attenuation than the "inner" mode, on account of the greater volume of conducting material in the outer part of the stack. With a linear variation in $\bar{\epsilon}$, α/α_0 does not approach a limit for large C , but the fields of the lowest-attenuation mode are concentrated near the outer surface of the stack as the frequency is increased.

Since for a given stack the parameter C is directly proportional to frequency, the plots of Fig. 9 need only the introduction of appropriate scale factors to read attenuation vs frequency directly. For example, Fig. 10 shows curves for cables of various diameters, with $d/D=0.1$ and $\theta_0 = \frac{1}{2}$, when the variation of $\bar{\epsilon}$ from one

side of the stack to the other is 0.1 per cent of $\bar{\epsilon}_0$ (that is, $\Delta\bar{\epsilon}/\bar{\epsilon}_0=0.001$). To convert these to curves for $\Delta\bar{\epsilon}/\bar{\epsilon}_0=0.01$, the frequencies shown should be divided by 10, while for $\Delta\bar{\epsilon}/\bar{\epsilon}_0=0.0001$, the frequencies should be multiplied by 10, and so forth.

From a study of additional types of nonuniformity by Morgan it was concluded that a steady increase or decrease in the value of $\bar{\epsilon}$ across the stack, such as has been considered here, is the most serious kind of nonuniformity. If there are several fluctuations in $\bar{\epsilon}$ across the stack, their effects will tend to average out.

No computations have been made as yet to determine how the effects of finite conductor thickness and nonuniformity compound in a physical cable, but the two effects combined will certainly lead to a higher attenuation constant than either effect separately.

Finally, it should be pointed out that although stack variations in the circumferential and longitudinal directions have been neglected here for mathematical simplicity, on physical grounds it is likely that such variations, if present, will add an appreciable amount to the

total attenuation of the line. If we consider two cross sections of a laminated cable separated by a certain distance and having different transverse nonuniformities, the field pattern of the lowest mode will be different at the two cross sections, and so in traversing the intervening distance the power will be partly reflected and partly converted to higher modes with higher attenuation constants. The reflected or mode converted power will be at least partly lost, with a consequent increase in the over-all attenuation of the cable. Hence the estimate of the increase in attenuation which one gets by considering only the radial variation at an average cross section is certain to be optimistic, in that it neglects completely the effects of variations in other directions.

ACKNOWLEDGMENT

We wish to thank Miss B. B. Cetlin, Mrs. G. J. Rowe, and Mrs. M. M. Neff for the extensive work on the analog computer and the IBM calculator necessary to obtain the curves of Figs. 9 and 10.

Reflection Coefficients of Irregular Terrain*

KENNETH BULLINGTON†, SENIOR MEMBER, IRE

Summary—Radio relay paths with strong ground reflections experience more fading than similar paths with negligible ground reflections. In order to minimize fading the route survey for the transcontinental microwave-relay system included measurements of ground reflection coefficients on most of the proposed repeater sections. In most cases the reflection coefficients at 4,000 mc were in the range from 0.2–0.4. Attempts to correlate these results with the path profiles and to obtain a suitable theoretical explanation indicate that no simple relation exists but that a statistical relationship can be found to fit the observed data.

RADIO WAVES are reflected from the earth's surface in essentially the same way as light is reflected from a mirror. The receiving antenna "sees" not only the transmitting antenna but also its image mirrored in the ground. The reflected signal either adds to the direct signal or subtracts from it, depending on the phase difference between the two paths. When the surface is smooth, the reflected wave is approximately equal in magnitude to the direct signal and almost complete phase cancellation occurs at certain antenna locations. On the other hand when the terrain is very rough, the reflected wave is scattered and its intensity in any one direction is so small that regardless of the phase difference it can have only a minor effect on the received signal intensity.

* Decimal classification: R115.23XR480. Original manuscript received by the IRE, November 24, 1953; revised manuscript received, April 8, 1954. Presented at Naval Elec. Lab., San Diego, Calif., April, 1953.

† Bell Telephone Labs., New York, N. Y.

For a particular frequency and distance it is possible to choose antenna heights so that the direct and reflected waves add in phase during average atmospheric conditions. Unfortunately, the phase difference between the direct and reflected rays varies with meteorological conditions, and a combination of fixed antenna heights designed for phase addition most of the time may result in fading caused by phase opposition for a small percentage of the time. Although fading on line of sight paths can arise from several different causes, paths having strong ground reflections ordinarily give poorer over-all performance than paths having small ground reflections. Consequently in engineering radio systems it is important to know the relation between the magnitude of the reflected ray and the profile of the path.

EXPERIMENTAL RESULTS

Considerable information on the intensity of the ground-reflected ray at 4,000 mc has been obtained by the Bell Telephone Laboratories and the American Telephone and Telegraph Company during the engineering of the transcontinental microwave-radio-relay system. The variation in the received signal with antenna height was measured on many of the proposed repeater sections by the use of 57-inch paraboloid antennas on portable 200-foot towers, and from these data the ground reflection coefficients have been computed. The purpose of these short-term radio tests, made prior to the actual

construction, was to insure adequate clearance and to investigate ground reflections as a guide in minimizing fading.

$$\phi = 2\pi \frac{C}{H_0} \frac{(H)}{(H_0)}$$

where H is the average clearance and $\pm C$ is the deviation in the profile as illustrated in Fig. 3; the factor H_0 is the first Fresnel zone clearance and includes both the distance and the wavelength. (The first Fresnel zone clearance in the middle of a 30-mile path is about 100 feet at 4,000 mc.) H/H_0 is essentially unity for computations of reflection coefficient based on the first maxima of the height-loss curve. On the path profile shown in Fig. 2, the ratio C/H_0 has been judged to be slightly over one half. Since considerable simplification and judgment are required in applying a single number to an actual profile, relative accuracy and not absolute accuracy is the best that can be expected.

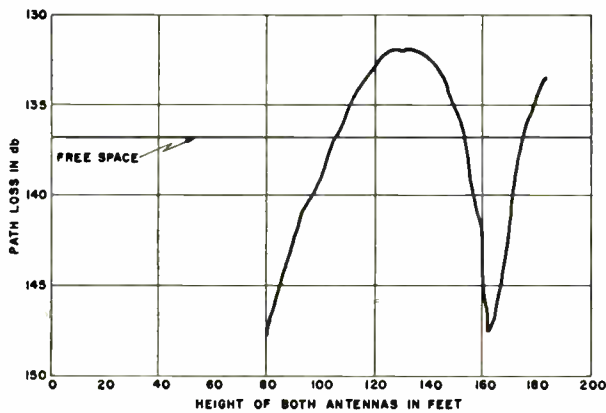

Fig. 1—Antenna height vs path loss, Gibbon-Elm Creek, Nebraska path, 4,000 mc.

Strong reflections were found, as expected, on over-water paths and on the Utah Salt Flats. Outside of these extreme cases the next strongest ground reflection was measured on a path in central Nebraska. The measured variation in received signal with height is shown in Fig. 1, and the profile of this relatively barren path is shown in Fig. 2. The difference between the first maximum and the minimum is almost 16 decibels, which indicates a reflection coefficient of about 0.72.

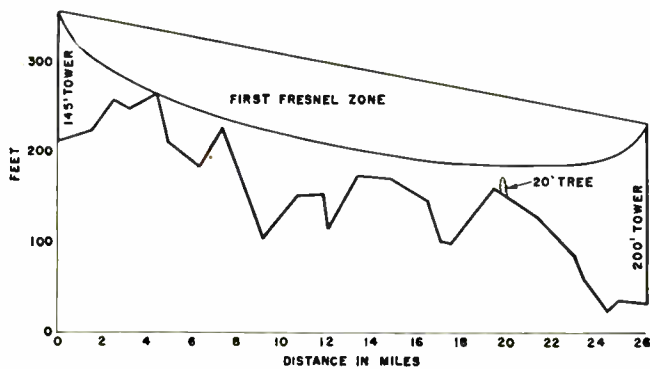

Fig. 2—Path profile, Gibbon to Elm Creek, 26.2 miles.

It was found that the antenna heights at which the maxima and minima occur varied with the time of day so no fixed combination could be optimum all of the time. Moreover, it was found that moving the tower by only about 100 feet at one terminal reduced the reflection coefficient on this path from 0.72 to about 0.55, which indicates that the magnitude of the reflection coefficient cannot be predicted accurately from the gross features of the path profile.

Although an exact prediction does not seem possible (except in special simplified cases) a plot of the reflection coefficients measured on a number of paths would be expected to be distributed around a mean value which decreases uniformly as the degree of roughness increases.

A useful criterion of roughness is the phase deviation

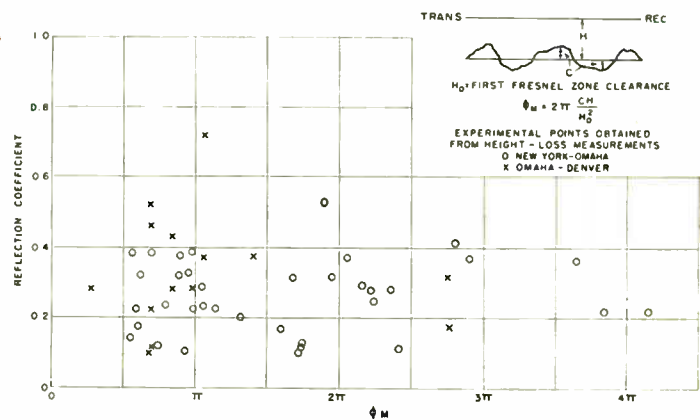

Fig. 3—Reflection coefficients of irregular terrain, 4,000 mc.

The experimental results obtained along the New York-Denver section of the transcontinental route are shown in Fig. 3. The magnitude of the reflection coefficients indicated along the ordinate have been computed from the antenna-height-loss curves and the degree of roughness shown along the abscissa has been estimated from the path profiles. In general the measurements were made on the more doubtful paths. No data are available on most of the Pennsylvania sections and on several other paths that obviously had adequate clearance and were sufficiently rough.

The data on the New York-Omaha section of the route has been separated from the Omaha-Denver section to show that the difference in the type of terrain does not add significantly to the spread in the over-all results. At first some of the low-reflection coefficients were attributed to absorption in the numerous trees along some of the paths but an approximately equal percentage of low reflections was found in the relatively flat, treeless areas in Eastern Colorado.

The classical Rayleigh criterion of roughness indicates that specular reflection occurs when the phase deviations are less than about $\pm\pi/2$ and that diffuse reflections result when the phase deviations are greater than $\pm\pi/2$. On this basis all of the paths measured except one would be considered rough.

THEORETICAL CONSIDERATIONS

A rigorous determination of the reflection from a rough surface is a difficult problem.^{1,2,3} In fact it is virtually impossible except for certain idealized profiles. In general it is not possible to represent an actual profile by a reasonable number of parameters. Considerable judgment is required in formulating the problem and the end result may be no more than a range of possible answers. An approximate solution that may be a useful guide in understanding the experimental data is derived in the Appendix. The net result is that the reflection coefficient from a rough surface can be expressed by

$$|R_r| = \int_{-\infty}^{\infty} p(\phi) \cos \phi d\phi.$$

The angle ϕ is the change in phase of each elemental component of the reflected wave caused by the departure of the rough surface from a median plane surface. The factor $p(\phi)$ is the probability distribution of all the values of ϕ along the path. The product $p(\phi_1) d\phi$ is the fraction of the profile for which $\phi_1 < \phi < \phi_1 + d\phi$. It is assumed that ϕ has many oscillations along the transmission path.

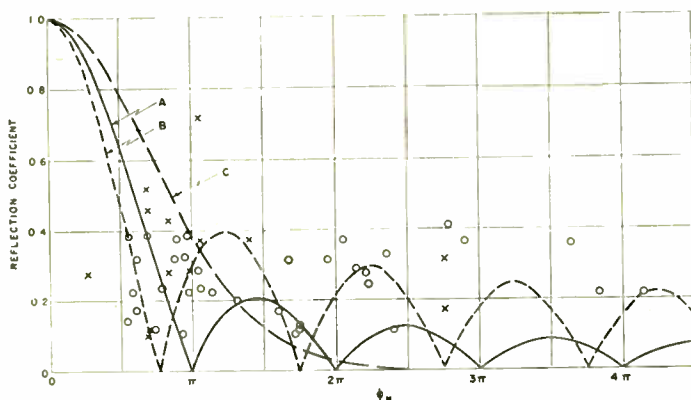

Fig. 4—Reflection coefficients of irregular terrain. Comparison of experimental and computed values.

Curve	Variations in terrain
A	Sawtooth
B	Sine-wave
C	Random

Several possible computed values of the reflection coefficient are shown in Fig. 4. Curve A assumes that the phase angle ϕ varies uniformly between two maximum values, $-\phi_m$ and ϕ_m ; the corresponding path has essentially a sawtooth profile. Curve B assumes that the phase angle ϕ varies as a sine wave, whose maximum value is $\pm\phi_m$, which means a corrugated or sine wave profile. In both cases it is evident that a slight departure from the idealized profile will tend to fill in the nulls, so perhaps the envelope of the maxima would be more suitable as an upper boundary. Finally, Curve C as-

¹ S. O. Rice, "Reflection of electromagnetic waves from slightly rough surfaces," *Communications on Pure and Applied Mathematics*, pp. 351-378; August, 1951.
² W. S. Ament, "Toward a theory of reflection by a rough surface," *PROC. I.R.E.*, vol. 41, pp. 142-146; January, 1953.
³ V. Twersky, "On the nonspecular reflection of electromagnetic waves," *Jour. Appl. Phys.*, vol. 22, pp. 825-835; 1951.

sumes that the phase angle ϕ varies in a random manner; in this case ϕ_m along the abscissa is no longer taken as an absolute maximum but is interpreted as the value exceeded in less than 1 per cent of the total path. A choice of a lower percentage as a limit would move this curve toward the right; in addition, any departure from complete randomness seems likely to increase the low values appreciably.

One conclusion is that reflection coefficients of greater than 0.5 seldom occur on near grazing paths at 4,000 mc. These results are based on the use of 57-inch paraboloid antennas and stronger reflections may be found with smaller antennas. A second conclusion is that there is no simple relationship between the geometry of the path and the resulting reflection coefficient. Since so many variables are involved, a statistical explanation seems all that can be expected for general engineering use. Rice¹ has pointed out that the experimental data can be represented by a Rayleigh distribution having a median value of about 0.28.

APPENDIX

An approximate solution for the reflection coefficient of a rough surface can be obtained by a first-order correction on the reflection from a smooth surface.

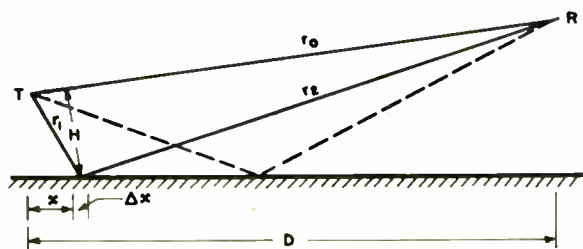

Fig. 5—Plane surface geometry.

The ordinary case of reflection from a plane surface is illustrated in Fig. 5. The familiar reflected ray shown as a dotted line can be considered to be the sum of many components from all parts of the path. For example, some of the power radiated from the transmitter T falls on the small area $\Delta x \Delta y$, where Δy is in the plane perpendicular to the paper. As both Δx and Δy become small compared with the wavelength the differential area $dx dy$ behaves like an isotropic antenna both in receiving from transmitter T and in reradiating toward receiver R. On this basis, the wave reflected from a plane surface can be presented by the following integral

$$|R_s| = \left[\int_{-\infty}^{\infty} \int_0^D A_{xy} e^{i\theta} dx dy \right] \text{real part} \quad (1)$$

where

A_{xy} = amplitude of the wave that travels on path $r_1 + r_2$ relative to the amplitude of direct wave.

$$= \frac{\left(\frac{\lambda}{4\pi r_1}\right) \left(\frac{\lambda}{4\pi r_2}\right) \sqrt{G_R' G_T'}}{\left(\frac{\lambda}{4\pi r_0}\right) \sqrt{G_T G_R}}$$

$$= \left(\frac{\lambda r_0}{4\pi r_1 r_2} \right),$$

when the transmitting and receiving antenna gains are essentially the same for both the direct and reflected rays.

θ = phase delay of reflected path relative to direct path.

$$= \frac{2\pi}{\lambda} (r_1 + r_2 - r_0) + \psi$$

$$\approx \frac{\pi H^2}{H_0^2} + \psi$$

ψ = phase shift on reflection $\approx \pi$ for near grazing incidence.

H_0 = Clearance required for first Fresnel Zone.

$$= \sqrt{\frac{\lambda x(D-x)}{D}}$$

H = Clearance between direct ray and plane surface.

The above integral (which is derived either from radio-propagation theory or from Huygen's principle) is difficult to solve directly, but there is no need to solve it since image theory indicates that the answer is

$$R_s \approx -1. \tag{2}$$

For the rough surface illustrated in Fig. 6, the corresponding expression for the reflection coefficient is

$$|R_r| = \left[\int_{-\infty}^{\infty} \int_0^D A_{xy}' e^{i(\theta+\phi)} dx dy \right] \text{real part.} \tag{3}$$

The phase angle ϕ is the deviation in phase caused by the departure of the actual surface from the idealized plane surface, and is given by

$$\phi = 2\pi \left(\frac{C}{H_0} \right) \left(\frac{H}{H_0} \right),$$

where C and H are shown on Fig. 6.

In this approximate solution it is assumed that the angle ϕ is essentially independent of x and y and is known only by its statistical distribution $p(\phi)$, which is defined by

$$\int_{-\infty}^{\infty} p(\phi) d\phi = 1. \tag{4}$$

The expression for the reflection coefficient given in (3) can now be factored as follows.

$$|R_r| = \left[\int_{-\infty}^{\infty} \int_0^D A_{xy}' e^{i\theta} dx dy \right] \cdot \left[\int_{-\infty}^{\infty} p(\phi) e^{i\phi} d\phi \right] \text{real part.} \tag{5}$$

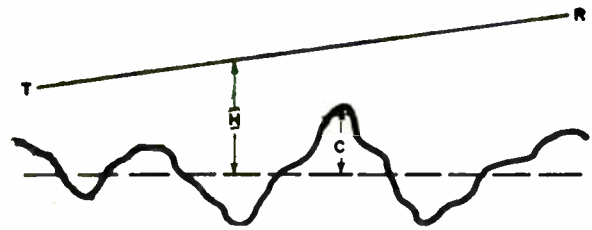

Fig. 6—Rough surface geometry.

The factor A_{xy}' is essentially equal to A_{xy} for all points along the profile that are within line of sight of both terminals. Where the surface is so rough that the surface is shadowed from one or both terminals A_{xy}' would be expected to be less than A_{xy} , but in this case the associated large changes in phase angle ϕ make the precise value of A_{xy}' relatively unimportant in a statistical sense. Consequently in this approximate solution it is assumed that

$$A_{xy}' = A_{xy}. \tag{6}$$

With the above two assumptions (3) reduces to

$$|R_r| = \left[\int_{-\infty}^{\infty} \int_0^D A_{xy} e^{i\theta} dx dy \right] \cdot \left[\int_{-\infty}^{\infty} p(\phi) e^{i\phi} d\phi \right] \text{real part.} \tag{7}$$

The first term is the reflection coefficient of a plane surface and is essentially equal to unity. Hence this factor can be ignored with the following result

$$|R_r| = \int_{-\infty}^{\infty} p(\phi) \cos \phi d\phi. \tag{8}$$

At first glance the separation of variables (shown in (5)–(8)) and the cancellation of one factor appears to be a mathematical error since the real part of the product of two complex numbers is not the product of the two real parts. An alternate method would have been to write (1) to (7) in terms of $\cos(\theta+\phi) = \cos \theta \cos \phi - \sin \theta \sin \phi$. Since ϕ varies much more rapidly than θ and is of random sign, the importance of the $\sin \theta \sin \phi$ term becomes negligible in the summation.

The expression given in (8) can be used to compute the reflection coefficient for various types of profiles. For example, when all values of ϕ between $-\phi_m$ and $+\phi_m$ are equally probable,

$$p(\phi) = \frac{1}{2\phi_m},$$

and

$$R_r = \frac{2}{2\phi_m} \int_{-\phi_m}^{\phi_m} \cos \phi d\phi = \frac{\sin \phi_m}{\phi_m}. \tag{9}$$

This case corresponds to a sawtooth profile with uniform height but not necessarily uniform slope.

When ϕ varies sinusoidally as $\phi = \phi_m \sin \nu$ (where ν is an arbitrary parameter), the profile approaches a sine

wave and

$$p(\phi) = \frac{1}{2\pi\phi_m \cos \nu}.$$

This results in

$$R_r = \frac{2}{\pi} \int_0^{\pi/2} \cos(\phi_m \sin \nu) d\nu = J_0(\phi_m), \quad (10)$$

where J_0 is the Bessel Function of zero order.

A third interesting example results from the assumption that ϕ varies in accordance with the normal probability distribution having a standard deviation σ . In this case

$$p(\phi) = \frac{e^{-\phi^2/2\sigma^2}}{\sqrt{2\pi}\sigma},$$

and

$$\begin{aligned} R_r &= \frac{1}{\sqrt{2\pi}\sigma} \int_{-\infty}^{\infty} e^{-\phi^2/2\sigma^2} \cos \phi d\phi \\ &= e^{-\sigma^2/2}. \end{aligned} \quad (11)$$

This result is essentially the same as that discussed by Ament and derived earlier by Pekeris, MacFarlane, and possibly others. If ϕ_m is interpreted as the value exceeded less than 1 per cent of the time,

$$\phi_m = 2.3\sigma,$$

and

$$R_r = e^{-(\phi_m/3.24)}. \quad (12)$$

Other possible variations include

$$\left[\frac{\sin \frac{\phi_m}{2}}{\frac{\phi_m}{2}} \right]^2$$

which results from a triangular distribution of ϕ , and

$$\cos \frac{\phi_m}{2} J_0 \left(\frac{\phi_m}{2} \right)$$

which occurs when $\phi = \phi_m \sin^2 \nu$.

The net result is that the theoretical values of the reflection coefficient of a rough surface vary over a wide range and depend critically on the type of roughness assumed.

ACKNOWLEDGMENT

The author wishes to express his appreciation to A. G. Oxehufwud and others in the American Telephone and Telegraph Co. who made most of the measurements and to S. O. Rice and J. L. Glaser of the Bell Telephone Laboratories for their helpful suggestions.

On the Design of Arrays*

J. N. HINES†, ASSOCIATE, IRE, V. H. RUMSEY†, SENIOR MEMBER, IRE, AND
T. E. TICE†, ASSOCIATE, IRE

Summary—The usual method of array design, which employs pattern multiplication, is an approximation which is often adequate but which never predicts exactly the pattern of any practical array. An exact method is discussed. It is compared with the approximate method by applying both methods to a practical array of traveling-wave slot antennas. The results show that while pattern multiplication is useful for obtaining a first approximation, the exact method must be employed for arrays which are to be designed for low side lobes.

INTRODUCTION

IT HAS BEEN found, as a matter of practical experience, that the usual method of array design does not predict the pattern of the array with sufficient accuracy in cases where the array is designed for very

low side lobes.¹ The purpose of this paper is to point out where the usual method of design is in error and to introduce a rigorously correct method of design. The difference between the two methods is illustrated by applying them to an array of traveling-wave slot antennas.

To illustrate the nature of the problem suppose that we know the currents which flow into the individual elements of an array when the array is energized by connecting it to a transmitter. We find that the radiation pattern obtained from the array does not agree with the pattern as usually calculated from the known set of currents, although the disagreement is often small and in some cases insignificant. It is found, however, that in many cases the usual calculations are practically useless at low signal levels and that the disagreement with

* Decimal classification: R125.1×R325.1. Original manuscript received by the IRE, October 13, 1953; revised manuscript received, March 26, 1954. This work has been supported by funds supplied the Ohio State University Research Foundation by the Wright-Air Development Command, WADC, Wright-Patterson Air Force Base, Ohio.

† Antenna Lab., Dept. Elec. Eng., Ohio State Univ., Columbus, Ohio.

¹ J. N. Hines, V. H. Rumsey, and C. H. Walter, "Traveling-wave slot antennas," PROC. I.R.E., vol. 41, pp. 1624-1631; November, 1953.

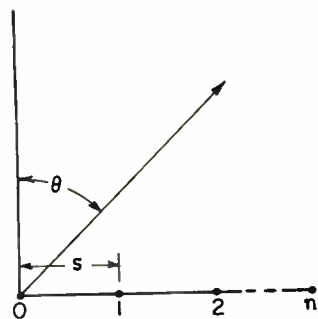

Fig. 1

measurements cannot possibly be explained on the grounds that the currents into the individual elements are not known with sufficient accuracy. Thus we are not concerned with the problem of mutual impedance between elements, or the problem of holding the currents in individual elements to design values in presence of mutual impedance, or any problem concerning the network representation of the antenna. We are concerned with the scattering or diffraction of radiation by the physical structure of the array.

ANALYSIS OF ARRAY PATTERNS

Consider an array of identical antennas, such as half-wave dipoles, which are arranged in a uniform lattice. In the usual method it is assumed that the pattern of the array is given by the product of an array factor, which depends only on the lattice arrangement, and the primary pattern, which depends only on the type of antenna used to make up the array. For example, this method predicts that the pattern of an array of half-wave dipoles is the product of an array factor and the pattern of a half-wave dipole. It usually gives very good results when applied to half-wave dipoles and this well known fact is apt to create the impression that it is a correct method. Actually it is an approximation which may be quite inadequate for many problems of array design. The error is in the assumption that the pattern of each element (when radiating in the presence of the remaining elements) is the same as the pattern of an isolated element (when radiating in the absence of all other elements); this is never true in practice although it may be very nearly true in certain cases.

An exact method of design can be stated very simply as follows. Let P_n represent the radiation pattern obtained when a unit current is injected into the n th pair of array terminals and all other terminal pairs of the array are open-circuited. Let I_0, I_1, I_2, \dots represent the currents flowing into the terminal pairs when all elements of the array are energized. Then it follows from the principle of superposition, that the pattern of the array is represented by the expression

$$P = I_0 P_0 + I_1 P_1 + I_2 P_2 + \dots \quad (1)$$

The connection between (1) and the approximate

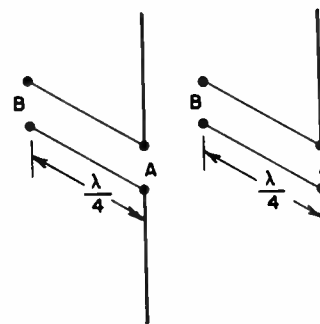

Fig. 2

method can be illustrated by considering a uniformly spaced linear array, as in Fig. 1. It is assumed, in the approximate method, that the primary patterns are identical. For the pattern in a plane containing the array this implies that

$$P_n = P_0 \exp [j\beta n s \sin \theta] \quad (2)$$

where β represents the propagation constant and s and θ are defined in Fig. 1. Then (1) reduces to

$$P = P_0 [I_0 + I_1 \exp (j\beta s \sin \theta) + I_2 \exp (j\beta 2s \sin \theta) \dots] \quad (3)$$

in which the expression in square brackets represents the array factor.

To apply the exact method (1) we have to construct the array of antennas and measure each pattern P_n in the presence of the entire array structure. To apply the approximate method we have to construct only one antenna of the array and measure the pattern which it radiates by itself. Thus the exact method can be used to determine the distribution of currents I_0, I_1, I_2, \dots which gives the best approximation to a desired pattern but it is not suitable for determining the number of array elements and their spacing. In practice one would use the approximate method to obtain a first approximation to the array structure, build it, and then apply the exact procedure to determine the best pattern that can be obtained from it. Usually this shows that the array could be improved by a small modification of the structure. When the structure has been fixed, the feed system can be designed according to the exact procedure and then the resulting pattern will be exactly as predicted.

The exact method can be formulated equally well in terms of the patterns Q_n obtained when unit voltage is applied to the n th input with all other inputs short circuited. If there is mutual impedance between the inputs, the patterns Q_n will be essentially different from the patterns P_n : both P_n and Q_n will be affected by the location of the terminals. For example, suppose that the array consists of two parallel half-wave dipoles as in Fig. 2. If the terminals are taken as the position A in Fig. 2, the patterns P_n are almost the same as for a half-wave dipole by itself, and the patterns Q_n are quite

different. If the terminals are taken at a position *B*, a quarter wavelength along the transmission line from *A*, the patterns P_n are the same as the Q 's obtained from position *A* and vice-versa. Thus where mutual impedance between inputs to the array is significant, one would try to select the position of the input terminals to make the functions P_n or Q_n as simple as possible.

If the mutual impedance between terminals is insignificant the patterns P_n and Q_n are the same, apart from a constant, and are independent of the loads connected to the unexcited inputs. However, these patterns in general will differ from the pattern of a single element with all other elements removed.

APPLICATION TO TRAVELING-WAVE SLOT ANTENNAS

An array of four parallel traveling-wave slot antennas was constructed to illustrate the order of magnitude of the difference between the approximate and exact methods. It is convenient to use traveling-wave slots because the mutual impedance between input terminals is insignificant. Fig. 3 shows a typical element of the array:

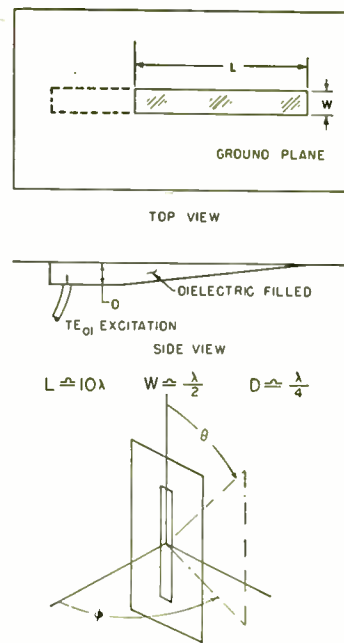

Fig. 3—Sketch of a tapered-depth traveling-wave slot antenna used as the arraying element.

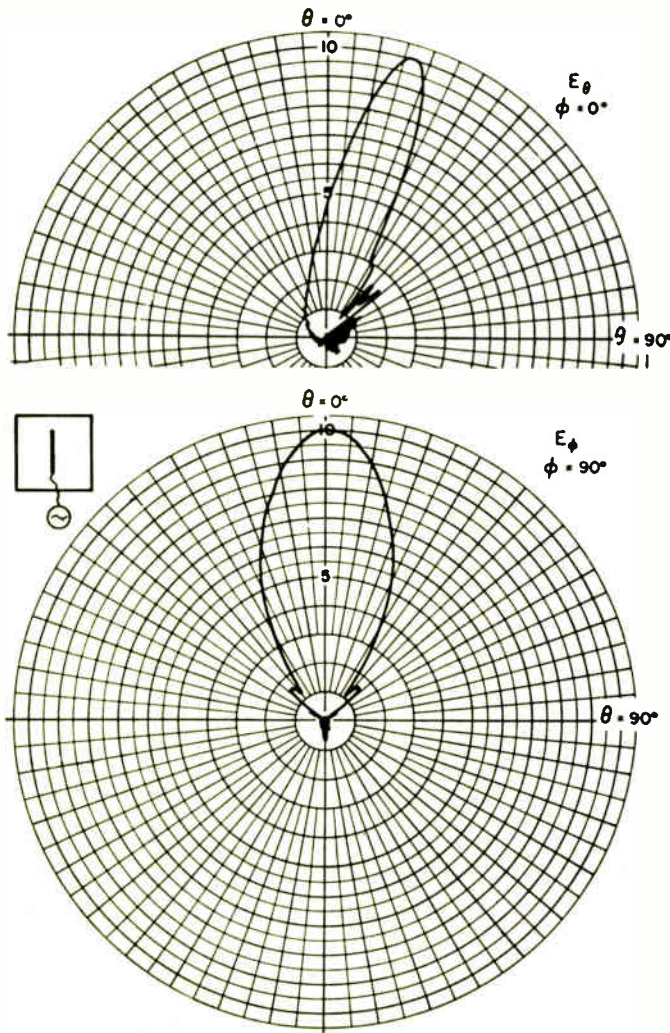

Fig. 4—Measured radiation patterns of an isolated tapered-depth traveling-wave slot antenna. $L = 10 \lambda$, $W = 0.67 \lambda$.

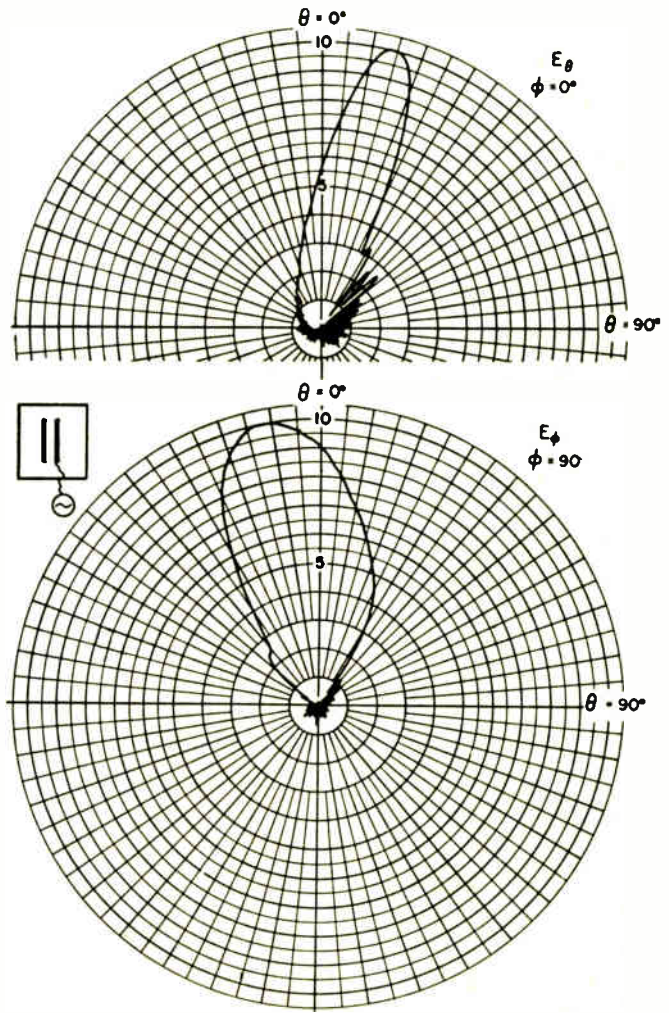

Fig. 5—Measured patterns of the tapered-depth slot radiating in the presence of an adjacent parasitic slot (one wavelength spacing).

is quite difficult and it is also difficult to determine accurately the relation between these patterns and the input voltage. The relation to the input voltage was obtained by measuring at the same time the signal picked up by a monitoring probe in the feed section of waveguide and the radiated signal. The array patterns were calculated for the current distributions (I_1, I_2, I_3, I_4) represented by $(1, 1, 1, 1)$, $(1, j, -1, -j)$ and $(1, -1, 1, -1)$. The results are shown in Fig. 8, from which it is apparent that the approximate method is practically useless at signal levels less than 10 per cent (-20 db) of the maximum.

CONCLUSIONS

The usual method (pattern multiplication) of array design, in which it is assumed that the primary patterns are identical for an array of identical antennas, is an approximation which is satisfactory for predicting a first approximation to the number of elements and their spacing in the array. It is usually adequate for calculating the pattern shape at signal levels, within 30 per cent

it was chosen because it has a good end-fire radiation pattern over a 2:1 frequency band and is easily fed from a conventional waveguide. Fig. 4 shows the principal patterns measured in the co-ordinate system shown in Fig. 3. These are the patterns which would be used in the approximate method. Fig. 5 shows the patterns obtained from the same antenna as an element of a two-element array. Observe that the $E_\theta(\theta)$ at $\phi = 0$ degree is practically the same as that in Fig. 4 whereas the $E_\phi(\theta)$ at $\phi = 90$ degree pattern is significantly different. Thus the approximate method is evidently adequate for predicting the $\phi = 0$ degree array pattern but palpably inadequate for predicting the $\phi = 90$ degree array pattern. Fig. 6 shows the same patterns for a three-element array. Effect on the $\phi = 90$ degree $E_\phi(\theta)$ pattern is shown in Fig. 7, page 1266. The $E_\phi(\theta)$ patterns for a four-element array were measured in amplitude and phase relative to the voltage applied at the input. Measurement of the amplitude presents no particular difficulty. Measurement of the phase pattern

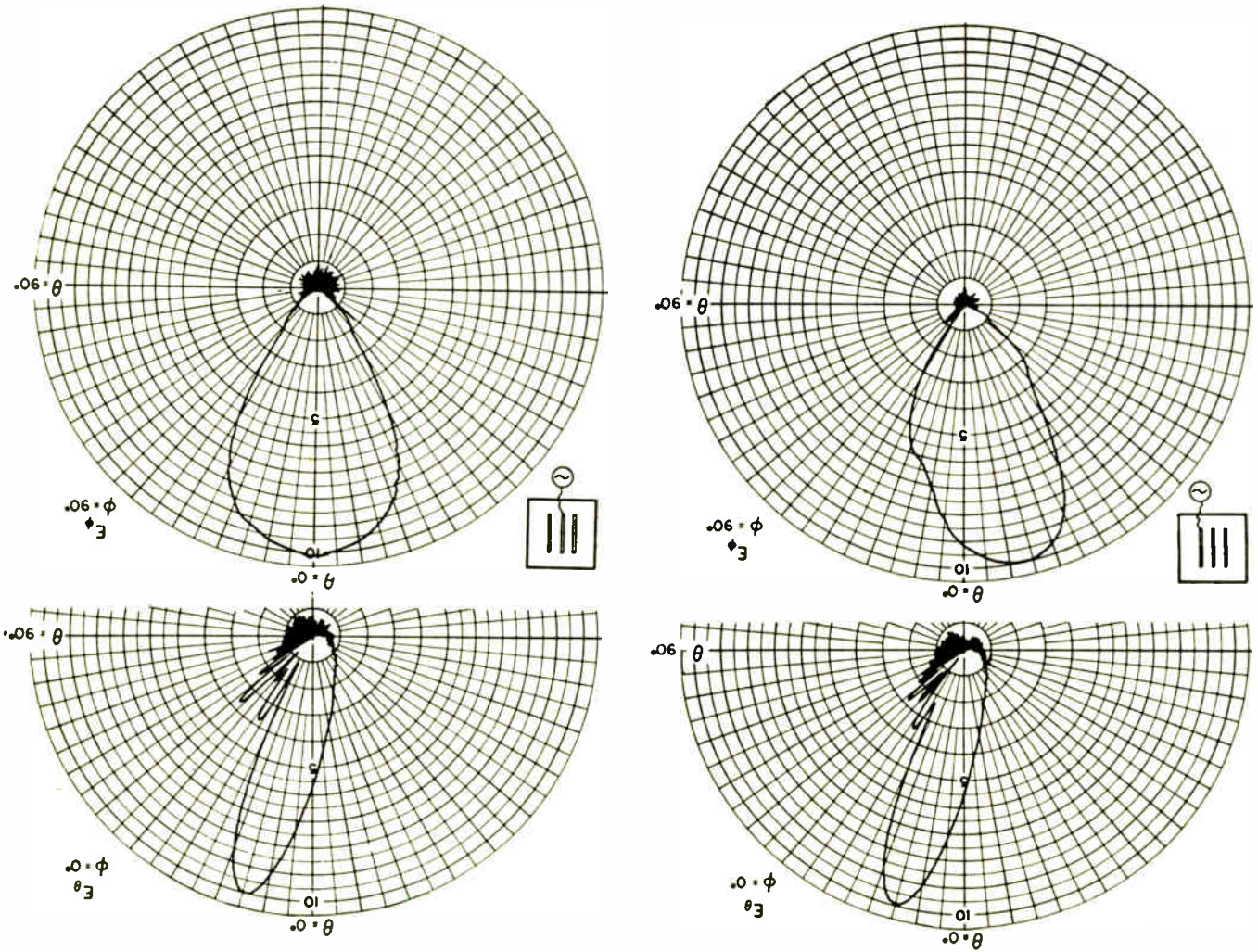

Fig. 6—Measured patterns of the tapered-depth slot radiating in the presence of two adjacent parasitic slots, (one wavelength spacing).

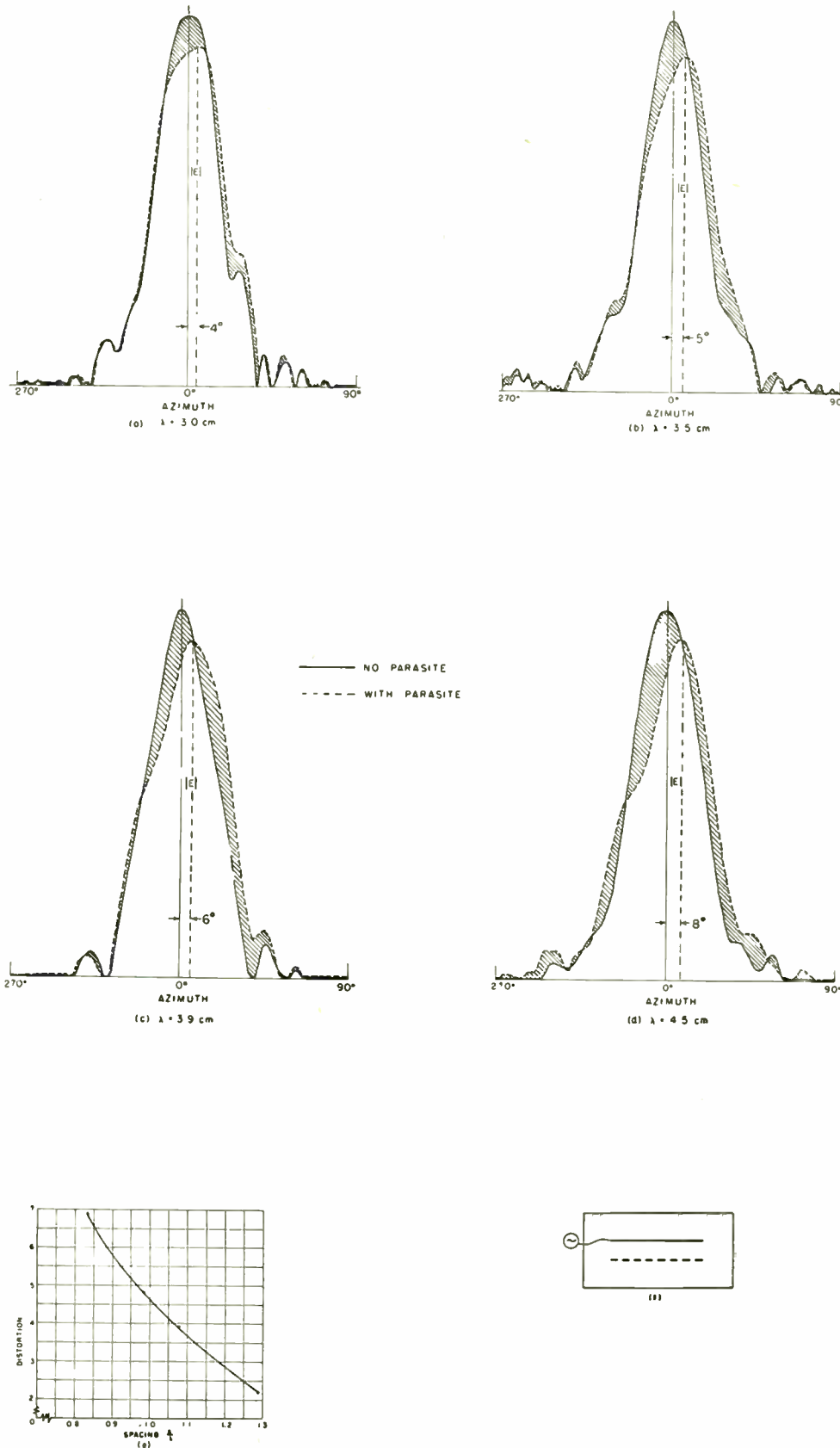

Fig. 7—Distortion due to parasitic slot. In (e), distortion figures as a function of frequency, the ordinate is proportional to the crosshatched area in (a), (b), (c), and (d) above.

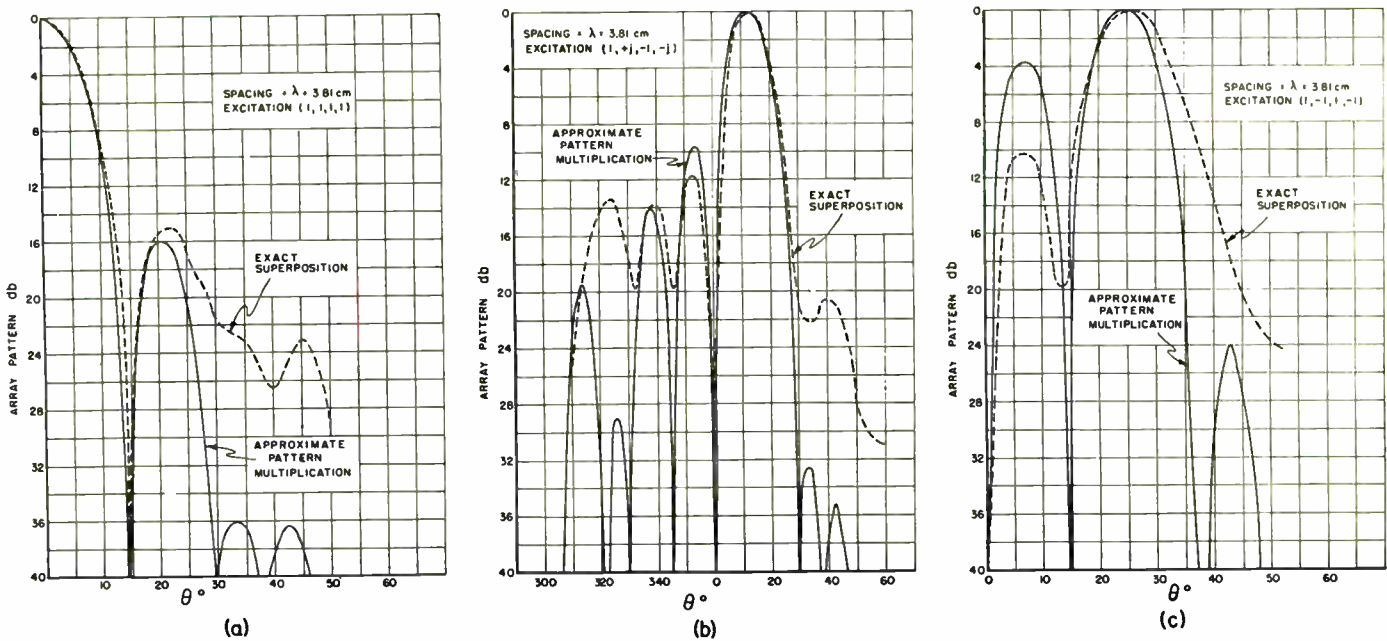

Fig. 8—Calculated array patterns. (a) Array pattern—0-degree phasing; (b) Array pattern—90-degree phasing; (c) Array pattern—180-degree phasing.

(10 db) of the maximum (but not always as shown by Fig. 8(c)). For certain principal patterns this approximate method is practically useless at signal levels less than 10 per cent (20 db) of the maximum but for the principal patterns in the orthogonal plane the approxi-

mate method appears to be better by an order of magnitude. We conclude that pattern multiplication should be used only to obtain a first approximation and that the exact method should always be used for arrays which are to be designed for low side lobes.

CORRECTION

I. Gumowski author of the paper, "Transient Response in FM," which appeared on pages 819-822 of the May, 1954 issue of the PROCEEDINGS OF THE I.R.E., has requested that the editors publish the following corrections:

1: In the second line preceding equation (3), $f(t) = a\delta(t)$ should read $f(t) = a\delta(-t)$.

2: Equation (3) should read as follows

$$\int_{-\infty}^{+\infty} e^{-j\omega t} \cdot e^{jaY(-t)} \cdot e^{j\omega_0 t} dl = \pi(e^{ja} + 1)\delta(\omega - \omega_0) + j \frac{e^{ja} - 1}{\omega - \omega_0}$$

3: Equation (4) should read

$$\int_{-\infty}^{+\infty} e^{-j\omega t} \cdot e^{jaY(t)} \cdot e^{j\omega_0 t} dl$$

$$= \pi\delta(\omega - \omega_0) + \pi\delta(\omega - \omega_0 - a) - j \frac{a}{(\omega - \omega_0)(\omega - \omega_0 - a)}$$

4: The second line of equation (7a) should read

$$\frac{1}{2\pi} \int_{-\infty}^{+\infty} e^{j\omega t} A'(\omega) \frac{-ja}{(\omega - \omega_0)(\omega - \omega_0 - a)} d\omega$$

5: The fourth line of equation (7a) should read

$$\frac{ja}{2\pi} \int_{-\infty}^{+\infty} e^{jx t} \frac{-A(x)}{x(x - a)} dx$$

6: In the third line of equation (5a), one factor is missing. This line should read

$$\frac{1}{2} (e^{ja} + 1) e^{j\omega_0 t} \int_{-\infty}^{+\infty} e^{jx t} A(x) \delta(x) dx$$

Reciprocity Relations in Active 3-Terminal Elements*

JACOB SHEKEL†, ASSOCIATE, IRE

Summary—A vacuum tube or a transistor, operating linearly under small-signal conditions, may be represented as a resistive (i.e., nonreactive) 3-terminal network element. Such an element may be considered as composed of a triangle of resistors and a 3-terminal gyrator. If the element is active, at least one resistor is negative.

The activity or passivity of the element is shown to be dependent on the three resistors, while the reciprocity relation is obeyed or violated according to whether the gyrator is absent or present respectively. It is also shown that an active 3-terminal element cannot obey reciprocity and remain stable, so that the gyrator has a stabilizing effect.

Some general relations are derived concerning 3-terminal active elements. These relations apply to any active element that is described by a 3-terminal resistive network, without regard to the physical principles underlying its operation.

INTRODUCTION

VACUUM TUBES and transistors are regarded as active network elements, because power gain may be realized when they are incorporated in networks. Any network containing a vacuum tube or a transistor also violates the reciprocity relation. Is there any necessary connection between the properties of activity and nonreciprocity, or is this just a coincidence due to the physical principles underlying the operation of these elements?

It is intended, in this paper, to discuss the general 3-terminal active element, without regard to the physical principle of operation, be it electron mobility in vacuum, hole mobility in crystals, or any other principle. Treatment is based on a "black box" representation, as in Fig. 1, where only terminal voltages and currents are of interest, and not anything that goes on within the box.

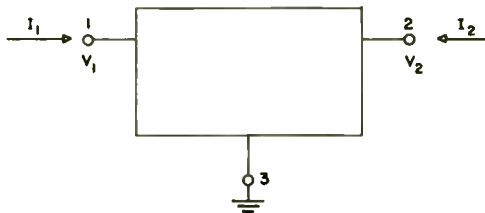

Fig. 1—The general 3-terminal element.

We assume the following about the element in Fig. 1:

1. The voltages V_1 and V_2 are measured with respect to terminal 3. (This assumption is made temporarily only, and in the next section the restriction on the voltage-reference terminal will be removed.)
2. The currents I_1 and I_2 into the terminals are single-valued differentiable functions of the voltages,

$$\begin{aligned} I_1 &= I_1(V_1, V_2) \\ I_2 &= I_2(V_1, V_2) \end{aligned} \quad (1)$$

for the range of I and V under discussion.

* Decimal classification: R143XR282.12. Original manuscript received by the Institute, September 10, 1953; revised manuscript received, February 15, 1954.

† 8 Ben Yehuda Street, Haifa, Israel.

As usual, after we have the empirical current-voltage characteristics (1), we choose an operating point and pass to the small-signal approximation at this point. Let the changes of voltage and current about the operating point be denoted by lower case v and i , then

$$\begin{aligned} i_1 &= \frac{\partial I_1}{\partial V_1} v_1 + \frac{\partial I_1}{\partial V_2} v_2 \\ i_2 &= \frac{\partial I_2}{\partial V_1} v_1 + \frac{\partial I_2}{\partial V_2} v_2 \end{aligned} \quad (2)$$

where the partial derivatives are computed at the operating point.

Writing, for short,

$$Y_{rs} = \frac{\partial I_r}{\partial V_s}, \quad (3)$$

(2) is equivalent to the matrix equation

$$\begin{Bmatrix} i_1 \\ i_2 \end{Bmatrix} = \begin{Bmatrix} Y_{11} & Y_{12} \\ Y_{21} & Y_{22} \end{Bmatrix} \times \begin{Bmatrix} v_1 \\ v_2 \end{Bmatrix}, \quad (4)$$

and, according to assumption 2, all the Y_{rs} are real.

The 3-terminal black box, for small-signal approximations, is thus represented by the real 2×2 Y matrix in (4). Discussion will be based on this representation as a 3-terminal resistive (real admittance values) network.

3-TERMINAL NETWORKS

The admittance matrix may be written as a sum of a symmetric matrix and a skew-symmetric one:

$$\begin{aligned} \begin{Bmatrix} Y_{11} & Y_{12} \\ Y_{21} & Y_{22} \end{Bmatrix} &= \begin{Bmatrix} Y_{11} & \frac{1}{2}(Y_{12} + Y_{21}) \\ \frac{1}{2}(Y_{12} + Y_{21}) & Y_{22} \end{Bmatrix} \\ &+ \begin{Bmatrix} 0 & \frac{1}{2}(Y_{12} - Y_{21}) \\ -\frac{1}{2}(Y_{12} - Y_{21}) & 0 \end{Bmatrix}. \end{aligned} \quad (5)$$

The symmetric matrix represents a network that obeys the reciprocity relation. Such a network may easily be constructed as a triangle of real admittances,

$$\begin{aligned} A &= Y_{22} + \frac{1}{2}(Y_{12} + Y_{21}) \text{ between terminals 2 and 3} \\ B &= Y_{11} + \frac{1}{2}(Y_{12} + Y_{21}) \text{ between terminals 3 and 1} \\ C &= -\frac{1}{2}(Y_{12} + Y_{21}) \text{ between terminals 1 and 2.} \end{aligned} \quad (6)$$

The skew-symmetric part of (5) represents a 3-terminal gyrator¹ of gyrating admittance

$$G = \frac{1}{2}(Y_{12} - Y_{21}). \quad (7)$$

The complete admittance matrix may now be written

$$\begin{Bmatrix} B + C & -C + G \\ -C - G & C + A \end{Bmatrix}, \quad (8)$$

¹ J. Shekel, "The gyrator as a 3-terminal element," PROC. I.R.E., vol. 41, pp. 1014-1016; August, 1953.

and the box of Fig. 1 may be represented by a parallel combination of a triangle of admittors and a 3-terminal gyrator, as in Fig. 2.

The determinant of the admittance matrix (8) is

$$D = (B + C)(C + A) - (-C + G)(-C - G)$$

$$D = AB + BC + CA + G^2. \tag{9}$$

The determinant of the symmetric component is

$$\Delta = (B + C)(C + A) - C^2$$

$$\Delta = AB + BC + CA \tag{10}$$

(the Δ notation is intended to suggest the triangle of admittors), and G^2 is the determinant of the skew-symmetric component, so that

$$D = \Delta + G^2. \tag{11}$$

The properties of a 3-terminal gyrator are invariant to a cyclic permutation of its terminals¹; the value of its determinant, G^2 , is invariant to any change of the grounding terminal, even if the terminals are permuted anti-cyclically. Δ , being a symmetric function in A , B , and C , is also invariant to the change of grounding terminal. It thus appears that (9), (10), and (11) do not depend on the assumption that terminal 3 was grounded and used as a voltage, reference terminal. D , Δ , and G are constants representative of the 3-terminal network in any of its grounding positions.

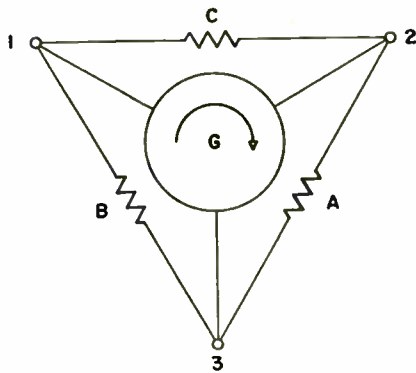

Fig. 2—General representation for small-signal approximation.

STABILITY

A 2-terminal element is active if the real part of its impedance or admittance is negative. This same property also causes instability, for such elements cause transients that do not die down with increasing time, but increase exponentially. It is then obvious that in 2-terminal elements, activity and stability (both under open-circuit and short-circuit conditions) are mutually exclusive properties. On the other hand, as will be shown in this paper, a 3-terminal element may be active and stable.

First, we shall augment the admittance matrix (8) by another row and column that will make the sum of each row and column equal to zero. This is the *indefinite admittance matrix*,² which represents the network without recourse to any arbitrary voltage-reference terminal.

$$\begin{vmatrix} B + C & -C + G & -B - G \\ -C - G & C + A & -A + G \\ -B + G & -A - G & A + B \end{vmatrix}. \tag{12}$$

An element on the main diagonal represents the input admittance between the corresponding terminal and a short-circuit between the other two terminals. Stability under short-circuit conditions is achieved only if all the elements on the main diagonal are positive.

$$B + C > 0$$

$$C + A > 0 \tag{13}$$

$$A + B > 0.$$

The input impedance under open-circuit conditions is obtained by inverting (8). In the inverse matrix, the elements on the main diagonal will be $(C+A)/D$ and $(B+C)/D$. The only other input impedance obtained under different grounding conditions is $(A+B)/D$. (When grounding any terminal, the corresponding row and column are to be deleted from (12),² and the resulting matrix inverted; but the determinant is the same D in any grounding position). In addition to (13), the requirement for open-circuit stability is then³

$$D > 0. \tag{14}$$

ACTIVITY

The power entering the network (assumed to have a real admittance matrix) is expressed—if we momentarily return to the case where terminal 3 is grounded—by the quadratic form

$$P = i_1 v_1 + i_2 v_2$$

$$= Y_{11} v_1^2 + (Y_{12} + Y_{21}) v_1 v_2 + Y_{22} v_2^2 \tag{15}$$

$$P = (B + C) v_1^2 - 2C v_1 v_2 + (C + A) v_2^2.$$

This quadratic form concerns only the symmetric part of the admittance matrix. The network is active if P is negative for some or all values of v_1 and v_2 .

The quadratic form cannot be negative definite—i.e., negative for *all* values of v_1 and v_2 —because the coefficients of the square terms are positive, as shown by (13). P may be negative only for *some* values of the voltages, and this only if the determinant of the quadratic form is negative. This is the determinant of the symmetric component of the admittance matrix, as in (10); so that the network is stable and active only if

$$\Delta < 0. \tag{16}$$

(This relation is again independent of the grounded terminal.)

¹ J. Shekel, "Voltage reference node—its transformations in nodal analysis," *Wireless Engineer*, vol. 31, pp. 6-10; January, 1954. See also J. Shekel, "Matrix representation of transistor circuits," *Proc. I.R.E.*, vol. 40, pp. 1493-1497; November, 1952.

² In a triode operating in class A, since there is no grid current, one row of the admittance matrix is composed of zeros, and $D=0$. Nevertheless, in practical applications, the grid and anode derive their voltages from sources of finite internal admittance, and these suffice to make the determinant of the combined element positive.

The last inequality shows that *at least* one of the admittances A , B , and C is negative; on the other hand, (13) shows that *at most* one of them may be negative. The conclusion is then that in the representation of a stable active network as in Fig. 2, *one and only one* of the admittors in the triangle is negative.

RECIPROcity

In the preceding section we have seen that, in the representation according to (8) and Fig. 2, the properties of activity and violation of reciprocity are due to different components. It is the presence of a negative admittance that "explains" the activity of the network, but it is the gyrator which causes violation of the reciprocity relation. Now the question arises, is the gyrator a necessary part of the representation, or may it be omitted?

Comparison of (16), (14), and (11) at once shows that if $G=0$, these relations are incompatible. This may be summed up as follows: *an active 3-terminal element cannot obey the reciprocity relation and remain stable.* The representation must incorporate a gyrator, whose gyrating admittance G is sufficient to make D positive (stability) though Δ be negative (activity). The gyrator thus has a stabilizing effect on the 3-terminal active element.

FRONT-TO-BACK GAIN RATIO

Consider a general 3-terminal element, with terminal 3 grounded. Let a current source i_1 with an internal admittance G_1 be connected between terminal 1 and ground, and let a load G_2 be connected between terminal 2 and ground. The power available from the source is

$$P_1 = \frac{i_1^2}{4G_1},$$

and the power delivered to the load is

$$P_2 = G_2 v_2^2.$$

The forward power gain from terminal 1 to 2 is, then,

$$K_{\text{forward}} = \frac{P_2}{P_1} = 4G_1 G_2 \left(\frac{v_2}{i_1} \right)^2 = 4G_1 G_2 Z_{21}^2. \quad (17)$$

If terminals 1 and 2 are interchanged, the back power gain is obtained:

$$K_{\text{back}} = 4G_1 G_2 Z_{12}^2, \quad (18)$$

and their ratio

$$\frac{K_{\text{forward}}}{K_{\text{back}}} = \left(\frac{Z_{21}}{Z_{12}} \right)^2 = \left(\frac{Y_{21}}{Y_{12}} \right)^2$$

is a characteristic of the 3-terminal element, and independent of the source and load admittances.

In the representation (8), this ratio is

$$\frac{K_{\text{forward}}}{K_{\text{back}}} = \left(\frac{-C - G}{-C + G} \right)^2 = \left(\frac{G + C}{G - C} \right)^2. \quad (19)$$

and it is greater or less than unity if C is positive or negative, respectively.

When the 3-terminal element is represented as in Fig. 2, the direction of power gain is along the arrow of the gyrator symbol or against it, according to whether the admittor opposite the grounded terminal is positive or negative, respectively. We have already seen that one, and only one, admittor is negative. Suppose the negative admittor is C , then the direction of power gain in the three grounding positions will be: 2 to 1, 2 to 3, and 3 to 1. If Fig. 2 represents a triode, terminals 1, 2, and 3 correspond to the anode, grid, and cathode, respectively. Still another property of the triode may be shown to be of general application: terminal 3, opposite the negative admittance C , is associated with an input admittance $A+B$, the sum of the two positive admittances, which is higher than either $B+C$ or $C+A$. This explains why the input or output admittance at the cathode is much higher than either at the anode or at the grid. Similar properties of the terminals may be found in stable transistors; they will be found in any stable, active 3-terminal element, that operates in a linear range.

CONCLUSION

Any 3-terminal element may be represented, for linear small-signal operation, by the arrangement shown in Fig. 2.

If the element is active and stable, one of the admittors is negative, the other two are positive, and the gyrator cannot be zero, but has a minimum value computable from (11).

In any such element, no matter on what physical principles its operation is based, the three terminals have distinct properties (exemplified by the properties of triode terminals), which fix their roles when the element is used to realize power gain:

1. An input terminal (grid)—always used as input, if ungrounded.
2. An output terminal (anode)—always used as output, if ungrounded.
3. An intermediate terminal (cathode)—used as either input or output, according to the role of the other ungrounded terminal. This terminal has the highest input (or output) admittance of the three.

In conclusion, the question stated in the introduction, about the connection between activity and nonreciprocity in 3-terminal networks may now be answered:

1. A 3-terminal network that violates the reciprocity relation is not necessarily active. Sufficient loading between the terminals of an active network will make Δ positive, and the network will then be passive without losing its nonreciprocity.
2. An active 3-terminal network, which is stable under both open-circuit and short-circuit conditions, must violate the reciprocity relation.

High-Frequency Compensation of RC Amplifiers*

FRANK A. MULLER†

Summary—The high-frequency compensation of single- and multistage resistance-coupled amplifiers is discussed with special reference to the transient response. Optimum parameters are given for a number of typical cases. It is shown that, for the simplest type of high-frequency compensation with one coil in the anode lead, staggering of the time constants in a multistage amplifier reduces the rise time to less than 45 per cent of the uncompensated value, as against a reduction to between 55 and 60 per cent for the case of identical stages. Other practical design considerations are also discussed.

INTRODUCTION

MANY NETWORKS have been designed to improve the high-frequency performance of resistance-coupled amplifiers. However, engineering data published in the literature are rarely sufficient to yield an optimum design for a specific application. More data are especially needed where design parameters have to be optimized with respect to a characteristic of the transient response, such as the rise time.

With reference to the frequency characteristic (gain vs frequency), important theoretical work has been done by Wheeler,¹ Bode,² Hansen,³ and others. With regard to the transient response, Mulligan⁴ has given approximative methods, based on theoretical considerations. These theoretical methods are intended primarily for the design of filters. Their application to high-frequency compensation is seriously hampered by the relations between pole and zero locations that are dictated by effective networks. As a consequence, lengthy and laborious calculations must be made. Among the many authors who have published useful information on the transient response are Bedford and Fredendall,⁵ Kallmann, Spencer, and Singer,⁶ and Walker and Wallman.⁷ Kallmann et al. especially give a good many examples, but their choice of parameters remains incidental.

* Decimal classification: R363.211. Original manuscript received by the Institute, May 28, 1953; revised manuscript received February 25, 1954.

† Formerly with the Massachusetts Institute of Technology, Cambridge, Mass.; now with the Natuurkundig Laboratorium of the University of Amsterdam, Holland.

¹ H. A. Wheeler, "Wide-band amplifiers for television," *PROC. I.R.E.*, vol. 27, p. 429; July, 1939.

² H. W. Bode, "Network Analysis and Feedback Amplifier Design," van Nostrand and Co., New York, N. Y., chap. 17; 1945.

³ W. W. Hansen, "On maximum gain-bandwidth product in amplifiers," *Jour. Appl. Phys.*, vol. 16, p. 528; September, 1945.

⁴ J. H. Mulligan, Jr., "The effect of pole and zero locations on the transient response of linear dynamic systems," *PROC. I.R.E.*, vol. 37, p. 516; May, 1949.

⁵ A. V. Bedford and G. L. Fredendall, "Transient response of multistage video-frequency amplifiers," *PROC. I.R.E.*, vol. 27, p. 277; April, 1939.

⁶ H. E. Kallmann, R. E. Spencer, and C. P. Singer, "Transient response," *PROC. I.R.E.*, vol. 33, p. 169; March, 1945.

⁷ H. Wallman, "Vacuum Tube Amplifiers," M.I.T. Radiation Laboratory Series. McGraw-Hill Book Co., Inc., New York, N. Y., vol. 18, chap. 2; 1948.

It is the purpose of this paper to give optimum solutions for parameters in a small number of relatively simple circuits with respect to a few specified criteria.

CHOICE OF PERFORMANCE CRITERIA

First of all, the most suitable criterium must be selected for any particular application. Two broad groups may be distinguished:

1. Applications where the gain characteristic (gain vs frequency) is the most important feature. A typical example is provided by an amplifier used in conjunction with a high-frequency voltmeter. Universal resistance-coupled amplifiers used for servicing or experimenting with radio-frequency circuits, which are called upon to pass one narrow-frequency band at the same time, belong in general to this group.

2. Applications where the transient response is the most important feature. A short rise time is required, but the percentage overshoot or the amplitude of subsequent damped oscillations that can be tolerated depends heavily on the application in hand. In video-frequency amplifiers for TV, oscillations of as much as 10 per cent will be acceptable. In oscillograph amplifiers, on the other hand, this figure will be only 1 per cent. Tolerances applying to pulse amplifiers vary from case to case, and sometimes are so narrow that the analytical requirement of no overshoot is useful as a practical approach.

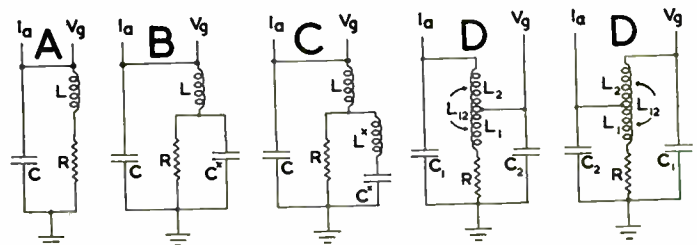

Fig. 1—Investigated networks.

NETWORKS INVESTIGATED

Fig. 1 shows the four networks A through D, considered in this paper. Network A, the shunt-peaking compensation, has only one adjustable parameter, the self-inductance of the coil, which will be given by $a = L/R^2C$ to rule out dimensions. Network B is determined by two parameters, $a = L/R^2C$, and $c = C^*/C$, and network C by three parameters, $a = L/R^2C$, $c = C^*/C$, and $d = L^*/R^2C$. Finally, network D is governed by one fixed parameter given by $q = C_1/(C_1 + C_2)$, and three adjustable parameters, $a = L_1/R^2(C_1 + C_2)$, $b = L_2/R^2(C_1 + C_2)$, and $k = L_{12}/\sqrt{L_1L_2}$.

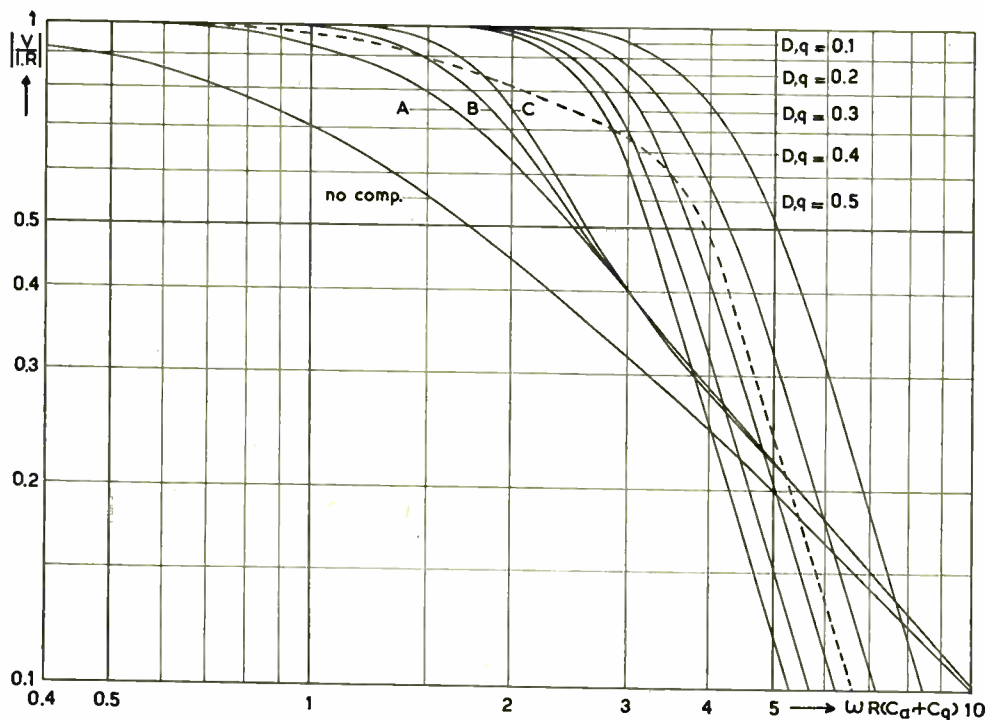

Fig. 2—Gain-frequency characteristics of the constant gain compensation of the various networks. The dotted line gives the gain-frequency characteristic of the 1 per cent tolerance compensation of network $D, q=0.5$.

From the reciprocity theorem, it follows that the two circuits D , shown in Fig. 1, have the same properties. Consequently, each problem concerning these circuits will have two solutions, one with $q < 0.5$ and one with $q > 0.5$. The solution for the case $q < 0.5$ is the best one, as it provides the best match between anode and grid capacitance. Therefore only the case $q < 0.5$ shall be considered.

CONSTANT-GAIN COMPENSATION

In general, as many conditions can be satisfied as there are adjustable parameters. For instance, to find optimum parameters for constant-gain compensation, the gain is expanded as a power series in ω^2 , and as many coefficients as possible of subsequent terms ω^2, ω^4 , and so forth, are made equal to zero. Fig. 2 and Table I give the results of this procedure.

In Fig. 3, curve 1 shows clearly how utterly inadequate this procedure is when a good transient response is aimed at. The transient response shown is one displayed by network $D, q=0.5$, when compensated for constant gain as indicated in Table I. The oscillations exceed by far the percentage acceptable in an oscillograph amplifier.

TABLE I

A:	$a=0.414$		
B:	$a=0.732$	$c=0.268$	
C:	$a=0.816$	$c=0.324$	$d=0.240$
D: $q=0.5$	$a=0.147$	$b=0.529$	$k=-0.237$
D: $q=0.4$	$a=0.161$	$b=0.510$	$k=-0.418$
D: $q=0.3$	$a=0.180$	$b=0.525$	$k=-0.550$
D: $q=0.2$	$a=0.201$	$b=0.592$	$k=-0.651$
D: $q=0.1$	$a=0.219$	$b=0.804$	$k=-0.736$

In cases where the gain characteristic is the most important feature, the frequency range can be extended still further by allowing fluctuations in the amplification within specified tolerance limits. No constant gain compensations with a tolerance have been calculated here. They lead to oscillations in the transient response even worse than those contingent on constant-amplitude compensation.

LINEAR-PHASE COMPENSATION

In searching for parameters suitable for applications falling into the second group (transient response the most important feature) it is not necessary to calculate the transient response itself. Fourier analysis shows that a steep leading edge of the transient response will be obtained by making the time-delay constant over as wide a frequency range as possible, that is, by making the phase shift proportional to frequency as far as possible. Table II gives optimum parameters for this type of compensation. As calculations are more complicated for linear-phase compensation, case C has been omitted.

In Fig. 3, curve 2 is the transient response of network $D, q=0.5$, compensated for linear-phase shift according to Table II. Although this result is not at all unsatis-

TABLE II

A:	$a=0.322$		
B:	$a=0.572$	$c=0.196$	
D: $q=0.5$	$a=0.129$	$b=0.357$	$k=-0.513$
D: $q=0.4$	$a=0.152$	$b=0.352$	$k=-0.629$
D: $q=0.3$	$a=0.176$	$b=0.373$	$k=-0.710$
D: $q=0.2$	$a=0.199$	$b=0.435$	$k=-0.771$
D: $q=0.1$	$a=0.219$	$b=0.618$	$k=-0.822$

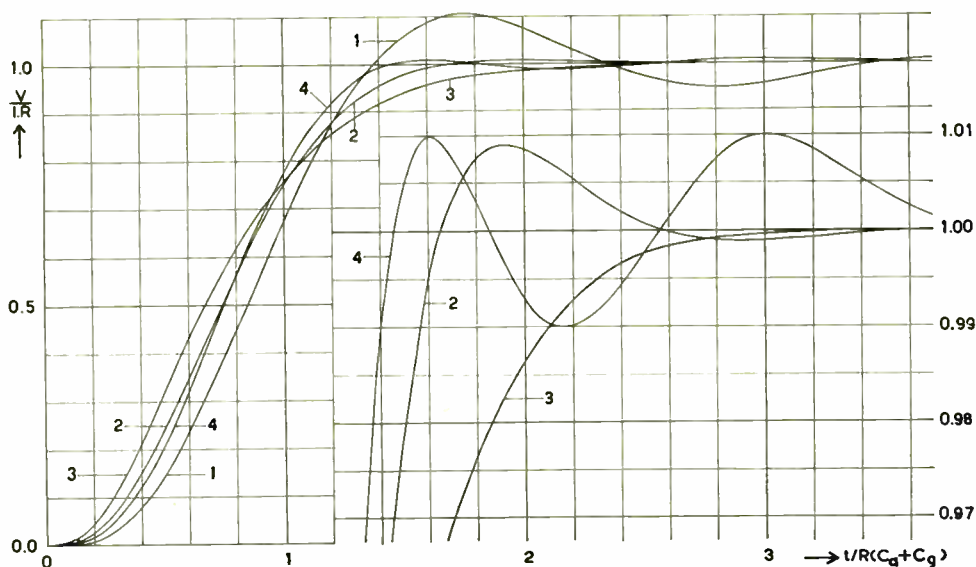

Fig. 3—Transient response of different types of compensation, network D, $q=0.5$: 1. constant gain compensation, 2. linear phase compensation, 3. critical compensation, 4. 1 per cent tolerance compensation. The tails of curves 2, 3, and 4 are also shown in twenty-fold magnification.

factory, this procedure is far from straightforward, and offers no possibilities of meeting specific tolerances.

COMPENSATION BASED ON THE TRANSIENT RESPONSE

It is a relatively simple problem to find optimum parameters for a transient response with the shortest possible rise time and no overshoot. Fig. 3, curve 3, gives an example of this critical compensation. This curve refers to network D, $q=0.5$. It is evident that the rise time is considerably longer than in the linear-phase compensated case (curve 2). It is generally true that for obtaining a short rise time, overshooting is essential. However, a tolerance has to be agreed on beforehand such that no oscillations exceeding the tolerance limit will be accepted. For a given tolerance the rise time will be understood to be the time elapsing between the departure of the transient response from the tolerance region around the zero line and the entrance into the tolerance region around the unit line.

For a given tolerance, the transient response with the shortest rise time will in general be tangent to the two tolerance limits around the unit line as many times as possible, so that the oscillations at the end of the transient response have equal amplitudes and increasing oscillation periods. This type of compensation will be referred to as "tolerance compensation." The critical compensation discussed before may be considered a limiting case as the design tolerance tends towards zero.

Table III summarizes the properties of network A. For a number of design tolerances, parameters are given that produce a transient response oscillating exactly between the tolerance limits. Also given are rise times as defined for the design tolerance as well as for wider tolerances. There is no point in quoting rise times for narrower tolerances than the design tolerance, as these would have to include all subsequent oscillations.

TABLE III—NETWORK A: RISE TIME Δt IN UNITS $R(C_a+C_q)$

Design tolerance	Parameter a	Rise time for a tolerance of			
		0.3%	1%	3%	10%
0	0	5.81	4.60	3.48	2.21
0.3%	0.250	3.67	2.99	2.32	1.54
1%	0.315	2.54	2.31	1.95	1.38
3%	0.350	—	2.05	1.80	1.30
10%	0.412	—	—	1.58	1.21
	0.56	—	—	—	1.08

For more complicated networks, the necessary number of calculations rapidly becomes immense. Therefore, the field of investigation has been steadily narrowed, as will be seen from Tables IV, V, VI that give the results for networks B, C, and D.

MULTISTAGE AMPLIFIERS

In designing compensated multistage amplifiers, it is customary to make all stages identical. Although, from an engineering point of view, this procedure means a considerable simplification, better results can be obtained with the same number of circuit elements through a more general approach. As early as 1930, Butterworth⁵ pointed out the importance of non-identical stages in connection with filter theory. Stagger-tuned wide-band amplifiers used in practice depend on the same principle. Many years later, Kallman, et al,⁶ Hansen,³ and others paid attention to the design problems involved. In the present paper, these problems will be considered with reference to tolerance compensation as defined above, and more specifically with a view to designing optimum networks with limited number of freely adjustable parameters. Our very modest means of computation forced us to restrict ourselves to study only a small number of stages compensated with shunt-peaked circuit A, but our results nevertheless may be indicative of a more general case.

⁵ S. Butterworth, "On the theory of filter amplifiers," *Exp. Wireless and Wireless Eng.* (London), vol. 7, pp. 536-541; 1930.

In describing a multistage amplifier with nonidentical RC constants, we need, in addition to the compensation parameters of individual stages, extra parameters describing the ratios of the individual RC constants. The product of these constants is fixed by the tube characteristics and the over-all gain required.

For an n -stage amplifier, n parameters r_i may be defined:

$$r_i = (\tau_1 \cdot \tau_2 \cdots \tau_n)^{-1/n} \cdot \tau_i$$

where $\tau = R(C_a + C_g)$. Obviously, $r_1 \cdot r_2 \cdots r_n = 1$, so that the n parameters r_i are equivalent to a set of $n-1$ independent parameters. An amplifier with n identical stages is characterized by

$$a_1 = a_2 = \cdots = a_n;$$

$$r_1 = r_2 = \cdots = r_n = 1.$$

The case of a two-stage amplifier shows that in most cases optimum compensation will require a set of entirely different parameters. This case is defined by three adjustable parameters which enable us to satisfy three conditions for either gain characteristic, phase characteristic, or transient response. Constant gain compensation requires: $r_1 = 0.628$, $a_1 = 1.119$, $r_2 = 1.592$, $a_2 = 0.270$.

Linear-phase compensation requires: $r_1 = 0.757$, $a_1 = 0.580$, $r_2 = 1.320$, $a_2 = 0.268$. Both of these solutions are highly asymmetrical.

Critical compensation requires a symmetrical solution: $r_1 = r_2 = 1$, $a_1 = a_2 = 0.25$, but already a tiny tolerance, 0.1 per cent, yields considerable deviations from symmetry: $r_1 = 0.624$, $a_1 = 0.741$, $r_2 = 1.596$, $a_2 = 0.292$.

Optimum parameters may also be calculated for amplifiers in which one or more stages are left uncom-

pensated. Data of a number of combinations of uncompensated stages (with maximum of 2) and compensated stages (with maximum of 3) are tabulated in Table IV. Rise times are given in units of the geometrical mean time constant $(\tau_1 \cdot \tau_2 \cdots \tau_n)^{1/n}$.

REMARKS ON SINGLE-STAGE AMPLIFIERS

Generally speaking, the specific viewpoint chosen is only of secondary importance when judging the relative merits of the various compensation networks. The 10 per cent rise time of the 1 per cent tolerance compensation may be a suitable general-purpose criterion, and will be used in the following survey.

Network B provides only a slight improvement over network A, but offers the additional possibility of fine adjustment of the overshoot by means of a trimming condenser. Network C seems hardly worthy of consideration in view of the very slight improvement over network B at the cost of an extra coil. Network D, on the other hand, means a considerable improvement. This improvement becomes more important when C_a and C_g are widely different. This four-terminal network is faster than those discussed by Walker and Wallman by as much as a factor of 1.25 to 1.30.

Fig. 4 shows a few representative curves. Note that in the relatively rare cases where the time delay must be kept down to a minimum, such as fast uni- or multi-vibrators, two-terminal networks will be used with preference to four-terminal networks.

An additional condition introduced by Walker and Wallman is meant to restrict the total duration of oscillations. In case the oscillations fall inside a per cent tolerance zone, this condition only makes sense when overloading of the amplifier occurs frequently. Fig. 3 shows that, under such circumstances, the tolerance

TABLE IV
RISE TIMES FOR MULTISTAGE AMPLIFIERS: NETWORK A

Type of amplifier and design tolerance		r_1	a_1	r_2	a_2	r_3	a_3	r_4	Rise time for a tolerance of				
									0.1%	0.3%	1%	3%	10%
2 stages 1 coil	0%	1.414	0.250	0.707	0	—	—	—	7.44	6.49	5.40	4.23	2.84
	0.1%	1.047	0.466	0.950	0	—	—	—	4.26	4.06	3.68	3.11	2.21
	0.3%	0.962	0.559	1.040	0	—	—	—	—	3.62	3.34	2.90	2.10
	1%	0.838	0.753	1.190	0	—	—	—	—	—	2.93	2.59	1.91
2 stages 2 coils	0%	1.000	0.250	1.000	0.250	—	—	—	5.86	5.11	4.24	3.39	2.32
	0.1%	0.624	0.741	1.596	0.292	—	—	—	3.31	3.15	2.87	2.46	1.78
	0.3%	0.564	0.953	1.772	0.305	—	—	—	—	2.88	2.68	2.32	1.69
	1%	0.482	1.400	2.073	0.325	—	—	—	—	—	2.40	2.13	1.58
3 stages 1 coil	0%	1.588	0.250	0.794	0	0.794	0	—	—	—	7.04	5.64	3.75
	1%	0.864	0.932	1.076	0	1.076	0	—	—	—	3.86	3.40	2.50
3 stages 2 coils	0%	1.260	0.250	1.260	0.250	0.630	0	—	—	—	6.14	4.88	3.31
	1%	0.335	3.087	1.580	0.565	1.889	0	—	—	—	2.99	2.62	1.92
3 stages 3 coils	0%	1.000	0.250	1.000	0.250	1.000	0.250	—	—	—	5.25	4.21	2.83
	1%	0.252	4.434	1.058	0.953	3.754	0.318	—	—	—	2.76	2.42	1.78
4 stages 2 coils	1%	0.296	4.562	1.451	0.612	1.525	0	1.525	—	—	3.57	3.09	2.25
4 stages 3 coils	1%	0.1655	10.29	0.724	1.625	2.623	0.541	3.184	—	—	3.16	2.74	2.02
5 stages 3 coils	1%	0.135	16.5	0.63	1.90	2.23	0.51	2.30*	—	—	3.55	3.11	2.28

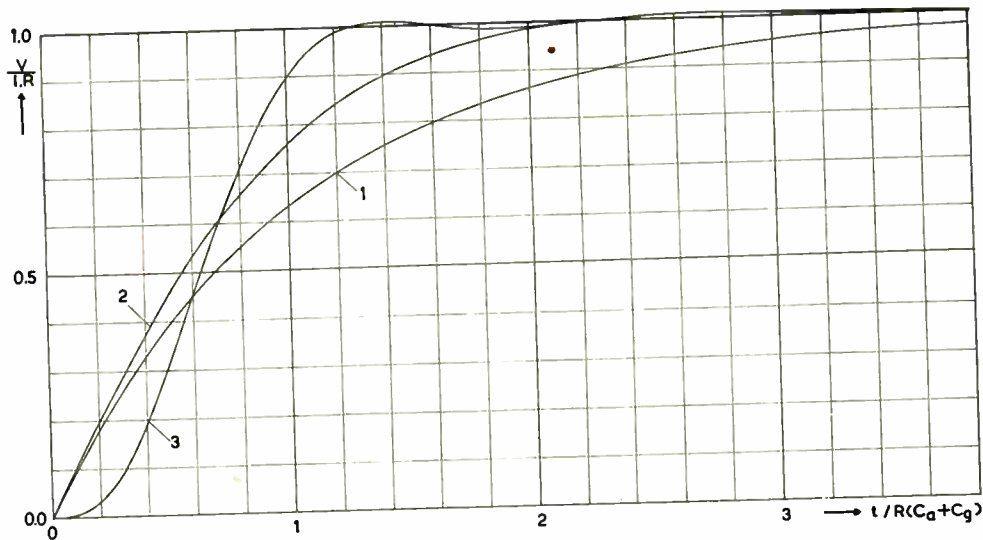

Fig. 4—Comparison of transient responses: 1. no compensation, 2. 1 per cent tolerance compensation of network A, 3. 1 per cent tolerance compensation of network D for an average value of q , taken here 0.3.

TABLE V—NETWORK B: RISE TIME Δt IN UNITS $R(C_a + C_d)$

Design tolerance	Parameters		Rise time for a tolerance of			
	a	c	0.3%	1%	3%	10%
0	0.422	0.125	3.20	2.63	2.09	1.40
0.3%	0.593	0.225	2.02	1.88	1.65	1.20
1%	0.661	0.280	—	1.66	1.50	1.17
3%	0.765	0.380	—	—	1.42	1.12

TABLE VI—NETWORK C: RISE TIME Δt IN UNITS $R(C_a + C_d)$

Design tolerance	Parameters			Rise time for a tolerance of			
	a	c	d	0.3%	1%	3%	10%
0	0.500	0.172	0.086	2.89	2.40	1.92	1.32
0.3%	0.637	0.261	0.267	1.81	1.68	1.49	1.13
1%	0.654	0.244	0.387	—	1.59	1.42	1.10

TABLE VII—Network D: RISE TIME Δt IN UNITS $R(C_a + C_d)$

Design tolerance	Parameters				Rise time for			
	q	a	b	k	0.3%	1%	3%	10%
0	0.5	0.125	0.250	-0.707	2.37	2.00	1.54	1.05
1%	0.5	0.170	0.373	-0.314	—	1.24	1.08	0.80
0	0.4	0.150	0.257	-0.767	2.21	1.86	1.43	0.98
1%	0.4	0.185	0.364	-0.459	—	1.16	1.01	0.75
0	0.3	0.175	0.282	-0.812	2.04	1.72	1.32	0.91
1%	0.3	0.203	0.386	-0.565	—	1.08	0.95	0.70
0	0.2	0.199	0.339	-0.848	1.73	1.55	1.19	0.81
1%	0.2	0.222	0.449	-0.653	—	0.98	0.86	0.64
0	0.1	0.221	0.498	-0.882	1.54	1.30	1.00	0.68
1%	0.1	0.237	0.635	-0.731	—	0.82	0.73	0.54

compensation is unsatisfactory. The fastest recovery is provided by the critical compensation, whereas the linear-phase compensation offers a compromise between a short rise time and a fast recovery.

The parts used in compensated amplifiers have to meet rather exacting specifications. In a 1 per cent tolerance compensation, for instance, a deviation of as little as 5 per cent in one of the parameter values may cause an additional 2 per cent overshoot. In this re-

spect, more leeway is allowed by the lower-tolerance compensations, the critical, and the linear-phase compensation. As an increase in design tolerance produces only a slight improvement in rise time, it is good practice to keep the design tolerance small.

CONCLUSIONS AND REMARKS ON MULTISTAGE AMPLIFIERS

In a multistage amplifier using the shunt-peaking network, critical compensation of all stages will reduce the rise time to some 65 per cent of the uncompensated value. Identical stages and an over-all overshoot of 1 per cent produces a rise time of 55 to 60 per cent of the uncompensated value. Staggered stages, as have been described, cut down the rise time to between 40 and 45 per cent of the uncompensated value. In addition, about a third of the stages can be left uncompensated without serious disadvantage. This simplification will counterbalance to some extent the complications involved in the design of nonidentical stages. Also, the dangers of inductive coupling between the compensating coils may be avoided more easily where space is at a premium.

When staggered stages and a 1 per cent design tolerance are used, the rise time turns out to increase much more slowly than proportional to the square root of the number of stages n . Within the range investigated, the increase was rather proportional to $\sqrt[3]{n}$.

Although of no importance for low-level applications, the sequence of the nonidentical stages deserves closer attention when distortion has to be taken into account. As distortion will primarily occur in the last stage, it will be advantageous to use the compensated stage with the largest time-constant as the last stage. However, it should be borne in mind that this stage must have a voltage range wide enough to handle the overshooting of the preceding stages, the percentage overshoot being much larger at the grid than at the anode of the output tube. Thus, it is unadvisable to utilize to the full the inequality of the stages for the purpose of increasing the

output signal-handling capability at the same given speed. Distortion of fast large-amplitude transients would be the result.

In order to obtain a comfortably high level after the first stage of amplification, it will be preferable to make this one a slow stage too, thus leaving the fast and overcompensated stages in the middle of the amplifier.

A reasonable sequence in a five-stage amplifier with three coils would be 4-5-1-2-3, where the numbers indicate the indices used in Table IV. In this amplifier, a voltage step at the input causes no overshooting after any of the first three stages, 20 per cent after the fourth stage, and of course, 1 per cent at the output. If the only limit on the signal amplitude is set by the final stage, the maximum distortionless output will be 50 per cent larger than from a similar amplifier with five identical stages.

More complicated networks than the shunt-peaking circuit will be required where the rise time has to be cut down as far as possible. Without the help of an electronic computer, it is, however, practically impossible to calculate optimum parameters for a staggered multistage amplifier with complicated coupling networks, and one is left with the only alternative of com-

pensating the individual stages separately. Probably, the advantage of staggered stages will also be much smaller for complicated networks than it is for the simple shunt-peaking compensation.

The 1 per cent tolerance compensation as has been previously computed for single-stage amplifiers is not applicable to multistage amplifiers. In subsequent stages, the first rapid oscillation would decrease, while the last long-period oscillation would progressively build up. A reasonable compromise will probably be presented by the linear-phase compensation, with possibly one stage of tolerance compensation.

ACKNOWLEDGMENT

The author wishes to express his gratitude to Professor J. Clay of the University of Amsterdam for kindly affording the opportunity of carrying this work out in his laboratory. To Mr. J. Berghuis and Mrs. Hillegonda S. Muller the author is indebted for taking care of the numerical calculations. The author is grateful to Dr. Hendrik den Hartog of the University of Amsterdam for many discussions and helpful suggestions, and to Dr. Britton Chance of the University of Pennsylvania for reading the manuscript.

IRE Standards on Electron Devices: Definitions of Terms Related to Phototubes, 1954

COMMITTEE PERSONNEL

Standards Committee 1953-1954

M. W. BALDWIN, JR., <i>Vice-Chairman</i>	A. G. JENSEN, <i>Chairman</i>	L. G. CUMMING, <i>Vice-Chairman</i>	E. WEBER, <i>Vice-Chairman</i>
K. E. Anspach	C. A. Cady	R. A. Hackbusch	D. C. Ports
J. Avins	P. S. Carter	P. J. Herbst	P. C. Sandretto
R. R. Batcher	A. G. Clavier	J. G. Kreer, Jr.	R. Serrell
W. R. Bennett	J. L. Dalke	E. A. Laport	R. F. Shea
J. G. Brainerd	A. W. Friend	W. P. Mason	R. E. Shelby
F. T. Budelman†	F. J. Gaffney	G. D. O'Neill	N. Smith
H. F. Burkhard	W. D. Goodale, Jr.	W. J. Poch	W. G. Tuller
† Deceased	J. E. Ward		

Definitions Co-ordinating Subcommittee

M. W. BALDWIN, JR., <i>Chairman</i>	E. A. Laport
P. S. Carter	J. G. Kreer, Jr.

Electron Devices Committee 1951-1954

G. D. O'NEILL, <i>Chairman</i> , '52-'54		R. M. RYDER, <i>Vice-Chairman</i> , '52-'54	
A. L. SAMUEL, <i>Past Chairman</i> , '51-'52	A. E. Anderson, '53-'54	R. S. Burnap, '51-'54	W. J. Dodds, '51-'54
E. M. Boone, '51-'54	J. W. Clark, '51-'52	W. G. Dow, '51-'52	G. A. Esperson, '51-'54
			C. E. Fay, '51-'53

W. R. Ferris, '51-'54	M. E. Hines, '53-'54	G. R. Kilgore, '53-'54	H. J. Reich, '51-'52
M. S. Glass, '51-'54	E. C. Homer, '51-'52†	J. A. Morton, '51-'52	A. C. Rockwood, '51-'54
J. E. Gorham, '51-'53†	R. B. Janes, '51-'54	I. E. Mourontseff, '51-'54†	A. L. Samuel, '51-'53
J. W. Greer, '51-'52	E. O. Johnson, '53-'54	L. S. Nergaard, '51-'54	W. G. Shepherd, '51-'54
L. A. Hendricks, '51-'52	S. F. Kaisel, '53-'54	H. L. Owens, '53-'54	R. W. Slinkman, '51-'54
T. J. Henry, '51-'54	J. W. Kearney, '51-'54	P. A. Redhead, '51-'54	H. L. Thorson, '51-'53
		C. M. Wheeler, '51-'54	

† Deceased.

Subcommittee on Cathode-Ray and Television Tubes

R. B. JANES, *Chairman*, '51-'54

K. A. Hoagland, '51-'54

R. G. Stoudenheimer, '51-'54

DEFINITIONS OF TERMS RELATED TO PHOTOTUBES, 1954*

Phototube

An electron tube that contains a photocathode, and has an output depending at every instant on the total photoelectric emission from the irradiated area of the photocathode.

Photocathode

An electrode used for obtaining photoelectric emission when irradiated.

Semi-transparent Photocathode

A photocathode in which radiant flux incident on one side produces photoelectric emission from the opposite side.

Multiplier Phototube

A phototube with one or more dynodes between its photocathode and the output electrode.

Photomultiplier

Deprecated—See Multiplier Phototube.

Radiant Sensitivity (of a Phototube)

The quotient of output current by incident radiant flux of a given wavelength at constant electrode voltages.

Note 1: The term output current as here used does not include the dark current.

Luminous Sensitivity (of a Phototube)

The quotient of output current by incident luminous flux at constant electrode voltages.

Note 1: The term output current as here used does not include the dark current.

Note 2: Since luminous sensitivity is not an absolute characteristic but depends on the spectral distribution of the incident flux, the term is commonly used to designate the sensitivity to light from a tungsten-filament lamp operating at a color temperature of 2870° K.

Cathode Luminous Sensitivity (of a Multiplier Phototube)

The quotient of photocathode current by incident luminous flux.

Note 1: The term photocathode current as here used does not include the dark current.

Spectral Characteristic (of a Phototube)

A relation, usually shown by a graph, between the radiant sensitivity and the wavelength of the incident radiant flux.

Quantum Efficiency (of a Phototube)

The average number of electrons photoelectrically emitted from the photocathode per incident photon of a given wavelength.

Electrode Dark Current (of a Phototube)

The electrode current that flows when there is no radiant flux incident on the photocathode.

Note 1: Since dark current may change considerably with temperature, temperature should be specified.

Equivalent Dark-Current Input

The incident luminous flux that would be required to give an output current equal to the dark current.

Note 1: Since dark current may change considerably with temperature, temperature should be specified.

Current Amplification (of a Multiplier Phototube)

The ratio of the output current to the photocathode current due to photoelectric emission at constant electrode voltages.

Note 1: Terms output current and photocathode current as here used do not include dark current.

Note 2: This characteristic is to be measured at levels of operation that will not cause saturation.

Gas Amplification Factor (of a Gas Phototube)

The ratio of radiant or luminous sensitivities with and without ionization of the contained gas.

* Reprints of this Standard, 54 IRE 7.S1, may be purchased while available from the Institute of Radio Engineers, 1 East 79 Street, New York 21, N. Y., at \$0.25 per copy. A 20 per cent discount will be allowed for 100 or more copies mailed to one address.

On the Filter Problem of the Power-Spectrum Analyzer*

S. S. L. CHANG†, SENIOR MEMBER, IRE

Summary—The function of a power-spectrum analyzer is to predict from a single finite length of wave record, which has the statistical properties of filtered random noise (e.g. ocean wave, turbulence etc.), the average power per unit bandwidth of an ensemble of such records at various frequencies. The signal derived from repeating the record is heterodyned with another signal whose frequency is scanned at a uniform rate across the entire spectrum and the resultant wave is passed through a narrow filter and then detected by a square-law detector. Two problems arise:

1. Due to its finite bandwidth, the filter performs a necessary weighted average on the power spectrum. What is the best filter response to minimize the intrinsic error associated with the prediction of an average characteristic of an ensemble from a single record? What practical filter is closest to the ideally best?

2. How fast can the frequency be scanned without appreciably deviating the filter response?

Definite solutions are given to the above problems. Eqs. (26) and (27) together with Table I give the lowest probable error for filters with various shapes of response curve. Eq. (32) defines the ideal filter which minimizes this error. The ideal filter can be very closely approximated by cascading a single resonant circuit to a pair of critically coupled resonant circuits with a Q -value $\sqrt{2}$ times that of the former. The filter response to varying frequency would not alter appreciably from its response to steady sinusoidal wave if the rate of frequency change is smaller than the square of the half bandwidth.

INTRODUCTION

THE PHYSICAL ACTION of repeating a wave record of finite duration indefinitely breaks a continuous power-density spectrum into discrete components. To approximate the continuous power-density spectrum by performing a weighted average of a finite number, \widehat{m} , of neighboring components introduces two essential sources of error, namely:

1. the statistical error, which is approximately equal to $1/\sqrt{\widehat{m}}$, and
2. the blurring error, which is due to the averaging processes and increases as \widehat{m} is increased.

It is apparent that for the weighted average power to have any significance at all, the power density $E(\omega_n)$ must not undergo appreciable change in the frequency spacing between two neighboring components. This can be accomplished physically by making the duration of wave record sufficiently long.

In order to minimize the statistical error, a large number of components are generally included in the averaging process. However, in so doing, the power density $E(\omega_n)$ undergoes appreciable change in the range of frequencies being so included and the blurring error becomes large. To determine the optimum bandwidth and attenuation curve of the filter both components must be taken into account.

A mathematical expression is obtained for the over-all probable error including both of the above mentioned factors. While other sources of error are also present, they are of similar smaller order of magnitude and neglected in the analysis:

1. In (3), the difference between the ensemble average power E_n of a discrete spectral line and the corresponding area $\eta E(\omega_n)$ of the continuous power-density spectrum is neglected. This is justifiable as the primary assumption for the averaging process is such that $E(\omega_n)$ and $E(\omega_n + 1)$ do not differ appreciably.

2. In (4), the area of the pass band of the filter is used as the normalizing quotient instead of the sum of filter responses at discrete lines. It is not in accord with common practice employed in manual averaging computations, but represents the actual situation in the electronic analyzer briefly described in the summary. In any case, the difference between the two methods of normalization is a small fraction of a line in the total sum while the statistical error referring to the same basis for comparison would be $\sqrt{\widehat{m}}$ lines.

Using pass band areas as the normalizing factor, measured power density $P(\omega)$ has the same dimensions as spectral density $E(\omega)$. It reduces to $E(\omega)$ in the ideal case of \widehat{m} being infinite while $\widehat{m}\eta$ being infinitesimal.

Once the mathematical expression of the probable error is obtained, variational methods are used to determine the minimum probable error and the associated optimum bandwidth as well as optimum shape of attenuation curve.

Error coefficients K_Δ are determined for various types of filters as a measure of their desirability. If the shape of the attenuation curve remains unaltered while the bandwidth of the filter varies, so that the over-all probable error is always at its minimum value, this minimum error is proportional to K_Δ . However, as the bandwidth is fixed in actual equipments, an alternative basis for comparison is to select different bandwidths for various filters so that they give the same statistical errors, and to compare the respective blurring errors. The blurring errors are proportional to K_Δ^5 . Physically, with the same equipment and everything else, the blurring error introduced by a double-tuned circuit would be 85 per cent more than that introduced by the approximate ideal filter.

The value $K_\Delta = \infty$ for the single-tuned circuit points to the fact that its cut off is too gradual to resolve the power spectrum sufficiently. Mathematically, as its effective pass band is not clearly defined, there are always some points on the power-density spectrum for which $d^2E(\omega)/d\omega^2$ and the resulting expression for the probable error is indeterminate.

* Decimal classification: R143.2. Original manuscript received by the IRE, November 9, 1953; revised manuscript received, March 5, 1954. This work was performed under Contract No. DA-49-055-Eng. 32 of Beach Erosion Board, Corps of Engineers.

† Dept. of Electrical Eng., New York University, N. Y., N. Y.

The result of the second part of the analysis about the allowable rate of scanning is what one would expect from purely physical considerations. The time for a resonant signal to build up in a narrow pass-band filter is approximately the reciprocal of the half bandwidth. If each spectral line is allowed to build up approximately to its full strength, it should stay in the pass band for a few times that duration. This is the same as saying that the rate of frequency change should be smaller than the square of the half bandwidth. The analysis also gives the difference in response between the transient case and the steady-state case so that one may make design estimations.

CRITERION OF THE OPTIMUM FILTER

In repeating a wave record of T seconds, the signal derived can be expressed as a Fourier series,

$$\sum_n \left(A_n \cos \frac{2\pi n t}{T} + b_n \sin \frac{2\pi n t}{T} \right).$$

According to Rice,¹ the probability that A_n has a value which lies between A_n and $A_n + dA_n$ is:

$$\frac{1}{\sqrt{\pi E_n}} e^{-A_n^2/E_n} dA_n$$

where E_n is the mean square error. The coefficient b_n is independent of A_n and has the same probability distribution. Let P_n denote the power of the n th spectral line, that is:

$$P_n = A_n^2 + b_n^2. \tag{1}$$

The probability that the power P_n has a value between P_n and $P_n + dP_n$ is:

$$\rho_n dP_n = \frac{1}{E_n} e^{-P_n/E_n} E_n dP_n \tag{2}$$

where ρ_n is the probability density. Eq. (2) follows directly from the probability distributions of the coefficients A_n to b_n .

Evidently, the ensemble average power for the n th harmonic is E_n . It is related to the continuous power-density spectrum by the following equation; approximately:

$$E_n = \eta E(\omega_n) \tag{3}$$

where $\eta = 2\pi/T$, and $\omega_n = n\eta$. The purpose of the wave

analyzer is to recover $E(\omega)$ from the finite wave record with the least probable error.

From (2), we see that the power contained in each Fourier component has a probable value from zero to a few times its ensemble mean. To record each component separately would cause a probable error of 100 per cent. The statistical error can be reduced by averaging the power contained in a number of components in the immediate neighborhood.² This weighted averaging process is automatically accomplished by the electrical wave filter in the power-spectrum analyzer.

While the statistical error is being reduced by averaging over a large number of components, another source of error is introduced by the averaging process. Evidently, the averaged quantity would fail to follow closely the variations in the power spectrum (or the ensemble mean), especially when the variations are rapid. An optimum filter should minimize the combined error due to both the statistical effect and the blurring effect.

PROBABLE ERROR

Let the function $e^{-2\alpha}$ of a filter be represented by $U^2(\Omega/\Delta)$, where $\Omega = \omega - \omega_0$, ω_0 being the center frequency, and Δ is some sort of bandwidth such that $U^2(\Omega/\Delta)$ is small for values of $|\Omega|$ larger than Δ . The normalized measured power at the output of the filter is:

$$P(\omega_0) = \frac{\sum_{n=1}^{\infty} P_n U^2\left(\frac{\Omega_n}{\Delta}\right)}{\int_{-\infty}^{\infty} U^2\left(\frac{\Omega}{\Delta}\right) d\Omega} \tag{4}$$

The error is

$$P(\omega_0) - E(\omega_0) = \frac{\sum_{n=1}^{\infty} (P_n - E_n) U^2\left(\frac{\Omega_n}{\Delta}\right) - \psi}{\int_{-\infty}^{\infty} U^2\left(\frac{\Omega}{\Delta}\right) d\Omega} \tag{5}$$

where

$$\psi = E(\omega_0) \int_{-\infty}^{\infty} U^2\left(\frac{\Omega}{\Delta}\right) d\Omega - \sum_{n=1}^{\infty} E_n U^2\left(\frac{\Omega_n}{\Delta}\right) \tag{6}$$

ψ is the error due to blurring. Note that it is independent of P_n .

The mean square error is the weighted average of the square of $P(\omega_0) - E(\omega_0)$. From (2) and (5), it is:

$$\mathcal{E}^2 = \frac{\int_0^{\infty} \int_0^{\infty} \dots \int_0^{\infty} \left[\sum_{n=1}^{\infty} (P_n - E_n) U^2\left(\frac{\Omega_n}{\Delta}\right) - \psi \right]^2 \prod_{n=1}^{\infty} \rho_n dP_n}{\left[\int_{-\infty}^{\infty} U^2\left(\frac{\Omega}{\Delta}\right) d\Omega \right]^2} \tag{7}$$

¹ S. O. Rice, "Mathematical analysis of random noise." *Bell Sys. Tech. Jour.*, vol. 23, 1944, vol. 24; 1945.

² J. W. Tukey, "The Sampling Theory of Power Spectrum Estimates. Symposium on Applications of Autocorrelation Analysis to Physical Problems," Woods Hole, Mass., Office of Naval Research, Washington, D. C.; 1949.

From (2), it follows:

$$\int_0^{\infty} (P_n - E_n) \rho_n dP_n = 0 \quad (8)$$

$$\int_0^{\infty} (P_n - E_n)^2 \rho_n dP_n = E_n^2 \quad (9)$$

$$\int_0^{\infty} \rho_n dP_n = 1. \quad (10)$$

Using (8), (9), and (10), (7) can be readily integrated. It is:

$$\mathcal{E}^2 = \frac{1}{I^2} \left\{ \sum_{n=1}^{\infty} E_n^2 U^4 \left(\frac{\Omega_n}{\Delta} \right) + \psi^2 \right\} \quad (11)$$

where I is the integral $\int_{-\infty}^{\infty} U^2(\Omega/\Delta) d\Omega$.

Eq. (11) shows that the over-all probable error \mathcal{E} can be expressed as

$$\mathcal{E}^2 = \mathcal{E}_p^2 + \mathcal{E}_b^2 \quad (12)$$

where \mathcal{E}_p is the statistical error,

$$\mathcal{E}_p^2 = \frac{1}{I^2} \sum_{n=1}^{\infty} E_n^2 U^4 \left(\frac{\Omega_n}{\Delta} \right) \quad (13)$$

and \mathcal{E}_b is the error due to blurring.

$$\mathcal{E}_b = \frac{\psi}{I}. \quad (14)$$

The statistical error can be simplified by noting that, to the first order of approximation, $E_n \cong \eta E(\omega_0)$, as $U(\Omega_n/\Delta)$ has appreciable magnitude only when Ω_n is small. To the same order of approximation the summation can be replaced by an integral. Therefore:

$$\mathcal{E}_p^2 = \frac{\eta E^2(\omega_0)}{I^2} \int_{-\infty}^{\infty} U^4 \left(\frac{\Omega}{\Delta} \right) d\Omega. \quad (15)$$

Next, the function ψ is to be evaluated. Since the statistical properties of the ensemble is similar to that of filtered random noise, $E(\omega)$ is same as the summation of the functions $e^{-2\alpha}$ of a number of physical networks. As this function of a passive network with dissipative elements is analytic and bounded for real values of frequency^{3,4} the mean-value theorem states that:

$$E(\omega) = E(\omega_0) + \left(\frac{dE}{d\omega} \right)_{\omega_0} (\omega - \omega_0) + \frac{1}{2} V(\omega, \omega_0) (\omega - \omega_0)^2 \quad (16)$$

where $V(\omega, \omega_0)$ is equal to the second derivative $d^2E/d\omega^2$ at some value of ω between ω and ω_0 . It follows that:

$$V(\omega_0, \omega_0) = \left(\frac{d^2E}{d\omega^2} \right)_{\omega_0} \quad (17)$$

³ W. J. Pierson, Jr., "A Unified Mathematical Theory for the Analysis Propagation and Refraction of Storm Generated Ocean Surface Waves—Parts I and II," Research Div., College of Eng., New York University; 1952.

⁴ W. J. Pierson, Jr., and W. Marks, "The Power Spectrum Analysis of Ocean Wave Records." *Trans. Amer. Geophys. Union*, vol. 33; Dec., 1952.

From (15), E_n can be expressed as:

$$E_n = \eta E(\omega_n) = \eta E(\omega_0) + \eta \left(\frac{dE}{d\omega} \right)_{\omega_0} \Omega_n + \eta V(\omega, \omega_0) \frac{\Omega_n^2}{2}. \quad (18)$$

Substituting (17) into (6), and replacing summations by integrals it becomes:

$$\psi = \left[\frac{dE}{d\omega} \right]_{\omega_0} \int_{-\infty}^{\infty} U^2 \left(\frac{\Omega}{\Delta} \right) \Omega d\Omega + \frac{1}{2} \left[\frac{d^2E}{d\omega^2} \right]_{\omega_0} \int_{-\infty}^{\infty} U^2 \left(\frac{\Omega}{\Delta} \right) \Omega^2 d\Omega. \quad (18a)$$

In deriving (18), $V(\omega, \omega_0)$ is replaced by $V(\omega_0, \omega_0)$, as $U^2(\Omega/\Delta)$ has appreciable value only in the immediate neighborhood of $\omega = \omega_0$.

As the values of $dE/d\omega$ and $d^2E/d\omega^2$ at ω_0 are independent quantities, to minimize the aggregated average ψ with respect to U for all possible values of the derivatives is mathematically equivalent to minimizing the absolute values of the two integrals of (18). The first integral vanishes if $U^2(\Omega/\Delta)$ is symmetrical with respect to Ω . While this condition is not the only possibility, a direct calculation without it by minimization of the second integral and (15) while holding the first integral equal to zero leads to the symmetrical filter of (32). As the calculation is straightforward, it will be omitted here. Instead, a slightly more complicated method which not only derives the ideal filter but also makes it possible to determine the relative merits of various practical filters will be presented.

EFFECT OF BANDWIDTH

With the assumption of symmetry of $U^2(\Omega/\Delta)$, (12) becomes:

$$\mathcal{E}^2 = \eta E^2(\omega_0) \frac{K}{I^2} + \frac{1}{4} E_{(2)}^2(\omega_0) \frac{J^2}{I^2} \quad (19)$$

where $E_{(2)}(\omega_0)$ is the value of the second derivative of $E(\omega)$ at $\omega = \omega_0$, and the functions J , K , and I denote:

$$I = \int_{-\infty}^{\infty} U^2 \left(\frac{\Omega}{\Delta} \right) d\Omega = \Delta \int_{-\infty}^{\infty} U^2 \left(\frac{\Omega}{\Delta} \right) d \left(\frac{\Omega}{\Delta} \right) = \Delta I_1 \quad (20)$$

$$J = \int_{-\infty}^{\infty} U^2 \left(\frac{\Omega}{\Delta} \right) \Omega^2 d\Omega = \Delta^3 \int_{-\infty}^{\infty} U^2 \left(\frac{\Omega}{\Delta} \right) \left(\frac{\Omega}{\Delta} \right)^2 d \left(\frac{\Omega}{\Delta} \right) = \Delta^3 J_1 \quad (21)$$

$$K = \int_{-\infty}^{\infty} U^4 \left(\frac{\Omega}{\Delta} \right) d\Omega = \Delta \int_{-\infty}^{\infty} U^4 \left(\frac{\Omega}{\Delta} \right) d \left(\frac{\Omega}{\Delta} \right) = \Delta K_1. \quad (22)$$

The definite integrals I_1 , J_1 , and K_1 are independent of Δ . Eq. (19) becomes:

$$\mathcal{E}^2 = \eta E^2(\omega_0) \frac{K_1}{I_1^2} \frac{1}{\Delta} + \frac{1}{4} E_{(2)}^2(\omega_0) \frac{J_1^2}{I_1^2} \Delta^4. \quad (23)$$

Eq. (23) states that while the statistical error is inversely proportional to the square root of bandwidth, error due to blurring is proportional to the fourth power of bandwidth. There exists a bandwidth for which the over-all error is a minimum. Setting $d\mathcal{E}^2/d\Delta = 0$, it is:

$$\Delta^5 = \frac{\eta E^2(\omega_0)}{E_{(2)}^2(\omega_0)} \frac{K_1}{J_1^2}. \quad (24)$$

Substitute (24) into (23); it becomes

$$\mathcal{E}^2 = \frac{5}{4} \eta^{\cdot 8} E^{1\cdot 6}(\omega_0) E_{(2)}^{\cdot 4}(\omega_0) \frac{K_1^{\cdot 8} J_1^{\cdot 4}}{I_1^2} \quad (25)$$

or

$$\mathcal{E} = K\mathcal{E} E^{\cdot 8}(\omega_0) [\eta^2 E_{(2)}(\omega_0)]^{\cdot 2} \quad (26)$$

$$K\mathcal{E} = \frac{\sqrt{5}}{2} \frac{K_1^{\cdot 4} J_1^{\cdot 2}}{I_1} \quad (27)$$

The error coefficient $K\mathcal{E}$, as defined by (27), gives a quantitative evaluation of the minimum error associated with filters of various shapes.

THE OPTIMUM FILTER AND ITS PRACTICAL APPROXIMATIONS

To determine the shape of the filter which minimizes $K\mathcal{E}$, its first-order variation with respect to U is set to zero:

$$\delta \ln K\mathcal{E} = 0. \quad (28)$$

Eq. (28) and the fact that δU is entirely arbitrary for various values of Ω/Δ leads to the following equation:

$$\frac{1.6U^3 \left(\frac{\Omega}{\Delta}\right)}{K_1} + \frac{.4U \left(\frac{\Omega}{\Delta}\right) \left(\frac{\Omega}{\Delta}\right)^2}{J_1} - \frac{2U \left(\frac{\Omega}{\Delta}\right)}{I_1} = 0. \quad (29)$$

This gives:

$$U \left(\frac{\Omega}{\Delta}\right) = 0 \quad (30)$$

or

$$U^2 \left(\frac{\Omega}{\Delta}\right) = \frac{5}{4} \frac{K_1}{I_1} - \frac{1}{4} \frac{K_1}{J_1} \left(\frac{\Omega}{\Delta}\right)^2. \quad (31)$$

Thus the response curve of the optimum filter at various values of Ω must be in accord with either (30) or (31). A simple but tedious calculation shows that among the various possibilities, the one which gives the lowest value of $K\mathcal{E}$ is:

$$U \left(\frac{\Omega}{\Delta}\right) = 0, \quad \text{for } |\Omega| > \Delta \quad (32)$$

$$U^2 \left(\frac{\Omega}{\Delta}\right) = A \left\{ 1 - \left(\frac{\Omega}{\Delta}\right)^2 \right\}, \quad \text{for } |\Omega| < \Delta.$$

Evidently the exact performance cannot be obtained with an actual filter. Eq. (32) can be written as:

$$U^2 \left(\frac{\Omega}{\Delta}\right) = \frac{A}{1 + \left(\frac{\Omega}{\Delta}\right)^2 + \left(\frac{\Omega}{\Delta}\right)^4 + \left(\frac{\Omega}{\Delta}\right)^6 + \dots} \quad (33)$$

Eq. (33) is exactly equivalent to (32) for all values of Ω . A good enough approximation can be obtained by stopping at the sixth power:

$$U^2 \left(\frac{\Omega}{\Delta}\right) = \frac{A}{1 + \left(\frac{\Omega}{\Delta}\right)^2 + \left(\frac{\Omega}{\Delta}\right)^4 + \left(\frac{\Omega}{\Delta}\right)^6}$$

$$= \frac{A}{\left[1 + \left(\frac{\Omega}{\Delta}\right)^2 \right] \left[1 + \left(\frac{\Omega}{\Delta}\right)^4 \right]} \quad (34)$$

Eq. (34) can be realized by isolated cascading of a single tuned circuit having a Q factor of $\omega_0/2\Delta$ and a pair of coupled tuned circuits having Q factors of $\omega_0/\sqrt{2}\Delta$ respectively.

The constant $K\mathcal{E}$ is calculated for different types of filters and the results are given in Table I.

TABLE I

Filter Type	$K\mathcal{E}$
Single Tuned Circuit	∞
Double Tuned Circuit (isolated)	.77
Triple Tuned Circuit (isolated)	.71
Tukey's Rectangular Response Filter ^{2,5}	.68
Filter of Equation 34	.68
Optimum Filter	.66

EFFECT OF VARYING FREQUENCY

Let the response of the filter to unit pulse at time τ be denoted by $F(t-\tau)$. The relation between the instantaneous input signal e_i and output signal e_o is:

$$e_o(t) = \int_{-\infty}^t e_i(\tau) F(t-\tau) d\tau. \quad (35)$$

For filters with a bandwidth Δ much smaller than the medium frequency ω_0 , the function $F(t-\tau)$ is a wave train of frequency ω_0 starting at $t=\tau$ and lasts for an interval of the order of $1/\Delta$. Hence the history of $e_i(\tau)$ which contributes to $e_o(t)$ in (35) is limited to the interval from $t-0(1/\Delta)$ to t , the notation $0(1/\Delta)$ meaning a time interval of the order of $1/\Delta$. Generally the period of scanning is many times $0(1/\Delta)$, and margins of safety are left at both ends of the entire spectrum.

⁵ J. W. Tukey and R. W. Hamming, "Measuring Noise Color," Bell Telephone Lab. Notes; 1949.

Thus the frequency of a single component of the input signal is:

$$\omega = \omega_1 + qt \quad (36)$$

where q is the rate of change of frequency, and ω_1 is a constant. The phase angle is:

$$\phi = \omega_1 t + \frac{1}{2}qt^2 + \phi_0, \quad (37)$$

ϕ_0 is the constant of integration. The input signal can be written as:

$$e_i(t) = E_i \sin(\omega_1 t + \frac{1}{2}qt^2 + \phi_0). \quad (38)$$

As the essential interest of this analysis lies in the general relationship between the filter response to the allowable value of q which does not alter it appreciably rather than the exact value of the output signal for certain particular filters, some convenient approximate form of $F(t)$ may be used. For the narrow-band filters, the envelope of its unit pulse-response function can be fairly well approximated by the function $e^{-\Delta_1^2(t-\tau)^2}$ where τ_1 is the time interval between the incident-pulse and peak-output response, and $1/\Delta_1$ is the approximate duration of the wave train. The approximate expression for $F(t)$ is:

$$F(t) = e^{-\Delta_1^2(t-\tau_1)^2} \sin \omega_0 t. \quad (39)$$

Substitute (38) and (39) into (35), it becomes

$$e_0(t) = E_i \int_{-\infty}^t \sin(\omega_1 \tau + \frac{1}{2}q\tau^2 + \phi_0) \cdot e^{-\Delta_1^2(t-\tau-\tau_1)^2} \sin \omega_0(t-\tau) d\tau. \quad (40)$$

As the exponential factor has negligible magnitude for negative values of $(t-\tau)$, to the same order of approximation as (39), the upper limit of the above integral can be extended to ∞ . The sine terms can be changed into the difference of two cosine terms. Eq. (40) becomes:

$$e_0(t) = \frac{E_i}{2} \int_{-\infty}^{\infty} e^{-\Delta_1^2(t-\tau-\tau_1)^2} \cdot \cos[(\omega_1 + \omega_0)\tau + \frac{1}{2}q\tau^2 + \phi_0 - \omega_0 t] d\tau - \frac{E_i}{2} \int_{-\infty}^{\infty} e^{-\Delta_1^2(t-\tau-\tau_1)^2} \cdot \cos[(\omega_1 - \omega_0)\tau + \frac{1}{2}q\tau^2 + \phi_0 + \omega_0 t] d\tau. \quad (41)$$

By writing the cosine factor as the real part of an exponential function, (41) can be readily integrated. The result is:

$$e_0(t) = \frac{\sqrt{\pi} E_i}{2 \left(\Delta_1^4 + \frac{q^2}{4} \right)^{1/2}} \left\{ e^{-[(\omega_1 + \omega_0) + q(t-\tau_1)] / (4\Delta_1^2 + q^2/\Delta_1^2)} \cos \phi_1(t) + e^{-[(\omega_1 - \omega_0) + q(t-\tau_1)] / (4\Delta_1 + q/\Delta_1^2)} \cos \phi_2(t) \right\}. \quad (42)$$

In (42) $\phi_1(t)$ and $\phi_2(t)$ are complicated expressions of t and will be omitted here as only the envelope of the output signal is of interest.

The first term is entirely negligible since $\omega_0 \gg \Delta_1$. Noting that $\omega = \omega_1 + qt$, the second term may be written as:

$$e_0(t) = \frac{\sqrt{\pi} E_i}{2 \left(\Delta_1^4 + \frac{q^2}{4} \right)^{1/4}} e^{-(\omega - \omega_0 - q\tau_1) / (4\Delta_1 + q/\Delta_1^2)} \cos \phi_2(t). \quad (43)$$

The sinusoidal response of the filter is obtained by taking the limit of (43) with q approaching zero. Its half bandwidth taken at the e^{-1} point is $2\Delta_1$.

With finite rate of change of frequency, (43) states:

1. The peak response is reduced by a factor of

$$\left\{ 1 + \frac{4q^2}{(\text{h.b.w.})^4} \right\}^{-1/4}.$$

2. The bandwidth is increased by a factor of

$$\left\{ 1 + \frac{4q^2}{(\text{h.b.w.})^4} \right\}^{1/2}.$$

3. The center frequency is shifted approximately by $q\tau_1 \approx q/\Delta_1 = 2q/\text{h.b.w.}$, since the time required to reach peak response is approximately $1/\Delta_1$.

The criterion for not altering appreciably the filter performance is, therefore:

$$q \ll \frac{(\text{h.b.w.})^2}{2}. \quad (44)$$

In the inequality (44), the half bandwidth and the rate of change of frequency are expressed in radians per second and radians per second per second respectively.

In the above derivations, q is treated as constant. However, the results are equally valid for varying rates of frequency change as long as the variation is small within a time interval of the order of the reciprocal of half bandwidth.

ACKNOWLEDGMENT

The writer is indebted to Joseph Caldwell and W. J. Pierson for their valuable discussions and help.

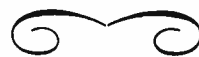

The Nondestructive Read-Out of Magnetic Cores*

ATHANASIOS PAPOULIS†

Summary—The purpose of the following is to analyze the performance of a magnetic core when a field H_y is applied perpendicular to the direction of the residual magnetization J_r , in particular to evaluate the magnitude of J_r after the applied field is removed.

INTRODUCTION

WHEN A MAGNETIC CORE is used as a storage element, the information “zero” or “one” is stored in the form of residual magnetization J_r in the $+z$ or $-z$ direction. The state of the core is sensed by application of a field in the $+z$ direction, bringing the core into the “zero” state; thus the information once used is lost. It is often necessary to sense the core more than once; this can be done by feeding the output signal back into the core, a process involving time delay and the need of additional equipment. Recently the idea was proposed at the Massachusetts Institute of Technology¹⁻³ of applying a field H_y in the y direction as a sensing signal, causing J_r to rotate in the direction of the applied field; the resulting flux change in the z direction to be read as a positive or negative signal in the read-out coil. When H_y is removed, J_r returns in whole or in part to its original position; it can thus be sensed again. In the following, an analysis of the above process will be given; in particular the evaluation of the recovered magnetization as a function of the applied signal will be attempted. In a macroscopic analysis of the behavior of a ferromagnetic material the magnetization J is assumed in the direction of the field H ; clearly such an assumption could not explain the above process which is based on the anisotropic properties of the material. The internal structure of the material must be considered.

THE DOMAIN ORIENTATION^{4,5}

In the absence of an external field the material is divided into magnetically saturated regions, the domains. The direction of their magnetization is not random but depends on the orientation of the grains and the inner tensions; however, with each preferred direction, the opposite is equally likely to occur so that the component of total magnetization in a given direction equals zero. If a magnetic field, H , is applied, the magnetization

* Decimal classification: R282.3. Original manuscript received by the IRE, November 6, 1953; revised manuscript received, March 16, 1954.

† Dept. of Electrical Engineering, Polytechnic Institute of Brooklyn, Brooklyn, N. Y.; Consultant, Burroughs Corp., Research Center, Paoli, Pa.

¹ D. A. Buck, “Nondestructive Sensing of Magnetic Cores,” M.I.T. Digital Computer Laboratory, Engineering Note E-454-1, Cambridge, Mass.; December 6, 1951.

² W. J. Frank, “Further Work on Non-destructive Read System,” M.I.T. Digital Computer Laboratory, Memorandum M-2195, Cambridge, Mass.; May 27, 1953.

³ D. A. Buck and W. J. Frank, “Nondestructive Sensing of Magnetic Cores,” AIEE Technical Paper 53-409; October, 1953.

⁴ R. Becker and W. Doering, “Ferromagnetismus,” J. Springer, Berlin, Germany; 1939.

⁵ R. Bozorth, “Ferromagnetism,” D. Van Nostrand Book Co., Inc., New York, N. Y.; 1951.

density J of each domain remains constant, only its direction changes so that there results a net component in the direction of the applied field. The orientation of the domains is such as to minimize the total energy associated with each direction. The sources of magnetic energy are as follows:

a. The crystalline energy E_{cr} , which for a cubic crystal is given by

$$E_{cr} = K(\alpha_1^2\alpha_2^2 + \alpha_1^2\alpha_3^2 + \alpha_2^2\alpha_3^2) \quad (1)$$

where K is the anisotropy constant of the material and $\alpha_1, \alpha_2, \alpha_3$ are the direction cosines of the magnetization with the cubic axes (in (1) the higher powers of α are omitted).

b. The magnetostrictive energy E_m , which for the case of isotropic magnetostriction is given by

$$E_m = \frac{3}{2}\lambda\sigma \sin^2 \theta \quad (2)$$

where λ is the magnetostrictive constant, σ the tension, and θ the angle between magnetization and tension.

c. The energy of the external field E_H , given by

$$E_H = -HJ \cos \theta \quad (3)$$

where H is the magnetic field, J the magnetization, and θ the angle between them. The determination of the domain size and orientation is in general complicated. Under certain assumptions concerning the relative magnitude of E_{cr} and E_m , and the geometry of the material, the problem can be simplified. In this paper materials will be considered with cubic crystal structure and with magnetostrictive energy E_m small compared to the crystalline energy E_{cr} . In this case the total energy associated with each direction is given by (1), if no external field is present; for $K > 0$, as it will be assumed in the following, E_{cr} becomes minimum for every direction parallel to one of the crystal axes.

THE GEOMETRY OF THE MATERIAL

The core under investigation will consist of a magnetic tape (Fig. 1) with rectangular cross section of dimensions d and h , wound in a toroidal form of radius r ; d will be small compared to h and r ; the tape will thus be approximated by a plane sheet of thickness d . The origin of co-ordinates will be at the middle of the strip and the x axis perpendicular to its surfaces. The material will be magnetized in the z direction and the sensing field H_y will be applied in the y direction; the read-out coil will read the flux variation in the z direction. The field H_y will be applied in the following two ways:³

a. *Externally.* In this case $H_y = H$ will have the same value in every point of the material.

b. *Internally.* By passing a uniform current through the metal in the z direction; with I the total current, the current density j is given by

$$j = \frac{I}{hd} \tag{4}$$

Hence the resulting field H_y varies with x as in

$$H_y = jx. \tag{5}$$

For the crystal orientation the following cases will be considered.

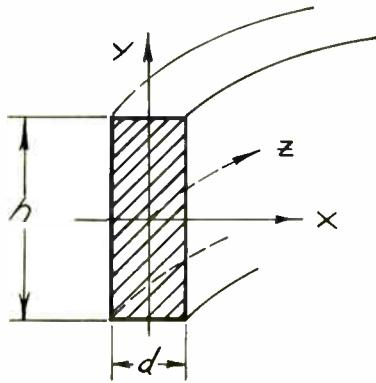

Fig. 1—Cross section of the magnetic material.

CRYSTAL AXES PARALLEL TO THE CO-ORDINATE AXES

Suppose a field is applied in the $+z$ direction; if it is sufficiently high, the total energy $E = E_{cr} + E_H$ becomes minimum when the domains are oriented parallel to the z axis, and the total magnetization in the z direction equals J . If the applied field is removed, the z axis, being a crystal axis, is one of the directions for which $E = E_{cr}$ is minimum; hence the domains remain parallel to the z axis and the remanent magnetization J_r equals J .

a. The field $H_y = H$ is applied externally; after the eddy currents die down, H_y will have the same value in all parts of the metal. In the presence of H the domains turn in the $y-z$ plane by an angle θ (Fig. 2), hence

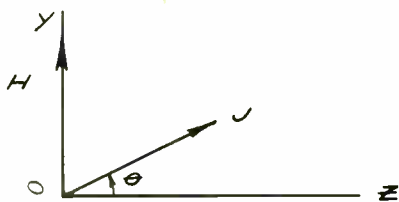

Fig. 2—Rotation of the domain J by an angle θ upon application of a field in the y direction; Oy, Oz crystal axes.

$\alpha_1 = 0, \alpha_2 = \sin \theta, \alpha_3 = \cos \theta$ and the angle between the field and the domain orientation is $90^\circ - \theta$. Therefore the total energy $E = E_{cr} + E_H$ is given by

$$E = K \sin^2 \theta \cos^2 \theta - IJ \sin \theta. \tag{6}$$

The angle θ is such as to minimize the total energy E ; equating to zero the derivative of E with respect to θ we obtain

$$\sin 4\theta = \frac{2HJ}{K} \cos \theta. \tag{7}$$

The solution of (7) in the interval $0 \leq \theta \leq 90^\circ$ is given by

$$\theta = 90^\circ \tag{8}$$

and

$$\sin \theta - 2 \sin^3 \theta = \frac{IJ}{2K}. \tag{9}$$

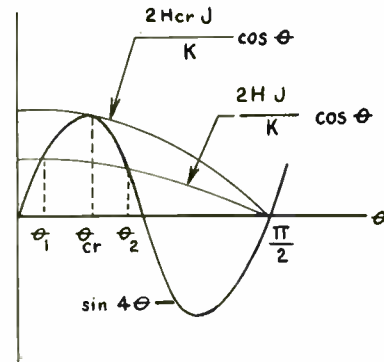

Fig. 3—Graphical solution of (7) for $H < H_{cr}$ and $H = H_{cr}$.

Fig. 3 gives a graphical solution of (7); the smaller root θ_1 gives the minimum of the energy E , hence the angle by which J rotates. With increasing I , θ_1 increases continuously until it reaches the value θ_{cr} corresponding to $I = H_{cr}$; for $I > H_{cr}$ the only possible solution of (7) is $\theta = 90^\circ$. Thus for $I > H_{cr}$ the domains turn discontinuously parallel to the y axis. It can easily be seen that the values of H_{cr} and θ_{cr} are given by (10) and (11).

$$H_{cr} = \frac{4}{3\sqrt{6}} \frac{K}{J} \tag{10}$$

$$\sin \theta_{cr} = \frac{1}{\sqrt{6}}, \quad \theta_{cr} \approx 24^\circ. \tag{11}$$

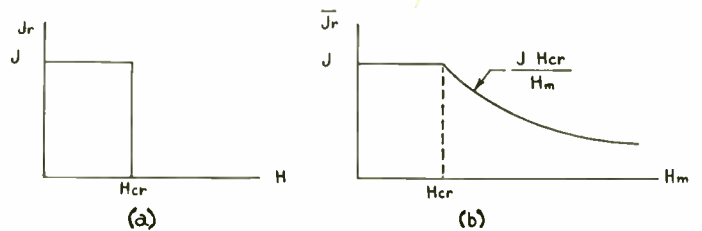

Fig. 4—Recovered magnetization in the z direction as function of the applied H : a. for an externally applied field, b. for an internally applied field.

From the above the recovered magnetization J_r in the z direction as a function of the applied I can be determined. Suppose $I \leq H_{cr}$; after I is removed, the domains turn parallel to the nearest crystal axis, the z axis in this case, hence $J_r = J$ and the z remanence is completely recovered. Suppose next that $I > H_{cr}$; since the domains have turned parallel to y axis which is one of crystal axes, they will remain in this direction after I is removed, thus magnetization in z direction is completely lost. Fig. 4(a) gives J_r as a function of applied H .

b. The field H is applied internally; inside the metal it varies as in (5) and at the surfaces it has the value

$$i \frac{d}{2} = H_m. \tag{12}$$

The orientation of the domains is given by the solution of

$$\sin 4\theta = \frac{2jxJ}{K} \cos \theta. \tag{13}$$

Clearly θ varies with x , being zero at the center and maximum at the surfaces:

$$x = \pm \frac{d}{2}.$$

If $H_m \leq H_{cr}$ then the domains throughout the metal turn by an angle smaller than θ_{cr} as defined in (11); hence when H is removed, they return parallel to the z axis and the z remanence is completely recovered. If $H_m > H_{cr}$, we define d_1 such that

$$j \frac{d_1}{2} = H_{cr}. \tag{14}$$

For $|x| \leq d_1$ the domains turn by an angle smaller than θ_{cr} ; for $|x| > d_1$ they turn parallel to the y axis; hence when H is removed, the remanence in the z direction is recovered only for $|x| \leq d_1$ and it is completely lost for $|x| > d_1$. The average residual magnetization \bar{J}_r in the z direction is therefore given by

$$\bar{J}_r = J \frac{d_1}{d}. \tag{15}$$

Fig. 4(b) gives \bar{J}_r as a function of H_m .

ONE OF THE CRYSTAL AXES IS IN THE x DIRECTION; THE OTHER TWO HAVE A RANDOM ORIENTATION

In the absence of a field the total magnetization is zero. If a sufficiently high field is applied in the z direction, the domains turn parallel to it and the saturation magnetization equals J . If this field is removed, the domains turn parallel to one of the crystal axes; from the six possible orientations the one which forms the smallest angle with the $+z$ direction is preferred, hence with ϕ the angle of a given domain with the $+z$ axis, ϕ is distributed at random in the interval

$$-\frac{\pi}{4} \leq \phi \leq \frac{\pi}{4}. \tag{16}$$

(Fig. 5), and the magnetization in the z direction is given by

$$J_r = \frac{2}{\pi} \int_{-\pi/4}^{\pi/4} J \cos \phi d\phi = \frac{2\sqrt{2}}{\pi} J. \tag{17}$$

a. When a field H is applied externally in the y direction the domains forming an angle ϕ with the z axis will

turn by an angle $\theta(\phi)$ (Fig. 6) such as to minimize the total energy

$$E = K \sin^2 \theta \cos^2 \theta - HJ \sin(\theta + \phi) \tag{18}$$

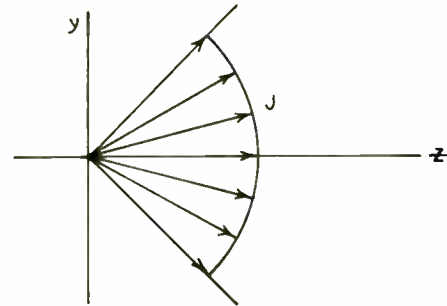

Fig. 5—Distribution of domains of a material magnetized in the z direction.

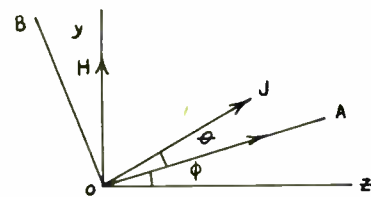

Fig. 6—Rotation of the domain J by an angle θ , upon application of a field in the y direction; OA, OB crystal axes.

since the angle which the domain forms with the applied field is $90 - (\theta + \phi)$. Equating to zero the derivative of E with respect to θ , we obtain

$$\sin 4\theta = \frac{2HJ}{K} \cos(\theta + \phi). \tag{19}$$

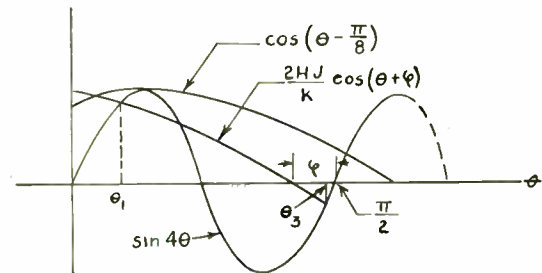

Fig. 7—Graphical solution of (19); upper curve for $\phi = -(\pi/8)$ and $H = K/2j$.

Equation (19) determines θ as a function of ϕ for a given H . The solution can be found graphically from the intersection of the two curves on each side of this equation (Fig. 7). The smaller root θ_1 determines the minimum of E and hence the angle by which J rotates when H is applied. It can be seen that for

$$H < \frac{K}{2J}$$

θ_1 is smaller than $\pi/8$, for every ϕ ; thus the domains remain closer to the crystal axis along which they were directed before H was applied. When H is removed, they return to their original position and the magnetization is fully recovered. For

$$H = \frac{K}{2J}$$

the curves $\sin 4\theta$ and $2HJ/K \cos [\theta - (\pi/8)]$ are tangent. For

$$\frac{K}{2J} < H < \frac{4}{3\sqrt{6}} \frac{K}{J} \quad (20)$$

the domains oriented in a sector $2\alpha < (\pi/4)$ symmetric about $-(\pi/8)$ rotate by an angle θ_3 greater than $(\pi/4)$, coming closer to a new crystal axis; hence when H is removed they turn to a direction perpendicular to their

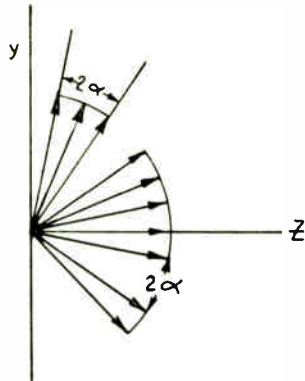

Fig. 8—Distribution of domains after H , satisfying the inequality (20), is removed.

original orientation, as in Fig. 8. Thus the magnetization in the z direction is given by

$$J_r = \frac{2\sqrt{2}}{\pi} J - \frac{2}{\pi} \int_{-(\pi/8)-\alpha}^{-(\pi/8)+\alpha} J(\cos \phi + \sin \phi) d\phi. \quad (21)$$

α can easily be obtained from H . For

$$H = \frac{4}{3\sqrt{6}} \frac{K}{J},$$

$$2\alpha = \frac{\pi}{4}$$

and J_r is given by

$$J_r = \frac{2}{\pi} J. \quad (22)$$

The magnetization is reduced to $1/\sqrt{2}$ of its original value. For

$$H > \frac{4}{3\sqrt{6}} \frac{K}{J}$$

there is a $\phi_m > 0$ such that all the domains with $\phi < \phi_m$ turn nearer to a new crystal axis and when H is removed the magnetization in the z direction is given by

$$J_r = \frac{2}{\pi} \int_{\phi_m}^{(\pi/2)+\phi_m} J \cos \phi d\phi = \frac{2J}{\pi} (\cos \phi_m - \sin \phi_m). \quad (23)$$

For $H = 2K/J$, $\phi_m = \pi/2$; hence for

$$H > \frac{2K}{J}$$

the magnetization J_r in the z direction is completely lost. If J_r , as given by (21) and (23), is plotted as a function of H , the curve $J_r(H)$ of Fig. 9(a) results.

b. The case of the internally applied field can be similarly analyzed. The remanent magnetization at a point x is given by the curve $J_r(H)$ of Fig. 9(a) where $H = jx$; therefore the average magnetization \bar{J}_r can be obtained from

$$\bar{J}_r = \frac{2}{d} \int_0^{d/2} J_r(jx) dx = \frac{1}{H_m} \int_0^{H_m} J_r(H) dH, \quad (24)$$

where H_m , as given by (12), is the value of the field at the surface of the material. Fig. 9(b) gives \bar{J}_r as a function of H_m .

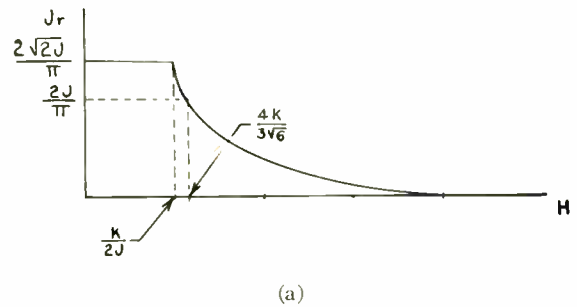

(a)

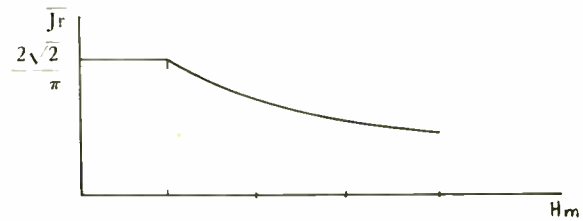

(b)

Fig. 9—Recovered magnetization in the z direction as a function of the applied H : a. for an externally applied field, b. for an internally applied field.

OUTPUT VOLTAGE

With $\Phi_z(t)$ the flux in the z direction, and N the number of turns of the read-out coil, the value of the output voltage

$$e(t) = N \frac{d\Phi_z(t)}{dt}$$

depends on the eddy-currents, the rise time of the applied field H_y , the load across the read-out coil. In all cases the integral

$$\frac{1}{N} \int_0^\infty e(t) dt = \Phi_z(0) - \Phi_z(\infty) = \Delta\Phi_z \quad (25)$$

depends on the initial and final value of the remanence in the z direction. If H_y is applied for a second time, since $\Phi_z(0)$ is not fully recovered, $\Delta\Phi_z$ is decreased. Its value remains unchanged on the subsequent readings. Thus with increasing H_y , $\Delta\Phi_z$ increases only for the first interrogation; for the following readings it obtains a maximum value for an optimum H_y , and for an addi-

tional increase of I_y it decreases. For the case of a single crystal externally interrogated, the optimum value of I_y is given by (10) and the corresponding value of $\Delta\Phi_z$ by

$$\Delta\Phi_z = (1 - \sqrt{\frac{5}{6}})\Phi_z(0). \tag{26}$$

For the other cases the values of I_y and $\Delta\Phi_z$ can similarly be evaluated.

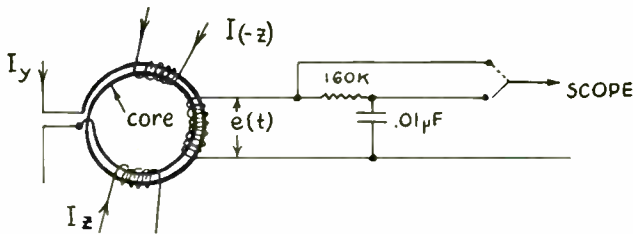

Fig. 10—Experimental setup for measuring $e(t)$ and $\Phi_z(t)$; I_y : internally applied sensing current; $I_z, I_{(-z)}$: magnetizing currents in the $+z$ and $-z$ direction.

EXPERIMENTAL RESULTS

The above scheme was first tried at the Digital Computer Laboratory at M.I.T.¹⁻³ where the idea was originated. The reader will find a detailed description of the experimental setups for obtaining the y field, voltage-output forms and the read-out time in the literature.¹⁻³ Experiments were performed also at the Magnetics Laboratory of the Research Division of Burroughs Corp. in Philadelphia; they largely agree with the re-

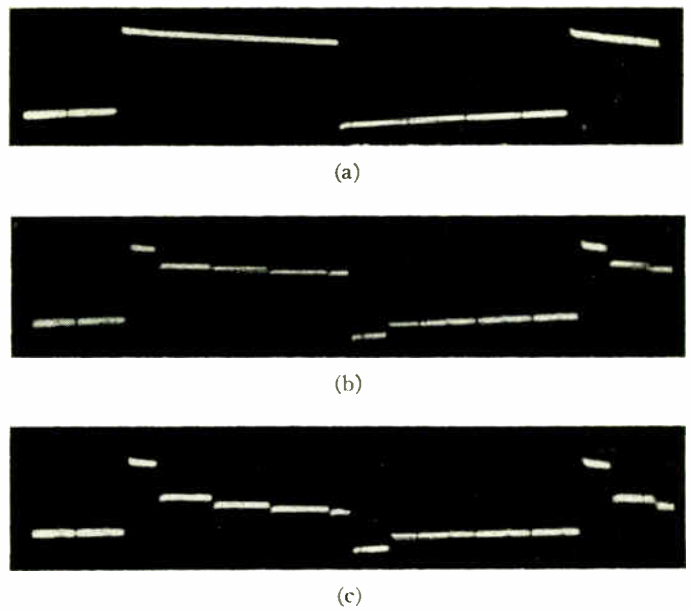

Fig. 11—Flux in the z direction for different values of the sensing current I_y : a. $I_y = 70\text{mA}$, b. $I_y = 750\text{mA}$, c. $I_y = 1.5\text{A}$.

sults described here. The cores were furnished by Magnetics Inc., Butler, Pa.

Fig. 10 illustrates the experimental setup. I_y is applied internally by passing a current pulse I_y through the core material. The core is switched in the $+z$ and $-z$ direction by the current pulses I_z and $I_{(-z)}$; the output voltage $e(t)$ is read directly or through an integrating circuit. Figs. 11(a) to 11(c) give the flux in the z direction

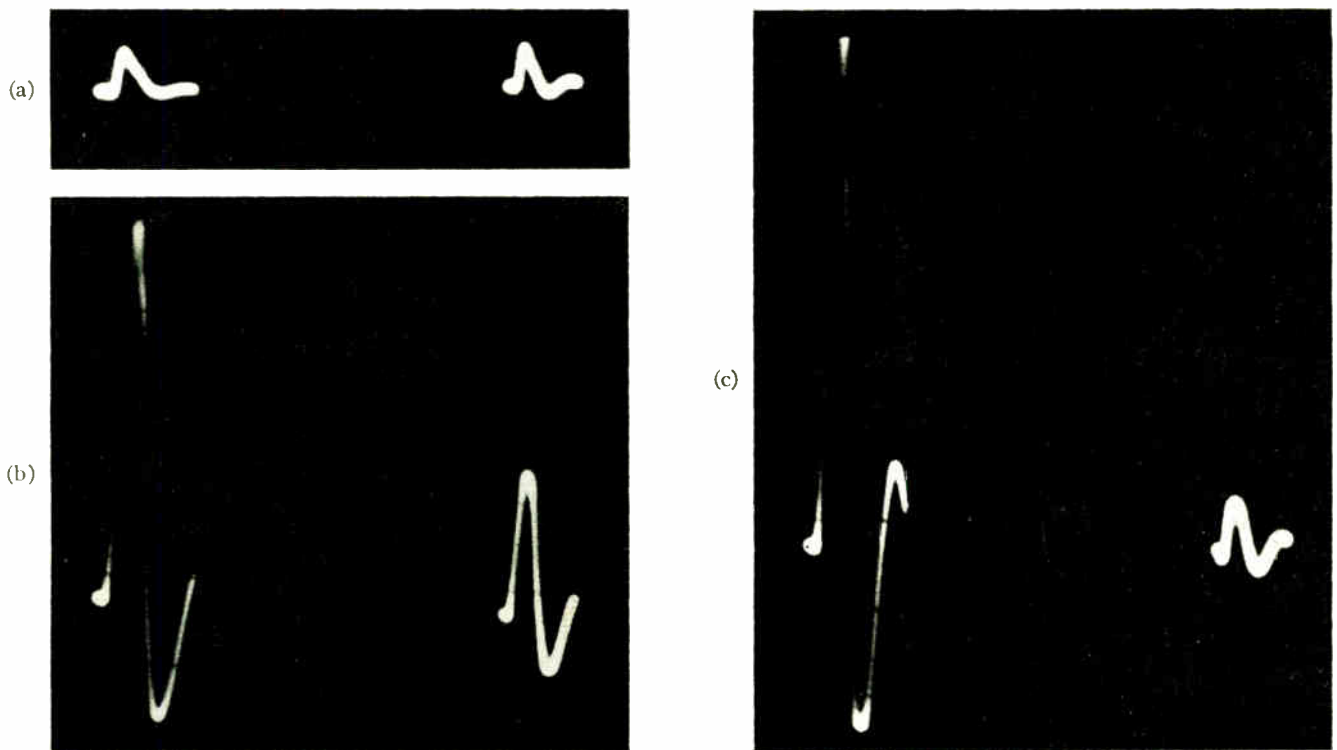

Fig. 12—Output voltage $e(t)$ for different values of the sensing current I_y : a. $I_y = 280\text{mA}$, b. $I_y = 570\text{mA}$, c. $I_y = 850\text{mA}$. curves to the left: for first application of I_y . Curves to the right: for second application of I_y .

for different values of I_y obtained with a 4-79 permalloy of $\frac{1}{2}$ -mil thickness; the sensing current I_y was applied four times for each direction

values of I_y : 70mA, 750mA, 1.5A.

Thus for small values of I_y (Fig. 11a), the magnetization is fully recovered (the slope of the flux line is due to the integrating circuit); as I_y increases, the magnetization decreases (see Fig. 9b). For the subsequent applications of I_y , the z remanence remains practically constant.

Figs. 12(a) to 12(c) give the voltage $e(t)$ for I_y applied and removed; the same material of thickness $\frac{1}{4}$ mil was used:

values of I_y : 280mA, 570mA, 850mA.

The curves at the left of each figure give $e(t)$ when I_y is first applied; the curves at the right of each figure give $e(t)$ when I_y is applied for the second time; for the subsequent applications of I_y , $e(t)$ remains unchanged. As I_y increases the first output increases, as can be seen in Fig. 12; the second output increases, reaches a maximum (Fig. 12b), and then it decreases with a further increase of I_y (Fig. 12c).

CONCLUSIONS

The above analysis was based on certain extreme assumptions concerning the crystal orientations; in an actual core the crystal axes are not unidirectional or random, but have a certain distribution $\beta(\phi)$ depending on the way the material is processed. In the direction of rolling $\beta(\phi)$ is higher.

The results of this paper can easily be extended to any $\beta(\phi)$. The remanence will be obtained from (21) and (23) by multiplying the integrand by $\beta(\phi)$; the corresponding graphs will lie between the curves of Fig. 4 and Fig. 9. The experimental results largely agree with the theory presented.

ACKNOWLEDGMENT

This paper was developed after discussion with T. C. Chen and R. A. Tracy of the Magnetics Laboratories of the Burroughs Research Center, then in Philadelphia. Their co-operation both in the development of the material and the preparation of this paper was most valuable.

False Echoes in Line-Type Radar Pulser*

REUBEN LEE†, FELLOW, IRE

Summary—This paper comprises studies made in formulating criteria for the elimination of false echoes in line-type radar pulsers. Equations and curves are derived for predicting the presence or absence of echoes in a given pulser. Experimental tests approximately verify the curves for pulses of 4-microseconds duration. A list of symbols used in the discussion appears at the end of the paper.

FALSE ECHOES observed in radar equipments are produced by oscillations in the magnetron after the main pulse ends. These oscillations may be produced by oscillatory backswing in the pulser, positive peaks of which cause the magnetron to oscillate.

Although negative pulses are required for magnetron oscillations, the pulses are ordinarily viewed on the oscilloscope screen in the upward or positive direction. Hence, the main pulse is regarded as positive, and the backswing as negative. Backswing may become positive, if oscillatory. This paper is concerned with the elimination of false echoes, which is a condition necessary for accurate and reliable information from the radar system.

Fig. 1 is a schematic diagram of the pulser chosen for study. This pulser is of the variety known as dc resonant

charging, with hold-off diode. The operation of the pulser is described elsewhere in the literature and will not be repeated in detail here.¹

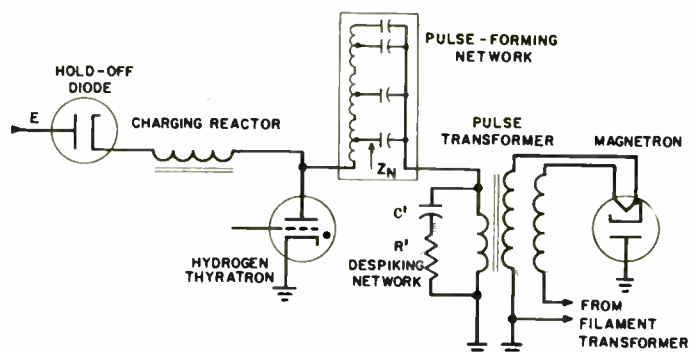

Fig. 1—Simplified schematic diagram of radar pulser.

After the pulse-forming network has charged up to voltage $2E$, it is prevented from discharging back through the dc source by the hold-off diode. At some subsequent instant, a trigger voltage on the grid of the hydrogen thyratron causes the thyratron to conduct and

* Decimal classification: R537.12. Original manuscript received by the IRE, August 24, 1953; revised manuscript received, April 23, 1954.

† Electronics Div., Westinghouse Electric Corp., Baltimore, Md.

¹G. N. Glasoe and J. V. Lebacqz, "Pulse Generators," M.I.T. Radiation Laboratory Series, vol. 5, McGraw-Hill Book Co., Inc., New York, N. Y.; 1948.

permits the pulse-forming network to discharge through the very low internal resistance of the thyatron.

The sudden discharge of current through the thyatron causes a voltage wave to start down the pulse-forming network as in Fig. 2. This voltage is an inverted step function with a value $(2E - E) = E$ each on both the network and the pulse-transformer primary. When it returns to the sending end of the network, this inverted

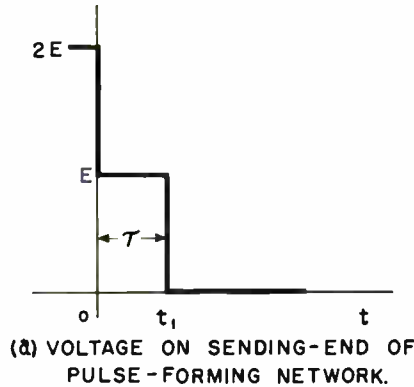

(a) VOLTAGE ON SENDING-END OF PULSE-FORMING NETWORK.

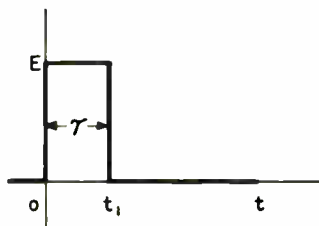

(b) VOLTAGE ON PULSE-TRANSFORMER PRIMARY WINDING

Fig. 2—Pulsar voltages.

wave again divides equally between the pulse-forming network and the pulse-transformer primary. At that instant, if there were no backswing there would be no voltage left on the pulse-forming network nor across the pulse-transformer primary, and the rf envelope of the magnetron would be a square pulse ending with a sudden drop of the voltage to zero at time t_1 . The pulse width τ is the length of time that the pulse takes to travel down the pulse-forming network and back, as in Fig. 2. After this, the circuit is ready to charge again through the charging reactor as before. Up to within a few per cent of operating voltage E , the magnetron is a comparatively light load; then it suddenly changes to a heavy load and continues to be so during the rest of the pulse. Because of this initial nonlinearity, current-pulse shape tends to depart materially from the ideal conditions depicted in Fig. 2. To compensate for this tendency, the $R'C'$ despiking network² is often added. R' is made equal to the pulse-forming network characteristic impedance Z_N . Capacitance C' is large enough so that voltage $2E$ divides equally between R' and Z_N during the time of pulse-voltage rise. But C' must not be greater than is prescribed by the condition $R'C' \ll \tau$, else

² *Ibid.*, p. 436.

the pulse shape would be seriously affected. It will be assumed in what follows that the voltage-pulse top remains at voltage E until time t_1 (Fig. 2).

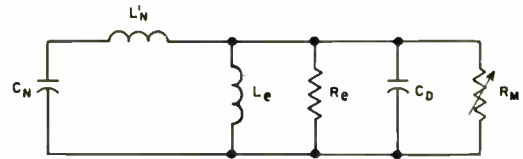

Fig. 3—Equivalent circuit of pulser.

At the end of the pulse, the reverse of the initial situation takes place and the magnetron unloads rapidly. The equivalent circuit for the trailing edge of the pulse is shown in Fig. 3, the magnetron resistance being shown as variable resistance R_M . Another nonlinear element in the circuit is the pulse-transformer open-circuit inductance L_e , which varies throughout the pulse from a rather small initial value to a value several times greater during the backswing interval. In this paper the inductance at time t_1 is denoted by L_e . A typical pulse hysteresis loop is shown in Fig. 4, and illustrates the increasing permeability up to point B_m , which corresponds to time t_1 in Fig. 2. Following the end of the pulse, the core induction first rises slightly and then decays slowly. For all values of decreasing induction below B_m the B - H slope is steep and the core permeability is high. This high permeability μ_d (Fig. 4) occurs during the backswing time interval, and usually is much greater than the permeability μ_e at the end of the pulse.

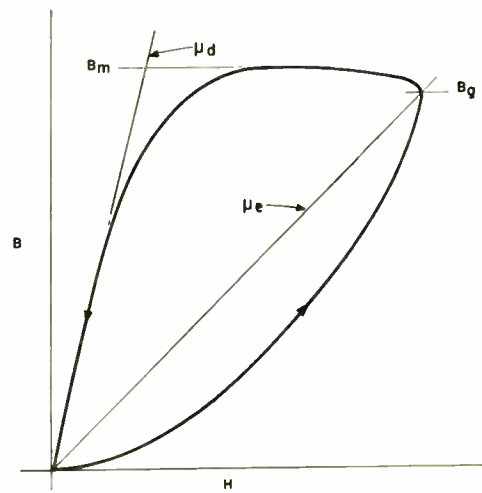

Fig. 4—Pulse permeability.

Resistance R' is effective only at the very beginning of the trailing edge because of the short time constant $R'C'$. Hence C' , along with the magnetron and transformer capacitance, is lumped into one capacitance C_D in Fig. 3. Pulse-forming network (PFN) is replaced³ by lumped capacitance C_N and inductance L_N .

Backswing voltage is caused by exciting current drawn by the pulse transformer during the main pulse.

³ *Ibid.*, pp. 260-265.

When appreciable exciting current is drawn, the pulse voltage does not stop at zero but goes negative, and if the pulse-transformer open-circuit inductance and circuit capacitance are not properly proportioned, the backswing is oscillatory so that positive backswing and false echoes result. Fig. 5 illustrates the type of pulse appearing on the magnetron when echoes are present. It will be noticed that the echoes are of two kinds: close echoes, adjacent to the main pulse; and distant echoes which may appear later at a comparatively longer time interval. Correspondingly, trailing-edge oscillations are of two general kinds: (a) a long-term or low-frequency oscillation (see Fig. 6) dependent on capacitance C_N and pulse transformer open-circuit inductance L_e , and (b) a superposed high-frequency oscillation dependent on capacitance C_D and L_N' =PFN inductance L_N plus pulse-transformer leakage inductance.

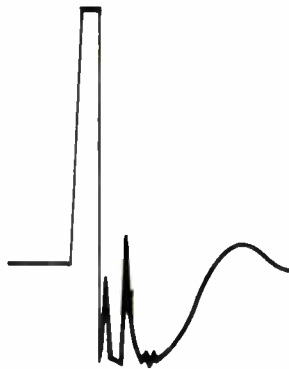

Fig. 5—Oscilloscope trace of pulse with false echoes.

Both low- and high-frequency-oscillation amplitudes depend on the amount of resistance in the circuit. At instant t_1 this resistance is R_M , the so-called magnetron static impedance, in comparison with which core loss equivalent resistance R_e is negligibly high. After the magnetron ceases conducting, only R_e remains. During the trailing-edge interval, circuit resistance varies from R_M to R_e .

It is shown in Appendix II that this nonlinear problem may be solved by a linear circuit method. Resistances R_e and R_M are replaced by their geometric mean R_I during the trailing-edge interval and part of the backswing immediately following. This applies to both low- and high-frequency-backswing oscillations during the interval t_2-t_1 (Fig. 6) and for some time thereafter. The low-frequency or long-term axis of backswing may then be computed from (13), in Appendix III. This equation is plotted for values of parameter k_3 in Fig. 7. Both the LC product and the L/C ratio of the circuit determine the wave shape of any portion of the pulse. Frequencies of any oscillations present on the front edge, trailing edge, or backswing are governed by the LC product effective in the circuit during the respective periods. Voltage amplitudes of these oscillations are governed by the ratio $\sqrt{L/C}$ to the circuit impedance. If the oscillations are damped out, the ratio

$$\frac{\sqrt{L/C}}{R}$$

still determines wave shape. One half of this ratio is designated k_1 , k_2 , k_3 , or k_4 , depending on the portion of the pulse as indicated in Fig. 6.

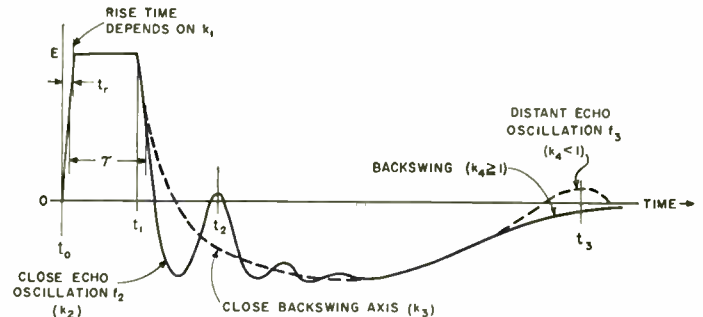

Fig. 6—Oscillations on pulse backswing.

If PFN produces an essentially square wave, front-edge wave shape at the magnetron is determined by the impedance ratio

$$k_1 = \frac{\sqrt{L_e/C_D}}{2R_M}$$

and it may be shown¹ that if $k_1=0.5$ the magnetron voltage and current rise to final value at $t_r=1.3\sqrt{L_e C_D}$, which is minimum time without oscillations. This k_1 has little influence on the trailing edge because L_e is usually small compared to L_N or L_e .

Oscillations occurring close to the trailing edge of the pulse are of frequency f_2 determined by $L_N' C_D'$ where $C_D' = C_D C_N / (C_D + C_N)$ and of amplitude determined by

$$k_2 = \frac{1}{2R_I} \sqrt{\frac{L_N'}{C_D'}}$$

This amplitude is superposed on the backswing as an axis, which, if oscillatory, has frequency f_3 determined by $L_e C_D'$. Since one purpose of good pulser design is the elimination of false echoes, the backswing axis considered here is always nonoscillatory. Assuming the thyatron is nonconducting for most of the backswing interval, the condition for nonoscillatory backswing is

$$\sqrt{\frac{L_e}{C_D'}} \geq 2R_I \text{ for the close part of the backswing}$$

and

$$\sqrt{\frac{J L_e}{C_D}} \geq 2R_e \text{ for the distant part, where } J = \frac{\mu_d}{\mu_e}$$

If

$$k_3 = \frac{1}{2R_I} \sqrt{\frac{L_e}{C_D'}}$$

and

$$k_4 = \frac{1}{2R_e} \sqrt{\frac{JL_e}{C_D}}$$

then

$$k_3 \geq k_4, \text{ because generally } \frac{R_E}{R_I} > \sqrt{\frac{JC_D'}{C_D}}$$

So if the pulser is designed to prevent distant echoes, $k_4 \geq 1$ and k_3 is several times the value of k_4 . Time intervals influenced by these impedances ratios are illustrated in Fig. 6.

The general effect of exciting current is to depress the backswing axis, as can be seen from Fig. 7. This may appear puzzling, because L_e is already a factor in determining k_3 and k_4 and hence the backswing. A distinction must be drawn between (a) the exciting current, already in L_e at instant t_1 (Fig. 6) and (b) the current caused by discharge of C_D after t_1 . Current (a) depends on the inductance at the end of the pulse, determined by the pulse permeability μ_e ; current (b) builds up as a

superposed surge on current (a). Exciting current does not affect the criterion for oscillations

$$k_4 = \frac{1}{2R_e} \sqrt{\frac{J_e}{C_D}} < 1;$$

it does, however, increase the backswing voltage for any given value of k_4 . The larger the exciting current that can be tolerated from the standpoint of pulse-top flatness, the less the likelihood of close echoes. Distant echoes are not affected. Hence a high ratio of μ_d to μ_e (see Fig. 4) is helpful in eliminating close echoes.

The ratio Δ of exciting current to load current is much less for the close echo than for the distant echo, because R_I is less than R_e . Close echo Δ is found as follows:

$$\text{Exciting current } i_M = E\tau/L_e$$

$$\text{Equivalent load current for interval } t_2 - t_1$$

$$i_L = \frac{E}{R_I}$$

so that

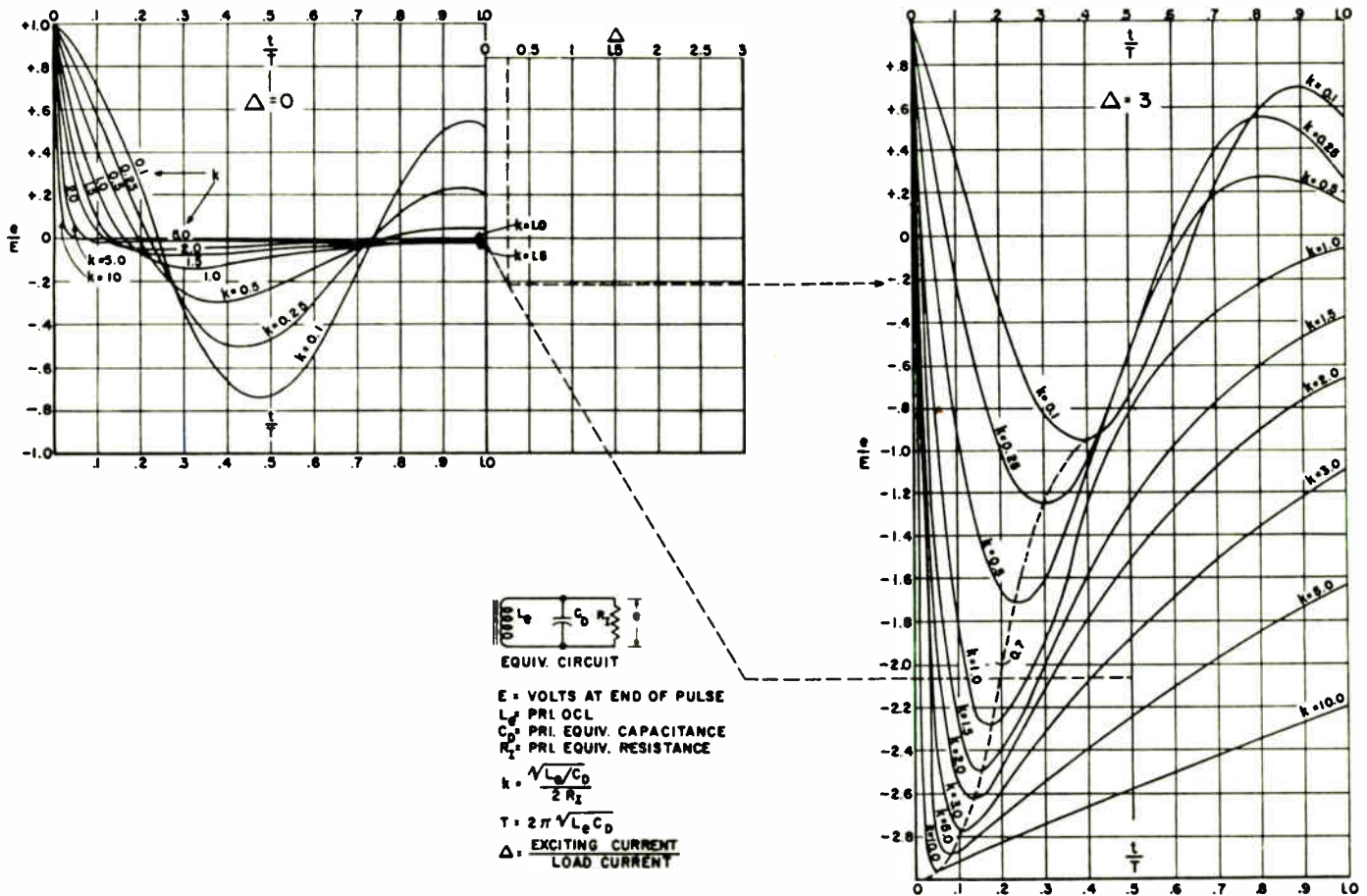

Fig. 7—Interpolation chart for finding backswing amplitude.

To find e/E at any time t/T , k and Δ :

- A. Take initial e/E for the appropriate t/T and k from left-hand chart, and project this point to the right to obtain intersection with $\Delta=0$ line.
 - B. Take second e/E at the same t/T and k from right-hand chart and project to the left to obtain intersection with $\Delta=3$ line.
 - C. Through these intersections draw a straight line.
 - D. Drop the given value of Δ to intersect this line; project horizontally to obtain actual e/E for given instant t .
- Example shown dotted is for $k=3.84$, $t/T=0.5$ and $\Delta=0.256$.
 Answer $e/E = -0.21$.

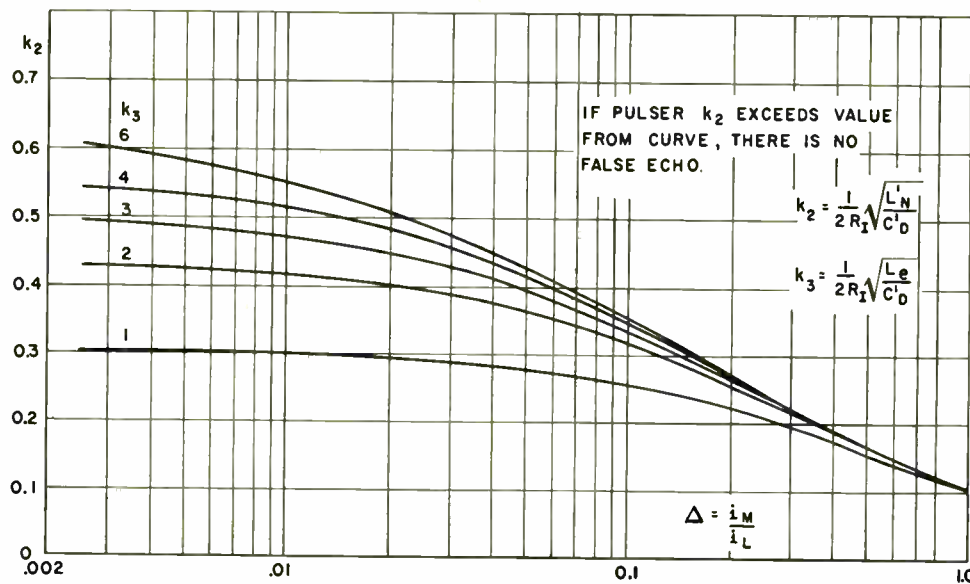

Fig. 8—Borderline of close false echoes.

$$\Delta = \frac{i_M}{i_L} = \frac{\tau R_I}{L_e} \tag{1}$$

Unless it is sufficiently damped, the first peak of oscillation produces close echo. It occurs at time t_2 (Fig. 6) such that

$$t_2 - t_1 = \frac{1}{f_2} = 2\pi\sqrt{L_N' C_D'} = \pi\tau\sqrt{\frac{C_D'}{C_N}} \tag{2}$$

To prevent close echo, the first positive peak of this oscillation should be no greater than the negative backswing-axis voltage at instant t_2 . Backswing-axis voltage is readily obtained from Fig. 7, and it may be equated to the amplitude of the first positive oscillation peak at time t_2 in order to determine the borderline condition between the presence or absence of close oscillations. This condition is set forth in (14) of Appendix III as a transcendental relation between k_2 , k_3 and Δ , which is plotted in Fig. 8. It will be noted that all values of k_2 in Fig. 8 are less than unity. Hence under the conditions here assumed, there is always a certain amount of oscillation on the backswing axis. But if k_2 is greater than the value given by Fig. 8, there is no close echo. To prevent false echoes it is best if k_2 exceeds this value substantially.

With short pulse duration the trailing edge may fall so slowly that close oscillations occur before the pulse voltage reaches zero. Usually, under this condition, the damping influence of the magnetron is great enough to reduce the oscillation amplitude below the coincident trailing-edge voltage. For this reason, close echoes are less likely to occur with narrow pulses.

For convenience, the various impedance ratios are tabulated in Table I at right.

In the design of a pulser, if k_2 is calculated and found to be less than the value from the appropriate curve of

Fig. 8, it may be possible to prevent close echoes by adding resistance across one of the pulse transformer windings, thus lowering R_e .

EXAMPLE

An experimental modulator is rated at 1,500 kw peak and produces 4μsec pulses. Other data are as follows:

- $Z_N = 25$ ohms
- $L_N = 50 \times 10^{-6}$ henry
- $C_N = 0.08 \times 10^{-6}$ farad
- $L_e = 5.0 \times 10^{-3}$ henry
- $C_D = 6,000 \times 10^{-12}$ farad
- $L_s = 11 \times 10^{-6}$ henry
- $R_M = 25$ ohms
- $R_e = 450$ ohms

$$J = \frac{\mu_e}{\mu_d} = 1.5.$$

TABLE I

Part of Pulse Affected	Value of Load Res.	Impedance Ratio Defined	Condition for Good Pulse Shape
Front Edge	R_M	$k_1 = \frac{1}{2R_M} \sqrt{\frac{L_s}{C_D}}$	$k_1 \geq 0.5$ for min. t_r with flat-top current pulse
Close Echo	$R_I = \sqrt{R_M R_e}$	$k_2 = \frac{1}{2R_I} \sqrt{\frac{L_N'}{C_D'}}$	$k_2 \geq$ value in Fig. 8 for no close echo
Backswing axis close to pulse	$R_I = \sqrt{R_M R_e}$	$k_3 = \frac{1}{2R_I} \sqrt{\frac{L_e}{C_D'}}$	$k_3 > k_4$ by definition
Distant Echo	R_e	$k_4 = \frac{1}{2R_e} \sqrt{\frac{L_e J}{C_D}}$	$k_4 \geq 1$ for no distant echo

From these values, the following may be calculated: Whence

Using (7),

$$R_I = \sqrt{450 \times 25} = 106 \text{ ohms.}$$

Using (1),

$$\Delta = \frac{4 \times 106 \times 10^{-3}}{5} = 0.085$$

$$C_{D'} = \frac{0.08 \times 6,000 \times 10^{-18}}{0.08 \times 10^{-6} + 6,000 \times 10^{-12}} = 5580 \times 10^{-12}$$

$$L_{N'} = (11.0 + 50) \times 10^{-6} = 61 \times 10^{-6}$$

Using (5),

$$\omega_2 = \sqrt{\frac{10^{18}}{61 \times 5,580}} = 1.71 \times 10^6$$

Whence

$$f_2 = \frac{\omega_2}{2\pi} = 0.274 \times 10^6 \text{ cycles}$$

and

$$t_2 - t_1 = \frac{1}{f_2} = 3.65 \mu \text{ sec.}$$

Impedance ratios are:

$$k_1 = \frac{1}{2 \times 25} \sqrt{\frac{11}{6,000 \times 10^{-6}}} = 0.85$$

$$k_2 = \frac{1}{2 \times 106} \sqrt{\frac{61 \times 10^{-6}}{5,580 \times 10^{-12}}} = 0.45$$

$$k_3 = \frac{1}{2 \times 106} \sqrt{\frac{5.0 \times 10^{-3}}{5,580 \times 10^{-12}}} = 4.0$$

$$k_4 = \frac{1}{2 \times 450} \sqrt{\frac{7.5 \times 10^{-3}}{6,000 \times 10^{-12}}} = 1.24$$

For these values of k_3 and Δ , the minimum k_2 from Fig. 8 needed to eliminate close echoes is 0.36. The ratio k_2 thus provides a margin of 25 per cent. With this margin, close oscillations are small enough to prevent false echoes. Since $k_4 = 1.24$, there is no distant echo.

APPENDIX I

With frequencies as well separated as f_2 and f_3 in Fig. 6, the frequency determinant Δ' yields these frequencies readily if R_e is large and $L_e \gg L_{N'}$,⁴

$$\begin{aligned} \frac{\Delta'}{R_e L_e} &= L_{N'} C_N C_D p^4 + (C_D + C_N) p^2 + \frac{1}{L_e} \\ &= A_4 p^4 + A_2 p^2 + A_0 \end{aligned} \tag{3}$$

⁴ *Ibid.*, p. 260.

$$\begin{aligned} \omega_2, \omega_3 &= \sqrt{\frac{A_2}{2A_4} \pm \sqrt{\frac{A_2^2}{4A_4^2} - \frac{A_0}{A_4}}} \\ &= \sqrt{\frac{A_2}{2A_4}} \sqrt{(1 \pm \sqrt{1 - F})}, \text{ where } F = \frac{4A_0 A_4}{A_2^2} \end{aligned} \tag{4}$$

Term F is very small in practical modulators, so that

$$\omega_2 = 2\pi f_2 \approx \sqrt{\frac{A_2}{A_4}} \approx \sqrt{\frac{C_D + C_N}{L_{N'} C_N C_D}} \tag{5}$$

$$\omega_3 = 2\pi f_3 \approx \sqrt{\frac{A_2 F}{4A_4}} \approx \sqrt{\frac{1}{L_e (C_D + C_N)}} \tag{6}$$

Note that f_2 is determined by C_N and C_D as if they were connected in series. If

$$C_N \gg C_D, \quad \omega_2 \approx \frac{1}{\sqrt{L_{N'} C_D}}$$

so that f_2 is governed by C_D rather than C_N regardless of whether the thyatron is conducting or not.

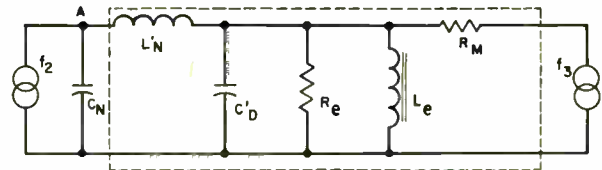

Fig. 9—Equivalent network for close false echoes.

APPENDIX II

The equivalent linear resistance of the load during the part of the backswing immediately following the pulse may be found by use of mixer theory developed by Peterson and Llewellyn.⁵ They assumed that a small high-frequency oscillation was superposed on a large low-frequency oscillation. They replaced the nonlinear network with a linear 4-terminal network having the high-frequency oscillation f_2 applied at one end and the low-frequency oscillation f_3 applied at the other end as in Fig. 9. These are the frequencies at which power is absorbed by the internal circuit. In the present problem these terms comprise only the frequencies of oscillation f_2 and f_3 in Fig. 6, provided the pulse transformer is resistive at both frequencies f_2 and f_3 . This is true when the transformer-leakage inductance and capacitance are negligible at frequency f_2 , a condition commonly encountered, because the time of rise $t_r \ll 1/f_2$. At frequencies f_2 and f_3 the circuit is resistive inasmuch as f_2 and f_3 are the resonant frequencies of the circuit. Actually, the circuit is resistive only for f_3 , but the transformer inductance L_e is usually large enough not to affect f_2 appreciably.

⁵ L. C. Peterson and F. B. Llewellyn, "The performance and measurement of mixers in terms of linear-network theory," *PROC. I.R.E.*, vol. 33, pp. 458-478; July, 1945.

Under these conditions, impedance Z_I looking into the network is

$$Z_I = \sqrt{Z_{oc}Z_{sc}} = \sqrt{R_e R_M}. \quad (7)$$

Equation (7) is rigorously true only for even functions of time, which the backswing, considered separately, is certainly not. Empirically it may be stated that, although (7) is approximate, it is useful in predicting false echoes if a suitable margin is provided in subsequent calculations.

APPENDIX III

It will be assumed here that at time t_1 , Fig. 6, the PFN capacitance suddenly gives up its charge E . This is equivalent to applying a negative pulse E at point A , Fig. 9, which previously was fully charged to voltage E . At any instant thereafter, voltage e across the termination R_I is related to E by

$$\frac{e}{E} = \frac{R_I}{R_I L_N C_D' p + L_N' p + R_I}. \quad (8)$$

Initial conditions are: (a) voltage e across R_I is initially zero and (b) voltage e initially appears across L_N' . Imposing these conditions on (8) and subtracting the previously existent voltage E , we have

$$\frac{e}{E} = \epsilon^{\alpha t_2} \left(\frac{\alpha_2}{\omega_2} \sin \omega_2 t - \cos \omega_2 t \right) \quad (9)$$

where

$$\alpha_2 = -\frac{1}{2C_D' R_I}$$

and

$$\omega_2 = \frac{1}{\sqrt{\frac{1}{L_N' C_D'} - \alpha_2^2}} = \frac{\sqrt{1 - k_2^2}}{\sqrt{L_N' C_D'}}. \quad (10)$$

Putting first derivative of (9) equal to zero,

$$(\alpha_2^2 + \omega_2) \sin \omega_2 t_2 = 0,$$

gives

$$\sin \omega_2 t_2 = 0, \text{ or } \omega_2 t_2 = \pi \text{ for the first negative peak} \\ = 2\pi \text{ for the first positive peak.}$$

Substituting $t_2 = 2\pi/\omega_2$ in (9), we have for the amplitude of the first positive peak

$$\frac{e}{E} = \epsilon^{2\pi\alpha_2/\omega_2} = \epsilon^{-2\pi k_2/\sqrt{1-k_2^2}}. \quad (11)$$

The equation for backswing axis is

$$\frac{e}{E} = \frac{(m_1 + 2\Delta m)\epsilon^{-m_1 t} - (m_2 + 2\Delta m)\epsilon^{-m_2 t}}{m_1 - m_2} \quad (12)$$

where

$$m_1, m_2 = -\frac{1}{2R_I C_D'} \pm \sqrt{\frac{1}{(2R_I C_D')^2} - \frac{1}{L_N C_D'}}$$

and

$$m = \frac{1}{2R_I C_D'}.$$

This may be transformed to

$$\frac{e}{E} = \frac{(a + 2\Delta)}{a - b} \epsilon^{-2\pi a k_3 t/T_d} - \frac{(b + 2\Delta)}{a - b} \epsilon^{-2\pi b k_3 t/T_d} \quad (13)$$

where

$$a = 1 + \sqrt{1 - 1/k_3^2}$$

$$b = 1 - \sqrt{1 - 1/k_3^2}$$

$$T_d = 2\pi\sqrt{L_N C_D'}.$$

Equation (13) is plotted in Fig. 7, with k_3 as parameter, and with the effect of Δ obtained by interpolation. The borderline of close echoes is reached when $t = t_2$ in Fig. 6, so that

$$\frac{k_3 t}{T_d} = \frac{2\pi k_3}{\omega_2} \cdot \frac{1}{2\pi\sqrt{L_N C_D'}} = \frac{k_2}{\sqrt{1 - k_2^2}}.$$

Then if we equate the voltages in (11) and (13) the f_2 oscillation amplitude is just equal to the backswing axis and there is no positive voltage, nor close false echo. This equality follows.

$$\epsilon^{-2\pi k_2/\sqrt{1-k_2^2}} = -\frac{1}{a - b} [(a + 2\Delta)\epsilon^{-2\pi k_2 a/\sqrt{1-k_2^2}} - (b + 2\Delta)\epsilon^{-2\pi k_2 b/\sqrt{1-k_2^2}}]. \quad (14)$$

Equation (14) is plotted in Fig. 8 with k_3 as parameter. For k_3 greater than 6, $a \approx 2$ and $b \approx 0$, and the curve lies very close to that for $k_3 = 6$.

LIST OF SYMBOLS

- A_0, A_2, A_4 = frequency equation coefficients [see (4)]
- $a = 1 + \sqrt{1 - 1/k_3^2}$
- $b = 1 - \sqrt{1 - 1/k_3^2}$
- B_0 = pulse-transformer core induction at end of pulse (gauss)
- B_m = maximum pulse-transformer core induction (gauss)
- C' = despiking capacitance (farads)
- C_D = modulator-circuit capacitance referred to pulse-transformer primary (farads)
- $C_D' = C_D C_N / C_D + C_N$
- C_N = PFN capacitance (farads)
- E = voltage at top of pulse
- e = pulse-transformer primary voltage at any instant
- f_1 = frequency of front-edge oscillations
- f_2 = frequency of close echo oscillations
- f_3 = frequency of distant echo oscillations

$$F = 4A_0A_4/A_2^2$$

$$i_L = F/R_I$$

i_m = exciting current

i_M = exciting current at $t = t_1$

$$j = \sqrt{-1}$$

$$J = \mu_d/\mu_e$$

k_1, k_2, k_3, k_4 = impedance ratios for front edge, close echo, backswing axis, and distant echo respectively

L_e = pulse-transformer open-circuit inductance (henrys)

L_s = pulse-transformer-leakage inductance, referred to primary (henrys)

L_N = total PFN inductance (henrys)

$$L_N' = L_s + L_N$$

$$m = \left\{ \begin{array}{l} \\ \\ \end{array} \right.$$

$m_1 =$ See (12), Appendix III

$$m_2 = \left\{ \begin{array}{l} \\ \\ \end{array} \right.$$

p = differential operator $d(\)/dt$

PFN = pulse-forming network

R' = despiking resistance (ohms)

R_e = pulse-transformer loss resistance, referred to primary (ohms)

R_I = equivalent backswing resistance = $\sqrt{R_e R_M}$ (ohms)

R_M = magnetron resistance referred to primary (ohms)

t = time in seconds

t_0 = start of pulse (see Fig. 6)

t_1 = end of pulse (see Fig. 6)

t_2 = instant at which close oscillation peaks

t_3 = instant at which distant oscillation peaks

t_3 = time of rise of front edge of pulse

T = backswing time constant (general)

T_d = time constant of long-term backswing

Z_I = backswing impedance = R_I effective value

Z_N = characteristic impedance of PFN

$Z_{oc} = Z_I$ with output open-circuited

$Z_{sc} = Z_I$ with output short-circuited

α_2 = damping factor for close echoes

Δ = ratio of $\frac{\text{exciting current}}{\text{load current}}$ at the end of

pulse ($t = t_1$)

Δ' = frequency determinant [see (3)]

$e = 2.718$ = base of natural logarithms

μ_d = permeability during backswing

μ_e = permeability at end of pulse ($t = t_1$, Fig. 6)

$\pi = 3.1416$

τ = pulse width in seconds

ω_2 = angular frequency of close echoes

ω_3 = angular frequency of distant echoes

ACKNOWLEDGMENT

The writer wishes to acknowledge the valuable assistance of Messrs. R. N. Riley and E. E. Newhall in doing the experimental and computational work upon which the conclusions of this paper were based.

Frequency Stable LC Oscillators*

J. K. CLAPP†, FELLOW, IRE

Summary—A simple theory of the conditions for oscillation, and of the frequency stability of inductance-capacitance oscillators is evolved from a survey of a number of papers on this subject. As some of these papers appeared in publications which are not readily accessible, some of the material may be new to workers in the United States. The condition for oscillation is shown to depend only upon the mutual conductance of the tube and the impedances, tapped on the tuned circuit, presented to the grid and plate circuits of the tube. For linear operation, the stability depends only on the Q of the controlling circuit, and the ratio of the change of interelectrode capacitance to mutual conductance of the tube, and is independent of the LC ratio. For nonlinear operation, however, the stability depends upon the factors given above and on the LC ratio, being improved when a high LC ratio is used. The best tube for high stability is shown to be the tube having the lowest ratio of interelectrode capacitance change to mutual conductance. For highest possible stability, very low level operation with some form of automatic level control is required. A brief historical chronology is included.

* Decimal classification: R355.911.4. Original manuscript received by the IRE, February 11, 1954.

† General Radio Co., Cambridge, Mass.

THIS DISCUSSION will be limited to that class of oscillator circuits in which the input and output circuits of the tube are connected across portions of the tuned circuit.

It can be shown^{1,2} that the condition for oscillation is given by:

$$1/g_m = \sqrt{Z_1' Z_2'} \quad (1)$$

where Z_1' is the impedance presented by the tapped portion of the tuned circuit to the grid circuit of the tube, and Z_2' is the impedance presented by the tapped portion of the tuned circuit to the plate circuit of the tube. The internal impedances Z_1 and Z_2 , of the input

¹ Jiri Vackar, "LC oscillators and their frequency stability," pp. 1-9, *Telsa Tech. Reports*, Czechoslovakia; December, 1949.

² J. K. Clapp, "An inductance-capacitance oscillator of unusual frequency stability," *Proc. I.R.E.*, vol. 36, pp. 356-358; March, 1948; Discussion, W. A. Roberts, *Proc. I.R.E.*, vol. 36, pp. 1261-1262; October, 1948.

and output circuits of the tube are assumed to be large by comparison to the tapped impedances Z_1' and Z_2' , which is generally the case in practice.

The effect of a change ΔC_1 in the input capacitance of the tube, connected across the tapped impedance Z_1' of the tuned circuit, causes a detuning equivalent to a change ΔC_0 in the tuned circuit capacitance C_0 , such that:

$$\Delta C_0/\Delta C_1 = Z_1'/R_0 \quad (2)$$

where R_0 is the parallel-resonant impedance of the tuned circuit.

If the tuned-circuit capacitance is C_0 , a change of ΔC_0 in this capacitance causes a fractional frequency change of

$$\Delta f/f = \Delta C_0/2C_0. \quad (3)$$

Substituting from (2) we have:

$$\Delta f/f = (Z_1'/2R_0)(\Delta C_1/C_0). \quad (4)$$

The larger the impedance Z_1' , the larger the frequency change. Similar considerations apply for changes in tube-output capacitance, ΔC_2 , and impedance Z_2' . For equal changes in *either* grid or plate capacitance, the minimum frequency change, when $Z_1'Z_2'$ is given by (1), occurs when $Z_1' = Z_2' = 1/g_m$ and, since $R_0 = Q/\omega C_0$, is

$$\begin{aligned} \Delta f/f &= (1/2R_0C_0)(\Delta C_1/g_m) = (\omega/2Q)(\Delta C_1/g_m) \\ &= 2\pi(f/2Q)(\Delta C_1/g_m) = \{1/2(L/R)\}(\Delta C_1/g_m). \end{aligned} \quad (5)$$

This condition makes the grid and plate voltages equal, and the tube consequently operates at low efficiency, which is not of prime importance for oscillators where frequency stability is the principal consideration.

In practice, however, it is frequently found that changes in plate-circuit capacitance of the tube are appreciably less than changes in the grid-circuit capacitance. Under such conditions, improved frequency stability and better efficiency can be obtained by not making $Z_1' = Z_2'$.

We can write the total frequency change, caused by changes in *both* grid and plate capacitances as:

$$\Delta f/f = (1/2R_0C_0)(Z_1'\Delta C_1 + Z_2'\Delta C_2). \quad (6)$$

Let $\Delta C_2 = \Delta C_1/k$, then

$$\Delta f/f = (1/2R_0C_0)(Z_1'\Delta C_1 + Z_2'\Delta C_1/k). \quad (7)$$

Remembering that the condition for oscillation requires the product of $Z_1'Z_2'$ to remain constant, divide Z_1' by a factor, m , and multiply Z_2' by the same factor.

Then

$$\Delta f/f = (1/2R_0C_0)\{(Z_1'/m)\Delta C_1 + mZ_2'(\Delta C_1/k)\} \quad (8)$$

which will be a minimum when the two terms in the right-hand brackets are equal. The original condition called for $Z_1' = Z_2' = 1/g_m$.

So we have

$$1/m = m/k, \quad (9)$$

from which

$$m = \sqrt{k} \quad (10)$$

and

$$\Delta f/f = (1/2R_0C_0)(\Delta C_1/g_m)(1/\sqrt{k} + 1/\sqrt{k}) \quad (11)$$

for the minimum value.³ In effect this makes equal the contributions of the grid and plate-circuit capacitances to the total frequency change.

Since $R_0 = Q/\omega C_0$ we can write (11) as

$$\begin{aligned} \Delta f/f &= (\omega/2Q)(\Delta C_1/g_m)(2/\sqrt{k}) \\ &= 2\pi(f/2Q)(\Delta C_1/g_m)(2/\sqrt{k}) \\ &= \{1/2(L/R)\}(\Delta C_1/g_m)(2/\sqrt{k}) \end{aligned} \quad (12)$$

when $\Delta C_2 = \Delta C_1/k$.

Equation (12) is instructive since it gives the value of the frequency coefficient immediately, when the quality of the controlling circuit and the $\Delta C_1/g_m$ ratio of the tube are known. If ΔC_1 were independent of g_m , that tube having the greatest g_m would give the best frequency stability, and this conclusion has been reached by several writers. In practice, however, the tubes having the larger values of mutual conductance have also the larger values of C_1 and larger values of ΔC_1 . The choice of a tube having very small tube capacitances, and small capacitance changes, associated with a moderate value of g_m will frequently result in a substantially lower $\Delta C_1/g_m$ ratio and better frequency stability. This is particularly true of secondary changes in tube capacitances such as those caused by changes in heater temperature, for example. Equation (12) also indicates that the frequency coefficient is independent of the LC_0 ratio of the tuned circuit, which is true as long as the assumption of linear operation is valid,—a conclusion reached by several writers. However, with non-linear operation, the frequency coefficient is not independent of the LC ratio, as will be shown later. Equation (12) also states that the stability depends only on the quality of the tuned circuit, and, for a given value of ΔC_1 , on the g_m of the tube. This latter term expresses, in effect, the minimum degree of coupling which can exist between the driving circuit and the controlling circuit.

A comparison of a few of a number of circuits which have been developed for frequency stable oscillators is of interest. The circuit, independently developed by Gouriet⁴ and Clapp,² is probably the simplest and is shown schematically in Fig. 1.

For the impedance presented to the grid circuit of the tube, we have

$$Z_1' = R_0C_v'^2/(C_v' + C_1)^2 \text{ where } C_v' = C_v/(1 + C_v/C_2) \quad (13)$$

³ With $\Delta C_2 = \Delta C_1/10$ and the original condition that $Z_1' = Z_2'$, $\Delta f/f = (\Delta C_1/2R_0C_0g_m)(1.1)$ from (5). Using (11), $\Delta f/f = (\Delta C_1/2R_0C_0g_m)(0.632)$, a change which is only about one-half as large.

⁴ G. G. Gouriet, "High stability oscillator," *Wireless Engineer*, pp. 105-112; April, 1950.

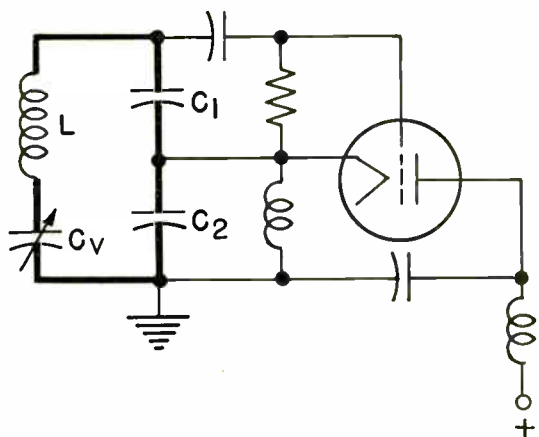

Fig. 1—Gouriet-Clapp.

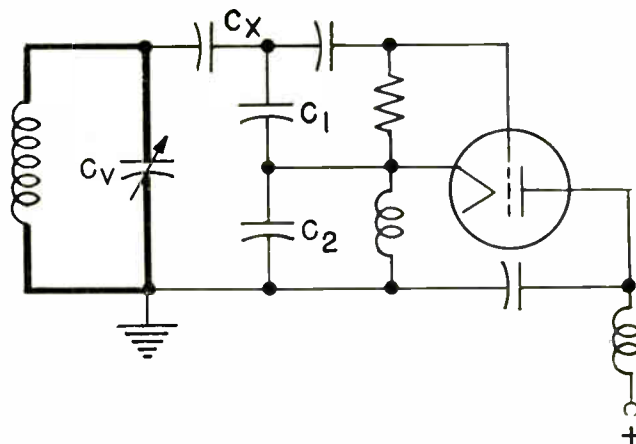

Fig. 2—Seiler.

and, since $C_2 \gg C_v$ and $C_1 \gg C_v$

$$Z_1' = R_0 C_v^2 / (C_v + C_1)^2 \cong R_0 (C_v / C_1)^2 \tag{14}$$

From similar considerations,

$$Z_2' \cong R_0 (C_v / C_2)^2 \tag{15}$$

and, for $C_1 = C_2 = C$

$$\sqrt{Z_1' Z_2'} = 1/g_m = R_0 (C_v / C)^2 \tag{16}$$

whence

$$g_m = (1/R_0) (C/C_v)^2 = \omega C^2 / Q C_v \tag{17}$$

We can obtain a qualitative indication of the change of amplitude with tuning as follows:

$$\omega^2 \cong 1/LC_v \text{ from which } C_v \propto k/\omega^2 \tag{18}$$

So

$$g_m \propto \omega C^2 / (Qk/\omega^2) \propto k\omega^3 / Q \tag{19}$$

This states that, assuming constant Q , the required value of g_m to maintain oscillation increases as the cube of the tuning frequency. In practice this means that as the circuit is tuned to higher frequencies, the amplitude of oscillation will fall and finally the circuit stops oscillating. Even if Q rises somewhat with frequency, as is often true, the falling off in amplitude is still very pronounced.

This oscillator is simple and is useful over a range of about 1.2:1 in frequency, where stability is important.⁵

A parallel counterpart of the Gouriet-Clapp oscillator was described by Seiler.⁶ The circuit is given schematically in Fig. 2.

For the impedance presented to the grid circuit

$$Z_1' = R_0 X_1^2 / (X_1 + X_z)^2 \cong R_0 C_z^2 / (C_1 + C_z)^2 \cong R_0 (C_z / C_1)^2 \tag{20}$$

with similar considerations for Z_2' .

Then

$$1/g_m = \sqrt{Z_1' Z_2'} = R_0 (C_z / C)^2 \tag{21}$$

$$g_m = (1/R_0) (C/C_z)^2 = (\omega C_v / Q) (C/C_z)^2 \tag{22}$$

Now

$$C_v \propto k/\omega^2 \tag{23}$$

So

$$g_m \propto k/\omega Q \tag{24}$$

With this circuit, assuming constant Q , the g_m required for oscillation is proportional to $1/\omega$, so that as the tuning is changed toward higher frequencies, the amplitude rises. This would be increased, if, as is often true, Q increases with frequency. This oscillator is useful over frequency ranges of about 1.8:1.

The inductive counterpart of Seiler's circuit, described by Lampkin,⁷ operates in the same manner. The tube is connected to points tapped on the inductive branch of the tuned circuit. The circuit shows a rather strong tendency to break into spurious oscillation, because of the inductive reactances across the tube input and output circuits.

Vackar¹ describes a circuit combining the features of the series and parallel arrangements and it is shown schematically in Fig. 3, on the following page.

⁵ In the author's paper² describing this circuit, the condition for oscillation was expressed in terms of the *series* impedance of the tuned circuit as:

$$g_m X_1 X_2 + X_1^2 / r_g + X_2^2 / r_p = R_s \tag{a}$$

which, for practical cases, reduces to:

$$g_m X_1 X_2 = R_0 \tag{b}$$

now express R_s in terms of the *parallel* resonant impedance, R_0 , of the tuned circuit, by writing X_0^2 / R_0 for R_s :

$$g_m X_1 X_2 = X_0^2 / R_0 \tag{c}$$

or

$$1/g_m = R_0 (X_1 X_2 / X_0^2) = \sqrt{R_0^2 (X_1 / X_0)^2 (X_2 / X_0)^2} = \sqrt{Z_1' Z_2'} \tag{d}$$

and, if $X_1 = X_2 = X$

$$1/g_m = R_0 (C_0 / C)^2 \cong R_0 (C_v / C)^2 \tag{e}$$

⁶ E. O. Seiler, "A variable frequency oscillator," *QST*, pp. 26-27; November, 1941.

⁷ G. F. Lampkin, "An improvement in constant frequency oscillators," *PROC. I.R.E.*, vol. 27, pp. 199-201; March, 1939.

Here

$$C_v' = C_v + C_x C_1 / (C_x + C_1) \tag{25}$$

$$\cong C_v \text{ when } C_1 \gg C_x \text{ and } C_v \gg C_x \tag{26}$$

$$Z_1' = R_0 \{ C_2^2 / (C_v' + C_2)^2 \} \{ C_x^2 / (C_x + C_1)^2 \} \\ \cong R_0 (C_x / C_1)^2 \tag{27}$$

$$Z_2' = R_0 C_v'^2 / (C_v' + C_2)^2 \cong R_0 (C_v / C_2)^2. \tag{28}$$

Then

$$g_m = (1/R_0)(C_2/C_v)(C_1/C_x) \\ = (\omega C_v / Q)(C_2/C_v)(C_1/C_x) \\ = (\omega / Q)(C_1 C_2 / C_x). \tag{29}$$

If Q is constant, the g_m required to maintain oscillation rises with the frequency, so the amplitude would slowly fall.

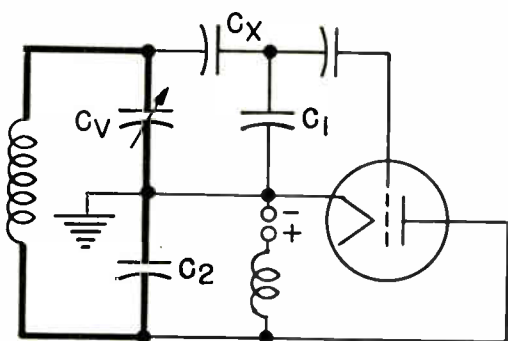

Fig. 3—Vackar.

If Q increases with frequency, however, the amplitude tends to remain reasonably constant. This circuit is useful over frequency ranges as great as 2.5:1.

Vackar,¹ Gouriet⁴ and Edson⁸ point out that under the condition of linear operation the stability is independent of the LC_v ratio. If this ratio is made zero, the "series-tuned" oscillator, of Fig. 1, becomes simply a Colpitts oscillator. To realize the correct impedance values to be presented to the tube, in order to maintain the frequency stability, the circuit reactances of a simple Colpitts oscillator become impracticably small.^{4,8}

There is an important cause for frequency instability, which is wholly neglected in the linear theory, and that is the effect of harmonic components due to the distortion caused by the tube. Llewellyn⁹ has shown that, by intermodulation, the harmonic components can cause a phase shift at the fundamental frequency. This phase shift can be considered as an equivalent modification of the generator impedance.⁴ This modification can be accounted for as a change in the generator capacitance, C_g , since the real part of the generator impedance must equal the loss resistance of the tuned circuit, which has been assumed to be constant.

⁸ W. A. Edson, "Vacuum Tube Oscillators," John Wiley and Sons, Inc., New York, N. Y., pp. 170-172; 1953.

⁹ F. W. Llewellyn, "Constant frequency oscillators," Proc. I.R.E., vol. 19, pp. 2063-2094; December, 1931.

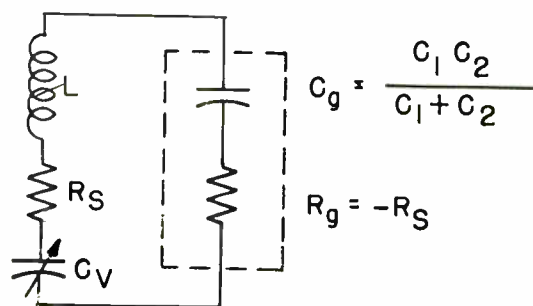

Fig. 4

For the discussion of the effect of distortion, it is convenient to reduce the schematic of Fig. 1, to the equivalent of Fig. 4. The change in frequency, resulting from a change in generator capacitance, C_g , is found as follows:

The generator phase angle is

$$\phi = \tan^{-1} 1 / \omega C_g R_g \tag{30}$$

$$\frac{dC_g}{d\phi} = -(\omega^2 R_g^2 C_g^2 + 1)(1 / \omega R_g) \\ = -(1 / \omega R_g + \omega R_g C_g^2) \\ = 1 / \omega R_g + \omega R_g C_g^2 \text{ since } R_g = -R_s. \tag{31}$$

The frequency is

$$f = 1 / 2\pi \sqrt{LC_v C_g / (C_v + C_g)} \\ = f_0 \sqrt{1 + C_v / C_g} \text{ where } f_0 = 1 / 2\pi \sqrt{LC_v} \tag{32}$$

and the change in frequency, with change of C_g is

$$\frac{df}{dC_g} = - (f_0 / 2\sqrt{1 + C_v / C_g}) (C_v / C_g^2) \\ = - (f_0 / 2) (C_v / C_g)^2 \text{ since } C_g \gg C_v. \tag{33}$$

From the condition for oscillation, when $C_1 = C_2 = 2C_g$

$$\omega^2 C_g^2 = g_m / 4R_s \tag{34}$$

and

$$C_g^2 = g_m / 4\omega^2 R_s. \tag{35}$$

Then

$$\frac{dC_g}{d\phi} = 1 / \omega R_s + g_m / 4\omega. \tag{36}$$

Substitute $1 / \omega C_v Q$ for R_s in (35) obtaining

$$C_g^2 = g_m C_v Q / 4\omega \tag{37}$$

from which

$$C_v / C_g^2 = 4\omega / g_m Q. \tag{38}$$

Substitute in the expression (33) obtaining:

$$\frac{df}{dC_g} = - f_0 C_v / 2C_g^2 = - 4\pi f_0^2 / g_m Q. \tag{39}$$

Then

$$\frac{df}{d\phi} = \frac{df}{dC_u} \cdot \frac{dC_u}{d\phi} = - (4\pi f_0^2 / g_m Q) (1/\omega R_s + \omega R_u C_u^2) = - (f/2Q + 1/\pi g_m L), \quad (40)$$

since

$$Q = \omega L / R_s.$$

The first term is the differential coefficient of frequency with respect to phase of the tuned circuit at resonance. The second term is very much larger than the first, and indicates that increasing L will reduce its effect. In other words, when distortion is present, a circuit of high LC_v ratio is desirable for best stability, whereas in the linear case the stability is independent of the LC_v ratio.

The effect of a small quadrature current flowing through the generator impedance could produce a relatively large frequency change, which would be quite sensitive to changes in plate supply voltage, for example. Such a quadrature current might be caused by unintentional feedback from a subsequent amplifier stage. The use of a high LC_v ratio in the tuned circuit can reduce the frequency change caused by phase change by 100 or more times over the change experienced in a simple Colpitts oscillator.

All of the above brings out the fact that careful connection of output amplifiers is necessary, and that the tube must be operated in as nearly a linear manner as possible. Taking the output across a low resistance in the plate circuit and using some form of automatic level control are proper steps.

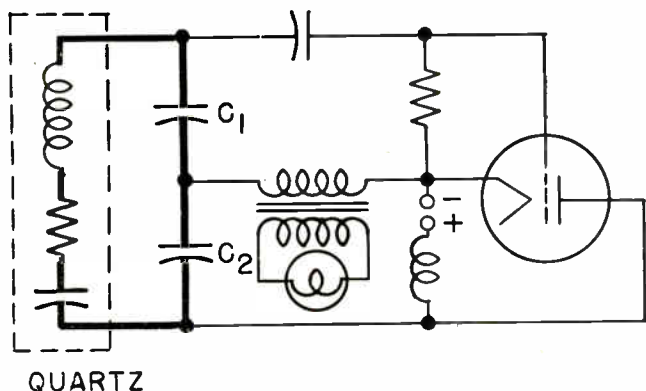

Fig. 5—Hansen.

The "series-tuned" circuit stems from the crystal oscillator which we have used for several years. The shunt capacitors assume lower values than in LC circuits because of the extremely small series capacitance of the quartz vibrator. The resistance of the quartz vibrator is also much higher than that of an LC -tuned circuit.

Hansen¹⁰ describes a crystal oscillator of this type with a lamp in the cathode lead to provide automatic control of amplitude, Fig. 5. To adjust the effective

¹⁰ H. N. Hansen, "A crystal oscillator for carrier supply," *Philips Tele. News*, vol. X, pp. 1-15; January, 1949.

value of feedback resistance to the desired value, the lamp is coupled through a transformer.

Analysis of the circuit, with feedback, results in equations identical with those obtained with no feedback except that g_m is replaced by g_m' , the reduced value of g_m caused by feedback. If a lamp is used for the feedback resistor, the effective resistance becomes a function of ac-plate current, so that an increase in level is offset by a reduction of g_m' . This control is obtained without change of bias.

Enhanced control could be obtained by amplifying the oscillator output, rectifying it and applying the rectified current to the lamp.

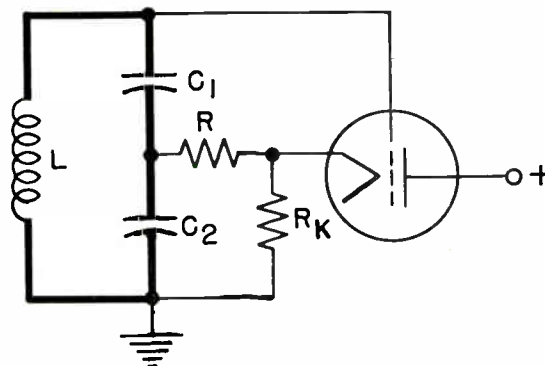

Fig. 6—Harris.

A circuit somewhat similar to the above feedback circuit has been described by Harris¹¹ as a "Q multiplier" circuit, Fig. 6. In this circuit, a cathode follower amplifier is connected through a high resistance to a tap on a tuned circuit, the high impedance point of which is returned to the grid. If the drop in output voltage to the tap on the tuned circuit is offset by the voltage stepup of the tuned circuit, the circuit will oscillate. If the gain of the completely degenerated amplifier approximates unity, then the value of series resistance is $R_0/4$ for oscillation, if the tuned circuit is tapped halfway up. In this oscillator, the output circuit is almost completely isolated from the tube output circuit; the tube input circuit is placed across the entire tuned circuit. Since changes in tube input capacitance are reduced by feedback, this circuit has possibilities as a stable oscillator, particularly for low frequencies.

HISTORICAL CHRONOLOGY

The criterion for oscillation, $1/g_m = \sqrt{Z_1'Z_2'}$, means that the highest stability, with respect to changes of the internal capacitances of the tube, can be achieved by connecting the grid and plate circuits to points on the tuned circuit of as low impedance as possible and still maintain oscillation.

This criterion, expressed in slightly different ways, was discovered by a number of authors (as mentioned in this paper) and was realized in various forms of circuits.

¹¹ H. E. Harris, "A simplified Q multiplier," *Electronics*, pp. 130-134; May, 1951.

The oscillator developed by Gouriet, which it is stated, has been used in the B. B. C. since 1938,⁴ was not described in the technical press until 1947 and then in a book, "Radio Engineering" by E. K. Sandeman. The circuit was independently developed by Clapp in 1946 (described in the PROCEEDINGS OF THE I.R.E., 1948).² The circuits developed by Seiler (*QST*, 1941)⁶ and Lampkin (PROCEEDINGS OF THE I.R.E., 1939)⁷ follow the same criterion, but were not described clearly on the

impedance concept.

During the war development of stable oscillators in Czechoslovakia was carried out independently and without exchange of technical information with the West. The circuit of Fig. 3 of this paper was developed by *Radioslavia* in 1945, but publication did not occur until 1949.¹ Meanwhile, the same circuit was developed independently by O. Landini in Italy and was described in *Radio Rivista*, 1948.

Precision Quartz Resonator Frequency Standards*

J. M. SHAULL†, SENIOR MEMBER, IRE, AND J. H. SHOAF†, MEMBER, IRE

Summary—High-precision quartz crystal resonators were recently added as a part of the primary standard of frequency at the National Bureau of Standards. Their reliability over short and long periods of time resulted in establishment of a frequency and time reference system constant to 1 part in 10^{10} per day. Measurement equipment and methods, are described in detail. The equivalent circuit for the crystal unit is discussed and the effects of external influences such as stray capacitance, electric and magnetic fields, connecting cables, ambient temperatures, and amplitude of vibration are considered. An assessment method is discussed. This method is based on the fitting of a natural aging or drift curve for each resonator to an observed curve after sufficient performance data are obtained. The use of resonators with crystal clocks represents one of the simplest and most reliable and economical methods of establishing a precise frequency reference in terms of mean solar time and of noting deviations in the earth's rate of rotation.

INTRODUCTION

HIGH-PRECISION quartz crystal resonators were added in 1951 as a part of the primary standard of frequency at the National Bureau of Standards. Their reliability over short and long periods of time has resulted in improved performance evaluation of the primary oscillators. It is now possible to determine day-to-day changes in standard oscillators, and in the frequencies as transmitted from WWV, with a precision of 1 part in 10^{10} . New developments in research, electronic guidance, control and communication systems indicate a need for a precision and constancy of this order.

As early as 1946 detailed bridge measurements were made on a number of 100-kc GT quartz crystal units to determine their suitability for use in new frequency standards. Bridge measurements on crystal units as

resonators enable one to determine such characteristics as temperature coefficient, Q , daily drift, relative stability and susceptibility to vibration. Other important factors readily studied are variation of frequency and series resistance with changes in driving current.

Development of Precision Resonators

Precision crystal units with higher Q values were becoming available, enabling more sensitive comparisons with the primary standard of frequency. Improved GT quartz crystal units were designed and built at the Bell Telephone Laboratories.¹ During development about 40 crystal units were tested at the National Bureau of Standards with the objectives of obtaining reduced initial aging or drifting in frequency, higher operating Q , lower temperature-frequency coefficient and a more linear frequency-amplitude characteristic in the operating range.

Design considerations centered around two principal types, one being generally similar to those used in Loran oscillators but using improved techniques and evaporated gold electrodes. A few of another type were made, similar to the above, but approximately three times as thick. Such an increase in thickness gives a much larger ratio of volume to area and thus was expected to show smaller effects from surface changes with age. Although somewhat higher Q (as high as 4 million at room temperature) was obtained with the thicker plates, aging was not significantly improved over that obtained with the thin crystals and susceptibility to mechanical shock was greater. The values in Table I Column one, opposite, are typical for the better units of each type.

* Decimal classification: R214.2. Original manuscript received by the IRE, January 5, 1954; revised manuscript received, April 21, 1954.

† National Bureau of Standards, Washington, D. C.

¹ J. P. Griffin, "High stability 100-kc crystal units for frequency standards," *Bell Labs. Record*, vol. 30, pp. 433-438; Nov., 1952.

TABLE I

GT Type	Equivalent L , henries	Equivalent Series R	Static C $\mu\mu f$	Q (mil- lion)	Frequency drift, parts per 10^9 /day		
					Initial	After 1 yr.	After 3 yrs.
Earlier types	17.2	40	58	0.27	20	2.9	1.2
New Thin	23.4	6.4	40	2.3	3.5	0.70	0.15
New Thick	60.7	11	18	3.5	3.4	0.40	0.10

Advantages of Resonators

In an oscillator the resulting frequency stability is influenced by the variations of a number of circuit components, tube aging, power-supply fluctuations, and load variations, in addition to changes in the crystal unit itself. Crystal resonators as measured in a balanced bridge network of low impedance are essentially free of all these difficulties and are not subject to interruptions caused by tube and component failures. They can be measured at very low driving currents where frequency is independent of amplitude. The resonator is an auxiliary standard; its use requires a precision-adjustable oscillator and one or more unadjusted oscillators to serve as a frequency reference and continuous source of standard frequency. However, temporary failures in the auxiliary equipment cause no discrepancies in the resonator-reference frequency.

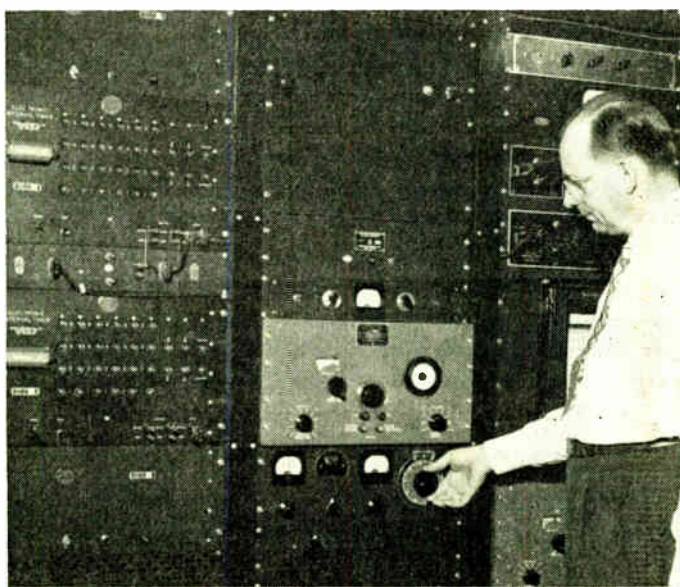

Fig. 1—Resonator frequency standards and associated measurement equipment.

DESCRIPTION OF EQUIPMENT

The resonator frequency standards as shown in Fig. 1 include the following: (1) temperature control chamber for resonator crystals, near bottom of right rack (with a similar chamber for experimental tests in left rack), (2) special low-impedance bridge, (3) precision adjustable oscillator located above the bridge, (4) high-gain, narrow-band receiver, (5) frequency multipliers and

converter, (6) dual electronic frequency counters, in top of left rack.

Temperature Control

The temperature control compartment containing eight resonator crystals is made up of five concentric cubical aluminum boxes with an outer plywood enclosure. Several layers of heavy wool felt are used between alternate walls with mat type heaters and mercury column thermostats on intermediate walls. The thermostats control the operation of the heaters through sensitive relays having mercury-wetted contacts. After more than two years of continuous operation, daily observations of the inner compartment thermometer showed less than 0.01 degree C. variation over the entire period. Maximum daily changes computed from known temperature coefficients of the crystals, were less than 0.001 degree C. A similar outer compartment as used on several new standard oscillators gave an ambient temperature reduction factor of better than 200 to 1. The inner temperature stability obtainable is limited primarily by the functional precision of the inner thermostat rather than by the product of the outer and inner oven reduction factors. The eight crystals in the compartment have temperature-frequency coefficients ranging between ± 20 and 200 parts in 10^9 per degree at the operating point of 41.25 degrees C.

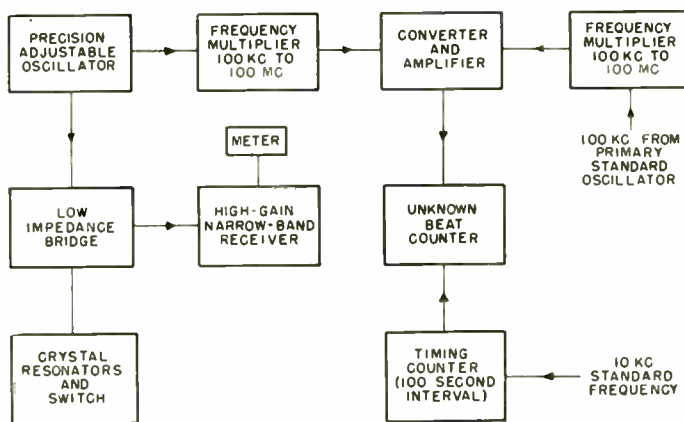

Fig. 2—Block diagram of resonator measuring equipment.

Crystal Measuring Equipment

A block diagram of the resonator measuring equipment is shown in Fig. 2. A 100-kc oscillator, adjustable over a range of approximately ± 1 cycle and with a resetability and 100-second constancy of about 1 part in 10^{10} , is used to drive a special Wheatstone bridge with a resonator crystal connected as one of the bridge arms. In making a measurement the oscillator is adjusted to the series resonant frequency of the crystal and the variable resistive arm is adjusted to equal the equivalent series resistance of the crystal.

A specially constructed narrow-band receiver is used as a balance detector. A balanced input transformer

matches the output impedance of the bridge to a three-stage tuned amplifier operating at 100-kc. For large signals, as the bridge is being balanced, the grid of the third stage develops an avc voltage which is applied to the other two grids, thus giving a logarithmic response. A 101-kc output from a crystal oscillator in the receiver is applied with the signal to one pair of diodes of a IN71 germanium quad rectifier to obtain an IF frequency of 1-kc. A two-stage tuned IF amplifier supplies the 1-kc signal to the other pair of rectifiers to operate the dc indicating meter. Half-scale deflection is obtained with an input of less than one-tenth of a microvolt. The half-power bandwidth of the receiver is approximately 30 cycles.

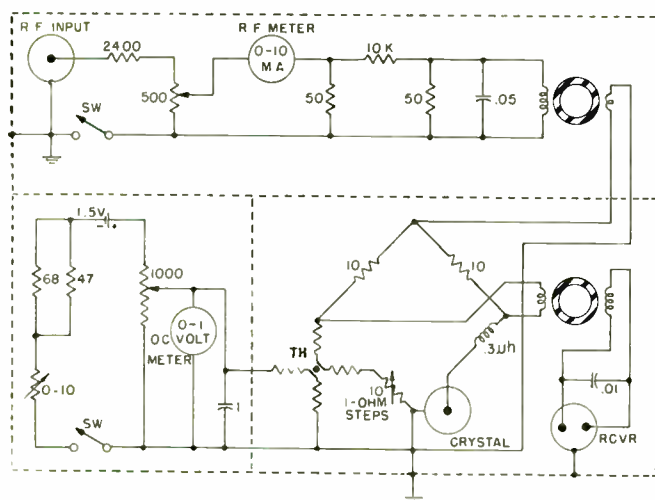

Fig. 3—Circuit of low-impedance crystal bridge.

A circuit schematic of the bridge is shown in Fig. 3. The rf input is connected through an adjustable attenuator and meter to permit setting the bridge input to give a crystal current of approximately 10 microamperes. Impedance matching transformers with low capacitive coupling between windings are used to couple into and out of the bridge network. The fixed bridge arms are 10-ohm matched resistors of low inductance. An inductance compensated 10-ohm resistor with 1-ohm steps is used in the arm adjacent to the crystal in series with a special indirectly-heated, evacuated tungsten thermistor. By means of the decade resistor and the thermistor, resistance values between 4 and 18 ohms can be set within 0.001 ohm. The 0.3 μ h rf choke in series with the crystal arm is used to compensate for the small amount of inductance in the decade resistor. Stray reactances in the bridge networks and coupling circuits were kept to a minimum and careful attention was given to shielding and grounding.

Other methods of measuring crystal resonators which require an adjustment of drive frequency only have been considered. These methods are much more readily adapted to automatic measuring systems, but may require considerable development to gain the precision and reliability of the bridge method currently used for

manual measurements. The use of a crystal phase discriminator followed by a high gain amplifier and indicator or servo device showed promise. Another scheme, given preliminary tests, slowly swept the drive oscillator through the resonator frequency and automatically disconnected it as resonance was passed. The exponentially decaying resonator output was amplified and limited, multiplied to 1,000 mc and measured by electronic counters. With the high Q crystals a 10-second count was readily obtained. Results were not consistent, nor of desired precision, perhaps because of stray coupling and phase shifts in the amplifier and limiter stages as extremely high gain is required.

Frequency Comparison Equipment

In making crystal measurements it is necessary to compare the adjustable driving oscillator to a high degree of precision with one of the oscillators associated with the primary standard of frequency. This is done by multiplying both the adjustable and standard oscillator frequencies to 100 mc and obtaining the beat or difference frequency from a converter. Frequency multiplication is accomplished by Class C harmonic amplifiers and filters in steps of 2 and 5 in each of three decade stages. The difference frequency is counted for precisely 100 seconds and directly displayed in parts in 10^{10} on the top electronic counter shown in the left rack of Fig. 1. The bottom counter simultaneously counts a standard frequency of 10 kc to determine the counting interval by stopping both units after it has registered a total of 1 million pulses.

MEASUREMENTS

The equipment described has been in daily use for over two years in measuring eight selected crystal units as a part of the primary standard of frequency and in making periodic special tests on experimental units. A similar bridge with plug-in resistance units and an external calibrated attenuator were used in conjunction with the above equipment to make tests of frequency and resistance variation with changes in amplitude of driving current. Commercial bridges and receivers were also used in the earlier 100-kc measurements and at other frequencies, especially 5 mc, with a precision of about 1 part in 10^9 .

Equivalent Circuit of a Crystal Unit

The equivalent circuit of a quartz-crystal unit near a major mode of vibration is shown in the inset in Fig. 4. L_1 , C_1 , and R_1 are the equivalent of the motional impedances in the crystal and C_0 is the static capacitance of the electrodes and the holder. In use an external capacitance also is combined with C_0 resulting from terminals and leads and it is this over-all equivalent network that is effective in a given application. In the bridge measurements, near series resonance, the frequency sensitivity for a given bridge and detector combination is a function of the crystal reactance change with fre-

quency, as shown by the following equation:

$$\frac{df}{f} \approx \frac{dx}{2QR}$$

For the crystals used, having a Q of about 2 million, successive measurements have shown that a frequency sensitivity of better than 1 part in 10^{10} is readily obtained.

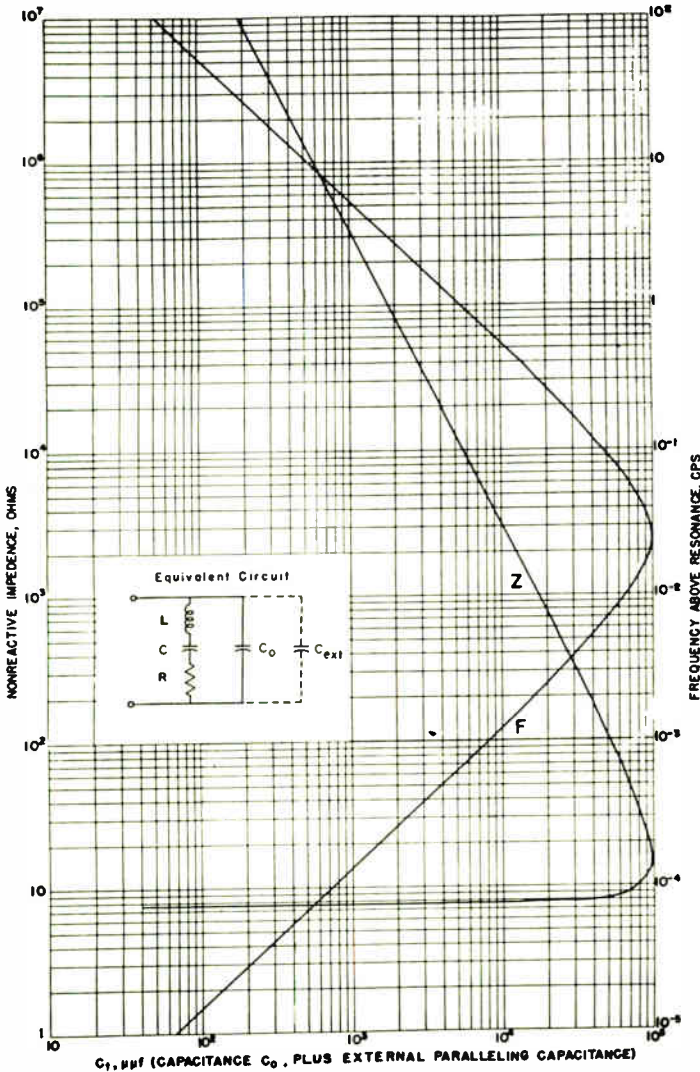

Fig. 4—Crystal frequency and impedance curves.

Experimental Measurements

Frequency and resistance variation versus amplitude of vibration (crystal current) tests were made on each of the crystal units and proved to be one of the most useful methods of determining relative performance. Generally three successive amplitude curves were obtained; on some units reproducibility was excellent while on others deviations, particularly in the first run, were noted. Sudden breaks in the frequency curve were generally associated with corresponding resistance changes. On these units difficulty in balancing the bridge was frequently noted and day-to-day constancy was inferior to

those exhibiting stable characteristics. Amplitude curves for three crystal units are shown in Fig. 5. Some crystals had even greater irregularities than shown in Fig. 5 (solid curve) which were attributed to other coupled modes of vibration or mechanical imperfections.

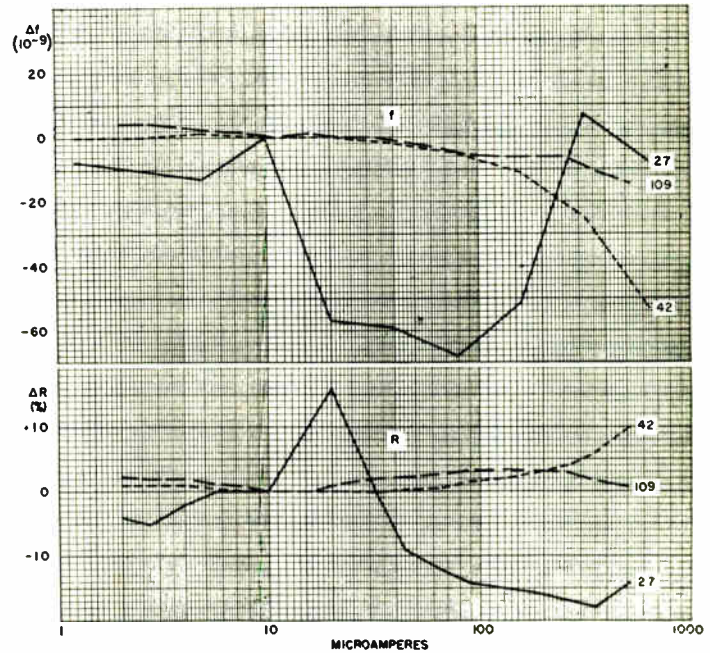

Fig. 5—Frequency and resistance variation versus crystal current for three GT crystal units.

Frequency-temperature coefficients for GT-cut crystals are generally low over a wide temperature range. Precise coefficients near 40 degrees were readily obtained by shutting off the inner resonator oven control; most units ranged between 0 and 200 parts in 10^9 per degree C. Variation of resistance over a wide temperature range for a number of crystals was found to be between 0.5 and 1.5 per cent per degree C. For instance, units operated at dry ice temperature (-78 degrees C.) had resistances approximately one-half as large (twice the Q) as when operated at room temperature. There is some evidence that the daily frequency drift rate is less at the lower temperatures.

As it is necessary to have external capacitance across the crystal in any useful application, this effect was investigated using bridge measurements. Fig. 4 shows frequency and impedance changes versus paralleling external capacitance observed for one of the resonators. A large amount of useful information is shown on this graph; for example, the portions of the curves below the knees apply to series resonance while the top portions apply to anti-resonance. At the turning point, resonant and anti-resonant frequencies coincide with a single nonreactive impedance. At this point the capacitive reactance of $(C_{ext} + C_0)$ and the nonreactive terminal impedance are both equal to twice the equivalent series resistance of the crystal at series resonance. With additional capacitance a nonreactive impedance cannot be

obtained. Considerable capacitance can be added across a high Q crystal unit without appreciably changing the series resonant frequency.

The effect due to a mismatched connecting coaxial cable, however, is more pronounced. For example, with a 7.5-ohm crystal having a Q of 2 million connected to the bridge with a 50-ohm coaxial cable, where the line loss is small compared to the crystal resistance, the frequency is lowered about 2 parts in 10^9 per foot.

A dc polarizing voltage, applied through a 1-megohm resistor and varied over a maximum range of ± 900 volts, showed a frequency variation of very nearly 1 part in 10^8 per volt.

A static magnetic field of 2,000 gauss, applied to an electrostatically shielded crystal unit, changed the frequency less than 5 parts in 10^8 .

Other effects noted on the crystal units with unshielded glass envelopes, especially when wrapped with nonmetallic insulating material, were a reduction of as much as 30 per cent in Q and frequency changes as great as $+1$ part in 10^6 . Later units were therefore provided with a metal covering to eliminate this difficulty. It was found that changes in the physical orientation of the crystal caused the resonant frequency to vary by as much as 1 part in 10^7 . For maximum mechanical strength the horizontal position was considered most desirable and was used where possible.

Procedure for Daily Measurements

A crystal resonator measurement is made by connecting it into the bridge by means of the selector switch and making successive adjustments of increasingly fine order on the drive oscillator frequency, bridge resistance dials and receiver gain to obtain a minimum reading on the indicating meter of the receiver. As fine balance is approached it is necessary to make very small adjustments, observing the effect for several seconds. This is because of the very high crystal Q , which prevents sudden changes in the vibrating frequency of the crystal. When finally balanced, the crystal arm has a nonreactive impedance equal to its series resistance if no uncompensated stray reactance exists in the other bridge arms. Because of the low impedance used no adjustable compensation was provided, any small residual reactance in the bridge is compensated by the crystal arm being very slightly off resonance at balance. The series resistances of the crystal units measured have shown very little change since installation. Resistance data are incidental to the process of frequency determination, although are useful in certain crystal studies.

The frequency of the drive oscillator is measured at balance for each of the crystal resonators by comparing it with a selected reference oscillator as explained previously. Two consecutive measurements made on each crystal daily verify an over-all precision of ± 1 part in 10^{10} in intercomparison of the resonators and the refer-

ence oscillator. After sufficient data are available the extrapolated daily frequencies are useful in predicting the relative performance of the reference in a manner similar to that used with a group of oscillators.²

When first installed it was planned to use the resonators only to establish a more constant day-to-day reference frequency. However, their consistent reliability over both short and long periods when compared with several new oscillators, led to their consideration for rating existing clocks. Performance data on NBS crystal clocks have been supplied to the Naval Observatory for a number of years. These clocks, when compared by means of the WWV transmitted time signals with other precision clocks, are used to establish a continuous time system to which corrections are made by star observations. By comparing a resonator's frequency at regular intervals with the frequency of the oscillator driving one of these clocks, a mean value of frequency difference during the interval may be obtained. This difference frequency may be used to calculate the equivalent time difference which would have occurred if the resonator crystal had been used to drive a clock. These time differences when summed constitute a "resonator clock" rated in terms of the oscillator clock to which it has been referred. For valid results, the frequencies of both the crystal clock and the resonator clock must have uniform rates (clock accelerations) over periods of time considerably longer than the measurement intervals. For more than two years these computations have been made on four of the best resonators and the equivalent time thus obtained compares favorably with the best crystal clocks. Data on these resonator clocks are also given to the Naval Observatory to supplement the crystal clock data.

RESONATOR PERFORMANCE EVALUATION

Frequency-drift curves for a two-year period for each of the eight resonator crystals as compared with the weighted 100-day mean frequency determinations for the primary standard are shown in Fig. 6. It may be noted that the crystals drift rather constantly to a higher frequency with a gradually decreasing rate. It has been observed for a number of years that precision crystal oscillators and resonators have drift curves that very closely follow a natural aging or logarithmic law; that is, total drift when measured from $t = 1$ to any time t days later is

$$D = \alpha \log_e t.$$

The drift (or aging) rate at any time, t is

$$R = \frac{dD}{dt} = \alpha/t.$$

² J. M. Shaull, "Adjustment of high-precision frequency and time standards," *Proc. I.R.E.*, vol. 38, pp. 6-15; January, 1950.

Thus α represents the instantaneous hypothetical drift at $t=1$ day if t is given in days. For crystals older than about 30 days these equations have proved to be highly consistent. It seems obvious that they are not applicable near the region of $t=0$. Even if valid for $t=1$ day, the value for α is not directly measurable, as a crystal starts drifting from the time it is ground and mounted. The magnitude of α and the value for t , may be found by determining two successive drift rates a known number of days ($t_2 - t_1$) apart and solving for α and t_1 , in simultaneous equations as follows:

$$R_1 = \alpha/t_1$$

$$R_2 = \alpha/[t_1 + (t_2 - t_1)]$$

Knowing these constants, it is possible to determine the predicted drift rate for any future period. A new daily rate of drift is determined monthly by this method for each of the resonators. These data and similar extrapolations for several oscillators are used in establishing a uniform mean reference standard from which individual frequency standards are calibrated. The eight crystal resonators used as a part of the primary standard of frequency for the past two years have resulted in the ability to determine day-to-day performance of all reliable oscillators and resonators in the group within 1 part in 10^{10} in relative value. The 100-day absolute frequency values are uncertain to about 1 part in 10^8 , dependent on the earth's mean rate of rotation.

Assessment Over Long Intervals

Periodic variations, reflected similarly in each of the resonator performance curves as normally plotted on an expanded scale, led to an investigation relating to variations in the earth's rate of rotation. Both random and periodic variations in the earth's rate have been known to exist for a number of years and approximate magnitudes of these variations have recently been reported by numerous observers. Over periods of years the larger changes may be verified by astronomical methods alone. To determine changes as they occur it is necessary to depend on extremely reliable clocks operating over extended periods. The demonstrated reliability of the resonator clocks when rated by means of the improved oscillator clocks at NBS enables these phenomena to be evaluated to a higher order of precision than heretofore possible.

Referring again to Fig. 6, the dashed curve, L_2 , represents a computed logarithmic segment which most nearly coincides with the observed drift for resonator No. 2. Each curve is displaced 2 parts in 10^8 at the beginning of the graph for clarity in plotting. In searching for variations in the earth's rate, frequency curves for each resonator based only on the equivalent time changes as shown by 20-day Naval Observatory corrections are used rather than the 100-day mean frequency

values as shown in Fig. 6. These curves were compared with the computed logarithmic drift curves for four of the best resonators and the residual deviations from the resulting uniform frequency and time were obtained.

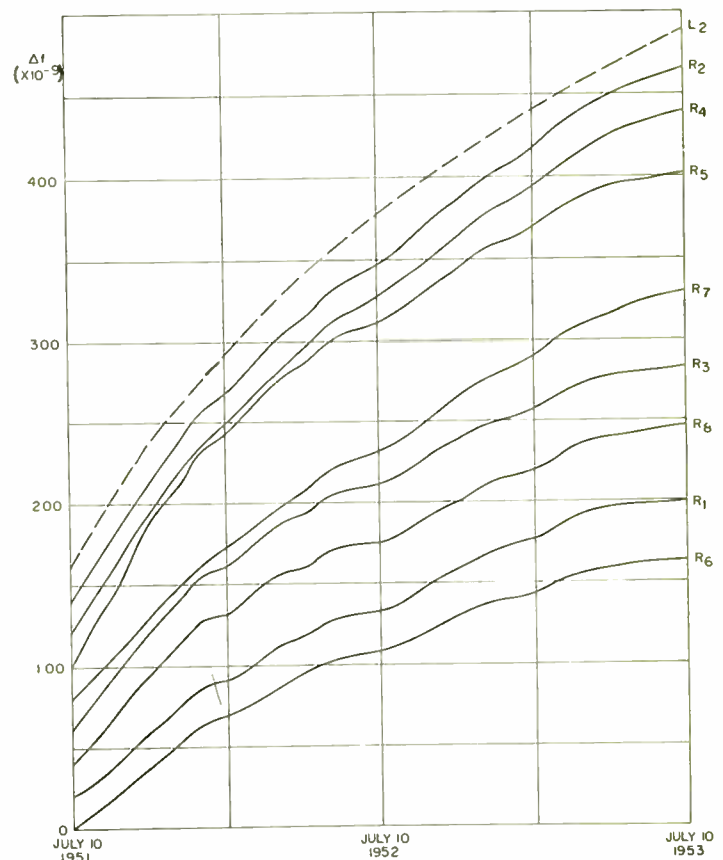

Fig. 6—Frequency drift based on absolute values for eight resonator crystals and computed logarithmic drift for one unit (dashed curve). Δf , expressed in parts in 10^9 , indicates change from the fundamental frequency.

Results of these computations are shown in Fig. 7, on the following page. It may be noted that the curves for each of the resonators are very similar. The changes in magnitude and phase of the frequency curves are most significant and may be taken to reflect similar changes, of the opposite sign, in the earth's rate. As the residual frequency curves shown represent differences between slightly dissimilar curves starting from an arbitrary point, it is apparent that the zero reference co-ordinate might be shifted if a different starting point were chosen. Also because of the curve fitting method for zero total integrated time difference, changes in the total interval used or end point chosen would cause somewhat similar effects. The shape of the frequency curve is not appreciably changed by these operations; however, the magnitude and shape of the resulting integrated time curve is considerably altered. Thus, for this curve fitting method, the time-computed frequency values for the beginning and ending of the period should represent mean values at these two end points to obtain the lowest value of maximum time de-

viation. The values for α and t_1 were computed over a period July 10, 1951 to March 1, 1953 and the curves were continued to complete the two year period. It seems a slightly different starting point might have reduced somewhat the maximum time deviation as shown.

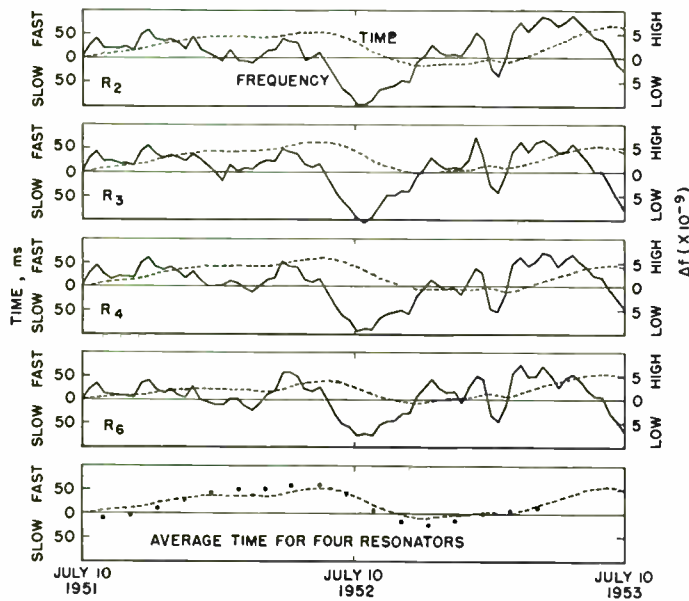

Fig. 7—Residual frequency and time curves for four crystal resonators. With reversed signs these curves reflect variations in the earth's rate of rotation. Dotted points on the average graph show the curve corrected for polar variation.

This was apparent only after considerable computation of the time curves and was believed to be of secondary importance from a frequency standpoint. The first part of the curves may not precisely follow the logarithmic law, as the two-year period taken started only three months after the resonators were installed. Future predictions for these performance curves should be much more precise because of the longer total intervals and the much lower drift rates as the resonators become older. Also, on one unit frequencies and integrated time values were computed for every fifth day to check the validity of the curves using values for only every tenth day. The two curves were practically identical. The average time curve of Fig. 7 with reversed signs may be taken to reflect the approximate variations in the earth's rate of rotation. The resonator frequency and time curves (through March 1953) were computed using Naval Observatory corrections from which the polar variation term had not been removed. Since April 1, 1953 the N2 corrections with polar variation term removed have been used. The dotted points on the average time graph show the curve corrected for combined variation in longitude at the Washington and Florida observatories caused by polar variation.

Fig. 8 illustrates the reliability of the logarithmic method of extrapolation over long intervals. This curve was computed for oscillator No. 24 in a manner similar to that used with the resonators using a single equation

for the entire period. Values used were

$$\alpha = 118 \times 10^{-8}/\text{day} \text{ and } t_1 = 403 \text{ days.}$$

During the entire five-year period the greatest departure from the computed logarithmic curve was 1.8 parts in 10^8 ; average deviation without regard to sign was less than 1 part in 10^8 .

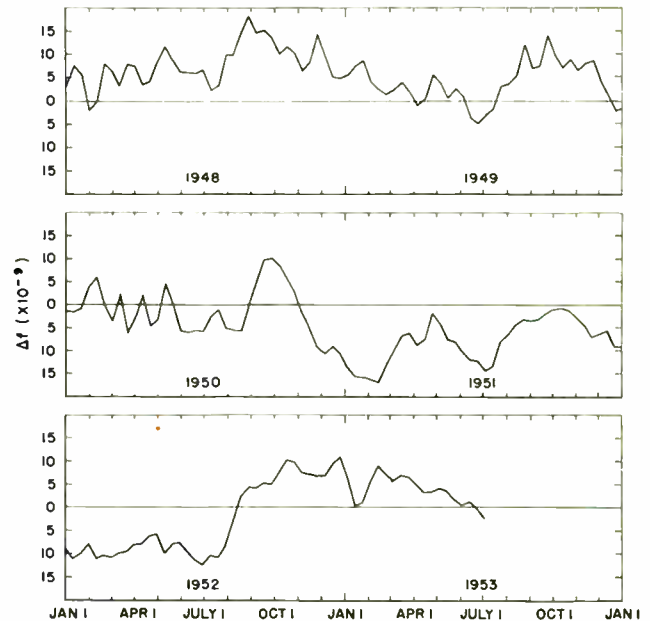

Fig. 8—Residual frequency curve for oscillator no. 24.

CONCLUSIONS

Precision quartz crystal resonators and applicable instrumentation have been developed to a degree of constancy and reliability which equals or exceeds the performance of the best crystal oscillators. When used to evaluate the performance of several precision oscillators of similar stability, a relative reference frequency, constant to 1 part in 10^{10} per day, may be established. To determine frequencies and time intervals in terms of the mean solar second, it is necessary to select a period over which the mean values will be considered and to make either periodic step adjustments or to uniformly "steer" the derived values to conform with any significant changes in the earth's rate. Thus occasional monthly or quarterly periodic frequency calibrations, even though difficult, with some invariant standard when available would be highly advantageous, and would establish a uniform frequency and time system.

Meanwhile, the logarithmic method of extrapolation, applied to an undisturbed group of quartz crystal resonators and oscillators, represents perhaps the nearest approach to an invariant frequency and time standard. The use of a group of crystal resonators to rate oscillators of similar constancy represents one of the most reliable and economical methods of establishing a precise frequency reference in terms of mean solar time and of studying deviations in the earth's rate of rotation.

The High-Accuracy Logarithmic Receiver*

T. H. CHAMBERS† AND I. H. PAGE‡

Summary—There are numerous applications in electronics for a device which will derive “instantaneously” the logarithm of an applied function. If this operation can be accomplished accurately, the device has wide application in analog computing, for multiplying, dividing, and determining ratios. In addition, whenever compression of a wide dynamic range of signal levels into a restricted presentation range is desired, such a device is in general optimum.

This paper shows how any arbitrary number of points distributed uniformly in amplitude may be made to fit a logarithmic response by means of the “successive detection” principle and how the deviation from true logarithmic response between these points can be essentially eliminated by use of the “multiple level detection” technique. The use of dc degeneration in an IF amplifier to stabilize tube characteristics is demonstrated, and three highly precise logarithmic receivers with bandwidths of 1.8 to 9 mc are described.

INTRODUCTION

MANY physical measurements of electrical quantities must be made over a wider range of levels than can be accommodated with linear instruments. When dynamic analyses of large numbers of samples with large variations in amplitude must be made at megacycle rates nonlinear amplifiers with precisely controlled dynamic-logarithmic characteristics are invaluable. “Instantaneous” determination of the product or ratio of two signals can be obtained by simply adding or subtracting their logarithms, thereby opening up new methods of analog computing of certain functions.

A number of methods have been exploited in the past to obtain a logarithmic characteristic in an amplifier or attenuator to compress a wide-input dynamic range into a smaller-output dynamic range. These methods may be lumped into two general types: nonlinear loading utilizing nonlinear resistances¹ to give a circuit impedance which is a function of signal level; and successive detection with progressive signal limiting² to give output voltage increments proportional to input voltage ratios. Both types have been successfully used to give approximate logarithmic characteristics to amplifiers and attenuators.

When a precise logarithmic characteristic is required to give analog computations a reasonable degree of precision, a re-evaluation of the primary methods must be made in order to determine how accurately a nonlinear function can be derived from notoriously nonuniform devices, such as vacuum tubes and crystal diodes. Because of the temperature dependence of crystal charac-

teristics, it seems best to eliminate them from consideration. Using the nonlinear characteristics of diodes or multigrad tubes in their low current regions is also dangerous because this characteristic is not well controlled in manufacture and may vary widely from one sample to another of a given type. Vacuum-tube amplifiers may, however, be made quite linear by means of negative feedback. If such amplifiers can be operated in one of two conditions, either linearly or limiting to give an output independent of input, a highly stable characteristic can be obtained. On this premise a successive detection logarithmic receiver has been developed. Each IF stage is operated as an infinite impedance detector for high signal levels with a limited IF gain of unity and as a linear IF amplifier for low signal levels with high dc degeneration of tube characteristics by means of the high-cathode load resistance from which the high-level detected output is derived. By using a number of such identical stages in cascade and a parallel summing circuit to add the detected outputs of all stages, an accurate logarithmic response over a very wide range of input signal levels can be obtained.

The accuracy of a logarithmic receiver is best quoted in terms of input voltage ratios. If the deviation of the output from a true logarithmic characteristic can be maintained within such limits that the input level can be determined within a specified percentage of its true value, within the specified dynamic range, the accuracy is defined. For example, if the output deviation is less than ± 0.1 volt and a 60-db input signal range corresponds to a 10-volt output range, the accuracy is $\pm .6$ db.

Because of practical engineering considerations the accuracy of a successive-detection logarithmic receiver is probably limited to the order of 1/100 of the input dynamic range expressed in db or to $\frac{1}{2}$ db, whichever is larger.

The dynamic range of a successive-detection logarithmic receiver is limited only by the total weak-signal gain which can be built into its IF amplifier. Dynamic ranges of 60–100 db³ may be obtained with weak signal bandwidths of the order of 1 to 10 mc.

The bandwidth of a logarithmic receiver is dependent on signal level. For weak signals all interstage coupling circuits are cascaded and the bandwidth is determined by the narrowing factor of all stages. As the level becomes higher, more and more stages are bypassed and the bandwidth becomes wider. For this reason when precise control of bandwidth is desired, it must be realized by inserting the bandwidth determining factor ahead of

* Decimal classification: R360×R363. Original manuscript received by the IRE, December 11, 1953; revised manuscript received, May 3, 1954.

† Naval Research Laboratory, Washington, D. C.

¹ Diodes, crystal rectifiers, “thyrite.”

² S. N. VanVoorhis, “Microwave Receivers,” Radiation Laboratory Series, McGraw-Hill Book Company, Inc., New York, N. Y., vol. 23, pp. 583–606.

³ The log receiver will ordinarily be preceded by a preamplifier of 20- to 60-db gain to insure good noise figure, as well as to allow for gain and bandwidth control.

the logarithmic amplifier, and making weak-signal bandwidth of the amplifier itself sufficiently wide so that it is essentially out of the picture.

DESIGN FUNDAMENTALS

Of the known methods of developing nonlinear receiver characteristics, the successive detection system seems to be best suited to the requirements of the high accuracy logarithmic receiver. This method gives an over-all receiver response which is relatively independent of individual tube and circuit characteristics and may therefore be made stable and accurate despite normal tube and component variations and tolerances.

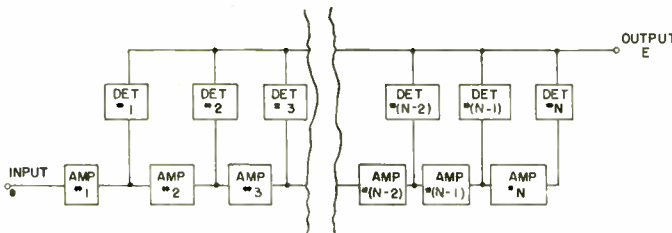

Fig. 1—Elementary successive detection logarithmic receiver.

Consider a successive detection receiver as shown in Fig. 1, using N stages, identical in design and with a stage gain of G . Let us apply to this receiver a signal of level e_1 such that the last detector gives an output E_1 . If we increase the input to G times its original value, quite obviously the next-to-last detector will now be operating under the conditions under which the last detector was originally operating and will have an output of E_1 . Also, if the original input-signal level e_1 was reasonable, the last detector will now be operating at saturation and will have an output E_s . Since the detector outputs are added linearly, the receiver output will be $E_s + E_1$. By similar reasoning, for another increase in input, to $G^2 e_1$, the output signal will increase to $2E_s + E_1$. Or, in the general case, for an input signal

$$e = G^n e_1,$$

the output signal will be

$$E = nE_s + E_1.$$

This is the desired logarithmic response; but perhaps of more importance, it has been derived, for the set of points considered, without reference to the characteristic of an individual stage, but with reference only to the similarity of stages. Thus, the only requirement which must be met in order to insure that the characteristic be truly logarithmic at a given set of N points evenly spaced over a given range, R , of input levels (expressed in db), is that the characteristic be developed by N similar stages of gain (R/N) db.

Consider now what happens between these points. Quite obviously, since limiting IF amplifiers and detectors have smooth characteristics, the curve will be smooth between points of the given set (probably

slightly s-shaped) and hence, if N is large, the entire curve must approximate a logarithmic characteristic with no large errors, and with only a small cyclic error possible.

In regard to this small cyclic error, it can be shown that given a degenerate step function $f(x)$ (such as the detection characteristic of a back-biased IF stage) if a new function

$$F(x) = \sum_{m=0}^M \frac{1}{M} f\left(x - m \frac{a}{M}\right)$$

is formed, this new function will, in the range x to $x+a$, more nearly approach a linear function than the original function $f(x)$. This "linearizing" effect can be used to good advantage in the design of a logarithmic receiver by the simple expedient of adjusting the dynamic range and the gain of the individual stage to values such that the nonlinear (but not yet limited) portions of the characteristics of two or more stages overlap. By this means, the small cyclic error may be reduced to an extremely low value, and an almost perfect logarithmic characteristic may be realized.

This improvement in accuracy is, of course, not obtained without paying a price. If the characteristics of individual stages are made to overlap, true logarithmic response of the requisite slope will not start until a level is reached at which the requisite number of stages have started to detect. Thus, the logarithmic response will start at a somewhat higher level, and, for similar reasons, will end at a somewhat lower level.

Fortunately, this restriction of logarithmic range by what might be called "end effect" is not serious, since it may be compensated for by increasing the slope (and output) of the last detector.

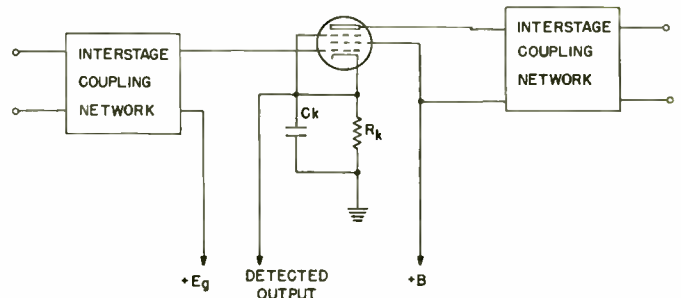

Fig. 2—The basic nonamplified back-biased stage of the logarithmic receiver.

Next, consider the type of IF amplifier and detector to be used in the successive detection system. The back-biased IF amplifier is well known and has been widely used in the design of pulse receivers. In this application it has shown exceptional stability and freedom from the effects of varying tube parameters. Because of this, and because the back-biased amplifier is inherently a limiting amplifier and a detector in a single stage, it is a reasonable choice for the basic stage of a log receiver.

Fig. 2 shows the basic back-biased IF amplifier stage.

It will be noted that this single stage is perfectly straightforward except that the cathode bias resistor is unusually large and a positive bias is applied to the grid. This positive voltage is made sufficiently large to operate the tube under normal bias conditions (despite the relatively large positive cathode voltage) so that, for small input signals, it operates as a normal IF amplifier. For large input signals, however, average plate current will be increased (as in an infinite-impedance detector), thus increasing the bias developed across the cathode resistor. This increased bias will cause clipping of the negative peaks of the incoming signal with a resultant loss in IF gain. If the cathode resistor is large enough, gain will ultimately reduce to unity so that the stage is effectively a limiter.

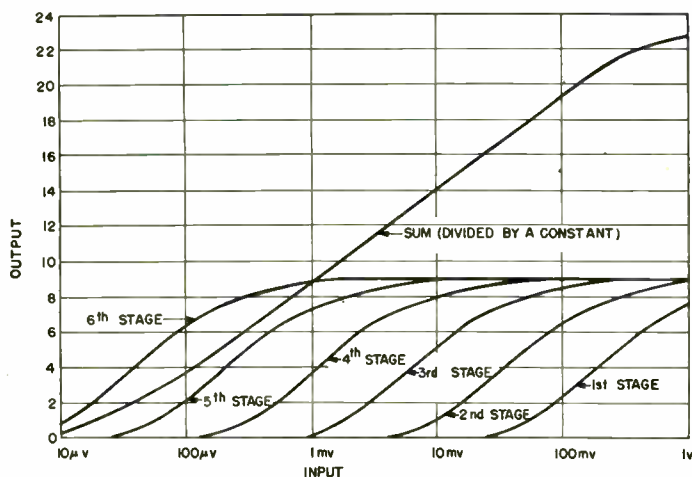

Fig. 3—Idealized detection characteristics six-stage (back-biased) logarithmic receiver.

Consider the action of a receiver consisting of, for example, six such stages. Fig. 3 shows the idealized characteristic of each stage as well as the resultant from summing the detected outputs. As expected, each stage follows a characteristic which is, at low level, approximately square law; and at higher levels, where the preceding stage is losing gain, a limiting characteristic. These individual stage characteristic curves are displaced from each other by the small-signal stage gain (15 db in this case) and overlap to an extent such that, in general, there are at least three stages contributing slope to the output characteristic. This output characteristic is seen to be an almost perfect logarithmic characteristic from about the midpoint of the fifth stage characteristic to about the midpoint of the first stage curve; a range approximately equal to the small signal gain of four stages. In an actual receiver, this range may be extended about 10 db by compensation of the rather severe end-effect apparent at the low level end of the characteristic.

It should be pointed out in connection with this curve that the stage which drives the first logarithmic stage must also be a back-biased stage. Since the first logarithmic stage depends, for the shape of its characteristic

at high levels, on the limiting action of the stage which precedes it, it is evident that this driving stage should be a back-biased stage similar in design to the logarithmic stages.

Thus far, we have considered only the steady state characteristic of the system. In a practical receiver, a cathode-bypass capacitance sufficiently large to minimize IF degeneration and to prevent spurious oscillation must be used. The value of the cathode resistor must then be made low enough to allow the cathode time constant to follow the desired video frequencies. This condition may be met with conventional circuitry for video frequencies up to about 5 mc, but with tubes having a separate suppressor connection, video frequencies up to 10 mc may be handled. In either case, the cathode resistor and associated positive grid bias will be high enough not only to allow proper back-biasing action (so that the steady state considerations hold) but also to allow sufficient dc degeneration to stabilize tube characteristics.

The obvious method of summing the video outputs of the IF amplifier cathodes is in a network of resistors. This method has two drawbacks: first, since resistors are bilateral elements, some fraction of the output of each stage will be impressed on every other stage, thus upsetting its characteristic and damaging the over-all characteristic; and second, each IF amplifier delays the IF pulse a small amount so that compensating delay must be introduced into the video pulses from the earlier stages if all signal components are to be summed in correct phase. This latter defect is remedied by the use of a low pass filter (artificial delay line) for summing. The former defect, however, indicates the use of some unilateral device, such as a vacuum tube, between each cathode and the summing delay line. In the high-accuracy logarithmic receivers, separate tubes (referred to as pickoff tubes) are used so that the gain to the last detected output may be increased to compensate for end effect. In lower accuracy logarithmic receivers, and in linear-logarithmic receivers, the IF tubes themselves may be used as the pickoff tubes by the simple expedient of placing the summing delay line in series with their plate returns. This method reduces the number of tubes in the receiver, but has several disadvantages. In the first place, compensation for end effect is not possible, and secondly, the summing delay line itself forms the IF-ground return for the IF-amplifier plate circuits and in a wide-band strip where the delay line must pass frequencies which are an appreciable fraction of the IF frequency, the feedback path which this delay line constitutes is likely to introduce instability problems.

THE DESIGN OF A LOGARITHMIC RECEIVER

Although the use of the principle of successive detection reduces the problem of designing a logarithmic receiver to one of designing a number of linear circuits, there are several unusual concepts which warrant some

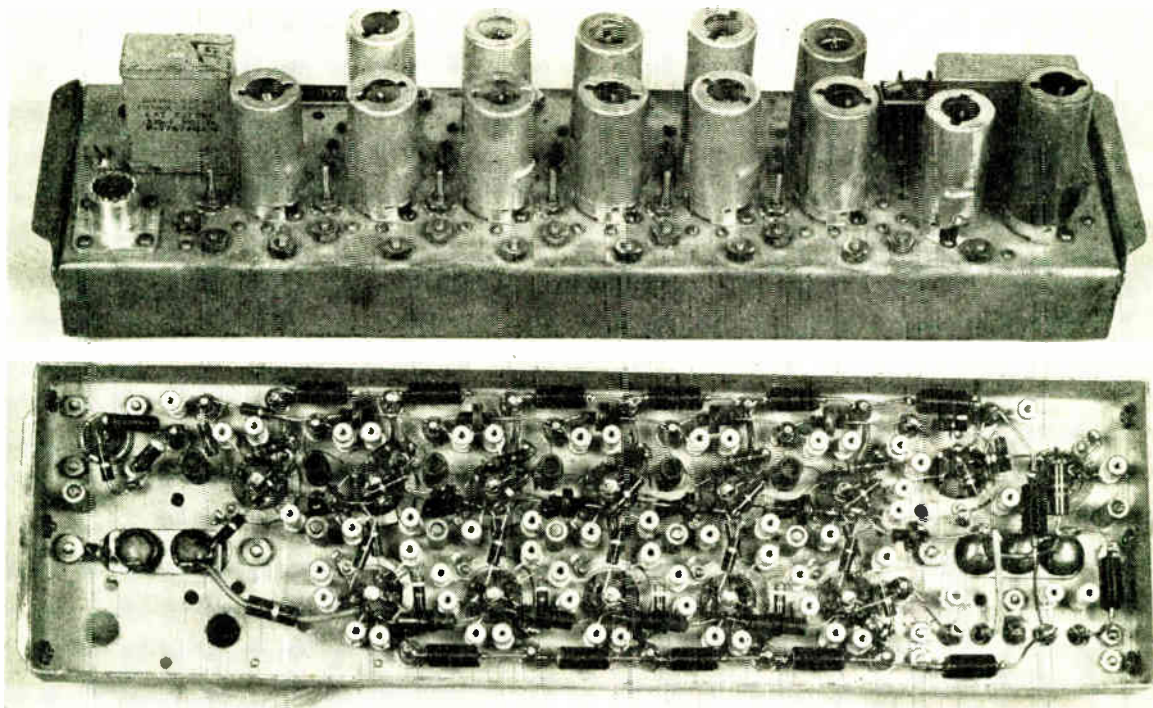

Fig. 4—Narrow-band logarithmic receiver.

discussion. Consider first the concept of receiver gain. In a nonlinear system, the term gain has no meaning except when referred to a particular input level. Although this reference level may be chosen quite arbitrarily, the most logical choice seems to be the rms level of the noise which will be fed to the strip. When the receiver is operating under this condition, all HF stages except the last will be operating in the linear portion of their characteristics and the last will be operating as a simple infinite impedance detector. Thus, individual stage gain, and the number of stages required to bring the available noise level up to the 3 to 5 volts normally applied to the grid of the last stage may be easily calculated using well-known procedures. In making these calculations, it should be borne in mind that, although there is no theoretical reason why the back-biased amplifier cannot have the same small-signal gain-bandwidth factor as the linear amplifier, in practice a loss of about 3 db will ordinarily be suffered as a result of operation of the tubes at below normal plate current (and hence below normal G_m) and a loss of 1 or 2 db will ordinarily result from HF degeneration due to the small cathode return capacitance required by considerations of video pass band. Experience has indicated that these two effects may most easily be accounted for in gain calculations by simply considering the gain-bandwidth factor of the HF tubes as reduced to about 0.6 of its normal value.

The number of these stages which must be made logarithmic may be determined quite easily from a knowledge of the individual stage gain and the required logarithmic range. Assuming that pickoff tubes are used and end effect is compensated, the logarithmic range

will be about equal to the small-signal gain of one less than the number of logarithmic stages included. Thus, the number of logarithmic stages must be:

$$N \geq \frac{R}{G} + 1$$

where:

N = the number of logarithmic stages to be included,
 R = the required logarithmic range in db,
 G = the small signal stage gain in db, and the inequality sign allows N to assume the next higher integral value when R/G is not integral.

Once the number of HF stages has been determined, the design of the interstage coupling networks may be carried out by any of the well-known methods⁴ with the added condition that stage-to-stage symmetry be preserved in these interstage networks. This added condition has the effect of limiting the choice of possible interstages to synchronous single- or multiple-tuned systems. Stagger-tuned, stagger-damped, and feedback systems cannot be used in the high-accuracy logarithmic receiver. One additional point which must be remembered in the design of the interstages is that the control of receiver bandwidth must be done ahead of the logarithmic stages. Since detection moves back to earlier stages as level increases, the effective narrowing factor, and hence the over-all bandwidth of the interstage system will be dependent on signal level if the interstages in the logarithmic portion of the receiver are used for bandwidth control.

⁴ G. E. Valley, Henry Wallman, *et al.*, "Vacuum Tube Amplifiers," Radiation Laboratory Series, McGraw-Hill Book Company, Inc., New York, N. Y., vol. 18, Chaps. 4 and 5; 1948.

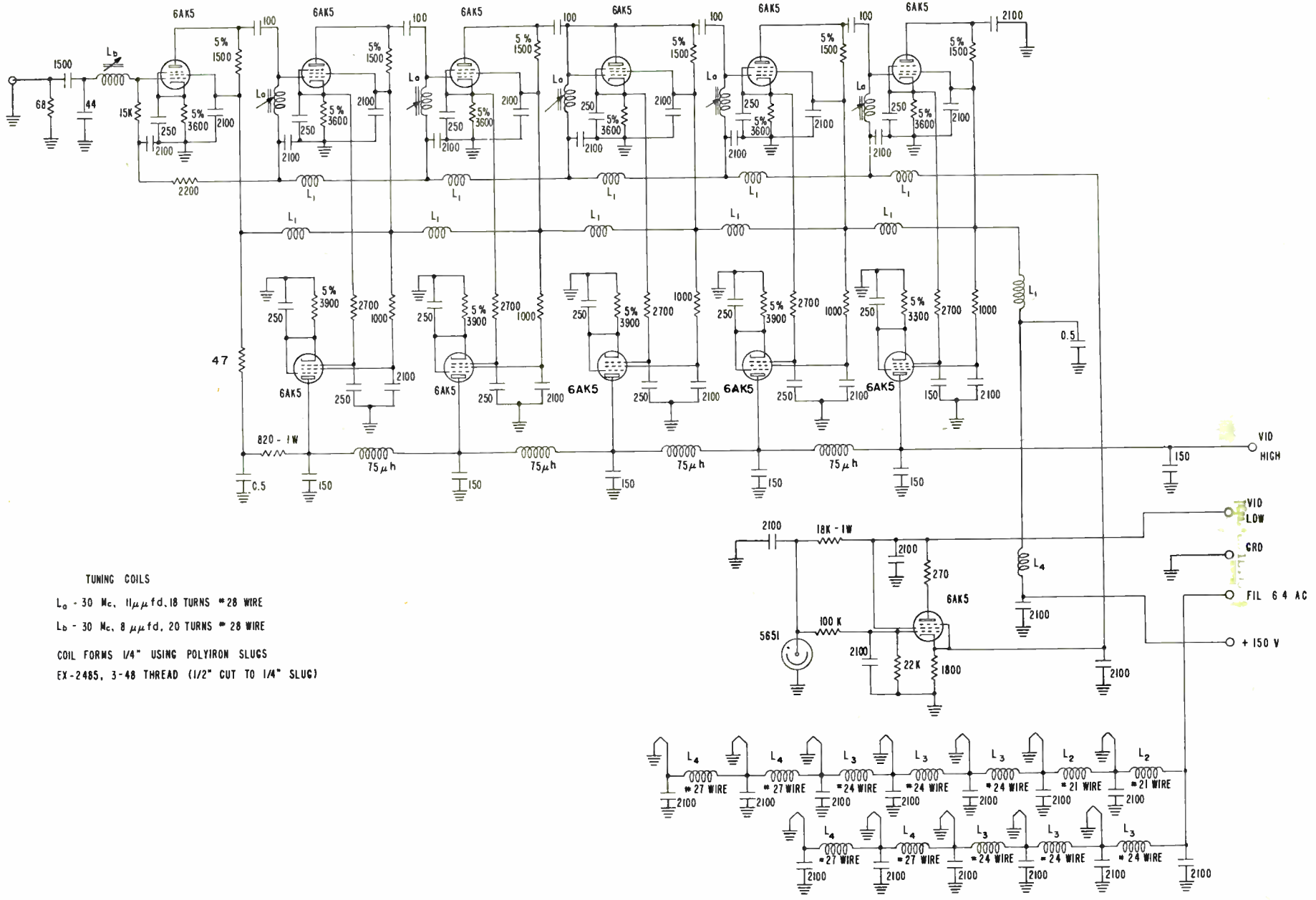

TUNING COILS
 L₀ - 30 Mc. 11µµfd. 18 TURNS = 28 WIRE
 L_b - 30 Mc. 8 µµfd. 20 TURNS = 28 WIRE
 COIL FORMS 1/4" USING POLYIRON SLUGS
 EX-2485, 3-48 THREAD (1/2" CUT TO 1/4" SLUG)

Fig. 5.

When the design of the interstage networks is complete, the design of the actual IF circuit may be undertaken. Here again, the usual design procedures apply, except that the value of the cathode resistor is made unusually high and a positive voltage is applied to the grid returns. The exact value of the cathode resistor is not at all critical. Experience has shown that, for proper back-biasing action it should have a value at least 25 per cent greater than transfer impedance of the interstage network at resonance. Values greater than this will not interfere with back-biasing action and may usually be used to advantage since they provide additional dc degeneration of tube characteristics, and better stage-to-stage symmetry.

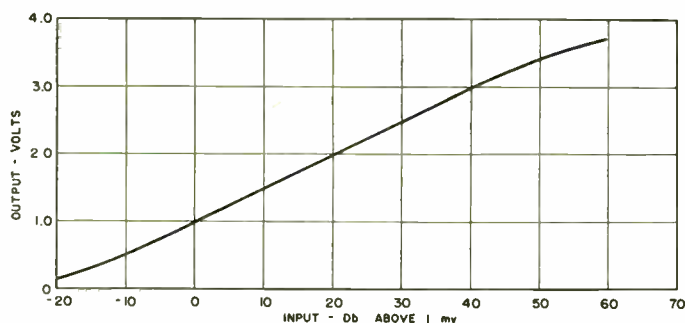

Fig. 6—Amplitude response of narrow-band logarithmic receiver.

The upper limit on the value of the cathode resistor will be set by video characteristics. The recovery time of the receiver following a pulse will be determined by the time constant consisting of the cathode resistor and capacitor, and since for reasons of IF degeneration, the capacitance must be made reasonably large, the value of the resistor will have to be made low enough to provide the desired recovery time.

When the value of the cathode resistors has been selected, the grid voltage will be set to give the proper tube operating current. Again, the tube operating current is not critical, but a current of from 0.7 to 0.8 the value ordinarily used for the tube type chosen has been found to give best results. In connection with the source of this voltage, it should be noted that when signals with steep wave fronts are applied to the receiver, the grids of the IF stages will draw pulses of grid current. Unless the impedance of the source of this voltage is low (a few hundred ohms) this grid current will lead to poor recovery time and to ringing on the steep wave fronts.

The design of the video system for the successive detection logarithmic receiver may be carried out in much the same manner as the design of a distributed amplifier.⁵ Indeed, irrespective of whether separate pickoff tubes are or are not used, the video load circuit (delay line) may be calculated in exactly the same manner as for a distributed amplifier using as interstage delay, the envelope delay of the IF interstages. If pickoff tubes are used, their cathode resistors should be about ten per cent higher than the cathode resistors of the logarithmic IF stages. Adjustment of the end-effect compensation may be done empirically, but experience has shown that a resistance in the last pickoff tube cathode, which is about twenty per cent lower than for the other pickoff tubes (about ten per cent lower than logarithmic stage cathode resistors), is about optimum.

Rough output level calculations are made by assuming an rms noise level of about 2.5 volts applied to the grid of one tube for the low-level end of the range, and a signal of about five volts applied to each tube for the

⁵ E. L. Ginzton, W. R. Hewlett, J. H. Jasberg, and J. D. Noe, "Distributed amplification," *Proc. I.R.E.*, vol. 36, pp. 946-969; August, 1948.

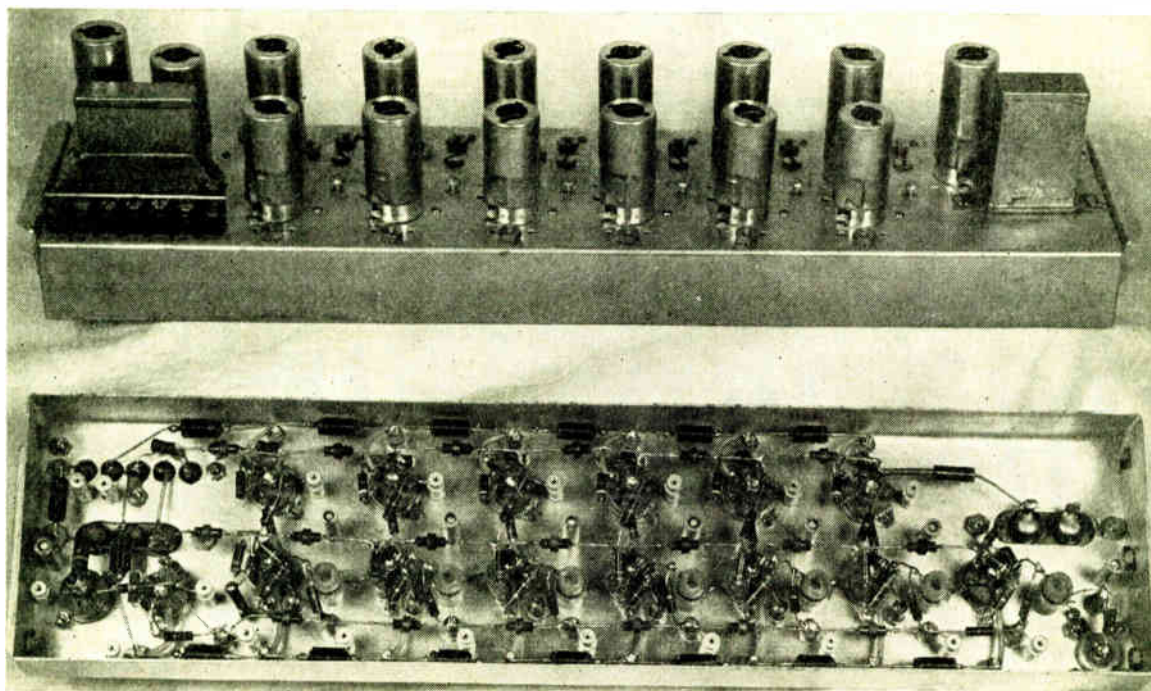

Fig. 7—Broad-band logarithmic receivers.

high-level end of the range. In the case where pickoff tubes are not used, this leads to the relations

$$E_{\text{noise}} = 2.5 \frac{R_1}{2R_k},$$

and

$$E_{\text{max}} = 5.0 \frac{NR_1}{2R_k},$$

where

- E_{noise} = rms noise output level in volts,
- E_{max} = maximum signal output level in volts,
- R_1 = summing delay line terminating resistor,
- R_k = IF stage cathode resistor, and
- N = the number of logarithmic stages.

In the receiver using pickoff tubes, the relations will

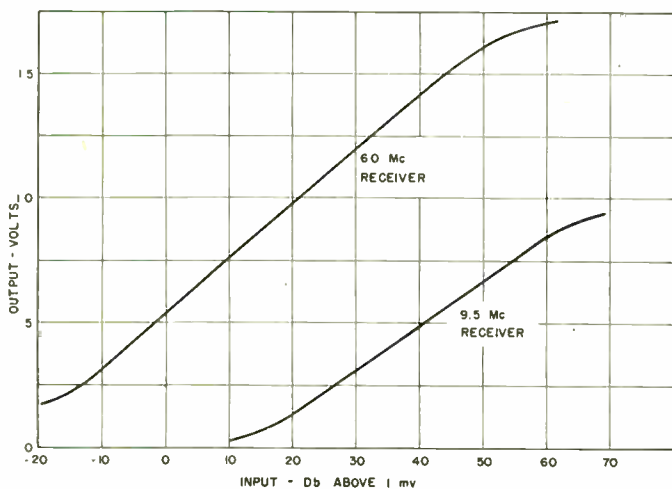

Fig. 9—Amplitude responses of broad-band logarithmic receivers.

be the same except that R_k will now be the resistance in the cathode of the pickoff tube. In a strip compensated for end-effect, the value of this resistor is not the same for all stages. However, since the difference amounts to only a few per cent, the use of a constant average value for R_k is permissible.

PRACTICAL RECEIVERS

Three different receivers have been developed and studied as examples of high accuracy logarithmic receivers. The first of these (Figs. 4, page 1310, 5, page 1311, and 6, page 1312) has a weak signal bandwidth of 1.8 mc and a logarithmic characteristic accurate to about 0.6 db over a range of input levels of about 60 db.

The second receiver (Figs. 7, page 1312, 8, page 1313, and 9) has a weak signal bandwidth of 6.5 mc and a logarithmic characteristic accurate to about 0.6 db over a range of input levels again of about 60 db. Reference to the circuit diagram of this receiver (Fig. 8) will show that a rather unusual suppressor grid connection is used in the IF amplifier stages. Because of the very short rise time required in the IF amplifier cathode circuits of this receiver, the cathode capacitors had to be made very small; so small that if 6AK5 tubes had been used, capacitive feed-back from plate to suppressor and thence to cathode would have led to instability problems. To avoid this difficulty, the 6CB6 has been used as the IF amplifier so that the suppressor can be effectively grounded for IF and video and a very small capacitance used in the cathode circuit.

The third receiver (also shown by Figs. 7, 8 and 9) has a weak signal beamwidth of 9.5 mc and logarithmic range of about 40 db. Accuracy of its characteristic is again about $\pm .6$ db.

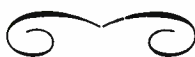

CORRECTION

"IRE Standards on Television: Methods of Measurement of Aspect Ratio and Geometric Distortion," which appeared on pages 1098-1103 of the July, 1954 issue of the PROCEEDINGS OF THE I.R.E., should have included the following reference at the end of the paper:

I. C. Abrahams and R. C. Thor, "A precision line selector for television use," 1953 Convention Record of the I.R.E., Part 4—Broadcasting and Television, page 45.

Coaxial Line with Helical Inner Conductor*

W. SICHAK†, MEMBER, IRE

Summary—To obtain an approximate solution for the fields in a coaxial line with a helical inner conductor, the helix is replaced by a fictitious surface that is conducting only in the helix direction, an approximation used in the early work on traveling-wave tubes. Maxwell's equations are solved for the lowest "mode" (all fields independent of angle) when the medium inside the helix has permittivity and permeability different from that of the medium surrounding the helix. Equations for the velocity along the axis, characteristic impedance, attenuation constant, and Q are given.

The significant parameter is $(2\pi Na)(2\pi a/\lambda)$. N = number of turns per unit length, a = helix radius, and λ = wavelength. When this parameter is considerably less than 1, the velocity and characteristic impedance depend only on the dimensions. The dielectric inside the helix has only a second-order effect, while the dielectric outside the helix has a first-order effect. The wave appears to propagate along the helix wire with the velocity of light only when the outer conductor is very close to the helix; as the outer-conductor diameter is increased, the apparent velocity along the wire gradually increases and reaches a limiting value when the outer conductor is infinitely large. For the shapes generally used, the apparent velocity along the wire is rarely more than 30 per cent greater than the velocity of light, but with an infinitely large outer conductor this velocity can be 2 or 3 times the velocity of light.

When $(2\pi Na)(2\pi a/\lambda)$ is greater than 1, the wave appears to propagate along the helix wire with the velocity of light, and the characteristic impedance depends only on the ratio of wavelength to helix radius. Introducing higher-dielectric-constant material inside or outside of the helix has a first-order effect, and the effect is the same whether the material is inside or outside the helix.

The outer-conductor loss is appreciable, about one-fourth to one-half the helix loss for the usual shapes with low velocities along the axis. The unloaded Q 's can be about the same as with conventional coaxial lines. The Q does not depend on the length of the resonator if $(2\pi Na)(2\pi a/\lambda)$ is less than about 0.5, so that for frequencies below about 500 mc the volume is considerably less than the volume of a conventional coaxial-line resonator. A few measurements to check the formulas for Q are presented.

INTRODUCTION

COAXIAL LINES with helical inner conductors are used in many applications—in traveling-wave tubes, as delay lines, high- Q resonators, and high-characteristic-impedance transmission lines, and in extending microwave impedance-matching techniques to frequencies as low as 300 kc. An analysis of this transmission line is given in this paper. The equations reduce to those previously published when (a) the number of turns per unit length goes to zero (the standard coaxial line) and (b) the outer conductor is removed (the helix used in traveling-wave tubes). The assumption that the electromagnetic wave travels along the helix wire with a velocity very close to that of light is not true except in extreme cases so that formulas based on this assumption may be in error.

Maxwell's equations are solved by replacing the helix with a fictitious surface that is conducting only in the helix direction. This method has been successfully used

in the early work on traveling-wave tubes.^{1,2} All fields are assumed to be independent of angle (the lowest "mode"). These assumptions have been questioned on sound theoretical grounds, but the results given here are good enough for most engineering applications. The details of the derivation are given in the appendix.

After this paper was written, a translation of a paper³ originally published in Russian was obtained. It presents a general solution of the problem, emphasizing the high-frequency behavior with an electron beam. There is no discussion or derivation of characteristic impedance, velocity, or Q , the main points of this paper. Another paper⁴ gives an expression for the velocity and an approximate expression for the characteristic impedance.

VELOCITY

When the dielectrics on both sides of the helix are identical, the velocity along the axis is given by

$$\left(\frac{c}{V}\right)^2 = 1 + \left(\frac{M\lambda}{2\pi a}\right)^2, \quad (1)$$

$$(2\pi Na) \frac{2\pi a}{\lambda} = M \frac{J_0(jM)}{J_1(jM)} \left[\frac{H_0^{(1)}(jMb/a) - H_0^{(1)}(jM)}{J_0(jMb/a) - J_0(jM)} \frac{H_1^{(1)}(jMb/a) - H_1^{(1)}(jM)}{J_1(jMb/a) - J_1(jM)} \right]^{1/2}. \quad (2)$$

All symbols are defined in the glossary.

These equations can be solved by plotting $(2\pi Na)(2\pi a/\lambda)$ against M , with b/a as a parameter as shown in Fig. 1, page 1216, for $\epsilon_1 = \epsilon_2$. Then if N , a , and λ are known, the velocity can be obtained from the first equation.

When the diameters are small ($b/\lambda < V/2\pi c$), the above equations simplify to

$$\left(\frac{c}{V}\right)^2 \approx 1 + \frac{[1 - (a/b)^2](2\pi Na)^2}{2 \ln(b/a)} = 1 + T^2(2\pi Na)^2. \quad (3)$$

T versus b/a is plotted in Fig. 2, page 1216. Usually $(2\pi Na)^2$ is large, so that

$$\left(\frac{c}{V}\right) \approx T(2\pi Na) \approx (2\pi Na)(a/b)^{1/2}. \quad (4)$$

The last approximation becomes inaccurate for large

† Federal Telecommunication Labs., Nutley, N. J.

¹ J. R. Pierce, "Traveling Wave Tubes," D. Van Nostrand Co., Inc., New York, N. Y., p. 229; 1950 See also J. R. Pierce, "Theory of beam-type traveling-wave tubes," *Proc. I.R.E.*, vol. 35, pp. 111-123; February, 1947.

² L. L. Chu and J. D. Jackson, "Field theory of traveling-wave tubes," *Proc. I.R.E.*, vol. 36, pp. 853-863; July, 1948.

³ L. N. Loshakov, "Propagation of waves along a coaxial spiral line in the presence of an electron beam," *Jour. Tech. Phys.*, vol. 19, pp. 578-595; May, 1949.

⁴ C. O. Lund, "Broadband transition from coaxial line to helix," *RCA Rev.*, vol. 11, pp. 133-142; March, 1950.

* Decimal classification: R117.1. Original manuscript received, March 12, 1953; revised manuscript received, October 9, 1953.

values of b/a . The factor T , is for $(2\pi Na) \gg 1$, the ratio of the velocity of light to the velocity of the wave along the wire. This ratio does not depart markedly from 1 for most practical cases, but in the case of helical antennas⁵ this ratio can be larger than 2.

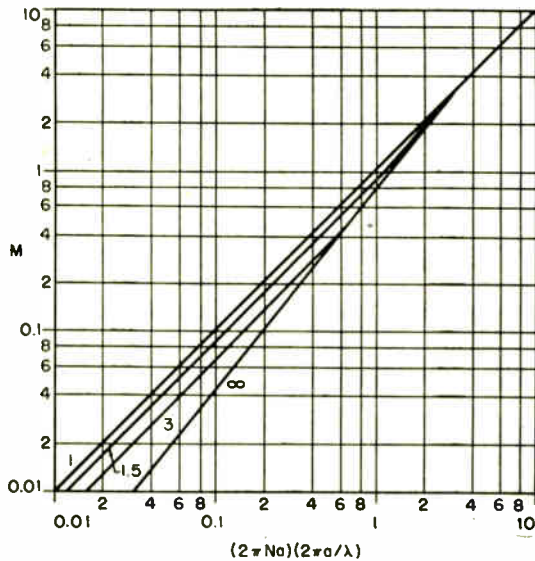

Fig. 1— M plotted against $(2\pi Na)(2\pi a/\lambda)$ for the indicated values of b/a .

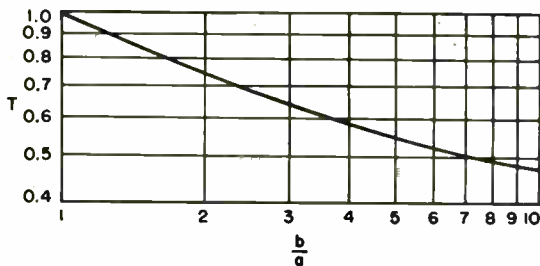

Fig. 2— T in (3) is a function of b/a .

When the diameters are large ($b/\lambda > V/c$), the equations reduce to

$$(c/V)^2 \approx 1 + (2\pi Na)^2 = 1/\sin^2 \psi. \quad (5)$$

For this case (usually encountered in traveling-wave tubes), the wave travels along the wire with the velocity of light. When the diameters are small and the dielectric inside the helix is different from the dielectric outside the helix, the velocity is very nearly the same as if the dielectric were uniform throughout. On the other hand, for large diameters

$$\frac{c_2}{V} \approx (2\pi Na) \left[\frac{\epsilon_1 + \epsilon_2}{2} \right]^{1/2}. \quad (6)$$

This case is interesting because the velocity is the same whether the dielectric is inside the helix or outside

⁵ A. G. Kandoian and W. Sichak, "Wide-frequency-range tuned helical antennas and circuits," 1953 IRE Convention Record, pp. 42-45; see also A. G. Kandoian and W. Sichak, "Wide-frequency-range tuned helical antennas and circuits," Electrical Communication, vol. 30, pp. 294-299; December, 1953.

of it and in addition does not depend on the ratio of diameters.

CHARACTERISTIC IMPEDANCE

The voltage is the integral of E_{r2} from $r=a$ to $r=b$. The current is given by

$$I = 2\pi a H_{\theta 2}(r=a) - j\omega\epsilon_1 \int_0^a E_{z1}(2\pi r) dr$$

$$Z_0 = \frac{c}{v} 30\pi J_0^2(jM) \left| \frac{H_0^{(1)}(jMb/a)}{J_0(jMb/a)} - \frac{H_0^{(1)}(jM)}{J_0(jM)} \right|. \quad (7)$$

Fig. 3 shows how the characteristic impedance varies with M and b/a for $\epsilon_1 = \epsilon_2$. When the diameters are small, this equation reduces to

$$Z_0 \approx \frac{c_2}{V} \left(\frac{\epsilon_0}{\epsilon_2} \right)^{1/2} 60 \ln(b/a). \quad (8)$$

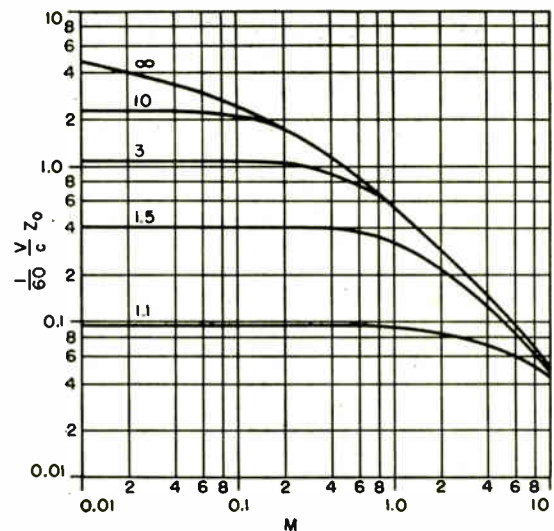

Fig. 3—Relation of M to $(1/60)(V/c)Z_0$ for indicated values of b/a .

Using (3), this can be written

$$Z_0 \approx 120\pi Na \left[\frac{(1 - a^2/b^2)}{2 \ln(b/a)} \right]^{1/2} \left(\frac{\epsilon_0}{\epsilon_2} \right)^{1/2}$$

$$= 120NaT \left(\frac{\epsilon_0}{\epsilon_2} \right)^{1/2}. \quad (9)$$

As Winkler⁶ has shown, the maximum value when holding N and a constant is obtained with $b/a = 2.06$.

This approximation holds when the curves in Fig. 3 have zero slope. For the usual values of b/a (1.5 or greater), M must be less than about 0.4.

For $b/a = \infty$ and $\epsilon_1 = \epsilon_2$, the characteristic impedance is

$$Z_0 = \frac{c}{V} 30\pi J_0(jM) H_0^{(1)}(jM). \quad (10)$$

⁶ M. R. Winkler, Discussion on "High impedance cable," by H. E. Kallman, Proc. I.R.E., vol. 35, p. 1097; October, 1947.

For $M < 1/2$

$$Z_0 \approx 60 \frac{c}{V} \ln(1.12/M). \tag{11}$$

For $M > 1/2$

$$Z_0 \approx \frac{c}{V} \frac{30}{M} \approx \frac{30\lambda}{2\pi a}. \tag{12}$$

The last approximation holds when $c/V \gg 1$.

The standard formula for the inductance of a long solenoid can be obtained by treating the solenoid as a short length of short-circuited line and using (10) and (29).

LOSSES AND Q

A. Outer-Conductor Losses

The power loss in the outer conductor can be calculated since the tangential magnetic field is known.⁷ The power lost per square meter of surface is

$$P_L = \pi b (H_x^2 + H_\theta^2) Z_{wall}. \tag{13}$$

The attenuation constant is

$$\alpha = \frac{P_L}{2P_{ino}} = \frac{P_L}{2I^2 Z_0}. \tag{14}$$

For small diameters and high velocity ratios (the usual case of interest),

$$H_x \gg H_\theta, \tag{15}$$

$$I \approx 2\pi a H_{\theta 2}(r = a),$$

$$\alpha \approx \frac{Z_{wall}}{4\pi b Z_0} \left(\frac{a}{b}\right)^2 (2\pi Na)^2. \tag{16}$$

A result similar to (16) has been obtained by Bogle.⁸ The factor $Z_{wall}/(4\pi b Z_0)$ is the attenuation constant due to the outer conductor in an ordinary coaxial line.

B. Helix Losses

The procedure used to calculate the outer-conductor losses leads to erroneous results when applied to the helix because the boundary conditions of the helix are not satisfied exactly. An approximate result can be obtained by assuming that the resistance of the helix is the same as an isolated conductor of the same diameter.

$$\alpha \approx \frac{Z_{wall}(2\pi Na)}{4\pi d Z_0} = \frac{Z_{wall}(2\pi Na)^2}{8\pi^2 a Z_0 (Nd)}. \tag{17}$$

The factor $(2\pi Na)$ is introduced because the unit of length is taken along the axis rather than along the helix wire.

This approximation does not take into account the proximity effect (apparent increase of resistance in a conductor due to the proximity of other conductors).

⁷ R. I. Sarbacher and W. A. Edson, "Hyper and Ultrahigh Frequency Engineering," John Wiley & Sons, Inc., New York, N. Y., p. 262; 1943.

⁸ A. G. Bogle, "Effective inductance and resistance of screened coils," *JIEE (London)*, vol. 87, pp. 299-316; September, 1940.

C. Q

The unloaded Q using copper conductors is given by⁹

$$Q = \beta/2\alpha. \tag{18}$$

For small diameters, this becomes

$$Q \approx \frac{120\pi a(1 - a^2/b^2)f_{mc}^{1/2}}{\left[\frac{1}{2\pi Nd} + \left(\frac{a}{b}\right)^2\right]}. \tag{19}$$

This equation indicates that the optimum value of (Nd) is one as large as possible due to the approximations used in deriving these equations. However, it is known from experimental data that the optimum value of (Nd) is between 0.3 and 0.4.

The optimum value of b/a depends on (Nd) . Using $(Nd) = 0.35$ and $b/a = 2.23$, the Q is

$$Q_{opt} \approx 250bf_{mc}^{1/2}. \tag{20}$$

For a coaxial line with $b/a = 3.6$

$$Q_{opt} = 210bf_{mc}^{1/2}. \tag{21}$$

These optimum Q 's have been derived without regard to the resulting volume, subject only to the restriction that $(2\pi Na)$ $(2\pi a/\lambda)$ be less than 0.5-1.0. The quantity $Q/volume$ is a maximum for $(Nd) = 0.35$ when $b/a = 1.57$.

$$Q_{opt} \approx 200bf_{mc}^{1/2}. \tag{22}$$

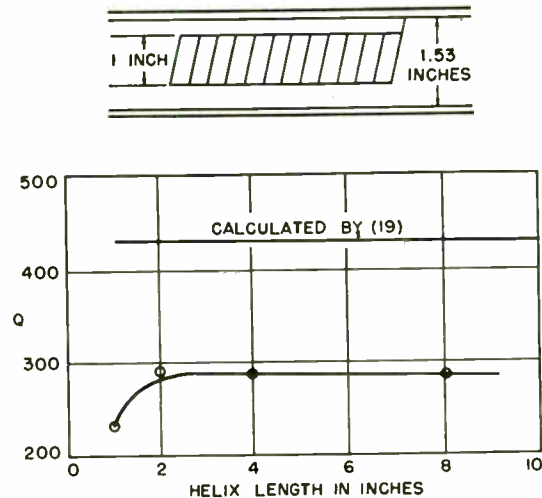

Fig. 4—Experimental and calculated values of Q versus helix length. In the experimental helix, $Nd = 1/3$ and there were 116 turns with one end connected to the outer conductor.

EXPERIMENTAL RESULTS

According to (19), the Q does not depend on the length or volume of the resonator. Measurements were made on a series of resonators with the same helix and outer-conductor diameters but with different wire diameters and turns per inch in the helix, but holding the product (Nd) constant. The coils ranged in length from 1 inch to 8 inches. The resonant frequencies were near 9 mc. Q versus helix length is shown in Fig. 4. Over most of the

⁹ "Reference Data for Radio Engineers," Federal Telephone and Radio Corp., third edition, pp. 304-319; 1949.

range, the Q is constant and equal to about two-thirds of the calculated values. Some of the discrepancy between measurement and theory is due to the use of commercial copper, to the method of soldering the helix to the outer conductor, and to the use of a solid polystyrene form for winding the helices. The shortest helix has a characteristic impedance less than the others (because $(2\pi Na)/(2\pi a/\lambda)$ is about 1) so that its Q should be smaller.

GLOSSARY

a = mean radius of helix
 b = outer-conductor radius

$$B = \frac{p_1 \tan \psi J_0(p_1 a)}{j\omega\mu_1 J_1(p_1 a)}$$

c = velocity of light
 d = radius of helix wire

$$D = \frac{J_0(p_2 a)}{-GJ_0(p_2 a) + N_0(p_2 a)}$$

E_x, E_r, E_θ = electric field in the indicated direction
 f = frequency
 f_{mc} = frequency in megacycles

$$F = \frac{p_2 \tan \psi J_0(p_2 a)}{j\omega\mu_2 [-HJ_1(p_2 a) + N_1(p_2 a)]}$$

$$G = \frac{N_0(p_2 b)}{J_0(p_2 b)}$$

$$H = \frac{N_1(p_2 b)}{J_1(p_2 b)}$$

H_x, H_r, H_θ = magnetic field in the indicated direction
 $H_0^{(1)}, H_1^{(1)}$ = Hankel functions of the first kind

I = current

J_0, J_1 = Bessel functions of the first kind

$M = |pa|$

N = number of turns per unit length

N_0, N_1 = Bessel functions of the second kind

$p^2 = \gamma^2 + \omega^2\epsilon\mu$

P_{inc} = incident power

Q = quality factor

V = velocity along the axis

Z_0 = characteristic impedance

$Z_{wall} = (\pi f\mu/\sigma)^{1/2}$

α = attenuation constant

$\beta = 2\pi/\lambda$ = phase constant along the axis

$\beta_0 = 2\pi/\lambda_0$ = free-space phase constant

$\gamma = \alpha + j\beta$ = propagation constant

ϵ = permittivity

λ = wavelength

μ = permeability

σ = conductivity

$\omega = 2\pi \times$ frequency

APPENDIX

Fields and Propagation Constants

The co-ordinate system is shown in Fig. 5. All conductors and dielectrics are assumed lossless, and the fields are independent of θ . Inside the helix, the longitudinal fields are taken to be of the form

$$\begin{aligned} E_{z1} &= J_0(p_1 r), \\ H_{z1} &= BJ_0(p_1 r). \end{aligned} \quad (23)$$

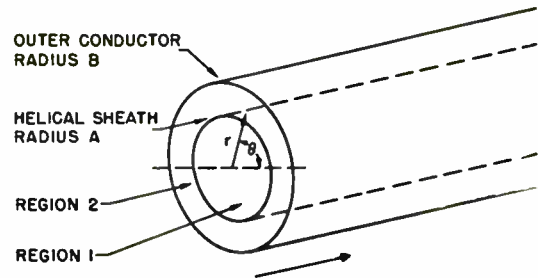

Fig. 5—Co-ordinate system. ψ is the angle between a turn of the helix and the cross-sectional plane of the helix.

Bessel functions of the second kind are not used because they go to infinity at $r = 0$.

Between the helix and the outer conductor, the longitudinal fields are taken to be of the form

$$\begin{aligned} E_{z2} &= D[-GJ_0(p_2 r) + N_0(p_2 r)], \\ H_{z2} &= F[-HJ_0(p_2 r) + N_0(p_2 r)]. \end{aligned} \quad (24)$$

The boundary conditions $E_{z2} = 0$ and $\partial H_{z2}/\partial r = 0$ at $r = b$ have been applied in the above equations.

By using Maxwell's equations¹⁰ the remaining fields can be determined.

Inside the helix ($r \leq a$)

$$\begin{aligned} E_{r1} &= \frac{\gamma_1}{p_1} J_1(p_1 r), \\ E_{\theta 1} &= \frac{(-)Bj\omega\mu_1}{p_1} J_1(p_1 r), \\ H_{r1} &= \frac{B\gamma_1}{p_1} J_1(p_1 r), \\ H_{\theta 1} &= \frac{j\omega\epsilon_1}{p_1} J_1(p_1 r). \end{aligned} \quad (25)$$

Outside the helix ($a \leq r \leq b$)

$$\begin{aligned} E_{r2} &= \frac{D\gamma_2}{p_2} [-GJ_1(p_2 r) + N_1(p_2 r)], \\ E_{\theta 2} &= \frac{-Fj\omega\mu_2}{p_2} [-HJ_1(p_2 r) + N_1(p_2 r)], \\ H_{r2} &= \frac{F\gamma_2}{p_2} [-HJ_1(p_2 r) + N_1(p_2 r)], \\ H_{\theta 2} &= \frac{Dj\omega\epsilon_2}{p_2} [-GJ_1(p_2 r) + N_1(p_2 r)]. \end{aligned} \quad (26)$$

¹⁰ R. I. Sarbacher and W. A. Edson, "Hyper and Ultrahigh Frequency Engineering," John Wiley & Sons, Inc., N. Y., 1943; p. 243.

The factor $e^{j(\omega t - \gamma z)}$ multiplying the right-hand sides of all of the above equations has been omitted.

The boundary conditions at the helical sheet ($r = a$) are

$$\begin{aligned} E_{z1} &= E_{z2}, \\ E_{\theta 1} &= E_{\theta 2}, \\ \frac{E_{z1}}{E_{\theta 1}} &= \frac{E_{z2}}{E_{\theta 2}} = -\cot \psi, \\ (H_{x1} - H_{x2}) + (H_{\theta 1} - H_{\theta 2}) \cot \psi &= 0. \end{aligned} \tag{27}$$

For a nontrivial (that is, one in which the coefficients B , D , and F are not zero) solution to exist, the following equation must hold

$$\omega^2 \frac{\mu_2}{p_2} \cot^2 \psi \left\{ \frac{\epsilon_2 \left[-GJ_1(p_2a) + N_1(p_2a) - \frac{\epsilon_1 J_1(p_1a)}{p_1 J_0(p_1a)} \right]}{-GJ_0(p_2a) + N_0(p_2a)} \right\}$$

$$= - \left(\frac{\mu_2}{\mu_1} \right) \left(\frac{p_1}{p_2} \left[\frac{J_0(p_1a)}{J_1(p_1a)} + \frac{-HJ_0(p_2a) + N_0(p_2a)}{-HJ_1(p_2a) + N_1(p_2a)} \right] \right). \tag{28}$$

This equation determines the propagation constant when the dimensions, dielectric constants, etc. are specified. When the outer conductor is removed, the equation reduces to that given by Harris.¹¹ When the dielectric on both sides of the helix is identical and the outer conductor is removed, the equation becomes

$$\frac{\beta_0^2 \cot^2 \psi}{p^2} = - \frac{J_0(pa)H_0^{(1)}(pa)}{J_1(pa)H_1^{(1)}(pa)}. \tag{29}$$

This result is the same as that given by Pierce,¹ and by Chu and Jackson.²

¹¹ L. A. Harris, H. R. Johnson, A. Karp, and L. D. Smullin, "Some measurements of phase velocity along a helix with dielectric supports," RLE (MIT) Report No. 93; January 21, 1949.

CORRECTION

G. L. Matthaei, author of the paper, "Conformal Mapping for Filter Transfer Function Synthesis," which appeared on pages 1658-1664 of the November, 1953 issue of the PROCEEDINGS OF THE I.R.E., has requested that the editors publish the following corrections:

Due to a computational oversight, a false check was obtained on (30) and (31). To yield the reported accuracy, the argument of these equations must be cut in half so they will read for the double-charge procedure

$$\nu \approx \left[\cosh \left(\frac{n\pi K}{4K'} \right) \right]^4, \tag{30b}$$

and for the single-charge procedure

$$\nu \approx \left[\cosh \left(\frac{n\pi K}{4K'} \right) \right]^2. \tag{31b}$$

The check described in the paper was obtained by accidental use of the form, (31).

To derive (30b) and (31b), it is necessary to use one more chain of poles in the approximating function than was indicated by (29). Then for the *single-charge* procedure the equation analogous to (29) is

$$\frac{\cosh \left(\frac{n\pi w}{2K'} \right)}{\cosh \left[\frac{n\pi(w + K)}{2K'} \right] \cosh \left[\frac{n\pi(w - K)}{2K'} \right]}. \tag{29a}$$

This function gives much better results because the extra row of poles along the line $u = +K$ improves the approximation along the iv axis, while due to the influence of its excess of zeros at infinity, (29a) also gives a better approximation along the line $u = -K$. Computing ν from (29a) gives for the single-charge procedure

$$\nu = \frac{H'(-K + jK')}{H'(jK')} \approx \frac{\cosh^3 \left(\frac{n\pi K}{2K'} \right)}{\cosh \left(\frac{n\pi K}{K'} \right)}. \tag{31a}$$

If $n\pi K/4K' = 1.9$, (31a) gives about 0.05 per cent error, and the error decreases rapidly as $n\pi K/4K'$ increases. If $n\pi K/4K' = 2.7$, (31a) can be approximated by (31b) to give less than 1 per cent over-all error, and again the error will decrease rapidly as the argument increases. Equation (30b) can be obtained in an analogous manner from (29a) squared.

Correspondence

Noise in a Nonlinear Conductance*

The space-charge thermal-noise reduction factor derived by North¹ can be shown qualitatively by a simple comparison of the "scale factors" of the spectra for temperature-limited and space-charge-limited noise. It can further be shown that a simple equivalent network derived from I/E and $\partial I/\partial E$ can be used to represent the tube, or other nonlinear conductance, as a noise source.

The spectrum of shot noise, either temperature-limited or space-charge-limited, is well known to be uniform for frequencies small compared with the reciprocal of the transit time. Furthermore, it is well established that the mean-square fluctuation current is proportional to the direct current for a particular type of current limiting.

In a diode circuit the direct current flowing through the diode itself is made up of in-flight electrons. Regardless of whether the diode is temperature or space-charge limited, the diode current is determined by the average rate of flow of charge in coulombs per second. However, during flight the electrons have a velocity function determined by the type of limiting. Therefore, on the basis that noise currents result from currents induced in external circuit by flight of the individual electrons, it is logical that differences in velocity functions may cause differences in noise currents. Fig. 1 shows a time diagram of the elementary electron

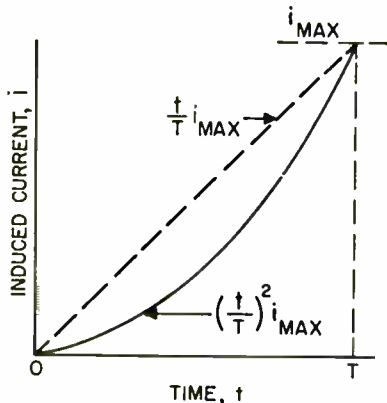

Fig. 1—Time diagram of electron flights—solid curve is for space charge limiting, dashed curve is for temperature limiting.

flights, the dashed curve representing temperature-limited operation and the solid curve representing space-charge-limited operation. The contributions to the direct current in both of the cases shown in Fig. 1 are equal. Although the low-frequency spectrum in each case is that for random combinations of impulses (i.e., a uniform spectrum), the magnitudes or "scale factors" in the two cases will be different because of the different

shapes of the elementary electron flights. The ratio of the scale factors of the two spectra will be in the ratio of the induced currents. Therefore,

$$\begin{aligned} \frac{(\overline{i_n^2})_{SCL}}{(\overline{i_n^2})_{TL}} &= \frac{i_{SCL}}{i_{TL}} \\ &= \frac{1}{T} \int_0^T i_{\max} \left(\frac{t}{T}\right)^2 dt \\ &= \frac{1}{T} \int_0^T i_{\max} \left(\frac{t}{T}\right) dt \\ &= 2/3. \end{aligned} \quad (1)$$

This result agrees well with North's approximate result, $\theta \approx 0.644$.

The same result is obtainable from the Child-Langmuir equation for space-charge limited current (which, is itself, related directly to Fig. 1), $I = kE^{3/2}$. If the diode is considered as a resistor from which only thermal noise current is available, the conductance determining the noise current is the conductance related to the number of current carriers flowing, or I/E . On the basis of small-signal theory, however, the available noise power is $i_n^2/(4\partial I/\partial E)$. The output noise ratio of the diode will, therefore, not be unity. Instead, the noise must be altered by a factor $(I/E)/(\partial I/\partial E)$, which is $2/3$ from the Child-Langmuir equation.

It can be deduced by generalizing on the same argument that, since an arbitrary nonlinear conductance can be represented over a restricted range by $I = KE^x$, the effective noise temperature will be

$$t_{\text{eff}} = \frac{I}{X} \quad (2)$$

when in this case t is noise temperature, not time.

Equation (2) suggests a simple equivalent circuit for noise calculations on nonlinear resistors, "noisy" conductance I/E in parallel with noise-free conductance $\partial I/\partial E - I/E$. Since the effective noise temperature of parallel conductances is

$$t_{\text{eff}} = \frac{G_1 t_1 + G_2 t_2 + \dots + G_n t_n}{G_1 + G_2 + \dots + G_n} \quad (3)$$

the result of (2) can be obtained for the proposed equivalent circuit.

It is suggested that a reduction in available noise power caused by nonlinearity of conductance may explain the fractional noise temperatures observed in many crystal rectifiers at small forward currents.^{2,3,4} For such an explanation to be possible, it is only necessary that X be larger than t in (2). For microwave mixer crystals X reaches values between 2 and 5 at forward currents of the

order of 0.5 milliampere. Since noise temperatures of this order or less may occur, regions of forward current will probably exist where $X > t$ and $t_{\text{eff}} < 1$.

P. D. STRUM
Applied Electronics Section
Airborne Instruments Lab.
Mineola, N. Y.

Distributed Amplifiers*

Delmar Payne's conclusion from analysis¹ that the gain of a distributed amplifier can be doubled by reflective termination of the plate line raises some interesting questions which the writer has discussed more fully elsewhere.² It is preferred to reserve the term "gain" for power gain (voltage can often be changed by devices such as transformers which involve neither gain nor loss); and since a reflective termination of a loss-free line precludes delivery of power to the load, such a system cannot give power gain.

The advantage of the distributed amplifier in general can be explained as follows. Amplifying devices such as thermionic tubes release power into the output circuit in proportion to the energy stored in the input circuit: for a given storage $\frac{1}{2}CV_0^2$ in the input capacitance one has an available power $i^2 r_a/4$ in the anode circuit. Rapid response (wide frequency-band) requires that the $\frac{1}{2}CV_0^2$ should be rapidly disposed of when the signal changes, and in simple amplifiers this is achieved by dissipation, e.g. shunting the input with a relatively low-resistance leak; but in the distributed amplifier the stored energy is passed on to the next stage instead of being dissipated, so that the same input energy can control any number of amplifying devices in sequence. On this basis one would expect reflective termination of the grid line to double the gain by making the signal energy traverse the system twice. Unfortunately this will give maximum advantage only at frequencies such that the resulting standing wave has a length equal to the distance between the points of connection to the tubes, and will reduce gain at other frequencies. This illustrates the point that not gain alone but gain-bandwidth is the proper criterion for amplifier performance.²

Finally it should be remembered that although the distributed amplifier gives a greater gain-bandwidth than a single one of its constituent amplifiers, it delays the signal by the transmission time of the line and therefore does not improve the gain/delay ratio of the amplifier. However, delay is generally insignificant in other than closed-loop systems so that this is not an important limitation of distributed amplifiers.

D. A. BELL
Dept. of Elec. Eng.
Univ. of Birmingham
England

* Received by the IRE, February 8, 1954.

¹ D. O. North, "Fluctuations in space-charged currents at moderately high frequencies, part II," R.C.A. Rev., vol. 4, pp. 441-472; April, 1940; and vol. 5, pp. 106-124; July, 1940.

² Private communication from C. T. McCoy of Philco Corporation.

³ R. N. Smith, material included in "Crystal Rectifiers," by H. C. Torrey and C. A. Whitmer, vol. 13, Rad. Lab. Series, McGraw-Hill, New York, N. Y., pp. 185-186; 1948.

⁴ R. W. Douglas and E. G. James, "Crystal diodes," Jour. IRE, part III, vol. 98, p. 163; May, 1951. Discussion on the Papers by Mr. Douglas, Dr. James, and Mr. Scott, Jour. IRE, part III, vol. 98, p. 183; May, 1951.

* Received by the IRE, April 6, 1954.

¹ D. V. Payne, "Distributed amplifier theory," Proc. I.R.E., vol. 41, p. 759; June, 1953.

² D. A. Bell, "General theory of electromagnet amplifiers," to be published in *Wireless Engineer*.

Correspondence

Impedance Transformation in Folded Dipoles*

I would like to express my appreciation of M. Zakhaim's letter on the above.¹

The scalar potential in the proximity of a dipole with circular cylindrical elements is (with good approximation) logarithmic. It can, therefore, be considered as a potential of a two-dimensional electrostatic field, as M. Zakhaim has shown, for conductors of any shape of cross-section.

Incidentally, I myself have used the same interpretation when I presented the folded dipole formulas in a popular, elementary form in "Amateur Radio," Melbourne (Australia), vol. 15, no. 5, May 1947.

Furthermore, plotting of two-dimensional electrostatic fields was used to determine the practical range of the formulas in my paper,² given in the last paragraphs of Section IV and Section V.

We can summarize by saying that the two-dimensional electrostatic field is encountered, (1) on statically charged parallel conductors, (2) when electromagnetic waves travel along parallel conductors (of infinite length), and (3) with good approximation, in the proximity of the radiating conductors of folded dipoles.

The explanation for the last mentioned fact is that the field on and near the surface of a dipole element is adequately defined by the charges in the neighborhood. The more distant (retarded) charges have no pronounced influence. Consequently the charge distribution along the antenna is not critical as mentioned already in the penultimate paragraph of Section III of my paper.¹

R. GUERTLER

The N.S.W. Univ. of Technology
School of Elec. Eng.
Sydney, Australia

* Received by the IRE, April 5, 1954.

¹ M. Zakhaim, correspondence on "Impedance transformation in folded dipoles," PROC. IRE, vol. 41, p. 1061; August, 1953.

² R. Guertler, "Impedance transformation in folded dipoles," PROC. IRE, vol. 38, p. 1042; September, 1950.

A Bridge Equivalent for a Brune Cycle Terminated in a Resistor*

In a previous letter to the editor,¹ a conversion cycle was suggested that converts the Brune cycle with an ideal transformer into a cycle without an ideal transformer. Since the case of a biquadratic function has been widely used in the literature (because of its simplicity), a further treatment of this case is of special interest. In the case of a biquadratic driving-point impedance function representing a Brune cycle with an ideal

* Received by the IRE, February 11, 1954. This work was supported in part by the Signal Corps, the Air Materiel Command, and the Office of Naval Research.

¹ F. M. Reza, "Synthesis of one terminal-pair passive networks without ideal transformers," PROC. I.R.E., vol. 42, p. 349, January, 1954.

transformer, one has to replace the network of the driving-point impedance z of Fig. 1 by a resistor r . The values of the elements of the conversion cycle (Fig. 2, reference 1) are readily computed from formulas suggested in reference 1.

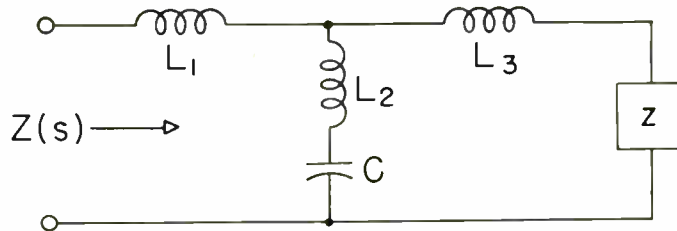

Fig. 1—A Brune cycle with an ideal transformer. Case $L_1 > 0$

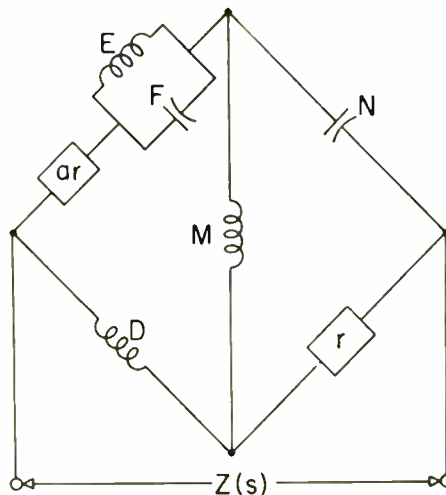

Fig. 2—An unbalanced bridge structure equivalent to Fig. 1 for $z = r$.

$$L_3 k + z(k) = 0, \quad k = -\frac{r}{L_3}$$

$$Z_A = \frac{k^2 L_2 (L_3 s + z)}{s z + L_3 k^2} = r$$

$$Z_B = \frac{L_1^2}{L_3} \cdot \frac{L_3 k^2 + s z}{L_3 s + z} = \frac{r(L_1 + L_2)}{L_2 + L_3}$$

The conversion cycle contains eight elements, in contrast with only five elements of the Brune network (including one negative element).

In an effort to reduce the number of elements of the conversion cycle, note that this cycle presents a balanced bridge.² This fact suggests that an unbalanced bridge may be considered next. A bridge structure corresponding to Fig. 1 is suggested in Fig. 2, with the proper values of the elements.

² F. M. Reza, "A supplement to the Brune synthesis," Presented to the AIEE Winter Convention, January, 1954.

$$D = L_1 \quad a = \frac{L_1 + L_2}{L_2 + L_3}$$

$$M = \frac{L_3 L_2 c k^2}{L_2 c k^2 - 1} \quad N = c - \frac{1}{k^2 L_3}$$

$$E = \frac{L_1^2 (1 + c L_2 k^2)^2}{L_2 (1 - c L_3 k^2)} \quad F = \frac{L_2^2 c (1 - c L_3 k^2)}{L_1^2 (1 + c L_2 k^2)^2}$$

Note that this equivalent structure contains seven elements. Only in very special cases of some biquadratic functions, reduction of the number of elements to a minimum of five is possible.

In the case of $L_1 < 0$, one may follow the identical procedure on the admittance basis.

The above considerations have been generalized to give an equivalent network without ideal transformers for a Brune network with any number of ideal transformers.

F. M. REZA
Research Lab. of Electronics
Dept. of Elec. Eng.
Mass. Inst. of Tech.
Cambridge, Mass.

NTSC Signal Specifications for Color Television*

A correction should be noted on page 19 of the January 1954 issue of the PROCEEDINGS, second column, fifteenth line, which reads: "1. The chrominance signal is so proportioned that it vanishes for the chromaticity of CIE illuminant C ($x=0.310$, $y=0.316$)." This is the language officially adopted by the NTSC in July, 1953. However, in November of 1953 the FCC requested a clarification of this standard particularly since there was ambiguity regarding the part of the system at which illuminant C was to be used as a reference. The matter was referred to the NTSC Editorial Committee and the standard was rewritten to remove the ambiguity. The revised version was submitted to the FCC on Nov. 16, 1953.

The color television standards as approved and promulgated by the FCC on December 17, 1953, follow the revised version of the standard as follows: "Paragraph 3.682 (20) (v)—The radiated chrominance subcarrier shall vanish on the reference white of the scene."^{2a}

D. G. FINK
Chairman, NTSC Editorial Committee

* Received by the IRE, March 12, 1954.

^{2a} The numerical values of the signal specification assume that this condition will be reproduced as CIE Illuminant C ($x=0.310$, $y=0.316$).

Correspondence

Ages of Creativeness of Electronic Engineers*

A recent study¹ of the quality and quantity of creative output in relation to age indicated that the most notable contributions to the fields of mathematics, physics, and electronics were made at the greatest rate when the individuals were not more than 30-34 years old. A sample analysis of the ages of contributors to the PROCEEDINGS OF THE I.R.E. has been found to agree closely with this study.

Fig. 1 shows histograms of the ages of 474 contributors to the PROCEEDINGS OF THE I.R.E. in 1931, 1941, and 1951, respectively. These years were selected to see if there were any changes in age patterns in the past few decades. Data were not readily available for years prior to 1931, and World War II years were avoided. Fig. 2 shows the ages of 117 contributors to two special issues of the PROCEEDINGS, the Transistor issue in November, 1952, and the Computer issue in October, 1953. These particular issues were examined in order to see the distribution of ages of pioneers in two new fields.

It is desirable to make statistical adjustments to these histograms of chronological age productivity in order to take account of the variation of the number of individuals alive at successive age levels. If there were half as many engineers ages 40-44 as 30-34, it might be reasonable to expect only half as many creative works in a period such as a year. Fig. 3 shows the Census² figures for percentage of the American population at various age levels. It is assumed that electronic engineers are normal human beings and that these statistics apply.

Fig. 4 has three curves. The solid line shows the ages at which 62 men born between 1845 and 1875 made 170 important contributions to electrical development as determined in Dr. Lehman's study of age and achievement. The broken line shows the ages of 474 contributors to the PROCEEDINGS OF THE I.R.E. in 1931, 1941, and 1951. This curve represents the data given in the histograms of Fig. 1 which have been combined, grouped by five-year intervals and statistically adjusted to make allowance for the smaller number of engineers alive at older age levels. Finally, the dotted line indicates the ages of the 117 contributors to the special Transistor and Computer issues of the PROCEEDINGS. This curve represents the data of Fig. 2 adjusted as described above.

This brief analysis raises many questions of interest both to individual engineers and those responsible for engineering management. Remembering that these statistics are basically averages reflecting over-all conditions and do not apply to a particular individual, an engineer might well ask him-

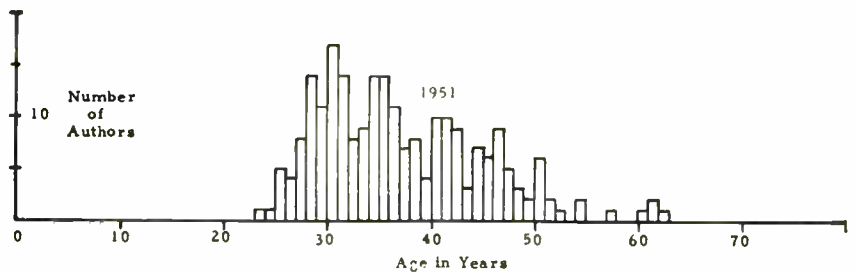
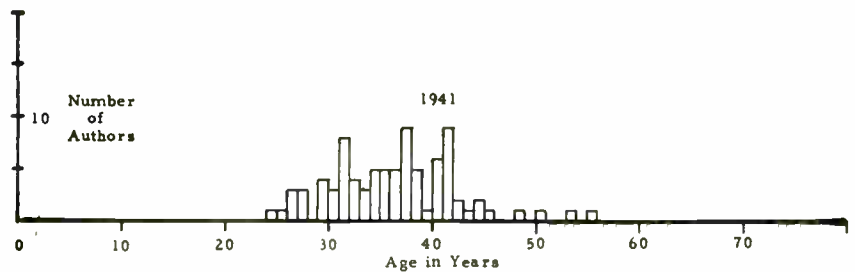
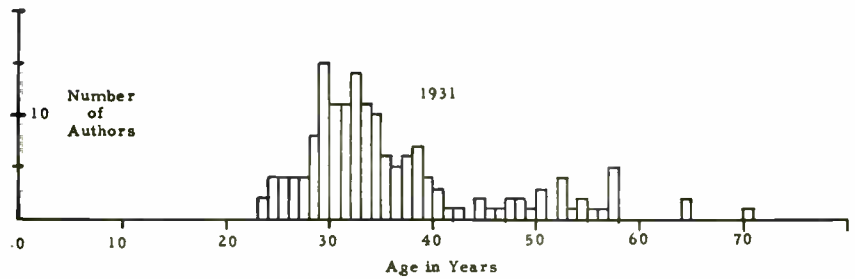

Fig. 1—Age of contributors to PROCEEDINGS OF THE I.R.E.



Fig. 2—Age of contributors to special issues of the PROCEEDINGS OF THE I.R.E.

self whether he is in a job which permits him to learn in his formative years and create in his creative years. He should avoid blind-alley jobs which fritter away his time doing sub-professional tasks during years when creative power might be strongest. He might

also consider whether or not a promotion which might require his becoming a junior administrator is worth the temporary salary advantage in the long run if this should occur at an age when he is still near the peak of creativeness.

* Received by the IRE, March 15, 1954.
¹H. C. Lehman, "Age and Achievement," *Memoirs of the American Philosophical Society*, vol. 33, Princeton University Press, 1953.
²Sixteenth Census of the United States: 1940 Population, "Characteristics by Age," part I, U. S. Summary, vol. 14, p. 3.

Correspondence

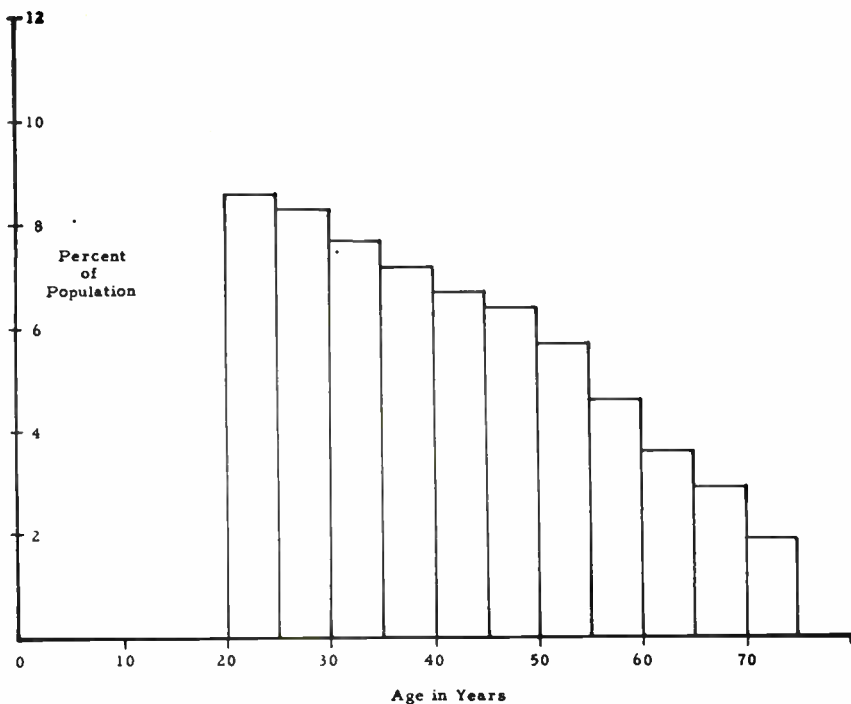

Fig. 3—Percentage of population at various ages.

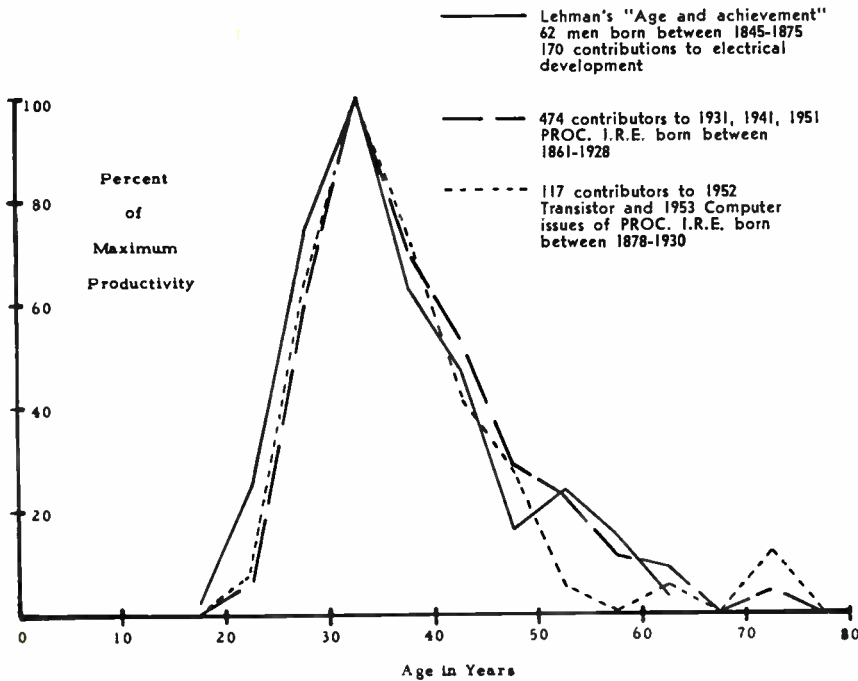

Fig. 4—Age and creativeness.

Executives responsible for engineering management have, of course, been worrying about problems of how to make maximum use of engineers.³ Age studies may indicate

³ "How to improve the Utilization of Engineering Manpower," National Society of Professional Engineers; 1953.

one area where direct action can be taken to avoid wasting engineers' talents on non-creative activities during creative ages. Constructive policies of providing an adequate number of technician assistants and protection from some of the time and energy consuming administrative routines seem indi-

cated. Perhaps some means of rewarding engineers which does not require turning them into administrators and executives is necessary.

RUSSELL COILE
4323 Rosedale Avenue
Bethesda 14, Md.

Internal Transistor Oscillations*

The frequency of present day transistor oscillators is limited to the vicinity of the alpha cutoff frequency but this limitation can be overcome by the use of self-oscillations and their higher modes.

Some 35 years ago, the transit time region of vacuum tubes was opened by the discovery of electron oscillations around a positive grid, the so-called BARKHAUSEN oscillations.¹ The characteristic of these internal oscillations in a retarding-field tube is that their frequency, in a first order approximation, is a function of the grid potential. Additional phenomena are higher modes or overtones.²

In the transistor field, an equivalent phenomenon occurs in the form of internal oscillations without external resonance systems being present although the principle is not based on oscillating electrons or holes. Based on a "Dual Miller Effect," the emitter "sees" the collector capacity as a duet which means in the form of a negative capacity equivalent to an induced inductance. This inductance, in connection with the "cold" transistor capacities, forms a resonator which, in turn, is excited by the negative component of the transistor resistance. BARKHAUSEN electron oscillations and the new transistor oscillations reveal their duality by the formulas $f_o^2/V_o = \text{const.}$ in the first case and $f_o^2/I_c = \text{const.}$ in the transistor case, which differ only in that the positive grid-potential V_o is replaced with the collector current I_c .

Without overloading the commercially available point-contact transistor of today, the frequency f_o of the self-oscillations runs as high as 75 mc which is from 100- to 200-per cent above the alpha cutoff value. In addition, oscillations of a higher mode reach up to the tenth order of harmonics. Consequently, self-oscillating transistors in combination with cavity resonators produce uhf. Transistors of the future having higher cutoff frequencies may easily produce several hundred megacycles and their overtones then enter the microwave region.

H. E. HOLLMANN
U S. Naval Air Missile Test Center
Point Mugu, Calif.

* Received by the IRE, March 15, 1954.

¹ H. Barkhausen and H. Kurz, "Die kürzesten mit Vakuumröhren herstellbaren Wellen," *Phys. Zeits.*, vol. 21, pp. 1-6; 1920.

² H. E. Hollman, "On the mechanism of electron oscillations in a triode," *Proc. I.R.E.*, vol. 17, p. 229; 1929.

IRE News and Radio Notes

WORLD SYMPOSIUM PLANNED FOR JANUARY

A World Symposium on Applied Solar Energy will be held next January 12-15 under the leadership of Stanford Research Institute. Headquarters for the symposium will be the Westward Ho Hotel in Phoenix, Arizona.

The four-day meeting of leading world scientific and industrial interests in solar energy utilization will attempt to evaluate present knowledge in terms of practical applications. Special sessions will be devoted to the potential use of solar energy to solve problems of individual industries.

Major centers of solar energy research in the United States will be represented and arrangements are being made for presentations by solar scientists and engineers from England, France, Germany, India, Japan, Australia and South Africa.

The Association for Applied Solar Energy, formed last March 17 by a group of Southwestern industrialists, bankers, agriculturalists and educators, is sponsoring the symposium. Chairman of the symposium is Lewis W. Douglas, and Merritt L. Kastens is vice-chairman.

Special sessions have been planned for the January symposium to cover the uses of solar energy in the fields of agriculture, the construction industry, the metal fabrication industry, the chemical process industry, and power and fuel research. It is expected that these sessions will be widely attended by members of these fields.

Another special session will be held for representatives of the United States, foreign governments and large charitable foundations concerned with living standards in underdeveloped areas. According to Mr. Kastens, who is in charge of advance planning for the symposium, "The abundant energy of the sun offers many regions of the earth hope of new water development, domestic heat for cooking and space heating and possible new food and fuel sources."

COMPUTER PUBLICATIONS AVAILABLE

Copies of the following publications on electronic computers are available at the prices listed from the Institute of Radio Engineers, 1 East 79 St., New York 21, N.Y.: "Review of Electronic Digital Computers," Joint AIEE-IRE Computer Conference, December, 1951, Philadelphia, Pa., \$3.50 per copy; "Input and Output Equipment used in Computing Systems," Joint AIEE-IRE-ACM Computer Conference," December, 1952, New York, N.Y., \$4.00 per copy; "Proceedings of the Joint AIEE-IRE-ACM Western Computer Conference," February, 1953, Los Angeles, Calif., \$3.50 per copy; "Proceedings of the AIEE-IRE-ACM Joint Eastern Computer Conference," held December 8-10, 1953, in Washington, D.C., \$3.00 per copy; "Trends in Computers: Automatic Control and Data Processing," Joint IRE-AIEE-ACM Western Computer Conference, February, 1954, Los Angeles, Calif., \$3.00 per copy.

First Call For Papers

IRE NATIONAL CONVENTION—NEW YORK CITY— MARCH 21-24, 1955

Prospective authors are requested to submit all of the following information:

- (1) 100-word abstract in triplicate with title of paper and full name and address of author.
- (2) 500-word summary in triplicate with title of paper and full name and address of author.
- (3) Indicate the technical field in which your paper falls:

Aeronautical & Navigational Electronics	Industrial Electronics
Antennas & Propagation	Information Theory
Audio	Instrumentation
Broadcast & Television Receivers	Medical Electronics
Broadcast Transmission Systems	Microwave Theory & Techniques
Circuit Theory	Nuclear Science
Communications Systems	Production Techniques
Component Parts	Quality Control
Electron Devices	Radio Telemetry & Remote Control
Electronic Computers	Ultrasonics Engineering
Engineering Management	Vehicular Communications

Deadline for acceptance of papers: November 15, 1954

Address all material to: Mr. _____, Chairman
1955 Technical Program Committee
Institute of Radio Engineers, Inc.
1 East 79 Street
New York 21, N. Y.

Calendar of COMING EVENTS

- IRE-WCEMA Western Electronic Show & Convention, Pan Pacific Auditorium, Los Angeles, Calif., August 25-27
- IRE-AIEE-URSI Symposium on Information Theory, Massachusetts Institute of Technology, Cambridge, Mass., September 15-17
- Cedar Rapids Conference on Communications, Cedar Rapids, Iowa, September 17-18
- IRE Professional Group on Industrial Electronics Annual Conference, Mellon Institute of Industrial Research, Pittsburgh, Pa., September 29-30
- IRE Professional Group on Vehicular Communications Meeting, Rice Hotel, Houston, Texas, September 30-October 1
- National Electronics Conference, Hotel Sherman, Chicago, Ill., October 4-6
- IRE Professional Group on Nuclear Science Annual Conference, Sherman Hotel, Chicago, Ill., October 6-7
- Symposium on Marine Communication and Navigation, Hotel Somerset, Boston, Mass., October 13-15
- IRE-RETMA Radio Fall Meeting, Hotel Syracuse, Syracuse, N. Y., October 18-20
- IRE Baltimore Section-PGANE East Coast Conference on Airborne and Navigational Electronics, Sheraton-Belvedere Hotel, Baltimore, Md., November 4-5
- IRE-PIB Microwave Symposium, Engineering Societies Auditorium, New York, N. Y., November 8-10
- IRE-AIEE Conference on Electrical Techniques in Medicine and Biology, Morrison Hotel, Chicago, Ill., November 10-11
- IRE Quality Control Symposium, Statler Hotel, New York, N. Y., November 12-13
- Symposium on Fluctuation Phenomena in Microwave Sources, Western Union Auditorium, New York, N. Y., November 18-19
- IRE Kansas City Section Annual Electronics Conference, Hotel President, Kansas City, Mo., November 18-19
- IRE-AIEE-ACM Eastern Computer Conference, Bellevue-Stratford Hotel, Philadelphia, Pa., December 8-10
- IRE-AIEE-NBS-URSI Conference on High Frequency Measurements, Hotel Statler, Washington, D. C., January 17-19
- IRE National Convention, Waldorf-Astoria Hotel and Kingsbridge Armory, New York, N. Y., March 21-24

NEW REGIONAL BOUNDARY PLAN ADOPTED

The IRE Board of Directors recently adopted a new Regional boundary plan, which will become effective on January 5, 1955. This plan was worked out very carefully, in consultation with the Sections, to provide for a more even distribution of membership and Sections among the Regions. Consideration was also given to travel problems and community of interest.

A comparison of the present and new Regional territories is given at the right. The second column indicates the present distributions and the third column the new distribution of Sections among the Regions. The figures in parentheses in the center column indicate the Regions to which the Sections so marked will be transferred; in the right-hand column the figures in parentheses indicate the Regions *from* which they will be transferred.

EVERITT AND SAMUEL APPOINTED TO TECHNICAL PANEL

William L. Everitt (A'29-M'29-F'38) and Arthur L. Samuel (A'24-VA'39-SM'44-F'45) have been appointed to membership on the Technical Advisory Panel on Electronics, which is a part of the Office of Research and Development, Department of Defense.

Dr. Everitt is Dean of the College of Engineering, University of Illinois. He was the recipient of the 1954 I.R.E. Medal of Honor, and is a past-president of the I.R.E. Dr. Samuel is Manager of Research at the I.B.M. Corporation.

Dr. Everitt and Dr. Samuel are the first of about 50 representatives of industry who will be appointed to the Technical Advisory Panel on Electronics.

POPPELE HEADS VOICE OF AMERICA

J. R. Poppele (A'30-M'39-SM'43-F'50), former vice president in charge of engineering for Mutual Broadcasting System, has recently been appointed director of the Voice of America.

Mr. Poppele has been in communications and radio work for many years, the majority of which he served with Station WOR and the Mutual Broadcasting System. He served from 1945 to 1952 as president of the Television Broadcasters Association. In his new post, Mr. Poppele will be continuing in the field of communications—spreading the "Story of America" throughout the world.

Mr. Popelle has been on many IRE committees, and served as a Director in 1947.

CONFERENCE ON TUBE TECHNIQUES

The Second National Conference on Tube Techniques will be held on October 25-28 in the Western Union Auditorium, 60 Hudson Street, New York, N. Y., under the sponsorship of the Working Group on Tube Techniques of the Department of Defense.

Papers should be submitted to Dr. Harold Jacobs, Thermionics Branch, Evans Signal Laboratory, Belmar, N. J. Further information on the Conference may be obtained by writing to: Harold J. Sullivan, Advisory Group on Electron Tubes, 346 Broadway, New York, N. Y.

Region No.	Present Plan	New Plan
1	Boston Conn. Valley	(January 5, 1955) Binghampton (4) Boston Buffalo-Niagara (4) Conn. Valley Elmira-Corning (4) Ithaca (4) Rochester (4) Rome-Utica (4) Schenectady (2) Syracuse (4)
2	Long Island New York Schenectady (1)	Long Island New York Princeton (3)
3	Baltimore N. Carolina—Va. Philadelphia Princeton (2) Washington	Atlanta (6) Baltimore Central Florida (6) Huntsville (6) Miami (6) N. Carolina—Va. Philadelphia Washington
4	Akron Binghampton (1) Buffalo—Niagara (1) Cleveland Columbus Detroit Elmira—Corning (1) Emporium Ithaca (1) Pittsburgh Rochester (1) Rome—Utica (1) Syracuse (1) Toledo Williamsport	Akron Cincinnati (5) Cleveland Columbus Dayton (5)* Detroit Emporium Pittsburgh Toledo Williamsport
5	Cedar Rapids Chicago Cincinnati (4) Dayton (4)* Denver (6) Des Moines—Ames Evans.—Owens. Fort Wayne Indianapolis Louisville Milwaukee Omaha—Lincoln St. Louis (6) Twin Cities	Cedar Rapids Chicago Des Moines—Ames Evans.—Owens. Fort Wayne Indianapolis Louisville Milwaukee Omaha—Lincoln Twin Cities
6	Atlanta (3) Beaumont—Pt. Arthur Central Florida (3) Dallas—Ft. Worth Houston Huntsville (3) Miami (3) New Orleans Oklahoma City San Antonio Tulsa	Beaumont—Pt. Arthur Dallas—Ft. Worth Denver (5) El Paso (7) Houston Kansas City (5) Little Rock (5) New Orleans Oklahoma City St. Louis (5) San Antonio Tulsa
7	Alb.—Los Alamos El Paso (6) Hawaii Inyokern Los Angeles Phoenix Portland Sacramento Salt Lake San Diego San Francisco Seattle	Alb.—Los Alamos Hawaii Inyokern Los Angeles Phoenix Portland Sacramento Salt Lake San Diego San Francisco Seattle
8	NO CHANGE	

* Effective January, 1956.

MILLIMETER WAVE SYMPOSIUM HELD IN WASHINGTON

The first nonclassified Symposium on Millimeter Waves, sponsored by the Professional Group on Microwave Theory and Techniques, was held on May 5, 1954 in co-operation with URSI at the National Bureau of Standards in Washington, D.C.

The theme of the Symposium was millimeter waves and featured a program of eleven technical papers covering a broad field of research, development, and application, presented by prominent scientists and engineers from all sections of the country. Approximately 200 people attended each of the two technical sessions, which were held in the East Building, Room 414, at the National Bureau of Standards.

Extensive research in the millimeter wave spectrum give indications that it will occupy a very prominent place in the electromagnetic spectrum. Millimeter waves offer the research physicist a new tool for spectroscopic and molecular studies; they give the radio engineer a frequency spectrum far wider than the entire presently utilized radio frequency spectrum, including microwave frequencies, and the future should yield new concepts of RF generation and transmission.

Highlighting the sessions was a paper on dielectric waveguide, which showed the possibility of propagating these millimeter waves along a simple flexible dielectric rod with very low attenuation, and a paper on a millimeter wave amplifier of the helix traveling wave type which contained a helix made of wire with a thickness the order of a human hair, having relatively large gain and broadband characteristics. Other papers, describing millimeter wave research tools and millimeter wave generation, were also presented. A complete list of the papers will be published in a forthcoming issue of the TRANSACTIONS OF THE PGMTT.

The Chairman of the morning session was A. G. Clavier, Chairman of the Professional Group on Microwave Theory and Techniques, and the Chairman of the afternoon session was W. W. Mumford, Chairman-elect of the PGMTT. The co-operation received from the URSI technical and program committees was excellent and it is hoped that other co-sponsored symposia with this group will be held in the future. Appreciation is expressed to Dr. A. H. Waynick, Chairman, USA National Committee, URSI; Dr. E. C. Jordan, Chairman, Commission VIa; Dr. J. Pettit, Chairman, Commission VIb; and A. C. Beck, Chairman of the PGMTT Papers Procurement Committee, for their help in making this a most successful symposium.

PROFESSIONAL GROUP NEWS

NEW SECTION APPROVED

At their meeting on May 5, the IRE Board of Directors approved a petition for the Northern New Jersey Subsection to become a full Section.

The Board has also recently approved the following new Professional Group chapters: The Boston chapters of the Professional Groups on Engineering Management, Microwave Theory and Techniques, and Nu-

clear Science; the Dayton Chapters of the Professional Groups on Engineering Management and Radio Telemetry and Remote Control; the Dallas-Fort Worth Chapter of the Professional Group on Engineering Management; the Akron Chapter of the Professional Group on Electronic Computers; and the Buffalo-Niagara Chapter of the Professional Group on Microwave Theory and Techniques.

At the May 4 meeting, the Board approved the Dallas-Ft. Worth Chapter of the Professional Group on Electronic Computers, and the Boston Chapter of the Professional Group on Engineering Management. These new chapters make a total of 96 official Chapters of 20 Groups in 26 Sections.

CALL FOR PAPERS ON COMPONENT PARTS

The Professional Group on Component Parts is now in the process of organizing the publication of its TRANSACTIONS on a regular quarterly basis. In order to do this, the number of papers submitted for publication must be increased to a considerable degree. The Group, therefore would encourage everyone in this field, whether he is a member of the PGCP or not, to submit papers for possible publication.

It is felt that a quarterly publication in this important field would be of great value, and its establishment is to a great degree dependent on membership co-operation. Papers should be submitted to: W. G. Tuller, Melpar, Inc., 452 Swann Avenue, Alexandria, Va.

PROFESSIONAL GROUPS ELECT OFFICERS

The Professional Group on Electronic Computers recently held an election for the offices of Chairman, Vice Chairman, and members of the Administrative Committee. The following men were elected: Harry L. Larson, Chairman; James R. Weiner, Vice Chairman; Isaac L. Auerbach, Werner Buchholz, Bernard Gordon, William L. Martin, and Jerre D. Noe, members of the Administrative Committee.

The Los Angeles Chapter of the Professional Group on Circuit Theory has elected the following officers for the year 1954-55: Chairman, W. R. Abbott; Secretary-Treasurer, J. E. Jacobs; Members of the Steering Committee, J. Heilform and H. Low.

The Detroit Chapter of the Professional Group on Electronic Computers recently elected the following new officers: Chairman, E. Calvin Johnson; Vice Chairman, Roy S. Hock; Secretary, Thomas T. Yamauchi; Program Chairman, Donald E. Hart; Membership and Papers Chairman, Robert A. Roggenbuck; and Publicity and Arrangements Chairman, Gerald L. Licht.

NEW PGA CHAPTER APPROVED

The Phoenix Chapter of the Professional Group on Audio was officially approved by the Executive Committee on January 5, 1954. The Chapter, which had been active on an informal basis for some time, was an outgrowth of a series of technical discussions pertaining to audio prepared by members of this Section.

In the summer of 1953 a technical session was held in which a paper of a tutorial type and papers pertaining to recent equipment development were presented. The co-opera-

tion of a local broadcasting company, allowing the use of their major studio, was of great aid and fully appreciated since the papers included demonstrations of reproducing systems. The attendance of this first meeting was far greater than expected and the program as a whole was enthusiastically received.

A second technical session was conducted in the fall of 1953 of an experimental-instructional nature. Here, a subjective comparison of various loudspeakers was conducted. Types such as the bass reflex, the loaded horn, the R-J enclosure, etc., were employed. The meeting was purposely semi-technical and members were encouraged to bring their wives and guests; thus, not only demonstrating a typical meeting but also providing a larger audience to be used as the measuring medium. A surprising number of people who had never heard reproduced disc recording over a high quality system were present, and the program was a success from that standpoint alone. Because of the enthusiasm and participation shown in the technical discussion meeting, it was apparent that a nucleus for forming a professional group existed, and efforts towards this end culminated in the formation of the Phoenix Chapter.

The first formal meeting of this Chapter was held March 5, 1954, for the election of officers and discussion of future plans of the Chapter. Officers elected were: North C. Ham, Chairman, and Andrew B. Jacobsen, Secretary-Treasurer. A tapescript of the "Physics of Music and Hearing," by W. E. Koch, was also presented at the meeting.

The Chapter has tentatively planned to continue with its technical meetings of the tutorial type both on a level for the members and the general public. Also, meetings featuring guest speakers are to be conducted throughout the year.

OBITUARIES

Walter R. Jones (A'26-M'42-SM'43) died recently. He was Professor of Electrical Engineering at Cornell University at the time of his death. Prior to his affiliation with Cornell, he was with Sylvania Electrical Products, Inc. for nearly twenty years.

Mr. Jones was a Fellow of the Radio Club of America.



Ilya E. Mouromtseff (A'34-SM'45-F'47), Professor of Physics at Upsala College, died recently. Prior to his acceptance of the professorship at Upsala, he had been affiliated with Westinghouse Electric Corp. for more than twenty years, in the Tube Division and the Electronics Department. In 1947, he was awarded the Westinghouse Order of Merit.



I. E. MOUROMTSEFF

Professor Mourontseff was a member of the American Physics Society, the AIEE, and the New Jersey and National Societies of Professional Engineers.

TECHNICAL COMMITTEE NOTES

The **Antennas and Waveguides** Committee met on April 14th. P. H. Smith was acting Chairman. The committee unanimously thanked its outgoing Chairman, D. C. Ports, for his untiring efforts and inspiring leadership in connection with the work of this committee. The committee was informed that in the interest of expedience a proposed introduction for the Definitions of Waveguide Component Terms was prepared by P. H. Smith and edited by D. C. Ports and that this is currently on "grand tour" with the definitions. The committee will have a final opportunity of approving or rejecting this. There were some changes made in the latest version of the proposed Standards on Waveguide and Waveguide Components Measurements.

On April 8th the **Feedback Control Systems** Committee convened under the chairmanship of J. E. Ward. Chairman Ward reviewed the discussions of the joint meeting of the Committee and the Subcommittee last month. It was decided that since agreement had been reached regarding the use of a summing point at this meeting, that it would now be possible to proceed with the preparation of the report tentatively entitled "Recommended Symbols and Terminology for Feedback Control Systems." Chairman Ward will prepare a draft of the report (excluding terminology which will be prepared by the subcommittee) for discussion at the next meeting. It was reported that W. M. Pease has resigned as IRE representative on ASA Committee Y10.14 and that Chairman Ward has been asked to select a new representative. The new wording of the scope of the Feedback Control Systems Committee approved by the Standards Committee on February 11, 1954 was given. The discussion of Measurements and Standards of Performance was continued. E. A. Sabin reported on the list of terms he had investigated since the last meeting. The following definitions—Command Resolution, Control Accuracy, Control Precision and Control Resolution—taken from the AIEE Proposed Standards of Terminology for Feedback Control Systems were also discussed. G. A. Biernson reported on the list of terms that had been assigned to him at a previous meeting.

The **Sound Recording and Reproducing** Committee convened on April 9th under the chairmanship of A. W. Friend. It was announced that Messrs. Ellis W. D'Arcy, Marvin Camras, and Alvin H. Willis had been appointed members of the committee and that Messrs. J. H. McGuigan and R. E. Zenner had resigned because of other activities. Dr. Peterson, Chairman of Subcommittee 19.1, was absent. Dr. Friend read a letter from him stating that he has appointed John S. Boyers to the membership of this Subcommittee. He also stated that the three proposals prepared by his Subcommittee are still in the process of revision in accordance with suggestions from the main committee. Mr. Thompson, Chairman of Subcommittee 19.2, could not be present. The Chairman reported that Lincoln Thompson had told that his Subcommittee is still working on the tentative standard on "Disk Frequency Records" and that they hope to have the material ready by the time of the next meeting of the main committee. The scope

of the committee which appeared in the Minutes of January 19th was considered by the Standards Committee and resulted in the deletion of Item 4 and the modification of other details to correspond with changes made in other committee scopes during the same meeting. The Chairman also reported that some areas of conflict between this tentative scope and the scopes of other IRE Committees have been under consideration, that the Standards Committee has formed an ad hoc committee to deal with these conflicts and to report back with recommendations for their resolution, and that the Chairmen of all committees involved have been appointed to membership on the ad hoc committee. Dr. Begun called to express his interest in initiating work on the relative phasing of signals on multiple track record films or tapes. The Committee agreed to include this matter on the agenda of its next meeting, if Dr. Begun could arrange to be in attendance to present his ideas.

The **Standards** Committee met on May 13th with the new Chairman, Dr. Ernst Weber, presiding. The Committee considered a letter from the Eastern Definitions Subcommittee of the Electronic Computers Committee which requested permission to print in the Professional Group Transactions an unapproved glossary of terms labeled "Not an IRE Standard." The Standards Committee suggested that the glossary could be widely circulated for the desired comments, but that the policy of publishing only approved standards in official IRE publications be upheld. The Committee endorsed a request from P. S. Christaldi, Chairman of the Measurements and Instrumentation Committee, to the Executive Committee that reprints of IRE Standards be furnished to members of all committees and subcommittees for reference purposes. Jack Avins, Chairman of the Ad Hoc Committee on a New Unit for Logarithmic Ratios, reported that progress toward mutual understanding had been made at an informal meeting of several persons particularly interested in this subject, which was held on April 15. The Committee agreed to study all available material on the subject before the next meeting, and take a definite action at that time. The Committee planned to consult professional societies and educational leaders in several scientific fields before definitely trying to standardize a new unit. The Committee considered the Proposed Standards on Pulses: Methods of Measurement of Pulse Quantities which had been submitted by the Radio Transmitters Committee. It was agreed that further technical editing be done before resubmitting to the Standards Committee. The Committee made several changes in the Proposed Standards on Receivers: Methods of Measurement of Interference Output of Television Receivers in the Range of 300 to 10,000 KC and gave its approval to the revised version. Mr. Baldwin announced that a list of Transistor Definitions prepared by the Electron Devices Committee would be considered at the next meeting on June 10.

The **Audio Techniques** Committee met on May 12, with Don E. Maxwell, the new Chairman, presiding. Two new members, O. C. Bixler and G. H. Grenier, were introduced to the Committee. The Chairman an-

nounced the resignation of H. W. Augustadt and expressed the appreciation of the Committee for his fine contributions to the Committee, especially on the Standards on Audio Techniques: Definitions of Terms, 1953 which will be published in the PROCEEDINGS in the near future. The Committee made revisions in the Proposed Standards on Audio Systems and Components Excluding Recording: Methods of Measurement.

The **Standards** Committee met on June 10 under the chairmanship of Ernst Weber. After much discussion on two proposed terms for a new unit for logarithmic ratios ("logit" and "decilog") the Committee voted to adopt the term "decilog." The choice of a symbol was referred to the IRE Symbols Committee. The Committee also approved the Electron Devices Committee's Proposed Standards on Electron Devices: Definitions of Semiconductor Terms (54 IRE 7.S2).

On May 7 the **Facsimile** Committee convened under the chairmanship of Henry Burkhard. There was a discussion on the preparation of the IRE facsimile test chart. Various committee members were assigned the job of preparing certain sections of the master. Action was taken by the committee on a number of definitions.

The **Radio Transmitters** Committee met on May 20 under the chairmanship of P. J. Herbst. There was a discussion by the committee on the definition of "spurious radiation." It was H. R. Butler's opinion that "spurious radiation" described only the unwanted radiation outside the assigned band. A. E. Kerwien disagreed with Mr. Butler and suggested that although it would be easier to define "spurious radiation" as unwanted radiation outside the assigned band, that the problem of unwanted radiation inside the assigned band was a part of the same problem, and should be described by the same general term. A vote was taken, the result of which was five to four in favor of Mr. Kerwien's opinion. The vote was so close that no action was taken and Mr. Kerwien and Mr. Butler were asked to prepare arguments for each side of the question for submission to the entire Committee for a vote by mail. The next item on the agenda was a discussion of 53 IRE 15.6 PSI Standards on Television: Methods of Testing Television Broadcast Transmitters. T. M. Gluyas, Chairman of Subcommittee 15.6, stated that as suggested by the committee in its meeting on February 18 the section 1.1.3 (a) had been amended. Mr. Gluyas distributed copies of the Subcommittee's revision of Section 4.1. Mr. Herbst asked that the subcommittee give a fuller explanation of the Technique of Measuring (Section 4.1.2 (c)) and Mr. Gluyas agreed to do so. Mr. Herbst announced that the Proposed Standards on Pulses: Methods of Measurement of Pulse Quantities, Part I, 1954, had been considered by the Standards Committee at its meeting on May 13, and that they had asked that this Standard be edited. It will be considered again by that Committee at a later date. H. E. Goldstine, acting Chairman of Subcommittee 15.2 stated that revisions were being made from comments received on the August 1953 version of the Proposed Standards on Methods of Testing Radio-Telegraph Transmitters (below 50 mc) and that it would be submitted to the committee in the near future.

Western Electronic Show & Convention*

PRELIMINARY PROGRAM

PAN PACIFIC AUDITORIUM, LOS ANGELES, CALIF.—AUGUST 25–27, 1954

NEW DEVELOPMENTS IN TELEMETERING

Session Chairman (Not yet announced.)

- "Delay Line Controlled Subcarrier Discriminator," K. A. Morgan and R. F. Blake, Naval Research Laboratory
- "A Temperature Stable Transistorized V.C.O.," F. M. Riddle, California Institute of Technology
- "A Transistorized FM/FM Telemetering System," R. E. Colander and C. M. Kortman, Pacific Div., Bendix Aviation Corp.
- "A High Performance RF Preamplifier and Multicoupler," W. S. Knowles, formerly of the Applied Science Corporation of Princeton, and K. M. Uglow, Consulting Engineer

APPLICATION OF COMPONENT PARTS

Session Chairman: M. B. Carlton, Co-ordinator of Reliability Office of the Assistant Secretary of Defense

- "Short Time Ratings for Paper Capacitors," W. M. Allison, Sprague Electric Co.
- "Rotating Components and Their Application to Advanced Electronic Systems," R. N. Brown, Kearfote Company, Inc.
- "Appraisal of Wire-Wound Potentiometers," J. A. Csepely, Westinghouse Electric Corp.
- "Relay Characteristics and Application," C. F. Cameron, Oklahoma A & M College

PROFESSIONAL GROUP ON ELECTRONIC COMPUTERS

Session Chairman (Not yet announced.)

- "A Dependent Variable Analog Function Generator," C. J. Savant, Jr., North American Aviation, Inc. and R. C. Howard, Bell Telephone Laboratories
- "Automatic Iteration on an Electronic Analog Computer," L. B. Wadel, Chance-Vought Aircraft, Inc.
- "A Logarithmic Voltage Quantizer," E. M. Glaser and H. Blasbalg, Johns Hopkins University

TELEMETERING AS APPLIED TO PILOTED AIRCRAFT

Session Chairman (Not yet announced.)

RECENT DEVELOPMENTS IN PARTS

Session Chairman (Not yet announced.)

- "The User Looks At the Component Parts Problem," A. M. Okun, Bell Aircraft Corp.
- "Packaging of Component Parts for High Intensity Vibration Environments," M. G. Comuntzis, California Institute of Technology
- "A Sensitive Nonmagnetic Relay," Mullenbach Electrical Mfg. Co.
- "Temperature Stabilization of Transistor Amplifiers," R. B. Hurley, Convair

* Sponsored jointly by the Los Angeles and San Francisco Section of the IRE and the West Coast Electronic Manufacturers Association.

- "Reliable Electronics Through Protective Coating Techniques," E. R. Gamson and A. Henesian, Stanford Research Institute

COMPUTERS

Session Chairman, Marc Shiowitz, Computer Research Corp. of California

- "Transistor Flip-Flops for High-Speed Digital Computers," E. U. Cohler, Massachusetts Institute of Technology
- "Computer-Programmed Preventive Maintenance for Internal Memory Sections of the E.R.A. 1103," S. R. Gray, Engineering Research Associates Division of Remington Rand, Inc.

CIRCUIT DESIGN

Session Chairman, J. L. Bower, N. A. A., Aerophysics Laboratory

- "The Transistor Emitter-Coupled Amplifier," D. W. Slaughter, California Institute of Technology
- "Wideband Frequency Discriminators for AFC Systems," L. S. Stokes, Hughes Aircraft Co.

TELEMETERING THEORY

Session Chairman, (Not yet announced.)

- "Interpretation of Sequential Samples from Commutated Data," L. L. Rauch, University of Michigan

MANAGEMENT

Session Chairman, (Not yet announced.)

- "Are Engineers People?" A. M. Zaren, Stanford Research Institute
- "Some Factors Related to Management of an Applied Research Project," H. Iams, Hughes Aircraft Co.
- "More Engineering per Dollar," B. Dempster, Electronic Engineering Co.

COMPUTERS

Session Chairman, (Not yet announced.)

- "Efficient Linkage of Graphical Data and Digital Computers," E. D. Lucas, Jr., Benson-Lehner Corp.
- "An Input-Output System for a Digital Control Computer," L. P. Retzinger, Librascope, Inc.

VEHICULAR COMMUNICATIONS

Session Chairman, (Not yet announced.)

- "Effect of Front-End Receiver Design on Over-all Receiver Performance, and Resulting Systems Performance," A. C. Manke, General Electric Co.

PROFESSIONAL GROUP ON ELECTRONIC DEVICES

Session Chairman, (Not yet announced.)

BROADCAST AND TV RECEIVERS

Session Chairman, Stanley Cutler, Pacific Mercury Television Mfg. Corp.

- "Amplitude and Phase Compensation in Color Television Receivers," E. L. Michales, Packard-Bell Co.

"The Planning and Performance of a Completely Integrated Source of Television Signals from Film," A. D. Emurian, Philco Corp.

- "Some Advances in Color Television Receivers," A. V. Loughren, Hazeltine Corp.
- "A Color Camera for the NTSC System," R. J. Stahl, Color Television, Inc.

SYSTEMS ANALYSIS

Session Chairman, L. Weinberg, Hughes Aircraft Co.

- "Frequency Memory in Multiple-Mode Oscillators," W. A. Edson, Stanford University
- "A Mathematical Analysis of a Series Circuit Containing Periodically Varying Resistance," L. A. Pipes, University of California and U. S. Naval Ordnance Test Station
- "Analytical Determination of Response of Certain Time-Varying Linear Feedback Systems," W. E. Mathews, Hughes Aircraft Co.

VEHICULAR COMMUNICATIONS

Session Chairman, (Not yet announced.)

- "Some Basic Considerations in Selective Signaling Systems," T. W. Sanders, Sanders and Sanders Electronic Engineering
- "Integration of Mobile VHF with Microwave Radio Solves Vexing Problems," J. R. Neubauer, Radio Corp. of America
- Panel Discussion:* "Communication Frequency Allocations," moderated by E. M. Webster, Federal Communications Commission

MANAGEMENT

Session Chairman, (not yet announced.)

AIRBORNE ELECTRONICS

Session Chairman, J. A. Marsh, North American Aviation, Inc.

- "Simplified Aircraft Response Functions," R. F. Drenick and R. B. Headley, Radio Corp. of America
- "A Servo Mechanism Approach to the Problem of Communication for Aircraft Control," S. J. O'Neil, Air Force Cambridge Research Center
- "Cumulative Probability of Radar Detection," L. Rider, T. Rooney and B. Rudwick, General Electric Co.

MICROWAVE THEORY AND TECHNIQUES

Session Chairman, (not yet announced.)

- "Design of Broadband Waveguide Rotary Joints," John Guarraera and Jerome Fisch, Reeves Instrument Corp.

"Design Considerations for Multichannel Coaxial-Line Rotary Joints," J. D. Hall, Sperry Gyroscope Co.

ELECTRON DEVICES

Session Chairman, (not yet announced.)

This session will be devoted to papers on semiconductor devices. Due to the large number of excellent papers received, and the rapid advances being made in the semiconductor field, final selection of papers will be announced in the final program.

MICROWAVE THEORY AND TECHNIQUES

Session Chairman, (not yet announced.)

"Microstrip—A Printed Microwave Transmission System," H. F. Engelmann, Federal Telecommunication Laboratories
 "Precision Microwave Measurements of Waveguide Voltage Standing Wave Ratios," I. N. Anderson, Airtron, Inc.

ELECTRON DEVICES

Session Chairman, (not yet announced.)

"PARAN—A Precision Automatic Ranging System," R. W. Johnson, R. M. Parsons Co.

"Isolating Devices for Use with Tail-Cap Aircraft Antennas," R. L. Tanner, Stanford Research Institute

"Cooling Requirement Charts for Electronic Equipment," L. J. Lyons, Heat Transfer Consultant

ULTRASONIC ENGINEERING

Session Chairman, (not yet announced.)

"Ultrasonic Cleaning of Miniature Devices," Q. C. McKenna, McKenna Laboratories
 "Composite Piezoelectric Resonators," W. G. Cady, California Institute of Technology

Abstracts of Transactions of the I.R.E.

The following issues of "Transactions" have just been published, and are now available from The Institute of Radio Engineers, Inc., 1 East 79 Street, New York 21, N. Y. at the following prices. The contents of each issue and, where available, abstracts of technical papers are given below.

Sponsoring Group	Publication	Group Members	IRE Members	Non-Members*
Broadcast and Television Receivers	PGBTR-7	\$1.15	\$1.70	\$3.45
Microwave Theory and Techniques	Vol. MTT-2, No. 2	\$1.25	\$1.85	\$3.75

* Public libraries and colleges can purchase copies at IRE Member rates.

BROADCAST AND TELEVISION RECEIVERS

PGBTR-7, JULY, 1954

Minutes of the Group Administrative Committee Meeting

UHF Tuner Design for the 6BA4—Ralph S. Brown

Tuner design concepts for UHF grounded grid amplifiers using the new 6BA4 rocket tube are discussed. The four terminal admittances are used as the basis for these concepts. A brief review of noise and gain considerations of a UHF amplifier tube is included. A number of types of circuit parameters such as lumped constants and coaxial lines are given consideration as applied to input and output UHF amplifiers. Both boosters and tuners are included in the circuit discussion, and noise figure, gain and bandwidth data on experimental models is compared to theory.

The Design of IF Amplifiers for Color Television Receivers—J. Avins

The design of IF amplifiers for color television receivers is confronted with the problems inherent in black-and-white amplifiers plus new problems introduced by the addition of the chrominance subcarrier and its sidebands. This paper evaluates these problems as they affect the design of the IF amplifier. The principal problem is that of providing adequate rejection at 41.25 mc without introducing excessive delay in the color sideband region which is separated from the sound carrier by less than 1 per cent of the signal frequency. Novel non-minimum phase shift trap circuits are described which provide the required attenuation with low delay distortion.

The Measurement of Yoke Astigmatism—R. A. Bloomsburgh

Astigmatism, the principal deflection yoke aberration, sets a fundamental limit on the performance of cathode ray tube displays and is possessed by all yokes in varying type and degree. This paper analyzes the structure of an astigmatic beam with a view to measuring its properties objectively. Optical concepts are useful in describing the beam distortions encountered and two methods of achieving a numerical rating are outlined. Microscope measurements of the variation of spot shape along the beam path yield quantitative data regarding the primary and secondary foci. These data provide a basis for isolating the "optical" characteristics of deflection yokes. Methods of classifying and evaluating astigmatic errors in both monochrome and color displays are discussed.

Semiconductor Diodes for TV Receivers—Joseph P. Roveto

A New Approach to Series Heater Strings for Television—Frank Roberts

The presence of voltage surges in series heater strings represents a major source of tube failures. Tubes supplied by various tube manufacturers behave differently in the heater string. A method of tube evaluation outside the heater string enables prediction of surge conditions in the string. Surge-free operation can be readily obtained by tube selection. This selection does not provide for trouble-free operation in the event of field tube replacement. It is necessary to establish industry standardization of heater characteristics to eliminate all trouble.

Interference to Color and Monochrome Television Receivers by Oscillator Radiation and Other CW Signals—E. W. Chapin, William K. Roberts, and Lawrence C. Middlekamp

The concept and the measurement of the Beat Size Effect in television are discussed. It is shown that as a result of this effect a monochrome signal may tolerate interference 25 to 30 db stronger when the interference falls in the upper part of the channel as compared to the level which may be tolerated near the picture carrier. NTSC color television does not enjoy this advantage.

MICROWAVE THEORY AND TECHNIQUES

VOL. MTT-2, No. 2, JULY, 1954

A Traveling-Wave Electron Deflection System—Richard C. Honey

Several types of traveling-wave electron deflection structures that can be used in microwave oscillographs are described and compared. An interaction structure consisting of a folded wire over a plane is considered in detail, both theoretically and experimentally. A general analysis of the interaction of electrons with sinusoidally varying transverse electric fields is presented and is applied to traveling-wave deflection systems. This analysis gives quantitative information about the interdependence of deflection and drift space lengths, beam velocities, frequencies, and phase velocities along the structure. Limitations on the design and performance of traveling-wave deflection system can be determined from this analysis.

Crystal Checker for Balanced Mixers—P. D. Strum

This paper describes the use of a dc crystal checker to match crystal pairs for balanced mixer operation. The noise characteristics of klystron local oscillator tubes are presented together with a discussion of their effect on receiver noise figure. The results of a brief analysis of the influence of IF resistance and conversion loss unbalances on noise suppression is given.

Calibration curves for the dc crystal checker show the relation between TEST reading and noise temperature, conversion loss and noise figure. An operating procedure is described whereby crystals can be matched into pairs for balanced mixer use. It is shown experimentally at S band that the use of the crystal checker permits reduction of maximum receiver noise figure by about 1 db and average noise figure by about .5 db. It is further shown experimentally at X band that minimum noise suppression can be increased by about 5 db and average noise suppression by about 10 db.

Curves are presented showing theoretical noise suppression in terms of the fractional differences in IF resistance and unbalance in conversion loss. From these curves it is shown that the required degree of matching for local oscil-

lator noise suppression is within the accuracy of the dc crystal checker.

A plot of excess local oscillator noise from 1000 megacycles to 24,000 megacycles is given, and it is shown that excess noise is approximately proportional to radio frequency. A plot is also given of excess local oscillator noise as a function of intermediate frequency, and it is shown that the excess noise is approximately inversely proportional to the intermediate frequency.

As a result of the checking procedure that is described, it is concluded that unmatched crystal pairs can be matched adequately for local oscillator noise suppression by the use of the dc crystal checker and that crystals can be chosen for best noise figure.

A Technique for Stabilizing Microwave Oscillators—Jerome L. Altman

The stabilization of microwave oscillators whose short term deviations in frequency are in the order of one part in 10^8 is discussed in this article. The control system, which consists of a dual mode reference cavity and feedback amplifier, is applied to a reflex klystron oscillator.

Circuit analysis and practical design considerations are presented. A practical method of measuring the actual frequency stability is given.

Use of Crystals in Balanced Mixers—Jesse Taub and Paul J. Giordano

The crystal parameters to be considered for obtaining accurate information about local oscillator noise suppression in a balanced mixer are theoretically presented. The interrelationship between available local oscillator noise suppression and the important design characteristics of microwave receivers are discussed and curves are plotted. A method of accurately measuring local oscillator noise suppression is given and experimental data are correlated with theoretical results.

A Coaxial Line Filled with Two Non-Concentric Dielectrics—D. J. Angelakos

An analysis has been made of a coaxial transmission line composed of two coaxial cylindrical conductors. Two dielectrics fill different angular portions of the volume between the conductors. The propagation constants (primarily the guide wavelength) are determined by a resonant condition applied to the plane transverse to the direction of propagation. Experimental verification is given for near unity values of the ratio of the outer to the inner radius. In addition, an experimental investigation has been made of the properties of the guide wavelength as a function of frequency and larger ratios of the radii.

H_{01} Mode Circular Waveguide Components—D. A. Lanciani

A convenient method of launching the H_{01}

mode in round waveguide is described. Four resonant slots are employed in a compact end-feed transition design. Construction details and performance curves are given. Also described is a developmental bend which avoids the H_{01} - E_{11} mode degeneracy problem by employing a superimposed pair of "E" and "H" plane rectangular waveguide bends. A mode absorber is described which is capable of reducing the mode impurities inherent in the transition design to a level of less than 0.1 per cent of the emerging H_{01} mode power. Other possible applications of the H_{01} wave to problems other than low loss microwave transmission are briefly considered.

Characteristic Impedance of the Shielded-Strip Transmission Line—Seymour B. Cohn

Simple formulas are given for the characteristic impedance of a transmission line consisting of a conducting strip of rectangular cross section centered between parallel conducting plates at ground potential. The formulas agree to within 1.2 per cent with an exact formula for a zero thickness strip. In the case of finite thickness up to a quarter of the plate spacing, the formulas are expected to be at least that accurate. A family of characteristic impedance curves given in this paper should prove useful to the design engineer.

Bibliography on Directional Couplers—Richard F. Schwartz

Books

Discontinuous Automatic Control by Irmgard Flügge-Lotz

Published (1953) by Princeton University Press, Princeton, N. J. 159 pages+2-page index+vii pages+5 pages appendixes. 102 figures. $6\frac{1}{2} \times 9\frac{1}{2}$. \$5.00.

Irmgard Flügge-Lotz is with Stanford University.

This book deals with the theory and design of systems employing on-off control. Such systems possess the advantages of simplicity, ruggedness, and low cost. Because of these features, on-off control is particularly useful in expendable devices such as guided missiles. The difficulty is that engineering analysis and design of such systems is by no means simple. Two approaches to the design problem are currently in use. The first employs the describing function which linearizes the system by relating the fundamental component of the output of the on-off device to the input when it is sinusoidally excited. This method leads only to a prediction of stability and is not useful for specifying the performance of the system in the time domain. The second method employs the phase plane and is much more difficult to apply but it yields information on the performance of the system in the time domain. This book deals with the theory of and the graphical technique for using the phase plane as the medium for design of on-off feedback control systems.

The controlled systems treated in this book are those whose motion in one dimension can be described by linear second-order differential equations. While most of the material deals with such systems having one degree of freedom, the last chapter deals with the problem of guided missiles having three degrees of freedom. The author shows how the methods for the single dimension systems can be generalized to cover this problem.

One of the types of discontinuous controllers considered in this book is the "perfect" type which applies full positive or full negative control depending on the sign of a control function, F . The latter may be composed of the weighted sum of the system displacement or rate of displacement. Also included are on-off controllers having such imperfections as hysteresis, dead space or time delay. The outputs of these controllers may be either displacement or velocity applied to the control element. The book shows how phase curves for these various conditions can be constructed and interpreted for design.

The material contained in this book is very valuable to the control engineer since it offers all in one volume a useful technique for employment of the phase plane or phase space in design. Information on this subject is available only in the current literature, incompletely in various textbooks or in works on nonlinear mechanics not specifically directed to feedback control. The major unfavorable criticism is to be found in its excessive compactness and in the manner of expression. The author writes in the compact manner to which mathematicians are accustomed but lacking in motivation or explanation. It is significant to note that not a single block diagram so commonly used by engineers to express system interconnection appears in this book with the result that the reader often loses all contact with the physical problem. The reader is warned that this book is not easily read but that it must be carefully studied to be fully understood. Nevertheless, this book is an excellent source of information on the design of on-off feedback control systems.

JOHN R. RAGAZZINI
Columbia University
New York, N. Y.

Advanced Mathematics in Physics and Engineering by Arthur Bronwell

Published (1953) by the McGraw-Hill Book Company, 330 West 42nd Street, New York 36, N. Y. 467 pages+7-page index+xvii pages. 133 figures. $9\frac{1}{2} \times 6\frac{1}{2}$. \$6.00.

There are numerous texts which present an exposition of the branches of mathematics which constitute the principal analytical tools of the physical scientist. In the preface to this book the author expresses the aim of developing the fundamental mathematical formulations in those fields which are the common ground of the physicist and the engineer.

This reviewer finds it difficult to reconcile the author's aim with the present trend toward increasing specialization. In this day and age, is it possible to present within the compass of a volume of average length an adequate treatment of the mathematics of physics and the diverse branches of engineering? This is what the author attempts to do and, in this reviewer's opinion, does not succeed in doing to the complete satisfaction of either the physicist or the engineer.

Of necessity many important topics are treated inadequately, or are omitted altogether. Thus, there is nothing on matrix algebra and linear vector spaces, very little on the calculus of variations, nothing on approximate methods, and not enough on the Laplace transformation. So far as it goes, however, there is much to commend in the author's exposition of the subject matter. There is plenty of motivation and little of pedantry. The standard of mathematical rigor is somewhat higher than in comparable texts, but when expedient the author restricts himself to the formulation and discussion of theorems, giving references to pertinent textbooks for proofs. There is a profu-

sion of well-chosen illustrative examples and a large number of exercises. References to the literature are generally adequate.

The book begins with a chapter on infinite series, which is followed by five chapters dealing largely with the Fourier series and integral, and the solution of ordinary and partial differential equations. In the next three chapters the methods developed in the preceding chapters are applied to the analysis of vibrations in lumped—and distributed—constant systems.

At this point the continuity of presentation is broken by a chapter on vector analysis, which is followed by a chapter on the solution of second order partial differential equations, with applications to heat flow, fluid dynamics and electromagnetic theory comprising the material of Chapters 12, 13, and 14. The remainder (about one fourth) of the book is devoted to the theory of complex variable and the Laplace transformation. The treatment of the latter is somewhat perfunctory and not modern in spirit. In particular, much too little space is devoted to the delta function and other types of singularity functions.

Perhaps the most outstanding feature of the book is its "teachability." Many readers will probably find it useful as a general reference. This reviewer is very pleased to have Professor Bronwell's work on his bookshelf, and so undoubtedly will most of its readers.

L. A. ZADEH
Columbia University
New York, N. Y.

Soft Magnetic Materials for Telecommunications by C. E. Richards and A. C. Lynch

Published (1953) by Interscience Publishers, Inc., New York, N. Y., and Pergamon Press, Ltd., London, England. 332 pages+14-page index+vii pages. Illustrated.

C. E. Richards and A. C. Lynch are with the Post Office Engineering Research Station in England.

This book contains a collection of 35 papers by British, French, German, and Dutch experts presented at an informal conference held at the Post Office Engineering Research Station in April, 1952. The editors, C. E. Richards and A. C. Lynch who organized the meetings, are also contributing authors. The subject of the conference was designated as "Soft magnetic materials whose properties are of use or significance for telecommunications."

Several areas of interest are covered, including properties and composition of magnetic materials, various aspects of the theory of ferromagnetism and special effects, and magnetic measurements. Specific papers deal with: theories of high permeability and low coercivity, high-frequency permeability of ferromagnetic bodies, iron losses under special conditions, physical aspects of hysteresis and eddy-current losses, relaxation phenomena, Jordan- and Richter-type after-effects, residual losses, properties of ferromagnetic powders and ferrites, magnetostriction of ferromagnetic powders and ferrites, magnetostriction of ferrites, laminated flake-iron powder material, pulse and a-c measurements on materials having rectangular B-H loops. The papers for the most part contain original contributions to their respective subjects.

The volume contains an up-to-date account of the many facets of magnetic

theory and experiment. As such, it should prove to be of great value both to the physicist or electrical engineer who desires to keep abreast with current developments in the field, and to the novice who already has a knowledge of the fundamentals of ferromagnetism and who wishes to advance it. In other cases, the book might also serve the engineer having a more special or limited interest.

EDWARD J. SMITH
Polytechnic Institute of Brooklyn
Brooklyn, N. Y.

Introduction to Solid State Physics by Charles Kittel

Published (1953) by John Wiley & Sons, Inc., 440 4th Avenue, New York 16, N. Y. and Chapman & Hall Ltd., London, England. 343 pages+18-page index+33-page appendix+xiii pages. 16 figures. 5½×9½. \$7.00.

Charles Kittel is Professor of Physics at the University of California, Berkeley, Calif.

The modern electronics engineer has found that the properties of solids are playing an essential role in many of the devices with which he is concerned. He can design equipment better and derive greater intellectual satisfaction from his work by gaining insight about the basic physical processes which occur in conductors, semi-conductors, insulators, ferromagnetics, ferroelectrics, and phosphors. The recent text by Professor Kittel opens a more pleasant path to understanding than has been available before.

In the author's words, "This volume is intended as an introductory text book in Solid State Physics for senior and beginning graduate students in physics, chemistry, and engineering. My object has been to write an elementary and short account of representative aspects of the physics of solids. The level of presentation supposes that the reader will have a general familiarity with modern atomic physics to the extent of the undergraduate courses offered under this title in many universities. A course in Quantum Mechanics is not a prerequisite to reading this book, but the reader should have been exposed to the Planck radiation law, the de Broglie relation, the Bohr theory of the hydrogen atom, the Zeeman effect, and the wave equation for free particles. Advanced topics of solids, in particular those requiring a formal background of Quantum Mechanics, are developed in appendices."

One of the chief merits of this book is its brevity. Although 343 pages is not in itself a small number, it is not uncommon to find texts of even greater length devoted to the subject of only one of Kittel's chapters. This brevity, coupled with emphasis on the physical principles and suppression of elaborate mathematical machinery make for unusually easy reading in this field. The serious student may also develop his understanding further by exercising with problems of varying degrees of difficulty that follow each chapter.

The desirable brevity is, of course, also a disadvantage since it is incompatible with detailed discussions of the properties of some of the most interesting new phenomena. Although up-to-date discussions of such subjects as the ferrites and transistors are given, they are not adequate for apparatus design purposes. The reader may rely on them, however, as a basis on which to understand better the information furnished by manu-

facturers or in technical articles.

It is difficult to see how in the large subject of solid state physics a better compromise could be made between completeness and complexity on the one hand, and brevity and simplicity on the other.

WILLIAM SHOCKLEY
Bell Telephone Laboratories, Inc.
Murray Hill, N. J.

Transistors by Louis E. Garner, Jr.

Published (1953) by Coyne Electrical School, 500 South Paulina, Chicago, Ill. 98 pages+2-page index+5-page appendix. 45 figures. 5½×8½. \$1.50.

This book is written primarily for servicemen and technicians in a popular language and tone. The introduction discusses the history of the transistor and the general effect of its development on the communication field. Subsequent chapters treat the transistor characteristics, amplifier, and oscillator circuits, transistor components and the care and servicing of transistors. A separate chapter is devoted to special transistor circuits such as dc amplifiers, RF detectors, clippers, multivibrators, etc. Another chapter describes some experimental circuits with typical component values. The appendix lists the ratings of 44 transistor types produced by nine manufacturers.

There are a number of hasty generalizations, such as the broad statement that the transistor is a current amplifier, although a few pages later the author tells that in a grounded base circuit the current amplification is always less than 1. (This latter statement is made without restricting it to junction transistors.) Another unique statement is made on page 43. "The grounded collector amplifier may serve as a bilateral or two-way amplifier under some conditions. The input and output connections may be interchanged, permitting a signal to be amplified in either the forward or inverse directions."

On page 63 a number of push-pull circuits are shown. The second figure shows a complementary pair, with parallel input and balanced output. This reviewer has seen this circuit before, but he is still puzzled by its origin and operation, since two properly balanced units would cancel the signal.

One extenuating point may be brought out in defense of the book; since it was to be published early, the author had missed the benefit of publications that improved the understanding of transistors considerably. If the author had given himself just one extra year, he could have spent his enthusiasm with greater benefit to the reader.

GEORGE C. SZIKLAI
RCA Laboratories
Princeton, N. J.

Radio Data Charts—5th Edition by R. T. Betty, revised by J. McG. Sowerby

Published (1953) by Iliffe & Sons, Ltd., Dorset House, Stamford Street, London, S.E. 1, England. 91 pages+43 charts. 8½×10½. 5s. 6d.

These charts are a revised collection of nomographs or abacs originally published in 1930. They provide a ready means for making many of the simple calculations involved in the design of radio equipment.

The charts start with such simple subjects as frequency vs. wavelength and the relations between inductance, capacity and resonant frequency. These are followed by

nomographs for the determination of the inductance of single layer and multilayer coils, the optimum wire size for minimum rf resistance of coils and the change in inductance and "Q" caused by a shield can.

The "Universal Selectivity Chart" is easy to use and provides a convenient shortcut method of designing tuned, coupled transformers.

The nomographs on transmission lines, giving "Q," resonant impedance and the length of a quarter-wave capacity-loaded line are convenient for the designer of receivers to operate at the higher radio-frequency ranges.

Of the total of 43 nomographs, the last 16 are concerned with the design of iron-cored power- and audio-transformers and chokes and with audio frequency circuitry.

Some slight confusion will be occasioned by the differences between British and American practices. For example, the radio frequency band designations (uhf, vhf, etc.) do not coincide with American usage. The wire tables and wire sizes used in the charts are in the British "Standard Wire Gauge" which is different from the American Brown & Sharpe gauge. The "Mains" transformer designs are based on 50 cycle ac.

But in spite of minor difficulties occasioned by British nomenclature, the collection of charts is a valuable tool any American engineer would be glad to have available as a ready reference.

STUART W. SEELEY
RCA Industry Service Laboratory
New York, N. Y.

Low Frequency Amplification by N. A. J. Voorhoeve

Published (1953) by Philips Technical Library, N. V. Philips' Gloeilampenfabrieken, Eindhoven, Holland. 484 pages +6-page index +5-page supplement +xv pages. Illustrated. 6 X9.

The title of the book does an injustice to it in two respects: the book being of European origin, the words "Low Frequency" (see the German Niederfrequenz) covers the range of frequencies which in this country is called "audio frequency"; however, even "Audio Frequency Amplification" would not adequately describe the book, since there are quite a number of chapters dealing with subjects other than amplifiers, such as transducers, reproducers, principles of acoustics and so forth.

When attempting to cover the whole field of audio engineering with the limits of one book, the question of what to put into the book, and equally important, what to leave out, is an ever-present one. An author cannot hope to satisfy all readers in this

respect, but it appears to this reviewer that no important subject in the field has been omitted, and that the degree to which the author has gone into details on the various topics is consistent. This results in a well-balanced presentation, without the often-found fault of lavishing an amount of attention out of proportion to the rest on one particular subject (usually the author's pet). For the reader who wishes to go into greater detail, a comprehensive list of references is added to each chapter (limited in usefulness, however, as mentioned below).

The book was written by a member of the engineering staff of the Philips organization in Holland, and was translated in Great Britain. It is the combination of these two effects which will make the book less valuable to an American reader than it would otherwise be. As an example, he will have to learn that the transconductance of a tube is called the "slope," designated by S_1 , of a valve. The terminology, however, will not give the reader familiar with the subject any serious trouble; what is of more importance is that all the equipment described in the book, from tubes to loud speakers, is European equipment. Furthermore, a high percentage of the references given at the end of the chapters are European references which the average American reader will have difficulty in obtaining, and in reading after he has obtained them. In fairness, it should be pointed out that this situation will make the book very valuable to those interested in European practices.

In view of the fine and consistent treatment of the theoretical aspects of Audio Engineering, which do not change with the location on the globe, the book may still be recommended as a desirable addition to the library of an audio engineer, if he does not object to the fact that much of the material describing European equipment will not be of much use to him.

WALTHER RICHTER
5426 N. Kent Avenue
Milwaukee, Wis.

A Hyperbolic Protractor for Microwave Impedance Measurements and Other Purposes by G. A. Deschamps

Published (1953) by the Federal Telecommunications Laboratories, Nutley 10, N. J. 44 pages. 39 figures. 7½ X10½. \$2.50.

This pamphlet introduces the author's very ingenious Hyperbolic Protractor, a working sample of which is supplied in an envelope attached to the back cover. The protractor is intended to be used with a new type of impedance chart called the Projective Chart which is simply related to the

familiar Smith Chart. The author apparently feels that the relation between the Smith Chart and the Projective Chart is so simple that no working models of the Projective Chart need to be supplied or shown in the text. While it almost certainly is true that an experienced worker who is familiar with the projective chart would soon learn to use the Hyperbolic Protractor with the Smith Chart or with a blank unit circle, the lack of such a model is believed to be a distinct stumbling block to the new reader.

The author has chosen a list of twenty-one typical problems with which to demonstrate the usefulness and versatility of the new Protractor and the Projective Chart. While a few of the initial problems are more easily solved by the use of the Smith Chart, it is shown that one who understands the new system can much more simply solve many problems involving losses, standing wave ratios, and impedance transformations encountered in two terminal-pair junctions and transformers. This is especially true for such junctions or transformers in cascade.

That the new Hyperbolic Protractor and the Projective Chart represent a novel and highly desirable advance in the field of transmission line measurements can hardly be questioned. The only serious criticism of this pamphlet lies in the inadequate presentation of the material. There is almost no mention of the theory behind the Projective Chart and there is no demonstration that the problem solutions are correct or that they agree with more fundamental (though more tedious) pencil and paper computations. The problem solutions consist of instructions to find certain points, draw certain lines, find certain intersections of lines, and so on. The finding of a few points and the drawing of a few lines is certainly a very simple process and is highly desirable when that is all that is needed to solve otherwise complicated problems. However, the lack of any explanation concerning why the lines are drawn and what they represent physically or theoretically is likely to cause confusion of the reader, an unsureness of the process involved, and a general reluctance to try the new system.

It is to be hoped that Mr. Deschamps may see fit to bring out a revised and more complete edition of this pamphlet because the Hyperbolic Protractor and the Projective Chart appear to be very desirable tools to add to the kits of those people who work with waveguide or transmission line components.

JOHN F. P. MARTIN
Bell Telephone Laboratories, Inc.
Whippany, N. J.



Abstracts and References

Compiled by the Radio Research Organization of the Department of Scientific and Industrial Research, London, England, and Published by Arrangement with that Department and the *Wireless Engineer*, London, England

NOTE: The Institute of Radio Engineers does not have available copies of the publications mentioned in these pages, nor does it have reprints of the articles abstracted. Correspondence regarding these articles and requests for their procurement should be addressed to the individual publications, not to the IRE.

Acoustics and Audio Frequencies.....	1333
Antennas and Transmission Lines.....	1333
Automatic Computers.....	1334
Circuits and Circuit Elements.....	1335
General Physics.....	1337
Geophysical and Extraterrestrial Phenomena.....	1338
Location and Aids to Navigation.....	1338
Materials and Subsidiary Techniques.....	1339
Mathematics.....	1341
Measurements and Test Gear.....	1341
Other Applications of Radio and Electronics.....	1342
Propagation of Waves.....	1343
Reception.....	1343
Stations and Communications Systems.....	1344
Subsidiary Apparatus.....	1344
Television and Phototelegraphy.....	1344
Transmission.....	1345
Tubes and Thermionics.....	1346
Miscellaneous.....	1346

The number in heavy type at the upper left of each Abstract is its Universal Decimal Classification number and is not to be confused with the Decimal Classification used by the United States National Bureau of Standards. The number in heavy type at the top right is the serial number of the Abstract. DC numbers marked with a dagger (†) must be regarded as provisional.

A new section has been introduced covering the general technique of electromagnetic waves, oscillations and pulses (i.e. transmission lines and circuits), as distinct from specific applications to telecommunications. The new section is numbered 621.37, with subdivisions. Full details of the new classification, and of the numbers which become obsolete as a result of its introduction, are given in PE Note 535, obtainable from The International Federation for Documentation, Willem Witsenplein 6, The Hague, Netherlands, or from The British Standards Institution, 2 Park Street, London, W.1., England.

Section 621.396.67, dealing with Antennas, has been modified and expanded; details of the new classifications are given in PE Note 519.

Section 621.396.96, with subdivisions, has been introduced to cover Radar; details of the new classifications are given in PE Note 518.

New Subject Section

A section headed Automatic Computers has been introduced.

ACOUSTICS AND AUDIO FREQUENCIES

534+621.395.61/.62:061.3 1977
Proceedings of the First I.C.A. [International Commission on Acoustics] Congress on Electroacoustics—(*Acustica*, vol. 4, pp. 1-306; 1954.) Text of papers presented at the congress held in the Netherlands, June, 1953. See also 2855 of 1953.

534.6:621.375 1978
Use of Variable-Gain Amplifiers in Acoustic Measurements—A. Moles. (*Rev. Gén. Elec.*, vol. 63, pp. 35-52; Jan., 1954.) Two methods of use are distinguished, namely (a) for maintaining a constant intensity of sound from the test source, and (b) for obtaining response curves of a sound source or detector or of an intervening transmission medium. Applications to the investigation of the acoustics of halls and

The Index to the Abstracts and References published in the PROC. I.R.E. from February 1953 through January 1954 is published by *Wireless Engineer* and included in the March 1954 issue of that journal. Copies of this issue may be purchased for \$1 (including postage) from the Institute of Radio Engineers, 1 East 79th Street, New York 21, N.Y. As supplies are limited, the publishers ask us to stress the need for early application for copies. Included with the Index is a selected list of journals scanned for abstracting with publishers' addresses.

of the transmission properties of partitions etc. are described. See also 3767 of 1947.

534.75:621.3.018.78 1979

The Audibility of Linear Distortions of Natural [musical] Sounds—N. Mayer. (*Funk u. Ton*, vol. 8, pp. 1-6; Jan., 1954.) Subjective tests were made using music reproduced by a loud-speaker associated with a variable-frequency-response amplifier. The least perceptible decrease of the mean amplitude over an octave is 4 db in the medium and high af range and 10 db at the low-frequency end of the range.

534.84 1980

Behaviour of Sound in a Room with Absorbent Walls—S. Eutizi. (*Alta Frequenza*, vol. 23, pp. 3-15; Feb., 1954.) The equation of propagation for a parallelepiped room with absorbent walls is obtained in a form involving a series expansion, and an explicit third-approximation solution is given for a cubic room. Resonance frequencies and reverberation times are calculated for some examples. An improved formula is derived for calculating Sabine's absorption coefficient.

534.862.4 1981

Measurement and Evaluation of the Interference Effect of Noises—E. Belger. (*Fernmeldelech. Z.*, vol. 7, pp. 25-32; Jan., 1954.) Report of subjective tests of the effect of warbled or interrupted tones and of thermal noise with a bandwidth of a musical third superimposed on reproduced music.

621.395.61 1982

Experiments on the Construction of a "One-Dimensional" Directional Microphone—G. Kurtze. (*Tech. Mitt. schweiz. Telegr.-Teleph-Verw.*, vol. 32, pp. 27-31; Jan. 1, 1954.) An arrangement in which sound arriving from undesired directions is suppressed by interference is achieved by mounting a slotted tube on the front of an ordinary microphone. A modification which is frequency independent within certain limits is also described. Calculated and measured polar diagrams are shown.

621.395.61:534.321.9 1983

Modulation of Ultrasonic Standing Waves in Air—L. Pimonow. (*Ann. Télécommun.*, vol. 9, pp. 24-28; Jan., 1954.) Standing waves from a single ultrasonic source may be modulated by a lf source, e.g. the human voice. A "gas-microphone" arrangement based on this principle is described, having 3 per cent modulation depth at 30 kc. The device will not operate at frequencies below 15 kc. Theory is developed to explain the phenomena.

621.395.623.7:534.321.9 1984

Marked Demodulation in Air of Two Ultra-

sonic Waves of Different Frequencies—S. Klein. (*Ann. Télécommun.*, vol. 9, pp. 21-23; Jan., 1954.) See 958 of April (Maulois).

621.395.625.3:621.385.832 1985

Investigation of Core Structures for the Electron-Beam Reproducing Head in Magnetic Recording—J. W. Gratian. (*Trans. I.R.E.*, vol. AU-2, pp. 27-38; Jan./Feb., 1954.) An investigation has been made of factors contributing to losses at the upper end of the frequency range in the electron-tube magnetic pickup described by Skellett et al. (11 of January). Strip-type structures have been designed for the external cores; an output of the order of 0.2v and a frequency range of about 1 cps-15 kc is obtained with a tape speed of 10 inches.

ANTENNAS AND TRANSMISSION LINES

621.315.212 1986

The Evaluation of Cable Irregularities at Very High Frequencies—W. W. H. Clarke and J. D. S. Hinchliffe. (*Proc. IEE*, Part IV, vol. 101, pp. 55-60; Feb., 1954. Digest, *ibid.*, Part III, vol. 101, pp. 44-46; Jan., 1954.) "The magnitude and distribution of cable irregularities are related statistically to the end-to-end input-impedance difference under conditions involving a large number of wavelengths and appreciable attenuation. The manner of variation of the measured quantities with frequency and irregularity magnitude and distribution is revealed. These relationships are shown in the form of master curves for a particular cable on the assumption of exponential fault correlation."

621.372 1987

Coupling of Modes of Propagation—J. R. Pierce. (*Jour. Appl. Phys.*, vol. 25, pp. 179-183; Feb., 1954.) "When two lossless modes of propagation are coupled, waves which increase or decrease with distance may arise when the power flow of the two modes is in opposite directions or when power is generated in the coupling device. This behavior is characteristic of wave filters, traveling-wave tubes, double-stream amplifiers, and space-charge-wave amplifiers. Such behavior is analyzed assuming linearity and conservation of energy only."

621.372.2 1988

Designing Surface-Wave Transmission Lines—G. Goubau. (*Electronics*, vol. 27, pp. 180-184; April, 1954.) The theory of the surface-wave line is outlined and the effects of precipitation are discussed. Measurements have been made at about 250 mc on a 2-mile line with a loss of 6 db per mile, and at about 2 kmc on a 130-foot antenna-feeder line with a total loss of about 2 db. Design graphs are given for lines using polyethylene-coated Cu wire. Launching loss is also considered; best

results were obtained using a horn with an inner conductor down to the line diameter.

621.372.2:621.396.67 1989

Foundations of an Exact Theory of the Wave Field of a Transmission Line—G. A. Grinberg and B. E. Bonshtedt. (*Zh. tekh. Fiz.*, vol. 24, pp. 67–95; Jan., 1954.) The propagation of cm waves along a straight conductor of circular cross-section, located above and parallel to the surface of a plane homogeneous earth is considered theoretically. The exact solution is derived first, then approximate solutions are found and the effect of the earth on the field above it is calculated. The complex velocity of propagation along the conductor, the effective parameters of the line and wave field near the earth are also calculated. The solutions by Sommerfeld, Mie, Pollaczek (*Elekt. Nachr.-Tech.*, vol. 4, pp. 295–304 and 515–525; 1927) and others are briefly discussed.

621.372.2.029.64 1990

Microstrip—A New Transmission Technique for the Kilomegacycle Range—D. D. Grieg and H. F. Engelmann. (*Proc. I.R.E.*, *Aust.*, vol. 15, pp. 13–19; Jan., 1954.) Reprint. See 621 of 1953.

621.372.8 1991

Transmission and Matching Theory of Homogeneously Guided Waves—F. J. Tischer. (*Arch. elekt. Übertragung*, vol. 8, pp. 8–14 and 75–84; Jan./Feb., 1954.) Mathematical expressions for propagation in waveguide systems are derived directly from Maxwell's equations. The orthogonal curvilinear coordinate system is used. Particular cases considered include propagation in cylindrical systems and the effects of terminations, inhomogeneities, discontinuities, and coupling.

621.372.8 1992

Propagation of Microwaves through a Cylindrical Metallic Guide fitted coaxially with Two Different Dielectrics: Part 4—S. K. Chatterjee. (*Jour. Ind. Inst. Sci.*, Section B, vol. 36, pp. 1–13; Jan., 1954.) The field components and propagation constants for hybrid modes are derived theoretically. Part 3: 1671 of June.

621.372.8 1993

Representation of the Electromagnetic Field in a Waveguide with Absorbent Walls—M. De Socio. (*R. C. Acad. naz. Lincei*, vol. 16, pp. 63–68; Jan., 1954.) Analysis is given for a system comprising plane parallel conductors with a homogeneous dielectric filling the space between them. The field can be represented by two superimposed evanescent plane waves, of which the one can be considered as the reflection of the other at the walls of the interspace.

621.396.67 1994

Radiation Resistance and Gain of Homogeneous Ring Quasi-Array—H. L. Knudsen. (*Proc. I.R.E.*, vol. 42, pp. 686–695; April, 1954.) Continuation of analysis presented previously (2570 of 1953). Ring arrays of tangential or radial dipoles are considered. To simplify the calculation of gain and radiation resistance the number of dipoles is assumed to be infinite. The method of calculation is similar to that of Foster (46 of 1945), who investigated the particular case of constant phase round the ring, and is also related to that of Page (1862 of 1948) for axial dipoles.

621.396.676 1995

Designing Flush Antennas for High-Speed Aircraft—J. V. N. Granger. (*Electronics*, vol. 27, pp. 136–140; March, 1954.) A general discussion of the design problems encountered.

621.396.677.3.091.22 1996

A New Method of Measuring the Gain of Linear-Array Antennas—S. Uda and Y. Mushiike. (*Sci. Rep. Res. Inst. Tohoku Univ., Ser. B.*, vol. 4, pp. 51–65; Dec., 1952.) A

method of calculating the gain of linear antennas from the measured radiation patterns in the equatorial plane is briefly described. The necessary formulas, which involve sine power-series and use of Simpson's summation rule, are derived. An alternative graphical method is indicated. The methods are particularly applicable to the Yagi-Uda type antenna.

621.396.677.4 1997

Radiation from a Ground Antenna—J. R. Wait. (*Canad. Jour. Tech.*, vol. 32, pp. 1–9; Jan., 1954.) Theory of the wave antenna is developed and possible alternative modes of operation are discussed. Curves are presented for determining radiation characteristics.

621.396.677.8:538.52:537.311.5 1998

On the Current Induced in a Conducting Ribbon by a Current Filament Parallel to it—B. B. Moullin. (*Proc. IEE*, Part IV, vol. 101, pp. 7–17; Feb., 1954.) Full paper. See 704 of March.

621.396.677.832 1999

Measurements on Corner-Reflector Aerials—G. Burkhardt. (*Fernmeldezech. Z.*, vol. 7, pp. 55–56; Feb., 1954.) Curves are presented showing variation of gain with distance a between dipole and vertex, at 50–70 cm λ , for 60 degrees and 72 degrees corner-reflector antennas, for values of a up to 2λ and 1.6λ respectively. For wide-band antennas a reflector angle of 72 degrees is better than one of 60 degrees or 90 degrees because the gain variation is not so great. See also 2224 of 1953 (Harris).

621.396.677.85 2000

Tolerances in Parameters of Microwave Lenses—D. H. Shinn and T. C. Cheston. (*Marconi Rev.*, 1st Quarter, vol. 17, pp. 1–9; 1954.) Lenses comprising metal plates or square metal tubes are considered. Formulas for the constructional and electrical tolerances derived by Risser (*Microwave Antenna Theory and Design*, chapter 11) are generalized and extended. Some consistent errors can be corrected by refocusing. Tolerances in phase-corrected reflectors are treated in an appendix.

621.396.677.85 2001

Secondary Beams from Metal Lenses—T. C. Cheston. (*Marconi Rev.*, 1st Quarter, vol. 17, pp. 10–15; 1954.) Microwave lenses of parallel-plate or square-tube type are considered, and the conditions for the occurrence of secondary beams are derived using diffraction-grating theory. A sphero-ellipsoidal lens is less liable to generate secondary beams than is a plano-ellipsoidal or a plano-hyperboloidal lens. For scanning over wide angles it is impractical to design lenses free from secondary beams, because the required low value of refractive index is undesirable from the point of view of matching.

AUTOMATIC COMPUTERS

681.142 2002

Partial Drift Compensation in Electronic D. C. Analog Computers for Differential Equations—L. E. Löfgren. (*Appl. Sci. Res.*, vol. B4, pp. 109–123; 1954.) A method particularly suitable for computers with time-shared elements is described. The number of compensation points can be much smaller than the number of drift sources. The method is illustrated by describing the compensation of a machine for computing direction cosines.

681.142 2003

Analog Computing by Heat Transfer—P. H. Savet. (*Tele-Tech*, vol. 13, pp. 101, 122; Feb., 1954.) Multiplier, divider, ac integrating and differentiating circuits are described, based on the use of a thermal transducer. This transducer consists basically of a pair of heater elements each one of which is in thermal contact with one of a pair of temperature sensing elements mounted in a Wheatstone bridge cir-

cuit. Appropriate application to the heater elements of two electrical input signals creates a temperature difference proportional to their product between the sensing elements.

681.142 2004

FOSDIC—A Film Optical Sensing Device for Input to Computers—(*Tech. News. Bull. nat. Bur. Stand.*, vol. 38, pp. 24–27; Feb., 1954.) An instrument is described for processing written records, such as answers to questionnaires. Marks made with ordinary pen or pencil at special locations on microfilm are converted into electrical pulses, by means of a flying-spot scanning system. The pulses are recorded on magnetic tape for input to the computer. See also *Tele-Tech*, vol. 13, pp. 78–79; 140; Feb., 1954.

681.142 2005

Fast-Acting Digital Memory Systems—I. L. Auerbach. (*Elect. Mfg.*, vol. 52, pp. 100–107 and 136–143; Oct./Nov., 1953.) A survey of moderate- and high-speed storage techniques for digital computers.

681.142:538.221 2006

Penetration of an Electromagnetic Wave into a Ferromagnetic Material—A. Papoulis. (*Jour. Appl. Phys.*, vol. 25, pp. 169–176; Feb., 1954.) An investigation of the magnetization of metallic-ribbon toroidal cores with rectangular hysteresis loop, used as computer storage elements. Approximate solutions are obtained for the field inside the core under different conditions of loading. Theoretical and experimental output waveforms show close agreement for high magnetizing force and thickness of core material >0.5 mil.

681.142:538.221:621.318.134 2007

Ferromagnetic Spinels with Rectangular Hysteresis Loops—I. J. Hegyi. (*Jour. Appl. Phys.*, vol. 25, pp. 176–178; Feb., 1954.) Tests made on materials of different composition show $MgO \cdot 3MnFe_2O_4$ to be most suitable for magnetic storage elements. For rings of outside diameter 55 mil, inside diameter 35 mil, the coercive force is about 3 oersteds and switch-over time $0.3 \mu s$. Rings of 0.5-cm outside diameter have a lower coercive force.

681.142:621-526 2008

Servo Control of the Position and Size of an Optical Scanning System—T. Kilburn and E. R. Laithwaite. (*Proc. IEE*, Part IV, vol. 101, pp. 129–134; Feb., 1954.) "A method of controlling the position and size of a television-type raster relative to arbitrary references by means of four servo mechanisms is described. One of the applications of such a system is that of a reading device for punched cards. A system for reading any one of a stack of cards without removing the selected card has been developed using the servo-controlled raster. The design of the servo mechanisms for this application is described in detail."

681.142:621.3 (084.2) 2009

Electronic-Circuit Technique for a High-Speed Computer—G. Piel. (*Onde élect.*, vol. 34, pp. 38–46; Jan., 1954.) Commonly used computer-circuit units based on a triode or Ge diode are represented by a symbol indicating the unit and its mode of operation. The functions of different combinations of the basic units are listed and their application in a serial binary-scale computer is illustrated using the notation described.

681.142:621.318.572 2010

New Flip-flop Chain Circuits used in Computers for counting to Base 10 and Base 12—J. J. Bruzacc. (*Onde élect.*, vol. 34, pp. 59–62; Jan., 1954.) Modifications to the Potter decade arrangement are described.

681.142:621.372 2011

An Improved Experimental Iteration Method for Use with Resistance-Network

Analogues—G. Liebmann and R. Bailey. (*Brit. Jour. Appl. Phys.*, vol. 5, pp. 32–35; Jan., 1954.) A development of the method previously described by Liebmann (2839 of 1952). The error signals for a number of network nodes are displayed simultaneously on a cr-tube screen, so that it is always possible to work on the worst error instead of making adjustments cyclically.

681.142:621.374.5 **2012**
The Mercury-Delay-Line Storage System of the Ace Pilot Model Electronic Computer—E. A. Newman, D. O. Clayden, and M. A. Wright. (*Proc. IEE*, Part II, vol. 101, p. 65; Feb., 1954.) Discussion on 61 of January.

681.142:621.375.2.024 **2013**
Time-Shared Amplifier Stabilizes Computers—D. W. Slaughter. (*Electronics*, vol. 27, pp. 188–190; April, 1954.) Drift in the dc operational amplifiers of analog computers is reduced by connecting them periodically to the output of an auxiliary stabilizing amplifier. The advantages of using a direct-coupled rather than a chopper type of amplifier for this purpose are indicated. Circuit details are described, including the switching and filtering arrangements.

CIRCUITS AND CIRCUIT ELEMENTS

534.321.9:534.213:621.396.6 **2014**
Metal Ultrasonic Delay Lines—R. W. Mebs, J. Hel Darr, and J. D. Grimsley. (*Jour. Res. Nat. Bur. Stand.*, vol. 51, pp. 209–220; Nov., 1953.) An experimental investigation was made with the object of finding a metal or alloy suitable for the transmission of 10-mc pulses at temperatures between –50 degrees C. and +200 degrees C. with a delay <50 μ s independent of temperature. The effect of various constructions, crystal attachment methods and materials, and treatment of the delay-line material was investigated; the results are tabulated and shown graphically. An isoelastic iron alloy containing ~36 per cent Ni, 7–8 per cent Cr and other minor constituents, used with overcured epoxy-resin quartz-crystal attachments, gave the best transmission characteristics. A shorter account of the work is given in *Tech. News Bull. Nat. Bur. Stand.*, vol. 38, pp. 38–39; March, 1954.

621.3.015.3:517.942.82 **2015**
The Calculation of Transients in Dynamical Systems—Ward. (See 2163.)

621.3.018.75:621.387.4 **2016**
A Stable High-Speed Multichannel Pulse Analyzer—E. Gatti. (*Nuovo Cim.*, vol. 11, pp. 153–162; Feb. 1, 1954. In English.) Pulse selection in each channel is accomplished by a single discriminator whose threshold is set at a height corresponding to the upper boundary of the channel, the channel width being determined by suitably shaping the incoming pulses.

621.316.726.029.6:621.376.3 **2017**
Frequency Discrimination and Stabilization of Square-Wave Modulated Microwave Transmissions—C. H. M. Turner. (*Proc. IEE*, Part IV, vol. 101, pp. 61–72; Feb., 1954.) Full paper. See 652 of March.

621.316.729 **2018**
Pulling Effect in Synchronized Systems—Z. Jelonek, O. Celinski, and R. Syski. (*Proc. IEE*, Part IV, vol. 101, pp. 108–117. Digest, *ibid.*, Part III, vol. 101, pp. 50–52.) Synchronization of a tube oscillator with a low-pass filter in the feedback loop is considered, and the phase-equation method of analysis applied, with parameters M and T , proportional to the detuning and to the filter time-constant respectively. For $|M| < 1$, the operating point lies within the synchronization range, but the system remains in the asynchronous state (i.e. pulling effect exists) for values of $|M|$ greater than a critical value M_0 . For $|M| < M_0$ the

system is synchronized, and, if this is an initial condition of the system, synchronization will be maintained for values of $|M|$ up to unity. A graph of the pulling function, i.e. the relation between M_0 and T , obtained in part by analysis, in part from experiment, is shown. The case of a limiter in the feedback loop is also considered.

621.316.8.029.5 **2019**
The Design of a Radio-Frequency Coaxial Resistor—C. T. Kohn. (*Proc. IEE*, Part IV, vol. 101, pp. 146–153; Feb., 1954. Digest, *ibid.*, Part III, vol. 101, pp. 48–50; Jan., 1954.) Characteristics of the cylindrical coaxial resistor, intended for use as a reflection-free termination, are discussed and design curves given. The jacket diameter is chosen to maintain the resistive component of the resistor at the required value. The reactive component may be compensated in two ways. The first, suitable for resistor lengths $< 0.08\lambda$, consists in undercutting the line. The second requires the insertion of a short-circuited transmission line in series with the resistor, and will give either perfect compensation over a restricted frequency range, or less accurate compensation over a wider range. The effect of the holder is taken into account.

621.318.4 **2020**
Iron-free Cylindrical Coils with Reduced External Field—G. Kirschstein. (*Arch. Elektrotech.*, vol. 41, pp. 222–230; 1954.) The design of coils with zero magnetic moment is described and the necessary formulae are given. The arrangement consists of three coaxial coils connected so that the outer coil produces a field opposing that of the two inner coils and of such magnitude as to reduce the external field to nearly zero. The internal field is approximately equal to that of the innermost coil alone. Coils of this type are useful e.g. for focusing electron beams, for magnetic measurements and for inductance standards. See also *Phys. Z.*, vol. 41, pp. 53–55; Feb. 15, 1940 (Steinhaus and Kussmann).

621.318.423 **2021**
Design of High-Frequency Coils for High Currents—E. Karger. (*Funk u. Ton*, vol. 8, pp. 7–18; Jan., 1954.) A practical guide to the design of single-layer air-cored cylindrical coils and a short-circuit variometer. The dissipation of heat, electrical breakdown potential, and the various losses are considered. Formulas, tables and an inductance/coil-dimensions nomogram are given.

621.319.4 **2022**
The Performance of Dried and Sealed Mica Capacitors—G. H. Rayner and L. H. Ford. (*Jour. Sci. Inst.*, vol. 31, pp. 3–6; Jan., 1954.) Good stability has been achieved in an 0.01- μ F capacitor by drying it for a year and then mounting it in a sealed container. The interdependence of the variations of capacitance and power factor over the frequency range 10 cps–10 kc are discussed.

621.319.45 **2023**
Tantalum Electrolytic Capacitors—Nguyen Thien-Chi and J. Vergnolle. (*Ann. Radioelect.*, vol. 9, pp. 83–97; Jan., 1954.) A general review of types of electrolytic capacitors and problems of design, manufacture and testing of Ta types. Data are presented for three C.S.F. capacitors, having volumes of 1.7, 1.1 and 0.5 cm³, with average capacitances of 50, 25 and 12 μ F respectively at 70-v operation.

621.372 **2024**
Normalization of the Frequency Dependence of Impedance and Amplifier Circuits: Outline of Generalized Circuit Theory—K. H. R. Weber. (*Nachr. Tech.*, vol. 4, pp. 13–19; Jan., 1954.)

621.372:517.63 **2025**
Some Observations on Time considered as

a Complex Variable—E. C. Cherry. (*Onde élect.*, vol. 34, pp. 7–13; Jan., 1954.) Results of applying this concept in Fourier and Laplace transformations are examined, and its application to the analysis of transients is discussed. A practical interpretation of reversing the real-time/complex-frequency relation is given with reference to echo phenomena.

621.372:621.314.7 **2026**
The Transistor as a Network Element—J. T. Bangert. (*Bell. Syst. Tech. Jour.*, vol. 33, pp. 329–352; March, 1954.) The use of transistors for (a) reduction of dissipation, (b) elimination of inductance, (c) production of delay, (d) inversion of impedance is discussed. Improvements in performance can be achieved which would otherwise be unobtainable or uneconomic.

621.372:621.396.822:530.162 **2027**
The Brownian Movement of Linear and Nonlinear Systems—D. K. C. MacDonald. (*Phil. Mag.*, vol. 45, pp. 63–68; Jan., 1954.) The application of Brownian-movement analysis to systems with a nonlinear relaxation mechanism (e.g. electrical conductivity) is considered. A statistical hypothesis is proposed which enables a calculation to be made of the Brownian movement and corresponding frequency spectrum of such systems. The results are relevant to the study of electrical noise.

621.372:621.396.822:530.162 **2028**
Note on the Theory of Brownian Motion in Nonlinear Systems—D. Polder. (*Phil. Mag.*, vol. 45, pp. 69–72; Jan., 1954.) The hypothesis advanced by MacDonald (2027 above) is shown to be not self-consistent.

621.372.5 **2029**
A New Method of Synthesis of Reactance Networks—A. Talbot. (*Proc. IEE*, Part IV, vol. 101, pp. 73–90; Feb., 1954. Digest, *ibid.*, Part III, vol. 101, pp. 46–48; Jan., 1954.) Since the chain matrix of a cascade combination of quadrupoles is the product of the individual chain matrices, and since synthesis of a complicated network by the insertionless method involves obtaining a number of simple sections to be connected in cascade, the chain matrix is chosen for this purpose. A method of factorizing any realizable chain matrix into two such matrices of lower order is presented. Repeated factorizations ultimately yield sections simple enough to be synthesized. The method involves only simple algebra and a new theorem concerning reactance and impedance functions.

621.372.5 **2030**
Lumped-Parameter Delay Lines—H. Feisel. (*Onde élect.*, vol. 34, pp. 53–58; Jan., 1954.) The application of rigorous filter theory to delay lines comprising a series of coaxial coils is difficult owing to the coupling between non-adjacent coils. An experimental method of obtaining frequency characteristics is outlined. The latter can be corrected by connecting a capacitor across adjacent coils. Filter theory is applied to give an indication of suitable capacitance values.

621.372.5:621.3.015.3 **2031**
Monotonic Transient Response—O. P. D. Cuttidge. (*Proc. IEE*, Part IV, vol. 101, pp. 46–54; Feb., 1954. Digest, *ibid.*, Part III, vol. 101, pp. 43–44; Jan., 1954.) Restrictions are derived which must be placed on the poles and zeros of the system function of a linear system with lumped constants in order that the response of the system to a step-function drive shall be monotonic. System functions having up to three zeros are considered. A method of dealing with systems containing more than three zeros is explained.

621.372.5:621.3.018.78 **2032**
Distortion of Arbitrarily Shaped Curves by RC Sections—E. William. (*Funk u. Ton*, vol. 8, pp. 30–46 and 87–99; Jan./Feb., 1954.) A

method is given of calculating the distortion by an RC network of any signal which is expressible as the sum of a power series and terms containing exponential functions of the circuit time constants. Tables and nomograms are given for calculating the output form given the input curve, and vice versa, for rectangular, trapezoidal, triangular, parabolic and exponential-type pulses.

621.372.51:621.396.67 2033

Matching Circuits for Asymmetrical Wire Aerials—A. Simon. (*Frequenz*, vol. 8, pp. 48–56; Feb., 1954.) A comparison of various types of antenna coupling circuits used particularly at medium and long wavelengths, and of the ease of adjustment for use at different frequencies. The discussion shows that the most advantageous circuits consist of two variable reactances used in conjunction with an impedance meter. Examples of this type for use at 1.5–12 mc or at medium waves are shown.

621.372.512 2034

Action of Periodic Telegraphy Signals on Cascaded RLC Resonant Circuits—J. Marique. (*Rev. HF, Brussels*, vol. 2, pp. 233–244; 1954.) The response to rectangular, trapezoidal and sine-squared pulses of a cascaded arrangement of up to three similar tuned circuits is investigated theoretically and the results compared with the response of a single tuned circuit (3241 of 1953). The effect of bandwidth and signal repetition frequency is studied from the point of view of using the circuit for Fourier analysis and for reception of telegraphy.

621.372.54 2035

Explicit Formulae for the Calculation of Filter Circuits with Generalized Parameters—V. Fetzer. (*Arch. elekt. Übertragung*, vol. 8, pp. 31–46; Jan., 1954.) An extension of previous work (1545 of 1952) to the antimetrical low-pass, the symmetrical and the antimetrical band-pass characteristic functions and the determination of the transmission factor.

621.372.54 2036

The Smoothing of Loss Attenuation in Basic Types of Ladder Filter—H. Matthes. (*Frequenz*, vol. 7, pp. 360–368; Dec., 1953, and vol. 8, pp. 17–28; Jan., 1954.) The characteristics of basic and terminating half-sections with losses are derived from image-parameter theory, and the results applied to show how the attenuation can be smoothed by introducing mismatch at the end of the filter or by inserting series and/or shunt resistors at properly chosen points within the network.

621.372.54:621.3.015.3 2037

The Transient Response of R, F, and I.F. Filters to a Wave Packet—A. W. Gent. (*Proc. IEE*, Part IV, vol. 101, p. 164; Feb., 1954.) Discussion on 963 of 1953.

621.372.56 2038

A Stable Voltage-Controlled Logarithmic Attenuator—G. E. Boggs. (*Proc. I.R.E.*, vol. 42, pp. 696–700; April, 1954.) The variable-impedance element is a triode operated so that the cathode impedance varies approximately inversely as the transconductance. Stabilization is achieved by the use of dc feedback with a suitable increase in loop gain. Design procedure is given for both high- and low-input types. Experimental results are discussed.

621.372.6 2039

Design of RC Wide-Band 90-Degree Phase-Difference Network—D. K. Weaver, Jr. (*Proc. I.R.E.*, vol. 42, pp. 671–676; April, 1954.) The arrangement comprises two all-pass networks, as described by Orchard (1356 of 1950). The pole-zero pairs are first determined so as to give the 90-degree difference of phase shift over the frequency band, and the networks are synthesized from the response functions thus found. Design procedure is detailed

step by step and is illustrated by a numerical example. Notes on construction and alignment are included.

621.372.8:538.614 2040

A Nonreciprocal Microwave Component—M. L. Kales, H. N. Chait, and N. G. Sakiotis. (*Jour. Appl. Phys.*, vol. 24, pp. 816–817; June, 1953.) In the presence of a steady magnetic field the permeability of a ferrite is an asymmetrical tensor. This property is applied in the construction of a nonreciprocal device comprising a waveguide in which a ferrite block is arranged asymmetrically and parallel to the axis, a static magnetic field being applied transversely. Experimental results are given.

621.373.4 2041

Valve Oscillators with Voltage-Controlled Frequency Dependence—H. Wilde. (*Frequenz*, vol. 18, pp. 1–7; Jan., 1954.) A discussion of various circuits in which reactance is varied by application of control voltage, and a comparison of their performance in respect of bandwidth and output at medium and high frequencies.

621.373.42 2042

Ultra-Low-Frequency Three-Phase Oscillator—G. Smiley. (*Proc. I.R.E.*, vol. 42, pp. 677–680; April, 1954.) An oscillator for the frequency range 0.01 cps–1 kc uses three identical networks each comprising a polystyrene capacitor and a stable resistor, in a star arrangement radiating from the power supply. The circuit is in effect a three-stage amplifier, oscillations occurring at the frequency for which the phase shift is 60 degrees in each RC network. Use is made of the Miller effect to keep down the size and cost of the frequency-determining elements.

621.373.42.029.55/.62:621.318.572 2043

Electronically-Tuned Wide-Range Oscillator—D. D. King and R. L. Konigsberg. (*Electronics*, vol. 27, pp. 184–186; March, 1954.) A helical transmission line with Ge diodes mounted at intervals of $\lambda/4$ is used as tuning element in a Colpitts circuit. Tuning is accomplished by applying a switching pulse to a selected diode to short the line. The five tuning positions give frequencies of about 8.6, 14, 22, 34, and 46 mc respectively. The length of helical line required is very much less than that of a parallel-conductor line for the same frequency. Satisfactory operation of an experimental model was achieved at switching rates up to 1000 pulses/second.

621.373.421 2044

Perturbations of a Nonlinear Filtered Oscillator—G. Cahen. (*Onde Elect.*, vol. 34, pp. 80–89; Jan., 1954.) Analysis, summarized earlier (1279 and 1624 of 1953), of the effect of a disturbance on the behavior of an oscillator comprising a nonlinear amplifier, feedback loop and low-pass filter. See also 972 of 1953 (Cahen and Loeb).

621.373.421.029.4/.51 2045

Audio Oscillator uses New RC Design—J. H. Owens. (*Electronics*, vol. 27, pp. 176–177; March, 1954.) A signal generator covering the range of 11 cps–100 kc in four bands has both low-pass and high-pass RC filters incorporated in the feedback loop to give good frequency stability and good waveform. Amplified ac is included in a commercial adaptation of the circuit.

621.374:621.314.632:546.289 2046

"Positive-Cap" Germanium Diode—Reeves. (See 2256.)

621.374:621.396.82 2047

Noise Discriminator for Periodic Signals—R. L. Conger and L. E. Schilberg. (*Rev. Sci. Instr.*, vol. 25, pp. 52–54; Jan., 1954.) The periodic signal, of any waveform, is applied through a phase inverter to one pair of terminals

of a resistance bridge including two diode rectifiers. Periodic pulses are applied to the other pair of bridge terminals. During each pulse the diodes are unblocked and the signal passes to an integrating circuit with an adjustable time constant. If the pulse frequency is slightly greater than the signal frequency the output obtained has the waveform of the noise-free input signal and a much lower frequency; random noise, mains interference, and any other disturbance of a frequency which is not a multiple of the signal frequency will not be reproduced. The unit was designed for use with nuclear-magnetic resonance apparatus.

621.374.4:621.373.421.13 2048

Subharmonic Crystal Oscillators—M. O. Thompson, Jr., C. E. Tschiegg, and M. Green-span. (*Rev. Sci. Instr.*, vol. 25, pp. 8–12; Jan., 1954.) The operating frequency of a relaxation oscillator can be stabilized at a submultiple of a crystal frequency. In a conventional blocking oscillator with a crystal connected across the third winding of the pulse transformer, frequency division by factors up to several thousand can be effected. A multivibrator with crystal between anode and grid of one valve gave good frequency and pulse-width stability when operating with a division factor of 100. Details of these two circuits are given; three others have been examined, namely a screen-coupled-phantastron, a thyatron, and a transistor circuit.

621.375:534.6 2049

Use of Variable-Gain Amplifiers in Acoustic Measurements—Moles (See 1978.)

621.375.132.018.78 2050

Harmonic Distortion and Negative Feedback—E. E. Zeppler. (*Wireless Engr.*, vol. 31, pp. 118–121; May, 1954.) Different methods of defining gain in relation to the output-voltage/input-voltage characteristic of an amplifier are discussed; for a nonlinear amplifier it is reasonable to base the definition on the average slope. A method is indicated for constructing the characteristic of the amplifier with feedback from that of the amplifier without. Distortion can be reduced by means of feedback even for flat regions of the characteristic; this result is in disagreement with that of Rowlands (2278 of 1953). Detailed analysis is given for several types of amplifier.

621.375.2.018.75:621.373.431.1 2051

Application of the Multivibrator Principle in Counter-Tube Amplifiers—W. Kroebel and G. Stutzer. (*Z. angew. Phys.*, vol. 6, pp. 14–19; Jan., 1954.) A description is given of a pulse amplifier based on a multivibrator circuit, which gives an output pulse of amplitude 180v with a leading-edge slope of 1.1×10^{-9} second/v for a 0.3-mv input pulse.

621.375.222 2052

Cathode-Coupled Valves—T. W. Brady. (*Wireless Engr.*, vol. 31, pp. 111–114; May, 1954.) A graphical method is described for investigating cathode-coupled amplifiers. The method is demonstrated in relation to a circuit using a Type-ECC33 twin triode, and involves the construction of composite load lines on the anode characteristics. An initial trial solution must be found to determine the voltage across the cathode resistor in the quiescent case.

621.375.232.3 2053

An AC Cathode-Follower Circuit of Very High Input Impedance—J. R. Macdonald. (*Rev. Sci. Instr.*, vol. 25, pp. 144–147; Feb., 1954.) A push-pull amplifier for the range 10^2 – 10^4 cps is described. Each half of the input consists of a cathode follower with gain approximately unity with a constant-current cathode load constituted by a further tube. The effect of grid-anode capacitance in the input valve is reduced by driving the anode by another cathode follower in series with it. Input capacitance is < 0.3 pF and input resistance

$>4 \times 10^9 \Omega$ up to 3.2 kc. Circuit modifications to obtain zero or negative input capacitance are explained.

621.375.3 2054
Flux Preset High-Speed Magnetic Amplifiers—C. B. House. (*Elect. Eng.*, vol. 73, p. 51; Jan., 1954.) Digest of paper to be published in *Trans. AIEE*, vol. 72, 1953.

621.375.3 2055
Parallel-Connected Magnetic Amplifiers—S. H. Chow. (*Jour. Appl. Phys.*, vol. 25, pp. 216–221; Feb., 1954.) A complete analysis, based on a single-valued B/H relation, is made for three types of load: resistive, inductive and capacitive. Transient response is considered. Analysis of feedback amplifiers shows clearly the "jump" phenomenon in the output characteristic.

621.375.4 2056
High-Frequency Transistor Amplifiers—W. F. Chow. (*Electronics*, vol. 27, pp. 142–145; April, 1954.) Transistor equivalent circuits appropriate for h.f. wide-band operation are presented. Input and output impedance and power gain for grounded-base and grounded-emitter arrangements are discussed. The design of an IF amplifier using four *n-p-n* transistors is described as an example; the bandwidth is 14 kc centered at 455 kc, and the gain is 18 db per stage.

621.375.4 2057
Transistor Equations using h-Parameters—C. C. Cheng. (*Electronics*, vol. 27, pp. 191–192, 194; April, 1954.) Transistor circuit calculations are simplified by making use of fundamental parameters for the four-terminal network corresponding to the base-input common-emitter circuit. Circuit equations in terms of these parameters are tabulated for the three basic configurations.

621.375.4 2058
Practical Two-Stage Transistor Amplifiers R. L. Riddle. (*Electronics*, vol. 27, pp. 169–171; April, 1954.) The effects of feedback and choice of coupling circuits are discussed. Experimentally determined operating characteristics are presented for the three most useful arrangements, (a) grounded-emitter to grounded-emitter, (b) grounded-base to grounded-emitter, and (c) grounded-collector to grounded-emitter, using commercially available junction transistors.

621.375.4 2059
Design of Transistor Power Amplifiers—S. K. Ghandil. (*Electronics*, vol. 27, pp. 146–149; March, 1954.) Methods are outlined for obtaining maximum power output consistent with acceptable distortion. Factors considered include stage gain and power supply. Using values obtainable with the GE2N34 *p-n-p* transistor, two numerical examples are worked out (a) a class-A push-pull grounded-base arrangement for a 100-mw low distortion af amplifier, and (b) a class-B grounded-emitter arrangement for a 300-mw output stage.

621.375.4.024 2060
Temperature-Compensated D.C. Transistor Amplifier—E. Keonjian. (*Proc. I.R.E.*, vol. 42, pp. 661–671; April, 1954.) The variation of transistor parameters with temperature is discussed. Compensation can be provided by using temperature-sensitive resistors. A description is given of an experimental dc amplifier compensated in this way. See also 1367 of May.

621.376.5:621.385.029.6 2061
Pulse Formation and Supply for Magnetrans—H. G. Bruijning. (*Tijdschr. ned. Radio-genoot.*, vol. 19, pp. 11–23; Jan., 1954.) Discussion of the design of a modulator capable of handling pulses of the order of 30 A at 30 kv with a duration of 1 μ s and a repetition rate of

1000 per second. The method of pulse formation used is based on the slow charging and rapid discharging of a capacitor. The use of artificial lines for pulse shaping is described. If a pulse transformer is usual the charging voltage need not be unduly high.

621.396.6 2062
Trends of Development in the Field of Electrical Components for Telecommunication—P. Henninger. (*Frequenz*, vol. 7, pp. 345–359; Dec., 1953 and vol. 8, pp. 7–17; Jan., 1954.) Component design is considered from the point of view of the physics and chemistry involved in meeting the requirements of (a) operation over a particular frequency band, (b) operation under conditions of prescribed current waveform and intensity, (c) operation under peak loads, (d) operation at low loss, (e) operation under given ambient conditions, (f) operation under restrictions of tolerance, (g) stability and durability.

621.396.6:061.4 2063
Components Exhibition. Trends in Developments Portrayed at the R.E.C.M.F. Show—(*Wireless World*, vol. 60, pp. 206–210; May, 1954.) A review of the exhibition held in London, April, 1954.

621.396.6.002.2 2064
Printed-Circuit Design Sources—(*Elect. Mfg.*, vol. 52, pp. 129–132 and 316; Dec., 1953.) A detailed guide to commercial design and manufacturing sources available in the U.S.A.

621.396.6.002.2.001.4 2065
Standardization of Printed Circuit Materials—W. Hannahs, J. Caffiaux, and N. Stein. (*Tele-Tech.* vol. 13, pp. 68–70 and 155; Feb., 1954.) Results of tests on metal-clad plastic laminates for (a) thermal endurance under simulated manufacturing conditions, (b) adhesion variation between the center and the edge of the sheet, (c) bond strength during solder dipping and hand soldering, (d) effects of dust, are shown graphically. These and other types of bond-strength tests are discussed from the point of view of establishing quality standards and standard conditions of test. The positioning of components to avoid bond stress, and the proper choice of operating temperatures are also considered.

GENERAL PHYSICS

537.122 2066
A Theory of the Electron—H. T. Flint and E. M. Williamson. (*Nuovo Cim.*, vol. 11, pp. 188–189; Feb. 1, 1954. In English.) An essentially classical theory is proposed by analogy with the gravitational theory of matter; it is based on equations of the form suggested by Mie in 1912. The mass of the electron is accounted for by means of the energy of the field.

537.311.5:621.3.015.3 2057
Diffusion of Pulsed Currents in Conductors—L. M. Vallese. (*Jour. Appl. Phys.*, vol. 25, pp. 225–228; Feb., 1954.) Theoretical investigation of the density distribution and the equivalent depth of penetration of a transient current, for the case of a plane TEM wave incident normally upon a plane conductor. Particular pulse waveforms are considered. See also 1900 of 1950.

537.52 2068
The Decay of the Space Charges in Intermittent Discharges in Neon and Argon—D. Brini and P. Veronesi. (*Nuovo Cim.*, vol. 10, pp. 1662–1672; Dec. 1, 1953. In English.) The influence of the gas pressure and electrode separation on the decay of the space charges is investigated experimentally. The decay times for both neon and argon appear to be of the order of 10^{-8} sec, and are nearly proportional to the pressure over the range of measurement (about 1–40 Torr). Possible explanations of these values are discussed, and the various regions of the static characteristic are related

to the functioning of counters and periodic discharges.

537.523 2069
The High-Pressure Glow Discharge in Air—W. A. Gambling and H. Edels. (*Brit. Jour. Appl. Phys.*, vol. 5, pp. 36–39; Jan., 1954.) Report of observations on the glow discharge in air at a pressure of about 760 mm Hg, between Cu and W electrodes; characteristics are given for discharge lengths of 0–8 mm and currents of 0.01–0.5 A.

537.525.5:621.396.822 2070
Spectrum Intensities and Radio Frequency Noise in a D.C. Hydrogen Arc—S. E. Williams and V. Maslen. (*Nature (London)*, vol. 173, pp. 361–362; Feb. 20, 1954.) Rf noise generated by the arc was reduced by shunting the arc with a capacitor; this caused an incidental modification of the ultraviolet spectrum. The results suggest a connection between the noise intensity and the distribution of energy among the electrons.

537.533:546.74 2071
Investigation of the Electron Emission from Nickel—G. V. Spivak and A. Gel'berg. (*Compt. Rend. Acad. Sci. (U.R.S.S.)*, vol. 94, pp. 455–458; Jan. 21, 1954. In Russian.) Experiments show that the work function of a single crystal of Ni, reduced in hydrogen, is higher above the Curie point than below it. This result is shown graphically. Field strengths of about 6×10^7 V/cm were used in measurements of electron emission from a point source. Photographs of the emission patterns are shown.

537.56 2072
A Note on the Formula for the Mobility of Electrons with Mean Free Path varying with Velocity—P. M. Davidson. (*Proc. Phys. Soc.*, vol. 67, pp. 159–161; Feb. 1, 1954. Correction, *ibid.*, vol. 67, p. 279; March 1, 1954.) A correct generalized formula is derived for the electronic drift velocity in an ionized gas, taking the Townsend-Ramsauer effect into account.

537.582 2073
Theory of the Work Function of Metals—W. Oldekop and F. Sauter. (*Z. Phys.*, vol. 136, pp. 534–546; Jan. 25, 1954.) The polarizing action of individual electrons on the distribution of the remaining electrons in the conduction band is investigated by means of extended Thomas-Fermi statistics and the effect on the magnitude of the work function calculated. In alkali metals the work function is determined largely by this polarization effect (image force) and only slightly by the electrostatic double-layer at the metal boundary.

538.248 2074
Fluctuation Magnetic After-Effect—J. C. Barbier. (*Ann. Phys. (Paris)*, vol. 9, pp. 84–140; Jan./Feb., 1954.) Thesis, based on Neel's theory, on the irreversible after-effect in ferromagnetic materials which is identified with the residual loss. Earlier reports of the work were noted in 2237 of 1952 and 1661 of 1950, in which it should have been stated that the square root of the remanent magnetization is proportional to the logarithm of time elapsed from the suppression of the field and to the logarithm of the duration of application.

538.3 2075
Self-Consistent Electrodynamics—O. Buneman. (*Proc. Camb. Phil. Soc.*, vol. 50, Part 1, pp. 77–97; Jan., 1954.) "The idea of direct action between streams is applied to a continuous charged fluid and combined with the new formulation of the electrodynamical laws of motion in terms of conservation of circulation. A simple and rigorous integrated formulation is thus obtained from the Maxwell-Lorentz differential equations, applicable to co-existing positive and negative fluids, as well as vacuum. Exact solutions are obtained, among them one which represents self-consistent, self-main-

tained flow in a hollow tubular region of infinite axial extent. It is hoped this tube might be bent into a torus and that an electron model will result from merely quantizing the one or two vortices around which this flow-pattern circulates."

538.52:537.311.5:621.396.677.8 2076

On the Current induced in a Conducting Ribbon by a Current Filament Parallel to it—E. B. Moullin. (*Proc. IEE*, Part IV, vol. 101, pp. 7-17; Feb., 1954.) Full paper. See 704 of March.

538.56:535.422 2077

On the Complete Theory of Diffraction of Electric Waves by a Perfect Conducting Wedge—Y. Nomura. (*Sci. Rep. Res. Inst. Tohoku Univ., Ser. B*, vol. 4, pp. 29-50; Dec., 1952.) Continuation of work abstracted in 374 of 1952. The analysis is revised and completed, and errata are corrected.

538.566:535.42 2078

Diffraction of Electromagnetic Waves by an Aperture in a Large Screen—J. H. Crysdale. (*Jour. Appl. Phys.*, vol. 25, pp. 269-270; Feb., 1954.) Bekefi's approximate formula (709 of March) is derived simply by another method.

538.569.4.029.65:535.33 2079

One-to-Two Millimeter Wave Spectroscopy: Part 4—Experimental Methods and Results for OCS, CH₃F, and H₂O—W. C. King and W. Gordy. (*Phys. Rev.*, vol. 93, pp. 407-412; Feb. 1, 1954.) Continuation of work reported previously (2623 of 1953). Multiplier and detector performance were greatly improved by using crystals small compared to the wavelength to be detected. A new tuning technique based on known absorption lines was developed. Measurements made included that of a new water-vapor line at 183.31130 ± 0.00030 kmc.

GEOPHYSICAL AND EXTRATERRESTRIAL PHENOMENA

523.2/.8:621.396.822]:621.396.621 2080

A D.C. Comparison Radiometer—Selove. (See 2205.)

523.746 2081

Revised Data for the Mean Sunspot Curve—W. Gleissberg. (*Naturwissenschaften*, vol. 41, p. 82; Feb., 1954.) When the data for the present nearly concluded 11-year cycle are included with those for the seventeen preceding cycles, the mean curve exhibits a slightly steeper rise and a slightly shallower fall, thus increasing its asymmetry.

523.746:550.386 2082

Controls of Geomagnetic Activity by Sunspots—U. Becker and J. F. Denisse. (*Jour. Atmos. Terr. Phys.*, vol. 5, pp. 70-72; March, 1954.) Becker (*Z. Astrophys.*, vol. 32, p. 195; 1953.) showed that a decrease of magnetic activity occurs when two sunspots or groups of sunspots are symmetrically located on the solar disk with respect to the solar equator. On the basis of this work and that of Denisse (2642 of 1953), it should be possible to forecast each year, on an average, about 80 perturbed and 75 quiet days.

523.854:621.396.822 2083

Identification of the Most Powerful Discrete Sources of Radio Emission of the Galaxy with the Residua of Supernovae Exploded in the Last 2000 Years—I. S. Shklovski. (*Compt. Rend. Acad. Sci. (U.R.S.S.)*, vol. 94, pp. 417-420; Jan. 21, 1954. In Russian.)

550.38:551.510.535:621.396.11 2084

Experimental Determination of the Total Intensity of the Terrestrial Magnetic Field in the Lower Region of the Upper Atmosphere (E Layer)—M. Cutolo. (*Nuovo Cim.*, vol. 10, pp. 915-925; July 1, 1953.) Fuller account of work described previously (720 of March).

551.510.535 2085

Plasma Theory of the Ionosphere—I. Lucas and A. Schlüter. (*Arch. elekt. Übertragung*, vol. 8, pp. 27-30; Jan., 1954.) The basic equations for the dynamic and electrical behavior of the ionosphere are derived from the theory of a neutral plasma, and are used to investigate the problems of diffusion of the plasma at layer boundaries, cm damping of air movements and tidal oscillations of the ionosphere.

551.510.535 2086

Electron Density in the Upper Atmosphere and Interpretation of the *h'f* Curves of Ionosphere Virtual Height: Part 2—F. Mariani. (*Ann. Geosf.*, vol. 6, pp. 533-553; Oct., 1953.) A calculation is made of the optical path of a wave reflected by a Chapman layer with a semithickness 2.5 H (where H is the scale height). Comparison of the results with those obtained previously (3598 of 1953) indicates that the lower half of such a layer is closely approximated by a parabolic layer of semithickness 1.5 H. The electron density distribution is investigated for regions of superposition of the F₁ and true F₂ layers, taking recombination into account. The linear superposition formula used previously is found to be inadequate and is replaced by the formula $N = (N_1^2 + N_2^2)^{1/2}$, where N₁ and N₂ are the independent densities of the F₁ and the true F₂ layers.

551.510.535 2087

A Tentative Model of the Equilibrium Height Distribution of Nitric Oxide in the High Atmosphere and the Resulting D Layer—A. P. Mitra. (*Jour. Atmos. Terr. Phys.*, vol. 5, pp. 28-43; March, 1954.) Two possible processes for the production of NO are considered, (a) three-body recombination with O, and (b) photodissociation of N₂O into N and NO. The distribution of known constituents of the atmosphere in the 50-100-km range is discussed, and the NO height distribution derived for the two possible production processes. D-layer ionization characteristics are satisfactorily explained, assuming photoionization of NO at $\lambda < 1300 \text{ \AA}$, and the electron distribution is derived, both for the case of photochemical equilibrium of NO and for a nonequilibrium distribution under the condition of complete mixing.

551.510.535 2088

The Determination of the Electron Density Distribution of an Ionosphere Layer in the Presence of an External Magnetic Field—J. M. Kelso. (*Jour. Atmos. Terr. Phys.*, vol. 5, pp. 11-27; March, 1954.) "The electron density distribution is determined by finding the actual heights at which waves of various frequencies are reflected. These true heights are obtained from experimental *h'f* curves by obtaining the exact solution, as a convergent series of integrals, of the integral equation giving the group height as a function of frequency. The errors arising in the numerical work are shown by applying the procedure to *h'f* curves obtained theoretically from layers of known shape, and such errors are seen to be small compared with those made through use of other procedures."

551.510.535 2089

Regularities in the F Region of the Ionosphere—B. Chatterjee. (*Nature, (London)*, vol. 173, pp. 263-264; Feb. 6, 1954.) Justification of the assumptions made in 407 of February is presented.

551.510.535:551.543 2090

Correlation between Variations of Surface Pressure and Ionospheric Parameters—M. R. Kundu. (*Indian Jour. Phys.*, vol. 27, pp. 235-243; May, 1953.) A statistical analysis was made of meteorological and ionospheric data obtained at Calcutta during the period 1948-1951. Correlation between variations of ionosphere parameters and of surface pressure was found at least for some months of the year. The results are in agreement with those obtained in

Australia by Martyn and Pulley (*Proc. Roy. Soc. A*, vol. 154, p. 455; 1936.) Previously proposed tentative explanations based on variations of ozone content or the effects of circulation in the troposphere are examined; further data are required in order to assess their correctness.

551.510.535:551.55 2091

Recent Advances in the Study of Ionospheric Winds—L. A. Manning. (*Bull. Amer. Met. Soc.*, vol. 34, pp. 401-405; Nov., 1953.) The radio-fading method developed by Mitra (96 of 1950) and the meteor-trail-echo method developed by Manning et al. (3052 of 1950) for investigating ionospheric winds are briefly reviewed, and results so far obtained are discussed.

551.510.535:621.396.11 2092

The Effect of Sunrise on the Reflection Height of Low Frequency Waves—S. B. Brown and W. Petrie. (*Canad. Jour. Phys.*, vol. 32, pp. 90-98; Jan., 1954.) The observed sudden changes of phase and amplitude of 16-kc waves transmitted over distances of 540 km are discussed in relation to the geometry of the system at the change-over from night-time to day-time reflection height (95 km and 70 km respectively). The effect cannot be due to photoionization of atmospheric molecules, but may be due to the removal of electrons from negative oxygen ions by visible and near-infrared radiations; calculations are presented giving support to this view. The rate of fall of the reflection height is discussed.

551.594.13:551.508.11 2093

Measurement of the Electrical Conductivity in the Upper Air by Radiosonde—S. P. Venkiteshwaran, B. K. Gupta and B. B. Huddar. (*Proc. Indian Acad. Sci. A*, vol. 38, pp. 109-115; Aug., 1953.) Description of a measurement technique using the Gerdien conductivity apparatus in conjunction with a tube electrometer and an af-modulated American type radiosonde.

551.594.21 2094

Generation of Electricity in Thunderstorms—B. J. Mason. (*Elect. Times*, vol. 125, pp. 159-163; Feb. 4, 1954.) A general account of the origin and nature of lightning.

551.594.6:538.566 2095

The Higher-Order Modes in the Propagation of Long Electric Waves in the Earth-Air-Ionosphere System and Two Applications (Horizontal and Vertical Dipole)—Schumann. (See 2195.)

LOCATION AND AIDS TO NAVIGATION

621.396.93:621.396.663 2096

Investigation of the Interference Field of Electromagnetic Waves with a C.R. Direction Finder—J. Pietzner. (*Fernmeldetechn. Z.*, vol. 7, pp. 80-84; Feb., 1954.) Description of a system for determining the directions of two interfering transmitters operating on the same frequency. The Adcock- and vertical-antenna systems are used in conjunction with a goniometer so that the signals applied to the Y and X plates of the cro are the signals received effectively by aerials with cardioid and figure-of-eight polar diagrams respectively. The two goniometer settings at which the cro trace reduces to a straight line are ϕ_1 and $\phi_2 - \phi_1 - 180$ degrees, respectively, where ϕ_1 and ϕ_2 are the bearings for the two transmitters.

621.396.962.3:621.396.621 2097

Use of Superregenerative Receivers as Intermediate-Frequency Amplifiers for Pulsed Radar Reception—S. Marmor. (*Onde élect.*, vol. 34, pp. 73-79; Jan., 1954.) Operating principles of a superregenerative receiver for pulse reception (481 of 1952) are outlined. Its performance at a wavelength of 3.2 cm is compared with that

of a conventional superheterodyne receiver. Typical ppi and Type-A displays in the two cases are compared.

621.396.962.3:621.396.882 2098

The Minimum Usable Signal in Radar Reception and its Improvement by Certain Correlation Techniques—L. Gérardin. (*Onde élect.*, vol. 34, pp. 67–72; Jan., 1954.) The definition of minimum usable signal in terms of signal/noise ratio and probability of detection is discussed. Experimental results obtained at a wavelength of 10 cm, using a 12-inch cr tube with ppi display, are in agreement with calculations reported by Ross (1653 of 1951). For a ppi display, under normal conditions the minimum usable signal is the tangential signal, viz. a signal 8 db above rms noise power. Principles of design of linear and nonlinear filters effectively increasing signal/noise ratio are outlined.

621.396.962.38 2099

Secondary Surveillance Radar—D. A. Levell. (*Wireless World*, vol. 60, pp. 227–230; May, 1954.) An experimental system tried at London Airport uses an interrogation frequency of 1.215 kmc and a response frequency of 1.375 kmc. The interrogating signal comprises three 1- μ s pulses, (a) a reference pulse actuating gating circuits in the airborne transponder, (b) a control pulse, and (c) the interrogator pulse proper. The separation between the leading edges of (a) and (b) is 5 μ s and that between the leading edges of (a) and (c) is 16 μ s. (a) and (c) are produced by the same oscillator and radiated from the same directional aerial, (b) is produced separately and radiated omnidirectionally. When the received control pulse exceeds the following interrogator pulse by more than 3 db the interrogator pulse is prevented from passing through the gate. Side-lobe responses are thus prevented.

621.396.963.325 2100

Circular Radar Cuts Rain Clutter—W. D. White. (*Electronics*, vol. 27, pp. 158–180; March, 1954.) A 1.3-kmc radar unit was modified for use with circularly polarized radiation by covering the dish-shaped reflector with wire mesh. Improvements in target/precipitation ratio varying from 8 to 25 db were obtained. The adverse effect of ground reflections is noted. Details are given of the statistical method used in measurements on aircraft targets.

621.396.969.33 + 621.396.969.36 2101

A Survey of Five Years' Progress in Marine Radar—F. J. Wylie. (*Jour. Inst. Nav.*, vol. 7, pp. 59–77; Jan., 1954.)

MATERIALS AND SUBSIDIARY TECHNIQUES

531.788.7 2102

Ultra-High Vacuum: Part 2—Limiting Factors on the Attainment of Very Low Pressures—D. Alpert and R. S. Buritz. (*Jour. Appl. Phys.*, vol. 25, pp. 202–209; Feb., 1954.) Continuation of work reported in 3603 of 1953 (Alpert). Calibration of the Bayard-Alpert ionization gauge shows that its characteristic is linear over most of its useful range, 5×10^{-10} – 10^{-3} mm Hg. The achievement of very low pressures in glass systems is limited ultimately by diffusion of atmospheric He through the walls. A simplified omegatron [*Phys. Rev.*, vol. 82, pp. 697–702; June 1, 1951. (Sommer et al.)] has been developed for the measurement of partial pressures in a highly evacuated system.

535.215:546.817.221 2103

Bulk Photoconductivity in Lead Sulphide—D. E. Soule and R. J. Cashman. (*Phys. Rev.*, vol. 93, pp. 635–636; Feb. 1, 1954.) Preliminary results of experiments at 77 degrees K. on three cleaved synthetic PbS crystals are reported. The crystal surface was scanned by a light spot and the resulting photocurrent measured. Current maxima were found at points on the crystal at which internal potential barriers were known to exist.

535.215.3:538.639:546.289 2104

Contribution to the Study of the Photomagnetolectric Effect in Germanium—H. Bulliard. (*Ann. Phys.*, (Paris), vol. 9, pp. 52–83; Jan./Feb., 1954.) Detailed report of a theoretical and experimental investigation. See also 2015 and 2016 of 1953 (Aigrain and Bulliard). Values for the coefficient of volume recombination and the surface recombination velocity are calculated.

535.3:546.817.221 + 546.817.231 + 546.817.241 2105

Further Measurements on the Optical Properties of Lead Sulphide, Selenide and Telluride—D. G. Avery. (*Proc. Phys. Soc.*, vol. 67, pp. 2–8; Jan. 1, 1954.) Continuation of earlier work (2018 of 1953). Measurements have been made at wavelengths up to 6 μ , using reflection techniques. Temperature effects on PbS and the effects of baking in an O₂ atmosphere are discussed.

535.34:[537.311.31 + 537.311.33 2106

On the Theory of Optical Absorption in Metals and Semiconductors—R. Wolfe. (*Proc. Phys. Soc.*, vol. 67, pp. 74–84; Jan. 1, 1954.) A quantum-mechanics method is described for calculating the effect on the optical absorption of any of the factors responsible for electrical resistance. The electrons scattered by imperfections in the crystal lattice are considered to absorb light by a photo-electric process. The results calculated, using a first-order approximation, for the case where the conduction electrons are scattered by dissolved impurities are similar to those obtained using semi-classical theory in which the current set up by the light is assumed to be damped by the impurities. For semiconductors, the new method gives much lower absorption values than the semi-classical method. The use of exact wave functions for the very slow electrons in semiconductors would give greatly increased absorption coefficients.

535.37 2107

Emission Spectra of Multiply Activated Electroluminescent Materials—G. Destriau. (*Jour. Phys. Rad.*, vol. 15, pp. 13–15; Jan., 1954.) The spectra are composed of bands associated respectively with the different activators. The electroluminescence spectra may be very different from the fluorescence spectra, and are greatly influenced by the frequency and intensity of the exciting field.

535.37 2108

Periodic Variations of Brightness in Electroluminescence and in Luminous Surface Effects—G. Curie and D. Curie. (*Jour. Phys. Rad.*, vol. 15, pp. 61–62; Jan., 1954.) The observed phase shift of electroluminescence brightness variations with respect to the exciting field is interpreted as supporting the view that electroluminescence is essentially a volume rather than a surface effect.

535.57 2109

Temperature Dependence of the Electroluminescence of ZnS and ZnO Phosphors—H. Gobrecht, D. Hahn, and H. E. Gumlich. (*Z. Phys.*, vol. 136, pp. 623–630; Jan. 25, 1954.) Further investigations (see 2110 below) revealed an electrothermoluminescence effect in variously activated ZnS and ZnO phosphors, the luminescence/temperature curve exhibiting maxima at a number of points when the phosphor is slowly heated from –100 degrees C. to room temperature. The positions of the maxima are independent of field strength and frequency. On cooling, luminescence increases monotonically over a large part or the whole of the temperature range.

535.37:538.228 2110

Electroluminescence of Various Phosphors and its Dependence on the Strength and Frequency of the Alternating Electric Field—

H. Gobrecht, D. Hahn, and H. E. Gumlich. (*Z. Phys.*, vol. 136, pp. 612–622; Jan. 25, 1954.) Electroluminescence was produced in phosphors at –100 degrees C. by using alternating fields of strengths between 10⁴ and 10⁵ v/cm and frequencies between 100 cps and 10 kc. Results show that Zn and Cd sulphides and ZnO are excited more easily than other materials, that oxidizing pre-treatment of the sulphides reduces their electroluminescence field-strength threshold, and that luminescence can be excited in other materials by a glow-discharge caused by the field. Several criteria for distinguishing true electroluminescence from this latter case are given. The intensity of electroluminescence increases with field strength and frequency. Possible causes of these phenomena are discussed.

535.37:537.533.8 2111

The Effect of Organic Vapor on the Secondary Emission of Phosphors—P. H. Dowling and J. R. Sewell. (*Jour. Appl. Phys.*, vol. 25, pp. 228–230; Feb., 1954.) Experiments show that surface contamination causes a rapid reduction of the secondary emission ratio. If the bombardment voltage is sufficiently high this results in a progressive decrease in the surface potential and a corresponding decrease in apparent fluorescence efficiency. The relation between this effect and true "phosphor burn" is discussed. Organic-vapor contamination may accelerate the development of "cross burn" in cr tubes.

535.376 2112

Characteristics of Radioluminescence in Crystals—G. T. Wright and G. F. J. Garlick. (*Brit. Jour. Appl. Phys.*, vol. 5, pp. 13–18; Jan., 1954.) Report of an experimental investigation of the variation of light output with particle energy for single crystals or organic and inorganic phosphors excited by α particles.

535.376 2113

A Luminescent Screen for Use with Very-Low-Velocity Electrons—S. F. Kaisel and C. B. Clark. (*Jour. Opt. Soc. Amer.*, vol. 44, pp. 134–135; Feb., 1954.) Screens responding to excitation by electrons with energy as low as 3 ev are prepared by settling a phosphor designated as "hex ZnO:(Zn)" on to a glass plate previously coated with a transparent conducting film.

535.376 2114

Excitation of Zinc Oxide Phosphors by Low-Energy Electrons—R. E. Shrader and S. F. Kaisel. (*Jour. Opt. Soc. Amer.*, vol. 44, pp. 135–139; Feb., 1954.) An experimental investigation was made for cases where the energy of the exciting electrons was not greater than that of the observed photons. The results suggest that any electron accepted by the crystal lattice is capable of producing luminescence in ZnO phosphors, no matter how low the bombarding voltage.

537.227 2115

Phase Transitions in Ferroelectric KNbO₃—G. Shirane, H. Danner, A. Pavlovic, and R. Pepinsky. (*Phys. Rev.*, vol. 93, pp. 672–673; Feb. 15, 1954.) A third phase transition has been observed at –10 degrees C. on heating and –55 degrees C. on cooling, a change from orthorhombic to rhombohedral structure being accompanied by an abrupt change of dielectric constant.

537.227:546.431.824–31 2116

Effect of a Two-Dimensional Pressure on the Curie Point of Barium Titanate—P. W. Forsbergh, Jr. (*Phys. Rev.*, vol. 93, pp. 686–692; Feb. 15, 1954.) A disk-shaped single-crystal specimen of BaTiO₃ was subjected to pressure on its edges and not on its faces. The transition temperature increased with the two-dimensional pressure. This result is discussed in relation to previous experiments in which hydrostatic pressure was applied.

- 537.311.31:548.0 2117
Lattice Defects and the Electrical Resistivity of Metals—T. Broom. (*Advance Phys.*, vol. 3, pp. 26–83; Jan., 1954.) Calculations of the effect of lattice defects on resistivity are summarized and the results are discussed in relation to observations made by quenching, irradiation and deformation experiments.
- 537.311.31:669–124.2 2118
The Effect of Cold-Work on the Electrical Resistivity of Alloys and the Law of Recovery—J. O. Linde. (*Appl. Sci. Res.*, vol. B4, pp. 73–86; 1954.) Measurements are reported on alloys with Cu, Ag or Au as matrix component. The resistivity changes resulting from cold working differ greatly for the various alloys. Au-Cr and Au-Fe alloys exhibit a decrease of resistivity. Recovery is studied for various annealing temperatures. A law is established expressing the resistivity change as a function of temperature and time. The results are discussed in relation to theory.
- 537.311.33 2119
Theory of the Differential Thermoelectric Power of Semiconductors—G. Lautz. (*Z. Naturf.*, vol. 8a, pp. 361–371; June, 1953.) Two formulas are derived for determining the Fermi level, the one applicable at the low temperatures associated with impurity semiconduction and the other applicable at the medium and high temperatures associated with the transition from impurity to intrinsic conditions and with purely intrinsic semiconduction. Expressions for the thermoelectric power are derived which are valid over a wide temperature range. These can be used to determine activation energy, width of energy gap and apparent mass of charge carriers. The limits of validity of the approximate formulas are demonstrated by comparison with exact solutions for two examples. Some experimental results on the temperature dependence of the thermoelectric power are discussed, showing qualitative agreement with the theoretical results.
- 537.311.33 2120
On the Existence of Hertzian Absorption Bands in Monatomic Semiconductors (Boron, Selenium)—J. Meinel. (*Jour. Phys. Radium*, vol. 15, pp. 124–125; Feb., 1954.) Preliminary results of measurements at temperatures in the range 88 degrees–300 degrees K. and at frequencies from 100 cps to 400 kc show that one or more absorption bands exist.
- 537.311.33:546.24:535.323 2121
Infrared Index of Refraction of Tellurium Crystals—P. A. Hartig and J. J. Loferski. (*Jour. Opt. Soc. Amer.*, vol. 44, pp. 17–18; Jan., 1954.)
- 437.311.33:546.24–1:535.343 2122
Infrared Optical Properties of Single Crystals of Tellurium—J. J. Loferski. (*Phys. Rev.*, vol. 93, pp. 707–716; Feb. 15, 1954.) The absorption and photoconductivity were investigated experimentally, the effects of temperature variation, crystal anisotropy and Se additions being studied. The variation of energy gap with temperature is -2×10^{-5} eV/degrees C. The photoconductivity is barely detectable at room temperature but is considerably enhanced at 90 degrees K. Results obtained with two SeTe alloys indicate that the reduction of the lattice parameter is accompanied by an increase of the energy gap.
- 537.311.33:546.289 2123
Orientation Relationships in Cast Germanium—W. C. Ellis and J. Fageant. (*Jour. Metals*, vol. 6, pp. 291–294; Feb., 1954.)
- 537.311.33:546.289 2124
Dislocations in Plastically Deformed Germanium—G. L. Pearson, W. T. Read, Jr., and F. J. Morin. (*Phys. Rev.*, vol. 93, pp. 666–667; Feb. 15, 1954.) Hall-effect, conductivity and lifetime measurements were made on rods of *n*-type and of *p*-type Ge which had been bent while heated to about 650 degrees C., and on control specimens. The results are consistent with the hypothesis that edge dislocations are associated with acceptor levels in the middle or upper half of the energy gap.
- 537.311.33:546.289 2125
Redistribution of Solutes by Formation and Solidification of a Molten Zone—W. G. Pfann. (*Jour. Metals*, vol. 6, pp. 294–297; Feb., 1954.) Description of the production of step or graded *p-n* junctions in semiconductors by melting and re-solidifying a zone of a homogeneous ingot containing suitable concentrations of a donor and an acceptor in solid solution.
- 537.311.33:546.289 2126
Some Electrical Properties of Germanium Crystals containing Compensated Impurities—V. Ozarow. (*Phys. Rev.*, vol. 93, pp. 371–372; Feb. 1, 1954.) Three compensated *n*-type Ge crystals containing both radioantimony and radioindium in varying amounts, and one uncompensated crystal doped with Sb only were prepared. Measurements of Hall constant and resistivity were made in the temperature range 78–393 degrees K. Marked differences in the characteristics of compensated and uncompensated crystals of comparable resistivities were noted.
- 537.311.33:546.289 2127
Electrical Properties of *N*-Type Germanium—P. P. Debye and E. M. Conwell. (*Phys. Rev.*, vol. 93, pp. 693–706; Feb. 15, 1954.) Measurements of the conductivity and Hall-effect over the temperature range 11 degrees–300 degrees K. were made on specimens with various controlled amounts of added arsenic, the room-temperature resistivities ranging from 43 to 0.005 Ω .cm. The results are used as the basis of a comprehensive review of semiconductor theory. The evidence supports the view that the constant-energy surfaces are not spherical, though results based on this simplifying assumption agree in many respects with the experimental results.
- 537.311.33:546.289 2128
Self-Diffusion in Germanium—H. Letaw, Jr., L. M. Slifkin and W. M. Portnoy. (*Phys. Rev.*, vol. 93, pp. 892–893; Feb. 15, 1954.) Diffusion in thin slabs of Ge with a plating of Ce^{71} was determined by measuring the concentration of Ge^{71} in cuts of known mass and thickness. The results are discussed in relation to the vacancy-motion theory of diffusion.
- 537.311.33:546.289 2129
Measurement of Minority Carrier Lifetime and Contact Injection Ratio on Transistor Materials—A. Many. (*Proc. Phys. Soc.*, vol. 67, pp. 9–17; Jan. 1, 1954.) Lifetime is determined by observing the decay of resistance of a filament of the material during an injecting pulse. By using a bridge circuit incorporating a RC network electrically analogous to the filament, the lifetime can be read directly on a calibrated dial. The measurement range extends down to 1 μ s, with an accuracy usually to within about 5 per cent. Measurements on *n*-type Ge with soldered contacts are reported; the injection ratio is proportional to the current through the contact.
- 537.311.33:546.289 2130
The Temperature Dependence of the Drift Mobility of Injected Holes in Germanium—R. Lawrence. (*Proc. Phys. Soc.*, vol. 67, pp. 18–27; Jan. 1, 1954.) Report of an experimental investigation of the effect of trapping in *n*-type Ge, and of the nature of the traps. The results have been reported previously (2332 of 1953).
- 537.311.33:546.289:535.323 2131
The Index of Refraction of Germanium measured by an Interference Method—D. H. Rank, H. E. Bennett, and D. C. Cronmeyer. (*Jour. Opt. Soc. Amer.*, vol. 44, pp. 13–16; Jan., 1954.) Measurements in the wavelength range 2.0–2.4 μ are reported.
- 537.311.33:546.289:537.533.8 2132
Secondary Electron Emission from Germanium—J. R. Johnson and K. G. McKay. (*Phys. Rev.*, vol. 93, pp. 668–672; Feb. 15, 1954.) Measurements were made on single crystals with *p-n* junctions. The secondary-emission yield δ exhibited a maximum value of about 1.15 at room temperature at a primary voltage of about 500v. δ has a small negative temperature coefficient but is independent of donor or acceptor concentrations up to 10^{19} /cm³. No effects due to space-charge fields under the surface were observed in the case of Ge. The secondary-emission process in semiconductors generally is compared with that in metals and insulators.
- 537.311.33:546.682.86 2133
Radiation Effects in Indium Antimonide—J. W. Cleland and J. H. Crawford, Jr. (*Phys. Rev.*, vol. 93, pp. 894–895; Feb. 15, 1954.) Polycrystalline specimens of both *n*-type and *p*-type InSb were subjected to neutron irradiation. The results of conductivity and Hall-coefficient measurements indicate that (a) donor impurities are introduced by transmutations in the expected manner, and (b) lattice defects produced by fast neutrons act as electron traps in *n*-type material. The evidence is insufficient to indicate whether these defects behave predominantly as acceptors or hole traps in *p*-type material.
- 537.311.33:546.682.86 2134
Anomalous Optical Absorption Limit in InSb—E. Burstein. (*Phys. Rev.*, vol. 93, pp. 632–633; Feb. 1, 1954.) Experimental results in agreement with those of Tanenbaum and Briggs (1098 of April) were obtained. An alternative theoretical explanation is offered, based on the very small effective mass of the electrons in InSb. This is associated with small effective density of states and with a small degeneracy concentration. InSb therefore becomes degenerate at relatively low electron densities.
- 537.311.33:546.811–17:538.632 2135
Electronic Conduction in Grey Tin—J. T. Kendall. (*Phil. Mag.*, vol. 45, pp. 141–157; Feb., 1954.) The conductivity and Hall constant of grey tin containing antimony and/or gallium were measured over the temperature range 77 degrees–286 degrees K., and the number of charge carriers and their mobility were calculated from the results. A comparison is made with the corresponding properties of Si and Ge. Results are tabulated and shown graphically.
- 537.311.33:546.817.221 2136
Antimony Content and Semiconductor Properties of Synthetic Lead Sulphide Photoconductive Elements—H. G. Smolczyk. (*Naturwissenschaften*, vol. 41, p. 84; Feb., 1954.) A preliminary report of experimental work. Measurements were made of the internal photoelectric effect and of the thermoelectric effect for specimens containing different amounts of Sb and prepared under controlled pressure of sulphur vapor. The possibility of producing PbS *p-n* junctions is indicated.
- 537.311.33:548.0:546.817.221 2137
A Variation Principle for Electronic Wave Functions in Crystals—D. P. Jenkins and L. Pincherle. (*Phil. Mag.*, vol. 45, pp. 93–99; Jan., 1954.) A variation principle giving the energy levels of electrons in polyatomic lattices is presented. The method is used to redetermine some of the energy levels of PbS; the results are in agreement with those obtained by other methods [2037 of 1953 (Bell et al.)].
- 537.311.33:548.55 2138
Preparation of Single Crystals of Semiconductor Compounds of Type $A^{III}B^V$ —R. Gremmelmaier and O. Madelung. (*Z. Naturf.*, vol. 8a, pp. 333, 304A; May, 1953.) A method of pulling from the melt is used similar to that described by Teal et al. (1682 of 1951). Photo-

graphs of a single-crystal specimen of InSb and a polycrystalline specimen of AlSb produced by the method are shown.

- 537.311.33:621.396.822 2139
Some Notes on Gisolff's Theory of Electron Fluctuation Phenomena in Semiconductors—K. W. Böer. (*Ann. Phys., Lpz.*, vol. 14, pp. 87-96; Jan. 5, 1954.) Gisolff's formulas (667 of 1950) are evaluated by introducing a statistical distribution of lifetimes for the conduction electrons. The effect of field distortion in the barrier layer is taken into account. The magnitude of the effect is compared with that of the Nyquist noise.
- 538.22 2140
Effects of Band Shape on the Magnetic and Thermal Properties of Metals and Alloys—E. W. Elcock, P. Rhodes, and A. Teviotdale. (*Proc. Roy. Soc. A.*, vol. 221, pp. 53-77; Jan. 7, 1954.)
- 538.221 2141
Notes on the Theory of the Magnetic Properties of Hard Materials—L. Néel. (*Appl. Sci. Res.*, vol. B4, pp. 13-24; 1954. In French.) The theory of magnetic hysteresis for single-domain small grains is considered. By taking into account (a) the dispersion of the values of the coercive force for the individual grains and (b) the interaction force between the grains and the dispersion of the values of this force, numerical results are obtained which agree well with experimental results for good permanent magnets.
- 538.221:532.111 2142
The Change of Ferromagnetic Curie Points with Hydrostatic Pressure—L. Patrick. (*Phys. Rev.*, vol. 93, pp. 384-392; Feb. 1, 1954.) Consistent results for eight materials measured in a liquid compression system were obtained. Results for five other materials measured in a gas compression system were less satisfactory. Neither the Bozorth nor the Néel theoretical interaction curve agrees with the experimental observations; this may be due to neglect of the part played by conduction electrons in the interaction.
- 538.221:532.111 2143
The Influence of Pressure on the Curie Temperature of Iron and Nickel—R. Smoluchowski. (*Phys. Rev.*, vol. 93, pp. 392-393; Feb. 1, 1954.) A comparison is made between Patrick's measurements (2142 above) and theory based on a Brillouin function.
- 538.221:[621.318.124+621.318.134] 2144
Magnetic Resonance Phenomena in Ferrites—F. Brown and D. Park. (*Phys. Rev.*, vol. 93, pp. 381-384; Feb. 1, 1954.) The resonance frequencies in the microwave and infrared regions are calculated, taking into account the effects of anisotropy, external field, and differences in magnetization and g values between the two sublattices. The relation between the anisotropy fields in the expressions derived and the measured equivalent anisotropy field is discussed. Theoretical and experimental results for single-crystal Ni ferrite are in good agreement. See also 1828 of June (Wangness).
- 538.221:621.318.134 2145
Microwave Resonance Absorption in Nickel Ferrite-Aluminate—T. R. McGuire. (*Phys. Rev.*, vol. 93, pp. 682-686; Feb. 15, 1954.) Results are reported of experiments on materials having the composition $\text{NiOAl}_x\text{Fe}_{2-x}\text{O}_3$, with particular attention to the composition for which the value of x is 0.7, at which value the magnetic moment is zero.
- 538.221:621.318.134 2146
Ferrites for Microwave Circuits and Digital Computers—E. Albers-Schoenberg. (*Jour. Appl. Phys.*, vol. 25, pp. 152-154; Feb., 1954.) Properties of two classes of commercially available Mg-Mn ferrites are discussed. One class is characterized by low losses and a Faraday rotation effect at microwave frequencies; the other by high resistivity and a rectangular hysteresis loop useful in magnetic storage systems operating at high speed.
- 538.221:621.318.134:681.142 2147
Ferromagnetic Spinel with Rectangular Hysteresis Loops—Hegyí. (See 2007.)
- 538.221:681.142 2148
Penetration of an Electromagnetic Wave into a Ferromagnetic Material—Papoulis. (See 2006.)
- 549.0:546.39.185-841:539.374 2149
The Plastic Deformation of Ammonium Dihydrogen Phosphate—P. L. Smith and E. I. Salkovitz. (*Jour. Appl. Phys.*, vol. 25, pp. 237-239; Feb., 1954.) Plastic deformation was produced in ADP single crystals by loading specimens as a simple beam at about 100 degrees C. This deformation does not appreciably alter the piezoelectric or elastic properties.
- 549.514.51:621.372.412.002.2 2150
V.H.F. Crystal Grinding—E. A. Gerber. (*Electronics*, vol. 27, pp. 161-163; March, 1954.) Round crystals for frequency control in the range 20-180 mc are finished by fastening the blanks to a work-holder when about 0.7 mm thick and reducing them to the required thickness on optical lapping machines. Crystals with low series resistance are obtained. Unwanted modes of vibration are reduced.
- 621.315.61 2151
New Nonrigid Materials for the Functional Design of Electrical Insulating Systems—A. E. Javitz. (*Elect. Mfg.*, vol. 52, pp. 123-138; Sept., 1953.) A survey of the properties and performance of recently developed types of insulation in the form of film, tape, sheet, and paper.
- 621.315.612.029.6 2152
Materials and Problems of High-Frequency Ceramics—J. Kainz. (*Elektrotech. u. Maschinenb.*, vol. 70, pp. 473-478 and 525-530; Nov. 1 and Dec. 1, 1953.) A survey paper. Composition and properties of various ceramic insulating materials are tabulated and shown in graphs. Investigations of the colloid systems by means of the electron microscope are described.
- 621.315.616 2153
Conductivity induced in Insulating Materials by X-rays—J. F. Fowler and F. T. Farmer. (*Nature (London)*, vol. 173, pp. 317-318; Feb. 13, 1954.) Measurements on polythene and perspex are reported, the results are of interest in connection with the determination of the energy-level distribution of the material.
- 621.791.342.6:546.682 2154
A Technique of Soldering to Thin Metal Films—R. B. Belser. (*Rev. Sci. Instr.*, vol. 25, pp. 180-183; Feb., 1954.) By using In and certain of its alloys as a solder, without a flux, adherence of thin metal films to glass or quartz substrates may be obtained without damage to the film. The technique has been successfully applied in the mechanical suspension of mirrors, for making electrical contact with thin metal films and for mounting piezoelectric crystals. Soldered connections have been made to films of 18 metals including Al, Ti, and Zr.

MATHEMATICS

- 514.1 2155
Some Formulae of P. Stein and Others concerning Trigonometrical Sums—N. B. Slater. (*Proc. Camb. Phil. Soc.*, vol. 50, Part 1, pp. 33-39; Jan., 1954.) Formulas relevant to problems of alternating currents in cables are discussed.
- 517.43 2156
Approximations in Operational Methods—J. Brodin. (*Ann. Télécommun.*, vol. 9, pp. 1-8; Jan., 1954.)
- 517.5 2157
Recurrence Relations for Prolate Spheroidal Wave Functions—I. Marx. (*Jour. Math. Phys.*, vol. 32, pp. 269-275; Jan., 1954.)
- 517.6 2158
An Approximate Method of Evaluating Integral Transforms—A. H. Zemanian. (*Jour. Appl. Phys.*, vol. 25, pp. 262-266; Feb., 1954.) The method developed is quite general and has been applied to Fourier, Laplace, Mellin, and Hankel transforms. It may also be effective in evaluating numerically an integral with a highly oscillatory term in its integrand.
- 517.63 2159
On Inverting Laplace Transforms of the Form $h(s)/(p(s)+q(s)e^{-\tau s}$ —T. E. Hull and W. A. Wolfe. (*Canad. Jour. Phys.*, vol. 32, pp. 72-80; Jan., 1954.)
- 517.9 2160
A Sufficient Condition for an Infinite Discrete Spectrum—C. R. Putnam. (*Quart. Appl. Math.*, vol. 11, pp. 484-487; Jan., 1954.) A study of the problem of obtaining a sufficient criterion in order that the equation $x''+f(t)x=0$ be oscillatory, for the particular case that $f(t)$ satisfies the limit relation $f(t) \rightarrow 0$ as $t \rightarrow \infty$.
- 517.9 2161
On the Gaps in the Spectrum of the Hill Equation—C. R. Putnam. (*Quart. Appl. Math.*, vol. 11, pp. 496-498; Jan., 1954.)
- 517.93 2162
Geometrical Integration of Nonlinear Second-Order Differential Equations with Second Member—G. Cahen. (*Bull. Soc. Franç. Élect.*, vol. 4, pp. 44-50; Jan., 1954.) A study is made of equations of the type
- $$\ddot{x} + b(x)\dot{x} + \tau(x) = g(t),$$
- and is extended to equations containing a further term $a(x)x^2$ or $c(\dot{x})$.
- 517.942.82:621.3.015.3 2163
The Calculation of Transients in Dynamical Systems—E. E. Ward. (*Proc. Camb. Phil. Soc.*, vol. 50, Part 1, pp. 49-59; Jan., 1954.) The calculation of transients by Tricomi's method, using Laguerre functions, is a practical alternative to the use of partial fractions. This is shown by considering numerical examples of Laplace transforms ranging from quadratic to sixth-power polynomials. The composition of the coefficients of the Laguerre series is analyzed, and the conditions for rapid convergence are indicated.
- 519.53 2164
A Method of Solving Very Large Physical Systems in Easy Stages—G. Kron. (*Proc. I.R.E.*, vol. 42, pp. 680-686; April, 1954.) By using the subdivision method of dealing with large systems (202 of January), the amount of calculation required to obtain the solution can be reduced approximately in the ratio $2/n^2$, where n is the number of subdivisions. The method is illustrated by solving the two-dimensional Maxwell field equations by subdividing their electric-circuit models.

MEASUREMENTS AND TEST GEAR

- 529.7 2165
The Determination of Time and Frequency—H. M. Smith. (*Proc. IEE*, Part II, vol. 101, pp. 64-65; Feb., 1954.) Discussion on 2223 of 1951.
- 621.317.3:621.314.632:546.289 2166
Use of the Germanium Rectifier for the Measurement of Current, Voltage and Power at High Frequency: Part 2—Power Measurement—J. Schiele. (*Arch. Tech. Messen.*, pp. 21-22; Jan., 1954.) Two examples are illustrated. Part 1: 1498 of May.
- 621.317.3:621.372.56.029.63/.64 2167
Mismatch Errors in the Measurement of Ultrahigh-Frequency and Microwave Variable Attenuators—R. W. Beatty. (*Jour. Res. Nat.*

Bur. Stand., vol. 52, pp. 7-9; Jan., 1954.) Expressions for the mismatch error are derived by analysis and an example is given to show that the mismatch error in measuring the difference in attenuation between two attenuators is less than the sum of the mismatch errors obtained when measuring each attenuator individually.

621.317.3:621.396.722 2168
The B.B.C. Measurement and Technical Receiving Station at Tatsfield—Griffiths. (*See* 2210.)

621.317.3.089.6:621.372.8 2169
The Calibration of the Slotted Section for Precision Microwave Measurements—A. A. Oliner. (*Rev. Sci. Instr.*, vol. 25, pp. 13-20; Jan., 1954.) A calibration procedure is described in which compensation is made for the slight change in guide wavelength and characteristic impedance due to the slot, and for discontinuities at the end of the slot and at coupling elements, bead supports, etc. Practical instructions are given for constructing a calibration curve valid for purely reactive terminations, from which correction factors are derived for the position of the voltage node and the value of swr in dissipative structures.

621.317.326:621.314.626 2170
Pulse Measurement with Peak-Voltage Rectifier Circuit—E. de Gruyter. (*Bull. schweiz. elektrotech. Ver.*, vol. 45, pp. 61-70; Feb. 6, 1954.) The suitability of direct-indicating peak voltmeters for measuring pulse trains is examined. For instruments using contact rectifiers, general error curves are given taking account of the instrument constants, the pulse width and the voltage reading, for different pulse shapes. Calibration of individual instruments is thus rendered unnecessary. An unknown pulse width can be determined from comparative measurements.

621.317.335.3.029.63:621.315.615 2171
Two New Methods of determining the Electrical Constants of Liquids in the Decimetre Waveband—O. Huber. (*Z. angew. Phys.*, vol. 6, pp. 9-14; Jan., 1954.) The dielectric constant and the loss tangent are determined from measurements using a vertical coaxial line. In the first method, the voltage variations at a fixed probe are determined as a function of the depth of the liquid, the input termination being reflection-free. The second method depends on the change of resonance frequency of the short-circuited line when the liquid is introduced. See also 3046 of 1951.

621.317.336:621.372.8 2172
Measurement of Waveguide Impedance—A. Cunliffe and D. P. Saville. (*Wireless Engr.*, vol. 31, pp. 115-118; May, 1954.) The two horizontal arms of a T junction are connected respectively to a waveguide section with a sliding short-circuiting termination and to the unknown impedance, while the vertical arm is connected to the source. Voltage is measured by means of a fixed probe in the arm connected to the unknown impedance, and the value of the latter is found by adjusting the short circuit to produce resonance. Theory of the method is given. Results of experiments using a wavelength of 3.2 cm indicate that the accuracy compares favorably with that of the usual methods. The apparatus can be used over a wide-frequency band.

621.317.34:621.315.212 2173
A Pulse Method for the Quantitative Determination of Nonuniformities in Wide-Band Cables—L. Krügel. (*Fernmeldetechn. Z.*, vol. 7, pp. 3-9; Jan., 1954.) A simple method suitable for investigating very small irregularities is described.

621.317.42:538.221 2174
The Effect of the Forster Probe on Measurements in the Vicinity of a Ferromagnetic Material—F. Brandstaetter. (*Elektrotech. u. Maschinenb.*, vol. 70, pp. 484-487; Nov. 1,

1953.) An investigation of the influence of the macroscopic structure of the ferromagnetic material on the divergence between readings obtained with this instrument (1506 of May) and theoretically calculated values.

621.317.7:621.372.412 2175
Quartz Crystal Testing—R. Rollin. (*Wireless World*, vol. 60, pp. 220-223; May, 1954.) The principles described by Biggs and Wells (969 of 1946) are applied in equipment for evaluating the quality of crystals over the frequency range 50 kc-2 mc. A two-tube oscillator with band-switching and input-capacitance switching is used in conjunction with a calibrated variable-impedance element which can be substituted for the crystal. The complete circuit is shown.

621.317.7.087 2176
Direct-Indicating Recording Instruments—S. R. Gilford. (*Elect. Mfg.*, vol. 52, pp. 114-121 and 120-128; Nov./Dec., 1953.) A survey covering applications, functional requirements, design, and operating principles.

621.317.723 2177
A Vibrating Needle Electrometer—Y. L. Yousef and R. Kamel. (*Jour. Sci. Instr.*, vol. 31, pp. 13-15; Jan., 1954.) The es force due to the charge under test is modulated so that instead of simply deflecting the suspended needle it produces a resonant vibration whose amplitude is proportional to the charge.

621.317.73/.74:621.315.212 2178
The Development of a Precision Termination for 0.375-inch Polythene-Disc-Insulated Coaxial Cable—R. J. Cheetham, E. L. Mather and W. W. H. Clarke. (*Proc. IEE*, Part IV, vol. 101, pp. 135-145; Feb., 1954.) The adjustment facilities necessary in a precision termination are determined from theoretical considerations and test requirements. Details are given of the development of a circuit suitable for use in pulse testing and in the determination of end impedances to within about 0.05 Ω . In bridge testing, similar accuracies in both real and imaginary parts may be obtained between 50 kc and 8 mc.

621.317.755 2179
Gated Time Markers for C.R.O. Display—P. Steinberg. (*Electronics*, vol. 27, pp. 150-151; March, 1954.) The waveform under examination and a series of marker dots are presented in alternate horizontal sweeps of the cro; the position and brightness of the two traces can thus be adjusted separately. A brief description is given of the circuit. Reading accuracy is increased by providing a vernier scale of marker dots.

621.317.755:621.314.7.012.6 2180
Characteristic-Curve Tracer for Transistors—H. Lennartz. (*Funk u. Ton*, vol. 8, pp. 25-29; Jan., 1954.) Description of equipment used in conjunction with a cro.

621.317.755:621.385.832 2181
An Interesting Four-Beam Cathode-Ray Tube—Wendling. (*See* 2267.)

621.317.791 2182
Universal Meter for Measuring Voltages at High Impedances, Micromicroamperes, and Insulation Resistance—W. R. Clark, R. E. Watson, and G. C. Mergner. (*Elect. Eng.*, vol. 73, pp. 41-45; Jan., 1954.) Direct voltages up to 500v., direct currents down to 10^{-12} A and insulation resistance up to $10^{12}\Omega$ are measured by a null method with maximum full-scale-deflection errors of 1.5, 3.5, and 5 per cent respectively. The meter circuit includes a chopper-type stabilized feedback amplifier. To be published also in *Trans. AIEE*, vol. 72, 1953.

621.373.44 2183
Current-Step Waveform Generator—V. A. Babits, S. R. Spengler, and R. V. Morris. (*Electronics*, vol. 27, pp. 164-167; March, 1954.) A

circuit is described for producing stepped currents capable of providing stepped values of magnetic field such as are required e.g. for rotating the plane of polarization in microwave experiments. The arrangement comprises voltage-step generator, pulse generator and output stage driving a coil of inductance 1.5-3H.

621.387.001.4 2184
A Method of Testing Cold-Cathode Tubes—D. L. Benson and D. H. Vogan. (*P. O. Elect. Eng. Jour.*, vol. 46, Part 4, pp. 196-197; Jan., 1954.) In the usual methods of testing dc breakdown potential, using manual control, it is difficult to vary the potential across the gap at the optimum speed. An automatically operating circuit for this purpose is described.

621.396.6.002.2.001.4 2185
Standardization of Printed Circuit Materials—Hannahs, Caffius, and Stein. (*See* 2065.)

OTHER APPLICATIONS OF RADIO AND ELECTRONICS

621.317.755:621.3.018.75:615.471 2186
A Time-Marker for Electrocardiography—M. A. Bullen and L. A. Daynes. (*Jour. Sci. Instr.*, vol. 31, pp. 6-7; Jan., 1954.) A simple circuit using gas-filled counting tubes is described by means of which time-marking signals at four repetition rates between 5 and 100 per second can be derived from ac mains or a suitable oscillator; the signals are superposed on the electrocardiograph displayed on the cro screen, no separate channel being required.

621.37.794 2187
Electronic Air-War Game simulates Missile Strikes—L. I. Davis. (*Electronics*, vol. 27, pp. 146-152; April, 1954.) Circuit arrangements are described for illustrating the main principles involved in air warfare. The two participants each have two electric potentials at their disposal, one of which controls the attack and the other the defence. The operating time scale is such as to enable logical decisions to be made regarding choice of targets etc.

621.383.2 2188
Development of [electron-optical] Image Converters and Image Intensifiers—F. Eckart. (*Ann. Phys., Lpz.*, vol. 14, pp. 1-13; Jan. 5, 1954.) Resolving power is estimated, particular designs, including two-stage types, are described, and applications are indicated.

621.384.611/.612 2189
A Synchrocyclotron with Fixed Operating Frequency—F. Ollendorff. (*Elektrotech. u. Maschinenb.*, vol. 71, pp. 10-15; Jan. 1, 1954.)

621.384.611 2190
Cyclotron Oscillators and the Shifting-Inter-Dee Ground Surface—F. H. Schmidt and M. J. Jakobson. (*Rev. Sci. Instr.*, vol. 25, pp. 136-139; Feb., 1954.) The push-pull mode of oscillation of a two-dee cyclotron can be described in terms of a ground potential surface between the dees. Unbalance in dee voltages can be interpreted as a shift of the position of the ground surface. The electrical implications of a particular adjustment can be applied by the cyclotron operator.

621.385.833 2191
Calculation of some Magnetic and Electric Fields with Cylindrical Symmetry—Y. Axner. (*Appl. Sci. Res.*, vol. B4, pp. 124-136; 1954.) Fields having cylindrical symmetry and also mirror symmetry with respect to a median plane are discussed; the field strength in the median plane is given. Solutions are presented in the form of power expansions; analytical solutions are obtained when the field strength in the median plane as a function of the radius is given by a polynomial.

621.385.833 2192
Investigation of the Mechanism of the For-

mation of the Image in an Electron Microscope—I. G. Stoyanova and A. I. Frimer. (*Compt. Rend. Acad. Sci. (U.R.S.S.)*, vol. 94, pp. 459-462; Jan. 21, 1954. In Russian.) Experimental investigation of the dependence of the image contrast on the thickness of the specimen and on the electron energy, in dark-field and bright-field image presentations.

621.387.4 2193
The New Counters—S. C. Curran. (*Sci. Progr.*, vol. 42, pp. 32-45; Jan., 1954.) A review of developments in particle counters, with 47 references.

621.387.424 2194
Velocity of Discharge Propagation in Self-Quenching Geiger-Müller Counters—P. A. C. Mortier and J. F. Roose. (*Proc. Phys. Soc.*, vol. 67, pp. 161-163; Feb. 1, 1954.)

PROPAGATION OF WAVES

538.566:551.594.6 2195
The Higher-Order Modes in the Propagation of Long Electric Waves in the Earth-Air-Ionosphere System and Two Applications (Horizontal and Vertical Dipole)—W. O. Schumann. (*Z. angew. Phys.*, vol. 6, pp. 35-43; Jan., 1954.) Expressions for the propagation and the radiation intensities of higher-order modes of very long (> 3 km) waves are derived and applied. For very long waves the Bessel functions can be approximated by exponential terms. The numerical illustrations include the case of lighting signals. See also 1544 of May.

538.566.3 2196
Propagation of Plane Electromagnetic Waves in a Homogeneous Plasma (Ionosphere)—R. Jancel and T. Kahan. (*Jour. Phys. Radium*, vol. 15, pp. 26-33; Jan., 1954.) Mathematical analysis based on magneto-ionic theory developed previously (1030 of April). Refractive index, double refraction, phase and group velocities, attenuation, polarization and critical frequencies are studied. The range of validity of classical formulas relating to ionospheric propagation is discussed.

621.396.11 2197
Diffraction of Plane Radio Waves by a Parabolic Cylinder—S. O. Rice. (*Bell. Syst. Tech. Jour.*, vol. 33, pp. 417-504; March, 1954.) Expressions are given for the diffraction field far behind, and the surface currents on, a parabolic cylinder. Approximate values for the field strength and current density are given for the case when the radius of curvature of the cylinder is large compared with λ . The method of analysis makes use of parabolic cylinder functions of large complex order. The results indicate that the knife-edge representation is valid even for gently rounded hills when the angle of diffraction is small, but that the formulae developed are applicable to calculation of the shadows cast by hills in microwave propagation when the angle of diffraction is so large that the knife-edge representation is invalid.

621.396.11:535.15 2198
Birefringence in Crystals and in the Ionosphere—C. H. M. Turner. (*Canad. Jour. Phys.*, vol. 32, pp. 16-34; Jan., 1954.) Propagation of plane em waves in the ionosphere is compared with that in an optically inactive crystal, as in the work of Lange-Hesse (2863 of 1952); damping due to collisions of electrons with other particles is taken into account. In the ionosphere the plane wave is always characterized by three components of the field vectors, one of which is linearly polarized along the direction of the uniform magnetic field while the other two are circularly polarized in opposite senses in the plane perpendicular to the magnetic field.

621.396.11:551.510.535 2199
Oblique Propagation of Radio Waves over a Curved Earth—B. Chatterjee. (*Indian Jour. Phys.*, vol. 27, pp. 257-268; May, 1953.) Book-

er's analysis of oblique propagation (*Phil. Trans. A*, vol. 237, pp. 411-451; 1938.) is extended to take account of the earth's curvature by introducing appropriate correction factors. The values obtained for group retardation, attenuation and lateral deviation in the refracting region are higher than those for the flat earth and are in better agreement with experimental results.

621.396.11.029.51 2200
The Ionospheric Propagation of Radio Waves of Frequency 30-65 kc/s over Short Distances—R. N. Bracewell, J. Harwood, and T. W. Straker. (*Proc. IEE*, Part IV, vol. 101, pp. 154-162; Feb., 1954. Digest, *ibid.*, Part III, vol. 101, pp. 108-110; March, 1954.) Experiments carried out at Cambridge on waves reflected from the ionosphere at steep incidence are described. The phases and amplitudes of two linearly polarized components of the downcoming wave were measured with reference to the ground wave. Results are compared with those obtained by Straker for 16-kc waves, and show that (a) the day-to-day variations of the downcoming wave were greater at the higher frequencies, (b) the change in height of reflection in passing from day to night was about the same for all the frequencies, (c) the amplitudes by day and night in summer were very different except at 16 kc, and (d) the polarization at all the frequencies was approximately circular, left-handed and constant.

621.396.11.029.62:621.396.812 2201
U.S.W. Extended-Range [propagation] and Inversions—H. Wisbar. (*Funk-Technik (Berlin)*, vol. 9, pp. 8-10; Jan., 1954.) Reception and transmission over abnormally long distances by a North-West German amateur station operating in the 2-m band, in the period from March to October 1953, is correlated with meteorological conditions, particularly barometric pressure systems. Propagation distances up to 1100 km were recorded. The effect of wide spread fog is also noted.

621.396.11.029.62:621.397.5 2202
Wave Propagation and Television Broadcasting at Very High Frequencies—Smith-Rose. (*See* 2234.)

621.396.81+621.396.65 2203
Microwave as Applied to Railroad Operation in the Gulf Coast Area—Thomas. (*See* 2219.)

621.396.82.029.62 2204
Prediction of the Likelihood of Interference at Frequencies of 30 to 42 Megacycles in Alaska—T. N. Gautier, Jr., and C. J. Sargent. (*Jour. Res. Nat. Bur. Stand.*, vol. 52, pp. 21-31; Jan., 1954.) A full report is presented of an investigation of the likelihood of interference with the operation of a proposed vhf line-of-sight network, either from ionospheric propagation of signals between stations of the network, or from stations outside the network. Diurnal, seasonal, and sunspot-cycle variations are studied. The likelihood of interference is inferred from the likelihood of occurrence of m.u.f.s equal to or greater than the operation frequencies. Calculations were made for paths involving reflections from (a) the F_2 layer and (b) the sporadic-E layer.

RECEPTION

621.396.621:[523.2/.8:621.396.822 2205
A D.C. Comparison Radiometer—W. Selove. (*Rev. Sci. Instr.*, vol. 25, pp. 120-122; Feb., 1954.) Apparatus for measuring rf radiation from astronomical sources is described in which a comparison signal is transmitted through the receiving system along with the incoming signal, as a means of measuring the gain of the system and of cancelling the effect of gain fluctuations. The two signals are separated at the receiver output by a pair of filters. The rectified outputs of the two filters are compared, and the difference constitutes the final output

signal. For a signal with bandwidth narrow compared with the receiving system bandwidth, the maximum improvement attainable over the switching-type comparison radiometer is 3.2 db.

621.396.621:621.314.7 2206
An Experimental Transistor Personal Broadcast Receiver—L. E. Barton. (*Trans. I.R.E.*, No. PGBTR-5, pp. 6-13; Jan., 1954.) Details are given of an A.M. receiver using 6 rf junction transistors of the type described in 1955 of June (Mueller and Pankove), three conventional junction transistors for class-B audio drive and output stages, and two diodes. Battery drain is < 12 ma, and maximum output is 150 mw. Sensitivity and signal/noise ratio are comparable to those of conventional receivers.

621.396.621:621.372.2 2207
The History of the Homodyne and Synchrodyne—D. G. Tucker. (*Jour. Brit. I.R.E.*, vol. 14, pp. 143-154; April, 1954.) An account is given of the independent development of the synchronous demodulation system from Colebrook's homodyne and from Tucker's synchrodyne. 62 references.

621.396.621:621.396.822 2208
The Minimum Detectable Change in the Mean Noise-Input Power to a Radio Receiver—D. G. Lampard. (*Proc. IEE*, Part IV, vol. 101, pp. 118-128; Feb., 1954. Digest, *ibid.*, Part III, vol. 101, pp. 111-113; March, 1954.) Expressions for the minimum detectable change involving only the pre-detector and the post-detector filter responses have been derived for receivers using either a power-law instantaneous detector (full- or half-wave type) or an ideal power-law envelope detector. Using these expressions and making appropriate approximations, an example, in which the pre-detector filter is a single tuned circuit and the post-detector filter is a simple RC integrator, is worked out in detail. The results, presented in simple form, show clearly the effect of the filter bandwidths and the detector law on the sensitivity of the receiver to changes in noise input power.

621.396.662.078 2209
A Wideband Searching Automatic Frequency Control Circuit of New Type—H. Wallman. (*Chalmers tek. Högsk. Handl.*, no. 132, 21 pp.; 1953.) A system in which the local oscillator automatically "searches" a wide frequency range to locate its correct frequency before the afc operates, cannot be based on a simple IF discriminator. In the system described the frequency-sensing element is an IF resonant circuit with a detector and a circuit differentiating the detector output with respect to time. Frequency search is effected by a motor-driven coarse-tuning capacitor; an appropriate output from the differentiator actuates a multivibrator which changes the phase of the motor supply, causing the motor to reverse. The coarse-tuning capacitor stops and a fine-tuning capacitor is engaged. The continued presence of a signal gives a periodic output from the differentiator so that the latter capacitor oscillates back and forth every second through about ± 10 degrees. Over this range a free-play gear operates so that the coarse-tuning capacitor is at rest. The system has important application at ulf. Details are given of a model operated at 214 mc with an automatic search range of 500 kc.

621.396.722:621.317.3 2210
The B.B.C. Measurement and Technical Receiving Station at Tatsfield—H. V. Griffiths. (*B.B.C. Quart.*, vol. 9, pp. 43-56; Spring, 1954.) The development, functions and equipment of the station are described. Work undertaken is classified under eight main headings. It involves measurement of frequency (mainly carrier frequencies between 150 kc and 150 mc), field strength, and atmospheric noise; relaying programmes for broadcast or transcription; in-

terference identification and program-schedule checking; df and wave angle measurements; measurement of modulation depth and side-band dispersion. Frequency-checking procedure and apparatus in particular are noted. Four frequency standards are maintained.

621.396.828 2211
Funk-Entstörung. [Book Review]—F. Seele-
 mann. Publishers: E. Olsner, Darmstadt, 832
 pp., 1954. DM56. (*Frequenz*, vol. 8, pp. 61-62;
 Feb., 1954.) Published on behalf of the Federal
 German Post Office. Sources of radio interference
 are discussed and methods of measure-
 ment and suppression described. A chapter is
 devoted to the construction of low-interference
 electrical apparatus and machines.

STATIONS AND COMMUNICATION SYSTEMS

621.376.2 2212
**A General Solution of the Two-Frequency
 Modulation Product Problem: Part 1**—R. L.
 Sternberg and H. Kaufman. (*Jour. Math.
 Phys.*, vol. 32, pp. 233-242; Jan., 1954.) A
 method is presented for readily obtaining ap-
 proximate numerical values of the amplitudes
 of the modulation products occurring in the
 output of an arbitrary modulator with contin-
 uous output/input characteristic, to which a
 two-frequency input is applied. A partial ana-
 lytical solution of the problem is also given. Ex-
 act values are obtainable in cases such as that
 of the biased ideal rectifier considered by Ben-
 nett (3506 of 1947).

621.376.3.015.7 2213
**Frequency Spectra of Individual H.F. Pulses
 with Varying Carrier Frequency**—S. I. Bytsch-
 kow. (*Nachr. Tech.*, vol. 4, pp. 7-13; Jan., 1954.)
 Translated from *Radiotekhnika, Moscow*, vol.
 5, 1950. Analytical expressions are derived for
 the spectral density for different types of varia-
 tion of the carrier frequency during the pulse; a
 graphical method for finding the spectrum is
 given. The choice of receiver bandwidth for
 such systems is discussed.

621.39+621.317]:519.23 2214
**Probability of Causal Events in Telecom-
 munications and Measurement Technique**—
 J. Loeb. (*Ann. Télécommun.*, vol. 9, pp. 15-19;
 Jan., 1954.) Application of Bayes' Law to the
 calculation of Shannon's equivocation $H_y(x)$
 and to the matching of a source to a channel
 with noise.

621.39.001.11 2215
Two Types of Error due to Noise—J. Loeb.
 (*Ann. Télécommun.*, vol. 9, pp. 29-34; Feb.,
 1954.) Probability theory (2214 above) is dis-
 cussed in relation to binary-code telegraphy,
 when the probability of mistaking a signal for
 noise is quite independent of the probability of
 accepting a noise voltage as a signal. The ef-
 fect of additive and multiplicative iteration
 techniques on the probability of error is ex-
 amined. According to a "principle of comple-
 ments," for a given signal/noise ratio no re-
 ceiver modification can give a simultaneous re-
 duction of the two types of error.

621.39.001.11 2216
**Geometric Aspects of Least Squares
 Smoothing**—A. A. Hauser, Jr. (*Proc. I.R.E.*,
 vol. 42, pp. 701-704; April, 1954.) Function
 space techniques used by Shannon and Zadeh
 to clarify concepts in communication theory
 are considered. "An understanding of the opera-
 tion of a least squares smoother is enhanced by
 establishing an m -dimensional space in which
 inputs and outputs are vectors and the smoo-
 ther is a transformation. The concept of trans-
 mission and rejection manifold as established by
 Zadeh is introduced and the manner in which
 signal and noise are separated is illustrated geo-
 metrically. An explicit pictorial representation

of the process is given for the three dimensional
 case."

621.395.44:621.315.212 2217
S900-101 Coaxial-Pair Equipment—(*Cables
 & Trans.*, vol. 8, pp. 4-125; Jan., 1954.) A se-
 ries of articles gives details of the planning of
 the system used in France, of the design of cer-
 tain individual items of equipment for repeater
 and terminal stations and of gear for servicing,
 testing, and maintenance work.

621.396.4:621.396.65 2218
**Experimental Radio Bearer Equipment for
 Carrier Telephone Systems**—W. S. McGuire
 and A. G. Bird. (*Jour. Brit. I.R.E.*, vol. 14, pp.
 171-188; April, 1954.) Reprint. See 3412 of
 1953.

621.396.65+621.396.81 2219
**Microwave as Applied to Railroad Opera-
 tion in the Gulf Coast Area**—L. R. Thomas.
Elect. Eng., vol. 73, pp. 63-67; Jan., 1954.) A
 radio link for a path of approximately 70 miles
 and comprising two terminal and three repeater
 stations is described. Eight pam channels are
 provided; the equipment operates in the 6.7-kmc
 range. Propagation tests over a period of nearly
 two years show that, even when the aerial
 heights have been suitably chosen, fading may
 be experienced due to (a) temperature inver-
 sions or changes in humidity, and (b) fog at one
 of the station sites. To be published also in
Trans. AIEE, vol. 72, 1953.

621.396.65 2220
**Carrier-Current Radio Links in the Light of
 C.C.I.F. Recommendations**—J. P. Vasseur.
 (*Ann. Radioélect.*, vol. 9, pp. 47-82; Jan.,
 1954.) C.C.I.F. recommendations in respect of
 signal/noise and signal/crosstalk ratios are con-
 sidered in relation to FM links. The noise con-
 tribution of each element in the transmission
 chain is assessed, and the minimum perform-
 ance required of each element specified. A 2500-
 km FM link will require careful planning if it is
 to satisfy C.C.I.F. requirements. Sine-wave
 signals are suitable for testing individual ele-
 ments, but noise-modulated sine-wave signals
 are preferable for over-all tests of the complete
 link.

621.396.97:621.397:24/.26 2221
**Technical Arrangements for the Sound and
 Television Broadcasts of the Coronation Cere-
 monies on 2nd June, 1953**—Procter, Pulling,
 and Williams. (See 2231.)

SUBSIDIARY APPARATUS

621-526:621.3.015.7 2222
**The Pulse Transfer Function and Its Appli-
 cation to Sampling Servo Systems**—R. H.
 Barker. (*Proc. IEE*, Part IV, vol. 101, pp. 152-
 163; Feb., 1954.) Discussion on 1131 of 1953.

621.3.013.783.001.4 2223
**Measuring the Effectiveness of Shielding
 Materials**—C. DeVore. (*Elect. Mfg.*, vol. 52,
 pp. 122-125; Aug., 1953.) A method developed
 at the U. S. Naval Research Laboratory is de-
 scribed. Only a small sample of the material un-
 der test, e.g. wire mesh or conducting coating,
 is needed. The sample is inserted between two
 shield cans containing transmitting and receiv-
 ing aeriels respectively, and the attenuation in-
 crease produced by the sample is observed. The
 frequency range investigated is 15 kc-100 mc;
 it may be possible to extend the method to
 higher frequencies by using waveguide tech-
 nique.

621.314.57:621.387 2224
Thyratron Inverter—J. D. Howells. (*Wire-
 less World*, vol. 60, pp. 237-241; May, 1954.)
 Description of a unit giving 100w at 240v, 50
 cps from dc mains.

621.314.6 2225
**Rectifier with Smoothing Capacitor and
 High-Vacuum Valves or Selenium Rectifiers**—
 K. Müller-Lübeck. (*Arch. Elektrotech.*, vol. 41,
 pp. 181-195; 1954.) Exact equations are de-
 rived for a p -phase rectifier circuit with a ca-
 pacitance connected across the load. For prac-
 tical use approximate formulae are derived, and
 their application is illustrated by the design of a
 two-phase rectifier for an output of 2.25 kv,
 0.7a.

621.314.63+621.316.93]:546.28 2226
**Silicon P-N Junction Power Rectifiers and
 Lightning Protectors**—G. L. Pearson and C. S.
 Fuller. (*Proc. I.R.E.*, vol. 42, p. 760; April,
 1954.) A method of preparing large-area-junc-
 tion diodes is indicated, in which donor (e.g. P)
 or acceptor (e.g. B) impurities are diffused into
 high-purity single crystals of Si at temperatures
 above 1000 degrees C. Low-resistivity surface
 layers are produced, facilitating the application
 of contacts. Electrical characteristics are pre-
 sented of a power rectifier and a lightning pro-
 tector prepared by this method.

621.316.722.1 2227
**A Simple Mains Unit for Highly Constant
 Alternating Voltages and Currents**—H. Helke.
 (*Elektrotech. Z., Edn A*, vol. 75, pp. 11-13; Jan.
 1, 1954.) A unit giving a voltage continuously
 variable up to 600v and currents up to 6a is de-
 scribed, the voltage varying not more than
 ± 0.1 per cent with mains voltage variations up
 to ± 10 per cent and mains frequency varia-
 tions up to 0.5 per cent.

621.316.722.1 2228
**A New D.C. Electronic Voltage-Stabilizing
 Circuit**—R. B. Mackenzie. (*Proc. IEE*, Part
 II, vol. 101, pp. 59-63; Feb., 1954.) The detect-
 ing element across the supply consists of a nega-
 tive-resistance and a positive-resistance ele-
 ment of equal numerical values in series. By
 controlling the negative resistance complete
 compensation can be achieved. A circuit built
 on a similar principle but using a different type
 of negative-resistance element was described by
 Patchett (227 of 1951). A stabilizer with an out-
 put of 400v is described in detail; the output
 can be maintained constant to within ± 0.001
 per cent for an input fluctuation of ± 10 per
 cent and a load variation of 1-20 ma. The cir-
 cuit is suitable for voltages from 70v upwards.

621.318.5 2229
Relay Standardization—(*Elect. Mfg.*, vol.
 52, pp. 146-154, 380; Sept., 1953.) Summarized
 report of proceedings of symposium on em re-
 lays, held at Oklahoma in June, 1953. Military
 applications were the main consideration.

621.355 2230
Recent Patents on Electrical Accumulators
 —L. Jumau. (*Rev. gén. Élect.*, vol. 63, pp. 59-
 70 and 129-142; Feb./March, 1954.) Review of
 developments. For previous review see 3177 of
 1950.

TELEVISION AND PHOTOTELEGRAPHY

621.397.24/.26:621.396.97 2231
**Technical Arrangements for the Sound and
 Television Broadcasts of the Coronation Cere-
 monies on 2nd June, 1953**—W. S. Procter,
 M. J. L. Pulling, and F. Williams. (*Proc. IEE*,
 Part I, vol. 101, pp. 57-72; March, 1954. Dis-
 cussion, pp. 73-78.) A comprehensive descrip-
 tion of the arrangements and equipment used
 for the simultaneous broadcasts to the United
 Kingdom and parts of Western Europe. An ac-
 count is included of the sound and television re-
 cording arrangements of the B.B.C. and the
 North American organizations, which enabled
 telerecordings to be screened in America within
 11 hours of the event. See also 2804 of 1953
 (Bridgewater).

621.397.26 2232
U.H.F.-TV Satellite Operation—J. S. Allen.

(*Sylvania Technologist*, vol. 7, pp. 3-7; Jan., 1954.) An unattended system is described consisting of two transmitters, one on a hilltop and the other about 1½ miles away in the small town to be served. Programs picked up at the hilltop station are re-broadcast on channel 22 (518-524 mc) and relayed by low-power microwave link to the town transmitter, broadcasting on channel 82 (878-884 mc).

621.397.335 2233
Portable Sync Generator for TV Broadcasting—H. E. Ennes. (*Electronics*, vol. 27, pp. 138-141; April, 1954.) Description, including detailed circuit diagram, of equipment using 22 miniature tubes and providing a standard R.E.T.M.A. synchronizing signal at 4 v negative peak to peak across 75Ω.

621.397.5:621.396.11.029.62 2234
Wave Propagation and Television Broadcasting at Very High Frequencies—R. L. Smith-Rose. (*Proc. I.R.E. (Aust.)*, vol. 15, pp. 7-12; Jan., 1954.) "The fundamental factors determining the bandwidth of a television system are reviewed and the present arrangement of the vhf channels in the B.B.C. service is outlined. Experiments on the propagation of radio waves over various distances in the frequency range 30 to 100 mc are then described and the results related to the problem of extending the service by means of shared channels."

621.397.5(083.74)(931) 2235
The Choice of a Television Standard—N. R. Palmer. (*Radio & Electronics (Wellington, N. Z.)*, vol. 8, pp. 17-19; Feb. 1, 1954.) Discussion of various considerations affecting the choice of appropriate standards for operation in New Zealand. The only difference between the New Zealand recommendations and standard British practice was in the choice of horizontal polarization. The frequency channels recommended were 48-53 mc for Wellington, 53-58 mc for Dunedin, 58-63 mc for Christchurch and 63-68 mc for Auckland.

621.397.61:535.316/.319].001.4 2236
The Measurement of the Performance of Lenses—W. N. Sproson. (*B.B.C. Quart.*, vol. 8, pp. 55-64; Spring, 1953.) Lenses for television cameras and other television purposes are discussed.

621.397.611:778.5 2237
New Method for Television Film Scanning—T. Stutz. (*Tech. Mitt. schweiz. Telegr.-Teleph. Verw.*, vol. 32, pp. 1-27; Jan. 1, 1954.) A comprehensive analysis is made of known methods, and a description is given of a continuous-motion picture projector using two optical systems in alternation. The film motion is compensated by moving the axes of the optical systems alternately forward and backward with respect to the film travel. The arrangement is used in conjunction with a flying-spot scanner.

621.397.611:778.5 2238
New 35-mm Television Film Scanner—E. H. Traub. (*Jour. Soc. Mot. Pict. & Telev. Eng.*, vol. 62, pp. 45-54; Jan., 1954.) A flying-spot system with continuous exposure and continuous film motion combined with optical compensation by means of a new type of rotating-prism device is described.

621.397.611.2 2239
The Supericonoscope IS 9 mm/10—R. Just. (*Radio Tech. (Vienna)*, vol. 30, pp. 13-21; Jan. 1954.) Detailed description of a recently developed German camera tube with magnetic deflection and focusing systems. Associated supply, scanning and protection circuits are shown and operating characteristics are discussed, particularly sensitivity and performance at different levels of illumination.

621.397.611.2:537.531 2240
X-Ray Noise Observation using a Photoconductive Pickup Tube—A. D. Cope and

A. Rose. (*Jour. Appl. Phys.*, vol. 25, pp. 240-242; Feb., 1954.) X-ray images have been recorded directly using a vidicon tube with Se target 0.001-inch thick. Noise effects due to the absorbed photons are clearly visible. Clear transmitted pictures at a rate of 30/second were obtained when irradiating the vidicon with a 5-ma 100-kv beam at a distance of 2 feet.

621.397.62 2241
An Outline of the British Television System: Part 3—Receiving the Picture Waveform—D. Wray. (*P.O. Elect. Eng. Jour.*, vol. 46, Part 4, pp. 166-170; Jan., 1954.) Typical antennas and circuits for domestic receivers are described; the effects of receiver faults and external interference on reception are discussed. Part 2: 873 of March.

621.397.62 2242
Band III Converter—G. H. Russell. (*Wireless World*, vol. 60, pp. 211-213; May, 1954.) A simple circuit for adapting Band-I television receivers to accommodate either of the two proposed British Band-III television channels uses a self-oscillating type of mixer whose output is fed to the receiver via a step-down IF transformer. Details are given of components and alignment procedure.

621.397.62 2243
Signal Overload Relay for Television Receivers—C. Masucci, J. R. Peltz, and W. B. Whalley. (*Electronics*, vol. 27, pp. 153-155; April, 1954.) When a high-sensitivity receiver is operated in an area where alternative strong and weak signals are available, it is desirable to make provision for automatically reducing the gain for the strong signal and restoring it for the weak one; the same arrangement can be used simply to prevent overloading. The device described consists of a relay in the rf and IF anode circuits which is arranged to cut out the rf amplifier tube when the agc voltage reaches a set level.

621.397.62:535.623 2244
Color Decoder Simplifications based on a Beam Deflection Tube—R. Adler and C. Heuer. (*Trans. I.R.E.*, No. PGBTR-5, pp. 64-70; Jan., 1954.) In a synchronous demodulator for the NTSC two-component color signal, the usual multigrad tube is replaced by a beam tube; one signal component is applied to a conventional control grid, and the other to a deflection control system. Circuit arrangements and experimental results are presented.

621.397.62:535.623 2245
TV Color Detectors use Pulsed-Envelope Method—K. Schlesinger. (*Electronics*, vol. 27, pp. 142-145; March, 1954.) Synchronous detection of the two quadrature components of the NTSC color signal is accomplished by means of rectifiers, which may be conventional diodes or triodes, keyed in and out by a local oscillator. Balanced and unbalanced arrangements are described. See also *Trans. I.R.E.*, No. PGBTR-5, pp. 53-63; Jan., 1954.

621.397.62:621.385.832:537.531 2246
The Production of X Rays by Television C.R. Tubes—K. H. J. Rottgardt. (*Fernmelde- tech. Z.*, vol. 7, pp. 74-75; Feb., 1954.) X-ray film measurements on the Tube MW 36-44, the Lorenz Bs 42 R-3 and Bs 42 R-6 cr tubes, at anode voltages ≥ 16 kv, indicate that the amount of X-ray radiation penetrating the glass envelope is negligible. An editorial note adds that the radiation intensity from a 15-kv tube was equivalent to that from 1 μ g Ra, i.e. of the same order as that from a luminous watch-dial.

621.397.621.018.75 2247
Development of Television Pulse-Regeneration Equipment—K. H. Vogt. (*Fernmelde- tech. Z.*, vol. 7, pp. 53-55; Feb., 1954.) Description of equipment used at H6hbeck relay sta-

tion. For a description of similar equipment see 558 of February (Dr6scher).

621.397.621.2:535.623:535.37 2248
The Preparation of Phosphor Screens for Color Television Tubes—S. Levy and A. K. Levine. (*Jour. Elec. Chem. Soc.*, vol. 101, pp. 99-103; Feb., 1954.) See 3440 of 1953.

621.397.813 2249
"Sensation-Correct" Gamma Correction of Television Pictures—P. R. Arendt. (*Arch. elekt. 6bertragung*, vol. 8, pp. 1-4; Jan., 1954.) Results of subjective tests indicate that equalization to unity gamma causes a distortion of the half-tone scale. The construction of subjectively correct equidistance brightness scales for given adaptation levels is discussed.

621.397.828 2250
Beat between Sound Carrier and Color Signal Components in a Television Receiver—J. E. Allen. (*Trans. I.R.E.*, No. PGBTR-5, pp. 71-86; Jan., 1954.) Reception of signals conforming to the NTSC standards is discussed. Analysis of the beat produced in the detector between the sound carrier and the color subcarrier, and visible as streaks in the picture, shows that the sound carrier attenuation must be at least 14 db greater than the desired reduction in beat level below a full black-to-white transition. Tests show that 30-db attenuation is required for beat suppression. The sound level must therefore be at least 44 db below mid-band response. To allow for transmission variations, a further margin should be provided. The requirement is more easily realizable in a receiver with a response curve sloping so as to reduce the response to the color subcarrier. Effects of the beat in the chrominance channel are simultaneously suppressed.

TRANSMISSION

621.376.32 2251
Frequency Modulation of Microwaves—S. Freedman. (*Radio & Telev. News, Radio-Electronic Eng. Sec.*, vol. 51, pp. 16-18; Jan., 1954.) Direct frequency modulation of the carrier frequency in a system comprising microwave generator and resonant cavity is achieved by altering the dimensions of the resonant cavity. One wall of the cavity consists of a light framework supporting a series of concentric wire rings. This framework replaces the cone in a loudspeaker, and vibrates when af signals are applied to the loudspeaker. The vibrating wall is not in electrical connection with the main body of the cavity. A TEO_a mode must be used. Modifications may be made so that the system operates as an afc unit.

621.396.61 2252
High Power H.F. Broadcast Transmitters—D. F. Bowers and J. F. Ennos. (*Marconi Rev.*, vol. 17, pp. 16-36; 1st Quarter, 1954.) A detailed account is given of the design of a series of 100-kv transmitters Type BD.253 for the frequency bands 160-285 kc, 525-1605 kc and 5.9-26.1 mc respectively. Good over-all efficiency is obtained by using tubes with thoriated tungsten filaments, air cooling is used. Tube filaments are heated by ac, and hum is reduced by feedback. Hot-cathode Hg-vapour rectifiers provide the hv supply.

621.396.61 2253
Design of Transmitter Power Stages from Valve Data (with Formulae)—V. Lacmann. (*Frequenz*, vol. 7, pp. 369-375; Dec., 1953.) Formulas for calculating operating conditions for these circuits are presented, based mainly on applied anode voltage, maximum anode dissipation and maximum emission current as parameters. It is assumed that the tube is operated so that the voltage drop across it is a minimum consistent with maximum anode current, but modifications to the formulas are indicated for other cases. Diagrams are given

from which efficiency can be estimated under various operating conditions. The practical application of the formulas is illustrated for power amplifier and frequency-doubler stages.

621.396.61:621.314.7 2254
160-Metre Transistor Transmitter—A. Cockle. (*Wireless World*, vol. 60, p. 217; May, 1954.) A Type-OC51 transistor (alpha cutoff at 1.5 mc) is used in an amateur transmitter employing the negative-resistance base-oscillator principle and locked over about 1 kc by a 1.8 mc crystal. With power up to 100 mw, signals have been received at distances up to 30 miles.

621.396.61.029.58:621.396.65 2255
Single-Sideband Multi-Channel Operation of Short-Wave Point-to-Point Radio Links: Part 4(b)—An Independent-Sideband High-Power Short-Wave Transmitter—Design and Performance—H. E. Sturgess and F. W. Newson. (*P.O. Elec. Eng. Jour.*, vol. 46, Part 4, pp. 191-195; Jan., 1954.) Part 4(a): 882 of March.

621.396.61.029.62 2256
V.H.F./U.H.F. Transmitters for Experimental Work—(*Elec. Jour.*, vol. 152, pp. 1031-1032; March 26, 1954.) A band-III transmitter for use by the B.B.C. is described. Square-waveform modulation at 1 kc is provided for purposes of field strength measurements, and pulse modulation for investigation of multipath transmission and echo effects. Only one rf circuit is used for both conditions of modulation. The transmitter is intended for operation in a van, and the power-supply unit is accordingly designed to deal with large variations of mains supplies. The output is 150w cw. The development of another band-III transmitter and of band-IV and band-V transmitters is mentioned.

TUBES AND THERMIONICS

621.314.632:546.289:621.374 2257
"Positive-Gap" Germanium Diode—A. H. Reeves. (*Onde élect.*, vol. 34, pp. 32-37; Jan., 1954.) A suitable point contact, such as Ag with As impurity, and a suitable electrical forming technique produce a discontinuity in the diode forward characteristic useful in pulse techniques. Its application in a 20-mc pulse generator and in counting and trigger circuits operating at higher frequencies is illustrated.

621.314.7 2258
The Theory of Physical Principles Involved in the A-Type Transistor Action—Y. Watanabe and N. Honda. (*Sci. Rep. Res. Inst. Tohoku Univ.*, Ser. B, vol. 4, pp. 117-163; Dec., 1952.) Detailed consideration of the nature of the barrier layer of the collector contact and the mechanism of rectification of high-back-voltage Ge rectifiers, and of the mechanism of transistor action principally in n-type Ge. A comparison of the theoretical results with the experimental results of Bardeen and Brattain (2979 of 1949) shows satisfactory agreement. The current feedback factor is also considered.

621.314.7.001.4 2259
Measuring Transistor Temperature Rise—J. Tellerman. (*Electronics*, vol. 27, pp. 185-187; April, 1954.) The temperature rise as a function of the power dissipation is determined by noting the change in the reverse collector current, for zero emitter current. Circuits are illustrated for providing an oscilloscope or a meter indication of collector current. Experiments with Type 2520 and 2521 transistors using various cooling arrangements showed that the temperature rise could be reduced from about 26 degrees to about 20 degrees above an ambient temperature of 27 degrees C., thus permitting

an increase of 25-30 per cent in the power dissipation.

621.314.7.012.6:621.317.755 2260
Characteristic-Curve Tracer for Transistors—H. Lennartz. (*Funk u. Ton*, vol. 8, pp. 25-29; Jan., 1954.) Description of equipment used in conjunction with a cro.

621.383.2 2261
Alkali Photocells: Part 2—M. Ploke. (*Arch. Tech. Messen*, pp. 15-18; Jan., 1954.) 70 references. Part 1: 1608 of May.

621.385.029.63/.64 2262
On the Focusing of High-Current Electron

Beams—G. R. Brewer. (*Jour. Appl. Phys.*, vol. 25, pp. 243-251; Feb., 1954.) The trajectories of electrons under the influence of magnetic and space-charge forces in a system of periodically spaced magnetic lenses are determined. Graphs are presented for use in designing a focusing system for given values of current, voltage, and beam diameter. Use of multiple magnetic-lens systems of the type investigated offers considerable economies over the use of long focusing coils for travelling-wave tubes.

621.385.032.2:537.533.9 2263
Some Effects of Slow Electron Bombardment in Thermionic Valves—D. A. Wright. (*Brit. Jour. Appl. Phys.*, vol. 5, pp. 108-111; March, 1954.) A review of recent work. See also 1748 of June (Wright and Woods).

621.385.032.216 2264
Decay of Emission from an Oxide-coated Cathode due to Adsorption of Matter liberated from the Anode—S. Deb. (*Jour. Brit. I.R.E.*, vol. 14, pp. 157-167; April, 1954.) Two types of adsorption procedure are distinguished, (a) when the adsorbed particles remain mobile on the surface, (b) when the adsorbed particles are immobile. Equations for the decay processes in the two cases are given in integral form and are solved numerically using estimated values of the constants involved. An approximate analytical solution is also given for case (a). The decay in this case is generally of short duration and the emission current is likely to recover spontaneously, whereas in case (b) the decay is of long duration and is likely to be permanent. Differences between the pulsed and dc behavior are explained on the hypothesis that the poisoning of the cathode is only temporary in the pulsed case.

621.385.032.216 2265
On the Crystallization of Alkaline Earth Carbonates and Effects of Sizes and Shapes of these Crystals on the Oxide-Coated Cathodes—H. Nukiyama, E. Takagi, and A. Sato. (*Sci. Rep. Res. Inst. Tohoku Univ.*, Ser. B, vol. 4, pp. 87-103; Dec., 1952.) The principal conclusions of this experimental investigation are: (a) in the crystallization of carbonates by the precipitation method, temperature, concentration of reactants and pH of precipitant are important, (b) the velocity of decomposition into oxides on heating in vacuum depends mainly on the shape rather than the size of the crystals, and (c) thermionic emission is not strongly influenced by crystal shape or size.

621.385.2 2266
Test of Langmuir's Three-Halves Power Law, Deviations due to β^2 -Factor and Secondary Emission—P. L. Walraven. (*Appl. Sci. Res.*, vol. B3, pp. 393-399; 1954.) Results of measurements on a cylindrical diode, in which the filament current and the anode voltage were interrupted alternately at a rate of 3500/seconds, indicate that there is a large deviation from Langmuir's law due to an additional space charge which is produced mainly by reflected electrons at anode voltages up to 30v; the correction factor should then be

$\beta^2(1+2\alpha)$ instead of β^2 , where α is the reflection coefficient. For a Ta anode α is 14 per cent. The correction for the space charge in a planar diode is also derived.

621.385.3.012 2267
Calculation of Characteristic Curves for Planar Triodes—O. Heymann. (*Frequenz*, vol. 8, pp. 33-40; Feb., 1954.) Equations for the slope and tube current are derived from the tube geometry, taking into consideration the formation of "islands" by the grid wires. The slope equation relates the cut-off potential to the grid-cathode distance and can conveniently be used as the starting point for tube design. The numerical values of the elliptic integrals occurring in the equations are shown graphically and tabulated. See also 3609 of 1952 (Dahlke).

621.385.8 2268
Approximate Electrode Shapes for a Cylindrical Electron Beam—E. R. Harrison. (*Brit. Jour. Appl. Phys.*, vol. 5, pp. 40-41; Jan., 1954.) With the aid of some approximations, a simple equation is derived for the shapes of electrodes to produce a parallel beam of rotational symmetry in which the current is space-charge limited. The method has been used for designing a proton-beam accelerator.

621.385.832:537.533 2269
The Geometrical-Optical Distribution of Intensity over the Focused Spot of the Deflected Electron Beam—H. Grumm. (*Optik, Stuttgart*, vol. 11, pp. 32-43; 1954.) Analysis is presented which gives the approximate distribution with far less calculation than by the method based on wave mechanics.

621.385.832:621.317.755 2270
An Interesting Four-Beam Cathode-Ray Tube—H. F. Wendling. (*Funk-Technik (Berlin)*, vol. 9, pp. 102-103; Feb., 1954.) The single-gun oscillograph tube, Type V113, has a first cylindrical es lens producing a ribbon beam; this is deflected as a whole by the es horizontal-deflection system and is split into four in passing through the multiple es vertical-deflection system, the individual ribbon beams being restored to pencil form by the multiple cylindrical lens constituted by the apertures of the vertical-deflection system in combination with the post-deflection accelerator.

621.396.822:537.533 2271
Cathode Boundary Conditions and Noise Minima in Electron Beams—R. Wiesner and H. W. König. (*Arch. elekt. Übertragung*, vol. 8, pp. 5-7; Jan., 1954.) The assumption of the existence of a convection-current fluctuation at the cathode in addition to the velocity fluctuation leads to a theoretical noise distribution in good agreement with that found experimentally by Cutler and Quate (1274 of 1951). In particular the noise minima have values differing from zero.

MISCELLANEOUS

061.4:[621.317.7+621.35 2272
Physical Society's Exhibition [1954]—(*Wireless Engr.*, vol. 31, pp. 132-136; May, 1954.) Brief descriptions are given of selected exhibits. See also *Elect. Times*, vol. 125, pp. 506-509; April 8, 1954, and *Instr. Practice*, vol. 8, pp. 234-244; March, 1954.

621.37/.39 2273
Radio Progress during 1953—(Proc. I.R.E., vol. 42, pp. 705-759; April, 1954.) A review presented with the main purpose of giving specialist workers an idea of developments in fields other than their own. Over 1100 references are given. The headings under which the material is arranged are almost identical with those used for the 1952 review.

The first characteristic which the user has a right to expect in a precision potentiometer is accurate performance...and in precision potentiometers, performance depends upon the coil.

In an accurate linear potentiometer, any given amount of slider travel must result in a corresponding voltage change...no matter which portion of the coil is traversed.

To achieve this, a potentiometer manufacturer is careful to select resistance wire of uniform thickness...and to space it as accurately as possible when winding it around the core.

Like all manufacturers of precision potentiometers, we select our resistance wires from the good ones available from several sources...picking the proper alloy and size to meet your requirements.

Up to this point, making precision potentiometers is not particularly difficult.

The first critical phase is the series of operations involved in coil winding...and Helipot Corporation engineers have developed a special machine...unique in the industry...which performs the coil-making operations in continuous sequence.

First the core wire travels through pressure rollers which take out all kinks. Next...in a dustfree chamber...the resistance wire is wrapped around the core. To insure even spacing, the rate of travel of the core wire and the speed at which the resistance wire is wound are both minutely controlled.

The wire travels on...through a small pre-heater...then past jets which coat it with just the right amount of insulating varnish...and through an infrared oven to dry the varnish. Finally, the wire is coiled into a helix of the correct diameter by another set of rollers...and cut to the desired length of one to forty turns.

All this is done by the machine in a continuous operation...carefully controlled at each step...followed by microscopic inspection and rigorous testing of the completed coils.

At Helipot's Pasadena plant, a battery of these high-speed coil-winding machines assures full-scale production of high-quality coils...produced automatically with considerable saving of time and effort.

See our exhibit at the Wescon Show, August 25 to 27, at Pan Pacific Auditorium, Los Angeles...featuring our full line of single-turn and multi-turn precision potentiometers, and turns-counting DUODIALS*

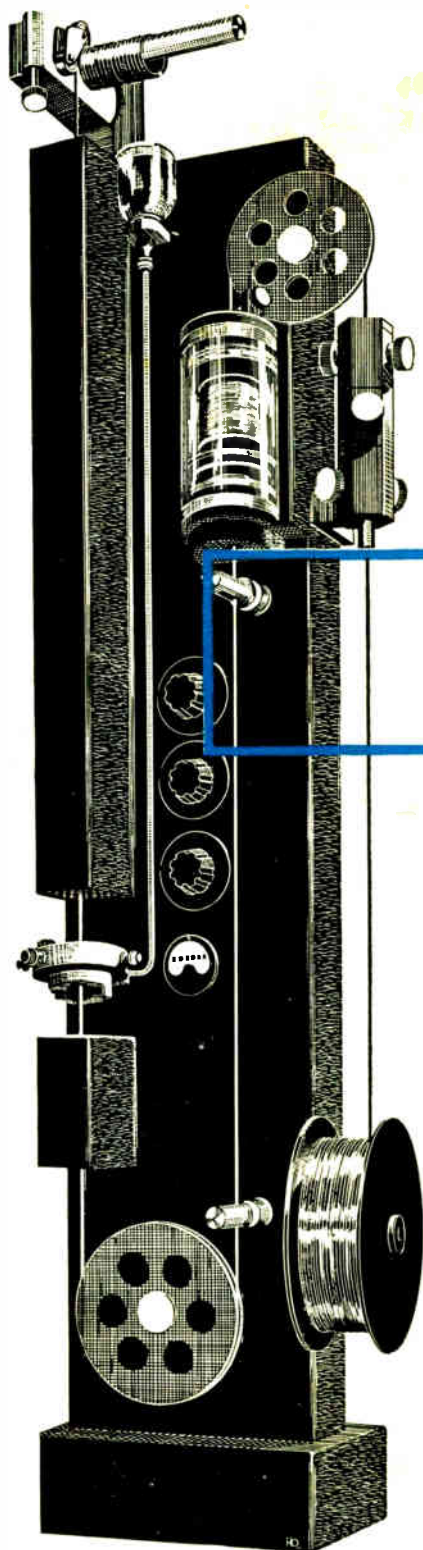

HOW TO WIND UP WITH A BETTER COIL!

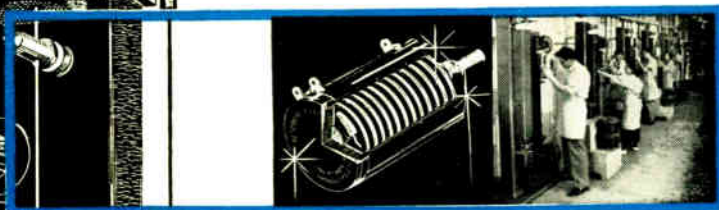

Helipot*...first in precision potentiometers...makes sure that, in every Helipot, you do have a better coil. Specially-developed coil winding machines are but one of the many ways in which Helipot has pioneered, in the manufacture of better precision potentiometers.

The coil winding machine is another example of how Helipot has applied mass-production techniques to delicate operations requiring extreme accuracy...insuring the lowest price consistent with the high quality you expect in Helipot products.

"Accuracy of Potentiometer Linearity Measurements" by Robert McDonald and Irving J. Hogan...reprint of a significant article in Tele-Tech and Electronic Industries...is yours for the asking. Please request Data File 802.

* T. M. REG. 221

Helipot

first in precision potentiometers

Helipot Corporation / South Pasadena, California
Engineering representatives in principal cities
a division of BECKMAN INSTRUMENTS, INC.



Inventory

OF EQUIPMENT AT

Western Union Telegraph Co.
Development & Research Dept.
Electronics Research Div.
Water Mill, N. Y.

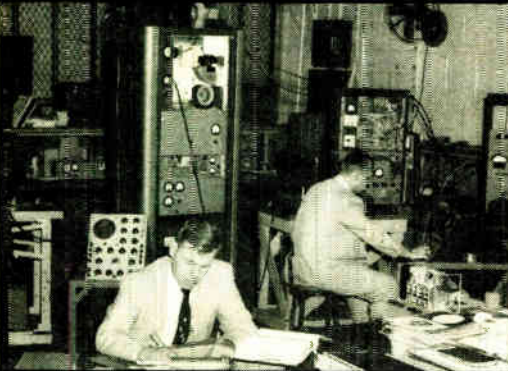

INCLUDES **13**
hallicrafters
RECEIVERS



HALLICRAFTERS SX88

Wherever world wide, all band radio reception is important and reliability of receiver performance paramount, there is bound to be **HALLICRAFTERS!** The radio man's radio.

*Used by 33 governments,
sold in 89 countries.*

hallicrafters

CHICAGO 24, ILLINOIS

Contributors

(Continued from page 62A)

S. P. Morgan has been a research mathematician with Bell Telephone Laboratories since 1947, specializing in electromagnetic theory. He has been particularly concerned with problems of waveguide and coaxial-cable transmission, and with microwave antenna theory. His paper appears on page 1250 of this issue.



S. P. MORGAN

He was born on July 14, 1923, in San Diego, Calif.

He attended the California Institute of Technology, where he received the B.S. degree in 1943, the M.S. in 1944, and the Ph.D. in 1947.

Dr. Morgan is a member of the American Physical Society, Tau Beta Pi, and is an associate member of Sigma Xi.



F. A. Muller is now with the Physical laboratory of the University of Amsterdam. His paper appears on page 1271 of this issue.



F. A. MULLER

He was born in Utrecht, Netherlands in 1920. He studied physics at the University of Amsterdam and received the Ph.D. degree in physics in 1951. The year 1953 was spent as a guest at the Research Laboratory of Electronics at

the Massachusetts Institute of Technology.

Dr. Muller is a member of the "Nederlandse Natuurkundige Vereniging" and of the "Genootschap ter bevordering der Natuur-, Genees-, en Heelkunde."



J. B. Oakes (S'48-A'50) is an associate physicist at the Applied Physics Laboratory of The Johns Hopkins University, where he is engaged in transistor circuit design work. His paper appears on page 1235 of this issue.



J. B. OAKES

He was born in Lyndonville, N. Y. on January 21, 1928. He received the B.S. degree in physics from the Rensselaer Polytechnic Institute in 1949

and the M.S. in physics from the University of Michigan in 1950. Following graduation, Mr. Oakes worked with the nuclear reactor group at the Brookhaven National Laboratory in Upton, Long Island, N. Y., during 1950 and 1951.

Mr. Oakes is a member of the American Physical Society.

(Continued on page 70A)

ZOPHAR

---WAXES

---COMPOUNDS

Zophar Waxes, resins and compounds to impregnate, dip, seal, embed, or pot electronic and electrical equipment or components of all types; radio, television, etc. Cold flows from 100°F. to 285°F. Special waxes non-cracking at -76°F. Compounds meeting Government specifications plain or fungus resistant. Let us help you with your engineering problems.



ZOPHAR MILLS, INC.
112-130 26th Street,
Brooklyn 32, N. Y.

New Standard of
Professional Recording

Dynacord

PROFESSIONAL TAPE RECORDER
by PENTRON

BOOTHS
614 & 615
WESCON SHOW
Los Angeles

Conforms throughout to NARTB standards. For portable use, rack mounting or custom installation. See . . . hear . . . other new Pentron hi-fi and portable models . . . the only complete line in the industry.

THE PENTRON CORP. Dept. IREB
777 S. Tripp Ave., Chicago 24, Ill.

PENTRON

Canada:
Atlas Radio Corp., Ltd., Toronto

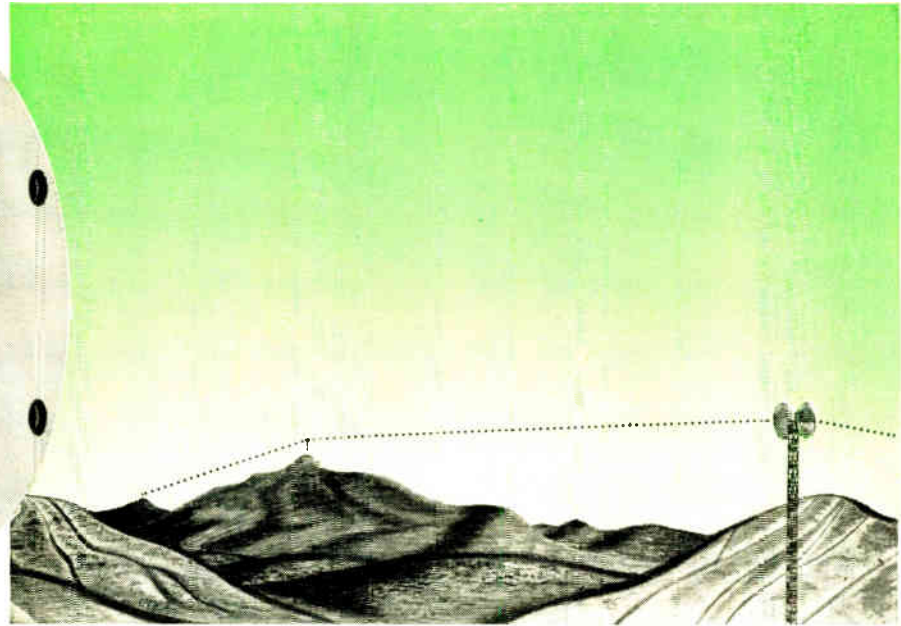
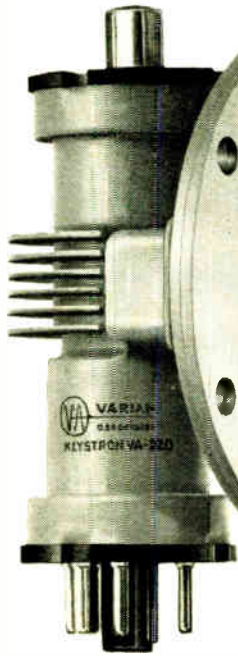

NOW... at **half** the former cost

VARIAN brings you

A NEW, HIGH PERFORMANCE RELAY KLYSTRON

It's the VA-220, another outstanding example of Varian design leadership . . . research and product engineering that brings you the most dramatic cost reduction in the history of high performance klystrons — **with no compromise in quality.**

**UNSURPASSED
FOR EVERY
RELAY APPLICATION**

Microwave relay system designers and equipment buyers have long known that Varian relay klystrons are unmatched for frequency stability, power to override noise, reliability and long life. The VA-220 gives you performance that even exceeds the high standards set by Varian X-26 klystrons . . . at half the cost.

In the 6000 - 8000 megacycle band, VA-220 klystrons will consistently outperform all others. Here are six reasons why this sensational new klystron is your best buy for all relay applications:

**THESE ADVANTAGES
MEAN TOP PERFORMANCE**

- **Greater Power**—VA-220 high power klystrons are conservatively rated. They will deliver more than rated power without failure.
- **Greater Frequency Stability**—VA-220 klystrons have negligible frequency drift.
- **Greater Uniformity**—Varian mass production techniques assure uniformity—every klystron is as reliable as a nut and bolt.
- **Longer Life**—VA-220 klystrons can be operated at full power for thousands of hours, at low power for years.
- **Less Distortion, Less Noise**—FM distortion and inherent noise are negligible—60 db below a 1-megacycle deviation.
- **Lower Cost**—VA-220 klystrons cost far less than any other relay klystron with comparable performance characteristics.

TYPE	FREQUENCY RANGE	RESONATOR VOLTAGE	POWER OUTPUT	BANDWIDTH	MODULATION SENSITIVITY
VA-220*	5925 - 7425 mc	750 v	1.2 watts	35 mc	375 kc/v
*VA-220 B, C, D, E and F each cover a frequency range of approximately 300 mc					

FOR COMPLETE SPECIFICATIONS . . . and technical data on the VA-220 and other Varian klystrons, write to the Varian Application Engineering Department today.

IN KLYSTRONS,
THE MARK OF
LEADERSHIP IS



VARIAN associates
PALO ALTO 2, CALIFORNIA

Representatives in all principal cities.

WEST COASTERS! SEE US AT THE McCoy BOOTH 817 RADIO ENGINEERS SHOW

MCCOY "MCMITE" SUB-MINIATURE M-20 CRYSTAL

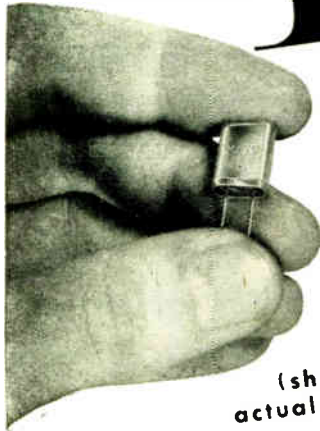

The McCoy M-20 "McMite" is a Subminiature hermetically sealed unit which delivers the same performance as a regular sized crystal, yet takes up just one-fifth the space formerly required.

The M-20 "McMite" Subminiature crystal unit meets MIL-C-3098A specification for type CR-55/U. It is being produced in fundamental frequencies from 5 mc up and in overtone frequencies from 15 mc up. There is no sacrifice of stability or dependability when compared with crystals mounted in the regular HC-6/U holder.

(shown actual size)

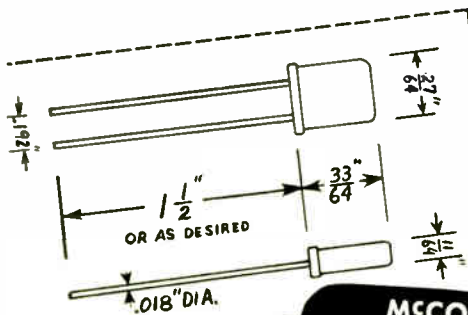

FREQUENCY RANGE
5 mc to 110 mc

MCCOY MO-1 MO-1L CRYSTAL OVENS (OCTAL) (LOCTAL)

MO-1 (OCTAL)

Hermetic or gasket seal. Holds 1 or 2 McCoy M-1 (HC-6/U) crystal units. Temperature: 65°C to 85°C (adjustable). Stability: $\pm 5^\circ\text{C}$ from nominal. Ambient Ranges: -55°C to 5°C below nominal. Power: less than 6 watts. 6, 12 or 24 volt operation.

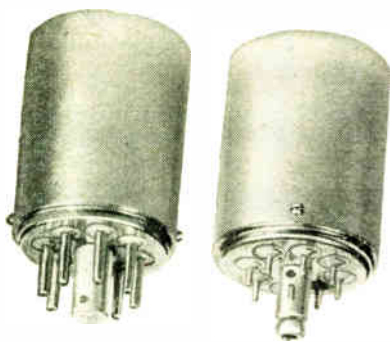

MO-1
(OCTAL)

MO-1L
(LOCTAL)

MO-1L (LOCTAL)

see description MO-1

One or the other of these McCoy Ovens is the answer to the problem of maintaining close temperature control in all transmitting and receiving equipment—mobile, railway, marine and aircraft.

Write, wire or call us for full information on these or any other of your crystal requirements.

McCoy

ELECTRONICS COMPANY
MT. HOLLY SPRINGS, PA.

I gotta
shop around



"PRICE BUYING"

VS.

"ECONOMY BUYING"

Sometimes we save our customers money by charging them what at first seems to be a little more.

But, in the long run, the accuracy of our products saves you cost of assembly time and makes you money by speeding your assembly line and by satisfying your customers.

CONRAD & MOSER

Workers in Aluminum,
Brass, Steel & Plastics

DESIGNING

ENGINEERING • MANUFACTURING
MECHANISMS • MACHINES
PARTS • TOOLS • DIES • MOLDS
STAMPINGS • CASTINGS
MACHINING • SHEET METAL
ENCLOSURES & CHASSIS
1/8 to 1/2 NAVY SPEC ALUMINUM
SPOT WELDING AND HELIARC
WELDING.

2 Borden Ave.

Long Island City 1, N.Y.

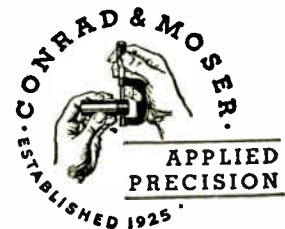

TEST

ANALYZE

EVALUATE

Telemetry Performance Quickly and Accurately

SIGNAL GENERATOR

Type 202-D

Frequency Range 175-250 mc.

With the type 202-D Signal Generator, you can quickly and accurately test, analyze and evaluate the performance of telemetry receivers and associated equipment. Note that the frequency coverage of the instrument is provided in a single range between 175-250 mc.

SPECIFICATIONS:

RF RANGE: 175-250 megacycles in one range, accurate to $\pm 0.5\%$. Main frequency dial also calibrated in 24 equal divisions for use with vernier frequency dial.

VERNIER FREQUENCY DIAL: This dial is divided into approximately 100 equal scale divisions and is coupled to the main frequency dial by a 24:1 gear train. The approximate frequency change per vernier division is 35 kc.

FREQUENCY MODULATION (DEVIATION): The FM deviation is continuously variable from zero to 240 kc. The modulation meter is calibrated in three FM ranges (1) 0-24 kc., (2) 0-80 kc., and (3) 0-240 kc. deviation.

AMPLITUDE MODULATION: Utilizing the internal audio oscillator amplitude modulation may be obtained over the range of 0-50% with meter calibration points of 30% and 50%. By means of an external audio oscillator the RF carrier may be amplitude modulated to substantially 100%. A front panel jack is provided which permits direct connection of an external modulating voltage source to the final stage for pulse and square wave modulation. Under these conditions the rise time of the modulated carrier is less than 0.25 microseconds and the decay time less than 0.8 microseconds.

MODULATION CONTROLS: Separate potentiometers are provided for continuous control of FM and AM levels.

MODULATING OSCILLATOR: The internal AF oscillator may be switched to provide either frequency or amplitude modulation. It may also be switched off. Eight fixed frequencies between 50 cycles and 15 kilocycles are available, any one of which may be selected by a rotary type switch.

RF OUTPUT VOLTAGE: The RF output voltage is continuously variable over a range from 0.1 microvolt to 0.2 volts at the terminals of the output cable. The impedance of the RF output jack, looking into the instrument, is 53 ohms resistive.

DISTORTION: FM: The overall FM distortion at 75 kc. is less than 2% and at 240 kc. less than 10%.

AM: The distortion present at the RF output for 30% amplitude



modulation is less than 3% and for 50% AM less than 6.5. At 100% the distortion is 12% to 15% depending upon the modulating frequency.

SPURIOUS RF OUTPUT: All spurious RF output voltages are at least 25 db. below the desired fundamental. Total RMS spurious FM from the 60 cycles power source is down more than 50 db., with 75 kc. deviation as a reference level.

EXTERNAL MODULATION REQUIREMENTS:

Frequency Modulation: The deviation sensitivity is 50 kc. per volt. For external FM the input impedance is 1500 ohms.

Amplitude Modulation: Approximately 45 volts are required for 50% modulation and 100 volts for 100% modulation. For external AM the input impedance is 7500 ohms.

Audio Voltage for External Use: There is available at the FM external oscillator binding posts about 5 volts a.c. maximum and at the AM external oscillator binding posts, 50 volts maximum.

DIMENSIONS AND WEIGHT: Outside cabinet dimensions: 17" high, 13½" wide, 11½" deep. Weight: 35 pounds.

Price: \$980.00 F.O.B. Boonton, N. J.



BOONTON RADIO
BOONTON · N · J · U · S · A · Corporation

FREQUENCY STANDARD

This precision instrument is a source of highly stabilized frequencies covering the range from 10 kc to 50 mc at intervals of 10 kc, 100 kc, or 1 mc. Stability of one part in 10^7 per 24 hours has been achieved by a unique method of temperature stabilization. Frequency dividers and multivibrators develop the wide range of frequencies available.

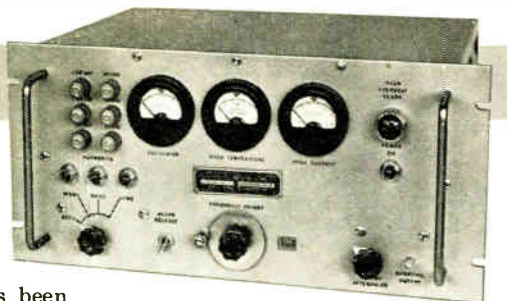

MODEL 701

MODULATION MONITOR

The Model 252 Modulation Monitor measures the percentage of modulation of AM transmitters operating from 100-225 mc, or 225 mc-400 mc. It features: wide VHF range; over-modulation indicator; carrier level indicator; audio output monitoring; low noise and hum.



MODEL 252

Write for catalog and detailed specifications.

NEW LONDON INSTRUMENT Company

P. O. BOX 189P
NEW LONDON, CONN.

Sel-Rex

BRIGHT GOLD PROCESS

NOW USED BY THE NATION'S LARGEST PRODUCER OF AN CONNECTORS

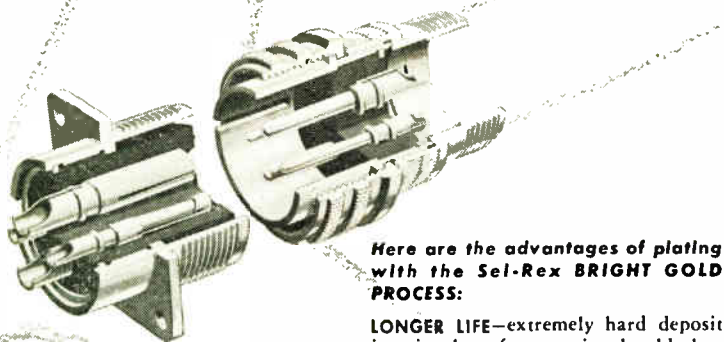

Here are the advantages of plating with the Sel-Rex BRIGHT GOLD PROCESS:

LONGER LIFE—extremely hard deposit is twice that of conventional gold, thus resists wear and abrasion even on sliding or wiping contacts.

IMPROVED PERFORMANCE—the smooth, fine grained deposit assures a superior contact surface, both electrically and mechanically.

GREATHER ECONOMY — uniform metal distribution, even in deep recesses and interior surfaces, gives greater protection with less gold. The solution operates at room temperature and is simple to maintain.

BETTER APPEARANCE—the mirror-like finish will not corrode or oxidize—each part maintains a like-new appearance and has indefinite stock life.

Packaged in 1, 5 and 10 ounce bottles.

Simplicity of operation

... uniform, high quality performance ... characteristics that cannot be achieved with any other gold plating process—just a few of the reasons why American Phenolic Corp. uses the SEL-REX BRIGHT GOLD PROCESS to electroplate high quality AMPHENOL AN Connector contacts.

SEL-REX PRECIOUS METALS, INC.
Dept. IRE-8, 229 Main Street • Belleville 9, N.J.

Contributors

(Continued from page 66A)

I. H. Page is consultant to the Radar Division of the Naval Research Laboratory, Washington, D. C. His paper appears on page 1307 of this issue.



I. H. PAGE

He was born in St. Paul, Minnesota on November 5, 1912. He graduated with special honors from Hamline University in St. Paul, obtaining a B.S. in Physics in June, 1934. In 1937 he was employed as a Physicist in the Special Research Section of the Naval Research Laboratory where he had an opportunity to contribute to early Navy radar development. During the war he led a group developing radar and countermeasures receivers, and in 1945 he was made Head of the Receiver and Indicator Section of the Search Radar Branch. In 1948 he received the Distinguished Civilian Service award from the Secretary of the Navy for work in the field of radar anti-jamming. In 1951 he was made Head of the RF Section.

He is a member of the American Physical Society, and the Scientific Research Society of America.



Dr. A. Papoulis has been Assistant Professor of Electrical Engineering at the Polytechnic Institute of Brooklyn since the Fall of 1952. Dr. Papoulis has also been with the Burroughs Corporation since 1951. His paper appears on page 1283 of this issue.



A. PAPOULIS

Born in 1921 in Greece, he studied at the Polytechnic Institute of Athens from 1937 to 1942, receiving a degree in Mechanical and Electrical Engineering.

He came to the United States in August, 1945, and began graduate work in 1946 at the Moore School of Electrical Engineering of the University of Pennsylvania. He obtained the Master's degree in Electrical Engineering in 1947 and continued his graduate work with a Harrison Fellowship. He received the M.A. in Mathematics in 1948 and the Ph.D. in Mathematics in February, 1950.

Dr. Papoulis taught also at the University of Pennsylvania from 1948 to 1951, and at Union College from 1951 to 1952.



G. W. Reiland joined the Minneapolis-Honeywell Regulator Company Research Laboratory in 1952. Since that date he has

(Continued on page 72A)

SYLVANIA

ROCKET TUBES

(PLANAR TRIODES)

*The Answer to Efficient Power
at 1000 to 4000 Megacycles*

Low Lead Inductance
Low Interelectrode Capacitance
Rugged Planar Construction
Small Size
Moderate Input requirements
Good frequency-temperature
Characteristics

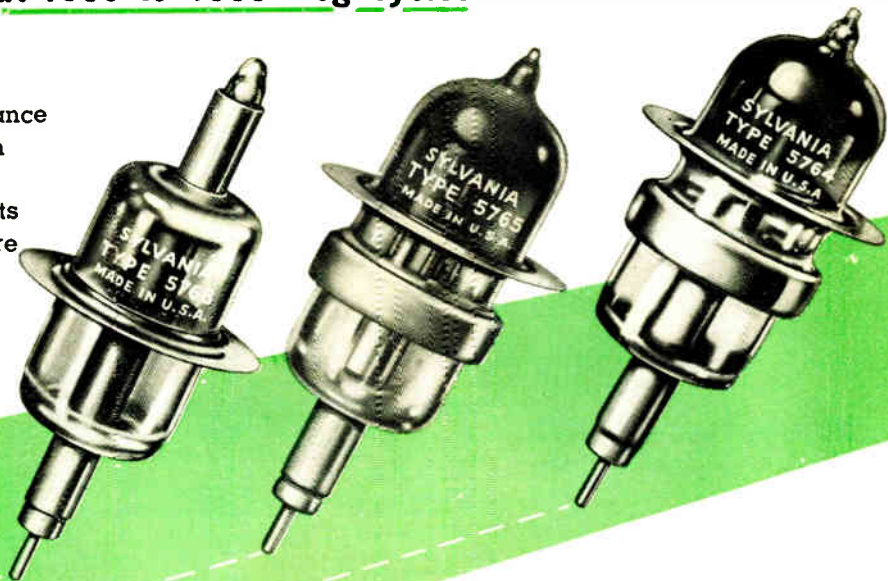

TYPICAL APPLICATIONS

TYPE	SERVICE	FREQUENCY MC	OUTPUT
2C36	Pulsed oscillator	1000	125 Watts
2C37	CW oscillator	1000-3300	450 MW.
5764	Pulsed oscillator	2900	200 Watts
5765	CW Tunable oscillator	900-2900	250 MW. Av over the band
5768	CW Tunable amplifier	1000-3000	10 db. av gain
RT434	CW oscillator for butterfly type circuits	1000-3000	400 MW.

Still more reasons why it pays to SPECIFY SYLVANIA

For complete information concerning Sylvania Rocket Tubes or other electronic tubes write to Sylvania, Dept. 4E-3108.

SYLVANIA

Sylvania Electric Products Inc.



1740 Broadway, New York 19, N. Y.

LIGHTING • RADIO • ELECTRONICS • TELEVISION

In Canada: Sylvania Electric (Canada) Ltd., University Tower Bldg., St. Catherine St., Montreal, P. Q.

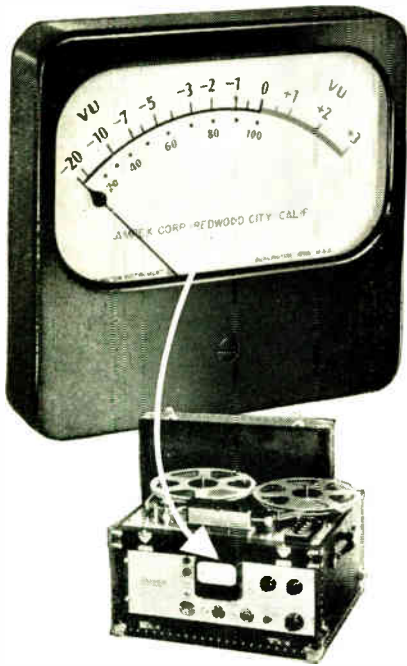

Try this on
your recorder!

Model 745
4½" Semi-Flash

Famous names choose Burlington for consistent quality and prompt service. Burlington offers the widest range of VU meters—from 1½" to 4½" in a variety of case materials and styles including bakelite, metal, hermetically sealed and sealed ruggedized. Square, Round, Rectangular and Fan-shaped. Standard meters of every description. "If you don't see it—ask for it"—

WRITE FOR CATALOGUE N1
Shows cases, ranges, prices

BURLINGTON INSTRUMENT COMPANY
129 Third Street, Burlington, Iowa

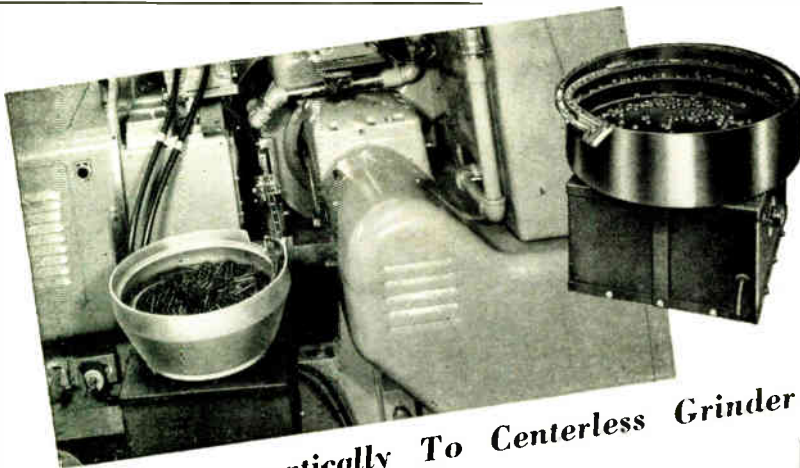

Slugs Fed Automatically To Centerless Grinder
with **SYNTRON**

PARTS FEEDERS

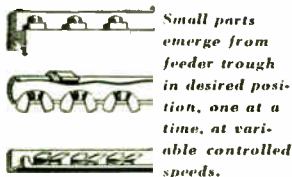

Small parts emerge from feeder trough in desired position, one at a time, at variable controlled speeds.

Providing completely automatic, oriented, single file feeding to grinding, packaging, inspecting, and many other automatic machines—Syntron Parts Feeders greatly increase capacities and speeds for production handling of small parts. Economical—compact—easy to install.

WRITE FOR COMPLETE CATALOGUE DATA—FREE

SYNTRON COMPANY
242 Lexington Avenue
Homer City, Penna.

Contributors

(Continued from page 70A)



G. W. REILAND

been engaged in research and development of power transistors. His paper appears on page 1247 of this issue.

He was born on October 27, 1926 in St. Paul, Minnesota. He received the B.S. degree in Physics from St. Thomas College, St. Paul, Minnesota in

1951. Following graduation, he served two years in the U. S. Air Force, where he did work pertaining to radio operation and maintenance.

Mr. Reiland has worked in commercial and amateur communications since 1945.



E. G. Roka joined the Minneapolis-Honeywell Regulator Company in 1951 and pursued research activities in semiconductor physics and development of power transistors. Dr. Roka is presently Supervisor of the Semi-conductor Group at the Honeywell Research Center. His paper appears on page 1247 of this issue.



E. G. ROKA

He was born in Budapest, Hungary on April 25, 1922.

He received his engineering physics degree from the Technische Hochschule Charlottenburg, and his D.Sci. degree in physics from the University of Goettingen in 1950.

From 1946 to 1951, Dr. Roka worked in the Max Planck Institute for Physik in Goettingen on different research projects in the field of theoretical and experimental physics and applied mathematics.



D. Romell has been a Research Assistant in the Division of Electronics, Royal Institute of Technology, under Professor



D. ROMELL

Alfvén, since 1948, and is now heading a team engaged in tube research and development. His previous work has included experimental investigations on plasma resonance phenomena. His paper appears on page 1239 of this issue.

He was born in Stockholm, Sweden, in 1921. He attended school at Ithaca, N. Y. In 1949 he graduated from the Royal Institute of Technology, Stockholm. Before graduation, he

(Continued on page 74A)

A. C. Household ELECTRICITY
Anywhere...
IN YOUR OWN CAR!

BE PREPARED FOR
ANY EMERGENCY
WITH **ATR** INVERTERS!

**THIS
COULD
HAPPEN!**

Ideal for
Emergency Lighting
and Power Applications
for Civil Defense, Red
Cross, Rescue Work, etc.
Simply Using Extension
Cords.



EASY
TO
INSTALL
EASY
TO
OPERATE

Also...

**Dictate Reports
Accurately - Promptly!**

make your car, boat or plane
a "rolling office"

WITH **ATR**
INVERTERS

for changing your storage battery current
to A. C. Household ELECTRICITY



Anywhere...
in your own car!

LIST
PRICE **\$2250**
AND UP

ATR INVERTERS especially designed for
operating standard 110 volt A. C.

- TAPE RECORDERS • DICTATING MACHINES
- WIRE RECORDERS • ELECTRIC RAZORS

See your jobber or write factory today
for complete information



AMERICAN TELEVISION & RADIO CO.
Quality Products Since 1931
SAINT PAUL 1, MINNESOTA - U. S. A.

for **SPECIFIC** microwave information
on "new" components or
"standard" plumbing

If you use microwave components
... you can benefit from Airtron's
broad range of engineering experi-
ence in designing and producing
both advanced and so-called "stan-
dard" plumbing. For specific,
helpful information ... prepared
by and for engineers ... merely
fill in the obligation free coupon
below and send it to us.



**BRANCHING AND
BALANCED DUPLEXERS**

Standard and special
duplexers, from 6.66 x 3.41
to .360 x .220 O. D. Power,
performance and packaging
to meet your applications.
Bulletin T-2200.

DIRECTIONAL COUPLERS

4 basic types in all wave-
guide sizes from 6.66 x
3.41 to .360 x .220 O. D.
Broadband couplings and
directivities to meet your
needs. Bulletin T-2400.

BALANCED MIXERS

Mixers with waveguide
crystal mounts or coaxial
crystal mounts covering a
frequency range from 400
to 40,000 megacycles.
"Standardized" and spe-
cial types. Bulletin T-2600.

**AIRTRON PRECISION
CASTING FACILITIES**

Precision castings, holding
tolerances of $\pm .002$ "
per inch of dimension, economi-
cally made to your own
specifications. Bulletin 6002.

FLEXIBLE WAVEGUIDE

Available in all sizes for
high power pressurized ap-
plications over wide tem-
perature ranges. Seamless,
twistable, preformed and
circular. Special wave-
guides to meet specific
problems. Cat. 101A.

**TWO-POSITION
WAVEGUIDE SWITCHES**

For rapid on/off or cyclic
switching to or from noise
sources, signal generators,
dummy loads, etc. Low
VSWR, excellent crosstalk
and high peak power per-
formance. Cat. 2331.

SHORT SLOT HYBRIDS

Precision cast one piece
hybrids. Low VSWR, ex-
cellent isolation and low
attenuation over broad
bandwidths. Used in bal-
anced mixers, duplexers,
power splitters. Cat. 2361.

K-BAND TEST HORNS

For test purposes over the
frequency range from
12,400 to 40,000 mc. One
piece aluminum castings to
close tolerances. Low VSWR.
Low secondary lobes.
Cat. 3291.

WAVEGUIDE MAGIC TEES

Hybrid junctions for power
splitting with minimum
energy loss. From 3.00 x
1.50 to all smaller standard
and military sizes. Low
VSWR and excellent broad-
band isolation. Cat. 3330.

OTHER AIRTRON PRODUCTS

- Folded Hybrids • Quick Disconnects • VSWR Standards • High Power Dummy Loads
- Antenna Horns • Waveguide Bends, Twists, Elbows and Transitions • Rotating Joints
- RF and Pressure Gaskets • Aircraft Junction Boxes and Cable Assemblies

USE THIS HANDY COUPON

Airtron INC.

Linden, New Jersey

Branch Offices

- ALBUQUERQUE
- CHICAGO
- DALLAS
- DAYTON
- KANSAS CITY
- LOS ANGELES
- SAN FRANCISCO
- SEATTLE

AIRTRON, INC.

1107 West Elizabeth Ave.
Linden, N.J.

Please send me without obligation information on.....

NAME.....TITLE.....

COMPANY.....

STREET.....

CITY.....ZONE.....STATE.....

Check here if you want Airtron representative to call.

CO-AX

4 mf/ft

★
ULTRA LOW

capacitance
& attenuation

WE ARE SPECIALLY ORGANIZED
TO HANDLE DIRECT ORDERS OR
ENQUIRIES FROM OVERSEAS
SPOT DELIVERIES FOR U.S.
BILLED IN DOLLARS—
SETTLEMENT BY YOUR CHECK
CABLE OR AIRMAIL TODAY



TYPE	μF/ft	IMPED.Ω	O.D.
C1	7.3	150	.36"
C11	6.3	173	.36"
C2	6.3	171	.44"
C22	5.5	184	.44"
C3	5.4	197	.64"
C33	4.8	220	.64"
C4	4.6	229	1.03"
C44	4.1	252	1.03"

NEW 'MX and SM' SUBMINIATURE CONNECTORS
Constant 50Ω-63Ω-70Ω impedances

TRANSRADIO LTD. 138a Cromwell Rd. London SW7 ENGLAND

CABLES: TRANSRAD, LONDON

IT'S
HARVEY
FOR PROMPT
"OFF-THE-SHELF" DELIVERY

Whether it's equipment, components or other electronic requirements, you will always find them in Harvey's extensive stocks, ready for immediate delivery to you anywhere.

WRITE
PHONE
or WIRE

Harvey's twenty-five years of service to the industry are your assurance of understanding 'know-how' and complete dependability.



Telephone
JUdson 2-1500

HARVEY
RADIO COMPANY, INC.
103 West 43rd St., New York 36, N. Y.

Contributors

(Continued from page 72A)

spent a year and a half building the installation and maintenance organization for "Pathfinder" radars in Sweden, having first attended a radar training course at the Raytheon Radar School, Nahant, Mass., in 1946.

He is a member of the Swedish Association of Engineers and Architects.



V. H. Rumsey (SM'50) has been supervisor of the Antenna Laboratory at The Ohio State University since 1948. He is also



V. H. RUMSEY

active in the teaching field, having been appointed an Assistant Professor in 1948, and Associate Professor in 1950, in the Department of Electrical Engineering, of The Ohio State University. His paper appears on page 1262 of this issue.

He was born in 1919, in Devizes, England. He graduated from Cambridge in 1941 with an honors degree with distinction in Part III of mathematical tripos. In the United Kingdom civil service, he was a third-class assistant in 1941, a junior scientific officer in 1942, and a scientific officer in 1943 at TRE, Great Malvern, England. From 1943 to 1945 he was the head of the antenna section of the Combined Research Group at the Naval Research Laboratories in Washington, D. C. As a senior scientific officer in the United Kingdom civil service from 1945 to 1948, he worked as a theoretical physicist at the Canadian atomic energy project.

Mr. Rumsey is a past member of the I.R.E. Committee on Antennas and Waveguides, a former chairman of the Research and Development Board Panel on Antennas and Propagation, and a member of the International URSI Commissions on Radio Standards and Measurements, and Antennas and Circuits.



J. M. Shaull (SM'52), whose paper appears on page 1300 of this issue joined the staff of the National Bureau of Standards,



J. M. SHAULL

in 1939, serving as operator at the Bureau's standard-frequency radio station WWV. From 1941 to 1943 he designed and helped to construct and install the frequency and time interval control equipment for the new WWV station. The following year he designed and supervised construction of the Bureau's microwave frequency standard, com-

(Continued on page 76A)

From "The House of Resistors"*
come these outstanding

miniaturized controls

CARBON AND WIRE-WOUND

Series 48 ($\frac{3}{8}$ " dia.)
composition-element con-
trols. 500 ohms to
5 megohms, linear; 2500
ohms to 2.5 megohms,
non-linear. Standard toler-
ances: 100,000 ohms
and under, plus/minus 10%;
above, 20%. 0.2 watt
rating. • Series 49 ($\frac{3}{4}$ " dia.)
wire-wound controls.
10 ohms to 10,000 ohms;
special, 1 to 10 ohms,
10,000 to 20,000 ohms,
Standard tolerances:
plus/minus 5%; special,
1%. 1.5 watt rating;
special, 2 watt.

...AND NOW WITH SWITCH

Factory-attached S.P.S.T.
switches for both Series
48 and 49. Multipole decked
switch assemblies
available. Single and dual
units, with or without
switch. Sturdy—yet tiny!

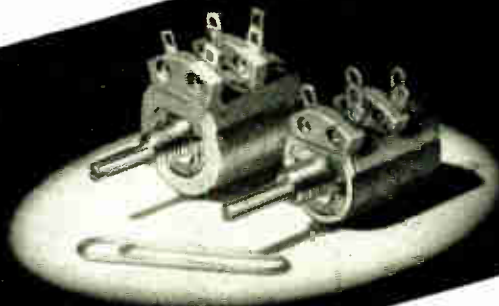
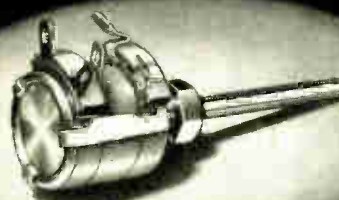
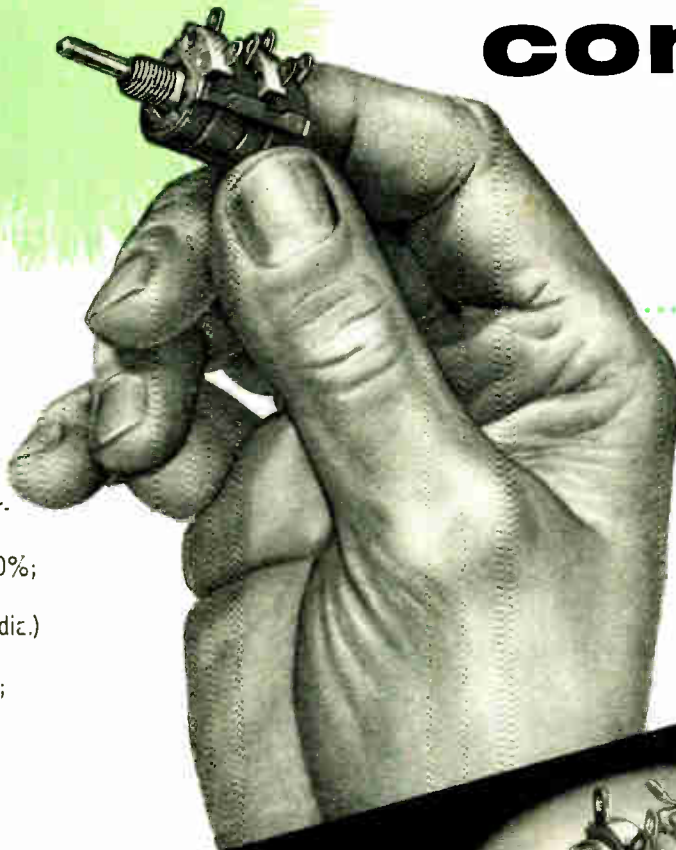

CONSULT US regarding your control
and resistor requirements for miniaturized assemblies.
Write for engineering data. Let us quote.



*Trade-mark

CONTROLS and RESISTORS

CLAROSTAT MFG. CO., INC., DOVER, NEW HAMPSHIRE
In Canada: CANADIAN MARCONI CO., Ltd., Toronto, Ont.

VECTRON'S NEW SA 25 Microwave Spectrum Analyzer

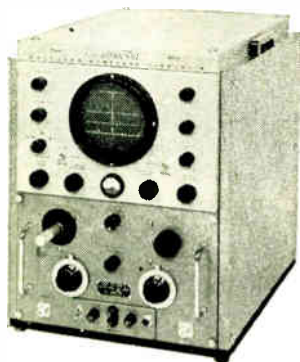

covers the Microwave Spectrum
**800 mc/s to 10,250 mc/s
ON FUNDAMENTALS**

ACCURATE — Calibrated micrometer wave-meters . . . lifetime accuracy to .05% with incremental accuracy to better than .005% independent of Klystron changes. Transmission wavemeters for maximum indication without "pulling".

RELIABLE — Double conversion for stability with minimum drift . . . standard replaceable klystrons . . . no complex harmonic interference. Highly efficient circuits with minimum power consumption, designed for cool, continuous operation.

ECONOMICAL — 99.8% of all microwave research, development, production, test, installation and maintenance requires precise work in a specific portion of the microwave spectrum, usually only a few hundred megacycles wide. Compromise coverage of large areas costs more and delivers less.

VECTRON'S new SA 25 Microwave Spectrum Analyzer provides adequate tuning range for the 99.8% of spectrum analyzer requirements through the use of interchangeable R.F. Heads.

Interchangeable R.F. Heads available to 40 kilomegacycles

25L1	800-2400mc/s	25X2a	5700-7425mc/s
2051	2400-3650mc/s	25X2	6250-7425mc/s
2051a	2400-4040mc/s	20X1b	9500-10,250mc/s
25C1b	4240-4910mc/s	20X1a	8500-10,250mc/s
25C1a	4240-5900mc/s	20X1	8500-9660mc/s
25C1	5100-5900mc/s	25K1	15,300-17,700mc/s
25X2b	5700-6600mc/s	25K2	22,800-26,400mc/s
25KQ1	34,000-38,500mc/s		



WRITE FOR BULLETIN SA25

and bulletins on
R. F. Heads
in the frequency
range you use.



VECTRON, inc.

Electronic and Electro-Mechanical Equipment
402 MAIN STREET, WALTHAM 54, MASS.

VECTRON FOR DESIGN AND MANUFACTURE OF:
Precision Electronic Components Microwave Test Equipment
Electronic Networks and Filters Radar Units and Systems
Complete Electronic Systems Special Test Instruments
Variable Frequency Power Supplies Electronic Control Units

Contributors

(Continued from page 74A)

pleting the project in 1946. Since then, until his transfer in October 1953 to the Diamond Ordnance Fuze Laboratory, he has been responsible for monitoring the accuracy of the WWV standard frequency and time transmissions and improving the standards and methods associated with and constituting the primary standard of frequency.

He was born in Hagerstown, Maryland, on August 31, 1910. He has held amateur radio licenses since 1930, and commercial radiotelephone since 1937. In 1935 he came to Washington, D. C., and worked at several Government departments, during which time he graduated from Capitol Radio Engineering Institute and attended George Washington University. In 1938 he was employed in the engineering department of Bendix Radio Corporation, Baltimore, Maryland, calibrating and adjusting precise frequency measurement equipment.

Jacob Shekel (A'52) is employed by the Scientific Department of the Ministry of Defense of Israel, where he does research and development work in the fields of network analysis and synthesis and uhf techniques. His paper appears on page 1268 of this issue.



JACOB SHEKEL

He was born in Bialystok, Poland on January 6, 1926. He received his engineering education at the Hebrew Institute of Technology in Haifa, Israel, and graduated with the degree Ingénieur (E.E.) in 1951. Since February, 1953, Mr. Shekel has been a visiting lecturer at the Israel Institute of Technology in Haifa, Israel in addition to his regular employment.

During the summer of 1949 Mr. Shekel was a guest student on the Foreign Students Summer Project at the Massachusetts Institute of Technology, where he took a course on microwaves.

J. H. Shoaf (M'53), whose paper appears on page 1300 of this issue joined the staff of the Central Radio Propagation



J. H. SHOAF

Laboratory at the National Bureau of Standards, Washington, D. C. in 1949. Since then he has been employed in the frequency and time section of the CRPL and is at present responsible for maintaining the primary standard of frequency, monitoring of WWV fre-

(Continued on page 78A)

Over 85% of the torque wrenches
used in industry are

STURTEVANT TORQUE WRENCHES

Read by Sight, Sound or Feel.

- Permanently Accurate
- Practically Indestructible
- Faster—Easier to use
- Automatic Release
- All Capacities

in inch grams...inch
ounces...inch pounds
...foot pounds
(All sizes from
0-6000 ft. lbs.)



Every
manufacturer,
design and
production man
should have
this valuable
data. Sent upon
request.

PA **STURTEVANT CO**
ADDISON [QUALITY] ILLINOIS

TYPE 904 VHF-UHF NOISE GENERATOR



FREQUENCY RANGE
(mc/sec): 10 to 1000
NOISE FACTOR RANGE
(db): 20
CHARACTERISTIC IMPEDANCE:
50 ohms (unbonded)

This calibrated broadband noise source permits direct measurements of noise factors as high as 20 db for r-f amplifiers and receivers operating in the range from 10 to 1000 mc/s. Equipment is housed in an attractive metal cabinet.

Write for Catalog

PolYTECHNIC
RESEARCH & DEVELOPMENT CO., Inc.
55 JOHNSON ST., BROOKLYN 1, N.Y.
West Coast
741 N. Seward St., Hollywood 38, Cal.

Watch
for the
NEW

GTR Series



TROUBLE-FREE
*low impedance**
MERCURY BATTERIES
for transistor circuits



General gives you a choice of 8 batteries, four mercury, from the RG1 to the B-3, made with General's exclusive non-shorting surge weld process. Four sizes in carbon-zinc batteries round out the line. Here is a transistor power supply, versatile to meet almost any requirement, with proven performance.

*Internal impedance of General's RG1 varies only from 2.5 to 4 ohms throughout the service life of the battery.

MERCURY CELLS . . . No's RG1, 1.3 volts; B-1, 2.6 volts; B-2, 2.6 volts; B-3, 3.9 volts. Exclusive General construction prevents contamination of chemicals and shorting . . . provides full guaranteed shelf and service life. (RG1 guaranteed at full 1100 milliamp hours.)

"N" SERIES . . . No's. EP-671, 1.5 volts; EP-672, 3.0 volts; EP-673, 1.5 volts. These carbon-zinc, metal clad cells give over 50% of the service life of comparable mercury cells . . . cost less than one-half and weigh 20% less. (400 milliamp hour rating on drains of 5 to 6 M/A.)

EP-921 . . . This 1.5 volt cell gives outstanding performance in low-drain transistor service. (2000 milliamp hour rating on drains up to 6 M/A.)

**8
NEW
TRANSISTOR
BATTERIES**

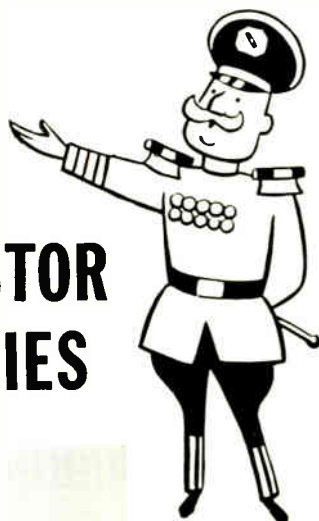

**GENERAL
DRY BATTERIES, INCORPORATED**
13000 ATHENS AVENUE CLEVELAND 7, OHIO
Offices in Principal Cities

DEPEND ON



RELIABLE ELECTRON TUBES



With electronic controls taking over more and more operational functions in military and industrial applications, it is becoming increasingly important that the electron tubes used be dependable under extremely severe conditions. This applies particularly to installations in aircraft where tubes must operate reliably at high altitudes, while subjected to continuous vibration, varying voltages and frequent shock. Because of their advanced design and construction . . . born of never-ceasing research and special production skills . . . Bendix Red Bank Reliable Electron Tubes have the dependability necessary to meet these severe operating conditions. You can depend on our long, specialized experience to give you the right answer . . . for all types of regular as well as special-purpose tube applications. Tubes can be supplied to both commercial and military specifications. Call on us for full details.

Manufacturers of Special-Purpose Electron Tubes, Inverters, Dynamotors, Voltage Regulators and Fractional D. C. Motors

DESIGNATION AND TYPE					TYPICAL OPERATING CONDITIONS		
Type	Proto-type	Bendix No.	Description	Base And Bulb	Heater Voltage	Plate Voltage Per Plate	M.A. Load
5838	6X5	TE-3	Full Wave Rectifier	Octal T-9	12.6	350.	70.
5839	6X5	TE-2	Full Wave Rectifier	Octal T-9	26.5	350.	70.
5852	6X5	TE-5	Full Wave Rectifier	Octal T-9	6.3	350.	70.
5993	6X4	TE-10	Full Wave Rectifier	9-Pin Miniature	6.3	350.	70.
6106	5Y3	TE-22	Full Wave Rectifier	Octal T-9	5.0	350.	100.

Type	Proto-type	Bendix No.	Description	Base And Bulb	Heater Voltage	Plate Voltage	Screen Voltage	Grid Voltage	Gm	Plate Current	Power Output
5992	6V6	TE-8	Beam Power Amplifier	Octal T-9	6.3	250.	250.	12.5	4000	45. MA	3.5 W
*6094	6AQ5 6005	TE-18	Beam Power Amplifier	9-Pin Miniature	6.3	250.	250.	12.5	4500	45. MA	3.5 W
6385	2C51 5670	TE-21	Double Triode	9-Pin Miniature	6.3	150.	—	-2.0	5000	8. MA	—

*Tube Manufactured with Hard (Nonex) Glass for High Temperature Operation (Max. Bulb Temp. 300°C.)



DIVISION OF



EATONTOWN, N. J.

West Coast Sales and Service: 117 E. Provedencia Ave., Burbank, Calif. • Export Sales: Bendix International Division, 205 East 42nd St., New York 17, N. Y. Canadian Distributor: Aviation Electric Ltd., P.O. Box 6102, Montreal, P. Q.

Contributors

(Continued from page 76A)

quency and time transmissions, and the design and development of improved frequency standards and monitoring equipment.

He was born in Smithfield, Pennsylvania, on May 12, 1922. He attended West Virginia University for one and one-half years before entering the United States Army. After returning from the service, Mr. Shoaf attended The Moore School of Electrical Engineering at the University of Pennsylvania and received the B.S. degree in Electrical Engineering from there in 1949.



W. Sichak (M'46) has been with the Federal Telecommunication Laboratories, working on microwave antennas and allied equipment since 1945. He is a department head in the radio and radar components division of the laboratories. From 1942-1945 he was engaged in developing microwave radar antennas at the Radiation Laboratory of the Massachusetts Institute of Tech-



W. SICHAK

(Continued on page 80A)

new
laboratory kit
saves design-in time

ACTUAL SIZE!

MICRODOT®
World's smallest COAX connectors, cables and assemblies

The unique flexibility of Microdot Kit #553 provides scores of coax assembly combinations. Save valuable time in "try-out," pre-production and design-in . . . keep products design competitive with Microdot advantages. Order Kit #553 today.

MICRODOT
1826 FREMONT ST.
SO. PASADENA, CALIF.

ERIE

dependable electronic components

ERIE HIGH VOLTAGE CERAMICONS



Erie offers a wide selection of disc and molded-type ceramicons for high voltage service. Available in ratings between 1000 V. and 30 KV. for high potential tuning, by-passing and filtering applications.

ERIE "K-LOK" HIGH STABILITY DISC CERAMICONS



Values up to .0047 mfd at 500 V. are available in tolerances as close as $\pm 5\%$. Capacity variations with temperature, age and voltage are exceptionally small. A truly premium capacitor.

ERIE BUTTON MICA CAPACITORS



Values from 15 mmf to 8100 mmf are available in tolerances as close as $\pm 2\%$. Rated at 500 VDCW. "Q" value exceeds 1000 for values above 100 mmf. Available for maximum operating temperatures of 85°C. and 125°C. Extremely low inductance makes these very compact capacitors ideal for VHF and UHF applications.

ERIE BY-PASS AND COMPENSATING CERAMICONS



To meet exacting temperature compensation, by-passing, coupling and filtering requirements. Compensating units available from .75 to 1380 mmf. "Hi-K" by-pass units available from 100 mmf to .01 mfd.

ERIE STAND-OFF AND FEED-THRU CERAMICONS



Erie offers a wide selection of chassis—mounting capacitors designed to overcome radiation and critical by-passing problems. Available in both temperature compensating and "Hi-K" materials. Manufactured in values up to 1500 mmf with 500 V. rating.

Ceramicon, Hi-K, K-LOK, GP, Button, and Plexicon are registered trade names of Erie Resistor Corporation



ERIE RESISTOR CORPORATION . . . ELECTRONICS DIVISION

Main Offices and Factories: **ERIE, PA.**

Sales Offices: Cliffside, N. J. • Comden, N. J. • Chicago, Ill. • Detroit, Mich. • Cincinnati, Ohio • Fort Wayne, Ind. • Los Angeles, Calif. • Toronto, Ontario

Manufacturing Subsidiaries:

HOLLY SPRINGS, MISSISSIPPI • LONDON, ENGLAND • TRENTON, ONTARIO

DONNER SCIENTIFIC CO.

A new source of high performance instrumentation!

Laboratory Oscillator

MODEL 10
\$150

specifications

f.o.b. Berkeley, California

FREQUENCY RANGE

2 cps to 2 mcs in six overlapping decade ranges.

FREQUENCY RESPONSE

Constant output ± 1 db.

OUTPUT

Over 20 volts r. m. s. Neither reactive nor resistive loading will cause distortion of the output waveform.

OUTPUT IMPEDANCE
2500 ohms

DISTORTION
Less than 1% at full output

FREQUENCY STABILITY

Drift less than 2% including warmup. No zero setting required. Line voltage variations of 10% change frequency less than 0.1%.



WEIGHT
15.5 pounds

SIZE
Panel 7 $\frac{1}{2}$ " x 10 $\frac{1}{2}$ ", depth 8 $\frac{1}{8}$ "



specifications

FREQUENCY RANGE

50 cps to 50,000 cps

SIZE

Panel 9 $\frac{1}{4}$ " x 14 $\frac{1}{4}$ ", depth 9 $\frac{1}{8}$ "

FREQUENCY CALIBRATION

Calibration accuracy is 3%, with the calibration covering a 250° sweep of the six-inch, planetary driven dial.

INPUT VOLTAGE RANGE

50 millivolts to 500 volts r.m.s., superimposed on DC potentials up to 600 volts. A coarse attenuator with 20 db steps and a continuous fine attenuator are provided to set the meter to 100% for the fundamental component.

POWER SUPPLY

VR-Tube regulation of high voltage, amperite regulation of the local oscillator heater current, and temperature compensation of the frequency determining elements permit normal operation with line voltage variation up to $\pm 10\%$.

INPUT IMPEDANCE
200,000 ohms

WEIGHT
17.5 pounds.

Wave Analyzer

MODEL 20

\$395

f.o.b. Berkeley California

Contributors

(Continued from page 78A)

nology. His paper appears on page 1315 of this issue.

Mr. Sichak was born on January 7, 1916 in Lyndora, Pennsylvania. He received the B.A. degree in physics from Allegheny College in 1942.

He holds membership in the American Physical Society.



C. E. Smith (A'30-M'39-SM'43) expanded the operation of Carl E. Smith Consulting Radio Engineers in 1953 specializing in radio,



C. E. SMITH

television, and industrial electronics. His paper appears on page 1222 of this issue.

He was born near Eldon, Ia., on November 18, 1906. He received the B.S. degree in electrical engineering from Iowa State College in 1940, and the

M.S. degree in electrical engineering from the Ohio State University in 1932. In 1936 he received the professional degree of electrical engineer from the Ohio State University for research work on broadcast-transmitter antenna design.

In 1931 he was a student engineer with the Victor Division, RCA, Camden, N. J. In 1932 he joined the technical staff of the United Broadcasting Company, where he became assistant chief engineer in 1936, chief engineer in 1941, and vice-president in charge of engineering in 1946-53.

In 1934 he founded the Smith Practical Radio Institute. In 1946 the Cleveland Institute of Radio Electronics Inc. was organized as successor to the Smith Practical Radio Institute of Cleveland, Ohio, and Nilson Radio School of New York City. Mr. Smith was elected president of this Institute, which offers a variety of home-study training courses.

During World War II, on leave from 1942-46, he was assistant director of the operational research staff of the Chief Signal Officer of the United States Army.

Mr. Smith is a member of the AIEE, the American Society for Engineering Education, the Society of Motion Picture and Television Engineers, the Association of Federal Communications Consulting Engineers and a professional member of the Cleveland Engineering Society.

(Continued on page 82A)

**1955
Radio Engineering
Show
March 21-25, 1955
Kingsbridge Armory,
New York**

DONNER SCIENTIFIC CO.

2829 - 7TH STREET
BERKELEY 10, CALIFORNIA

• Write for data sheets and name of nearest representative

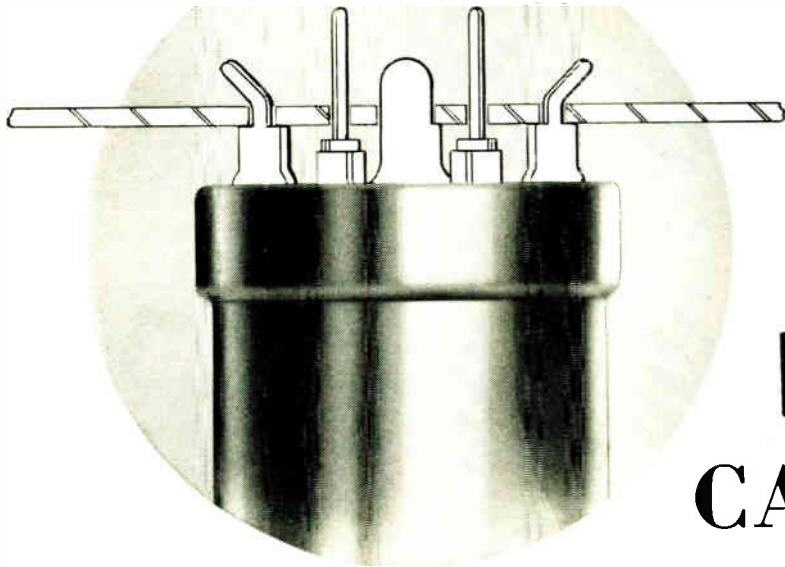

P. R. MALLORY & CO. Inc.

MALLORY CAPACITORS

designed for easy mounting on printed circuits



A new line of Mallory FP Electrolytic Capacitors features mounting prongs and terminals specifically designed for use with printed electronic circuits. These new features give you practical, fool proof mounting—plus the high standards of performance which have earned FP Capacitors outstanding acceptance by leading manufacturers.

Note the shoulders cut in the mounting tabs, to hold the capacitor clear of the chassis. You can print the circuit on *both* sides, without danger of shorting against the case.

Keyed mounting tabs assure correct positioning. Solder terminals are smaller . . . save chassis space, need only a small solder drop to hold securely.

To give a strong mechanical mounting, the prongs can be spread conveniently by means of a simple jig. Aluminum risers from the foil stop short of the soldering area of the terminal . . . can't contaminate the solder.

Write or call us for complete technical information, and for cooperative engineering analysis of your specific capacitor application.

**FOR USE ON
CONVENTIONAL CHASSIS**



The same special FP Capacitors are also usable on any metal chassis, for service replacement or other applications where they can be individually mounted. For production line use on conventional chassis, the standard Mallory FP Capacitors are recommended.

Expect more . . . Get more from **MALLORY**

Parts distributors in all major cities stock Mallory standard components for your convenience.

Serving Industry with These Products:

- Electromechanical—Resistors • Switches • Television Tuners • Vibrators
- Electrochemical—Capacitors • Rectifiers • Mercury Batteries
- Metallurgical—Contacts • Special Metals and Ceramics • Welding Materials



NEY'S SMALL PARTS

PLAY A **BIG** PART IN
PRECISION INSTRUMENTS

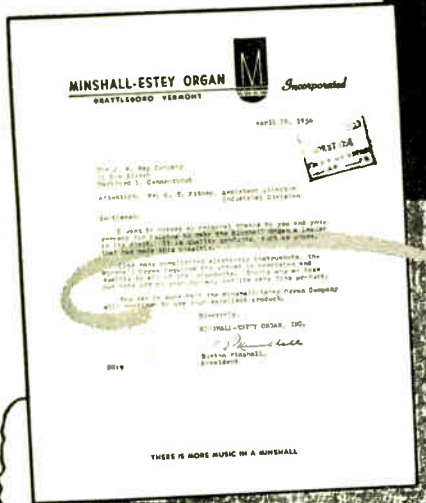

"Like many complicated electronic instruments, the Minshall Organ requires the utmost in precision and quality in all of its components. That's why we take our hats off to your company and its very fine product."

With ideal physical and electrical properties, resistance to tarnish and most corrosive atmospheres, Ney Precious Metals, fabricated into slip rings, brushes, wipers, and contacts, have again demonstrated their superiority for use in precision electrical and electronic apparatus. Improve the accuracy and prolong the life of your instrument by using Ney Precious Metal Alloys. Write today to... Engineering Department.

THE J. M. NEY COMPANY

Specialists in Precious Metal Metallurgy Since 1812

171 ELM STREET, HARTFORD 1, CONNECTICUT

13NY54B

There is Always One Leader in Every Field

BODNAR INDUSTRIES, Inc.

leads in the field of

PLASTIC LIGHTING PANELS AND DIALS

BECAUSE OF Quality • Uniformity • Performance
Design & Layout "Know-How Service"
Quantity Production Promptly

NEW YORK —19 Railroad Ave., New Rochelle (Home Office)

CALIFORNIA—4440 Lankershim Blvd., P.O. Box 264, North Hollywood

CANADA —44 Wellington St. E., Toronto

VISIT OUR WESCON BOOTH 1211



**ENVELOPE
DELAY
TRACER
MODEL EDT-1**

▶FAST▶ACCURATE▶DEPENDABLE

Instantaneously determines envelope delay and amplitude characteristic of amplifiers, networks, or complete television systems. Eliminates tedious plotting and mathematical computation. Envelope delay at single frequencies read directly in microseconds on calibrated meter. Using a sweep generator and oscilloscope, entire envelope delay can be observed over the swept range. Separate meter for amplitude characteristic measurement. Supplied with regulated power supply and mounting rack. Complete data forwarded on request.

Wickes manufactures a complete line of color television instruments for signal generating and distribution, test and measurement, and signal certification. Write for detailed information.

Wickes ENGINEERING AND CONSTRUCTION COMPANY

12TH STREET AND FERRY AVENUE

ESTABLISHED 1920

CAMDEN 4, NEW JERSEY

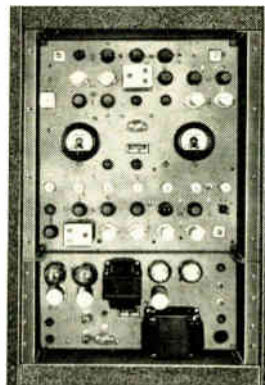

Contributors

(Continued from page 80A)

T. E. Tice (S'46-A'50) has been a project engineer at the Antenna Laboratory of The Ohio State University, since 1948, engaged in research related to micro-wave antenna measuring techniques, the design of aircraft antennas, the analysis of elliptically polarized antennas, and the design of radomes. From January, 1952 to the present, he has been an Assistant Professor in the Department of Electrical Engineering of The Ohio State University. His paper appears on page 1262 of this issue.



T. E. TICE

He was born in Florence, Ala., in 1924. He received his academic training at Marshall College, The University of Wyoming, The University of Idaho, and The Ohio State University. From The Ohio State University he received his Ph.D. in electrical engineering in 1951.

During World War II he was a communications officer in the U. S. Army Signal Corps.

Dr. Tice is a member of Sigma Xi, Tau Beta Pi, Eta Kappa Nu, and Chi Beta Phi. At present he is a faculty advisor to the student branch, AIEE-IRE, at The Ohio State University.

J. O. Weldon (A'26-SM'46) organized the partnership firm of Weldon & Carr, Consulting Radio Engineers, in Washington, D. C. in 1945. He went to Dallas in 1946 to establish the Dallas office of Weldon & Carr and to organize the Continental Electronics Manufacturing Company, which has engaged in the manufacture of broadcast transmitters and associated equipment since that date. His paper appears on page 1222 of this issue.



J. O. WELDON

He started radio engineering work for broadcast stations in 1927. Along with other transmitter design projects, he constructed a 500,000 watt AM broadcast station using a high-efficiency linear power amplifier which was placed in operation in 1938. From 1940 to 1942 he acted as transmitter design consultant for a U. S. manufacturer. From 1942 to 1945, Mr. Weldon was employed as Chief of the Bureau of Communication Facilities, Overseas Branch, Office of War Information, where he was responsible for planning expansion of the technical facilities for International Broadcasting in the United States, and establishing Voice of America Relay Stations overseas.

PROCEEDINGS OF THE I.R.E. August, 1954

ANALOG COMPUTER and SIMULATION FACILITIES now available



**NATIONAL NETWORK OF
EASE* COMPUTER FACILITIES
OFFERS IMPORTANT BENEFITS**

ELECTRONIC
ANALOG
SIMULATING
EQUIPMENT

Now available for consultation and hire are competently-staffed independent organizations fully-equipped with EASE computers and linked in a network to provide full interchange of experience and operational techniques.

Users of any local facility thus receive two important benefits: (1) availability of complete EASE computation and simulation equipment of latest design, at all times; (2) most advanced techniques, and an ever-growing fund of experience, as developed by all network members.

You are cordially invited to visit and investigate the nearest organization having an EASE facility, (see list below) and to discuss your problems involving mathematical analysis, system simulation and other phases of research, design or development work in which modern analog computer techniques offer substantial savings in time and cost.

RICHMOND, CALIF. (San Francisco area)
Berkeley division Beckman Instruments Inc.
Chalmer Janes: LAndscape 6-7730

LOS ANGELES, CALIF.
Dynamics, Incorporated
E. Noneman: ARizona 7-6786

BIRMINGHAM, ALA.
Southern Research Institute
A. J. Thomas, Jr.: 54-2491

ROSELAND, N.J. (New York City Area)
Gawler-Knaap Co.
Allyn W. Janes: DIgby 4-8417

**CHICAGO, DETROIT, BATON ROUGE,
MONTREAL**—facilities open soon.

Computer application bulletins available
on request... please address Dept.
M-38

Berkeley *division*
BECKMAN INSTRUMENTS INC.

2200 WRIGHT AVENUE, RICHMOND, CALIF.

Where **SHOCK** and **VIBRATION**
are a Problem . . .

ENGINEERS CHOOSE
the rugged *Phil-trol*
27
RELAY

**For
AVIATION
and
ELECTRONIC
INDUSTRIES**

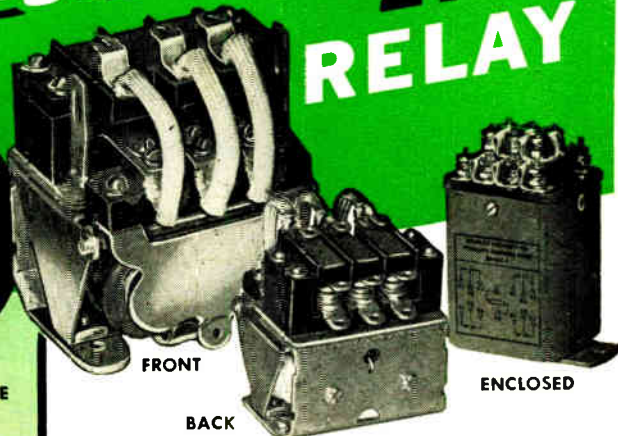

TYPE 27QA-3 POLE

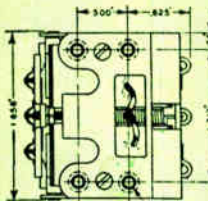
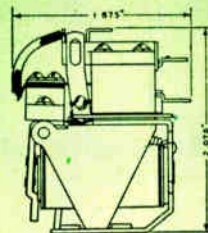

Ø.32 TAPPED MOUNTING HOLES

Phil-trol Type 27 Relays are available in 1, 2, 3, 4 or 5 pole, single or double throw. Operating voltage up to 230 D.C., resistance up to 13,400 ohms, minimum operating current is .001 amps. Available enclosed in dust cover or hermetically sealed.

■ Proved performance of Phil-trol 27 Relays in many vitally important applications has built great demand for this sturdy, sensitive and highly efficient relay. For instance, they are used for: propeller pitch control . . . cabin pressure and temperature control . . . guided missiles . . . computers . . . communication equipment . . . and many other electronic devices.

Phil-trol 27 Relays have unusual features like two-coil construction, which allows greater operating force for a given power input, and also completely eliminates magnetizing force losses at the armature hinge. The rigid frame and balanced armature design provides stability under conditions of high acceleration, severe vibration or shock.

For complete details on all of the many Phil-trol Relays available, write for the new Catalog shown below.

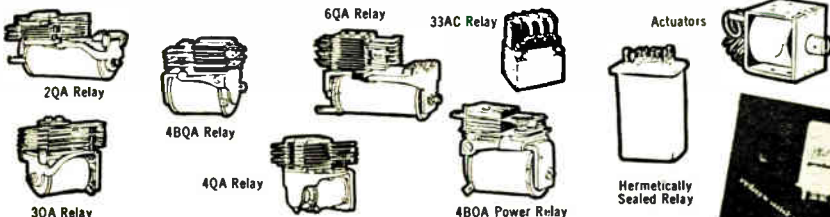

Phil-trol
IS THE REGISTERED TRADEMARK OF
PHILLIPS CONTROL CORP.
JOLIET, ILLINOIS

A THOR CORPORATION SUBSIDIARY
OFFICES IN ALL PRINCIPAL CITIES

PHILLIPS CONTROL CORP., Dept. PI, Joliet, Ill.
Please send me a free copy of the new Phil-trol Relay and Actuator Catalog. Also, please arrange to have a Phil-trol Sales Engineer call on me.

Name _____
Company _____
Street _____
City _____ Zone _____ State _____

**This ONE instrument checks RF, IF,
and AF performance of receivers**

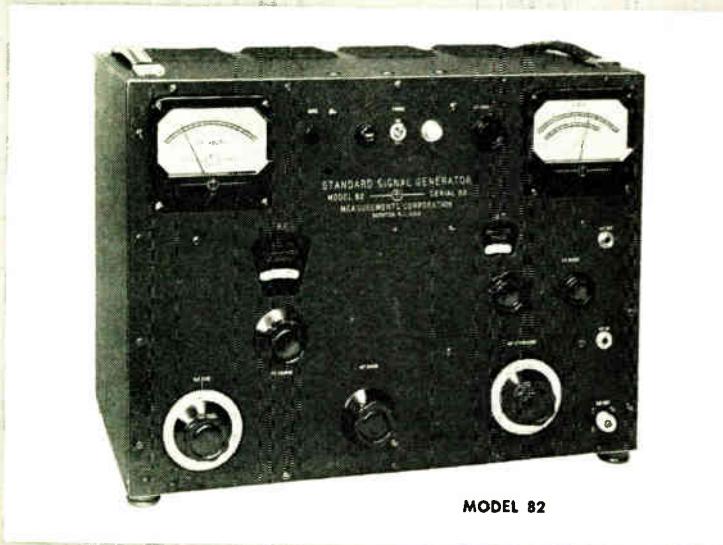

MODEL 82

MEASUREMENTS'

Standard Signal Generator

Frequency Range: 20 cycles-50 mc.

The Model 82 Standard Signal Generator provides extremely wide frequency coverage. It comprises a low-frequency oscillator covering the range from 20 cycles to 200 kc., and a high-frequency oscillator in the range from 80 kc. to 50 mc.

It is designed for audio and radio frequency measurements of AM, FM and television receivers; for testing and checking the frequency response of audio systems; as a driving source for AF and RF bridges; for testing video and wide-band amplifiers.

FEATURES:

- Continuous frequency coverage from 20 cycles to 50 mc.
- Direct-reading individually calibrated dials.
- Low harmonic content.
- Accurate, metered output.
- Mutual inductance type attenuator for high frequency oscillator.
- Stray field and leakage negligible.
- Completely self-contained.

SPECIFICATIONS:

FREQUENCY RANGE: 20 cps to 200 kc. in four ranges. 80 kc. to 50 mc. in seven ranges, plus one blank range.

FREQUENCY CALIBRATION: Each range individually calibrated. 20 cps to 200 kc. accurate to $\pm 5\%$. 80 kc. to 50 mc. accurate to $\pm 1\%$.

OUTPUT VOLTAGE AND IMPEDANCE: 0-50 v. across 7500 ohms from 20 cycles to 200 kc.; Output voltage and impedance in this range can be reduced by external attenuator. 0.1 μ v. to 1 v. across 50 ohms over most of the range from 80 kc. to 50 mc.

MODULATION: Continuously variable from 0-50% from 20 cycles to 20 kc. from internal variable oscillator or external source.

HARMONIC OUTPUT: Less than 1% from 20 cycles to 20 kc.; 3% or less from 20 kc. to 50 mc.

LEAKAGE AND STRAY FIELD: Less than 1 μ v. from 80 kc. to 50 mc.

POWER SUPPLY: 117 v., 50-60 cycles. 75 watts.



ANTENNAS AND PROPAGATION

The Albuquerque-Los Alamos Chapter of the Professional Group on Antennas and Propagation met on April 9 at Mitchell Hall, University of New Mexico, under the chairmanship of R. K. Moore, Secretary of the Albuquerque-Los Alamos Section. J. W. Herbstreit, Project Engineer with the Central Radio Propagation Laboratory, spoke on "UIF Television, Boom or Bust."

The Group also met on May 12 at the Sandia Base under the chairmanship of R. B. Jacques. Tom G. Banks, Jr., Sandia Corp., presented a paper entitled "Design Criteria and Methods for Broadcast Antennas." The following officers were elected for the coming year: F. J. Janza, Chairman; N. J. Gamara, Vice Chairman; and J. McLay, Secretary.

AUDIO

The Albuquerque-Los Alamos Chapter of the Professional Group on Audio met on May 17 at the Radiation Therapy Building, Lovelace Clinic, Albuquerque, New Mexico, under the chairmanship of Don V. Couden. C. A. Morterud, Sandia Corp., presented a paper entitled "Recording Characteristics and Equalizers." Records demonstrating these characteristics were reproduced through the new Heath Kit pre-amp, Williamson amplifier, and R-J enclosure.

The Cleveland Chapter met on May 20 at Station WHK, Studio 3, in Cleveland, under the chairmanship of Herbert Heller. Two papers were presented on tapescript: "Microphones for High Intensity" by J. K. Hilliard, and "Sound Survey Meter" by Arnold Peterson. The papers were discussed by H. R. Mull. Election of officers was held at this meeting, and Chapter By-Laws were adopted.

The Houston Chapter met on May 26 at the Southern States Life Insurance Company Building in Houston, with L. A. Geddes presiding. A paper on "Silicon Transistors" was presented by Dr. Adcock of the Texas Instrument Co., Dallas, Texas.

BROADCAST TRANSMISSION SYSTEMS

The Boston Chapter of the Professional Group on Broadcast Transmission Systems met on March 11 at WCOP Studio in Boston. Sidney V. Stadig presided. Lew Page, engineer with General Electric Co., spoke on "Practical Considerations in Installation of TV Studio Equipment."

CIRCUIT THEORY

The Philadelphia Chapter of the Professional Group on Circuit Theory met on May 13 at the University of Pennsylvania under the chairmanship of Herman Epstein. R. M. Foster, Professor of Mathematics at the Polytechnic Institute of Brooklyn, presented a paper entitled "Some Recent Developments in Network Theory."

(Continued on page 86A)

Laboratory Standards



MEASUREMENTS CORPORATION
BOONTON · NEW JERSEY

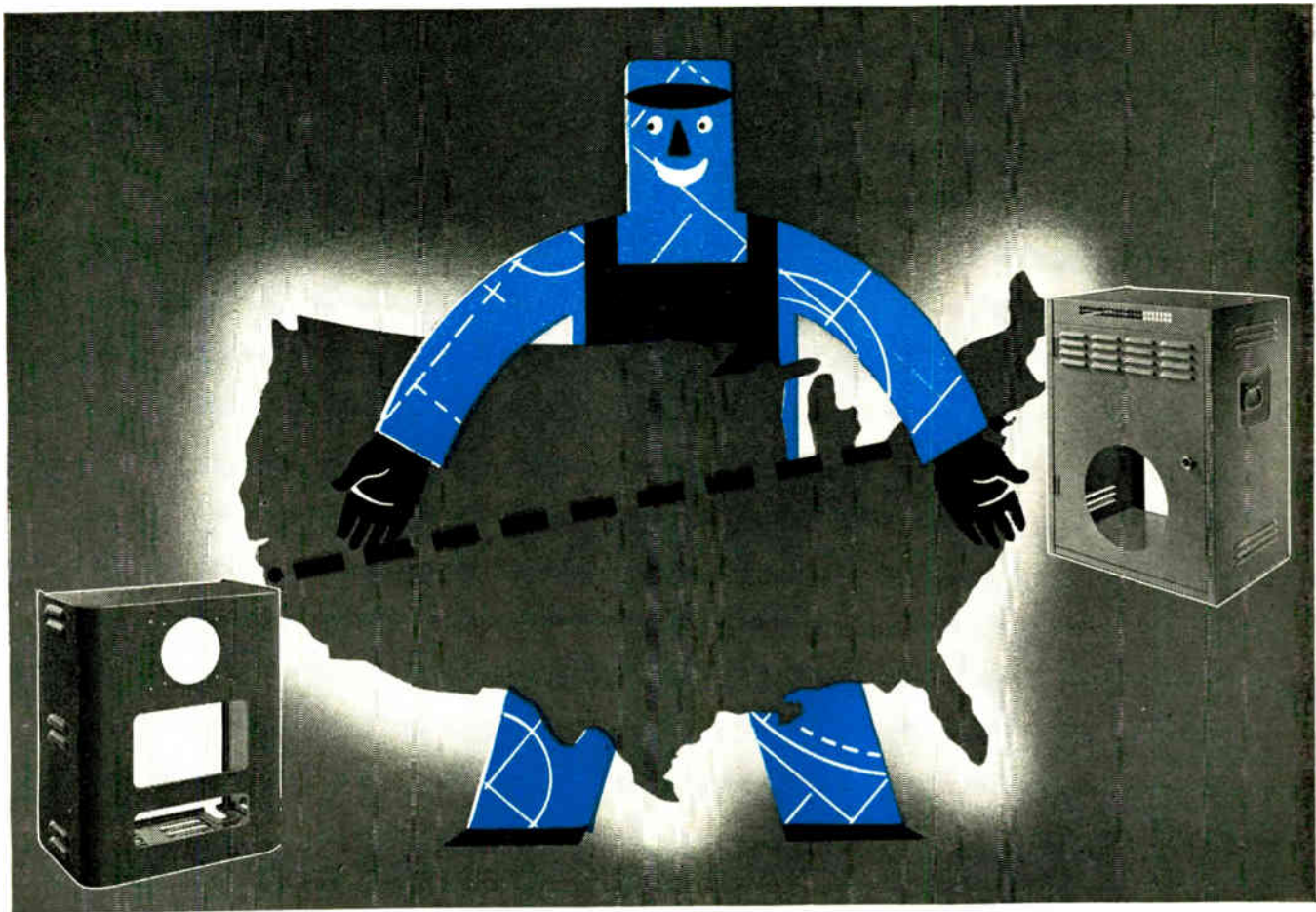

EAST or WEST... NORTH or SOUTH only KARP can offer deep cuts in your enclosure costs!

Distance is no barrier to the money-saving advantages
of KARP'S exclusive "one-stop" Service.

Where else can you find . . .

- ★ 3000 stock tools and dies that eliminate or reduce new tooling costs . . . Complete fabrication, finishing and assembly facilities, in an 88,000 sq. ft. modern plant that permits mass production techniques, assuring . . . Rapid production output geared to cut your inventory needs, through . . . Experienced design counsel and Engineering Service.

Let KARP prove that your initial and production costs on cabinets, enclosures, chassis, and housings can be low, whether you need ten or ten thousand units. There is no obligation for quotations on your blue prints, samples or sketches. Write or phone, today!

You are cordially invited to visit the Karp Display at the Western Electronic Show and Convention, Los Angeles, Calif., August 25th, 26th, 27th, Booths 618 and 619.

KARP METAL PRODUCTS CO.

DIVISION OF H & B AMERICAN MACHINE COMPANY, INC.

Main office & Plant
211 - 63rd Street, Brooklyn 20, N. Y.
Telephone: HYacinth 2-7700

West Coast Plant
3420 Wesley Street, Culver City, Calif.
Telephone: LAMont 9-4343



enclosures reflect the skills within

- FACILITIES FOR ENGINEERED SHEET METAL FABRICATIONS: in aluminum or steel • long run or short • spot, arc, gas or heliarc welding • any type finish
- Modern plant—3 city blocks long
 - Thousands of dies available
 - Most modern of sheet metal fabricating equipment
 - U. S. Air Force Certified Welding Facilities
 - Air-conditioned spray room . . . complete baking facilities
 - Complete sub-assembly facilities

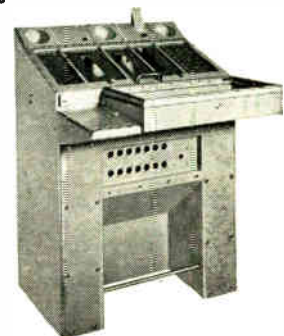

It pays to choose crystals from the world's most complete line!

Whether your crystal requirement involves extreme miniaturization, stability, unusual frequencies, weight reduction or maximum protection against moisture, temperature changes, shock or vibration, Standard Piezo has the answer . . . fully tested and proved in the world's most critical military, aviation, commercial, and industrial services.

STANDARD PIEZO COMPANY
Carlisle, Pa.



NEW 20-PAGE CATALOG ON REQUEST

STANDARD PIEZO CRYSTALS

... by the Pioneers of Modern Crystal Development

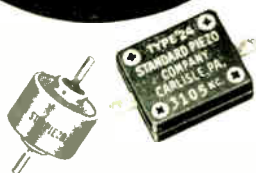

(Continued from page 84-A)

COMPONENT PARTS

The Philadelphia Chapter of the Professional Group on Component Parts held a joint meeting with the Professional Group on Electron Devices on April 27 at the Franklin Institute in Philadelphia under the chairmanship of D. C. Bowen, Chairman of the PGCP. R. D. Wilson, of the Electrical Engineering Department of Cornell University, presented a paper entitled "Those Unreliable Thermionic Tubes."

ELECTRONIC COMPUTERS

The Albuquerque-Los Alamos Chapter of the Professional Group on Electronic Computers met on April 21 at Mitchell Hall of the University of New Mexico, with Vice Chairman Karl Ball presiding. Mr. Ball also presented a paper entitled "General Purpose Digital Computers."

The Group also met on May 19 to hear J. E. Gross of the Sandia Corp. speak on "Engineering Applications of Boolean Algebra." The present officers were reelected to serve for the coming year.

ELECTRON DEVICES

The New York and Long Island Chapter of the Professional Group on Electron Devices met on May 13 at the General

Electric Co. Auditorium in New York, under the chairmanship of C. E. Fay. Harold Jacobs spoke on a paper, "Point Contact Silicon Transistors," written by Harold Jacobs, Frank Brand and Wesley Matthew of the Signal Corps Engineering Laboratories, Ft. Monmouth, N. J. Mason A. Clark of Bell Telephone Laboratories spoke on "Characteristics and Applications of a Power Transistor."

The San Francisco Chapter met on May 19 at the Stanford University Physics Department under the chairmanship of John S. McCullough. Earl E. Sargent of Chromatic TV Laboratories spoke on "Color Television." Officers elected for the coming year are: Stanley F. Kaisel, Chairman; Herman Smith, Vice Chairman; and Donald Dunn, Secretary-Treasurer.

INFORMATION THEORY

The Albuquerque-Los Alamos Chapter of the Professional Group on Information Theory met on May 12 at Mitchell Hall, University of New Mexico, under the chairmanship of B. L. Basore. Mr. Basore presented a paper entitled "Information, Entropy or Negentropy." The following officers were elected for the coming year: C. H. Bidwell, Chairman; J. McLay, Vice Chairman; and R. M. McGehee, Secretary.

MICROWAVE THEORY AND TECHNIQUES

The Albuquerque-Los Alamos Chapter of the Professional Group on Microwave Theory and Techniques met on March 31

(Continued on page 88-A)

WELDMATIC STORED-ENERGY WELDER USES SIMPLE, RELIABLE CIRCUIT

115 VAC 50-60 Cycle INPUT

HEAT CONTROL

SWITCHING DEVICE

ENERGY STORAGE CAPACITORS

PULSE TRANSFORMER

WELDER ELECTRODES

ELECTRODE PRESSURE CONTROL

7 AMPS MAX. (RECHARGING)

1 AMP NORMAL (STANDBY)

15-450 VDC

0.1-1 SEC. CHARGING CAPACITOR

0.3-1.2 MILLISECONDS

DISCHARGE VOLTAGE

300-9000 AMPS

0.1-60 WATT-SEC. WELD ENERGY

0.3-1.2 MILLISEC. OUTPUT CURRENT

Ultra-short current pulse permits welding Copper, Silver, Magnetic Alloys and most other metals. Welds wires, tabs, lugs, posts and other parts instantly. Eliminates solder, flux, brazing, rivets, etc.

Write for descriptive brochure.

UNITEK CORPORATION
275 North Halstead Avenue • Pasadena 8, California

Unitek WELDMATIC

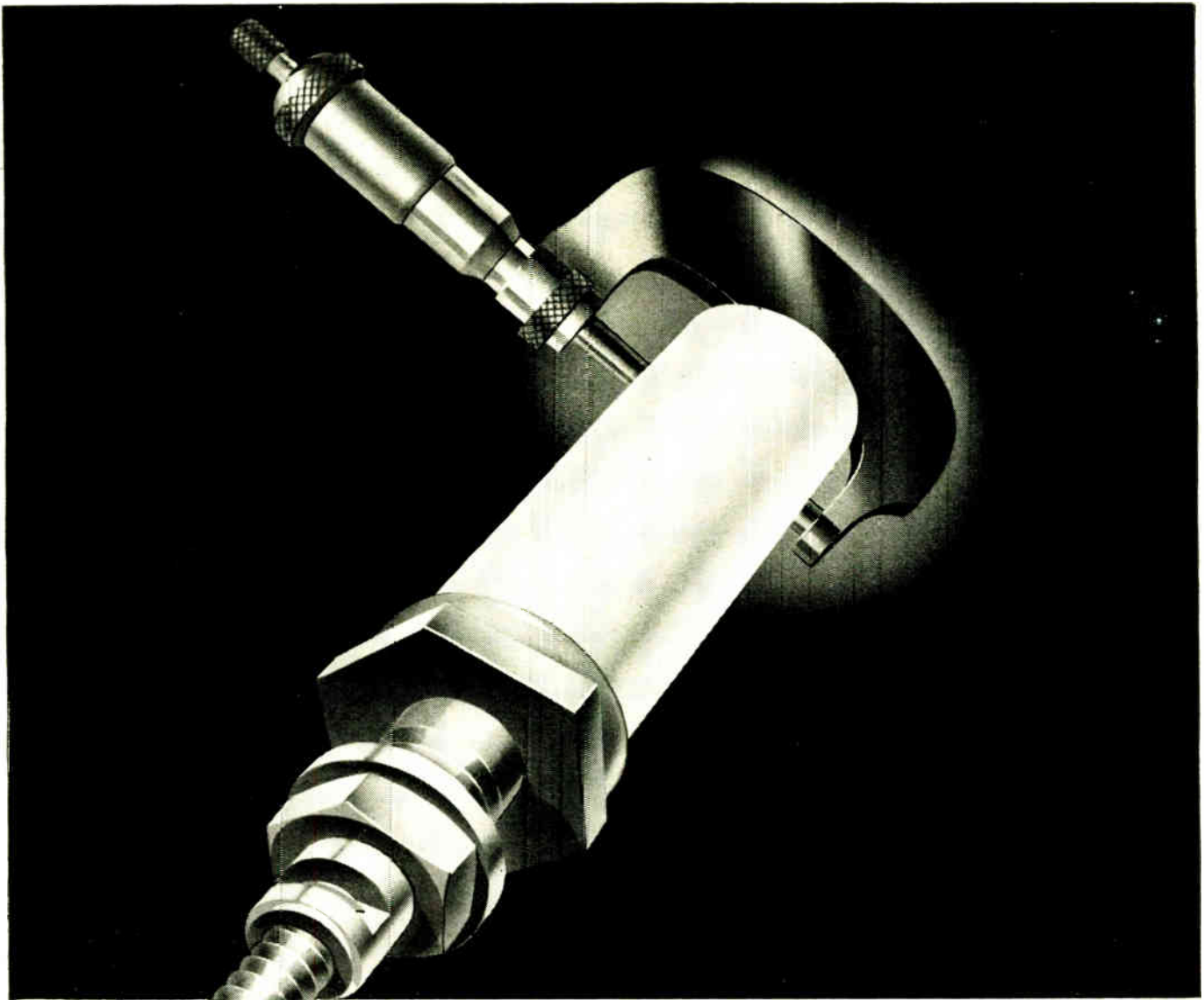

How to pass a physical exam

CTC's coil forms pass their physical exams in great shape — thanks to precision manufacture.

The basic materials of these forms are certified, then checked again by us, before the forms are made. Each manufacturing detail is quality controlled to the high quality standards that enable us to offer *guaranteed* electronic components, custom or standard.

Forms then get these physical check-ups: *mounting studs* checked for internal and external threads, for general size and electroplating; *form* checked for I.D., O.D. and concentricity; *slug* checked for threads, dimensions, electroplating and checked electrically for Q and permeability; *final assembly* checked for tightness, chips and cracks.

Other CTC components benefiting from CTC precision manufacture include terminal boards, terminals, capacitors, swagers, hardware, insulated terminals and coils. For all specifications and prices, write to Cambridge Thermionic Corporation, 456 Concord

Avenue, Cambridge 38, Massachusetts. West Coast Manufacturers contact: E. V. Roberts, 5068 West Washington Blvd., Los Angeles 16 and 988 Market St., San Francisco, California.

Coil Form Data: Made of grade L-5 silicone impregnated ceramic. Winding diameters from .205" to 1/2". Mounted heights from 1 1/2" to 1 1/4". Certain forms, known as Type C, are also available with silicone fibreglas terminal retaining collars permitting 2 to 4 terminals. These are excellent for bifilar windings and advantageous for single pie windings because they permit terminals to be located above or below winding, thus shortening wiring to circuit elements.



Laboratory Coil Kit. Type X2060 aids in developing prototypes and pilot models. Contains 10 slug tuned coils of L86 size Type C, ranging from 2 Microhenries to 800 Microhenries, each slightly overlapping next coil in scale. Kit contains mounting hardware and lists such information as inductance range, wire size, number of turns, Q value. Coils are color-coded to chart for easy quantity-order.

CAMBRIDGE THERMIONIC CORPORATION

*makers of guaranteed electronic components,
custom or standard*



MICROWAVE POWER MEASUREMENT

FROM DEGREES...

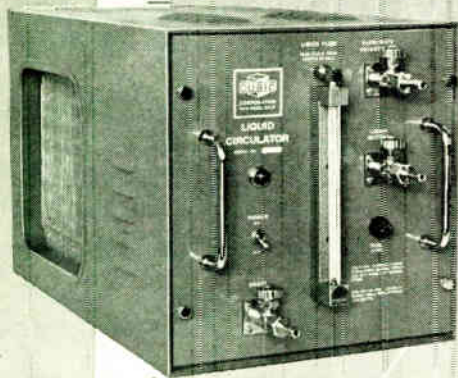

CIRCULATOR

SPECIFICATIONS

Av. Power 0-600 watts
 Peak 600 watts
 VSWR 1.1 max.
 Freq. range
 Basic unit 2.6 to 3.95 kmc
 With Adapters 2.6 to 18.0 kmc

...TO WATTS directly!

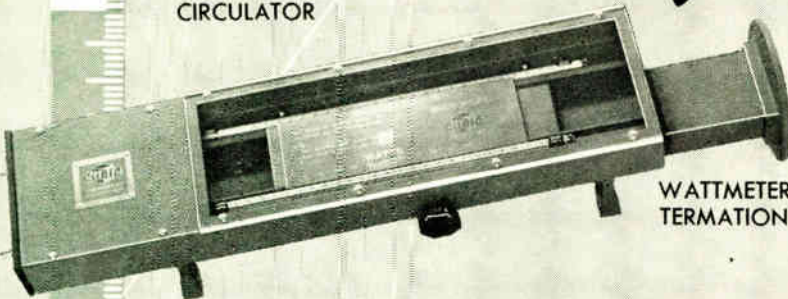

WATTMETER TERMINATION

CUBIC'S 2-UNIT CALORIMETRIC WATTMETERS

... for obtaining direct power readings in testing electronic equipment—without guessing!

Three of the world's largest producers of electronic equipment have recently made CUBIC Calorimetric Wattmeters standard test equipment in their laboratories and plants.

For very good reason. No other instrument designed for power measurement gives you direct power readings... with such precision, and yet so simple in its application.

The model shown is the MC-1B for power measurement from 2600 to 26,500 MC. Also available are the models MCX-1A (coaxial type) for power measurement from 100 to 3000 MC, and MCL-1A (L-Band waveguide type) for power measurement from 1120 to 2600 MC.

Whether checking field equipment, developing or making acceptance tests on new equipment or magnetrons in the lab, or in production, one of CUBIC'S Calorimetric Wattmeters will be an invaluable addition to your test equipment. Standard laboratories calibrate secondary power devices, especially bridge type bolometer instruments. Exact calibration is provided month to month.

Write for more information, and ask for our catalog of other test equipment and waveguide components. Or if you have a problem in development or engineering, CUBIC offers the services of its engineering staff and facilities in its solution.



CUBIC CORPORATION

ELECTRONIC EQUIPMENT RESEARCH...DEVELOPMENT
 2481 CANON STREET,
 SAN DIEGO, 6, CALIFORNIA



(Continued from page 86A)

at the University of New Mexico, under the chairmanship of Net Wilde. Mr. Wilde and Ted Church, of the Sandia Corp., presented a paper entitled "Applications of Microwaves."

NUCLEAR SCIENCE

The Connecticut Valley Chapter of the Professional Group on Nuclear Science met on May 27 at Mitchell Junior College, New London, Conn., under the chairmanship of Thomas H. Kirby. David W. Cardwell, Superintendent of the Engineering & Mechanical Division of the Oak Ridge National Laboratory, spoke on "The Role of Engineers in the Atomic Energy Field."

RADIO TELEMETRY AND REMOTE CONTROL

The Los Angeles Chapter of the Professional Group on Radio Telemetry and Remote Control met on May 11 at the IAS Building in Los Angeles, under the chairmanship of R. A. Rawlins. G. L. Larse, Lockheed Aircraft Corp., spoke on "A Versatile FM Subcarrier Oscillator," and Doyle F. Mattson, also of Lockheed Corp., spoke on "Low-Level DC Input Signals in FM/FM Telemetry."

VEHICULAR COMMUNICATIONS

The Detroit Chapter of the Professional Group on Vehicular Communications met on April 28 under the chairmanship of T. Rykala. John Holmbeck, Chief Engineer of the James Knights Co., Sandwich, Ill., presented a paper entitled "New Techniques in Crystal Developments."

The Houston Chapter of the Group met on May 6. Jerry Stoyer, of Communications Engineering Co., Dallas, Texas, spoke on "VHF Antennas." H. G. Brown of RCA presented a paper on "Color Television." It was a joint meeting with members interested in forming a Broadcast Chapter. A petition was circulated and Paul Hundorf was appointed temporary chairman.

The Washington, D. C., Chapter met on May 15 at the Capital Airlines National Airport Administration Building in Washington under the chairmanship of Merle Floegel. The meeting was highlighted by a field trip to the National Airport to see the operation of vehicular radio units on ramp, the control tower, the flight control room, and the radio maintenance shop.

For complete information about joining IRE Professional Groups see pages 102A & 103A of this issue.

DC to AC Conversion—No moving parts or filaments

with the

MAGNETIC MODULATOR

Now Available in 60 and 400 Cycle Designs

A CONVERTER WITH HIGH SHOCK AND VIBRATION RESISTANCE AND PRACTICALLY UNLIMITED LIFE—OPERATION IN AMBIENT TEMPERATURES FROM -55°C TO $+200^{\circ}\text{C}$

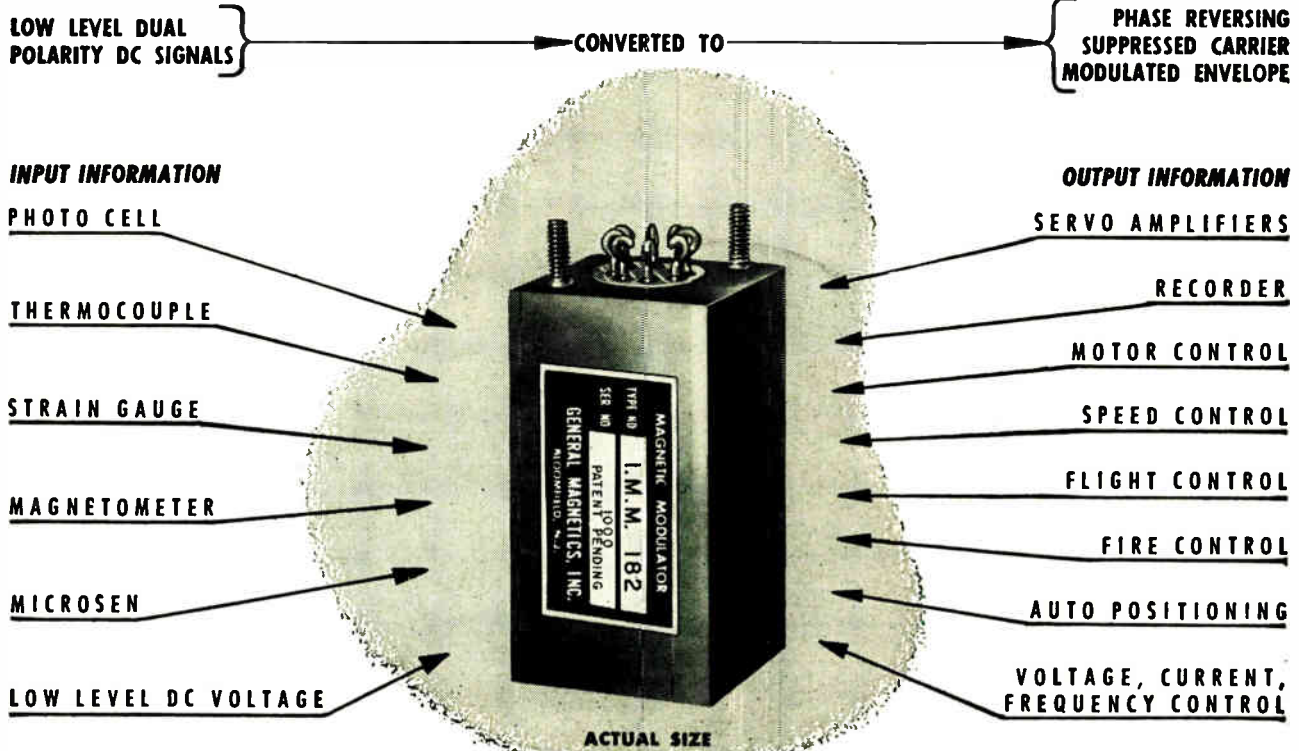

The Magnetic Modulator is designed to convert low level dual polarity DC signals into AC signals of corresponding amplitude and phase sense. A descriptive list of typical specifications is shown in the chart to the right.

TYPICAL SPECIFICATIONS

Weight 4 oz. Output impedance 5,000 ohms
 Temp. rise ... negligible Output at null ... 10 mv. rms. max.
 Life unlimited Output phase ... 0 or 180 ± 5 deg.
 Harmonic Distortion Less than 10%, above 0.1V output

We specialize in control systems and MAGNETIC AMPLIFIER components for automatic flight, fire control, analog computers, guided missiles, nuclear applications, antennas and gun turrets, commercial power amplifiers, and control systems.

Parameter	Input Modulators		Thermocouple & Strain Gage Converters	
Type No.	IMM-249	IMM-182	MTC-247	MTC-210-HF
Frequency	60 Cycles	400 Cycles	60 Cycles	400 Cycles
Signal Winding Res.	4000 Ohms	2000 Ohms	100 Ohms	60 Ohms
AC Excitation	5V RMS	0.7 V RMS	1.0V RMS	0.8V RMS
Input Signal DC	0 to $\pm 400\mu\text{A}$	0 to $\pm 40\mu\text{A}$	0 to ± 30 Millivolts	0 to ± 20 Millivolts
AC Output	0-2 Volts RMS Phase Reversing	0-1V RMS Phase Reversing	0-0.8V RMS Phase Reversing	0-1.0V RMS Phase Reversing
O.A. Dimen. in.	$1\frac{1}{2} \times 1\frac{1}{2} \times 2\frac{1}{2}$	$1\frac{1}{2} \times 1\frac{1}{2} \times 2\frac{1}{2}$	$1\frac{1}{2} \times 1\frac{1}{2} \times 2\frac{1}{2}$	$1\frac{1}{2} \times 1\frac{1}{2} \times 2\frac{1}{2}$
Response Curve				

WRITE ON YOUR LETTERHEAD FOR MAGNETIC MODULATOR CATALOG "A"

GENERAL **MAGNETICS**
 135 Bloomfield Ave. Bloomfield, N. J.



Teamed To Exploit ACCURACY-



MODEL 855-A1

esi OSCILLATOR AMPLIFIER

- Complete operation of the 250-C1 bridge with AC power.
- Highly stable oscillator providing any fixed frequency from 100 CPS to 10 KC with plug-in networks.
- Maximum sensitivity. Visual null indicator driven by highly selective amplifier with over 65 DB gain.

MODEL 250-C1

esi IMPEDANCE BRIDGE

- Most accurate, widest range impedance bridge available. Resistance—1 milliohm to 11 megohms. Capacitance—1 μf to 1100 μf s. Impedance—1 μh to 1100 henrys.
- Simplified controls. Color index dials. Clearly marked terminals.
- Compact, light, portable. 9" x 11" x 11" over-all.

Featuring esi DEKADIAL

Precise resistance, capacitance, inductance readings to four significant figures. Accuracy: resistance $\pm 0.1\%$, capacitance $\pm 0.25\%$; inductance $\pm 1.0\%$.

PRICES

- ◆ Model 855-A1 Oscillator-Amplifier.....\$170
- ◆ Model 250-C1 Impedance Bridge.....\$340
- ◆ Team.....\$510

NATIONWIDE



REPRESENTATION

ELECTRO-MEASUREMENTS, INC.

FORMERLY BROWN ELECTRO-MEASUREMENT CORP.

4312 S. E. STARK STREET

PORTLAND 15, OREGON

Ideal for
ANTENNA
CONNECTIONS
PHOTO-CELL WORK
MICROPHONE
CONNECTIONS

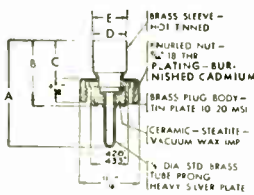

SUPPLIED IN 1 & 2 CONTACT TYPES

JONES SHIELDED TYPE PLUGS & SOCKETS

LOW LOSS PLUGS AND SOCKETS FOR HIGH FREQUENCY CONNECTIONS

For quality construction thruout, and fine finish, see diagram above.

101 Series furnished with $\frac{1}{4}$ ", .290", $\frac{5}{16}$ ", $\frac{3}{8}$ ", or $\frac{1}{2}$ " ferrule for cable entrance. Knurled nut securely fastens unit together. Plugs have ceramic insulation; sockets bakelite. Assembly meets Navy specifications.

202 Series Phosphor bronze knife-switch type socket contacts engage both sides of flat plug contacts—double contact area. Plugs and sockets have molded bakelite insulation.

For full details and engineering data ask for Jones Catalog No. 20.

JONES MEANS PROVEN QUALITY



P-101- $\frac{1}{4}$

S-101



P-202-CCT



S-202-B



WIRE STRIPPING: Your jobs are peculiar to your own business and may be governed by such variables as kind and size of wire, what you use it for, your production requirements, and other similar factors.

So we may serve you promptly and efficiently, tell us what you are now doing and your hopes in the way of improved quality, increased production and lower costs.

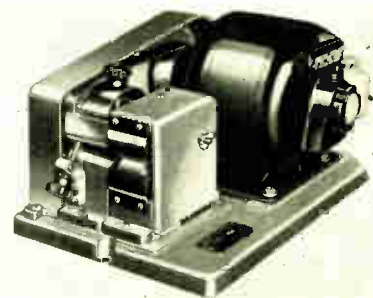

Illustration shows a MODEL "D-1" Two-Wheel Stripper, which is but one of the many different types of machines made. This one uses $1\frac{1}{4}$ " diameter stripping wheels and is ordinarily used to strip any type of Film Insulation from wires in the range of AWG #25 to AWG #44. A wide variety of stripping wheels are available, made from FybRglass and Brush Wire, all designed to provide economical service.

This particular machine is only \$156.25, f.o.b. Syracuse, exclusive of stripping wheels. It is available on a Test-Rental Plan or may be purchased out of savings over a ten month period.

For a confidential report containing our recommendations, send samples and complete information to

Rush Wire Stripping Division
The Eraser Company, Inc.
1060 South Clinton Street
Syracuse 4, New York

IRE People

John G. Brainerd (A'33-M'39-SM'43-F'51) has been recently appointed Director of the Moore School of Electrical Engineering of the University of Pennsylvania.

Dr. Brainerd was born in 1904 in Philadelphia, Pa. He received the B.S. degree in 1925 from the University of Pennsylvania, and the Sc.D. in 1934 from the same institution.

He began teaching at the Moore School of Electrical Engineering in 1925 as an instructor, and at the time of his appointment as Director was Professor of Education and Research there.

Dr. Brainerd has been an active member of the IRE for many years, serving on many committees and professional groups. He was vice-chairman of the Philadelphia Section from 1952-1953.



The election of Robert E. Shelby (A'29-M'36-SM'43-F'48) as Vice President and Chief Engineer of the National Broadcasting Company was announced recently.



R. E. SHELBY

Born in Austin, Texas, on July 20, 1906, Mr. Shelby was graduated from the University of Texas, where he received the degrees of Bachelor of Science in Electrical Engineering, Bachelor of Arts, and Master of Arts. He went to work for NBC in 1929, shortly after he was graduated from college. Since then he has played a large part in NBC television research work—both black-and-white and color, and in recent years has served as head of Color TV Systems Development at NBC.

Mr. Shelby is a Fellow of the American Institute of Electrical Engineers, and a member of the Society of Motion Picture and Television Engineers. He is also a member of Tau Beta Pi, Phi Beta Kappa, Eta Kappa Nu, and Sigma Xi.



Rudolf Feldt (M'44-SM'53) recently joined the Federal Telecommunication Laboratories as Manager of the newly-established Instrument Division. He will survey and coordinate the activities of the IT&T System companies in the field of instrumentation.



RUDOLF FELDT

Before joining Federal Telecommunication Laboratories, Mr. Feldt had been Manager of the Instrument Division Plant of Allen B. DuMont Laboratories, Inc. since 1947. He became associated with DuMont in 1942 as Research

(Continued on page 92A)

UHF BALUNS

COMPLETE COVERAGE FOR TV FREQUENCIES

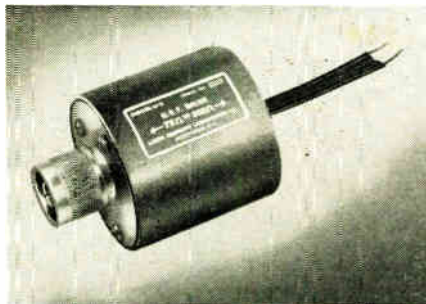

FEATURES:

- VSWR: Less than 1.2 over band
- Insertion Loss: Less than 0.2 DB
- Balance Efficiency: Better than 85%
- Size: 2" diameter x 2" long

Model U-2A 50 to 300 PRICE \$45

Model U-2 75 to 300 PRICE \$35

WRITE FOR COMPLETE CATALOG RU-I

LINEAR EQUIPMENT LABORATORIES, INC.
BRIGHTWATER PLACE • MASSAQUA, L. I., N. Y.

VHF BALUNS

COMPLETE COVERAGE FOR TV FREQUENCIES

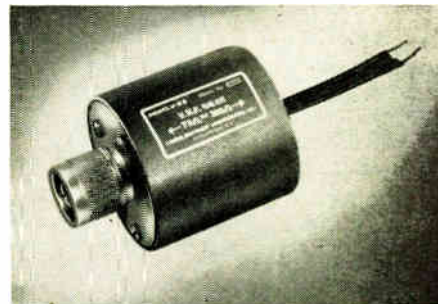

FEATURES:

- VSWR: Less than 1.2 over band
- Insertion Loss: Less than 0.2 DB
- Balance Efficiency: Better than 85%
- Size: 2" diameter x 2 3/4" long

Model V-6A 50 to 300 PRICE \$45

Model V-6B 75 to 300 PRICE \$35

WRITE FOR COMPLETE CATALOG RV-I

LINEAR EQUIPMENT LABORATORIES, INC.
BRIGHTWATER PLACE • MASSAQUA, L. I., N. Y.

CAPITOL RADIO ENGINEERING INSTITUTE

Advanced Home Study and Residence Courses in Practical Radio-Electronics and Television Engineering

Pioneer in Radio Engineering Instruction Since 1927

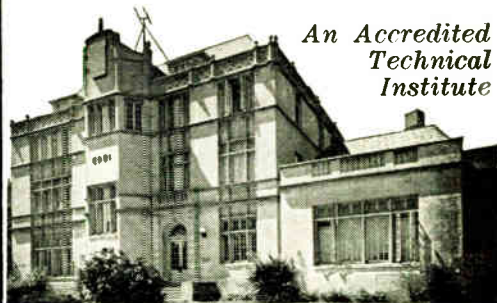

An Accredited Technical Institute

Request your free Home Study or Resident School Catalog by writing to: Dept 26A8
3224 16th St., N. W. Washington 10, D. C.
Approved for Veteran Training

TOP HAT FOR PLUG-IN UNITS

A widely used, dependable, improved clamp for electron tubes, relays and capacitors.



WRITE FOR FREE CATALOG

EASY TO APPLY
INSTANTLY RELEASED
POSITIVE LOCKING ACTION



TIMES FACSIMILE CORPORATION
540 West 58 St., New York 19, N. Y.
1523 L St., N. W. Washington 5, D. C.

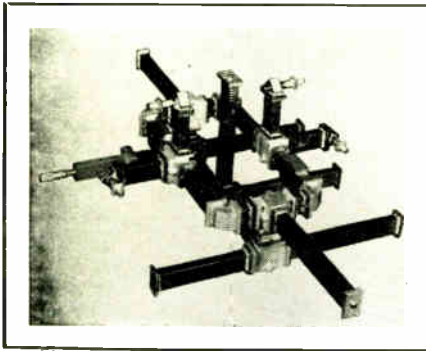

MICROWAVE DEVELOPMENTS

Wheeler Laboratories is an engineering organization offering consulting and engineering services in the fields of radio and radar.

The waveguide labyrinth pictured above is an impedance measuring circuit developed by Wheeler Laboratories. It is used in conjunction with our sweeping oscillator to display on an oscilloscope screen a continuous polar plot, over the 12-percent X-band, of the magnitude and phase of the reflection from a waveguide component.

At present, Wheeler Laboratories comprises a staff of twenty engineers under the personal direction of Harold A. Wheeler, with supporting facilities including a group of designers and a model shop.

A brief summary of our work will be sent on request, and comprehensive engineering reports on some of our developments are available. Inquiries are welcomed regarding your particular problems in microwave design and development.

Wheeler Laboratories, Inc.

122 Cutter Mill Road, Great Neck, N.Y.
 HUinter 2-7876

IRE People

(Continued from page 91A)

Engineer. Mr. Feldt is a graduate of the Institute of Technology, Berlin, Germany, where he received the degree of Electrical Engineer. Prior to his activities in this country, he was engaged in extensive research and sales engineering in Germany and France. During this time, he was associated with AEG, C. Lorenz and Co., LTT (Conflans), and Radiophon.



The promotion of P. S. Christaldi (S'35-A'40-SM'44-F'52) from Assistant Manager to Manager of the Instrument Division of Allen B. DuMont Laboratories, Inc., was recently announced.

Dr. Christaldi holds the Ph.D. degree in Physics from Rensselaer Polytechnic Institute. He has been associated with Allen B. DuMont Laboratories since 1938. He was appointed Chief Engineer of the company in 1941, and in 1947 became Engineering Manager of the Instrument Division. He was made Assistant Manager of the Division in 1953.

He has represented DuMont on numerous industry and technical committees. He is a member of Sigma Xi, the American Radio Relay League, a Fellow of the Radio Club of America, and is President of the Montclair Society of Engineers.



Gerald K. Miller (A'38-SM'46) has been transferred by the Schlumberger Well Surveying Corporation to a position as assistant to the head of research at the Research Center in Ridgefield, Conn. He was formerly assistant to the head of engineering in Houston, Texas.



G. K. MILLER

A native of Indiana, Mr. Miller received his B.S. and M.S. degrees from Purdue University in 1932 and 1938. Before becoming associated with the Schlumberger Corporation in 1941 he taught in the Communications Department of the School of Electrical Engineering and carried on research in the Engineering Experiment Station at Purdue.

In Houston, Mr. Miller was a Charter Member of the Houston Section of the IRE and served it in various capacities including the Chairmanship of the Section in 1950. He was also Chairman of the 4th Southwestern IRE Conference and Radio Engineering Show which was held in Houston in May, 1952.

Mr. Miller is a member of Eta Kappa Nu, Tau Beta Pi, and Sigma Xi.

(Continued on page 94A)

VECO COMPONENTS

Simplify
CIRCUITRY

- DISC
- BEAD
- WASHER
- ROD TYPES

Have You considered all the possibilities of designing for compactness, simplicity, and increased sensitivity?

VECO THERMISTORS, as components, are supplying the solutions to many design and circuitry problems.

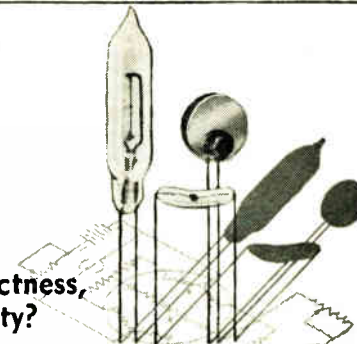

VECO THERMISTORS have an extremely high negative temperature coefficient of electrical resistance. Their small size and extreme sensitivity to thermal changes offer engineers a circuit element which can be utilized in new designs, and in improving old equipment. VECO THERMISTOR DATA BOOK available.

Some Present Uses: Time delay • Gas analysis • Volume limiting • Surge protection • Vacuum manometry • Flow measurement • Temperature control • Temperature measurement • Radar power measurement • Temperature compensation • Oscillator stabilization • and many others.

VISIT VICTORY in booth 627 at the WESTERN ELECTRONIC SHOW & CONVENTION—August 25-27, Los Angeles, Calif.

\$5.00 cash or money order will bring you the VECO EXPERIMENTORS' THERMISTOR-VARISTOR package, No. 168—7 items and application circuitry—over a \$15.00 value!

Manufacturers of:
ELECTRONIC & THERMAL CONTROL INSTRUMENTS
TEMPERATURE SENSING DEVICES
COMBUSTION ANALYZERS
 Tel. UNIONVILLE 2-7150

Victory
ENGINEERING CORPORATION
 Springfield Road, Union, N. J.

IRE People
 use the
IRE DIRECTORY
 1954 edition coming soon!

IT'S SPRAGUE FOR Ceramic Capacitors

**EVERY TYPE AND RATING FOR
SMALL OR LARGE PRODUCTION RUNS!**

Sprague can provide you with the best capacitors for your requirements. And when it comes to ceramic capacitors, large plants with adequate production and tooling facilities offer prompt delivery for small or large production runs.

In the East, Sprague ceramic capacitors are made at North Adams, Mass., and Nashua, N. H. The Midwest is served by Sprague's wholly owned subsidiary, the Herlec Corporation of Grafton, Wis.

Some of Sprague's newest developments are shown at right. For future developments in ceramic capacitors, look to Sprague for the ultimate in performance, miniaturization, and reliability.

SPRAGUE ELECTRIC CO.

235 Marshall St., North Adams, Mass.

Sprague, on request, will provide you with complete application engineering service for optimum results in the use of ceramic capacitors, and printed resistor-capacitor networks.

NEW! 'RING' CERAMIC CAPACITORS to clean up chassis



Designed to fit around 7-pin miniature tube sockets, these capacitors may contain 2, 3, or 4 sections. They result in a neat physical layout while reducing space to a minimum. Positive positioning of the ultra short leads between the capacitor and socket terminals eliminates lead dress problems and, consequently, allows "hot" circuit designs. Voltage ratings from 100 to 500 d-c. Write for Engineering Bulletin 610.

NEW! FLAT 'PAN' CERAMIC CAPACITORS simplify circuit design



Mounted flat against a chassis with a screw or rivet, these miniature capacitors provide a highly secure mounting. 1 to 4 sections in the shallow pan are insulated and moisture-protected by a phenolic resin. Ideal for military electronics. These units have an unusually high self resonant frequency, and eliminate lead dress problems when mounted adjacent to a miniature tube socket. Available in ratings from 100 to 500 volts d-c. Write for Engineering Bulletin 611.

WIDELY-USED CERAMIC CAPACITORS for electronics, radio, and TV



Shown at left are a few of the many other types of ceramic capacitors available from Sprague. These include:

- Buttons ● Discs ● Hi-Voltage Moldeds
- Precision Ceramic Trimmers ● Plates
- Printed resistor-capacitor networks
- Hermetically sealed, metal cup and tubular precision capacitors

For complete details on any type of ceramic capacitor — it pays to ask Sprague. Write for catalog data on the types in which you are interested.

SPRAGUE

WORLD'S LARGEST CAPACITOR MANUFACTURER

Export for the Americas: Sprague Electric International Ltd., North Adams, Mass. CABLE: SPREXINT



Type
535

**HANDLES MOST
LABORATORY
REQUIREMENTS**

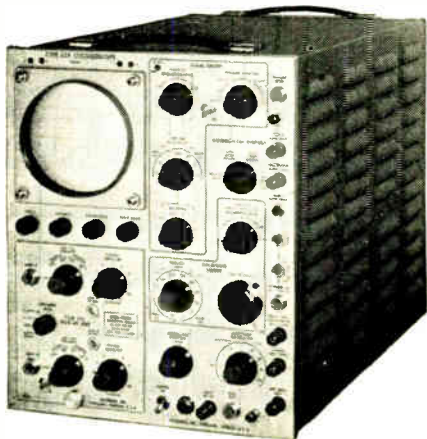

The Type 535 Oscilloscope is designed to fit most laboratory requirements. It uses plug-in vertical preamplifiers for maximum flexibility in signal handling. Sweep-speed range is 600 million to one—the widest you can get in a single oscilloscope. Accelerating potential is high enough to permit photographing a single sweep... even at the fastest sweep speed.

Delayed Sweeps. Accurately-delayed triggered sweeps enable you to select and make detailed observations of minute portions of waveforms and pulse chains.

Direct-Reading in Time and Amplitude. You can read time and amplitude with accuracies comparable to indicating meters.

Sweep Range—0.02 μ sec/cm to 12 sec/cm.

10KV Accelerating Potential

Flexible Sweep Delay—1 μ sec to 0.1 sec.

Price—\$1300 plus price of desired plug-in units

PLUG-IN UNITS

TYPE 53A—DC to 10 mc, 0.05 v/cm to 50 v/cm\$85

TYPE 53B—Same as 53A with additional ac-sensitivity to 5mv/cm\$125

TYPE 53C—Dual-trace unit. Two identical amplifier channels, dc to 9 mc, 0.05 v/cm to 50 v/cm. Electronic switching triggered by oscilloscope sweep, or free-running at about 100 kc.\$275

TYPE 53D—Differential input. DC to 350 kc at 1 mv/cm—passband increasing to 2 mc at 50 mv/cm. Full range—1 mv/cm to 125 v/cm.\$145

Prices f.o.b. Portland (Beaverton) Oregon

See the Type 535 at Booths
556 and 557 at the 1954 WESCON



Tektronix, Inc.

P. O. Box 831B
Portland 7, Oregon
Phone: CYPress 2-2611
Cable: TEKTRONIX

for the best in
TEFLON*



depend on



- Uniformity
- Controlled Density
- Product Purity
- Accurate Dimension

Since Teflon first became available, "John Crane" has successfully engineered its application to solve innumerable and widely varying problems. Typical of this is the development of packings and other products for handling corrosive liquids and gases. Other important examples include production of electronic parts of high dielectric strength and low loss factor for vhf, uhf, and microwave insulation; also in the employment of its anti-stick characteristics in the handling of adhesive materials.

These and other application developments are closely tied with "John Crane's" fabricating technique, which has resulted in Teflon products of the finest uniformity, controlled density, product purity and accurate dimension.

Teflon is available in rods, tubing or sheets or in special molded and machined forms such as bellows, "C-V" Rings, braided packings, valve discs, electrical parts, washers, dough sheeting rolls, heat sealing jaws and countless other forms. Glass, carbon or graphite filled Teflon is also available.

Consult "John Crane" on your requirements. Send for 12-page illustrated catalog, *The Best in Teflon*, containing important data and suggested applications. Crane Packing Company, 1303 Belle Plaine Ave., Chicago 13, Ill.



*DuPont trademark

In Canada: Crane Packing Co., Ltd.,
617 Parkdale Avenue, N., Hamilton, Ont.



CRANE PACKING COMPANY

Heiland

Amplifier System

The most complete, yet easiest to operate amplifier system ever developed for oscillographic recording

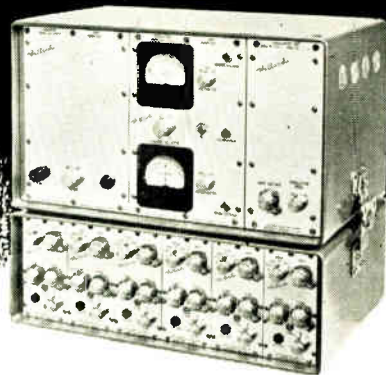

Model 119 Carrier and Linear or Integrating Amplifier System.

Heiland's model 119 Amplifier System, used in conjunction with Heiland Recording Oscillographs, has received wide acclaim from engineers for its extreme versatility, accuracy and simplicity of operation in the amplification of static and dynamic current phenomena.

This small, compact instrument, which can be provided for either rack, table, or shock mounting with available accessories, is housed in a rugged, yet lightweight cast aluminum case finished in attractive silver-gray gloss enamel.

Write or wire for complete information on the Model 119 Amplifier System, Heiland Recording Oscillographs, Galvanometers and Bridge Balance Units.

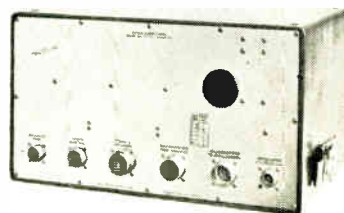

Power Supply Assembly (Rear View)



Amplifier Assembly (Rear View)



Heiland takes pleasure in announcing the opening of its new Eastern regional office at 561 Washington Ave., Dumont, New Jersey.

Heiland Research Corporation

130 East Fifth Ave.,
Denver, Colorado

Industrial Engineering Notes

(Continued from page 94A)

volts per meter at 1,000 feet, and that a type approval procedure be established for out of band ultrasonic medical equipment. The proposed amendment makes specific provision for ultrasonic equipment and provides a type approval procedure for this equipment to operate on frequencies outside the industrial, scientific and medical frequency bands. The proposal also includes a new limitation on direct radiation from ultrasonic equipment as well as a limit for radio frequency energy that may be conducted along the power lines. The Commission stated that type approval is proposed for these equipments despite the general policy of granting type approval only to equipment operating within the industrial, scientific and medical frequency bands, since information at hand indicates that it is apparently impracticable to operate ultrasonic equipment in these bands. . . . The Federal Communications Commission recently approved extension of the CONELRAD plan to the amateur radio services and issued an order amending Part 12 of the Rules Governing the Amateur Radio Services concerning the use of frequencies in the 3,500-4,000 kc band in the Pacific Possessions. In extending CONELRAD to the amateur services FCC said that the stations would receive the radio alert from broadcast stations and then cease operation unless specifically authorized by the Commission to continue on the air. The plan, it was pointed out, will not go into effect until appropriate rules and regulations have been approved and such covering rule making will be initiated shortly. The Commission also announced an order amending Part 12 to bring amateur frequency usage in the Pacific Possessions into accordance with the Atlantic City frequency allocations. The changes became effective July 2.

RETMA ACTIVITIES

Dr. W. R. G. Baker, Director of the RETMA Engineering Department, has declared that the only valid and active RETMA Recommended Standards are those appearing in the post-war format. This decision was made, according to Associate Director Virgil M. Graham, because there has been considerable confusion as to the RETMA Recommended Standards now in effect, particularly as regards the old pre-war "M" sheets and their content. He pointed out that much of this old material has been rescinded, much has been superseded by post-war Standards, and a great deal of that remaining now is obsolete so that "the residue that might be considered valid is quite small." To eliminate any possible source of confusion, only those Standards in the post-war format now are valid. . . . Copies of the report from the Conference on Reliability of Electrical Connections will be available shortly in printed form, according to a report from the RETMA Engineering Department. The Conference was held April 15-16 at the Illinois Institute of Technology

under the sponsorship of the RETMA Engineering Department with the cooperation of the Aircraft Industries Association. Over 600 people attended the meetings which covered methods of connecting to the terminations of wires and cables to produce equipment free from the difficulties caused by loose or broken connections. Particular attention was given to the reliability of aircraft equipment as to internal wiring and external cabling. The printed conference report will include not only the papers presented but also transcripts of question-and-answer periods and several supplementary articles relating to connection reliability. The conference report is priced at \$5 per copy and orders may be placed with the RETMA Engineering Department, 500 Fifth Avenue, New York 36, N. Y. . . . **Dr. W. R. G. Baker, Director of the RETMA Engineering Department, has announced that the following Standards Proposals have been approved to become RETMA Recommended Standards:** S.P. 367—Production Testing of Radio Receiver Speakers; S.P. 392—Proposed Addition to REC-113A "Vibrating Interrupters and Rectifiers for Auto Radio"; S.P. 397—Revision of ET-105B "Dimensional Characteristics of Electron Tubes"; S.P. 398—Revision of ET-103C "Electron Tube Bases, Caps and Terminals"; S.P. 399—"Standard of Good Engineering Practice Regarding the Antenna Input Impedance of a Television Receiver"; S.P. 400—Revision of ET-106B "Gauges for Electron Tube Bases"; S.P. 401—Addition to ET-105B "Dimensional Characteristics of Electron Tubes." The new Standards will be printed shortly in the usual RETMA format and will be distributed through the normal channels, he said. . . . **Approximately 400 copies of the proceedings of the 1954 Electronic Components Symposium remain to be sold from the first and only printing of the document, according to Symposium Treasurer A. E. Zdobysz.** A total of 1,500 copies of the document, containing the complete text of all addresses together with illustrations, are being printed for delivery on or before August 1. Copies of the book, containing the proceedings of the three-day technical meeting held in Washington on May 4-6, may be obtained from A. E. Zdobysz, 1 Thomas Circle, Washington 5, D. C., at \$4.50 each.

INDUSTRY STATISTICS

Production of radio and television receivers in the first 17 weeks of this year declined from the unit output of the same 1953 period, but television remained above the first four months of 1952, according to a report recently received from the RETMA Statistical Department. Cumulative television production in the first 17 weeks of this year totaled 1,904,718 units, it was reported, compared with 2,827,821 receivers manufactured in 1953 and 1,647,708 in 1952 comparable periods. The radio output totaled 3,326,800 sets in the 17-week period compared with 4,993,720

(Continued on page 98A)

NEW lower priced FOCOMAG USES SINGLE FERRITE MAGNET

Another **HEPPNER** First

- Lower priced, compact. Cuts receiver costs. Uses only **ONE** ferrite magnet (an exclusive feature).
- Superior focusing - more uniform field. The sintered ferrite is extremely uniform throughout. Focuses all tubes up to 27".
- Completely shielded. No harmful external field.
- Extended focus range has very fine adjustment to exact focus.
- Built-in centering device.
- Flexible nylon adjusting shaft eliminates breakage.
- Picture positioning lever. You specify mounting arrangement.

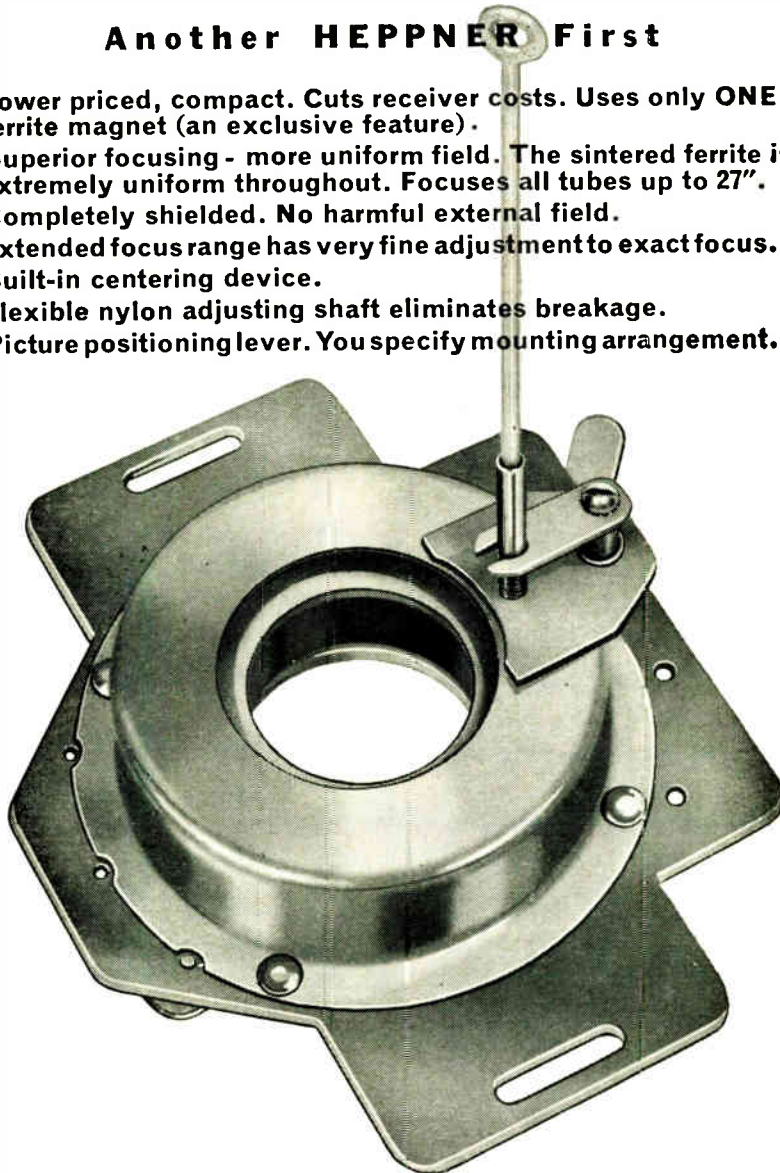

Lower your set costs with this NEW FOCOMAG. Write today for further information.

HEPPNER

MANUFACTURING COMPANY

Round Lake, Illinois (50 Miles Northwest of Chicago)
Phone: 6-2161

SPECIALISTS IN ELECTRO-MAGNETIC DEVICES

Representatives: **John J. Kopple**
60 E. 42nd St. New York 17, N. Y.

James C. Muggleworth
506 Richey Ave., W. Collingswood, N. J.

Ralph Haffey
R. R. 1, U. S. 27, Coldwater Pd.,
Ft. Wayne 8, Indiana

Irv. M. Cochrane Co.
408 So. Alvarado St., Los Angeles, Calif.

THE INSTRUMENT FOR YOUR MAGNETIC PROBLEMS

D-79 GAUSSMETER

FEATURES —

- Reads 10 to 30,000 Gauss Flux Fields
- Probe is only .025" thick
- Active area .01 square inches
- Net Weight only 10½ lbs.
- Power Supply 105-125 Volts, 50-60 Cycle
- Overall size 13" high, 10½" wide, 6¾" deep



A complete precision built unit that will measure flux density and determine the direction of "flow". It will locate and measure "stray fields", plot variations in strength and offers a fine use for checking production lots against a standard. It is simple to operate—no ballistic readings . . . no jerking or pulling. Comes in protective carrying case.

Write for literature—Dept. I-854

Dyna-Labs



1075 STEWART AVE.
GARDEN CITY, N. Y.
Phone
GARDEN CITY 3-2700

New SUB-MINIATURE TRIMMER POTENTIOMETER

Intended for use as preset adjustable resistors in miniaturized equipment, these units are easily attached to chassis or printed circuits by means of convenient mounting lugs. They are available in values ranging from 1000 ohms to 1 megohm with a tolerance rating of $\pm 20\%$.

Each unit measures only .530 inches in diameter, and only .281 inches in depth. Adjustment is made by means of a special tool. Once the selected value is adjusted, the setting is locked and cannot be accidentally shifted.

The resistor track is carbon composition and linear in character. Nominal rating is .1 watt at 70°C ambient.

Manufactured in
England and Canada



For complete data
and specifications
write to Dept JH-4



ROCKBAR CORPORATION 215 East 37th Street, New York 16, N. Y.

Industrial Engineering Notes

(Continued from page 97A)

radios produced in the same four months of 1953 and 4,863,456 sets in the 1952 period. Of the nearly two million TV sets produced in the first four months, 4,731 were color receivers and 450,262 of the black-and-white sets were equipped at the factory to tune the UHF channels. Color set production was reported to have been 3,447 units in April while 112,833 were produced with UHF tuners.

TECHNICAL

A new electronic clinical thermometer, known as "Swiftem," which gives an accurate temperature reading in five to seven seconds—less time than it takes to "shake down" the mercury in the conventional glass rod type—was demonstrated recently by the Army. The inventor of the new device is Col. George T. Perkins, an Army dentist, of San Antonio, Texas. The new electronic thermometer, reportedly representing the first change in clinical thermometers since the mercury column type was introduced as a diagnostic instrument in 1867, is light of weight and small enough to fit easily in the palm of the hand. It operates by a finger button switch and is powered by a mercury cell battery which operates over a wide temperature range and is unaffected by humidity, the Defense Department announced. Connecting the case with the sensing unit or probe is a transmission cord, the length of which does not affect the sensitivity or accuracy of the instrument. The probe, with the thermistor attached at the tip, is less than five inches long. The new device is said to provide a greater degree of accuracy. . . . The Air Co-ordinating Committee, top policy making body for aeronautics in the Commerce Department, recently announced that printed copies of its report, "Electronic Systems of Air Navigation," now are available. The committee is headed by Under Secretary of Commerce for Transportation Robert B. Murray, Jr. The report, the first co-ordinated report of its kind, comprehensively covers the various electronic navigation systems, both technically and economically. It covers such navigation systems as Navarho, Consol, Decca, Loran, VHF, Omni-directional Range and DME. Copies of the report may be obtained from the Office of Technical Services, Department of Commerce, Washington, D. C., for \$1 per copy. . . . The Office of Technical Services, Commerce Department, in its May issue of the "Bibliography of Technical Reports," lists studies in the field of electronics of interest to the industry. Following is a partial listing of the government-sponsored research reports which can be purchased, for the reported price, from the Photoduplication Section, Library of Congress, Washington 25, D. C.: "Collision Frequency of Electrons in the Ionosphere," PB 113222, microfilm, \$2.25, photostat, \$5; "Interpretation of Experimental Results Dealing with the Ambipolar Diffusion of Helium Ions and Electrons Across an Annular Magnetic Field

in a Microwave Toroid," PB 113331, microfilm, \$2.50, photostat, \$5.25; "Microwave Spectrum of the Water Molecule," PB 113327, microfilm, \$6.50, photostat, \$21.50; "Tunable Waveguide Cavity Resonators for Broadband Operation of Reflex Klystrons," PB 113493, microfilm, \$2.50, photostat, \$5.25; "End-Correction for Coaxial Line when Driving an Antenna Over a Ground Screen," PB 113482, microfilm, \$2.25, photostat, \$4; "Impedance of Resonant Transmission Lines and Waveguides," PB 113495, microfilm, \$2, photostat, \$2.75; "Wideband Searching Automatic Frequency Control Circuit of New Type," PB 113454, microfilm, \$2.25, photostat, \$4; "Method of Test Checking an Electronic Digital Computer," PB 113341, microfilm, \$5.75, photostat, \$17.75; "Measurements Performed with Microwaves on the Diffusion of the He⁺ and Electrons Perpendicular to a Magnetic Field," PB 113330, microfilm, \$2.50, photostat, \$4; "Research in Physical Electronics. Quarterly Progress Report No. 4 Under Contract No. AF (604)-524 for the Period 15 June, 1953 to 15 Sept., 1953," PB 113471, microfilm, \$9.25, photostat, \$34.

The National Bureau of Standards recently announced the development of an electronics instrument which automatically detects changes in the physiological condition of a patient under anesthesia throughout the course of an operation. Called the NBS Physiological Monitor, the instrument was developed under the sponsorship of the Veterans Administration. The new electronic instrument measures changes in the patient's blood pressure, heart beat and respiration as they occur and presents the data on a panel for interpretation by the surgeon or anesthesiologist. A permanent record of the patient's condition during the operation is also provided by a recording device incorporated in the assembly. All of the electronic assemblies used in the Physiological Monitor were made so as to be easily replaceable, and the "plug-in" type of structure was chosen to facilitate servicing. A detailed description of the NBS electronic development will be published in the August issue of *The Technical News Bulletin*, NBS monthly publication.

TELEVISION

The Long Lines Department of AT&T, which during May celebrated the sixth anniversary of network television transmission, marked another milestone recently when the 300th station began receiving interconnected network service. The Station is WKNY-TV, Kingston, N. Y. According to AT&T the 300 interconnected stations are located in 191 different cities and receive service via more than 54,000 channel miles of coaxial cable and radio relay facilities.

STANDARDIZATION

The American Standards Association announced recently that John W. McNair has been named to the newly-created post of Assistant Technical Director of the Association. He will continue as Secretary of the U. S. National Committee of the International Electrotechnical Commission.

for Radar • Communications • Laboratory • Computers

SERIES M200 Miniature i. f. Amplifiers



Here's a brand new way to design i. f. strips! Simply reach for your purchase order pad, specify the characteristics you desire, and mail to Instruments for Industries, Inc. Standard models are available from stock, special designs get prompt attention from our engineering and production staff.

I. F. I.'s fast, convenient service on i. f. strips and other types of broad-band amplifiers has saved valuable design and production time for many leading companies. For complete details write: Instruments for Industries, Inc., 125 Old Country Road, Mineola, N. Y.



Specifications of Standard Units

	M260	M230
Band center frequency	60 mc	30 mc
Band width	10 mc	2 mc
Voltage gain	110 db	120 db
Output power	up to 0.02 watts	up to 0.1 watts
Input impedance	50 ohms	50 ohms
Input V. S. W. R.	less than 1.2:1	less than 1.2:1
	over pass band	over pass band

- 8 — 6AK5's mounted on flat chassis, 1½" x 15"
- Standard BNC cable connectors used for r-f terminals

Note: M230 model available with 1.5 db noise figure

INSTRUMENTS FOR INDUSTRIES, INC. 125 Old Country Road
Mineola, N. Y.



The boys from Bendix, headed by Les Swartz, had some fun with the bus system running between the Waldorf-Astoria hotel and Kingsbridge Armory, at the 1954 Radio Engineering Show. They fixed up one bus with a 20' sign showing sled, dogteam, and Will Copp. Mrs. Copp and daughter Valerie produced a miniature husky from

the family livestock to complete the picture. Incidentally, Will Copp's Hudson Bay Transit Company will operate 18 busses (50% more than this year) at a 7½ minute schedule, for the 1955 Radio Engineering Show, and the new contractor promises better rolling stock and strict adherence to the time schedule.

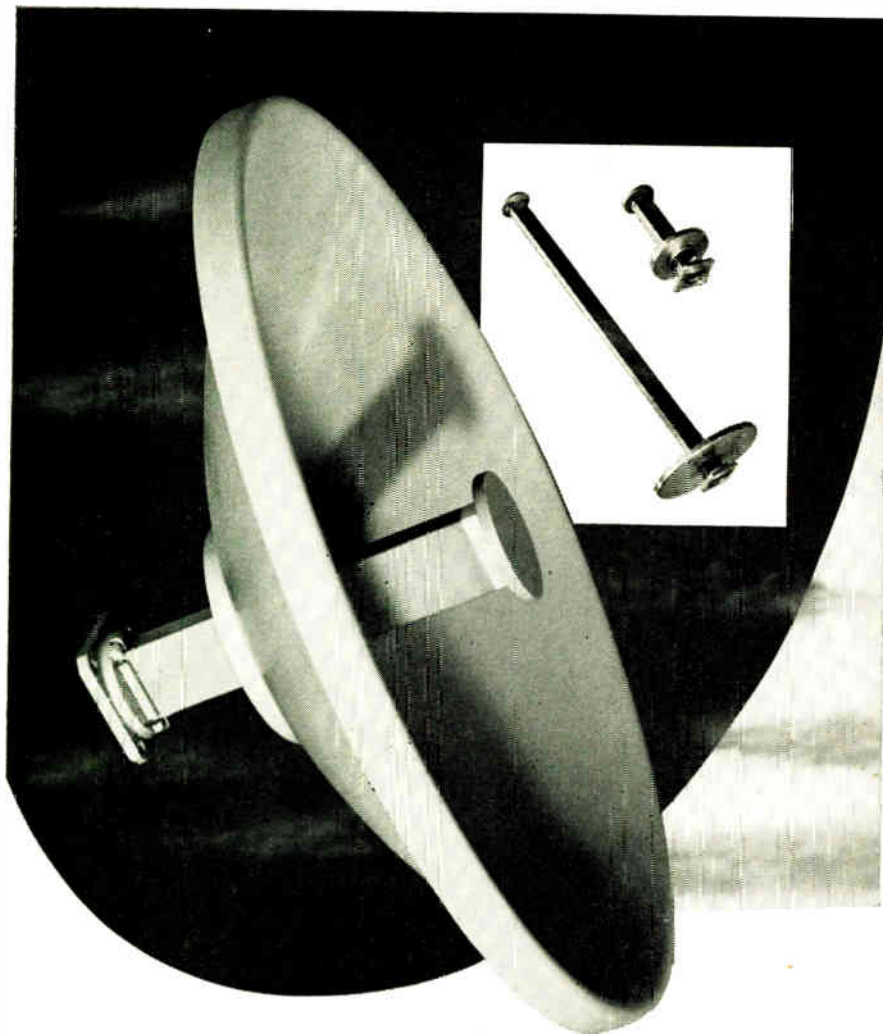

PARABOLIC ANTENNAS *for the X-band*

Quick delivery of parabolic antennas for the X-band is now possible. Designed and manufactured by The Gabriel Laboratories, these antennas meet, or better, required civilian and military specifications. Precision reflectors are illuminated by a modified Gabriel wave guide feed — the same Gabriel design which has received universal recognition in the 7000 mc commercial relay band. Large orders can be filled quickly due to the extensive manufacturing facilities of our affiliate, Gabriel Electronics Division.

These antennas are available with dish sizes of 1, 2, 3, 4, and 6 foot diameters — have a standard three or four point adjustable mounting — and are equipped with a UG-40A/U input flange which is suitable for use in pressurized systems. Feed and dish de-icers are also available for extreme weather conditions.

- Frequency coverage (two ranges) — 8900 to 9300 mc; 9300 to 9750 mc.
- VSWR — less than 1.2 :1 throughout each range.
- Each antenna can be spot tuned to a specific frequency, with a VSWR of less than 1.05 :1.

For analysis of your antenna or microwave problem, write or phone NEedham 3-0005.

the **GABRIEL** *laboratories*
 THE GABRIEL COMPANY • 135 CRESCENT ST. • NEEDHAM HEIGHTS, MASS.



AKRON

"Remote Control of Pilotless Aircraft," by P. R. Murray, Wright Air Development Center; Election of officers; May 20, 1954.

"Application of Analog Computers to Flood Control Problems," by N. P. Tomlinson, Goodyear Aircraft Corp.; May 27, 1954.

ALBUQUERQUE-LOS ALAMOS

"Physical Analogs for Analytic Functions," by Dr. J. M. Pettit, Stanford University; April 30, 1954.

"New Developments in Microwave Tubes," by J. R. Pierce, Bell Telephone Labs.; Editor, IRE PROCEEDINGS; June 4, 1954.

BINGHAMTON

Election of officers; May 17, 1954.

BOSTON

"New Developments in Communications," by J. E. Smith, Raytheon Mfg.; election of officers, May 20, 1954.

CEDAR RAPIDS

Student papers: "Switching Algebra," by D. R. Wilson; "Theory of the Mechanical Differential Analyzer," by G. B. Treu and "Audio Spectrometry," by M. G. Beebe; May 12, 1954.

CINCINNATI

"A Highly Complex Digital Control System," by John Meszar, Bell Telephone Labs.; May 16, 1954.

Eighth Annual Television Conference; April 24, 1954.

Student Competition: "Noise Suppression," by Richard Donze; "Variable Width Pulse Generator," by Robert Kinsman; "Seasonal Changes in Broadcast Frequency Ground Wave Propagation," by Carl Osterbrock and "Simultaneous Linear Equation Electronic Computer," by William Schneider; May 18, 1954.

CLEVELAND

Election of officers and student papers: "Measurements with Coax Slotted Lines and Two-Wire Lines," by D. A. Havlock; "Measurements of Reverberation Time with a Logarithmic Amplifier," by P. T. Marth and "Design of Acoustic Filters," by T. C. Mercer; May 25, 1954.

DALLAS-FORT WORTH

"Why the Rate Autopilot?" by Don Povejsil, Westinghouse Electric Company; May 13, 1954.

Inspection trip of Chance Vought Aircraft Plant conducted by J. R. Campbell, Chief Electronic Design Engineer; May 27, 1954.

"Things that are Texas," by W. H. Kittrell; "High Fidelity Demonstration," by Mr. Underwood, Audio Associates; election of officers; June 12, 1954.

DES MOINES-AMES

"C.B.S. Chromocoder," by I. C. Abrahams, General Electric; May 18, 1954.

ELMIRA-CORNING

"Radio Astronomy," by Prof. C. R. Burrows, Cornell University; Election of officers; May 17, 1954.

EL PASO

Two films of Raytheon Manufacturing Company; June 2, 1954.

EVANSVILLE-OWENSBORO

"Airborne Electronics Looks to the Future," by George Rappaport, Wright Field; June 9, 1954.



FORT WAYNE

"Musical Engineering," by Dr. H. F. Olson, R.C.A. Research Lab.; May 27, 1954.

"The Georgian 3-Way Hi-Fi Speaker System and Components," by Howard Souther assisted by L. S. Hoodwin, both of Electro-Voice Co.; election of officers; June 3, 1954.

HAWAII

Film, "Ionosphere Effects on Radio Wave Propagation"; May 12, 1954.

Election of officers; June 9, 1954.

HOUSTON

"The Radio Engineers Crystal Ball," by Dr. A. W. Straiton, Regional Director; May 18, 1954.

HUNTSVILLE

"A Is For Atom," by G. L. Sadler, Redstone Arsenal; May 26, 1954.

INDIANAPOLIS

Conducted tour of office and facilities main office Bell Telephone Company; May 7, 1954.

"A New Miniature TV Camera," by J. Alinsky, Thompson Products, Inc.; election of officers; May 13, 1954.

INYOKERN

Tapescript, "Magnetic recording" and "Design Considerations in High Speed Electronic Counters," by Allen Bagley, Hewlett-Packard; June 7, 1954.

LONG ISLAND

"Atomic Battery," by Paul Rappaport, RCA; May 11, 1954.

NEW ORLEANS

"Color Television," by Sam Tarantur, Admiral Radio Corporation; May 13, 1954.

"Use of Electronic Equipment for Horizontal Control in Petroleum Exploration in the Gulf of Mexico," by George Roussel, Offshore-Raydist, Inc.; May 28, 1954.

NEW YORK

"High Fidelity," by H. H. Scott, Hermon Hosmer Scott, Inc.; May 5, 1954.

"The Origin and Rise of Radio Communication," by Lloyd Espenschied, retired, Bell Telephone Labs., Inc.; June 2, 1954.

NORTH CAROLINA-VIRGINIA

Virginia Engineers Annual Joint Meeting; May 21-22, 1954.

NORTHERN NEW JERSEY

"VHF Radio Relay System in Northwestern Canada," by S. T. Fisher, Radio Engineering Products Ltd.; election of officers; May 12, 1954.

OKLAHOMA CITY

"Instrumentation and Control of Physical Systems," by Dr. J. D. Trimmer, University of Tennessee; April 13, 1954.

"Wire Photo as a Means of Communication," by Arthur Bruno, student, Oklahoma University; and "The Ear and High Fidelity," by Jack Warhurst, also a student at Oklahoma University; May 11, 1954.

PHOENIX

"The Engineer Faces a Paradox," by John Hessel, Signal Corps Eng'g. Labs., Fort Monmouth; April 9, 1954.

"IRE Activities," by Prof. J. M. Pettit, University of Stanford; "A Broad-Band Tube-to-Line Matching Network," by Russel Yost, Motorola, Inc.; April 28, 1954.

"Our Expanding Technology," by Dr. J. W. McRae, Sandia Corporations; May 28, 1954.

(Continued on page 104A)

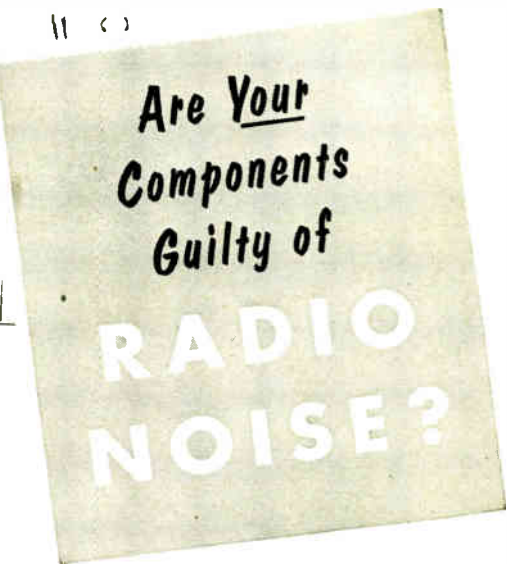

POTTER can tell you "why"

POTTER can tell you "how"

and **POTTER** can make the **FILTER** that will confirm that "how"

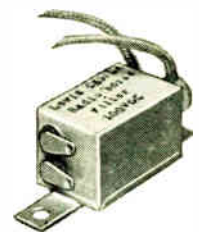

Once it's stated completely and correctly, a problem is half solved.

Potter can put the facts and figures of your problem on paper . . . can

chart its limits in laboratory tests . . . can

engineer the solution. And Potter

can embody that solution in

subsequent design and production.

Call Potter to engineer, design and

produce the filter to solve your

radio interference problem.

Write for Bulletin 41E.

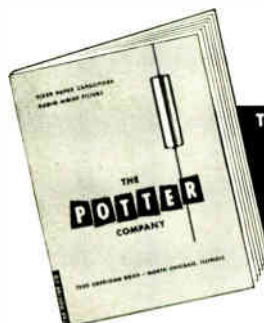

THE **potter** COMPANY

SPECIALISTS IN
FIXED PAPER
CAPACITORS
SINCE 1925

1950 SHERIDAN ROAD
NORTH CHICAGO, ILL.

Something New Has Been Added!



The 21 IRE Professional Groups show the expansion pattern of a modern engineering society in meeting the diversified needs of its members in the ever widening science of radio-electronics.

Membership in a Professional Group is open to any paid-up member of the I.R.E. The cost is only an annual extra publications fee, usually \$2. This fee is shown in the descriptions that follow.

An IRE Member may join as many Professional Groups as serve his interest and wishes. Such membership serves to associate him with other engineers of the same specialized interests within the radio-electronic field.

The 21 Professional Groups are listed below, together with a brief definition of each, the name of the Group Chairman, and publications to date.
* Means still available.

Aeronautical and Navigational Electronics

The application of electronics to operation and traffic control of aircraft and to navigation of all craft.

Dr. K. Charlton Black, Chairman, Polytechnic Research & Development Co., 55 Johnson Street, Brooklyn 1, N.Y.

Fee \$2. 12 Transactions. 4 Newsletters, *4, *5, *6, *8, & *9, and *Vol. ANE-1, No. 1.

Antennas and Propagation

Technical advances in antennas and wave propagation theory and the utilization of techniques or products of this field.

Mr. D. C. Ports, Chairman, Jansky & Bailey, 1339 Wisconsin Ave., N.W., Washington 7, D.C.

Fee \$4. 9 Transactions, 1 Newsletter. *4, *Vol. AF-1, Nos. 1, 2; *Vol. AF-2, Nos. 1-3.

Audio

Technology of communication at audio frequencies and of the audio portion of radio frequency systems, including acoustic terminations, recording and reproduction.

Dr. Vincent Salmon, Chairman, Stanford Research Institute, Stanford, California.

Fee \$2. 19 Transactions, 4 Newsletters. *5, *7, *10. *Vol. AU-1, Nos. 1-6; *Vol. AU-2, Nos. 1-3.

Broadcast & Television Receivers

The design and manufacture of broadcast and television receivers and components and activities related thereto.

Mr. Earl I. Anderson, Chairman, Assistant Manager, Industry Service Lab., RCA Laboratory Div., 711-5th Ave., New York, N.Y.

Fee \$2. 7 Transactions. *1, *2, *3, *5, *6, *7.

Broadcast Transmission Systems

Broadcast transmission systems engineering, including the design and utilization of broadcast equipment.

Mr. Lewis Winner, Chairman, Editor, Television Engineering, 52 Vanderbilt Avenue, New York 17, N.Y.

Fee \$2. Convention Report.

Circuit Theory

Design and theory of operation of circuits for use in radio and electronic equipment.

Dr. Chester H. Page, Chairman, National Bureau of Standards, Connecticut Ave., Washington 25, D.C.

Fee \$2. 3 Transactions. *1, *2, *Vol. CT-1, No. 1.

THE INSTITUTE OF RADIO

IRE's 21 Professional Groups

<p>Communications Systems</p> <p><i>Radio and wire telephone, telegraph and facsimile in marine, aeronautical, radio-relay, coaxial cable and fixed station services.</i></p> <p>Col. J. Z. Millar, Chairman, Western Union Telegraph Company, 60 Hudson St., New York 13, N.Y.</p> <p>Fee \$2. 3 Transactions. 5 Newsletters. *Vol. CS-1, No. 1, *Vol. CS-2, Nos. 1-2.</p>	<p>Component Parts</p> <p><i>The characteristics, limitations, applications, development, performance and reliability of component parts.</i></p> <p>Mr. Floyd A. Paul, Chairman, Bendix Development, 166 W. Olive Ave., Burbank, Calif.</p> <p>Fee \$2. Transaction* PGCP*1.</p>	<p>Electron Devices</p> <p><i>Electron devices, including particularly electron tubes and solid state devices.</i></p> <p>Mr. George A. Espersen, Chairman, Phillips Laboratories, Inc., Irvington-on-Hudson, N.Y.</p> <p>Fee \$2. 7 Transactions, 3 Newsletters, 2 Technical Bulletins. *1, *2, *4, *Vol. ED-1, Nos. 1-3.</p>
<p>Electronic Computers</p> <p><i>Design and operation of electronic computers.</i></p> <p>Mr. Harry T. Larson, Chairman, Ramo-Wooldrige Corp., 8820 Belanca, Los Angeles 45, Calif.</p> <p>Fee \$2. 7 Transactions, 5 Newsletters. *Vol. EC-2, Nos. 2-4; *Vol. EC-3, Nos. 1-2.</p>	<p>Engineering Management</p> <p><i>Engineering management and administration as applied to technical, industrial and educational activities in the field of electronics.</i></p> <p>Mr. Charles J. Breitwieser, Chairman, RCA Victor Division, Camden, N.J.</p> <p>Fee \$1. 1 Transaction, 8 Newsletters. *1.</p>	<p>Industrial Electronics</p> <p><i>Electronics pertaining to control, treatment and measurement, specifically in industrial processes.</i></p> <p>George P. Bosomworth, Chairman, Firestone Tire & Rubber Co., Akron 17, Ohio</p> <p>Fee \$2. Transactions, *PGIE-1.</p>
<p>Information Theory</p> <p><i>Information theory and its application in radio circuitry and systems.</i></p> <p>Dr. William G. Tuller, Chairman, Melpar, Inc., 452 Swann Ave., Alexandria, Va.</p> <p>Fee \$2. 3 Transactions, 1 Newsletter. *2, *3.</p>	<p>Instrumentation</p> <p><i>Measurements and instrumentation utilizing electronic techniques.</i></p> <p>Mr. R. L. Sink, Consolidated Engineering Corp., 300 N. Sierra Madre Villa, Pasadena, Calif.</p> <p>Fee \$1. 3 Transactions. *2, *3.</p>	<p>Medical Electronics</p> <p><i>The application of electronics engineering to the problems of the medical profession.</i></p> <p>Dr. J. F. Herrick, Chairman, Mayo Clinic, Rochester, Minn.</p> <p>Fee \$1. 1 Transaction. 3 Newsletters. *1.</p>
<p>Microwave Theory and Techniques</p> <p><i>Microwave theory, microwave circuitry and techniques, microwave measurements and the generation and amplification of microwaves.</i></p> <p>Mr. W. W. Mumford, Chairman, Bell Telephone Laboratories, Whippany, N.J.</p> <p>Fee \$2. 4 Transactions. *Vol. MTT-1, No. 2; *Vol. MTT-2, Nos. 1-2.</p>	<p>Nuclear Science</p> <p><i>Application of electronic techniques and devices to the nuclear field.</i></p> <p>Dr. Lloyd V. Berkner, Assoc. Universities, Inc., 350 5th Ave., New York 1, N.Y.</p> <p>Fee \$2. Transactions, 3 Newsletters.</p>	<p>Quality Control</p> <p><i>Techniques of determining and controlling the quality of electronic parts and equipment during their manufacture.</i></p> <p>Mr. Leon Bass, Chairman, Manager, Quality Eng., Jet Eng. Dept., General Electric Co., Cincinnati 15, Ohio.</p> <p>Fee \$2. 3 Transactions, 1 Newsletter. *1, *2, *3.</p>
<p>Radio Telemetry and Remote Control</p> <p><i>The control of devices and the measurement and recording of data from a remote point by radio.</i></p> <p>Mr. Martin V. Kiebert, Jr., Chairman, P. R. Mallory & Co., Inc., Tuner Div., Indianapolis 6, Ind.</p> <p>Fee \$1. Transactions, Newsletter.</p>	<p>Vehicular Communications</p> <p><i>Communications problems in the field of land and mobile radio services, such as public safety, public utilities, railroads, commercial land transportation, etc.</i></p> <p>Mr. W. A. Shipman, Chairman, Columbia Gas Sys. Ser. Corp., 120 East 41 Street, New York 17, N.Y.</p> <p>Fee \$2. 4 Transactions, 2 Newsletters. *2, *3, *4.</p>	<p>Ultrasonics Engineering</p> <p><i>Ultrasonic measurements and communications, including underwater sound, ultrasonic delay lines, and various chemical and industrial ultrasonic devices.</i></p> <p>Mr. A. L. Lane, Chairman, 706 Chillum Road, Apt. 101, Hyattsville, Md.</p> <p>Fee \$2. 1 Transaction, 4 Newsletters. *1.</p>

ENGINEERS

1 East 79th Street, New York 21, N. Y.

The Nation's Newest Million Welcomes You To
THE FIFTH ANNUAL MEETING AND EXHIBIT
of the
Professional Group on Vehicular Communications

Sponsored by the
Houston Section
Rice Hotel
Sept. 30 - Oct. 1
Paul Franklin, Chmn.
Walton Greer, Sect. Chmn.

Address General
Inquiries to:
L. A. M. Barnette
P. O. Box 2180
Houston, Texas

THEME:

The Communications Engineer's Role in American Industry

EXHIBITS SPEAKERS BANQUET TOUR

For Information on

Exhibits

Registration

Housing

Papers

Write to:

McKinley Rhodes
P. O. Box 2511, Houston 1

Harvey Wheeler
P. O. Box 1234, Houston 1

Lester Mullan
Station KTRH, Houston 2

Carroll Turner
6422 Long Dr., Houston 17



(Continued from page 101A)

PITTSBURGH

"Color Television as a Transmission Problem," by W. T. Wintringham, Bell Telephone Labs., Inc.; May 10, 1954.

PORTLAND

Tapescript: "RCA Color TV System," by J. W. Wentworth, RCA; election of officers; May 20, 1954.
"Band-Pass Filters, Using Standard Components," by V. M. Brittain, Tektronix, Inc.; June 17, 1954.

ROCHESTER

"Guided Missiles are a Must," by D. E. Mullen, General Electric Company; April 22, 1954.
"Color Television Receivers," by R. J. Farber, Hazeltine Corp.; May 27, 1954.

ROME-UTICA

"Reliability in Electronics," by Gen. Wright, Rome Air Development Center; "Factors Influencing the Assignment of Radio Frequencies," by Dr. N. Smith, Willow Run Research Center, University of Michigan; election of officers; June 8, 1954.

SACRAMENTO

"Theory of High Current Density Electron Beams," by Dr. J. W. Lebacqz, Stanford University; "Practical Aspects of High Density Electron Beams and Design of Klystron Tubes," by Bertram Ryland, also of Stanford University; June 11, 1954.

SAN DIEGO

"Techniques of High Speed Broadband Waveguide Switching for Millimeter and Centimeter Wavelengths," by W. L. Teeter, U. S. Navy Electronics Lab.; June 1, 1954.

SAN FRANCISCO

"Brazil—A Friendly Neighbor," by Dr. Karl Spangenberg; June 4, 1954.

SCHENECTADY

"Inspection trip to UHF Television Station WTRI; May 10, 1954.

SYRACUSE

"The Past and Future of Electronics," by W. C. White, General Electric Company; election of officers; April 22, 1954.

TOLEDO

"A Study in Transconductance," by James LaRue and "Missile Guidance by Celestial Methods," by Richard Kiene, both students, University of Toledo; April 8, 1954.

Film, "Project Tinkertoy" and demonstration of Willys TV camera by John McGee, Willys Electronics Division; May 13, 1954.

TORONTO

"Design of Micro Strip Lines," by H. Griffiths, Canadian Westinghouse of Canada; election of officers; April 5, 1954.

"The Rapid Transit Commission and Control System," by Mr. Doran, Toronto Transit Commission; April 26, 1954.

TULSA

"Comparison of High Fidelity and Conventional Audio Systems," with demonstrations, by Harry Rasmussen, Radio Station KVDO; election of officers; May 27, 1954.

Precision **DIRECTIONAL COUPLERS**
50 MC TO 3300 MC
FOR LABORATORY AND INCORPORATION APPLICATIONS

Model No.	Frequency Range (Mc)
500-0Y	50 - 200
500-1Y	200 - 500
500-2Y	500 - 1000
500-3Y	1000 - 2000
500-4Y	1500 - 2500
500-5Y	2500 - 3300

Specifications:

Coupling (C) 30 db or as specified
Directivity: C + 10 db minimum
Arm balance: within .04 db
Arms matched to 1.25 on 50 ohms
VSWR: below 1.05:1
Price: \$160.00 Delivery from stock

QUALITY DEVELOPMENT AND PRODUCTION OF
MICROWAVE COMPONENTS, INSTRUMENTS,
ASSEMBLIES AND SYSTEMS.

CATALOG
R-5
ON REQUEST

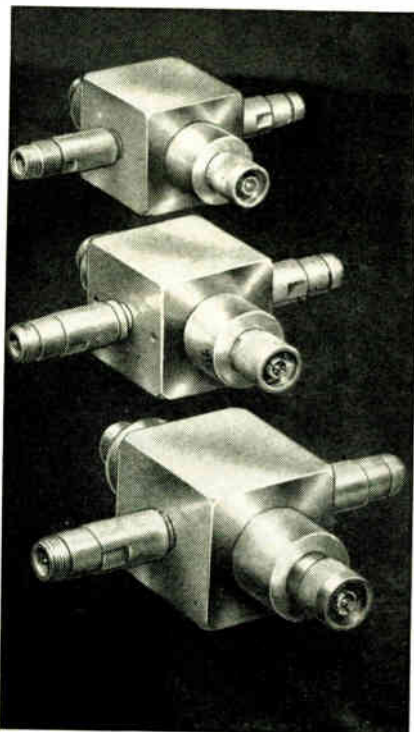



TWIN CITIES

"Outline of Activities in IRE Region 5," by C. J. Marshall, Regional Director; Inspection trip to University of Minnesota's Linear Accelerator. Dr. J. H. Williams host; election of officers; May 25, 1954.

WINNIPEG

"Continental-wide Toll Dialing System," by G. A. Muir, Manitoba Telephone System; April 28, 1954. Election of officers; May 26, 1954.

SUBSECTIONS

BERKSHIRE COUNTY

"Compromises in Aircraft Equipment Design," by J. A. Kohn, General Electric Company; election of officers; June 7, 1954.

BUENAVENTURA

"The Induction Air Blast Facility at U. S. NAMTC," by Robert Richardson, U. S. NAMTC; "Use and Testing of Glow Discharge Tubes and Selenium Rectifiers," by Lloyd Jones, TV Station KEYT; May 13, 1954.

CHARLESTON

Tom of Southern Bell Tel. and Tel. Company, T. A. Shea, host; election of officers; June 11, 1954.

EAST BAY

"A Function Multiplier for an Analog Computer," by Mr. Hussey and "Measurement of Frequency," by Frank Boff, both of Berkeley Division of Beckman Instrument; May 19, 1954.

LANCASTER

"Requirements of the Amplifier in a High-Fidelity Audio System," by L. H. Good, RCA; election of officers; May 12, 1954.

MONMOUTH

"An Out-Guessing Machine," by D. W. Hagelbarger, Bell Telephone Labs.; April 21, 1954. "Some Interesting Aspects of Waveguide Transmission," by A. C. Beck, Bell Telephone Labs.; election of officers; May 19, 1954.

ORANGE BELT

"Relationship Between Engineering and Management," by Prof. W. J. King, U.C.L.A. and "Demonstration of Color Television Receiver," by E. L. Michaels, Packard Bell Company; election of officers; June 9, 1954.

TUCSON

"Color Television," by Jerry Walker, KVOA TV; May 27, 1954.

USAFIT

"Application of Microwave Optics in Antenna Systems," by Dr. Roy Spencer, Cambridge Research Center; June 4, 1954.

Magnetic Relay Bulletin

R-B-M Div., Essex Wire Corp., Logansport, Ind., has recently printed a quick reference, 4-page bulletin showing the various types of open and hermetically sealed ac and dc relays in its line.

This bulletin indicates general characteristics including maximum coil resistance and power requirements, contact forms available, approximate weight and dimensions. While this bulletin is not intended to enable engineering to select the exact relay required, it is indicative of the scope of relays available. For your free copy of Bulletin 560A write to W. D. Loux at the firm.

Stoddart NM-20B • 150kc to 25mc
Commercial Equivalent of AN/PRM-1A

WIDE FREQUENCY RANGE... Covering the most widely used portion of the radio-frequency spectrum, the NM-20B is a precision instrument designed for field or laboratory measurement, analysis and interpretation of all types of radiated and conducted radio-frequency signals and interference. Sturdy dependability, broad frequency range and a full complement of accessories fit this instrument's outstanding characteristics to an impressive variety of applications. Includes standard broadcast band, radio range, WWV, ship-to-shore, amateur and other communication frequencies.

SELF-CONTAINED BATTERIES... Battery power allows portable operation of the NM-20B. The ac power supply permits operation from 105 to 125 volts or 210 to 250 volts ac at any frequency between 50 cps and 1600 cps. Its versatile power requirements and special weather-proof construction provide unlimited field operation.

PICKUP DEVICES... Pickup devices available for use with the NM-20B include the loop and loop probe, rod antennas and matching impedances for conductive inputs. These permit unlimited usefulness in measuring both conducted and radiated interference.

Stoddart RI-FI* Meters cover the frequency range 14kc to 1000mc

VLF

NM-10A, 14kc to 250kc
 Commercial Equivalent of AN/URM-6B. Very low frequencies.

VHF

NM-30A, 20mc to 400mc
 Commercial Equivalent of AN/URM-47. Frequency range includes FM and TV bands.

UHF

NM-50A, 375mc to 1000mc
 Commercial Equivalent of AN/URM-17. Frequency range includes Citizens band and UHF color TV band.

STODDART AIRCRAFT RADIO Co., Inc.
 6644-C Santa Monica Blvd., Hollywood 38, California • Hollywood 4-9294

Your future's on the rise when you're an aviation electronics engineer

with **RCA!**

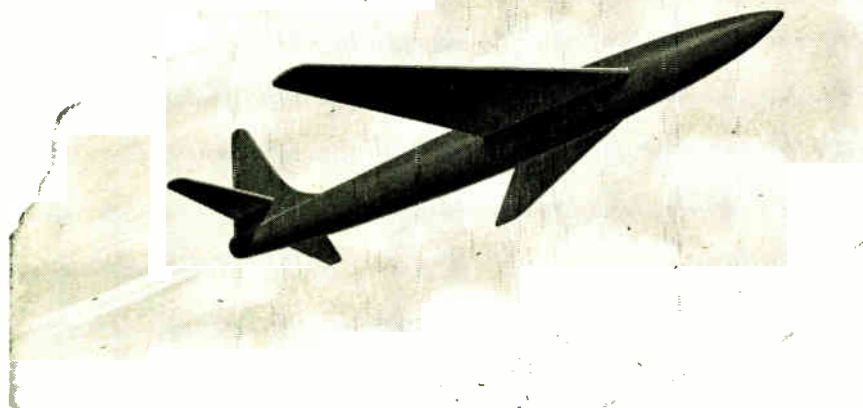

FIRE CONTROL PRECISION NAVIGATION COMMUNICATIONS

POSITIONS IN: **SYSTEMS, ANALYSIS, DEVELOPMENT or
DESIGN ENGINEERING**

Specialize in: Radar . . . Analog Computers . . . Digital Computers . . . Servo Mechanisms . . . Shock & Vibration . . . Circuitry . . . Heat Transfer . . . Remote Controls . . . Sub-Miniaturization . . . Automatic Flight . . . Design for Automation . . . Transistorization.

You should have 4 or more years' professional experience and a degree in electrical or mechanical engineering, or physics.

In these positions at RCA, there's a real engineering challenge. You'll enjoy professional status . . . recognition for accomplishment . . . unexcelled facilities . . . engineering graduate study with company-paid tuition . . . plus many company-paid benefits. Pleasant suburban and country living. Relocation assistance available.

Look into the RCA career that's waiting for you! Send a complete resume of education and experience to:

Mr. John R. Weld, Employment Manager
Dept. B-453H, Radio Corporation of America
Camden 2, New Jersey



RADIO CORPORATION OF AMERICA

Tmks.®



The following positions of interest to I.R.E. members have been reported as open. Apply in writing, addressing reply to company mentioned or to Box No. . . . The Institute reserves the right to refuse any announcement without giving a reason for the refusal.

PROCEEDINGS of the I.R.E.

1 East 79th St., New York 21, N.Y.

ENGINEERS

1—**ELECTRONICS:** Minimum of 5 years experience in circuit design with primary emphasis on pulse circuitry and high frequency RF techniques.

2—**MECHANICAL:** Minimum of five years experience in packaging electronic equipment as well as in mechanical design of small electro-mechanical devices.

This company is engaged in the field of telemetering, developing and producing transmitters, receivers, data treating equipment and special electronic and electro-mechanical devices. Permanent positions are offered with liberal benefits. Send complete resume to Applied Science Corporation of Princeton, P. O. Box 44, Princeton, N.J. Tel. Plainsboro 3-4141.

INSTRUCTORS—PROFESSORS

Teaching positions for September 1, 1954 are available at a University in the southeast. Associate Professor, \$5,500-\$9,400; Instructors, \$3,500-\$4,300; graduate assistants (MS in 12 months), \$110. per month, tuition free. Box 772.

SOUND SALES ENGINEERS

Wanted experienced Sound Sales Engineer to begin work as assistant to Division Manager in fast growing organization preeminent in HF Industry and specializing in manufacture of electro-acoustic products. Position requires ability to answer technical correspondence, participate in designs to meet consumer requirements, assist in conduct of trade shows, write some copy, and gradually to assume administrative duties. Some travel. Degree desirable but not necessary if backed by experience in associated industry. Requires moving to suburb of South Bend, 90 miles east of Chicago. Contact Souther, Electro-Voice, Buchanan, Michigan.

ELECTRONIC DEVELOPMENT ENGINEER

Particularly capable development engineer, audio and acoustic equipment, electronic circuits, laboratory instruments, etc. BS or MS and enough experience to prove capacity for independent original work. Accomplishment-motivated man interested in non-specialized work, freedom and advancement possible with small expanding electronics manufacturer. Located one mile from M.I.T. and Harvard, part-time graduate work possible. Apply V. H. Pomper, H. H. Scott, Inc., 385 Putnam Ave., Cambridge 39, Mass.

ENGINEER OR PHYSICIST

For research and product development of thermistors. Direct experience required. Should be capable of taking complete responsibility. Good opportunity in new plant of midwestern electrical components manufacturer. Reply in confidence, giving education, experience and salary desired. Box 773.

(Continued on page 108A)

J. F. Mandrow (left) and T. W. Connolly prepare a problem in dynamic analysis of an interceptor fire control system for solution on analog computing equipment.



B. D. McVey (foreground) and E. Foxman examine operation of interceptor fire control system with equipment simulating in-flight performance of target, fire control system, and interceptor.



**PLANNING
PERFORMANCE**

In the development of advanced radar fire control systems for all-weather military aircraft, system design objectives are determined by systems engineering and analysis. To implement these objectives the next step is the detailed analysis, design, and evaluation of the individual subsystems and units.

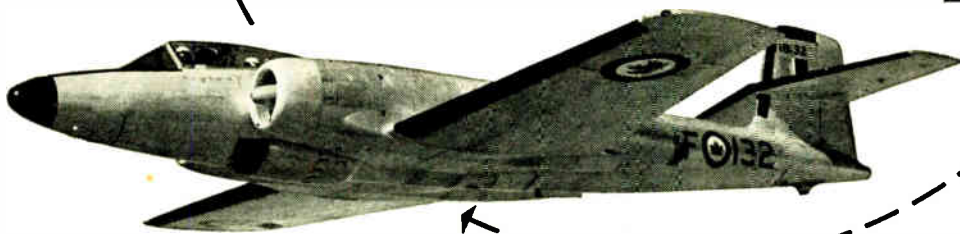

The Avro Canada CF-100 of the RCAF is one of the all-weather interceptors equipped with Hughes radar fire control system.

At Hughes special simulation equipment is used to synthesize aircraft and system performance. The simulator provides a means for examining system performance under laboratory-controlled conditions. In the case of airborne systems such study would otherwise require hundreds of hours of expensive flight testing to achieve comparable results.

Three important aspects of this work are:

Determination of effects on over-all dynamic stability of items such as dynamic range of amplifiers, filtering included to reduce effects of noise, aerodynamic response characteristics of the aircraft, and characteristics of computers.

Evaluation of existing systems, subsystems, or units to determine degree of modification necessary in order to meet new installation or performance requirements.

Assessment of completed systems under simulated operation to establish performance before start of production. Simulator studies are correlated with actual flight tests, helping to predict in-flight performance with reduced flight testing.

SYSTEMS ENGINEERS—CIRCUIT ENGINEERS

Further advancements in the field of radar fire control are creating new positions on our Staff for engineers experienced in the fields of systems engineering and circuit design, or for those interested in entering these areas.

Assurance is required that relocation of the applicant will not cause disruption of an urgent military project.

*Scientific and
Engineering Staff*
HUGHES
RESEARCH
AND DEVELOPMENT
LABORATORIES

Culver City, Los Angeles County, California

Visit the
HUGHES EXHIBIT at the
**WESTERN ELECTRONIC SHOW
AND CONVENTION**
Los Angeles, August 25, 26, 27 • Pan Pacific Auditorium

ENGINEERS

looking for . . .

. . . a good start?

. . . rapid development of your professional skill?

You can have both at Sperry,

PIONEERS IN A WIDE RANGE OF FIELDS, FOR MORE THAN 43 YEARS

We invite you to investigate the exceptional employment opportunities available on our unusually large research, design, and development staff, in many fields including the following:

Klystron & traveling tube research • Analogue & digital Computers • Radar • Hydraulics • Communication Equipment • Pulse Transformers • Servo Mechanisms • Electronic Circuits • Aircraft Controls • Instrumentation • Fractional H.P. Motors • Magnetic Amplifiers • Radio Frequency & Microwave Measurement.

PUBLICATIONS ENGINEERS To write manuals and engineering reports.

Advanced and challenging assignments • Association with top Engineers • Interesting, diversified work • Remuneration based on professional abilities • Modern plant—latest laboratory facilities • Adequate housing • And of course, employee benefits, and congenial surroundings, among the finest.

Please submit resume to our Engineering Personnel Section. (Personal interviews may be arranged in your city.)

SPERRY GYROSCOPE CO.

Division of the Sperry Corp.
Great Neck, Long Island, N.Y.



Should You Change Your Job This Fall?

If you would like a job with more interest, freedom and individual recognition—we suggest you send, at once, for the Gilfillan brochure. Here you will find many of the reasons why outstanding engineers are building lifetime careers with Gilfillan, the pioneer of GCA radar. Gilfillan is now designing equipment for all three military services, dealing with advanced or unsolved techniques; and working with problems in coming civilian fields. Ideas begin at Gilfillan. Initiative is encouraged. Pay is paced to ability, not seniority. You owe yourself complete information about opportunity with Gilfillan before you come to a decision. For your brochure, write R. E. Bell, Department 84.

Gilfillan Brothers

1815 Venice Boulevard
Los Angeles 6, California



(Continued from page 106A)

PROFESSORS

Technion, Israel Institute of Technology, Haifa, Israel, proposes to appoint one Professor of Electrical Engineering with special qualifications in telecommunications, one Associate Professor of Electrical Power Engineering and one Professor of Mathematics. Applicant should have first-rate professional and academic qualifications, be willing to integrate themselves into the life of the country, and, in due course teach Hebrew. Applications with full details should be sent in duplicate, for transmission to Haifa, to the American Technion Society, 1000 Fifth Ave., New York 28, N.Y.

EXECUTIVE SALES MANAGER

(TV-Radio and Electronic Components)

A leading progressive midwest company in the electronic component manufacturing field, requires the services of a proven sales executive. Individual to qualify must be able to head its Sales Department: have a successful sales background in component manufacturing. Also must be acquainted with and possess the ability to deal with nationally known set manufacturers. This is an excellent opportunity offering a salary to commensurate with a top level position. Write fully, in confidence for an early interview. Box 774.

ASSISTANT PROFESSOR

Assistant Professor of Electrical Engineering, University of North Dakota, Grand Forks, North Dakota. Duties: teaching electronics and communication courses to under-graduate students. Appointment to begin Sept. 1954. An advanced degree plus some teaching or industrial experience preferred. Submit resume of education and experience to Head, Electrical Engineering Dept.

INSTRUCTORS

California State Polytechnic College plans additions to its staff in the Electronic and Radio Engineering Dept. to teach (1) courses in fields, waves and antennas, and (2) intermediate level courses in circuits. For information write: Harold P. Hayes, Dean of Engineering, San Luis Obispo, California.

ENGINEER

Engineer with substantial experience in development of electronic instruments who is interested in administrative and operational aspects of a development laboratory. Particular field of operation is in physical measurements. Located in Chicago area. Box 778.

ELECTRONIC ENGINEERS

Several positions for graduate engineers are available in research and development Dept. An opening for a Project Engineer with industrial experience, who will be responsible for scheduling and co-ordinating an engineering project including fabrication of experimental and small production quantities of airborne equipment. Also openings for an engineer with experience in circuit design and in development and testing of new equipment in the 100 kc to 250 mc frequency range, and for an engineer with experience in microwave radar circuits and HIF techniques. Reply to Robert L. Blanchard, Trans-Sonics, Inc., Bedford, Mass.

(Continued on page 110A)

ENGINEERS

The APPLIED PHYSICS LABORATORY OF THE JOHNS HOPKINS UNIVERSITY offers an exceptional opportunity for professional advancement in a well-established laboratory with a reputation for the encouragement of individual responsibility and self-direction. Our program of

GUIDED MISSILE

RESEARCH AND
DEVELOPMENT

provides such an opportunity for men qualified in:

ELECTRONIC CIRCUIT DESIGN AND ANALYSIS
DEVELOPMENT AND APPLICATION OF TRANSISTOR CIRCUITRY
SERVOMECHANISMS AND CONTROL SYSTEM ANALYSIS
ELECTRONIC EQUIPMENT PACKAGING
INSTRUMENT DESIGN
MISSILE SYSTEMS DEVELOPMENT
FLIGHT TESTING

Please send your resume to

Glover B. Mayfield

APPLIED PHYSICS LABORATORY
THE JOHNS HOPKINS UNIVERSITY
8621 Georgia Avenue
Silver Spring, Maryland

A well established company and a leader in its field has positions open in engineering for the following:

A. Engineers experienced in the design of modern machine switching circuits. Should have ability to think in terms of relay circuitry and do independent design work. A good knowledge of problems involving reliability and common practice in modern telephone systems is essential.

B. Engineers with experience in the design and application of telephone and/or industrial relays. A good working knowledge of materials from both the magnetic and mechanical standpoints is required. Design and application work will stress reliability and long life of components.

Reply in confidence, fully stating details of personal and professional history as well as education. Expense paid interviews will be arranged for those applicants demonstrating suitable qualifications in first letter. Salaries will be liberal and as justified by qualifications. Location: Middlewest.

Box 784
INSTITUTE OF RADIO ENGINEERS
1 East 79th St.
New York 21, N.Y.

New opportunities for MATHEMATICIANS

as
Applied Science
Representatives
with

IBM

These are excellent positions requiring top level work as consultants and educators in the application of IBM electronic computing equipment to the most challenging problems of business and science.

The opportunities for growth in this vast new field are exciting.

Employment assignments are available in major cities throughout the United States.

Good salaries, excellent working conditions, exceptional employee benefits.

Minimum requirements: Major or graduate degree in Mathematics, Physics, or Engineering with Applied Mathematics equivalent.

Desirable, but not required: Previous experience in teaching applied mathematics and use of automatic computing equipment.

Write, giving full details, including experience and education, to

Dr. C. C. Hurd, Director
Applied Science Division
Room 105

INTERNATIONAL BUSINESS MACHINES
590 Madison Avenue
New York 22, N. Y.

ELECTRONIC ENGINEERS & PHYSICISTS

OUR STEADILY EXPANDING LABORATORY OPERATIONS ASSURE PERMANENT POSITIONS AND UNEXCELLED OPPORTUNITY FOR PROFESSIONAL GROWTH IN

RESEARCH - DEVELOPMENT - DESIGN

ELECTRONIC COUNTERMEASURES
RADAR SYSTEMS
MICROWAVE COMPONENTS
AIRBORNE ANTENNAS
MISSILE GUIDANCE CONTROL SYSTEMS
SOLID STATE PHYSICS
TELEVISION

THE EMPLOYMENT DEPT.

ADDRESS INQUIRIES TO: **CAPEHART FARNSWORTH CO.**
FORT WAYNE, IND.

COMPUTER Field Engineers

... the *Key* to your future

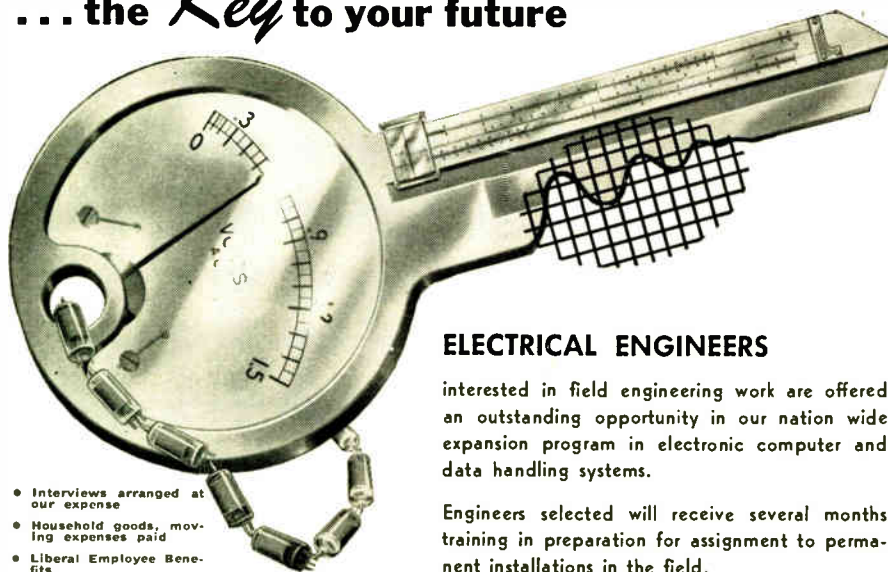

- Interviews arranged at our expense
- Household goods, moving expenses paid
- Liberal Employee Benefits

ELECTRICAL ENGINEERS

interested in field engineering work are offered an outstanding opportunity in our nation wide expansion program in electronic computer and data handling systems.

Engineers selected will receive several months training in preparation for assignment to permanent installations in the field.

Send written resume to:

Engineering Research Associates | Division of **Remington Rand**
1902 West Minnehaha Avenue, Dept. E-11, St. Paul W4, Minnesota

Positions Open

(Continued from page 108A)

FLIGHT INSTRUMENTATION

High ranking BS or MS in electrical engineering. 1 to 2 years' experience. Develop control equipment and recording instrumentation for use in full scale aircraft flight dynamics programs. Experience in servo-mechanisms and/or communication theory desired. Box 780.

MISSILE GUIDANCE

BSEE, with several years' experience in guidance. Duties will entail design, simulation and testing (static and dynamic) of components and complete systems. Base of operations is up-state New York, but applicants must be willing to spend several months at our test facility in the southwest. Box 781.

SENIOR ELECTRONIC ENGINEER

Physics or Electronic Engineer from a recognized university with at least 5 years' experience in electronic circuit design. British subject preferred. Salary commensurate with ability. Send resume to Chief Engineer, Cossor (Canada) Limited, 301 Windsor St., Halifax, N.S., Canada.

ENGINEER

The English Electric Company, Ltd., Luton, England have an interesting vacancy for work on the development of new ideas in microwave circuitry, waveguides and miniaturisation. Apply with full particulars and quoting ref. 1160c to Dept. C.P.S. 336/7 Strand, London W.C.2, England.

ELECTRONIC ENGINEER

An opportunity for young, versatile and ingenious electronic engineers to gain experience in the application of transistors to a wide variety of circuits is offered by the English Electric Company Ltd., Luton, England. Write with full details to Dept. C.P.S. 336/7 Strand, W.C.2 London, England quoting reference 1325.

ELECTRICAL ENGINEER

Electrical Engineer to conduct research pertaining to radar guidance systems. Some knowledge of modern statistics, information theory, radar plan position indicators and their interpretation. Preferably 3 to 5 years experience. Reply by resume to Personnel Dept., The Franklin Institute, Philadelphia 3, Pa.

ELECTRONIC ENGINEERS

Nationally known electronic component manufacturer desires services of graduate electrical engineers having 2-4 years experience in electronic field for product engineering work. Ability to coordinate with sales and manufacturing necessary. Submit resume or letter outlining education and experience to Employment Manager, Centralab Div., Globe-Union Inc., 900 E. Keefe Ave., Milwaukee, Wisconsin.

TELEVISION BROADCAST TECHNICIANS

CBS has openings in New York City for assistant technicians (\$78.00 per week) and full technicians (starting \$85.00 per week, progressing automatically in steps to \$104.00 after one year and \$165.00 after four years) in television studio operations and maintenance. Technical backgrounds and aptitude for operational work are required. Interviews by appointment will be required following written application to CBS Television Technical Operations, 524 West 57 St., New York, N.Y.

(Continued on page 112A)

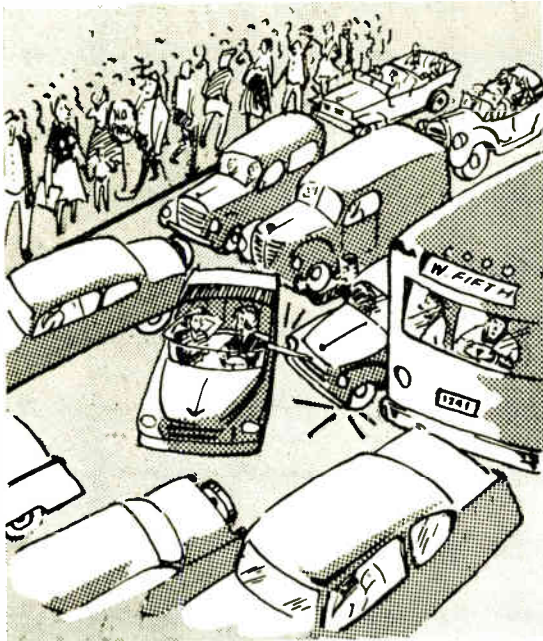

5:00 P.M.

BEDLAM

or the

BEACH ?

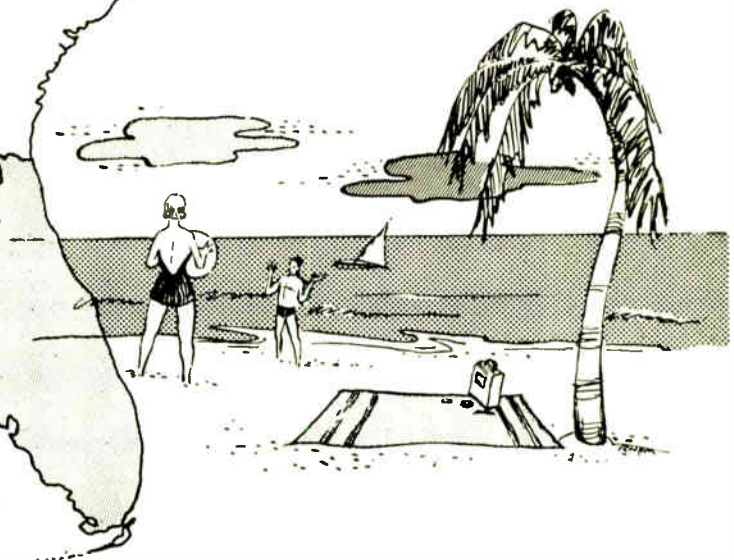

Does quitting time mean fighting traffic, inconvenience, and irritation? It can be mighty tiresome spending a large part of your day on commuting—time that could better be spent at the beach . . . or golf course . . . or fishing . . . or just relaxing.

Of course, here at RADIATION that's a problem we don't have. Our engineers can live close to the plant, even within walking distance, and still enjoy suburban living. And this Florida living is something to enjoy.

There are many such "bonuses" to living and working in Florida . . . low taxes, low living costs, comfortable and inexpensive housing, year 'round outdoor life, to mention but a few.

And, more important, are the opportunities offered

engineers by RADIATION, Inc. Engaged in electronic research and development in the fields of avionics, nucleonics, and automation, our work offers a challenge which provides our engineers with unlimited opportunity for future growth. Many of our projects involve problems new in concept and broad in scope . . . their successful solution often advances the state of the art.

Our engineers work in well-equipped, air-conditioned laboratories, associate with top-flight engineers and consultants, and enjoy the benefits of a 40-hour week, group insurance, and a progressive profit-sharing plan.

Qualified engineers interested in joining RADIATION are invited to submit resumes to the Director of Personnel, Drawer Q, Melbourne, Florida.



RADIATION Inc.

Electronic RESEARCH · DEVELOPMENT · PRODUCTION

Melbourne Fla.
Orlando Fla.

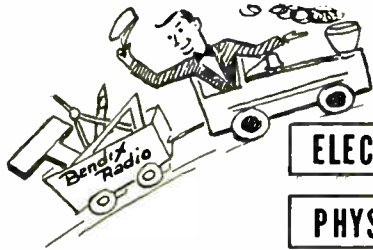

Full Steam Ahead

ELECTRONICS ENG.

PHYSICISTS

MECHANICAL ENG.

with
**BENDIX
RADIO**

It's full steam ahead at Bendix Radio . . . More work to be done! More experienced engineers needed! More interesting, challenging positions to be filled! Your future is bright when you join the efficient Bendix Radio team!

Excellent salaries.

Semi-annual work reviews with advancement on merit.

Modern, air-conditioned plant located in beautiful suburban area with ample housing, good schools, attractive shopping centers, major league sports.

Numerous employee benefits.

**Challenging work in
The development of:**

Radar (Airborne and Ground)

Auto Radio and Test Equip.

Airborne & Mobile Comm. Equip.

Missile Guidance Systems

Computer Applications

Research & Development

(Incl. Transistors and Printed Circuitry)

Call, wire or write Mr. L.H. Noggle, Dept. M

Bendix Radio

**DIVISION OF BENDIX AVIATION CORP.
BALTIMORE 4, MD.**

VALley 3-2200

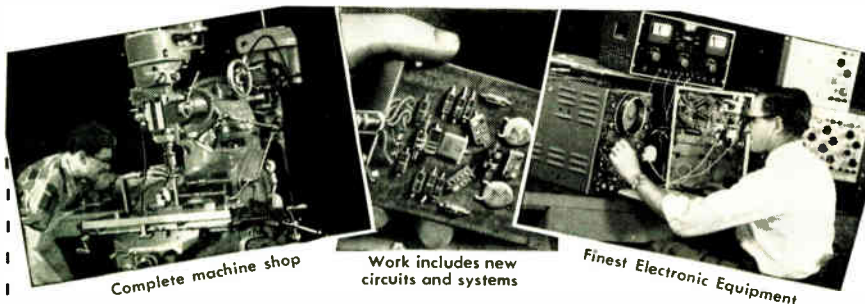

Complete machine shop

Work includes new circuits and systems

Finest Electronic Equipment

*Leaders and
Specialists in*

"ENGINEERING"

offered splendid opportunities in Boston Engineering Laboratory!

Men qualified to handle high level assignments in electronics are offered a challenging opportunity in Boston, under ideal working conditions divorced from production. The laboratory provides stimulating projects, an atmosphere of scientific progress and provides assistance towards your personal advancement or professional recognition. You will work with a top level technical staff possessing the finest facilities. Administrative positions are open to men qualified to guide the efforts of others.

MICROWAVE ENGINEERS

Senior engineers to handle design and development projects and provide technical direction of other top-level engineers working on microwave circuits and microwave plumbing in the development of military airborne electronic equipment. Should have 5 years' experience in such work and at least a BS degree.

**RADAR SYSTEMS AND
CIRCUIT ENGINEER**

To assume responsibility for electronic circuit design for major elements of complex airborne electronic equipment. Should have a BS degree and about 5 years' experience.

Sylvania provides financial support for advanced education as well as a liberal insurance, pension and medical program. Investigate a career with Sylvania.



INTERVIEWS BY APPOINTMENT

Don Bradley, Personnel Manager, Boston Engineering Lab.

SYLVANIA ELECTRIC PRODUCTS INC.

70 FORSYTH STREET • BOSTON, MASSACHUSETTS • KEnmore 6-8900

Positions Open

(Continued from page 110A)

ENGINEER

Young man wanted with college education, electrical and electronic training and sales experience for excellent sales position with one of nation's largest national electrical distributors. Location middle west. Products include broadcasting (AM, FM, TV) equipment, sound, vacuum tube, radio communication and industrial electronic parts. Position offers a conservative, steady, comfortable living backed by sickness, hospital and death benefits, liberal pension plan and company profit-sharing plan. Send summary of qualifications and background to Box 782.

**ELECTRONIC ENGINEERS AND
PHYSICISTS**

Opportunities for electronic engineers and physicists interested in research and development in the fields of microwave radar, digital computer components, telemetering, infrared spectroscopy, guided missile systems, guided missile fusing, and over-all evaluation of guided missiles. Work is well equipped, new laboratory in centrally-located rural area of southern California. For information, write to Personnel Director, Naval Ordnance Laboratory, Corona, Calif.



Positions Wanted By Armed Forces Veterans

In order to give a reasonably equal opportunity to all applicants and to avoid overcrowding of the corresponding column, the following rules have been adopted:

The Institute publishes free of charge notices of positions wanted by I.R.E. members who are now in the Service or have received an honorable discharge. Such notices should not have more than five lines. They may be inserted only after a lapse of one month or more following a previous insertion and the maximum number of insertions is three per year. The Institute necessarily reserves the right to decline any announcement without assignment of reason.

ENGINEER

BSEE (with honors) University of Illinois, 1951. Part credit towards MS. Age 26, married, 2 children. 2 years Navy electronic technician. 2½ years R.&D. experience in military servo applications (missiles, flight simulators, analog computers). Desires position as research engineer with an organization engaged in the application of feedback control to industrial processes. Midwest location preferred. Box 739 W.

**ADVERTISING & PUBLIC RELATIONS
MANAGER**

BS Engineering/Bus. Adm., MBA Marketing. 10 years progressive experience in all phases of industrial promotion: program planning, budgeting & administration, agency and media liaison, space and promotional copy planning, writing and editing, pamphlets & brochures, technical publicity. Press, industry & Government relations. Licensed radio operator with background in radio and electronic equipment promotion. Age 34. Box 740 W.

Positions Wanted

ELECTRONIC SCIENTIST—PHYSICIST

BS, MA credit Columbia University. Age 37, married. 12 years experience in circuitry, antennas and propagation, upper atmosphere research, countermeasures and electron tubes. Patents, member of three national committees. Organizer and head of large R & D section. Desires responsible, creative and challenging R & D position, preferably electron tubes. Prefer west coast, New England. Box 741 W.

SENIOR ELECTRONICS ENGINEER

Senior electronics engineer, presently project leader on 6 figure Air Force development contract. BEE, MEE, Tau Beta Pi. Under 30, married. Experience in UHF, servos, digital techniques, contract negotiation. Desires responsible position. Will relocate anywhere in east. Box 742 W.

JUNIOR ELECTRONICS ENGINEER

Age 28, USN. ETN 2/c. BEE Pratt Institute. Experience: 2½ years electronic technician and inspector. 2 years TV repair. Interested in testing and development in New York area. Box 743 W.

ENGINEER

BSEE; recent M.B.A. (ind. Mgt.). 6 years experience, largely technical, with some administration and customer contact. Desires work in administration, sales or product development. Prefer western U. S. location. Box 744 W.

ATTORNEY—ENGINEER

Age 39. Seeks position utilizing broad background. BSEE 1937. LL.B. 1954. 17 years engineering experience: electrical construction and maintenance, steel mill; World War II Lt. Colonel, Corps of Engineers; electronic development and design; radio communications. TV broadcasting and missile control. Box 753 W.

ENGINEER

Age 34, married, 2 children. BSME Mass. Institute of Technology 1942, Tau Beta Pi. Graduate work in mathematics and servomechanisms. 1½ years packaging machinery design; 6½ years in instrumentation research development and management including personnel, patents, contracts, sales, etc. Currently full time consulting work for company investigating entry into electronic field. Interested in administrative engineering position in electromechanical development and promotion. Box 754 W.

PHYSICAL CHEMIST—INSTRUMENTALIST

Ph.D. Physical Chemistry June 1954. 4 years teaching experience. 3 years experience in the design and construction of electronic instruments. Interested in photoconductivity and photoluminescence but versatile. Age 26, married, veteran. Box 756 W.

ELECTRONICS DEVELOPMENT ENGINEER

BEE 1950, age 29. 2 years experience in guided missile research and development; 1 year development work in geophysical instrumentation. Desires to continue research or development work with company on west coast. Box 757 W.

(Continued on page 115A)

PHYSICISTS RESEARCH ENGINEERS

THE RADIATION LABORATORY OF THE JOHNS HOPKINS UNIVERSITY HAS POSITIONS FOR PHYSICISTS AND ENGINEERS IN THE FIELDS OF:

- SYSTEMS ANALYSIS
- INFRARED TECHNIQUES
- ELECTRONIC CIRCUITS
- MICROWAVES
- STATISTICAL COMMUNICATION THEORY

THIS UNIVERSITY LABORATORY OFFERS A VARIETY OF INTERESTING PROBLEMS IN ADVANCED ELECTRONICS FOR QUALIFIED SENIOR MEN CAPABLE OF CREATIVE RESEARCH AND DEVELOPMENT EFFORT
A POSITION HERE MEANS:

- Favorable Arrangements for Advanced Study in the Graduate Schools
- Faculty Rank and Privileges for Senior Staff
- One Month Vacation
- Excellent Laboratory Facilities Located Near the University Campus
- Good Growth and Promotional Possibilities

RADIATION LABORATORY THE JOHNS HOPKINS UNIVERSITY

HOMEWOOD CAMPUS

BALTIMORE 18, MD.

Stability and opportunity for ELECTRONIC ENGINEERS at the "Laboratory in the Sky"

One of America's leading centers of long-range radio and electronic developments offers outstanding opportunities for accomplishment, advancement and stability. Write for booklet describing projects, facilities and employee benefits.

INTERESTING ASSIGNMENTS IN:

Microwave Links • Pulse Networks • Radar
Direction Finders • Air Navigation Systems
Television Transmitters and Studio Equipment
Antennas • Computers • Guided Missiles
Telephone and Wire Transmission Systems
Microwave and Gas Discharge Tubes • Dielectrics

MAIL THIS COUPON TODAY

*Federal
Telecommunication
Laboratories*

A Division of International Telephone
and Telegraph Corporation



Federal Telecommunication IR-8
Laboratories
500 Washington Ave., Nutley, N. J.
Please send me a copy of "Your
future is with FTL."

Name _____
Address _____
City _____ Zone _____ State _____

NORDEN

**OFFERS UNUSUAL
OPPORTUNITIES FOR
COMPETENT ENGINEERS**

**Electronic
Mechanical
Electro-Mechanical**

**FOR RESEARCH
AND DEVELOPMENT
WORK ON**

Servo Mechanisms

Microwave Equipment

Antennas

Infrared Equipment

Communications Equipment

Computers

Gyroscopes

Radar

- Liberal Hospitalization Plan
- Merit Salary Reviews
- Excellent Working Conditions
- Ideally located in Westchester County

•
Please telephone or send resume and salary requirements to the Personnel Department. All inquiries will be handled in confidence.

•
**THE
NORDEN LABORATORIES
CORPORATION**

**121 Westmoreland Avenue
White Plains, New York
White Plains 6-4300**

An assurance is required that the relocation of an applicant will not cause disruption of an urgent military project.

ENGINEERS DESIGNERS

Investigate opportunities at **ERCO**

**ENGINEERING
& RESEARCH
CORPORATION**

DRAFTSMEN

We point to our achievements at ERCO with pride . . . to the Ercoupe, our electronic flight simulators, machine tools, and armament products, which we have designed and built . . . to the plant which offers diversified tools for electro-mechanical and mechanical fabrications, enabling us to build what we design . . . to the men who work at ERCO and who have made this progress possible.

But we are constantly on the alert for new men to add fresh impetus to that progress . . . paying top salaries to capable people.

ERCO is convenient too—whether you drive, ride, or fly. Transit and railway lines are handy, parking facilities are ample, and ERCO Field is available to those who fly.

You can choose a home from a number of fine nearby residential areas convenient to both shopping centers and plant . . . and you can further your education at the many nearby universities.

You will find that although ERCO is the largest privately owned design and manufacturing plant in the Washington area, it is small enough to recognize and reward individual initiative.

ERCO now needs Electronic Engineers (all levels with some overseas positions available), Aerodynamicists, Computer Engineers, Mechanical Designers, and Machinery Designers. For further information, call WA. 7-4444—ext. 106.

ENGINEERING AND RESEARCH CORPORATION
RIVERDALE · MARYLAND



Electronic Engineering Company of California

The Electronic Engineering Company of California is an independent firm engaged in the design, development and fabrication of electronic equipment for private industry and the Armed Forces. Founded and managed by electronic engineers, the Electronic Engineering Company offers a broad background of experience, highly trained personnel, excellent facilities plus a well integrated, expanding organization.

The Electronic Engineering Company has openings for engineers with experience and background in industrial and military electronics.

Please send resume of experience and education with salary requirements to:

Electronic Engineering Company of California
100 SOUTH ALVARADO STREET
LOS ANGELES · 57 · CALIFORNIA

PHYSICIST

Experienced physicist or electronics engineer with Ph.D. degree for development work on electronic tubes. Minimum of five to ten years experience in this field is prerequisite. Send complete resume or apply in person to:

Research Division

NATIONAL UNION ELECTRIC CORP.
350 Scotland Rd. Orange, N.J.

Positions Wanted

(Continued from page 113A)

ELECTRONICS SCIENTIST

BA degree, Physics; 6 months at Harvard and M.I.T., wartime radar schools. Experience includes 3 years Army radar officer; 1½ years instrumentation technician in nuclear research; 3 years of electronics research; 2 years analyst and consulting engineer for military communications intelligence agency; 1½ years owner of general electronics service company. Desires position in any phase of electronics field with good opportunity for advancement. Box 758 W.

ELECTRONICS ENGINEER

Desires technical, sales or administrative position with expanding organization inside or outside U.S.A. 7 years experience in electronics including research and development, technical writing, supervisory responsibilities, and 3 years of systems engineering. BS in physics and graduate courses in E.E. Age 34, married. Box 759 W.

ENGINEER

BSEE, Tau Beta Pi, 1951. Age 29, single. 3 years Navy Electronic Technician. 3 years experience in electronic circuit design and development. Desires position as application or sales engineer. Will relocate any place in east. Box 772 W.

ENGINEER

BSEE with 2 years experience in fire control system calibration, 2 years in field service on computer, radar and hydraulic transmissions; 2 years U.S. Navy electronic technician. Desires position as sales engineer or manufacturer's representative. Age 28, married. Prefer west, south or midwest location. Box 773 W.

(Continued on page 117A)

ELECTRONIC ENGINEERS

**ADVANCE YOUR CAREER
WITH A LEADER IN
WESTERN ELECTRONICS**

An expanding program of:

- research • development
- production
- specialized military equipment
- advanced commercial design
- real creative challenge

Special receivers and transmitters, DF and DME, various instruments and Transistor applications—special devices. Studies in noise, radar, miniaturization and test equipment. Relocating expenses, good insurance plan, central location, steady advancement.

Send resume to L. D. Stearns
Engineering Employment Manager

Hoffman

LABORATORIES, INC.

(SUBSIDIARY OF HOFFMAN RADIO CORP.)

3761 S. HILL ST., LOS ANGELES,
CALIF.



SPECIAL OPPORTUNITIES FOR ELECTRONIC ENGINEERS

Convair in beautiful, sunny San Diego invites you to join an "engineers" engineering department. Interesting, challenging, essential long-range projects in missiles, engineering research and electronics development. Positions open in these specialized fields:

Microwave Antennae	Dynamics Testing
Microwave Components	Telemetry
Electronic Packaging	Servomechanisms
Mathematical Physics	Electron Tubes
Electronic Components	Radome Design
Electronic Systems	Digital Computers
Applied Mathematics	Test Equipment
Transmitters & Receivers	Miniature Circuits

Generous travel allowances to those accepted. For free brochure, write Mr. H. T. Brooks, Engineering Dept. 800

CONVAIR

IN BEAUTIFUL
SAN DIEGO

Division of General Dynamics

3302 PACIFIC HIWAY
SAN DIEGO 12, CALIFORNIA



advanced electronics developments
create new opportunities for engineers
at General Electric

▶ **ENGINEERS
PHYSICISTS**

New revolutionary developments are under way at General Electric. Behind each advance are the General Electric engineers . . . working with the finest facilities . . . exploring the most challenging aspects of their field . . . knowing the sense of stability and progress their work provides.

And, with each new advance, broadening the scope of electronics . . . new challenges, new opportunities constantly arise.

The opportunity is ever-growing at General Electric. And, an excellent salary and liberal benefits are other advantages worth knowing about.

Experience required in the following fields:

*Advanced Development, Design, Field Service
and Technical Writing in connection with:*

**MILITARY RADIO & RADAR MULTIPLEX MICROWAVE
MOBILE COMMUNICATION COMMUNICATIONS
ELECTRONIC COMPONENTS
TELEVISION, TUBES & ANTENNAS**

Bachelor's or advanced degrees in Electrical or Mechanical Engineering, Physics, and/or experience in electronics industry necessary.

Please send resume to: Dept. 8-4-P, Technical Personnel

GENERAL  ELECTRIC

ELECTRONICS PARK, SYRACUSE, N. Y.

FORD

**DEVELOPMENT
ENGINEERS**

FOR: Design Engineering, Practical Research,
Investigations of Theories, Functional Analysis

An interesting challenge for senior design engineers to work directly with top project supervisors helping through the prototype stage new developments in:

- Automatic Control Instruments
- Airborne Armament Systems
- Electronic Navigational Aids
- Guided Missile Controls
- Magnetic Amplifiers
- Computing Equipment

For these jobs we are interested in men with two or more years experience in electro-mechanical work related to the above fields or in men with superior scholastic records in physics, electrical, electronic or mechanical engineering.

YOU'LL LIKE WORKING AT FORD INSTRUMENT

- Not too large, not too small
- Pension Plan
- Stable but progressive company
- Nine Paid Holidays
- N. Y. C. location with all its additional varied opportunities
- Two Weeks vacation with pay
- Above-average fringe benefits
- Tuition assistance for further related studies

Our policy of permanency of positions and continuity of service does not allow us to employ engineers unless there is a *clear and definite need for them projected years into the future*. And we promote from within. If you can qualify, we urge you to contact by mail, or if in N. Y. C. phone:

Mr. P. F. McCaffrey, Stillwell 4-9000, Extension 416

FORD INSTRUMENT COMPANY

Division of the Sperry Corporation

31-10 Thomson Ave., Long Island City, N. Y. (20 minutes from the heart of New York City)

**Electronic
and
Mechanical Engineers!**

Motorola Research Laboratories, located in the healthful climate of Arizona's Valley of the Sun, has several openings for experienced engineers in the following fields:

Electronic research and development for missile guidance, radar and VHF communications.

Mechanical design of missile-borne and vehicular electronics equipment.

Analysis and laboratory work involving development of new types of airborne and ground radiators and waveguide components.

VHF and microwave antenna and waveguide circuitry.

Transistor development

Desire men with B.S. degree or above. Salary commensurate with education and experience. Free health, accident and life insurance. Free hospitalization. Profit sharing. Paid holidays. Sick leave. Vacations. Ideal working conditions. Plenty of housing, reasonably priced. Excellent schools. Exceptionally mild and dry winter climate.

WRITE: J. A. Chambers, Manager
Motorola Research Laboratory
3102 North 56th Street
Phoenix, Arizona

Positions Wanted

(Continued from page 115A)

SALES OR LIAISON ENGINEER

BEE 1948, 80% of MSc in applied mathematics to date; Licensed professional engineer, N.Y. Age 30, married, one heir. 6 years diversified experience military comm. and electronics. Desires challenging sales or liaison opportunity. Salary requirement modest, secondary to large potential. Box 774 W.

ENGINEER

BEE Rensselaer Polytechnic Institute (Communications) 1950. Age 28, married. 2½ years Navy FC 2/c. 4 years field engineering experience with fire control, Communication, and television equipments. Desires position with future in design or development work. Box 775 W.

ELECTRONICS ENGINEER

BEE Polytechnic Institute of Brooklyn 1954, age 32, married, veteran. 5 years field engineering and supervision (35) men, radio, radar and sonar systems, including classified projects; 2 years industrial electronics design and development; 3 years broad electro-mechanical experience. Desires development and/or production engineering position, N. Y. metropolitan area preferred. Box 776 W.

ENGINEER

BEE in power and radio engineering. 9 years experience in repair, design and development of mechanical, electrical and electronic equipment. Lieut. U.S. Navy. Familiar with aircraft and aircraft auxiliaries. Personnel experience. Age 31, married. Desires interesting and responsible position. Available October. Box 777 W.

ENGINEER

BEE, electronics option, University of Michigan, 1951. Age 26, married, 2 children. Experience in test equipment and flight simulators. Interested in design and development. Resume upon request. Box 760 W.

SALES ENGINEER

BEE, ten years experience in all phases of military electronics. Desires a challenging opportunity in a sales capacity with progressive firm. Metropolitan New York area. Box 778 W.



The following transfers and admissions were approved to be effective as of July 1, 1954:

Transfer to Senior Member

- Aksim, V. E., 216 Dovercourt Ave., Ottawa, Ont., Canada
Bachman, W. S., 26 Spruce St., Southport, Conn.
Backer, C. M., Philco Corp., 4700 Wissahickon Ave., Philadelphia 44, Pa.
Bagno, S. M., 4318 Van Dam St., Long Island City 1, L. I., N. Y.
Binns, J. R., 58-25 Little Neck Pkwy., Little Neck 62, L. I., N. Y.
Bird, G. T., Idylwood Rd., Falls Church, Va.
(Continued on page 119A)

A program of

SUPPORTING RESEARCH

The Ramo-Wooldridge Corporation has established a major policy of maintaining a strong program of supporting research in fields related to the company's major technical areas of activity, but not otherwise directly associated with development projects. Approximately ten percent of the total technical effort of the company will be allocated to general research work, to help insure the maintenance of advanced standards of scientific and engineering competence throughout the organization.

Positions are now available for scientists and research engineers to work in the following fields:

Information theory
Digital computer theory
Servo theory
Propagation of electromagnetic waves
Microwave resonance phenomena
Magnetic devices—
amplifiers, ferrites, memory elements

The Ramo-Wooldridge Corporation

8820 BELLANCA AVENUE
LOS ANGELES 45, CALIFORNIA

Pacific Semiconductors, Inc., while a new company, is organized around a central group of scientists, engineers, and administrators who have unusual records of recent accomplishment in the semiconductor field. Backed by several millions of dollars of corporate financing, rapid progress is anticipated in the development, manufacture and sale of semiconductor devices of advanced design, including diodes and transistors.

Positions are now available for semiconductor physicists, transistor circuit engineers, sales and application engineers, and experienced semiconductor research assistants.

PACIFIC SEMICONDUCTORS, INC.

6316 W. 92nd Street

Los Angeles 45, California

a subsidiary of

The Ramo-Wooldridge Corporation

The Fairchild
Guided Missiles Division
Has Created Several Interesting
Openings for

A FEW TOP ENGINEERS

Who Would Welcome
an Opportunity of Making
Individual Contributions
to Important Military and
Industrial Development Programs

The openings are
new positions
in two categories:

Research and Development—M.S. required, Ph. D. in E. E. or Physics preferred. Minimum of five years experience in circuit design, computer technique, radar development, industrial instrumentation. Unlimited opportunity for original contribution. Modern, completely equipped laboratory in a major division of a fast-growing corporation, with both military and industrial products.

Systems Engineering—M.S. in E.E. or A.E. with five years experience in guided missiles or electronic systems. Opportunity to participate at responsible level in systems design and testing activity. Moderate sized group provides opportunity for individual recognition, coupled with all large company advantages.



Excellent housing available in area.
Convenient to New York City.
Wonderful recreational facilities. Fine
beaches, fishing, boating, golfing.

Send resumes to Personnel Manager



ENGINE AND AIRPLANE CORPORATION
FAIRCHILD
Guided Missiles Division
WYANDANCH, N. Y.

National Research Council requires a PATENT OFFICER at Ottawa

The successful applicant will be required to undertake various duties dealing with Patent applications in the Electronic field.

University graduation in Engineering Physics, Electrical Engineering, or Physics, with specialization in Electronics is required. Pertinent experience desirable but not essential.

Initial salary up to \$4,620 per annum depending on qualifications.

Apply by letter giving full details of education and experience to the Employment Officer, National Research Council, Sussex Street, Ottawa, Ontario.

Preference will be given to Canadian citizens.

AERONAUTICAL RADIO, INC. offers work in RELIABILITY—KEY TO THE FUTURE OF ELECTRONICS

Growing numbers of electronics engineers are recognizing the critical importance of reliability in future expansion of the uses of electronics. ARINC, a pioneer and leader in the search for reliability, has a few select openings for well-qualified engineers of good educational background and work experience. Positions are available both in the field-investigation and headquarters-analysis phases of an important reliability project, with possibility of some overseas assignments. This work will appeal to those with a sound knowledge of electron tubes and/or circuitry, and with an interest in using engineering funda-

mentals and original thought to solve problems in design, application, maintenance, and many other areas of electronics.

ARINC also invites inquiries from technical writers capable of editing, rewriting, and supervising publication of narrative-type engineering reports. A clear, straightforward writing style and a meticulous regard for accuracy and integrity of the basic material are absolute essentials.

All replies will be held in confidence. Address resume of experience and education to Mr. J. W. Dunkel.

Box 786, Institute of Radio Engineers
1 East 79th St., New York 21, N.Y.

ENGINEERS EE and ME PHYSICISTS DESIGNERS

1. For Development and Field Service of airborne navigational instruments.
2. For Development and Design of magnetic recording systems.

Remember these
Kollsman advantages:
The most modern facilities
in a clean, conveniently
located plant; a
congenial atmosphere
in which you can do your
best work; interesting and
diversified assignments in the
design and development of
America's finest aircraft
instruments.

Please submit resumes to:
Employment Manager



KOLLSMAN Instrument Corp.

80-08 45th Ave., Elmhurst,
Long Island, N.Y.



(Continued from page 117A)

- Blon, J. L., San Martin 379, Buenos Aires, Argentina
- Brooks, F. E., Jr., 4310 Airport Blvd., Austin 2, Tex.
- Carpantier, V. J., 2111 San Rae Dr., Dayton 9, Ohio
- Caswell, J. N., 117 Willow St., Garden City, L. I., N. Y.
- Constant, P. C., Jr., 3014 E. Meyer Blvd., Kansas City, 30, Mo.
- Cronvich, J. A., Electrical Engineering Department, Tulane University, New Orleans 18, La.
- Dixon, J. T., 913 Rollins Dr., Bucknell Manor, Alexandria, Va.
- Giffin, K. A., 744 Ammar Ave., Pacific Palisades, Calif.
- Gildersleeve, R. E., 632 Jamesville Ave., Syracuse 10, N. Y.
- Graber, L. J., 158 Albertson Pl., Mineola, L. I., N. Y.
- Halstead, W. K., 128 Locust Grove Rd., Rosemont, Pa.
- Henke, W. G., 5115 Drummond Pl., Chicago 39, Ill.
- Hill, W. R., Jr., Electrical Engineering Department, University of Washington, Seattle 5, Wash.
- Hulst, G. D., 37 College Ave., Upper Montclair, N. J.
- Kegel, A. G., Air Arm Division, Engineer, Westinghouse Electric Corp., Friendship International Airport, Baltimore, Md.
- Klopfenstein, R. W., 142 Spruce St., Princeton, N. J.
- Krausz, R., Stanford Research Institute, 4000 Mount Lee Dr., Los Angeles 28, Calif.
- Merwin, R. L., Jr., 601 E. Third, Dayton 2, Ohio
- Morrin, T. H., Engineering Department, Stanford Research Institute, Stanford, Calif.
- Moseley, S. T., 108 Peck Court, University Heights, Syracuse 10, N. Y.
- Newman, S. O., 1504 S. Meadow Rd., East Meadow, L. I., N. Y.
- Olding, N. R., Canadian Broadcasting Corp., Box 6000, Montreal, Que., Canada
- Oliver, J. K., Aeronautical Electronic Laboratory, Naval Air Development Center, Johnsville, Pa.
- Plotkin, L. E., 3222 Mansfield Ave., S.E., Cedar Rapids, Iowa
- Purnell, L. S., 25 Tanager La., Levittown, L. I., N. Y.
- Quatenan, M. H., 7238 N. Meade Ave., Chicago 30, Ill.
- Raabe, H. P., 202 Park Dr., Dayton 10, Ohio
- Richmond, A. E., Box 441, Portland 7, Ore.
- Ropiequet, R. L., 2645 S.W. Austin Rd., Portland, Ore.
- Rossoff, A. L., 188 Surrey Commons, Lynbrook, L. I., N. Y.
- Rothstein, J., 21 E. Bergen Pl., Red Bank, N. J.
- Schoenfuss, A. F., 96 Winifred Dr., North Merrick, L. I., N. Y.
- Sharp, H., Box 960, Denver 1, Colo.
- Shontz, L. A., Jr., 5401 Lane Rd., Kansas City 29, Mo.
- Staake, D. B., 4531 Everett St., Kensington, Md.
- Stout, T. M., Electrical Engineering Department, University of Washington, Seattle 5, Wash.
- Tajima, G. K., 6277 Taft Ave., Richmond 9, Calif.
- Ziegler, F. W., Sperry Gyroscope Co., Great Neck, L. I., N. Y.

Admission to Senior Member

Ackermann, E. G., Obernkirchen 520, Admiral Scheer Strasse, Grafschaft, Schaumburg, Germany

(Continued on page 120A)



*Career-chance
of a lifetime for*

**RESEARCH
and DESIGN
SPECIALISTS**

in LOCKHEED'S expanding Missile Systems Division

Recently formed from other Lockheed engineering organizations to prepare for the era of automatic flight, Lockheed's Missile Systems Division has a few openings for highly-qualified specialists in research, design and proposal work.

The type of work involved in the Division's contracts—along with its expansion program—makes these openings outstanding opportunities for achievement. The positions call for engineers of senior or group leader level. Engineers who qualify probably have worked on missile, radar-computer, counter-measure, IFF, AMTI or similar projects.

LOCKHEED has openings for:

Research Specialists

with broad experience in missile guidance problems, missile proposal work, control system analysis and evaluation, and servo-mechanisms. Strong electronics and electro-mechanical background needed.

Design Specialists

with broad experience in missile proposal work and systems analysis. The positions also require experience in missile design, electronics, communications, microwave techniques, systems evaluation, airframe design, aerodynamics, structures and mechanics.

In addition to outstanding career opportunities, the Missile Systems Division offers you excellent salaries commensurate with your experience, generous travel and moving allowances, an unusually wide range of employee benefits and a chance for you and your family to enjoy life in Southern California.

Coupon below is for your convenience.

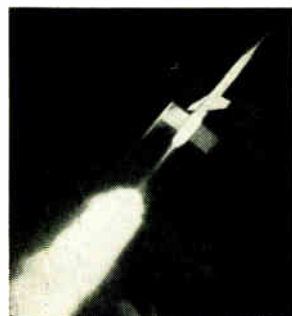

L. R. Osgood Dept. IRE-M-8

LOCKHEED MISSILE SYSTEMS DIVISION
7701 Woodley Avenue, Van Nuys, California

Dear Sir: Please send me information on the Missile Systems Division.

name _____

field of engineering _____

street address _____

city and state _____

engineers ... physicists ... STYMIED?

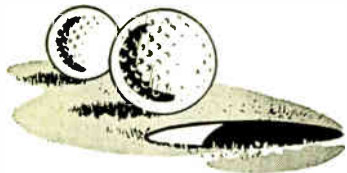

Have you come to a standstill in your work — future stymied?

Then by all means let us tell you about Melpar and the interesting assignments it can offer qualified men. We're increasing our engineering staff again . . . for the eighth consecutive year — and that means a real "ground-floor opportunity" for you.

We have a variety of challenging project assignments, both military and commercial including the following:

- Data Handling Equipment (*magnetic cores, magnetic recording equipment, digital computing techniques, analogue to digital conversion, shaft digitizers*)
- Flight Simulation (*servomechanisms, pulse, circuitry, electronic cabling*)
- High Frequency Antennas
- Audio and Video Circuit Design
- Small Mechanisms Design
- Mechanical Packaging of Electronic Components
- Measuring Techniques and fundamental investigations of the behavior of Mechanical Systems
- Radioactive Tracer Techniques
- Instrumentation and Control Devices (*servo, pneumatic and electric control*)

A grand future awaits you at Melpar — and pleasant living in the delightful suburbs of the Nation's Capital. Write us today for personal interview in your locality.

Address Personnel Director

melpar
INCORPORATED

440 Swann Avenue
Alexandria, Virginia
or Galen Street
Watertown, Mass.

A SUBSIDIARY OF THE
WESTINGHOUSE AIR BRAKE CO.



(Continued from page 119A)

Baird, J., General Electric Co., Ithaca, N. Y.
Berger, J., 8021 S. Dante Ave., Chicago 19, Ill.
Bergeson, A. H., Box 73, Lexington 73, Mass.
Borck, C. A., 463 Pelham Rd., New Rochelle, N. Y.
Caldes, W. E., 3101—37 Pl., Sandia Base, Albuquerque, N. Mex.
Cohen, R. M., 37 Charles St., Belleville 9, N. J.
Collins, G. E., 2804 John, Fort Wayne 5, Ind.
Corderman, W. P., 1030—26 Rd., S., Arlington 2, Va.
Cordrey, E. E., R.F.D. 1, Cabot, Ark.
Gray, W. A., 165 Western Dr., Short Hills, N. J.
Hadlock, C. F., 41 Bellington St., Arlington, Mass.
Hugenholz, E. H., 22 Marchwood Dr., Wilson Heights, Toronto, Ont., Canada
Hurford, A. F., 3196 W. Sandia Dr., Sandia Base, Albuquerque, N. Mex.
Jesty, L. C., "The Barn," Church Rd., Burnhamon-Crouch, Essex, England
Karstad, K., RCA Laboratories Division, Princeton, N. J.
LaRue, A. D., 75 Simonds Rd., Lexington 73, Mass.
Nalbantian, J. H., 303 Slocum Ave., Syracuse 4, N. Y.
Silk, N. R., 2116 Montezuma Ave., Alhambra, Calif.
Tarboux, J. G., Rm. 2503, East Engineering, University of Michigan, Ann Arbor, Mich.
Tweeddale, J. E., 12 Hamilton Pl., Garden City, L. I., N. Y.
Watt, A. D., National Bureau of Standards, Boulder, Colo.
Williams, N. T., 36 Hawthorne Ave., Bloomfield, N. J.
Zazvorka, J. Jr., 337 Pasadena Pl., Corpus Christi, Tex.

Transfer to Member

Akers, R. F., 604 E. Juniper St., Oxnard, Calif.
Ball, J. D., 1444 Arlington, Houston 8, Tex.
Bendett, R. M., 110-34—62 Dr., Forest Hills 75, L. I., N. Y.
Blake, J. T., Apt. 1-F, 1 Marshall St., Irvington, N. J.
Boyle, J. M., 205 B Entwistle, USNOTS, China Lake, Calif.
Brock, W. R., 4235 N. Oakley, Chicago 18, Ill.
Chernof, J., 8651 Wyngate St., Sunland, Calif.
Clark, C. M., 532 Princeton Cir., W., Fullerton, Calif.
Gillen, R. G., 122 Sunnyside Blvd., Dumont, N. J.
Harris, J. E., Jr., Melpar, Inc., 452 Swann Ave., Alexandria, Va.
Heberling, W. W., Jr., 9 Floyd Ave., Bloomfield, N. J.
Hoffman, S., 2731 Burkshire Ave., Los Angeles 64, Calif.
Hylas, A. E., 90 Hazel St., Clifton, N. J.
Johnson, J. R., 464 Pleasant Valley Rd., Poughkeepsie, N. Y.
Kaufman, I., 1254 Lake Shore Dr., Massapequa Park, L. I., N. Y.
King, E. J., 233 Linden Ave., Towson 4, Md.
Kirsch, H. A., 528-K Nimitz Ave., China Lake, Calif.
LaHiff, W. J., 612 West 144 St., New York, N. Y.
Lester, P. S., Box 202, San Diego 12, Calif.
Miller, M. M., 10 Owen St., Mattapan, Mass.
Moore, C. H., 214 Pershing Rd., Raleigh, N. C.
Pantek, H. R., 407 E. Kingsley, Ann Arbor, Mich.
Pyle, M. O., 224 Hickory La., Haddonfield, N. J.
Reust, R. H., 17320 Ohio Dr., Detroit 21, Mich.
Shepard, E. S., Jr., 5716 N. 19 St., Phoenix, Ariz.
Stevens, R. W., 2748 Mansfield Dr., Burbank, Calif.
Tejuja, M. M., 29, Negandi Nagar, Sitladevi Temple Rd., Mahim, Bombay 16, India
Whitten, C. L., Western Electric Engineer, c/o Post Ordnance Officer, Fort Niagara, Youngstown, N. Y.
Wiggins, E. T., 8515-D Crenshaw Blvd., Inglewood, Calif.

(Continued on page 122A)

ELECTRONICS RESEARCH ENGINEER

To head newly formed electronics section of expanding research division for large, stable New England optical goods manufacturer.

Approximately ten years broad experience in electronics and applications, particularly instrumentation, desired. Some knowledge of optics helpful but not essential. Advanced degree preferable. Substantial salary and fringe benefits. Ideal working and living conditions. Work largely commercial rather than government.

Please submit full resume and salary requirements to

Box 785
INSTITUTE OF RADIO
ENGINEERS
1 East 79th Street
New York 21, N.Y.

TUBE ENGINEERS FOR SYLVANIA

Five or more years' experience on tube development. Familiarity with Microwave Tube development particularly desirable.

Work in Sylvania's expanding Traveling Wave Tube Development Program at the

Research Laboratories
SYLVANIA
ELECTRIC PRODUCTS INC.
Bayside, Long Island, N.Y.

... where you can live and work in New York's finest residential area

Please send resume of experience to
E. W. Doty
Manager of Personnel

ELECTRONICS ENGINEERS AND APPLIED PHYSICISTS

For a long-range research and development program in air armament. Interested in both senior and junior men for work on:

Infrared systems and components,
Simulators and computers,
Ordnance and ordnance test equipment, and

Instrumentation for aircraft and missile test ranges. (Locate in Chicago or Florida.)

Complete, modern laboratory and shop facilities. Professional atmosphere on a university campus, with salaries equivalent to industry. Liberal vacation and other benefits. U.S. citizenship required. Send brief resume with request for application form to:

Scientific Personnel Office

CHICAGO MIDWAY LABORATORIES
The University of Chicago

6040 South Greenwood Avenue
Chicago 37, Illinois



ENGINEERS

Have you developed a "Success Perspective"?

If a year or two of practical experience has given you the youthful maturity that demands more than just a job, you may be interested in our "career opportunities" in color TV, crystal products and electronic tubes.

Submit resume or address request for personal interview to D. Bellat, Personnel Director.

TUNG-SOL ELECTRIC INC.
200 Bloomfield Avenue
Bloomfield, N.J.

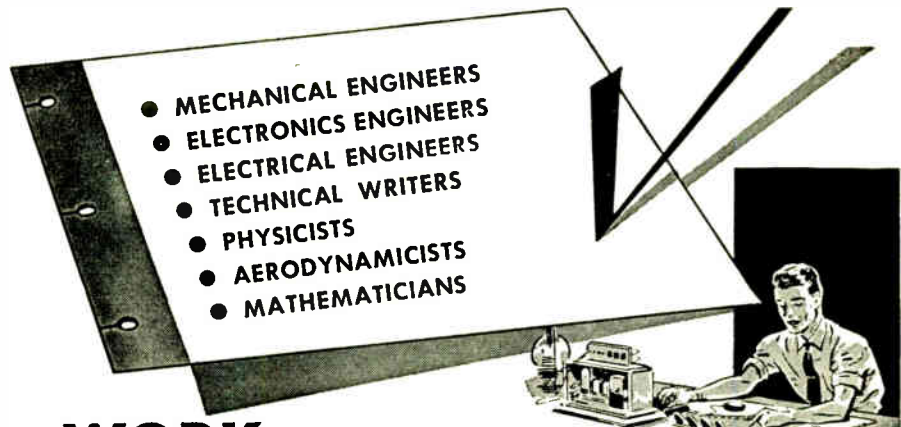

WORK ON THE FRONT LINE OF THE NATION'S VITAL DEFENSE PROGRAM. Sandia Corporation is engaged in the development and production of atomic weapons—a challenging new field that offers opportunities in research and development to men with Bachelor's or advanced degrees, with or without applicable experience. Here you can work with able colleagues, eminent consultants and superior facilities on advanced projects of high importance — and also build a permanent career in a rapidly expanding field with a company that recognizes individual ability and initiative.

LIVE IN ALBUQUERQUE, THE HEART OF THE SUNNY SOUTHWEST. Located in the historic Rio Grande Valley at the foot of the Sandia Mountains, mile-high Albuquerque is famous for its climate—mild, dry and sunny the year around. A modern, cosmopolitan city of 150,000, Albuquerque offers unique advantages as a place in which to live. Albuquerque's schools, churches, theaters, parks, and modern shopping facilities afford advantages of metropolitan life—yet hunting, fishing, skiing and a multitude of scenic and historic attractions may all be found within a few hours' drive of the city. New residents have little difficulty in obtaining adequate housing.

ENJOY THESE OTHER IMPORTANT ADVANTAGES. These are permanent positions with Sandia Corporation, a subsidiary of the Western Electric Company, which operates Sandia Laboratory under contract with the Atomic Energy Commission. Working conditions are excellent, and salaries are commensurate with qualifications. Liberal employee benefits include paid vacations, sickness benefits, group life insurance, and a contributory retirement plan. This is not a Civil Service appointment.



Make Application to:

PROFESSIONAL EMPLOYMENT
DIVISION A

SANDIA
Corporation

SANDIA BASE • ALBUQUERQUE, NEW MEXICO

UNLIMITED OPPORTUNITIES for . . . Electrical Engineers and Physicists to do Digital Computer Engineering

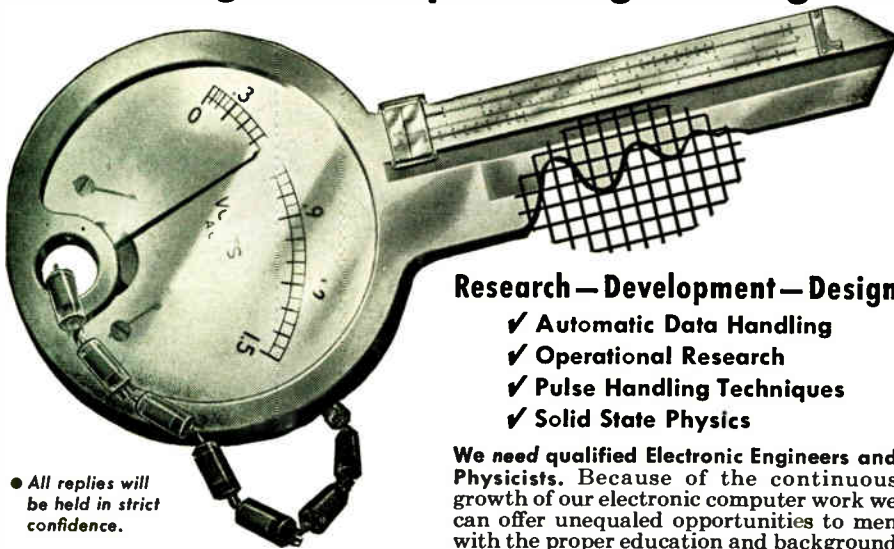

- All replies will be held in strict confidence.
- Interviews will be arranged at our expense.

Research—Development—Design

- ✓ Automatic Data Handling
- ✓ Operational Research
- ✓ Pulse Handling Techniques
- ✓ Solid State Physics

We need qualified Electronic Engineers and Physicists. Because of the continuous growth of our electronic computer work we can offer unequaled opportunities to men with the proper education and background in the Electronics field . . . permanent positions, financial security, professional development.

HERE IS THE KEY TO YOUR FUTURE...

ENGINEERING RESEARCH ASSOCIATES
DIVISION OF **Remington Rand**
1902 West Minnehaha Avenue St. Paul W4, Minnesota

ELECTRONIC ENGINEERS-TECHNICIANS

Unusual opportunities for qualified engineers and technicians in beautiful vacationland San Diego—country's most rapidly expanding electronic center. CUBIC'S controlled expansion program calls for additional electronics engineers—both junior and senior grade, and technicians, with research and development type experience. We offer immediate association with long-term military and commercial instrumentation, DME, phase type systems and microwave development projects. Rapid advancement assured with achievement. Send resume of experience to Personnel Director.

CUBIC CORPORATION
2841 Canon Street
in vacationland San Diego, California

GENERAL MAGNETICS, INC.

has openings for

ELECTRICAL ENGINEERS

With at least three years experience in design and development of MAGNETIC SERVO AMPLIFIERS & VOLTAGE REGULATORS.

A chance to grow with a young and progressive company. Salary and advancement commensurate with ability. State education, experience and salary requirements.

Address all inquiries to:

GENERAL MAGNETICS, INC.
135 Bloomfield Ave. Bloomfield, N.J.



(Continued from page 120A)

Admission to Member

- Alan, H. H., c/o Gunnery Office, U.S.S. Northampton, CLC-1, Fleet Post Office, New York, N. Y.
- Anderson, G. P., Metals Research Laboratory, Richardson Hall, Brown University, Providence 12, R. I.
- Barandon, E. D., Fairchild Camera and Instrument Corp., Syosset, L. I., N. Y.
- Beckler, H. E., 4109 Paseo, Kansas City 10, Mo.
- Bridgen, G. A., John Brown University, Siloam Springs, Ark.
- Burnside, E. D., 505 Calvin La., Rockville, Md.
- Chapin, R. C., 4901 W. Amherst, Dallas 9, Tex.
- Chick, B. B., 100 Fisk St., Providence 5, R. I.
- Chitinanda, P., Box 535, 3337 TT SQ, Scott AFB, Ill.
- Clay, J. P., 447 Norway Ave., Huntington, W. Va.
- Clink, W. L., Ralston, Alta., Canada
- Comer, J. W., Box 1035, Kimble Glass Co., Toledo 1, Ohio
- Comte, G. N., Rue de Cuire, 71, Lyons 4, France
- Corons, B. E., 220 E. Masterson, Fort Wayne, Ind.
- Cotter, M. A., 4555 Henry Hudson Pkwy., W., New York 71, N. Y.
- Danner, B. L., 1939 Calvert St., N.W., Washington, D. C.
- Davis, W. T., Jr., 4142 Anita, Houston 4, Tex.
- Gablehouse, R. H., 1112 Monroe, S.E., Albuquerque, N. Mex.
- Gray, J. O., 310 E. Hollywood Blvd., Fort Walton Beach, Fla.
- Hagaman, B. G., Birch St., Braddock Acres, R.F.D. 3, Alexandria, Va.
- Hansell, P. D., 32-42 82 St., Jackson Heights, L. I., N. Y.
- Hecht, N. E., 406 Clay Rd., Henrietta, N. Y.
- Held, H., 129 Ringdahl Ct., Apt. 8, Rome, N. Y.
- Holdren, E. H., Box 1503, Burlington, N. C.
- Horne, C. P., 5919 Tenth Rd., N., Arlington 5, Va.
- Lee, W. L., 4903 Hull St., Skokie, Ill.
- Lemke, M. F., 605 Mansfield Ave., Ottawa, Ont., Canada
- Lewis, W. P., 303 Evergreen Dr., Moorestown, N. J.
- Looney, D. H., Bell Telephone Laboratories, Inc., Murray Hill, N. J.
- Lundon, J. J., Parkway Apts., Apt. 8-A, Haddonfield, N. J.
- Lwin, M., c/o Embassy of Burma, 2300 "S" St., N.W., Washington, D. C.
- Mathamel, F. A., Burroughs Corp, 6071 Second Ave., Detroit 32, Mich.
- McGill, W. T., 7509 Mazatlan Rd., El Paso, Tex.
- Mesel, E., 3001 Edwin Ave., Fort Lee, N. J.
- O'Maley, J. B., 205 Beebe Rd., Mineola, L. I., N. Y.
- Powell, J. W., 13783—34 Ave., S., Seattle 88, Wash.
- Redstone, C. W., 520 S. Second Ave., Mount Vernon, N. Y.
- Riley, A. J., Ridgewood La., Wilton, Conn.
- Robinson, R. A., Northwest Telephone Co., 2226 W. Tenth Ave., Vancouver 9, B. C., Canada
- Schalk, R. F., 1520 N. Laverne Ave., Chicago 51, Ill.
- Schoenwetter, H. K., 2439 Fred Ct., Bellmore, L. I., N. Y.
- Schubert, E. J., 901 Kirkwood Ave., Ottawa, Ont., Canada
- Scott, J. H., 5718 Euclid, N.E., Albuquerque, N. Mex.
- Seymour, J. C., 2408 N. Kate, Oklahoma City, Okla.
- Sharpe, L. E., 317 Ocean Ave., Malverne, L. I., N. Y.
- Shaver, W. W., Corning Glass Works, Corning, N. Y.

(Continued on page 123A)

ENGINEERS

SYSTEMS RADAR SERVO COMPUTER

BACKGROUND: Responsible positions open for top level development and project engineers with practical and research experience in:

**Advanced Electronic Circuits
and Systems**
Microwave Radar
**Microwave Receivers
and Transmitters**



Requirements emphasize advanced analytical and/or management experience on highly complex electronic and electro-mechanical systems.

Kindly send resume and salary requirements to

The W.L. MAXSON Corp.
460 W. 34th ST., NEW YORK 1, N.Y.

NEW HORIZONS

Today's horizons in electronic engineering are limited only by the vision of the individual himself. To those qualified men who desire to stand on the constantly changing frontiers of electronic development, we offer a chance to pioneer and grow with a soundly-established, yet young and progressive company.

• Electronic Field Engineers

**Local and Field
Assignments Available**

At least 5 years' experience in any one of these fields: Servo Mechanisms; Special Weapons; Microwaves; Antennas; Circuit Design; Flight Simulators; Radio Propagation; Electronic Computers and Communications.

Qualified to instruct in the operation and supervise installation, maintenance and repair of Radar, Sonar, Flight Simulators and allied electronic equipment in the field.

Salary and advancement commensurate with ability; liberal vacation, sick leave, 9 paid holidays, group life, sickness and accident insurance plans, and a worthwhile pension system.

STAVID Engineering, Inc.

Personnel Office, 312 Park Avenue
Plainfield, N.J.—Plainfield 6-4806



(Continued from page 122A)

- Stahl, R. W., 200 Elm Ave., North Hills, Pa.
Tchou, M., Electrical Engineering Department,
Columbia University, Broadway and 116
St., New York 27, N. Y.
Treseder, R. C., 819 Uhrig Ave., Dayton 6, Ohio
Van Bladel, J. G., Rue Des Deux Gares, 80, Brus-
sels, Belgium
Vellines, W. E., Jr., The Chesapeake and Potomac
Telephone Co. of Va., 703 E. Grace St.,
Richmond 19, Va.
von Roesgen, C. A., Bell Telephone Laboratories,
Mountain Ave., Murray Hill, Summit,
N. J.
Watson, R. J., 705 Topeka Blvd., San Antonio,
Tex.
Weed, N. M., 448 Norris Rd., Centerville, Calif.
Wolf, M. L., 7 Colonial Lawns, Bath, N. Y.

The following elections to the Associate
grade were approved to be effective as of
July 1, 1954:

- Agnew, J. A., Toll Area Engineer, Bell Telephone
Company of Canada, Montreal, Que.,
Canada
Austin, J. H., 1476 Newton St., N.W., Washington
10, D. C.
Backlund, D. L., 348 North "N" St., Livermore,
Calif.
Bakula, T. W., 1144 Williams St., Collinsville, Ill.
Bearinger, V. W., 500 Washington Ave., S., Hop-
kins, Minn.
Bindi, R., Via La Goletta 7/16, Rome, Italy
Bingham, R. C., 457 Berkshire Ave., Springfield,
Mass.
Boeckeler, B. C., 2312 Wabansia Ave., Chicago 47,
Ill.
Bousek, R. J., 2400 G Ave., N.E., Cedar Rapids,
Iowa
Brown, F. W., National Bureau of Standards, Boul-
der, Colo.
Bryan, D. H., Apt. 103, 2807 Connecticut Ave.,
N.W., Washington 8, D. C.
Bunker, G. B., 229A Fairchild St., Wright-Patter-
son AFB, Ohio
Cahn, L., 2212 Washington Ave., Silver Spring, Md.
Cameron, T. G., 2263 Vineville Ave., Macon, Ga.
Clapp, R. O., 2037 Aylmer St., Montreal, Que.,
Canada
Clauson, W. W., 372 Pestana Way, Livermore,
Calif.
Clarke, B. C., 125 Tabor St., Eastview, Ont.,
Canada
Cohen, A. W., 14421 S. Normandie Ave., Gardena,
Calif.
Constantine, A., Box 471, Mahway, N. J.
Commons, S. R., 5616 Lawndale, Houston, Tex.
Cook, M., 2311 N. Front St., Apt. 808, Harrisburg,
Pa.
Cook, R. M., Box 30, Ramey AFB, Puerto Rico
Coombs, C. C., Jr., 1132 Croyden Dr., Dayton 10,
Ohio
Corrado, V. M., 9 Temple St., Williston Park, L. I.,
N. Y.
Davis, D. A., 7840 E. Fourth Pl., Downey, Calif.
Dodge, C. A., Jr., Stanford Research Institute,
Stanford, Calif.
Dugroo, R. E., 670 High St., Holyoke, Mass.
Duncanson, A. B., 3768 Hayes St., N.E., Washing-
ton 19, D. C.
Dutkowskii, W., 540 Tait St., St. Laurent, Que.,
Canada
Emmett, J. T., 1810 N. 37 Pl., Phoenix, Ariz.
Engstrom, D. E., Box 15-A, R.F.D. 2, Vashon,
Wash.
Eytan, K., Evron, Doar, Naharid, Israel
Fauss, G. C., 1936 W. Graham Rd., Cuyahoga Falls,
Ohio

(Continued on page 124A)

ENGINEERS

have you considered
what a career at
General Precision Laboratory
can mean to you?

Electronics, systems, computer,
field and related engineers will
find few opportunities which can
match the advantages at General
Precision.

It's a growing research labora-
tory, subsidiary of the large and
diversified General Precision
Equipment Corporation. Work is
on a variety of interesting long-
range projects, and men with
initiative and ability are given
prompt recognition for their
achievements.

Living and working conditions are
of the best. The modern labora-
tory is located in New York's
Westchester County, known
throughout the country for its
beautiful surroundings and high
standard of living . . . and only
one hour from metropolitan New
York city with its wealth of cul-
tural and educational activities.

If you're interested in a perma-
nent, satisfying career, send your
resume to Mr. H. F. Ware, Per-
sonnel Director. Expenses will be
paid for qualified applicants who
come for interviews.

GENERAL PRECISION LABORATORY INCORPORATED

A subsidiary of
General Precision Equipment Corporation
63 Bedford Road
Pleasantville New York

If you have design experience in

MAGNETIC AMPLIFIERS
CRYSTAL and L. C. FILTERS
MINIATURE TRANSFORMERS
PLASTIC ENCAPSULATION TECHNIQUES

(or if you are an engineer desiring experience in these fields)

... you owe yourself an investigation of the career advantages offered by Communication Accessories Company, Hickman Mills, Missouri . . . located in South Suburban Kansas City, where you and your family can enjoy advantages of:

1. Management - owned expanding organization.
2. Rural atmosphere — 25 minutes to metropolitan Kansas City.
3. Newly developed housing facilities, schools and shopping centers.

For confidential negotiations, address inquiries to W. S. Bonebright, V.P.,

COMMUNICATION ACCESSORIES COMPANY

Hickman Mills, Missouri



(Continued from page 123A)

- Femiano, D. J., 3203 Tenth St., N.E., Washington 17, D. C.
- Frieburg, H. E., 51st M & S Group, APO 917, c/o Postmaster, San Francisco, Calif.
- Gaskell, L. E., APO 187, (HOW) 1761, c/o Postmaster General, San Francisco, Calif.
- Gavaldon, A. L., 1005 Mundy Ave., El Paso, Tex.
- Gillin, G. F., 218 Summer St., New Bedford, Mass.
- Gordon, J. M., 1609 Russel Ave., Evansville, Ind.
- Greene, C. K., 66 Wells Dr., Dayton 3, Ohio
- Grinnell, W. T., Navy 230, Box 10, 3rd Division, c/o Postmaster, Seattle, Wash.
- Gross, H. L., 6473 Milton St., Philadelphia 91, Pa.
- Hans, E., 4034 West Blvd., Los Angeles 8, Calif.
- Hatton, G. H. T., 111-A Angelo St., South Perth, West Australia
- Hennoek, F. B., Commissioner F.C.C., New Post Office Building, Washington 25, D. C.
- Hess, J. C., III, 65-09—99 St., Forrest Hills, L. I., N. Y.
- Hewitt, J. E., 4916 S. Cedar, Lansing, Mich.
- Hill, J. H., Bull Mill Rd., Chester, N. Y.
- Hoffman, R. D., 1655 N. Cherokee St., N., Hollywood 28, Calif.
- Holliday, W. A., Blackberry La., Norwalk, Conn.
- Hoops, H. W., 3 Halsted St., Verona, N. J.
- Horn, V. M., Metropolitan Life Insurance Co., Madison Ave., New York 10, N. Y.
- Houck, J. P., 2451 S.E. Salmon St., Portland, Ore.
- Howard, R. M., 3219 W. 117 St., Cleveland 11, Ohio
- Howe, L. W., 1018 S. Seventh St., Richmond, Ind.
- Hyde, D. A., 3250 S. Dexter St., Denver 20, Colo.
- Intagliata, S. J., 18 Wayland St., Hartford 14, Conn.
- Jacobs, H. L., 3875 Ruby St., Oakland 9, Calif.
- Jaycox, R. L., 1263 First Ave., S.E., Cedar Rapids, Iowa
- Jones, A. F., 20438 Almar Dr., Shaker Heights 22, Ohio
- Kenyon, S. W., Y.M.C.A., Syracuse, N. Y.
- Khan, F. R., 1637 Kingston Rd., Kokomo, Ind.
- Kiehl, L. G., 3 Anchorage Dr., R.F.D. 3, Bethesda 14, Md.
- Klok, B., 3036 Euclid Ave., Vancouver 16, B. C., Canada
- Krausz, R., 49 Grove, Stamford, Conn.
- Krieger, R. W., Apt. 261, 114 Franklin St., Morristown, N. J.
- Kritzell, R. M., HQ AFAC, Eglin AFB, Fla.
- Lazier, W. A., Sprague Electric Co., North Adams, Mass.
- Libaw, W. H., 4600 Coldwater Canyon Dr., North Hollywood, Calif.
- Licon, O. H., 2011 Grandview Ave., El Paso, Tex.
- Light, G., 12 Britton St., Jersey City 6, N. J.
- Locke, R. V., Jr., 563 W. Brown Rd., Las Cruces, N. Mex.
- Lombardo, A., 6933 Park Ave., Merchantville 8, N. J.
- Low, S. T., Hiawatha Trailer Ct., Marion, Iowa.
- Luedde, W. J., 1026 Yale St., Richmond Heights 17, Mo.
- Lyon, T. I., 4737 N. Marlborough Dr., Whitefish Bay 11, Wis.
- Matz, M. L., 708 Fifth St., S.E., Waseca, Minn.
- McCord, H. L., 12308½ Montana Ave., Los Angeles 49, Calif.
- McCoy, D. R., 2409 Shrewsbury Rd., Columbus 21, Ohio
- McDermott, E. P., 604 North St., Falls Church, Va.
- Mellard, D., Hotel du Marshan, Marshan, Tangier, Morocco
- Moore, B. G., Jr., Box 808, Pensacola, Fla.
- Moore, R. L., 2103 Roanoke Rd., San Marino 9, Calif.
- Muller, R. A., 29 Volser Strasse, Innsbruck, Austria

(Continued on page 125A)

CONVAIR
In beautiful SAN DIEGO
NEEDS EXPERIENCED
DEFLECTION YOKE ENGINEER

Graduate electronic engineer with minimum of three years' experience in yoke design and evaluation. Circuit design experience will be of value.

This opportunity in the advanced Convair Engineering Department offers you the challenge of a wide variety of far-reaching projects, excellent salary and personal benefits, top-notch patent-royalty arrangement, fine working conditions, generous travel and moving allowances.

San Diego offers you beaches, mountains, desert resorts and Mexico . . . all minutes away. A new, pleasant way of life for you and your family.

ALSO UNUSUAL OPPORTUNITIES FOR OTHER QUALIFIED ENGINEERS.

WRITE GIVING COMPLETE EDUCATION AND EXPERIENCE

to C. F. HARTELL
Character Project

CONVAIR

A Division of General Dynamics
Box K, Old Town Station
San Diego, California



is offered for intelligent, imaginative engineers and scientists to join the staff of a progressive and self-sustaining, university-affiliated research and development laboratory. We are desirous of expanding our permanent staff in such fields as electronic instrumentation, missile guidance, microwave applications, design of special-purpose electronic computers, and in various other applied research fields of electronics and physics.

Salary structure and benefit programs are on a par with industry. In addition, there are many tangible advantages, such as our self-sponsored internal research policy, of interest to men with ingenuity and initiative.

CORNELL AERONAUTICAL LABORATORY, INC.
BUFFALO 21, NEW YORK



Membership

(Continued from page 124A)

Murray, W. H., 1544 Slaterville Rd., Ithaca, N.Y.
Neith, E. F., Jr., 1008 St. Louis Ave., East St. Louis, Ill.
Nicely, W. A., Chicago Telephone Supply Corp., Elkhart, Ind.
Nussbaum, A., Honeywell Research Center, Hopkins, Minn.
Oldani, C. M., 210 S. 15 St., San Jose 12, Calif.
Oliveros, C. G., Jr., Box 3220, USAFIT, Wright-Patterson AFB, Ohio
Paley, W. S., CBS, 485 Madison Ave., New York, N. Y.
Pallozola, M. F., 1263 Willow Creek La., Rock Hill 19, Mo.
Pappas, M. J., 32 Central Ave., Dayton 6, Ohio
Parker, G. S., 2 Stoddard Pl., Brooklyn 25, N. Y.
Paul, A. J., Jr., 280 Ardmore St., Ferndale, Mich.
Pearce, C. R., 104 Vista Del Mar, Redondo Beach, Calif.
Pearlman, A. R., 34 Beachcroft St., Brighton 35, Mass.
Penberthy, E. J., Radio Condenser Co., Davis and Copewood Sts., Camden 3, N. J.
Perkins, N. K., 29 Kingwood Pk., Poughkeepsie, N. Y.
Ping, R. A., 8 Henry St., Hampton, Va.
Planinac, J. W., Box 3048, USAFIT, Wright-Patterson AFB, Ohio
Polchow, W. F., 4711 Louisa Dr., New Orleans 22, La.
Poole, K. M., 67 Gales Dr., New Providence, N. J.
Pugh, M. D., All America Cables, Casilla 2336, Lima, Peru
Rabinowitz, R. M., 109 Ringdahl Ct., Rome, N. Y.
Ramm, H. F., 1717 W. Elm St., Denison, Tex.
Reid, C. A., 103 Longwood Cts., Huntsville, Ala.
Reineke, R. C., 904 Fairway Dr., N.W., Albuquerque, N. Mex.
Rogers, C. L., Jr., Box 1006, Cocoa, Fla.
Ruddell, E. E., 4179 Schwinn Dr., Dayton 4, Ohio
Salzer, J. E., USS Yorktown (CVA-10), c/o FPO, San Francisco, Calif.
Sanfilippo, L. T., 216 Joy, Los Angeles 42, Calif.
Scharff, J. H., Box 3132, Hq. USAFIT, Wright-Patterson AFB, Ohio
Schebler, B. J., 1828 W. Seventh St., Davenport, Iowa
Schmid, L. H., 70 Kingfisher Rd., Levittown, L. I., N. Y.
Schneider, B. K., 199 S. Portland Ave., Brooklyn 17, N. Y.
Scroggins, E. B., 1026 Rosepoint Dr., Houston, Tex.
Silkman, H. G., Goodyear Aircraft Corp., 1210 Massillon Rd., Department 453, Plant C, Akron 15, Ohio
Slade, C. B., B364D Lincoln Laboratory, Box 73, Lexington 73, Mass.
Slotty, E. P., 3816 N. 62 St., Milwaukee 16, Wis.
Smith, H. A., 12 Miller St., West Quincy 69, Mass.
Steinruck, C. F., Jr., 3007 School House La., Philadelphia 34, Pa.
Stine, D. A., 1915 Wisconsin, N.E., Albuquerque, N. Mex.
Stokely, B. J., 4961 Quincy St., St. Louis 9, Mo.
Stump, L. W., 1725 Sherlock Ave., N. Burnaby, B. C., Canada
Susek, J. F., Jr., 6851 Plymouth, University City 14, Mo.
Suske, C. C., 627 Leonard St., Brooklyn 22, N. Y.
Stein, D. B., 67-62—152 St., Flushing 67, L. I., N. Y.
Still, J. G., Friden Calculating Machine Co., 2350 Washington Ave., San Leandro, Calif.
Sykes, R. T., 110 Duncan Station Rd., McKeesport, Pa.
Thomas, D. E., 1655 Holland Ave., Utica, N. Y.
Thompson, F. C., 13B Maple Dr., Oak Grove Apts., Baltimore 20, Md.
Trzyna, J., 340 Bonnie Brae, Itasca, Ill.
Waggoner, G. J., 129 Orchard Dr., Belleville, Ill.
Wahlstrom, R. N., 124 Ringdahl Ct., Rome, N. Y.
Weller, G. S., 14408 Henry St., Berkeley, Calif.

(Continued on page 126A)



Admiral

Offers ENGINEERING CAREERS with a future

Positions are available in our organization at all levels for qualified personnel in the following fields:

*Television
*Military Communications
Commercial
*Commercial Radio
Military
*Radar
Monochrome
Color

Our rapidly expanding interests in these and other fields opens many opportunities for experienced electrical engineers as well as recent graduates.

Chicago location offers excellent opportunities for further study and graduate work in the electronics field.

Personal interviews will be arranged at the convenience of qualified applicants.

We suggest you write Mr. Walter Wecker, Personnel Department to get more information on career opportunities, advanced educational plans and other advantages.

ADMIRAL CORPORATION 3800 W. Cortland St.
Chicago 47, Illinois

ENGINEERING OR SCIENTIFIC FIELD REPRESENTATIVE

The National Union Research Division has an unusual opening for a physicist or engineer to act as field representative covering research selling. Requirements for this position are: A college degree and knowledge of electron tube research in all its phases plus the ability to deal with technical and executive personnel. From 5 to 10 years experience in this field is desired. Send complete resume or apply in person to:

Research Division

NATIONAL UNION ELECTRIC CORP.
350 Scotland Rd.

Orange, N.J.

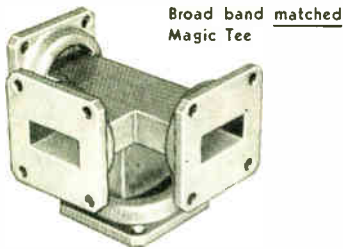

Broad band matched Magic Tee



VSWR Calibrator

PRECISE WAVEGUIDE DEVICES



Precision Slide Tuner

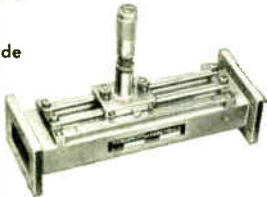

Hi Power Movable Short



Unequaled experience in producing simple or complex test components that combine laboratory precision with production ease. Get the most quality values your dollars can buy—consult our field Engineers or send us your specifications for microwave test components.

Make Technicraft your source for flexible waveguides and custom built microwave plumbing also.



TECHNICRAFT LABORATORIES

1525 Thomaston Road
THOMASTON, CONNECTICUT

West Coast Office | Westron, 6907½ Melrose Ave.,
Los Angeles 38, California

Membership

(Continued from page 125A)

Wendahl, R. E., Hughes Aircraft Co., Florence and Teale Sts., Culver City, Calif.

Williams, G. E., 3866 W. Land Park Dr., Sacramento, Calif.

Wood, W. M., 3328 W. 144 St., Cleveland 11, Ohio

Zumba, C. F., 4 New Southgate Rd., Buffalo 15, N. Y.

News—New Products

(Continued from page 18A)

Transistor Noise Figure Meter

The Model NFT Transistor Noise Figure Meter, which automatically measures noise figures of transistors, transistor amplifiers, and related devices, has been developed by **Electronic Research Associates, Inc.**, 715 Main St., North Caldwell, N. J.



The instrument eliminates the present manual procedure of noise figure measurement. By automatically comparing the internal noise of the transistor with a calibrated noise source, a continuous direct reading of noise figure is obtained.

The Model NFT operates on the basic principle of synchronously connecting and disconnecting a calibrated noise generator to the input of the transistor or transistor amplifier under test. A comparison between the internal generated noise and the calibrated noise source is automatically made in the output circuit, and by means of a feedback loop, the output power of the external noise source is equated to that of the device under test. The output power of the noise generator for these conditions is directly proportional to noise figure and this makes it possible to display the noise figure value directly on a calibrated power indicating meter. Since a common amplifier and filter is utilized in the instrument and the characteristics of these elements do not change during the fraction of a second synchronous switching time, the measurement is independent of gain drifts and band-width changes.

The noise figure measurement is made to I.R.E. standards and is proportional to one cycle bandwidth at 1,000 cps. Noise figure range for both transistors and transistor amplifiers is 5 to 60 db \pm 1 db. As an aid in simplifying transistor measurement, an internal power supply for supplying both emitter and collector biases is incorporated into the instrument. These biases can be varied over a wide range for optimizing the parameters for minimum noise figure.

The unit is self-contained in a hardwood cabinet, 19x8 panel, 13 inches deep, and operates from an input source of 115 volts ac, 60 cps.

(Continued on page 128A)



Relays

by

GUARDIAN

FOR EVERY CONTROL NEED

• SENSITIVE	• TELEPHONE
• MIDGET	• MOTOR
• AIRCRAFT	• CONTROL
• PULSING	• HIGH FRE-
• ANTENNA	• QUENCY
• OVERLOAD	• INTER-
• RADIO	• LOCKING
• UNDERLOAD	• STEPPING
• MULTIPLE	• TIME
• CONTACT DELAY	
• HERMETICALLY SEALED SOLENOID SWITCHES	
• SOLENOID CONTACTORS	
• CONTROL ASSEMBLIES	

Write

GUARDIAN ELECTRIC MANUFACTURING COMPANY

1628-J W. WALNUT ST.,
CHICAGO 12, ILL.

BE SAFE WITH

Q-max

A-27

LOW-LOSS LACQUER & CEMENT

- Q-Max is widely accepted as the standard for R-F circuit components because it is chemically engineered for this sole purpose.
- Q-Max provides a clear, practically loss-free covering, penetrates deeply, seals out moisture, imparts rigidity and promotes electrical stability.
- Q-Max is easy to apply, dries quickly and adheres to practically all materials. It is useful over a wide temperature range and serves as a mild flux on tinned surfaces.
- Q-Max is an ideal impregnant for "high" Q coils. Coil "Q" remains nearly constant from wet application to dry finish. In 1, 5 and 55 gallon containers.

Communication Products Company, Inc.

MARLBORO, NEW JERSEY (MONMOUTH COUNTY)
Telephone: Freehold 8-1880



COMMUNICATIONS EQUIPMENT CO.

MICROWAVE COMPONENTS

10 CM.—RG48/U Waveguide

10CM ECHO BOX: Tunable from 3200-3333 Mc. For checking out radar transmitters, for spectrum analysis, etc. Complete with pickup antenna and coupling devices. \$27.50

10 CM ANTENNA ASSEMBLY: 3000-3300 Mc. Parabolic Dish, 29 inch Diam. Fed from dipole. Rotation: 360 Deg. Azimuth at speeds of 20 and 10 RPM. Tilt: 20 deg. above and below horizontal. Motor-Driven by 2-28V motors, 4.5 A. Total drain. Azimuth info. is fed to select mechanism, and elevation data is obtained from Azimuth potentiometer. Net weight 65 lbs. \$78.50

POWER SPLITTER for use with type 726 or any 10 CM Shpherd Klystron. Energy is fed from Klystron antenna through dual pick-up system to 2 type "N" connectors. \$22.50 EACH

DIRECTIONAL COUPLER, Broadband type "N" Coupling, 20 db, with std flanges, Navy 20AB-147A-AN-2 \$32.50

LHTR. LIGHTHOUSE ASSEMBLY. Parts of RT39 APG 5 & APG 15, Receiver and Trans. Cavities w/assce. Tr. Cavity and Type X CMA, To Recv. Tasc. 3040, 2045, 1127, Tunable APX 2400-2700 Mc. Silver Plated. \$22.50

BEACON LIGHTHOUSE cavity p/o UPN-2 Beacon 10 cm. Mfg. Bernard Rice, each \$27.50

MAGNETRON TO WAVEGUIDE Coupler with 721-A Duplexer Cavity, gold plated \$45.00

721A TR BOX complete with tube and tuning plungers. \$12.50

McNALLY KLYSTRON CAVITIES for 707B or 2K28, 2700-2900 Mc. \$4.00

WAVEGUIDE TO 7/8" RIGID COAX "DOOR-KNOB" ADAPTER CHOKE FLANGE SILVER PLATED BRAD BAND \$32.50

AS14A AP-10 CM Pick up Dipole with "N" \$4.50

HOLMDELL-TO-TYPE "N" Male Adaptors, W. E. #D167284 \$2.75

I.F. AMP. STRIP: 30 MC, 30 db, gain, 4 MC Band-width, uses 6AC7's—with video detector. A.F.C. less tubes \$24.00

BEACON ANTENNA, AS31/APN-7 in Lucite Ball, Type "N" feed \$22.50

ANTENNA, AT19A/APR: Broadband Conical 300-3300 MC Type "N" Feed \$12.50

"E" PLANE BENDS, 90 deg. less flanges \$7.50

3 CM.—RG 52/U Waveguide

3 CM ANTENNA ASSEMBLY: Uses 17" paraboloid dish, operating from 24 vdc motor. Beam pattern: 5 deg. in both Azimuth and elevation. Sector Scan: over 160 deg. at 35 scans per minute. Elevation Scan: over 2 deg. Tilt Over 24 deg. \$85.00

Cross-Guide Directional Coupler, UG 39 flanges to flange. Main Guide is 6" Long, with 90 Deg. "E" Plane bend at one end, and is fitted with Std. UG 39/UG 40 flanges. Coupling flange: 20 db Nominal \$22.50

FLEX. WAVEGUIDE SECTION, 1 ft. long, With UG-40/UG-39 flanges. Attenuation is less than 0.1 db, at 9375 mc, and VSWR is less than 1.02. Rubber covered \$7.50

3CM Motor-Driven Echo Box



Cavity Q is 30,000. Tuning range 80 mc. Motor operates from 24 VDC Type, "N" INPUT \$32.50

VSWR Measuring Section. Consisting of 6" straight section, with 2 pick-up, Type "N" Output Jacks. Mounted 1/2 Wave apart \$7.50

1" x 1/2" waveguide 3' lengths, UG 39 flanges to UG40 cover. Silver plated per length \$5.00

Rotating-joints supplied either with or without deck mounting. With UG40 flanges each. \$17.50

Bulkhead Feed-thru Assembly \$15.00

Pressure Gauge Section 15 lb. gauge and pressure nipple \$10.00

Pressure Gauge, 15 lbs. \$2.50

Directional Coupler, UG-40/U Take off 20db \$17.50

TR-ATR Duplexer section for above \$8.50

Rotary joint choke to choke with deck mounting \$17.50

90 degree elbows, "E" plane 2 1/2" radius \$12.50

Microwave Receiver, 3 CM, Sensitivity: 10-13g Watts. Complete with L.O. and APX Mixer and Waveguide Input Circuits, 6 I.F. Stages give approximately 120 DV gain at a bandwidth of 1.7 MC. Video Bandwidth: 2 MC. Uses latest type AFC circuit. Complete with all tubes, including 723A/B Local Oscillator \$175.00

ADAPTER, waveguide to type "N", UG 39/UG 39/UG 39 \$14.50

ADAPTER, UG-163/U round cover to special bd. Flange for TS-45, etc. \$2.50 ea.

1 1/2" x 3/8" WAVEGUIDE

VSWR SECTION, 6" L. with 2-type "N" pickups mounted 1/2 wave apart \$7.50

GG 98B/APQ 13 1/2" Flex. Sect. 1 1/2" x 3/8" OD \$7.50

Slug Tuner Attenuator W.E. guide, gold plated \$6.50

BI-Directional Coupler, Type "N" Takeoff 25 db, coupling \$22.50

BI-Directional Coupler, UG-32 Takeoff 25 db, coupling \$24.95

Waveguide-to-Type "N" Adapter, Broadband \$17.50

MAGNETRONS

Type	Peak Range (MC)	Peak Power Out (KW)	Duty Ratio	Price
2J21A	3345-9405	50		\$ 8.75
2J22	3267-3333	265		7.50
2J26	2992-3019	275		7.49
2J27	2965-2992	275	.002	19.95
2J29	2914-2939	275	.002	44.95
2J31	2820-2860	285	.002	24.50
2J32	2780-2820	285	.002	28.50
2J38*	3249-3265	5		16.50
2J39*	3267-3333	8.7		24.50
2J48	9310-9320	50	.001	24.50
2J49	9000-9160	50	.001	59.50
2J56*	9215-9275	50	.001	132.50
2J61†	3000-3100	35	.002	34.50
2J62†	2914-3010	35	.002	34.50
3J31	24-27 MC	50	.001	85.00
4J34	2740-2780	900		125.00
4J38	3550-3600	750	.001	169.45
4J42†	670-730	30	.003	169.50
5J23	1044-1056	475	.001	49.00
700B	690-700	40	.002	22.50
700D	710-720	40	.002	39.75
706EY	3038-3069	200	.001	32.50
706CY	2976-3007	200	.001	32.50
725-A	9345-9405	50	.001	Write
QK601*	2845-3005	100 CW		85.00
QK61†	2975-3170	100 CW		85.00
QK62†	3135-3330	100 CW		85.00
QK259†	2700-2900	800	.001	249.00

*—Packaged with magnet.
†—Tunable over indicated range.

KLYSTRONS

723A	\$12.50	2K25/723A/B	\$27.50
723A/B	19.50	417-A (West' Hse)	17.50

VARISTORS

D-167208	\$1.35	D-171812	\$1.63
D-171858	\$1.42	D-172155	\$1.50
O-168687	\$1.35	D-167176	\$1.25

THERMISTORS

D-164699 Bead Type DCR: 1525-2550 Ohms @ 75 Deg. F. Coefficient: 2% Per. Deg. Fahr. Max. Current 25 MA AC/DC \$2.50
D-167332 Bead Type, DCR is 1525-2550 Ohms. Rated 25 MA at 825-1175 VDC \$1.35
D-167613 Disk Type DCR: 355 Ohms @ 75 Deg. F. P.M. 2.5%. 1 Watt \$1.35
D-166228 Disk Type 7120 Ohms @ 60°F. 4220 Ohms @ 80°F. 2590 Ohms @ 100°F. 1640 Ohms @ 120°F. \$1.35

—IN STOCK—

A1A	APS-4	APT-4	SJ-1
APA-9	APS-6	MKIV	TAJ
APA-10	ASD	MKX	TBK
APN-3	ASH	RC145	TBL
APN-7	B40	RC148	SCR520*
APN-9*	DAST	SO-1	SCR521
APS-2	DBST	SO-8	SCR518
APS-3	APT-2	SG-1	

* COMPONENTS. † LORAN EQUIPMENT.

—TEST SETS—

TS-10	TS-12	TS-159
TS-35A	TS-56	TS-268
TS-47	TS-34	TSX-4SE

SICKLES MODEL III RANGE CALIBRATOR \$365.00

TS 98A/AP VOLTAGE DIVIDER \$75.00

TS 90 DUMMY LOAD, 50 OHMS IMPEDANCE, WILL HANDLE 500 WATTS AT PEAK OF 5000 VOLTS DIVIDER RATIO 50:1 \$145.00

TS 235/UP DUMMY ANTENNA 500-1500 MC IMPEDANCE: 50 OHMS 1000 WATTS AVERAGE POWER \$225.00

I. F. AMPLIFIER STRIPS

MODEL SO: 30 McGain figure is 120 db. Bandwidth: 2Mc. Uses 6 stages of 6AC7 Plus one video detector. Less Tubes \$24.50

Model 15: 30 Mc center frequency. Bandwidth: 2.5 Mc. gain figure: 65 db. Uses 5 stages of 6AC7's. Has D. C. Restorer and Video Detector. A.F.C. Strip included. Input impedance: 50 Ohms. Less tubes \$27.50

Model APS-4: Miniature IF strip, using 6AK5's 60 Mc center Freq. Gain: 95db at Bandwidth of 2.7 Mc. Less tubes \$45.00

JAN WAVEGUIDE FLANGES

UG 39/U	\$1.10	UG 51/U	\$1.65
UG 40/U	\$1.25	UG 52/U	\$3.40
UG 40A/U	\$1.65	UG 52A/U	\$3.40

PULSE NETWORKS

15A—1-400-50: 15 KV. "A" CKT. 1 microsec. 100 PPS. 50 ohms imp. \$24.50

G.E. 23E (3-84-810) 8-2.24-405 50PPT: 3KV "E" CKT Dual Unit: Unit 1, 3 sections, 0.84 Microsec. 810 PPS. 50 ohms imp. Unit 2, 3 Sections, 2.21 microsec. 405 PPS 50 ohms imp. \$6.50

7-5E3-1-200-67P. 7.5 KV "E" Circuit, 1 microsec. 200 PPS. 67 ohms impedance 3 sections \$7.50

7-5E4-16-60. 67P. 7.5 KV "E" Circuit, 4 sections 16 microsec. 60 PPS. 67 ohms impedance \$15.00

7-5E3-3-200-67P. 7.5 KV. "E" Circuit, 3 microsec. 200 PPS. ohms imp. 3 sections \$12.50

2755: 10KV, 2.2usec., 375 PPS, 50 ohms imp. \$27.50

2754: 10KV, 0.85usec., 750 PPS, 50 ohms imp. \$27.50

KS865 CHARGING CHOKE: 115-150 H @ .02A, 32 40H @ .08A, 21KV Test \$37.50

G.E. 25E5-1-350-50 PPT. "E" SKT. 1 Microsec. Pulse @ 350 PPS, 50 OHMS Impedance \$69.50

KS9623 CHARGING CHOKE: 16H @ 75 MA, 380 Ohms DCR, 9000 Vac test \$14.95

G.E. 6E3-5-2000 50 PPT: 6 KV. "E" Circuit 0.5 usec /2000 PPS/50 ohms/2 sections \$7.50

PULSE EQUIPMENT

MIT. MOD. 3 HARD TUBE PULSER: Output Pulse Power 144 KW (12 KV at 12 Anpd. Duty Ratio) .001 max. Pulse duration: 5, 1.0, 2.0 microsec. Input voltage: 115 v. 400 to 2400 cps. Uses: 1-71B, 1-89-B, 3-72's, 1-73, New Less Cover—\$135

ASD Modulator Units, mfd. by Sperry. Hard tube pulser delivers Pk. pulse of 144 kw. Similar to Mod. 3 unit. Brand new, less tubes \$85.00

Airborne RF head, model A1A, delivers 50 Kw peak output at 9000 mc. at .001 duty. Complete with pulser unit and all tubes. Used, excel. \$185.00

PULSE TRANSFORMERS

Westinghouse 4P37: Primary: 50 ohms imp, 750 v. Sec. 15 kv, 1000 ohms imp. Bifilar filament trans, built in, delivers 12.6 v at 2.5 amp. (Pri. 115 v, 400 cps) \$37.50

RAYTHEON WX 4298E: Primary 4KV., 1.0 USEC. SEC. 16KV-16 AMP DUTY RATIO: .001 400 CYCLE FIL. TRANS. "BUILT-IN" \$42.50

WECO: KS 9948: Primary 700 ohms; Sec: 50 ohms. Plate Voltage: 18 KV. Part of APQ-13 \$12.50



GE 2K-2449A
Primary: 9.23 KV, 50 ohms Imp.
Secondary: 28 KV, 450 ohms.
Pulse length: 1.0/5 usec @ 635/120 PPS, Pk Power Out: 1.740 KW
Bifilar: 1.5 amps (as shown) \$62.50

GE 2K-2748-A, 0.5 usec @ 2000 PPS, Pk. Pwr. out is 32 KW impedance 40:100 ohm output. Pri. volts 2.3 KV Pk. Sec. volts 11.5 KV Pk. Bifilar rated at 1.3 Amp. Fitted with magnetron well \$39.50

K-2745 Primary: 3.1/2.8 KV, 50 ohms Z. Secondary: 14/12.6 KV 1025 ohms Z. Pulse Length: 0.25/1.0 usec @ 600/600 PPS, Pk. Power 200/150 KW. Bifilar: 1.3 Amp. Has "built-in" magnetron well \$42.50

K-2461-A, Primary: 3.1/2.6 KV—50 ohms (line). Secondary 14/11.5 KV—1000 ohms Z. Pulse Length: 1 usec @ 600 PPS, Pk. Power Out: 200/130 KW. Bifilar: 1.3 Amp. Fitted with magnetron well \$39.75

K35145—Pulse Inversion; PRI: 5 KV PK. Pulse Negative, Sec: Pos. Pulse, 4 KV; 1 usec. and 600 DUTY RATIO \$6.50

54J318-1-3 w/ds. Ratio: 1:1:1, 1:10 uh. W/ds. 2.5 ohms DCR \$3.50

UTAH X-1511-1: Dual Transformer, 2 W/ds. per section 1:1 Ratio per sec 18 MH inductance 30 ohms DCR \$5.00

UTAH X-1507-1-1: Two sections, 3 W/ds. per section, 1:1:1 Ratio, 3 MH, 6 ohms DCR per W/dg. \$5.00

68G711: Ratio: 4:1 Pri: 200V, Sec. 53V, 1.0 usec Pulse @ 2000 PPS, 0.016 KVA \$4.50

TR1049 Ratio 2:1 Pri. 220 MH, 50 Ohms, sec. 0.75 H, DCR 100 Ohms \$6.75

K-904695-501: Ratio 1:1, Pri. Imp. 40 Ohm, Sec. Imp. 40 Ohms, Passes pulse 0.6 usec with 0.05 usec rise \$8.95

Ray UX 7896—Pulse Output Pri. 5v sec. 41v \$7.50

Ray UX 8442—Pulse Inversion—40v + 40v \$7.50

PHILCO 352-7250, 352-7251, 352-7287 \$5 ea.

RAYTHEON: UX8693, UX5986, UX-7307 \$5 ea.

W.E.: D-166310, D-166638, KS9800, KD-163247, full rated capacity, with Cracked Beads, but will operate at \$5.00

UX 8693 (85CS 2290627-54): 3 W/ds. 32 turns 218 wire, DCR is: 362,372/4 ohms. Total voltage: 2500 vdc. \$5.00

D-166173: Input: 50 ohms Z. Output: 900 ohms Z. W/ds. Freq. range 10 kc-2mc. P/O AN/APQ 13 \$12.50

K-2450: Pulse Inversion auto-transformer: primary 13 kv, 4 usec. Output: 14 kv @ 100 kw peak \$34.50

TSX-4SE ANALYZER

3 cm. Spectrum analyzer, similar to TS 148, but with greater sensitivity. Freq. range: 8500-9600 MC. Post-tubes: Absorption wavemeter, waveguide Beyond cutoff attenuator, 20 mc I.F. Strip, 120 db gain. Operates from 115V/220V, 50-1200 CPS Price On Request

MAIL ORDERS PROMPTLY FILLED. ALL PRICES F.O.B. NEW YORK CITY. 25% DEPOSIT WITH ORDER. BALANCE C.O.D. RATED CONCERNS SEND P. O.

131 Liberty St., New York 7, N. Y. Dept I-8 Chas. Rosen Phone: Dlgby 9-4124

PROFESSIONAL ENGINEERING CARDS

**ALFRED W. BARBER
LABORATORIES**
Specializing in the Communications Field and
in Laboratory Equipment
Offices, Laboratory and Model Shop at:
32-44 Francis Lewis Blvd., Flushing, L.I., N.Y.
Telephone: Independence 3-3306

CROSBY LABORATORIES, INC.
MURRAY G. CROSBY & STAFF
RADIO-ELECTRONIC RESEARCH
DEVELOPMENT & ENGINEERING
COMMUNICATIONS, FM & TV
ROBBINS LANE
HICKSVILLE, NEW YORK
HICKSVILLE 3-3191

**INTERFERENCE MEASUREMENT SERVICES
OF
DYNAMIC ELECTRONICS—N.Y., INC.**
Director—H. S. BENNETT, DR. ENG., P.E.
Specialists in determining equipment
compliance with government
radio interference
specifications.
73-39 WOODHAVEN BLVD.
GLENDALE, L.I. IL-9-7000

ELDICO OF NEW YORK, INC.
Donald J. S. Merten and Engineering Staff
Consultants on Interference Elimination
from Transmitters, Induction Heaters,
Diathermy, etc.
72 East Second Street, Mineola, L.I., N.Y.
Garden City 7-0383

RADIO INTERFERENCE MEASUREMENTS
under
MIL-I-16910 FCC, Part 18
MIL-I-17623 MIL-S-4957
MIL-I-6181B and others
ELECTRO-SEARCH
4337 N. 5th Street Philadelphia 40, Pa.
Gladstone 5-5353

ELK ELECTRONIC LABORATORIES, INC.
Jack Rosenbaum
Specializing in design and development of
Test Equipment for the communications,
radar and allied fields
333 West 52nd St., New York 19, PL-7-0520

FREDERICK RESEARCH CORPORATION
Carl L. Frederick, D.Sc., President
Bethesda 14, Maryland • OLiver 4-5897
Engineering Research and Development, Eval-
uation, Technical Writing and Publishing—Elec-
tronic and Electro-mechanical Systems, Test
Equipment, Radio Interference, Instrumentation,
Controls.

PAUL GODLEY CO.
Consulting Radio Engineers
P.O. Box J, Upper Montclair, N.J.
Offs & Lab.: Great Notch, N.J.
Phone: Montclair 3-3000
Established 1926

**GOVERNMENT CONTRACT LIAISON AND
CONSULTANTS
GORDON ASSOCIATES, INC.**
Specializing in Signal Corps Electronic Require-
ments, Technical Manuals, Tabular List of
Parts, Drawings
L. Gordon, Pres. P. Treston, Ch. Engr.
157 Broad Street Telephone
Red Bank, New Jersey Red Bank 6-2743

HOGAN LABORATORIES, INC.
John V. L. Hogan, Pres.
APPLIED RESEARCH, DEVELOPMENT,
ENGINEERING
Est. 1929. Electronics, Optics, Mechanisms,
Facsimile Communication, Digital Computers,
Electro-sensitive recording media, Instrumenta-
tion.
155 Perry Street, New York 14 CHelsea 2-7855

News—New Products
(Continued from page 126A)
**Sprague Receives RETMA
Medal of Honor**



Robert C. Sprague, left, chairman of the board of the Sprague Electric Co., North Adams, Mass., receives the Medal of Honor of the Radio-Electronic-Television Manufacturers Association from Glenn McDaniel, president of the RETMA. Mr. Sprague, third to receive the medal in the Association's history, was honored for his contributions to the progress of the electronics industry during the 1954 RETMA annual meeting at the Palmer House in Chicago, June 17.

Long active in the affairs of the electronics industry, Mr. Sprague has been a RETMA director since 1943 and was chairman of its Parts Div. from 1944 to 1946. He served as RETMA president in 1950, and became its first board chairman in 1951, a post which he still holds.

**Solid Ultrasonic Delay
Lines Bulletin**

Andersen Laboratories Inc., 39 Talcott Rd., West Hartford 10, Conn., has printed a new 12-page technical bulletin No. 54 on solid ultrasonic delay lines with particular reference to the superiority of quartz to mercury and metal lines.

Theory, performance, circuitry and specification data are also included.

**1955
Radio Engineering
Show
March 21-25, 1955
Kingsbridge Armory
New York**

LEONARD R. KAHN
Consultant in Communications and Electronics
Single-Sideband and Frequency-Shift Systems
Diversity Reception - Modulation Theory
Applications of Magnetic Tape Recording
Elizabeth Bldg., 22 Pine St., Freeport, L.I., N.Y.
Freeport 9-8800

Harry W. Houck Jerry B. Minter
John M. van Beuren
RESEARCH ENGINEERS
Specialists in the Design and
Development of Electronic Test Instruments
c/o MEASUREMENTS CORP.
BOONTON, N.J.

L. J. CASTRIOTA M. WIND
S. W. ROSENTHAL P. G. MARIOTTI
Microwave Consultants
Radio Frequency and Microwave Components
Cable—Waveguide—Coax
Dielectric Evaluation
Telephone G.P.O. Box 844
BOulevard 3-2096 Brooklyn 1, N.Y.

N. G. Parke S. J. O'Neil
Parke Mathematical Laboratories, Inc.
Specialists in engineering analysis and
computation in the fields of electronics and
aeronautics.
Independence Court • Concord, Massachusetts
Telephone Concord 827

PICKARD AND BURNS, INC.
Consulting Electronic Engineers
Analysis and Evaluation of Radio Systems
Research, Development, Design and Production
of Special Electronic Equipment and Antennas.
240 Highland Ave. Needham 94, Mass.

RADIO SONIC CORP.
ENGINEERS—QUALITY ASSURANCE
Testing, Processing
Electron Tubes, Semiconductors, Models, Produc-
tion Test Equipment, Antennas, Analyzers, Power
Supplies, Ultrasonics, Advanced Development
G. EMERSON PRAY, PRESIDENT
32 W. 22nd St., New York 10, N.Y. ORegon 5-0085

Paul Rosenberg Associates
Consulting Physicists
100 STEVENS AVE. • MOUNT VERNON, NEW YORK
CABLE: PHYSICIST MOUNT VERNON 7-8040

M. D. Ercolino and Associates
ANTENNA CONSULTANTS
Research and Development
Communication Arrays
Commercial and Amateur
FM and TV
c/o TELREX, INC. ASBURY PARK, N.J.
Phone Prospect 5-7252

WHEELER LABORATORIES, INC.
Radio and Electronics
Consulting — Research — Development
R-F Circuits — Lines — Antennas
Microwave Components—Test Equipment
Harold A. Wheeler and Engineering Staff
Great Neck, N.Y. HUnter 2-7876

NEW!

A 3-WAY PACKAGING SERVICE

offering complete protection
for the most delicate instruments
and components

CARGO PACKERS

1. Contract packaging for electronic, photographic and aircraft equipment.
2. Packaging kits for packaging delicate components in your own plant.
3. Packaging design and consulting service to work with your engineers on new and re-designed products.

CARGO PACKERS serves leading manufacturers including J. M. Loge, Federal Telephone & Radio Corp., Amperex Electronics Corp., Eastman Kodak Recordak Div., Allen B. Dumont Labs., Pioneer Electronics, Times Facsimile Corp. and many others.

FOR COMPLETE
INFORMATION
MAIL COUPON!

MARSHANK SALES CO.

672 SO. LAFAYETTE PARK PLACE
LOS ANGELES 5, CALIFORNIA

As authorized Western representatives
for Cargo Packers, Inc., please

- SEND ILLUSTRATED CATALOG
 HAVE A SALES ENGINEER CALL

NAME _____

COMPANY _____

STREET _____

CITY _____

STATE _____

IF YOU NEED EXTRA-FAST SERVICE,
TELEPHONE DUnkirk 7-8235
DUnkirk 8-5055

Visit us at Booth 753 WESCON.

VISIT BOOTH 753

Wescon Show & Convention

PAN PACIFIC AUDITORIUM
LOS ANGELES, CALIFORNIA
AUGUST 25, 26 & 27

NOW

NEW YORK —
73 RUTLEDGE ST., BROOKLYN 11, N. Y.

CARGO PACKERS EAST & WEST COAST PACKAGING SERVICE!

CALIFORNIA —
2050 BROADWAY, SANTA MONICA

Individually-engineered

CLIMATE-PROOF, SHOCK-PROOF PACKAGING

To meet the increased, country-wide demands of the electronics industry. Cargo Packers has now inaugurated complete facilities in the West Coast area also, for packaging protection of delicate instruments, equipment and components, including

- Special Assembly Equipment
- Experts in Military Specifications
- Economical Production line methods
- Full Compliance in Every Detail
- Competent Consulting Service



12-PAGE BROCHURE tells how to avoid the pitfalls, gives complete detailed information on C.P. methods of protective packaging.

Whether in storage or in transit anywhere, absolute protection against strain, stress, shock, vibration, temperature or humidity fluctuations, moisture — or even skin damage — is assured by Cargo Packers' individual attention to every job. For recommendations on specific packaging problems, call or write our Sales-Engineering Department today.

CARGO PACKERS

INCORPORATED

New York — 73 RUTLEDGE ST., BROOKLYN 11, N. Y.
California — 2050 BROADWAY, SANTA MONICA

CLIMATE-PROOF PACKAGING

CARGO

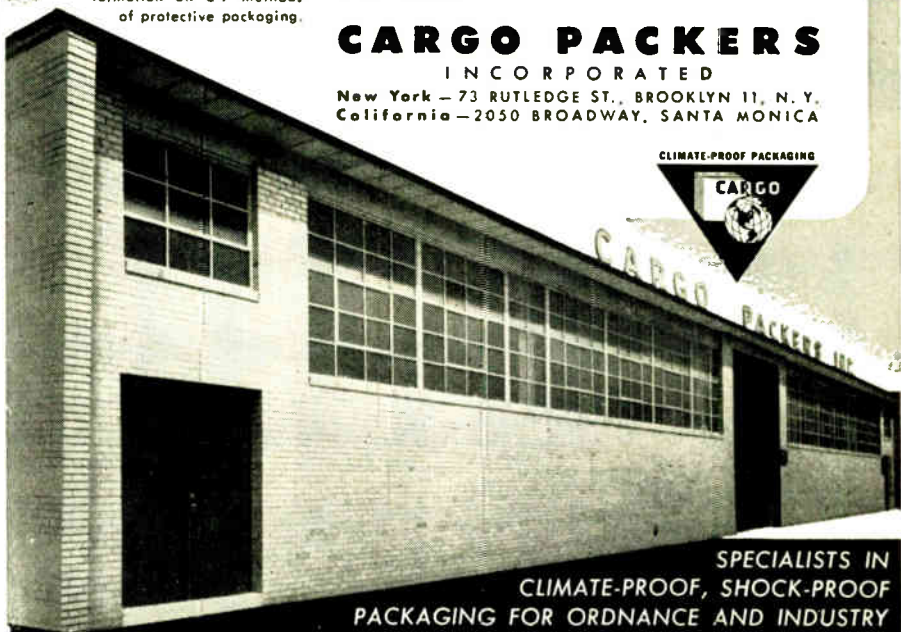

SPECIALISTS IN
CLIMATE-PROOF, SHOCK-PROOF
PACKAGING FOR ORDNANCE AND INDUSTRY

INDEX AND DISPLAY ADVERTISERS

Meetings with Exhibits	2A
News-New Products	16A
Contributors	50A
Professional Group Meetings	84A
IRE People	91A
Industrial Engineering Notes	94A
Section Meetings	100A
Positions Open	106A
Positions Wanted by Armed Forces	
Veterans	112A
Membership	117A

DISPLAY ADVERTISERS

Acme Electric Corp.	62A
Admiral Corporation	125A
Aeronautical Radio, Inc.	118A
Aerovox Corp.	18A
Airtron, Inc.	73A
Allen-Bradley Co.	32A
American Lava Corp.	59A
American Phenolic Corp.	30A
American Television & Radio Co.	73A
Amperite Company	58A
Ampex Corporation	40A
Arnold Engineering Co.	26A
Associated Specialties Co.	94A
Avion Instrument Corp.	52A
Ballantine Laboratories, Inc.	54A
Barber Labs., Alfred W.	128A
Bell Telephone Labs., Inc.	4A
Bendix Aviation Corp., (Bendix Radio Comm. Div.)	112A

Bendix Aviation Corp., (Red Bank Div.)	78A
Berkeley Scientific (Div. Beckman Instr., Inc.)	83A
Bodnar Industries, Inc.	82A
Bomac Labs., Inc.	13A
Boonton Radio Corp.	69A
Brush Electronics Co. (Bruehl & Kjaer)	30A
Burlington Instr. Co.	72A
Bussmann Mfg. Co.	63A

Cambridge Thermionic Corp.	87A
Cannon Electric Co.	15A
Capehart-Farnsworth Co.	110A
Capitol Radio Eng. Inst.	91A
Cargo Packers, Inc.	129A
Carter Motor Co.	130A
Centralab, Div. Globe-Union	36A
Chicago Midway Labs.	121A
Clarostat Mfg. Co., Inc.	75A
Cohn Mfg. Co., Inc., Sigmund	60A
Collins Radio Co.	55A
Communication Accessories Co.	124A
Communication Products Co.	126A
Communications Equipment Co.	127A
Conrad & Moser	68A
Cons. Vultee Aircraft Corp. (Empl.)	115A
Cons. Vultee (Convair, Character Div.)	124A
Cornell Aeronautical Lab., Inc.	124A
Cornell-Dubilier Elec. Co.	Cov. III
Crane Packing Co.	95A
Crosby Labs., Inc.	128A
Cubic Corp.	88A, 122A

Dale Products, Inc.	20A
Daven Co.	17A
Donner Scientific Co.	80A
Du Mont Labs., Inc., Allen B.	8A
Dyna-Labs., Inc.	98A
Dynamic Electronics—N.Y., Inc.	128A

Eitel-McCullough, Inc.	31A
Eldico of New York, Inc.	128A
Electrical Indust. (Div. Amperex Electr.)	27A
Electro-Measurements, Inc.	90A

NEW

PANORAMIC SPECTRUM ANALYZER SPA-1

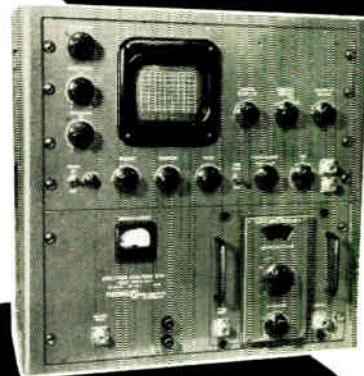

now 50 mc to 4000 mc

WITH TWO TUNING HEADS

Check these outstanding

features:

- Low noise input, less than 0.5 microvolts across 50 ohms, for high usable sensitivity
- 10 MC maximum sweepwidth, continuously reducible to 0 MC
- Continuously variable differential markers, ± 50 kc to ± 5 mc
- Continuously variable resolution (I.F. bandwidth) 9 kc to 100 kc
- 1 cps to 60 cps sweep rate, continuously variable with single control
- DC coupled video amplifier for analysis of CW signals
- Three selectable amplitude scales, 40 db log, 20 db linear and square law
- Low frequency swept oscillator provides high inherent stability
- Excellent construction and design make the equipment unparallelled for minimum down time
- Optional bezels and CRTs for visual examination or camera use.
- Low cost

Tuning Heads

RF-2 50 mc-250 mc
RF-3 220 mc-4000 mc in five ranges

Inquiries invited on Panoramic Spectrum Analyzers for special problems. Write today for descriptive literature.



- Makers of
- Panadaptor
- Analyzer
- Panoramic Sonic Analyzer
- Panoramic Ultrasonic Analyzer

12 South Second Avenue, Mount Vernon, N.Y.
MOUNT VERNON 4-3970

NEW Carter SLIDE CHART

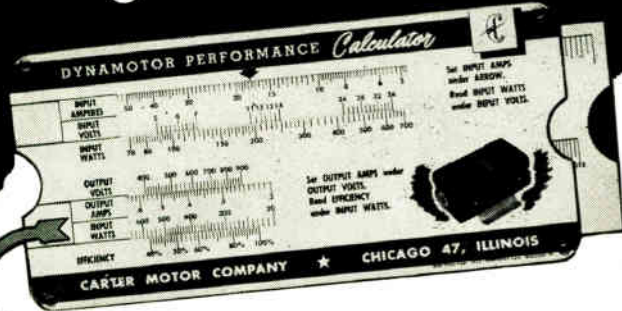

SHOWS DYNAMOTOR EFFICIENCY

25¢ at a Glance!

AT YOUR RADIO PARTS DISTRIBUTOR OR ELECTRONIC EQUIPMENT SUPPLIER

WRITE for FREE DYNAMOTOR CATALOG

Now it's easy to compare Dynamotor performance efficiency under actual operating conditions. Nameplate information plus this simple slide chart enables you to read instantly the efficiency percentage right from the Calculator scale. Reverse side gives other useful information. Handy 3" x 6" pocket size, color printed on sturdy laminated stock, varnished to resist soil. For sale by radio parts distributors and electronic equipment suppliers, or 25¢ postpaid.

Carter Motor Co.

2645 N. MAPLEWOOD AVE. CHICAGO 47

World's largest Exclusive Manufacturers of mobile radio rotary power Supplies.

high stability MINIATURIZED JK GLASLINE CRYSTAL

- Minimum Aging Drift • Miniature Size
- High Q. For Maximum Performance

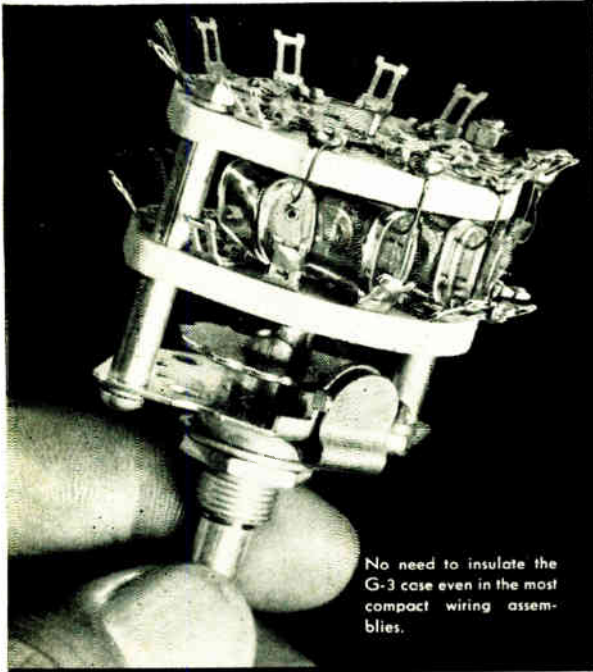

No need to insulate the G-3 case even in the most compact wiring assemblies.

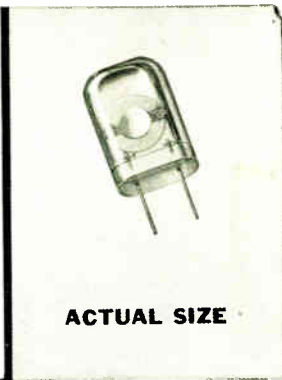

ACTUAL SIZE



THE NEW STABILIZED JK-G3

Smaller than a thumbnail, the miniature JK G-3 was developed in anticipation of today's growing need for minimum size with maximum stability. The smallest of the JK Glasline crystals to match today's most critical requirements. The frequency range is 10 mc to 100 mc. Sealing crystals in glass makes possible the techniques necessary to set new stability records.* Consult us for your requirements.

The JAMES KNIGHTS Company
Crystals for the Critical - SANDWICH, ILLINOIS



**JK
STABILIZED G-9J**
1 kc to 10 kc
Frequency tolerance
over range of -40 to
+70°C:
w/o ckt. adj. $\pm .03\%$
with ckt. adj. $\pm .02\%$



**JK
STABILIZED G-9**
4 kc to 500 kc and 1.2
to 5 mc



***JK
STABILIZED G-12A**

540 kc to 1600 kc
At 1000 kc has proven a
stability potential of one
part in 100 million.*
Available for standords
or non-temperature con-
trolled broadcast use
(F.C.C. approved). *As
tested in leading U.S.
Gov't Lab.



JK STABILIZED G-12
99 kc to 180 kc
Frequency tolerance:
 $\pm .0005\%$, 25 to 70°C

DISPLAY ADVERTISERS

Electro-Pulse, Inc.	62A
Electro-Search	128A
Electronic Eng. Co. of Calif.	114A
Elk Electronic Labs., Inc.	128A
Engineering Associates	94A
Engineering and Research Corp.	114A
Engineering Res. Assoc., Inc. (Div. Rem. Rand)	110A, 122A
Eraser Co., Inc.	90A
Erie Resistor Corp.	79A
Fairchild Eng. & Airp. Corp. (Guided Missile Div.)	19A, 118A
Fansteel Metallurgical Corp.	42A
Federal Telecommunication Labs. Inc.	113A
Ford Instrument Co.	116A
Frederick Research Corp.	128A
Frequency Standards	14A
Gabriel Labs.	100A
General Dry Batteries, Inc.	77A
General Electric Co. (Apparatus Dept.)	51A
General Electric Co. (Empl.)	116A
General Electric Co. (Tube Div.)	25A
General Magnetics, Inc.	89A, 122A
General Precision Lab., Inc.	123A
General Radio Co.	Cov. IV
Gillfillan Bros., Inc.	108A
Godley Co., Paul	128A
Gordon Associates	128A
Guardian Electric Mfg. Co.	126A
Hallicrafters Co.	66A
Harvey Radio Co., Inc.	74A
Heiland Research Corp.	96A
Helipot Corp.	65A
Heppner Mfg. Co.	97A
Hermetic Seal Prods. Co.	53A
Hewlett-Packard Co.	11A
Hoffman Labs., Inc. (Empl.)	115A
Hogan Labs., Inc.	128A
Hudson Tool & Die Co., Inc.	6A
Hughes Aircraft Co.	45A
Hughes Research & Dev. Labs.	107A
Hycor Co., Inc.	28A
Iliffe & Sons, Ltd.	12A
Impedance, Inc.	104A
Institute of Radio Engineers	1A, 2A, 102A & 103A, 104A
Instruments for Industries	99A
International Business Machines	109A
International Rectifier Corp.	21A
Johns Hopkins Univ., Applied Physics Lab.	109A
Johns Hopkins Univ., Radiation Lab.	113A
Jones Div., Howard B. (Cinch Mfg. Corp.)	90A
Kahle Eng. Co.	20A
Kahn, Leonard R.	128A
Karp Metal Prod. Co. Inc.	85A
Kay Electric Co.	2A
Kearfott Co., Inc.	28A
Keystone Products Co.	49A
Knights Co., James	131A
Kollsman Instrument Corp. (Empl.)	118A
Laboratory for Electronics, Inc.	29A
Lambda Electronics Corp.	38A
Lapp Insulator Co., Inc.	24A
Librascope, Inc.	52A
Linear Equipment Labs.	91A
Lockheed Aircraft Corp. (Missile Systems Div.)	119A
Lord Mfg. Co.	43A
Magnetics, Inc.	54A
Mallory & Co., Inc., P. R.	81A
Maxson Corp., W. L.	123A
McCoy Electronics Co.	68A
Measurements Corp.	84A, 128A
Melpar, Inc.	120A

DISPLAY ADVERTISERS

Microdot Div., Felts Corp.	78A
Microwave Consultants	128A
Midland Mfg. Co., Inc.	33A
Millen Mfg. Co., Inc., James	7A
Motorola, Inc. (Empl.)	116A
N.R.K. Mfg. & Eng. Co.	94A
National Research Council	118A
National Union Electric Corp. (Res. Div.)	114A
National Union Electric Corp. (Empl.)	125A
New London Instrument Co.	70A
Ney Co., J. M.	82A
Norden Labs., Corp.	114A
Panoramic Radio Prods. Inc.	130A
Parke Mathematical Labs., Inc.	128A
Pentron Corp.	66A
Phillips Control Corp.	83A
Pickard & Burns, Inc.	128A
Polarad Electronics Corp.	9A, 57A
Polytechnic Res. & Dev. Co., Inc.	76A
Potter Co.	101A
Premier Instrument Corp.	60A
Radiation, Inc. (Empl.)	111A
Radio Corp. of America (Empl.)	106A
Radio Corp. of America	64A
Radio Materials Corp.	61A
Radio Receptor Co., Inc.	47A
Radio Sonic Corp.	128A
Ramo-Wooldridge Corp.	117A
Raytheon Mfg. Co. (Rec. Tubes)	5A
Resinite Corp.	56A
Rockbar Corp.	98A
Rosen Eng. Prod. Co. Inc., Raymond	48A
Rosenberg Assoc., Paul	128A
Sandia Corp. (Empl.)	121A
Secor Metals Corp.	48A
Sei-Rex Precious Metals, Inc.	70A
Sierra Electronic Corp.	39A
Specific Products	39A
Sperry Gyroscope Co. (Empl.)	108A
Sprague Electric Co.	3A, 93A
Stackpole Carbon Co.	23A
Standard Piezo Co.	86A
Stavid Eng. Inc. (Empl.)	123A
Stoddart Aircraft Radio Co.	22A, 105A
Sturtevant Co., P.A.	76A
Sylvania Elec. Prods. Inc. (Electr. Div.)	71A
Sylvania Elec. Prods. Inc. (Empl.)	120A
Sylvania Elec. Prods. Inc. (Boston Eng. Lab.)	112A
Synthane Corp.	44A
Syntron Co.	72A
Technicraft Labs., Inc.	126A
Technology Instr. Corp.	37A
Tektronix, Inc.	22A, 95A
Telrex, Inc.	128A
Terpening Co., L. H.	46A
Texas Instruments, Inc.	41A
Times Facsimile Corp.	91A
Transradio, Ltd.	74A
Triad Transformer Corp.	24A
Truscon Steel Co.	10A
Tung-Sol Electric Inc. (Empl.)	121A
Tung-Sol Electric Inc.	34A, 35A
United States Gasket Co.	132A
United Transformer Co.	Cov. 11
Unitex Corp.	86A
Varian Associates	67A
Vectron, Inc.	76A
Victory Engineering Corp.	92A
Wheeler Laboratories Inc.	92A, 128A
White Dental Mfg. Co., S.S.	58A
White Dental Mfg. Co., S.S.	50A
Wickes Engineering & Construction Co.	82A
Zophar Mills, Inc.	66A

replacing GLASS with TEFLON

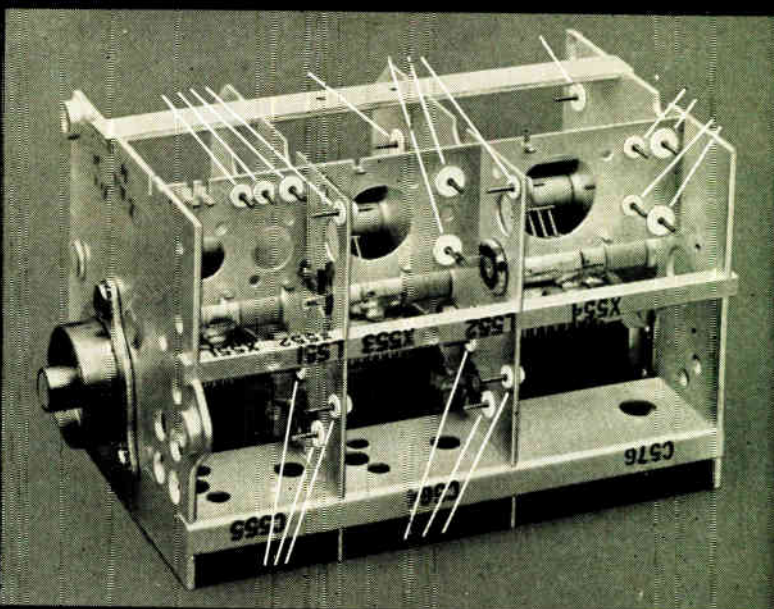

Chemelec Stand-Off and Feed-Through Insulators

● Tough, resilient TEFLON made these miniatures possible—and **BETTER**—than glass-insulated components.

COMPRESSION MOUNTING, without breakage.

WITHSTAND SHOCK and vibration in service.

NO ADDITIONAL HARDWARE NEEDED.

ASSEMBLY COSTS GREATLY REDUCED.

THE PLASTIC'S "MEMORY" securely locks insulators permanently in place. Minimum pull test 10 lbs., insulator to deck, hardware to insulator.

MINIATURIZATION is easily accomplished.

INVESTIGATE Chemelec Stand-Off and Feed-Through Insulators for superior service and lower assembly costs.

SEVEN STOCK SIZES, including sub-miniatures. Other dimensions feasible.

WRITE for Chemelec Bulletin EC-1153.

● TEFLON's superior insulating characteristics made these miniatures possible—and **BETTER**—especially for high frequency, high voltage or current, high temperature service.

HIGHER surface and volume resistivity.

LOWER loss factor and dielectric constant.

HIGHER dielectric strength.

WIDER service temperature range (−110° F to + 500° F).

ZERO water absorption (A.S.T.M. Test).

WON'T CARBONIZE under arcing or DC-plate.

**UNITED
STATES
GASKET
COMPANY**

**FLUOROCARBON
PRODUCTS, INC., DIVISION
CAMDEN 1 • NEW JERSEY**

Representatives in Principal
Cities Throughout the World



Another C-D "first"

Consistently Dependable Cornell-Dubilier Budroc* steatite-cased capacitors

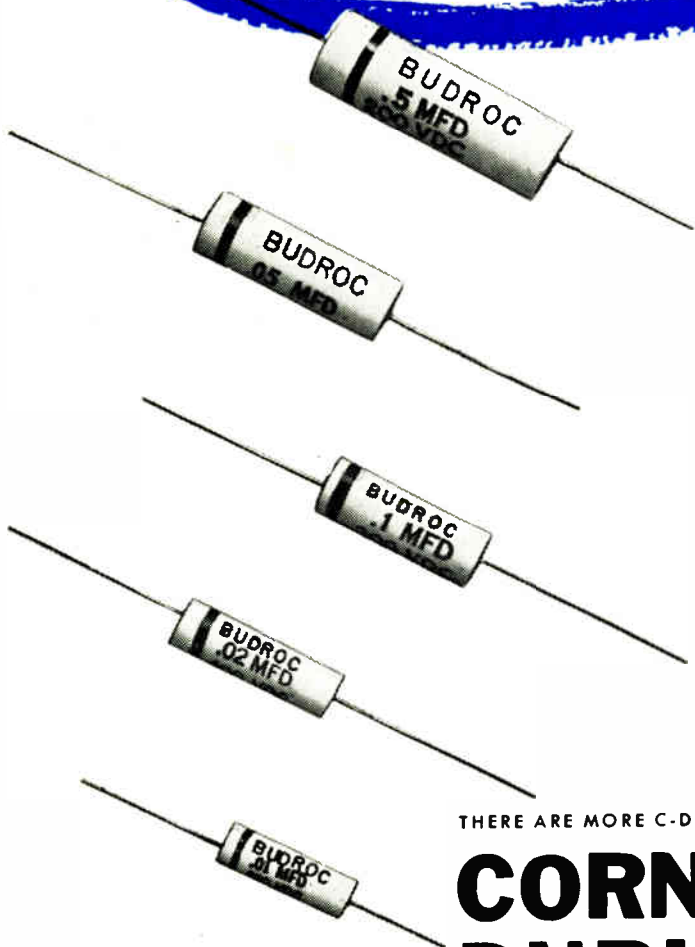

**The outstanding capacitor
for high fidelity and
high frequency applications**

To the long list of Cornell-Dubilier "firsts" add another important development: the C-D Budroc* steatite-cased tubular capacitor. It is unquestionably the finest paper tubular ever made for the initial equipment manufacturer.

Budroc capacitors are non-inductively wound and housed in a tube of the finest ceramic (steatite) completely fabricated in our own plant, under close and constant supervision and quality control from start to finish. The specially developed C-D end fill will not soften, melt or flow at any rated operating temperature.

Send for engineering samples of this superb humidity proof, new C-D capacitor! Use our Technical Advisory Service for your special application problems. Bulletin NB-154 on request.

*Cornell-Dubilier Electric Corp., Dept. M-84
South Plainfield, New Jersey.*

THERE ARE MORE C-D CAPACITORS IN USE TODAY THAN ANY OTHER MAKE

CORNELL DUBILIER *Capacitors*



PLANTS IN SOUTH PLAINFIELD, N. J.; NEW BEDFORD, WORCESTER AND CAMBRIDGE, MASS.; PROVIDENCE AND HOPE VALLEY, R. I.; INDIANAPOLIS, IND.; FUGOAT SPRINGS AND SANFORD, N. C.; AND SUBSIDIARY, THE RADIART CORPORATION, CLEVELAND, OHIO



ANTENNAS



ROTORS



CAPACITORS



VIBRATORS



CONVERTERS

*00



LOCATION — Master Test Station, Measurements Laboratory, CBS-Hytron Electronic Tube Plant, Danvers, Massachusetts

General Radio Vacuum-Tube Bridge measures dynamic characteristics of 12BH7 twin triode at final inspection station. Sample tubes from all CBS-Hytron production runs are measured daily at this test station to insure uniform production quality.

This General Radio instrument is used by the CBS-Hytron Engineering Department to design-test the dynamic and static characteristics of all CBS-Hytron vacuum tubes . . . from miniatures to transmitting tubes.

At CBS-Hytron, the Type 561-D Vacuum-Tube Bridge is the standard for all other tube-testing equipment.

Photograph Courtesy CBS-Hytron

TYPE 561-D VACUUM-TUBE BRIDGE . . . \$750.

for Accurately Measuring

Dynamic and Static Characteristics of Vacuum-Tubes and Transistors

★ The General Radio Type 561-D Vacuum-Tube Bridge has for over two decades been used by design and production test groups for the rapid and reliable measurement of tube characteristics.

★ Now! Transistor parameters . . . both forward and reverse Voltage-Amplification, Resistance, and Transconductance . . . can be measured as well.

★ Measurements are direct reading . . . there are no awkward correction factors

★ Negative coefficients can be measured as readily as positive values

★ Interelectrode capacitance is effectively balanced by a unique method which makes possible the *independent* measurement of all three tube and transistor parameters — low-power transmitting tubes may also be measured

★ Direct-Reading Range

Amplification factor (μ): 0.001 to 10,000

Dynamic plate resistance (r_p): 50 ohms to 20 megohms

Transconductance (g_m): 0.02 to 50,000 micromhos

The above ranges can be exceeded under proper conditions

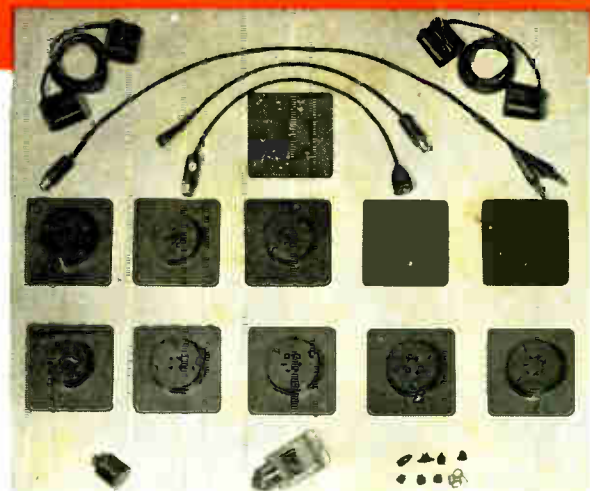

★ Ten different adaptor plates are provided for mounting all commonly used tubes and transistors — a “universal” adaptor is supplied for conveniently measuring unmounted or nonstandard tubes — additional sockets are provided for transistors and subminiature tubes with short leads

★ The Type 1214-A Unit Oscillator operating at 1 kc and Type 1212-A Unit Null Detector are recommended for use with the Type 561-D Vacuum-Tube Bridge

.....Since 1915



Manufacturers of Electronic Apparatus for Science and Industry

GENERAL RADIO Company

275 Massachusetts Avenue, Cambridge 39, Massachusetts, U. S. A.

90 West Street NEW YORK 4
8055 13th St. Silver Spring, Md. WASHINGTON, D. C.
920 S. Michigan Avenue CHICAGO 5
1000 N. Seward Street LOS ANGELES 28

ADMITTANCE METERS
AMPLIFIERS
COAXIAL ELEMENTS
DISTORTION METERS
OSCILLATORS

FREQUENCY MEASURING APPARATUS
FREQUENCY STANDARDS
IMPEDANCE BRIDGES
LIGHT METERS
MEGOHMMETERS
MODULATION METERS
MOTOR CONTROLS
NULL DETECTORS
OSCILLATORS

PARTS & ACCESSORIES
POLAROSCOPES
PRECISION CAPACITORS
PULSE GENERATORS
R-L-C DECADES
R-L-C STANDARDS
SIGNAL GENERATORS
SOUND & VIBRATION METERS
STROBOSCOPES

TV & BROADCAST MONITORS
U-H-F MEASURING EQUIPMENT
UNIT INSTRUMENTS
VARIACS
V-T VOLTMETERS
WAVE ANALYZERS
WAVE FILTERS

Write for
Complete Information