

Proceedings



of the I·R·E

A Journal of Communications and Electronic Engineering

August, 1950

Volume 38

Number 8



For details of West Coast Regional Convention, see page 953.

Part I of the IRE Standards on Electron Tubes: Methods of Testing, 1950, appears in this issue.

PROCEEDINGS OF THE I.R.E.

- Positive-Ion Emission
- Marketing Symposium
- A Crystal Amplifier
- Microspacer Electrode Technique
- Meteoric Echo Study of Upper Atmosphere Winds
- Dielectric-Constant Measurements at 100-1,000 Mc
- A Double-Crystal Goniometer
- Product Phase Modulation and Demodulation
- Determination of Attenuation from Impedance Measurements
- Current Distributions on Antennas
- Noise Levels in the Sub-Arctic
- IRE Standards on Electron Tubes
- Abstracts and References

TABLE OF CONTENTS, INDICATED BY BLACK-AND-WHITE MARGIN, FOLLOWS PAGE 32A

The Institute of Radio Engineers



MINIATURE COMPONENTS FROM STOCK...

SUBOUNCER UNITS

FOR HEARING AIDS... VEST POCKET RADIOS... MIDGET DEVICES

UTC Sub-Ouncer units fulfill an essential requirement for miniaturized components having relatively high efficiency and wide frequency response. Through the use of special nickel iron core materials and winding methods, these miniature units have performance and dependability characteristics far superior to any other comparable items. They are ideal for hearing aids, miniature radios, and other types of miniature electronic equipment. The coils employ automatic layer windings of double Formex wire... in a molded Nylon bobbin. All insulation is of cellulose acetate. Four inch color coded flexible leads are employed, securely anchored mechanically. No mounting facilities are provided, since this would preclude maximum flexibility in location. Units are vacuum impregnated and double (water proof) sealed. The curves below indicate the excellent frequency response available. Alternate curves are shown to indicate operating characteristics in various typical applications.

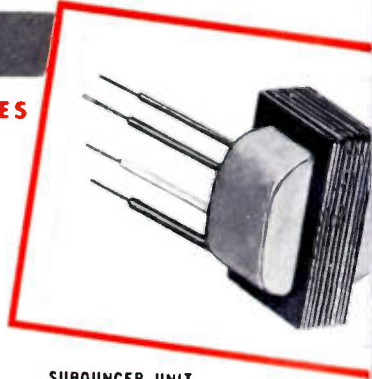

SUBOUNCER UNIT
Dimensions...9/16" x 5/8" x 7/8"
Weight......03 lb.

Type	Application	Level	Pri. Imp.	D.C. in Pri.	Sec. Imp.	Pri. Res.	Sec. Res.	List Price
*S0-1	Input	+ 4 V U.	200 50	0	250,000 62,500	16	2650	\$5.60
S0-2	Interstage/3:1	+ 4 V U.	10,000	0	90,000	225	1850	5.60
*S0-3	Plate to Line	+ 20 V U.	10,000 25,000	3 mil. 1.5 mil.	200 500	1300	30	5.60
S0-4	Output	+ 20 V U.	30,000	1.0 mil.	50	1800	4.3	5.60
S0-5	Reactor 50 HY at 1 mil.	D.C.	3000 ohms	D.C.	Res.			5.10
S0-6	Output	+ 20 V U.	100,000	5 mil.	60	3250	3.8	5.60

*Impedance ratio is fixed, 1250:1 for S0-1, 1:50 for S0-3. Any impedance between the values shown may be employed.

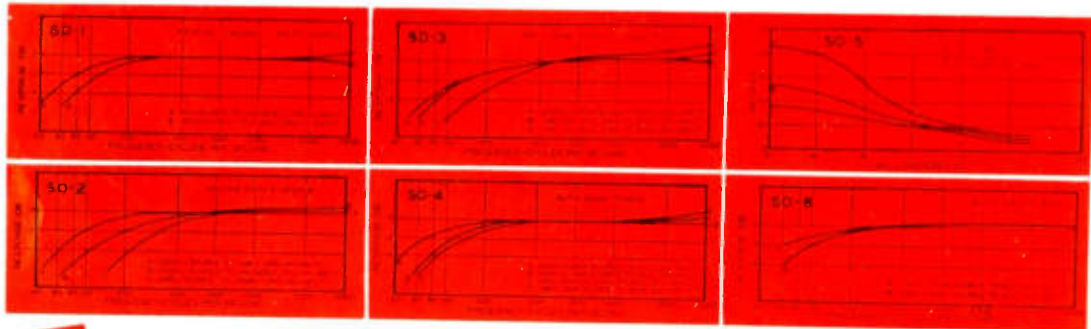

SUB-SUBOUNCER UNITS

FOR HEARING AIDS AND ULTRA-MINIATURE EQUIPMENT

UTC Sub-SubOuncer units have exceptionally high efficiency and frequency range in their ultra-miniature size. This has been effected through the use of specially selected Hiperm-Alloy core material and special winding methods. The constructional details are identical to those of the Sub-Ouncer units described above. The curves below show actual characteristics under typical conditions of application.

Type	Application	Level	Pri. Imp.	D.C. in Pri.	Sec. Imp.	Pri. Res.	Sec. Res.	List Price
*SS0-1	Input	+ 4 V U.	200 50	0	250,000 62,500	13.5	3700	\$5.60
SS0-2	Interstage/3:1	+ 4 V U.	10,000	0	90,000	750	3250	5.60
*SS0-3	Plate to Line	+ 20 V U.	10,000 25,000	3 mil. 1.5 mil.	200 500	2600	35	5.60
SS0-4	Output	+ 20 V U.	30,000	1.0 mil.	50	2875	4.6	5.60
SS0-5	Reactor 50 HY at 1 mil.	D.C.	4400 ohms	D.C.	Res.			5.10
SS0-6	Output	+ 20 V U.	100,000	.5 mil.	60	4700	3.3	5.60

*Impedance ratio is fixed, 1250:1 for SS0-1, 1:50 for SS0-3. Any impedance between the values shown may be employed.

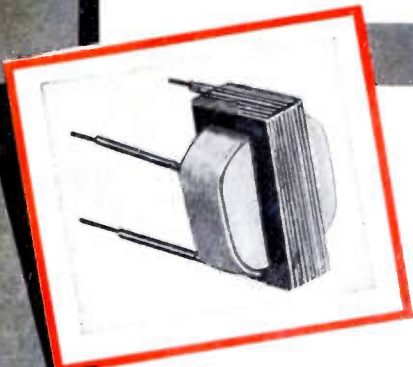
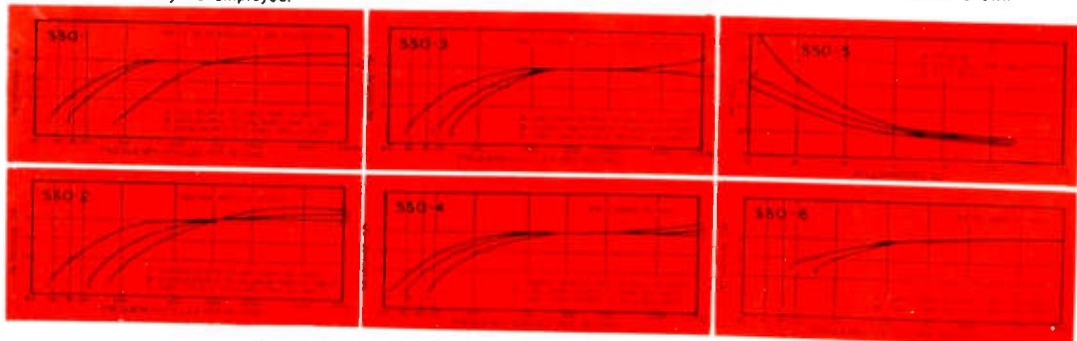

SUB-SUBOUNCER UNIT
Dimensions...7/16" x 3/4" x 5/8"
Weight......02 lb.

United Transformer Co.

150 VARICK STREET NEW YORK 13, N. Y.
EXPORT DIVISION: 13 EAST 40th STREET, NEW YORK 16, N. Y. CABLES: "ARLAB"

Meeting Opportunities

Of major importance in the interchange of engineering knowledge is the opportunity provided by national, sectional, and joint meetings of the IRE and interested other groups. These technical meetings, often with exhibits, bring engineers of like interests together, ideas are exchanged, and problems solved.



September 13-15 • West Coast Convention of the IRE

and the Pacific Electronic Exhibit—Long Beach, California

"To Pacific Coast organizations, who find it increasingly difficult to release any but a few key people for attendance at Eastern conventions, the West Coast Convention offers an opportunity for their engineers to hear papers by leading scientists and engineers in their field. To Eastern organizations, it furnishes an oppor-

tunity to become better acquainted with electronic science and industry on the West Coast. To all, it is an indication of the growing electronic activity in the West."

(From a definition of the 1949 West Coast Convention, by William R. Hewlett. It fits 1950.)

September 18-22 • Instrument Society of America Meeting

and Fifth National Instrument Exhibit

Founded and sponsored by the Instrument Society of America, the National Instrument Show with its technical sessions and educational meetings is a roving convention designed to take the story of better production control through instrumentation annually into a new industrial center.

This Fifth Meeting goes to the Memorial Auditorium at Buffalo, New York. The IRE Buffalo Section takes a co-operative part, and the meeting and exhibits have a special significance to the IRE Professional groups both of "Quality Control" and "Instrumentation." Information: Richard Rimbach, 921 Ridge Ave., Pittsburgh 12.

September 25-27 • National Electronics Conference

Well announced on this page, in June, the Conference will be held at the Edgewater Beach Hotel in Chicago. It is jointly sponsored by the Chicago Sections of IRE and the AIEE and three Universities. Ten major technical sessions held during the three days cover all phases of radio, television and industrial electronics.

This Sixth Conference will also highlight the 25th Anniversary of the Chicago IRE Section, by featuring "25 Years of Progress" as the theme for the largest manufacturers' exhibit yet undertaken, and distribution of the Chicagoland section of the 1950 IRE Directory. Information: Kipling Adams, Rm. 212, 920 S. Michigan Ave., Chicago 5.

AIEE-IRE Conference on Electronic Instrumentation in Nucleonics and Medicine, October 23-25

Nucleonic Manufacturers Exhibit

This is the Third Joint Meeting sponsored by IRE and AIEE annually. The sessions and exhibits will be at the Park Sheraton Hotel, 56th Street and Seventh Avenue, New York City. The first day, Monday, is devoted to medical aspects of the subject, and the second and third day to Nucleonics.

To meet growing interest, especially of the IRE Professional Group on Nucleonics, a larger lecture hall has been obtained in the Park-Sheraton Ballroom and increased exhibit space is provided in adjoining halls on the floor above. Information: Wm. C. Copp, Rm. 706, 303 West 42nd St., New York 20.

IRE Regional Meetings Promote Electronic Progress

PROCEEDINGS OF THE I.R.E. August, 1950, Vol. 38, No. 8. Published monthly by The Institute of Radio Engineers, Inc., at 1 East 79 Street, New York 21, N.Y. Price \$2.25 per copy. Subscriptions: United States and Canada, \$18.00 a year; foreign countries \$19.00 a year. Entered as second class matter, October 26, 1927, at the post office at Menasha, Wisconsin, under the act of March 3, 1879. Acceptance for mailing at a special rate of postage is provided for in the act of February 28, 1925, embodied in Paragraph 4, Section 412, P. L. and R., authorized October 26, 1927.

Table of Contents will be found following page 32A

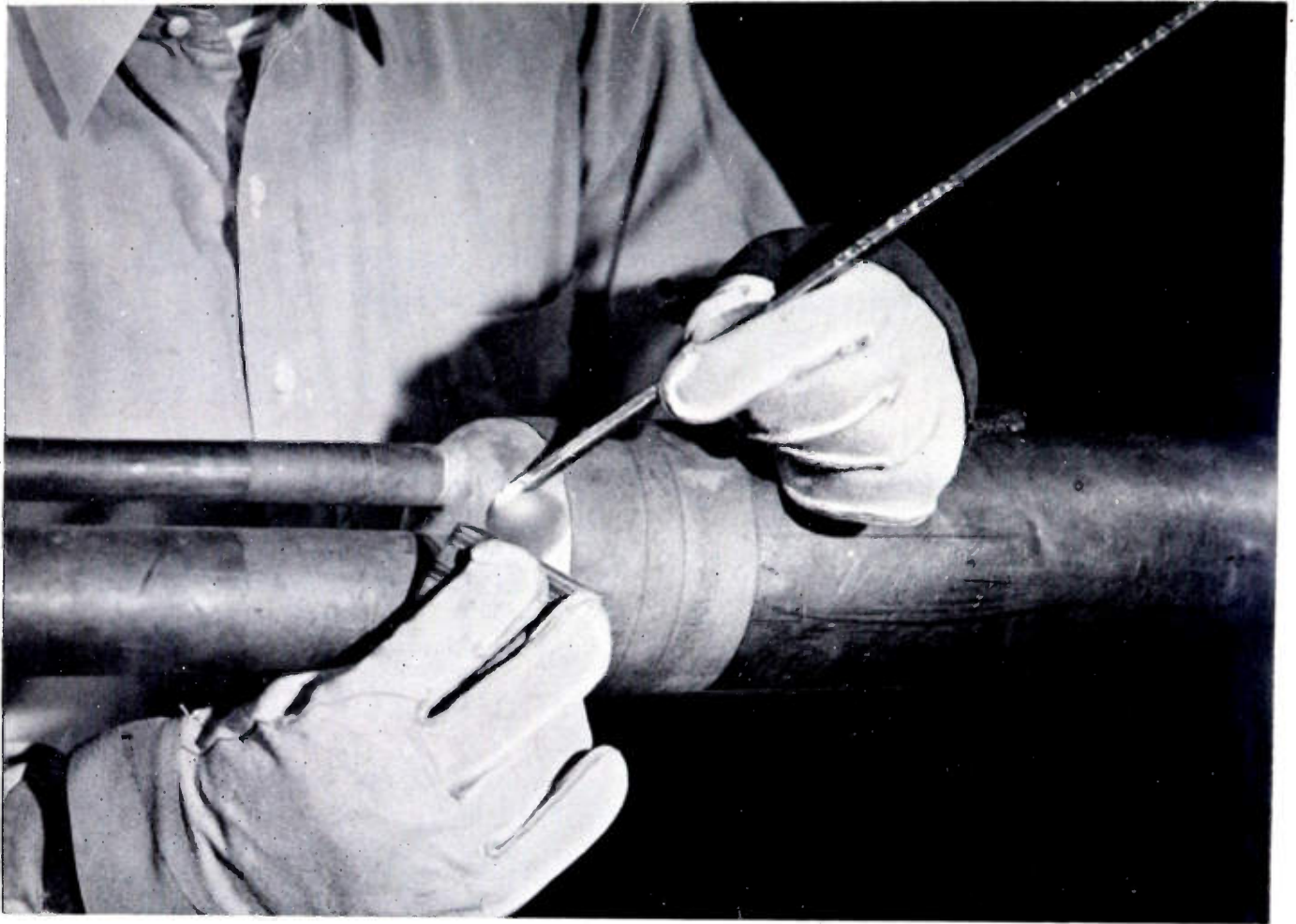

*He seals out
trouble...*

**TO KEEP THE COST
OF YOUR TELEPHONE
SERVICE DOWN**

To make cable joints tight and strong, splicers formerly used lots of solder. Then, Bell Telephone Laboratories developed a new technique for making better joints with much less solder. This saves one million pounds of solder a year — helps keep the price of your telephone service low.

Two kinds of solder are now used. One makes the splice strong; the other seals it. First, the splicer builds up a joint with a solder of lead and tin, which flows easily under his wiping cloth. To seal the joint, he applies a light coating of low-melting-point solder, composed of lead, tin and bismuth. On contact with the still hot joint, it flows into and seals every pore.

Cable-sealing solder is only one of 30 low-melting-point alloys which Bell metallurgists have developed for special uses — in fuse wires, for example, and in the solder connecting hair-like wires to piezoelectric crystals for electric wave filters.

Continuing research with a substance seemingly as commonplace as solder demonstrates again how Bell scientists help keep your telephone service the world's best.

BELL TELEPHONE LABORATORIES



• WORKING CONTINUALLY TO KEEP YOUR TELEPHONE
SERVICE BIG IN VALUE AND LOW IN COST

NEW SIGNAL GENERATOR

FAST DIRECT READINGS

**800 mc to
2100 mc**

NO CHARTS OR INTERPOLATIONS



-hp- 614A UHF Signal Generator

Direct reading output, accuracy ± 1 db...Constant internal impedance, SWR 3 db...Direct frequency control...External modulation 0.5 microseconds pulses to square waves...CW, FM, pulsed output.

This new *-hp-* signal generator will save you hours of time and work in making UHF measurements between 800 and 2100 mc. Its many different modulation and pulsing capabilities mean these man-hour economies can be applied to a wide variety of measurements—receiver sensitivity and alignment, signal-to-noise ratio, conversion gain, standing wave ratios, antenna gain and transmission line characteristics, to name but a few.

Carrier frequency in mc can be set and read directly on the large central tuning dial. R-f output from the klystron oscillator is also directly set and read in microvolts or db. No calibration charts or tedious interpolation are necessary. And thanks to the unique *-hp-* automatic tracking mechanism, no voltage adjustments

are needed during operation.

R-f output ranges from 0.1 volt to 0.1 microvolt. Output may be continuous, pulsed, or frequency modulated at power supply frequency. The instrument may be modulated either externally or internally and may be synchronized with positive or negative pulses or sine waves.

Because of its wide range, high stability and versatile usefulness, this new *-hp-* signal generator is adaptable to almost any uhf measuring need. The instrument is available for early delivery. Contact your *-hp-* field representative or write direct to factory for complete details and technical specifications.

HEWLETT-PACKARD CO.

1874-D Page Mill Road, Palo Alto, California
Export Agents: Frozar & Honsen, Ltd.
301 Clay Street • San Francisco, Calif., U.S.A.

SPECIFICATIONS

FREQUENCY RANGE:

800 to 2100 mc. Selection is made by means of a single directly-calibrated control covering entire range. No charts are necessary.

FREQUENCY CALIBRATION ACCURACY:

$\pm 1\%$.

OUTPUT RANGE:

1 milliwatt or .223 volts to 0.1 microvolt (0 dbm to -127 dbm). Directly calibrated in microvolts and db; continuously monitored.

ATTENUATOR ACCURACY:

Within ± 1 db without correction charts. A correction chart is provided when greater accuracy is desired.

50 ohms. SWR 3 db (VSWR 1.4).

EXTERNAL MODULATION:

By external pulses, positive or negative, peak amplitude 40 to 70v., 0.5-microseconds to square wave.

FM MODULATION:

Oscillator frequency sweeps at power line frequency. Phasing and sweep range controls provided. Maximum deviation approximately ± 5 mc.

INTERNAL MODULATION:

Pulse repetition rate variable from 40 to 4000 per second; pulse length variable from 1 to 10 microseconds. Pulse rise and decay approximately 0.1 microseconds.

TRIGGER PULSES OUT:

1. Simultaneous with r-f pulse.
2. In advance of r-f pulse, variable 3 to 300 microseconds.
(Both approximately 1 microsecond rise time, height 10 to 40 volts.)

EXTERNAL SYNC PULSE REQUIRED:

Amplitude from 10 to 50 volts of either positive or negative polarity and 1 to 20 microseconds width. May also be synchronized with sine waves.

Data subject to change without notice.

 **laboratory instruments**
FOR SPEED AND ACCURACY

*Proof
of Strength*
IN
**TRUSCON
TOWERS OF
STRENGTH**

**Tower on
KSRO Hit
By Plane**

Two navy fighter pilots from the Aircraft Carrier Boxer narrowly escaped injury yesterday in two separate mishaps at Santa Rosa Naval Air Base.

Yesterday morning a VF-8 fighter piloted by Ensign J. P. McCarthy brushed a wing against one of Radio Station KSRO's 194-foot high transmitter towers. The impact sent approximately eight inches of the plane's wing—aluminum, fabric and landing lights—fluttering to the ground.

The aircraft, however, did not go out of control. The pilot zoomed close to the ground, apparently discovered the plane was still navigable, and turned towards his Alameda Naval Air Station base. Two companions flew a protective escort at his side.

AT APPROXIMATELY 3 p. m., a similar type fighter groundlooped and was badly damaged as it set down for a landing at the Santa Rosa strip.

The pilot, Lt. (j.g.) J. G. Rickel, was uninjured except for minor scratches.

The earlier mishap bent about 10 feet of the KSRO tower but did not force the station off the air. In fact, station attendants were unaware of the accident until mid-afternoon when shifts were changed and nearby residents carried over some of the wing pieces that fell from the plane.

Note particularly the last paragraph of this interesting news story, giving the details of an accidental and impressive test of Truscon Radio Tower strength.

Ability to stand up under the most unusual operating conditions is a characteristic of Truscon Towers of Strength. Throughout the world these strong, sturdy fingers of steel are setting new performance records. Truscon draws upon this background of world-wide experience to engineer and erect exactly the type of tower needed for each particular operating and geographical condition. Your phone call

or letter to any convenient Truscon district office, or to our home office in Youngstown, will bring you immediate, capable engineering assistance.

TRUSCON 
SELF-SUPPORTING
AND UNIFORM **TOWERS**
CROSS SECTION GUYED
TRUSCON COPPER MESH GROUND SCREEN

TRUSCON STEEL COMPANY
YOUNGSTOWN 1, OHIO
Subsidiary of Republic Steel Corporation

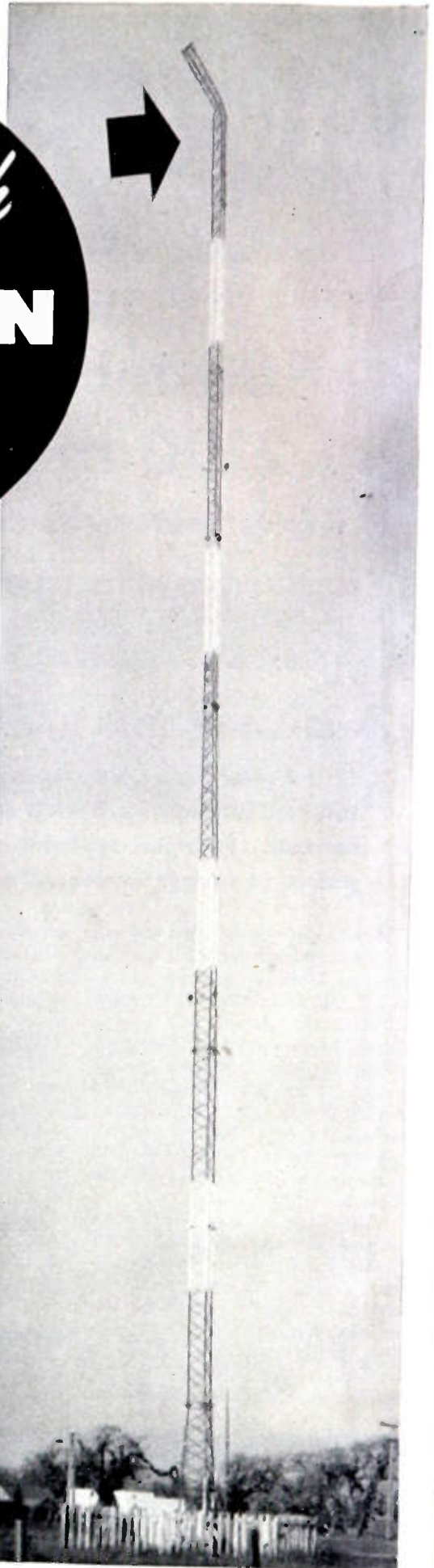

Now the improved

GL-2C39-A HIGH-MU LIGHTHOUSE TRIODE!

Crowns 15 years of General Electric research and development in closely-spaced planar tubes for microwave applications.

★ Amplification factor 100.
★ Plate dissipation 100 w.

★ Top frequency above 2,500 mc.
★ Meets JAN specifications.

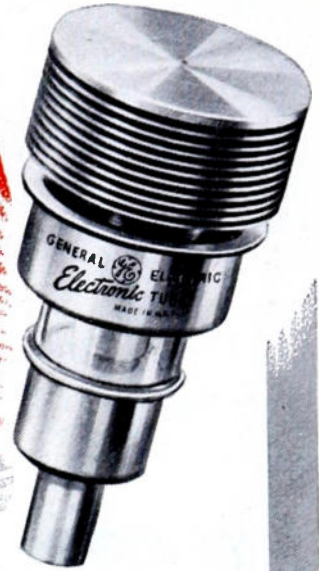

GL-2C39-A

ELECTRICAL CHARACTERISTICS

Cathode	coated unipotential
Heater voltage	6.3 v
Heater current	1.0 amp
Amplification factor, average	100
Direct interelectrode capacitances, average:	
Grid-plate	1.95 μmfd
Grid-cathode	6.50 μmfd
Plate-cathode	0.035 μmfd
Transconductance, average ($I_b = 70\text{ma}$, $E_b = 600\text{v}$)	22,000 μmhos

MAX RATINGS, R-F POWER AMPLIFIER SERVICE

Class-C FM Telephony or Telegraphy, key-down conditions, per tube.

D-c plate voltage	1,000 v
D-c cathode current	125 ma
D-c grid voltage	-150 v
Peak positive r-f grid voltage	30 v
Peak negative r-f grid voltage	-400 v
Plate dissipation	100 w
Grid dissipation	2 w

HERE is notable G-E design progress over earlier Lighthouse Types GL-2C38 and GL-2C39, which in turn originated in the laboratories of General Electric Company as the fruition of many years of tube pioneering work.

Newest, most efficient of planar types that make real the vast possibilities of the microwave regions, the GL-2C39-A combines physical compactness ($2\frac{3}{4}$ by $1\frac{3}{4}$ inches) with excellent characteristics as a power amplifier, oscillator, or frequency multiplier.

Important fields of use—where the GL-2C39-A's suitability is so marked that designers are making this fine tube their first choice—include:

- Aircraft traffic and location controls
- Broadcast relay equipment
- Microwave test apparatus
- Military communications
- Utility telemetering and communication systems

On these . . . and other . . . applications, General Electric tube engineers will be glad to work closely with you, and with the men at your drawing-boards who handle the details of circuit design. G-E experience with u-h-f types that goes back nearly two decades, and includes countless individual applications, is yours for the asking.

Phone, wire, or write for immediate response to your inquiry about the price of the GL-2C39-A, or for performance facts beyond those given in the right-hand column. Address *Electronics Department, General Electric Company, Schenectady 5, New York.*

GENERAL ELECTRIC

180-JS

The new Eimac 4X150G will . . .



DELIVER 20 KW AS A PULSED AMPLIFIER OR OSCILLATOR TO OVER 1200 Mc.

GIVE A POWER-GAIN OF 10 AT 1200 Mc.

PROVIDE 100 WATTS CW POWER AT 750 Mc. WITH A POWER GAIN OF 8.

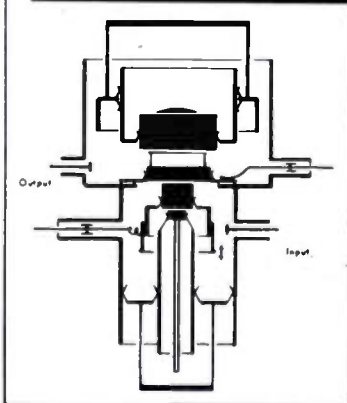
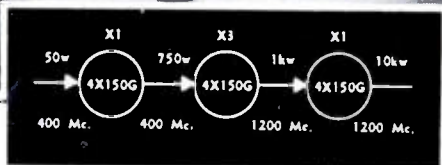

These illustrations show an example of the simplicity made possible by the 4X150G. The cavity is for a broad-band 1200 Mc. power amplifier for a pulse application. The block diagram indicates the tube line-up of the IPA, tripler, and final PA stages. More detailed data on the 4X150G are available. Please make requests on your company letter-head.

The 4X150G has been specifically designed to make feasible relatively high power at UHF. It is excellent as an amplifier, oscillator or frequency multiplier in either pulse or cw service. Good efficiency is obtained over a wide range of plate voltages to over 1500 Mc.

Power-gains of 10 are easily obtainable at 1200 Mc. when pulsed, and peak pulsed outputs of 20 kw per tube are possible without extending the tube beyond its maximum ratings.

At lower frequencies, for instance around 750 Mc., the 4X150G operating as a cw amplifier will provide 100 watts output with but 12½ watts of grid-drive . . . a power-gain of 8, with complete stability.

These examples are only indicative of the tube's potentialities. More comprehensive data are contained in a new data sheet, available upon request.

E I T E L - M c C U L L O U G H , I N C .
S a n B r u n o , C a l i f o r n i a

Export Agents: Frazer & Hansen,
301 Clay St., San Francisco, California

Follow the Leaders to

Eimac
TUBES

The Power for R-F

The 4X150G is another Eimac-developed contribution to electronic progress.



258

PRODUCED BY THE MILLIONS



Final Inspection

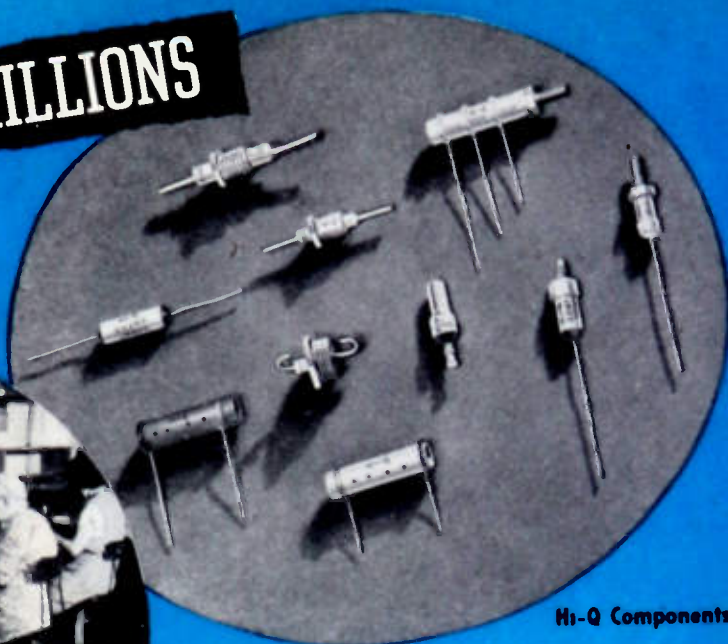

Hi-Q Components

- and every single one is Individually Tested!

Hi-Q COMPONENTS

Capacitors
Trimmers • Choke Coils
Wire Wound Resistors

BETTER 4 WAYS

- ✓ PRECISION
- ✓ UNIFORMITY
- ✓ DEPENDABILITY
- ✓ MINIATURIZATION

Though **Hi-Q** Ceramic Components are produced at a rate of several million a month, each and every single one is individually tested at each stage of production and as a part of final inspection before shipment. That is one of the reasons why you can depend on all **Hi-Q** Components to precisely meet specifications, ratings and tolerances. That is one of the reasons why they are used by virtually all leading producers of television, communications and electronic equipment.

You are invited to write now for a copy of the brand new **Hi-Q** Datalog.

JOBBERS — ADDRESS: 740 Belleville Ave., New Bedford, Mass.

Hi-Q

Electrical Reactance Corp.

FRANKLINVILLE, N. Y.

SALES OFFICES: New York, Philadelphia
Detroit, Chicago, Los Angeles

PLANTS: Franklinville, N. Y., Olean, N. Y.
Jessup, Pa., Myrtle Beach, S. C.



Logistics

for resistors too!

For adequate supplies of resistors in an ever-widening market, depend on IRC logistics. Already the largest manufacturer of resistors in the world, IRC has increased its output tremendously to meet your requirements. And in addition, IRC capacity is now being supplemented by licensees in Canada and Denmark—while English, Australian and Italian licensees provide resistors for other world markets formerly supplied from the United States. IRC availability extends even to your urgent, small-order requirements for standard resistors. Through our Industrial Service Plan, your IRC Distributor can supply these promptly from full stocks of the most popular types and sizes.

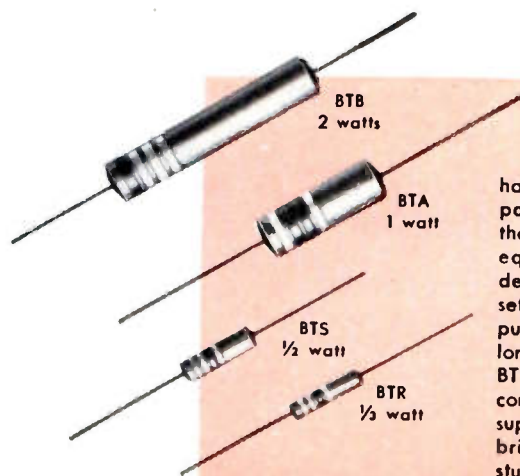

Stock-piling of advanced BT's

has been proved practical by IRC's study of resistor-use patterns. A recently completed three-year profile shows that 80% of the BT resistors used in TV and radio equipment include only 30 values. This holds true despite design changes and shifts in the industry's emphasis on sets. And these facts prove that you can now simplify purchasing, stocking and expediting practices by placing long-term orders covering your basic, recurring needs for BT's. Engineered to meet JAN-R-11 specifications for fixed composition resistors, IRC BT's have established their superiority in all important characteristics. Bulletin B-1 brings you full details of IRC BT's, and a copy of our study is yours for the asking.

is important

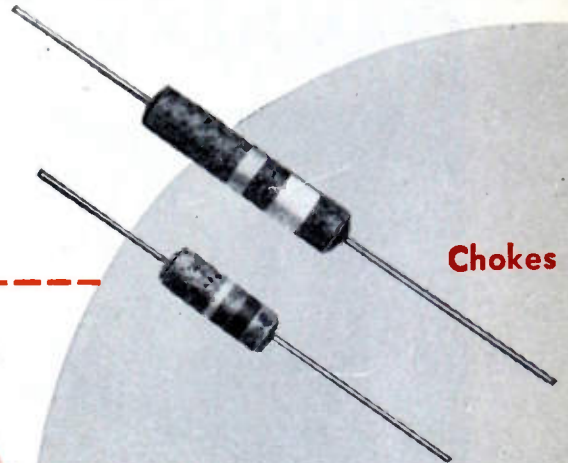

Chokes

Modern mass production equipment . . .

plus exclusive manufacturing techniques, make IRC Insulated Chokes relatively inexpensive — and offer considerable savings over ordinary types. Available in two sizes, IRC chokes are insulated in molded phenolic housings for full protection against high humidity, abrasion, damage during assembly, and danger of shorting to chassis. "Q" improves with rise in frequency and is sufficiently high for broad-band tuning in FM and TV regions. Resistance is low enough to permit use as filament chokes for moderately high power tubes. Coupon brings you full information in Bulletin H-1.

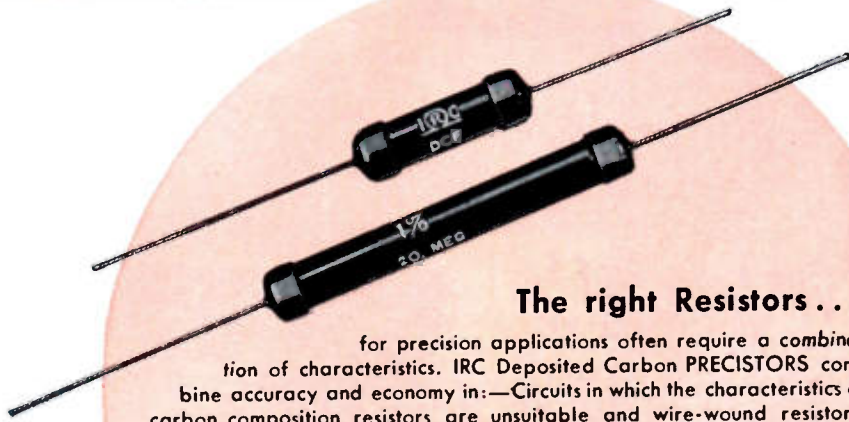

The right Resistors . . .

for precision applications often require a combination of characteristics. IRC Deposited Carbon PRECISTORS combine accuracy and economy in:—Circuits in which the characteristics of carbon composition resistors are unsuitable and wire-wound resistors too expensive — Metering and voltage divider circuits requiring high stability and close tolerance of the resistance values — High-frequency applications. The two sizes of IRC PRECISTORS are manufactured to customers' specifications, rather than to standard RMA values (subject, of course, to minimum and maximum values for each type). For complete data on characteristics and values, mail coupon for Bulletin B-4.

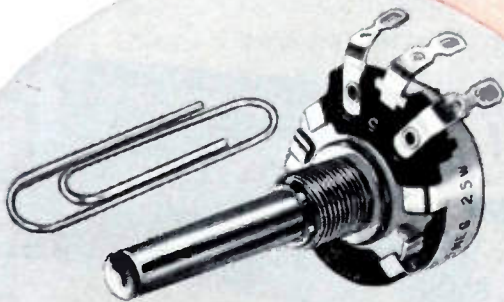

Dependable source of small-size controls . . .

IRC meets your requirements with the new 1 3/16" Type Q. Mechanization of production and testing assures increased supplies of these miniature controls. And elimination of hand operations provides complete uniformity of construction and performance. New IRC Type Q Controls are rugged and compact. Resistance element is the best IRC has ever produced. Increased arc of rotation permits the same resistance ratios used in larger IRC Controls. IRC Type Q's are characterized by low noise level, negligible changes in resistance even after long exposure to humidity, unusual durability and efficiency, and adaptability to a wide variety of small-space applications. Bulletin A-1 gives full information.

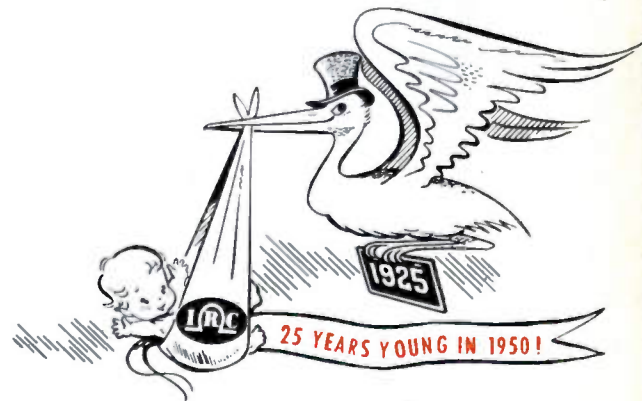

Wherever the Circuit Says ~~~~

- Power Resistors • Voltmeter Multipliers
- Insulated Composition Resistors • Low Wattage Wire Wounds • Controls
- Rheostats • Voltage Dividers • Precisions • Deposited Carbon Precistors • High Frequency and High Voltage Resistors • Insulated Chokes

INTERNATIONAL RESISTANCE COMPANY

401 N. Broad Street, Philadelphia 8, Pa.

In Canada: International Resistance Co., Ltd., Toronto, Licensee

INTERNATIONAL RESISTANCE CO.
405 N. BROAD ST., PHILADELPHIA 8, PA.

Please send me complete information on the items checked below:

- | | |
|--|--|
| <input type="checkbox"/> Advanced BT Resistors (B-1) | <input type="checkbox"/> New Q Controls (A-1) |
| <input type="checkbox"/> PRECISTORS (B-4) | <input type="checkbox"/> Insulated Chokes (H-1) |
| <input type="checkbox"/> IRC Study of Resistor Use | <input type="checkbox"/> Name and Address of local IRC Distributor |

NAME.....
 TITLE.....
 COMPANY.....
 ADDRESS.....
 CITY..... STATE.....

STANDARD RI-FI* METERS

14 kc to 1000 mc!

DEVELOPED BY **STODDART**
FOR THE ARMED FORCES.

AVAILABLE COMMERCIALY.



VHF!
15 MC
to
400 MC
NMA - 5

Commercial equivalent of TS-587/U.
Sensitivity as two-terminal voltmeter, (95 ohms balanced)
2 microvolts 15-125 MC; 5 microvolts 88-400 MC. Field
intensity measurements using calibrated dipole. Frequency
range includes FM and TV Bands.

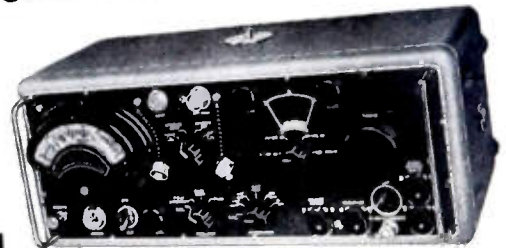

VLF!
14 KC
to
250 KC
NM - 10A

Commercial equivalent of AN/URM-6.
A new achievement in sensitivity! Field intensity measure-
ments, 1 microvolt-per-meter using rod; 10 microvolts-per-
meter using shielded directive loop. As two-terminal volt-
meter, 1 microvolt.

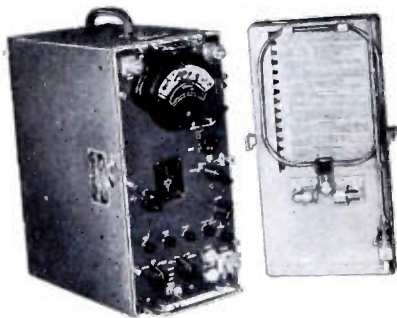

HF!
150 KC
to
25 MC
NM - 20A

Commercial equivalent of AN/PRM-1.
Self-contained batteries. A.C. supply optional. Sensitivity as
two-terminal voltmeter, 1 microvolt. Field intensity with 1/2
meter rod antenna, 2 microvolts-per-meter; rotatable loop
supplied. Includes standard broadcast band, radio range,
WWV, and communications frequencies.



UHF!
375 MC
to
1000 MC
NM - 50A

Commercial equivalent of AN/URM-17.
Sensitivity as two-terminal voltmeter, (50-ohm coaxial input)
10 microvolts. Field intensity measurements using calibrated
dipole. Frequency range includes Citizens Band and UHF
color TV Band.

Since 1944 Stoddart RI-FI* instruments have established the
standard for superior quality and unexcelled performance.
These instruments fully comply with test equipment require-
ments of such radio interference specifications as JAN-I-225,
ASA C63.2, 16E4(SHIPS), AN-I-24a, AN-I-42, AN-I-27a, AN-I-40
and others. Many of these specifications were written or re-
vised to the standards of performance demonstrated in
Stoddart equipment.

The rugged and reliable instruments illustrated above serve
equally well in field or laboratory. Individually calibrated
for consistent results using internal standard of reference.
Meter scales marked in microvolts and DB above one microvolt.
Function selector enables measurement of sinusoidal or complex
waveforms, giving average, peak or quasi-peak values.
Accessories provide means for measuring either conducted
or radiated r.f. voltages. Graphic recorder available.

*Radio Interference and Field Intensity.

STODDART AIRCRAFT RADIO CO.

6644 SANTA MONICA BLVD., HOLLYWOOD 38, CALIF.
Hillside 9294

Precision Attenuation for UHF I

Less than 1.2 VSWR to 3000 MC.
Turret Attenuator:

0, 10, 20, 30, 40, 50 DB.
Accuracy \pm .5 DB.

Patents applied for.



Tiny BUT **TOUGH**

EL-MENCO CAPACITORS

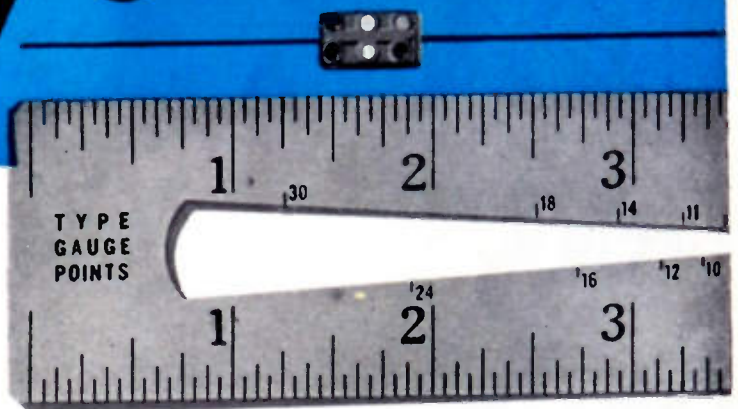

Built to Stand Up Under Severe Stress and Strain

Fixed mica El-Menco condensers are tiny but tough. They give sustained superior performance under adverse conditions. Pretested at *double* their working voltage, El-Menco capacitors prove their ruggedness *before* leaving the factory.

They are tested for dielectric strength, insulation resistance and capacity value.

When you want peak performance put them in your product. You can depend on El-Menco to stand up under critical operating conditions and extremes of temperature and climate.

Always Specify El-Menco — The Capacitor That's Tiny But Tough.

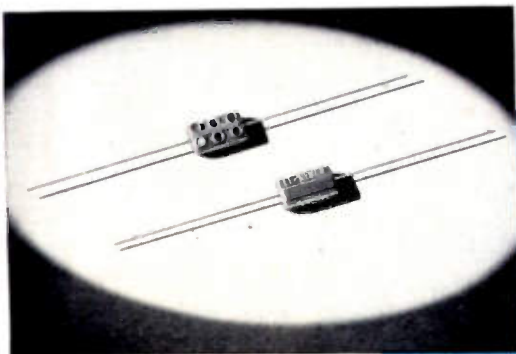

CM-15

THE ELECTRO MOTIVE MFG. CO., Inc.
WILLIMANTIC CONNECTICUT

Actual Size $9/32'' \times 1/2'' \times 3/16''$.
For Television, Radio and other Electronic Appliances.
2 mmf. — 420 mmf. cap. at 500v DCw.
2 mmf. — 525 mmf. cap. at 300v DCw.
Temp. Co-efficient ± 50 parts per million per degree
C for most capacity values.
6-dot color coded.

Write on your
firm letterhead
for Catalog and Samples.



MOLDED MICA

EL-MENCO

CAPACITORS

MICA TRIMMER

FOREIGN RADIO AND ELECTRONIC MANUFACTURERS COMMUNICATE DIRECT WITH OUR EXPORT DEPT. AT WILLIMANTIC, CONN. FOR INFORMATION.
ARCO ELECTRONICS, INC. 135 Liberty St., New York, N. Y.—Sole Agent for Jobbers and Distributors in U.S. and Canada

THE INSIDE STORY: WHY SPRAGUE MOLDED TUBULARS OUTPERFORM ALL OTHERS!

Molded paper tubulars may look alike from the outside. But there's a whale of a difference inside—the part that really counts in the performance of your products.

The *exclusive* difference in Sprague molded phenolic tubulars is that: *each is made by the same dry-assembly process as large metal-encased oil capacitors.* They cannot be contaminated during manufacture!

Every Sprague molded tubular from 200 to 12,500 volts is molded *dry*. After molding it is impregnated under high vacuum through an opening in the eyelet terminal. A lead is then inserted and the terminal solder sealed. Result? A capacitor that offers you superior heat and moisture protection . . . top insulation resistance . . . high capacitance stability and retrace under wide temperature variations.

Small wonder then why Sprague molded tubulars are preferred for the toughest television and auto radio applications. Take advantage of this superiority by calling in a Sprague representative today. Or, write for Engineering Bulletins 210B and 214.



SPRAGUE[®]
PIONEERS IN

SPRAGUE ELECTRIC COMPANY
North Adams, Massachusetts

ELECTRIC AND ELECTRONIC DEVELOPMENT

A "Brand New" SOLUTION TO YOUR AUDIO MEASUREMENT PROBLEMS

FEATURES

FREQUENCY RANGE:
20 cps to 20 KC.

ACCURACY:
Accuracy is ± 0.1 db, from
20 cps to 20 KC.

OUTPUT LEVELS:
Ranges of output levels:
+4 to -110 db and -10 to
-124 db in steps of 0.1 db.

ACCESSIBILITY:
All components accessible
from front of rack panel—
for ease of servicing.

IMPEDANCE RANGES:
(a) *Source Section*—600-
150 ohms internally
terminated.
600-250-150-30 ohms
unterminated.
(b) *Load Section*—600-
250-150-16-8-4 ohms.

Daven's Moderate Priced Transmission Measuring Set

This is the instrument for which you have been waiting! For accuracy and efficiency, the Daven Type 11 A gain set, will fill your bill. Incorporating many of the features employed in more expensive models, this unit may be used to make all the precise measurements required by the FCC. This is a direct reading instrument, entirely eliminating time-consuming computations.

A new design feature, permits the servicing and inspection of all components from the front of the panel, with a maximum of ease and in a minimum of time.

It is no longer necessary to use makeshift equipment for determining the transmission characteristics of audio systems. The Type 11 A gain set has been priced low enough to place it within the reach of the most limited budget.

APPLICATIONS

- AUDIO GAIN MEASUREMENTS.
- AUDIO LOSS MEASUREMENTS.
- MEASUREMENTS OF MATCHING AND BRIDGING DEVICES.
- COMPLEX CIRCUIT MEASUREMENTS.
- MEASURING MISMATCH LOSS.
- FREQUENCY RESPONSE MEASUREMENTS.
- CHECKING CABLE LOSS.
- TELEPHONE REPEATER MEASUREMENTS.
- VOLUME LEVEL READINGS.

Now Available for
Immediate Delivery
from Stock.

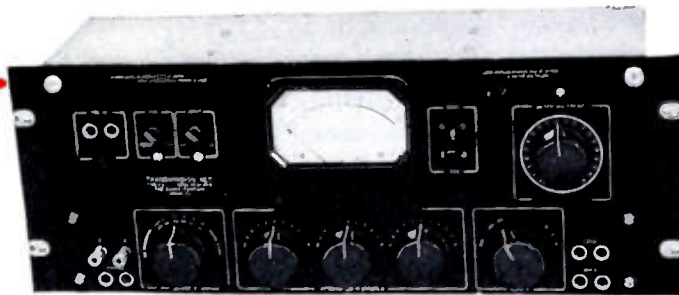

ALWAYS SPECIFY DAVEN FOR PRECISION EQUIPMENT

Write to Dept. IE-8
for additional
Information.

THE **DAVEN** CO.

191 CENTRAL AVENUE
NEWARK 4, NEW JERSEY

**Service
Beyond
The Sale!**

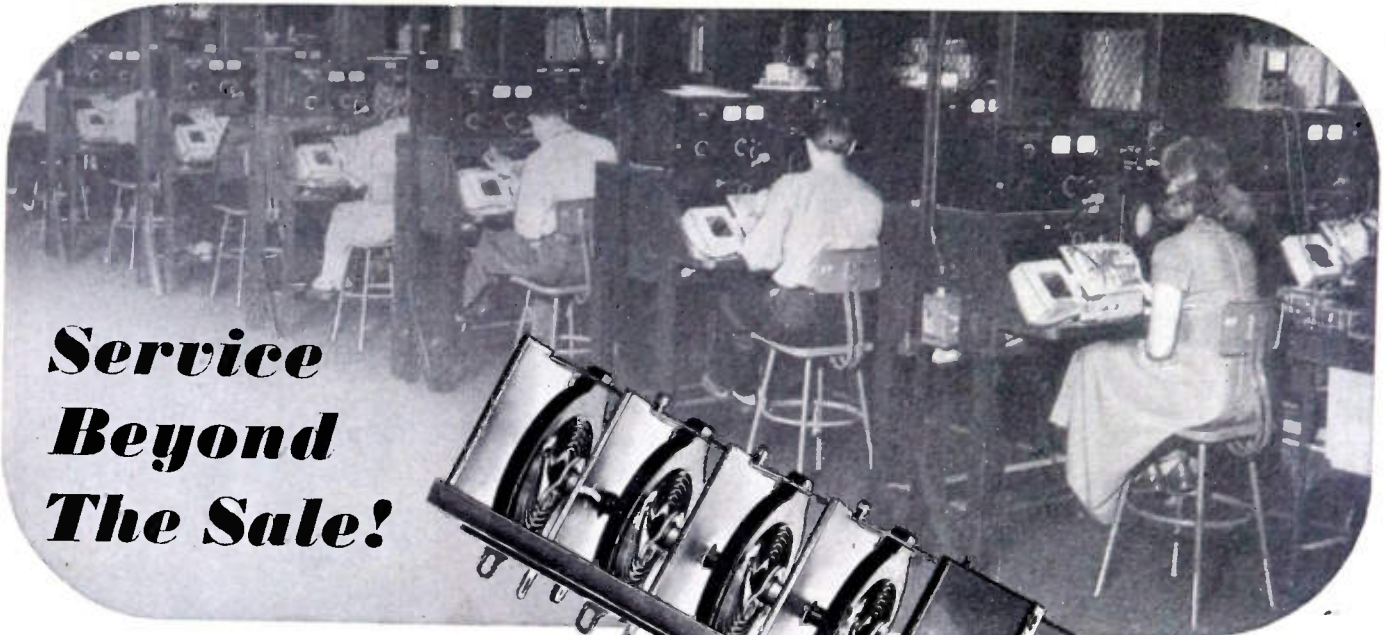

Photo courtesy
Allen B. DuMont Labs., Inc.

Mallory Cuts Factory Television Alignments by 6 to 1

Television receiver manufacturers who are employing the Mallory Inductuner* are giving their customers far more enjoyment . . . split-hair tuning accuracy, greater selectivity and stability, finger tip compensation for drift, complete FM radio coverage.

In addition, they find it possible to simplify their front end design and reduce assembly operation. For example, there are just two aligning operations on each of the three or four sections of the Inductuner, compared with six times as many on other types of tuners.

Added selling features! Reduced costs! And now, in the new Spiral Inductuner these important advantages are yours at a price no higher than other tuning devices.

If you want electronic parts of complete dependability and superior performance, from a supplier qualified to work hand in hand with you in the solution of design problems, turn to Mallory!

Outstanding Advantages of the new Mallory Spiral Inductuner:

1. A single control for easy selection and fine tuning of any television or FM channel.
2. Easily adapted to UHF converter use.
3. Excellent stability eliminates frequency drift.
4. Supplied in three- or four-section designs.
5. Far more quiet operation; permits high signal-to-noise ratio in front end designs.
6. Free from microphonics.
7. Greater selectivity on high frequency channels.
8. Eliminates "bunching" of high band channels. Covers entire range in only six turns.
9. Simplifies front end design and production.
10. Reduces assembly costs.

*Reg. trade mark of P. R. Mallory & Co., Inc. for inductance tuning devices covered by Mallory-Ware patents.

Television Tuners, Special Switches, Controls and Resistors

P. R. MALLORY & CO., Inc.
MALLORY

P. R. MALLORY & CO., Inc., INDIANAPOLIS 6, INDIANA

SERVING INDUSTRY WITH

Capacitors	Contacts
Controls	Resistors
Rectifiers	Vibrators
Special Switches	Power Supplies
Resistance	Welding Materials

Jobs For
TV and RADIO



CLEVELAND
COSMALITE* and CLEVELITE*

Laminated Phenolic Tubes

Outstanding as the Standard of Quality!

COSMALITE known for its many years of Top Performance.
CLEVELITE for its ability to meet unusual specifications.

Available in diameters, wall thicknesses, and lengths desired.

These CLEVELAND TUBES combine . . . High Dielectric Strength
. . . Low Moisture Absorption . . . Great Mechanical Strength . . .
Excellent Machining Properties . . . Low Power Factor . . . and
Good Dimensional Stability.

For the best . . . "Call Cleveland." Samples on request.

* Trade Mark

The **CLEVELAND CONTAINER Co.**
6201 BARBERTON AVE. CLEVELAND 2, OHIO

PLANTS AND SALES OFFICES at Plymouth, Wis., Chicago, Detroit, Ogdensburg, N.Y., Jamesburg, N.J.
ABRASIVE DIVISION at Cleveland, Ohio
CANADIAN PLANT: The Cleveland Container, Canada, Ltd., Prescott, Ontario

REPRESENTATIVES

NEW YORK AREA

R. T. MURRAY, 614 CENTRAL AVE., EAST ORANGE, N. J.

NEW ENGLAND

R. S. PETTIGREW & CO., 968 FARMINGTON AVE.
WEST HARTFORD, CONN.

CANADA

WM. T. BARRON, EIGHTH LINE, RR #1, GAKVILLE, ONTARIO



Ask about
CLEVELAND TUBES

in various types and specifications
being used in the Electrical Industry.

* REVERE
COPPER AND
BRASS HELPS
keep TV
Sales Hot
FOR
CROSLEY

...makes
Cabinets
Cool and
Classy

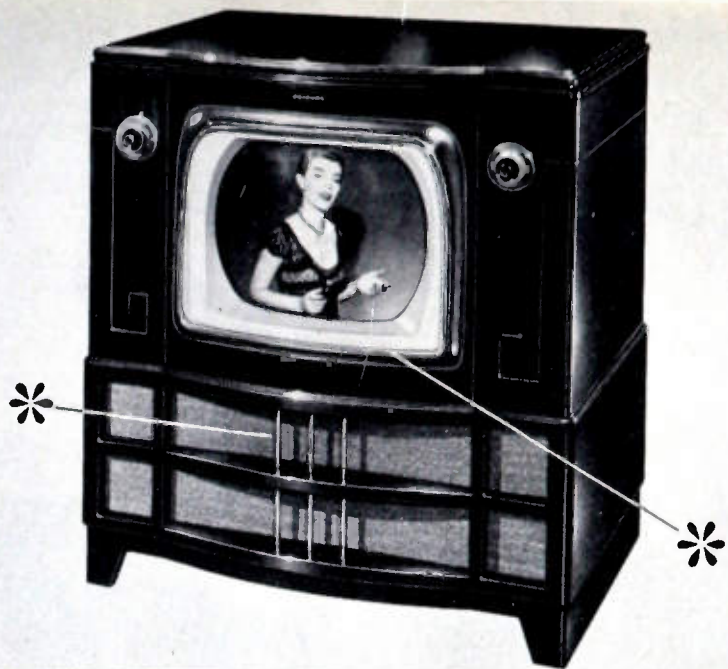

The newest Crosley Television Cabinets are striking examples of how copper and brass can be used to give products sales appeal as well as serve a utilitarian purpose.

All models, two of which are shown above, are equipped with gleaming bezels which frame the television screens. They are made for the Crosley Corporation from Revere 90-10 Commercial Bronze. The table model shown is equipped with two control escutcheons drawn from this same metal by the Rex Engineering Company, Cincinnati, Ohio. The table model also has two strips of .0016" Revere Soft Copper of 5½" width on the under side of the top of the cabinet. This acts as an insulator by conducting any heat generated, away from the wooden cabinets. For, although copper is the best heat conductor of the commercial metals, when highly polished it dissipates rather than absorbs heat.

Note on the console model, shown above, how the three Revere Brass Tubes add a touch of luxury and richness to the cabinet.

Perhaps Revere Copper or Brass or one of its other metals or alloys can help in the development and improvement of your product. Why not call the nearest Revere Sales Office and see?

REVERE
COPPER AND BRASS INCORPORATED

Founded by Paul Revere in 1801

230 Park Avenue, New York 17, New York

*Mills: Baltimore, Md.; Chicago, Ill.; Detroit, Mich.; Los Angeles and
Riverside, Calif.; New Bedford, Mass.; Rome, N. Y.*

Sales Offices in Principal Cities, Distributors Everywhere

For many uses...

ALSiMAG[®] parts may be better than metal parts
...and less expensive

A large family of technical ceramics, under the trade name ALSiMag, is custom made into parts to fit individual requirements. These are versatile ceramics. You can choose the one that combines the

physical characteristics required for your use. Characteristics of the more frequently used ALSiMag ceramics are accurately determined. They're shown on ALSiMag Property Chart 501, sent free on request.

CONSIDER THESE GENERAL CHARACTERISTICS. THEY MAY HELP YOU FIND THE ANSWER TO ONE OF YOUR DESIGN OR PERFORMANCE PROBLEMS.

CHARACTERISTIC	TYPICAL OF MOST METALS	TYPICAL OF ALSiMag CERAMICS
Creep	Variable, but frequently excessive	Frequently can be used where metals fail
Resistance to Corrosion	Variable, but generally poor	Chemically inert
Resistance to Electrolytic Action	Generally poor	Excellent
Abrasion Resistance (Hardness)	Variable	Excellent
Resistance to Impact	Generally good	Variable, fair to poor
Compressive Strength	Excellent	Good
Magnetic Properties	Variable	Non-magnetic
Electrical Insulating Properties	Conductor	Non-conductor
Thermal Insulating Properties	Poor	Good
Dimensional Accuracy	Excellent	Can be ground to any desired tolerance

FABRICATION COST: ALSiMag parts are produced to your specifications. The material is machined in the unfired state, then converted to a very hard material by firing. Thus where parts of great hardness are required, they can generally be produced in ALSiMag at a major saving in cost. Certain small and relatively simple shapes can be produced in large quantity an automatic production machinery at costs below that of any other material or production method.

ENGINEERING COOPERATION: Send us your blue prints and an outline of your requirements. Our engineers will submit recommendations for economy in design and material. Test samples made to your specifications at reasonable cost enable you to check your design quickly and inexpensively.

AMERICAN LAVA CORPORATION

49TH YEAR OF CERAMIC LEADERSHIP
 CHATTANOOGA 5, TENNESSEE

OFFICES: METROPOLITAN AREA: 671 Broad St., Newark, N. J., Mitchell 2-8159 • CHICAGO, 9 South Clinton St., Central 6-1721
 PHILADELPHIA, 1649 North Broad St., Stevenson 4-2823 • LOS ANGELES, 232 South Hill St., Mutual 9076
 NEW ENGLAND, 38-B Brattle St., Cambridge, Mass., Kirkland 7-4498 • ST. LOUIS, 1123 Washington Ave., Garfield 4959

DELTAMAX *-now available!*

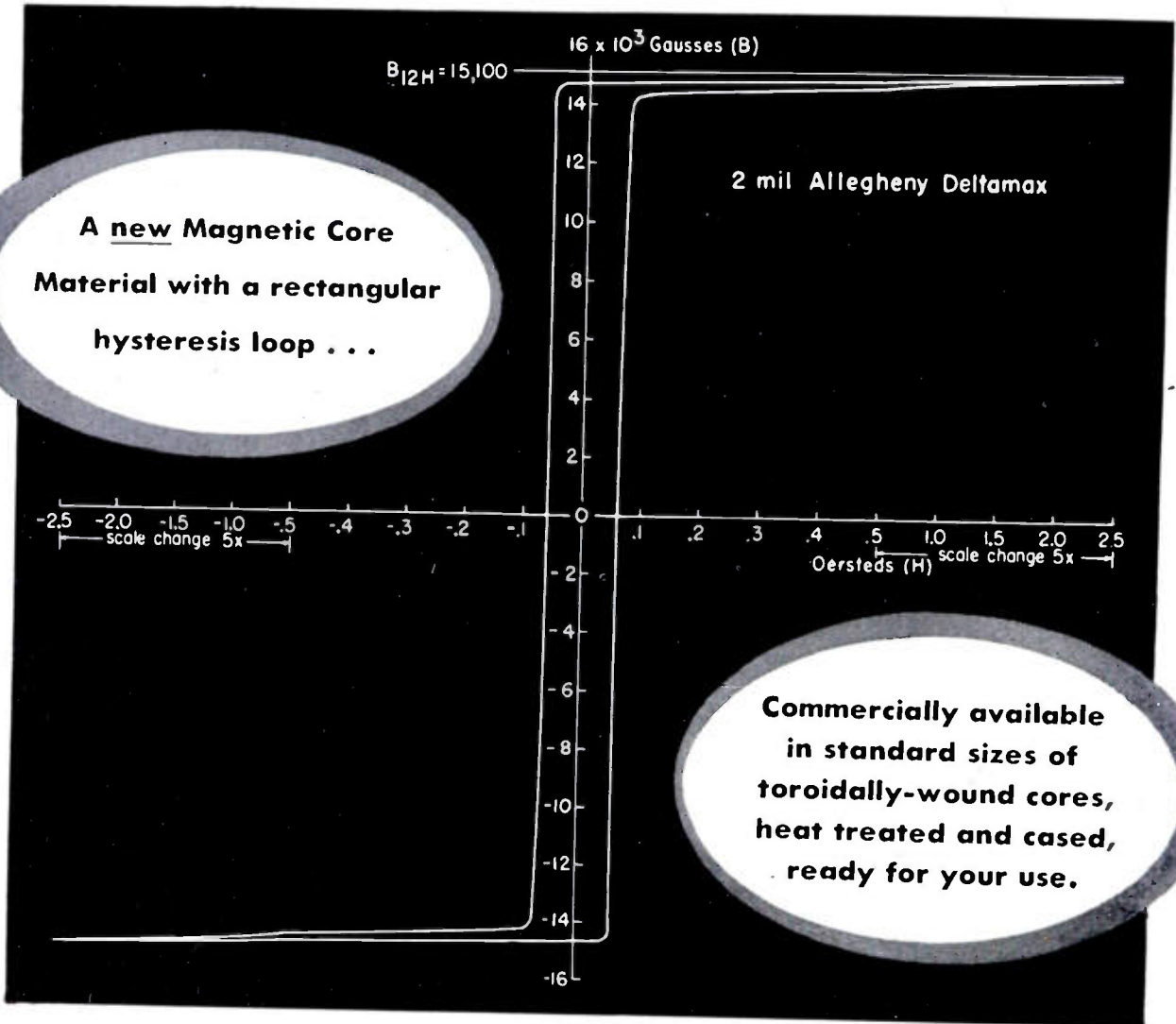

Where can YOU use a Magnetic Material with these specialized, dependable characteristics?

The properties of Deltamax are invaluable for many electronic applications, such as new and improved types of mechanical rectifiers, magnetic amplifiers, saturable reactors, peaking transformers, etc. This new magnetic material is available now as "packaged" units (cased cores ready for winding and final assembly) distributed by the Arnold organization. Every step in manufacture has been fully developed; designers can rely on

complete consistency in each standard size of core.

Deltamax is the most recent extension of the family of special, high-quality electrical materials produced by Allegheny Ludlum, steel-makers to the electrical industry. It is an orientated 50% nickel-iron alloy, characterized by a rectangular hysteresis loop with sharply defined knees, combining high saturation with low coercivity.

● Call on us for technical data.



THE ARNOLD ENGINEERING COMPANY

SUBSIDIARY OF ALLEGHENY LUDLUM STEEL CORPORATION
147 EAST ONTARIO STREET, CHICAGO 11, ILLINOIS

WAD 2379

PROCEEDINGS OF THE I.R.E.

August, 1950

Microline

* CROSS-GUIDE DIRECTIONAL COUPLERS

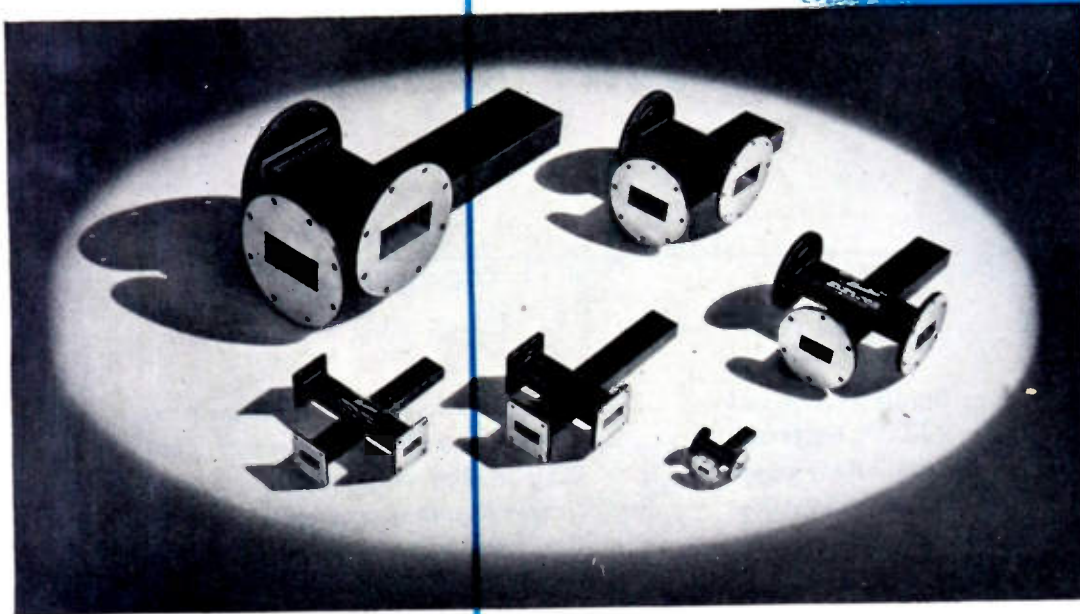

■ Sperry has a complete line of Cross-Guide Directional Couplers for all frequencies ranging from 2600 to 40,000 mc. These couplers are superior to other types of directional couplers in high directivity and unusually uniform coupling characteristics.

■ The coupling varies less than 3 db over the entire useful frequency band of the waveguide transmission line, whereas other types of couplers have attenuation which varies rapidly with frequency. Calibration accuracy on these instruments is ± 0.5 db through the quoted range. Operating temperature range is from -40° to $+55^\circ$ C and humidity effects are negligible.

■ Cross-Guide Directional Couplers, part of Sperry's MICROLINE*, are versatile, precision instruments well adapted for general laboratory and pro-

duction test work. They differ in appearance only in their external dimensions. Each consists of two rectangular waveguides, a primary and secondary guide, joined perpendicularly to each other. Coupling is provided by slots cut in the common wall between the waveguides. One end of the secondary waveguide is terminated in a matched load.

■ In addition to the superior electrical properties of the Cross-Guide Directional Couplers, they are also physically constructed for convenient assembly into a waveguide system. Our Industrial Department will be glad to give you additional information on these as well as other MICROLINE instruments.

ELECTRICAL CHARACTERISTICS			LINE AND CONNECTOR TYPES		
Model No.	Frequency Range (Kmc)	Nominal Coupling (Db)	Waveguide		Connectors Both Arms AN Type
			AN Type	Size (in.-O.D.)	
306	2.6-4.0	30	RG-58/U	3x1½x.080	UG-214/U
233	4.0-6.0	24	RG-49/U	2x1x.064	UG-149A/U
321	4.0-6.0	30			
322	4.0-6.0	40			
209	5.3-8.1	24	RG-50/U	1½x¾x.064	UG-344/U
237	5.3-8.1	30			
235	8.1-12.4	20	RG-52/U	1x½x.050	UG-39/U
236	8.1-12.4	24			
234	8.1-12.4	40			
388	12.4-17.0	20	RG-91/U	.702x.391x.040	UG-419/U
413	18.0-26.5	20	RG-53/U	½x¼x.040	UG-425/U
415	18.0-26.5	40			
405	26.5-36.0	20	RG-96/U	.360x.220x.040	UG-381/U

*TRADE MARK

SPERRY

GYROSCOPE COMPANY

DIVISION OF THE SPERRY CORPORATION, GREAT NECK, NEW YORK • NEW YORK • CLEVELAND • NEW ORLEANS • LOS ANGELES • SAN FRANCISCO • SEATTLE

An Open Letter

TO THE RADIO & TELEVISION INDUSTRY

about Allen-Bradley Resistors

WARNING! — Allen-Bradley fixed and adjustable resistors are sold . . . under the Allen-Bradley name . . . *exclusively to manufacturers*. They are not merchandised by Allen-Bradley through dealers, jobbers, distributors, or agents.

In spite of continued expansion of plant facilities, Allen-Bradley resistor production has not been able to catch up with the demands of our customers . . . the original equipment manufacturers. We sincerely regret that this shortage so often affects our customers' production schedules.

No trade outlet for radio component parts can, therefore, legitimately represent itself as an Allen-Bradley authorized dealer, even though it may acquire an occasional inventory of surplus resistors through a roundabout course. Such supplies of Allen-Bradley fixed and adjustable resistors were never obtained direct from the Allen-Bradley Company, whose productive effort is dedicated to providing electronic equipment manufacturers with resistors of the finest quality.

Allen-Bradley Co.

[Handwritten Signature]
President



Bradleyunit Molded Fixed Resistors
1/2 watt . . . 1 watt . . . 2 watt ratings.

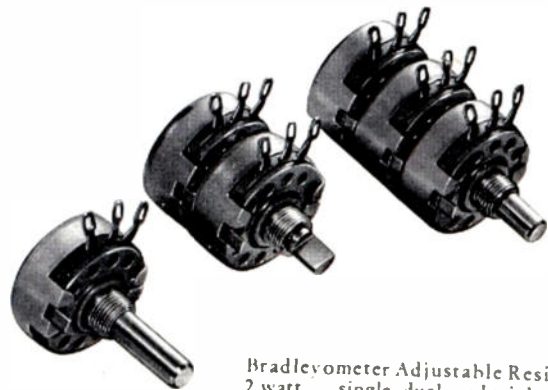

Bradleyometer Adjustable Resistors
2 watt . . . single, dual, and triple units.



ALLEN-BRADLEY

FIXED & ADJUSTABLE RADIO RESISTORS

Sold exclusively to manufacturers

QUALITY

of radio and electronic equipment

".. one of many
'firsts' at Rauland..."

says **Harold T. Cookson,**
manager, Hatry & Young, Lawrence, Mass.



"My experience with Rauland picture tubes has shown that you have an outstanding product. Rauland research has developed feature after feature that result in easier servicing and better viewing. Your new Indicator Gun, for accurate ion trap magnet adjustment without

mirrors or guesswork, is one more of the many 'firsts' at Rauland that are contributing to television progress. And the variety of types offered, supplementing our regular tube line, enables us to give the complete picture tube service our customers expect."

From Rauland Research in the past year...

The **FIRST** Luxide Screen ("Black" Tube)

The **FIRST** Indicator Gun

The **FIRST** 12" Metal Tube

The **FIRST** Reflection-Proof Screen

THE RAULAND CORPORATION



Perfection Through Research

4245 N. KNOX AVENUE • CHICAGO 41, ILLINOIS



For new simplicity, wide range, and high accuracy in the control of modern electronic circuits...

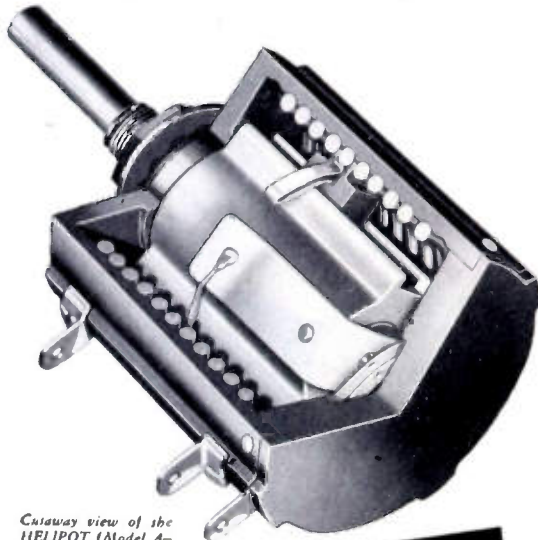

Cutaway view of the HELIPOT (Model A-10 Turn - 1 3/4" Diameter)

THE BECKMAN Helipot

(Trademark of the HELICAL POTentiometer)

Provides many times greater resistance control in same panel space as conventional potentiometers!

IF YOU are designing or manufacturing any type of precision electronic equipment be sure to investigate the greater convenience, utility, range and compactness that can be incorporated into your equipment by using the revolutionary HELIPOT for rheostat-potentiometer control applications... and by using the new DUODIAL turns-indicating knob described at right.

Briefly, here is the HELIPOT principle... whereas a conventional potentiometer consists of a single coil of resistance winding, the HELIPOT has a resistance element many times longer coiled helically into a case which requires no more panel space than the conventional unit. A simple, foolproof guide controls the slider contact so that it follows the helical path of the resistance winding from end to end as a single knob is rotated. Result... with no increase in panel space requirements, the HELIPOT gives you as much as 12 times* the control surface. You get far greater accuracy, finer settings, increased range—with maximum compactness and operating simplicity!

COMPLETE RANGE OF TYPES AND SIZES

The HELIPOT is available in a complete range of types and sizes to meet a wide variety of control applications...

MODEL A: 5 watts, 10 turns, 46" slide wire length, 1 3/8" case dia., resistances 10 to 50,000 ohms, 3600° rotation.

MODEL B: 10 watts, 15 turns, 140" slide wire length, 3 1/8" case dia., resistances 50 to 200,000 ohms, 5400° rotation.

MODEL C: 3 watts, 3 turns, 13 1/2" slide wire length, 1 3/8" case dia., resistances 5 to 15,000 ohms, 1080° rotation.

MODEL D: 15 watts, 25 turns, 234" slide wire length, 3 1/8" case dia., resistances 100 to 300,000 ohms, 9000° rotation.

MODEL E: 20 watts, 40 turns, 373" slide wire length, 3 1/8" case dia., resistances 150 to 500,000 ohms, 14,400° rotation.

Also, the HELIPOT is available in various special designs... with double shaft extensions, in multiple assemblies, integral dual units, etc.

Let us study your potentiometer problems and suggest how the HELIPOT can be used—possibly is already being used by others in your industry—to increase the accuracy, convenience and simplicity of modern electronic equipment. No obligation, of course. Write today outlining your problem.

*Data for Model A, 1 3/4" dia. Helipot. Other models give even greater control range in 3" case diameters.

THE BECKMAN Duodial



The inner, or Primary dial of the DUODIAL shows exact angular position of shaft during each revolution. The outer, or Secondary dial shows number of complete revolutions made by the Primary dial.

A multi-turn rotational-indicating knob dial for use with the HELIPOT and other multiple turn devices.

THE DUODIAL is a unique advancement in knob dial design. It consists essentially of a primary knob dial geared to a concentric turns-indicating secondary dial—and the entire unit is so compact it requires only a 2" diameter panel space!

The DUODIAL is so designed that—as the primary dial rotates through each complete revolution—the secondary dial moves one division on its scale. Thus, the secondary dial counts the number of complete revolutions made by the primary dial. When used with the HELIPOT, the DUODIAL registers both the angular position of the slider contact on any given helix as well as the particular helix on which the slider is positioned.

Besides its use on the HELIPOT, the DUODIAL is readily adaptable to other helically wound devices as well as to many conventional gear-driven controls where extra dial length is desired without wasting panel space. It is compact, simple and rugged. It contains only two moving parts, both made entirely of metal. It cannot be damaged through jamming of the driven unit, or by forcing beyond any mechanical stop. It is not subject to error from backlash of internal gears.

TWO SIZES—MANY RATIOS

The DUODIAL is now available in two types—the Model "R" (illustrated above) which is 2" in diameter, and the new Model "W" which is 4 1/4" in diameter and is ideal for main control applications. Standard turns-ratios include 10:1, 15:1, 25:1 and 40:1 (ratio between primary and secondary dials). Other ratios can be provided on special order. The 10:1 ratio DUODIAL can be readily employed with devices operating fewer than 10 revolutions and is recommended for the 3-turn HELIPOT. In all types, the primary dial and shaft operate with a 1:1 ratio, and all types mount directly on a 1/4" round shaft.



Send for this HELIPOT AND DUODIAL CATALOG!

Contains complete data, construction details, etc., on the many sizes and types of HELIPOTS... and on the many unique features of the DUODIAL. Send for your free copy today!

THE Helipot CORPORATION, SOUTH PASADENA 6, CALIFORNIA



e "GP" Molded Insulated Ceramics
 5 MMF—5,000 MMF
 e "GP" Dipped Insulated Ceramics
 5 MMF—5,000 MMF.
 rie "GP" Non-Insulated Ceramics
 5 MMF—5,000 MMF.



Erie Disc Ceramics
Up to .01MFD



Cinch-Erie Plexicon Tube Sockets with 1,000 MMF built in by-pass condensers



Types L-4, L-7, S-5 Suppressors for Spark Plugs and Distributors

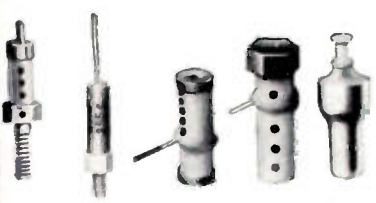

Type 720A **Types 323 and 324** **Type 2322** **Type 2336** **Type 325**
 Insulated

Erie Stand-Off Ceramics
5 MMF—5,000 MMF



Button Mica Condensers
15 MMF—6,000 MMF

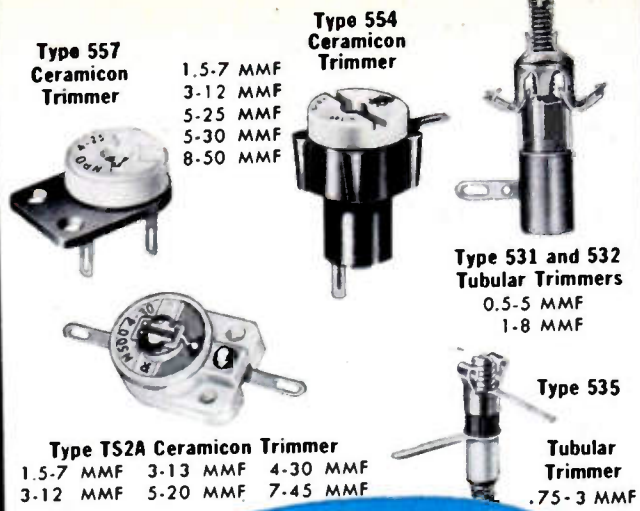

Type 557 Ceramicon Trimmer
 1.5-7 MMF
 3-12 MMF
 5-25 MMF
 5-30 MMF
 8-50 MMF

Type 554 Ceramicon Trimmer

Type 531 and 532 Tubular Trimmers
 0.5-5 MMF
 1-8 MMF

Type 535

Tubular Trimmer
 .75-3 MMF

Type TS2A Ceramicon Trimmer
 1.5-7 MMF 3-13 MMF 4-30 MMF
 3-12 MMF 5-20 MMF 7-45 MMF

for better electronic products...

ERIE RESISTOR COMPONENTS

The dependability and accuracy to close tolerances required for Television and Broadcast applications are combined in Erie Ceramics with compact design, tubular in form, for easy installation on the assembly lines.

Erie manufactures a complete line of Ceramic and Button Mica Condensers for transmitter and receiver applications: Carbon Suppressors, Custom Injection Molded Plastic Knobs, Dials, Bezels, Name Plates and Coil Forms. Our engineering department will work with you in developing specially designed components for efficient space-saving sub-assemblies. Complete technical information on request.

**Ceramicon, Hi-K, GP, and Plexicon are registered trade names of Erie Resistor Corporation.*

Electronics Division
ERIE RESISTOR CORP., ERIE, PA.
 LONDON, ENGLAND • TORONTO, CANADA

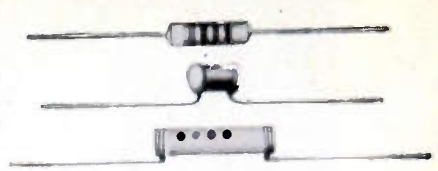

Temperature Compensating Molded Insulated Ceramics *
0.5 MMF—550 MMF

Temperature Compensating Dipped Insulated Ceramics
0.5 MMF—1,800 MMF

Temperature Compensating Non-Insulated Ceramics
0.5 MMF—1,800 MMF



Type 357



Type 362

Feed-Thru Ceramics
 5 MMF—1,000 MMF
 5 MMF—1,500 MMF

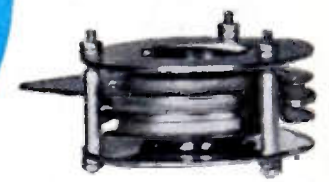

Type 3688

High Voltage Ceramics
 Up to 15,000 Volts WORKING

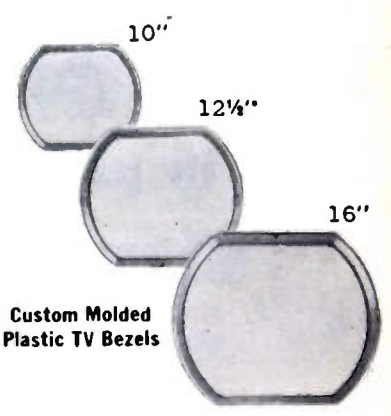

Custom Molded Plastic TV Bezels



Custom Injection Molded Plastic Knobs, Dials, Bezels, Name Plates, Coil Forms, etc.

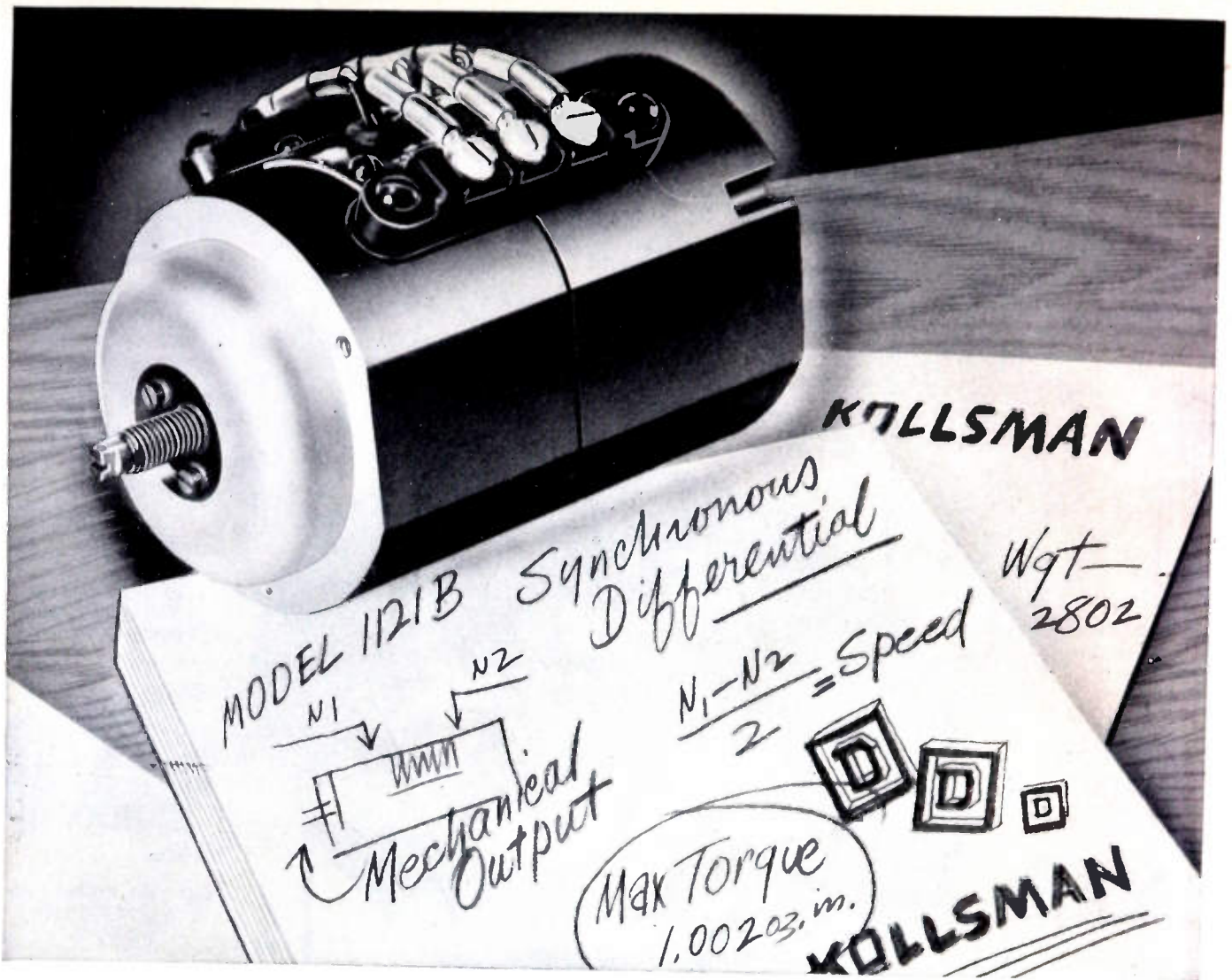

High sensitivity, instant response in position- or speed-control servo systems

The Kollsman Synchronous Differential is an electro-mechanical device, combining two small hysteresis-type, variable frequency synchronous motors with a smoothly functioning system of differential gearing.

This torque-producing, half-speed synchroscope, designed in various models to operate from single- or polyphase sources, is applicable in many position- and speed-control servo systems wherein a high degree of precision is essential.

The Synchronous Differential represents a complete line of miniature special purpose AC motors precision-engineered by Kollsman, specialists for

over twenty years in aircraft instrumentation and control. The line includes induction motors, and generators, Teletorque units, permanent magnet generators, drag cup motors, Circuroils and motor-driven induction generators.

Among these, the design engineer may well find the exact solution to his instrumentation or control problem. If not, the skill and experience of Kollsman engineers are available to produce units that meet his exact specifications. For complete information, write: Kollsman Instrument Division, Square D Company, 80-08 45th Avenue, Elmhurst, New York.

KOLLSMAN INSTRUMENT DIVISION

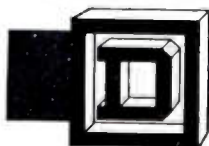

SQUARE D COMPANY

ELMHURST, NEW YORK

GLENDALE, CALIFORNIA

**±1% CONSTANT VOLTAGE
with less than 3%
harmonic distortion**

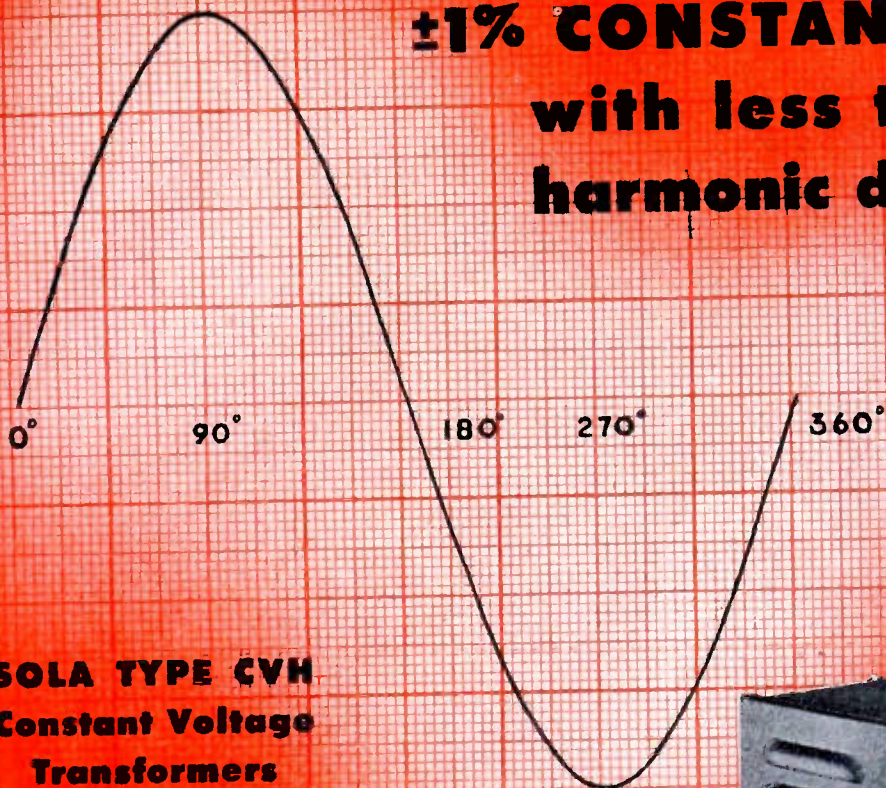

**SOLA TYPE CVH
Constant Voltage
Transformers**

Made under one or more
of the following Patent
No's.: 2,143,745; 2,212,198;
2,346,621 and Patents
Pending.

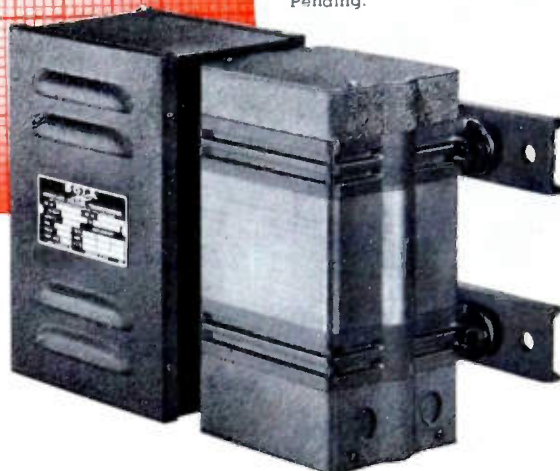

Type CVH, SOLA Constant Voltage Transformers are designed for use with equipment that requires a source of constant, undistorted voltage. They provide all of the voltage stabilizing characteristics of the standard SOLA Constant Voltage Transformer ($\pm 1\%$ regulation), with less than 3% harmonic distortion of the sinusoidal output voltage wave.

Type CVH Transformers may be used for the most exacting applications such as general laboratory work, instrument calibration, precision VHF and microwave testing or other operations involving elements which are sensitive to power frequencies harmonically related to the fundamental.

As in all SOLA Constant Voltage Transformers, the regulation is automatic and instantaneous. There are no moving parts, no manual adjustments and every unit is self-protecting against short circuit.

Type CVH SOLA Constant Voltage Transformers are available from your electronics distributor in the following capacities: 60 V.A., 120 V.A., 250 V.A., 500 V.A., 1000 V.A., 2000 V.A.

WRITE FOR THESE BULLETINS

KCVH-136—complete electrical and mechanical characteristics of type CVH Constant Voltage Transformers.

KCV-102—complete engineering handbook and catalog of standard Constant Voltage Transformers available for remedial or built-in applications.

SOLA *Constant Voltage*
TRANSFORMERS

Transformers for: Constant Voltage • Cold Cathode Lighting • Airport Lighting • Series Lighting • Fluorescent Lighting • Luminous Tube Signs
Oil Burner Ignition • X-Ray • Power • Controls • Signal Systems • etc. • SOLA ELECTRIC COMPANY, 4633 W. 16th Street, Chicago 50, Illinois

Manufactured under license by: ENDURANCE ELECTRIC CO., Concord West, N. S. W., Australia • ADVANCE COMPONENTS LTD., Walthamstow, E., England
UCOA RADIO S.A., Buenos Aires, Argentina • M. C. B. & VERITABLE ALTER, Courbevoie (Seine), France

BLAW-KNOX *builds* **ANOTHER** **RINGSIDE SEAT** *to the Events* *of the World*

For its ultra-modern station in the heart of down-town Louisville, WHAS engineers specified a Blaw-Knox Heavy Duty Type H-40 Tower 526 ft. high to support safely its 10,000 lb., 12 bay high gain TV antenna.

Telecasting top-flight national and regional programs, WHAS will open up a new market for TV sets and provide ringside seats for appreciative thousands in the populous and progressive Louisville area.

BLAW-KNOX DIVISION
OF BLAW-KNOX COMPANY
2037 Farmers Bank Bldg., Pittsburgh, Pa.

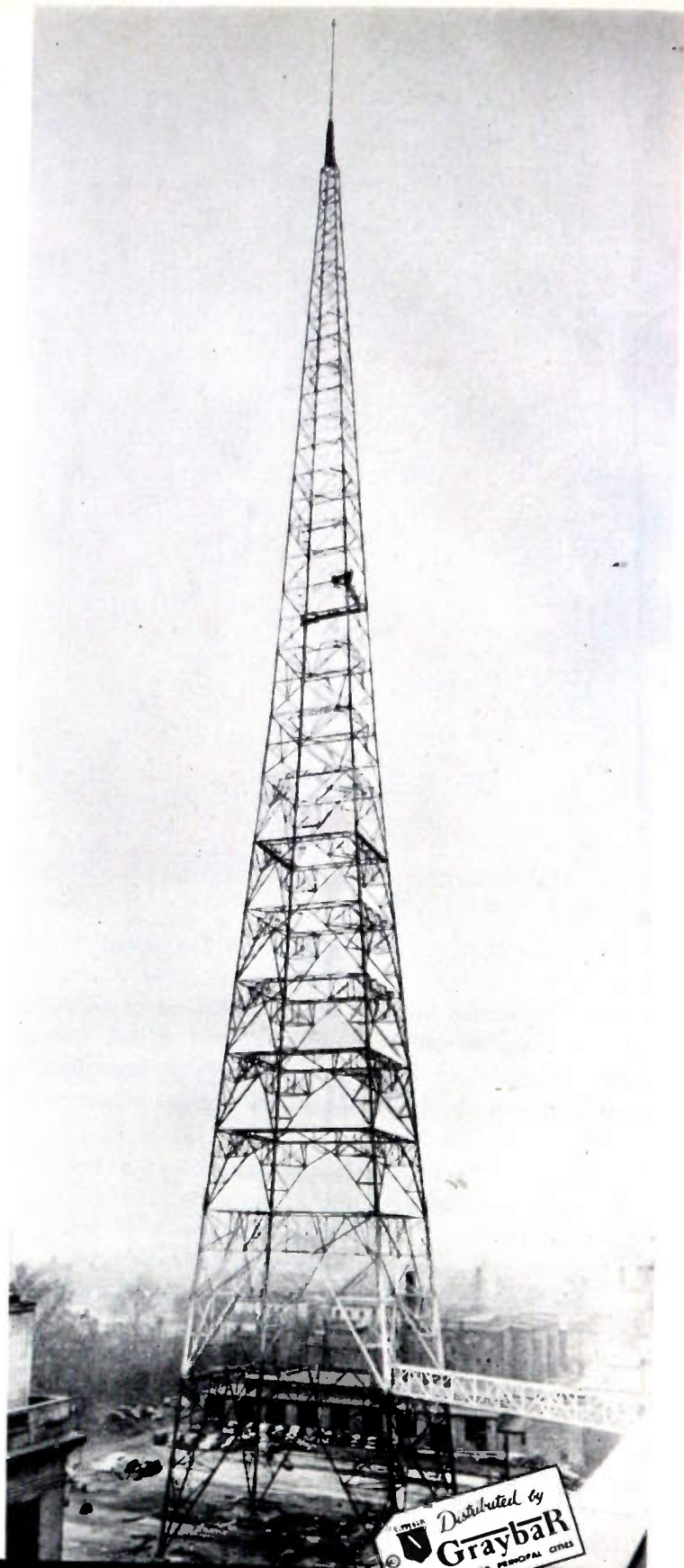

Distributed by
Graybar
OFFICES IN 100 PRINCIPAL CITIES

BLAW-KNOX ANTENNA **TOWERS**

Now... At Last!...

A PLATE CIRCUIT POWER RELAY NEW CLARE RELAY IS TWO RELAYS IN ONE



Side view of typical CLARE Type "CP" Power Relay.



Front view showing convenient terminal arrangement.

It takes one watt or more to operate an ordinary power relay; hence, it has to be operated from a sensitive relay or a high-current tube. This new Type "CP" Power Relay, truly two relays in one, will operate on less than 200 milliwatts—with, for example, a 6,500-ohm coil. Will operate in the plate circuit of any triode, including miniatures. Simplifies equipment; saves money and space; will outwear several ordinary power relays.

SALIENT FEATURES

Sensitivity. Pickup current can be as low as 3 milliamperes—with a 12,000-ohm coil.

Marginal operation. Dropout current can be as high as 58% of pickup current.

Heavy load capacity. D. P. D. T. contacts conservatively rated at 10 amperes, 230 volts, a-c; proved by one million operations at 30 amperes inrush, 10 amperes break.

No contact bounce.

Interlock contacts. A single-pole interlock can be provided, if required.

Fast operation. Operate time can be as low as 30 milliseconds.

Heavy insulation. Minimum of one-half inch creepage over exposed areas.

Convenient terminal facilities. Screw terminals recessed in terminal block in orderly array. No separate terminal board needed.

Versatile mounting. Front, back, or surface mounting.

Long mechanical life. 25 million operations, without readjustment.

Long operational life. One million operations at rated contact load, without readjustment.

No pigtailed to break. On test, the long flexible contact springs have exceeded by 100 times the normal life expectancy of

pigtail connections, commonly used on power relays.

Wide choice of coils. Like other Clare relays, this relay is custom-built to fit the application. Our engineers can choose from hundreds of different coil specifications the one best suited for the job.

**For complete information
send for Clare bulletin No. 113**

CLARE sales engineers are at your service to help with your individual relay problem. Located in principal cities, their expert knowledge of relay problems is readily available. Look in your classified telephone directory or address: C. P. Clare & Co., 4719 West Sunnyside Ave., Chicago 30, Ill. In Canada: Canadian Line Materials Ltd., Toronto 13. Cable address: CLARELAY.

CLARE RELAYS...

First in the Industrial Field



FOR THE MOST EXACTING
INSULATING REQUIREMENTS

IT'S **MYCALEX** 410

PRECISION-MOLDED COMPONENTS
AT NEW LOW PRICES

No insulating material compares with MYCALEX 410 for today's exacting requirements—where advanced circuits and higher frequencies demand a combination of these properties:

Extremely low loss factor (low as .015 at 1 MC)
high dielectric strength . . . high arc resistance, close dimensional tolerances . . . high dimensional stability under extreme humidity and temperature changes . . . high heat resistance . . . ability to mold in metal inserts with a tight, rigid bond . . . freedom from cold flow . . . high mechanical strength.

Remember, you no longer have to "design around" the problem of cost. New low MYCALEX 410 prices compare favorably with lesser insulators such as bakelite and phenolics. Specify MYCALEX custom-molded parts for the most critical insulating needs. Whatever your problems, our engineers will cooperate in the solution.



MYCALEX CORP. OF AMERICA

"Owners of 'MYCALEX' Patents"

Executive Offices: 30 Rockefeller Plaza, New York 20, N. Y.

Plant and General Offices: Clifton, N. J.

For Reliability, I use
OHMITE



BROWN DEVIL RESISTORS

Sturdy, wire-wound, vitreous-enameled resistors for voltage dropping, bias units, bleeders, etc. In 5, 10, and 20-watts; values to 100,000 ohms.



FIXED RESISTORS

Resistance wire is wound over a ceramic core, permanently locked in place, insulated and protected by Ohmite vitreous enamel. In 25, 50, 100, 160, and 200-watt stock sizes; values from 1 to 250,000 ohms.



DIVIDOHM RESISTORS

You can quickly adjust these handy vitreous-enameled resistors to the exact resistance you want, or put on taps wherever needed for multi-tap resistors and voltage dividers. In sizes from 10 to 200 watts, to 100,000 ohms.



LITTLE DEVIL* COMPOSITION RESISTORS

Tiny, molded, fixed resistors—individually marked with resistance and wattage rating— $\frac{1}{2}$, 1, and 2-watt sizes, $\pm 10\%$ tol. Also $\pm 5\%$ tol. 10 Ohms to 22 megohms.



DUMMY ANTENNA RESISTORS

For loading transmitters or other r.f. sources. New, rugged, vitreous-enameled units are practically non-reactive within their recommended frequency range. 100 And 250-watt sizes, 52 to 600 ohms, $\pm 5\%$.



MOLDED* COMPOSITION POTENTIOMETER

A high-quality, 2-watt unit with a good margin of safety. Resistance element is solid molded—not a film. The noise level is low and decreases with use.



CLOSE CONTROL RHEOSTATS

Insure permanently smooth, close control. Widely used in industry. All ceramic, vitreous enameled; 25, 50, 75, 100, 150, 225, 300, 500, 750, and 1000-watt sizes.



DIRECTION INDICATOR POTENTIOMETER

Compact, low cost. Used in a simple potentiometer circuit as a transmitting element to remotely indicate the position of a rotary-beam antenna.



HIGH-CURRENT TAP SWITCHES

Compact, all-ceramic, multipoint, rotary selectors for a-c use. Self-cleaning, silver-to-silver contacts. Rated at 10, 15, 25, 50, and 100 amperes. Two or more can be mounted in tandem.



POWER LINE CHOKES

Keep r.f. currents from going out over the power line and causing interference with radio receivers. Also used to stop incoming r.f. interference. Has a ceramic core and moistureproof coating. In 5, 10, and 20 amps.



RADIO FREQUENCY CHOKES

Single-layer wound on low power-factor steatite or bakelite cores, with moistureproof coating. Seven stock sizes for all frequencies, 3 to 520 mc. Two units rated 600 ma, others rated 1000 ma.



NEW OHM'S LAW CALCULATOR

Redesigned! Figures all Ohm's Law problems, including parallel resistance, with one setting of the slide. Also has standard slide rule scale. Send 25c in coin.

*So that these two exceptionally high-quality products will be universally obtainable, Ohmite Manufacturing Company, in cooperation with the Allen Bradley Company, has arranged for the Type AR (Allen Bradley Type A) control and Little Devil Molded Composition Resistor (Allen Bradley Types ER, GR, and HR) to be available from stock at Ohmite distributors.



SEND FOR CATALOG NO. 40 on Company Letterhead

Provides 96 pages of engineering information

OHMITE MANUFACTURING CO.
4861 Flournoy St. Chicago 44, Ill.

Be Right with **OHMITE**
Reg. U. S. Pat. Off.



AUGUST, 1950

New Communications Recorder

Known as the Audiolog, a new recording unit especially designed for logging and monitoring radio and phone communications has been announced by Audiolog Corp., 440 Peralta Ave., San Leandro, Calif.



An important feature of the unit is the use of a thin, flexible, reusable sleeve or tube of magnetic material upon which an entire hour of speech or code communications can be recorded. The use of the sleeve eliminates the usual spooling and reeling. The flexible sleeves can be "telescoped" so that a 24-hour log can be filed as a compact unit. The reusable sleeves do not deteriorate with repeated playbacks, and tests indicate they will retain the recording indefinitely.

The magnetic recording sleeve is slipped over the internally-driven rotating drum on the Audiolog instrument, and is held in position by a quick-release tension bar which permits easy sleeve changing. Separate recording and playback heads move longitudinally across the drum, so arranged that any recorded portion may be played back while recording is in progress. Recording and playback heads are equipped with inexpensive polepieces, which can be quickly replaced like phonograph needles when worn. An advance magnet on the recording head automatically "erases" previously recorded material when re-using old sleeves.

The recorders are available in either portable or rack-mounted stationary units in single or dual type. The dual-recorder unit has automatic changeover. A small portable unit, using 30 minute recording sleeves, is also available.

These manufacturers have invited PROCEEDINGS readers to write for literature and further technical information. Please mention your I.R.E. affiliation.

Bolometer Amplifier

Pickard & Burns, Inc., 240 Highland Ave., Needham 94, Mass., Model 100 Bolometer amplifier is a high-quality portable instrument designed for use in testing antenna systems or other rf networks.

The amplifier features a tunable band-pass filter covering the frequency range of 400- to 5,000-cps, with bandwidths of 6 to 300 cps. It provides for automatic normalization of input signals and for accurately expanding input voltages to facilitate measuring standing-wave ratios in well-matched systems. A 100-db input voltage range is metered, while an undecaded output voltage range of 80 db is available for automatic recording equipments. The input circuits are designed for either crystal or bolometer probes. Amplification is linear to ± 1 per cent with a minimum useful input of 0.1 microvolt.



Description—The Model 100 is a heterodyne type of amplifier in which input signals to both the signal and monitor inputs are heterodyned to a 50-kc intermediate frequency. Signals at the 50-kc intermediate frequency are then passed through a crystal filter, amplified, and metered. Voltage to the recorder output is obtained by reconvertng the 50-kc signal to the original input frequency.

Magnetic and electrostatic shielding permits the amplifier to function under usual laboratory and field conditions without interference from other equipments.

This equipment was originally developed in co-operation with the Office of Naval Research on specifications prepared by the Antenna Instrumentation Sub-Panel R.D.B. and the Test Equipment Subcommittee of A.R.E.C. It is now available to the industry and is described in detail in Bulletin L-110, obtainable from the manufacturer.

Printed Circuit TV Tuner

A new "Dynamic Tuner," using a rotating turret with the tuning assembly for each TV channel placed in 12 different sections around its periphery, is being produced by The Hallicrafters Co., 4401 W. Fifth Ave., Chicago 24, Ill. As the turret is turned by the channel selector knob, the proper tuning assembly is moved into position.

The tuning coils for each channel, instead of being wound with wire, are photographically printed on a single strip of plastic, measuring only about $\frac{1}{8}$ inch wide and $4\frac{1}{4}$ inches long.

The uniformity and accuracy of the printed coil strips may be seen from the way in which the strips are prepared. The process is begun with a large thin sheet of copper bonded to a sheet of phenolic plastic. Then the copper is coated with a light-sensitive enamel and a photographic print made, leaving many patterns of the desired circuit on the copper. The sheet is then placed in an acid bath and the parts not covered by the enamel are etched completely away. What remains are the many printed circuits, each having precisely the same shape and thickness of copper. The individual strips are then cut off the large sheet, thus producing many sets of coils with identical electronic characteristics.

Rotary Slide Rule for Coil Winding Computation

A gear computer for universal coil winding has been developed by Production Equipment Co., 37 W. Main St., Oyster Bay 9, L. I., N. Y. This rule gives complete data regarding number of crossovers, q (number of crossovers in one winding cycle), and selection of idler gears to provide the required gain for all wire, cam, and coil sizes.

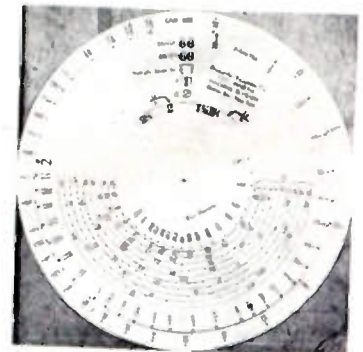

Coil engineers interested in production and design of universal windings will find this rotary slide rule of priceless value in saving time and in improving coil structure.

(Continued on page 48A)



Lavoie

**DEVELOPED
and
PRODUCED
ELECTRONIC
SYSTEMS**

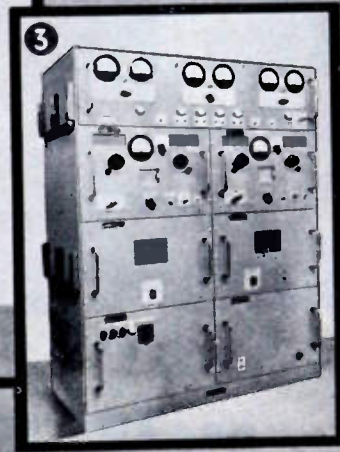
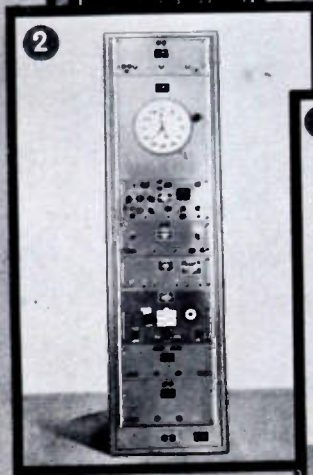
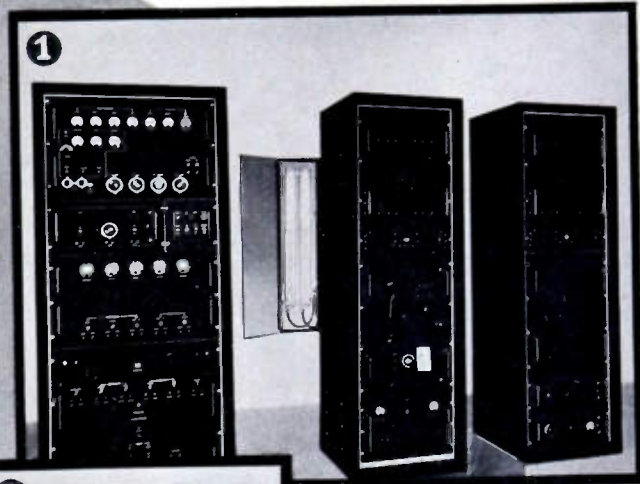

For Example:

- ① **VHF Omnidirectional Radio Range System** for aircraft navigation. This system has been standardized by international agreement as the best method of short range navigation for aircraft.
- ② **Time Standard.** A precision time standard, providing standard frequency and time service.
- ③ **Range Transmitter.** A 200 to 400 KC four course aural A-N Radio Range Transmitter with an output of 100 watts. Adcock or loop antenna; simultaneous voice modulation; telephone dial remote control.

... DEVELOPED • DESIGNED • PRODUCED by LAVOIE LABORATORIES and typical of both LAVOIE engineering versatility and LAVOIE manufacturing skill. As UHF specialists, we have the experience and the facilities for precise production at low cost.

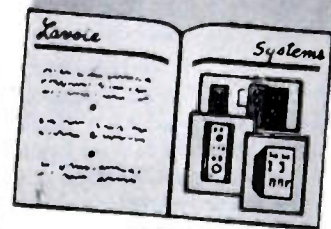

Lavoie Laboratories, Inc.

RADIO ENGINEERS AND MANUFACTURERS
MORGANVILLE, N. J.

LAVOIE FACILITIES REPORT

● Address us on your letterhead—and we shall be glad to send you a copy, or consult with you at your convenience.

Specialists in the Development and Manufacture of UHF Equipment

Team Mates...



... for mobile communications

HERE ARE TWO unbeatable VHF power tube combinations for mobile transmitter designs where high efficiency and extreme compactness are paramount requirements. All four of these RCA-developed tubes have high power gain and may therefore be operated at relatively low plate voltage to provide large power output with small driving power.

The RCA-5763 miniature type beam power tube is very suitable as an output stage of low-power mobile transmitters and as a doubler or tripler in higher-power units. It can be operated with full input up to 175 Mc. The RCA-2E26 is intended primarily for use in the driver stages or the output stage of emergency mobile or FM transmitters. It can be operated with full input up to 125 Mc. and will provide an output of about 13 watts at 160 Mc.

The RCA-5618 power pentode and the RCA-2E24 beam power tube are quick-heating types with low fila-

ment drain, and are particularly suitable for mobile and emergency-communications transmitters where the operating power supply must be kept small. Both types are designed for intermittent operation. The RCA-5618 is superior as a doubler or tripler; the RCA-2E24, as the final amplifier in low-power FM transmitters.

Already proved in thousands of installations, these RCA tubes can be depended upon for their quality, ruggedness, and superior performance.

RCA Application Engineers are ready to work with you in applying any of these or other RCA tube types to your specific designs. For further information write RCA, Commercial Engineering, Section H44R, Harrison, New Jersey.

RCA Laboratories, Princeton, N. J.

THE FOUNTAINHEAD OF
MODERN TUBE DEVELOPMENT IS RCA



RADIO CORPORATION of AMERICA
ELECTRON TUBES

HARRISON, N. J.

PROCEEDINGS OF THE I.R.E.

BOARD OF DIRECTORS, 1950*

Raymond F. Guy
President

R. A. Watson-Watt
Vice-President

D. B. Sinclair
Treasurer

Haraden Pratt
Secretary

Alfred N. Goldsmith
Editor

B. E. Shackelford
Senior Past President

Stuart L. Bailey
Junior Past President

1950

Ben Akerman (6)

W. R. G. Baker

T. H. Clark

J. V. L. Hogan (2)

T. A. Hunter

H. E. Kranz (4)

F. H. R. Pounsett (8)

J. E. Shepherd

J. A. Stratton

1950-1951

A. V. Eastman (7)

W. L. Everitt

D. G. Fink

F. Hamburger Jr. (3)

H. J. Reich (1)

J. D. Reid (5)

1950-1952

W. R. Hewlett

J. W. McRae

•

Harold R. Zeamans
General Counsel

•

George W. Bailey
Executive Secretary

Laurence G. Cumming
Technical Secretary

•

Changes of address (with advance notice of fifteen days) and communications regarding subscriptions and payments should be mailed to the Secretary of the Institute, at 450 Ahnaip St., Menasha, Wisconsin, or 1 East 79 Street, New York 21, N. Y.

All rights of republication, including translation into foreign languages, are reserved by the Institute. Abstracts of papers, with mention of their source, may be printed. Requests for republication privileges should be addressed to The Institute of Radio Engineers.

* Numerals in parentheses following Directors' names designate Region number.

Published Monthly by

The Institute of Radio Engineers, Inc.

VOLUME 38

August, 1950

NUMBER 8

PROCEEDINGS OF THE I.R.E.

Chairmen of Recent IRE Sections—H. R. Hegbar, Akron, and T. G. Morrissey, Denver.....	850
The Engineer and Publicity..... Virgil M. Graham	851
3681. Positive-Ion Emission, a Neglected Phenomenon.... W. C. White	852
Marketing Symposium:	
3682. The Modern Concept of Marketing..... Ernest H. Vogel	858
3683. Market Research..... Ernest H. Vogel	859
3684. Product Planning and Design..... Dan H. L. Jensen	859
3685. Production Scheduling and Inventory Control.... Ernest H. Vogel	860
3686. Sales Planning and Distribution..... Lee McCanne	861
3687. Servicing the Product..... Ernest H. Vogel	864
3688. Sales Training and Sales Promotion for Television. W. E. Macke	865
3689. National Advertising..... M. F. Mahony	866
3690. A Crystal Amplifier with High Input Impedance.....	
..... Otmar M. Stuetzer	868
3691. Microspacer Electrode Technique..... Otmar M. Stuetzer	871
3692. Meteoric Echo Study of Upper Atmosphere Winds.....	
..... L. A. Manning, O. G. Villard, and A. M. Peterson	877
3693. Complex Dielectric-Constant Measurements in the 100- to 1,000-Megacycle Range..... A. G. Holtum, Jr.	883
3694. A Double-Crystal X-Ray Goniometer for Accurate Orientation Determination..... W. L. Bond	886
3695. Product Phase Modulation and Demodulation Donald B. Harris	890
3696. Determination of Attenuation from Impedance Measurements..... R. W. Beatty	895
3697. Current Distributions on Transmitting and Receiving Antennas..... T. Morita	898
3037. Correction and Clarification of "Automatic Volume Control as a Feedback Problem"..... Bernard M. Oliver	904
3698. Noise Levels in the American Sub-Artic..... N. C. Gerson	905
3699. Standards on Electron Tubes: Methods of Testing, 1950—Part I	917
Contributors to PROCEEDINGS OF THE I.R.E.....	949
Correspondence:	
3470. "A Note on the Measurement of Impedance with the Impedometer"..... W. Sichak	951
3700. "Polarization of Low-Frequency Radio Waves Reflected from the Ionosphere"..... A. H. Benner, C. H. Grace, and J. M. Kelso	951

INSTITUTE NEWS AND RADIO NOTES SECTION

Full Agenda Announced for IRE West Coast Convention.....	953
Industrial Engineering Notes.....	954
IRE People.....	956
Symposium on Antennas and Propagation—Summaries of Technical Papers.....	958
Books:	
3701. "N.A.B. Engineering Handbook, Fourth Edition".....	
..... Reviewed by Albert Preisman	962
3702. "Electronics: Experimental Techniques" by W. C. Elmore and Matthew L. Sands.....	
..... Reviewed by Frederick W. Grover	962
3703. Abstracts and References.....	963
News—New Products..... 30A	Membership..... 42A
Section Meetings..... 37A	Positions Open..... 50A
Student Branch Meetings..... 40A	Positions Wanted..... 52A
Advertising Index.....	71A

EDITORIAL DEPARTMENT

Alfred N. Goldsmith
Editor

F. K. Gannett
Technical Editor

Mary L. Potter
Assistant Editor

•

ADVERTISING DEPARTMENT

William C. Copp
Advertising Manager

Lillian Petranek
Assistant Advertising Manager

•

BOARD OF EDITORS

Alfred N. Goldsmith
Chairman

PAPERS REVIEW COMMITTEE

George F. Metcalf
Chairman

Responsibility for the contents of papers published in the PROCEEDINGS OF THE I.R.E. rests upon the authors. Statements made in papers are not binding on the Institute or its members.



Chairmen of Recent IRE Sections



Howard R. Hegbar

AKRON SECTION

Howard R. Hegbar, Chairman of the recently formed Akron Section during 1949-1950, was born on February 22, 1915, at Valley City, N. D. He was graduated from North Dakota State College in 1937 with the B.S.E.E. and received the Ph.D. degree in 1941 from the University of Wisconsin, where he was engaged in research on the transition from the glow to arc discharge in mercury vapor rectifiers. He was granted a Wisconsin Alumni Research Foundation Scholarship during 1937-1938, a Fellowship from 1938 to 1939, and a Research Assistantship during 1939-1940 and 1940-1941.

Dr. Hegbar joined the Radio Corporation of America in 1941 at their plant in Harrison, N. J. He moved to the laboratories at Princeton in 1942 and remained until 1946, working on uhf power tubes and microwave magnetrons and on the development of the internally neutralized duplex tetrode uhf transmitting power tube which has found application in television transmitters. In 1946 he joined the aerophysics department of the Goodyear Aircraft Corporation in Akron, Ohio, and is now in charge of the electronics and dynamics section.

He became a Student Member of the IRE in 1941, an Associate Member in 1942, and a Senior Member in 1946. He was Chairman of the Akron Subsection in 1948-1949, and was influential in the organization of activities which led to the formation of the Akron Section. His term expired June 1, and he is succeeded by James S. Hill.



T. G. Morrissey

DENVER SECTION

T. G. Morrissey, Chairman of the Denver Section for 1949-1950 was born on January 23, 1915, at Denver, Colo. He was graduated in 1936 from the University of Colorado with the B.S. degree in electrical engineering, and that year became associated with the Bell Telephone Laboratories of New York, N. Y., and Deal, N. J., as a member of the Radio Research Department.

Mr. Morrissey worked on the development of overseas radio-telephone short-wave radio transmitters, and also on the early developments of loran and radar systems.

From 1942 until 1946 he was an engineer in the transmission department of A. T. & T. Co., Long Lines Dept., Denver Division. He worked on the transcontinental carrier telephone systems, both in buried cable and on open wire, and on the coaxial cable. He also served as technical advisor to radio station KFEL during this period.

At the present time Mr. Morrissey is chief engineer of KFEL and KFEL-FM, and has been associated with the station since 1946 in that capacity. In addition to the usual management of the technical operations and staff, he has also directed propagation tests at 500 Mc of experimental television station WXEL (now KA2XBE).

Mr. Morrissey, who is also a member of the Colorado Society of Engineers, became a Member of The Institute of Radio Engineers in 1947 and was elevated to the rank of Senior Member in 1950. He was succeeded on June 1 by W. E. Clyne.

As is pointed out in the following guest editorial, it is a common custom of most engineers to "hide their light under a bushel." This undue modesty may result in less appreciation and support than is justified by the quality and value of their work. Ethically there seems no objection to factual and dignified statements of engineering accomplishment.

The author of the following commentary has been a Director of the IRE for a number of years and a member of many of its Committees. He holds the post of Director of Technical Relations of Sylvania Electric Products Inc. His viewpoints expressed here merit thoughtful consideration by the readers of the PROCEEDINGS.—*The Editor.*

The Engineer and Publicity

VIRGIL M. GRAHAM

The engineers and the publicity or public relations men too often seem to lack mutual understanding, possibly because there is a considerable difference in their methods of attack on problems. Too many engineers feel that publicity, particularly of them personally, is something immoral. They feel that their works should speak for themselves. In many cases they do, but they would "speak louder" with appropriate publicizing, with the result that the particular engineer's reputation would be enhanced not only in his profession but even in his own company.

Desirable engineering publicity must, of course, be factual, dignified, and newsworthy. When these conditions prevail, the engineer should welcome publicity as a useful adjunct to his own ability in the advancement of his career. Many of our best known engineering figures, while unquestionably outstanding in their ability, are much better known and more highly regarded because of the proper use of publicity tools than they would have been if their works had been left to speak for themselves. This is in no way a discredit to the engineers or the publicists involved. Both have done their jobs and the world is better off for both the work and the augmented knowledge of it.

What applies to the individual engineer also concerns engineering departments and professional societies. The engineering department will find that its status within its company may be enhanced because of external publicity. As has been remarked, "Management reads over the public's shoulder." It is not too strange that management may be much more impressed by a good news story in the press than it would be by the usual internal engineering report about the same accomplishment.

In professional society activity the engineers in any one field can do much to raise their status in the whole engineering profession and in the esteem of the public by an appropriate public relations program. Here again the tendency to feel self-sufficient in the work of the society can be very harmful, because the news-gatherers are not going to come after the society for stories unless it has already made a reputation for news-making. This can be done most expeditiously by suitable use of publicity practices of a dignified, factual nature. However, this requires a broad, long-term understanding of publicity and public relations methods on the part of the management body of the society involved. Unfortunately, such understanding seems all too rare.

It is interesting to note that the physicists have come to understand the value of public relations and as a result have been popularly awarded credit for much of the war effort, a good share of which should have been given to the engineers who sweated the physicists' basic ideas into producible designs.

Positive-Ion Emission, a Neglected Phenomenon*

W. C. WHITE†, FELLOW, IRE

Summary—About fifty years ago, much scientific work was done on the passage of electricity in air between two electrodes, one of which was red hot. A little later, as an outgrowth from these experiments, electron emission in a high vacuum proved to be of such interest and promise in the new but expanding science of electronics that the phenomenon in air has been all but forgotten.

However, a new, interesting, and useful leak detector has been developed from this neglected effect, and there is reason to believe that positive-ion emission may well be of importance for other applications.

INTRODUCTION

IT HAS BEEN known for over 200 years that red-hot metals possessed unusual electrical properties. The early experimenters studied the accumulation and loss of positive and negative electrical charges on masses of hot metal. The basic fact discovered was that a red-hot metal loses a charge much more rapidly than the same metal when cold.

As the experimental methods used in developing the science of electricity advanced, studies were made of the conduction of electricity through the air between two electrodes when one of these electrodes was red hot. In such cases, it was found that a current would pass through the air when the red-hot electrode was either negative or positive, but it was very evident that the two were quite different phenomena. By the late nineteenth century, knowledge of the subject had developed to the point where the customary procedure was the use of a fine wire or ribbon of platinum heated by an electric current. All of these early experimenters were plagued by conflicting or contradictory results. Very often when a test was repeated, the results were not only quantitatively different but qualitatively so. It was common experience for one scientist to find totally different effects when he repeated the work of some predecessor in the field. In struggling with this problem, it was found helpful to enclose the electrodes, often in a glass bulb, as this eliminated variations due to air currents, humidity, dust, and other factors. Soon it was discovered that by working at lower air pressures and even in a good vacuum, more reproducible results were obtainable.

It was also found that the phenomenon when the hot electrode was negative was much more reproducible, more constant and, in general, involved larger currents. Fleming, in England, found that an evacuated two-electrode structure with a hot cathode could be made a usable detector of electromagnetic radiations. Soon deForest introduced the grid, and ever since that time the utilization of the thermionic emission of electrons has been developed by leaps and bounds. The interest

and glamour of this expanding science utilizing the electron caused the neglect of the companion phenomenon of the emission of positive ions from a hot anode.

The idiosyncrasies of positive-ion emission, even in a confined gas, have never been completely mastered. If one reads through the literature,^{1,2} it is very evident that it was a most difficult field in which to get good experimental results, largely because both the theory and the practice contain a bewildering array of variables. As a matter of fact, even with our improved knowledge and apparatus of today, the results of experiments with positive-ion emission are discouragingly uncertain and contradictory.

The changed state of the art is indicated by the fact that Richardson's book² contains three chapters (about 100 pages) devoted to thermionic emission of positive ions and there were many other references to aspects of this phenomenon throughout the book. However, when Reimann published his book,³ positive-ion emission was covered in a matter of a few paragraphs.

THE PHENOMENON OF POSITIVE-ION EMISSION

There is, of course, a basic difference between the thermionic emission of electrons and those of positive ions. The electron is a unit charge of electricity and is not associated with a specific material. On the other hand, a positive ion is a positively charged particle of some definite material. It follows, therefore, that one would expect a nonuniformity in the characteristics of positive ions from different sources, plus the fact that chemical reactions may often complicate the phenomenon.

Although, as has been mentioned, a reading of the literature on positive-ion emission is full of contradictions and leads to a feeling of discouragement as regards its understanding and use, there are certain well-established facts, as follows:

1. Material for the Hot Anode. If in the study of positive ions, one wishes to conduct experiments in either a gas or a high vacuum, the metal platinum is almost universally employed as the base metal. It has been used because of its high melting point, freedom from oxidation in the air when operated at a bright red heat, and general chemical inertness. It is also less expensive and easier to handle than such metals as rhodium and iridium, which are also probably quite

¹ J. J. Thomson, "Conduction of Electricity Through Gases," Cambridge University Press, 2nd Ed., Cambridge, Mass.; 1906.

² O. W. Richardson, "The Emission of Electricity from Hot Bodies," Longmans, Green and Co., New York, N. Y.; 1916.

³ A. L. Reimann, "Thermionic Emission," John Wiley and Sons, Inc., New York, N. Y.; 1934.

* Decimal classification: 621.375.605×537.1. Original manuscript received by the Institute, May 23, 1950.

† General Electric Research Laboratory, Schenectady, N. Y.

suitable. Platinum is also favorable to the retaining of special coatings that can be added by spraying or dipping.

2. Phenomenon in a High Vacuum. If a high-vacuum diode is constructed with a platinum wire as a hot anode, it will be found that the positive-ion emission current initially may be about the same order of magnitude as the electron current. However, this positive-ion emission current falls off rapidly so that in a few minutes or few hours it has reached a very low value, probably a value of only a few microamperes. If operation is continued at as high a filament temperature as practical (platinum melts at about 1773°C), for hundreds of hours or longer, the positive-ion emission current will drop to an extremely low value, about 10^{-12} amperes (Fig. 1). This assumes, of course, that the envelope of the diode is continually evacuated to remove all gaseous products evolved from the fila-

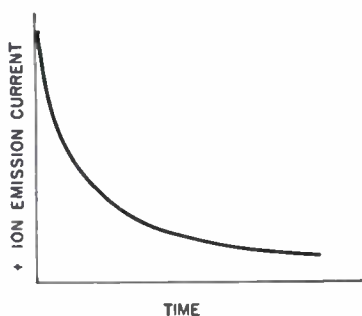

Fig. 1—Decay with time of positive-ion emission current from a thermionic anode.

ment. The ability of such a platinum ribbon to emit again a relatively large positive-ion current may be restored in a number of ways, such as exposure to gases or air, making it the negative electrode from another positive-ion source or operating as an electrode in a glow discharge. In all such cases, however, the recovery is but temporary and soon the emission current will again drop to about its former low value.

If the platinum filament is coated with certain chemical compounds, the values of positive-ion emission current may be enormously increased and the emission life increased also, but always the current will fall with time and sooner or later, the added material will either be evaporated away or what remains will no longer contribute an appreciable added emission current.

3. Effect of Gas Pressure. If a pure inert gas is admitted to the bulb, there is, in general, some increase in the positive-ion emission current. Again there is the same general phenomenon of a falling off of the current with time to a low value.

4. Positive-Ion Emission in the Open Air. In the case of a red-hot platinum filament open to the atmosphere, the same general rapid decrease of emission current will occur with time. Not only are the results more variable than in a high vacuum, but the final more or

less steady value of current that is reached after hundreds of hours of operation is usually several orders of magnitude higher than it would be in a high vacuum. If the platinum wire or ribbon is wound on a piece of ceramic material, this higher value of final positive-ion emission is even more pronounced. In other words, a normal atmosphere plus certain associated materials constantly renew the ability of the platinum to emit positive ions.

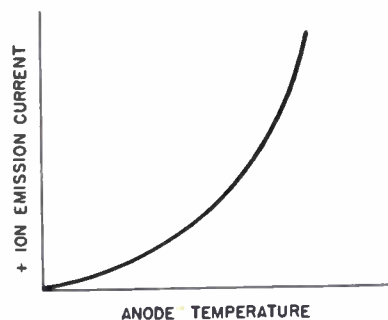

Fig. 2—Exponential increase of positive-ion emission current with increase of anode temperature.

5. Sensitivity to Anode Temperature Variation. Both the normal positive emission current in air (Fig. 2) and the sensitivity to contaminants in the air rise very rapidly with anode temperature. The general relationship between emission and temperature is not too different from that in the case of electron emission of a thermionic cathode in a high vacuum. There are a number of things which affect the anode temperature sufficiently to cause marked variations in emission current. Among such factors are variations in air flow, temperature and humidity of the air, and thermal effects from chemical action.

6. Surface Accumulation Effect. If the anode-to-cathode circuit is opened for a few seconds or a few minutes and then reclosed, there is a high initial value of current which decreases more or less rapidly until the former steady value is again reached. In general, the longer the circuit is interrupted the higher the peak value attained (Fig. 3). There is a maximum

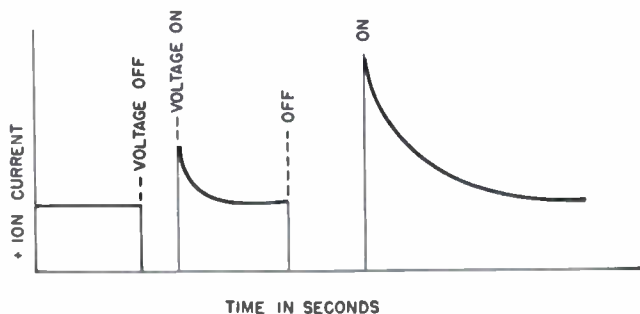

Fig. 3—The positive-ion emission current from a hot anode is temporarily increased after an interval during which the cathode voltage has been removed. This results from an accumulation of ion-forming material on the hot anode surface.

limit for this peak current after the circuit has been open a certain length of time. In some cases, the space charge between positive ions in the interelectrode space also limits the peak current. It is believed that this storing-up effect is due to the accumulation of positive-ion-forming material on the surface of the hot anode.⁴ In a general way, this effect may be likened to the formation of an electron-emitting surface on thoriated tungsten.

SENSITIVITY TO HALOGEN COMPOUND VAPORS

Although there is much in the literature on the increase of positive-ion emission current obtained from coating the platinum surface with chemical salts and also on the changes in emission due to well-known inert gases, the extraordinary sensitivity of the interelectrode current to small concentrations of halogen compound vapors seems to have gone unnoticed⁵ until very recently. Just why this was the case is not too evident. Possibly it results from the practice of the early experimenters of operating the red-hot platinum anodes in a high vacuum for some time in order to get more reproducible results. We do know now that the phenomenon is most marked in air.

Once the proper conditions for the realization of this effect of halogens are set up, it is so striking that it is no wonder that a field of usefulness was soon uncovered. These conditions are operation in air, the use of sensitizing material to aid in keeping the platinum active, and the use of sufficient areas and a close enough spacing to give large enough currents for a practical device.

The development of the leak detector based on this phenomenon is a good example of the importance of timing in a research and development project. In the great majority of cases, the discovery or the working out of some new physical or chemical effect is either far ahead of its time, or so late that other ways of doing the same thing have been uncovered and utilized before. In this device, the timing was quite fortunate. In the manufacture of household refrigerators, as well as office water coolers and room air-conditioning units, the early refrigerant used was ammonia vapor. The toxic effect of this vapor was a most undesirable factor. The next refrigerant to be used was sulphur dioxide and, although an improvement, it still left much to be desired. A number of years ago, a new refrigerant, known by the trademark Freon, was developed and is now largely used. It proved to be satisfactory, both thermodynamically and because of freedom from toxic effects and odor. However, the detection of leaks proved to be quite difficult. This became particularly important because the trend over the years in small refrigerating units has been toward a sealed mechanism. The charge of the refrigerant introduced at the time of manufacture must,

for customer satisfaction, last for the life of the mechanism, which is numbered in years. This accentuated the leak problem. Thus the extraordinary sensitivity of the positive-ion emission from platinum in air to halogen compound vapors was a most welcome tool. Incidentally, Freon, a chloro fluoro methane, seems to give unusually good response in this device and has but few undesirable secondary effects.

Although, as noted above, the usefulness of this phenomenon was recognized at a very opportune time in the refrigerator industry, it just missed being a really important factor in lowering the cost of the setting up of the Gaseous Diffusion Plant of the Atomic Energy Commission during the war. In the separation of the uranium isotope U-235, tremendous systems of tubing, valves, couplings, etc., had to be made leak-free. The order of magnitude of this phase of vacuum engineering can be appreciated from the fact that in this problem alone, which might seem minor, 1,100 men were engaged at the peak of activities.⁶ All sorts of methods and devices were used in this large-scale hunt for leaks, the most important being the use of a new, high-developed mass spectrometer. Undoubtedly, if the halogen compound leak detector had been available at that time, much money might have been saved. Ironically enough, the basic observation of the great sensitivity of this positive-ion phenomenon was made in 1944, but its value as a leak detector was not envisioned until the end of the war when there was time to follow up this and a number of other observations that during the war years had looked interesting.

DESCRIPTION OF THE LEAK DETECTOR

The heart of this device is the electrode structure or what is commonly called the sensitive element. Basically this element is a diode with a heater anode. As all of these elements operate in air, platinum is used for the heater wire, as well as the anode and cathode. The heater wire is wound on a small threaded ceramic cylinder and this is slipped inside of a small, hollow, closed-end, platinum cylinder. The cathode is a surrounding cylinder, also of platinum, with a spacing of about 35 mils between the two electrodes. The whole electrode structure is only about the diameter of a lead-pencil ferrule and not much longer. The heater operates at 12 volts and requires three to four amperes. The electrode structure is mounted on a ceramic base, the design being such that it can be slipped into a tube of larger diameter and, due to a mica washer, the air flow in the larger tube is forced through the interelectrode space. This element is pictured in Fig. 4 and a cross-section view of one form of construction is shown in Fig. 5.

The voltage used between electrodes is made as high as possible and yet avoids corona-type discharges that might occur under certain conditions. In practice, this is

⁴ R. C. Evans, "The equilibrium of atoms and ions adsorbed on a metal surface," *Proc. Cambridge Phil. Soc.*, vol. 29, p. 161; 1933.

⁵ J. J. Thomson, "On the passage of electricity through hot gases," *Phil. Mag.*, vol. 29, p. 358; April, 1890.

⁶ R. B. Jacobs and H. F. Zuhr, "New developments in vacuum engineering," *Jour. Appl. Phys.*, vol. 18, p. 43; January, 1947.

about 300 volts dc. At this voltage and with the anode operating at rated temperature, the steady interelectrode current in a properly aged unit is in the order of 1 to 10 microamperes. The sensitivity of this element is

but not essential element in the circuit is a protective series resistance for the microammeter. To utilize the device as a leak detector, a current of the air to be tested must be constantly passed between the elec-



Fig. 4—The sensitive element of the leak detector.

such that a few parts of Freon per 10,000 of air may increase this current several fold. A really heavy dose of a halogen vapor may increase it nearly 1,000 fold.

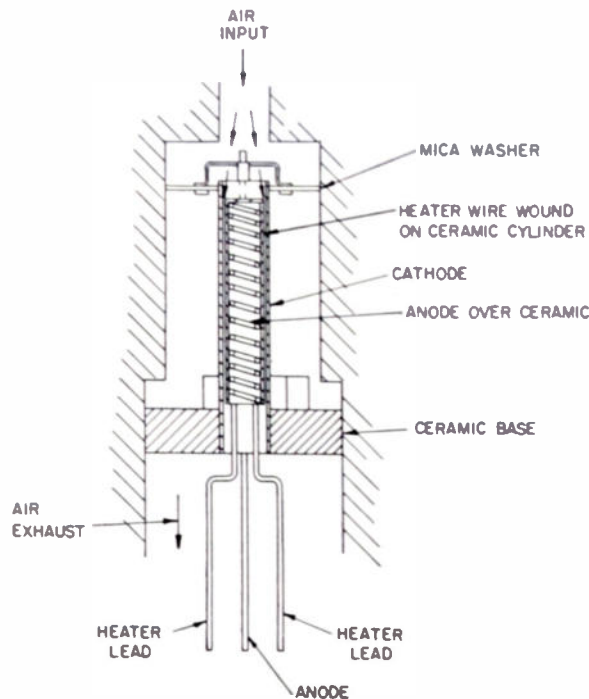

Fig. 5—Cross section of a sensitive element.

The basic electrical circuit is extremely simple, consisting of a dc power supply of about 300 volts, a filament supply, which may be ac, of 12 volts, and some device for indicating or responding to the changes of interelectrode current (Fig. 6). The most convenient device of this sort is a 0-to-50 microammeter. Another desirable

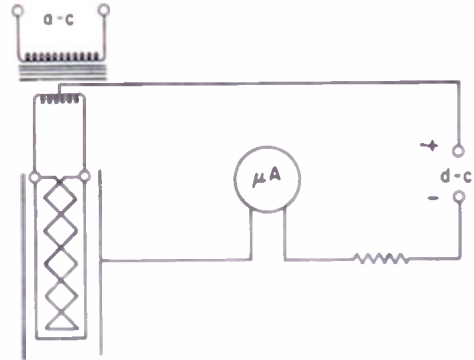

Fig. 6—Elementary circuit of the leak detector.

trodes. Experience has shown that this in effect is a miniature vacuum cleaner, and that dust and other particles are always picked up in factories. Air filters are used, of course, but there is always a likelihood of short circuit between the elements and, therefore, a protective resistance is desirable.

In actual practice, a microammeter is not too sturdy an instrument for factory use, and it has been found that the operator needs to give undivided observation to the leak detector probe while moving it near suspected spots for leaks. In such cases, looking frequently at an instrument for a response is not practical. Therefore, the leak detector is equipped with either an aural response or some sort of flashing-light indicator in the field of vision of the operator. A very simple, practical arrangement of the former is a glow-tube relaxation circuit oscillator including a loudspeaker or headphones to give an audible response from the audio-frequency oscillator output.⁷ Thus, when a leak is found, the device

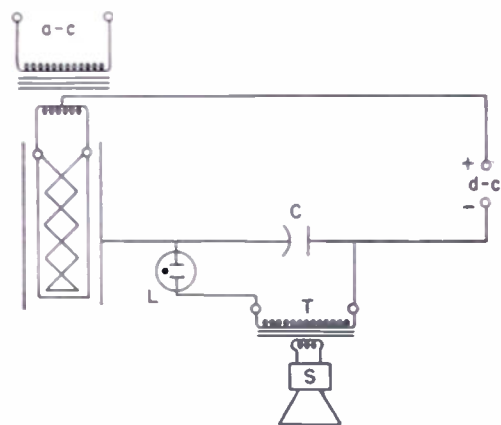

Fig. 7—A leak detector circuit incorporating a relaxation oscillator and speaker to provide an audible response.

T = impedance match transformer
L = glow lamp
S = loudspeaker
C = capacitor.

⁷ W. C. White and J. S. Hickey, "Electronics simulates sense of smell," *Electronics*, vol. 21, p. 100; March, 1948.

either emits a raucous note or the frequency of this note is markedly changed. The circuit for an arrangement of this sort is shown in Fig. 7.

For applications where the presence of a leak is sought at a specific spot and also a very high sensitivity is needed, an instrument indication is desirable. In such cases an amplifier stage is added to the circuit, so that a milliammeter may be employed.

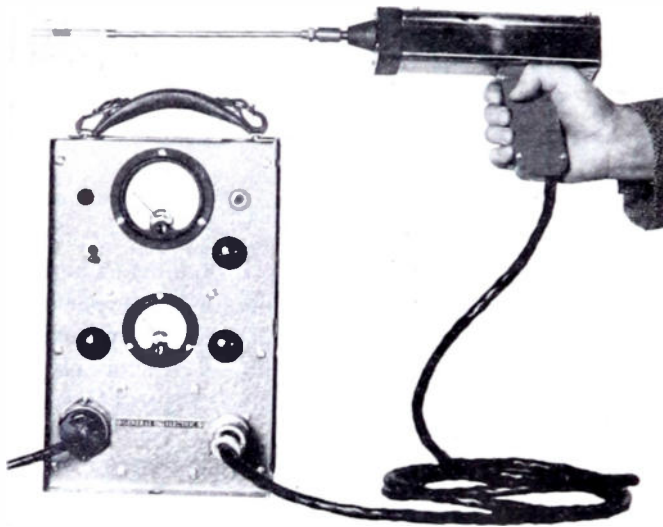

Fig. 8—The head and control unit of a leak detector.

The leak detector as used in industry⁸ either incorporates the sensitive element with its little air-suction blower in a hand-held head, as indicated in Fig. 8, or the sensitive element may be in the control chassis and the air to be tested is then sucked through a short tube. In either case, the end of the search tube sucking in air is moved over locations suspected of having leaks. This mode of operation is shown in Fig. 9, which illustrates a refrigerator unit being checked for leaks.

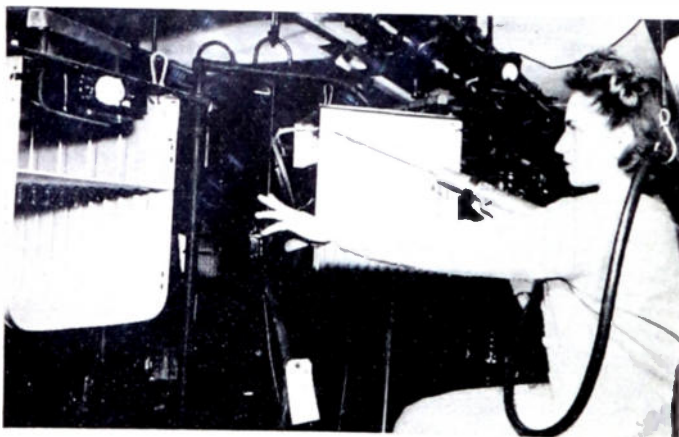

Fig. 9—Using a leak detector to check refrigerator units in a factory production line.

⁸ W. C. White and J. S. Hickey, "Vapor leak detection by thermionic effects," *Elec. Ind. & Instr.*, vol. 2, p. 7; March, 1948.

The procedure is simple in the case of refrigerating units because the Freon gas used is a halogen compound under pressure and gives a particularly good response in the detector. In the case of its application to tanks, valves, and pipes, these are filled with air at a pressure normal to their regular intended use and to this air is added a small amount of Freon. In practice, about 5 to 10 per cent of Freon by volume is ample. In Fig. 10 a detector is shown being used to check seam welds on the casing of a huge turbo alternator. In this application, it is necessary to have the casing of this alternator free from leaks as it normally operates with a slight pressure of hydrogen so as to reduce windage loss, increase heat conduction from the rotor and minimize oxidation of the insulation.



Fig. 10—Testing a seam weld for leaks on a large turbo-alternator casing.

A variety of techniques have been developed for the expeditious testing of various devices for leaks.⁹ What is considered a leak has been found to vary tremendously with the operation involved. To a physicist, it may be almost expressed in some cases in molecules of gas per unit of time. In the case of an aircraft manufacturer interested in the pressurizing of a plane cabin, it may be expressed as the ability of a fair-sized pump to keep up the pressure. The halogen vapor leak detector is a very sensitive device and is not suitable for gross leaks. Just as in the case of scales, one does not weigh tons of coal on a balance used by an assayer. The leak detector described is simply overpowered by large doses of a halogen compound vapor. Fortunately, there are other simple methods of finding the location of large leaks.

Probably the greatest problem confronting the use of this leak detector in factories is to free the surrounding atmosphere sufficiently from the gas to be detected.

⁹ J. R. Neff, "How to test for leaks reliably, quickly and at low cost," *Gen. Elec. Rev.*, vol. 52, p. 41; October, 1949.

Good ventilation is necessary. It has been found by experience that normally air in a room contaminated with a vapor does not become uniformly diffused and thus establish a constant level, but rather the contamination occurs in layers that move about the room much as is often observable with clouds of cigarette smoke.

THE THEORY OF OPERATION

What actually happens when there are variations of positive-ion emission from hot platinum in air, particularly when subjected to contaminants, is not well established. As a matter of fact, there is no generally accepted explanation for a number of the characteristics that have been observed.

Tests by a number of experimenters utilizing the mass spectrometer principle have indicated that in a high vacuum the carriers of the current are positive ions of potassium, and in some cases sodium. A number of scientists have found that platinum contains a minute but almost inexhaustible amount of potassium molecules.¹⁰ In a high vacuum they are slowly diffused to the surface and in the case of a diode they are slowly removed. In air this elimination does not seem to occur to the same degree. Every laboratory worker is familiar with the fact that a piece of platinum wire, when inserted in a Bunsen burner flame, gives a yellowish tinge to the flame, characteristic of sodium. In a few moments, however, this disappears, but if the wire is laid aside for a few hours or a few days, the same effect will again be noticed, which indicates that in normal air, which always contains more or less dust, there is a source of sodium and possibly other of the alkali metals. It is believed that one or more of these metals, notably potassium, furnishes the positive-ion material for the interelectrode current flow and halogen molecules striking the hot surface speed up this formation of positive ions.

Just why the halogens are relatively so much more effective in doing this in comparison with other molecules has not been clearly established, but it is known that the halogens are unique in that they have a strong affinity for electrons. As a matter of fact, in a table of electron affinities of materials in which this factor has been tested, the halogens are positive, whereas the other elements are negative.¹¹ There is also reason to believe that the extraordinary sensitivity of the device, that is, its response to a few parts per 10,000 or less, is a somewhat different phenomenon than its response to very concentrated volumes of halogen where the current may increase in the order of 1,000 fold.

It has been found by experience that the highly sensi-

tive response goes down quite rapidly if the sensitive element is exposed either to small concentrations for too long a time or to high concentrations. In general, the sensitivity recovers with normal operation in pure air. However, in some cases of too heavy a dose of a halogen compound, the platinum surface may suffer a chemical change and leave a contaminating deposit on the electrode structure which must be mechanically removed.

As has been indicated, the theory of operation of the device is not too well established, although the effects are sufficiently understood to allow the design and use of a practical leak detector.

FURTHER OPPORTUNITIES FOR RESEARCH AND DEVELOPMENT

The phenomenon of positive-ion emission in air has been so long neglected and exhibits so many peculiarities and interesting effects that it should be a most rewarding field for further study, research, and development. Apparently two things have deterred further work in the field.

A background in the work of electronics has led most workers to carry on their experiments in a high vacuum, rather than in air. This has been a natural tendency because in a high vacuum the phenomena are much simpler, the effects more reproducible, and the controls more effective. However, it is very probable that in so doing researchers in the past have missed much that is interesting and valuable.

A second factor is that a reading of the literature gives a sense of discouragement to any would-be worker on this phenomenon. Much of this is found in reports of work done many years ago before improved techniques were developed. However, even today an experimenter in this field is frequently confronted with contradictory findings.

There are a number of ways in which further study of positive-ion emission appears to be promising. Some of these are:

1. Further extension of the detection of gases, vapors, and suspended air particles, such as smoke. In the case of solid particles, it is possible, of course, to get response from other elements than halogens. Some solid chemical compounds give more or less positive-ion emission when applied to a red-hot surface.

In a way, the device described simulates the sense of smell and thus conceivably might play a part in developments from the science of cybernetics.¹²

In this field, variations of light, sound, temperature, and touch are often used to control a "machine" directly, rather than through the medium of the human senses and the muscular responses that follow. A device that responds to an odor, therefore, might well be an-

¹⁰ H. A. Barton, B. P. Harnwell, and C. H. Kunsman, "Analysis of positive ions emitted from a new source," *Phys. Rev.*, vol. 27, p. 739; June, 1926.

¹¹ D. K. Rice, "Electronic Structure and Chemical Binding," McGraw-Hill Book Co., New York, N. Y., pp. 101 and 237; 1940.

¹² Norbert Wiener, "Cybernetics," John Wiley and Sons, Inc., New York, N. Y.; 1949.

other tool for this science to use to advantage.

2. To lower the voltage required to pass either alternating current or direct current through air or a vapor or gas.

3. To provide a sealed bulb device with an inert gas or vapor filling or even a vacuum to give new and useful electrical characteristics based upon the differ-

ence of the positive-ion charge, mass, or mobility from that of electrons.

It is probably fair to say that our knowledge of positive-ion emission and its utilization today is about where the application of electron emission in a vacuum was at the time deForest introduced the grid, and thus brought about the beginnings of a whole science.

MARKETING SYMPOSIUM

The engineer does his work and finds the fruition of his efforts within his social and industrial environments. If he does not understand his surroundings and, within reasonable limits, adapt his aims, plans, products, and services to the requirements of that environment, even his most sincere and capable efforts may all too often be nullified, to his disappointment or even stultification.

It is accordingly desirable that there be presented in the PROCEEDINGS OF THE I.R.E. at least a modicum of material descriptive of production and merchandising problems and processes. To effectuate such publication, the Board of Directors of the Institute has approved the publication of a limited amount of such material over the years. Examples of such publication have appeared in the PROCEEDINGS pages, and have evoked a favorable response, judging from communications received from our readers.

Carrying such publication further, there appear in the following pages a group of papers presented at the Marketing Symposium of the March, 1949, IRE National Convention.

Engineers will understand that the extreme definiteness of terminology and expression characteristic of engineering papers are neither to be expected nor possible in the realm of descriptions of industrial matters. This limitation, however, does not preclude the following papers from having a distinctly important educational and personal value to the engineer. These papers are accordingly commended to the attention of all engineers who desire a well-rounded picture of a part of the industrial system to which they contribute, and who also wish some guidance of practical nature in so adjusting their thoughts and actions as best to serve the industry of which they are an essential part as well as the country where that industry flourishes.—*The Editor.*

The Modern Concept of Marketing*

ERNEST H. VOGEL†

SINCE THE WAR, there has been an increasing tendency on the part of industry to organize its general sales activities on a much broader base. This new concept is becoming known under the name of *Marketing*. This broader approach to the science of merchandising is receiving major attention in many of the finest universities, and excellent text books have been prepared to cover this ramified general subject.

The broad term "marketing" obviously includes all the functions which previously came under the general heading of "sales." But, in its wider application, marketing embraces also many functions and responsibilities which rested heretofore in other areas within a manufacturer's organization.

In this symposium these various functions and how they operate in relation to each other will be explored in order to provide a clear understanding of this new broad concept of "marketing."

The new concept of marketing begins to apply, not when a product is offered for sale, but when the plans for that product are first initiated. The design of the product, its market, anticipated volume, the required manufacturing facilities, the question of whether or not the existing sales force is adequate—all are factors of planning that must be settled before the product can be offered for sale. If reasonable assurance of profit is expected, these factors must receive early and scientific consideration.

It is essential that this new concept of marketing be regarded as a "science" for, unlike the old methods of taking goods to market based on guesswork, gambles, and expedience, this marketing plan has for its base the scientific search and use of facts.

Planning based on "facts," objectives based on "facts," execution of jobs guided by "facts," and examination of result measured in terms of "facts"—these put the mark of "science" on this new concept of marketing.

A modern marketing plan embraces the responsibility for and the co-ordination of the following functions:

- Market Research
- Product Planning
- Production Scheduling & Inventory Control
- Sales Planning and Distribution
- Product Service
- Sales Promotion and Training
- Advertising.

In order to understand and appreciate more fully this concept of marketing, it is essential to examine each of these functions and how it relates to the over-all operational responsibility of a modern marketing organization.

* Decimal classification: R740. Original manuscript received by the Institute, December 27, 1949. Marketing Symposium presented, 1949 National IRE Convention, New York, N. Y., March 10, 1949.
† General Electric Company, Electronics Park, Syracuse, N. Y.

Market Research*

ERNEST H. VOGEL†

MARKET research has important application to good product development. Consumer's likes and dislikes are a set of facts that are just as objective and can be established just as firmly, as the facts of material and labor costs.

It is the business of market research to obtain, analyze, and interpret information on consumer facts. In addition, market research should disclose the essential facts necessary for determining the following:

- Size and location of market
- Product requirements of the market
- Product specifications
- Production scheduling and inventory control of factory output to best serve the market
- Prices at which product can be best sold to the market
- Advertising and sales promotion plans for steadily developing the market
- General business conditions and trends affecting the market.

Market research and its findings do not necessarily represent final conclusions. Those employed in marketing will never have a slide rule with which they can calculate the right answers. They must, of necessity, treat with too many variables—too many human reactions and opinions. In the final analysis, experience and good business judgment must sway the ultimate conclusion. Therefore, they welcome market and product research as a tool—a very necessary tool that offers firm facts that eliminate much of the guesswork, gambles, and the playing of hunches that have resulted in so many commercial failures in the past.

* Decimal classification: R740. Original manuscript received by the Institute, December 27, 1949. Marketing Symposium presented, 1949 IRE National Convention, New York, N. Y., March 10, 1949.

† General Electric Company, Syracuse, N. Y.

Market research revolves primarily around two major functions:

1. Statistical Research

This is the science of accumulating, compiling, and tabulating basic statistics on which fundamental planning may be based. In the radio industry there are several excellent sources of such material, which enable the intelligent determination of sales objectives in relation to industry expectation in all the varied classes of receivers which are manufactured:

(a) *RMA Statistics*. Most members of RMA report weekly their production and shipments of radio and television receivers, broken down into a dozen or more basic classifications. A compilation of these reports is sent in turn to each contributing member which enables him to become informed regarding the over-all movement of each classification nationally, and his own performance percentage-wise of the total industry sales. Certain industry inventory figures are also included, which provide danger signals against over-production and inventory controls. Also, over years of reporting, certain seasonal trends are established, which prove valuable in guiding production schedules and timing for the introduction of new merchandise.

(b) *RCA License Statistics*. RCA issues monthly a summary of industry production and sales, based on manufacturers' royalty reports. This summary provides an effective check on the RMA figures and a valuable ingredient in the compilation of general figures to indicate industry trends by the various categories of merchandise.

From various other sources, other vital data are secured covering broad economic factors, such as population, home owners, income tax returns, auto registrations, projected national income, cost of living, rate of employment, and the extent of the so-called

discretionary dollar available for expenditure on other than living necessities.

Combining these factors, the manufacturer can set up a fairly accurate statistical picture which enables him to project industry volume by type of merchandise and the part he expects to play in it. This activity is basic and has been in use constantly by most manufacturers to determine the most accurate figures on which to base their conclusions. This statistical information is utilized to good advantage in sales planning and distribution, as will be shown later.

2. Trade and Product Research

Most manufacturers maintain, on a systematic basis, direct contact in the field with leading dealers to secure their immediate reaction and opinion of the sales possibilities, not only of their own product, but those offered by competition. This is vitally important, particularly in relation to television receivers, where changes are made often and quickly, due to the rapid development of this new art. This continuous contact enables the manufacturer to keep currently familiar with each new product as it is introduced by competition, its technical makeup, any new feature which might indicate an advance in the art and, of equal importance, to advise the manufacturer of the difficulties which competition may be experiencing on their new models. This familiarity with competing products and their field experience will provide the manufacturer with information that may indicate whether a change in a particular design is necessary to meet ingenious competitive developments, or advise and warn him not to incorporate specifications, circuits, or other technical innovations which have proved unsatisfactory and troublesome in competing goods. It is evident, therefore, that the subject of field product research is directly related to the vital subject of product planning,

Product Planning and Design*

DAN H. L. JENSEN†

IT HAS BEEN shown that the work that goes into market research provides a basis for product planning. These procedures are used to a great extent in planning, particularly the results of statistical research. Field product research, however, is only one of the phases of successful product

development. A somewhat more personal and rule-of-thumb method of collecting and correlating information must also be employed. It has been found that the ideas incorporated into a new line of products are apt to stem from many sources, such as:

1. Research engineering, wherein the product group includes ideas for technical improvements.

2. The field sales organization, through the medium of conventions, dealers meetings, and through special field trips made

with key sales personnel to dealers' stores to determine the acceptability of all of the products in their stores.

3. Production engineering, whereby the study of the problems encountered in the factory may often lead to new methods of assembly that can be incorporated in future designs. These methods often lead to greater standardization and simpler organization of component parts.

4. Quality control, which aids in the study of quality factors that cost out of

* Decimal classification: R740. Original manuscript received by the Institute, December 27, 1949. Marketing Symposium presented, 1949 IRE National Convention, New York, N. Y., March 10, 1949.

† Philco Corporation, Philadelphia, Pa.

proportion to their sales value, enabling the manufacturer to stress those items which will give the consumer the greatest return for his dollar.

5. Chassis engineering, which enables reduction in component size, simplification of circuits, simpler solutions to mechanical problems, and constant guidance in formations of the product to give maximum performance for least cost.

6. Product design and development, whose basic responsibility is to conceive of new consumer product ideas.

7. Top management, which supplies timing from an economic viewpoint, and evaluation of the fundamental approaches from a standpoint of price and sales appeal.

In order to catalyze the ideas from these sources of material, it is necessary that a specific group be assigned the primary problem of co-ordinating information received. It is their responsibility to crystallize the information in such form that the responsible executives are familiar with the program and can offer criticism according to policy-forming top management thinking.

Once a model is in production, statistical records are kept which help in analyzing trends and which give specific data for determining the approaches that should be taken. For example, records are kept on the relative production rate, the selling rate, and the stock available at any given week for each model, enabling the manufacturer to keep a close check on the sale of his product. A sudden increase of stock on hand, commencing at a time when the production running rate is relatively constant, would be a warning signal that for some reason the model is backing up in distributors' stocks. The manufacturer would then get in touch with key distributors all over the country to determine whether the reason for this slow-down is competitive, whether it lies within his own product, or whether it is a general market condition

which would indicate that any product at that price would sell slowly at that time.

Records are also kept on all competitive makes of models, including list prices, features, and complete cost information, which enable each company to analyze from a purely statistical viewpoint how it stands with respect to competitors. Using this information along with industry figures on the percentage of sales, the manufacturer can determine whether business is becoming stronger or weaker in every individual phase of the market.

The actual development of a new radio model starts with the determination of the general price range in which it is to sell. A list price is determined, and from this a breakdown cost is made showing what should be spent in the broad general brackets of chassis, cabinet, packing, and assembly labor. A further analysis of each of these items discloses just what can be put into the set in materials and labor.

Immediately following these initial steps, work on the design of chassis and the cabinet is started. Careful attention is given to the layout of electronic and mechanical parts in order that factory costs may be kept at a minimum, and eventual use by the consumer is never forgotten.

Concurrently with the building of the models, the cost estimating groups are working on the cabinet and chassis designs so that when the models are shown to the sales group, a suggested list price at a specific discount and gross profit structure has been determined and can be discussed as it relates itself to the rest of the line.

A running rate is determined for the various lines of production which establishes what the average over-all gross on each line of products can be. This gross is pre-established as necessary for good business practice, and it is the responsibility of the product group to come up with a line of products that will make it profitable for that

division of the corporation to operate.

During the course of this procedure, schedules are set up, starting with management's assignment of the problem and ending with the start of production.

When the product has reached approval stage from the standpoint of the product design group, a design data sheet is turned over to the engineering organization giving explicit data as to what the product shall be from the consumer's point of view. This data sheet is the official indication to the operating division of the organization that a product has been approved by the sales management group, and sets in motion the wheels of production.

The engineer will be interested in knowing the kind of personnel required in the organization of a product design and development group. If the group is small, it will probably include men who have been trained either in school or by experience in the specific application of industrial design to the creation of new products; however, when the staff exceeds four or five people, it is well to diversify this background to include personnel trained in such creative arts as architecture, painting, sculpture, and interior decorating, along with industrial designers who combine experience in fine arts with a knowledge of engineering. The allied talents of such a group can be well co-ordinated and applied to the creation of new merchandise. The group should also include complete model-making facilities for the basic raw materials, and a finishing laboratory which can apply finishes to simulate all materials.

Finally, it is important to have a business staff to keep the work flowing from its initial sketch stage to the review of the finished model by sales executives at scheduled intervals.

This brief discussion constitutes one phase of the application of market and field research in product planning and design.

Production Scheduling and Inventory Control*

ERNEST H. VOGEL†

IT LOGICALLY follows that, after the market is surveyed as accurately as possible and the product planned to fill market requirements, the factory must be provided with production releases for a firm quantity of units to be produced, and that daily, weekly, and monthly production rates be established in advance. Such firm commitments on the factory should be made under the direction of the top management

of the marketing operation. Such schedules must be based on a reasonably optimistic sales objective and must be co-ordinated with factory facilities. Schedules that extend sales beyond a reasonable expectancy or contemplate production rates greater than the factory can produce are dangerous. They lead to excess inventory available at the wrong time and result in losses.

The objective of maximum turnover of inventory and maximum return on invested capital is constantly in front of the manufacturer. Inventory is one of the largest items of capital investment. While many items of capital investment, due to their nature, cannot be easily changed, inventory can be controlled to give a greater return

or profit to the company. There is no more effective way to revolve capital and increase profits than through rapid inventory turnover.

The main problem in inventory control has to do with making a master schedule from which a budgeted rate of production output is determined. This schedule must be based on a marketing forecast and a continuous application of judgment, based on sound market analysis, to anticipate and determine changing conditions. Control of production and inventories, based on market facts, should make it possible to shorten production cycles to weeks, as compared to months, as has been the experience during the past three years.

* Decimal classification: R740. Original manuscript received by the Institute, December 27, 1949. Marketing Symposium presented, 1949 National IRE Convention, New York, N. Y., March 10, 1949.

† General Electric Company, Electronics Park, Syracuse, N. Y.

The marketing organization should be responsible for negotiating a mutually agreeable production schedule with the factory. Once accepted by manufacturing, that schedule is as much a part of the customer's contract as the price, and must be met. Marketing must plan its sales activities in its markets, and plan and *time* the

production it needs to satisfy those markets.

If product planning is properly done and if production schedules are accepted and met, the company is assured of *the all-important element of timing*. With full knowledge and control of the product development and production rate, the sales man-

agers can prepare comprehensive campaigns and sales tools for aggressive merchandising with confidence. *Then, sales planning becomes the creative activity it has always been considered.*

This brings us to the next major step in modern marketing—proper and effective sales planning and distribution.

Sales Planning and Distribution*

LEE McCANNE†, SENIOR MEMBER, IRE

ENGINEERS are usually concerned with product planning. It is important that engineers understand the sales planning involved in disposing of the products they have designed.

It is timely that light be thrown on selling methods, distribution channels, and selling costs in the television industry. Already, television presents a paradox, a twilight zone, with a sellers' market continuing or developing anew for certain brands and picture sizes, while a buyers' market has definitely arrived for certain other brands and picture sizes. It is important to the prestige and prosperity of this industry that we recognize the pitfalls and avoid those weak merchandising practices which gave the radio industry a "racket" aspect before the war. The most cloistered research engineer may find his job security threatened unless television can be established on a stable marketing plan, with definite functions and responsibilities to be performed by the dealer and the distributor at costs which can be known and anticipated.

In 1939 there were television sets with a bigger picture than the 10-inch cathode-ray tube on which the postwar industry decided to standardize. Yet, as remarkable as television was in 1939, sets did not sell. The reasons why are probably as mystifying to engineers as the circuits would be to the salesman on a retail floor. Largely it was due to the application of contemporary radio sales techniques rather than recognizing television's special market problems. In 1940, when it became apparent that television sets were not moving off of radio dealers' floors, a few pioneer manufacturers went to considerable expense in metropolitan New York to establish direct selling operations or supplement the dealers' selling functions. New York was then the one market that had television programs at all comparable to those of any single-station television city today. Under this direct selling plan, the dealer produced a prospect

list. Then a television selling specialist went with the dealer's salesman to call upon prospects and close sales. Only with this extra effort were sets moved off a dealer's floor and, at that, largely into public places with the thought in mind that, if people would not go to the dealer's store to get a demonstration, they would at least be exposed to television occasionally in public places.

Sales planning endeavors to answer these questions:

1. Where are the prospective customers for this product?
2. How many potential customers are there?
3. In what kind of store or outlet will they look for this product?
4. How can those outlets best be contacted and served?
5. Are middle-men (distributors, sales agents, etc.) necessary or desirable?
6. How many salesmen are needed in the field?
7. How should their territories be established?
8. How much supervision will they need?
9. Where are the warehouses or branch offices needed?
10. How can the company keep track of, and control, the activities and inventories and all units in this marketing structure?
11. How should the product be installed and serviced?
12. What, if anything, can be done about price maintenance?

It might appear that these questions can be answered "once and for all" by each manufacturer, but in practice they need frequent review and attention. Product plans may be upset or altered by the sales plan. The number, size, and style of models in a line, for example, may be changed by a decision to display them in furniture stores rather than sporting goods stores. It is well when product plans, sales plans, and sales promotion plans can proceed concurrently, in parallel, rather than in series.

The first question, where are the prospects, is answered simply for a television

sales manager by the nature of television itself. The market is entirely domestic at present, not a national market, but limited to the cities and areas served by television stations.

When it comes to determining the *best* markets in which to spend one's selling efforts, the first question is not so simple. The cities which have a choice of two or more programs, or a television network connection, are better markets than isolated cities which have only one station, independently programed. Some manufacturers will concentrate their efforts on a selected few television areas; while others will endeavor to develop all possible television markets.

Determining how many potential customers there are in an area, and their buying power, has been the aim of many a statistical study with the results weighted by various factors. Sometimes a formula or "Buying Power Index" is the result, jealously guarded by the manufacturer who spent a lot of time and money to compute it. Figures on the population, the number of home owners, the number of electrified homes, the number of radio homes, are available for every county in the nation. Other factors such as income tax returns, subscribers to the magazines in which the manufacturer advertises, telephones in use, or automobile license registrations may be used to indicate per capita buying power. Two more factors are needed. One of them indicates the relative share of the total television market which the particular manufacturer or brand intends to capture. The other is an experience factor, recognizing the effect of past sales and sales promotion as a cumulative local selling help in swaying more prospects, depending upon the extent to which each market has already been cultivated.

Department stores, music stores, furniture stores, hardware stores, dry goods stores, jewelry stores, sporting goods stores—any one of these may be the complete or partial answer to the third question on the type of dealers to be franchised. Manufacturer-owned retail stores and display rooms have rarely been used in the television business but are common in some industries, such as shoe stores. Direct-to-consumer selling by mail, or through mail or-

* Decimal classification: R740. Original manuscript received by the Institute, December 27, 1949. Marketing Symposium presented, 1949 National IRE Convention, New York, N. Y., March 10, 1949.

† Stromberg-Carlson Company, Rochester, N. Y.

der catalogue houses is broadly followed by producers of television kits and some manufacturers of small television sets.

In the classical method of distribution, the manufacturer sells to a wholesale distributor who, in turn, sells to a dealer who sells and serves the customer. That is the distribution process which involves the full list of marketing functions. Any other method aims to streamline the process by short-cutting one or more functions and consequent costs.

To answer the fifth question regarding the use of wholesalers or "jobbers," or of commission sales agents, the manufacturer must determine whether he can afford the sales force, traveling expenses, regional warehouses for quick deliveries, credit department and finance plan, and trade-paper advertising that may be necessary if he is going to compete with established local wholesalers for the retailer's attention. Many manufacturers use local wholesalers in every market; many more use wholesalers in most territories but sell direct to dealers in a few selected markets; while a few manufacturers sell direct to dealers nationally but usually concentrate their efforts on the large metropolitan centers. It must be acknowledged that some manufacturers have answered question 5 one way for some markets (establishing their own wholesale office, sales force, and warehouse in New York or Chicago, for example) and the other way for other parts of the country.

The "middle man" in the classic pattern of distribution buys from the manufacturer and sells to dealers. In television (after deducting the dealer discount of 25, 28, 30 or 33 per cent, depending somewhat on price range), he has a gross profit margin on the remainder of 10 to 18 per cent. That is considerably less than 10 to 18 per cent of the list price; it is 10 to 18 per cent of *what is left* after the dealer's discount has been deducted from the list price. Thus, if the dealer's discount is 30 per cent (leaving 70 per cent of the list price as the dealer's cost of the merchandise) and the distributor discount is 10 per cent, the distributor's gross margin is 10 per cent of 70 per cent, or 7 per cent of the list price.

Within this gross margin, the distributor aims to make a net profit, and also to:

1. Pay his rent and overhead in proportion as television is related to the rest of his wholesale business.
2. Pay the freight from the manufacturer's plant.
3. Buy and store merchandise in advance of the peak season demands, to be ready to make immediate delivery when the demands materialize. This may require bank loans, at interest.
4. Employ wholesale traveling salesmen.
5. Co-operate with the manufacturer and dealer in local advertising.
6. Maintain spare parts and establish service depots for his dealers.
7. Promote sales through displays and demonstrations at radio shows, home shows, county fairs, etc.
8. Conduct sales-training meetings for dealers' salesmen.

9. Train service men and installers.
10. Advise dealers regarding location of the television department, arrangement of floor display, window display, and demonstration rooms.
11. Arrange bank or finance company loans to dealers for floor samples and time-payment customer paper; or extend credit to his dealers, collect these accounts, and charge off any bad debts.
12. Support local television stations by sponsoring programs during daylight hours to facilitate home installations and store demonstrations.
13. Deliver the instrument from his warehouse to the dealer's store, or to the customer's home, crated or uncrated, as desired.
14. Police his territory, using comparison shoppers to report price-cutting by his dealers and competitor dealers.
15. Absorb losses on any slow-moving merchandise.

That is quite a list of distributor functions. Each of them can be costly. While some brands allow only 10 per cent of the dealer's cost to the distributor for performing these functions, other brands sold through distributors may allow as much as 18 per cent on some models, the difference being the degree to which the manufacturer counts upon his distributor to advertise and promote the sales.

One effort to streamline the classical distribution plan is through the use of a manufacturer's sales agent instead of a distributor. Under this plan, the manufacturer usually has to stockpile and warehouse television sets ahead of the season at his own expense, bill the dealers, and make collections from them after they buy from the commission agent. The agent's commission is therefore smaller than a distributor discount.

Some other manufacturers, to streamline the distribution plan, elect to sell a private brand or "stencil" merchandise direct to a mercantile chain of stores. Here a group or chain of stores pool their buying requirements in an effort to function as wholesalers as well as retailers. Unless they are concentrated in one market, they have shipping and warehousing problems similar to those involved when a manufacturer sells direct to dealers. There are fewer people to co-operate in advertising and in sales promotion efforts. The manufacturer who sells stencil brand merchandise loses his identity and builds a reputation and a market structure which he cannot control. Its permanent value to him is questionable.

Many books have been written about selecting salesmen, assigning territories, and supervising them in the field. There isn't space to do more than mention the problems raised by questions six through nine above. In general, the manufacturer's salesmen usually need more supervision than they receive. Many times, attendance at an annual convention—perhaps not even held at the factory—to see the new models is the only direct personal contact they have with sales and sales promotion managers all year. Some companies have been finding that their salesmen are more effective when given close

supervision, even to the extent of appointing one traveling supervisor for every five or six salesmen.

As to inventories and controlling the activities of their dealers and distributors asked in question ten, most manufacturers have their salesmen's call reports list the inventories of distributors and dealers, then have these figures tabulated by business machines and statistical departments to help them keep their fingers on the pulse of the arteries through which our goods flow to consumers. Here, direct-to-dealer selling has some advantage in the off season. Your own salesmen, employed exclusively to sell television sets, can put more effort on your product at periods of the year when a jobber's salesman would be spending his efforts on refrigerators, washing machines, or other appliances. For this reason, in some sales promotion plans, contests and special advertising campaigns are deliberately timed to keep up the continuity of interest and activity throughout the year.

As to the eleventh question, regarding installation and maintenance, it is debatable whether television would have made such a good start *without* by-passing the dealer until recently for proper installation and servicing, or forcing the dealer to pay enough attention to good installation, and to teaching each operator of a television set what to expect and what not to expect when using it. Under one plan the dealer and dealer's salesmen were relieved of this responsibility by the manufacturer himself, or by an installing and service organization engaged by the manufacturer for the purpose. This plan assured customer satisfaction by seeing to it that time and money were spent on a good installation. It pointed out dramatically to dealers that they had previously been inclined to neglect their responsibilities in making a good installation. It took away from the dealer, however, part of the close relationship he should maintain with his customer. And it left the dealer's salesmen free to oversell the product, promising results which might not be fully realized due to installation problems.

Another plan is for the dealer himself to handle installation and service, or to engage an installing company on contract and to sell his customer a service contract.

As to question twelve on price control, state and federal Fair Trade laws are relatively new. A few manufacturers invoke them to fix prices on a national or regional basis. Others permit their distributors to exercise local option with regard to fair trading, and some invoke the act if only to prevent the advertising of cut prices. The difficulty of maintaining a stable price structure for television sets is increased by:

1. The need for an installation and service contract charge.
2. The possibility of a trade-in allowance for a radio or even an older or smaller television set.
3. Finance charges for a time-payment sale as against sales for cash.
4. Possible needs for companion merchandise, such as an indoor antenna, a table for television table models, a record player attachment, or a booster amplifier.

Sometimes a dealer "throws in" some free companion merchandise or offers a price reduction in the belief, perhaps fallacious, that he will not be called upon by that customer to perform some of the retail functions and responsibilities for which he should be accountable.

A good distributor polices his territory with regard to trade-in, service, installation, and price-cutting practices as a protection to his consumer public and to the diligent, scrupulous dealers. He must know what goes on in all television stores in his territory. Fair trade and price maintenance laws may help, but have yet to prove as effective as a good determined distributor.

In considering what some of these retail functions are and how each function adds to the dealer's cost of doing business, it is careless thinking to assume that all cost to the dealer occurs *after* he has made a sale. The following costs begin before a customer ever enters his store:

1. Pay rent, taxes, telephone and power bills, insurance, and clerical overhead.
2. Pay for the merchandise.
3. *Receive it, and store it in his warehouse.
4. *Uncrate it, install the picture tube, try it out. Set up push buttons (if any) for local stations. Make a record of the chassis and picture tube serial numbers.
5. Buy the manufacturer's literature, sign, and sales aids.
6. Display a full line of samples on his sales floor. This may tie up a sizable investment all year or all season, and involve finance costs for a floor-plan loan. He may sacrifice his profit on samples which become shopworn or obsolete while on display.
7. Set off the floor samples with proper backgrounds, flood lights, rugs, draperies, chairs, platforms, etc.
8. Display one or more samples in a store window, with attractive settings installed by a window trimmer.
9. Identify himself in the classified telephone directory as a dealer for that brand.
10. Advertise in local newspapers, on billboards, or on radio stations and television programs to direct prospects to his store.
11. Employ and train sales personnel.
12. Send buyers and sales supervisors to meetings and conventions for sales-training information.
13. Install suitable antennas for the store and, if necessary, filter the power line in order to make demonstrations in the store.
14. *Purchase or lease trucks for delivery, on a full-time or stand-by basis.
15. *Engage installers, and acquire a stock of antenna accessories.
16. *Make service arrangements, with a suitable stock of spare parts.

* These functions may be performed by the distributor, at a charge to the dealer or customer.

After the customer orders a set, the dealer encounters further sales costs, as follows:

1. Polish the cabinet.
2. Deliver the set. (This may require two men.)
3. Install it. Test and adjust it in the home—*when all stations are operating*. With some stations operating evenings only, or intermittently, this can require costly call-backs.
4. Get a credit rating on the customer (unless the set is sold for cash or to a trusted charge account customer). This can cost anywhere from a five-cent telephone call to several dollars.
5. Sell time-payment paper to a bank or finance company, engage a collection agency, or make periodic requests for time-payment collections by letter and telephone.
6. Send a salesman on a follow-up call to see that all adult members of the family know how to operate the television set, including the radio and record-changer, if any.
7. Provide service facilities and pay the cost of removing parts and installing replacing parts (furnished by the manufacturer, less transportation costs), if any parts prove defective within the guarantee period.
8. Be prepared to send the installers back to relocate or orient the antenna whenever a new television station starts operating. (On higher frequency channels, this can be a seasonal requirement after leaves drop off trees, etc., on existing stations as well.)
9. Collect and transmit any state or local sales tax, gross business tax, etc.

That adds up to 25 selling functions performed by the dealer, 16 of them before the customer walks in and 9 more to take care of the customer's order. This outline merely touches the high spots; it is impossible to recount here all of the sales promotion activities, for example, which a dealer may undertake in any week.

Television sets and television marketing methods have been changing so fast that it is too early to spend time and money to survey the cost of doing business in big and little television stores and draw off any averages. There is a rough yardstick for comparison, however, from the radio business before the war. Back in 1936 and 1937, our company made a study of nearly 100 representative dealers' costs of doing business in the radio industry, and it ran about 34 per cent. The average industry list price of radio sets, taken from *Electrical Merchandising*, was then \$55.80. This same source shows that the average list price of television sets was \$484 in 1947 and \$416 in 1948. Allowing for these larger unit sales and better store management, it may still be said that a dealer is doing well to pay the cost of these 25 selling expenses out of his gross profit and still have a reasonable net profit for himself. If he ends with an unreasonable profit he is prob-

ably neglecting some of his functions, and that may cause the customers to turn to some other dealer in the future.

In launching television sets on a large scale, the manufacturers had to face two alternatives. Either the price would be so high that it would put many potential consumers out of the market, or else the manufacturer, distributor, and dealer would have to operate on less gross margin than had become customary on radio sets. It is because the latter alternative was chosen that 10-inch table model television sets have sold at prices well under \$400, and some smaller television sets at prices beginning at \$100.

In the face of these 25 costly retail selling functions and a gross margin which may be 25, 28, 30, or 33 per cent, how can it happen that some dealers will cut prices by drastic amounts or give large discounts?

There are three ways in which this can come about. Each contributes to an unstable market and a lack of respect for the product.

The first way is the franchising of too many dealers, including people who do not have a store or who have no permanent interest in the television business. Operating at practically no overhead, doing no advertising, proselyting by sending prospects to established retail stores for the display, demonstration, and user information, and without the "follow up" interest for service and customer satisfaction that a dealer must have who is looking to the future, these sales opportunists can short-cut many of the selling expenses and be but parasites. Distributors and manufacturers are shortsighted in selling merchandise to these people.

The second way in which this can come about is for established dealers to try to "capture business" from each other. This can quickly mushroom into a price war. Usually this starts with wishful thinking, the retailer hoping against hope that *this* customer won't require any call-backs; he will do *his own* installing and instructing of other users in his household; *this* set won't require any service; *this* customer will pay cash immediately, or meet all his payments without prompting. He may not appreciate that each and every instrument sold must bear its part of his overhead expenses, his salesman's salaries, his taxes, his cost for literature and advertising and window and floor displays. The people who suffer when this thinking proves wishful are the dealer himself, his wife and children. In no time at all, faced with continuing and inexorable selling costs, his profits are gone, his salary is gone, his inventory is gone, and his store is gone—with the loss to the industry of one more sales outlet. It means less respect for any price structure, less demand for engineering services, less strength in the whole industry to compete for the consumer's dollar against the automobile industry, the building trades, the coal miners, the dairy trade, and all those industries which somehow seem to be more successful in promoting an attitude of "live and let live."

When price wars are in full swing, the situation may get beyond the control of any and all distributors. The dealer who wishes to avoid price wars must choose one of two alternatives: either to represent a manufacturer who does not invite price disturb-

ances at frequent intervals, or to promote his own stencil brand, made by some manufacturer unknown to the customer, and rely solely on the prestige of the store. It is harder to sell a stencil brand than one which is advertised and displayed more widely, especially in merchandise as intricate and complicated as a television set.

The third way in which this can come about is when a dealer, distributor, or manufacturer becomes financially involved, with his funds tied up in inventory when pressing obligations must be paid. It costs a lot of money to buy a stock of television sets. That money could and should be turned over quickly through sales, repeated purchases, and repeat sales. Whenever this process breaks down or slows down, someone may be forced to sell at a loss.

When you, as an engineer or an employee, buy a set for your own use and agree to cart it home, install the cathode-ray tube yourself, maintain it, erect the antenna, instruct the other users in your household, and pay for it out of payroll deductions, you are by-passing some of these 25 selling costs. To that extent, you are entitled to some price concession or discount. Moreover, there is an intangible but appreciable value in having you get experience with your Company's

products; we never know when this may lead to suggestions for improvement, for new uses, and to more sales to your friends and neighbors. Employee purchase plans quite generally, therefore, permit the acquisition of one or more instruments a year at a price only a little higher than the dealer pays.

The average lay customer, however, needs and is entitled to all 25 items of selling expense performed by a good retailer. Even if he pays less money and doesn't get any "follow up" attention, it is an unsatisfactory purchase and he didn't get his money's worth.

At one time list prices on radio sets amounted to four or five times the factory cost. That was long before the war. Since then margins have been reduced on radio sets as well as television, advertising costs are distributed over a greater volume of business, and distribution has become more efficient. This has brought list prices on television sets down well below three times the bare cost of materials and direct labor in the product which engineers have labored to produce so economically. In addition to dealer and distributor discounts, the list price must pay its share of the manufacturer's overhead, taxes, and royalties. It must provide the customer a reliable prod-

uct, of uniformly good quality, safe to use in his home.

Those of us in the selling end of television, together with many engineers, share a great faith in television and are determined to see that the public gets good programs, proper installation, a set of good quality, and maintenance attention so that they will be pleasantly surprised with this new medium of entertainment and education, and anxious to come back to us again and again. We see an ultimate market for two or more television sets in every home. We want the favorable market reaction which will result in the customers' thinking of television as worth more than it costs in the dollars he has to take out of his pocket or out of the bank. Sometimes it is as difficult to get the customer to part with his money as it is to get him to go to the dentist and part with a tooth. This is especially true of that small part of the selling price which assures the customer of the continued interest and attention of a good retailer. But buying a television set and expecting it to receive all the local stations, present and future, without this attention is about as sensible as buying an automobile direct from the factory, without any lubrication, adjustments, road test, or warranty by the local dealer.

Servicing the Product*

ERNEST H. VOGEL†

SERVICE to the customer has been stressed as an important function of the distributor and dealer. Service is also a prime responsibility of the manufacturer, because in the original design and on the production line rests the answer to whether this field service will be excessive and costly, or fall within the normal expectancy for a highly technical product, such as radio and television.

This fundamental responsibility is another important function of marketing. Product service should not be thought about only when the customer raises complaints. Some foresight must be used in establishing service programs. Product service is a problem that is born with a product, along with the problems of manufacturing cost, selling price, distribution, and others.

Product service starts logically on the drawing board of the design engineer. This is

the place it must start in any planned service program. This is a basic principle. Together with sales factors, manufacturing factors, and engineering factors, the design engineer must have available for his guidance a stated policy of service for the new product. This stated policy he will then design into the product.

It should have a bearing on the designer's choice of materials, his decision on strength and safety factors of individual parts. It should help to guide his thinking on mechanical operation. Product service should help dictate product design. "What are the plans for service? Who is going to do the servicing? What are the limitations of the average service man in the field? Where will service be rendered—under what conditions?" *All these are questions of importance to the design engineer.* The answers to these questions are influencing factors that he will design into a new product.

The manufacturing organization, too, is vitally interested in the stated service policy, because the manufacturing organization must build into the product that standard of

quality that is required to meet a stated service policy.

Service cannot be considered a necessary evil. It is a positive function that has attraction and interest and inspiration, because it must be designed, built, and sold, just as the product itself is designed, built, and sold.

The operation of product service must be subject to constant scrutiny. The goal of prompt, efficient service, priced right for the customer, must always be kept in mind. Service in the field *must be prompt, it must be efficient, it must be economical* to the customer. It is the responsibility of marketing to build service into a profit operation.

* * *

The functions of marketing have been traced to the final phase—that of presenting the product to the public. This function falls into two broad categories:

- (a) Sales training and sales promotion.
- (b) National advertising.

Consequently, each of these subjects will be treated separately.

* Decimal classification: R730. Original manuscript received by the Institute, December 27, 1949. Marketing Symposium presented, 1949 National IRE Convention, New York, N. Y., March 10, 1949.

† General Electric Company, Electronics Park, Syracuse, N. Y.

Sales Training and Sales Promotion for Television*

WILLIAM E. MACKET†

SALES training and sales promotion are the two phases of marketing closest to the product at point of sale. The responsibility of sales training and sales promotion is that of converting prospects into customers. An intelligently designed, engineered, and manufactured product is without a taker unless the retail sales organization is sales trained to the task of selling the advantages of that product to a prospective buyer. The education of the dealer salesmen, then, becomes a responsibility of the manufacturer, which is classified as "sales training."

The two phases of sales training are: first, the advance information which is given to wholesale and retail selling organizations at the time the product is first introduced to the distributor, the dealer, and the buying public.

The other phase of sales training is the more detailed information which is given to the wholesale and retail selling organizations after the product has been in the field anywhere from three to six months. In this second phase, there is opportunity to evaluate from actual field experience the shortcomings of the first material furnished, and also to add the experiences of the growing list of product owners and users which gives a second foundation on which to build a good demonstration and sales story for the retail salesmen.

Going back to the material for the first phase of sales training, this is accumulated by members of the sales and advertising departments from the inception of the product through to its final approved production models.

Specifically, let us see how this procedure worked out in relation to our present television line. All through the process of product planning on these models and the sales planning that is done concurrently, it became obvious to both sales and engineering that this new merchandise would have two principal features, which we believed would be outstanding—the Giant Circle Screen and the Bull's-Eye Automatic Tuner.

It was felt that these features represented a real engineering contribution to the art—and a definite "plus service" to the customer. But the fact that the company was enthusi-

astic meant practically nothing unless the merits of these features and enthusiasm could be transmitted on to distributors, their selling organization, and to the dealers, who ultimately sell this product to the public. This also holds true on many other built-in features that were put into the merchandise—those hidden inside the cabinet. These also had to be fully explained, expounded, and made part of the general sales presentation.

To secure the detailed material for sales training in the initial period, a closely coordinated product planning program between the heads of sales, advertising, and engineering, including electrical engineers and cabinet designers is required.

In the course of product development there are several meetings covering the various features that are to be incorporated. When the final approved sample is made available to the advertising department for advertising, sales training, and sales promotional purposes, the engineering department also prepares a complete tabulation of all the details as related to the product and its design. These include all mechanical and electrical specifications with their interpretation of the competitive sales advantages of given features.

In other words, when the advertising department receives the first advertising sample it is able to gain all of the information with regard to the product and its sales features which can be translated into advertising, training, and selling for all promotional purposes.

In the initial phase of sales training, complete specification books and presentation books are then prepared which are given to the dealers with this advance product information. In the case of major features of a radio or television line, a motion picture film is produced which is used at the company national convention, and then by distributors to sales train their field selling organization and their retail dealer sales organization.

Naturally, some of the first pieces of promotion material which are developed and produced for consumer interest become, in effect, sales training material at the retail salesmen's level.

In considering the second phase of sales training a complete scholastic program is prepared which can be used by the distributors and wholesalers in training their sales organization, and again used by their sales organization in training retail salesmen. Included are such items as sound slide films

explaining the hidden features of a product; those that are incorporated in a television chassis, for example, which neither the dealer nor the consumer has an opportunity to see or know about by simply looking at the set. In addition, material is provided which makes it possible for dealers to demonstrate the features which the engineers have put into the actual operation and performance of the television sets.

Putting this material into film and coordinating it with a sound film ensures that the same story is told to the thousand or more personnel in the wholesale selling organizations, and, to the 20,000 dealers and their retail salesmen across the country.

Supplementary material in the form of television chassis cut-aways are made a part of the advance sales training kit. In actual meetings with selling organizations, a breakdown of the entire television chassis and its six major components, which are each individual chassis combined into one master chassis, are physically shown and discussed. Such important material as the sound system is described in detail in the case of television. Then, to be sure that all of the salesmen at the manufacturing, the wholesale, and retail selling level have the complete advance product information program or sales training material, the entire story is put into a pocket manual profusely illustrated with the pictures that are used in the slide films, the description and advantages of those features, as well as recommended demonstration techniques to use on the prospects.

With reference to promotion, it was felt at Zenith that the most important single phase of promoting products is through intelligent and continual sales training. The things that are normally classified or described by an advertising man as "promotional material," such as window signs, window displays, lithograph pieces, line folders, envelope stuffers, give-away gadgets—all of these are considered promotion and are definitely a part of the promotion picture, but promotion activities will continue to be expanded on the basis of sales training. It is felt that the printed word for the consumer at the point of sale will become increasingly secondary to the more important factor of having the selling organization all the way down the line familiar with what the engineers, the sales management, and the executive management put into the product, so that it can be sold to a public that knows what makes it work, how it works, and what it does for the buyer in his own home.

* Decimal classification: R740 X R583. Original manuscript received by the Institute, December 27, 1949. Marketing Symposium presented, 1949 National IRE Convention, New York, N. Y., March 10, 1949.

† Hotpoint Corporation, Chicago, Ill.

National Advertising*

M. F. MAHONY†

THERE is indeed room for a lot more understanding on the subject of national advertising, even though advertising itself is one of the world's oldest arts. The history of advertising in all its forms harks back through the ages, and into the haze that hides the beginning of humanity.

So far as is known, the cave man did no trading. He produced nothing. He had nothing to sell and nothing to advertise. When mother needed a new dress, father took his club in hand and went out and killed a bear. But as men discovered that they could get food and clothing by trading their own specialties for these necessities, the art of advertising began to develop. As skill in making things grew, each craftsman's output increased. When a man found rivals in his line, it became necessary to do some selling to persuade them, and he evolved a selling talk.

In modern life, advertising is basically an educational force. It informs the people of the existence and nature of commodities by explaining the advantages to be derived from their use and creates for them a wider demand. It inspires new thoughts, new desires, and new actions. By changing the attitude of the mind, it changes the material condition of the people.

It is the primary concern of this paper to discuss modern advertising as a force in creating the wants and desires which sustain the markets that industry must have in order to exist. Let us begin by taking a look at the national market. The Census Bureau tells us that the population of the United States today is crowding the 150 million mark. But to be of any use, that figure must be broken down by sexes, age groups, occupations, income groups, racial groups, living habits, buying habits, and scores of other ways, to get a sharp, clearly focused picture of the relationships between our particular product and the potential number of buyers.

Furthermore, we have got to find out where these buyers are, when they buy, how they buy, what they buy, and from whom they buy. As a general rule, these data can be readily produced by marketing and media experts, but frequently comprehensive supplemental market research is necessary to provide facts essential to the shaping of sound sales policies and marketing objectives.

Advertising agencies maintain highly skilled research staffs which constantly probe all strata of consumers to determine quantitative and qualitative indices of taste, preference, and opinion. These provide a base for fairly reliable advance estimates of public response to a given merchandising activity. Today, practically all

large manufacturers engage in extensive market research to build their production and sales forecasting on a solid foundation. The methods followed are far from infallible but they reduce susceptibility to error and pay off handsomely as investment insurance.

Therefore, Step No. 1 in the development of a sound advertising and merchandising program is market research.

At every stage of life the individual is exposed to publications, radio programs, and other advertising media, edited to appeal to the interest fostered by his particular situation, occupation, and environment. As a youngster whose main quest is thrill and adventure, he reads comic books and listens to the Jack Armstrong and Captain Midnight programs.

As the individual progresses his interests broaden. This broadening takes place along certain well-defined patterns which characterize our native customs and culture. Wherever these patterns are sufficiently pronounced to become common denominators, there will be found specialized publications catering to the interests of these common groups. For instance: radio engineers keep informed about the developments of the radio industry by reading their particular trade publications. Therefore, these publications represent channels which may be used effectually for advertising the various classes and types of equipment which they buy or use in following their vocation.

On the other hand, there are many interests which radio engineers hold in common with all other people. They eat, drink, sleep, rear families, vote, build homes, drive cars, and want to be entertained. They worry about their health, their jobs, their taxes—just like the person next door. These universal interests provide the basis for the editorial appeal used in general magazines such as the great weeklies, *Life*, *Saturday Evening Post*, *Collier's*, and in the top-flight radio programs like the variety shows of Jack Benny and Fred Allen. The dramatic presentations of the Lux Radio Theatre and Hollywood Screen Guild, and the sensational newscasters like Walter Winchell. All of these vehicles are designed to capitalize mass interest—both men and women—young and old—and, therefore, they represent good advertising media for products sold to a mass market.

All of this adds up to the fact that mass-consumed products require mass media, whereas specialized products require specialized media.

Having established by market research the type of people we want to reach to sell a specific kind of product, we are then ready to consider the second phase in the development of an advertising program, which is selection of advertising media.

The main problem in media selection is to buy the right kind of coverage at the lowest effective cost. This requires keen analysis of rates, circulation, readership, and mer-

chandising influence, to the point where it is possible to weigh the value of each available medium in relation to the task. The agency media man might properly be described as a rate-and-cost engineer. He applies every conceivable yardstick in comparing one buy against another. At times his findings may seem inconsistent, but in the long run he is usually proved right.

There are four broad classifications of media which cover all kinds of advertising:

1. *Media which reach all kinds of people in all kinds of places.* Network radio using a broad appeal variety show, such as the Jack Benny program, is a good example. Here there is nation-wide coverage reaching men, women and children, without regard to income, occupation, age, marital status, or other selective factors.

2. *Media reaching particular kinds of people in all kinds of places.* A good example of this class would be the *National Geographic Magazine* which distributes its million circulation nationally to readers who are somewhat above average in income, education, home ownership, and other selective factors.

3. *Media which reach all kinds of people in particular places.* This would be the daily newspaper read by nearly everyone within the confines of its market with little qualitative selectivity, but with definite geographic selectivity.

4. *Media reaching particular kinds of people in particular businesses, vocations, cultural, or racial groups.* This would include practically all trade, technical, and scientific publications, as well as those of the most highly selective appeal in terms of race, language, religion, etc.

Once the marketing and media people have established the broad picture of the audience it is desired to reach, the next step is to isolate and evaluate all the media available for this purpose.

Let us suppose the particular problem at hand involves developing an advertising program on television receivers. Market surveys show that television sets are purchased in substantial volume, even at today's prices, by all except the very lowest income groups. They are bought by the tavern keeper, the doctor, the lawyer, the merchant, the clerk, and the mechanic. In other words, the television market is a mass market which must be reached by mass advertising media.

We also know that television receivers can be sold only in those areas which enjoy television broadcasting service. This means that media must be employed which reach all kinds of people in the particular places that have television stations. At present there are some thirty areas in this group. In these areas less than half the total United States families are located. And since magazine circulation follows population distribution very closely, it is found that magazines place less than half their circulation in these same markets. Under the circumstances, it

* Decimal classification: R740. Original manuscript received by the Institute, December 27, 1949. Marketing Symposium presented, 1949 National IRE Convention, New York, N. Y., March 10, 1949.

† Maxon, Inc., New York, N. Y.

would be inadvisable to allocate a large part of the appropriation for magazine advertising because more than half the circulation would go into markets where television receivers were not available for purchase.

But it must not be forgotten that new stations are being built all the time, and perhaps in 1950 television service will be available to a majority of United States families. In other words, television is rapidly moving toward the status of a national market. Therefore, some usage of magazines might be justified on the basis that even the outside circulation would eventually pay off in sales. In any event, magazines would be secondary in importance to newspapers supplemented by local radio, outdoor posting, and possibly other mass local media.

The choice of particular newspapers would depend on comparisons of rates, circulation, and merchandising influence to establish the best buys for money to be spent. Size and frequency of insertions would be influenced by an analysis of competitive practices, as well as consultations with distributors and dealers to determine the best timing for the advertisements.

With the budgets, schedules, and general program set, we can now proceed with the development of specific advertisements.

The ads are first made in layout form with accompanying typewritten text. Layouts and copy must be cleared sufficiently in advance to allow time for manufacturing the electrotypes or mats which are provided to the newspapers. Bearing in mind that the advertisements must be submitted, not only to the client's advertising department, but through engineering, legal, and patent departments also, it is understandable that a considerable amount of lead time is necessary in preparing advertisements for publication. Even after the design and copy for the advertisement are approved, art work must be prepared, copy must be set in type, and engravings must be made. About six weeks of lead time is required on newspaper advertising. If it is necessary to have advance proofs in the dealers' hands before publication date, even six weeks would not be enough.

On magazine advertising, approximately four months of lead time is needed for a color advertisement. This seems like a lot until this time is broken into components. Remember, magazines cannot be printed in a matter of hours, as are newspapers. Some weekly magazines go to press two to three weeks before publication date. Plates for 4-color advertisements must be turned over to the magazine eight weeks ahead of publication. It takes four weeks to manufacture these plates, and another three weeks to procure art and type. That totals up to fifteen weeks, leaving little more than ten days for handling clearances and corrections.

On black-and-white magazine advertising, the deadlines are shorter and less time is required for art and production, but even so, from ten to twelve weeks of lead time is necessary. Even on trade advertisements, the client's copy must be finally okayed about six weeks in advance of publication to insure appearance.

In the radio and television receiver busi-

ness, these advance dates present particularly serious problems. Product lines are in a constant state of change with new models being introduced and old models being closed out. No one would want to rise or fall by his ability to predict day in and day out what marketing conditions would have to be met four months hence. Yet, that is exactly what advertising and marketing people must do, and they must do it successfully if their advertising campaigns are to be successful.

The planning of the advertising manager is entirely dependent upon the performance of the engineering and manufacturing departments. He must commit himself in advance to be sure that his announcement of a new product coincides with its introduction. If he tries to play safe, some rival may beat him to the punch. If he jumps the gun and the factory fails to deliver, dealers complain about money being wasted by advertising a product they do not have.

So far in this discussion we have considered what may be called the mechanical or mathematical areas of advertising. We have looked at the market in terms of statistics. We have outlined how media are evaluated. We have traced some advertisement production procedures to show the effect they have on time schedules. But of even greater importance is the concept of the advertising itself. In other words, what message is put in the space or time that has been purchased. The skill with which this message is formulated and dramatized for presentation will determine how well the advertisement is read—how successfully the reader is impressed. If Advertiser A can devise his messages so they attract twice as many readers per page as Advertiser B, he is accomplishing double the result for the same money.

There is no magic formula whereby the efficiency of an advertisement can be calculated in advance. In this respect, the placement of an advertisement is like learning to swim—one has to get wet to find whether his concept will really work. The best advertising is usually a blend of experience and experimentation. Experience teaches the advertising man never to forget that markets are people and that people behave like human beings. They respond with startling regularity to certain basic appeals—economy, comfort, convenience, security, pride, affection, recognition—to name but a few of the most potent. When such appeals are tellingly related to product advantages, and supported by facts proving superiority over competitive products, the advertising will usually do a good job.

If the basic appeals have been carefully chosen and the facts painstakingly assembled, the message can remain fundamentally the same as long as the product and the economic conditions under which it is sold remain the same. By a process of experimentation, more effectual ways can be found to dramatize the message, make it more understandable, or give it a feeling of timeliness and freshness that will enhance its appeal. Change for the sake of change, however, frequently results in the substitution of weak appeals for those with established selling power.

The advertising man has available to him certain yardsticks for measuring the relative efficiency of advertisements after they have appeared. First, of course, is the cash register, beyond which nothing else should be needed! Unfortunately, not all businesses are in position to measure directly advertising results against sales performance. Accordingly, synthetic yardsticks have been devised. Among these are the Starch Advertisement Rating Service and the Hooper Radio Reports. The Starch Service checks the observation and readership of consumer magazine advertising. It reports the percentage of magazine readers who see a specific ad and read various parts of the copy. The Hooper Report gives the percentage of radio listeners who tune in a particular program, and also those who are able to identify the sponsor. Both of these services are valuable in pointing out the approximate size of the audience actually reached as compared to the circulation that has been bought. Neither has any positive relationship to sales performance. So both must be interpreted with this fact constantly in mind.

Another popular way to measure the response of an advertising campaign is through coupon return. Different test advertisements containing an identical coupon offer can be used not only to check the power of different appeals, but the relative value of different media.

At one time or another, most big advertisers use all of these methods for checking the performance of their advertisements. In addition, periodic consumer studies are made to chart the course of preference for the advertiser's brand.

This does not mean that all advertising is prepared and executed in a sound, systematic, organized way. Nothing could be further from the truth. Most advertising is actually produced too hurriedly, and under such great pressure that there is simply not time to take advantage of all the safeguards available. Nor should we look forward with any joy to a day that might permit of such Utopian operation. For it could come only in a planned world—a world in which the statistic would be the master, not the servant of man—a world without the very competition that serves as the greatest spur to the progress of our fast-moving industrial machine.

What has been said above about publication advertising applies, in a general way, to sales literature and sales promotion, all of which requires sound planning, careful execution, and comprehensive performance-checking to achieve its maximum productivity. These results can only be realized by thorough organization within each company, supported by equally thorough organization on the part of its advertising agency and its suppliers. The margin by which an advertiser can get ahead of his job determines the amount of time he can devote to product design research, marketing research, and creative planning for the future. The same thought applies to the advertising agency. They can do a better job for the company if the company will permit them to get far enough ahead on their production work to avoid chronic "deadline jitters."

A Crystal Amplifier with High Input Impedance*

OTMAR M. STUETZER†, ASSOCIATE, IRE

Summary—Experiments with a device similar to the Bell Transistor, but with a high input impedance, are reported. In the present stage of development it appears useful as an impedance transducer with an appreciable current and power gain at lower frequencies.

I. INTRODUCTION

THE TRANSDUCER to be reported on consists of a point- or line-type metal-to-semiconductor contact, in the neighborhood of which a high electric field can be applied between an additional electrode and the crystal surface. This can be made to control to a certain extent a current flowing through the rectifying contact. The underlying mechanism is closely related to the modulation of conductance observed by Shockley.¹ The device was termed a "fieldistor" in the laboratory.²

Fig. 1 shows a suitable electrode system, held to-

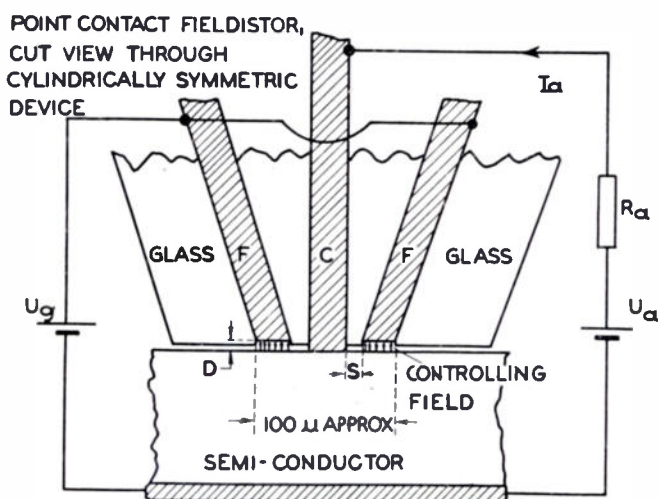

Fig. 1—Schematic diagram of point-contact-type fieldistor.

gether by a glass spacer and pressed by a spring arrangement (not shown) against a ground semiconductor surface. A voltage U_a causes a current I_a through the contact center wire C into the semiconductor. A voltage U_g between bases and surrounding control electrodes F , separated from the surface by a distance D , generates an electric field as indicated and so induces surface charges on the semiconductor. To obtain necessary field strengths of the order of 10^4 volts per centimeter with a small controlling voltage U_g , D has to be very small—in

* Decimal classification: R362.1×R363. Original manuscript received by the Institute, May 5, 1950.

† Components and Systems Laboratory, Air Matériel Command, Dayton, Ohio.

¹ W. Shockley and G. L. Pearson, "Modulation of conductors of thin films of semi-conductors by surface charges," *Phys. Rev.*, vol. 74, p. 232; July, 1948.

² O. M. Stuetzer, "Experiments for controlling the current flow through a metal semi-conductor contact," presented, IRE Conference on Electronic Devices, Princeton, N. J., June 2, 1949.

the order of 10^{-4} cm. The electrode wire diameters used varied between 5 and 30 microns. The technique of manufacturing such electrode systems is described in a separate paper.³

A line-contact-type combination is sketched in Fig. 2.

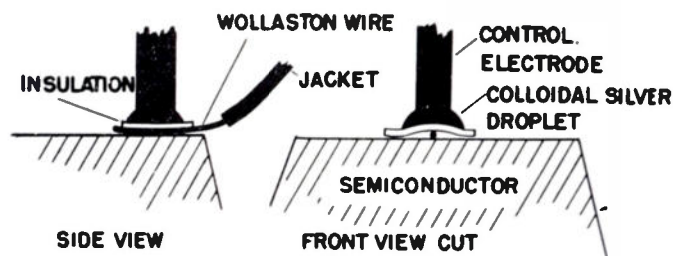

Fig. 2—Line-contact fieldistor arrangement.

A (wollastone) platinum wire of $2\frac{1}{2}$ microns diameter is pressed against the crystal by a metal rod, with a 10- to 30-micron strip of insulating material inserted. A droplet of colloidal silver may insure metal conductivity along the upper surface of the insulator, which is to be connected to the controlling potential U_g .

Fig. 3 shows experimental models of the device mounted on conventional tube bases.

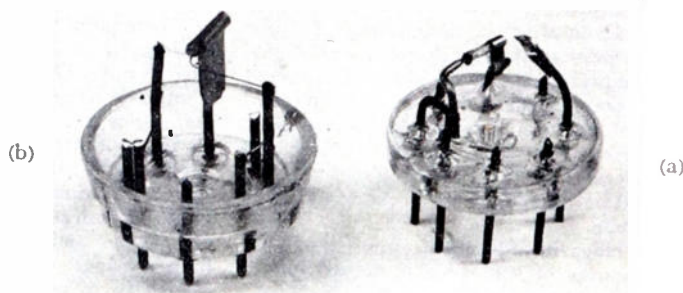

Fig. 3—Experimental fieldistor models, mounted on standard octal tube bases. (a) Spacer-type fieldistor. (b) Line-contact type, wax sealed.

The transducer obtained in such or similar ways resembles a vacuum triode; a field controls current flow. For convenience in circuit applications we may call I_a the "anode current," U_g the "grid bias," and ascribe as a performance figure the transconductance $\partial I_a / \partial U_g$.

With variation of semiconductor material, surface treatment, aging processes, and electrode dimensions, a number of effects are obtained. We will limit ourselves to discussion of a series of experiments where the reproducibility was satisfactory, because the material

³ O. M. Stuetzer, "Microspacer electrode technique," *PROC. I.R.E.*, pp. 871-876, this issue.

used, so-called "high back voltage" germanium, was fairly uniform.

II. EXPERIMENTS WITH GERMANIUM

A. Manufacturing Process

50-point-contact and 50-line-contact type transducers were built with germanium pellets taken from 1N34 or 1N38 Sylvania rectifiers. Their surfaces were cleaned with acetone and alcohol. After assembly, the units were connected to an U_a - I_a plotter and a wobbled "grid" voltage U_g was applied. The contact was moved until the characteristic plot showed a marked influence of the control voltage (see Fig. 4).

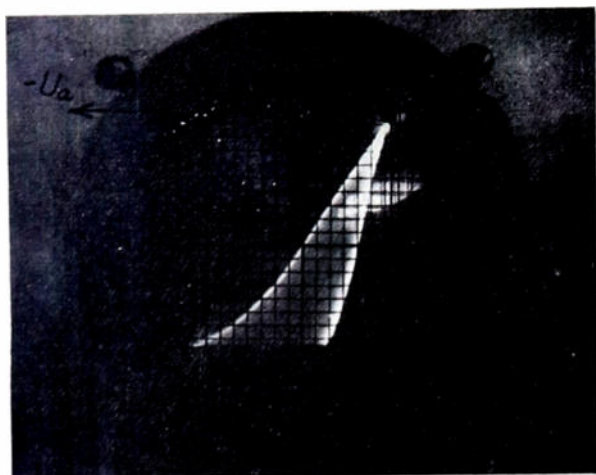

Fig. 4— I_a - U_a characteristic of a line-type fieldistor. (10,000 cps saw-tooth current through contact, 25 volts, 60 cps and adequate dc bias on control electrode.)

About 20 per cent of the samples could be made so as to work immediately. Their mutual conductance was increased by half an order of magnitude when (water-free) transformer oil was brought between the control electrodes and the crystal. Ten per cent more of the units could be made to show the effect after oil application. The input resistance of the samples described was generally higher than 100 megohms, which is due to leakage.

Almost all of the remaining 70 per cent of the crystals could be made to work by insertion of a suitable organic liquid of high resistivity, for example, amylacetate. At first this gave a marked conductivity due to high field strengths, but after some hours of "surface treatment" by passing current through the control electrode system, most of the liquid had disappeared, except probably a surface layer. If the dc input impedance of the units was higher than 10 megohms, these "wet" fieldistors were considered acceptable.

The transducers obtained this way were sealed with wax or Dekhotinsky cement and aged for 10 hours by passing a comparatively large current through the contact.

B. Direct-Current Measurements

About one third of the amplifiers obtained in the manner described above showed an increase in collector current I_a , both with high positive and negative control voltages U_g . A representative example of an I_a - U_g characteristic is plotted in Fig. 5. It is believed that a

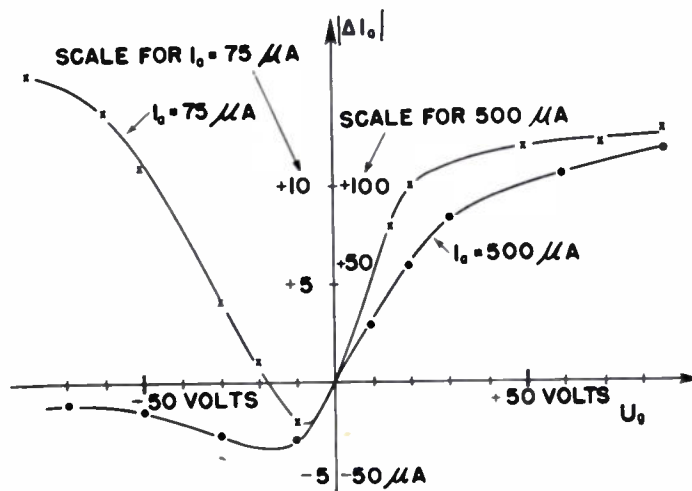

Fig. 5—Change in plate current ΔI_a versus bias U_g .

large part of the other two thirds would show the same effect if the field strengths could be made high enough. For fear of breakdown, this was not attempted.

Especially with the "wet" fieldistor type, the negative bias slope is in almost all cases markedly preferred. Fig. 6 shows an I_a - U_a characteristic plot of a sample con-

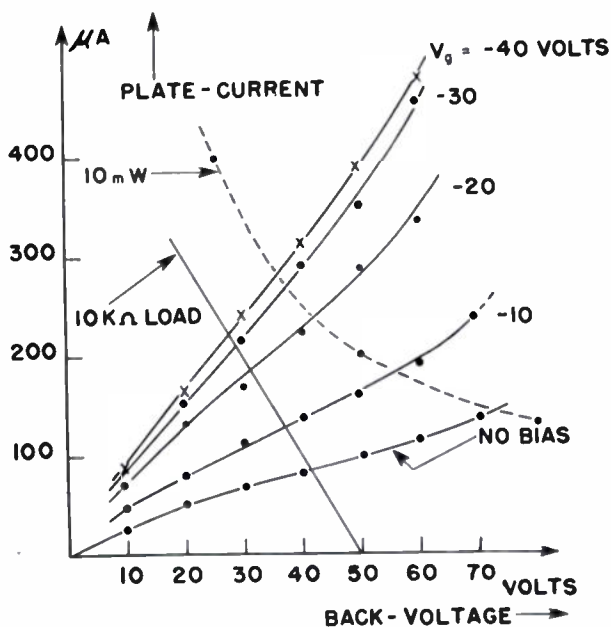

Fig. 6—Typical fieldistor characteristic. (Load line represents 100 K ohms, not 10, as shown.)

sidered good; its input impedance was above 100 megohms on dry days. Curves for positive bias are not shown.

The influence of the position of the contact and the surface treatment are so dominant that the precise in-

fluence of electrode dimensions (for instance, S and D in Fig. 1) could not be determined; in general, the transconductance is higher, the smaller D is; "dry" fieldistors require S below 50 microns. Direct-current transconductances between 2 and 20 micromhos can be reproduced and will stay rather stable over long periods with about 90 per cent of the devices; five early samples have maintained their ratings within 20 per cent for over a year. Mutual conductances up to 200 micromhos were obtained occasionally.

C. Alternating-Current Response

Fig. 7 shows some representative frequency characteristics. The liquid-treated type is especially suited for operation at lower frequencies. Occasionally the converse effect was observed. If the usual negative bias amplification region (see Fig. 4) has a positive counterpart, this, in general, shows the better frequency response.

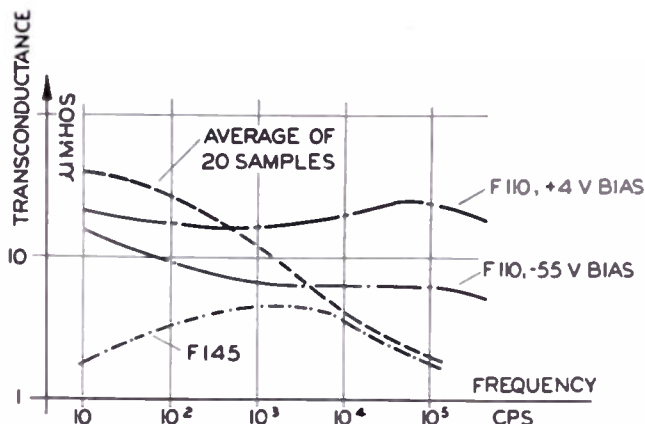

Fig. 7—Frequency characteristics of representative samples of fieldistors.

As is to be expected from the dc characteristic of Fig. 5, a positive pulse on the grid will appear as a positive or a negative pulse on the load R_a , depending on the polarity of the bias applied. In conformity with the measured frequency characteristics, the pulse rise times vary from below 1 microsecond to 50 microseconds.

D. Amplification

For direct-current the idealized fieldistor should have an infinite current amplification; due to unavoidable leakage, amplification of only 10,000 to 100,000 times can be reached. Its voltage amplification, as can be seen from the measured transconductances in combination with an input impedance from 10,000 to 50,000 ohms, is at best around unity. Therefore the described models have to be considered impedance transducers, rather than amplifiers. For alternating current, an input capacitance of around $3 \mu\mu\text{f}$ for the spacer type and $1 \mu\mu\text{f}$ for the line type, and a grid-plate capacitance of $3 \mu\mu\text{f}$ should be taken into account.

E. Modulation Experiments

If the plate voltage U_a is superimposed with almost as large an ac component, the transconductance with re-

spect to this component is in many cases several times larger than the dc value.

F. Noise

As is to be expected, the noise properties of the device are about the same as those of the transistor, which uses the same collector.

With good samples about a 0.1-volt signal is necessary to produce an output voltage equal to noise at 1,000 cps. With increasing plate current a value can be found above which noise increases faster than the mutual conductance.

III. THEORETICAL CONSIDERATIONS

The reported experiment and a great many others show that the nature of the underlying effect is rather complex. Qualitatively the results may be partially explained with the present idealized concept of a rectifying barrier.^{4,5}

For our germanium example, a positive space-charge layer is present on the surface of the semiconductor, bulging out to a depth of about 10^{-4} cm underneath the negatively charged collector contact (see Fig. 8). Conduction in the lower and middle part of it is effected by free electrons. On the surface, hole conduction may be present, due either to mass-action-law equilibrium requirements or to surface impurity acceptors.

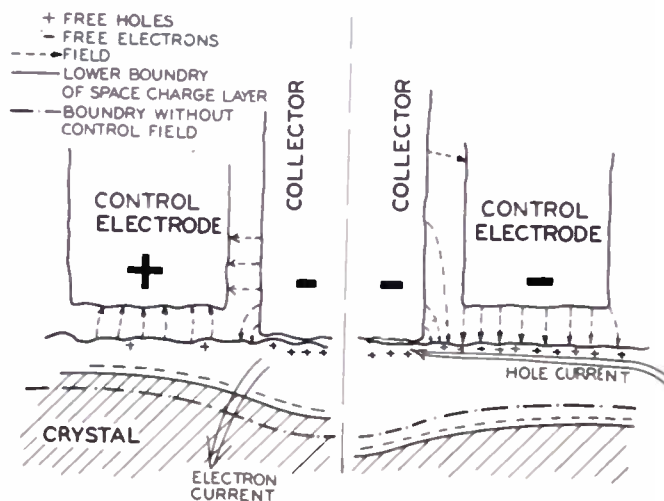

Fig. 8—Assumed electronic configuration for positive and for negative control bias. (Arrows indicate negative field direction.)

Let us apply a sufficiently high positive voltage to our control electrode. As Shockley⁴ pointed out, the induced negative surface charge will decrease the depth of our space-charge layer, thus decreasing the impedance along the indicated current path (see Fig. 8, left).

⁴ W. Shockley, "Zur Halbleitertheorie der Sperrschicht, und Spitzengleichrichter," *Zeit. für Phys.*, vol. 113, pp. 367-414; May, 1939.

⁵ J. Bardeen and W. Brattain, "The physical principles involved in transistor action," *Phys. Rev.*, vol. 75, pp. 1208-1225; April, 1949.

An applied negative potential may increase the barrier depth so far that hole conduction along the surface becomes dominant, and thus the impedance decreases again. (See Fig. 8, right.)

Depending on the original depth of the barrier layer, the presumed change from internal to surface conduction may take place at very different applied control fields, as is observed.

Liquid (and solid) dielectrics in the space between control electrodes and crystal increase the induced surface charge in proportion to the dielectric constant; with a number of materials, as oil, the mutual conductance increases roughly at the same rate. Other liquids have a more pronounced effect, even in a very thin layer on the surface. This might be compared to the lowering of the work function as is known for a thorium-ion layer on the surface of tungsten; if, for example, a standard high back-voltage rectifier is sprayed with a thin mist of almost nonconducting butyl acetate, its impedance decreases almost immediately by an appreciable order of magnitude. If the polarized liquid ions effecting such a change are made to alter their orientation under the influence of an outside electric field, controlling effects might be obtained. The "lyoelectric" potential concept is more fully discussed in the literature.^{6,7}

⁶ W. Freundlich, "Kapillarchemie," vol. 1, p. 395; 1930.

⁷ N. K. Adam, "The Physics and Chemistry of Surfaces," Oxford University Press, New York, N. Y.; 1941.

This idealized picture neglects temperature effects, mechanical forces due to high field strengths which might modulate the contact pressure, migration of impurities near the surface due to electrolytic processes, and many of the finer details connected with our weak concept of "surface" and "contact."

The experiments reported permit some retrospective remarks on high back-voltage rectifying contacts: the electrostatic field associated with the contact electrode proper (as indicated in Fig. 8) may be thought of as a controlling field, tending to decrease the impedance of the device at high back voltages.

IV. CONCLUSION

The manner in which crystal amplifiers with high input impedance can be built has been described. High current amplifications and voltage amplifications around unity were achieved. An audio oscillator, an audio amplifier, and a dc relay amplifier were built. With the figures of mutual conductance that are presently obtainable, however, the device should rather be classified as an impedance transducer. It can also be used to change the polarity of a pulse by means of a variable bias.

ACKNOWLEDGMENT

Thanks are due to W. P. Schulz. Without his mechanical skill, the work could not have been performed.

Microspacer Electrode Technique*

OTMAR M. STUETZER†, ASSOCIATE, IRE

Summary—A novel technique for obtaining stable and extremely small spacings is reported. Though of possible general usefulness, it is elaborated on from the standpoint of electronics only. Its essential feature is the use of insulating spacers of glass, quartz, or plastic, drawn down from convenient size to microscopic dimensions and combined with metal or semiconductor electrodes.

To illustrate some applications, the use of the technique in experimental work is described.

I. DRAWING OF SPACERS

CYLINDRICAL PIECES of material of a certain plasticity can be "drawn down": their cross section can be permanently reduced with a corresponding gain in length by applying longitudinal (and sometimes radial) forces. This process is being widely used for cross sections of complete axial symmetry, i.e., for rods and tubes of circular cross sections.

* Decimal classification: R331 X R281.1. Original manuscript received by the Institute, May 3, 1950.

† Components and Systems Laboratory, Air Matériel Command, Dayton, Ohio.

The technique to be described makes use of the experimental fact that for many materials a degree of plasticity exists whereby very complex cross sections can be drawn, the geometry remaining surprisingly unchanged. The law of similitude will be very closely fulfilled within a certain range of plasticity. The closer the geometry of the cross section approaches circular symmetry, the wider will be the range of viscosity that may be employed. In addition, there must be a certain balance of filled and empty parts of the geometry.

These rather general statements will be illustrated and explained with a few examples.

Hard and soft glass are very well suited for the drawing-down process. So, for example, "spacers" as represented in Fig. 1 were obtained in the following way: The cross-section geometries in question were first composed of standard glass tubing of about 3-mm outside diameter and 50-mm length, with the single tubes held in place by being pressed or sealed to a larger surround-

ing tube or to each other, according to geometry. The center part of the configuration was heated with a torch for about 20-mm length, taken out of the flame, and then drawn down fast by axial pull to about a 4-foot length. A reduction in diameter d_1 to d_0 (compare Fig. 5) of about 1 to 20 was used.

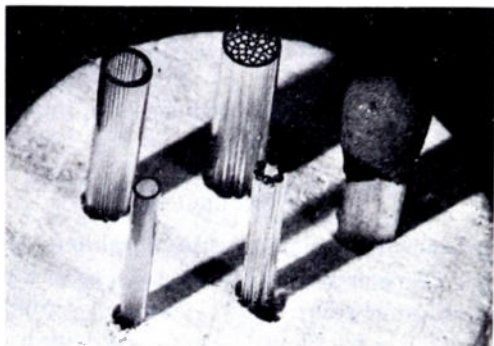

Fig. 1—Glass microspacers with matchhead.

The spacers of Fig. 1 were cut (not ground) out of the drawn-down configurations. Fig. 2 shows a top view of spacers in the plane of cutting, by which the accuracy of the drawing process may be judged roughly.

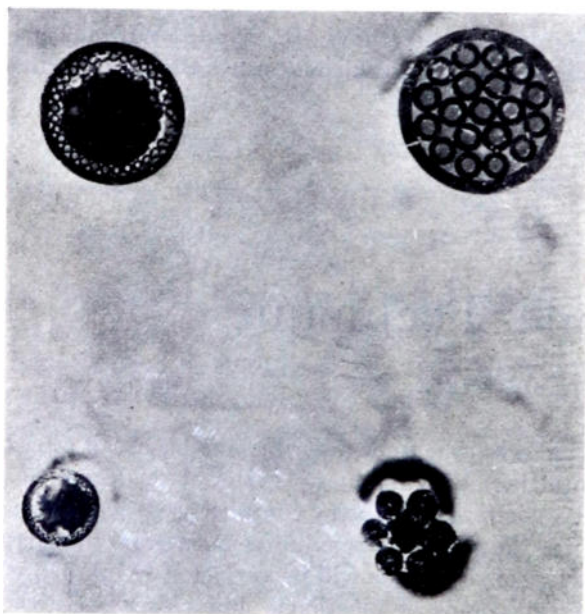

Fig. 2—Top view of Fig. 1.

Measurements show that the law of similitude is not exactly fulfilled between the original composition and the drawn-down spacer, but that only the configuration of holes and filled spaces stays similar. This means that round holes stay round over a wide range of viscosity, i.e., temperature.

The ratio r = (wall thickness of tube elements) to (diameter of the tube elements), however, changes somewhat, in all cases in favor of the wall thickness. Depending on temperature and on the original ratio, changes in r from 5 to 25 per cent were observed. But, if the tem-

perature of drawing is kept constant, this ratio will stay constant within 5 per cent for consecutive samples of the same geometry with diameter reduction ratios between 15 and 25. Therefore the reproducibility of spacer geometries is satisfactory. (The main difficulty is to select the original tubing within a few per cent tolerance.)

The noncritical drawing temperature for all kinds of glass is closer to the "softening point" than the "working point" mentioned in Corning specifications. A skilled glassblower will "feel" the right plasticity after some practice, so oven heating is not necessary unless great precision is desired. It is felt that surface forces due to surface cooling during the drawing process are somewhat responsible for the ease and simplicity of operation.

With quartz (or "vycor"), with its higher viscosity and heat conductivity, temperature tolerances are much narrower. It is imperative that the element tubes be fused together before drawing. A sufficiently large torch has to be used to heat a piece at least twice the diameter of the original composition. Care must be taken to insure thorough, uniform heating. The optimum drawing temperature seems to be approximately midway between the softening and working points. Inaccuracies of the composition, which stay proportional in glass, tend to increase in quartz. In spite of that, tolerances of reproduction of 5 per cent can be reached with hand operation. Fig. 3 shows some cross sections used for experiments, together with some glass spacers.

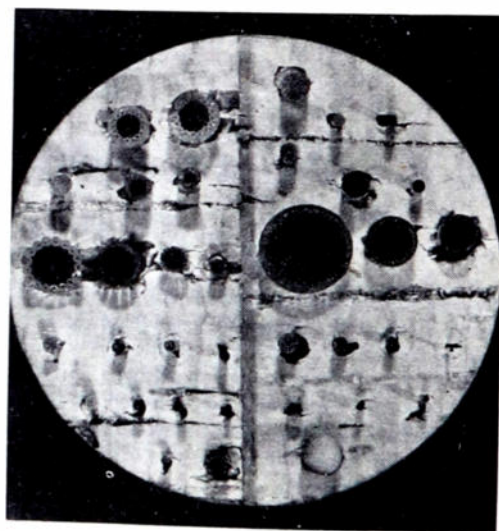

Fig. 3—(Right) glass spacers and (left) quartz spacers on cork base. Lower right matchhead for convenience.

Plastic (polystyrene, plexiglass) also lends itself to the technique of drawing down, if adequately softened by heat or chemicals. The original compositions can be cast, molded, drilled, or punched. With proper care, square or rectangular cross sections of inside holes or outside boundaries can be used. Fig. 4 shows an example. The tolerances obtainable with polystyrene seem to be much the same as with glass, but this observation was based on experience only with specimens where the holes

constituted a comparatively small part of the otherwise solid cross section. So-called "high-temperature polystyrene" is not suited to the technique.

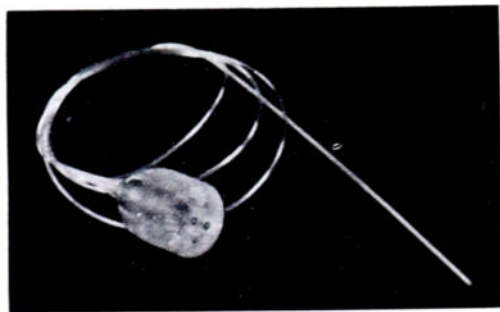

Fig. 4—7-hole polystyrene sonde, drawn down from $\frac{1}{8}$ -inch piece.

The tolerances discussed so far have concerned only the radial cross section of the spacer. In the axial direction (see Fig. 5), where there is a smooth transition from the original geometry to the smallest diameter, we can, within certain tolerances, define the following sections: a "straight" part *C*, bound on both sides by "conical" sections *B*, from which funnel-shaped transitions lead

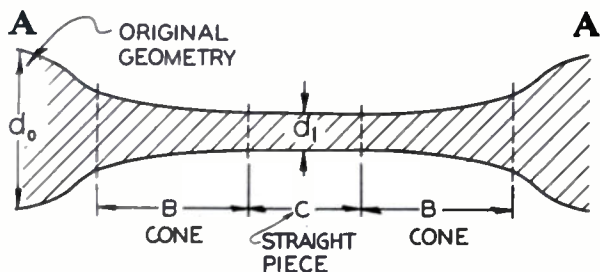

Fig. 5—Axial view of drawn-down geometry (scale distorted).

to the original dimension *A*. With the glass-spacer samples mentioned above made by hand, *C* could be obtained 2 feet long with a $2\frac{1}{2}$ per cent tolerance in d_1 , *B* being around 1 foot with a pitch of below $1/200$. The ratio d_0 to d_1 used was about 15. Experiments indicate that with machine operations these figures can be surpassed. With plastic (polystyrene, plexiglass) more favorable figures were obtained, *C/B* being 10 with about the same tolerance.

II. SPACER-ELECTRODE COMBINATIONS

For use in electronics, metal or semiconductor electrodes have to be attached to the spacers. The techniques to be recommended vary vastly with the purpose.

Of course wires can be passed through the spacer holes; as it is easy to obtain almost perfectly round holes, wires up to 95 per cent of the hole diameter can be inserted. The funnel-shaped transition part (see Fig. 5) helps appreciably in inserting wires into the conical part *B* and through it into the straight part *C* of a whole drawn combination. Part *C* can then be cut into small spacers and the necessary additional wire can be passed through the holes and cut separately into suitable

lengths. Fig. 6 shows a quartz-tungsten cage-grid arrangement obtained this way; from one drawn piece and with one insertion operation about 20 such "grids"

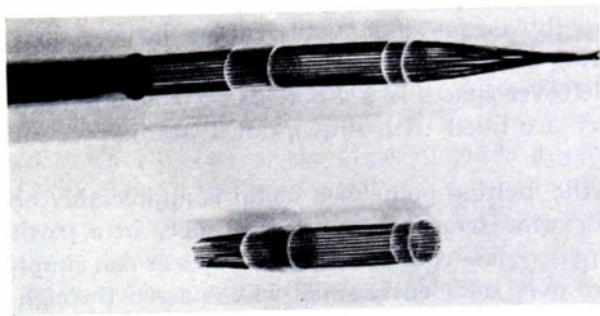

Fig. 6—Tungsten-quartz cage-grid combination, real diameter, 1.2 mm.

can be made by consecutively cutting and following the wire. (See the upper part of Fig. 6, which is a cut-out of such an operation.)

Depending upon application, the wires can be fastened to the insulator by twisting, by cement, in the case of plastic by wetting with a solvent for the plastic, and in the case of glass by sealing. The latter can be made vacuum-tight with suitably chosen materials; the wires have to be degassed beforehand.

In the grid arrangement of Fig. 6, the *W* wires are sealed to one side of the spacer by making the quartz settle down by means of a small spot torch.

With quartz and glass, suitable metal or semiconductor material can be drawn down together with the spacer. The melting point of the electrode material has to be at least 30°C below the drawing temperature of the glass; careful degassing is necessary. A good match of the coefficients of expansion (for instance, quartz and invar) is helpful, but not necessary. Those holes of the original geometry, which later on shall contain the

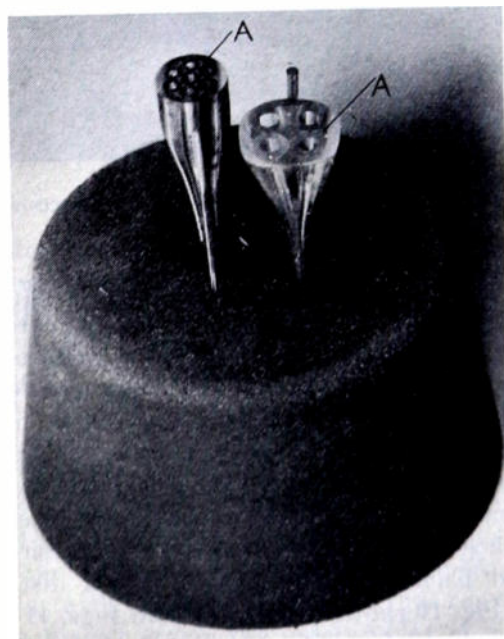

Fig. 7—Pyrex spacers with antimony (A) codrawn electrodes.

electrode, have to be filled with the respective metal or semiconductor which should first be melted to a pellet in the center of the drawing piece. It is advantageous to connect both sides of the combination to a vacuum pump (by means of movable rubber hoses); then the drawing can be done as usual. For example, in Fig. 7, the leftover spaces in a 4-hole and a 7-hole pyrex glass spacer are filled with drawn-down antimony "shield" electrodes.

If the melting point of a metal is appreciably above the drawing temperature (for instance, in a platinum and pyrex-glass combination), the spacer can simply be drawn over sufficiently small wires passed through the original configuration. The surface forces of the spacer material will take care of keeping the small wires very close to the place where, without wires, a longitudinal hole would have originated. Examples are described below.

III. EXTREMELY SMALL SPACINGS

To obtain extremely small *radial* spacings (i.e., spacings perpendicular to electrodes), the following method illustrated by a representative example proved convenient.

By two consecutive drawing processes, as described, a spacer of about 1-mm outside diameter is manufactured, containing a center hole and one or more concentric systems of surrounding holes. (See Fig. 8.) Tungsten or platinum wires, which are most easily obtainable, of 5- to 25-microns outside diameter are filed through these holes, which are very wide for such wires. Then the



Fig. 8 Basic workpiece for "fieldistor" microspacer with match head for comparison.

combination is drawn down again slightly ($d_1:d_0 \approx \frac{1}{2}$) and at the same time is twisted approximately one turn. Fig. 9 indicates the operation; 2 wires only are shown and a rotation through 270° is represented. The wires come together very closely and can be made to touch if the glass is soft enough. Contact, if desired at all, can be indicated by a number of ohmmeters.

The spacer is then cut, as indicated, at a place where the distance between wires is smaller than desired, and is ground back until the desired lateral distance is reached. Fig. 10 shows a side view and Figs. 11 and 12 show top views of a cut and ground spacer with one center wire and 6 and 18 surrounding ones, respectively.

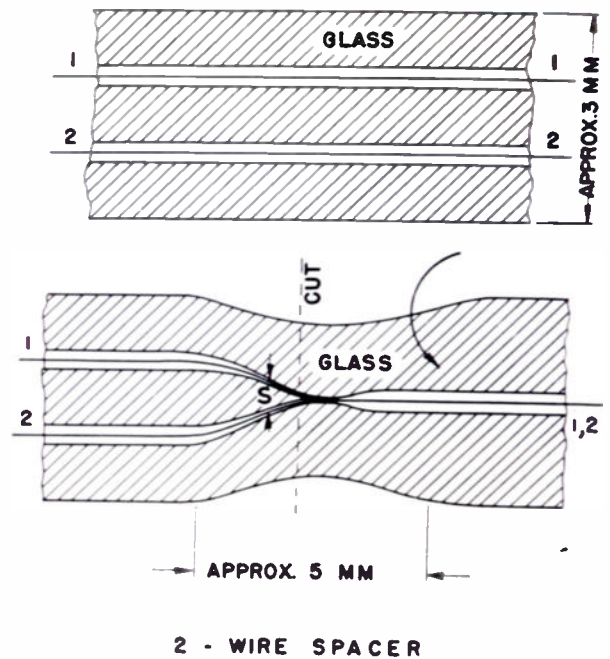

Fig. 9—Manufacturing of extremely small radial distances.

Lateral distances s between 2 and 100 microns can be obtained with an accuracy of 5 to 30 per cent, depending on s . Spacings of the order of the wavelength of visible light (0.5 micron) were reached and measured electrically, but could not, of course, be photographed.

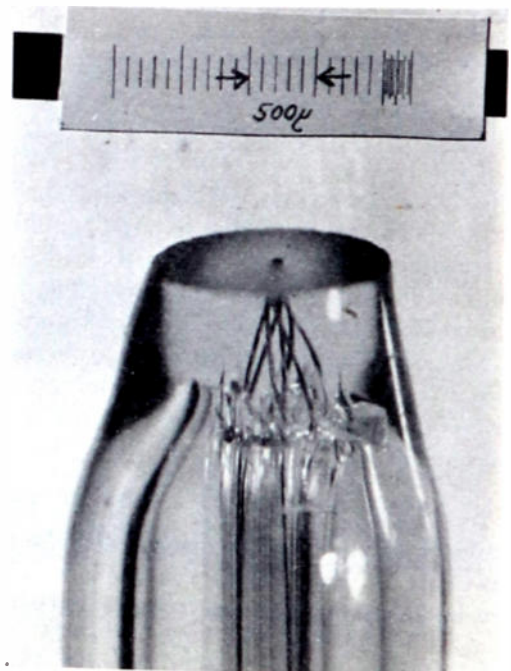

Fig. 10—7-electrode microspacer.

Extremely small *axial* spacings are most easily obtained by allowing the ends of the electrodes either to protrude above or remain below the ground surface. Let us consider a spacer, manufactured as described above, and ground along a surface perpendicular to the various wires it contains (Fig. 13).

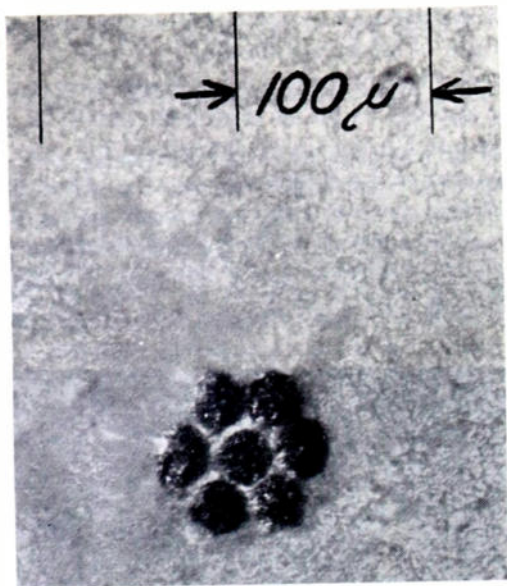

Fig. 11—7-electrode configuration, top view (25μ wires).

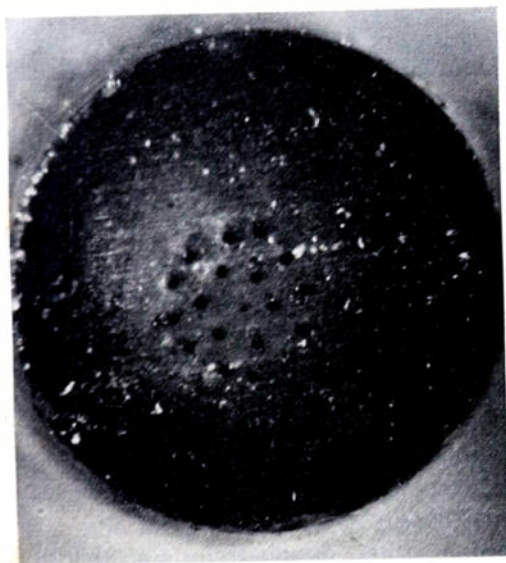

Fig. 12—19-electrode configuration, top view (12μ wires).

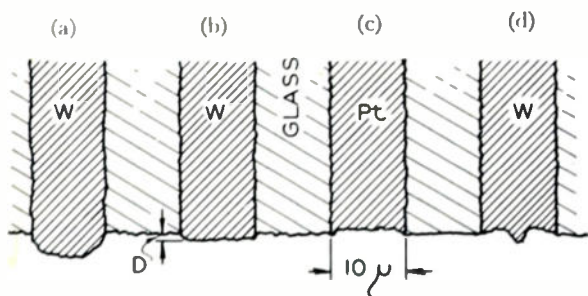

Fig. 13—Shaping of sealed-in wires by grinding and etching.

Since it is harder than glass, a tungsten wire will not be ground down as much as glass, and so will protrude from the surface. If the grinding powder is very rough (2μ), the wire will end in a rounded cap with a height of about 2 to 5 microns. (See Fig. 13(a).) If polishing powder ($\approx 0.1\mu$) is used, an almost flat wire surface will protrude about $\frac{1}{2}$ micron from the glass. (Fig. 13 (b).)

Materials softer than glass will show the converse effect. (See Fig. 13(c).) The tolerances of reproduction for these extremely small distances are about 30 per cent.

If various (positive and negative) distances D are required for electrodes on the same spacer and made of the same material, this can no longer be achieved by grinding. In this case, the ends of those wires which are to be made shorter must be connected to a battery and etched down by electrolysis. (For tungsten a current density of about 1,000 amp per cm^2 is recommended; a convenient electrolyte is 2 per cent $\text{Na}(\text{OH})_2$ in water.) It is even possible to change the shape of the electrode this way; short etching with high voltage in low-concentration electrolytes will produce points on the original wires, as indicated in Fig. 13(d).

In certain cases it is suitable to etch down the glass surface instead of the wires, by immersion in a 30-per cent hydrofluoric-acid solution. A rough glass surface has to be expected from which the wire tips protrude.

IV. EXAMPLES FOR APPLICATION

The following examples for microspacer technique are just a few which were needed for the author's experiments. Combinations and variations will occur to anyone versed in the art.

Fig. 14 shows an experimental *subminiature* power triode of strict coaxial design with anode envelope. With 2 watts heater power and 2 watts plate dissipation, the transconductance is 1,000 micromhos and the amplifica-

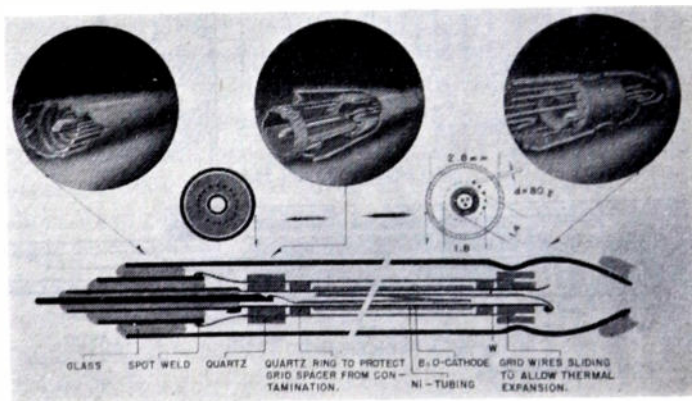

Fig. 14—Subminiature triode.

tion factor is 16. The tube uses quartz spacers similar to those represented in Fig. 6. The ratings were maintained over a life test of 1,000 hours. Fig. 15 shows two experimental models, (a) and (c), and a cut-open model (d) of the tube.

Spacers of suitable sealing glass are handy for subminiature-tube glass bases; an example is visible in Fig. 15(b), a directly heated diode.

Glass-metal spacers, like those in Figs. 10, 11, and 12, are used to advantage in crystal investigations. Experimental multifold rectifiers and transistorlike devices were built with it. One advantage is that contact areas can be achieved practically independent of pressure if a wire tip, like the one represented in Fig. 12(b) (diam-

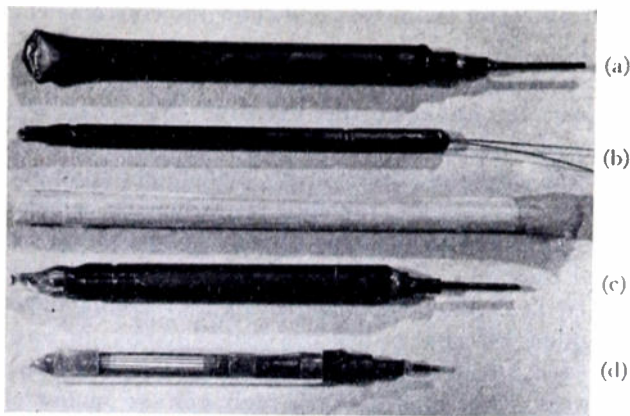

Fig. 15—Subminiature tubes, with match for comparison.

eter about 10μ), is pressed against a ground crystal surface; it cannot be deformed to any extent by high contact pressure.

Extremely small radial and axial spacings are needed to build a crystal transducer like the one sketched in Fig. 16(a). A center wire of about 10 microns diameter is surrounded by six more electrode wires, approximating a circular electrode, and etched back by about 1 micron. A voltage applied between the outside electrodes and a germanium or silicon crystal pressed against the ground glass spacer will produce a relatively

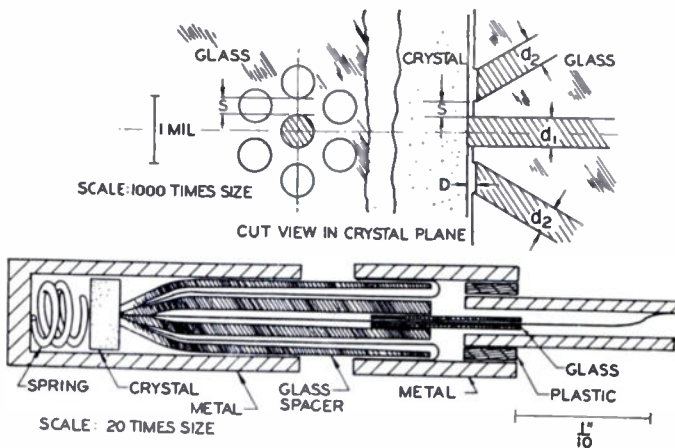

Fig. 16—Crystal transducer, cut view.

high electric field between outside electrodes and crystal. This, in a way not yet completely understood, will influence a current flowing through the high back voltage rectifier contact consisting of the center wire and the crystal. Details will be published separately.¹

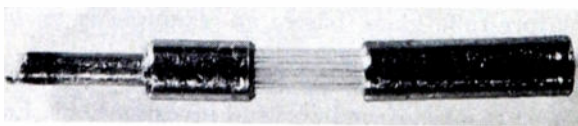

Fig. 17—Subminiature "fieldistor."

¹ O. M. Stuetzer, "A crystal amplifier with high input impedance," *Proc. I.R.E.*, pp. 868-871, this issue.

Fig. 16(b) shows a cut view of the device. Fig. 17 is a photograph of an actual model.

The technique of drawing down also may, with proper care, be applied to plane arrangements; it is, however, generally much easier to start with round cross sections. These can then be flattened out. Fig. 18 shows a ring spacer (lower left) drawn down conventionally. Wires can be fed through its holes by means of the matching transition part (upper left). The arrangement is cut along its axis, and with the cut side up placed into an

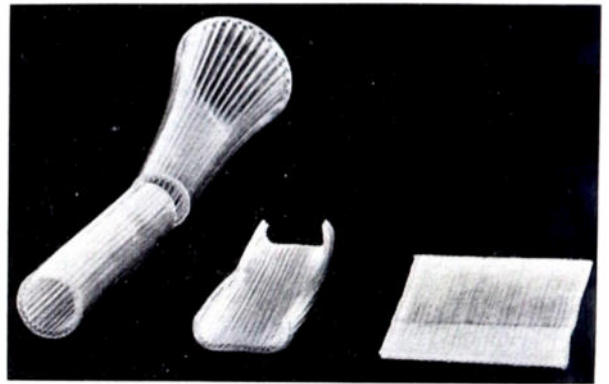

Fig. 18—Manufacturing of flat wire screen.

oven about 50°C warmer than the softening temperature of the material. The heat is applied on the bottom of the piece by placing it on a plane of highly heat-conductive material. The piece straightens itself automatically (center); finally more heat is applied, so that the glass will collapse and seal to the wires (right). By grinding and etching operations, several kinds of useful flat screens can be obtained. Their use for special scanning and storage tubes and for color television (consecutive elementary tubes for different colors) can only be mentioned here.

Promising other applications for thermoelements, semiconductor bolometers, and other devices, where drawn-down semiconductor electrodes are advantageous, shall also be restricted to mere mentioning.

V. CONCLUSIONS

The microspacer technique described above constitutes a simple and, with careful operation, an accurate means of governing small electrode spacings.

It has so far been used for laboratory investigations and for laboratory production in small quantities.

ACKNOWLEDGMENTS

The author is very much indebted to the late C. Ohl, who proved that glass configurations can be made to be more accurate than is generally believed, and who took a very active part in the early development of the technique described. W. P. Schulz has made many valuable contributions to this work, and E. Benz must be mentioned for his unusual skill in glasswork.

Meteor Echo Study of Upper Atmosphere Winds*

L. A. MANNING†, ASSOCIATE, IRE, O. G. VILLARD, JR.†, ASSOCIATE, IRE, AND A. M. PETERSON†

Summary—A method is developed for measuring the velocity of winds in the 90- to 110-kilometer height region of the upper atmosphere. From the Doppler frequency shift imparted to a continuous-wave reflection from a meteoric ionization column, a measure of the wind drift of the trail is found. Statistical analysis enables average wind velocities to be measured to within perhaps 20 per cent, and direction to 20°, in a period of one or two hours. Observations made during the early morning hours in the summer of 1949 show typical average wind velocities to be 125 kilometers per hour, with motions from south-southwest and north the most common. On some occasions, evidence of a nonuniform wind structure is found.

IN RECENT YEARS a steadily increasing interest in the properties of the upper atmosphere has highlighted the need for knowledge of the wind systems in the ionosphere. Such information has long been desired by students of terrestrial magnetism and ionospheric physics, and it is now becoming of importance to military planners as well.

Measurements of winds at altitudes well above the range of the sounding balloon have been difficult and restricted to chance occurrence. Observation of the contortion and drift of the luminous trains left by exceptionally bright meteors has enabled a few estimates of air movements to be made at widely separated times and geographical locations. The fortuitous nature of the event and the difficulty of accurate triangulation restrict the usefulness as well as the accuracy of these measurements.^{1,2} Again, wind information has been obtained by noting the drift of the exceptionally rare noctilucent clouds. These clouds occur only at an altitude of 82 kilometers, and are seen only at high latitudes.³ More recently, two methods of studying wind motions by radio observations have been discussed in the literature. Ferrell⁴ has described measurements of the drift of clouds of sporadic-*E* ionization as a possible means for the study of wind motions at altitudes of about 120 kilometers. Such measurements are made possible by the co-operative efforts of many hundreds of amateur radio operators who report sporadic-*E*-propagated contacts. It remains to be demonstrated that the drift which is observed is a wind drift rather than a mo-

tion of the causative agent or condition which causes the ionization to become concentrated in sporadic-*E* clouds. Another method of wind measurement, applicable to heights in the *E* region, has recently been disclosed by Mitra.⁵ It is based upon recording the rate of fading of signals which have been reflected from an irregular moving ionosphere. The method has the advantage that winds are determined in a single experiment which is to a large extent under the control of the operator. It has not been shown, however, that the presence of the earth's magnetic field does not cause the electron wind measured by this experiment to differ in direction and magnitude from the true wind, consisting of an average motion of neutral molecules.

In the present paper is described a new method for experimentally determining wind direction and velocity in the 80- to 110-kilometer height region of the upper atmosphere. The method does not depend upon any special assistance in the form of unusual or hard-to-observe phenomena, and is capable of supplying information on a region of the atmosphere which has not as yet been studied on a regular basis.

THE METEOR ECHOES

The tools or probes used in the wind investigation are ionization columns created in the lower ionosphere by the passage of meteors.^{6,7} Upon entering this region, even relatively small particles create cylinders of ionization whose lengths are measured in tens of kilometers, but whose radii are a thousand times smaller. In the presence of winds it is to be expected that these thin, short-lived columns are transported with a translational velocity which may be detected by radio echo means. We shall first outline the conditions under which such echoes are detected, and then investigate the special properties the echoes should exhibit when winds are considered.

Because the ionization produced by the passage of a meteor is distributed along what amounts to a line, the strength of the reflected signal from the column is very aspect sensitive. In the majority of instances an echo can be received only when the trail is perpendicular to a ray from the observatory. Immediately upon the passage of the meteor, a "burst" of reflected signal is received, lasting typically for a second or so until the ionization has been dissipated. Fig. 1 illustrates the geometry of the reflection, and a sketch of received signal am-

* Decimal classification: R113.415XR248. Original manuscript received by the Institute, January 16, 1950. This work was supported jointly by the Navy Department Office of Naval Research and the U. S. Army Signal Corps under ONR Contract N6-ONR-251 Consolidated Task No. 7.

† Electronics Research Laboratory, Stanford University, Stanford, Calif.

¹ C. P. Olivier, "Long enduring meteor trains," *Proc. Amer. Phil. Soc.*, vol. 85, pp. 93-135; January, 1942.

² C. P. Olivier, "Long enduring meteor trains," second paper, *Proc. Amer. Phil. Soc.*, vol. 91, pp. 315-327; October, 1947.

³ C. Stormer, "Height and velocity of luminous night clouds observed in Norway, 1932," *Vid. -Akad. Avh. I. M.-N. Kl.*, no. 2; 1933.

⁴ O. P. Ferrell, "Upper atmosphere circulation as indicated by drifting and dissipation of intense sporadic-*E* clouds," *Proc. I.R.E.*, vol. 37, p. 879; July, 1948.

⁵ S. N. Mitra, "A radio method of measuring winds in the ionosphere," Part III, *Jour. IEE*, vol. 96, pp. 441-446; September, 1949.

⁶ L. A. Manning, "The theory of the radio detection of meteors," *Jour. Appl. Phys.*, vol. 19, pp. 689-699; August, 1948.

⁷ L. A. Manning, O. G. Villard, Jr., and A. M. Peterson, "Radio Doppler investigation of meteoric heights and velocities," *Jour. Appl. Phys.*, vol. 20, pp. 475-479; May, 1949.

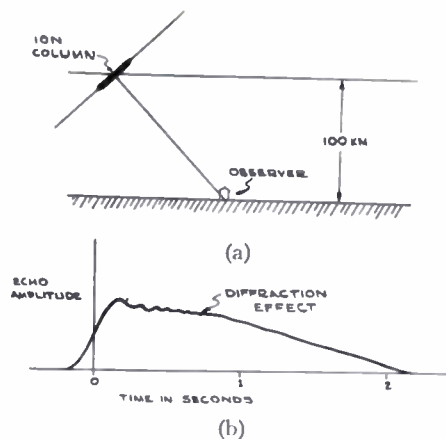

Fig. 1—(a) Geometry of reflection. (b) Typical amplitude of reflected signal.

plitude versus time as typically observed. The fluctuations in amplitude of the echo noted just after the initial rise result from diffraction effects as the trail forms to its full length, and are a measure of the velocity of the meteor.⁸

EFFECTS OF WINDS UPON ION TRAILS

On the basis of earlier investigations there is reason to suspect the existence of winds having velocities somewhere between zero and 600 kilometers per hour at meteoric heights. We shall first suppose the existence of such winds, then investigate what effects they may be expected to have upon meteor echoes, and finally show how the nature of the winds may be deduced from the echo effects. Due to wind drift alone, there should be no change in the amplitude of the reflections, since the trail will drift little more than a tenth of one per cent of the distance to the observatory in a second. If we examine the radio-frequency phase of the received echo, however, we shall find that whenever the reflector moves towards the observatory by half a wavelength, there will be a full-cycle shift in the reflected wave. The reflection from the electron cloud can be shown to be analogous in this respect to the reflection from a metallic reflector. By beating the echo with a portion of the transmitted signal, it is possible to detect motion of the reflector in terms of cyclic fluctuations of the resultant signal. In Fig. 2 is sketched an echo from a target which has moved almost three half-wavelengths in the duration of the reflection, with a velocity of one-half wavelength per second. The preliminary high-frequency fluctuation is known as a "meteor whistle," and, like the diffraction fluctuations, is a measure of the velocity of the meteoric particle which formed the column.⁷ This velocity should not be confused with the much slower wind drift of the fully formed trail. The low beat frequency exhibited in Fig. 2 is called a "body Doppler." At a wavelength of ten meters, a radial drift velocity of 100 kilometers per hour would produce a body Doppler of 5.5 cps.

⁸ C. D. Ellyett and J. G. Davies, "Velocity of meteors measured by diffraction of radio waves from trails during formation," *Nature*, vol. 161, pp. 596-597; April 17, 1948.

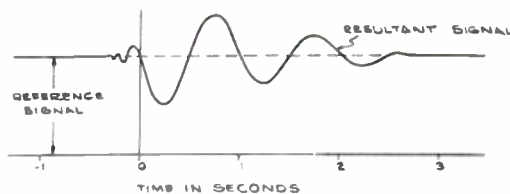

Fig. 2—Beat between transmitted continuous wave and echo from moving column.

DOPPLER SHIFT CAUSED BY A UNIFORM WIND

Assume that a uniform upper atmosphere wind exists which is everywhere the same in direction and velocity. We may then examine the Doppler shift such a wind will produce upon a particular meteor reflection, as a function of the position of the meteor. Set up a rectangular co-ordinate system with z the vertical co-ordinate, and so rotated that the wind vector lies in the $y-z$ plane. The wind velocity w may then be expressed as a space vector as follows:

$$\vec{w} = \vec{j}w \cos \alpha - \vec{k}w \sin \alpha \tag{1}$$

where α is the dip angle of the wind with respect to the horizontal, and \vec{j} and \vec{k} are unit vectors in the y and z directions. If we now call \vec{r} the position vector of the meteor with respect to an origin at the observatory, the component v of the trail drift velocity towards the observatory will be

$$v = \frac{\vec{r}}{r} \cdot \vec{w} \tag{2}$$

where r , the magnitude of the position vector, is the range. Using the notation that h is the column altitude, ρ the horizontal distance from the observatory, and θ the

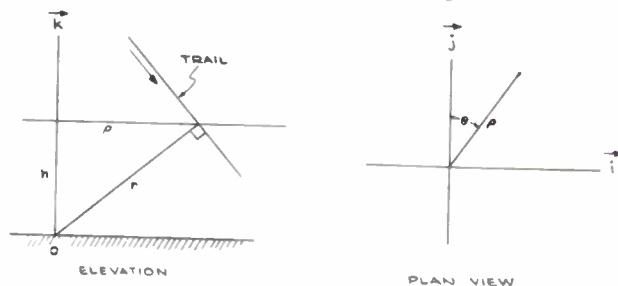

Fig. 3—Co-ordinates of the ionization column.

angle between the projections of \vec{r} and \vec{w} in the horizontal plane, as in Fig. 3, we find

$$\vec{r} = \vec{i}\rho \sin \theta + \vec{j}\rho \cos \theta + \vec{k}h \tag{3}$$

where \vec{i} is the unit vector in the x direction; so that, using (2), and the relation $\rho = (r^2 - h^2)^{1/2}$, we find that

$$v = w[1 - (h/r)^2]^{1/2} \cos \alpha \cos \theta - w(h/r) \sin \alpha \tag{4}$$

for the radial velocity of the reflection point.

It will be seen that the Doppler shift for a uniform wind varies sinusoidally with the bearing angle θ of the

observed meteor, thus suggesting a statistical means for determining the direction of an average wind motion. In particular, if the Doppler shift F , related to the radial velocity v by

$$F = -\frac{2v}{\lambda} \tag{5}$$

where λ is the wavelength, be determined for many meteors distributed at random about the observatory, the wind direction will correspond to the azimuth for which the largest average negative (receding) shift F is obtained, provided that h/r is independent of θ . Fig. 4 is a plot of (5), with v determined from (4), for an as-

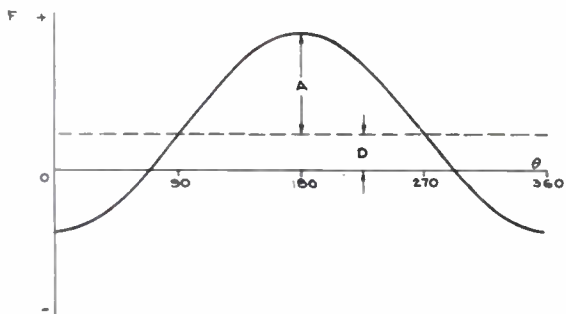

Fig. 4—Theoretical variation of Doppler shift (radial velocity) with azimuth.

sumed h/r of 0.7, and a dip angle of 20° in (4). It will be noted that under these conditions the average value of Doppler frequency is displaced by an amount dependent upon the dip angle of the average wind. If $h/r=0.7$, displacement may be expressed as a fraction of the sine amplitude A simply as

$$\frac{D}{A} = \tan \alpha \tag{6}$$

where D/A is the fractional displacement.

PROCEDURE FOR WIND ANALYSIS

Assume that meteors have been detected in many directions at known ranges r , and that for each of the meteors the velocity of approach or recession v has been determined. For practical reasons the directions θ may be determined only to within one of some number of sectors, say the 16 points of the compass. It is then possible to find the average radial velocity \bar{v} in each given sector, and to plot this average velocity, or the average Doppler shift \bar{F} , versus direction. In accordance with (4) and (5) the value of \bar{F} for a given sector θ_m , assuming $\alpha = 0$, is

$$\bar{F} = -\frac{2w}{\lambda} \cos \theta_m \left(\frac{\sum_{n=1}^{n=N} \left[1 - \left(\frac{h_n}{r_n} \right)^2 \right]^{1/2}}{N} \right) \tag{7}$$

where N observations are made in the sector of direction θ_m . To the extent that the summation is independent of θ , which is to say that the range distribution of the observed meteors is independent of azimuth, the average observed Doppler shift will vary sinusoidally with θ , and

Fourier analysis of the observed \bar{F} 's versus θ will yield the coefficient

$$-\frac{2w}{\lambda N} \sum_{n=1}^{n=N} \left[1 - \left(\frac{h_n}{r_n} \right)^2 \right]^{1/2}$$

Designating the Fourier amplitude of the cosine- θ variation of observed shift by A , the wind speed is

$$w = \frac{\lambda}{2} A \left(\frac{N}{\sum_{n=1}^{n=N} \left[1 - \left(\frac{h_n}{r_n} \right)^2 \right]^{1/2}} \right) \tag{8}$$

Analysis of typical nonshower records has shown the last factor in (8) to be substantially independent of azimuth, and to have a value of the order of 4/3. For most accurate results, however, the summation should be performed from the actual data.

EXPERIMENTAL VERIFICATION OF THE THEORY

Using equipment to be described in the next section, it has been possible to obtain experimental results which are consistent with the previously developed theory based on the assumption of a uniform average wind.

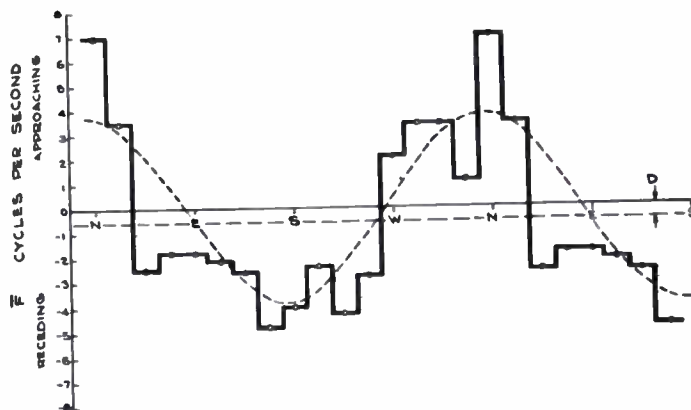

Fig. 5—Average body-Doppler frequency \bar{F} versus direction on September 11, 1949.

In Fig. 5 is shown a plot of average body-Doppler frequency versus direction as obtained experimentally. Fourier analysis of these ordinates can be made to determine the direction and magnitude of the wind. The wind comes from the direction corresponding to the positive peak of the best-fitting sine wave.

Study of many plots such as that in Fig. 5 has shown that the constant displacement term D in the Fourier analysis tends to be less than the sine amplitude A by a ratio of eight or more to one, the ratio increasing when larger samples of data are used. Use of (6) then serves to demonstrate the average winds to be horizontal to within a few degrees.

The importance of this observation is principally that it excludes the possibility that the observed electron cloud drift is in any way different from that of the true wind. A difference could conceivably exist because of the effect of the earth's magnetic field on electron motion. If the electronic collision frequency is below the gyro frequency, electrons can move freely only parallel to the

earth's field, so that in the absence of electric attraction to positive ions, the drift of electrons would not correspond to that of the true wind, but rather to the component of the true wind in the direction of the magnetic field. Calculation shows that the electron collision frequency equals the gyro frequency at about 100 kilometers,^{9,10} which is in the neighborhood of meteoric reflection heights. Having shown the electron drift to be horizontal within a few degrees, while the magnetic dip is about 65° , we have shown that magnetic effects do not impair the accuracy of the wind determination. It may be noted that the height at which the ionic collision frequency equals the ionic gyro frequency is about 130 to 150 kilometers. Above this height positive and negative charges will drift in the magnetic-field direction, while in the intermediate altitude range of the *E* layer careful study will be needed to determine what resultant motion the ionization acquires. The wind velocity determinations described by Mitra,⁵ which are based upon fading rates in the *E* layer, appear to depend on electron drift in this intermediate region. Experimental proof that his observed winds are not affected by the earth's magnetic field would be reassuring.

EXPERIMENTAL EQUIPMENT

The Doppler recordings of reflected signal that have been used in the wind studies have been made using continuous-wave emissions of approximately 1-kilowatt power at a frequency of 23.1 Mc. In addition, a pulsed transmitter has been operated at 17.3 Mc for range determinations. In a previous paper the authors have described some of the techniques involved in receiving and recording the echoes.⁷ For wind studies the system described previously must be augmented by a direction finder, and by a sense indicator which will determine whether the received signal is shifted to a frequency a few cycles above or below that transmitted.

Ordinary direction finders are not adapted for meteoric work because a meteor echo is a relatively weak signal of very short duration. In order to determine successfully a meteor's bearing, a direction finder is needed which will distinguish the received signals in terms of range, and will give a positive, instantaneous indication of direction involving no sense ambiguity. A special meteor direction finder was constructed which provides the needed features. An electronically sweeping antenna pattern is obtained by using an array of four vertical antennas spaced about a vertical reflector. Each antenna then radiates principally to a single quadrant, and their outputs are amplified by four sinusoidally gated preamplifiers before being combined and amplified by a receiver of ordinary design. Effectively, a single rotating

beam is obtained. The presentation involves sixteen separate *A*-scope range patterns all displayed on a single sweep. Fig. 6 shows the appearance of the resultant oscilloscope pattern.

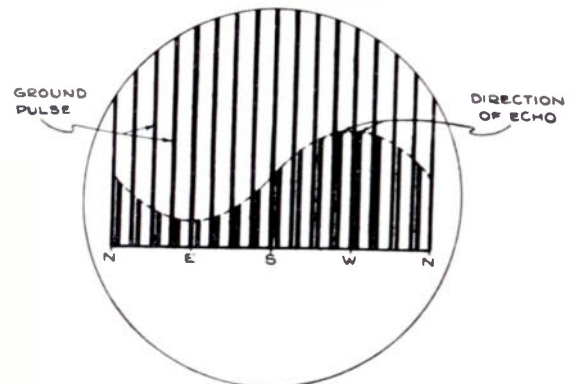

Fig. 6—Direction-finder presentation.

During a single sweep the antenna pattern is caused to go through one revolution, and it consequently modulates the envelope of the received pulse amplitudes as shown in the drawing. It has been found that echoes of fractional-second duration can be measured with this instrument despite the presence of stronger reflections in other directions, because of the range resolution in the sixteen *A*-scope patterns. The eye is well able to determine the largest of sixteen spikes arranged in this way. Polar presentations, on the other hand, were found to be extremely confusing.

The problem of detecting the sign of a Doppler shift of perhaps half a cycle per second superimposed upon a 23-Mc carrier again required special methods for its solution.

Consider Fig. 7, which is a vector plot of wave amplitude and phase relative to the transmitted wave. In this plot the reflected-wave vector will not be stationary. It will revolve at the difference frequency corresponding

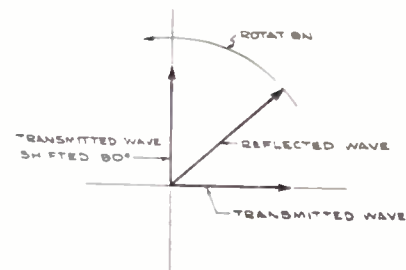

Fig. 7—Vector relationships in the sense detector.

to the Doppler shift, and the direction of rotation will correspond to the sign of the shift. When the reflected wave is in phase with the transmitted wave, the beat will have maximum amplitude. If, however, the reflected wave is combined with a signal of transmitted frequency but possessing a 90° phase lead, a beat will be obtained which is shifted 90° at the beat frequency. It is evident that for the phasing shown in Fig. 7, clockwise rotation of the reflected vector will cause the beat with the shifted transmitted wave to lead the phase of the beat with the unshifted transmitted wave. If the sign of

⁹ E. F. George, "Electronic collisional frequency in the upper atmosphere," *Proc. I.R.E.*, vol. 35, pp. 249-256; March, 1947.

¹⁰ G. Griminger, "Analysis of Temperature, Pressure, and Density of the Atmosphere Extending to Extreme Altitudes," Project RAND Report No. R-105 Douglas Aircraft Co., Inc., November 1, 1948.

the Doppler shift, and hence the rotation, is reversed, the beat will lead in the other channel. Fig. 8 shows

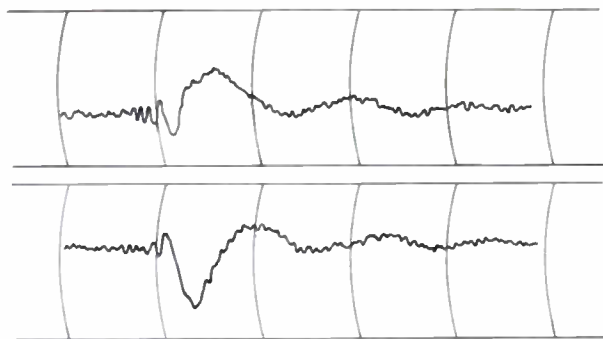

Fig. 8—Doppler beats demonstrating technique of determining sign of shift.

beats recorded using this principle, and clearly demonstrating a 90° phase shift enabling the sign of the Doppler shift to be determined.

FURTHER CHARACTERISTICS OF THE DOPPLER SHIFT

We have, on the assumption that uniform average winds exist at meteoric heights, determined the effect they should have upon meteoric echoes. A method of measuring wind direction and velocity based on these assumptions has been outlined, and experimental observations are found to give results consistent with the theory. It should be pointed out that other measurable properties of the experimental Doppler shift are also consistent with the wind interpretation.

The wind theory predicts a body Doppler which will have no systematic variation in beat frequency throughout the duration of an echo. Statistical study has demonstrated only random fluctuations in frequency during the life of an echo, so that no appreciable component of velocity may be accredited to an expansion-contraction process such as would be caused by trail diffusion. When the Doppler shift for a given reflection is investigated using two carrier frequencies simultaneously, it is found

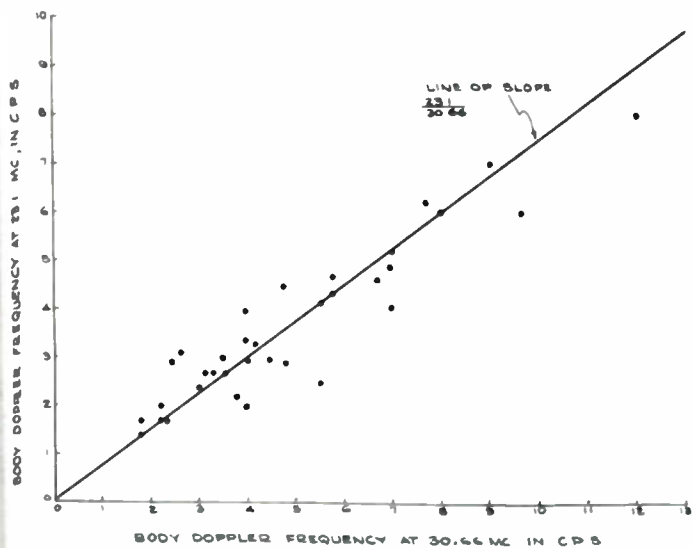

Fig. 9—Proportionality of body-Doppler frequency to carrier frequency.

that the beat frequency is directly proportional to the carrier frequency, as shown in Fig. 9. The velocity of the reflecting surface is hence not a function of the radio frequency, as it might be if varying penetration into an ionized cloud were involved. Further proof that horizontal motion of the clouds is involved has been obtained by plotting body-Doppler frequency versus slant range. The observed increase of frequency with range is consistent with the geometry of reflection from a horizontally moving body.

DESCRIPTION OF OBSERVED WINDS

On about a dozen and a half occasions during the summer of 1949, measurements of wind conditions have been made. The hours prior to sunrise were selected for the measurements because the lack of interfering signals and the maximum rate of meteoric arrival at that time simplify the measurement problem. It was found that in a period of about two hours enough echoes could be obtained to determine the average wind conditions with good reliability. In Fig. 10 is shown a vector plot of the wind velocities and directions as determined by these tests. It will be seen that south-southwest is the most favored direction during the period of observation, and that average velocities of 100 to 150 kilometers per hour are representative.

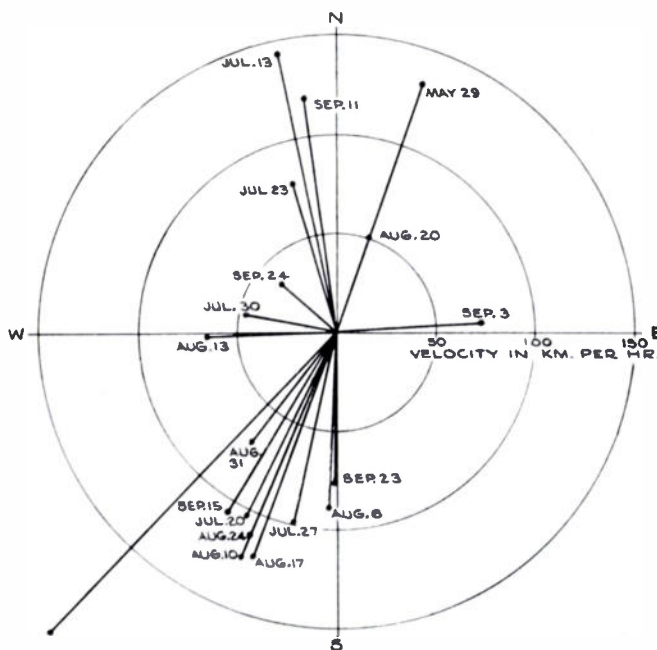
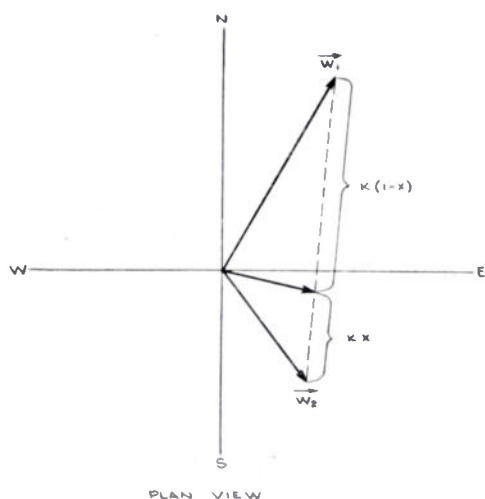

Fig. 10—Average upper-atmosphere wind velocities during the summer of 1949, between 3 and 6 A.M., local time, at Stanford University, Stanford, Calif. Winds blow from indicated directions.

The winds which were found originating from the west were especially interesting because of their low apparent speed and unusual direction. Examination of the Doppler frequency data for these days shows a large scatter in the observed shifts corresponding to a given bearing. Both negative and positive shifts were found in profusion in many sectors. The conclusion seems to be that the wind motion was either very turbulent and

changeable, or that it was blowing in two opposing directions in strata of different altitudes. It has been found on several occasions that the occurrence of these "confused" winds correlates with the presence of diffuse traces in 100-kc vertical-incidence ionosphere soundings,¹¹ but sufficient data have not yet been obtained to establish the connection beyond all doubt.

If it is assumed that the "confused" echoes result from observations with a fraction x of the meteors falling in one stratum, then a fraction $(1-x)$ will fall in the remaining layer. Fig. 11 demonstrates the resultant wind that will be determined by analyzing such data as though all the reflections were in a single stratum. It will be seen that the tip of the resultant vector lies along a line connecting the tip of the true wind vectors in the layers involved. The same result would be obtained if there were only one stratum, and it is assumed that the wind blew first in one direction and then in another during the period of measurement.



11—Resultant wind when observation is made in two strata. It will be seen that the tip of the resultant vector lies along a line connecting the tip of the wind vectors in the strata involved.

It might be of interest to point out that on most occasions the highest observed body-Doppler frequency corresponds to a radial drift of the individual meteor trail of the order of three or four times the average (horizontal) wind velocity. Since both positive and negative Doppler shifts are observed in each direction on a typical night, it is seen that the instantaneous upper atmosphere winds are clearly nonuniform and variable. This behavior seems to be compatible with the observed rapid deformations of the visible trails left by exceptionally large meteors.

USE OF LEAST-SQUARE ANALYSIS

When an experimental plot of average body-Doppler frequency versus direction is obtained, Fourier analysis may be used to determine the amplitude A of the sinusoidal variation. It commonly occurs, however, that

¹¹ R. A. Helliwell, "Ionospheric virtual height measurements at 100 kilocycles." Proc. I.R.E., vol. 37, pp. 887-894; August, 1949.

meteors do not arrive in random directions about an observer. There is a tendency for meteors to strike the earth on its forward side in its orbit around the sun.¹² Because of the perpendicular nature of the reflection process, this directional property appears also in the distribution of observed echoes in azimuth. In those directions in which meteors are most plentiful the average body Doppler is determined with a much smaller statistical error than in the less favored directions. An ordinary Fourier analysis of the average body Doppler gives no weight to the better determined points. Consequently, a "weighted Fourier analysis" has been used in the actual reductions. This analysis has been made by assuming the average displacement D to be zero, and then seeking the amplitude of the sinusoidal variation which produces the least mean-squared deviation from the average ordinates, when the ordinates are given a multiplicity corresponding to the number of observations. It can be shown that this formulation is equivalent to achieving the least mean-squared deviation from the individual experimental points. If all ordinates are evenly weighted, the present analysis reduces to a simple Fourier analysis.

Let the equation of the best fitting sine variation be $y = -A \cos(\theta - \phi)$ where A is the desired amplitude, ϕ is the direction in which the wind blows, and θ is the azimuth at which the shift y is obtained. We shall then seek the values of ϕ and A which will minimize the error E given by

$$E^2 = \sum_{n=1}^{n=N} [A \cos(\theta_n - \phi) + y_n]^2 \quad (9)$$

where y_n is the experimental ordinate in sector n . By minimizing E with respect to ϕ and A , two simultaneous equations may be obtained in $\cos \phi$ and $\sin \phi$. Using the abbreviation $\sin \theta_n = s$, $\cos \theta_n = c$

$$\begin{aligned} \cos \phi (A \sum c^2) + \sin \phi (A \sum cs) &= - \sum y_n c \\ \cos \phi (A \sum cs) + \sin \phi (A \sum s^2) &= - \sum y_n s. \end{aligned}$$

Solving for $\tan \phi$

$$\tan \phi = \frac{\sum c^2 \sum y_n s - \sum cs \sum y_n c}{\sum s^2 \sum y_n c - \sum sc \sum y_n s} \quad (10)$$

while the amplitude A is

$$A = \left| \frac{\sum y_n c [1 + \tan^2 \phi]^{1/2}}{\sum c^2 + \tan \phi \sum sc} \right|. \quad (11)$$

With the use of these formulas it is possible to obtain wind speeds and directions even when one or more sectors are completely deficient in data.

CONCLUSIONS

A method has been developed for determining the magnitude and direction of winds in the 90- to 100-km height region of the upper atmosphere. The method

¹² Fletcher G. Watson, "Between the Planets," The Blakiston Company, Philadelphia, Pa., p. 97; 1941.

is based upon measurement of the Doppler shift imparted by the wind drift to reflections from meteoric ionization columns. In the present stage of development, one or two hours of observation serve to specify average velocities to within perhaps twenty per cent and direction to better than twenty degrees. A score of measurements made during the summer of 1949 have shown the average winds to be horizontal and to have velocities of the order of 125 km. The most usual direction was from south-southwest, with north second. Upon some occasions, record reduction based upon the assumption of a single uniform wind yields an apparently low-velocity wind of intermediate direction. At these times, the average wind which is

measured is probably the resultant of intermittent winds blowing in different directions at the same altitude, or of winds blowing in different directions at differing altitudes. A suggestion of a correlation has been observed between the existence of such wind conditions, and diffuse traces in low-frequency ionosphere sounding.

Extension of the scope of the measurement program in order to investigate the diurnal, seasonal, and geographic variations of the wind is desirable. Convenient methods for measuring the height of the reflections are also needed so that possible vertical stratification in the wind system may be investigated. The meteoric ionization method is the first available for wind studies at 90 to 100 km on any but a completely fortuitous basis.

Complex Dielectric-Constant Measurements in the 100- to 1,000-Megacycle Range*

A. G. HOLTUM, JR.†, ASSOCIATE, IRE

Summary—A method is described wherein the dielectric constant and conductivity of lossy materials may be determined quickly and conveniently. A sample of the material is incorporated as the dielectric of a capacitor which acts as a load terminating a slotted measuring line. The complex impedance of this load can be determined by the conventional method from the voltage standing-wave ratio and position of the minimum. The inherent limitations of the method restrict its application to medium- and high-loss materials because of the very high standing-wave ratios encountered as the conductivity decreases. However, the dielectric constant alone may be measured for low-loss materials.

Standardized components are used throughout, with the exception of the sample holder.

I. INTRODUCTION

AT MICROWAVE FREQUENCIES the dielectric properties of nonconducting materials may be determined from the propagation characteristics of an electromagnetic wave through the medium. Various methods of attacking this problem are discussed in the literature, which includes an extensive bibliography of recent work in this field.¹

Application of these methods to the frequency range from 100 to 1,000 Mc is in some cases feasible. The sizes and shapes of the material sample required, however, become cumbersome as the frequency is decreased.

Following suggestions in the literature, the details of an alternative method have been worked out and ap-

plied. This method consists of incorporating the sample, which is in the shape of a small disk, as the dielectric of a capacitor which acts as a load terminating a slotted coaxial transmission line. The problem then becomes one of simply measuring the terminating complex impedance, utilizing standard transmission-line techniques.

The limitations of the method are obvious, inasmuch as a measurable voltage standing-wave ratio would necessarily require the value of the equivalent parallel resistance to be close to the same order of magnitude as the characteristic impedance of the measuring line. The real part of the dielectric constant may be determined for low-loss dielectrics, however, from the position of the minimum alone.

II. THEORY

The electromagnetic properties of any ordinary material, which is isotropic and homogeneous in the macroscopic sense, can be completely specified by two complex constants—the complex dielectric constant ϵ_c and the complex permeability μ_c . These can be expressed as follows:

$$\epsilon_c = \epsilon' - j\epsilon'' = \epsilon_0 k(1 - j \tan \delta) \quad (1)$$

$$\mu_c = \mu' - j\mu'' = \mu_0 \quad (\text{for nonmetallic materials}), \quad (2)$$

where ϵ' is the real part of the dielectric constant, K is the specific inductive capacity, ϵ'' is the loss factor, and μ' and μ'' are the real and imaginary parts of the permeability.

$$k = \epsilon'/\epsilon_0 \text{ and } \tan \delta = \epsilon''/\epsilon'$$

$$\epsilon_0 = \text{dielectric constant of free space} = 8.854 \times 10^{-12} \text{ farads per meter}$$

* Decimal classification: R216.1. Original manuscript received by the Institute, September 26, 1949; revised manuscript received, April 3, 1950.

† Signal Corps Engineering Laboratories, Fort Monmouth, N. J.
¹ C. G. Montgomery, "Technique of Microwave Measurements," Rad. Lab. Ser., vol. 11, McGraw-Hill Book Co, New York, N. Y.; 1947.

μ_0 = permeability of free space = 1.257×10^{-6} henry per meter (rationalized mks system).

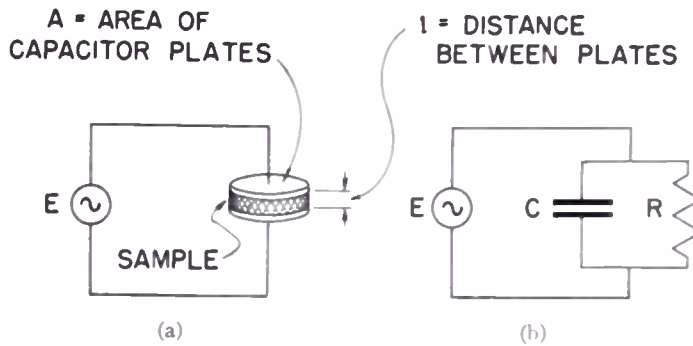

Fig. 1—(a) Diagram of sample material incorporated as the dielectric of a capacitor across which a sinusoidal voltage is applied. (b) Equivalent circuit.

If the material is incorporated as the dielectric in a capacitor (see Fig. 1), we have the following relationships:

$$R = l / A \sigma = l / A \omega \epsilon'' \quad \text{and} \quad C = A \epsilon' / l$$

$$Z_B = \frac{1}{1/R + j\omega(C + C_s)} \tag{3}$$

$$Z_{B(out)} = \frac{1}{j\omega(C_s + C_s)} \tag{4}$$

where Z_B is the complex impedance of the capacitor with sample in place and $Z_{B(out)}$ is the impedance with the sample removed, l is the distance between capacitor plates, A is the area of the plates, σ is the conductivity of the sample, R and C are the equivalent resistance and capacitance of the load in parallel, C_s is the stray capacity, and C_a is the computed capacity with the sample removed, $C = kC_a$ and $C_a = 0.2244A/l$ micromicrofarads. (where A is in square inches and l is in inches) $\omega = 2\pi f$.

If we incorporate this load as the termination of a slotted coaxial line, and neglect the losses in the line, we have from the standard transmission-line equations²

$$\frac{Z_B}{Z_0} = \frac{1 - j\rho \tan \beta x}{\rho - j \tan \beta x} \tag{5}$$

$$Z_{B(out)}/Z_0 = -j \tan \beta x_{(out)} \quad \text{since} \quad \rho_{(out)} \rightarrow \infty, \tag{6}$$

where Z_0 is the characteristic impedance of the line and x is the distance of the minimum voltage from the load with sample in place, $x_{(out)}$ is the distance with sample removed, $\beta = 2\pi/\lambda$ where λ = wavelength in free space, and $\rho = E_{max}/E_{min}$, the ratio of the maximum to the minimum voltage on the line.

From the previous relationships, we can derive

$$k = \frac{\epsilon'}{\epsilon_0} = \frac{(\rho^2 - 1) \tan \beta x}{C_a \omega Z_0 (1 + \rho^2 \tan^2 \beta x)} - \frac{1}{C_a \omega Z_0 \tan \beta x_{(out)}} + 1 \tag{7}$$

² R. W. P. King, H. R. Mimno, and A. H. Wing, "Transmission Lines, Antennas and Wave Guides," McGraw-Hill Book Co., New York, N. Y., p. 41; 1945.

$$\tan \delta = \frac{\rho(\tan^2 \beta x + 1)}{C_a \omega Z_0 (1 + \rho^2 \tan^2 \beta x) k} \tag{8}$$

III. AIDS TO COMPUTATION

A. Smith Chart

Where accuracy of Smith Chart readings is sufficient, it is convenient to measure the complex load by conventional methods, and determine directly from its admittance the values of the dielectric constant and loss tangent.

$$Y_s/Y_0 = g + jb, \tag{9}$$

where Y_s is the complex load admittance, $Y_0 = 1/Z_0$, g is the relative conductance, and b is the relative susceptance of the load. g and b are read directly from the chart, and from their values, R and $(C + C_s)$ may be easily determined:

$$R = Z_0/g \quad \text{and} \quad (C + C_s) = b/\omega Z_0. \tag{10}$$

After measuring C_s ,³ we can evaluate k and $\tan \delta$ from the following:

$$k = C/C_a = b/\omega Z_0 C_a - C_s/C_a \tag{11}$$

$$\tan \delta = \sigma / \omega \epsilon' = l / A R \omega \epsilon' = g / \omega Z_0 C_a k. \tag{12}$$

B. High Standing-Wave Ratio

If the standing-wave ratio is high, it may be desirable to determine its value by measurements around the minimum.

The voltage standing-wave ratio ρ can be expressed as an explicit function of the voltage minimum E_m , another voltage E_x , preferably some integral multiple of E_m , and θ , the distance along the line in degrees separating E_m

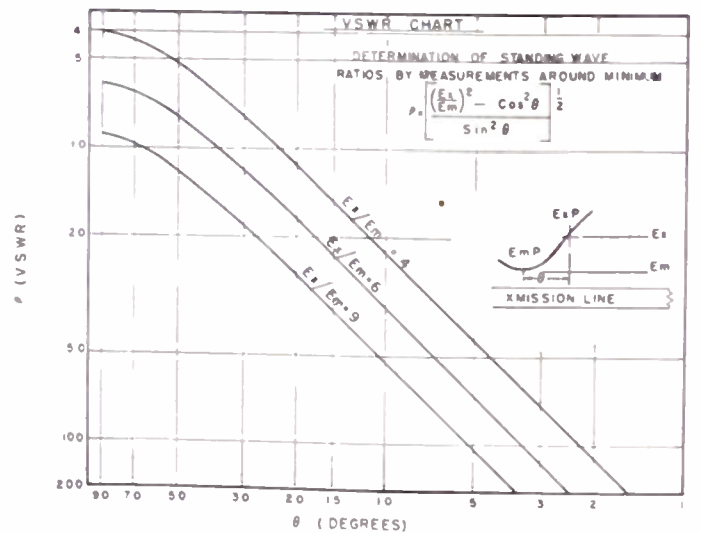

Fig. 2—Voltage-standing-wave-ratio chart.

³ The stray capacity C_s may be easily measured by the following procedure: 1. Measure reactance of empty sample holder. 2. Determine from this reactance the total capacity $(C_a + C_s)$. 3. Compute C_a . 4. Subtract this value from $(C_a + C_s)$ and obtain C_s .

and E_z . From the standard transmission line equations, we can derive⁴

$$\rho = \left[\frac{(E_z/E_m)^2 - \cos^2 \theta}{\sin^2 \theta} \right]^{1/2}$$

Fig. 2 shows this function plotted as a graphic aid.

IV. APPARATUS

The apparatus used, except for the sample holder, is conventional (see Fig. 3).

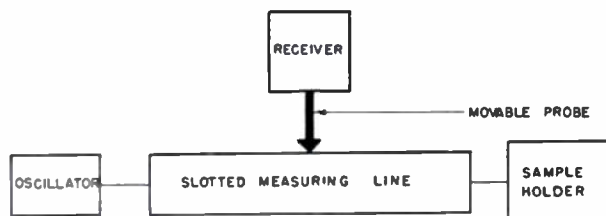

Fig. 3—Block diagram of measuring equipment.

The sample holder, shown in Figs. 4 and 5, was designed to fit the measuring line. It holds a sample 1.5 inches in diameter by $\frac{3}{16}$ inch thick, with provisions for small variations in sample thickness.

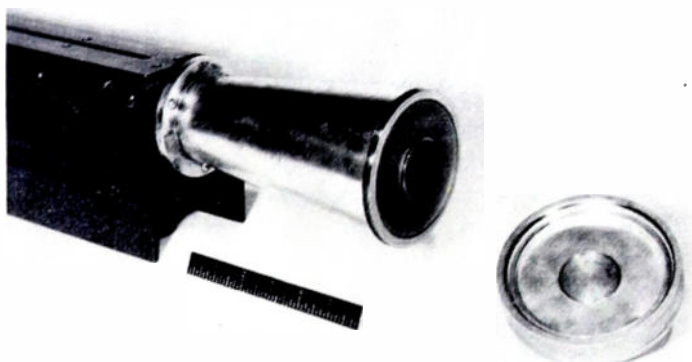

Fig. 4—Sample holder mounted on end of slotted line with cover removed and sample in place.

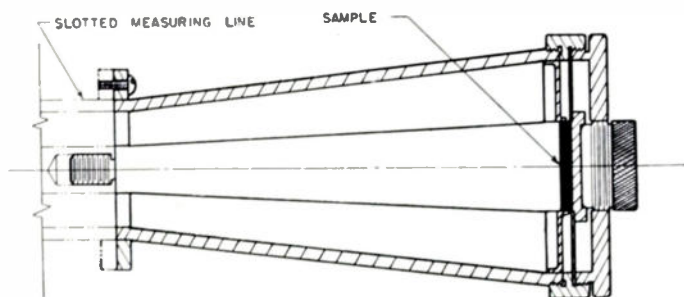

Fig. 5—Cross section of sample holder.

V. RESULTS AND CONCLUSIONS

The method and apparatus described have been in use for the past two years and have proved very satisfactory in the measurements of dielectrics at frequencies of

⁴ For a discussion of various techniques in the measurement of VSWR, see C. G. Montgomery, "Technique of Microwave Measurements," Rad. Lab. Ser. vol. 11, McGraw-Hill Book Co., New York, N. Y.; 1947.

100 to 1,000 Mc whose specific inductive capacity is in the order of 2 to 40 and whose loss tangent is in the neighborhood of 0.01 to 1.

Table I shows a number of measured values of some common plastics together with some comparisons of data obtained by other methods.

TABLE I

MATERIAL	FRE- QUENCY (Mc)	By Method Described		By Other Methods	
		k	$\tan \delta$	k	$\tan \delta$
Polystyrene	400	2.42		2.5	
Catalin—200	300	5.09	0.091	5.1	0.0878 ¹
	500	4.94	0.084		
	900	5.08	0.106		
Catalin—500	300	5.93	0.132	5.79	0.154 ¹
	500	5.73	0.140		
	900	4.79	0.151		
Catalin—700	300	5.16	0.143	4.14	0.174 ¹
	500	5.02	0.136		
	900	4.83	0.164		
Phenol Formaldehyde BM-120	166	4.71	0.071	4.73	0.064 ²

¹ "Tables of Dielectric Materials," vol. III, Technical Report No. X, Laboratory for Insulation Research, Massachusetts Institute of Technology, June, 1948.

² Measured by the Ohio State University Research Foundation using the method described in C. N. Works, T. W. Dakin, and F. W. Boggs, "A resonant cavity method for measuring dielectric properties at UHF," PROC. I.R.E., vol. 33, pp. 245-254; April, 1945.

Table II lists a number of samples containing various percentages of graphite and the measured values of their dielectric constants and loss tangents.

TABLE II

Phenol Formaldehyde, Bakelite BM-120 with the following amounts of powdered graphite (by weight):
 $f = 300$ Mc

Percentage Graphite	k	$\tan \delta$
4%	7.5	0.087
5%	8.1	0.099
6%	8.5	0.138
8%	14.4	0.165
10%	19.0	0.262

The order of accuracy that may be expected from the method depends, among other things, on the electrical characteristics of the sample and the precision of its fit in the sample holder. A quantitative evaluation of the accuracy, therefore, would necessarily be restricted to a narrow region of dielectric constant and loss tangent values. In view of these difficulties, a rigorous investigation of this question was not made. Comparisons made with other methods, however, of which the data in Table I are typical examples, are indicative of good agreement.

VI. ACKNOWLEDGMENT

The author is indebted to John Ruze for many initial suggestions, and to O. C. Woodyard and other members of the Evans Signal Laboratory Antenna Section for their help and encouragement.

A Double-Crystal X-Ray Goniometer for Accurate Orientation Determination*

W. L. BOND†, SENIOR MEMBER, IRE

Summary—An X-ray goniometer is turned into a double-crystal goniometer for use on precision cut AT quartz plates. Errors due to temperature change and to X-ray refraction are discussed. Precision of about one-tenth of a minute of arc is attained.

TO REDUCE the frequency shift of piezoelectric oscillator plates over a wide temperature range it is necessary to hold the orientation angles to close limits, for example ± 3 minutes for the ϕ angle of an AT plate of quartz. This precision is near the limits of accuracy of the single-crystal goniometers commercially available, as can be seen by studying the rocking curve of a quartz AT plate, Fig. 1. Here the Geiger counter or ionization chamber current reading I is plotted against the goniometer angle reading g . Even if g is kept constant, I is observed to fluctuate slightly due to instability of circuits of high amplification. It is difficult to find the peak of the curve of Fig. 1 because of its flatness and the presence of these fluctuations. If the rocking curve peak were much sharper, the fluctuations would have less importance.

The rocking curve can be sharpened slightly by using narrower slits, but then the current I becomes quite low even if the X-ray tube is operated at its maximum rating. The beam passed by the slits is of about a half-degree angle, and possibly it can be reduced to 10 minutes; one must find the center of this beam in order to measure g . Part of the curve broadness (about 2 minutes) is due to the X-ray beam having more than one wavelength present (see below).

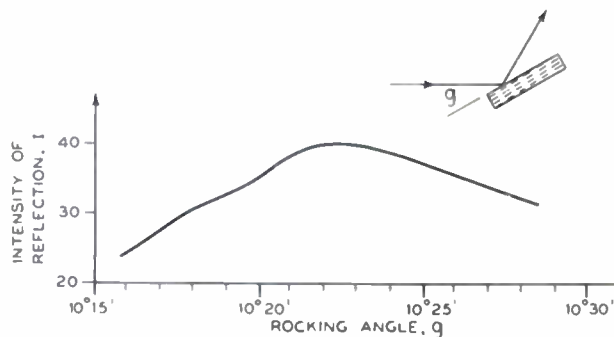

Fig. 1—A rocking curve for AT plate, single-crystal goniometer, copper radiation with nickel filter.

By replacing the slit system with an AT quartz plate and rotating the instrument $13^\circ 20'$ about a point directly under this crystal, the goniometer was converted into a double-crystal instrument. A micrometer tangent screw was used on the arm to allow reading angles to a

tenth minute. In the double-crystal goniometer the orientation is determined by observing when corresponding atomic planes of two similar crystals are parallel. This response is quite sharp, as shown in Fig. 2. This sharp curve is obtained using an X-ray tube current much smaller than the current used in the single-crystal instrument.

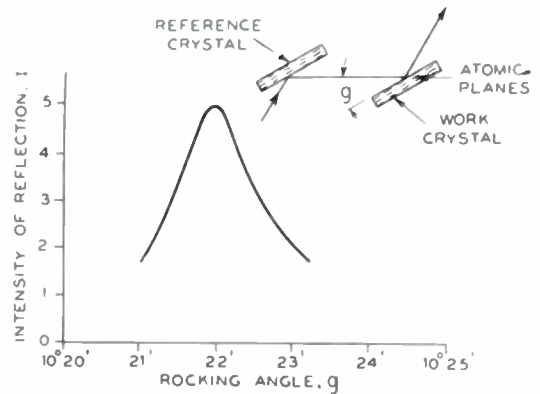

Fig. 2—A rocking curve for AT plate, double-crystal goniometer (no filter). Reference crystal ground with #400 silicon carbide and etched 10 mins 40 per cent hf, work crystal #400 grind, no etch.

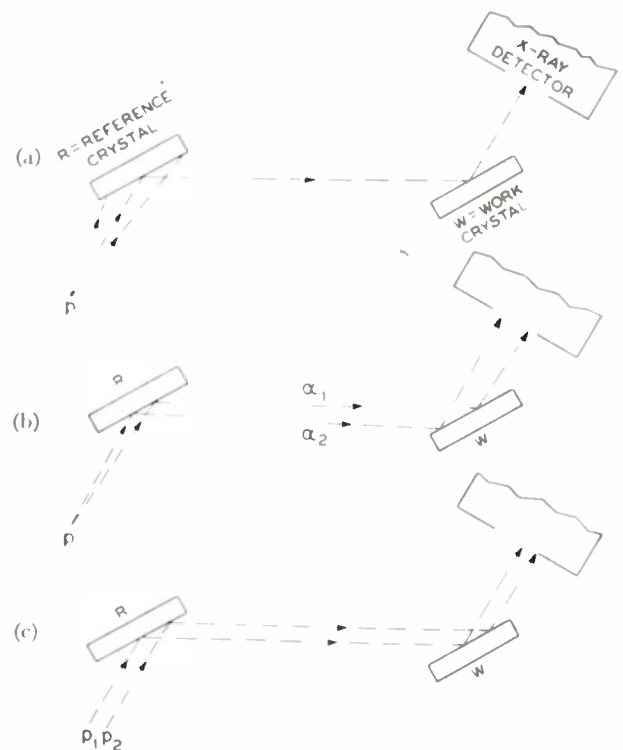

Fig. 3—X-ray reflections in double-crystal goniometer.

The atomic reflecting plane (01.1) of an AT plate should make an angle $\Delta = 38^\circ 12.7' - 35^\circ 15' = 2^\circ 58.3'$

* Decimal classification: R214.3. Original manuscript received by the Institute, November 14, 1949; revised manuscript received, April 12, 1950.

† Bell Telephone Laboratories, Murray Hill, N. J.

with the surface of the crystal. If the work crystal is reversed end for end in its holder, the crystal must be rotated through an angle 2Δ to re-establish the reflection. Hence a measurement of the amount of rotation necessary to find the peak after reversing the crystal gives us 2Δ , and also ϕ since $\phi = 38^\circ 12.7' - \Delta$.

The reason for the economy in X-ray energy is shown in Fig. 3(a), (b), and (c). Energy from any point p on the X-ray target spreads out to cover the crystal. At some point on the crystal the grazing angle is just right to give a reflection. By Bragg's law this angle is θ where

$$n\lambda = 2d \sin \theta,$$

λ being the wavelength of the radiation, n a small integer, generally 1 in our case, and d is the distance between atomic planes of the sort doing the reflecting. In Fig. 3(a) we see that this ray has reflected from the reference crystal and gone on to strike the work crystal. If the atomic reflecting planes of the two crystals are parallel, this ray arrives at the work crystals at the proper angle to reflect, and hence reflects and passes into the radiation detector. But the copper radiation is not monochromatic, as its greatest intensity is at $\lambda = 1.54050\text{\AA}$ called copper $K\alpha_1$, but at $\lambda = 1.54434\text{\AA}$ is another peak of about half this intensity called copper $K\alpha_2$. As shown in Fig. 3(b), if α_1 has found a spot at which to reflect from the reference crystal and hence reflects from both crystals there is also a spot at which the α_2 radiation can reflect and since the atomic planes of both crystals are parallel, it reflects from both and enters the radiation detector. Fig. 3(c) shows that every point on the target can thus send radiation into the radiation detector (in fact α_1 and α_2 and all near by wavelengths from every point on the target can enter the detector). That a spread of wavelengths can thus pass from the target to the detector is important to economy as shown by the intensity wavelength curve for copper in the $K\alpha$ region (Fig. 4). If only a narrow vertical strip of this curve could reflect from both crystals, most of the energy would be lost. If the reflecting

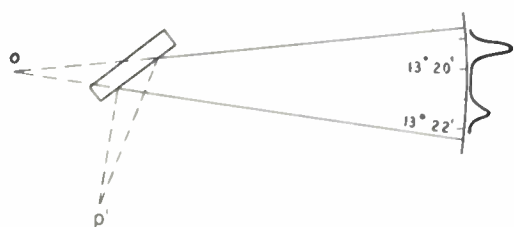

Fig. 4—Angular distribution of energy upon reflecting copper $K\alpha$ from (01.1) plane of quartz.

planes of the two crystals are parallel all the wavelengths under the curve, Fig. 4, will enter the detector. If the work crystal, Fig. 1, is rotated slightly about an axis perpendicular to the paper any wavelength reflected from the reference crystal arrives at the work crystal at the wrong angle to reflect. Hence no reflec-

tions occur for any value of λ . This must now be qualified. If the work crystal has slightly misoriented material in it or on its surface, some of this misoriented material will be at the proper angle and reflection will occur. Hence the rocking curve is not infinitely sharp. If the reference crystal is much more perfect than the work crystal the rocking curve is practically a plot of imperfection of the work crystal. A ground crystal gives a wide rocking curve; on etching the crystal the curve narrows markedly.

From the foregoing we see that a sheaf of X rays reflected from a crystal should have an energy distribution in angle as depicted in Fig. 4 (angles exaggerated). This is the intensity curve that a high resolution X-ray detector should give as it scans the beam, swinging about 0 as a center. Due to misoriented material on the crystal, this curve will be smeared out a little in angle.

We can picture what happens in reflection from two crystals by superposing two curves like that in Fig. 4. It is instructive to consider first an alternate method of getting double reflections, the arrangement shown at the upper left, Fig. 5. Here the work crystal W is positioned so that α_1 from the reference crystal R strikes W at the proper angle for reflection. However, α_2 requires a larger angle than does α_1 and hence leaves at a larger

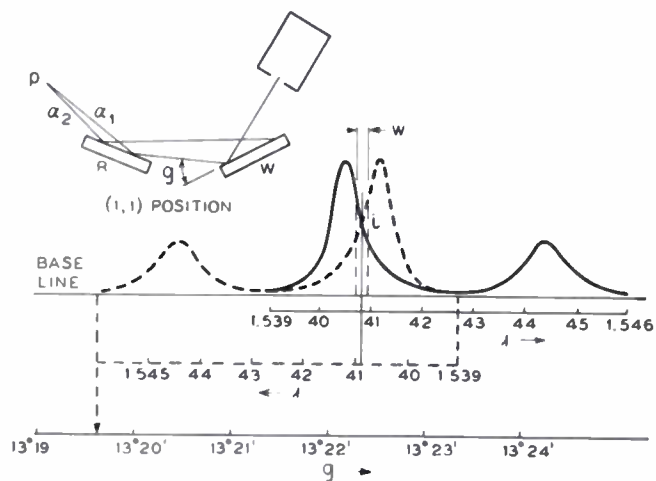

Fig. 5—Analysis of angular energy distribution for reflection from two quartz (01.1) planes in (1, 1) position.

angle and so arrives at W at a smaller angle than does α_1 . But this is not the right angle for α_2 reflection (it is too small by 2×2.06 minutes). Consequently one must rotate W 4.12 minutes from the α_1 reflection to find the α_2 reflection. This can be visualized as the sliding of two $I-\lambda$ curves past one another. For the parallel crystal arrangement of Fig. 1 (called (1, -1) position) the two curves should have λ increasing in the same direction, but for the arrangement of Fig. 5 (called (1, 1)) increasing λ for one curve is decreasing λ for the other as it is in Fig. 5. As the work crystal is rotated we can imagine the dotted curve (Fig. 5) being swept across the solid curve. For any grazing angle g the dotted curve intersects the solid curve at a point i that represents the

same wavelength on both curves; in Fig. 5 this is $\lambda = 1.5408$ for $g = 13^\circ 19.6'$. At this value of g the radiation detector should show a reading I that is proportional to the area of a vertical strip of width w under either curve, w being determined by the amount of misoriented material of both crystals. This width should be nearly constant for all values of g . Rough ground crystal surfaces have much misoriented material present; for such crystals, w will be wide. If the crystals are etched, w becomes smaller. We can see from this that intersections part way up a steep rise where the curve is concave outwards should show too high a detector current, because the long side of the strip has too much influence on the area of the strip. Hence a plot of I against g shows the peaks wider than they really are. If the crystals are etched, the peaks become narrower. For highly perfect crystals the I - g plot is practically an I - λ curve. It is obvious from Fig. 5 that the g readings for the maxima due to α_1 and α_2 will differ by twice the amount that would be had from Bragg's law for the two values of λ .

In the (1, -1) position as one curve is slid over the other, when one pair of corresponding points coincide all corresponding points coincide. A slight motion (more than $w/2$) either way destroys the coincidence everywhere at once. Hence we have a single peak and the sharpness of this peak is determined only by the distribution in angle of the misoriented material. This curve is a plot of this distribution in a plane. It is an observed fact that some crystals have misorientation material throughout, as shown by the fact that even after long periods of etching of the crystals, the curve in the (1, -1) position does not become narrow. Rock salt is an example. The narrowness of the (1-1) curve can be taken as a measure of perfection of a well-etched crystal.

It is possible to use different orders of reflection for the two crystals. The arrangement roughly like (1, 1) but where the first crystal (R) is used in the i^{th} order (i.e., n of $n\lambda = 2d \sin \theta$ is the integer i) and the second (W) in the j^{th} order is called the (i, j) position. Crystals arranged like (1, -1), except that the first crystal reflects in the i^{th} order and the second in the j^{th} , are said to be used in $(i, -j)$ position. Sharp peaks are had only for the position $(i, -i)$. That a curve for $(i, -j)$, $i \neq j$ has not a single sharp peak can be seen by imagining the sliding past one another of two I - λ curves which have different distances between their α_1 and α_2 maxima. Hence a goniometer for measurement of crystal orientation should be used only in an $(i, -i)$ position. Fig. 6 shows several rocking curves for different amounts of etching.

In the preceding discussion we have not considered the effects caused by the conical nature of a reflection sheet. Radiation from a point on the X-ray target finds not merely one point on the crystal R at which the incidence angle is right for Bragg reflection but many such points. The lines joining these points to the point on the

target form a cone. Similarly we can associate an "acceptance" cone with the crystal W . As g is varied, we can imagine part of one such cone as sweeping over the

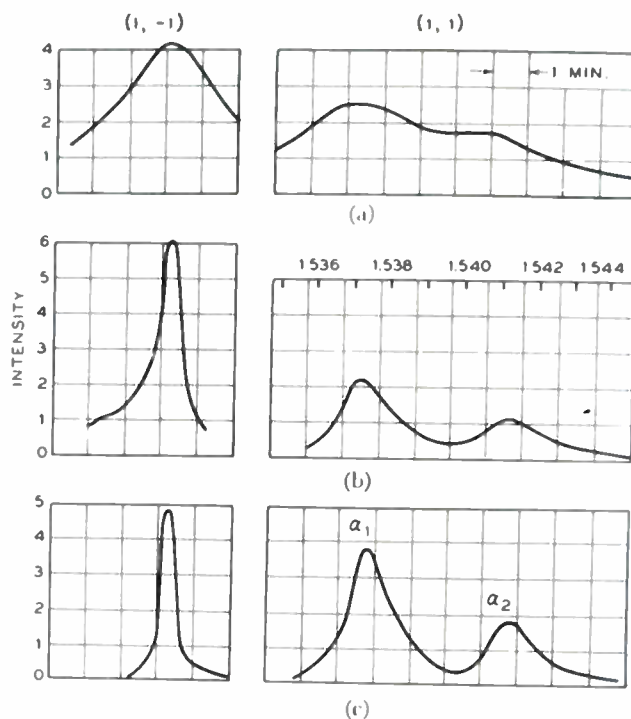

Fig. 6—Rocking curves for double-crystal goniometer for different amounts of etch. (a) #400 grind no etch. (b) #400 grind 10-minute etch. (c) #400 grind 60-minute etch.

other. The cones are given wall thickness w' and w'' to represent misoriented material on R and W , respectively. This is shown in Fig. 7(b). If now crystal W is tipped a little about the line LL , this in effect rotates the acceptance cone as in Fig. 7(c), so that the crossing

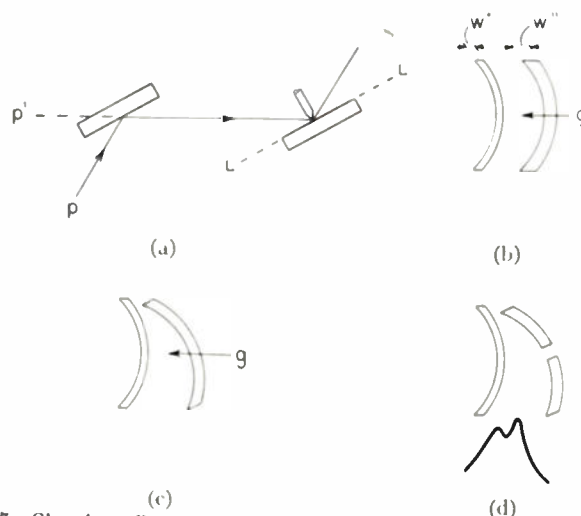

Fig. 7—Showing effect of stop pin and tilt of work crystal for double-crystal goniometer. (a) No-tilt, stop-pin centers work crystal. (b) Part of radiation cone of width W'' about to be swept by acceptance cone for case (a). (c) How a tilted acceptance cone would sweep the radiation cone to produce a broadened peak. (d) A gap in the acceptance cone produces a double peak on passing through the radiation cone.

is not abrupt. The top of the acceptance cone starts to enter the radiation cone, then leaves before the center has entered. If we consider the area in common as a measure of the detector current I , we get a qualitative picture of the dependence of I on g , and see that for a tipped crystal the peak is broadened. It is a common practice in the use of single-crystal goniometers to locate the work crystal at the center of rotation of the g circle by pressing the crystal against a stop pin. This puts a small gap in the acceptance cone, and as this cone sweeps over the radiation cone there is a double peak as shown in Fig. 7(d).

We have neglected the refraction of X rays up to this point; the index of refraction is generally very near unity so that little bending occurs at the surfaces. The refractive index is given by¹

$$1 - \delta \quad \text{where} \quad \delta = \frac{Ne^2}{2\pi m\nu^2},$$

where N is the number of orbital electrons per cm^3 of crystal, e is the charge on the electron, m is the mass of the electron $= 9.0 \times 10^{-28}$ gms, and ν is the frequency of the X-ray radiation. One atom of SiO_2 has $14 + 2 \times 8 = 30$ electrons and weights $60.1 \times 1.66 \times 10^{-24}$ gms while a cm^3 of quartz weighs 2.65 gms, whence $N = 8.0 \times 10^{23}$ electrons per cm^3 giving $\delta = 8.6 \times 10^{-6}$. Let θ and λ refer to the case where refraction has been neglected, so that

$$n\lambda = 2d \sin \theta.$$

Due to the refraction index differing from unity, θ and λ are different inside the crystal; call them θ' and λ' :

$$\lambda' = (1 + \delta)\lambda.$$

Let

$$\theta' = \theta + i.$$

But

$$n\lambda' = 2d \sin \theta'$$

so that

$$\sin i = \delta \tan \theta.$$

Let the grazing angle be $g' = T$ if the atomic planes make an angle Δ with the crystal surface

$$g' = \theta + \Delta + \epsilon',$$

ϵ' being the difference between g' and $\theta + \Delta$. By the law of refraction

$$\cos g' = (1 - \delta) \cot (\theta' + \Delta)$$

so that

$$\sin \epsilon' = [\tan \theta + \cot (\theta + \Delta)].$$

For the path of the departing beam

$$\sin \epsilon'' = \delta [\tan \theta + \cot (\theta - \Delta)].$$

Whence for an AT plate of quartz where θ is about $13^\circ 20'$, $\Delta = 2^\circ 58'$ we have

$$\epsilon' = 0.11 \text{ minutes}$$

$$\epsilon'' = 0.17 \text{ minutes.}$$

Since $g' = \theta + \Delta + \epsilon'$ and $g'' = \theta - \Delta + \epsilon''$, we have

$$\Delta = \frac{g' - g''}{2} + \frac{\epsilon'' - \epsilon'}{2},$$

whence in ignoring refraction we make an error in measuring the angle between the atomic reflecting planes and the crystal surface of amount $\epsilon = \epsilon'' - \epsilon'/2$, which is 0.03 minutes for an AT quartz plate.

Another possible source of error in attaining high precision in orientation is the effect of temperature on the crystal. An investigation into the dimensions of the unit cell of quartz^{2,3} shows that $a_0 = 4.9128 \text{ \AA}$, $c_0 = 1.1006 \text{ \AA}$ at 18°C . The expansion coefficient along the c axis is 7.8×10^{-6} and along the a axis is 14.6×10^{-6} per degree centigrade.⁴ Whence we see that at a temperature t degrees about 18°C the (01.1) plane makes an angle γ with the c axis where

$$\begin{aligned} \tan \gamma &= \frac{\frac{1}{2}\sqrt{3} a(1 + 14.6 \times 10^{-6} t)}{1.1006 a_0(1 + 7.8 \times 10^{-6} t)} \\ &= 0.78725(1 + 6.8 \times 10^{-6} t) \end{aligned}$$

whence $\gamma = 38^\circ 12.70' + (0.0115 t \text{ minutes})$. The spacing of planes (01.1) changes with temperature, but if the reference crystal is of the same material and orientation as the work crystal, the temperature change cancels out. For completeness however we include a calculation of this spacing.⁵ At 18°C

$$d_{01.1} = \frac{4.9128}{\sqrt{\frac{4}{3} + \left(\frac{1}{1.1006}\right)^2}} = 3.3429.$$

² M. V. Cohen, "Precision lattice constants from X-ray powder photographs," *Rev. Sci. Instr.*, vol. 6, pp. 68-74; March, 1935.

³ A. J. C. Wilson and H. Lipson, "The calibration of Dubye-Scherrer X-ray powder cameras," *Proc. Phys. Soc. (London)*, vol. 53, p. 245; 1941.

⁴ R. B. Sosman, "The Properties of Silica," Chemical Catalogue Co., New York, N. Y., p. 370; 1927.

⁵ R. W. G. Wyckoff, "The Structure of Crystals," Chemical Catalogue Co., New York, N. Y., p. 85; 1924.

¹ A. H. Compton and S. K. Allison, "X-Rays in Theory and Expt.," D. Van Nostrand, Inc., New York, N. Y., p. 280; 1935.

Product Phase Modulation and Demodulation*

DONALD B. HARRIS†, SENIOR MEMBER, IRE

Summary—A type of phase modulation system is described in which modulation of the phase angle of a carrier wave is brought about through an amplitude modulation process. The modulating voltage e_m is first impressed in parallel on a "sine phase converter" and a "cosine phase converter," which produce respectively, at their outputs, the functions $\sin ke_m$ and $\cos ke_m$. The first of these modulating functions is used to modulate, in a balanced modulator, the carrier wave, $\cos \omega t$. The second modulating function modulates in a similar balanced modulator the same carrier wave displaced in phase by 90 degrees, or $\sin \omega t$. The outputs of the two modulators are added to produce a phase-modulated wave in accordance with the trigonometric identity $\cos ke_m \cos \omega t + \sin ke_m \sin \omega t = \sin(\omega t - ke_m)$.

The "phase converters" proposed consist of oscilloscope tubes in which the phosphor has been replaced with an anode for collecting electrons, and a mask is interposed in the electron beam in order to produce, at the anode, a voltage proportional to the sine or cosine of the linear beam deflection, which in turn is proportional to the modulating voltage applied to the deflecting plates. It is indicated that phase deviations as high as $\pm 25\pi$ radians may be obtained with this system.

INTRODUCTION

IN A PREVIOUS PAPER¹ attention was called to a simple principle, through the application of which a single modulated wave in a spectrum of modulated waves may be selectively demodulated without preselection, and without cross modulation. It was shown that, if the spectrum transmitted is of the form

$$e_i = [\sum F_{an}(t) \cos n\omega t + \sum F_{bn}(t) \sin n\omega t] \quad (1)$$

where e_i is the instantaneous voltage of the complex modulated wave, $F_{an}(t)$ is a modulating function identified as being associated with a cosine carrier, by subscript a , n is any integer, ω is the angular frequency of a fundamental carrier wave, and $F_{bn}(t)$ is a modulating function identified as being associated with a sine carrier by subscript b , then, in order to demodulate the cosine carriers, it is only necessary to multiply by $\cos n\omega t$, and integrate, to obtain a demodulator output current

$$I_0 = \frac{\gamma_R \omega}{2\pi} \int_0^{2\pi/\omega} e_i(\cos n\omega t) dt = \frac{\gamma_R F_{an}(t)}{2}; \quad (2)$$

while, if it is desired to demodulate one of the sine carriers, the complex wave is multiplied by $\sin n\omega t$, and the result is integrated to obtain

$$I_0 = \frac{\gamma_R \omega}{2\pi} \int_0^{2\pi/\omega} e_i(\sin n\omega t) dt = \frac{\gamma_R F_{bn}(t)}{2}. \quad (3)$$

* Decimal classification: R148.3. Original manuscript received by the Institute, September 26, 1949; revised manuscript received, February 21, 1950.

† Collins Radio Company, Cedar Rapids, Iowa.

¹ D. B. Harris, "Selective demodulation," *PROC. I.R.E.*, vol. 35, pp. 565-372; June, 1947.

The factor γ_R depends on the characteristics of the demodulating device.

The applications suggested in the former paper involved, in general, systems in which amplitude modulation was employed; in other words, in which the amplitude of the modulating functions $F_{an}(t)$ and $F_{bn}(t)$ was a linear function of the modulating voltage involved. It is the purpose of the present paper to explore the possibilities of utilizing the general principle discussed for the purpose of producing and demodulating frequency- or phase-modulated waves, by making the angle of the $F_{an}(t)$ and $F_{bn}(t)$ a linear function of the modulating voltage involved. It is shown that by selection of a suitable form for the modulating functions $F_{an}(t)$ and $F_{bn}(t)$ satisfactory phase modulation can be produced through the employment of ordinary amplitude-modulation techniques. Examples are given of practical applications of the general principles developed, and it is shown, in particular, that it is possible by this means to produce unusually wide phase deviations.

GENERAL EQUATIONS FOR PHASE MODULATION

Inspection of (1) shows that the modulating functions $F_{an}(t)$ and $F_{bn}(t)$ must, in order to specify fully a modulated wave, have a form of the following general nature:

$$F_{an}(t) = \gamma_T E_{kn} G_{an}(t) \quad (4)$$

and

$$F_{bn}(t) = \gamma_T E_{kn} G_{bn}(t) \quad (5)$$

where $G_{an}(t)$ and $G_{bn}(t)$ are modulating waves, E_{kn} is the carrier amplitude, and γ_T is a constant depending on the characteristics of the modulating device. For phase-modulation purposes we assign a restricted form to the modulating waves $G_{an}(t)$ and $G_{bn}(t)$ in accordance with the following equations:

$$G_{an}(t) = E_{mn} \cos \phi_n \quad (6)$$

and

$$G_{bn}(t) = E_{mn} \sin \phi_n \quad (7)$$

where E_{mn} is the amplitude of the modulating wave and ϕ_n is the independent variable, the value of which is controlled by the modulating voltage being transmitted. Then the modulating functions become

$$F_{an}(t) = \gamma_T E_{kn} E_{mn} \cos \phi_n = E_{0n} \cos \phi_n \quad (8)$$

and

$$F_{bn}(t) = \gamma_T E_{kn} E_{mn} \sin \phi_n = E_{0n} \sin \phi_n \quad (9)$$

where E_{0n} is used in place $\gamma_T E_{kn} E_{mn}$ for the sake of simplicity of notation, and is the maximum amplitude of

the modulated envelope. If the modulation process has been carried out in accordance with these relationships, so that the transmitted wave is of the form

$$e_i = [\sum E_{0n} \cos \phi_n \cos n\omega t + \sum E_{0n} \sin \phi_n \sin n\omega t], \quad (10)$$

then the original phase-dependent modulating functions can be recovered at the receiving terminal by multiplying by a wave having the same frequency and phase as the carrier, and integrating, in the manner of (2) and (3), to obtain

$$I_0 = \frac{\gamma_R \omega}{2\pi} \int_0^{2\pi/\omega} e_i(\cos n\omega t) dt = \frac{\gamma_R E_{0n} \cos \phi_n}{2} \quad (11)$$

and

$$I_0 = \frac{\gamma_R \omega}{2\pi} \int_0^{2\pi/\omega} e_i(\sin n\omega t) dt = \frac{\gamma_R E_{0n} \sin \phi_n}{2}. \quad (12)$$

These equations have a particular application, as will be demonstrated later, in the case of data transmission, where it is desired to transmit shaft-position information from one point to another. Here, the independent variable ϕ_n is actually the angle of rotation of a shaft, and the modulating waves $E_{mn} \cos \phi_n$ and $E_{mn} \sin \phi_n$ are obtained directly from synchro generators coupled to the shaft.

A broader application of this principle to the problem of phase modulation in general is discovered by expanding (10) in accordance with the trigonometric identity

$$\cos A \cos B + \sin A \sin B = \cos (A - B) \quad (13)$$

which leads immediately to the equation

$$e_i = [\sum E_{0n} \cos \phi_n \cos n\omega t + \sum E_{0n} \sin \phi_n \sin n\omega t] = \sum E_{0n} \cos (n\omega t - \phi_n). \quad (14)$$

If, now, ϕ_n is a linear function of the modulating voltage e_{mn} , so that

$$\phi_n = ke_{mn} \quad (15)$$

where k is a constant depending on the structure of the device employed to set up the modulating function, then the modulating waves required at the output of this device, which might be called a "phase converter," must be (from (6) and (7))

$$G_{an}(t) = E_{mn} \cos ke_{mn} \quad (16)$$

and

$$G_{bn}(t) = E_{mn} \sin ke_{mn} \quad (17)$$

and the equation of the modulated wave becomes

$$e_i = \sum E_{0n} \cos (n\omega t - ke_{mn}), \quad (18)$$

which is the equation of a phase-modulated wave having a phase deviation proportional to the modulating voltage.

A MULTICHANNEL SYNCHRO SYSTEM

Fig. 1 is a schematic diagram of a multichannel synchro system employing the principles of (10), (11), and (12), in which a multiplicity of shaft positions is transmitted, over two 3,000-cycle-wide lines, or radio channels, without carrier preselection at the receiving station, using the synchros themselves as selective demodulators.

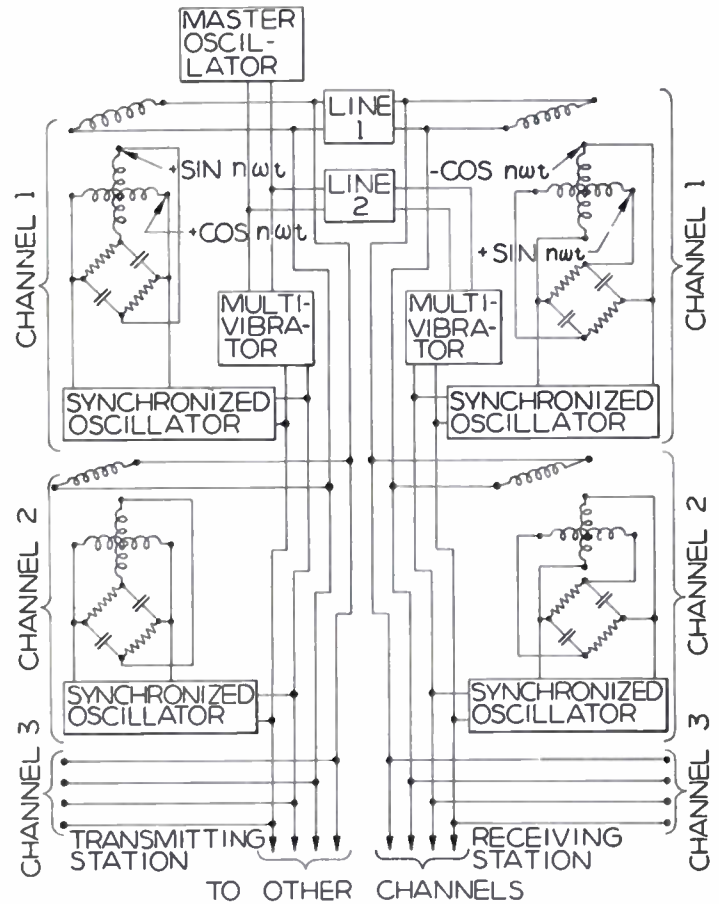

Fig. 1—Block diagram of multichannel synchro system.

First, considering the dynamics of the receiving synchros, it is seen that the instantaneous moment m_n tending to move the rotor of the synchro associated with any given channel is

$$m_n = Ke_r [e_{hn} \cos \phi_n' + e_{vn} \sin \phi_n'] \quad (19)$$

where k is a constant depending on the structure of the synchro, e_r is the instantaneous voltage impressed on the rotor, e_{hn} and e_{vn} are the instantaneous voltages impressed across the horizontal coil and vertical coil respectively, and ϕ' is the angle between the rotor and the horizontal stator.

It is evident that, in an ac-operated synchro system the unidirectional torque which tends to move the shaft to a new position is the average moment M taken over a period of time T equal to the period of the periodic term of lowest frequency. This average moment evidently is

$$M = \frac{1}{T} \int_0^T m_n dt$$

$$= \frac{K}{T} \int_0^T e_r [e_{hn} \cos \phi_n' + e_{vn} \sin \phi_n'] dt. \quad (20)$$

It is now necessary to consider the transmitting synchros in order to evaluate e_r , e_{hn} , and e_{vn} . At the transmitting terminal, a master oscillator drives a multivibrator which generates a nonsinusoidal wave, rich in harmonics, at a fundamental carrier frequency. This wave is picked up at each transmitting synchro unit from the oscillator bus, and impressed on a synchronized oscillator which is tuned to a harmonic of the fundamental carrier frequency. If the fundamental angular frequency is ω , the oscillator of any given channel will generate a wave having an angular frequency $n\omega$, where n is the number of the harmonic selected. The output of each oscillator is impressed on the horizontal stator directly and on the vertical stator through a phase network, which alters the phase of the carrier by 90° . The voltages across the stators induce corresponding voltages in the rotor coil which are impressed on the first line or radio channel. The line voltage due to a single synchro unit, then, is

$$e_{in} = E_{0n} \cos \phi_n \cos n\omega t + E_{0n} \sin \phi_n \sin n\omega t \quad (21)$$

where E_{0n} is the maximum amplitude of the modulated envelope and ϕ_n is the angle between the rotor and the horizontal stator.

Observing that each of the transmitting synchros will contribute a voltage to the line in accordance with (21) we have, for the total instantaneous line voltage, and for the receiving rotor voltage e_r , neglecting transmission loss,

$$e_i = e_r = \left[\sum E_{0n} \cos \phi_n \cos n\omega t + \sum E_{0n} \sin \phi_n \sin n\omega t \right], \quad (22)$$

an expression identical with (10)

The fundamental wave generated by the master oscillator is transmitted over a second line (or radio channel) to the receiving terminal, where it drives a multivibrator, the output of which is impressed in parallel on the inputs of synchronized oscillators associated with the various receiving synchros. The voltages impressed by the oscillators on the receiving horizontal and vertical stators through the phase networks are

$$e_{hn} = E_{kn} \sin n\omega t \quad (23)$$

and

$$e_{vn} = -E_{kn} \cos n\omega t. \quad (24)$$

We have now determined the values e_r , e_{kn} , and e_{vn} , required for substitution in the equation for the average moment of the receiving shaft (20). If we now let

$$KE_{kn} = \gamma_R \quad (25)$$

and choose to integrate over one period of the fundamental carrier wave, which is

$$T = \frac{2\pi}{\omega}$$

(20) becomes

$$M = \frac{\gamma_R \omega}{2\pi} \int_0^{2\pi/\omega} \left[\sum E_{0n} \cos \phi_n \cos n\omega t + \sum E_{0n} \sin \phi_n \sin n\omega t \right] \left[\sin n\omega t \cos \phi_n' - \cos n\omega t \sin \phi_n' \right] dt. \quad (26)$$

Reference to (10), (11), and (12) shows that (26) expresses a pair of product demodulation operations. The first term of the second factor of (26) is the multiplying factor of (12), also multiplied by another factor, $\cos \phi_n'$. If the expansion is carried out for this term only, it is seen that the result will be that of (12) multiplied by $\cos \phi_n'$. Similarly, expansion involving the second term of the second factor yields the result of (11) multiplied by $-\sin \phi_n'$. The algebraic sum of the two operations is

$$M = \frac{\gamma_R E_{0n}}{2} [\sin \phi_n \cos \phi_n' - \cos \phi_n \sin \phi_n']$$

$$= \frac{\gamma_R E_{0n}}{2} [\sin (\phi_n - \phi_n')]. \quad (27)$$

The receiving synchro has thus carried out a multi-channel product demodulation operation, in which it has selected its own particular modulating function, and rejected those of other channels. It is seen that in accordance with (27), the result is a steady, unidirectional moment which will turn the shaft until the two angles become equal, when the angle of the sine function becomes $(\phi_n - \phi_n') = 0$, and the torque ceases, leaving the transmitting and receiving synchros in alignment at the same angle. It is to be observed that, in effect, this is a frequency-division multiplex system, in which the supply voltages of the synchros themselves serve as carriers, eliminating complicated subcarrier arrangements.

A WIDE-DEVIATION PHASE-MODULATION SYSTEM

Fig. 2 is a schematic diagram of a "phase converter" adapted to produce the modulating waves defined by (16) and (17), which may be used to generate the phase-modulated wave of (18). This converter consists of a cathode-ray tube of almost conventional design, except that the phosphor has been replaced by an anode for collecting the electrons of the beam, and a mask (at anode potential) has been interposed in the beam immediately in front of the anode. The vertical plates are connected to a radio-frequency oscillator, the horizontal plates to a source of the modulating voltage e_{mn} . It is to be observed that the extent to which the beam is intercepted by the mask, in its vertical excursion, is dependent on its horizontal position, which, in turn, is determined by e_{mn} . The anode is connected to an integrating device, which may be a filter, or merely a simple condenser, so that the output of the anode circuit is proportional to the average value of the anode current

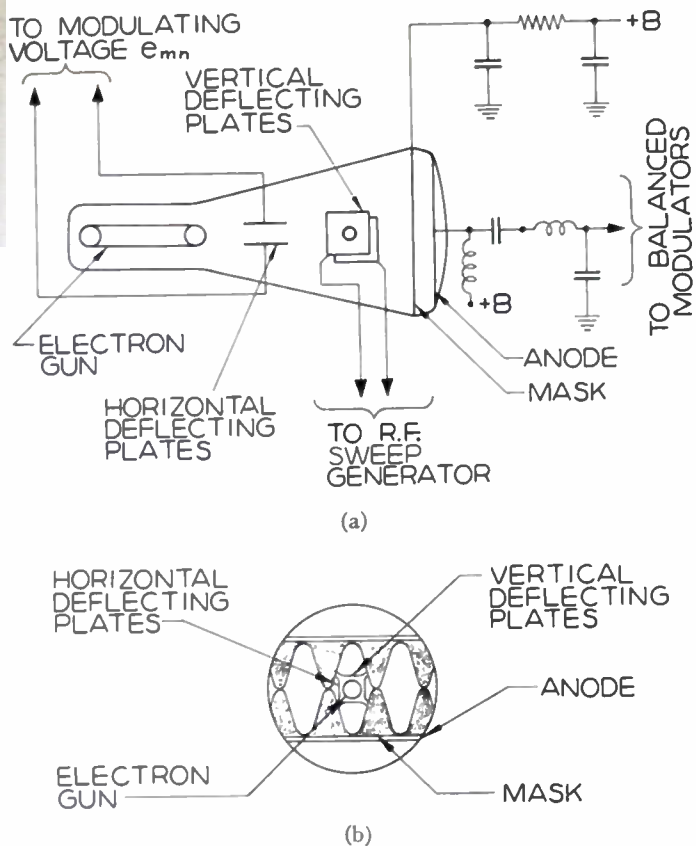

Fig. 2—Schematic diagram of "phase converter" for producing function $e_{pn} = E_{mn} \cos ke_{mn}$ (a) Top view. (b) End view.

during the radio-frequency cycle. By suitably choosing the outlines of the mask, it is seen that it is possible to produce an output function which is proportional to a large variety of functions of the modulating voltage e_{mn} . In this particular case, we are interested in producing an output voltage

$$e_{pn} = G_{an}(t) = E_{mn} \cos ke_{mn} \tag{28}$$

or

$$e_{pn} = G_{bn}(t) = E_{mn} \sin ke_{mn} \tag{29}$$

in accordance with (16) and (17).

Considering for the time being (28) only, it is now necessary to determine the shape of the mask which will produce this output function. We first assume that the radio-frequency deflecting voltage is sinusoidal in character, the instantaneous vertical deflection y being represented by the expression

$$y = A \sin \omega_y t \tag{30}$$

where A is the maximum amplitude of the deflection, and ω_y is the angular frequency of the radio-frequency wave.

The anode current, during the intervals when the anode is not masked is

$$I_a = \frac{dQ}{dt} \tag{31}$$

where Q is the quantity of electricity existing in the circuit at time t , and I_a is a known and constant quantity, being the normal anode current of the tube when the beam is not intercepted.

The average current during a time interval T is

$$I_{ave} = \frac{Q}{T} \tag{32}$$

and since, from (31)

$$Q = \int_0^{T_p} I_a dt = I_a T_Y \tag{33}$$

where T_Y is the time when current ceases to flow, we have, for the average current at a horizontal displacement x

$$I_x = \frac{I_a T_Y}{T} \tag{34}$$

Since the configuration of the mask is symmetrical, we need take the average over only one-quarter cycle of the radio-frequency deflecting wave, all other quarter cycles being identical. The time interval over which the integration is carried out is, then,

$$T = \frac{1}{4} \cdot \frac{2\pi}{\omega_y} = \frac{\pi}{2\omega_y} \tag{35}$$

and the average current is, by substitution in (34),

$$I_x = \frac{2I_a T_Y \omega_y}{\pi} \tag{36}$$

It is now necessary to express the time T_Y at which the beam is cut off in terms of the vertical displacement of the beam, in order to determine the required vertical distance Y from the horizontal center line to the edge of the mask, at horizontal displacement X . Returning to (30) we find that the time at which the beam is displaced a vertical distance y is

$$t = \frac{1}{\omega_y} \sin^{-1} \frac{y}{A} \tag{37}$$

Then the time T_Y at which the beam is displaced vertically a distance Y to the edge of the mask is

$$T_Y = \frac{1}{\omega_y} \sin^{-1} \frac{Y}{A} \tag{38}$$

Substituting (38) in (36) we have

$$I_x = \frac{2I_a}{\pi} \sin^{-1} \frac{Y}{A} \tag{39}$$

It is now required so to choose Y as a function of X in (39) that I_x will be a cosine function of x . It is immediately seen that I_x cannot be an exact cosine function of x , because the beam current can never be negative. Instead, we set up as the objective which we wish to produce the equation

$$I_x = \frac{I_{mn}}{2} \left(1 + \cos \frac{2\pi x}{\lambda} \right) \quad (40)$$

where I_{mn} is the amplitude of the output current wave, and λ is the distance between successive crests of the mask configuration. This is, of course, the equation of a direct current with a cosine wave of the same amplitude superimposed on it. Then we have, from (39),

$$\frac{2I_a}{\pi} \sin^{-1} \frac{Y}{A} = \frac{I_{mn}}{2} \left(1 + \cos \frac{2\pi X}{\lambda} \right). \quad (41)$$

Simplifying this relationship, we obtain, for the equation of the edge of the mask,

$$Y = .1 \sin \left[\frac{\pi I_{mn}}{4I_a} \left(1 + \cos \frac{2\pi X}{\lambda} \right) \right]. \quad (42)$$

The output current wave given by (40) is now passed through a filter to eliminate the direct current. The alternating current component sets up a voltage wave with an amplitude E_{mn} across the load impedance, to produce the required voltage wave

$$e_{pn} = E_{mn} \cos \frac{2\pi x}{\lambda} = E_{mn} \cos ke_{mn}, \quad (43)$$

where

$$k = \frac{2\pi c}{\lambda} \quad (44)$$

and c is a constant expressing the number of centimeters deflection per volt.

In a similar manner, it is found that the equation of

the mask edge required to produce the sine modulating function of (29) is

$$Y = .1 \sin \left[\frac{\pi I_{mn}}{4I_a} \left(1 + \sin \frac{2\pi X}{\lambda} \right) \right]. \quad (45)$$

CIRCUITRY AND PREDICTED RESULTS

Fig. 3, which is largely self-explanatory, shows a block diagram of a complete product phase-modulation system. The circuit contains 6 tubes, including the sweeping oscillator and the carrier source, as it is assumed that dual tubes will be employed in the balanced modulators.

Fig. 4 is a graph showing the outlines of the edge of the mask in the cosine phase converter. In plotting this

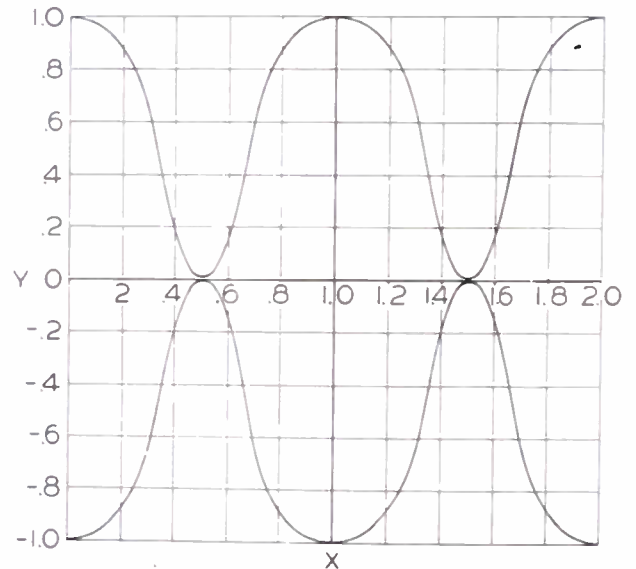

Fig. 4—Outline of cosine phase-converter mask.

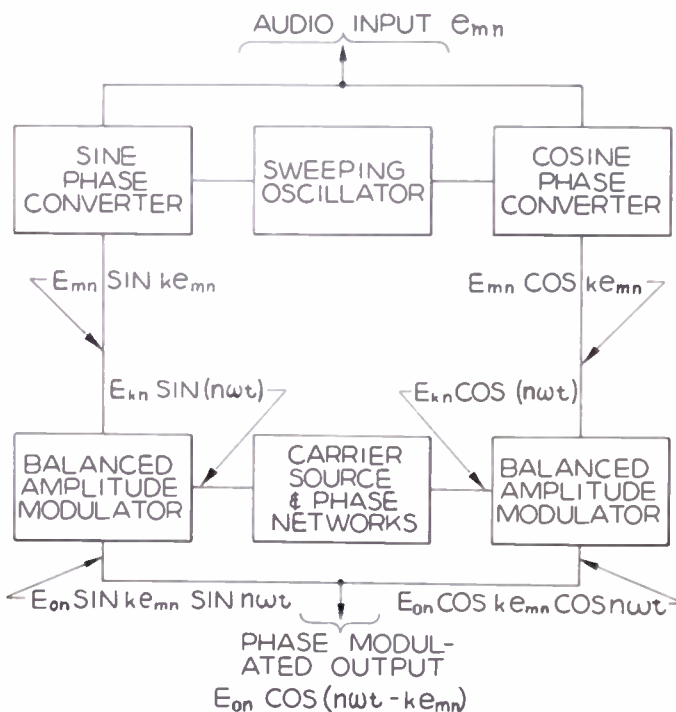

Fig. 3—Block diagram of product phase-modulation system.

curve, (42) has been simplified by making the following assumptions:

$$I_{mn} = I_a \quad (46)$$

$$A = 1 \text{ cm} \quad (47)$$

$$\lambda = 1 \text{ cm}. \quad (48)$$

Under these conditions, (42) reduces to

$$Y = \sin \left[\frac{\pi}{4} (1 + \cos 2\pi X) \right], \quad (49)$$

which is the function plotted in Fig. 4. Equation (43) also becomes

$$e_{pn} = E_{mn} \cos 2\pi x. \quad (50)$$

Similarly, the equation of the edge of the mask in the sine phase converter, making the same assumptions regarding the values of A and λ , becomes

$$Y = \sin \left[\frac{\pi}{4} (1 + \sin 2\pi X) \right] \quad (51)$$

and the output voltage of the sine phase converter is

$$e_{pn} = E_{mn} \sin 2\pi x. \quad (52)$$

From Fig. 4, and (50) and (52), it is evident that the wave goes through a complete cycle (2π radians) of phase deviation as the beam sweeps to the right or left a distance of 1 centimeter. With existing oscilloscopes it is no problem to maintain a linear relation between deflecting voltage and beam displacement for displacements from the center line as large as 5 inches or 12.5 centimeters. It therefore seems probable that, with this system, phase deviations as high as $\pm 25\pi$ radians may be achieved.

CONCLUSION

It has been the primary objective of this paper to present the principles of product phase modulation and demodulation from a general standpoint. This has been done in connection with (4) to (14).

In addition, an attempt has been made to disclose two possible applications of the general principles discussed. Of these, the multichannel synchro system appears to offer some promise from the standpoint of equipment simplicity and cost; and the wide-deviation phase-modulation system is apparently capable of producing a considerably greater deviation than any other system so far proposed.

ACKNOWLEDGMENTS

The author is indebted to W. W. Salisbury, Director of the Research Division of the Collins Radio Company, for his encouragement, and for the opportunity to do this work; and to his colleagues in the Collins Radio Company, D. O. McCoy, J. J. Livingood, I. H. Gerks, and J. W. Clark, for their helpful discussions of the subject.

Determination of Attenuation from Impedance Measurements*

R. W. BEATTY†, MEMBER, IRE

Summary—Heretofore, the determination of attenuation from impedance measurements has been applied to cases in which the reflections from the attenuator terminals were negligibly small. In the proposed method no restrictions are placed upon the attenuator except the requirement that it be a linear, passive, four-terminal network.

The dissipative and reflective components of attenuation A_D and A_R are measured separately. A_D is shown to be a function of the efficiency of the attenuator. The efficiency is determined from reflection coefficient measurements of the short-circuited attenuator. A_R is determined from a single voltage-standing-wave ratio measurement of the attenuator when terminated in a matched load.

Experimental data show close agreement with an independent method of determining attenuation.

I. INTRODUCTION

THE DETERMINATION of attenuation from impedance measurements of a short-circuited attenuator is well known.¹ It is usually assumed that the reflections caused by mismatch at the attenuator terminals are negligibly small. The purpose of this paper is to present an impedance method in which no restrictions are placed upon the attenuator except the requirement that it be a passive, linear four-terminal network.

Although the method is of general application, it has been developed for use with ultra-high-frequency and microwave measuring equipment. At lower frequencies

the method may be used, if measured impedances are converted to reflection coefficients.

II. THEORY

Attenuation is defined as the insertion loss which occurs when an attenuator is placed in a matched system.² In the matched transmission-line system shown in Fig. 1, the generator and load impedances are equal to the characteristic impedance of the line. The generator

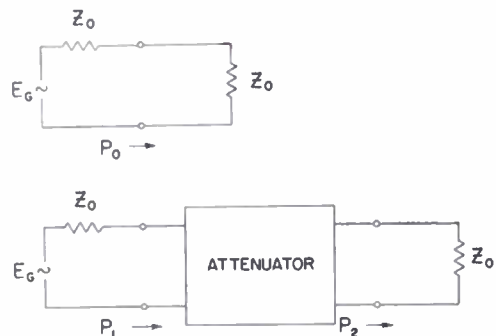

Fig. 1—Insertion loss in a matched system. $A_T = 10 \log_{10} (P/P_2)$.

voltage E_G is assumed to remain constant when the attenuator is inserted.

Referring to Fig. 1, it is apparent that the attenuation in decibels is

$$A_T = 10 \log_{10} \frac{P_0}{P_2}. \quad (1)$$

* Decimal classification: R247×R244. Original manuscript received by the Institute, October 14, 1949; revised manuscript received, April 24, 1950.

† National Bureau of Standards, Washington, D. C.
¹ C. G. Montgomery, "Technique of Microwave Measurements," McGraw-Hill Book Co., Inc., New York, N. Y., vol. 11, p. 818; 1947.

² See page 680 of footnote reference 1.

The total attenuation may be separated into two components by the following steps:

$$\frac{P_0}{P_2} = \frac{P_0}{P_1} \frac{P_1}{P_2} \quad (2)$$

$$A_T = 10 \log_{10} \frac{P_0}{P_1} + 10 \log_{10} \frac{P_1}{P_2} \quad (3)$$

The first component A_R is caused by reflection and the second component, A_D is caused by dissipation of energy. It has been shown³ that A_R is given by

$$A_R = 10 \log_{10} \frac{(\sigma_{1m} + 1)^2}{4\sigma_{1m}} \quad (4)$$

where σ_{1m} equals the voltage-standing-wave ratio measured at the input terminals of the attenuator when terminated in a matched load.

The determination of A_D involves the measurement of the power ratio P_1/P_2 or its reciprocal, the efficiency η_m of the attenuator when terminated in a matched load. The efficiency of a network can be determined from reflection coefficient measurements.⁴⁻⁶ In this method, the attenuator is reversed and its normal input terminals are connected to a variable reactance usually consisting of a short-circuited section of transmission line of variable length. The reflection coefficient measured at the other terminal pair is a function of the terminating reactance and has a circular locus. The radius R_2 of this reflection coefficient circle is equal to the efficiency η_m . The equation for A_D is:

$$A_D = 10 \log_{10} \frac{1}{\eta_m} = 10 \log_{10} \frac{1}{R_2} \quad (5)$$

III. MEASUREMENT PROCEDURE

The arrangement of apparatus for the individual measurement of A_R and A_D is shown in Fig. 2. In the measurement of A_R , it is necessary to match the load as closely as possible. The measured value of σ_{1m} is then substituted in (4) to obtain A_R .

The determination of A_D involves reversal of the attenuator and termination of its normal input terminals in a lossless variable reactance. The voltage-standing-wave ratio σ_N and the position l_N of the voltage node are measured with the standing-wave machine for selected positions of the short-circuiting plunger as it travels a total distance of half-wavelength. The reflection coefficient Γ_N may be calculated in each case from the following equation:⁷

$$|\Gamma_N| |\psi_N| = \frac{\sigma_N - 1}{\sigma_N + 1} |2bl_N \pm \pi| \quad (6)$$

The measured values of reflection coefficient are plotted as in Figs. 3 and 4. The circle is drawn which best fits the measured points and the radius R_2 of this circle yields A_D when substituted in (5).

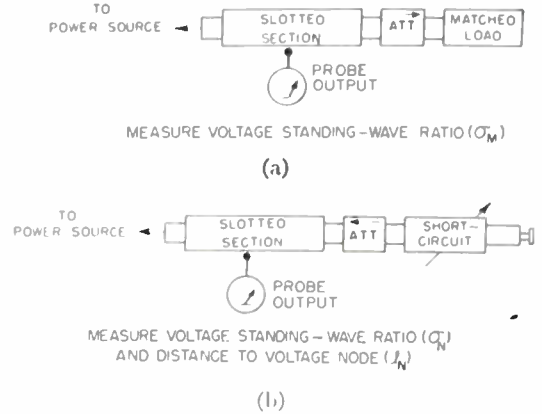

Fig. 2—Block diagram of apparatus used for measuring (a) reflective component of attenuation, and (b) dissipative component of attenuation.

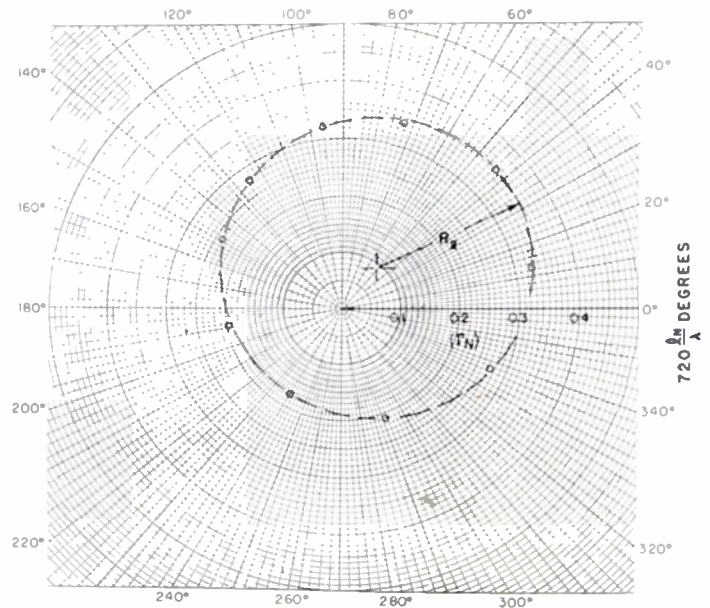

Fig. 3—Measured reflection coefficients of 6-dB attenuator, $A_D = 5.74$ db, 1,000 Mc, $R_2 = 0.266$.

The total attenuation A_T is

$$A_T = A_R + A_D = 10 \log_{10} \frac{(\sigma_{1m} + 1)^2}{4R_2\sigma_{1m}} \quad (7)$$

This equation is represented by the nomogram of Fig. 5.

IV. EXPERIMENTAL DATA

In order to further illustrate the method, experimental data were obtained on commercially available coaxial attenuators.

A standard 7/8-inch rigid coaxial transmission line was used with a Microline Model 361A impedance meter. Measurements were made at 1,000 Mc on four attenuators having nominal values of 3, 6, 10, and 20

³ See page 681 of footnote reference 1.

⁴ William Altar, "Measurement of dielectric properties of lossy materials," Westinghouse Lab. Res. Report R-94318-E, September 13, 1944.

⁵ William Altar, "Q-circles," Proc. I.R.E., vol. 35, pp. 355-351, 1947; and pp. 478-485, May, 1947.

⁶ A. L. Cullen, "Measurement of microwave-transmission efficiency," Wireless Eng., vol. 26, pp. 255-258; August, 1949.

⁷ See page 476 of footnote reference 1.

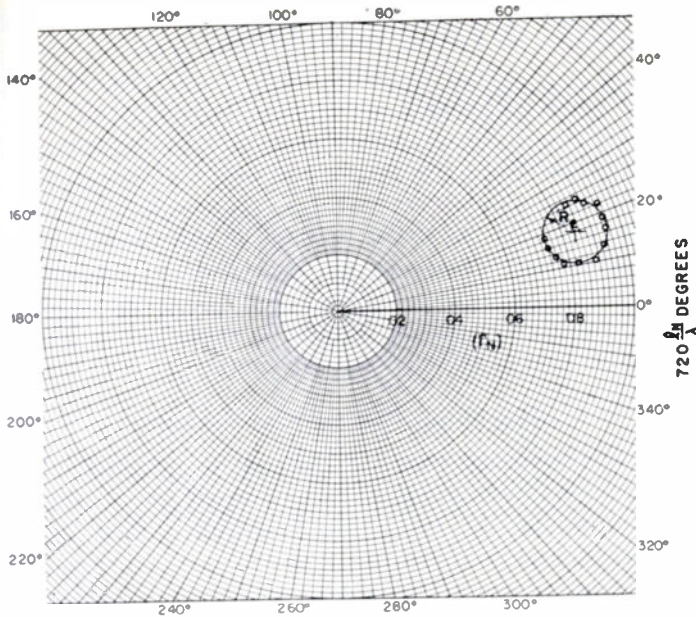

Fig. 4—Measured reflection coefficients of 20-db attenuator, $A_D = 19.74$ db, 1,000 Mc, $R_2 = 0.0106$.

decibels. The observed data in the measurement of A_D are shown in Figs. 3 and 4. (Lack of space prohibits showing more data.) It is apparent that the measured circles either enclose the origin or lie completely outside. In each case, R_2 may be expressed in terms of the minimum and maximum value of voltage-standing-wave ratio measured as the position of the short-circuit changes.

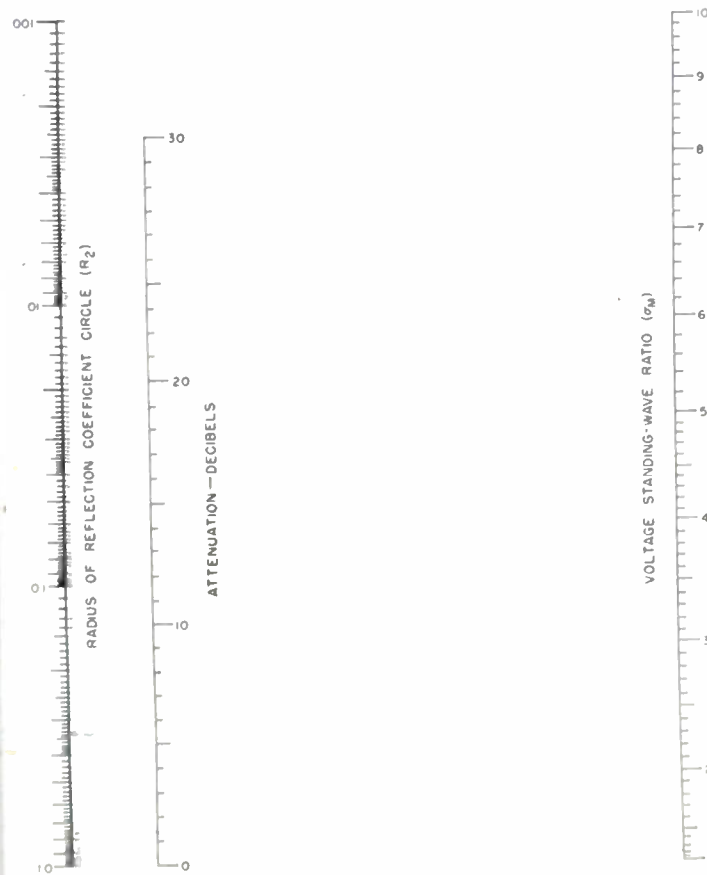

Fig. 5—Nomogram of equation $A_T = 10 \log_{10} (\sigma_{1m} + 1)^2 / 4R_2\sigma_{1m}$.

If the circle encloses the origin,

$$2R_2 = |\Gamma|_{\max} + |\Gamma|_{\min} = \frac{2(\sigma_{\max}\sigma_{\min} - 1)}{(\sigma_{\max} + 1)(\sigma_{\min} + 1)} \quad (8)$$

If the circle lies outside the origin,

$$2R_2 = |\Gamma|_{\max} - |\Gamma|_{\min} = \frac{2(\sigma_{\max} - \sigma_{\min})}{(\sigma_{\max} + 1)(\sigma_{\min} + 1)} \quad (9)$$

Although the radius R_2 can be obtained from the measurement of σ_{\max} and σ_{\min} , improved accuracy can be obtained by measuring a number of other points on the reflection coefficient circle.

In the measurement of A_R , the load impedance had a measured voltage-standing-wave ratio (VSWR) of 1.02. The data obtained in the measurement of A_R are shown in Fig. 6.

Nominal Value of Attenuation	MEASURED ATTENUATION					Difference
	Input VSWR	A_R	A_D	A_T	A_T From Power Ratio Method	
3 db	1.070	.005 db	287 db	288 db	285 db	.03 db
6 db	1.235	.048	5.74	5.79	5.75 db	.04 db
10 db	1.180	.030	9.50	9.53	9.53 db	.00 db
20 db	1.240	.050	19.74	19.79	19.81 db	.02 db

Fig. 6—Observed attenuation data.

The total attenuation A_T was also measured at 1,000 Mc by a power-ratio method using a bolometer detector⁸ which permits an accuracy better than ± 0.15 db. The results of both methods are shown in Fig. 6.

V. DISCUSSION OF ERRORS

The evaluation of the absolute accuracy of the proposed method has not been completed because of the complexity of the problem in the case of A_D .

However, the limited amount of experimental data obtained indicates that the impedance method accuracy is comparable with that of power ratio methods over the range of values considered. The very close agreement of the two methods is felt to be partly fortuitous, especially in the case of the 20-db attenuator.

The errors in the measurement of VSWR and nodal position have been related⁹ to the error in measurement of relative voltage in a slotted-section impedance machine. From these studies, it is to be expected that best accuracy is obtained for intermediate values of attenuation.

Besides these errors in measurement, the fact that it is difficult to obtain a perfectly matched load and a lossless variable reactance contribute to the over-all error.

⁸ Referred to as the "Ballantine Voltmeter Method" in the book "Technique of Microwave Measurements," by C. G. Montgomery, pp. 806, 841, as cited in footnote reference 1.

⁹ Errors of this nature were discussed in a paper by H. E. Sorrows, W. E. Ryan, and R. C. Ellenwood, "Evaluation of the accuracy of impedance measurements made with a slotted section of transmission line," presented, URSI-IRE Meeting, Washington, D. C., May 2, 1949.

Current Distributions on Transmitting and Receiving Antennas*

T. MORITA†, ASSOCIATE, IRE

Summary—A method for the direct measurement of the amplitude and phase of current and charge distribution along cylindrical antennas is presented for both transmission and reception. This method is applicable not only to the cylindrical antenna treated here but to many other antennas which may be used over a ground screen. The measured distribution on the transmitting antenna is continued into the coaxial line so that a complete picture of the system as a whole is obtained. The measured distribution on the receiving antenna is then shown to vary as a function of the terminating load as predicted by theory.

I. INTRODUCTION

UP TO THE PRESENT time, measurements of distributions on antennas have been limited to the absolute value of current or charge.^{1,2} Adopting the concept of the traveling-wave picture, a current wave can be assumed traveling to the end of the antenna and then being reflected back. The result obtained by assuming a 180-degree phase change at a minimum point indicates that there is no radiation. Actually, however, phase reversal takes place by means of phase rotation rather than by the amplitude going to zero, so that the current at any point on the antenna may be decomposed into two components, one in phase with the driving voltage, the other in phase quadrature.

The most recent experiment reported in this field involves the determination of phase by a graphical procedure based on the equation of continuity.³ In discussing the method, the author states that since the equation of continuity is a differential relation, graphical procedure must be followed and a high degree of accuracy cannot therefore be expected in the estimate of phase. In this paper, both amplitude and phase of current and charge on the antenna are measured directly and the measurements are continued into the coaxial transmission line so that a complete picture of the system is obtained. Measurements made on transmitting antennas indicate a terminal-zone effect identical with the discontinuities present in waveguide theory, where higher-order modes are introduced to satisfy the boundary condition at the discontinuity. Only for the case

of the unloaded receiving antenna is this discontinuity absent so that a much better correlation with theory is obtained. The measured results on the receiving antenna show the large variation possible in current distribution as a function of the load impedance.

II. MEASURING SETUP AND TECHNIQUE

It has been customary in the past to measure transmission-line impedance by using a small probe inserted in the coaxial line through a longitudinal slot on the outer conductor. In the setup to be described the alternative procedure is followed, incorporating a slotted inner conductor from which the probe protrudes. In this arrangement, the inner conductor may be extended over a ground screen and the extension used as an antenna, thereby permitting the probe to be moved both inside the line and on the antenna to measure the complete distribution of current or charge. The schematic diagram of Fig. 1 shows the rack-and-pinion arrangement for obtaining the continuously variable length of an-

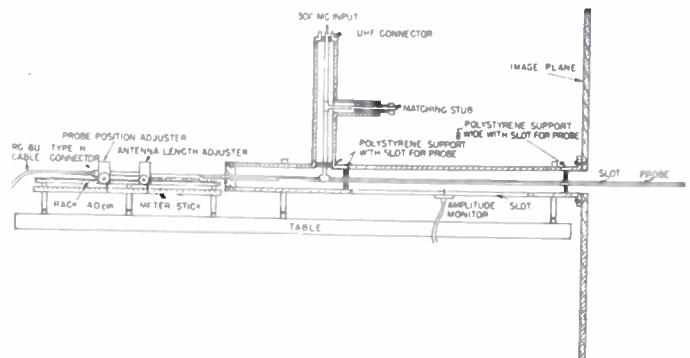

Fig. 1—Schematic diagram of measuring line.

tenna. The line leading from the probe to the detector is placed inside the inner conductor so that it is entirely shielded from radiation, thereby eliminating any perturbation of the radio-frequency field by this cable.

A. Amplitude Measurement

By the application of the first of two boundary conditions imposed on the metallic surface, the tangential component of the magnetic field is directly proportional to the surface-current density. Thus, by the use of a small shielded loop probe—in this case extending 2 mm over the surface of the antenna and 5 mm in width—the current distribution measurement can be made. The shielded loop is used to insure the elimination of the "dipole mode" pickup and to obtain a simple transformation of the loop to the coaxial detecting system.

The second boundary condition on the metallic surface requires that the charge density be proportional to

* Decimal classification: R221XR326.611. Original manuscript received by the Institute, January 23, 1950. Presented, 1949 National IRE Convention, New York, N. Y., March 8, 1949. The research reported in this paper was made possible through support extended Cruft Laboratory, Harvard University, by the Naval Department (Office of Naval Research), the Signal Corps, U. S. Army, and the U. S. Air Force, under ONR Contract N5ori-76 T. O. 1.

† Cruft Laboratory, Harvard University, Cambridge, Mass.

¹ H. E. Gihring and G. H. Brown, "General consideration of tower antennas for broadcast use," *Proc. I.R.E.*, vol. 23, pp. 311-356; April, 1935.

² L. S. Palmer and K. G. Gillar, "The distribution of uhf currents in long transmitting and receiving antennae," *Proc. IEE*, vol. 13, p. 285; 1938.

³ G. Barzilai, "Experimental determination of current and charge along cylindrical antennas," *Proc. I.R.E.*, vol. 37, pp. 825-829; July, 1949.

the normal component of the electric field. Accordingly, a small dipole protruding from the slotted inner conductor is used as a charge-indicating probe.

Fig. 2 is a block diagram of the measuring setup. For the transmitting antenna, connection *AB* is made. The signal source is a 300-Mc amplitude-modulated transmitter. The signal picked up by the probe is detected by

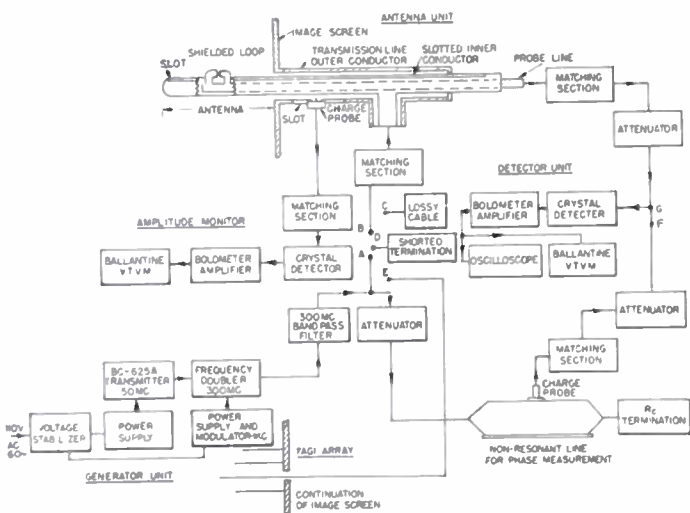

Fig. 2—Block diagram of measuring setup.

a 1N21B crystal. In the case of the receiving antenna a Yagi array located $7\frac{1}{2}$ wavelengths away is used to excite the unit of Fig. 1. To obtain the various loads for the receiving antenna, connection *BD* or *BC* is made. By measuring the standing-wave distributions in the line and referring the impedance to the antenna terminals, any desired loading may be obtained.

B. Phase Measurements

For a dissipationless transmission line terminated in its characteristic impedance, the current and voltage distributions at any point *x* along the line are given by the form

$$A = A_0 e^{-i\beta x},$$

so that the phase is retarded linearly with *x* while the amplitude remains constant. If the signal whose relative phase is to be determined is mixed with the reference signal from the probe on the Z_c terminated line, the resultant signal is the vector sum of the two signals. By moving the sliding probe along the "flat" line to a point where the two signals are 180 degrees out of phase, a minimum indication is obtained on the meter which establishes a reference point for measuring the relative phase. A variation in phase of the probe signal is compensated by a measured displacement Δx of the sliding probe, so that the relative phase difference $\Delta\phi$ between any two points is given by

$$\Delta\phi = \frac{2\pi\Delta x}{\lambda_g},$$

where λ_g is the wavelength inside the nonresonant transmission line. In Fig. 2, phase measurement is effected by connection *GF*.

III. MEASURED RESULTS

A. Transmitting Antenna

In Figs. 3 and 4 are shown the measured distributions of current and charge, together with their phases both inside the transmission line and on the antenna, for antenna lengths $\beta_0 h = \pi/2$ ($h = \lambda/4$) and $\beta_0 h = \pi$ ($h = \lambda/2$),

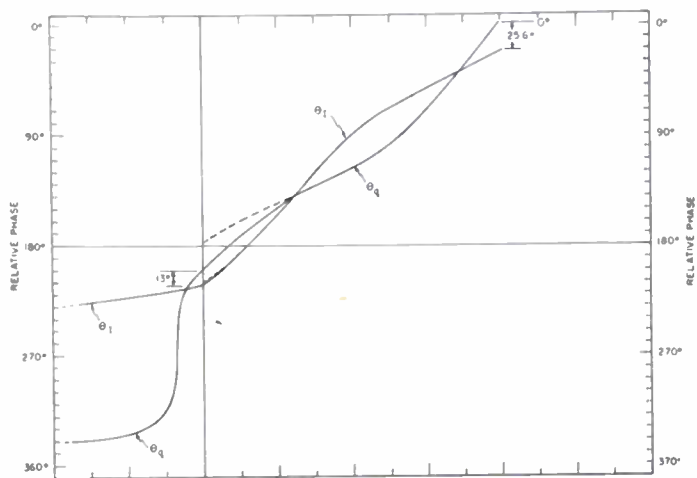

(a)

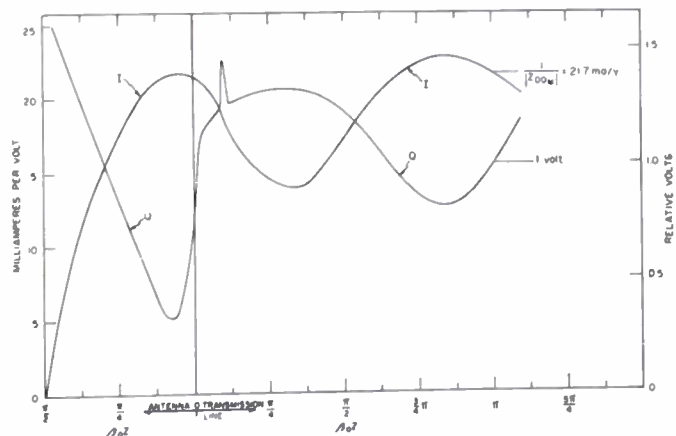

(b)

Fig. 3—Transmitting antenna current and charge distribution, $h = \lambda/4$.

(a) $\beta_0 h = (\pi/2)$. $\Omega = 2 \log (2h/a) = 10.12$

$$Z_{00} = 43 + j22.5 = 58.5 \angle 27.7^\circ$$

$$Z_{00M} = 41.9 + j20 = 46 \angle 25.6^\circ$$

θ_q = phase of charge distribution

θ_I = phase of current distribution

(b) I = current distribution; Q = charge distribution.

with $\beta_0 = 2\pi/\lambda$. Inside the transmission line the current and charge distributions behave in accordance with conventional transmission-line theory, with the current maximum occurring at the point of charge minimum. By taking the ratio of maximum to minimum of either current or charge distribution, and noting the position of the minimum with respect to the antenna terminals,

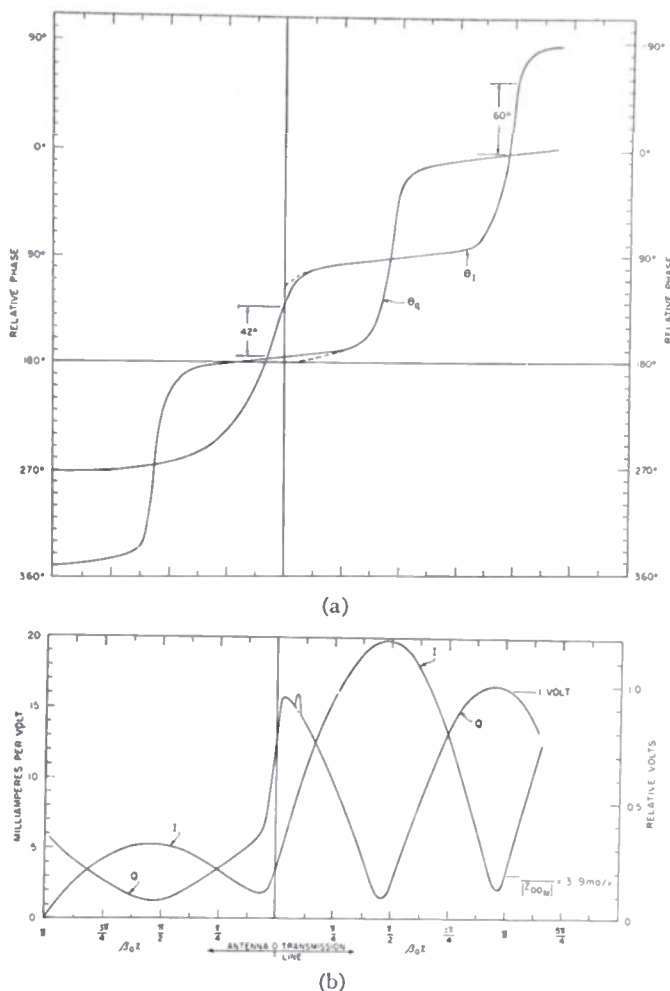

Fig. 4—Transmitting antenna current and charge distribution, $h = \lambda/2$.

(a) $\beta_0 h = \pi$, $\Omega = 11.5$

$$Z_{00} = 206 - j300 = 364 \angle -55.5^\circ$$

$$Z_{00M} = 157 - j272 = 314 \angle -60^\circ$$

θ_2 = phase of charge distribution

θ_1 = phase of current distribution

(b) I = current distribution; Q = charge distribution.

an impedance for the antenna load may be obtained. This is indicated as Z_{00M} in the figure. This measured value of impedance corresponds to the measured impedance exactly a half wavelength from the gap. The necessity for defining impedance in this manner may be seen from the wave picture inside the transmission line. At some distance back of the gap, only the dominant *TEM* mode is present. At the gap, however, higher-order modes are introduced to satisfy the boundary conditions at the discontinuity. That this is the case may be seen by the abrupt change in charge distribution and in the behavior of the phase distribution at the discontinuity. The sharp rise in charge distribution at a point $\beta_0 z = 0.314$ from the gap must not be confused with the gap discontinuity, however; it is to be attributed to the change in the dielectric constant due to the 1/8-inch polystyrene bead support for the inner conductor.

At a half wavelength from the gap, where the impedance is defined, only the dominant *TEM* mode is present, so that the charge distribution is proportional to the voltage distribution. Accordingly, if the voltage at this point is arbitrarily set at 1 volt, the admittance gives directly the current amplitude in milliamperes per volt. Further, at a point of current and charge maximum (or current and charge minimum), the current and charge are in phase. Thus, even though two independent measurements have been made for relative current and charge phase distribution, these two distributions can be directly correlated. Inside the transmission line, the phase distribution curves thus intersect at distances corresponding to a quarter wavelength. At any point, the phase difference between current and charge gives the phase angle of the impedance presented at that point by the antenna. For example, at a half wavelength from the gap, the respective phase differences of 26 degrees and 60 degrees for $\beta_0 h = \pi/2$ and π give the phase angle of the apparent impedance Z_{00M} . This differs slightly from the phase angle of the antenna impedance Z_{00} since the latter value has been corrected for the change in dielectric constant due to the polystyrene support. For $\beta_0 h = \pi/2$, the impedance of the antenna is close to that of the characteristic impedance of the transmission line ($Z_c = 60.6 \Omega$) so that the standing-wave ratio is not very high ($\text{SWR} = 1.65$) nor the phase variation very rapid. For $\beta_0 h = \pi$, the standing-wave ratio is high ($\text{SWR} = 10.6$) and the phase variation correspondingly rapid at the point of current minimum. For a line terminated in its characteristic impedance the phase varies linearly with distance; for a line terminated in an open or short circuit the phase varies abruptly as a step function.

At the gap terminals the deviation from normal transmission-line behavior may be seen from a comparison of the actual phase deviation with the normal phase deviation shown by the dotted line. The normal phase distribution is obtained from the distribution back of the gap where only the dominant *TEM* mode is present. The large mismatch between antenna and transmission line is noticeable for the $\beta_0 h = \pi$ case, where the maximum current amplitude inside the transmission line is about four times that of the maximum amplitude on the antenna. For $\beta_0 h = \pi/2$ the maximum amplitudes are nearly equal.

In Fig. 5 is shown the measured impedance, corrected for the bead support but not for the discontinuity at the gap terminals, compared with the theoretical values from the second-order King-Middleton solution for the cylindrical antenna.⁴ The theoretical model is based on the antenna center-driven by a slice generator of scalar-potential difference

$$V_0^e = \lim_{z \rightarrow 0} (\phi_{+z} - \phi_{-z}).$$

⁴ R. W. P. King and D. Middleton, "The cylindrical antenna, current and impedance," *Quart. Appl. Math.*, vol. III; January, 1946.

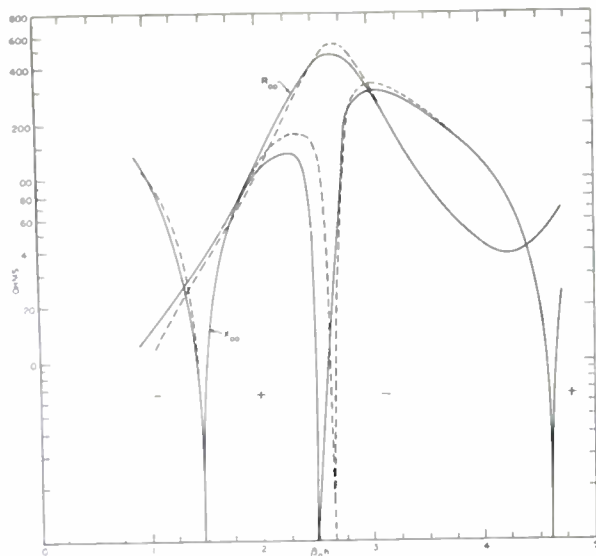

Fig. 5—Impedance curve for cylindrical dipole over ground screen; ——— measured; - - - - theoretical (King-Middle second order).

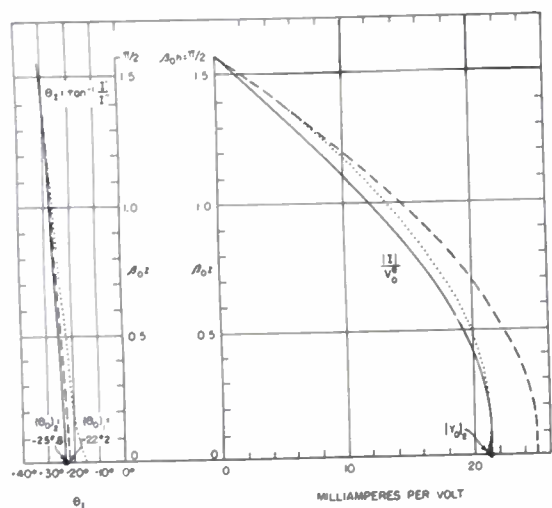

Fig. 6—Comparison of measured and theoretical current distribution, $h = \lambda/4$. ——— Second order (approximate); - - - - first order $\Omega = 10$; ····· experimental $\Omega = 10.12$.

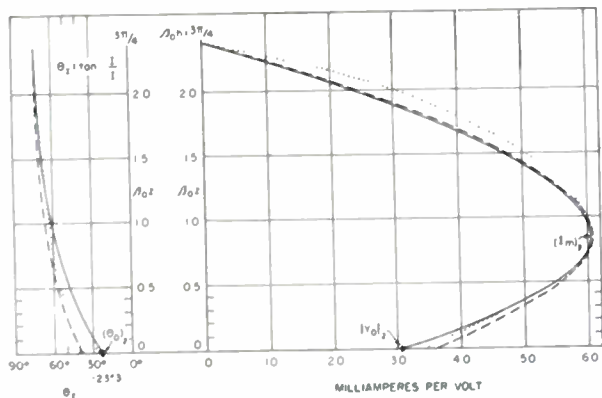

Fig. 7—Comparison of measured and theoretical current distribution, $h = 3/8\lambda$. ——— Second order (approximate); - - - - first order $\Omega = 10$; ····· experimental $\Omega = 10.76$.

In Figs. 6 through 9, the measured distributions for respective antenna lengths of $\beta_0 h = \pi/2$, $3\pi/4$ and $5\pi/4$ are plotted against the first-order and also the approximate second-order current distribution obtained from

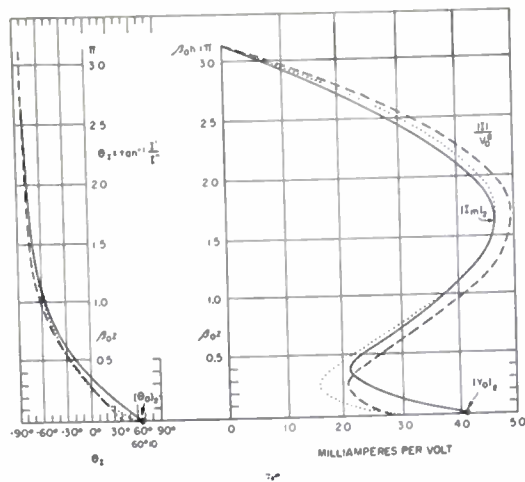

Fig. 8—Comparison of measured and theoretical current distribution, $h = \lambda/2$. ——— Second order (approximate); - - - - first order $\Omega = 10$; ····· experimental $\Omega = 11.5$.

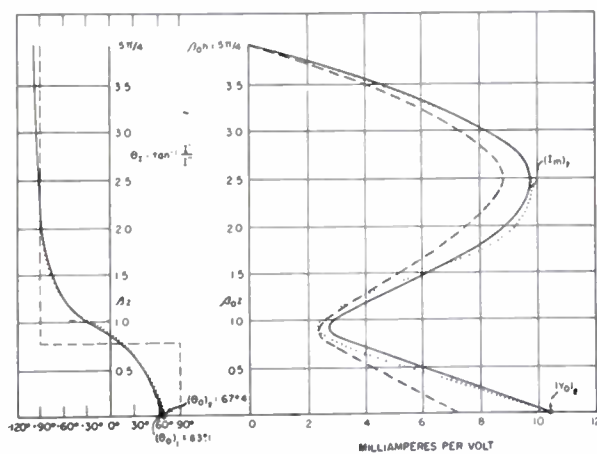

Fig. 9—Comparison of measured and theoretical current distribution, $h = 5/8\lambda$. ——— Second order (approximate); - - - - first order $\Omega = 10$; ····· experimental $\Omega = 11.94$.

the King-Middleton solution. Since there is no method for taking into account the discontinuity at the gap terminals, the measured amplitude curves have been normalized at the maximum of the theoretical curve, while the measured phase has been normalized at the end of the antenna. The phase variation on the antenna checks closely, except near the gap where the terminal-zone effect is present. Actually, in the absence of any terminal-zone effect, the current amplitude given in milliamperes per volt is identical with the absolute value of the antenna admittance, while the phase angle at the antenna terminals is the same as the phase angle of the admittance. Since the solution for the second-order distribution is excessively complicated, an approximate method based on the first-order distribution curves was used to obtain the theoretical curve. The input current of the first-order current distribution was corrected by the second-order impedances, while the maximum current on the antenna was found by assuming it to be proportional to the radiation resistance for the second-order theory. With these two points established, a curve based on the first-order distribution was

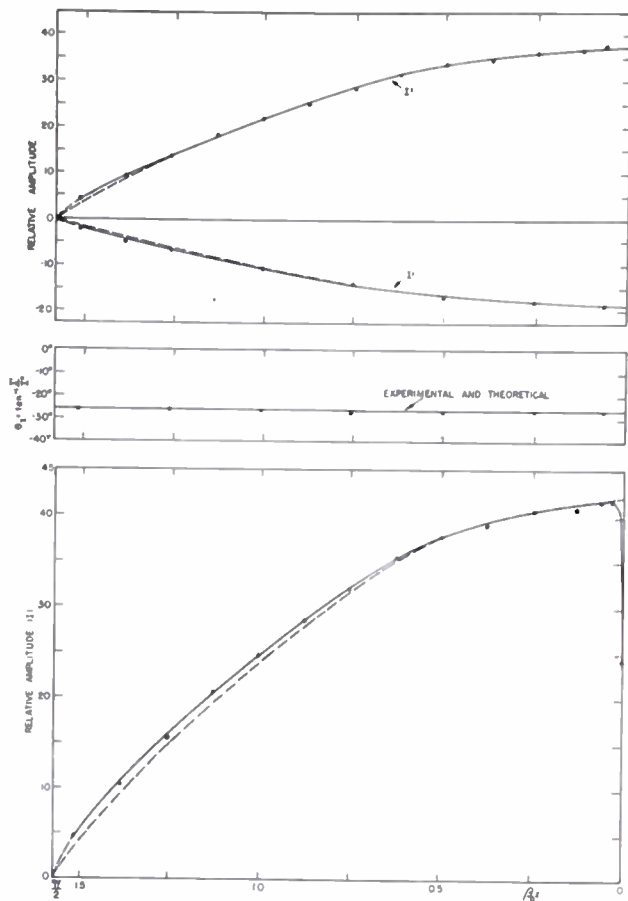

Fig. 10—Unloaded receiving antenna current distribution, $h = \lambda/4$, $\beta_0 h = (\pi/2)$, $\Omega = 10.12$. — Measured; - - - King-Middleton ($\Omega = 10$).

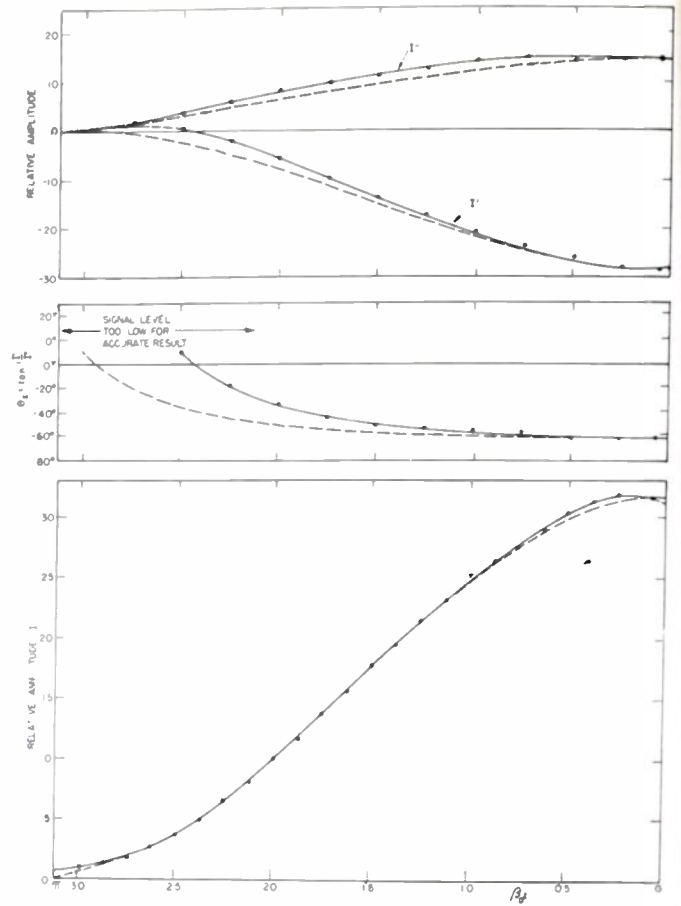

Fig. 11—Unloaded receiving antenna current distribution, $h = \lambda/2$, $\beta_0 h = \pi$, $\Omega = 11.5$. — Measured; - - - King-Middleton ($\Omega = 10$).

drawn in. The method, though in no sense rigorous, does nevertheless yield results which show the correct trend.

B. Receiving Antenna

Hitherto it has been customary in the treatment of the receiving antenna problem to assume the current along the antenna, whether loaded or unloaded, to be the same as a center-driven antenna of the same length. The assumption is based upon the indiscriminate use of the reciprocity theorem, the argument being that since the receiving and transmitting field patterns are identical, the current distributions must be the same. Von Korshenewsky⁵ first pointed out that when a plane wave is incident upon an unloaded antenna the current distribution is different from that of a transmitting antenna. By a fundamentally more rigorous analysis, Hallén⁶ and King and Harrison⁷ arrived at this same conclusion. It should be pointed out, however, that even though the current distributions may be different the impedances for transmission and reception are the same. This has been experimentally verified.⁸

⁵ N. Von Korshenewsky, "On the vibration of an oscillator in a radiation field," *Z. Tech. phys.*, vol. 10, p. 604; December 1929.

⁶ E. Hallén, "Theoretical investigation into the transmitting and receiving qualities of antennas," *Nova Acta Uppsala*, vol. II, pp. 1-44; November, 1938.

⁷ C. W. Harrison, Jr., and R. King, "The receiving antenna," *Proc. I.R.E.*, vol. 32, pp. 18-35; January, 1944.

⁸ D. G. Wilson, "Impedance Measurements on a Receiving Antenna," Doctoral Thesis, Harvard University; December, 1947.

The general solution of the integral equation obtained when a plane wave is incident upon an unloaded antenna is a superposition of two solutions

$$I(z) = I(-z)$$

and

$$I(z) = -I(-z).$$

The distribution of current obtained by using the symmetrical solution is unidirectional through the center of the antenna so that if a load is placed at the center a potential difference can be established across it. For the antisymmetrical solution, on the other hand, the current reduces to zero at the center and the currents in both halves flow simultaneously toward or away from the center so that no potential difference is established at the load. Since the total current is given by the superposition of these two solutions, the symmetrical solution describes only the total current at the center. For the special case in which the receiving and transmitting antennas are parallel—i.e., the incident plane wave is parallel to the receiving antenna—the antisymmetrical current vanishes and the total current is given only by the symmetrical component. Moreover, in the measurements to be described, the antennas are placed over a ground screen and hence from the principle of images it follows that only the symmetrical component can exist.

Unloaded Receiving Antenna: In Figs. 10 and 11 are shown the measured distributions for the unloaded receiving antenna ($Z_L=0$) for $\beta_0 h = \pi/2$ and π , compared with the theoretical curves of King. The correlation here is seen to be excellent. For this type of receiving antenna there is no gap terminal effect, since the antenna is short-circuited to the ground screen. The sharp drop in amplitude at $\beta_0 z = 0$ is due to the fact that the probe moves into the ground screen through a small slot. The currents I' and I'' are the components in phase and in phase quadrature with the incident E field obtained from the amplitude and phase data. For $\beta_0 h = \pi$, the distribution is seen to be completely different from that of the transmitting case shown in Fig. 4, with a current maximum occurring at the ground screen.

The Loaded Receiving Antenna: The effect of the unloaded receiving antenna considered above is merely to scatter the incident electromagnetic field after dissipating a small fraction of the total incident energy in ohmic losses due to finite conductivity of the antenna. In normal operation the receiving antenna is connected to a load impedance so that part of the incident energy will be utilized in the load, a small part dissipated in ohmic loss, and the rest re-radiated. With the aid of the compensation theorem it may be shown that the current distribution function at any point z along the receiving antenna, for any arbitrary load, can be decomposed into two functions $f_E(z)$ and $f_V(z)$, where $f_E(z)$ is the distribution function for the unloaded receiving antenna and $f_V(z)$ is the distribution function for the transmitting antenna. The amplitude and phase of the transmitting distribution $f_V(z)$ are functions of the terminating load impedance so that the actual distribution along the receiving antenna may be varied by varying the load impedance.

In Fig. 12 is shown the equivalent circuit for the receiving antenna at the terminals. The expression for I_0 , the current at the antenna terminals, is given by

$$I_0 = \frac{V}{Z_{00} + Z_L}$$

From this equivalent-circuit concept three important results follow:

1. The condition for maximum I_0 , when Z_L is variable, is the conventional resonance condition

$$Z_L = -jX_{00}$$

For this case a maximum broadside re-radiation occurs.
2. When the antenna is terminated in its conjugate impedance,

$$Z_L = Z_{00}^*$$

The power dissipated in the load is then equal to the power re-radiated, and maximum power transfer to the load occurs.

3. When the receiving antenna is terminated in an

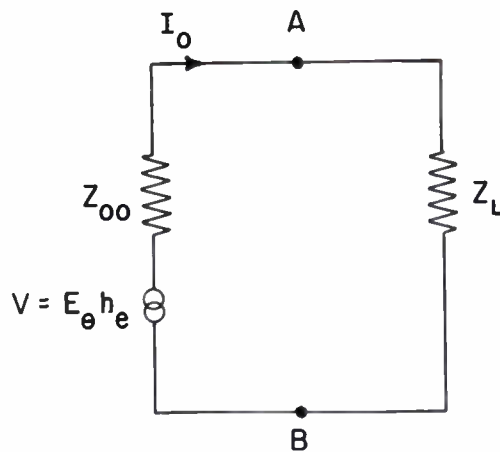

Fig. 12—Equivalent circuit of receiving antenna.
 Z_L = load impedance
 $Z_{00} = R_{00} + jX_{00}$ (self-impedance of antenna)
 E_0 = incident electric field
 h_e = effective height of antenna.

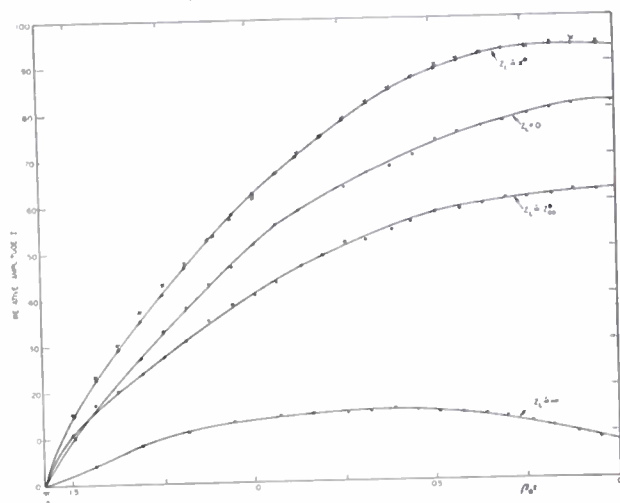

Fig. 13—Current distribution on receiving antenna for various loads. $\beta_0 h = (\pi/2)$. $\Omega = 12$. $E_{incident} = \text{constant}$. X = measured transmitting antenna current distribution.

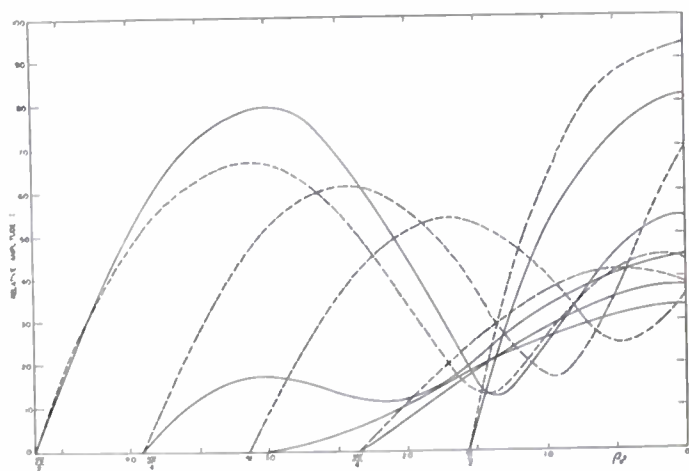

Fig. 14—Current distribution on receiving antenna. — $Z_L = 0$
- - - $Z_L = X_{00}^*$ with $E_{incident} = \text{constant}$.

open circuit

$$Z_L = \infty,$$

the current at the antenna terminals is zero.

To illustrate the three conditions, Fig. 13 shows the measured distribution for a quarter-wavelength antenna terminated by these three loads for the same incident E field. The top curve, showing the antenna terminated in its conjugate reactance, is compared with the distribution for the transmitting antenna given in Fig. 3. As predicted by theory, the transmitting-antenna distribution $f_V(z)$ predominates over the unloaded receiving-antenna distribution $f_E(z)$ shown below it for $Z_L=0$, and agrees very closely with the measured transmitting antenna current distribution. The open-circuited case $Z_L=\infty$ is only approximate because of the gap effect. This distribution was obtained by leaving the probe at the gap terminals and tuning a short-circuited section of transmission line for minimum current at the gap terminals. These results illustrate the wide range of distributions possible as functions of the load.

Finally, in Fig. 14 are the measured distributions for antennas of the respective lengths $\beta_0 h = \pi/2, 3\pi/4, \pi, 5\pi/4,$ and $3\pi/2$ for the unloaded and conjugate reactance terminations for the same incident E field. For $\beta_0 h = \pi/2$ and $\beta_0 h = 3\pi/2$ the current amplitudes are seen to be largest, while for $\beta_0 h = \pi$ the amplitude is very small. This indicates that the broadside scattering

should be greatest in the region of $\beta_0 h = \pi/2$ and $3\pi/2$, which is in agreement with the curves obtained by Van Vleck, Bloch, and Hamermesh.⁹

The effect upon the measured result of the slotted antenna, finite ground screen, probe loading, and the deviation of the incident E field from a plane wave front is discussed elsewhere.¹⁰

IV. CONCLUSION

A method has been presented for measuring the distribution of current and charge which gives not only the amplitude but also the phase on the antenna and on the transmission line. The method described is applicable to many other antennas which may be driven over a ground screen. At a later date a paper will be presented showing the results of current-distribution measurements on folded dipoles and closely coupled antennas.

ACKNOWLEDGMENT

The author gratefully acknowledges the guidance and encouragement of R. W. P. King of the Cruft Laboratory during the course of this investigation.

⁹ J. H. Van Vleck, F. Bloch, and M. Hamermesh, "Theory of radar reflections from wires or thin metallic strips," *Jour. Appl. Phys.*, vol. 18, pp. 274-294; March, 1947.

¹⁰ T. Morita, "The Measurement of Current and Charge Distributions on Cylindrical Antennas," Technical Report No. 66, Cruft Laboratory, Harvard University, February 1, 1949.



Correction and Clarification of

"Automatic Volume Control as a Feedback Problem"*

Bernard M. Oliver, author of the above-mentioned paper, has called to the attention of the editors an error in Fig. 7, and also noted that the paragraph following equation (19) is misleading. This equation is correct as given, but in discussing its significance he feels that it would be preferable to state the following:

"Hence the loop gain in an 'undelayed' system may be expressed solely in terms of the rf amplifier control characteristic and the operating control voltage. Two systems differing only in the amount of automatic volume control (avc) path amplification, $\mu_1(0)\beta(0)$, will have the same loop gain and the same rf amplification M when the control voltages V are equal. However this equality of control voltages will occur with different values of \bar{e}_1 and \bar{e}_2 in the two systems. Suppose, for example, that in system A , $\mu_1(0)\beta(0) = 1$, while in sys-

tem B , $\mu_1(0)\beta(0) = 10$. Then the same control voltage and loop gain will exist in both systems when \bar{e}_1 and \bar{e}_2 are 1/10 as great in system B as in system A . The higher $\mu_1(0)\beta(0)$ is made, the smaller the value of \bar{e}_1 required to produce a given loop gain."

From this it is apparent that the dotted curve (for the undelayed system) in Fig. 7 should be obtained by shifting the solid curve down one decade and to the left one decade. This latter shift was omitted in the published drawing. Obviously, all the curves should coincide for values of \bar{e}_1 so small that no avc action is produced. Since the curves are convex upward, the system with $\mu_1(0)\beta(0) = 10$ has more loop gain at any given value of \bar{e}_1 or \bar{e}_2 than the system with $\mu_1(0)\beta(0) = 1$, though not a great deal more.

The author wishes to thank Arno M. King of the Naval Research Laboratory who first pointed out these errors, and to apologize for any difficulties they may have caused.

* B. M. Oliver, "Automatic volume control as a feedback problem," *PROC. I.R.E.*, vol. 36, pp. 466-474; April, 1948.

Noise Levels in the American Sub-Arctic*

N. C. GERSON†

Summary—On the basis of six months' data, a comprehensive study was instituted of the atmospheric static intensity at a frequency of 150 kc in northern and southern Canada. Three noise levels, the average (a measure of the mean atmospheric noise level), quasi peak (a measure of the highest noise bursts indicated by the recorder), and absolute quasi peak (a measure of the maximum value of the highest noise bursts indicated by the recorder) were determined. The average level furnished a record of the average noise caused by bursts and background rumble; the quasi-peak level of atmospherics furnished a record of noise bursts (superimposed upon the usually negligible background); and the absolute quasi-peak level supplied the highest value of the bursts.

Various temporal and spatial distribution studies of the intensity of atmospherics were effected, such as diurnal, seasonal, latitudinal, and the like. The diurnal trend is absent or small during winter but increases markedly as summer is approached. The familiar rise and decline of noise intensity about sunset and sunrise, respectively, is found. Toward summer the increase in noise level rise occurs earlier and earlier, sometimes taking place shortly after noon, local standard time (LST). The daily cycle usually attains a minimum after sunrise and a maximum after sunset, although exceptions are found.

Seasonally, the static intensity is higher in June than January. At southern stations noise increased progressively from January to June.

A rise in recorded noise level above that of preceding and succeeding months took place at some stations in February. The increase in noise level during this time is attributed to precipitation static caused by the increased frequency and force of blizzards.

The noise level varied as a nonlinear function of colatitude.

INTRODUCTION

THIS PAPER deals with the level of atmospherics in the American sub-Arctic. Continuous measurements were made during the six-month period from January through June, 1947, at or near a frequency of 150 kc at the stations of Baker Lake, Churchill, Edmonton, Gloucester, Norman Wells, and Portage la Prairie, Canada (see Fig. 1). Technical details of the installation are shown in Table I. In general, local sources of artificial man-made noise were lacking at all stations.

MEASUREMENT STANDARDIZATION

Although the procedure involved is very similar in both cases, a determination of the atmospheric static level nevertheless is beset with considerably more obstacles than is the measurement of radio field intensity. For example, the characteristics and wave forms of noise disturbances vary tremendously since the various integrants are poorly defined and wildly fluctuating. These noise components arrive at a particular point with variable polarization, amplitude, direction, relative phase, etc. Thus it is impossible, in most cases, to define an

objective criterion of noise which may be conveniently employed as a standard of reference.

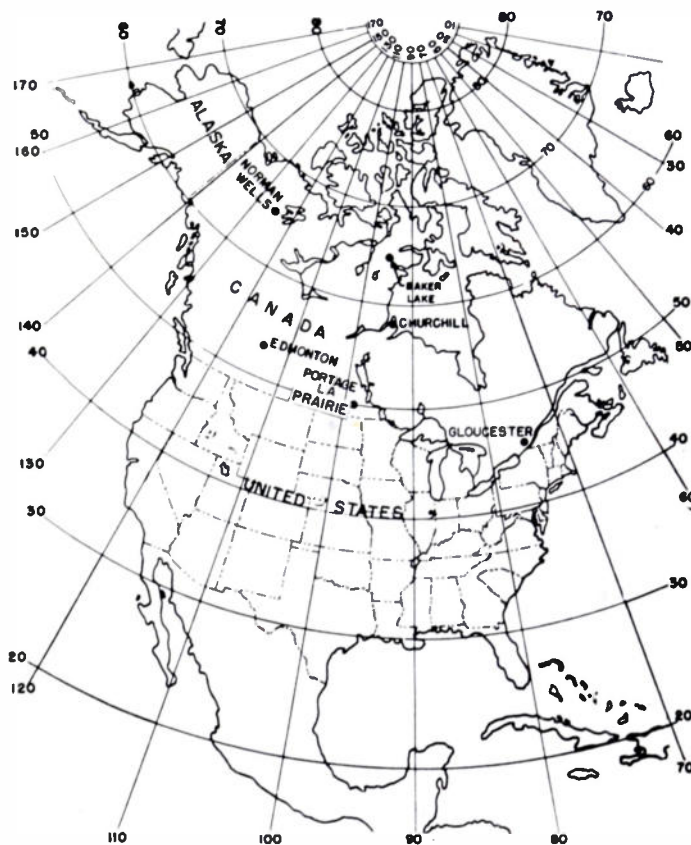

Fig. 1—Noise recorder station locations.

Heretofore, because of the above and other difficulties, the measurement of atmospherics at frequencies below 5,000 kc had been considered satisfactory if results were reproducible to about 30 to 50 per cent with similar measuring devices.¹ When different types of measuring instruments had been utilized to determine the same noise level, results disagreed enormously, perhaps by as large a ratio as 1,000 to 1. It is believed that with the precautions and standardizations taken in the present study, the instruments and calibrating techniques were sufficiently consistent so as to reproduce readings within about 10 per cent.

Undoubtedly a great portion of the disagreements usually found when determining noise intensities lie in the aforementioned erratic nature of atmospherics. However, a considerable degree of the encountered inaccuracy may be attributed directly to the instrumentation. It is important, therefore, in order to insure uniform, comparative, and meaningful results, to state

* Decimal classification: R272.1. Original manuscript received by the Institute, February 21, 1949; revised manuscript received, January 9, 1950.

† Air Force Cambridge Research Laboratories, Cambridge, Mass.

¹ H. E. Dinger and H. G. Paine, "Factors affecting the accuracy of radio noise meters," Proc. I.R.E., vol. 35, pp. 75-80; January, 1947.

TABLE I

Station	Latitude (°N)	Longitude (°W)	Operating Personnel*	Antenna System	Ground System
Baker Lake, Northwest Territories	64°18'56"	96°02'17"	RCCS	59-foot vertical mast	Radial system 20- to 150-foot copper wires
Churchill, Manitoba	58°56'57"	94°11'38"	RCN	T antenna, 80-foot vertical 80-foot horizontal	Copper mat surrounding building
Edmonton, Alberta	53°33'46"	113°31'28"	RCAF	59-foot vertical mast	Radial system 8- to 300-foot copper wires
Gloucester, Ontario	45°18'32"	75°30'50"	RCN	T antenna, 80-foot vertical, 80-foot horizontal	Ground system surrounding buildings
Norman Wells, Northwest Territories	65°16'29"	126°46'56"	RCAF	59-foot vertical mast	Radial system 20- to 150-foot copper wires
Portage la Prairie, Manitoba	49°55'22"	98°16'53"	RCAF	59-foot vertical mast	Copper mat; 20-foot lattice, approximately 200 feet square

* RCCS—Royal Canadian Corps of Signals.
RCN —Royal Canadian Navy.
RCAF—Royal Canadian Air Force.

fully the instrumental techniques and procedures involved. This will be done after first reviewing the most important factors which, in the measurement of noise, contribute to variations in the results.

Inaccuracies in noise mensuration at different locations or at different times generally may be ascribed to one or more of the following factors:

1. Difference in the receiving antenna
2. Difference in receiver characteristics, such as
 - (a) Bandwidth
 - (b) Image response
 - (c) Automatic volume control and weighting circuit constants
 - (d) Insufficient shielding
 - (e) Misalignment of radio-frequency circuits
3. Differences in the recording instrument
4. Inaccuracies in the attenuator settings of the calibrating signal generator
5. Operational variations:
 - (a) Variations in the power supply voltage
 - (b) Variations in tube characteristics
 - (c) Detuning of amplifier circuits by the Miller effect
 - (d) Overloading and other nonlinear effects in the receiver and/or recorder
6. Influences of personnel:
 - (a) Careless operation
 - (b) Inexactness of calibration techniques.

To standardize the equipment and measuring methods as much as possible and thus eliminate most of the above variables, the following action was taken:

Standard antennas, 59-foot steel masts having omnidirectional reception characteristics, were employed where possible. At two stations, Gloucester and Churchill, weather or construction hindrances led to the utilization of similar T antennas, each having about an 80-foot vertical and 80-foot horizontal section. The effective height was determined separately for each antenna.

Identical receivers operating at the same bandwidth were employed.

Identical recorders were in use.

Identical signal generators were employed. Accu-

racies of the attenuator steps were better than 10 per cent.

Electronic- and saturation-type voltage regulators were employed. Radio tubes were changed periodically.

Careless operation and inaccurate calibration techniques were avoided to a great extent by training all operating personnel in the uniform procedures to be followed.

It is evident that the uncontrolled variables common to all stations were located in the receiver, i.e., overloading and other nonlinear effects, and detuning of the amplifier circuits by the Miller effect. It is believed, however, that the total effect due to these two factors is very small. A further lack of standardization existed at two of the stations where T antennas rather than steel masts had been erected. Because of the flat top on the T antennas, and because noise rarely, if ever, is solely vertically polarized, noise intensities as obtained from the T antennas will be somewhat greater than those obtained from the steel masts under otherwise identical conditions. While the differences are believed to be small, their exact magnitudes are unknown.

It is believed advisable to detail the instrumentation phases in order that future investigators may be able to compare their results with those given here.

Apparatus

Note: The term "quasi-peak noise intensity" will be employed for what nominally is termed the "peak noise level." The true instantaneous highly peaked electromagnetic noise wave in space is decreased in amplitude during reception because of the finite bandwidth of the receiver. By introducing the phrase "quasi peak," the distinction between the peak intensity as recorded and the instantaneous highest intensity of the electromagnetic wave in space is emphasized.

The noise-measuring equipment operated during this test comprised an 18-tube superheterodyne receiver (Hammarlund Super Pro, Type BC-779-A) together with an automatic recorder (Esterline Angus). The receiver was modified to provide output voltages alternately proportional first to the quasi-peak and then to the average value of the atmospheric noise field intensity. This was accomplished in the usual fashion by

TABLE I

Station	Latitude (°N)	Longitude (°W)	Operating Personnel*	Antenna System	Ground System
Baker Lake, Northwest Territories	64°18'56"	96°02'17"	RCCS	59-foot vertical mast	Radial system 20- to 150-foot copper wires
Churchill, Manitoba	58°56'57"	94°11'38"	RCN	T antenna, 80-foot vertical, 80-foot horizontal	Copper mat surrounding building
Edmonton, Alberta	53°33'46"	113°31'28"	RCAF	59-foot vertical mast	Radial system 8- to 300-foot copper wires
Gloucester, Ontario	45°18'32"	75°30'50"	RCN	T antenna, 80-foot vertical, 80-foot horizontal	Ground system surrounding buildings
Norman Wells, Northwest Territories	65°16'29"	126°46'56"	RCAF	59-foot vertical mast	Radial system 20- to 150-foot copper wires
Portage la Prairie, Manitoba	49°55'22"	98°16'53"	RCAF	59-foot vertical mast	Copper mat; 20-foot lattice, approx- imately 200 feet square

* RCCS—Royal Canadian Corps of Signals.
RCN —Royal Canadian Navy.
RCAF—Royal Canadian Air Force.

fully the instrumental techniques and procedures involved. This will be done after first reviewing the most important factors which, in the measurement of noise, contribute to variations in the results.

Inaccuracies in noise mensuration at different locations or at different times generally may be ascribed to one or more of the following factors:

1. Difference in the receiving antenna
2. Difference in receiver characteristics, such as
 - (a) Bandwidth
 - (b) Image response
 - (c) Automatic volume control and weighting circuit constants
 - (d) Insufficient shielding
 - (e) Misalignment of radio-frequency circuits
3. Differences in the recording instrument
4. Inaccuracies in the attenuator settings of the calibrating signal generator
5. Operational variations:
 - (a) Variations in the power supply voltage
 - (b) Variations in tube characteristics
 - (c) Detuning of amplifier circuits by the Miller effect
 - (d) Overloading and other nonlinear effects in the receiver and/or recorder
6. Influences of personnel:
 - (a) Careless operation
 - (b) Inexactness of calibration techniques.

To standardize the equipment and measuring methods as much as possible and thus eliminate most of the above variables, the following action was taken:

Standard antennas, 59-foot steel masts having omnidirectional reception characteristics, were employed where possible. At two stations, Gloucester and Churchill, weather or construction hindrances led to the utilization of similar T antennas, each having about an 80-foot vertical and 80-foot horizontal section. The effective height was determined separately for each antenna.

Identical receivers operating at the same bandwidth were employed.

Identical recorders were in use.

Identical signal generators were employed. Accu-

racies of the attenuator steps were better than 10 per cent.

Electronic- and saturation-type voltage regulators were employed. Radio tubes were changed periodically.

Careless operation and inaccurate calibration techniques were avoided to a great extent by training all operating personnel in the uniform procedures to be followed.

It is evident that the uncontrolled variables common to all stations were located in the receiver, i.e., overloading and other nonlinear effects, and detuning of the amplifier circuits by the Miller effect. It is believed, however, that the total effect due to these two factors is very small. A further lack of standardization existed at two of the stations where T antennas rather than steel masts had been erected. Because of the flat top on the T antennas, and because noise rarely, if ever, is solely vertically polarized, noise intensities as obtained from the T antennas will be somewhat greater than those obtained from the steel masts under otherwise identical conditions. While the differences are believed to be small, their exact magnitudes are unknown.

It is believed advisable to detail the instrumentation phases in order that future investigators may be able to compare their results with those given here.

Apparatus

Note: The term "quasi-peak noise intensity" will be employed for what nominally is termed the "peak noise level." The true instantaneous highly peaked electromagnetic noise wave in space is decreased in amplitude during reception because of the finite bandwidth of the receiver. By introducing the phrase "quasi peak," the distinction between the peak intensity as recorded and the instantaneous highest intensity of the electromagnetic wave in space is emphasized.

The noise-measuring equipment operated during this test comprised an 18-tube superheterodyne receiver (Hammarlund Super Pro, Type BC-779-A) together with an automatic recorder (Esterline Angus). The receiver was modified to provide output voltages alternately proportional first to the quasi-peak and then to the average value of the atmospheric noise field intensity. This was accomplished in the usual fashion by

having the desired time constants in the receiver detector circuit. Alternate recordings of the quasi-peak and average value of static were effected by means of a cam-operated relay.

The receiver bandwidth was 2.42 kc. The charging time constant of the average circuit was 98 seconds and that of the quasi-peak circuit, 0.089 second. The recorder, a continuously recording milliammeter, had an unshunted range of 0-5 milliammeters and a paper chart movement of three inches per hour. Figs. 2 and 3 give the receiver circuit diagram and a block diagram showing the equipment arrangement, respectively.

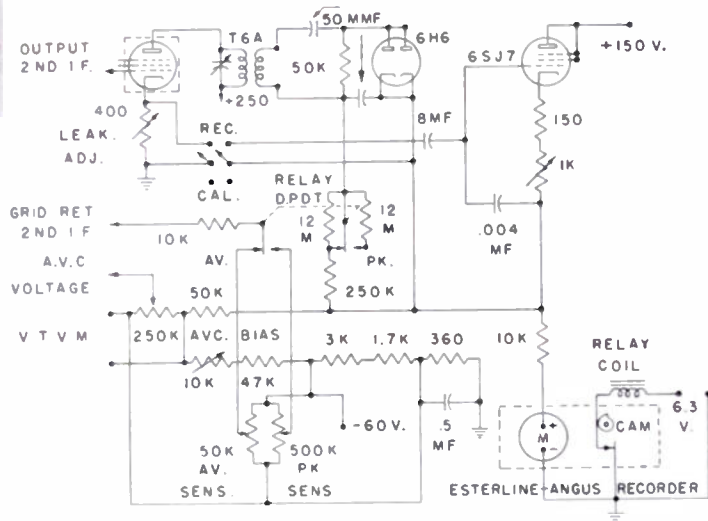

Fig. 2—Receiver circuit diagram.

compromise was adopted in the form of a trapezoidal 250-microsecond pulse having a recurrence rate of 25 per second. Inasmuch as receiver response is not necessarily the same for a sinusoidal as for a pulsed input, and since noise in a great many instances is of an impulsive or crashy nature, the pulse calibration procedure appeared more logical than that of employing modulated continuous waves. The wave form of atmospheric bursts was not duplicated; nevertheless, the utilization of pulses rather than continuous-wave signals allowed the receiver to be calibrated under conditions which more closely approached those encountered in actual operation. The pulse calibration was employed with the quasi-peak recording circuit. Conversely, when calibrating the average recording position, a continuous-wave modulated signal was employed.

A portable transmitter, radiating a 250-microsecond pulse at a recurrence rate of 25 per second, and a field intensity meter designed for the measurement of pulse amplitudes at low frequencies were employed to determine the antenna constants.

The equipment was calibrated in the usual manner. Deflections of the noise recorder for a series of given signal generator outputs provided convenient "abstraction scales," by means of which the noise levels could be abstracted from the record. Two abstraction scales were provided daily: a "peak-pulse" scale indicating that the receiver peak RC circuit was calibrated with the pulsed signal described above, and an "average continuous wave" scale indicating that the receiver average RC circuit was calibrated with a continuous-wave signal.

EVALUATION

The noise charts as received provided a wealth of minutia regarding temporal noise fluctuations, but in their recorded form they were mathematically rigid and not amenable to systematic compilation. Before central tendencies, trends, or correlations could be obtained, it was essential to convert the recorded data into a form suitable for statistical manipulation. The evaluation encompassed three phases: abstraction, reduction, and representation.

Abstraction

Employing the abstraction or calibration scales provided daily, three sets of data were removed from the record for each hour: the mean average noise level, the mean quasi-peak noise level, and the maximum or absolute quasi-peak noise level. The mean value was the arithmetic mean of the data for the hour considered and the "absolute" value was the maximum which was recorded during that hour. The "average continuous wave" (an average continuous-wave input signal to the receiver) calibration scale was employed to abstract average noise and the "peak-pulse" (a pulsed input signal to the receiver) calibration scale to abstract quasi-peak noise. The data were tabulated by hours of the day on a monthly basis.

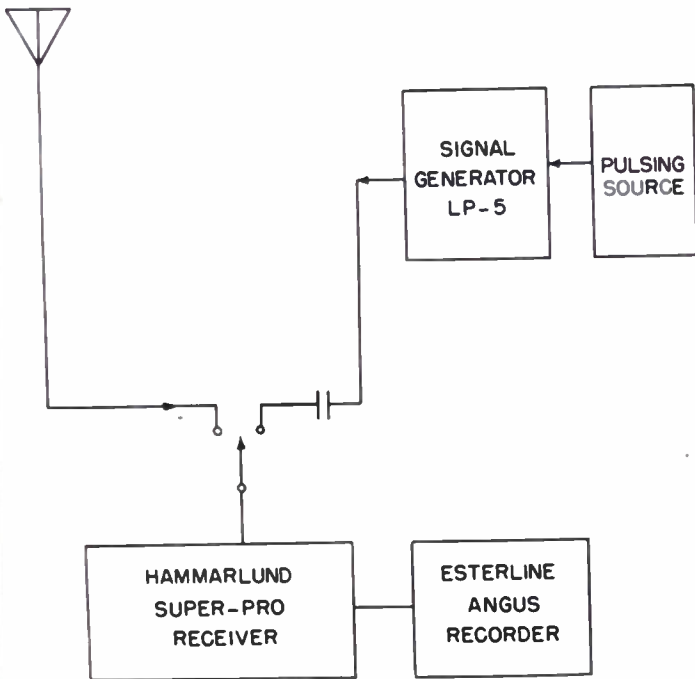

Fig. 3—Block diagram of arrangement of equipment.

In calibrating the apparatus in its quasi-peak recording position, it was decided to employ not a continuous-wave signal but a signal which simulated a typical noise burst. Since the best approximation to a noise burst, i.e., a delta function, is difficult to attain in practice, a

Reduction

Inasmuch as the static levels present occasional greatly outlying values, considerations of the desiderata for a satisfactory central tendency led to the choice of the median² as the best measure for the investigation at hand. The median is more stable and less affected by sampling fluctuations when, as in the case of atmospherics, magnitudes surge from low or moderate to extremely high values and then recede. As justifiable extensions of the median, the third quartile³ and the maximum (or highest) values were also chosen to represent the data.

A second but less important reason for employing the several quartile values arises from the nature of the data. The lower values of recorded noise are so low that they appear to indicate thermal noise of the receiver rather than true natural noise levels. In these instances, by excluding lower decile magnitudes, third or fourth quartiles provide a better portrayal of the data.

The median, third quartile, and maximum hourly noise values were obtained for each hour of the day considering that same hour of each day in the month. Values were obtained from at least twenty samples at all stations except at Baker Lake, where, particularly during February and April, 1947, the number of observations occasionally dropped to ten.

The quartiles of noise strength were reduced from microvolts receiver input to microvolts per meter at unit bandwidth through the use of the relationship

$$M = Q/aB^{1/2}$$

where M = quartile value of noise field intensity (microvolts per meter), a = antenna constant (meter), B = receiver bandwidth (kc), and Q = quartile value of recorded noise (microvolts receiver input).

Representation

Quartiles of the mean average, mean quasi-peak and absolute quasi-peak level of atmospherics are portrayed on a monthly basis for each station as quotidian, continental, and latitudinal variations.

DISCUSSION OF RESULTS

General

Undoubtedly the greatest portion of terrestrial atmospherics is generated in thunderstorms, probably by the transformation of heat energy (released by condensing water vapor) into mechanical energy (manifested by winds and turbulence) and subsequently into electrical energy (revealed by the production and separation of

² For a set of observations arranged in order of magnitude, the median is defined as the middle value if there is one, otherwise as the interpolated middle value. Thus, half the values are smaller than the median and half the values are greater than the median.

³ If a set of observations are arranged in order of magnitude and divided into four equal parts, the points of division are known as quartiles. The second quartile is identical with the median. Thus three-fourths of the observations are smaller in magnitude than the third quartile.

charged particles). Two other possible sources of terrestrial radio noise are also known: (1) storms of blowing particles that generate electric charges and potential gradients, and (2) random noise caused by high electrostatic fields between the ground and the air immediately above it. On the average, the static produced by the latter two sources is normally much smaller than that caused by thunderstorm activity. However, when exceptionally large potential gradients exist, the noise produced by the resulting local corona discharge may easily exceed that due to distant thunderstorms.

In general, the geographical source region of a very great portion of the radio static observed in middle and higher latitudes lies in the tropics or semitropics where the frequency of thunderstorms is greatest.⁴

Several admonitory remarks are necessary to insure that no misinterpretation of the data will result.

1. Set noise placed a lower limit to the sensitivity of the equipment. If a diurnal trend is absent, natural noise intensities are probably below those shown.
2. A small diurnal change probably indicates that set noise exceeded the lower portions of the daily variation.
3. The data represent noise intensities for the period from January through June, 1947. However, the exceptionally large sunspot activity during this period may have colored the results.
4. Maximum absolute quasi-peak⁵ and mean quasi-peak⁶ noise values during winter more closely approximate the true trend than do the medians.
5. The detection of noise may be made (a) by observation of an oscilloscope, (b) by aural perception wherein an observer listens to the received noise, or (c) by a meter. The results in each case may be quite different because of differences in the equipment and the senses involved. For example, the recovery of the eye (viewing an oscilloscope) to a noise burst is far superior to the ear hearing the same bursts. In the present instance, noise was recorded by meter.

Diurnal Noise Variation

Curves portraying the diurnal noise intensity variation are shown in Figs. 4 through 12.

In each figure, a heavy solid curve indicates the maximum value of the variable; a heavy dashed curve, the third quartile; and a light solid curve, the median. A heavy solid line is drawn at the top of the diagram to portray the hours of darkness, the beginning indicating sunset and the ending indicating sunrise. Whenever, because of limitations in the apparatus, the recorder pen swung off scale, a heavy dot was plotted on the graph at the value at which the pen went off scale. A dot thus

⁴ F. A. Berry, E. Bollay, and N. R. Beers, "Handbook of Meteorology," McGraw-Hill Book Co., New York, N. Y., p. 995; 1945.

⁵ The highest value considering only a series of the highest hourly noise values.

⁶ The arithmetic mean of a series of average hourly quasi-peak noise values.

signifies that the true noise level is to some unknown extent higher than the indicated value. If a sufficient number of such instances occurred during the month, it was possible for the third quartile or median to be an off-scale value. When the median was an off-scale value, then, since obviously both the third quartile and maximum values likewise were off-scale, one dot was plotted for all three measures. The microvolt-per-meter scale values were chosen to afford as uniform a representation

as possible. Noise levels which appear at the very bottom of the graph may be somewhat lower than depicted. The subsequent discussion will deal primarily with the mean quasi-peak noise level. It will be found that in a great majority of instances, the variations, trends, and the like, of the mean average and the absolute quasi-peak static intensities will be similar or identical to those of the mean quasi peak.

From an analysis of the data, several general features

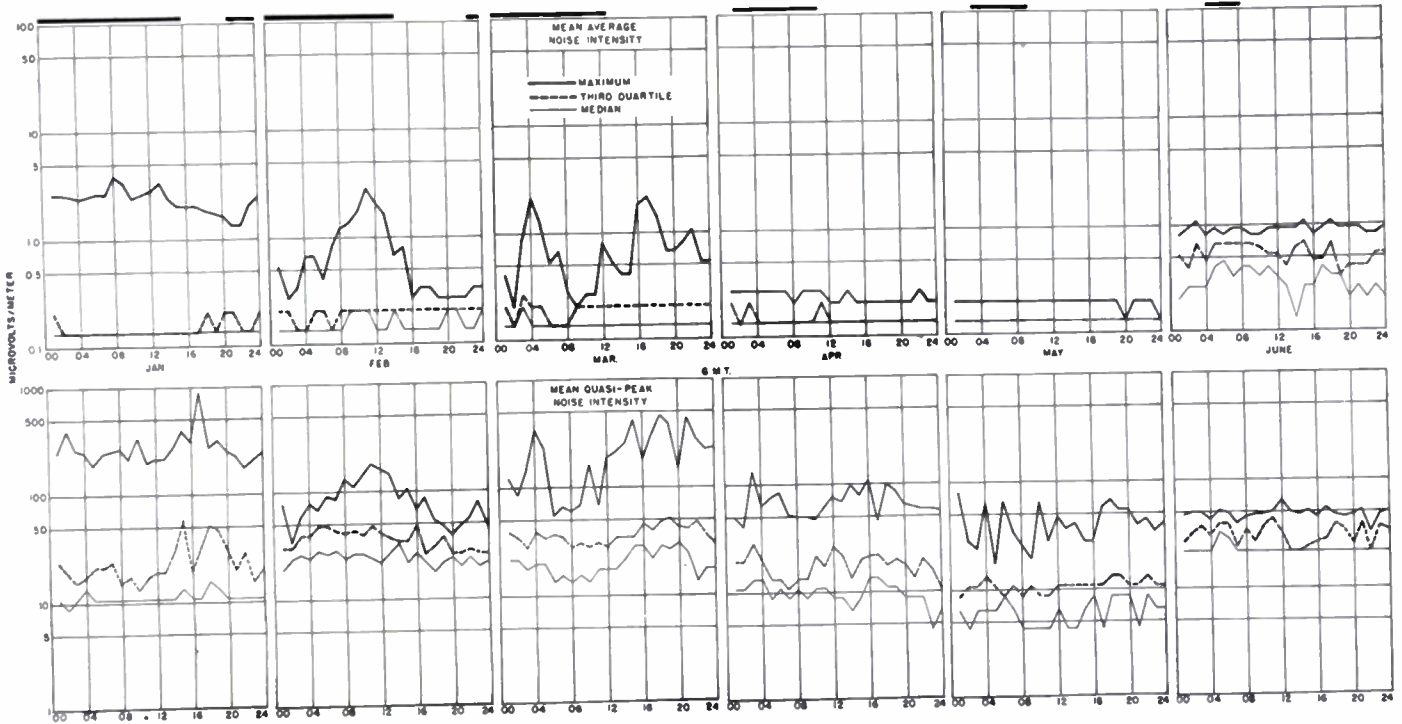

Fig. 4—Hourly mean average and mean quasi-peak noise intensity (January through June, 1947), Baker Lake, Northwest Territories.

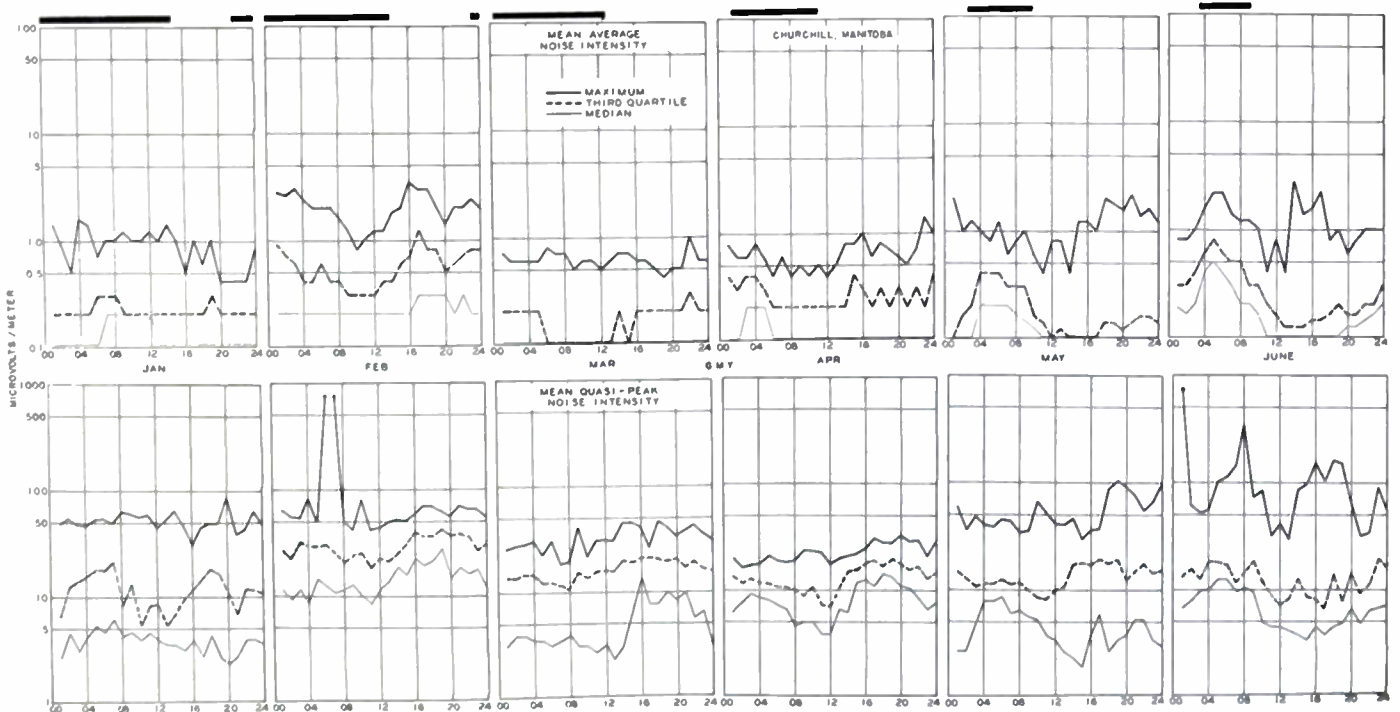

Fig. 5—Hourly mean average and mean quasi-peak noise intensity (January through June, 1947), Churchill, Manitoba.

are immediately evident. For the different months at the several stations, diurnal variations are similar, especially with regard to the greater nocturnal than daylight intensity of noise. Also, during winter the start of high nighttime static levels closely coincides with the arrival of sunset at the receiving station.

The mean average noise level curves do not reveal a diurnal variation during winter. The lack of an observable trend does not imply that the variation is absent,

but merely that the average level of atmospheric noise was of such a low intensity that it is obscured by set noise. Although the curves fail to reveal true noise levels, nevertheless they do indicate an upper limit to levels of average atmospheric noise which might be encountered at the location in question.

The diurnal cycle, which was lacking in the mean average noise data, evinces itself in the mean quasi-peak (from about March onwards) and absolute quasi-

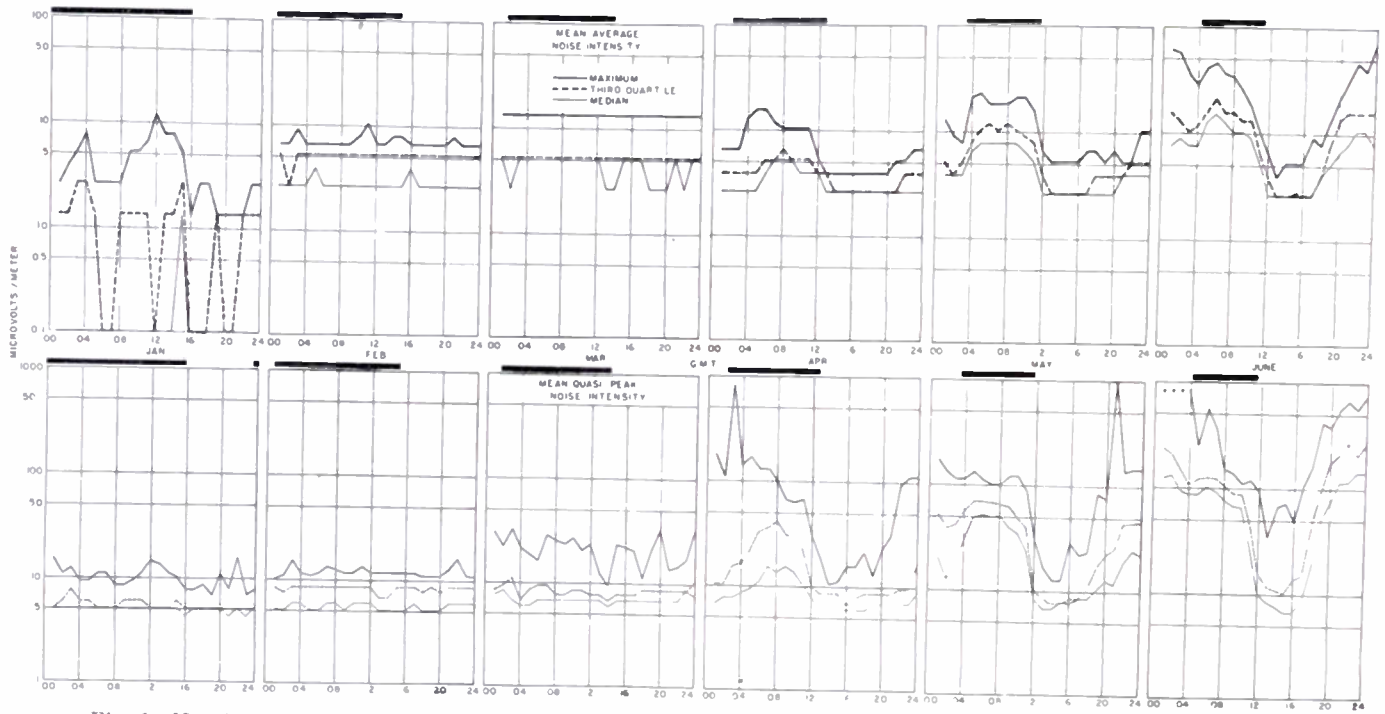

Fig. 6—Hourly mean average and mean quasi-peak noise intensity (January through June, 1947), Edmonton, Alberta.

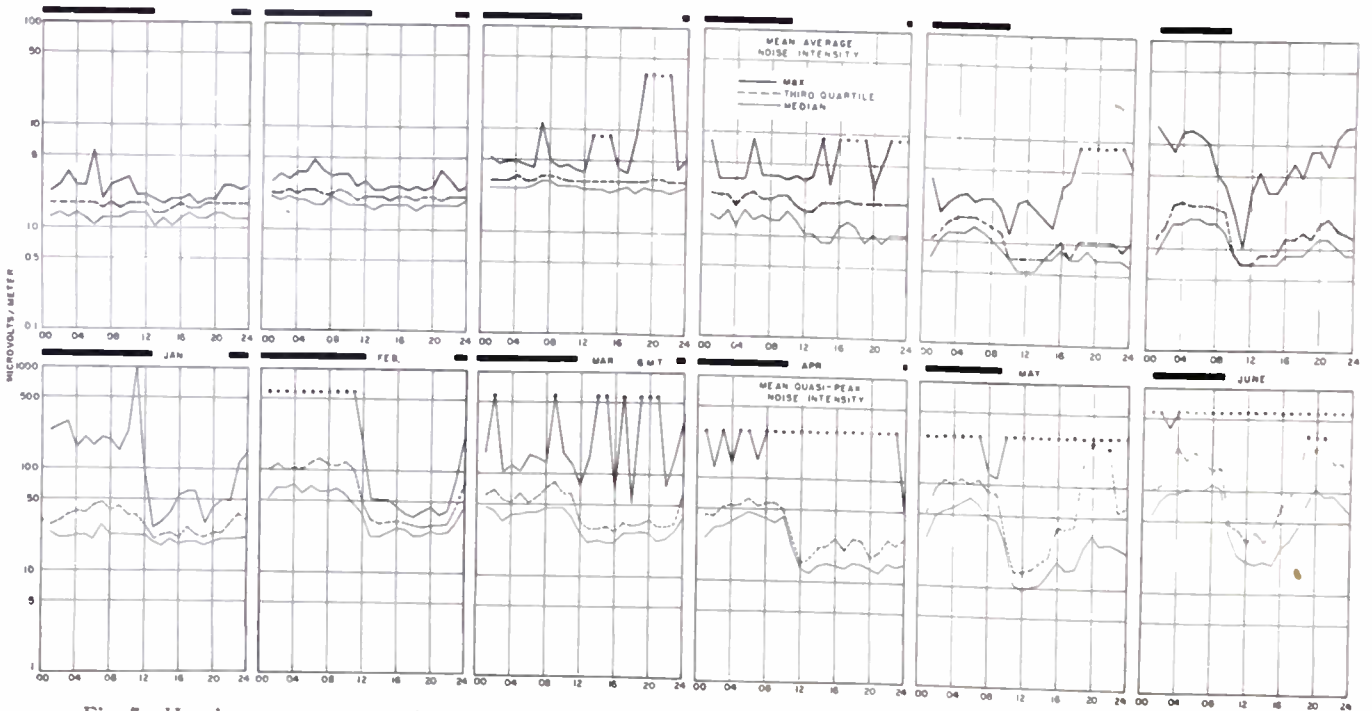

Fig. 7—Hourly mean average and mean quasi-peak noise intensity (January through June, 1947), Gloucester, Ontario.

peak curves (from January at some stations). The daily variation appears if not in the median then in the maximum values. During January and February, mean quasi-peak graphs indicated a diurnal trend, to some extent, at all stations except Norman Wells.

As the seasons progressed, the diurnal noise cycle showed certain progressive changes. The amplitude of the daily cycle and the magnitude of the static, which were very small in winter, became greater and greater

as the summer solstice was approached, reaching its maximum during June.

From climatological considerations, it is believed that the static intensity probably would culminate during July, after which the reverse effect, i.e., a gradual lowering of both the level of noise intensity and the diurnal variation, would occur until a minimum was reached in January and February. It should be noted that months equally spaced on either side of about July

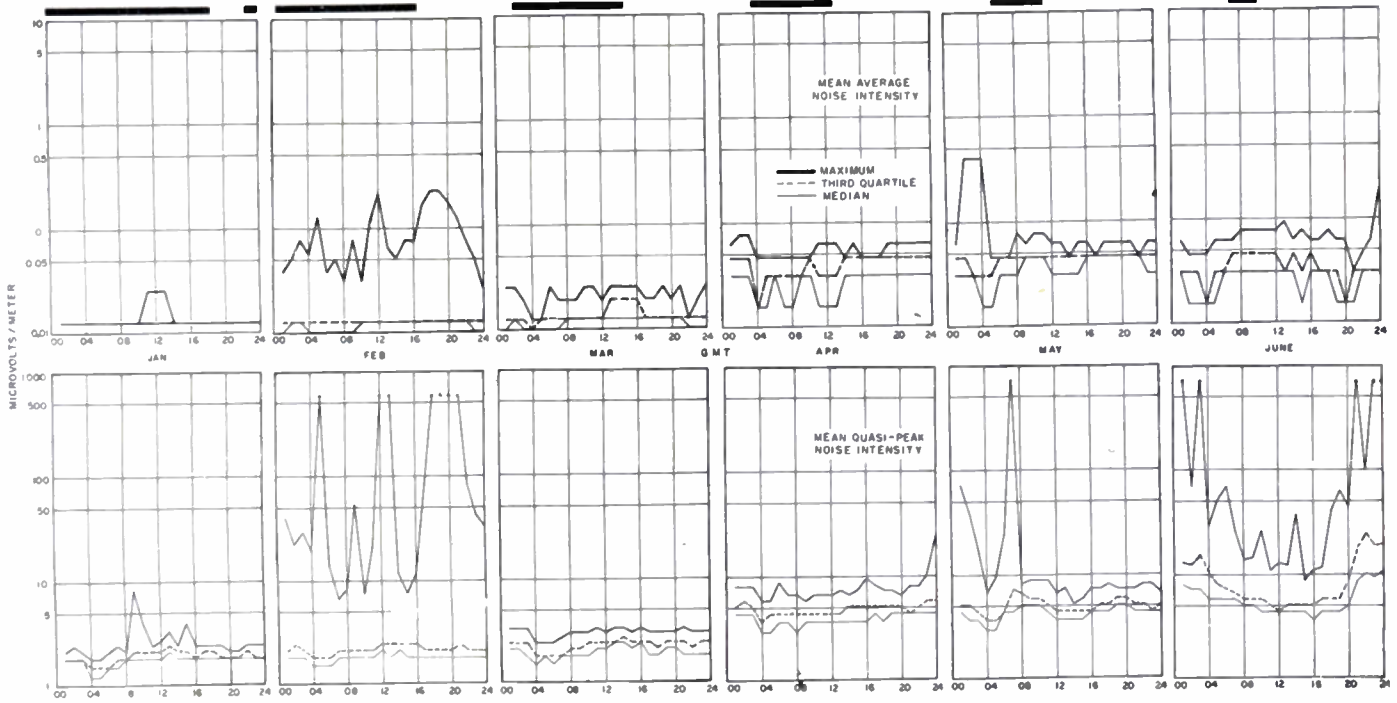

Fig. 8—Hourly mean average and mean quasi-peak noise intensity (January through June, 1947), Norman Wells, Northwest Territories.

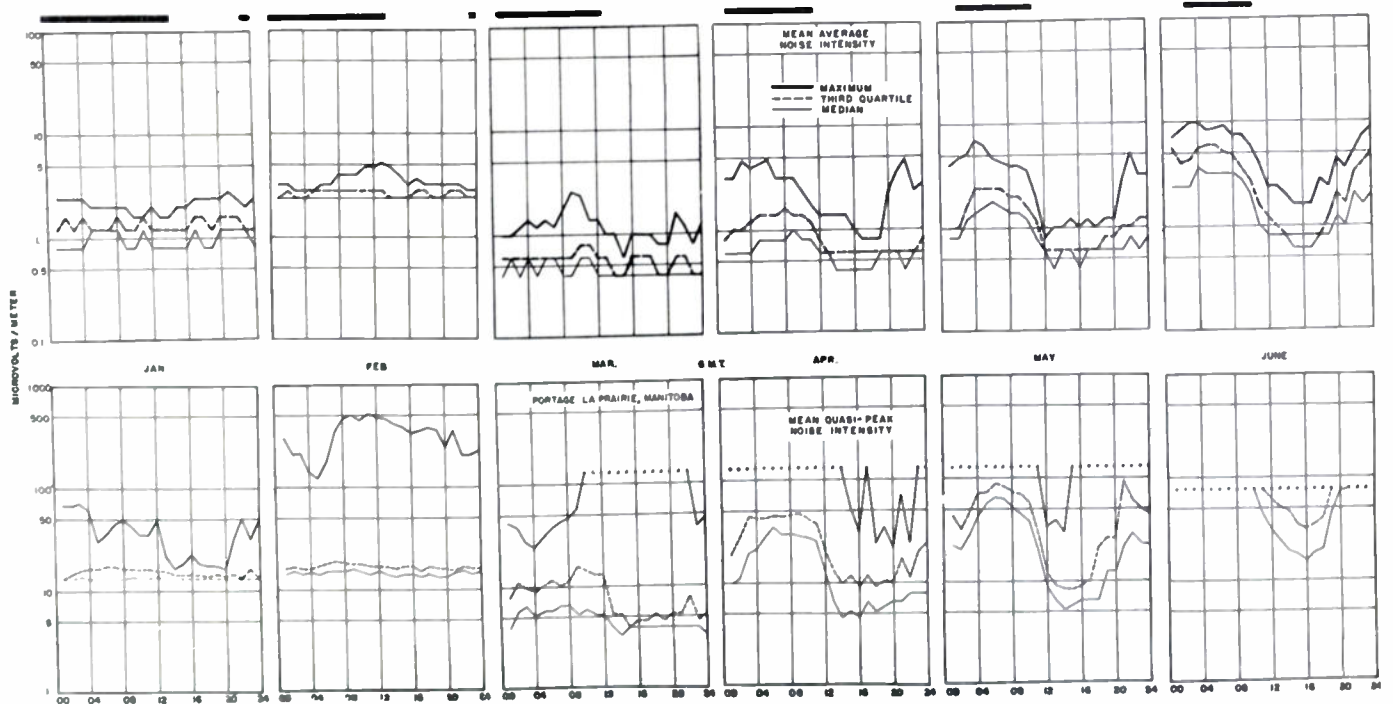

Fig. 9—Hourly mean average and mean quasi-peak noise intensity (January through June, 1947), Portage la Prairie, Manitoba.

1 would not necessarily have the same noise intensity and quotidian variation because of the quantitatively unpredictable effect of sunspot, magnetic, meteorological, and other influences.

A progressive change occurs in the diurnal variations of noise intensity as summer approximates. During January, February, and March, atmospherics begin to rise about sunset and attain maximum magnitudes several hours later during the night. A reduction of noise

commences, in general, several hours prior to sunrise, attaining minimum values at about dawn. This effect is best typified by the mean quasi-peak curves for Gloucester, and also several other stations (see Figs. 5, 6, 7, and 9).

As June approaches, the transition towards nocturnal static levels begins earlier and earlier with respect to sunset. Conversely, the decline from high nightly noise intensity towards the appreciably lower

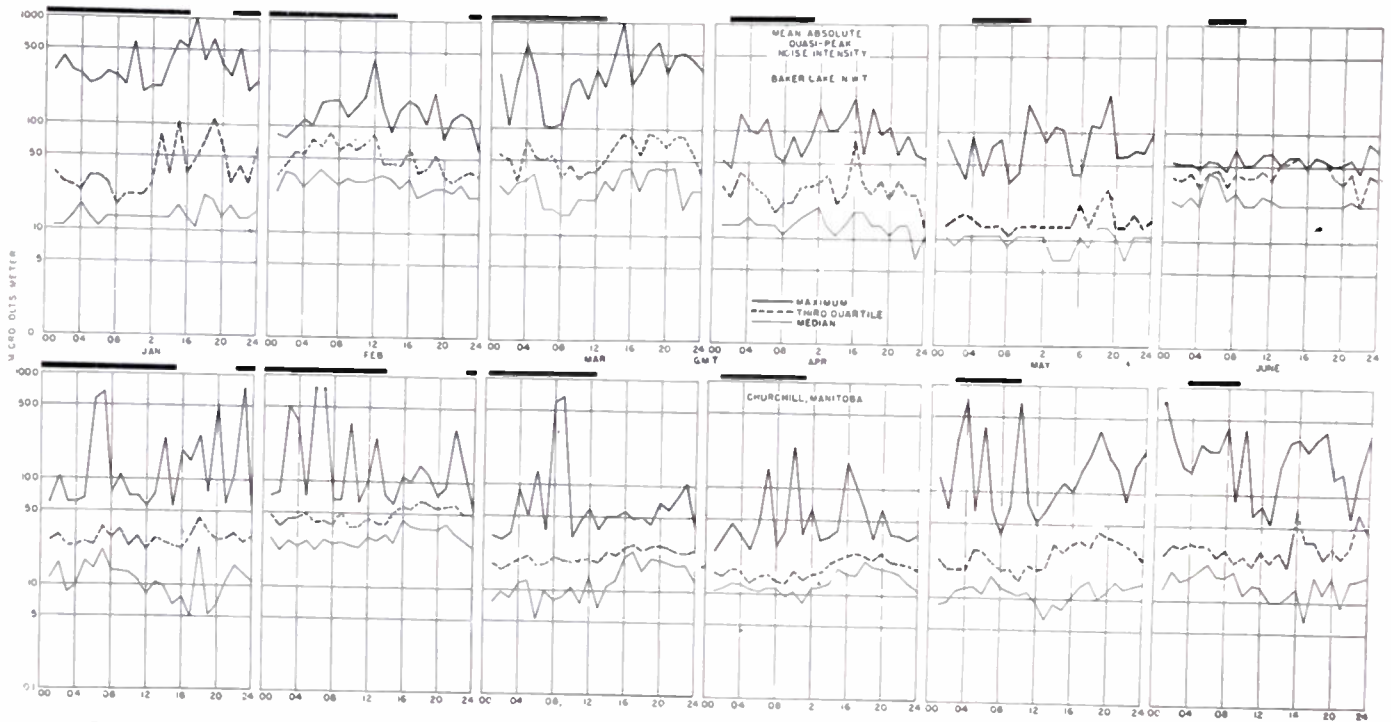

Fig. 10—Hourly absolute quasi-peak noise intensity (January through June, 1947), Baker Lake, Northwest Territories, and Churchill, Manitoba.

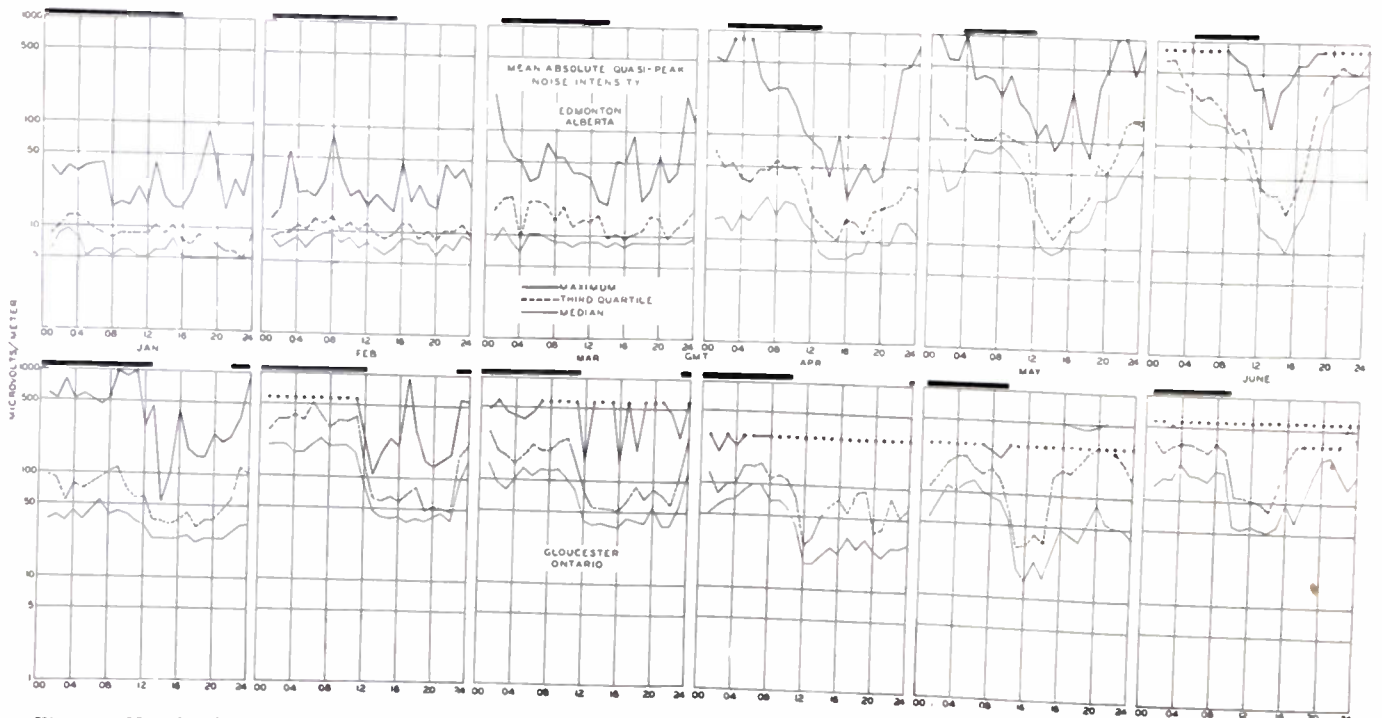

Fig. 11—Hourly absolute quasi-peak noise intensity (January through June, 1947), Edmonton, Alberta, and Gloucester, Ontario.

daylight magnitude occurs later and later with respect to sunrise. This phenomenon is distinctly observed in the May and June curves for Edmonton, Gloucester, and Portage la Prairie (see Figs. 6, 7, and 9). In each instance, (a) the reduction of the noise level during May and June begins about the time of sunrise and reaches low daylight values several hours later, and (b) the ascension of static intensity towards nighttime levels begins from about noon to several hours before sunset, and attains high values somewhat after sunset. At Edmonton (see Fig. 6) late afternoon noise values were of greater intensity than those occurring in darkness.

At the northernmost stations of Baker Lake and Norman Wells, where during June the sun is below the horizon for only about three out of twenty-four hours, clear-cut variations of the noise intensity with sunrise and sunset do not appear. The data for Norman Wells in June (see Figs. 8 and 12) show a slight diurnal variation which apparently bears no relation to the three hours of darkness existing at this station. However, if the data are examined in the light of sunset and sunrise at the closest noise sources, namely, those of Central America and the West Indies, a correspondence becomes evident. At the mean latitude and longitude of these noise centers (approximately 5° N and 75° W), the sun rises and sets at about 1040 and 2230 Greenwich Mean Time (GMT), respectively. The diurnal cycle at Norman Wells indicates a rising static level before tropical sunset and a declining noise level before tropical sunrise. A similar explanation may be applied to the diurnal variation at Churchill (see Figs. 5 and 10). The increase in the static level prior to the occurrence of

darkness at the tropics may be attributed to noise produced by the markedly increased frequency of electrical storms over North America during summer.

Extrapolating from the evidence presented above, it seems entirely plausible that as the latitude increases, the diurnal noise variation would present a decreasing mutuality with local sunrise and sunset, and a stronger interdependence with sunrise and sunset at the tropical noise source and the incidence of afternoon continental thunderstorm activity.

June and sometimes May curves as a rule show the existence of high afternoon static intensities anywhere during the period from noon through the evening. Undoubtedly, the cause of the afternoon static can be attributed directly to the relatively large-scale thunderstorm activity taking place over the North American continent. During the summer, a large increase in afternoon and early evening thunderstorms takes place over the eastern and central Rocky Mountain areas of United States and southern Canada. The combined effect of the noise generated by each individual lightning discharge results in a broadening of the diurnal noise cycle maximum; i.e., the high levels of noise become evident during the afternoon as well as at night.

The outstanding points regarding the diurnal fluctuation of low-frequency noise levels at high latitudes may be conveniently summarized as follows:

1. On the average, the magnitude of noise intensity rises noticeably about sunset, attains high levels at night, and decreases sharply about sunrise to a minimum shortly after daybreak.
2. At high latitude stations, the diurnal noise cycle

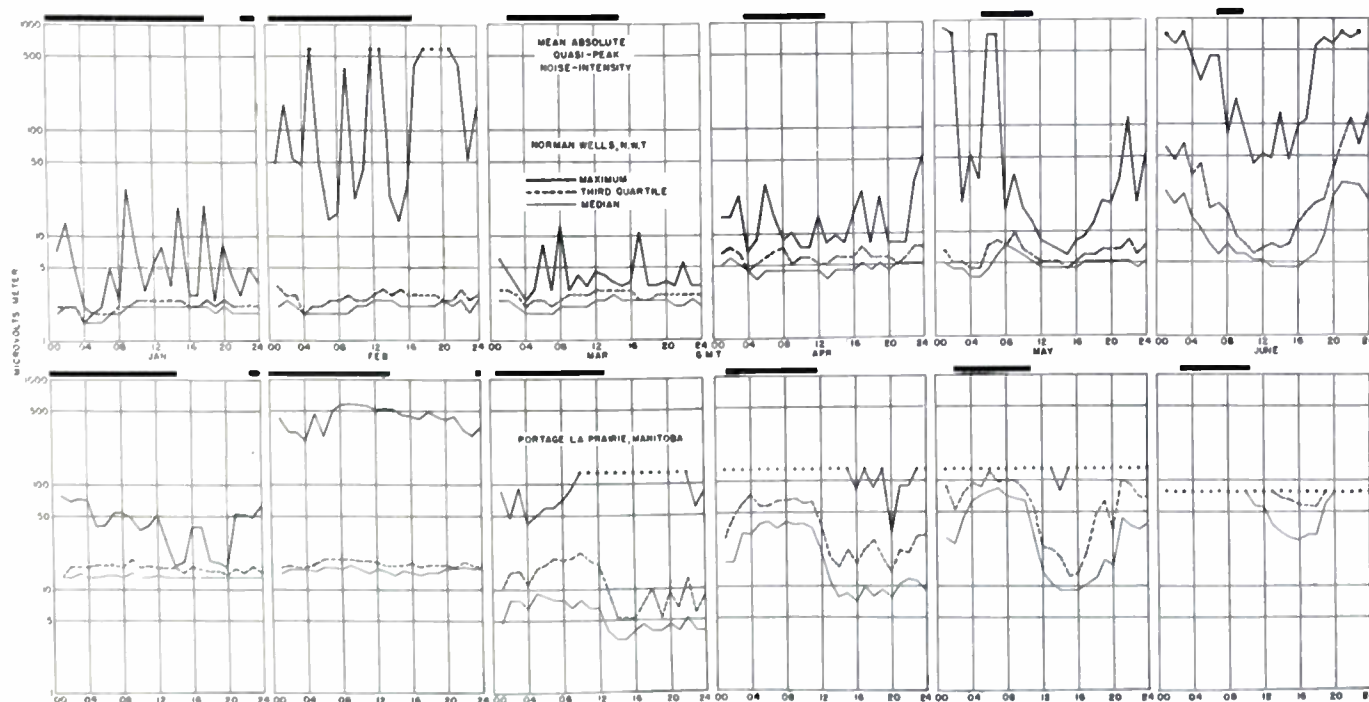

Fig. 12—Hourly absolute quasi-peak noise intensity (January through June, 1947), Norman Wells, Northwest Territories, and Portage la Prairie, Manitoba.

during summer apparently bears no simple relationship to local sunrise and sunset. The evidence indicates a relationship with sunrise and sunset at the tropical centers generating the noise and with the time of occurrence of continental afternoon thunderstorms.

3. The rise to nocturnal high noise levels occurs earlier with respect to sunset, and the decline from high nightly static to low daylight values occurs later with respect to sunrise in summer than in winter.

4. Broad maxima of noise extending from shortly after noon into darkness appear during the summer. The noise is traceable to vigorous thunderstorm activity over the North American continent during this season.

5. No diurnal trend is manifest during winter at the northernly stations. Set noise in this region apparently is appreciably higher than the mean average static level.

Seasonal Noise Variation

An indication of the six-month January-through-June trend can be obtained from the mean monthly values. These magnitudes, obtained by taking the mean of the hourly medians for each month, are graphed in Fig. 13.

From an inspection of the data, it is evident that January noise levels at all stations are lower than those occurring in June, generally by an appreciable factor. A noticeable exception occurs at Baker Lake, where June static intensities were lower than those of January.

A possible cause of the higher January than June noise levels at Baker Lake may be ascribed to the climatic and geophysical characteristics peculiar to the northwestern Hudson Bay region. Unlike the northern Mackenzie River Basin, the northern Hudson Bay area is more desolate and frigid. Norman Wells, for example, at a slightly higher latitude than Baker Lake, is still within the timbered terrain of North America, and its winter climate may be considered as moderate to severe. Baker Lake, however, lying well above the tree line, has a more rigorous winter climate with frequent blizzards approaching the buran in intensity. The climatic con-

ditions immediately suggest that precipitation static may be responsible for the rather high noise level at Baker Lake during the period indicated. The subject of precipitation static has been adequately discussed in the literature on numerous occasions,⁷⁻⁹ but a brief summary may prove helpful.

Two principal factors are responsible for this type of interference, which is caused by piezo- or tribo-electric effects associated with blowing hydrometeors or other particles. In the first instance, a charge builds up upon the antenna and discharges through the receiver to ground. In the second case, a charge exceeding the breakdown voltage is established upon the antenna or other nearby objects. The resultant corona discharge produces an induction field which produces a high noise level. A similar but much smaller effect is caused by the transfer of charges from one snow particle to a second.

An examination of the meteorological data reveals that during February at Norman Wells, a blizzard raged for one day, but that none occurred during January or March. On the other hand, at Baker Lake, blizzards were found on almost half the number of days during the months of January, February, and March.

As would be expected, precipitation-static noise levels associated with a blizzard may be very much higher than noise levels normally found. Thus, if blizzardous days were infrequent, the median noise levels would remain close to those normally existing, but maximum values would rise considerably to very high levels. On the other hand, if many days with blizzards were found during a month, both median and maximum noise values would climb considerably above the normal. The former condition is exemplified

⁷ H. M. Huckle, "Precipitation static interference upon aircraft and at ground stations," Proc. I.R.E., vol. 27, pp. 301-316; May, 1939.

⁸ L. P. Harrison, "Lightning discharges to aircraft and associated meteorological conditions," NACA Report 1001, Washington, D. C.; 1946.

⁹ Ross Gunn, et al., "Army Navy precipitation-static project." (Parts I, II, and III) Proc. I.R.E., vol. 34, pp. 156-178; April, 1946.

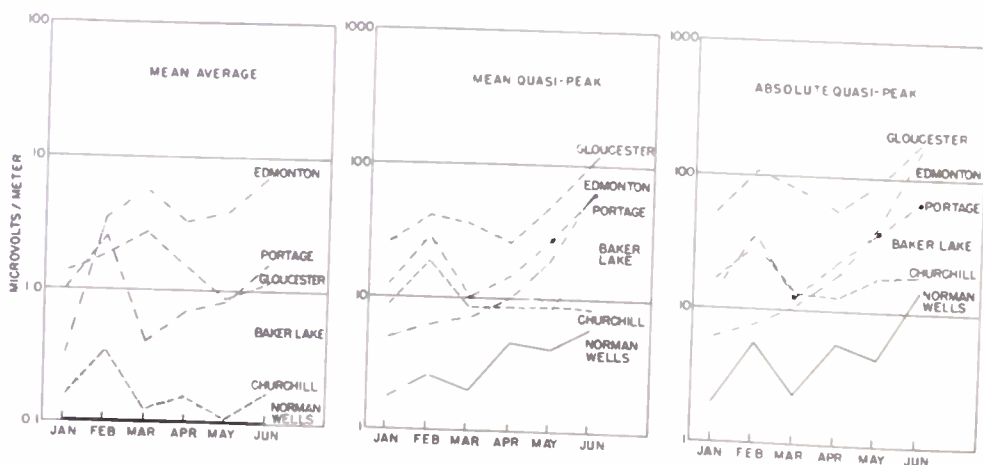

Fig. 13—Monthly noise intensities, January through June, 1947.

by Norman Wells in February and the latter by Baker Lake during January, February, and March, where thirteen blizzardy days were found during each month.

A similar situation was found at other stations (Churchill, Gloucester, and Portage la Prairie) where the noise level during February exceeded that during January or March. This increase in static noise level is imputed to the more frequent and more vigorous storms of blowing snow usually found in the month of February.

With the onset of spring conditions, in April, the number of blizzards fell off sharply, thereby removing the local level of atmospherics. After this time, natural noise was probably that propagated from the tropics and the thunderstorm areas of the continent.

During the summer, the more southerly stations indicated the high and somewhat erratic daily noise intensity trend which is characteristically found at localities not too distant from thunderstorm activity. Since June is one of the summer months during which local electrical storms contribute substantially to the total noise level, the daily curves may show relatively large noise-level fluctuations, depending upon the absence or presence of such a storm.

In general, the mean average noise field intensity is at a much lower level at all stations considered than for stations in the temperate zones.

A general increase in noise from winter to summer is found also in the mean quasi-peak and absolute quasi-peak maps (see section on *Continental Noise Variation*). At the southern stations, mean monthly quasi-peak noise intensities exceed 100 microvolts per meter during

June, but only about 25 microvolts per meter during January. It is interesting to note the increased noise level in February above that of both January and March. The cause for this rise is believed to be precipitation static.

The absolute quasi-peak noise intensity maps provide an indication of the noise levels to be overcome if communication is desired at all times at a frequency of 150 kc.

Continental Noise Variation

Values of mean monthly noise intensity at each station have been plotted on maps of North America for the six-month interval (see Fig. 14).

It is seen that the mean average monthly values for those stations located above 55° N latitude was less than one microvolt per meter throughout the period. On the whole, the very small variation disclosed indicates that set noise was probably the limiting factor. At the stations below 55° N latitude, noise rose gradually from January to June. Throughout the entire period the mean average monthly noise level was less than 10 microvolts per meter at all stations.

Variation of Noise with Latitude

It is evident that under the supposition that the tropical belt is the general center of terrestrial static generation, at least for the longer wavelengths, noise levels for a given low frequency should vary inversely with latitude. Some investigators have proposed a negative linear latitude trend for the noise-latitude relationship.

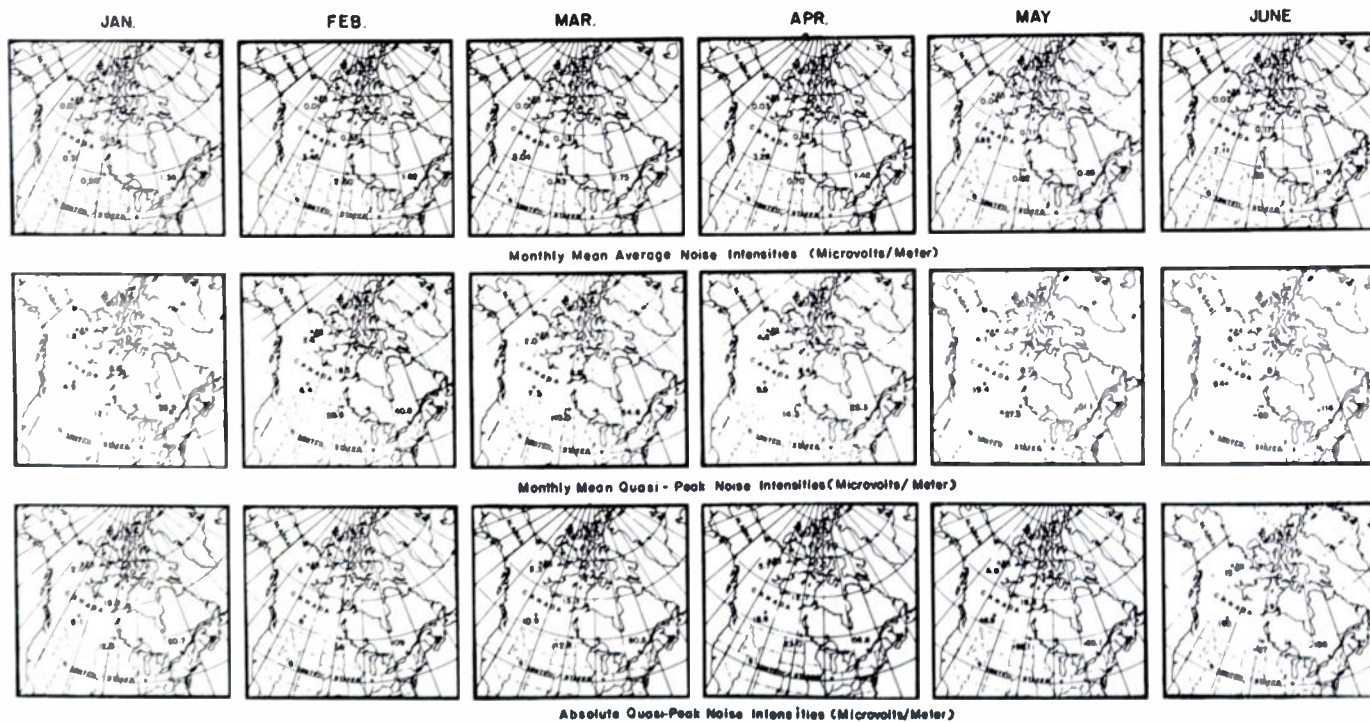

Fig. 14—Monthly noise intensities (maps), January through June, 1947.

At high latitudes, noise levels are exceptionally low. In addition to the very low intensities found in this study, an independent research body made the following qualitative conclusion:¹⁰ "Measurements were attempted at Crystal No. 2, Baffin Island (latitude 63° N, longitude 68° 30' W) for only a short period but because the very low natural static noise level was found to be below the level of local man-made noise, the measurements were not continued." These observations were made at a frequency of 170 kc.

In an attempt to determine the variability of atmospheric noise as a function of latitude, the relative intensities of the observed noise for all months were plotted as ordinates against degrees of latitude as abscissas (see Fig. 15). The relative intensity was obtained by normalizing the results of the mean quasi-peak noise level on those of the southernmost station, Gloucester, considered as unity.

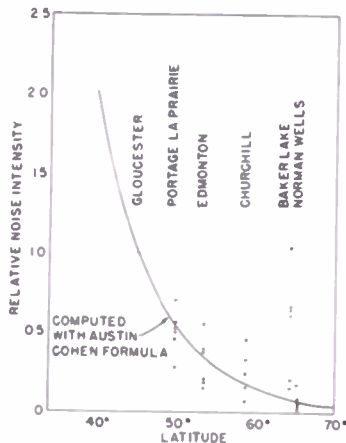

Fig. 15—Variation of noise intensity with latitude.

It is apparent that the relative noise intensity at Baker Lake is not in keeping with the trend at the remaining stations, but is higher. Because of the singular local conditions at this station, it had already been concluded that winter noise intensity at Baker Lake was appreciably influenced by precipitation static, and therefore was greater than that which would be expected if the tropical noise center were the sole noise source. For this reason, the relative noise intensities at Baker Lake will be ignored and only noise levels at the remaining locations will be discussed.

In examining the trend of noise versus latitude, a linear relationship is not evident. Such a relationship should hardly be expected, especially at the higher latitudes, if tropical regions are considered as the source of a major proportion of atmospheric noise.

Since the stations concerned in this investigation are located at high latitudes, it was felt that a reasonable first approximation to the expected noise variation

with latitude could be obtained through the use of the Austin-Cohen formula for the propagation of daytime sky-wave signal strengths. At the distances involved, tropical noise received at the recording stations was transmitted via the ionosphere and was thus entirely sky wave. The semi-empirical Austin-Cohen relationship for attenuation may be written

$$E = (3 \times 10^5 / R)(P / \theta \sin \theta)^{1/2} e^{-k\theta}$$

where $k = 46 \times 10^{-6} f^{0.6} R$, E = field intensity (microvolts per meter), R = radius of earth (km), P = radiated power (kw), θ = arc of earth from radiator to receiver (radians), and f = frequency (kc).

The relative intensity at latitudes θ_0 and θ of a given noise signal radiated at the equator is, therefore, given by

$$E / E_0 = [\theta_0(\sin \theta_0) / \theta(\sin \theta)]^{1/2} e^{k(\theta_0 - \theta)}$$

In order to compare data calculated from the above equation with those already plotted in Fig. 15, θ_0 was taken for the latitude of Gloucester ($\theta_0 = 45^\circ 18' 32''$). In the evaluation, the constants f and R were taken as $f = 150$ kc and $R = 6367.6$ km.

The important sources of atmospheric noise received over a major portion of North America are located in the West Indies and equatorial South America. A "center of gravity" for the combined regions of radio noise production may be taken as between latitudes 5° N to 10° N. For the purpose of this discussion, the noise was taken as originating at 10° N. Simple computation, however, will reveal that a choice of 5° N as the source of noise would give no appreciable deviation from the results to be described.

A graph of the received relative signal (or noise) levels for a signal transmitted at 10° N, considering the field intensity at Gloucester as unity, is shown as the heavy solid curve in Fig. 15. The fit of the curve to the observed data appears to indicate that the assumptions employed are closely true.

ACKNOWLEDGMENTS

Original impetus for this study was supplied by the establishment of the experimental low-frequency loran network in southern Canada.

The author is pleased to acknowledge the valuable comments and criticisms of Lt. Col. G. M. Higginson, USAF, and S. L. Seaton, and the invaluable field assistance of H. J. Doane. The study itself could not have been accomplished without the painstaking care and help of Miss Alta Schoettle, O. W. Armstrong, M. W. Begala, A. J. Beauchamp, J. Hoffman, L. D. Hogan, M. Setrin, M. S. Kelemen, E. T. Smith, Mrs. R. Halliday, and many others too numerous to mention. Finally, the author wishes to thank V. S. Carson for his constant encouragement.

¹⁰ Report ORS-P-23, Office of Chief Signal Officer, U. S. Army, Washington, D.C., p. 103; 1945.

Standards on Electron Tubes: Methods of Testing, 1950*

PART I

COMMITTEE PERSONNEL

Standards Committee, 1949-1950

J. G. BRAINERD, *Chairman*
A. B. CHAMBERLAIN, *Past Chairman*
A. G. JENSEN, *Vice-Chairman*
L. G. CUMMING, *Vice-Chairman*

M. W. Baldwin, Jr.
R. R. Batcher
S. J. Begun
H. S. Black
G. M. Brown
C. R. Burrows
Henri Busignies
W. G. Cady
P. S. Carter
Dudley Chambers

E. J. Content
J. W. Forrester
R. A. Hackbusch
L. R. Hafstad
J. V. L. Hogan
J. E. Keister
E. A. Laport
Wayne Mason
J. F. McDonald
L. S. Nergaard

A. F. Pomeroy
George Rappaport
E. S. Seeley
R. F. Shea
J. R. Steen
W. N. Tuttle
L. C. Van Atta
K. S. Van Dyke
D. E. Watts
Ernst Weber

L. E. Whittemore

Committee on Electron Tubes and Solid-State Devices, 1946-1950

L. S. NERGAARD, *Chairman*
R. S. BURNAP, *Past Chairman*

A. Y. Bentley
E. L. Chaffee
J. W. Clark
K. C. DeWalt
W. G. Dow
C. E. Fay
A. M. Glover
J. E. Gorham
George Grammer
J. W. Greer
L. B. Headrick

L. A. Hendricks
E. C. Homer
D. R. Hull
S. B. Ingram
S. J. Koch
Herbert Krauss
Louis Malter
D. E. Marshall
J. A. Morton
I. E. Mouromtseff
G. D. O'Neill

O. W. Pike
L. M. Price
P. A. Redhead
H. J. Reich
A. C. Rockwood
R. M. Ryder
A. L. Samuel
R. W. Slinkman
J. R. Steen
H. L. Thorson
C. M. Wheeler

Subcommittee on Cathode-Ray and Television Tubes

L. B. HEADRICK, *Chairman*
A. E. Anderson
A. Y. Bentley
W. A. Dickinson

R. E. Dorrell
M. S. Glass
H. C. Hergenrother
B. Kazan

L. C. Kunz
I. E. Lempert
H. W. Salinger
R. W. Sears

G. T. Waugh

* Reprints of this Standard, 50 IRE 7.S2 (Parts I and II), may be purchased while available from The Institute of Radio Engineers, 1 East 79 Street, New York 21, N. Y., at \$1.25 per copy. A 20 per cent discount will be allowed for 100 or more copies mailed to one address. This Standard supersedes 38 IRE 7.S1, *Standards on Electronics: Methods of Testing Vacuum Tubes, 1938*, except Section II—Phototubes. Part II of this Standard will appear in the September, 1950, issue of the PROCEEDINGS.

Subcommittee on Gas Tubes

H. L. THORSON, <i>Chairman</i>	J. P. Hagen	D. S. Peck
D. E. MARSHALL, <i>Past Chairman</i>	V. L. Holdaway	G. H. Rockwood
C. Greef	J. D. Le Van	W. Widmairer

Subcommittee on Power-Output High-Vacuum Tubes

C. M. WHEELER, <i>Chairman</i>	T. A. Elder	A. G. Nekut
I. E. MOURONTSEFF, <i>Past Chairman</i>	C. E. Fay	L. S. Nergaard
E. L. CHAFFEE, <i>Past Chairman</i>	R. W. Grantham	H. J. Reich
R. B. Ayer	J. W. Greer	E. E. Spitzer
J. W. Clark	H. E. Mendenhall	W. G. Wagener
	A. K. Wing, Jr.	

Magnetron Group

M. S. GLASS, <i>Chairman</i>	T. A. Elder	A. K. King, Jr.
C. M. WHEELER, <i>Past Chairman</i>	G. A. Esperson	E. C. Okress
J. J. Caldwell	G. R. Kilgore	Y. D. Smullin
	I. Walker	

Subcommittee on Small-Signal High-Vacuum Tubes

G. D. O'NEILL, <i>Chairman</i>	R. L. Freeman	F. R. Jarvis
A. C. ROCKWOOD, <i>Past Chairman</i>	A. E. Harrison	L. D. McArthur
E. M. Boone	T. J. Henry	C. T. Miller
A. G. Bousquet	L. N. Heynick	W. T. Millis
L. B. Curtis	M. E. Hines	J. A. Morton
W. G. Dow	E. C. Homer	H. M. Owen
H. E. Ellithorn	E. H. Hurlburt	L. F. Peterson
	R. M. Ryder	
	W. G. Shepherd	
	R. W. Slinkman	

Admittance and Noise Group

J. A. MORTON, *Chairman*
 F. M. Bailey
 C. E. Goddard
 W. A. Harris
 E. H. Hurlburt
 L. S. Nergaard

Electron Tube Coefficients Group

W. G. Dow, *Chairman*
 A. G. Bousquet
 A. C. Rockwood

Noise Group

R. M. RYDER, *Chairman*
 J. J. Freeman
 W. A. Harris
 E. H. Hurlburt
 N. T. Lavoo
 D. O. North
 F. K. Stodola

Klystrons Group

W. G. SHEPHERD, *Chairman*
 A. E. HARRISON, *Past Chairman*
 E. M. Boone

B. C. Gardner
 C. T. Goddard
 D. R. Hamilton
 J. O. McNally
 A. L. Samuel

T. J. Henry
 V. R. Learned
 E. G. Linder

1. GENERAL

1.1 Scope

This Standard deals with the methods of measurement of the important characteristics of electron tubes

1.2 General Precautions

Attention is called to the necessity, especially in tests of apparatus of low power, such as electron tubes intended for reception, of eliminating or correcting for errors due to the presence of the measuring instruments in the test circuit. This applies particularly to the currents taken by voltmeters and other shunt-connected apparatus, and to the voltage drops in ammeters and other series-connected apparatus.

Attention is also called to the desirability of keeping the test conditions, such as filament heating, plate potential, and plate current, within the safe limits specified by the manufacturers. If the specified safe limits are exceeded, the characteristics of the electron tube may be permanently altered and subsequent tests vitiated. When particular tests are required to extend somewhat beyond a specified safe limit (see Sections 2.1 and 3), such portions of the test should be made as rapidly as possible and preferably after the conclusion of the tests within the specified safe limit.

1.3 General Test Conditions

Except when the nature of a test calls for varying or abnormal conditions, all tests should be made at the normal rated conditions specified by the manufacturers of the electron tubes. If the manufacturer's rating is not specific, test conditions not specified should be selected in accordance with the best judgment of the tester and should be clearly and fully stated as a part of the test data. In general, measurements should be made after the tube has attained normal operating temperature.

When a filament is rated in both voltage and current, the rated voltage should be employed in tests. When filaments are to be used in series, the rated current may be employed, but this condition of measurement is to be stated as a part of the test data. Direct current should be used for filament heating, except where the normal operating condition is with alternating-current heating, in which case the use of the latter should be stated. When direct-current heating is employed, the negative filament terminal should be taken as the datum of potential. If the proper filament terminal to be used as the negative one is not indicated by the manufacturer or specified in any recognized standard manner for a given vacuum-tube structure, the terminal used as the negative one should be stated with the test data. When alternating-current heating is employed for a filamentary cathode, the midpoint (i.e., the center tap on the filament-transformer secondary, or the midpoint on a resistor shunting the filament) should be taken as the datum. It should be noted that these alternating-

and direct-current heating potential datum conditions are not equivalent and should not be expected to give equivalent readings. If substantially equivalent readings are desired for the two cases, the datum of potential for alternating-current heating must be taken at a point where the direct potential is more negative than that of the filament midpoint by an amount numerically equal to one half the root-mean-square value of the filament voltage. In the case of indirectly heated equipotential cathodes, the cathode is taken as the datum of potential. The connection of the cathode to any part of the heater circuit will usually have no effect upon the measured characteristics.

1.4 Classification of Tests for High-Vacuum Tubes

While all tests in these standards may be required in the testing of specific electron tubes, certain of them are more commonly applicable to one classification of tubes than to another. As a matter of convenience in locating tests that may be required, index letters *PO* and *SS* have been included in the section headings to indicate the methods of testing commonly of value for the general classes of high-vacuum tubes according to function. These classes are:

- Small-signal tubes (indicated by *SS*)
- Power-output tubes (indicated by *PO*)
- Cathode-ray tubes.

The term "small-signal tube" is here used to identify high-vacuum tubes designed primarily to function as devices in which power output is not ordinarily an important consideration.

The term "power-output tube" is here used to identify high-vacuum tubes designed primarily to function as devices in which power output is ordinarily an important consideration.

1.5 Tests for Small-Signal Tubes (SS)

The following are test methods generally applicable to small-signal tubes:

	Section
Filament or Heater Electrical Characteristics	2.1
Filament or Heater Heating Characteristic	2.2
Cathode Heating Time	2.3
Emission: Break-Away Point	3.2.2
Emission: Determination of Break-Away Point	3.2.3
Emission: Comparison of Emission Currents of Tubes	3.4
Emission: Field-Free Emission	3.5
Emission: Direct Emission Check	3.6.1
Emission: Indirect Emission Check	3.6.2
Static Characteristics	4.1
Load (Dynamic) Characteristics	4.2
Perveance: Graphical Methods	4.3.1.1
Residual Gas and Insulation Tests: Direct Method	5.1.1.1
Residual Gas and Insulation Tests: Indirect Method	5.1.1.2
Residual Gas and Insulation Tests: Subtraction Method	5.2.1
Residual Gas and Insulation Tests: Ionization-Gauge Method	5.2.2
Residual Gas and Insulation Tests: Leakage Currents	5.3
Grid Emission Currents: Subtraction Method	6.1.1
Grid Emission Currents: Direct Method	6.1.2
Grid Emission Currents: Secondary Grid Emission	6.2
Direct Interelectrode Capacitances: Radio-Frequency Bridge Method	7.1.1

Direct Interelectrode Capacitances: Transmission Method	7.1.2
Direct Interelectrode Capacitances: Substitution Methods	7.1.3
Electrode Resistance and Electrode Conductance	7.2.1
Transconductance	7.2.2
μ -Factor	7.2.3
General Precautions for Balance Methods	7.2.4
Conversion Transconductance	7.2.6
Oscillation Test for Converter Tubes	7.2.7
Converter Plate Resistance	7.2.8
Four-Pole Admittances	7.3
Rectification Characteristic	8.1.1
Transrectification Characteristic	8.1.2
Conductance for Rectification	8.2
Measurement of Harmonics	9.1
Measurement of Power Output	9.2

1.6 Tests for Power-Output Tubes (PO)

The following are test methods generally applicable to power-output tubes:

Filament or Heater Electrical Characteristics	2.1
Emission: Slope-Intersection Methods	3.1.2
Emission: Tangent Method	3.1.3
Emission: Determination of Break-Away Point	3.2.3
Emission: Extrapolation Method	3.3
Emission: Comparison of Emission Currents of Tubes	3.4
Emission: Field-Free Emission	3.5
Emission: Indirect Emission Check	3.6.2
Emission: Oscillation Emission Checks	3.6.3
Static Characteristics	4.1

Load (Dynamic) Characteristics	4.2
Perveance: Graphical Methods	4.3.1.1
Pulse Methods	4.4
Residual Gas and Insulation Tests: Direct Method	5.1.1.1
Residual Gas and Insulation Tests: Subtraction Method	5.2.1
Residual Gas and Insulation Tests: Ionization-Gauge Method	5.2.2
Residual Gas and Insulation Tests: Dynamic Method	5.2.3
Residual Gas and Insulation Tests: Leakage Currents	5.3
Grid Emission Currents: Subtraction Method	6.1.1
Grid Emission Currents: Direct Method	6.1.2
Grid Emission Currents: Dynamic Method	6.1.3
Grid Emission Currents: Secondary Grid Emission	6.2
Direct Interelectrode Capacitances: Radio-Frequency Bridge Method	7.1.1
Direct Interelectrode Capacitances: Transmission Method	7.1.2
Direct Interelectrode Capacitances: Substitution Methods	7.1.3
Electrode Resistance and Electrode Conductance	7.2.1
Transconductance	7.2.2
μ -Factor	7.2.3
Methods of Measuring Anode Dissipation	10.1
Methods of Measuring Grid Dissipation	10.2
Operating Tests of Large High-Vacuum Diodes	10.3
Radio-Frequency Operating Tests for Power-Output High-Vacuum Tubes	10.4

1.7 Tests for Cathode-Ray Tubes

The test methods for cathode-ray tubes are given in Section 11.

2. FILAMENT OR HEATER CHARACTERISTICS

2.1 Filament or Heater Electrical Characteristics (PO, SS)

Readings of filament or heater current and voltage are taken with voltage applied only to the filament or heater terminals. Measurements should be made over a range of filament temperatures from values too low to give appreciable electron emission in service to at least the safe maximum temperature.¹ The current should be measured when it has reached equilibrium and should be corrected for the current drawn by the voltmeter. Curves should be plotted with values of filament voltage as abscissas and values of filament current and filament power as ordinates.

The resistance of a cold filament or heater is much smaller than its resistance at normal operating temperature. If the filament of a large tube is connected directly to the heating source, excessive filament current may flow and cause damage to the tube. Therefore it may be necessary to limit the filament current to some specified starting value.

2.2 Filament or Heater Heating Characteristic (SS)

When tubes are operated with the filaments or heaters in series, it is desirable that the voltage be divided during the heating period as nearly as possible in accordance with the rated operating voltages of the individual filaments or heaters, in order to minimize the likelihood of burning out and to insure minimum heating

time of the entire complement. In order to judge the heating characteristic of individual tubes in a series string, the time variation of the filament or heater resistance of each tube should be compared with the average of the entire complement.

Measurements are made in a circuit such as that shown in Fig. 1, and the resulting data are plotted as per cent of rated or final heater resistance against time as in Fig. 2. In Fig. 1, T_1 and T_2 are a variable and a tapped transformer, respectively, having ratings adequate to insure good regulation. Switch S_1 is for energizing the complete circuit, and the combination of switch S_2 and resistor R_m is used to protect the meter A against excessive initial surges, the resistance of R_m being made equal to the impedance of the meter A . Protection against short circuits is afforded by the fuse.

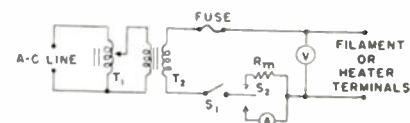

Fig. 1—Circuit arrangement for measuring filament or heater heating characteristics.

The output voltage of T_2 is to be equal to the rated heater voltage of the tube plus the drop through the low-resistance meter A or its equivalent R_m . From the readings of current I taken at known intervals, the percentage of the final resistance attained will be

$$\text{per cent} = 100 \frac{V}{IR_f}$$

¹ See Section 1.2, *General Precautions*.

where R_f is obtained from the final heater voltage at rated heater current.

In Fig. 2, the curves show the percentage of final heater resistance plotted against heating time. Curve *A* may be considered as average for indirectly heated tubes used for series operation, while curves *B* and *C* are for heaters having relatively fast and slow heating

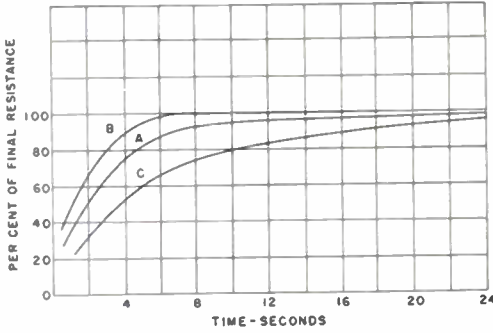

Fig. 2—Curves showing percentage of final heater resistance against heating time.

characteristics, respectively (when operated in series with tubes having heating characteristics such as *A*, Fig. 2). It will be noted that a tube such as that having the characteristic *B* (Fig. 2) will operate with heater temperature above the final value during part of the heating cycle, and the maximum voltage across the heater will exceed the rated value in proportion to the amount by which the curve of per cent of final heater resistance against time differs from the average of that characteristic for all tubes in the circuit. On the other hand, a tube having a characteristic like that of *C* (Fig. 2), will reach its final temperature more slowly when operated in a series circuit than the average tube, and the heater voltage will never exceed the rated proportional value.

2.3 Cathode Heating Time (SS)

For high-vacuum tubes, the cathode heating time is arbitrarily taken as the time required for the time rate of change of the cathode current to reach maximum. All applied voltages are to remain constant during the measurement. The electrodes must be at room temperature before the test is made.

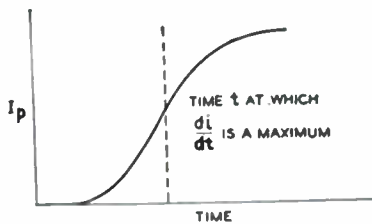

Fig. 3—Relation between plate current and time.

A sample plot of plate current against time is given in Fig. 3. From this it is seen that the plate current increases slowly at first, rises increasingly rapidly, and then slows down and gradually reaches its final value. The maximum time rate of change of cathode current

referred to above corresponds to the point of maximum slope or point of inflection of the curve of Fig. 3 and is defined mathematically as the maximum value of the first derivative of the plate current with respect to time. Measurement under this definition may be made by either of two circuits which give comparable results. The earlier Method A is in more general usage but the Method B is recommended for new equipment, as it is free of the possibility of difference in saturation effects between different transformers.

2.3.1 Method A

The instantaneous current flowing in the secondary of the step-down transformer of Fig. 4 depends only on the rate of change of the current in the primary and is independent of its final value. Hence, the time of the maximum rate of change will be indicated by the maximum deflection of the meter needle. The speed at which the meter needle moves is indicative of the acceleration and has no bearing on the problem; only the time required for the needle to reach the peak of the swing is of importance.

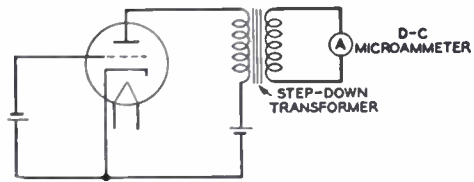

Fig. 4—Circuit arrangement for measuring cathode heating time.

The characteristics of the output transformer or meter are not of great importance as far as the result is concerned, although the meter should have a short period, and the step-down transformer should be selected to give convenient deflections.

2.3.2 Method B

In the circuit arrangement shown in Fig. 5, the meter preferably has a resistance of less than 1,000 ohms and the low-leakage capacitor has a capacitance of about 8 μ f. The shunting resistor is made variable to keep the indicator of the meter on scale. It is important that the meter used have good damping characteristics. The

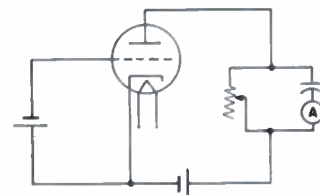

Fig. 5—Circuit arrangement for measuring cathode heating time.

time is taken from the instant the filament or heater circuit is closed to the instant the capacitor charging current reaches a maximum.

3. EMISSION TESTS

The emission properties of a tube are most completely defined by the diode characteristic of the tube.

Two regions of the diode characteristic are generally of importance. One is the temperature-limited-emission region in which the emission is essentially limited by the temperature of the cathode, rather than by the voltages applied to the electrodes (region *A* in Fig. 6). The other region of interest is that in which the departure from the law of space-charge-limited emission becomes noticeable (region *B* in Fig. 6).

These two regions may be represented quantitatively by two specific emission currents. Region *A* may be represented by the flection-point emission current shown as point *a* in Fig. 6. Region *B* may be represented by the inflection-point emission current shown as point *b* in Fig. 6.

The diode characteristic may also be used to determine the field-free emission current of the cathode.

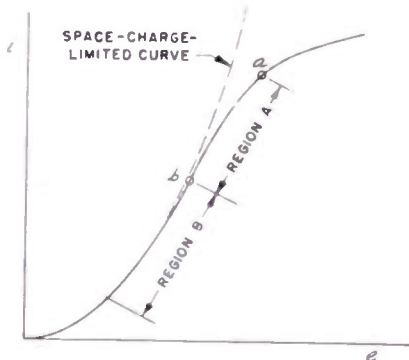

Fig. 6—Typical diode characteristic.

3.1 Measurement of Flection-Point Emission Current

The flection-point emission current, sometimes used as an approximate measure of total emission or temperature-limited emission, is defined as the current at the point on the diode characteristic where the second derivative has its maximum negative value. The value of this current may be obtained with reasonable accuracy from a diode characteristic taken by a suitable method, such as one of those described in Section 4.4.

3.1.1 Graphical Methods

An approximation of the flection-point emission current may be obtained from the diode characteristic by two graphical methods.

3.1.2 Slope-Intersection Method (PO)

The flection-point emission current is approximately equal to the current corresponding to the intersection of two straight lines representing the slopes of the diode characteristic in the space-charge-limited region and in the temperature-limited region, respectively (Fig. 7).

This method is particularly effective if the diode characteristic is plotted on log-log paper. It tends to give a current value higher than the actual flection-point current.

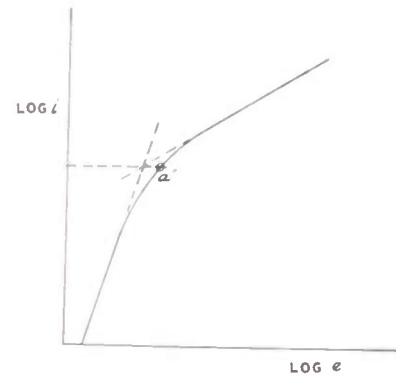

Fig. 7—Determination of flection-point emission current, slope-intersection method.

3.1.3 Tangent Method (PO)

The point of tangency of a line drawn through the origin, tangent to the diode characteristic, as shown in Fig. 8, will indicate the approximate flection-point emission current. If a curve tracer is used to obtain the diode characteristic, a rotatable line drawn on

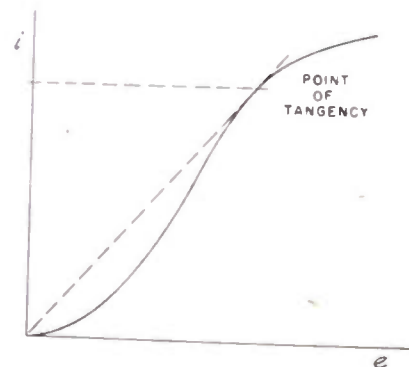

Fig. 8—Determination of flection-point emission current, tangent method.

transparent material may be affixed to the screen of the indicator at the origin of the trace so that it can be manually adjusted to tangency with the trace. This method tends to give a current value somewhat lower than that corresponding to the flection point.

3.2 Measurement of Inflection-Point Emission Current

The inflection-point emission current is defined as the current at the point on the diode characteristic at which the second derivative is zero. The value of this current may be obtained with reasonable accuracy from a diode characteristic taken by a suitable method, such as one of those described in Section 4.4.

3.2.1 Graphical Method

An approximation of the inflection-point emission current may be obtained from the diode characteristic by a graphical method. The complete diode characteristic of the tube must be obtained and plotted. Then, as in Section 3.1.3, a line l is drawn through the origin, tangent to the characteristic, as shown in Fig. 9. Another line m is then drawn parallel to l and tangent to the

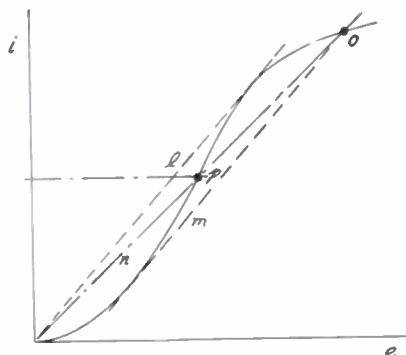

Fig. 9—Determination of inflection-point emission current, graphical method.

lower part of the characteristic. From the point O , where m intersects the characteristic, a line n is drawn through the origin. The intersection p of line n with the characteristic will approximate the inflection point.

3.2.2 Break-Away Point (SS)

The inflection-point emission current is of particular interest for small-signal tubes used as linear amplifiers. Such tubes usually employ oxide-coated cathodes, in which the measure of inflection-point emission current is close to the so-called break-away point.

3.2.3 Determination of Break-Away Point (PO, SS)

It can be shown experimentally that the break-away from the $3/2$ -power-law space-charge line in a diode characteristic of a tube with an oxide-coated cathode, plotted on $I^{2/3}$ paper² or on log-log paper, occurs very near the actual inflection point. Therefore, the break-away current i in Fig. 10 can be used as a measure of inflection-point emission current.

3.3 Extrapolation Method (PO)

The inflection-point and inflection-point emission currents cannot be determined when means are not available for obtaining the complete diode characteristic. An extrapolation method may, however, be used in making an approximate determination of the emission current at normal cathode heating power. This method is more satisfactory for tubes having pure metal cathodes, such as tungsten, than for tubes having thoriated-tungsten or oxide-coated cathodes.

² Special co-ordinate paper No. 25925 may be obtained from Keuffel & Esser Co., P. O. Box 278, Church Street Annex, New York 8, N. Y.

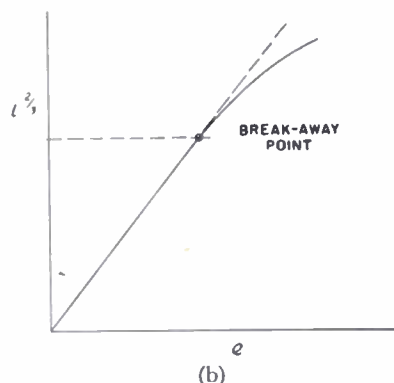
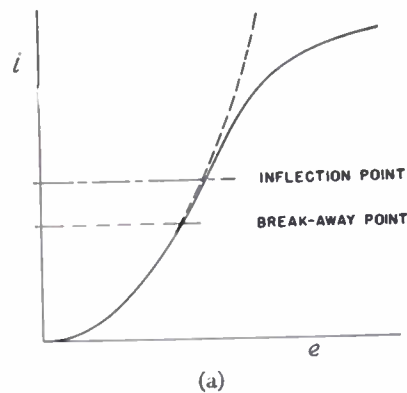

Fig. 10—Determination of emission break-away point.

Readings of emission current are taken at reduced cathode heating power over at least a one-to-ten range of cathode heating power, the maximum value being below that which would cause dangerous heating of the electrode. The diode voltage applied should be high enough to draw temperature-limited current from the cathode.

The results, when plotted on a specially prepared co-ordinate chart,³ should give a straight line which can be extended to determine the emission current at normal cathode heating power. If the graph is not straight, the extrapolation is unreliable. The departure from a straight line may be caused (1) by the use of electrode voltages that are too low to eliminate the effect of space charge, that is, to draw from the cathode all emitted electrons; (2) by decrease or increase of cathode temperature resulting from electron evaporation, back radiation from other electrodes, or the heating effect of the emission current on the cathode or its coating; and (3) by the presence of gas.

3.4 Comparison of Emission Currents of Tubes (PO, SS)

When it is desired to compare the emission currents of several tubes of the same type at the inflection point, inflection point, or any other specified point on the diode characteristic, such as point (e_i, i_i) in Fig. 11, it

³ The special co-ordinate paper known as Power Emission Chart, Form 358-98, may be obtained from Keuffel & Esser Co., P. O. Box 278 Church Street Annex, New York 8, N. Y.

is possible to use the following procedure, in which the effect of small variations in cathode area and electrode spacings is eliminated.

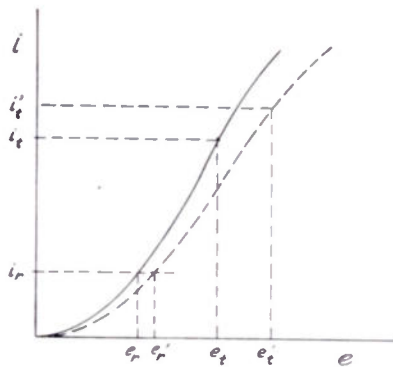

Fig. 11—Comparison of the emission currents of electron tubes.

A point (e_r, i_r) is selected on the lower portion of the reference diode characteristic. To compare any other tube with the reference tube, it is first necessary to determine the voltage e_r' required to obtain the same current i_r . The proper voltage e_t' for the tube under test will then be given by the relation $e_t' = e_t(e_r'/e_r)$. The current i_t' will be a measure of the emission of this tube compared with the current i_t of the reference tube.

3.4.1 Precautions

The voltage e_r should be chosen sufficiently high so that contact potential is negligible in comparison. If this is not possible, the contact potential of each tube should be measured and the voltage e_r corrected for this effect.

The relatively large current obtainable in the inflection-point region may cause a permanent change in the emission characteristic if the current is allowed to flow continuously. Since such a change must be avoided, pulse methods, described in Section 4.4, are desirable, and often essential.

3.5 Measurement of Field-Free Current (PO, SS)

The value of field-free emission current of a cathode may be obtained from the diode characteristic. For this purpose the data are plotted as $\log i$ versus \sqrt{e} , and sufficient data beyond the flexion point must be obtained to determine a straight line in this portion of the plot (Fig. 12). If this straight line is then extended

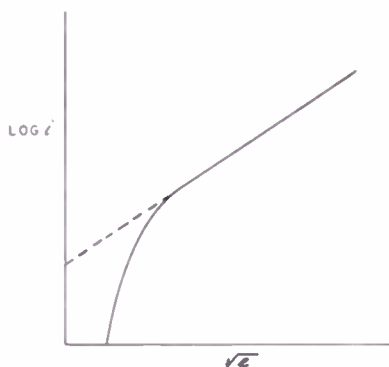

Fig. 12—Determination of field-free emission current.

to the point where it intersects the current axis, the value of current corresponding to this point will be the field-free emission current of the cathode. It may be found that sparking of the cathode, particularly with oxide-coated cathodes, occurs in the high-voltage region. Pulse methods, such as those described in Section 4.4, are usually necessary for obtaining the data.

3.6 Emission Checks

For the purpose of making quick checks on the electron emission of a tube where apparatus for taking a complete diode characteristic is not available, or where a rough check is sufficient, one of the following methods may be used. It is necessary that the values obtained in such checks be correlated with results of more accurate tests in order for such information to be of value.

3.6.1 Direct Emission Check (SS)

For routine test purposes, electron emission may be checked with the filament or heater voltage adjusted to the rated operating value. Then all electrodes in the tube, except the cathode, are connected together to form a composite anode. A voltage, specified for the tube type under test, is applied to the composite anode and a measurement is made of the electron current. The voltage may be direct or alternating.

In practice, anode potentials are chosen considerably lower than would be required for total emission. The choice of anode potential is determined to some extent by the sum of the maximum peak electrode currents that will be required in service, or by the maximum voltage that can be applied for a reasonable length of time to tubes of a given type without injury.

For small-signal tubes having indirectly heated cathodes, a satisfactory anode voltage is one that draws approximately one-fifth ampere per square centimeter of emitting surface.

3.6.2 Indirect Emission Check (PO, SS)

In tubes having filamentary cathodes that might be injured by passing a relatively large average emission current through the filament, it is frequently desirable to obtain an indirect check of the emission by noting the value of filament voltage for which a specific value of emission current is obtained. Provided a low value of anode voltage is employed, this method also avoids false readings caused by such effects as local overheating of the filament, gas currents, or field-emission currents.

3.6.3 Oscillation Emission Checks (PO)

The following method of checking emission, in which the tube is operated under specified conditions as a self-excited oscillator, is particularly adapted to use with power tubes having thoriated-tungsten filaments. The filament voltage is reduced until the total radio-frequency power output has been reduced by a specified percentage, and the filament voltage is then measured.

This value of filament voltage is an indirect measure of the filament activity. This method is arbitrary and gives relative check results that are valuable only as

long as individual tubes of the same type are compared. The results of this check depend in a great degree upon the circuit conditions.

4. CHARACTERISTICS OF AN ELECTRON TUBE

The static characteristics of an electron tube are valuable as a means of predicting the performance of the tube, since load characteristics may usually be computed for assumed circuit conditions. The various tube constants and the perveance may be calculated from families of static characteristics. Load characteristics may be obtained in some cases by actually operating the tube in the desired circuit and making the appropriate measurements.

4.1 Static Characteristics (PO, SS)

The more useful static characteristics of an electron tube are: electrode characteristics, constant-current characteristics, and transfer characteristics.

In general these characteristics may be obtained by direct-current methods up to the point where electrode dissipations exceed safe values. Pulse methods such as those described in Section 4.4 are necessary to obtain the information beyond this point. It is desirable to obtain static characteristics up to and slightly beyond the extreme conditions of voltage and current that the tube will experience in operation.

4.1.1 Direct-Current Method

A representative arrangement for the determination of the characteristics of vacuum tubes is shown in Fig. 13.

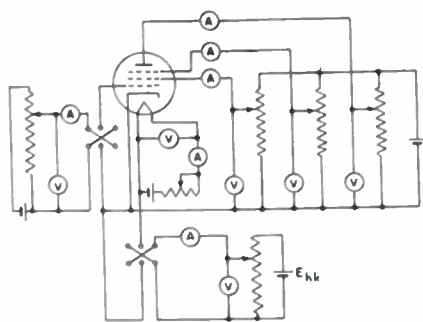

Fig. 13—Circuit arrangement for measuring static characteristics.

4.2 Load (Dynamic) Characteristics (PO, SS)

4.2.1 Calculation of Load Characteristics from Static Characteristic Charts

Various forms of static characteristic charts can be conveniently used for precalculation or verification of tube performance by plotting load characteristics on them. In many cases the shape of the load characteris-

tic can be predicted from the operating conditions and frequently is either a straight line or a portion of an ellipse. For example, class-A audio-frequency operation with resistive load may be represented as a straight line on a plate-characteristic chart. All classes of radio-frequency operation with resonant circuits in both input and output circuits are conveniently represented on a constant-current chart. Transfer characteristic charts are useful for class-B radio-frequency and audio-frequency plots when it is desired to examine the load characteristic directly for harmonics.

At frequencies where electron-transit-time effects become appreciable, it becomes inaccurate to calculate load characteristics from the static characteristics.

Load characteristics permit calculation of the entire performance data of the tube, such as input power, output power, efficiency, dissipation, excitation power, etc.

4.2.1.1 References

- (1) J. C. Warner and A. V. Loughren, "The output characteristics of amplifier tubes," *PROC. I.R.E.*, vol. 14, pp. 735-758; December, 1926.
- (2) B. J. Thompson, "Graphical determination of performance of push-pull audio amplifiers," *PROC. I.R.E.*, vol. 21, pp. 591-600; April, 1933.
- (3) I. E. Mouromtseff and H. N. Kozanowski, "Analysis of the operation of vacuum tubes as class C amplifiers," *PROC. I.R.E.*, vol. 23, pp. 752-778; July, 1935.
- (4) I. E. Mouromtseff and H. N. Kozanowski, "Comparative analysis of water-cooled tubes as class B audio amplifiers," *PROC. I.R.E.*, vol. 23, pp. 1224-1251; October, 1935.
- (5) E. L. Chaffee, "Power tube characteristics," *Electronics*, vol. 2, pp. 34-37, 42; June, 1938.

4.2.2 Direct Measurement of Load Characteristics

The load characteristics of a tube can be measured directly, without resort to calculation from the static characteristics. The tube should be set up for the required operating condition and the desired load characteristic observed by means of a cathode-ray oscillograph, the electrode voltage being applied to one pair of deflection plates and the voltage across a current-measuring resistor simultaneously applied to the other pair.

At frequencies at which electron transit time, tube capacitance, and tube lead inductance become important, they may have considerable effect upon the load characteristic. It is, therefore, advisable to take load characteristics at the frequency at which the tube is to be used.

4.2.2.1 *Precaution.* Care must be taken to insure that the measuring instrument and its connecting leads do not effect the shape of the load characteristic.

4.3 Perveance

4.3.1 Perveance of a Diode

According to the definition, the perveance of a diode is the quotient of the space-charge-limited cathode current by the three-halves power of the anode voltage. It is the constant G in the Child-Langmuir-Schottky equation

$$i_k = Ge_b^{3/2}$$

The numerical value of the perveance of a diode can be calculated from measurements of voltage and current within the space-charge-limited region. A voltage must be chosen sufficiently high so that such effects as those produced by contact potential are unimportant. If, however, the perveance must be calculated from low voltage data, factors such as contact potential and initial electron velocity must be considered.

4.3.1.1 *Graphical Methods (PO, SS).* If the diode current is plotted against the three-halves power of the voltage, the value of G will be the slope of the curve (Fig. 14). The value of G may also be found from the $\log i_k$ intercept when $\log i_k$ is plotted against $\log e_b$ (Fig. 15).

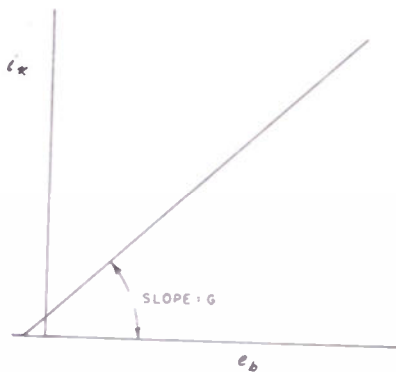

Fig. 14 Determination of the perveance of an electron tube from a 3/2 plot.

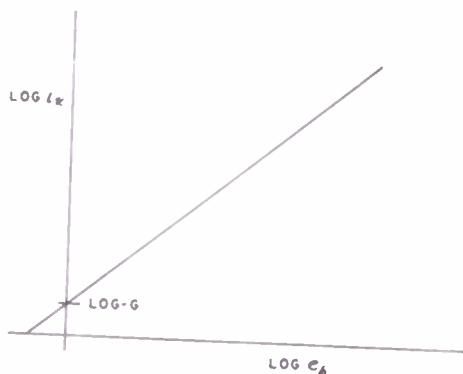

Fig. 15—Determination of the perveance of an electron tube from a logarithmic plot.

4.3.2 Perveance of a Triode or Multigrad Tube

The perveance of a triode is the perveance of the equivalent diode with a composite controlling voltage.

The composite controlling voltage e' may be calculated from the expression

$$e' = \frac{e_c + \frac{e_b}{\mu}}{1 + \frac{1}{\mu}}$$

For triodes with electrodes that can be treated as planes, it is convenient to assume the anode of the equivalent diode to be located at the grid. In this case, the following expression for the composite controlling voltage is used:

$$e' = \frac{e_c + \frac{e_b}{\mu}}{1 + \frac{1}{\mu} + \frac{4}{3} \frac{1}{\mu} \frac{X_2}{X_1}}$$

where X_1 represents the cathode-grid spacing and X_2 the grid-anode spacing. When electrode voltages are small, the voltages e_c and e_b must include the voltage equivalent of such effects as contact potential and initial electron velocity.

Usually, with multigrad tubes, it is sufficiently accurate to consider the screen grid as the anode and the screen-grid voltage as the anode voltage.

4.3.2.1 *Low-Voltage Correction.* The effects of initial electron velocity and contact potential may be represented by the internal correction voltage ϵ that is added to the diode or composite controlling voltage.

For a diode, the correction voltage is

$$\epsilon = (3/2)I_b r_b - e_b$$

For a negatively biased triode, the correction voltage is

$$\epsilon = \frac{3I_b \mu}{2g_m(\mu + 1)} - \frac{\mu e_c + e_b}{\mu + 1}$$

For a negatively biased multigrad tube, the value of g_m to be used is that obtained with all electrodes except the cathode and control grid tied together to form an anode which is held at the voltage ordinarily used for the screen grid.

4.3.3 References

- (1) I. Langmuir and K. F. Compton, "Electrical discharges in gases," Part II, chap. II and IV, *Rev. Mod. Phys.*, vol. 3, p. 237; April, 1931.
- (2) B. D. H. Tellegen, *Physica*, vol. 5c, p. 301; 1925.
- (3) F. B. Llewellyn, "Operation of ultra-high-frequency vacuum tubes," *Bell Sys. Tech. Jour.*, vol. 14, pp. 632-665; October 1, 1935.
- (4) W. G. Dow, "Equivalent electrostatic circuits for vacuum tubes," *PROC. I.R.E.*, vol. 28, pp. 548-556; December, 1940.

4.4 Pulse Methods (PO)

It is of considerable importance to know the static characteristics of electron tubes in the region where elec-

trode dissipation may exceed safe values. It is impossible to obtain these characteristics by the conventional direct-current methods without damaging the tube. In such cases it is necessary to employ pulse methods in which the tube is allowed to pass current only for short intervals of such duration and recurrence frequency that it is not damaged.

Pulse methods may be employed for obtaining electrode characteristics, transfer characteristics, or constant-current characteristics. The basic elements needed for a pulse method are the pulse generator and the current and voltage indicators. Where a single pulse generator is employed, it is usually connected to the control-grid circuit, as in Fig. 16, with the grid bias

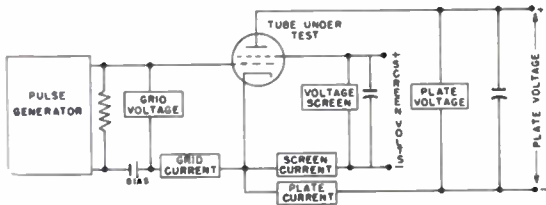

Fig. 16—Circuit arrangement for pulse measurement of tube characteristics, single-generator method.

past cutoff in the absence of the pulse. If more than one pulse generator is used, as in Fig. 17, it is necessary to synchronize the pulses. In general, a single pulse generator is adequate and the single-generator method is simpler than the two-generator method.

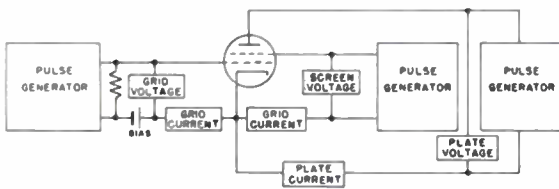

Fig. 17—Circuit arrangement for pulse measurement of tube characteristics, multiple-generator method.

Ordinarily, two methods are employed in obtaining characteristics, namely: the point-by-point method and the curve-tracer method. The point-by-point method consists of applying known pulse voltages to electrodes and simultaneously measuring the corresponding maximum pulse currents to the electrodes. The applied pulse voltages are adjusted point by point over the desired ranges to obtain a family of characteristic curves. The curve-tracer method consists of applying a pulse voltage of such magnitude that the entire range of the desired characteristic is covered and of such shape that the oscillograph indicator shows graphically the true relation between electrode current and voltage.

4.4.1 Point-by-Point Pulse Methods

4.4.1.1 Types of Pulse Generators.

4.4.1.1.1 Capacitor-Discharge Type. The discharge of a capacitor provides one of the simplest means for obtaining a voltage pulse. The capacitor may be discharged either directly through the tube under test, or

through a coupling device. In the absence of series impedance, the peak voltage applied to the tube is the voltage of the charged capacitor. Some means must be provided for switching the capacitor between charge and discharge circuits. The basic circuit is shown in Fig. 18. The switching device may be a mechanical switch, or an electron tube.

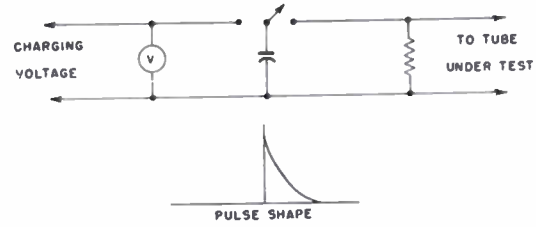

Fig. 18—Basic circuit arrangement for capacitor-discharge pulse generator.

Because of the very short duration of the pulse voltage in a simple capacitor discharge, it is difficult to provide an accurate current indicator of good accuracy. It may therefore be desirable to shape the applied pulse so-as to extend the duration of its peak. This may be done by the use of suitable networks and switching means. Figs. 19, 20, and 21 show circuits for obtaining various pulse shapes. In the circuits of Figs. 20 and 21, the resistance of the parallel combinations of the coupling resistor R and the load of the tube under test should approximate the characteristic impedance, $Z_0 = \sqrt{L/C}$, of the network. In all the above circuits, except that of Fig. 18, the pulse voltage must be measured directly across the tube under test by means of a suitable indicator.

In the circuit of Fig. 19, the vacuum tube may be considered as a pulse amplifier in which any pulse shape applied to the control-grid circuit is amplified and applied to the tube under test. This circuit has the advan-

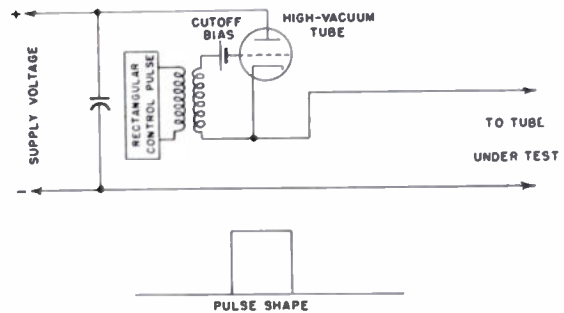

Fig. 19—Basic circuit arrangement for high-vacuum-tube pulse generator.

tage of not requiring a specific terminating impedance. Several amplifier tubes may operate in parallel to provide additional current if precautions usual for parallel operation are observed. There are several arrangements of this basic circuit that may be used, depending on the location of the ground connection and the polarity of the output pulse.

In case secondary-emission effects introduce a negative impedance, the pulse generator must be shunted with a noninductive load resistor of such value as to

maintain a net positive impedance at its terminals. This resistor R should be located between the generator and the current indicator as shown in Fig. 16.

4.4.1.1.2 Sine-Wave Type. Synchronous mechanical contactors or properly controlled thyratrons in conjunction with alternating voltages can be used to apply a half-cycle pulse, or a smaller portion of a cycle to the tube under test, as shown in Fig. 22. It is usually desirable to use only one out of every two or more cycles in order to keep the electrode dissipation low. The system should have low regulation in this type of circuit in order that the current drawn during the pulse cycle does not seriously drop the voltage.

4.4.1.2 Types of Indicators. Indicators are required for both current and voltage. In general, indicators for pulse methods may be divided into three types: dc meters, peak-reading meters, and oscillographs.

4.4.1.2.1 Direct-Current Meter Indicators. Meters are the simplest indicators but have limited application for obtaining electron-tube characteristics by pulse methods. A dc voltmeter may, for example, be used to read the capacitor voltage in the circuit of Fig. 18, a circuit that is sometimes useful in obtaining volt-ampere characteristics by point-by-point methods. The capacitor must have sufficient capacitance to meet the current requirements, and the meter reading must be corrected for the voltage drop across any series impedance. When a dc meter is used for measuring electrode voltage in conjunction with a cathode-ray oscillograph for recording pulse current, as in Fig. 24, satisfactory results are obtained in obtaining electrode characteristics.

The dc meter may also be a useful type of indicator in the circuit of Fig. 16, where it may be used to indicate the voltage of the plate or screen. If high accuracy is desired, correction must be made for the voltage drop in the plate- or screen-current indicator.

4.4.1.2.2 Peak-Reading Voltage Indicator. Peak-reading voltage indicators are useful in measuring the peak value of the pulse voltage applied to an electrode in obtaining vacuum-tube characteristics by point-by-point pulse methods.

In order to function successfully, the circuit consisting of the capacitor, resistance, and meter in Fig. 23 must have a time constant that is large with respect to the time interval between successive pulses. The indicator accuracy is greatest with rectangular pulses shown in Fig. 19, although good accuracy can be obtained with the pulse shapes shown in Fig. 20, 21, and 22 if the pulse duration is sufficient.

The peak-reading voltage indicator of Fig. 23 may be calibrated from a known dc source if correction is made for voltage drop in the high-vacuum diode. The usual practices of correcting for meter current or for voltage drop in current-measuring instruments should be followed. This type of indicator may be used also to determine peak current by measuring the peak voltage drop across a noninductive shunt resistor of known value.

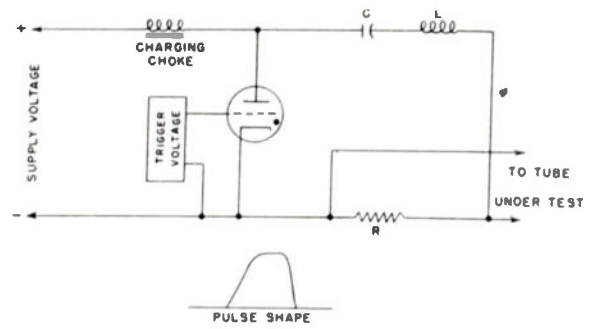

Fig. 20—Basic circuit arrangement for gas-tube LC pulse generator.

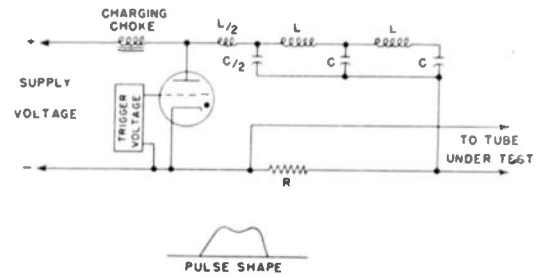

Fig. 21—Basic circuit arrangement for gas-tube pulse generator with pulse-forming line.

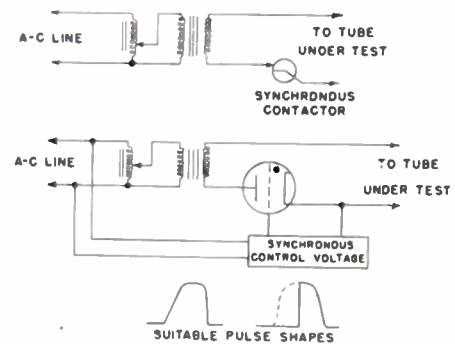

Fig. 22—Basic circuit arrangement for sine-wave-type pulse generator.

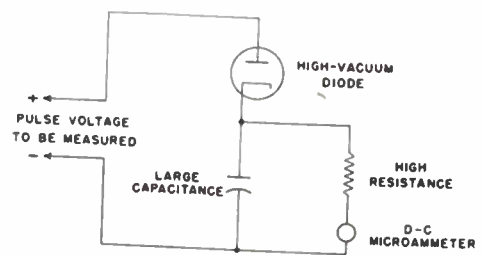

Fig. 23—Peak-reading voltage indicator.

The use of this indicator for current-measuring purposes may result in serious errors if the electrode characteristic of the tube under test exhibits a change of slope from positive to negative. Electrodes giving high secondary emission currents may have such characteristics, and a knowledge of the tube being tested or use of a cathode-ray oscillograph for checking purposes is desirable.

4.4.1.2.3 Cathode-Ray-Oscillograph Current Indicator. The indicator shown in Fig. 24 is useful in measuring the peak value of electrode currents in taking vacuum-tube characteristics by pulse methods in the circuits of Figs. 16 and 17. With large tubes, connection may in

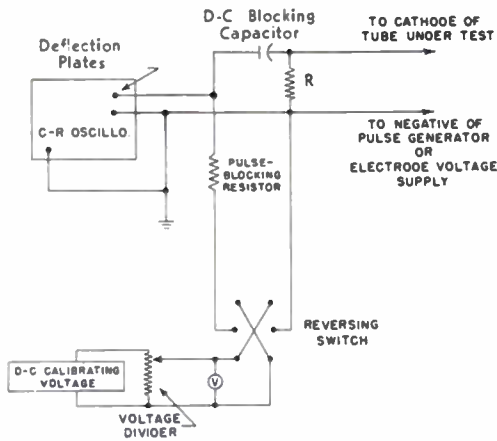

Fig. 24—Cathode-ray-oscillograph current indicator.

most instances be made directly to the vertical deflection plates of the oscillograph. Safety and good performance require that this method be applied only to those oscillographs in which connection may be made directly to deflection plates operated at or near ground potential.

It is usually desirable to utilize a linear horizontal sweep voltage, synchronized to the pulse-generator frequency, to spread out the current trace. In this manner the detection of possible errors, caused by the negative slope of electrode characteristics, is simplified. In obtaining characteristics having only a positive slope, however, the peak current value may be obtained without a sweep voltage simply by measuring the height of the vertical deflection line. The dc calibrating circuit shown in Fig. 24 provides a convenient method of reading the voltage drop produced in the resistor R by the electrode current. The use of a noninductive resistor is recommended, and connecting leads should be kept as short as possible. By means of the adjustable calibrating voltage, the cathode-ray beam may be depressed until the peak deflection coincides with the zero axis. The dc meter reading is then equal to the peak voltage drop in the current-measuring resistor if the reactance of the blocking capacitor is sufficiently small.

The same current indicator may be used to measure several electrode currents by switching it across various electrode-current-measuring resistors.

4.4.1.2.4 Cathode-Ray-Oscillograph Voltage and Current Indicators. Fig. 25 shows the diagram of a type of indicator that is useful in taking vacuum-tube characteristics by either point-by-point or curve-tracer methods.

(Note—In point-by-point methods, the vertical deflection corresponding to the maximum horizontal deflection must always be considered in plotting characteristics curves. For characteristics having only positive slopes, this vertical deflection will also be the maximum.)

A complete trace may be obtained on the cathode-ray screen by applying the proper electrode-voltage pulse.

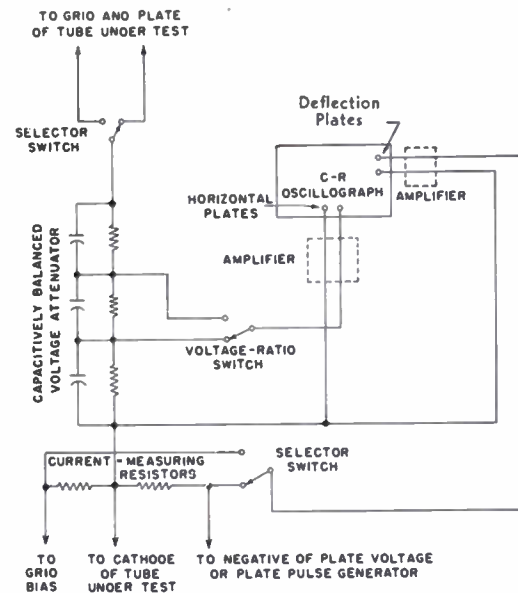

Fig. 25—Cathode-ray-oscillograph voltage and current indicator.

For large tubes, connection is usually made directly to the vertical and horizontal deflection plates. Amplifiers may be used if necessary, providing that they are designed with sufficient bandwidth and sufficiently linear phase-frequency response for the high-frequency components of the pulse.

For best results, the voltage attenuator should be capacitively balanced as shown in Fig. 25. Noninductive resistors should be used and all leads kept as short as possible. Switches make it possible to select the desired tube electrodes. The common method of calibrating the oscillograph screen by the use of known voltages to produce vertical and horizontal deflections may be used. Balancing of the voltage attenuator is achieved by making the ratio of capacitance to resistance of all sections alike. It is also important to take into consideration the input capacitance of the oscillograph. All leads must be properly shielded against stray fields.

The most reliable functioning of the indicator shown in Fig. 25 will be obtained with the common deflection-plate connection grounded. Since the voltage-attenuator current may then flow through the current-measuring resistors, suitable corrections must be made if the current is appreciable.

4.4.1.2.5 Cathode-Ray-Oscillograph Voltage and Current Indicators with Calibrating Trace. The indicator shown in Fig. 26 may also be used in the same manner as that shown in Fig. 25, but means must be provided for measuring the deflection-voltage co-ordinates of any point on a trace. Two sources of independently variable direct voltage are required. Two calibrating voltages are applied simultaneously to the respective deflecting plates by synchronous switches. The calibrating voltages are timed to occur during the intervals between pulses. A calibrating spot will be obtained which can be shifted horizontally and vertically until it coincides

with a desired point on the trace. The voltage co-ordinates of the point then correspond to the calibrating-meter readings. A correction is required for any drop that may occur in the synchronous switches. The calibrating voltage source must have sufficiently low impedance so that no appreciable change in calibrating voltage occurs during operation of the switches. The same precautions and considerations must be observed with this type of indicator as were described for the circuit of Fig. 25.

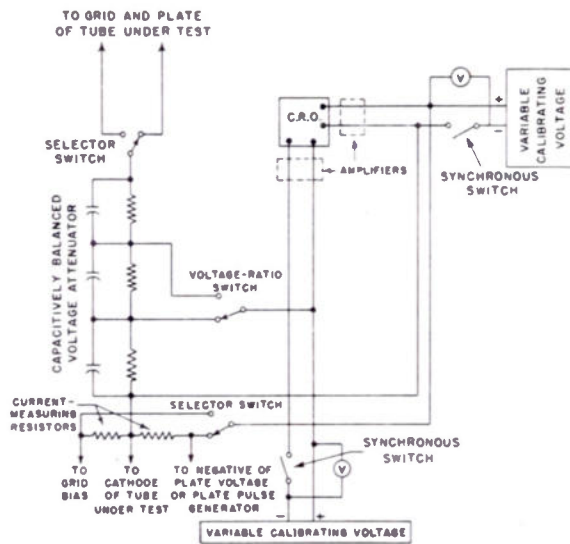

Fig. 26—Cathode-ray-oscillograph voltage and current indicator with calibrating voltages.

4.4.2 Curve-Tracer Method

It is sometimes of considerable advantage to view the complete characteristic of a tube in its useful range for the purposes of checking for irregularities, quickly checking performance, or recording characteristic data. For these purposes the curve tracer affords a very convenient means of presenting the characteristic. An oscillographic current and voltage indicator is required for a curve tracer, and in most practical cases a cathode-ray-oscillographic indicator will be used. Where a permanent record is required, the screen of the cathode-ray tube may be photographed or the data may be transcribed from the screen point by point. Point-by-point transcribing of data from the tracer may be faster than making separate point-by-point measurements by other methods, and has the advantage that the whole trace may be viewed for irregularities that might escape another method.

The type of pulse generator employed for the curve tracer may depend upon the type of characteristic that it is desired to view. In general, the pulse generator used for the independent variable should provide a triangular or sinusoidal pulse in order that the cathode-

ray beam will be deflected at a nearly uniform time rate and thus provide uniform illumination of the curve. If pulse generators are used for other parameters, they should usually provide rectangular pulses of good regulation. Pulses of less than 10-microseconds duration may result in loops in the trace because of phase effects in the input circuit of the tube under test. If it is necessary to use such short pulses, the circuits should be thoroughly checked for these effects.

4.4.2.1 Curve Tracer for Diode Characteristics. A curve tracer suitable for viewing diode characteristics consists of a pulse generator capable of supplying the required peak voltage and current, and a cathode-ray-oscillograph current indicator such as described in Sections 4.4.1.2.4 and 4.4.1.2.5. Any of the pulse generators described in Section 4.4.1.1 having the desired wave shape may be used. When very high currents and voltages are required, a circuit similar to that of Fig. 19 involving one or more amplifier tubes driven by a sinusoidal or triangular pulse may be advantageous.

4.4.2.2 Curve Tracer for Electrode Characteristics. In viewing electrode characteristics on a curve tracer, the sinusoidal or triangular pulse voltage must be applied to the electrode under test. All other electrode voltages must be held constant at the desired values during this pulse. It is necessary that the control grid be biased so that all current is cut off when no pulse is applied to the electrode under test. When the electrode under test is not the control grid, the control grid must be brought to the desired voltage and held at this value throughout the pulse. The regulation requirements for this voltage are severe. Other electrodes may be supplied from dc sources having large capacitances across them. If it is desired to view a family of curves, the parametric voltage must be changed in steps for successive pulses. This may be accomplished by means of synchronous contactors, or by means of electron tubes. If mechanical methods are used, precautions must be taken to prevent sparking of contacts.

4.4.2.3 Curve Tracer for Transfer Characteristics. A satisfactory curve tracer for viewing conventional transfer characteristics is relatively easy to provide, since the pulse is applied to the control grid of the tube under test and the pulse generator need supply only the relatively low peak control-grid current. The plate and other grids, if any, may be supplied from dc sources shunted by large capacitors in order to maintain the voltage constant. If it is desired to view a family of curves, the parametric voltages may be varied by synchronous means, as described in the previous section. If transfer characteristics from electrodes other than the control grid are required, the problem becomes similar to that of obtaining electrode characteristics.

Since a curve tracer for transfer characteristics is simpler to build and operate than one for other types of characteristics, and since data obtained from transfer characteristics may be replotted to show electrode char-

acteristics or constant-current characteristics, all necessary information can be obtained most easily in this manner.

4.4.2.4 *Curve Tracer for Constant-Current Characteristics.* Although it is possible to construct a curve tracer for showing constant-current characteristics, it is simpler to plot such curves from transfer characteristics obtained by the methods described in the previous section.

4.4.3 Bibliography

(1) E. L. Chaffee, "Oscillographic study of electron tube characteristics," *PROC. I.R.E.*, vol. 10, pp. 440-450; December, 1922.

(2) W. A. Schneider, "Use of an oscillograph for recording vacuum-tube characteristics," *PROC. I.R.E.*, vol. 16, pp. 674-680; May, 1928.

(3) H. N. Kozanowski and I. E. Mouronitseff, "Vacuum tube characteristics in the positive grid region by an oscillographic method," *PROC. I.R.E.*, vol. 21, pp. 1082-1096; August, 1933.

(4) E. L. Chaffee, "Power tube characteristics," *Electronics*, vol. 11, pp. 34-37; June, 1938.

(5) R. W. Porter, "Positive grid characteristics for triodes," *Elec. Eng.*, vol. 57, pp. 693-695; December, 1938.

(6) T. J. Douma and P. Zjlstra, "Recording the characteristics of transmitting valves," *Philips Tech. Rev.*, vol. 4, pp. 56-60; February, 1939.

(7) O. W. Livingston, "Oscillographic method for measuring positive-grid characteristics," *PROC. I.R.E.*, vol. 28, pp. 267-268; June, 1940.

(8) E. L. Chaffee, "The characteristic curves of the triode," *PROC. I.R.E.*, vol. 30, pp. 383-394; August, 1942.

(9) A. H. B. Walker, "Cathode ray curve tracer," *Wireless World*, vol. 50, pp. 266-268; September, 1944.

(10) A. J. Heins van der Van, "Testing amplifier output valves by means of the cathode ray tube," *Philips Tech. Rev.*, vol. 5, pp. 61-68; March, 1940.

(11) J. H. Owen Harries, "Impulse generator for testing high power tubes," *Electronics*, vol. 16, pp. 136-139; December, 1943.

(12) J. Millman and S. Moskowitz, "Tracing tube characteristics on a cathode ray oscilloscope," *Electronics*, vol. 14, pp. 36-39; March, 1941.

5. RESIDUAL GAS AND INSULATION TESTS

Vacuum tubes of the same type having satisfactory static and cathode characteristics may differ from one another in the degree of vacuum and of insulation between tube elements. These properties may affect the tube life and the relative freedom from complications in tube operation. The degree of vacuum can be estimated by measuring the gas (ionization) current; the insulation can be judged from the leakage current in the tube. In many cases, it is convenient and sufficient to measure both currents in the circuit of the negatively biased control grid.

5.1 Total Current to a Negatively Biased Control Grid

A minute electric current can always be observed in the circuit of the negatively biased control grid of a vacuum tube. Usually it consists of several component currents arising from various physical phenomena. The currents are superimposed upon one another and do not all flow in the same direction. These currents may result from the following causes: (1) Electrons from the cathode that reach the grid by virtue of contact potentials and initial velocities; (2) gas (ionization); (3) leakage; and (4) primary electron emission from the control grid. Currents arising from these causes are shown in Fig. 27.

5.1.1 Measurement of Total Negative Grid Current

5.1.1.1 *Direct Method (PO, SS).* With a negative bias on the control grid, voltages are applied to all other electrodes to establish a suitable electron current. After thermal equilibrium is reached, the current in the grid

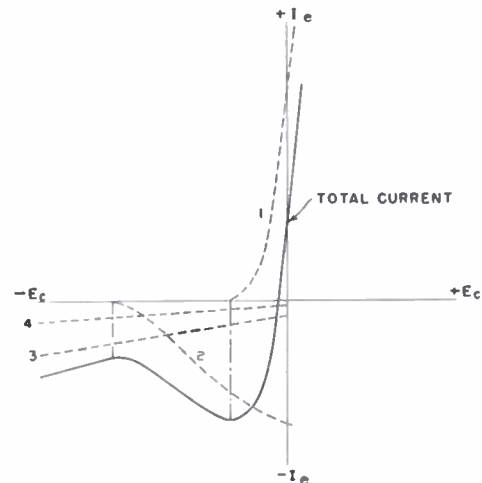

Fig. 27—Total grid current and its components. Curve 1—Electrons from the cathode that reach the grid by virtue of contact potentials and initial velocities. Curve 2—Ionization current. Curve 3—Leakage current. Curve 4—Electron emission from the control grid.

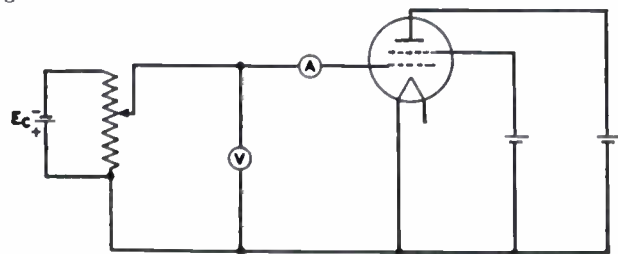

Fig. 28—Circuit arrangement for measuring total negative grid current.

circuit is measured. One circuit arrangement is shown in Fig. 28.

5.1.1.2 *Indirect Method (SS)*. A sensitive method of measuring total control-grid current, which is especially useful when the current is too small for convenient direct measurement by ordinary deflection instruments, is illustrated in Fig. 29. With the switch S closed

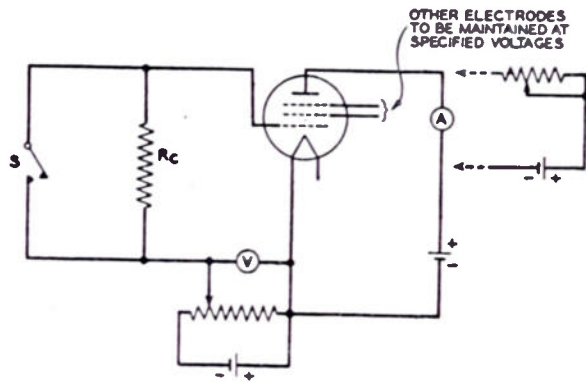

Fig. 29—Circuit arrangement for measuring small control-grid currents.

and the grid and plate voltages adjusted to the desired values, the plate current is read. R_c is then inserted into the grid circuit by opening the switch, and the grid bias E_c is readjusted so that the plate current returns to its former value. The grid current can be computed from the change in grid voltage ΔE_c necessary to maintain constant plate current, since

$$I_c = \Delta E_c / R_c.$$

The necessary value of R_c will depend upon the current to be measured. When a number of tubes of the same type are to be compared for grid current, it is often sufficient to estimate the relative grid current by noting the change in plate current when S is opened or closed.

The sensitivity of the method can be greatly improved by balancing out the normal plate current by the arrangement shown by the dotted line of Fig. 29, in order to permit the employment of a more sensitive plate-current meter.

5.1.1.3 *Precautions*. Leakage resistance across the switch S should be large in comparison with R_c .

5.2 Measurement of Gas (Ionization) Current

When the electrode voltages and currents are high enough, direct measurements under the desired operating conditions may be made with a microammeter, as explained in Section 5.2.1. In many cases there will not be sufficient ionization for these measurements at rated voltages. To check gas currents it is then necessary to use an indirect method such as those described in Sections 5.2.2 and 5.2.3. These methods serve to compare relative ionization in tubes of a given type, but do not afford a direct comparison of gas currents under operating voltages.

5.2.1. Subtraction Method (PO, SS)

Gas current can be determined by the circuit of Fig. 28. First, the total negative grid current is measured as

described above; grid bias is then increased to, or slightly beyond, the cutoff point and the grid current is again noted. If the primary grid emission is relatively small, gas current is approximately equal to the difference between the two readings. This is so because the gas current is included in the first reading, whereas there is no gas current during the second measurement as there is no electron current to produce gas ions. The second reading includes leakage current and primary grid-emission current. Leakage current may be assumed to be proportional to the grid voltage.

(Note—If the primary grid emission is not small, the results obtained by this method may be misleading. The primary grid-emission current will increase with grid voltage and may cause the difference between the two readings to be zero or even negative. Other methods are then required to evaluate the results.)

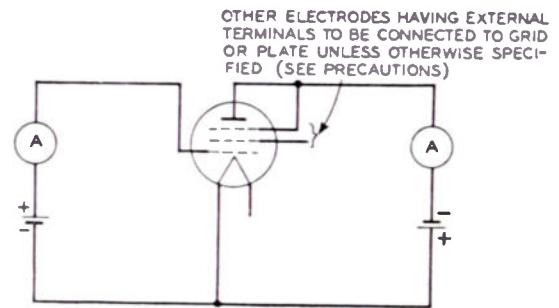

Fig. 30—Circuit arrangement for measuring gas current, ionization-gauge method.

5.2.2 Ionization-Gauge Method (PO, SS)

In many types of vacuum tubes, the degree of vacuum can be estimated without measuring the negative grid current. The method is based upon a circuit exemplified by Fig. 30, in which a positive voltage greater than the ionization potential is applied to the number-one grid and a negative voltage is applied to one or more other electrodes. Positive ions formed by the collision of electrons with gas molecules are collected by the negative electrodes. The resulting positive-ion current gives an indication of the gas density, and therefore gives a means for comparison of the degree of vacuum of individual tubes of the same design. Since the nature of the gas affects the measurement, it must be considered when measurements are made with different gases.

5.2.2.1 *Precaution*. Although the cathode temperature in this test must be adjusted to give a sufficiently high grid current for convenient readings, the grid current should not be too high, because bombardment of the grid may cause gas evolution. The same value of grid current for a given circuit must be used for comparison of the degree of vacuum in the tubes of the same design. Retarding-field oscillations that may occur during measurements in this circuit must be avoided by proper choice of voltage.

5.2.2.2 References.

(1) O. E. Buckley, "An ionization manometer," *Proc. Nat. Acad. Sci.*, vol. 2, pp. 683-685; December, 1916.

(2) C. G. Found and S. Dushman, "Studies with the ionization gauge," *Phys. Rev.*, series 2, vol. 17, pp. 7-20; January, 1921.

(3) L. Dunoyer, "Vacuum Practice," D. Van Nostrand Company, Inc., New York, N. Y., p. 100; 1926.

(4) E. K. Jaycox and H. W. Weinhart, "A new design of an ionization manometer," *Rev. Sci. Instr.*, vol. 2, pp. 401-411; July, 1931.

5.2.3 Dynamic Method (PO)

Gas current to the negatively biased plate can be measured in the circuit of Fig. 33, described in connection with the measurement of primary grid emission. In the application of this circuit to gas-current measurement, the plate circuit, shown by a broken line, must include a source of sufficiently negative direct potential and a sensitive dc meter for reading the ion current. An advantage inherent in this method is that gas current can be measured as a function of grid input power. Furthermore, by plotting a graph of gas current versus grid electron current, one may determine the input power at which evolution of gas from the grid just begins. At this value of power the graph begins to depart

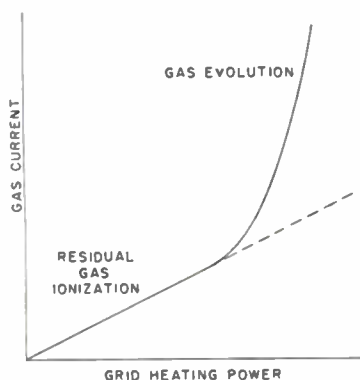

Fig. 31—Gas current as a function of grid dissipation.

rapidly from a straight line and bends upward (Fig. 31).

(Note—When a negative plate potential is used in the measurement of gas by methods 5.2.2 and 5.2.3, photoelectric emission from the plate may obscure gas-current reading. If photoemission is taking place, it may be recognized by projecting light from an external source onto the plate. If no change in gas current occurs under fixed potentials, it may be assumed that photoemission is negligible. Moreover, if the grid power is sufficient to heat the plate to the point of thermionic emission, the electron current from the plate may affect the gas-current reading. This condition may be recognized by the reversal of plate current when the plate potential is gradually reduced to zero.)

5.3 Leakage Currents (PO, SS)

Leakage currents should be measured with the insulating materials of the tube at or near operating temperatures. A suitable potential is applied between each two electrodes in turn and the current measured with the other electrodes floating.

Since these measurements may include emission currents from various electrodes, care should be taken that conditions are such as to preclude such emissions. These conditions may be approached by heating the tube under normal operating conditions, turning off the filament or heater, and making measurements as soon thereafter as the electrodes have cooled to the point where electron-emission currents will be negligible.

Leakage current between the heater and the cathode of a tube should be measured with the rated heater voltage applied. Either alternating or direct voltage may be used, as convenient. A direct voltage of approximately one hundred volts, in series with a microammeter, may then be applied between the cathode and the heater, and the leakage current measured.

6. GRID EMISSION CURRENTS

There are two types of electron emission from a grid that may, and frequently do, affect vacuum-tube operation: (1) thermionic electron emission; and (2) secondary electron emission.

6.1 Thermionic Grid Emission

During tube operation, the control grid is subject to heating by radiation and by electron bombardment when the grid potential becomes positive. As a result, the grid temperature may reach the level at which it begins to emit electrons thermionically. Consequently, an electron current from the grid to other electrodes may flow whenever the grid becomes negative with respect to these electrodes. The amount of such thermionic emission and the conditions under which its effects become appreciable can be determined by one of the following methods.

6.1.1 Subtraction Method (PO, SS)

The total negative grid current measured beyond the cutoff point, as described under Section 5.2.1, consists of the leakage current and the thermionic grid-emission current. Since grid-leakage current can be measured independently (Section 5.3), it can be subtracted from the total measured current to give the value of thermionic emission current. If the leakage current is negligible, the original measurement gives the grid-emission current directly.

(Note—The grid-emission and leakage currents are both related to temperature. Therefore, the total grid current must be measured as quickly as possible after the cathode current is cut off. The value of leakage current measured must be corrected to the voltage at which the total current was measured.)

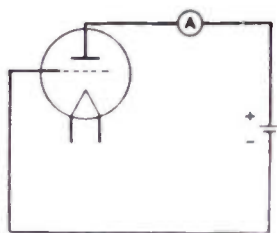

Fig. 32—Circuit arrangement for measuring grid-emission current, direct method.

6.1.2 Direct Method (PO, SS)

The connections for direct measurements of thermionic grid-emission current are shown in Fig. 32. During this test the electrodes should be at their normal operating temperatures. To this end it is recommended that the tube be operated in the usual way at its normal voltages for a time sufficient to insure normal temperature conditions. By means of switches the circuit shown in Fig. 32 is then quickly established and the grid emission is noted while the electrodes are still approximately at their normal temperatures. The cathode should be at its normal operating temperature throughout this test.

6.1.2.1 Precautions. The above test gives the grid emission directly only when the leakage between the grid and plate electrodes is negligible. If the leakage current is not negligible but is known, it can be subtracted from the observed current to obtain the grid-emission current.

6.1.2.2 Reference.

(1) A. F. Van Dyck and F. H. Engel, "Vacuum-tube production test," *Proc. I.R.E.*, vol. 16, pp. 1532-1552; November, 1928.

6.1.3 Dynamic Method (PO)

Measurement of thermionic grid emission as a function of grid dissipation power may be accomplished by use of the circuit shown in Fig. 33. In this arrangement

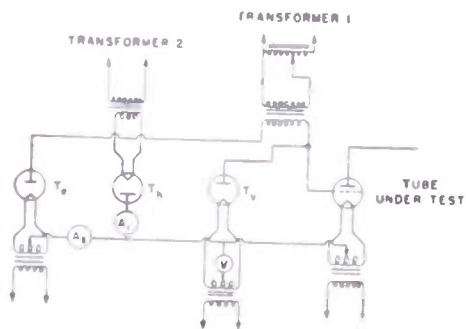

Fig. 33—Circuit arrangement for measuring primary grid emission.

the grid of the tube under test is heated by 60-cycle power from transformer 1 on every alternate half-cycle through rectifier T_h and ammeter A_1 . On the reverse half-cycle of transformer 1, a sensitive meter A_2 in series with rectifier T_v indicates the thermionic grid-emission current (and leakage current if present). Voltmeter V in series with rectifier T_v serves to indicate the voltage

on the grid on the heating half-cycle. With proper regard to the form factors of the various voltages and currents, the thermionic grid-emission current versus grid dissipation may be calculated. If a wattmeter is used in place of ammeter A_1 and voltmeter V , the grid dissipation can be read directly.

If necessary, grid emission can be measured in the tube with the anode heated to its normal operating temperature. A suitable circuit for this test is shown in Fig. 34. In this circuit, a switching device, mechanical

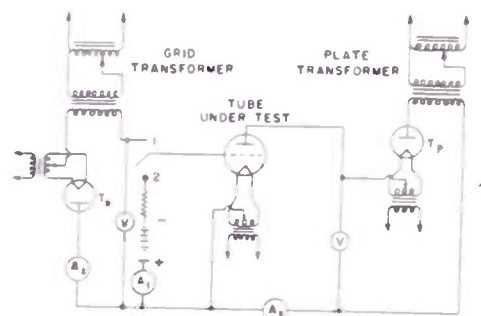

Fig. 34—Circuit arrangement for measuring primary grid emission with plate dissipation.

or electrical, is inserted into the grid circuit. In one position the heating current flows to the grid from the grid transformer through rectifier T_g and ammeter A_2 during one half-cycle of the 60-cycle supply. On the other half-cycle, the anode is heated from the plate transformer through rectifier T_p and ammeter A_3 . After the electrodes have attained operating temperatures, the switch is thrown to its other position, which connects the grid through sensitive meter A_1 to a negative voltage sufficient to cut off the plate current. The thermionic grid-emission current (including leakage current if present) under these conditions may be read on meter A_1 .

6.1.3.1 Reference.

(1) I. E. Mouromtseff and H. N. Kozanowski, "Grid temperature as a limiting factor in vacuum tube operation," *Proc. I.R.E.*, vol. 24, pp. 447-454; March, 1936.

6.2 Secondary Grid Emission (PO, SS)

Secondary electron emission from the grid surface as a result of electron bombardment is an ever-present phenomenon in electron tubes when positive potentials are applied to the grid statically or dynamically. Secondary-electron-emission current flows from the grid to other more positive electrodes as long as electron current flows to the grid. In the external grid circuit, the bombarding current and the secondary-emission current flow in opposite directions, and only their difference can be observed on a meter.

Pronounced secondary grid emission in a vacuum-tube amplifier or oscillator can help tube operation by increasing the output and efficiency or by reducing the grid-excitation power. It may, however, interfere with tube operation by preventing the realization of

linear amplification or by causing parasitic oscillations. Secondary grid emission may exert a detrimental effect when it is of such magnitude as to produce a negative grid resistance. Negative grid resistance is evidenced by a negative slope of the curve of grid current versus grid voltage, or even by reversal of grid current. In Fig. 35, the effect of secondary grid emission on the grid characteristic is shown. Region *a* of curve III is a negative-resistance region.

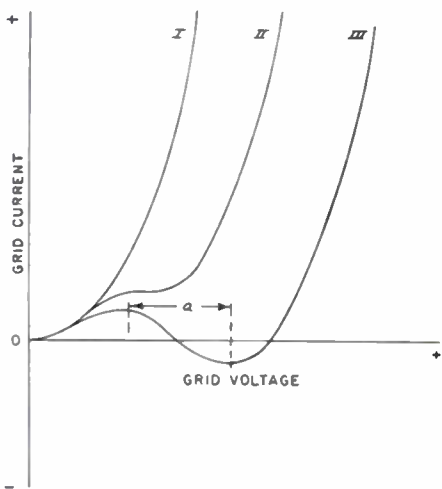

Fig. 35—Typical grid characteristics showing effects of secondary emission. Curve I—No appreciable secondary emission. Curve II—Appreciable secondary emission. Curve III—Pronounced secondary emission. (Note negative resistance in region *a*.)

The amount of secondary emission from the grid of a tube cannot be measured directly. Tubes of the same

type, however, may be compared as to the relative amount of secondary grid emission present by projecting a grid characteristic upon the screen of a cathode-ray tube as described in Section 4.4.2, or by checking by static means a point on the grid characteristic for chosen values of electrode voltages. If a static test is used, electrode voltages must be chosen that do not result in excessive electrode dissipation.

6.2.1 Calculation Method

The amount of secondary grid emission at any point on the tube characteristic may be calculated if the distribution of the thermionic electron current to the electrodes is known. The distribution of the thermionic electron current can be calculated approximately for various combinations of electrode voltages by use of empirical formulas.^{4,5} Knowledge of electrode spacings and dimensions is required for this calculation. This method, while not precise, is the only one available at the present time for determining the amount of secondary grid emission.

6.2.2 Reference

- (1) A. W. Hull, "The dynatron," PROC. I.R.E., vol. 6 pp. 5-35; February, 1918.

⁴ Karl Spangenberg, "Current division in plane-electrode triodes," PROC. I.R.E., vol. 28, pp. 226-235; May, 1940.

⁵ J. L. H. Jonker, "The current to a positive grid in electron tubes," Philips Res. Rep., vol. 1, pp. 13-32; October, 1945.

7. VACUUM-TUBE ADMITTANCES

From the point of view of the circuit design engineer, it is desirable to have a set of parameters that are characteristic of the tube alone, and that will enable a direct prediction of its behavior to be made over the useful frequency range when known or specified admittances are attached to its physically available terminals.

For zero frequency or very low frequencies up to the order of 10³ cycles per second, this specification and prediction of behavior may be accomplished through the measurement and use of the admittances comprising the familiar equivalent circuit that may be drawn for a triode as shown in Fig. 36.

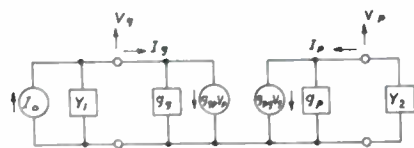

Fig. 36—Low-frequency equivalent circuit of a triode.

For frequencies of the order of 10³ to 10⁶ cycles per second the effects of the input, output, and feedback

capacitances are handled by adding them appropriately as shown in Fig. 37.

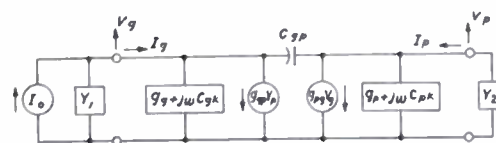

Fig. 37—Equivalent circuit of a triode for frequencies up to a megacycle per second.

In Section 7.1, methods are described for measuring the various capacitances such as C_{gk} , C_{gp} , and C_{pk} . If these measurements are made directly at the base of the tube, it must be realized that only the internal electrode and lead capacitances have been determined. To make possible the prediction of the behavior when known terminations are attached to the available terminals, the capacitances of the socket and shielding must be added to these capacitances. This may be accomplished most directly by measuring the desired capacitances in the actual socket and shield configuration to be used. Some standard conditions for such

measurements are given in the Radio Manufacturers Association standards. If an unconventional use of the tube is contemplated, the capacitances should be measured at the available terminals of whatever shield and connection arrangement is to be used.

In Section 7.2, methods are described for measuring the real parts of the various admittances making up the equivalent circuit, such as g_p , g_{pv} , g_{op} , and g_o . At frequencies up to about 10^6 cycles per second it is relatively unimportant whether these conductances are measured at the tube base or in the socket, since both the internal and external leads are sufficiently short so that only their capacitive effects need be considered.

At frequencies greater than about 10^7 cycles per second, marked increases in the input, output, forward, and feedback admittances occur other than those caused by the grid-plate capacitance. The causes for these modifications can generally be traced to either or both of the following effects: (1) The effect of the passive coupling circuit (both internal and external) connecting the electron stream to the externally available terminals. (2) The effects of the finite transit time of the electrons through the interelectrode spaces. When tubes with wire leads and closely spaced electrodes are used in conventional sockets, at frequencies up to about 10^8 cycles per second these increases are caused primarily by the coupling networks connecting the electron stream to the external terminations. These effects are taken into account in Fig. 38 by indicating

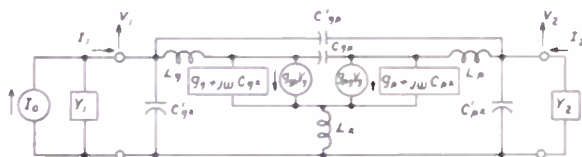

Fig. 38—Equivalent circuit of a triode for frequencies up to 100 Mc.

the lead self-inductance and mutual inductance and splitting the low-frequency capacitances into electrode parts and circuit parts. Not only has the circuit now become complicated for analysis, but a more serious defect has appeared: the new circuit elements that have been introduced cannot be measured directly from the external terminals alone.

At frequencies higher than about 10^8 cycles per second, additional modifications in the basic electronic admittances, caused by transit time, make it still more difficult to assign values to the various circuit elements, either by measurement or by calculation.

If we ignore the internal electronic and circuitual complexity existing between the available input and output terminals and focus attention only upon these terminals, we have simply the four-terminal box of Fig. 39. As is well known, four parameters are necessary to specify completely the behavior of such an active linear transducer. From among the many sets of such parameters that are available, consider the short-circuit input admittance

y_{11} , the output admittance y_{22} , the forward admittance y_{21} , and the feedback admittance y_{12} .



Fig. 39—Four-pole representation of an electron tube.

The behavior at all frequencies is then indicated by the nodal equations (1) and (2) subject to the terminal conditions (3) and (4). (See equations below).

$$I_1 = -y_{11}V_1 + y_{12}V_2 \tag{1}$$

$$I_2 = y_{21}V_1 + y_{22}V_2 \tag{2}$$

$$I_0 = I_1 + Y_1V_1 \tag{3}$$

$$I_2 = -Y_2V_2 \tag{4}$$

$$Y_{11} = \frac{I_1}{V_1} = y_{11} - \frac{y_{12}y_{21}}{y_{22} + Y_2} \tag{5}$$

$$\frac{V_2}{V_1} = \frac{-y_{21}}{y_{22} + Y_2} \tag{6}$$

Solution of these equations leads to expressions for the various design quantities, such as input admittance and voltage gain, which will be valid for all frequencies, only the values of the admittances y_{ij} changing with frequency. These admittances may be arranged in a simple circuit, as shown in Fig. 40. Comparison with



Fig. 40—Equivalent circuit of an electron-tube four-pole.

Fig. 36 makes it apparent at once that the circuits are the same in configuration so that the short-circuit admittances do reduce to the familiar electron-tube coefficient at low frequencies.⁶

As the frequency is increased, these admittances will vary and reflect in their changing values the effects of the coupling circuits and electron-transit times.

The important fact to be emphasized is that these admittances can be determined from measurements made only upon the external terminals, whereas the elements of Fig. 38 cannot be so determined.

In Section 7.3, methods are described in principle for measuring the short-circuit admittances over a wide frequency range. Apparatus employing lumped-circuit and coaxial-line-circuit techniques is described in some detail for frequencies of the order of 10^7 to 10^9 cycles per second. By using the same principles, but with different

⁶ Associated with the admittance type of analysis there must be the concept of impressed voltages. There are two graphical symbols for indicating the introduction of impressed currents into a circuit. These are shown in Figs. 41 and 42. That shown in Fig. 41 is used in all the preceding figures.

physical configurations of the circuits, such as waveguides with standing-wave devices, the frequency range may be extended indefinitely.

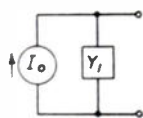

Fig. 41—Symbolism (a) for indicating the introduction of an impressed current.

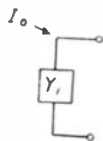

Fig. 42—Symbolism (b) for indicating the introduction of an impressed current.

7.1 Direct Interelectrode Capacitances

It is recommended that direct capacitances be measured, rather than total capacitances, each of which is the sum of two or more direct capacitances. In measurements of direct capacitance between two elements of multielement tubes, it is customary to connect all other elements to ground unless another connection is desired which more nearly simulates circuit operating conditions. Published capacitance values usually specify connections for the other elements in accordance with rules of the Radio Manufacturers Association. In general, it is customary to connect the heaters and screen grids to the cathode and to connect other sections or units to ground. Information as to the element connections for specific published capacitance values should be obtained from the published data sheets. The three direct capacitances of a triode are grid-plate capacitance C_{gp} , grid-cathode capacitance C_{gk} , and plate-cathode capacitance C_{pk} . When a tube is active, its direct interelectrode capacitances differ from the values obtained with a cold tube. The difference may be sufficient to be of importance in certain cases.

Interelectrode capacitances, unless otherwise specified, are measured with the cathode cold and with no direct voltages present. For details on approved conditions of measurement, see Standard ET-109-A of the Radio Manufacturers Association.

There follow several methods of measurements for interelectrode capacitances. The radio-frequency bridge method and the transmission method are applicable throughout the usual ranges of tube capacitances of the order of 0.0001 to 100 micromicrofarads. Substitution Method A is useful for capacitances above 1.0 micromicrofarad. Substitution Method B is more suitable for smaller capacitances. The capacitance values as read will depend on shielding geometry.^{7,8}

⁷ Generally used shielding dimensions and shields are included in the Standards and Standards Proposals of the Radio Manufacturers Association.

⁸ Leonard T. Pockman, "The dependence of interelectrode capacitance on shielding," *PROC. I.R.E.*, vol. 32, pp. 91-98; February, 1944.

Audio-frequency bridge measurements are not currently used for the measurement of small values of tube capacitances.

7.1.1 Radio-Frequency Bridge Method (PO, SS)

A bridge circuit for the measurement of direct interelectrode capacitances of a tube is shown in Fig. 43.

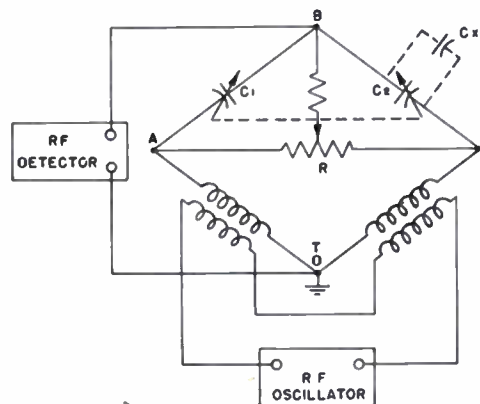

Fig. 43—Circuit arrangement for radio-frequency bridge for measuring interelectrode capacitances.

A stable oscillator, such as a crystal-controlled oscillator, supplies radio-frequency power through a closely coupled balanced transformer (T). Balance is indicated by a null-indicating vacuum-tube voltmeter which is made up of a tuned amplifier, diode rectifier, and direct-current meter indicator. For convenience, the capacitors are ganged differentially so that increase of one capacitance is accompanied by an equal decrease of the other. Balance may then be effected by varying the two capacitance branches until they are equal (when $C_X = C_1 - C_2$). Then, at balance, $C_X = |2\Delta C_1| = |2\Delta C_2|$. When an adapter is used, the tube capacitance is the difference in capacitance readings with the tube in and out of the adapter. An advantage of the bridge over the transmission or substitution method is that the conductive components of the tube admittances due to insulation losses, getter deposits, or other leakages, can be measured and balanced out independently of the capacitance reading. The effect of capacitance to ground is negligible as point B is at a center location in the bridge, where capacitance does not influence balance; and the capacitance from C to ground is across a closely coupled low-impedance winding that does not affect the capacitance balance or the voltage supplied to the bridge.

7.1.1.1 Reference.

(1) C. H. Young, "Measuring interelectrode capacitances," *Tele-Tech*, vol. 6, pp. 68-70, 109; February, 1947.

7.1.2. Transmission Method (PO, SS)

A circuit for measuring the direct interelectrode capacitances of a tube is shown schematically in Fig. 44.

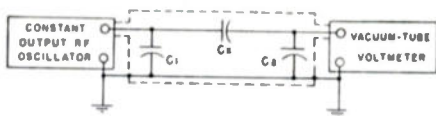

Fig. 44—Circuit arrangement for measuring interelectrode capacitance by transmission method.

The radio-frequency oscillator voltage is attenuated according to the range desired. The current in the unknown tube capacitance is amplified and measured by a tube voltmeter. The amplifier input is attenuated in conjunction with the oscillator output so that various ranges may be obtained. The oscillator-output and amplifier-input attenuators may be operated from a common control and calibrated in convenient decade steps. It is to be noted that large capacitors are required across the input and output so that the effect of the tube capacitances shunted across the input and output is negligible. The device is calibrated by using a known standard capacitor or a resistor of negligible shunt capacitance that may be calibrated in position. The parts must be shielded from one another to eliminate stray capacitances, because there is no way of balancing them out with this method.

7.1.3 Substitution Methods (PO, SS)

7.1.3.1 Method A, Substitution of Calibrated Capacitor for Tube Capacitance. Fig. 45 illustrates a substitution

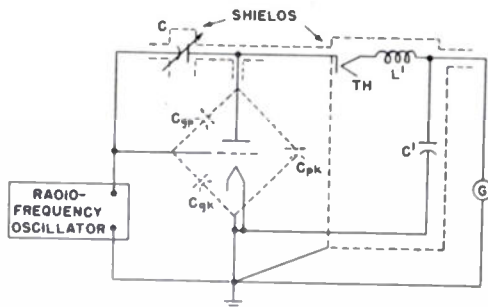

Fig. 45—Circuit arrangement for measuring interelectrode capacitance by Substitution Method A.

method (with set-up for grid-plate capacitance C_{gp}) using a radio-frequency oscillator as the source and a thermoelement TH and galvanometer G as the indicator. Alternatively, a vacuum-tube voltmeter may be used as an indicating device to obtain higher sensitivity. The shielded capacitor C is calibrated to read capacitance above an arbitrary reference point and should have a range as great as the largest capacitance to be measured. With C set at this reference point and the vacuum tube in the circuit, the galvanometer reading is taken. The vacuum tube is removed and C is adjusted until the galvanometer reading is the same as before. The added capacitance of C is then equal to the grid-plate capacitance C_{gp} . The radio-frequency oscillator should maintain constant voltage and frequency (or, at least, a constant product of these quantities). To verify that the oscillator is maintaining a constant product of

voltage and frequency, a thermoelement with galvanometer and filter may be connected in series with a small capacitance across the oscillator terminals. The connection from the plate of the vacuum tube through the thermoelement TH to the filament should be short if it is not shielded. The capacitor C' and coil L' constitute a filter system to keep radio-frequency current from flowing through the lead to the galvanometer G .

7.1.3.2 Method B, Substitution of Calibrated Capacitor for Low Tube Capacitances. For small capacitances such as the grid-plate capacitance of screen-grid tubes, the substitution method of Fig. 46 can be employed with a

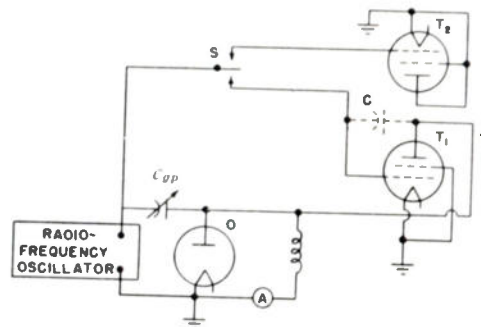

Fig. 46—Circuit arrangement for measuring interelectrode capacitance by Substitution Method B.

calibrated capacitor C of suitable range, a radio-frequency source of suitable voltage, and a detector of somewhat greater sensitivity than a thermoelement.

Because of the great sensitivity required to measure the very small values of capacitance, it is desirable that all disturbing influences be minimized. This is accomplished by keeping the capacitances across the oscillator and across the detector constant by means of a balancing tube.

The low-capacitance switch S is first thrown to the tube T_1 under test and the reading of the microammeter noted. The switch is then thrown to T_2 , the balance tube, which should be of the same type as T_1 , and the capacitor C is adjusted to give the same reading of the microammeter as before. The feedback capacitance C_{gp} is then equal to the added capacitance of C .

7.1.3.2.1 Precautions. In Method B, the voltage and frequency of the oscillator should remain constant, as indicated on the microammeter when a capacitive load is added. If this is not possible, the product of its output voltage and frequency must be constant.

Fig. 47 shows a balance tube T_2 . If such a balance

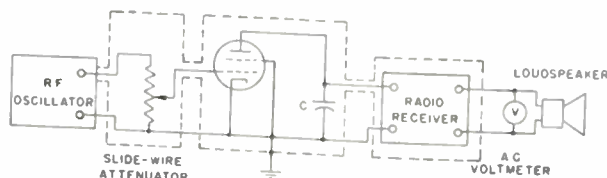

Fig. 47—Circuit arrangement for measuring interelectrode capacitance by Substitution Method C.

tube is used, its input resistance should be greater than 100 megohms; otherwise, serious errors will result when

low values of grid-plate capacitance are measured. If a tube with this high input resistance is not available, it may be replaced by a calibrated low-loss capacitor having a capacitance within 20 per cent of the grid-cathode capacitance of T_1 .

7.1.3.2.2 Reference.

(1) A. V. Loughren and H. W. Parker, "The measurement of direct interelectrode capacitance of vacuum tubes," PROC. I.R.E., vol. 17, pp. 957-965; June, 1929.

7.1.3.3 Method C, Comparison of Input Voltages for Standard and Unknown Capacitances for Constant Output. An alternative substitution method of high sensitivity is illustrated in Fig. 47. This method employs a calibrated variable-voltage source and a fixed standard capacitor instead of the fixed-voltage source and calibrated variable capacitor of Substitution Methods A and B. A standard signal generator is convenient for this purpose. The current through the grid-plate capacitance of the tube produces a voltage across the receiver input, which is shunted by a large capacitance C . In the arrangement shown in Fig. 47, the radio-frequency oscillator is modulated, and an alternating-current voltmeter connected across the terminals of the loudspeaker is used as an indicator.

A standard fixed capacitor C_s of the order of one-half micromicrofarad, suitably shielded, is first used in place of the tube shown in Fig. 48 and the attenuator set so that the impressed radio-frequency voltage is E_s with a standard audio-frequency output. The tube to be measured is next substituted for the standard capacitor and the attenuator readjusted until an impressed radio-frequency voltage E_x produces the same deflection at V . The unknown grid-plate capacitance is

$$C_{gp} = C_s \frac{E_s}{E_x}$$

The standard capacitor can be enclosed within a vacuum tube of standard dimensions. Two circular disks, two centimeters in diameter and spaced eight millimeters apart, will provide a standard capacitor of the proper order of magnitude. It may be calibrated by measurements on a differential capacitance bridge.

7.1.3.3.1 Precautions. The leads from the attenuator to the tube shield and from the latter to the voltage-measuring unit should be completely shielded, and the tube itself should be enclosed in a rather closely fitting cylindrical shield. For a double-ended tube, the test set is provided with a small contactor to the grid (or plate) cap, the lead to this contactor entering at the top of the shield. The lead from the plate or grid leaves at a point near the bottom of the shield. For a single-ended tube, shielding adequate for the elimination of capacitance components between the active tube and socket terminals should be provided. The obtaining of the required shielding may be checked by readings made with the tube removed from the socket, unless the tube base itself provides a shield.

The shunt capacitance C should be large compared to the plate-cathode capacitance of the tube under test; ordinarily a value of 500 micromicrofarads is satisfactory.

7.2 Vacuum-Tube Coefficients

This section is devoted to methods for measuring the low-frequency coefficients of vacuum tubes. The more commonly used coefficients are plate resistance, grid-plate transconductance, amplification factor, and conversion transconductance. The methods outlined apply not only to these coefficients, but also to the less commonly used coefficients referred to any one or to any pair of electrodes, such as plate-grid transconductance, grid resistance, conductance for rectification, grid-screen μ -factor, etc.

In general, most tube coefficients may be evaluated from the characteristic graph (see Section 4) or may be measured directly by a balance or null method of measurement employing an audio-frequency generator as the source of power and a null indicator (usually a telephone receiver, which is preceded by an amplifier for more precise results). The results obtained by balance methods are usually more reliable than the results obtained from the characteristic graphs, particularly in the measurement of coefficients of coated-cathode tubes. In the itemized portion of this section various coefficients are discussed individually. The basic circuits for measuring the coefficients by balance methods are shown schematically in Figs. 48 to 56. The circuit for measuring conversion transconductance is shown in Fig. 57.

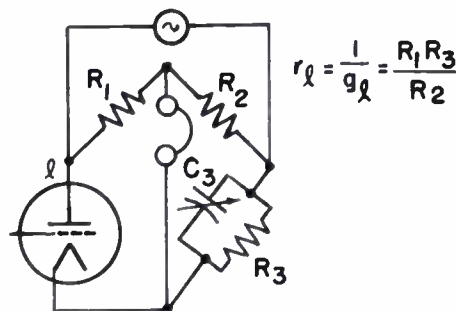

Fig. 48—Basic bridge circuit for measuring electrode resistance.

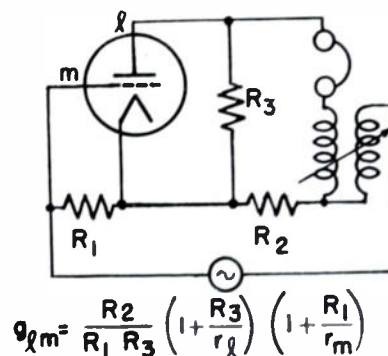

Fig. 49—Basic resistance-balance circuit for measuring transconductance.

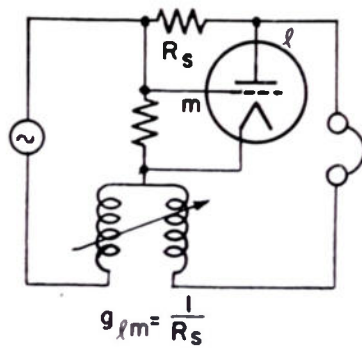

Fig. 50—Basic resistance-balance circuit for measuring the transconductance of tubes having low plate resistance.

$$g_{lm} = \frac{1}{R_s}$$

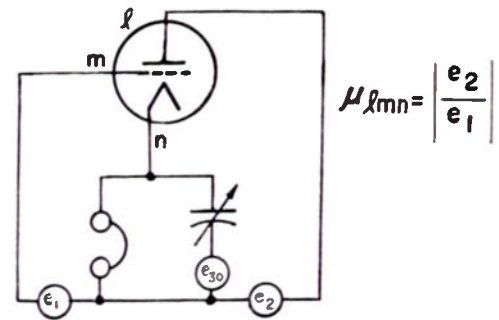

Fig. 55—Basic voltage-ratio circuit for measuring μ factor.

$$\mu_{lmn} = \left| \frac{e_2}{e_1} \right|$$

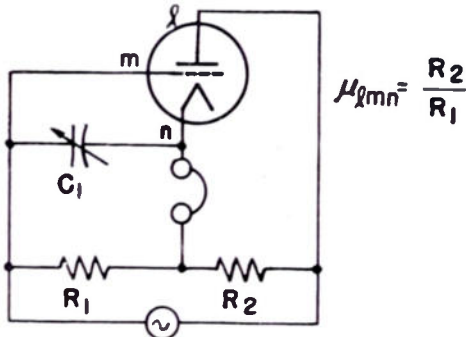

Fig. 51—Basic resistance-balance circuit for measuring μ factor.

$$\mu_{lmn} = \frac{R_2}{R_1}$$

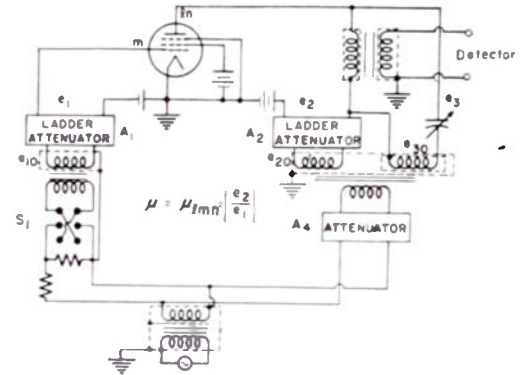

Fig. 56—Detailed voltage-ratio circuit for measuring μ factor.

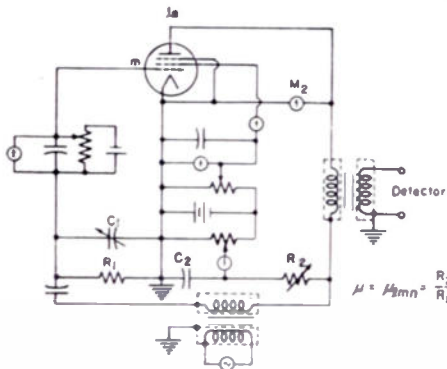

Fig. 52—Detailed resistance-balance circuit for measuring μ factor.

$$\mu = \mu_{lmn} = \frac{R_2}{R_1}$$

$$r_l = \frac{1}{g_l} = \left| \frac{e_2}{e_1} \right| R_s$$

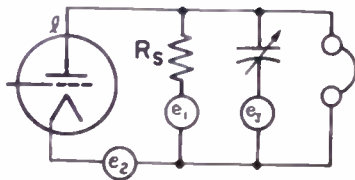
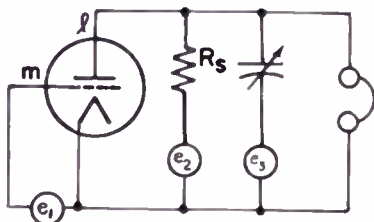

Fig. 53—Basic voltage-ratio circuit for measuring electrode resistance.



$$g_{lm} = \left| \frac{e_2}{e_1} \right| \frac{1}{R_s}$$

Fig. 54—Basic voltage-ratio circuit for measuring transconductance.

Two types of balance methods are described in this section. Figs. 48, 49, 50, 51 (and in more detail, Fig. 52) illustrate the resistance-ratio type of circuit in which an alternating voltage is introduced at only one point in the circuit, a null is obtained by the adjustment of impedances, and the value of the coefficient is expressed by a resistance ratio. Figs. 53, 54, 55 (and in more detail, Fig. 56) illustrate the voltage-ratio⁹⁻¹¹ type of circuit in which two or more properly phased alternating voltages are introduced into the circuit, a null is obtained by adjusting their relative magnitudes, and the value of the coefficient is expressed by a voltage ratio.

The voltage-ratio method¹⁰⁻¹² uses the same component parts for measuring all of the coefficients. Details of the method are illustrated in Fig. 56, which is an expanded version of Fig. 55 as applied to the determination of the amplification factor of a pentode. The method utilizes a system of transformers, capacitors, and attenuators to supply three independent, properly phased and adjusted voltages from a common source. The value of the coefficient at balance is a voltage ratio as indicated by the attenuator settings (Fig. 56), where the attenuator A_4 indicates the significant figures, and where the attenuator A_1 or the attenuator A_2 indicates the decimal point. The voltages e_{10} , e_{20} , and e_{30} must be in phase. This is accomplished by

⁹ W. N. Tuttle, "Dynamic measurement of electron tube coefficients," Proc. I.R.E., vol. 21, pp. 845-857; June, 1933.

¹⁰ H. J. Reich, "Theory and Applications of Electron Tubes," 2nd ed., McGraw-Hill Book Co., New York, N. Y.; 1944.

¹¹ F. E. Terman, "Radio Engineer's Handbook," 1st ed., McGraw-Hill Book Co., New York, N. Y.; 1943.

using similar transformers. Since the output resistances of the attenuators at e_1 and e_2 may be made small by proper design (less than 25 ohms), the voltage drop due to electrode currents through these attenuators usually may be neglected, and the electrode voltages are unaffected by the balancing procedure. Since the voltage sources are insulated from each other, the batteries or power supplies may be grounded at the cathode, and the phase-balancing voltage e_3 may always be connected across the null detector. The reversing switch S_1 permits measuring negative coefficients.

7.2.1 Electrode Resistance and Electrode Conductance (PO, SS)

7.2.1.1 The electrode resistance and electrode conductance may be obtained from the graph of the current to the electrode as ordinate, plotted against the voltage between that electrode and the cathode, all other electrode voltages being maintained constant. The tangent to this characteristic at any point is the electrode conductance at the electrode voltages corresponding to this point. The reciprocal of the tangent is the electrode resistance.

7.2.1.2 Electrode resistance and electrode conductance may also be determined by the bridge method given in Fig. 48. At balance the resistance and conductance are

$$r_l = \frac{1}{g_l} = \frac{R_1 R_3}{R_2}$$

In bridge measurements, the quadrature current is usually best balanced out by a small capacitor in an arm of the bridge adjacent to the arm containing the unknown. Care should be taken in choosing the bridge-arm resistances to insure that the current flowing to the electrode does not vary appreciably while the bridge is being balanced to a null.

7.2.1.3 The voltage-ratio method⁹⁻¹¹ for determining the electrode resistance and electrode conductance is given in Fig. 53. At balance the values of the coefficients are as follows:

$$r_l = \frac{1}{g_l} = \left| \frac{e_2}{e_1} \right| R_s$$

where R_s is a fixed resistor of perhaps 100,000 ohms, and the voltage ratio is indicated by the attenuator settings.

Grid conductance and plate conductance, as well as grid resistance and plate resistance, are but particular electrode coefficients and are measured by any of the methods outlined above.

7.2.1.4 Another method is available which lends itself to rapid testing of the plate resistance r_p of tubes such as the screen-grid type where the value of plate resistance is one-half megohm or higher. The circuit arrangement is shown in Fig. 57.

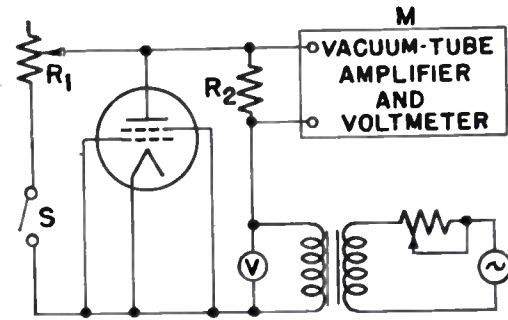

Fig. 57—Basic circuit for measuring the plate resistance of screen-grid tubes by the substitution method.

The tube is operated at normal voltages. Switch S is open. Alternating voltage is applied as indicated and adjusted until a convenient deflection is obtained on the vacuum-tube voltmeter M . The tube is then removed from the circuit and a resistor R_1 substituted for the internal resistance of the tube by closing switch S . R_1 is then adjusted to give the same deflection on M with the alternating voltage held constant at its original value. The value of R_1 is then the value of the plate resistance of the tube. R_2 should be made negligibly small in comparison with the plate resistance of the tube.

The arrangement can be made into a direct-reading device in three ways:

(a) By maintaining the alternating voltage constant and calibrating M in terms of the plate resistance of the tube. R_1 can be used in the manner described above for making calibration.

(b) By maintaining the deflection of M constant and calibrating the alternating-current voltmeter in terms of the tube plate resistance, R_1 being used for calibration purposes. This method gives a straight-line calibration between the alternating voltage and the tube plate resistance and is more conveniently used than (a).

(c) By maintaining the alternating voltage constant and varying R_2 to give constant deflection of M . Then r_p will be proportional to R_2 .

7.2.2 Transconductance (PO, SS)

7.2.2.1 Transconductance between any two electrodes may be determined graphically from the tangent to the graph of the current to the second electrode as ordinate, plotted against the voltage on the first electrode as abscissa, all other electrode voltages being maintained constant.

7.2.2.2 Transconductance may also be measured directly by the balance method of Fig. 49. When balance is attained,

$$g_{lm} = \frac{R_2}{R_1 R_3} \left(1 + \frac{R_3}{r_l} \right) \left(1 + \frac{R_1}{r_m} \right)$$

If R_3 and R_1 are negligibly small compared with the resistances of the electrodes l and m , the balance equation reduces to

$$g_{lm} = \frac{R_2}{R_1 R_3}$$

7.2.2.3 A second balance method,¹² which is useful for measuring power tubes, or in general when r_t is small, is shown in Fig. 50. The null is obtained by adjusting R_s , and at balance the transconductance is

$$g_{tm} = \frac{1}{R_s}$$

The value of the resistor in the grid circuit does not affect the measurement.

7.2.2.4 The voltage-ratio method,⁹⁻¹¹ which may be used for measuring transconductance of any value, is shown in Fig. 54. Here the transconductance is

$$g_{tm} = \left| \frac{e_2}{e_1} \right| \frac{1}{R_s}$$

where R_s is usually 100,000 ohms, and the voltage ratio is indicated by the attenuator settings.

The grid-plate transconductance, also known as the mutual conductance ($g_{po} = g_m$), may be measured by any of the methods outlined above.

7.2.3 μ Factor (PO, SS)

7.2.3.1 The μ factor may be measured dynamically or statically. The method of making static measurements is indicated by the defining equation

$$\mu_{lmn} = \left. \frac{\Delta e_l}{\Delta e_m} \right|_{e_n = \text{const.}}$$

7.2.3.2 Dynamically, the μ factor may be measured by the balance method of Fig. 51. The μ factor μ_{lmn} (the relative control effect of voltages at electrodes l and m on the current to electrode n) is determined by inserting the null indicator into the lead to electrode n . At balance,

$$\mu_{lmn} = \frac{R_2}{R_1}$$

7.2.3.3 An alternative dynamic-balance method⁹⁻¹¹ for measuring the μ factor is illustrated in Fig. 55. At balance,

$$\mu_{lmn} = \left| \frac{e_2}{e_1} \right|$$

7.2.3.4 The amplification factor of a tube is that μ factor for which the plate of the tube is both the constant-current electrode and one of the electrodes involved in relative control effect of voltage. Therefore, in determining the amplification factor the circuit of either Fig. 51 or 55 may be used, but the null detector must ordinarily be placed in the plate circuit (as shown in Figs. 52 and 56), since the defining equation states that the alternating component of the plate current is zero. If the tube is a triode and if there is no grid current

flowing, the null detector may be placed in the cathode circuit, if it is advantageous to do so.

7.2.4 General Precautions for Balance Methods (SS)

The magnitude of the impressed alternating voltage should always be small enough so that the results of the measurement are unaffected by a reduction of the impressed voltage.

All electrodes not directly involved in the measurement must be maintained constant at specified voltages.

To indicate the extent of circuit modification sometimes required to eliminate sources of error, the basic circuit for measuring μ factor by the resistance-ratio method (Fig. 51) is shown expanded in Fig. 52. Since this figure shows a method for measuring the amplification factor of a pentode (see paragraph 7.2.3.2. above) the detector is in the plate circuit. The impedance of C_2 must be negligible in comparison with resistance R_2 at the test frequency.

Balance methods employing an alternating-voltage generator require that consideration be given to the effects of stray capacitances and couplings, which may render balance difficult or impossible. The grounding and shielding of apparatus should be given special attention.¹³

Batteries and, in particular, dc supplies operated from the power line may introduce excessive capacitance across the network elements unless properly located with respect to ground. In the example of Fig. 52, the plate and screen supplies are at ground potential and the capacitance of the grid supply may be neglected because of the low resistance of R_1 . Capacitors of sufficiently low impedance to by-pass the audio-frequency currents must usually be shunted across the power supplies. Voltage-regulated power supplies provide excellent low-impedance devices for this purpose.

Audio-frequency generators and amplifiers that are operated from the power line will have appreciable capacitance to ground, the effect which must usually be minimized by the use of shielded transformers, as in Fig. 52, or of guard circuits.¹³

When direct current must flow through the generator or through the detector, low-resistance transformers or chokes must be used to minimize the direct voltage drop. Spurious coupling between the chokes or transformers must then be prevented by proper shielding orientation, and spacing of the component parts.

In some circuits, the direct voltage at an electrode may vary as balance adjustments are made. When this cannot be avoided by means of a blocking capacitor or by circuit rearrangement, the direct voltage is best measured at the electrode (see M_2 of Fig. 52) with a meter of sufficiently high resistance to preclude errors due to its shunting effect.

¹² C. B. Aiken and J. F. Bell, "A mutual conductance meter," *Communications*, vol. 18, p. 19; September, 1938.

¹³ B. Hague, "A-C Bridge Methods," 4th ed. Sir I. Pitman & Sons, Ltd., London, England, 1938.

Circuit resistors must be able to carry the electrode currents with negligible effect on their resistance value.

In the measurement of the coefficients of high-transconductance tubes, oscillation may occur. Oscillation of the tube under test may be evident in the lack of a sharp null point or may not be evident except in erroneous readings. Checks by other methods should therefore be made to establish freedom from oscillation in setting up a new bridge or in measuring high-transconductance tubes. Oscillation can be checked by the presence of grid current or by the change of plate current when the grid or plate terminal is grounded for the spurious frequency. Oscillation may be prevented by exercising care in choosing the length and the location of the leads to the tube socket, by the judicious use of by-pass capacitors, or by the insertion of a resistor in series with the appropriate electrode.

Circuit and interelectrode capacitances introduce quadrature currents that may have to be balanced out to attain an exact null. Various methods of quadrature balance are available. The mutual-inductance method illustrated in Fig. 50 couples, in proper phase, voltage from the generator to the detector (or on occasion to the grid circuit, if there is no grid current). Because of the resistance, self-inductance, and mutual inductance introduced in series with the detector, the balance conditions are modified, and a slight error may exist.^{14,15} In the capacitance method, a small variable capacitor is used, as for example at C_1 in Figs. 51 and 52. Both of these methods require readjustment for every change in the main balance network. This difficulty may be avoided by using an auxiliary capacitance bridge to balance out the quadrature component before the tube filament is turned on.^{14,15} In the voltage-ratio method, the out-of-phase voltage at the detector is balanced out by an equal voltage of opposite phase connected in parallel with the detector terminals.

7.2.5 References

- (1) E. L. Chaffee, "Theory of Thermionic Vacuum Tubes; Fundamentals—Amplifiers—Detectors," McGraw-Hill Book Co., New York, N. Y.; 1933. (Footnote 14.)
- (2) W. N. Tuttle, "Dynamic measurement of electron tube coefficients," PROC. I.R.E., vol. 21, pp. 845-857; June, 1933. (Footnote 9.)
- (3) C. L. Dawes, "A Course in Electrical Engineering," vol. 2, 3rd ed., McGraw-Hill Book Co., New York, N. Y.; 1934.
- (4) R. Hickman and F. Hunt, "The exact measurement of electron tube coefficients," Rev. Sci. Instr., vol. 6, pp. 268-276; September, 1935. (Footnote 15.)

¹⁴ E. L. Chaffee, "Theory of Thermionic Vacuum Tubes; Fundamentals—Amplifiers—Detectors," McGraw-Hill Book Co., New York, N. Y.; 1933.

¹⁵ R. Hickman and F. Hunt, "The exact measurement of electron tube coefficients," Rev. Sci. Instr., vol. 6, pp. 268-276; September, 1935.

(5) A. V. Eastman, "Fundamentals of Vacuum Tubes," 1st ed., McGraw-Hill Book Co., New York, N. Y.; 1937.

(6) A. L. Albert, "Fundamental Electronics and Vacuum Tubes," The Macmillan Co., New York, N. Y.; 1938.

(7) B. Hague, "A-C Bridge Methods," 4th ed., Sir I. Pitman & Sons, Ltd.; 1938. (Footnote 13.)

(8) C. B. Aiken and J. F. Bell, "A mutual conductance meter," Communications, vol. 18, p. 19; September, 1938. (Footnote 12.)

(9) H. J. Reich, "Theory and Applications of Electron Tubes," 2nd ed., McGraw-Hill Book Co., New York, N. Y.; 1944. (Footnote 10.)

(10) J. Millman and S. Seely, "Electronics," 1st ed., McGraw-Hill Book Co., New York, N. Y.; 1941.

(11) F. E. Terman, "Radio Engineer's Handbook," 1st ed., McGraw-Hill Book Co., New York, N. Y.; 1943. (Footnote 11.)

7.2.6 Conversion Transconductance (S_S)

The definition of conversion transconductance shows that if $f_1=f_2$, the difference frequency will be zero, corresponding to direct current. If the two signals are in phase, the plate current will be higher than with the two signals 180 degrees out of phase. The difference in direct plate current, caused by a reversal of the phase relation of the two signals, divided by twice the peak value of the alternating voltage on the signal grid, is the conversion transconductance. It is assumed that the voltage on the oscillator grid is adjusted to such a value that the current drawn by the grid corresponds to its rated value.

In practice, multigrid converter and mixer tubes may be measured in a circuit such as that shown on Fig. 58.

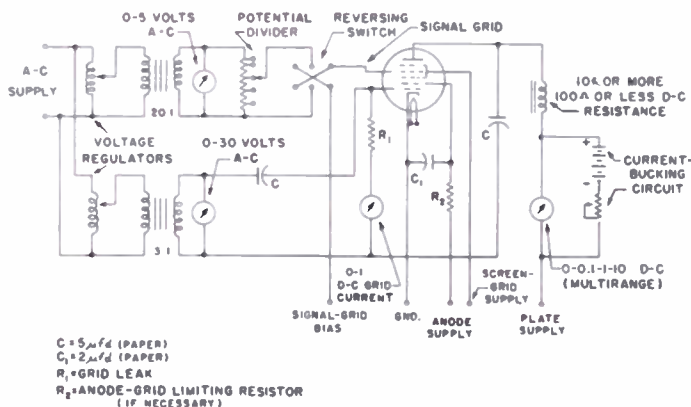

Fig. 58—Circuit arrangement for measuring conversion transconductance.

With grid resistor R_1 and grid current as rated, a signal voltage E_0 is applied to the signal grid 180 degrees out of phase with the voltage applied to the oscillator grid. The bucking circuit is adjusted to give zero reading of the plate-current meter, after which the phase of the signal voltage applied to one of the grids is reversed and the reading of the plate-current meter ΔI_b noted.

7.2.8 Converter Plate Resistance (SS)

The plate resistance of a converter or mixer tube may be measured under conditions simulating operation. With suitable oscillator excitation and all dc potentials applied to the tube, the plate resistance is measured as described in Section 7.2.1.

7.3 The Four-Pole Admittances (SS)

The definitions of the four-pole admittances indicate that the short-circuit driving-point and transfer admittances are to be measured with the tube operating. Since these admittances depend upon the shielding, socket, by-pass capacitors, and direct-current filters, as well as upon the internal circuit features and electron dynamics of the electron tube, it is important that the conditions of use be given as a part of the data until standard conditions for measurement are set up. When a new or nonstandard method of connection to the tube is contemplated, the admittances taken at the available terminals of the new arrangement may be markedly different from those obtained with the same tube in a different socket-filter combination.

Equation (5) of Section 7 and the definition show that the short-circuit input admittance y_{11} may be obtained from a measurement of the input admittance when the output termination Y_2 is effectively short-circuited at the frequency of measurement. When Y_2 is short-circuited, the second term of (5) is negligible. (Since a complete short circuit is not possible when the tube is operating, the effectiveness of the short circuit should be checked at the frequency of measurement by making certain that negligible variation in the input admittance is produced by an appreciable change in the output termination.) Similarly, the short-circuit output admittance may be obtained from a measurement of the output driving-point admittance when the input is effectively short-circuited at the frequency of measurement.

The transfer and feedback admittances may be obtained only by a transfer measurement, such as an observation of voltage gain as given by (6) of Section 7.

At frequencies up to the order of 10^7 cycles per second, conventional bridge methods may be employed to measure the input and output admittances.

At high frequencies, especially those at which the admittances begin to depart appreciably from the low-frequency tube parameters, bridge methods or the use of "Q meters" are so difficult as to be impracticable. Consequently, most of the useful data on admittances must be obtained by some version of the susceptance-variation or resistance-substitution method. Two of these methods will be described in the following section.

7.3.1 Susceptance-Variation Method of Measurement

The following method measurement is a form of the well-known reactance-variation method widely used for the measurement of two-terminal admittances. It is adapted to the determination of the transfer admittance, as well as to the driving-point admittances.

Fig. 60 is a semischematic diagram of the test equipment. In this figure, T is the active or passive transducer to be measured and Y_1 and Y_2 are calibrated variable-admittance elements, which may be of various forms, such as coils and capacitors, or adjustable-length lines. Signal-frequency voltage-measuring devices V_1 and V_2 are placed across the input and output terminals of the transducer; these may be simply crystal or diode voltmeters or heterodyne receivers.



Fig. 60—Semischematic diagram of equipment for measuring admittances by the susceptance-variation method.

Variable admittances Y_{c1} and Y_{c2} are used for coupling the input or output circuits to the signal oscillators.

If all four admittances are to be measured at any given frequency, the following sequence of operations is recommended.

7.3.1.1 Measurement of y_{11} .

(a) Short-circuit the output terminals 2-2. This may be done either by detuning Y_2 sufficiently or by placing a suitable by-pass capacitor directly across terminals 2-2.

(b) Excite the input circuit by coupling the signal oscillator loosely through Y_{c1} to Y_1 .

(c) Adjust Y_1 for resonance as indicated by a maximum reading of V_1 . In order to insure that the coupling to the oscillator is sufficiently small, reduce the coupling until further reduction does not change the setting of Y_1 for resonance. Record the calibrated values of G_1 and B_1 for this setting.

(d) Vary Y_1 on either side of resonance until the voltage V_1 is reduced by a factor $1/\sqrt{2}$. Record the calibrated values of this total variation of Y_1 between half-power points as ΔG_1 and ΔB_1 . In order to insure that the oscillator and detector are not loading the circuit, reduce the coupling until further reduction does not change the susceptance variation ΔB_1 . The short-circuit input susceptance is then given by the relation

$$B_{11} = -B_1 \quad (7)$$

and the short-circuit input conductance by the relation

$$y_{11} = \frac{\Delta B_1}{2} [(1 + 2\eta^2)^{\frac{1}{2}} + \eta] - G_1 \quad (8)$$

In most systems the inequality

$$\eta^2 = \left(\frac{\Delta G_1}{\Delta B_1} \right)^2 \ll 1 \quad (9)$$

holds; thus (2) may be approximated by the equation

$$y_{11} = \frac{\Delta B_1}{2} [1 + \eta + \eta^2] - G_1 \quad (10)$$

or even further by the relation

$$y_{11} = \frac{\Delta B_1}{2} - G_1 \quad (11)$$

if η is negligible.

7.3.1.2 Measurement of the Magnitude y_{12} .

(a) With the input termination still set at the value for resonance obtained in step (c) above, excite the output circuit through Y_{C2} . In the event that oscillation difficulties are encountered, detune the output circuit Y_2 or load it until oscillation stops.

(b) Record the voltmeter readings V_1 and V_2 .

The magnitude of the feedback admittance is then given by the relation

$$|y_{12}| = \left| \frac{V_1}{V_2} \right| \frac{\Delta B_1}{2} [(1 + 2\eta^2)^{1/2} + \eta] \quad (12)$$

and if

$$\eta^2 = \left(\frac{\Delta G_1}{\Delta B_1} \right)^2 \ll 1$$

(12) may be simplified to

$$|y_{12}| = \left| \frac{V_1}{V_2} \right| \frac{\Delta B_1}{2} [1 + \eta + \eta^2] \quad (13)$$

or

$$|y_{12}| = \frac{\Delta B_1}{2} \left| \frac{V_1}{V_2} \right| \quad (14)$$

where ΔG_1 and ΔB_1 are the values obtained in the preceding measurement of y_{11} .

7.3.1.3 Measurement of y_{22} . The short-circuit output admittance may be measured by following the pro-

cedure outlined for the input coefficient, the signal being coupled through Y_{C2} . If the subscripts 1 and 2 are interchanged, all of the above formulas concerning y_{11} may be used to relate y_{22} to the measured data.

7.3.1.4 Measurement of the magnitude of y_{21} . The magnitude of the forward admittance may be measured by following the procedure outlined previously for the measurement of the magnitude of y_{12} . If the subscripts 1 and 2 are interchanged, all of the formulas concerning $|y_{12}|$ may be used to relate $|y_{21}|$ to the measured data.

7.3.1.5 Susceptance-Variation Equipment. Fig. 61 is a cut-away assembly drawing of a susceptance-variation circuit in which 1 and 2 are adjustable-length wave coils¹⁶ comprising the main parts of the terminations Y_1 and Y_2 . Variable micrometer capacitors 3 and 4 provide a calibrated small variation in the susceptances of Y_1 and Y_2 when the coarser adjustments of the wave coils are too large to give the precision necessary to measure small conductance components of the admittances. Adjustable coupling capacitors 5 and 6 are illustrated schematically as Y_{C1} and Y_{C2} in Fig. 60. Adjustable probes 7 and 8 provide for coupling samples of the voltages V_1 and V_2 to a heterodyne receiver. These probes may be replaced by crystal voltmeters.

If the conductance being measured is small enough to be measured by the available range of the micrometer capacitor, the susceptance and conductance variations between $1/\sqrt{2}$ voltage points are given by

$$\begin{aligned} \Delta B &= \omega \Delta C \\ \Delta G &= 0 \end{aligned} \quad (15)$$

where ω is the angular frequency of measurement and

¹⁶ A wave coil is a coaxial line having a coiled center conductor.

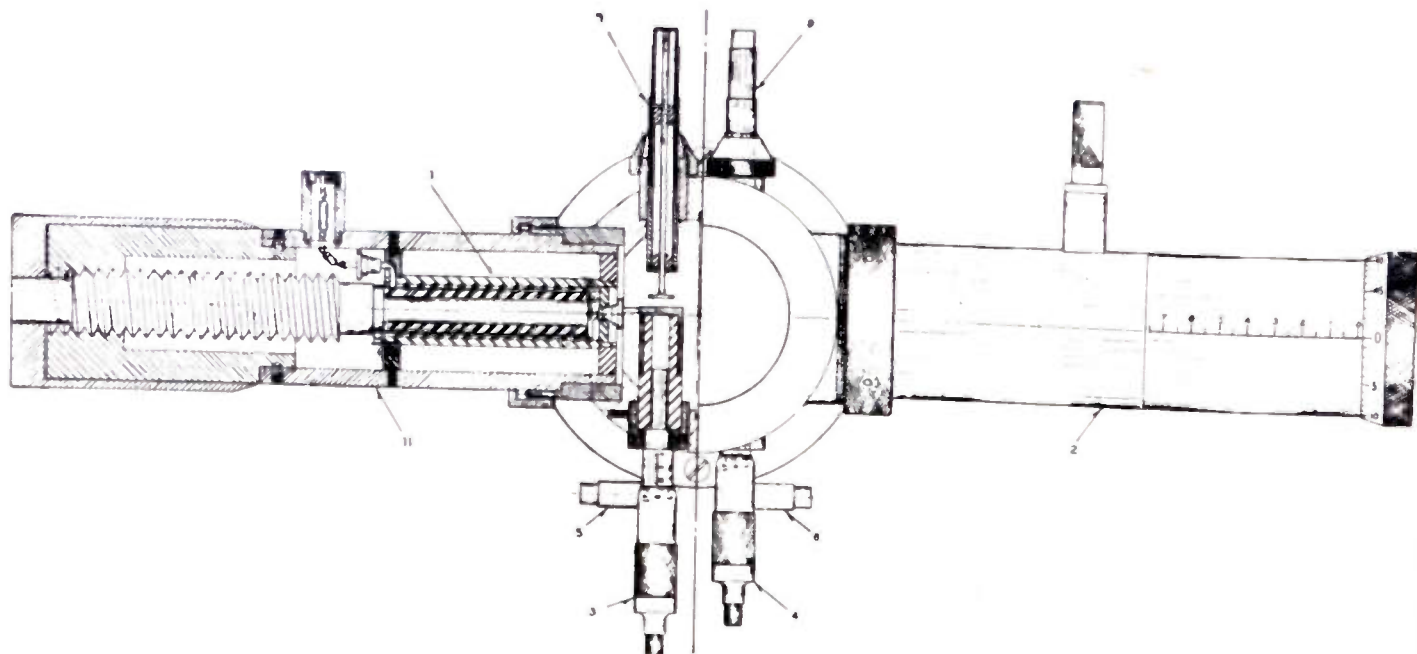

Fig. 61—Cut-away assembly drawing of a susceptance-variation circuit using wave coils.

ΔC is the micrometer capacitance variation between the half-power points. If the conductance to be measured is too large to be measured by the micrometer variation, the susceptance variation may be obtained by varying the wave-coil length. The quantities ΔB and ΔG may then be obtained directly from the calibration of the termination-circuit conductance and susceptance.

The calibrations are obtained by terminating the wave coil in various standard capacitors at a number of frequencies such that, for any one frequency, the wave coil can be resonated at a number of lengths. These small capacitors are made in such a form that the conductance is negligible and the capacitance is the low-frequency value over the entire frequency range. Consequently, the conductance of the circuit is

$$G_1 = \frac{\omega \Delta C}{2} \quad (16)$$

and the susceptance is

$$B_1 = -\omega C_s$$

where ω is the resonant angular frequency and the ΔC is the total capacitance variation between half-power points when the circuit is terminated in a standard capacitance C_s .

7.3.1.6 Coaxial-Line Termination Admittances. To extend the upper frequency limit of the susceptance-variation set described above, the adjustable wave coils may be replaced by adjustable-length coaxial lines, as shown in Fig. 62. By making the maximum electrical length of these lines slightly greater than that of the wave coils, a comfortable overlap in frequency can be

obtained. Line-type terminations may be calibrated in the same manner as wave coils, by means of similar standard capacitors. The measurement operations proceed in a manner similar to that described for the wave-coil setup.

7.3.1.7 Reference.

(1) RCA Application Note 118, "Input Admittances of Receiving Tubes."

7.3.2 Resistance-Substitution Method of Measurement

The resistance-substitution method applied only to the measurement of the conductive component of the admittance. The susceptive component must be measured by means of a calibrated susceptance element, as described in Section 7.3.1. Ideally, the resistance-substitution method involves, in the case of a two-terminal admittance, the removal of the electron-tube transducer from the calibrated admittance element and its replacement by a standard pure resistance of such a value that the voltage reading between the two terminals is the same as that obtained with the transducer in place. The calibrated susceptance element must be adjusted to resonance both before and after substitution of the resistance. If the measurement is of y_{11} , the following relations are obtained:

$$B_{11} = -B_1 \quad (17)$$

as in Section 7.3.1 above, and

$$G_{11} = 1/R \quad (18)$$

where R is the standard resistance of a value that satisfied (18).

There are practical difficulties in obtaining standard resistors having negligible reactance at frequencies of

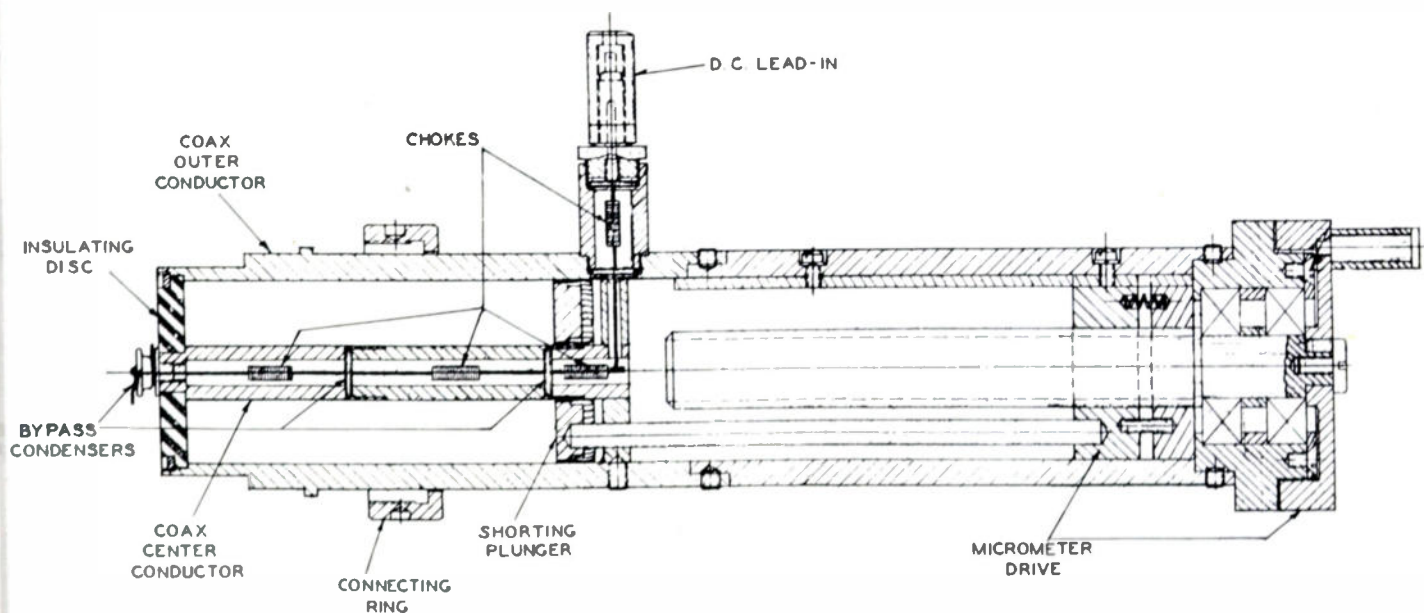

Fig. 62—Cut-away assembly drawing of a susceptance-variation circuit using coaxial lines.

the order of 10^8 cycles per second or higher. Wire-wound resistors are not usable at such frequencies. The most satisfactory types available are the metalized-glass or ceramic-rod resistors of relatively small physical size, having low-inductance terminals and very little distributed capacitance. A further difficulty arises from the fact that such resistors are obtainable only in discrete values of resistance. It would not be practicable to obtain the very large number of resistors needed to match the resistance of any electron-tube transducer. Hence, it is necessary to utilize a transformation property of the admittance-measuring equipment in order to match any arbitrary admittance with some one of a reasonably small set of standard resistors. A suitable resistance-substitution set consists of a transmission line of length l short-circuited at one end, having a characteristic admittance Y_0 and a propagation constant γ . If a known admittance Y is placed across the line at a distance x from the short-circuited end, as shown in

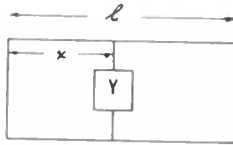

Fig. 63—Transmission-line admittance transformer.

Fig. 63, the admittance Y_t at the open end of the line is given by the relation

$$Y_t = Y \left[\frac{\sinh \gamma x}{\sinh \gamma l} \right]^2 \left[\frac{1}{1 + \frac{Y}{Y_0} \frac{\sinh \gamma x}{\sinh \gamma l} \sinh \gamma(l-x)} \right] \quad (19)$$

Conversely, the admittance Y_t is the admittance that would have to be placed at the open end of the line to produce the same effect there as the known admittance Y at the position x . Equation (19) then represents the property of the transmission line of converting admittance Y at position x into admittance Y_t at position l . This expression can be simplified for a low-loss line having a characteristic admittance Y_0 large compared with the bridging admittance Y . Thus if $Y_0 \gg Y$,

$$\left| \frac{Y}{Y_0} \frac{\sinh \gamma x}{\sinh \gamma l} \sinh \gamma(l-x) \right| \ll 1, \quad (20)$$

and the real part of the propagation constant γ of the line is small,

$$\left[\frac{\sinh \gamma x}{\sinh \gamma l} \right]^2 \approx \left[\frac{\sinh \beta x}{\sinh \beta l} \right]^2 \quad (21)$$

where $\beta = 2\pi/\lambda$. Equation (19) then simplifies to

$$Y_t = Y \left[\frac{\sin \beta x}{\sin \beta l} \right]^2 \quad (22)$$

If Y is a pure conductance of value $1/R$, then Y_t is the pure conductance

$$G_T = \frac{1}{R} \left[\frac{\sin \beta x}{\sin \beta l} \right]^2 \quad (23)$$

In the measurement of the short-circuit input admittance Y_{in} , a low-loss transmission line of large characteristic admittance is coupled loosely to an oscillator near the short-circuited end. At the open end are a voltage-detecting device and a calibrated capacitor, by means of which B_{in} is obtained from (17). With the unknown transducer across the open end and the capacitor adjusted to obtain resonance, a voltage reading is taken. The transducer is removed and one of the standard resistors placed across the line bridging the two conductors. The position of this resistor along the line is then adjusted and the system is readjusted for resonance with the calibrated capacitor until the voltage, as measured at the end of the line, is the same as before. By (23) we have

$$G_{in} = G_T = \frac{1}{R} \left[\frac{\sin \beta x}{\sin \beta l} \right]^2 \quad (24)$$

where R is the resistance of the standard placed x centimeters from the short-circuited end of the line. It is evident that a resistor must be selected having a resistance value near to but not larger than the reciprocal of G_{in} .

Since the transmission line should have low loss and low characteristic impedance, a coaxial line is desirable. The line will require a longitudinal opening or slot in order to permit one of the standard resistors to bridge the line at an adjustable position to satisfy the required voltage condition. An electron-tube voltmeter is capacitively coupled to the open end of the line across which the electron-tube transducer may be attached. Socket and filter arrangements for wire-lead tubes can be attached to this line. Radiation difficulties arising from the longitudinal opening in the line, together with the increasing difficulty in obtaining resistance standards at frequencies much above 3×10^8 cycles per second, appear to make this type of measuring equipment impracticable for measurements at higher frequencies on surface-lead tubes.

Contributors to Proceedings of the I.R.E.

R. W. Beatty (S'43-A'45-M'50) was born in York, Pa., on May 31, 1917. He received the B.S. degree in electrical engineering in 1939 from the George Washington University, and the S.M. degree in electrical communication from the Massachusetts Institute of Technology in 1943. From 1940 until 1942 he was associated with the Naval Research Laboratory, and then served as an officer in the U. S.

Naval Reserve from 1943 until 1946. He has had several years' experience in the field of consulting radio engineering.

At the present time Mr. Beatty is associated with the ultra-high-frequency group of the microwave standards section at the National Bureau of Standards, in Washington, D. C.



R. W. BEATTY



N. C. GERSON

he conducted research on physical and meteorological problems, including investigations of hail, thunderstorms, and lightning discharges to aircraft. In 1946 Mr. Gerson joined the low-frequency loran investigations and contributed toward the supervision of the various monitor stations which were associated with the project. He later undertook a comprehensive investigation of radio noise levels at low frequencies in the American sub-Arctic. In 1948 he joined the staff of the Geophysical Research Directorate.



Donald B. Harris (SM'45) was born at Minneapolis, Minn., on February 10, 1901. He received the B.A. degree from Yale University in 1922 after completing a physics major. He joined the Northwestern Bell Telephone Company in 1924, subsequently occupying various technical and administrative positions. In 1943 he became technical aide of Division 15 of the National Defense Research Committee



DONALD B. HARRIS

stationed at the Radio Research Laboratory, Harvard University.

Mr. Harris returned to the Northwestern Bell Telephone Company late in 1945 as Iowa area transmission and protection engineer, located in Des Moines. He joined the Collins Radio Company, Cedar Rapids, Iowa, as executive assistant to the director of research in 1947. He received the War Department and Navy Department Certificate of Appreciation in 1948. At the present time, he is Chairman of the Cedar Rapids Section of the IRE, a member of the Board of Editors of the IRE, and a member of the American Physical Society.



N. C. Gerson was born in Boston, Mass., on October 15, 1915. He was graduated from the University of Puerto Rico in 1943, and received the M.S. degree in physics from New York University. While in Puerto Rico, Mr. Gerson conducted some of the first experiments on obtaining upper-air wind velocities by means of radar observations on target-carrying balloons.

On completion of his university training, he entered the technical investigations section of the U. S. Weather Bureau, where

ate work in mathematics. At present he is doing part-time graduate work at the Fort Monmouth branch of Rutgers University.



A. G. HOLTUM, JR.

1945, Mr. Holtum has been employed at the Signal Corps Engineering Laboratories as a radio engineer, where he is engaged in development and design of high-frequency antenna systems.



Dan H. L. Jensen was born in New York, N. Y., in 1909. Following his completion of the arts and architecture course at the University of Pennsylvania, he joined the Philco Corporation, where he is the manager of the product design and development department. As Mr. Jensen's interests at Philco developed, he pursued supplementary studies in marketing, marketing research, chemistry, and application of plastics, at various times. He has also traveled abroad, observing arts and architecture and manufacturing processes.

As a member of the American Designers' Institute, Mr. Jensen serves on the Board of Trustees, has held the office of national treasurer for the past two years, and was formerly vice-chairman of the Philadelphia chapter. Among his outside activities, he is president of the Old Academy Players of Philadelphia, and is a director of the Lake Paupac Corporation.



DAN H. L. JENSEN



Alfred G. Holtum, Jr. (A'47) was born in Freeport, Ill., on August 26, 1918. He attended the Central YMCA College in Chicago and Carthage College in Carthage, Ill. He received the B.A. degree from New York University, where he also took gradu-

William E. Macke was born in Chicago, Ill., in December, 1912. In 1928 he joined the Grigsby-Grunow Company where he worked in the radio and refrigerator divi-

sions. In 1933 he became associated with the home appliances and radio division of Fairbanks Morse Company where, in 1934,



W. E. MACKE

he assumed the position of sales promotion and assistant advertising manager. From 1938 to 1941, Mr. Macke was with the Stewart-Warner Corporation in the advertising, merchandising, and sales promotion of radio, television, and major appliances. Then, until 1944, he was in charge of technical publications for Aircraft Heaters. In 1944 he joined Zenith Radio Corporation where he was elected director of advertising covering radio, television, and hearing aids in 1947.

Since 1949, Mr. Macke has been associated with Hotpoint, Inc., as manager of the merchandising division.



Michael F. Mahoney was born on July 18, 1898, in Troy, N. Y. He attended the Rensselaer Polytechnic Institute for two years. After war service he joined the General Electric Company in the switchboard engineering department, and entered sales and promotion work when the General Electric refrigerator was introduced nationally in 1927. He joined Maxon Inc., national advertising agency, in 1932 as merchandising consultant, and has supervised the agency's work for various advertisers in the automotive, electronics, food, and packaged goods fields. Mr. Mahoney is currently vice-president of the agency, in charge of its New York office.



M. F. MAHONEY

Laurence A. Manning was born at Palo Alto, Calif., on April 28, 1923. He received the A.B. degree from Stanford University in 1944, the M.Sc. degree in 1948, and the Ph.D. degree in 1949. During 1944 and 1945 he was on the staff of the Radio Research Laboratory, Harvard University, as a special research associate. During the year from 1945 to 1946 he was a teaching assistant in physics at Stanford University, and from 1946 to 1947 he was a research associate in electrical engineering. Since 1947 he has been an acting



L. A. MANNING

assistant professor of electrical engineering at Stanford.

Dr. Manning is a member of Phi Beta Kappa, Sigma Xi, the American Geophysical Union, and Commission 3 of the USA National Committee of the International Scientific Radio Union.



T. MORITA

Tetsu Morita (S'44-A'49) was born in Seattle, Wash., on February 5, 1923. He attended the University of Washington from 1940 to 1942, and received the B.Sc. degree in electrical engineering from the University of Nebraska in 1944. He received the M.S. and Ph.D. degrees from Harvard University in 1945 and 1949, respectively.

During 1944 Dr. Morita assisted in the Army Specialized Training Program at the University of Nebraska. From 1946 to 1947 he was a teaching fellow at Harvard University, where he was a research assistant during the period from 1947 to 1949. Dr. Morita has been a research fellow in electronics at Harvard since 1949 and he is, at present, group leader of the Antenna Group at Cruft Laboratory.



Lee McCanne (A'36-SM'45) was born in St. Louis, Mo., on May 14, 1905. In 1919 he obtained an amateur operator's license, and in 1920 he secured one of the first provisional radio telephone station licenses from the Department of Commerce under the call letters 8SR. He was graduated from the Massachusetts Institute of Technology in 1927, with the B.S. degree in electrical engineering administration. Beginning as a radio engineer in the Stromberg-Carlson laboratories in 1927, he transferred to sales engineering in 1931; was manager of the Te-lex Division (built-in remote control radios), 1932; manager of the sound equipment division, 1933; and radio sales manager, 1934. He became assistant general manager in 1940, and vice-president in 1945. Mr. McCanne was elected a director of the company in 1935, and served as secretary from 1935 to 1945. He currently has general responsibilities in public relations, advertising and sales promotion, industrial relations, and maintenance of plant properties.



LEE MCCANNE

Mr. McCanne's activities include membership on the advertising committee of the RMA during 1940-1942; chairman of the amplifier and sound equipment division of RMA, 1945-1946; chairman of school equip-

ment committee of RMA, 1945-1949; vice-president of the Electrical Association of Rochester, 1941; member of the Independent Pioneer Telephone Association; and of the Rochester Engineering Society.



Allen M. Peterson was born at Santa Clara, Calif., on May 22, 1922. He attended San Jose State College from 1939 to 1942.



A. M. PETERSON

He was associated with the electronics engineering group at Sacramento Air Service Command from 1942 to 1944. He was on active duty with the U.S. Army Air Forces from 1944 to 1946. Mr. Peterson has been at Stanford University since 1946, as a student and research assistant. He received the B.Sc. degree in 1948 and the M.Sc. degree in 1949 from Stanford University. He is at present a graduate student and research assistant in the Electronics Laboratory at Stanford University. He is a member of Sigma Xi.



Otmar M. Stuetzer (A'50) was born in 1912, in Nuremberg, Germany. He received the lower degrees in mathematics and physics at the University and the Technische Hochschule in Munich, working part-time as an instructor.



O. M. STUETZER

From 1936 to 1945 he was employed by the Drahtlostelegraphische Versuchsstation Graefelfing, later taken over by the Flugfunk-Forschungsinstitut Oberpfaffenhofen. From 1940 he served there as director of the general science and the microwave department. He was awarded the Dr. science degree in 1938, and the Dr. habil. degree in 1943, both from the Technische Hochschule, Munich. In parallel with his research work he lectured, and for a year held a responsible position with the German Research Council. In 1941 he received a Lilienthal Society award for his microwave work.

Since 1946, Dr. Stuetzer has been working for the Air Materiel Command, at Wright Field, Ohio.



William C. White (A'15-M'25-F'40) was born on March 24, 1890, in Brooklyn, N. Y. He received the E.E. degree from Columbia University in 1912. He has been associated with the General Electric Company since

graduation in a number of capacities in the field of electronics. At present he is electronics engineer of the Research Laboratory.



WILLIAM C. WHITE

Mr. White is a Fellow of the AIEE and a member of Sigma Xi and Tau Beta Pi. He was Treasurer of the IRE in 1946, and a Director from 1943 to 1947.

He has served on the following Institute committees, among others: Executive, Papers Procurement, Board of Editors, Awards, Nominations, Membership, and Professional Recognition.



Ernest H. Vogel was born in St. Louis, Mo., on July 22, 1907. He was graduated from the Pratt Institute of Design in Brook-

lyn, N. Y. Since 1919, when he joined Kohler Industries as advertising manager, he has specialized in the field of merchandising. Four years later he became advertising and merchandising manager for the American Piano Company. Mr. Vogel held that position until 1930, when he was made advertising and later sales manager for the RCA Victor Company.



ERNEST H. VOGEL

In 1936 General Electric made him manager of the radio sales department, which position he left to become vice-president in charge of sales for the Farnsworth Television and Radio Corporation. He resigned from Farnsworth in 1947, and in 1948 was appointed marketing manager for the General Electric electronics department, with headquarters at Electronics Park, Syracuse, N. Y.

Oswald G. Villard, Jr. (S'38-A'41) was born at Dobbs Ferry, N. Y., on September 17, 1916. In 1938 he received the A.B. degree in English literature from Yale University. He received the E.E. degree from Stanford University in 1943, and from 1941 to 1942 he was an acting instructor in electrical engineering at that university. From 1942 to 1946 he was a special research associate at the Radio Research Laboratory, Harvard University. He received the Ph.D. degree from Stanford University in 1949 and has been an acting assistant professor at Stanford since 1946.



O. G. VILLARD, JR.

Dr. Villard is a member of Sigma Xi, Phi Beta Kappa, and Commission 5 of the USA National Committee of the International Radio Scientific Union.

Correspondence

A Note on the Measurement of Impedance with the Impedometer*

Obtaining an impedance from measurements made with the impedometer¹ is simplified by using the Smith Chart. The impedometer gives directly the reflection coefficient and the voltage at a point on the line. Draw a circle with radius equal to the reflection coefficient around the center of the chart. Draw another circle with the radius equal to the probe voltage, using the $R/Z_0=0$ and $X/Z_0=0$ point as the center. One of the intersections is the impedance at the probe. If the reflection coefficient decreases (or probe voltage increases) when shunt capacity is added at the probe, the impedance is inductive. If the reflection coefficient increases (or probe voltage decreases), the impedance is capacitive.

The basis for this construction is illustrated in Fig. 1, which shows a Smith Chart (the R and X co-ordinates are omitted for clarity). The incident wave is a vector, with length equal to the radius of the chart, lying along the real axis. The reflected wave, of length K , is a vector whose phase depends on the position along the transmission line. The voltage V at any point on the line is the vector sum of the incident and reflected wave.

This method is useful when the Smith chart is used either to present impedance data or as an aid in designing matching networks.

To avoid calculation, a scale can be constructed and used repeatedly. The scale can be marked in voltage, power, or decibels. A distance equal to the radius of the Smith Chart corresponds to a reflection coefficient of unity (0 db), a distance equal to half the

radius corresponds to a reflection coefficient of $\frac{1}{2}$ (-6 db), etc. The length of the scale is twice the radius, so that the same scale can be used for the probe voltage. A Smith Chart with such a scale printed in a convenient position is available commercially.²

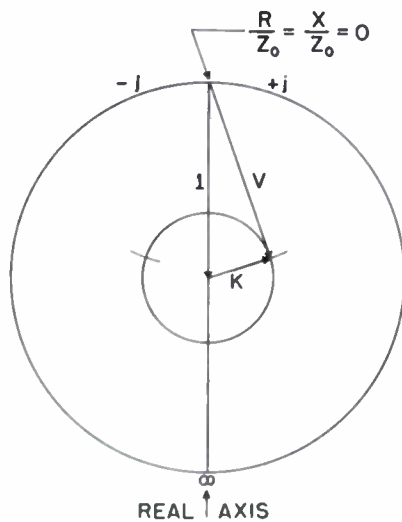

Fig. 1

radius corresponds to a reflection coefficient of $\frac{1}{2}$ (-6 db), etc. The length of the scale is twice the radius, so that the same scale can be used for the probe voltage. A Smith Chart with such a scale printed in a convenient position is available commercially.²

W. SICIAR

Federal Telecommunication Labs., Inc.
Nutley, N. J.

The Emeloid Co., Hillside 5, N. J.

Polarization of Low-Frequency Radio Waves Reflected from the Ionosphere*

Measurements of the limiting polarization of electromagnetic waves reflected from the ionosphere have been made at vertical incidence on 150 kc. These measurements were made primarily to determine whether split echoes observed near E -layer heights were due to magneto-ionic splitting, layer stratification, or partial reflection.

The experimental system for the measurement of the ellipticity and the angle ψ between the major axis of the ellipse and the plane defined by the earth's magnetic field and the direction of propagation is shown in Fig. 1. This is a standard system¹ using crossed loops, separate receiver channels, and an oscilloscopic presentation of the polarization ellipse.

A number of visual and photographic observations of single and split echoes have been made in recent months. The average values of the ellipticity and angle ψ for about thirty separate observations on single echoes are respectively 0.409 and 70.9°, where the ellipticity is the ratio of the minor to the major axis of the ellipse and the angle indicates a counter-clockwise angle measured from magnetic north to the major axis of the ellipse. Theoretical calculations of the limiting polarization for a gyro-magnetic angular frequency $\omega H = 9.406 \times 10^6$, an angle of 19° 8' between the downward direction of propagation and the earth's

* Received by the Institute, March 17, 1950.
¹ B. Parzen "Impedance measurements with directional couplers and supplementary voltage probe," Proc. I.R.E., vol. 37, pp. 1208-1211; October, 1949.

* Received by the Institute, November 25, 1949.
¹ E. V. Appleton and R. A. Watson-Watt, "Wireless measurements in the Arctic circle," Wireless World, vol. 24, p. 17; July, 1932.

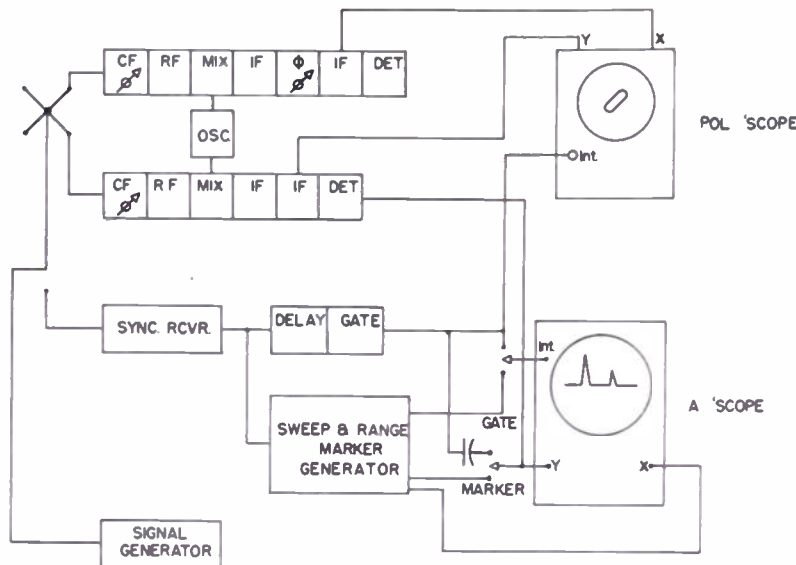

Fig. 1—Block diagram of polarimeter.

magnetic field (the intensity and dip angle of the earth's magnetic field were computed for an altitude of 100 km for this location), and an operation frequency of 150 kc for different values of collision frequency ν give

ν	0.8×10^6	1.0×10^6	1.2×10^6
ψ	$71^\circ 7'$	$67^\circ 44'$	$64^\circ 57'$
Ratio	0.648	0.672	0.701.

The separate parts of the split echoes appear to be of identical elliptical configuration and of the same rotation sense, although evidence is not in sufficient quantity or quality to date to be conclusive. These preliminary incomplete results tend to indicate that the observed splitting is not due to magneto-ionic splitting. Tests are continuing with more refined equipment to investigate this problem more thoroughly.

Fig. 2 shows a sample photograph of an experimentally obtained ellipse on which has been superimposed the theoretical ellipse cited above for $\nu = 0.8 \times 10^6$.

Preliminary calculations of the index of refraction and polarization have been made according to a slight modification of the method proposed by Bailey and Somerville.² The calculations include the earth's magnetic field and the angle the field makes with the direction of propagation, as well as the collision frequency. It is assumed that the properties of the medium vary slowly but no approximations, such as the quasi-longitudinal approximation, are used. The limiting polarization is determined by computing the polarization as a function of electron density at a given collision frequency, and extending the curve to the place where the electron density vanishes. This preliminary work shows the following results:

(1) The index of refraction for that component associated with the negative sign of the Appleton-Hartree Equation³ (modulus ρ of the polarization greater than unity) is always greater than unity. Accord-

² V. A. Bailey and J. M. Somerville, "Study of the magneto-ionic theory of wave propagation by means of simple formulae, linkages, and graphical devices," *Phil. Mag.*, vol. 26, pp. 888-905; November, 1938.

³ E. V. Appleton, "Wireless studies of the ionosphere," *Jour. IEE (Elec. Eng.)*, vol. 71, pp. 642-650; October, 1937.

ing to ray theory, this would mean that this component is not returned from the ionosphere.

(2) Calculations of limiting polarization give two ellipses whose ratio of minor to major axes is roughly 0.65, the one for which $\rho < 1$ rotates in a left-handed sense with the major axis located about 20° north

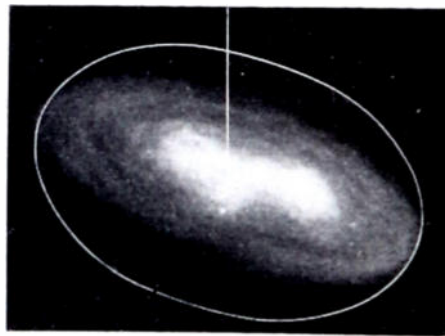

Fig. 2—Photograph of observed ellipse with theoretically calculated ellipse superimposed.

of magnetic west; the ellipse for $\rho > 1$ is right-handed and has its major axis about 20° west of magnetic north. (A table of exact values for the positive sign in the Appleton-Hartree Equation, i.e., for $\rho < 1$, is given above. The axial ratios for the two components are identical; their angles of tilt are complements.) In the absence of collision, the first ellipse mentioned would have its major axis east-west, while the second ellipse would lie in a north-south direction. It might be noted here that the polarization ellipses are not at right angles as erroneously stated by Taylor⁴ and Martyn.⁵ The correct relations of the ellipses were discussed in considerable detail by Booker.⁶

⁴ M. Taylor, "The Appleton-Hartree formula and dispersion curves for the propagation of electromagnetic waves through an ionized medium in the presence of an external magnetic field. Part 2: Curves with collisional friction," *Proc. Phys. Soc.*, vol. 46, pp. 408-419; May, 1934.

⁵ D. F. Martyn, "Dispersion and absorption curves for radio wave propagation in the ionosphere according to the magneto-ionic theory," *Phil. Mag.*, vol. 19, pp. 376-388; February, 1935.

⁶ H. G. Booker, "Some general properties of the formulae of the magneto-ionic theory," *Proc. Roy. Soc.*, vol. 147, pp. 352-382; November, 1934.

From the results of the measurements and calculations, the following tentative conclusions are proposed: (1) the split echoes that have been observed are not the result of magneto-ionic splitting, since the ellipses appear similar, while theory predicts a separation of 50° for magneto-ionic splitting, and since only one component, that associated with the positive sign of the Appleton-Hartree Equation, should theoretically be returned; (2) the polarization is left-handed; (3) the wave leaves the layer at a level where the collision frequency is roughly 0.8×10^6 .

There are several details which must be considered before the above conclusions are stated emphatically. Although the angle of tilt of the measured ellipse can be explained by suitably choosing the collision frequency, the theoretical ellipse is considerably more nearly circular than the experimental one. Despite the fact that ray theory does not permit the return of one of the two magneto-ionic components, it may be possible that the two are actually returned, but with presumably greatly different amplitudes. Calculations will be undertaken to attempt to determine whether such an effect could account, at least in part, for the discrepancy between theoretical and experimental axial ratios. Another possible cause of the discrepancy might lie in the values of terrestrial magnetic field strength and dip angle used in the calculations. An attempt is being made to determine the effect of errors in these quantities on the computed ellipse. Preliminary calculations show that this effect is not great. The sense of rotation of the polarization ellipse has not yet been determined experimentally. When this is done, it will prove to be a valuable test of the predicted results.

The transmitting antenna used in this work is aligned in a north-south direction. Thus the plane containing the electric vector of the outgoing signal will also contain the earth's magnetic field. It has been suggested to us by Professor Helliwell, of Stanford, that this may result in the excitation of only one magneto-ionic component. This effect, however, will not of itself prevent the solution of the present problem, i.e., whether the splits observed are magneto-ionic, or otherwise. There are two possible results which might be obtained when the sense of rotation of the polarization ellipses are determined experimentally: (1) if the senses of rotation of the split ellipses are the same, then only one magneto-ionic component is being observed and the splits are due to some cause other than magneto-ionic splitting; (2) if the rotations are opposed, then both magneto-ionic components are being excited, and the splitting is, at least in part, a magneto-ionic effect.

ACKNOWLEDGMENT

This work has been done under the direction of A. H. Waynick of The Pennsylvania State College and has been supported in part by the U. S. Air Force, through sponsorship of the Geophysical Research Directorate, Cambridge Field Station, AMC. A. H. BENNER, C. H. GRACE, and J. M. KILSO
Radio Propagation Lab.
The Pennsylvania State College, State College, Pa.

Institute News and Radio Notes

FULL AGENDA ANNOUNCED FOR IRE WEST COAST CONVENTION

An important technical program combined with the Sixth Annual Exhibit of the West Coast Electronic Manufacturers' Association will be presented at an outstanding annual event, the IRE West Coast Convention, to be held September 13, 14, and 15 at the Municipal Auditorium, Long Beach, Calif. Scientists, engineers, and individuals of allied interests have been invited to participate.



Municipal Auditorium, Long Beach, Calif.

The Papers Committee has tentatively scheduled technical papers covering the latest development in Computers, Antenna and Propagation Measurements, Passive and Active Circuits, Vacuum Tubes, Microwave Apparatus, Industrial and Nuclear Instrumentation, Theory, Television and Broadcasting, Audio, and miscellaneous topics.

The following registration fees have been announced: students, \$1.00; members, \$2.00; nonmembers, \$3.00. There will be no registration fee for wives of members.

V. J. Braun, publicity chairman, also has announced the tentative arrangements for inspection field trips including the following: a boat tour of Long Beach Harbor; a trip through Harbor Radar Station; open house at Telephone Company Mobile Transmitter Unit; a television audience participation show; an inspection tour of television production; a trip through high-frequency experimental TV station; and a tour of one of the Southern California's largest aircraft plants.

Ladies' activities will include a boat trip, cocktail party, fashion luncheon, TV show, and trips through Knott's Berry Farm and the artists resort at Laguna.

OVER 800 SCIENTISTS ATTEND DAYTON SECTION CONFERENCE

The second annual conference on "Modern Trends in Airborne Electronics," sponsored by the Dayton Section of The Institute of Radio Engineers, attracted approximately 800 scientists and engineers from all parts of the United States.

Presented during the conference, on May 3-5, were 57 technical papers devoted



Left to right: R. F. Guy, IRE President; J. D. Reid, Director of Region 5; and T. A. Hunter, Past Director of Region 5.

CINCINNATI SECTION HOLDS ANNUAL SPRING CONFERENCE

The Fourth Annual Spring Technical Conference of the Cincinnati Section of The Institute of Radio Engineers, held on April 29 at the Engineering Society Headquarters in Cincinnati, was an outstanding event of more than local interest. Over 350 persons attended, of whom 75 per cent were from outside the Cincinnati area. As in the past, the theme was "Television," and eight papers by prominent engineers were given, climaxed by the banquet address of Eastman Kodak Company's Ralph M. Evans on "Seeing Light and Color."

The conference was preceded on April 28 by the IRE regional committee meeting at the headquarters. High-lighting the conference were the following papers: "Practical Experience with 41-Mc IF Television Receiver" by D. W. Pugsley, General Electric

Company; "Integrated Nation-Wide Television Allocation Plan" by Robert P. Wake-man, Allen B. DuMont Laboratories; "Applications of Recent Developments of the Communications Theory, Including Art of Sampling, to Color Television" by Frank Bingley, Philco Corp.; and "Applications of Germanium Rectifiers" by E. W. Ulm, Sylvania Electric Products Inc.

The meeting included an inspection of the American Telephone and Telegraph Company's Microwave Relay Terminal, and featured a number of exhibits of new apparatus by prominent TV manufacturers.

Among the IRE officials present were President R. F. Guy, A. N. Goldsmith, Editor of PROCEEDINGS OF THE I.R.E., and Regional Director John D. Reid.

to such topics as: Vacuum Tubes, Computers, Aircraft Antenna, Communication and Navigation, Radio Interference and Noise, Measurements, Electronic Instrumentation, Circuits, Propagation, and Electronic Components and Techniques. 1,000-word abstracts of all technical papers were available to those registrants desiring them.

George Rappaport, president of the conference, was the presiding officer at the banquet at which William L. Everitt, Dean of Engineering of the University of Illinois, was toastmaster. Harold H. Buttner, president of the Federal Telecommunications Laboratories, introduced Lewis M. Clement, Di-

rector of Research and Engineering of the Crosley Division of the AVCO Manufacturing Corp., who was named the "Pioneer Man of the Year in Airborne Electronics."

Donald H. Menzel of the Harvard University Laboratory delivered the principal address at the banquet, at which Raymond F. Guy, President of IRE, was a guest of honor.

An elaborate exhibit showing in miniature the application of electronics to the operations of the United States Air Force was displayed, as well as 24 exhibits of modern designs of equipment, instruments, and components applicable to airborne electronics.



Left to right: Lewis M. Clement, William L. Everitt, Donald H. Menzel, George Rappaport, Harold H. Buttner, Richard P. Swofford.

TECHNICAL COMMITTEE NOTES

A meeting of the Standards Committee was held on May 18, under the Chairmanship of J. G. Brainerd. Two new subcommittees were formed, one headed by Wayne Mason, to study IRE's relation to Federal Agencies, military services, and international agencies in standardization. The other subcommittee, headed by Axel G. Jensen, has been assigned to study the relation of IRE to independent, domestic societies in standardization work. Several charts prepared by Technical Secretary L. G. Cumming, depicting IRE's relationship to organizations, have been issued to these subcommittees for study. . . . Mr. Keister, Chairman of the Video Techniques Committee, reported on the work in progress in his committee. This Committee recently completed a Standard on "Methods of Measurement of Time Rise, Pulse Width, and Pulse Timing of Video Pulses in Television," which has been approved by the Standards Committee, and will be published in a forthcoming issue of the PROCEEDINGS. Chairman Brainerd requested all Technical Committee Chairmen, when presenting new material for standardization, to secure the approval of the Chairman of the Symbols Committee regarding symbols, signs, designations, abbreviations, etc., and the approval of the Definitions Coordinator regarding definitions. Each sponsoring committee should consult the Master Index of IRE Definitions and the *Standard on Abbreviations, Graphical Symbols, Mathematical Signs, 1948*; as well as the *Designations for Electric, Electronic and Mechanical Parts and Their Symbols, 1949*. . . . The IRE/AIEE Committee on Noise Definitions has been activated and R. S. Tucker will serve as Chairman. Representation on this committee will include members from all committees dealing with noise. . . . A meeting of the Wave Propagation Committee was held on June 5 under the Chairmanship of Henry G. Booker. The progress of work going on in the subcommittees was reported by the chairman of each subcommittee. A new Subcommittee 24.6 was created to cover the field of Radio Astronomy with C. R. Burrows, Chairman. Additional members, active in the field of Radio Astronomy, will be added to the Wave Propagation Committee. . . . The Navigation Aids Committee under the chairmanship of P. C. Sandretto held a meeting on May 15. This Committee will participate in the annual meeting of the Institute of Aeronautical Sciences to be held in 1951. Details of this meeting will be announced later. . . . The Electron Tubes and Solid-State Devices Committee held a meeting on May 12, under the chairmanship of L. S. Nergaard. This Committee sponsored a Joint IRE/AIEE two-day Conference on Microwave Tubes and Solid-State Devices, which was held at the University of Michigan, June 22-23. The Conference proved most successful due to the very efficient management of the Conference Committee, under the chairmanship of R. S. Gorham. The University of New Hampshire has been tentatively chosen as the site of next year's conference. . . . The Circuits Committee under the chairmanship of W. N. Tuttle held a

meeting on May 25. Chairmen of the individual subcommittees reported on the activities of their various groups. Each of these subcommittees is presently engaged in the preparation and review of definitions of terms in their respective field. Subcommittee 4.3-Circuit Topology, has completed a list of Definitions on Network Topology for approval by the Standards Committee. . . . Chairman Lewis Winner of the Administrative Committee of the Broadcast Transmission Systems Professional Group called a meeting on May 5. A meeting of the Boston Group was held jointly with the IRE section in Bridgeport, Conn., on May 25. A most successful meeting of the Boston Group was held during the recent New England Regional Meeting at which the Group presented seven papers. . . . The Joint IRE/AIEE Nucleonics Symposium Planning Committee and the Program Committee held a meeting on May 31. G. W. Dunlap is Chairman of the Planning Committee and David Langmuir is Chairman of the Technical Program Committee. The Symposium will be held on October 23, 24, and 25 at the Hotel Park Sheraton, New York, N. Y. Complete details of this Symposium will be announced later. . . . The Joint Technical Advisory Committee held a meeting on May 16 under the chairmanship of J. V. L. Hogan. Axel Jensen, Consultant to JTAC, has been asked to revise Table I, in Volume IV of JTAC, bringing it up-to-date as far as the CBS field sequential system is concerned. Mr. Wintringham, Consultant to JTAC, has been asked to prepare a report on the Princeton and NBC observer tests to show the results reached by the various groups classified as to age, sex, etc. . . . The first meeting of the Joint IRE/AIEE Committee on High-Frequency Measurements was held at IRE Headquarters on May 19, with Ernst Weber presiding as Chairman. This group is sponsoring a three-day symposium in Washington, D. C., early in January, 1951. Details will be announced in this column of the PROCEEDINGS as plans are formulated.

EMPORIUM SECTION OF THE IRE
HOLDS ANNUAL SUMMER SEMINAR

The Summer Seminar of the Emporium Section of The Institute of Radio Engineers will be held on August 18 and 19 at Emporium, Pa.

The Seminar, which is the highlight of the year's activities for the Section, will include the presentation of papers on the subjects of color television, high-quality audio reproduction, and electronic remote control.

The speakers for the Seminar will include C. Wesley Carnahan of the Sandia Corporation, Albuquerque, N. Mex.; Norman Pickering of Pickering and Company, Oceanside, L. I., N. Y.; and R. M. Bowie of Sylvania Electric Products Inc., Bayside, L. I., N. Y.

Calendar of
COMING EVENTS

IRE West Coast Convention of 1950, Municipal Auditorium, Long Beach, Calif., September 13-15

National Electronics Conference, Chicago, Ill., September 25-27

IRE-AIEE Conference on Electronic Instrumentation in Nucleonics and Medicine, Hotel Sheraton, New York, N. Y., October 23-25

Radio Fall Meeting, Syracuse, N. Y., October 30, 31, November 1

Audio Fair, Sponsored by Audio Society of America, Hotel New Yorker, New York, N. Y., October 26-28

Industrial Engineering
Notes¹

TELEVISION NEWS

Again pointing to interference caused by the "unsatisfactory" design of television receivers, the FCC turned down an application of a TV station to change its channel from 7 to 2. The Yankee Network Station WNAC-TV, Boston, asked to make the change because of interference difficulties. The FCC urged the station to correct the trouble at the source, rather than by manipulating the outstanding frequency assignments. . . . The National Association of Broadcasters released to the press the text of a resolution urging all TV set manufacturers to install FM tuners in television sets. NAB said the resolution had been transmitted to all television receiver manufacturers. . . . Study Group 11 of the International Radio Consultative Committee (CCIR) during its recent meeting in London decided that it was too early to discuss standards for color television on an international basis, but that if possible color standards, when adopted, should be compatible with the black-and-white standards then in use, according to unofficial reports reaching Washington. The U. S. Delegation expressed no opinion on the color issue. The CCIR group agreed unanimously on the following according to reports from the meeting: vestigial sideband transmission for the vision signal; aspect ratio, 4 to 3; nonsynchronous operation; line interlacing 2 to 1; and unnecessary to have standard on polarization. No agreement was reached on field frequency, as all countries except the United States proposed 25 fields. The group, according to an unofficial report, expressed great interest in dot-interlace techniques, and a United States delegation report on the subject was well received. The number of television picture lines proposed by various countries were as follows: Austria, Belgium, Denmark, Switzerland, Sweden, Netherlands, and Italy, 625 lines;

¹ The data on which these NOTES are based were selected, by permission, from *Industry Reports*, issues of May 12, May 19, May 26, June 2, published by the Radio Manufacturers Association, whose helpful attitude is gladly acknowledged.

United Kingdom, 405 lines; France, 405 lines and 819 lines; Morocco-Tunisia, 819 lines; and the United States, 525 lines. France, United Kingdom, and Morocco-Tunisia proposed positive modulation and the United States proposed negative, while all other countries proposed further study of this problem. France, United Kingdom, and Morocco-Tunisia proposed positive AM sound, the U. S. proposed FM, while all other countries urged further study of the issue. . . .

Television receiver production in April continued at the same high level reached in March, according to a tabulation of reports from RMA member-companies, although the month's total dropped due to the fact that March figures covered five weeks and April tabulations four weeks. **Radio receiver production** also continued at a high level during April and reflected a higher average weekly output than was reached in March. Home sets totaled 648,352 and auto receivers 234,354 in April. . . . **TV set production**, broken down in each category according to tube sizes, confirmed the trends shown in recent and current cathode-ray tube reports toward larger size TV picture screens. The majority of TV receivers reported were between 12 and 15 inches in table models, 16 inches or larger in consoles and consolettes, but from 12 to 15 inches in phonograph combinations. . . . While **total manufacturing employment** at 14.1 million in April shows little gain over March, the net figures obscure a substantial increase of 117,000 in the durable good group, the U. S. Department of Labor's Bureau of Labor Statistics reported this week. The refrigerator and television industries, the Bureau noted, reported "sizeable increases for the fourth consecutive month." . . . The FCC announced at the close of the color hearing that it will continue with a **broad investigation into TV allocation problems**. This phase involves issues relating to allocating the 470- to 500-Mc band to common carriers and is being held in the Commission's hearing room (6121) in the New Post Office Building. Chairman Coy, in ruling upon the admissibility of a CTI exhibit concerning interference tests, took the occasion to reprimand the "industry" for its failure to supply what he termed "adequate interference data." . . . Declaring it is desirous of "reaching a determination at the earliest possible date with respect to the color issues," the FCC denied a plea by **Paramount Television Productions, Inc., and Chromatic Television Laboratories, Inc.**, to hold open the record of the color television hearing. The petition was granted in part, however, in that the FCC agree to allow the petitioners, who are developing a tri-color tube, to file briefs in the color proceedings.

FCC ACTIONS

FCC has called upon RMA to assist the Commission and FM set manufacturers in eliminating an air traffic hazard said to be caused by **FM receiver oscillator radiation** which interferes with navigational equipment on aircraft in the vicinity of airports. . . . The FCC has proposed to reserve

the frequency 89.1 Mc, Channel No. 206, for the prospective use of the **United Nations** in New York City. The noncommercial educational channel was reserved for the UN at the request of the Department of State. . . . The FCC also has proposed to change its rules regarding assignment of channels to miscellaneous carriers in the **Domestic Public Land Mobile Radio Services**. The Commission proposed to grant authorization to all common carriers in this service on an adjacent channel basis (60-kc separation) within a given geographical area. This would supplant the present policy of making alternate assignments (120-kc separation).

RADIO AND TELEVISION NEWS ABROAD

The U. S. Embassy at **Bogotá, Columbia**, has informed the Department of State and the Department of Commerce that the municipality of Bogotá is interested in installing and operating an experimental television station and distributing TV receivers there. . . . A British newspaper, the Daily Telegraph, has reported that an English concern has been awarded a **Brazilian television contract** over U. S. rivals because of that South American country's dollar shortage. According to a report from the American Embassy at London, Pye Ltd., is to supply a "complete television transmission station to Radio Television De Brazil." . . . The Government of **Cuba** has issued construction permits for three television stations but they are not expected to commence program operations before the latter part of this year, according to information received by the U. S. Department of Commerce. Construction permits have been issued the following concerns: Television del Caribe S. A. (Channel 3); Union Radio (Channel 4); and CMQ Network (Channel 6). The Commerce Department report says there are no TV receivers in Cuba now. It adds: "In order to stimulate this new service, the Government has under consideration a plan to permit the duty-free importation of television receivers for a limited time." . . . A total of 12,196,528 radio and television sets were licensed in the **British Isles** at the end of February, according to a report from London to the Department of Commerce. Television licenses numbered 310,014. Radio licenses in **Sweden** at the end of March totaled 2,116,401 compared with 2,095,475 at the end of December, 1949, and 2,080,452 on September 30, 1949. There are an estimated 306 licensed radio receivers for each 1,000 persons in Sweden. Imports of radio receivers into **Panama** in 1949 totaled 8,016 units valued at \$250,672, of which 7,738 units valued at \$240,084 were of U. S. manufacture. . . . A survey conducted by a group of **Venezuelan** distributors shows that the radio set and parts business in Venezuela is "down" and indicates it will be off from 30 to 50 per cent compared with 1949 sales, the U. S. Department of Commerce reports. The report also indicates that U. S. manufacturers are being undersold by European concerns. There is no television broadcasting in

Venezuela at present. "Possible broadcasters are said to be awaiting the outcome of trials of color television in the U. S.," according to the Commerce Department report. . . . At the end of February there were 1,988,935 licensed radios in the homes of **Australia**, 4,778 in schools, and 9,955 in automobiles, according to information received by the U. S. Department of Commerce. An estimated 92 per cent of the people in **Australia** have licensed radio receivers. . . . **Denmark** had a total of 1,216,586 licensed radio receivers at the end of March, 1950, an increase of 3.39 per cent over the corresponding period of 1949.

RESEARCH

A method for working with radioactive materials at a distance by remote control and stereo-television has been developed by the Remote Control Engineering Division of the Argonne National Laboratory, the Atomic Energy Commission has announced. "The new method involves manipulation by the use of various types of remote control devices while the operations or manipulations are viewed by use of stereo, or three-dimensional, television," the AEC said. The achievement marks an important step in the development of equipment and techniques needed by scientists in order to protect themselves from radiations emitted by many of the materials used in the atomic energy program. The Argonne's Remote Control Engineering Division is responsible for the study, design, and development of remote control equipment for use by scientists at Argonne or other Commission establishments who work with radioactive materials. The investigation of a three-dimensional television system was carried out by a group of remote control engineers under the leadership of H. R. Johnston, who is on loan to the Argonne National Laboratory from Northwestern University's Department of Electrical Engineering. Standard DuMont television camera equipment was modified for use in this development. A twin lens arrangement was used on the camera in place of the single lens used in the conventional television system. Standard television receiving equipment was modified to provide three-dimensional viewing. "The equipment may be used to operate in areas rendered uninhabitable by radioactive materials. Applications in weapons work may include handling of explosive materials and dearming or disposal of bombs. Industrial applications will also suggest themselves, especially chemical plant operations involving toxic materials." At the receiving end of the system, the two images appear side-by-side on the face of an ordinary television picture tube. Two polarizing filters whose axes of polarization are at right angles are placed immediately in front of the images, so that an observer wearing a pair of crossed polaroid spectacles will see only the right eye image with the right eye and the left eye image with the left eye. In addition, a pair of glass prisms are placed in front of the eyes to enable the observer to fuse the two pictures into a single three-dimensional image of the objects in front of the camera.

IRE People

Frank A. Polkinghorn (A'25-F'38) is returning to Bell Laboratories, Inc., New York, N. Y., after a two years' leave of absence spent on General MacArthur's staff in Tokyo, Japan.



F. A. POLKINGHORN

As director of the Research and Development Division of the Civil Communications Section of General Headquarters, he worked with the Japanese in connection with research, development, manufacturing, and education in the telecommunications field.

The telegraph and telegram system of Japan is owned and operated by the Ministry of Telecommunications of the Japanese government. One of the important projects under Polkinghorn's personal supervision was the reorganization of the Electrical Communications Laboratory, the research and development organization of the Ministry of Telecommunications.

Mr. Polkinghorn organized a group of electrical engineering professors from the leading universities of Japan. For the past year these groups have been active in raising the effectiveness of university engineering graduates. As part of the program, two university professors were sent to the United States to study, and others are expected to leave for the United States soon.

Mr. Polkinghorn also helped technical societies, particularly the Japan Institute of Electrical Engineers and the Institute of Electrical Communications Engineers, to become re-established and obtain rights for their periodicals to reprint from American technical journals.

Mr. Polkinghorn was graduated from the University of California with the electrical engineering degree in 1922. Before going to Japan in 1948, he spent more than twenty years in the Bell Telephone Laboratories, where he was principally engaged in the design of equipment used by the Bell System for transoceanic telephony from the United States to more than forty foreign countries.

Mr. Polkinghorn is also a member of the AIEE, the American Association for the Advancement of Science, the Montclair Society of Engineers, Phi Beta Kappa, Tau Beta Pi, Sigma Xi, and Eta Kappa Nu.

Harry R. Seelen (A'42-SM'49) has been appointed manager of the Lancaster engineering section of the RCA tube department. He has been manager of the services group of the Lancaster engineering section for the past seven years. Mr. Seelen, who has been with the tube department for 20 years, has been associated with the development of many important tube types, including acorn tubes, miniature tubes, cathode-ray tubes, and phototubes.

A graduate of Providence College in 1929 with the Bachelor of Science degree, Mr. Seelen joined the Westinghouse Electric Company that year. He went to RCA the following year, and in 1933 was placed in charge of experimental work on tubes.



Alexander Nadoso (A'39), professor of the "Escuela Superior Tecnica," (Army School of Engineering) in charge of telephony, died recently. A resident of Buenos Aires, Argentina, Mr. Nadoso was one of those IRE members who helped to organize the Buenos Aires Section.



A. NADOSO

Mr. Nadoso, who was born on September 11, 1902, at Nyiregyhaza, Hungary, studied at the Royal Academy at Budapest and was graduated in 1925.

He joined the Telephone Transmission Department of the Siemens Shuckert Co., and arrived in 1930 in Buenos Aires, where he was sent by Siemens Halske to study and prepare various projects concerning long-distance telephone communications. Mr. Nadoso took an active part in the installation of various lines and central telephone exchanges in Argentina and neighboring countries.

In 1933 Mr. Nadoso became associated with the Compania Telefonica del Plata and Compania Internacional de Telefonos.



Dana W. Atchley, Jr. (S'39-A'47-M'47) has been appointed Director of Engineering of Tracerlab, Inc., Boston, Mass. He has been sales manager of Tracerlab since 1947. The newly formed engineering division will include electronic and mechanical engineering designs, with special emphasis on operational quality and styling.

Born on October 27, 1917, in New York, N. Y., Mr. Atchley was graduated from the Loomis School, in Windsor, Conn., and received the B.S. degree from Harvard University in 1939.

During the war he served in the United States Navy, entering as an ensign, and was elevated to the rank of lieutenant commander, USNR, at the time of his release from active duty. He participated in elec-

tronic research and development mainly at the Naval Research Laboratory, Anacostia, D. C., where he was Technical Aide to the Director for Special Electronic Research and Development.

From July, 1940, until February, 1941, he was research engineer with the fluorescent lighting division, Sylvania Electric Products Inc., Salem, Mass.

Prior to joining Tracerlab, he was a sales engineer in charge of the Boston sales office of Electronics Division, Sylvania Electric Products Inc., and was associated with the general relationship between consumer and manufacturer of microwave and communications systems and components.



Curtis B. Plummer (A'39-M'44-SM'50), chief of FCC Engineering Bureau's Television Division, was named FCC chief engineer to succeed John A. Willoughby, who has held the position on an "acting" basis since January, 1948. Mr. Willoughby was appointed assistant chief engineer.



CURTIS B. PLUMMER

Mr. Plummer, who has been with the FCC since 1940, will be in charge of the new Office of Chief Engineer. He was graduated from the University of Maine with the B.S. degree in electrical engineering in 1935 and was affiliated with WHEB, WGAN, and Portland and Radio Receptor Co., in New York, N. Y., before joining FCC's Boston Office.

He was transferred to Washington headquarters in 1941, working in AM Division, until appointed chief of the television unit upon its creation in 1945. He attended high-frequency conferences in Atlantic City, Geneva, and Mexico City in 1947, 1948, and 1949, respectively.



F. Arthur Cobb (A'26-M'28-SM'43), managing director of Electronic Tubes Ltd., Kingsmead Ltd., Kingsmead Works, High Wycombe, Bucks., England, died recently. He was born on February 11, 1901, at Winchester Hants, England. He received the I.E.E. degree from Marconi Wireless College in 1926.

From 1918 to 1923 he was with Marconi Co., and then joined the British Broadcasting Corporation as assistant maintenance engineer, later becoming maintenance engineer of a London station.

In 1927 Mr. Cobb was appointed assistant chief engineer of the Indian Broadcasting Co., in Calcutta, India.

Walter E. Poor (A'29-VA'39), chairman of the board of Sylvania Electric Products Inc., died recently. He was also a director of the Company.



WALTER E. POOR

Mr. Poor was graduated from Massachusetts Institute of Technology in 1908 with the degree of electrical engineer. He was an electrical engineer for the Boston Elevated Railway from 1908 to 1909, and the Hugh Naron Contracting Company from 1909 to 1911. He joined his brothers in the manufacture of electric lamps with the Hygrade Lamp Company of Danvers, Mass., in 1911.

The Hygrade Lamp Co., predecessor of Sylvania Electric Products, after making new and renewed carbon filament lamps for 10 years, started in 1911 to make the new tungsten filament lamp. As electrical engineer for Hygrade, Mr. Poor took over the development and production of tungsten lamps, later becoming vice-president and general manager. In 1940 he was made executive vice-president, and in 1943 was elected president. He became chairman of the board in 1946.

For many years the company produced incandescent lamps, radio tubes and fluorescent lighting, and during World War II was a co-developer with the Emerson Radio and Phonograph Corporation of the radio-proximity fuze, also called the influence "VT" fuze. Placed in the nose of a projectile, it explodes upon approaching the first solid object in its path.

The fuze radiates electromagnetic waves which bounce back from the target, exploding above ground and inflicting a maximum of damage. After the war, it was revealed that the same fuze would make possible the manufacture of pocket radios no larger than a package of cigarettes.

Mr. Poor was a trustee of Salem (Mass.) Hospital, director of Junior Achievement Inc., director of the Sound-Sciber Corp., New Haven, and member of the Committee on Corporations of the Development Fund of Massachusetts Institute of Technology. He was also a member of the AIEE.

consulting services instituted for the research and development of automatic industrial controls and computers, ultrasonics, sonar, electronics, applied mathematics, and general engineering analysis. Formerly Dr. Roth and his associate, Stanley R. Rich, had been connected with the Raytheon Mfg. Co., Waltham, Mass., as leaders of servomechanisms and ultrasonics research activities.

Dr. Roth is a graduate of Columbia University and received the Ph.D. degree in physics and applied mathematics from the Massachusetts Institute of Technology. During the war he was engaged in research and development of radar equipment at the Radiation Laboratory at MIT.

At the termination of the war he was a consultant for several industrial firms, contributing to the development of electronic equipment for detecting oil, electronic aids for the navigation of aircraft and ships, high-speed electronic computers, and devices for automatically controlling industrial machines and processes.

Dr. Roth has conducted fundamental research in very-high-frequency sound, or ultrasonics, at MIT. During the course of these activities he has presented and published numerous theoretical and experimental papers. Prior to his position with Raytheon, he served as chief physicist of the Rieber Research Laboratory, New York, N. Y., and research leader of the Harvey Radio Laboratories of Cambridge, Mass.



Donald B. Sinclair (J'30-A'33-M'38-SM'43-F'43) has been appointed chief engineer of the General Radio Company, succeeding Melville Eastham (A'13-M'13-F'25) who has recently retired.



DONALD B. SINCLAIR

Dr. Sinclair was born at Winnipeg, Manitoba, Canada, on May 23, 1910. He was educated at the University of Manitoba, and then transferred to Massachusetts Institute of Technology, receiving the S.B. degree in 1931, the S.M. in 1932, and the Doctor of Science degree in 1935.

Dr. Sinclair has been associated with the Bell Telephone Laboratories and the New York Telephone Co. in New York, and with the Western Electric Co. at Hawthorne.

Joining the General Radio engineering staff in 1936, he was assistant chief engineer since 1944. He has worked mainly on the general development and design of high-frequency measuring instruments.

During the War Dr. Sinclair worked in the Countermeasures Division and the Guided Missiles Division of NDRC, receiving the President's Certificate of Merit for outstanding services.

Dr. Sinclair has been a member of the Board of the Institute since 1944, and is active on a number of committees. He is treasurer of the IRE for the 1949-1950 term. He is a member of the American Institute of Electrical Engineers and Sigma Xi.

David H. Hull (A'36-F'47) has joined the Raytheon Manufacturing Co., in Waltham, Mass., as assistant to the vice-president in charge of equipment divisions.



DAVID H. HULL

He recently retired from the United States Navy as a captain.

During the past two years, Captain Hull has been assistant technical director, International Telephone and Telegraph Corp., executive vice-president

and director of Capehart-Farnsworth Corp., and vice-president and director of Federal Telecommunication Laboratories.

Captain Hull was graduated from the U. S. Naval Academy in 1925, and received the M.S. degree from Harvard University in 1933. He was on continuous Naval service from 1921 to 1948, rising in rank from midshipman to captain. In 1940 he was designated an engineering duty officer.

During the decade prior to World War II, Captain Hull specialized in underwater sound and radar development. He initiated the design and operational use of vhf radio-telephone equipment for fleet tactics.

At the opening of the war, Captain Hull was serving as assistant to the director of the Naval Research Laboratory. Then he was transferred to the Bureau of Ships as head of the Electronics Design Branch. He was advanced to Deputy for Electronics and then became assistant chief of the Bureau of Electronics, the senior Navy position in the electronics field. He was responsible for the design, procurement, installation, and maintenance of all Navy electronic equipment.

Captain Hull was awarded the following decorations: Legion of Merit; Navy Commendation Ribbon; and campaign medals for Second Nicaraguan, American Defense, Pacific Theatre, and European Theatre, among others.

He is also a member of the Acoustical Society of America, AIEE, American Institute of Physics, Society of Naval Engineers, U. S. Naval Institute, and the Electronics Equipment Industry Advisory Committee-Munitions Board.



Edward B. Doll (A'38-SM'47) has joined the engineering staff of Stanford Research Institute of Stanford, Calif. Formerly he had been chief engineer of the North American Philips Company of New York, N. Y., for three years.

Dr. Doll is a graduate of California Institute of Technology. He taught electrical engineering at the University of Kentucky for three years. In June, 1941, he became a civilian scientist for the U. S. Navy's Bureau of Ordnance. Then he was with the Naval Ordnance Laboratory in Washington, D. C., and later head physicist for the Bureau at Pearl Harbor.

During 1943 to 1946 Dr. Doll was associated with the Manhattan District Project, as assistant group leader, group leader, and, finally, associate division leader at Los Alamos.

❖

Wilfred Roth (S'43-A'45-S'46-A'49) has announced the organization of the Rich-Roth Laboratories of East Hartford, Conn.,

Symposium on Antennas and Propagation*

SAN DIEGO, CALIFORNIA—APRIL 3-4, 1950

The appearance of these abstracts is in accordance with the recently formulated policy to publish in the PROCEEDINGS abstracts of papers presented at conferences sponsored by IRE Professional Groups.

SUMMARIES OF TECHNICAL PAPERS

Antenna Development

1. DIVERSITY SYSTEMS

H. P. GATES AND J. L. HERITAGE
(U. S. Navy Electronics Laboratory,
San Diego, Calif.)

Diversity systems were evaluated by comparing average signal-to-noise ratio and level fluctuation of the derived signal with corresponding figures for a single channel system. Consistent but diminishing improvement is expected as the number of diversity channels is increased. Two-channel tests over a 2,000-mile high-frequency circuit showed transmitter space diversity to be most effective, with polarization and receiver space diversity to be somewhat poorer. Effectiveness of space diversity varied with spacing; the optimum arrangement of collectors is dependent on the received-energy-direction-of-arrival function. Height diversity arrays may be optimized approximately for vhf ground-to-air communication.

2. APERTURE DISTRIBUTIONS FOR LOW SIDE-LOBE ANTENNAS

HENRY JASIK
(Airborne Instruments Laboratory, Inc.,
Mineola, L. I., N. Y.)

This paper discusses line source distributions which are suitable for low side-lobe antennas. The most useful distribution for the line source of discrete elements is that which produces the Tschebyscheff pattern. This case has been discussed in the literature and its optimum properties have been pointed out.

The optimum distribution for the continuous line source is not known. However, some of the higher order cosine functions are capable of producing low side-lobe patterns. A considerable improvement over the simple functions can be obtained by combining patterns so as to achieve partial cancellation of the side lobes. Several combined distributions are discussed and their properties compared with the simple distributions.

3. A SURVEY OF FM AND TV BROADCAST ANTENNA PROBLEMS

A. G. KANDOIAN
(Federal Telecommunications Laboratories,
Inc., Nutley, N. J.)

Transmitting antennas for FM and TV have many characteristics in common, al-

though the electrical performance requirements for TV are considerably more severe than those for FM. The final limitations as to what may or may not be accomplished economically from the antenna standpoint are really not electrical, however, but structural. The discussion includes the overall electrical and mechanical requirements of FM and TV antenna systems, followed by a review of the general theory and fundamentals on which all designs must be based. Two basic antenna types, the turnstile and the loop, designed in a variety of forms, have been used. The technical characteristics of the various commercially available antennas will be reviewed in some detail, along with a brief reference to the influence of RMA and FCC standards on the FM and TV antenna problem.

4. ANTENNAS FOR AIR NAVIGATION AND TRAFFIC CONTROL

H. R. SENF
(Air Navigation Development Board,
Washington, D. C.)

The nation-wide installation and operation of a new system for air navigation and traffic control is planned for about 1963. The frequency band of 1,000 to 1,600 Mc and several narrow channels at higher frequencies have been assigned for this work. A systems engineering study is being conducted prior to detailed formulation of methods and equipment to be used. An antenna research program is an integral part of this study. Research on means for achieving omnidirectional aircraft antenna patterns, including development of suitable pattern measuring techniques, is being done. Several equipments requiring such coverage are described.

5. WING-CAP AND TAIL-CAP AIRCRAFT ANTENNAS

J. T. BOLLJAHN
(Stanford Research Institute,
Stanford, Calif.)

Isolated-section antennas such as the wing-cap structures appear to offer a feasible solution to one of the most important aircraft antenna problems, namely, that of providing flush-mounted radiators for frequencies below 20 Mc. This paper describes the methods used and the results obtained in the first phase of a program designed to determine the electrical properties of such antennas. The work to date has been concerned with basic theoretical treatments and with model measurements of impedance characteristics and radiation patterns. The

impedance work involves a novel aircraft model consisting of two or more strip conductors lying in a plane and arranged to simulate as nearly as possible the shape of the airframe. Impedance measurements were actually made on a system of complementary slots in a large conducting sheet. The advantages and limitations of this procedure will be pointed out.

Symposium on Slots

6. SLOT ANTENNA DEVELOPMENT AND BASIC PRINCIPLES

PHILIP S. CARTER
(RCA Laboratories, Rocky Point, L. I., N. Y.)

Extensive experimentation during the last world war in England, Canada, and the United States is reviewed with specific attention to aircraft slot antennas developed by the RCA Laboratories. Slot arrays give excellent patterns for homing purposes. A very useful basic principle is that a thin slot in a conducting surface is the equivalent of an array of magnetic dipoles or small loops. When radiation takes place from the opening in a U-shaped surface, the size of the surface has a negligible effect on the omnidirectional transverse pattern if the spacing between the sides is less than one-eighth of a wavelength. When a slot is located in a metallic plate sheet, the radiation pattern in a plane transverse to the slot depends upon the dimensions of the conducting sheet; in longitudinal planes, the pattern depends principally upon slot length.

7. SLOTS AS COUPLING AND RADIATING ELEMENTS IN WAVEGUIDES

NATHAN MARCUVITZ
(Polytechnic Institute of Brooklyn,
Brooklyn, N. Y.)

The dominant mode discontinuities introduced by slots in waveguides may be represented rigorously by equivalent circuits. The relevant equivalent circuit parameters may be determined by simple transmission line considerations from the transverse electric field induced in the slots. However, the evaluation of this induced field leads to integral equations whose exact solution is unknown. The integral equations may nevertheless be employed to obtain the desired circuit parameters by variational expressions whose relative insensitivity to the slot field forms the basis for an approximation procedure. On judicious choice of the slot fields, the circuit parameters for slots of arbitrary size may be computed with engineering accuracy.

* Sponsored by the IRE Professional Group on Antennas and Propagation and Commissions 2, 3, and 6 of the USA National Committee of URSI, and held at the U. S. Navy Electronics Laboratory, San Diego, Calif.

8. EQUIVALENT CIRCUITS OF SLOT RADIATORS

NICHOLAS A. BEGOVICH
(Hughes Aircraft Company,
Culver City, Calif.)

The equivalent circuit of the simple types of narrow slots that can be cut in the walls of a rectangular waveguide have been developed. These equivalent circuits differ from those obtained by other investigators in that they show the interconnection of the slot's external admittance to the admittance seen in the waveguide by standing-wave measurements. The equivalent circuit of a two-slot array placed in a large metallic sheet has been used as the basis of the measurement of the mutual admittance between two slots. The experimentally measured values of the mutual admittance is in good agreement with the predicted theoretical value.

9. LONGITUDINAL SLOTS IN CONES

LESTER E. REUKEMA

(University of California, Berkeley, Calif.)

The impedance and three-dimensional radiation patterns of half-wave axial slots in a cone were measured between 8,460 and 9,900 Mc for five slot positions. Cone curvature and edge discontinuities showed negligible effects on either impedance or radiation pattern, even for slots within 2.5 wavelengths of cone apex or 3.8 wavelengths of cone edge. The principal *H*-plane pattern is practically that of a half-wave slot in an infinite plane. The transverse pattern is the same as that of an axial slot in a cylinder of the same diameter as that of the cone at the middle of the slot.

10. ON THE PROPERTIES OF TRAVELING-WAVE ELECTRIC AND TRANSVERSE MAGNETIC SLOTS

V. H. RUMSEY

(The Ohio State University
Foundation, Columbus, Ohio)

Owing to the complexity of half-wave slot arrays, the Ohio State University Antenna Laboratory first investigated a traveling-wave type of *TE* slot backed by a rectangular waveguide as suggested by Booker at TRE in 1942. The aperture energization is controlled by the slot width and the geometry of the waveguide or by use of several waveguide modes of appropriate phases and amplitudes. Substantial suppression of side lobes has been obtained over a 2-to-1 frequency range together with a broad-band impedance characteristic. Long *TM* slots are readily excited by means of the *TM* waveguide modes, their radiation being polarized perpendicular to the radiation due to a *TE* excitation.

11. CIRCULAR SLOTS IN X-BAND WAVEGUIDE

ROBERT W. BICKMORE

(University of California, Berkeley, Calif.)

A narrow annular ring centered in the broad face of *X*-band waveguide (propagating the *TE*₁₀ mode) is considered to have an arbitrary field distribution. The far-zone

field components, radiated power, and reflection coefficient in the waveguide are derived by taking the field in the slot as represented by a generalized Fourier series.

Experimental far-zone field patterns and impedance data are presented for one- and two-wavelength circumference slots in 15-wavelength-radius circular ground planes. The field distribution in each slot is shown to be determinable by graphical Fourier analysis of the *H*-plane pattern.

Tropospheric Propagation

12. THE EFFECTS OF ANTENNA DIRECTIVITY OF THE RECEPTION OF DISTANT FM STATIONS

A. W. STRAITON AND D. F. METCALF
(University of Texas, Austin, Tex.)

The theory of scattering proposed by Booker and Gordon¹ is used to interpret the signal received by scattering from a uniformly illuminated beam in an inhomogeneous atmosphere. The ratio of the scale of turbulence to the wavelength determines the angle of elevation at which maximum scattered signal is received.

Measurements at 100 and 9,375 Mc showed evidence that a significant part of the signal arrives at angles above the horizontal. Maxima in the scattered signal are noted at elevation angles in the vicinity of 40 and 0.5 degrees, respectively, for the two frequencies.

13. THE RESPONSE OF A DIRECTIVE ANTENNA TO SCATTERED RADIATION

F. W. SCHOTT

(U. S. Navy Electronics Laboratory,
San Diego, Calif.)

The response of a directive antenna is dependent on the mechanism whereby the energy is conveyed. This fact seems, however, to be generally neglected when the radar response to a scattering region such as a storm is considered. Since scattering may also be the dominant mechanism in the extraoptical propagation of microwaves, further consideration is warranted. An investigation has indicated the way in which the antenna response depends upon the physical extent of the scattering region. Results are presented which compare the behavior of several antennas of varying aperture.

14. AN INTEGRAL EQUATION APPROACH TO THE PROBLEMS OF PROPAGATION OVER AN IRREGULAR SURFACE

GEORGE A. HUFFORD

(National Bureau of Standards,
Washington, D. C.)

A technique has been devised which purports to find an approximate solution to the problem of vhf transmission over the earth, encumbered as it is with hills, trees, and buildings. This is accomplished by reducing

¹ H. G. Booker and W. E. Gordon "A theory of radio scattering in the troposphere," *Proc. I. R. E.*, vol. 38, pp. 401-412; April, 1950.

the problem to the approximately equivalent one of scalar wave propagation over an irregular surface on which a "homogeneous boundary" integral equation is derived. And then, after a number of approximations, this equation is simplified down to a point where, for any given profile of the terrain, a numerical solution can be easily made.

15. ON AN APPROXIMATE METHOD OF ANALYSIS OF NONSTANDARD TROPOSPHERIC RADIO WAVE PROPAGATION

J. W. GREEN

(U. S. Navy Electronics Laboratory,
San Diego, Calif.)

An approximate method of analysis of nonstandard tropospheric radio wave propagation proposed by Schelkunoff has been applied to several sets of experimental radio-meteorological data recorded under conditions of an elevated subsidence inversion. The method expressed the radio-field-strength profile in terms of elementary functions, and derives a value of the ratio of guided-wave amplitude to free-space amplitude. The derived values of radio-field-strength profile and the ratio of guided-wave to free-space-wave amplitude are compared with experimentally measured values. The range and degree of applicability and the limitations of the method are discussed.

16. THE INFLUENCE OF DETECTOR CHARACTERISTICS ON FIELD-INTENSITY RECORDING

W. Q. CRICHLAW AND J. W. HERBSTREIT
(National Bureau of Standards,
Washington, D. C.)

Propagation studies for evaluating interference between various services in the vhf and uhf regions necessitate measurement of low field intensities at extended ranges. An analysis has been made of transmitting and receiving systems, in particular as influenced by receiver detector characteristics. Both peak and average linear detectors have been analyzed mathematically in the presence of random noise for continuous-wave and pulse signal reception. Curves of normalized detector output voltage versus input signal-to-noise ratio are given for various pulse duty cycles and detector charge to discharge time-constant ratios. Results have been applied to a number of systems of recording, and their relative performance evaluated in terms of free-space maximum range.

Ionospheric Propagation

17. SKY-WAVE FIELD INTENSITY ANALYSIS

PAUL O. LAITINEN AND GEORGE W. HAYDON
(Fort Holabird, Baltimore, Md.)

This paper presents an engineering method of evaluating sky-wave field intensities in the high-frequency band. Sample problems show the accuracy for both relative and absolute values. Field intensity recordings were statistically analyzed to study daytime absorption, day-to-day variations, and absolute magnitudes. Variations

in ionospheric layer heights are accounted for. The distance factors and gyro-frequencies are based on a theoretical absorption height of 100 kilometers. For both day and night hours, the day-to-day variations in hourly median field intensities over a yearly period approximate the Rayleigh distribution. The theoretical peak receiver input voltages agree with yearly peak nighttime observed voltages.

18. HIGHER ORDER APPROXIMATIONS IN IONOSPHERIC WAVE PROPAGATION

J. FEINSTEIN

(National Bureau of Standards, Washington, D. C.)

It is found that the ionosphere is a linear medium for the propagation of electromagnetic waves only as a first approximation. Second-order terms give rise to harmonics, and to sum and difference frequencies when two independent waves transverse the same physical region. These new frequencies are of the nature of forced vibrations; in the case where their propagation characteristics are those of a natural mode of the region, a resonance effect occurs, the new wave increasing its energy at the expense of the interacting waves, and assuming an independent existence. While these effects couple energy from the primary wave, they do not affect its propagation characteristics.

19. IONOSPHERIC WAVE PROPAGATION AT LOW FREQUENCIES

J. FEINSTEIN

(National Bureau of Standards, Washington, D. C.)

The relatively large changes in electron density occurring within a wavelength at low frequencies require that true wave solutions be employed to determine the theoretical behavior of the ionosphere as a reflector of energy in this region. The field equations are set up for a model possessing a linear gradient of electron density; complete solutions are obtained for the case of normal incidence and a general geomagnetic field. Reflection coefficient, virtual height, and polarization characteristics are presented as a function of frequency over a wide range of parametric values of electron density gradient and collision frequency. Deviations from the corresponding results of ray theory are discussed, and a comparison with presently available experimental values is made.

20. ON THE NATURE OF THE LOWER IONOSPHERE

R. A. HELIHWELL, A. J. MALINCKRODT,
AND F. W. KRUSF, JR.

(Stanford University, Stanford, Calif.)

Pulse soundings of the ionosphere at 100 and 325 kc show extensive splitting of the reflected pulses. Examples of the effect are shown. An explanation based solely on magneto-ionic splitting is discussed, but is not considered tenable. A second, more likely, explanation is based on a model of the lower ionosphere involving two or more separate layers, the lower one or ones of which partially reflect and partially trans-

mit the incident energy. Numerous observational data are described, all of which can be explained readily in terms of this model, which is suggested as a basis for planning further experimental and theoretical work.

21. METEORIC ECHO STUDY OF IONOSPHERIC WINDS

L. A. MANNING, O. G. VILLARD, JR., AND
A. M. PETERSON

(Stanford University, Stanford, Calif.)

A method is described for determining the magnitude and direction of winds in the 90- to 110-km height region of the upper atmosphere. The method is based upon measurement of the Doppler shift imparted by the wind drift to reflections from meteoric ionization columns. In the present stage of development one or two hours of observation serve to specify velocities to within perhaps twenty per cent, and direction to better than twenty degrees. Average values of vector wind velocity and of scalar wind speed can be determined independently. Measurements have shown the average winds to be horizontal with velocities of the order of 120 kilometers per hour. Instantaneous wind speeds average several times higher. The most usual direction was south-southwest, with north second.

22. BACK-SCATTER STUDIES

A. M. PETERSON

(Stanford University, Stanford, Calif.)

The mechanism of *F*-layer propagated back-scatter is studied, using sweep frequency techniques. Particular attention is given to scatter in the vicinity of the vertical-incidence critical frequency. Calculations assuming parabolic distribution of ion density in the *F* layer provide time delay versus frequency curves. Very close agreement with experiment is found for the minimal time delay ray if scattering at the ground is assumed. Calculations based upon *E*-layer scattering do not check with experiment. The scatter echoes merge with the vertical-incidence *2F* echoes below the vertical incidence critical-frequency. Above this frequency the scatter delay is less than the *2F* delay. The linear increase in time delay with frequency predicted for a parabolic layer is confirmed by experiment.

Antenna Theory I

23. METHOD OF EVALUATING ANTENNA WAVE FRONTS

K. S. KELLEHLR

(Naval Research Laboratory, Washington, D. C.)

Two problems which arise in microwave antenna design are presented and discussed in this paper. First, the phase distribution across the aperture of a reflector is determined when the incident wave front and the reflector surface are known. Application is made to a conical incident wave front and a parabolic cylinder reflector, as well as to a spherical wave front and spherical reflector. The second problem considers the evaluation of a reflector surface which converts an incident wave front into a desired reflected

wave front. A general expression is obtained for the reflector which converts an arbitrary wave front into a plane.

24. PROGRESS IN THE PHYSICAL OPTICS OF METAL-PLATE MEDIA

B. A. LENGVEL

(Naval Research Laboratory, Washington, D. C.)

Groups working here and in England have considered the problem of wave propagation at the surface of metal-plate media. The theoretical work of Carlson and Heins was generalized to permit calculation of the phase and amplitude of waves reflected from a metal plate structure for the case of multiple beams due to diffraction effects, as well as the case in which propagation within the plates may occur in several modes. Numerical tables and graphs were prepared for the technically most important cases. Experimental work confirms the conclusions of the theory. Present knowledge about metal plate media is fairly complete, except for the effect of plate thickness.

25. WIDE-ANGLE SCANNING ANTENNA RESEARCH AT AFRL

ROY C. SPENCER

(Air Force Cambridge Research Laboratories, Cambridge, Mass.)

Metal Lenses: Both the "normal" and the "binormal" (constrained) type of pillbox lens have been studied, the latter utilizing Counter's two-point correction. Other types include: a variable index of refraction lens; a square-tubing lens for a point source and various types of achromatic lenses. *Reflectors:* Studies have been made on the aberrations of a spherical reflector with point source feed. A corrected (radial) line source has been designed and tested which compensates for the spherical aberration of a spherical reflector. *Geodesic Analogue of the Luneberg Lens:* A double-walled surface of revolution has been designed and built under a contract with Case Institute of Technology. It focuses well over 360° at both *X* and *S* bands.

26. RADIATION FROM CIRCULAR CURRENT SHEETS

W. R. LEPAGE, C. S. ROYS, AND S. SELBY
(Syracuse University, Syracuse, N. Y.)

An analysis is carried out for the three-dimensional radiation pattern of a system of co-planar concentric cylindrical current sheets. The cylinders are of small height, and have elements perpendicular to the plane of the circles. Solutions are available; one is general and the other emphasizes beam formation. A prescribed horizontal pattern can be synthesized by the use of either solution. In one case the pattern is expressed as a Fourier series, and the array reduces to a single circle. In the other case the pattern is expanded in a Bessel-Fourier series, and a system of concentric circles is required. The two methods may be combined to simultaneously synthesize prescribed horizontal and vertical patterns.

27. DIRECTIONAL ANTENNA ARRAYS OF ELEMENTS CIRCULARLY DISPOSED ABOUT A CYLINDRICAL REFLECTOR

W. R. LEPAGE AND R. F. HARRINGTON
(Syracuse University, Syracuse, N. Y.)

A general solution for the circular array is adapted to the case of an idealized array consisting of a circular current sheet, the element patterns of which are modified by a cylindrical reflector. For beam-co-phasal excitation, the solution is obtained as an infinite series of Bessel functions. The results are general, being applicable for any arbitrary radiation pattern of individual elements and tapering of the excitation. These characteristics are incorporated into the solution by the use of Fourier series. An experimental array has been constructed as a survey of patterns made for arrays of various diameters and numbers of elements. Good correlation between theoretical and experimental results is obtained.

plotted in the form of characteristic curves from which the guide wavelength can be found for given guide dimensions and operating wavelengths.

30. VECTOR GREEN'S FUNCTIONS

V. H. RUMSEY
(Ohio State University,
Columbus, Ohio)

A vector Green's Function satisfying the wave equation augmented by a three-dimensional Dirac delta function is considered. There follows a formulation which gives the field at any point in terms of boundary values. Correspondence between this formulation and Schelkunoff's equivalence theorem is shown, as is also the relationship to the double current sheet concept of Smythe. Applications to certain types of diffraction problems are demonstrated.

31. ANTENNAS NEAR CONDUCTING SHEETS OF FINITE SIZE

JOHN T. BOLLJAHN
(Stanford Research Institute,
Stanford, Calif.)

The first phase of the investigation deals with arbitrary antennas in the vicinity of plane conducting surfaces having arbitrary shapes and surface conductivities. Certain general results are obtained by considering a pair of antennas which are mirror images of one another with respect to the plane containing the conducting sheet.

The second phase is concerned with a study of the impedance and radiation patterns of monopole antennas located on perfectly conducting plane disks. The formulation of this problem employs spherical wave solutions in the manner of Schelkunoff's formulation of the biconical antenna problem.

Calculated and experimental results are compared for corresponding disk sizes.

32. ASYMMETRICALLY FED AND DOUBLE-FED ANTENNAS

C. T. TAI
(Stanford Research Institute,
Stanford, Calif.)

A simple theoretical investigation of the impedance of an asymmetrically fed thin, biconical antenna is made based upon the method of symmetrical components and the emf method. The general solution reduces to the well-known result for a center-fed antenna when the two arms are equal. For a half-wave antenna, the result is compatible with that obtained by Synge for a cylindrical antenna, and the one obtained by Flammer for a spheroidal antenna. The mean value formula derived by King is also obtained in a rather simple manner.

Antenna Instrumentation

33. SOME DEVELOPMENTS IN ANTENNA INSTRUMENTATION

V. H. RUMSEY
(Ohio State University, Columbus, Ohio)

A program at the Ohio State University Antenna Laboratory includes: (a) An automatic recorder which plots on the Smith Chart the variation with frequency of the impedance connected to a standard coaxial line. (b) A method for obtaining range discrimination at ranges of about 50 feet, such as is required to select only the desired signal in short range echo measurements. (c) A method of eliminating the insertion loss involved in the conventional piston attenuator technique for recording signal strength in db. (d) An apparatus for measuring the radiation efficiency of elliptically polarized antennas at 3 cm.

34. DESIGN AND APPLICATION OF MICROWAVE NETWORKS FOR BROAD-BAND AUTOMATIC CONTROL SYSTEMS

P. A. PORTMANN
(Naval Research Laboratory,
Washington, D. C.)

Automatic control of microwave equipments, such as impedance plotting instruments, requires the development of rf components whose controlled characteristics are independent of frequency. Such components may be constructed by making use of cross-polarized modes in rotatable sections of circular waveguide containing dielectric plates. The technique has been applied to the construction of: (1) elliptically polarized antenna feeds, (2) rotating joints with two transmission paths, and (3) a reflecting termination of variable phase. The reflecting termination is applied to impedance measurements utilizing reflection coefficient techniques. Phase measurements may thus be made independently of frequency and the measuring position on the line.

35. A LINEAR DETECTOR FOR SIGNALS IN NOISE

R. M. HATCH, JR.
(Stanford Research Institute,
Stanford, Calif.)

A sinusoidal signal below the noise level may be detected by a coherent detector. The desired signal and noise are mixed with sinusoidal signal of the same frequency and of fixed phase relationship in a balanced modulator circuit. The output consists of a dc component linearly proportional to the desired signal, together with a fluctuation which may be reduced by simple RC filters. With a time constant of about one second, a 1,000-cps signal may be detected 20 db below the noise level. An instrument employing this circuit, which is particularly useful in antenna pattern and impedance measurements, is described.

Antenna Theory II

28. RADIATION FROM DIELECTRIC ROD ANTENNAS OF UNIFORM CIRCULAR CROSS SECTION

A. E. MARSTON
(Naval Research Laboratory,
Washington, D. C.)

The inadequacy of simple linear array theory to account for the radiation from dielectric rod antennas of uniform circular cross section has been recognized for some time. To obtain a more comprehensive formulation of the radiation fields of such antennas, the method of assumed fields is employed. For a rod assumed to be excited in a single transmission mode, the contributions to the radiation field from both the side and the end of the rod are obtained in exact closed form valid for all modes. A number of interesting deductions follow from the formulas.

29. DIELECTRIC TUBE WAVEGUIDES

R. E. BEAM, M. M. ASTRAHAN, AND W. C. JAKES, JR.
(Northwestern University, Evanston, Ill.)

The boundary value problem posed by a lossless dielectric tube under propagating conditions is solved for dielectric rod and dielectric tube waveguides. In this treatment a characteristic or conditional equation is derived from field-continuity conditions at the boundaries between the air and dielectric regions. Solutions of this characteristic equation determine waves of the transverse magnetic, or *E* type, the transverse electric, or *H* type, and the hybrid types. Solutions for polystyrene waveguides carrying low order modes of the three types are

36. NEW INSTRUMENTS FOR VHF ANTENNA MEASUREMENTS

DAVID PACKARD
(Hewlett-Packard Company,
Palo Alto, Calif.)

A new signal generator, a direct-reading impedance bridge, and a tunable detector which are particularly useful for antenna measurements in the frequency range from 50 to 500 Mc have recently been developed. Together, these instruments provide rapid and accurate means of measuring antenna impedance. The bridge is direct-reading in magnitude of impedance and angle. Charts are available with impedance and phase angle contours, so the readings from the bridge may be plotted directly. Procedure for making impedance measurements with this new equipment is extremely simple.

37. A REFLECTOMETER FOR HF BAND

O. NORGORDEN
(Naval Research Laboratory,
Washington, D. C.)

The general principles of reflectometer or directional-coupler design at the ultra-high frequencies have been applied to the lower frequencies (2- to 30-Mc band). Theoretical design equations, given for an approximate equivalent circuit of the reflectometer, show that the circuit parameters are independent of the frequency. The sensitivity of the device is approximately proportional to the frequency. Design constants are given for a reflectometer designed for the 4- to 15-Mc band but which has been used over the 2- to 26-Mc band.

38. GENERATION OF VARIABLE FREQUENCY, CONTINUOUSLY ADJUSTABLE ELLIPTIC POLARIZATION IN A WAVE VERMICALLY INCIDENT UPON THE IONOSPHERE

M. G. MORGAN AND C. R. PAULSON
(Dartmouth College, Hanover, N. H.)

Synthesis of elliptic polarization loci with two components in space-quadrate in the horizontal plane was discussed. These components, varying sinusoidally with time, are controlled in amplitude and relative phase so as to produce any polarization desired. A dual-channel pulse-modulated transmitter applies the two components to quadrate-placed delta antennas. The principal feature of uniqueness in the transmitter is the balanced four-phase oscillator which operates at the signal frequency.

Books

N.A.B. Engineering Handbook, Fourth Edition

Published (1949) by National Association of Broadcasters, Washington, D. C. 650 pages +ix pages. 270 figures. 9x11. \$17.50.

This book is intended to take its place among the various radio engineering handbooks on the market today, and is for the purpose of presenting articles of a practical working nature, as well as material which will permit the reader to operate and maintain a broadcast station in a more efficient and economical manner. It has to a creditable degree achieved this purpose, and offers information not completely available in any other one book.

The material in part consists of reprints of articles appearing in various technical magazines, and in part of articles directly written for this handbook. The style and content is therefore variable; one article on "How to Improve Program Pickups" is of a somewhat immature nature, replete with clichés and obvious remarks.

On the other hand, the articles on television taken from RCA are excellent, and certain items are not readily found elsewhere. For example, the reason for the *trailing set* of six equalizing pulses is mentioned in the section on studio equipment, a matter not found in most other texts. The material on deflection circuits is also excellent.

Other articles of particular merit are "Radio Frequency Networks," "Magnetic Recording in Broadcasting," and "Location and Size Considerations of Television Transmitting and Programming Plants." The article on "Theory and Design of Directional Antenna Systems" is also very good, but unfortunately cannot directly supply the engineer with the fundamental information: Given a certain antenna pattern, what number of elements, spacing, current amplitudes and phasing must be used? The explicit

solution to this problem remains to be derived.

While on this matter, the reviewer wishes to note that the foreword to this article seems to stress unduly the author's position in the industry and the nature of the material, and the fact that it is available in a home-study course of college level at such-and-such an address. This appears to be in questionable taste, since none of the other authors received such "billing."

One or two errors were noted. For example, on page 3-1-34 the formula should be

$$\frac{T_o}{RC} = \frac{2}{\lambda} - 2$$

instead of

$$\frac{T_o}{R_c} = \frac{2}{\lambda} - 2,$$

and on page 3-4-02 the word should be "hanging-on" instead of "handing-on."

In general, this handbook is informative and contains useful material that should prove of value to the radio engineer as well as to the broadcast man. It is therefore recommended to the attention of all engineers who are engaged in broadcast and television activities.

ALBERT PREISMAN
Capitol Radio Engineering Institute
3224 16 St., N.W.
Washington 10, D. C.

Electronics: Experimental Techniques by W. C. Elmore and Matthew L. Sands

Published (1949) by McGraw-Hill Book Co., 330 West 42 St., New York 18, N. Y. 410 pages +6-page index +xviii pages, 182 figures. 6x9. \$3.75.

This is one of the first of a projected series of books recording the results of fundamental research carried on during the war in connection with the Manhattan Proj-

ect. Specifically, it deals with general laboratory circuits, methods, and techniques, developed at the Los Alamos laboratories, which come under declassified material and are regarded as of appreciable value to the scientific world in general.

Accordingly, the book is not a conventional laboratory manual for an electronics course, as might be inferred from its title, but it deals, rather, with the production, amplification, reception, and registration of electrical impulses of the order of length of microseconds. Throughout the book, transient, rather than steady-state operation, is in question.

Known circuit elements, such as relaxation oscillators and trigger circuits, are basic to the work and are treated at length in an early chapter. Specific forms of voltage amplifiers for transient signals, and electronic counters are considered in detail and at length. Chapters are also included which deal with oscillographs and associated apparatus, test and calibration equipment, and power supplies.

The reader is assumed to have "a general familiarity with textbook electronics and circuit analysis," but the general reader will find parts of the text rather difficult reading. To workers in the field of nuclear physics, however, and to those whose work lies in radar applications and in the development of modern apparatus for computation, the book offers a wealth of material of great theoretical and practical value and is to be regarded as of fundamental importance.

Its use as an advanced textbook in electronics supposes considerable attention by the teacher to the tying of its material in with the theory gained in the usual conventional course in electronics.

FREDERICK W. GROVER,
Union College,
Schenectady, N. Y.

Abstracts and References

Prepared by the National Physical Laboratory, Teddington, England, Published by Arrangement with the Department of Scientific and Industrial Research, England, and *Wireless Engineer*, London, England

NOTE: The Institute of Radio Engineers does not have available copies of the publications mentioned in these pages, nor does it have reprints of the articles abstracted. Correspondence regarding these articles and requests for their procurement should be addressed to the individual publications, and not to the IRE.

The Annual Index to these Abstracts and References, covering those published in the PROC. I.R.E. from February, 1949, through January, 1950, may be obtained for 2s. 8d. postage included from the *Wireless Engineer*, Dorset House, Stamford St., London S. E., England. This index includes a list of the journals abstracted together with the addresses of their publishers.

Acoustics and Audio Frequencies	963
Antennas and Transmission Lines	964
Circuits and Circuit Elements	964
General Physics	967
Geophysical and Extraterrestrial Phenomena	968
Location and Aids to Navigation	969
Materials and Subsidiary Techniques	969
Mathematics	970
Measurements and Test Gear	970
Other Applications of Radio and Electronics	971
Propagation of Waves	972
Reception	972
Stations and Communication Systems	973
Subsidiary Apparatus	973
Television and Phototelegraphy	973
Tubes and Thermionics	974
Miscellaneous	976

The number in heavy type at the upper left of each Abstract is its Universal Decimal Classification number and is not to be confused with the Decimal Classification used by the United States National Bureau of Standards. The number in heavy type at the top right is the serial number of the Abstract. DC numbers marked with a dagger (†) must be regarded as provisional.

ACOUSTICS AND AUDIO FREQUENCIES

534.212 **1560**
The Propagation of Sound Waves in an Open-Ended Channel—W. Chester. (*Phil. Mag.*, vol. 41, pp. 11-33; January, 1950.) An exact solution is obtained for a harmonic wave propagated in the dominant mode along a channel formed by two semi-infinite parallel plates, and undergoing reflection at the open end of the channel. The reflection and transmission coefficients and the end correction are evaluated. The reflection coefficient is $\exp[-2\pi b/\lambda]$ where $2b$ is the width of the channel and λ is the wavelength. Explicit formulas are also obtained for the change of phase in the returning wave, which is sensibly plane at large distances from the mouth, and for the transmitted energy.

534.232:534.321.9:621.3.087.6 **1561**
Pin-Pointing Ultrasonic Energy—H. J. Dana and J. L. van Meter. (*Electronics*, vol. 23, pp. 84-85; April, 1950.) Article based on 1949 National Electronics Conference paper. A magnetostriction oscillator is described which uses a thin-walled Ni-alloy tube with pointed ends in which fine holes are drilled axially. When excited at the natural frequency of about 20 kc, powerful air jets are expelled from the holes and produce visible changes on chemically treated paper. The ultrasonic energy concentrated in the jets is about 2 w.

534.321.9:534.22-14 **1562**
Velocity of Propagation of Ultrasonic Waves in Liquid Mixtures—D. Sette. (*Ricerca Sci.*, vol. 19, pp. 1338-1379; November and Decem-

ber, 1949.) A detailed review of work done since 1932, with a 16-page appendix tabulating results for a large number of solutions and organic liquid mixtures.

534.522.1.07 **1563**
An Improved Schlieren Apparatus Employing Multiple-Slit Gratings—T. A. Mortensen. (*Rev. Sci. Instr.*, vol. 21, pp. 3-6; January, 1950.) Larger fields are attained with an objective lens of given aperture by substituting gratings for the conventional knife-edge elements. In some cases a greater intensity of image illumination is also obtained.

534.6:621.395.623 **1564**
The Artificial Ear of the Centre National d'Études des Télécommunications—P. Chavasse. (*Compt. Rend. Acad. Sci.* (Paris), vol. 230, pp. 1390-1392; April 12, 1950.) Description of a device simulating the acoustic impedance of a normal human ear, with curves showing the concordance of measurements made with it and corresponding aural observations by 44 different individuals. See also 1058 of June.

534.6:621.395.623 **1565**
Comparison between the Artificial Ears Made by the [British] Post Office and by the Istituto Nazionale di Ultracustica—I. Barducci. (*Ricerca Sci.*, vol. 19, pp. 1312-1316; November and December, 1949.) Results of tests on these ears, using both Italian and British telephone receivers, showed their characteristics to be complementary. A systematic series of such comparisons should provide a basis for standardization.

534.833.4 **1566**
Coefficient of Acoustic Absorption for Materials Made in Italy—M. Nuovo. (*Ricerca Sci.*, vol. 19, pp. 1327-1331; November and December, 1949.) Graphical presentation of results for materials of various types, including those with cork, wood-pulp, vegetable- or mineral-fiber base.

621.395.61 **1567**
The KB-3A High-Fidelity Noise-Cancelling Microphone—L. J. Anderson and L. M. Wigginton. (*Audio Eng.*, vol. 34, pp. 16-17, 32; April, 1950.) A new design, providing improved discrimination against background noise.

621.395.623.7:621.396.621 **1568**
High-Efficiency Loudspeakers for Personal Radio Receivers—Olson, Bleazey, Preston, and Hackley. (See 1760.)

621.395.625.2:534.86 **1569**
Some Problems of Disk Recording for Broadcasting Purposes—F. O. Viol. (*Proc. I.R.E.*, vol. 38, pp. 233-238; March, 1950.) Reprint. See 541 of April.

621.395.625.2:621.395.8 **1570**
Noise Considerations in Sound-Recording Transmission Systems—F. L. Hopper. (*Jour. Soc. Mot. Pic. Eng.*, vol. 54, pp. 129-139; February, 1950.) Discussion of the unwanted noises that may be generated internally in sound-recording systems or introduced from external sources, and of the various methods used to limit the interferences. Rf and af disturbances, crosstalk, thermal noise, shot-effect, microphonics, and ac hum are considered.

621.395.625.3 **1571**
Adjustments for Obtaining Optimum Performance in Magnetic Recording—A. W. Friend. (*RCA Rev.*, vol. 11, pp. 38-54; March, 1950.) Methods of recording are discussed briefly. Using the high-frequency bias method, the harmonic distortion and noise level may be reduced considerably by the addition of dc bias to the recording current. The improved system is discussed at length and the results obtained under optimum operating conditions with a particular recording system are shown in numerous curves.

621.395.625.2 **1572**
Magnetic Recording in Motion Pictures—M. Rettinger. (*Audio Eng.*, vol. 34, pp. 9-12, 35 and 18-20, 43; March and April, 1950.) "The fundamental aspects of magnetic-tape recording, particularly for motion pictures, including a description of magnetic recording, reproducing and erasing head construction, and a discussion of ac biasing, together with experimental results."

621.395.667:621.392.5.012.3 **1573**
Equalizer Design Chart—Boegli. (See 1620.)

621.395.92 **1574**
Miniature Electromagnetic Earpiece for Portable Hearing-Aids—W. Güttner. (*Z. Angew. Phys.*, vol. 2, pp. 76-83; February, 1950.) Fundamental principles of design are discussed and two earpieces are described in which a Helmholtz resonator is coupled (a) behind and (b) in front of the membrane, to give sensitivity in the frequency range required. See also 1335 of July.

621.396.645.029.4 1575
For Golden Ears Only—Marshall. (See 1640.)

621.396.645.029.4 1576
Rauland 1825 High-Fidelity Phono Amplifier—(See 1641.)

681.85 1577
Design and Mounting of Pickup Arms—K. Pfeil. (*Funk. und Ton.*, vol. 4, pp. 140-147; March, 1950.) Study of common faults in alignment, and calculation of distortion produced.

681.85 1578
A Variable-Speed Turntable and Its Use in the Calibration of Disk Reproducing Pickups—H. E. Haynes and H. E. Roys. (Proc. I.R.E., vol. 38, pp. 239-243; March, 1950.) Paper presented at the 1949 National Electronics Conference, Chicago. To overcome the variable effects caused by changes in the physical wavelength of the undulations on the conventional variable-frequency type of test record, a procedure for obtaining the frequency response of a pickup has been devised in which variations of frequency are obtained by using a constant-frequency record on a variable-speed turntable. A suitable turntable is described and results obtained with it are discussed.

534.86 1579
Traité de Prise de Son (Treatise on Sound Pick-Up) [Book Review]—J. Bernhart. Publishers: Editions Eyrolles Paris, 1949, 382 pp., 2950 fr. (*Nature* (London), vol. 165, p. 501; April 1, 1950.) "There is . . . no other text in which can be found the fruits of so varied an experience in all forms of sound pick-up, covering as it does auditorium and studio acoustics, broadcasting, the film, directive properties of typical microphones, and stereophonic reproduction."

ANTENNAS AND TRANSMISSION LINES

621.315+621.396.67].011.2 1580
Input Impedance of a Two-Wire Open Line and Center-Driven Cylindrical Antenna—T. W. Winternitz. (Proc. I.R.E., vol. 38, pp. 299-300; March, 1950.) "Using potential theory, a method of analysis of the input impedance of a transmission line terminated by a cylindrical antenna is described. The results of application of this method to a particular configuration of line and antenna are presented."

621.315.212:621.397.5 1581
A Multicore Television Camera Cable—(*Engineer* (London), vol. 189, pp. 132-133; January 27, 1950.) A flexible cable of twenty-two conductors performing fourteen different functions. Balanced screened twin units for video and other circuits are spaced in a six-plus-one arrangement around the central starquad unit which carries the mains and the frame-scan currents. Six single wires are laid in the grooves between the six twins. All the units are solidly insulated. Over-all diameter is 0.85 in.

621.392.26† 1582
Waveguides [operating] beyond the Cut-Off Frequency: Application to Piston Attenuators—In the journal reference of 813 of May please read vol. 30 for vol. 29.

621.392.43 1583
Improvement of the Transformation Properties of the Exponential Line by Compensation Arrangements—A. Ruhrmann. (*Arch. Elec. (Übertragung)*, vol. 4, pp. 23-31; January, 1950.) A paper prepared for publication in 1943. By connecting series capacitors and shunt inductors and resistors of suitable values at the high-impedance and low-impedance

ends of an exponential line, satisfactory operation is obtained over a much wider frequency band. Three arrangements are described, giving progressively better compensation. The high-pass network equivalent of an exponential line with compensation circuits is discussed. See also 672 of 1948 (Zinke).

621.396.67 1584
On the Effective Length of a Linear Transmitting Antenna—C. J. Bouwkamp. (*Philips Res. Rep.*, vol. 4, pp. 179-188; June, 1949.) King's definition of effective length of a cylindrical center-driven antenna with a sine distribution of current is consistent with a new general extension for any distribution of antenna current. As an example, results for a top-loaded antenna are given in tables and diagrams.

621.396.67 1585
The Theory of N Coupled Parallel Antennas—R. King. (*Jour. Appl. Phys.*, vol. 21, pp. 94-103; February, 1950.) The integral-equation theory of coupled antennas developed by King and Harrison (3474 of 1944), Tai (2450 of 1948), and Bouwkamp (960 of 1949) is generalized to apply to any number of units arranged symmetrically in a circle. The case of four antennas at the corners of a square is discussed in detail. Application to cage and corner-reflector antennas is indicated. The driving voltages required to maintain specific currents in N parallel antennas arranged in line are determined; the currents corresponding to specified voltages can only be found by solving simultaneous integral equations, but an approximate analysis is given for the special case of $\lambda/2$ dipoles.

621.396.67 1586
Aerials Protected from Effects of Local Fields—G. Gällner. (*Arch. Elec. (Übertragung)*, vol. 4, pp. 71-75; February, 1950.) Two compensation arrangements are described which greatly reduce the interference from electrical machines or other possible sources of rf radiation near a receiving antenna.

621.396.67:621.317.74.029.64 1587
A New Type of Slotted Line Section—W. B. Wholey and W. N. Eldred. (Proc. I.R.E., vol. 38, pp. 244-248; March, 1950.) Full paper. Summary abstracted in 2716 of 1949.

621.396.67:621.392.26† 1588
The External Field Produced by a Slot in an Infinite Circular Cylinder—S. Silver and W. K. Saunders. (*Jour. Appl. Phys.*, vol. 21, pp. 153-158; February, 1950.) "Expressions are derived for the external field produced by a slot of arbitrary shape in the wall of a circular wave guide (of infinite extent and infinite conductivity), the tangential components of the electric field in the slot being assumed to have been prescribed. This is accomplished by matching a Fourier representation of the external field, built up by superposition of basic sets of cylindrical waves, to a Fourier expansion of the prescribed field over the surface of the cylindrical wave guide. The far-zone field is obtained by applying the method of steepest descent to the Fourier integrals that constitute the coefficients in the expansion for the external field. The results satisfy the radiation conditions for far-zone fields."

621.396.67:621.392.26† 1589
Radiation from a Transverse Slot in an Infinite Cylinder—C. H. Papas. (*Jour. Math. Phys.*, vol. 28, pp. 227-236; January, 1950.) An expression is obtained for the radiation assuming the electric field to be parallel to the slot width and its distribution along the slot to be that of the incident dominant mode. A

graphical example is given of the azimuthal distribution of the field radiated from a narrow slot of length $\lambda/2$ with a cosine distribution of the electric field along it.

621.396.67:621.392.26† 1590
The Radiation Characteristics of Conical Horn Antennas—A. P. King. (Proc. I.R.E., vol. 38, pp. 249-251; March, 1950.) Measurements at wavelengths of 3 cm and 10 cm of the radiation characteristics of conical horns with waveguide excitation are in good agreement with theoretical results for absolute gain. The variations of gain and effective area with dimensions are given and also a diagram for use in plotting the radiation characteristic for conical horns of optimum design.

621.396.67:629.13 1591
Shunt-Excited Flat-Plate Antennas with Applications to Aircraft Structures—J. V. N. Granger. (Proc. I.R.E., vol. 38, pp. 280-287; March, 1950.) 1949 IRE National Convention paper. Impedance/frequency characteristics of various shunt-fed plates are given, and the effect of varying the tapping point is shown. Operation is explained as an extension of folded dipole theory. Making the shunt-feed conductor part of the leading edge of the wing is suggested as aerodynamically sound. Impedance measurements on such an arrangement for 3-14 Mc and 90-160 Mc are given.

621.396.671 1592
Gain of Aerial Systems—J. Brown. (*Wireless Eng.*, vol. 27, pp. 132-133; April, 1950.) Further discussion. See 287 of March and 820 of May (Bell).

CIRCUITS AND CIRCUIT ELEMENTS

621.3.016.35 1593
When is Nyquist's Stability Criterion Valid?—J. Peters. (*Arch. Elec. (Übertragung)*, vol. 4, pp. 17-22; January, 1950.) A general criterion of stability is derived from consideration of matrix theory for active networks. Nyquist's criterion is found to agree with this general criterion only in the very important special case of no multiple negative feedback.

621.3.078 1594
The Design of Control Circuits with the Aid of Circle Diagrams—W. Oppelt. (*Arch. Elec. (Übertragung)*, vol. 4, pp. 11-16; January, 1950.)

621.314.2 1595
Practical Aspects of the Design of Intermediate-Frequency Transformers—C. E. S. Ridgers. (*Jour. Brit. I.R.E.*, vol. 10, pp. 97-124; March, 1950.) The various factors involved are analyzed and practical design equations are developed. Single- and double-tuned transformers and five different methods of coupling are considered. Comparisons are made between the calculated and observed performance of a particular design. Notes are included on two unconventional designs.

621.314.3† 1596
Transconductors and their Application—L. F. Borg. (*Elec. Times*, vol. 117, pp. 269-273; February 23, 1950.) Fundamental considerations for the design of transconductors are discussed and their properties examined. Suitable applications of these devices as magnetic amplifiers, rectifier controllers, and voltage regulators for alternators are described and illustrated by circuit diagrams.

621.314.3† 1597
Fundamentals of a Theory of the Magnetic Amplifier—W. Schilling. (*Electrotech. Z.*, vol. 71, pp. 7-13; January 6, 1950.)

- 621.314.3† 1598
The Magnetic Amplifier—R. Reinberg. *Wireless Eng.*, vol. 27, pp. 118–124; April, 1950.) “The transducer control characteristics determined by the shape of the magnetization curve of the transducer core and by the ratio between the peak value of alternating magnetic-flux density and the value of magnetic-flux density at the knee of the magnetization curve. The control characteristic has an optimum form in regard to range of linear control, low initial load current and absence of backlash of control at zero control current if the magnetization curve has a sharp bend at the knee and a high value of initial permeability, and when the peak value of alternating magnetic-flux density equals the value of magnetic-flux density at the knee of the magnetization curve.”
- 521.314.3† 1599
Magnetic Amplifiers—(*Elec. Times*, vol. 117, pp. 417–419; March 16, 1950.) Summaries of and discussion on the following papers presented at an Institution of Electrical Engineers meeting: **A New Theory of the Magnetic Amplifier**—A. G. Milnes. **The Fundamental Limitations of the Second-Harmonic Type of Magnetic Modulator as Applied to the Amplification of Small D.C. Signals**—F. C. Williams and S. W. Noble.
- 621.316.729:621.396.615 1600
Theory of Synchronization by Phase Control—E. Labin. (*Philips Res. Rep.*, vol. 4, pp. 291–315; August, 1949. In French.) A method is described for synchronizing a self-oscillator with a pilot frequency, the oscillator frequency being governed by a control voltage applied to a reactance tube. This control voltage is derived from a mixing stage in which the phases of oscillator and pilot are compared. The method is first considered for the case where both oscillations are sinusoidal and then extended to the case where one of the two oscillations is pulsed, as in the I.G.O. system (Impulse-Governed Oscillator). Experimental results showing the practical possibilities of the method are discussed.
- 621.016.8:621.396.822 1601
Dimensions and Noise of Resistors—A. Hettich. (*Frequenz*, vol. 4, pp. 14–25; January, 1950.) A distinction is drawn between spontaneous and current-excited noise, both types being thermal in origin, and a formula is derived for the latter in terms of the resistor length and cross section. The constant in the expression is the “specific noise coefficient” of the material. Increasing the dimensions of a resistor of fixed value while retaining geometric similarity reduces the current-excited noise. The two classes of noise may correspond respectively with longitudinal and transverse components of electron motion.
- 621.318.572 1602
New Application of Electronic Switches for Cathode-Ray Oscillographs—P. Harmegnies. (*IIF* (Brussels), no. 5, pp. 117–124; 1950.) The principles of electronic switching by grid-controlled thyratrons are discussed, by which means any number of phenomena may be viewed simultaneously on a cro. Such a circuit may be applied in representing different phenomena as functions of another variant, e.g., anode voltage, the co-ordinate axes appearing on the cro screen at the same time. An auxiliary device causes a marker trace to appear on the curve displayed. A uniform phase displacement of the synchronizing pulse moves this trace slowly along the curve so that it indicates the direction in which the curve is traced. A circuit is shown.
- 621.318.572 1603
An Automatically Synchronized Electronic Switch—W. A. Budlong and B. C. Lutz. (*Rev. Sci. Instr.*, vol. 21, pp. 167–168; February, 1950.) Square waves, 180° out of phase, are synchronized with either of two input signals and are used to cut off the respective signal amplifiers alternately. Operation is satisfactory from 25 to 15,000 cps with any input over 1.5 v.
- 621.392 1604
A Note on the Synthesis of Electric Networks According to Prescribed Transient Response—M. Nadler. (*Proc. I.R.E.*, vol. 38, p. 441; April, 1950.) A contribution to the solution of the problem of designing coupling networks for tube amplifiers to give a required response to a step function. The effect of the anode capacitance of the tubes is to impose restrictions on the shape of the transient waveform if a realizable coupling network is to result. These restrictions are given in mathematical form. See also 2461 of 1949 and 3104, 3360 of 1949 (Aigrain and Williams).
- 621.392 1605
The Synthesis of Resistor-Capacitor Networks—J. L. Bower and P. F. Ordnung. (*Proc. I.R.E.*, vol. 38, pp. 263–269; March, 1950.) 1949 IRE National Convention paper. A general method is described for deriving the balanced lattice with a prescribed output/input voltage ratio and with either unloaded output or a resistor-capacitor load. Methods of transformation to an unbalanced structure are outlined.
- 621.392 1606
A General Review of Linear Varying Parameter and Nonlinear Circuit Analysis—W. R. Bennett. (*Proc. I.R.E.*, vol. 38, pp. 259–263; March, 1950.) 1949 IRE National Convention paper. Variable and nonlinear systems are classified from the standpoint of their significance in communication problems. Methods of solution are reviewed and 41 relevant references are given.
- 621.392 1607
New Time Constants for the Study of Linear Electrical Lumped-Constant Circuits—L. de Luca. (*Poste e Telecomunicazioni*, vol. 17, pp. 621–629; December, 1949.) Two new time constants are defined: (a) the time constant of integration T_i , given by Q/I_0 , where Q and I_0 refer to the transient current, and (b) the time constant of differentiation τ_0 , given by $-\mathfrak{J}_0/\mathfrak{J}_0'$, where \mathfrak{J}_0 and \mathfrak{J}_0' are the initial complex current and its initial differential respectively. These are applied to the symbolic and characteristic equations of LCR circuits, and expressions for the current and charge at various time intervals are developed. Various examples are explained.
- 621.392 1608
Direct Measurement of Bandwidth—C. R. Ammerman. (*Elec. Eng.*, vol. 69, pp. 207–212; March, 1950.) The equivalent bandwidth of a network is defined as $f_2 - f_1 - \int_{f_1}^{f_2} (A_f^2 / A_0^2) df$, where A_f is the amplification of the network, a function of frequency, and A_0 is the maximum value of A_0 . The bandwidth may be found directly by comparing the network under test with a standard network. A noise voltage is applied to the two networks and the two output voltages are measured, from which the required bandwidth is obtained in terms of the ratio of the maximum output voltages of the two networks at their respective resonance frequencies, with input voltage constant, and the known bandwidth of the standard. The equipment is described and practical details of the method are given, with typical experimental results.
- 621.392.001.11 1609
Remarks on the Basis of Network Theory—R. M. Redheffer. (*Jour. Math. Phys.*, vol. 28, pp. 237–258; January, 1950.) Discussion of certain general theorems relative to transmission and reflection in transmission lines and networks.
- 621.392.001.11:621.3.015.3 1610
Applications of Network Theorems in Transient Analysis—Y. P. Yu. (*Jour. Frank. Inst.*, vol. 248, pp. 381–398; November, 1949.) An account of the application of selected theorems (Thévenin's, equivalent current-generator, compensation, and superposition) to the simplification of the solution of problems involving transients in electrical networks. In each case examples illustrating the method are given.
- 621.392.26†:621.396.611.39 1611
A Note on Coaxial Bethe Hole Directional Couplers—E. L. Ginzton and P. S. Goodwin. (*Proc. I.R.E.*, vol. 38, pp. 305–309; March, 1950.) Perfect directivity is theoretically obtainable at any wavelength if the diameter of the coupling hole is small compared with $\lambda/8$, but with such small holes the coupling is too weak for many applications. Increasing the coupling by enlarging the hole affects both SWR and directivity, but these can be restored to their proper values over a large frequency range by neutralizing the series inductance caused by the hole by means of added lumped capacitance.
- 621.392.43 1612
A Broadband Transition from Coaxial Line to Helix—C. O. Lund. (*RCA Rev.*, vol. 11, pp. 133–142; March, 1950.) The transition section is a cylindrical conductor with a helical slot of pitch varying from infinity to that of the helical line, with a coaxial cylindrical outer conductor. An approximate theory for the section is outlined, based on an impedance concept for helical lines and the theory of tapered transmission lines. Transitions of reasonable length can be constructed with a voltage SWR < 1.5 over a very wide band.
- 621.392.43 1613
The Wide-Band Problem in Decimetre-Wave Technique—H. H. Meinke. (*Electrotechnik* (Berlin), vol. 2, pp. 137–142; May, 1948.) Discussion of methods of compensating reactive elements to obtain minimum frequency dependence in the case of coupling circuits and wide-band antennas. Different circuit arrangements and various types of wide-band transformer are described.
- 621.392.43 1614
Impedance-Matching Networks—R. O. Rowlands. (*Wireless Eng.*, vol. 27, pp. 113–118; April, 1950.) “A method is described of designing a four-terminal network whose image impedance at one pair of terminals is a constant resistance and at the other pair of terminals a complex quantity varying with frequency.”
- 621.392.5 1615
Dissipative Quadripoles with Dual Iterative Impedance—R. Possenti. (*Poste e Telecomunicazioni*, vol. 17, pp. 225–230; April, 1949.) In certain cases a quadripole may have two physically realizable iterative impedances, only one of which is a pure reactance.
- 621.392.5 1616
Quadripoles—M. Leroy. (*Bull. Soc. Franç. Elec.*, vol. 10, pp. 128–134; March, 1950.) Discussion of the problem of the synthesis of 4-terminal networks. An alternative method to that of Gewertz (1934 Abstracts, p. 514) is suggested.

- 621.392.5 1617
Frequency Analysis of Variable Networks—L. A. Zadeh. (Proc. I.R.E., vol. 38, pp. 291-299; March, 1950.) 1949 IRE West Coast Convention paper. An approach to the analysis of linear networks with time-dependent impedance parameters is made by a frequency-domain technique in which a transfer factor or system function, which is a function of time, is used as in the analysis of nonvariable networks. Two methods of deriving the system function are considered, the first based on Schelkunoff's wave-perturbation method and the second, a much simpler method, for use with slowly-varying parameters only. The two methods are applied to a low-pass bandwidth-modulated RC half-section, the same result being obtained in both cases for conditions in which the second method is applicable.
- 621.392.5 1618
Investigation of the Effect of Resistive Damping on the Phase Shift in Lattice Networks—W. Taeger. (Funk. und Ton., vol. 4, pp. 107-118 and 193-198; March and April, 1950.) Damping factor (λ) and phase constant are calculated for networks with small and with large losses. A phase change only occurs in the pass-band when ohmic resistance may be neglected, and in the suppression band when circuit elements are lossy. Small resistive damping, up to $\lambda=0.1$, has only slight effect on the phase shift in a simple lattice network, but where L and C appear together in one of the branches slight damping alters the characteristics considerably.
- 621.392.5 1619
Attenuation and Delay Equalizers—W. R. Lundry. (Elec. Eng., vol. 69, p. 216; March, 1950.) Summary of AIEE Fall Meeting paper, 1949, discussing equalizers for coaxial lines such as those of the New York/Chicago television circuit. Since such long lines may require about 30 equalizers, manufacturing tolerances must necessarily be small, and provision must be made for individual adjustments of inductance and transmission loss.
- 621.392.5.012.3:621.395.667 1620
Equalizer Design Chart—C. P. Boegli. (Electronics, vol. 23, p. 114; April, 1950.) Bass and treble attenuation or accentuation of two types of RC equalizers are easily determined and curves thus obtained resemble those obtained by more exact computation.
- 621.392.5.018.1:621.396.615 1621
The Design of RC Oscillator Phase-Shifting Networks—T. S. Dutton and W. R. Hinton. (Electronic Eng., vol. 22, pp. 162-164; April, 1950.) Comment on 840 of May and author's reply.
- 621.392.52 1622
Admittance and Transfer Function for an n -Mesh RC Filter Network—E. W. Tschudi. (Proc. I.R.E., vol. 38, pp. 309-310; March, 1950.) The coefficients in the admittance and transfer functions of an n -mesh low-pass filter are exactly calculated as functions of n . If these functions are true for a particular value of n , they are also true for the value $(n+1)$ and also when $n=1$.
- 621.392.52.092 1623
Phase-Shift Calculation—W. Saraga and J. Freeman. (Wireless Eng., vol. 27, pp. 32-33; January, 1950.) Discussion of various simple methods of deriving an approximation to the curve showing the image phase-shift coefficient of a multi-section filter as a function of frequency.
- 621.392.52.092 1624
Phase-Shift Calculation—N. O. Johannes-

son. (Wireless Eng., vol. 27, p. 133; April, 1950.) A more exact method of calculation than that described by Saraga and Freeman (1623 above), for the particular case where all minima in the image attenuation are equal to one another. Simple formulas give easier calculation with little loss of accuracy.

- 621.396.611.3 1625
Resonant Frequencies and Characteristics of a Resonant Coupled Circuit—C. L. Cuccia. (RCA Rev., vol. 11, pp. 121-132; March, 1950.) The characteristics are derived and charted so that they may be used in predicting the performance of uhf tubes using an external resonant circuit for tuning, FM, and control.
- 621.396.611.4:537.533:621.396.619 1626
Interaction of a Spiral Electron Beam and a Resonant Microwave Cavity—F. K. Willenbrock and S. P. Cooke. (Jour. Appl. Phys., vol. 21, pp. 114-125; February, 1950.) The particular cavity considered here is of the cylindrical TE_{11} type in a steady axial magnetic field. If the cavity is excited in a linearly polarized mode, the electromagnetic field will drive the electrons in a helical trajectory with an expanding radius, and the electrons will excite and transfer energy to a degenerate mode oriented spatially at right angles to the driving field. In the driving plane of polarization (both planes of polarization if the cavity is excited in a circularly polarized mode), the electron beam will excite a field in phase opposition to the driving field in a manner analogous to the counter emf in an electromechanical generator. The converse case of a TE_{11} cavity excited by a spiral beam of electrons is also considered. Possible applications in microwave generators and modulators are mentioned.
- 621.396.615 1627
High-Stability Oscillator—G. G. Gouriet. (Wireless Eng., vol. 27, pp. 105-112; April, 1950.) The factors governing frequency stability are analyzed and a general expression for the stability of a series-resonant circuit is derived. The practical arrangement discussed is essentially a Colpitts oscillator in which a series LC circuit is substituted for the tuning inductance. Performance figures are given for the circuit used for many years as a variable-frequency driver for B.B.C. sw transmitters. See also 2193 of 1948 (Clapp).
- 621.396.615 1628
Phase-Shift Oscillator—W. C. Vaughan. (Wireless Eng., vol. 27, p. 129; April, 1950.) Corrections to paper abstracted in 324 of March.
- 621.396.615:621.396.611.21 1629
A High-Stability Quartz Oscillator—In the journal reference of 1107 of June please read vol. 30 for vol. 29.
- 621.396.615.11 1630
Frequency Stability and Parasitic Oscillations in a Bridge-Stabilized Low-Frequency Oscillator—H. Matthes. (Frequenz, vol. 4, pp. 1-10 and 41-50; January and February, 1950.) Circle diagrams of the loop amplification are used to study methods of suppressing unwanted oscillations in Meacham's oscillator (3717 of 1938 and 263 of 1939), which incorporates an amplitude-limiting bridge circuit and combined feedback. Variations of the transformer tuning, imperfect phasing of feedback circuits, and peculiarities of tube characteristics can cause spurious oscillations. Formulas are derived for calculating these effects. Suppression of oscillations above the nominal frequency (1 kc in the case considered) may lead to lower-frequency disturbance if the bypass capacitances are too small. Bridge-stabilized oscillators with only one transformer may

be somewhat more convenient; the design of wide-band circuits for this case is considered.

- 621.396.615.17 1631
The Miller Circuit as a Low-Speed Precision Integrator—I. A. D. Lewis. (Electronic Eng., vol. 22, p. 141; April, 1950.) Corrections to paper abstracted in 1111 of June.
- 621.396.619.23 1632
Balanced Rectifier Modulators Without Transformers—D. G. Tucker. (Electronic Eng., vol. 22, pp. 139-141; April, 1950.) Two types of modulator are described, a shunt and a series type. An approximate mathematical analysis of their performance is given and a note on the carrier (or switching) circuit is included.
- 621.396.619.23 1633
Non-Linear Effects in Rectifier Modulators—V. Belevitch. (Wireless Eng., vol. 27, pp. 130-131; April, 1950.) A more detailed analysis, taking account of the finite conductances of the rectifiers and the finite carrier-source resistance. The results of the analysis are outlined for (a) a ring modulator, (b) a Cowan modulator with an auxiliary rectifier connected in opposite polarity, and (c) a single Cowan modulator. See also 2184 of 1949 and 1552 of July (Tucker and Jeynes).
- 621.396.621.54:621.396.622.6 1634
On Mixing with Detectors—A. Klemt. (Frequenz, vol. 4, pp. 50-54; February, 1950.) Discussion of general design principles of hf mixer circuits. In crystal detectors, if the back resistance is large enough, the same relations hold as for diodes having the same slope. This back resistance should not fall below about 30 k Ω for mixing with the oscillator fundamental, or below about 100 k Ω for mixing with the 2nd or 3rd harmonics. Maximum amplification in the mixer stage occurs for an oscillator voltage of 1-2 v. Circuit arrangements for measurement of amplification, resistance, and equivalent noise resistance are shown.
- 621.396.645 1635
On the Theory of Semi-Distributed Amplifiers—J. L. Steinberg. (Onde Elec., vol. 30, pp. 121-127; March, 1950.) For the same bandwidth the classical feedback amplifier requires fewer tubes, but the distributed amplifier has a much lower noise factor. For a given bandwidth the noise factor of a distributed unit with n identical tubes decreases as n is increased, but approaches a limit when $n=6$. The semi-distributed amplifier described consists of a low-pass distributed input stage followed by a cascade mf amplifier. With such an amplifier it is possible to construct uhf radiation meters whose performance is comparable with that of optical pyrometers.
- 621.396.645 1636
Transmission Factor of Differential Amplifiers—D. H. Parnum. (Wireless Eng., vol. 27, pp. 125-129; April, 1950.) A cathode-coupled input stage is used to illustrate the theory. The effect of an anti-phase signal applied between the two grids of the stage cancels in the common cathode resistor and output at full gain is obtained between the anodes. An interfering in-phase signal applied between earth and the two grids in common produces negative feedback, which cuts the in-phase output; but if the halves of the stage are not identical there will be an anti-phase output from this input. The ratio, anti-phase gain/in-phase gain, is thus insufficient to define performance; a knowledge of the "transmission factor," defined as the ratio of (a) anti-phase gain due to anti-phase input, to (b) anti-phase gain due to in-phase input, is also required. A method

controlling the value of this factor is examined and recommendations are made for the sign of a successful amplifier. See also 680 1948 (Johnston).

1.396.645:539.16.08 1637
Noise in Ionization-Chamber Pulse Amplifiers—R. Wilson. (*Phil. Mag.*, vol. 41, pp. 76; January, 1950.) The general problem of detection of heavy ionizing particles in the presence of λ radiation and amplifier back-ground noise is considered. The dependence of signal-to-noise ratio on the shape of the initial current pulse is discussed. For optimum signal-to-noise ratio the pulse should have a certain exponential form. A circuit suitable for the production of such pulses is described.

1.396.645:681.142 1638
Analog Computers for Servo Problems—C. Donald. (See 1715.)

1.396.645.012.3 1639
Graphical Methods for the Study of Cathode-Follower Circuits—G. Salmel. (*Onde Elec.*, vol. 30, pp. 128-139; March, 1950.) Cathode-voltage/cathode-current characteristics analogous to those for anode loading afford means of rapid determination of optimum conditions for cathode-follower operation. Secondary phenomena such as those caused by an unbalanced input can also be treated by this method, which applies equally for complex loads, as in the case of a video-frequency amplifier with a very large pass-band.

1.396.645 1640
The Amplification of Very-Low-Frequency Electric Currents—G. Lehmann. (*Onde Elec.*, vol. 30, pp. 169-177; April, 1950.) Review of different methods.

1.396.645.029.4 1641
For Golden Ears Only—J. Marshall. (*Audio Eng.*, vol. 34, pp. 13-15, 33; April, 1950.) Description of a high-fidelity audio amplifier, including circuit diagram and component values. All components are standard commercial types. The circuit consists of a single-ended input stage transformer-coupled to a push-pull triode driver stage, again transformer-coupled to a push-pull triode output stage. Feedback is applied to each stage. The amplifier is capable of delivering 10 w over the range 20-20,000 cps with less than 1 per cent distortion. Below 8 w the distortion is too low to be measured accurately. Intermodulation distortion is approximately 1 per cent at 10 w and 2 per cent at 15 w.

1.396.645.029.4 1642
Rauland 1825 High-Fidelity Phono Amplifier—(*Audio Eng.*, vol. 34, p. 25; April, 1950.) Includes a preamplifier which may be attached to the main amplifier or mounted separately.

1.396.645.029.4 1643
Selective RC Audio-Frequency Amplifier—C. Feher and G. Kurtze. (*Frequenz*, vol. 4, p. 72-76; March, 1950.) Selectivity is achieved by use of a feedback circuit comprising a Wien-Robinson bridge, tuning being accomplished by adjustment of R and C in the ridge arms. In an amplifier illustrated, the frequency range is 25 cps to 30 kc and amplification about 5×10^3 . The bridge circuit may be switched out for wide-band operation with the same amplification.

1.396.645.029.4 1644
Audio-Frequency Selective Amplifiers—S. V. Punnett. (*Jour. Brit. I.R.E.*, vol. 10, pp. 9-59; February, 1950.) Three types of frequency-discriminator feedback circuit are considered, the simple RC series-parallel arrangement, the twin-T network and the

Wien bridge. The analysis covers the effective Q, bandwidth, gain variations and stability as functions of frequency. When constancy of the Q-factor of an amplifier is of primary importance, the twin-T network should be used, but it has the disadvantage of requiring variation of three components, which must be accurately ganged. When some variation of Q is permissible, the simple circuit with only two variable elements is preferable, being both cheaper and easier to align.

621.396.645.029.4/.52:621.396.822 1645
Selective Amplification at Low Frequencies—In the journal reference of 1120 of June please read vol. 30 for vol. 29.

621.396.645.37 1646
On the Power Gain and the Bandwidth of Feedback Amplifier Stages—A. van der Ziel and K. S. Knol. (*Philips Res. Rep.*, vol. 4, pp. 168-178; June, 1949.) The effects of feedback on the power gain g and bandwidth B of an amplifier stage are treated theoretically. When the stability limit is reached for a given feedback value, g remains finite and for correct output coupling can only have very high values when B is very small. Application of the formulas to a grounded-grid triode stage indicates that small output losses can give a large decrease of g . Values of Bg are plotted against g for various values of feedback capacitance and output losses.

621.396.813 1647
The Nonlinearity of Valve Circuits Due to the Voltage-Dependence of Valve Input Capacitance—F. Feil. (*Arch. Elec. Übertragung*, vol. 4, pp. 65-70; February, 1950.) In consequence of the space-charge effect, the input capacitance of a tube, and hence the impedance of the tube circuit, varies with the alternations of the applied voltage. In a screen-grid tube with a slope of 10 ma/v the capacitance variation may be 0.5 to 1 pF per 1 v change at the grid. Calculated values of the nonlinear distortion agree with those measured.

634.01+538.56 1648
Theory of Oscillations [Book Review]—A. A. Andronov and C. E. Chaikin. Publishers: Princeton University Press, Princeton, N. J., 1949, 336 pp., \$6.00. (*Proc. I.R.E.*, vol. 38, p. 449; April, 1950.) Published originally in Russia in 1937, and now appearing as an edited translation by a group at Princeton University. A presentation of "the basic mathematics relating to the theory of nonlinear oscillatory systems." The book is recommended to all those who are interested in learning more about the analysis of such systems and the differential equations that describe them.

621.3.015.3 1649
Transients in Linear Electrical Systems [Book Review]—K. A. Krug. Publisher: Gosenergoizdat, Moscow, 1948, 344 pp., 19 roubles. (*Bull. Acad. Sci. (URSS)*, no. 11, pp. 1741-1744; November, 1949. In Russian.)

621.392 1650
Communication Circuits [Book Review]—L. A. Ware and H. R. Reed. Publishers: J. Wiley and Sons, New York, 1949, 396 pp., \$5.00. (*Proc. I.R.E.*, vol. 38, p. 449; April, 1950.) "A very good book intended as first-course material for all students of communication engineering, regardless of the frequency range with which they will be concerned. The material is limited to lumped networks and transmission lines. No active circuits are included. For the field covered, the choice of material is good."

621.392.52 1651
Einführung in die Siebschaltungstheorie

der elektrischen Nachrichtentechnik (Introduction to the Theory of Filter Circuits for Electrical Communications) [Book Review]—R. Feldtkeller. Publishers: S. Hirzel Verlag, Stuttgart, 160 pp., 12 DM. (*Wireless Eng.*, vol. 27, p. 134; April, 1950.) This volume does not deal with high frequencies, which are treated in the author's *Theorie der Rundfunksieb-schaltungen* (584 of 1946). "The treatment throughout is very thorough and the book is undoubtedly a valuable addition to the literature of the subject."

621.396 1652
Electron-Tube Circuits [Book Review]—S. Seely. Publishers: McGraw-Hill Book Co., New York, 529 pp., \$6.00. (*Radio and Telev. News, Radio-Electronic Eng. Supplement*, vol. 14, p. 28; April, 1950.) "This college text is the outgrowth of several courses organized by the author on electron-tube circuits and applications that covered many of the important circuits in use during the second world war. Circuits for performing mathematical operations and those developed in connection with radar applications are discussed in greater detail than in most textbooks of today."

GENERAL PHYSICS

53.081+537.712 1653
Proposals and Recommendations Concerning the Definitions and Units of Electromagnetic Quantities—P. Cornelius. (*Philips Res. Rep.*, vol. 4, pp. 232-237; June, 1949.) A set of definitions of em quantities and the corresponding units which follow the adoption of the rationalized Giorgi system, with suggestions that may be useful in the transfer from one of the older cgs systems. See also 867 of May (Cornelius and Hamaker).

534.26+535.42 1654
On Certain Integral Equations in Diffraction Theory—J. W. Miles. (*Jour. Math. Phys.*, vol. 28, pp. 223-226; January, 1950.) For diffraction of a plane wave by an infinite slit, the integral equation defining the field in the slit is given, with solution, and also its Fourier transform and solution. Corresponding equations are obtained for diffraction by a ribbon. These results lead to useful integral relations between the Mathieu functions.

535.8 1655
On the Aberrations of the Field-Flattened Schmidt Camera—E. H. Linfoot and P. A. Wayman. (*Mon. Not. R. Astr. Soc.*, vol. 109, pp. 535-556; 1949.) A general aberration theory is developed and applied to a comparison of the optical performances of the field-flattened and the plain Schmidt cameras in a typical special case.

537.226.2:546.431.82 1656
Dielectric Constants and Polarizabilities of Ions in Simple Crystals and Barium Titanate—S. Roberts. (*Phys. Rev.*, vol. 76, pp. 1215-1220; October 15, 1949.)

537.52 1657
Plasma and the Langmuir Layer: On the Theory of Electrical Probes in Gas Discharges—F. Wenzl. (*Z. Angew. Phys.*, vol. 2, pp. 59-75; February, 1950.)

537.533:538.569:621.396.822 1658
Fluctuation Phenomena Arising in the Quantum Interaction of Electrons with High-Frequency Fields—D. K. C. MacDonald and R. Kompfner. (*Proc. I.R.E.*, vol. 38, p. 304; March, 1950.) Correction to 603 of April.

538.114 1659
Theory of Magnetic After-Effect for Massive Materials in the Rayleigh Domain—L. Néel. (*Jour. Phys. Radium*, vol. 11, pp. 49-61;

February, 1950.) Extension to massive materials of theory previously given for fine-grain materials. See also 3151 and 3152 of 1947, 2782 and 3159 of 1949.

538.221 1660
Laws Relating to Magnetic After-Effect—L. Lliboutry. (*Compt. Rend. Acad. Sci. (Paris)*, vol. 230, pp. 1042-1044; March 13, 1950.) In weak fields, the after-effect resulting from a variation of the magnetic field may be measured by applying a small additional variation of the same sign; this variation should have a certain minimum value. The phenomena are discussed with reference to Néel's theory (1659 above).

538.221 1661
Magnetic After-Effect in the Rayleigh Domain—J. C. Barbier. (*Compt. Rend. Acad. Sci. (Paris)*, vol. 230, pp. 1040-1041; March 13, 1950.) Experimental study of massive materials shows that the decrease of the square root of the remanent magnetization is proportional to the time elapsed from the suppression of the field, and is independent of the value of this field and the duration of its application. These results are in very good agreement with Néel's theory (1659 above).

538.24 1662
Practical Calculation of Magnetizing Force—A. A. Halacsy. (*Proc. IEE (London)*, vol. 97, pp. 37-42; March, 1950.) Any vector component of the magnetizing force at a point in space due to an electric current is directly related to a vector representing the surface swept over by the radius vector of length $1/\sqrt{r}$ with its origin and direction the same as those of the radius vector r directed from the point in question to consecutive points on the path of the influencing current. This relationship enables magnetizing force, distribution of the magnetic field, electromagnetic forces, etc., to be calculated by means of simple geometry in all practical cases, including those in which no simple analysis has so far been possible.

538.56 1663
Fresnel's Laws for Centimetre Waves—J. C. Simon. (*Compt. Rend. Acad. Sci. (Paris)*, vol. 230, pp. 1386-1388; April 12, 1950.) A note forming the introduction to a more comprehensive paper on diffraction effects obtained with perforated metal plates. Analogies with classical optical properties are confirmed experimentally; in particular, Brewster's law is verified.

538.56 1664
On the Focusing of a Wave—J. C. Simon. (*Compt. Rend. Acad. Sci. (Paris)*, vol. 230, pp. 1513-1514, April 24, 1950.) Further discussion of the analogy between radio and light waves (1132 of June). In the case of non-isotropic media the analogy is rather with crystal optics.

538.56 1665
Graphical Study of the Dispersion of Electro-Magneto-Ionic Waves—V. A. Bailey and J. A. Roberts. (*Aust. Jour. Sci. Res., Ser. A*, vol. 2, pp. 307-321; September, 1949.) A graphical method is given which leads to an approximate solution of the dispersion equation. The following information is readily obtained:—(a) the frequency bands in which undamped waves or wave-groups can grow as they progress, (b) the wave-number bands in which unattenuated waves can grow in time, (c) the phase and group velocities, refractive indices, and attenuation and damping coefficients, and (d) the effect of collisions between electrons and other particles on the attenuation of a wave or wave-group.

538.56:537.71 1666
Concerning "The Impedance of Free Space"—In the Journal reference of 876 of May please read vol. 30 for vol. 29.

538.561:537.533:[537.29+538.6] 1667
Generation and Amplification of Waves in Dense Charged Beams under Crossed Fields—O. Buneman. (*Nature (London)*, vol. 165, pp. 474-476; March 25, 1950.) Using plane electrodes without resonators or corrugations, a dense beam of charged particles may be made to produce oscillations similar to those in magnetrons, by a process which is purely electrostatic and can occur at low fields and low frequencies. The conclusions of a theoretical study of this phenomenon are discussed and expressions are given for the electric field distribution, the transverse particle-velocity distribution, the wave-velocity along the beam, and, in the case of a feedback system, the resonance frequency and amplification. The system may have value as a simple generator or amplifier for microwaves and the mechanism may possibly explain the production of solar noise. See also 3412 of 1949 (Haeff).

538.569.4+538.561.029.65 1668
Microwave Spectroscopy in the Region from Two to Three Millimeters—O. R. Gilliam, C. M. Johnson, and W. Gordly. (*Phys. Rev.*, vol. 78, pp. 140-144; April 15, 1950.) A description of the technique employed for spectroscopic measurements on gases such as CO at millimeter wavelengths. Wavelengths down to 1.96 mm have been generated by frequency multiplication using a silicon crystal and a klystron source.

538.569.4 1669
Measurements on the Absorption of Microwaves: Part 4—Non-Polar Liquids—D. H. Whiffen. (*Trans. Faraday Soc.*, vol. 46, pp. 124-130; February, 1950.) Experimental study and discussion of the small dielectric losses which occur in C_6H_6 and CCl_4 and in liquids with similar symmetrical molecules.

538.569.4 1670
Measurement on the Absorption of Microwaves: Part 5—The Variation of Relaxation Time with Solvent—D. H. Whiffen. (*Trans. Faraday Soc.*, vol. 46, pp. 130-136; February, 1950.) Description of a method of measurement of dielectric losses at 1.6-cm wavelength. Experimental results are given for 25 systems of polar molecules dissolved in nonpolar solvents.

538.66 1671
Action of a Periodic Magnetic Field on a Thin Spherical Metal Film—A. Colombani. (*Compt. Rend. Acad. Sci. (Paris)*, vol. 230, pp. 1149-1150; March 20, 1950.) Calculation of heating effects, based on electromagnetic potentials.

549.211:537.533.9:537.311.3 1672
Electron Bombardment Conductivity in Diamond: Part 2—K. G. McKay. (*Phys. Rev.*, vol. 77, pp. 816-825; March 15, 1950.) Previously published results have been revised by use of an improved alternating-field method of internal space-charge neutralization. Lower limits are set for the mobilities of electrons and positive holes at room temperature. Measurements of the decay of current due to internal space-charge fields are in reasonable agreement with theory. A double-pulse technique is used to study the rates of release of positive holes and electrons from traps.

537+538 1673
Principles of Electricity and Electromagnetism [Book Review]—G. P. Harnwell. Publishers: McGraw-Hill Book Company,

New York, 2nd edn, 670 pp., \$6.00. (*Rev. Sci. Instr.*, vol. 21, pp. 90-91; January, 1950.) A comprehensive textbook and valuable reference book for practising physicists and for electrical engineers whose work borders on physics. Much of the text has been rewritten. New topics added, include electron structure of crystals, magnetic induction accelerators, nuclear induction, vhf oscillators, and the propagation of em waves in metallic enclosures.

537.226 1674
Theory of Dielectrics [Book Review]—H. Fröhlich. Publishers: Clarendon Press, Oxford, 1949, 179 pp., \$4.50 or 18s. (*Rev. Sci. Instr.*, vol. 21, p. 90; January, 1950. *Trans. Faraday Soc.*, vol. 45, p. 1084; November, 1949.) "A systematic account of the theory of dielectric constant and of dielectric loss. The treatment, based on classical statistical mechanics, is rigorous and methodical. . . . The book can be recommended without reserve, not only to specialists in the field of dielectrics but also to all physicists, chemists, and applied scientists who wish to gain a clear and comprehensive grasp of this important field."

GEOPHYSICAL AND EXTRATERRESTRIAL PHENOMENA

521.15:538.12 1675
The Equations of Codazzi and the Relations between Electromagnetism and Gravitation—A. Gão. (*Phys. Rev.*, vol. 76, pp. 764-768; September 15, 1949.) See also 3128 of 1949.

523.53:621.396.9 1676
A Radio Echo Method for the Measurement of the Heights of the Reflecting Points of Meteor Trails—Clegg and Davidson. (See 1692.)

523.7:538.122 1677
The Sun's General Magnetic Field—P. A. Sweet. (*Mon. Not. R. Astr. Soc.*, vol. 109, pp. 507-516; 1949.) The effects of large-scale convection currents and differential angular velocity on the solar magnetic field are studied in detail.

523.72:621.396.822 1678
Transients in an Ionized Medium with Applications to Bursts of Solar Noise—J. C. Jaeger and K. C. Westfold. (*Aust. Jour. Sci. Res., Ser. A*, vol. 2, pp. 322-334; September, 1949.) Mathematical solutions of a number of transient problems in linear propagation in a homogeneous ionized medium are given. Discussion of the effects of collisions, inhomogeneity of medium, and magnetic field is included. If a localized disturbance occurs in the solar atmosphere where the collision frequency is ν and the frequency of plasma oscillations is ω_0 , radiation will be emitted on all frequencies greater than ν_0 with intensity determined by the nature of the disturbance, and with damping determined by ν . There is a small difference between the arrival times on different frequencies, and for each frequency there is a direct wave and an echo wave a few seconds later. Many of the phenomena of bursts of solar noise on frequencies between 85 Mc and 19 Mc are consistent with these predictions.

551.1+550.38 1679
The Earth's Interior and Geomagnetism—W. M. Elsasser. (*Rev. Mod. Phys.*, vol. 22, pp. 1-35; January, 1950.) A review of present knowledge of the earth's interior, excluding the extensive information available concerning the crust, with particular reference to seismic data, chemical composition, mechanical and thermal properties, and magnetic phenomena.

551.510.5 1680
Cellular Atmospheric Waves in the Ionosphere and Troposphere—D. F. Martyn.

Proc. Roy. Soc. A, vol. 201, pp. 216-234; March 22, 1950.) Horizontally traveling disturbances of electron densities in the F_2 region, and the supposed vertically traveling disturbances of Wells, Watts, and George (3279 of 1946) are both explainable as horizontally traveling atmospheric cellular waves, the theory of which is developed. These waves also appear to be the cause of the microbarometric oscillations in the troposphere. In the ionosphere, the earth's magnetic field affects the ionic motion and makes the horizontally traveling disturbances simulate vertically moving electron clouds. Consideration of the boundaries for the cellular waves indicates a value of γ , the ratio of the specific heats of air, considerably less than 1.4 in the F_2 region.

551.510.535 1681
On the Diurnal Variations of Electron Concentration of the F_2 Layer at Equatorial Stations—R. Eyfrig. (*Naturwissenschaften*, vol. 37, pp. 67-68; February, 1950.) The mean hourly values of f^oF_2 for two equatorial stations with about 180° difference in longitude, Huancayo and Bandoeng, for March and September, 1944, show a difference which is not explained by Appleton's temperature effect. The curve for Palau, March, 1944, is similar to that for Huancayo. The magnetic inclinations of these two stations are +0.3° and -0.5°, that of Bandoeng being about -32°. The flattening of the curve around noon is attributed to the influence of the geomagnetic field.

551.510.535:523.745 1682
The Effect of the Sun on the Normal E Layer of the Ionosphere—E. Harnischmacher. (*Compt. Rend. Acad. Sci. (Paris)*, vol. 230, pp. 1301-1302; March 27, 1950.) Previous investigations have indicated that in Chapman's law for the variation of critical frequency with the sun's zenithal angle, the index n should be higher than $\frac{1}{2}$. Analysis of more recent measurements leads to a formula giving values of n lying between 0.29 and 0.32 in latitude 48°, and between 0.33 and 0.36 at the equator if the mean monthly relative sunspot number varies between 0 and 150.

551.510.535:551.542 1683
A Correlation between Ionospheric Phenomena and Surface Pressure—M. W. Jones and J. G. Jones. (*Phys. Rev.*, vol. 77, p. 845; March 15, 1950.) Observations at College, Alaska, indicate that oscillations in the F layer are approximately in opposite phase to the oscillations of the air near the surface of the earth, as measured by the variations of barometric pressure.

551.510.535:621.396.11 1684
Ionospheric Recordings—A. Bolle, S. Sileni, and C. A. Tiberio. (*Ann. Geofis.*, vol. 2, pp. 377-387; July, 1949.) Systematic ionosphere soundings were resumed at the Istituto Nazionale di Geofisica in August, 1948. Graphs of F_2 critical frequencies for each month up to March, 1949, are given, and items of special interest discussed briefly. These include a few examples of triple magneto-ionic splitting. As reported by Newstead (2595 of 1948) they were accompanied by strong sporadic-E ionization and preceded by a fall in critical frequency.

551.577:621.396.9 1685
An Investigation of the Dimensions of Precipitation Echoes by Radar—J. R. Mather. (*Bull. Amer. Met. Soc.*, vol. 30, pp. 271-277; October, 1949.)

551.577:621.396.9 1686
The Rain Required for a Radar Echo—D. W. Perric. (*Bull. Amer. Met. Soc.*, vol. 30, pp. 278-281; October, 1949.)

551.594 1687
Observations of the Electric Field of the Atmosphere at Monaco—J. Rouch. (*Compt. Rend. Acad. Sci. (Paris)*, vol. 230, pp. 1485-1487; April 24, 1950.) The mean value of 269 measurements made during 1949, at altitude 70 m is 366 v/m. The field exhibits a seasonal variation, with a maximum in winter and minimum in summer. Meteorological conditions are given for the 3 occasions when the field was -1,000 v/m.

551.594.5 1688
Radar Reflections from Ruroras—P. A. Forsyth, W. Petrie, F. Vawter, and B. W. Currie. (*Nature (London)*, vol. 165, pp. 561-562; April 8, 1950.) Systematic search for radar echoes on frequencies of 3 kMc and 106.5 Mc has been carried out at Saskatoon, Canada. Echoes have been observed regularly on the lower frequency, but not at all on the higher one, during auroral displays. Whether the reflections are from the lower and brighter parts of the auroras or from levels a few kilometers above them cannot at present be decided, as the 106.5-Mc equipment could only be rotated about a vertical axis.

LOCATION AND AIDS TO NAVIGATION

621.96.9 1689
The Port Radar at Antwerp—(IIF (Brussels), no. 5, p. VII; 1950.) Brief notice of experimental radar equipment for the river Scheldt. The scanning antenna is about 15 m above river level and the range is adjustable between 40 and 2 miles. Several scanning towers may be installed at different points along the river banks with a central observation station or, alternatively, only one or two very high towers with special equipment may be used.

621.396.9 1690
Radar for the Merchant Navy—M. Gilli. (*Poste e Telecomunicazioni*, vol. 17, pp. 233-236; April, 1949.) An account of radar technique and equipment from the standpoint of current British and American practice.

621.396.9 1691
Volume Scanning with Conical Beams—D. Levine. (*Proc. I.R.E.*, vol. 38, pp. 287-290; March, 1950.) 1949 IRE National Convention paper. "The equations of motion for a radar scan that provides a nearly constant number of pulses to all point targets are derived. In addition, the periods for this scan and for the more conventional one having constant angular velocities are presented. For these types of scanner it is found that the optimum cross-over point between adjacent beams is at the 2.1-db point of the antenna pattern".

621.396.9:523.53 1692
A Radio Echo Method for the Measurement of the Heights of the Reflecting Points of Meteor Trails—J. A. Clegg and I. A. Davidson. (*Phil. Mag.*, vol. 41, pp. 77-85; January, 1950.) The range is determined from 60-Mc pulse echoes obtained by broadside reflection from the meteor trail and the elevation of the reflecting point is found by comparing the amplitudes of the echo signals picked up by two antennas mounted at different heights (usually $\lambda/2$ and $3\lambda/4$) above a plane horizontal, perfectly reflecting surface. Results obtained during the Quadrantid shower of 1949, are in good agreement with visual observations.

621.396.9:629.13.052]:621.396.6.001.2 1693
Mechanical Development of a Radio Altimeter—Croft. (*See* 1843.)

621.396.933 1694
Pictorial Display in Aircraft Navigation and Landing—L. F. Jones, H. J. Schrader, and J. N. Marshall. (*Proc. I.R.E.*, vol. 38, pp. 391-400; April, 1950.) According to the 15-year plan prepared by the USA Radio Technical Commission for Aeronautics, a pictorial situation display is to be provided at the ground station and in aircraft, and is to be used in the traffic-control zone. Displays for traffic control and instrument landing are illustrated. In traffic control the picture can be used in various ways, which are discussed, with particular reference to the telecan system. Developments are described concerning self-identification in the picture, the use of graphicon storage tubes, altitude coding, and picture brightness. Both further technical development and psychological investigation are necessary before optimum display methods can be determined.

MATERIALS AND SUBSIDIARY TECHNIQUES

537.226.2:546.431.82 1695
Dielectric Constants and Polarizabilities of Ions in Simple Crystals and Barium Titanate—S. Roberts. (*Phys. Rev.*, vol. 76, no. 8, pp. 1215-1220; October 15, 1949.)

537.311.31:538.221 1696
Improvements and Recent Results Relating to the Measurements of the Temperature Variation of the Resistance of Ferromagnetic Materials—G. Mannevy-Tassy. (*Compt. Rend. Acad. Sci. (Paris)*, vol. 230, pp. 1150-1152; March 20, 1950.)

538.221 1697
Study of Static and Dynamic Magnetostriction Phenomena of Austenitic Fe/Ni Alloys—H. Devèze. (*Ann. Phys. (Paris)*, vol. 5, pp. 80-114; January and February, 1950.) A thesis in four parts. The different apparatus used for static and dynamic measurements is described, particular attention being given to temperature stability. For measurement of elongation under a direct magnetizing force the optical interference method was preferred, as being both accurate and rapid. For dynamic measurements the radiation from the end of the ferromagnetic rod energized by a variable frequency 400-w ultrasonic generator was directed upon a quartz microphone. Static magnetostriction is studied as a function of nickel content in a series of cylindrical rods and also in 4 invar alloys subjected to different heat treatments. The theory of dynamic magnetostriction is developed to determine the amplitude of oscillations. Experimental results are analyzed and optimum operating conditions are established.

538.221 1698
The Preparation and Magnetic Properties of Ferrites of Manganese and Cobalt—C. Guillaud and H. Creveaux. (*Compt. Rend. Acad. Sci. (Paris)*, vol. 230, pp. 1256-1258; March 27, 1950.)

538.221 1699
Ferromagnetic Properties of Mixed Ferrites of Cobalt and Zinc and of Manganese and Zinc—C. Guillaud and H. Creveaux. (*Compt. Rend. Acad. Sci. (Paris)*, vol. 230, pp. 1458-1460; April 17, 1950.)

538.244.2:538.12 1700
The Magnetic Field Inside a Solenoid—J. R. Barker. (*Brit. Jour. Appl. Phys.*, vol. 1, pp. 65-67; March, 1950.) Convenient formulas are derived for computing the extent of the region of uniform field inside both thick and thin coils, and an estimate of their accuracy is made. A set of tables is included to simplify the calculations.

- 539.23:537.311.31 1701
 Dependence on Applied Potential of the Resistance of Very Thin Deposited Metal Films at Low Temperatures—N. Mostovetch and B. Vodar. (*Compt. Rend. Acad. Sci. (Paris)*, vol. 230, pp. 934-936; March 6, 1950.) Resistivity measurements for films of various metals in the temperature range 293°-2°K show marked departures from Ohm's law at low temperatures. A direct effect of the field on the conduction electrons is indicated.
- 546.431.82:621.315.612.4 1702
 The Dielectric Properties of Barium Titanate at Low Temperatures—R. F. Blunt and W. F. Love. (*Phys. Rev.*, vol. 76, pp. 1202-1204; October 15, 1949.)
- 546.431.82:621.315.612.4 1703
 Domain Structures and Phase Transitions in Barium Titanate—P. W. Forsbergh, Jr. (*Phys. Rev.*, vol. 76, pp. 1187-1201; October 15, 1949.)
- 546.431.82:621.315.612.4 1704
 The Electric and Optical Behavior of BaTiO₃ Single-Domain Crystals—W. J. Merz. (*Phys. Rev.*, vol. 76, pp. 1221-1225; October 15, 1950.)
- 548.0:537.228.1 1705
 Synthetic Crystals at Ultrasonic Frequencies—C. E. Green. (*Electronics*, vol. 23, pp. 110-112; April, 1950.) Short discussion of the relative advantages of ADP and Rochelle-salt crystals as compared with quartz, for the frequency range 10-150 kc. Ease of production may for some applications offset their large temperature coefficients of frequency.
- 549.514.51 1706
 Quartz, its Treatment and Its Use in Telecommunications Technique—R. Sœur, J. Norbert, P. Andrieux, and M. Corneise. (*Onde Élec.*, vol. 30, pp. 67-75 and 140-148; February and March, 1950.) Illustrated description of production technique, methods of mounting, and applications in oscillators and filters.
- 549.514.51:536.42 1707
 The $\delta\beta$ Transformation Point of Quartz indicated by the Dielectric Constant—J. P. Pérez. (*Compt. Rend. Acad. Sci. (Paris)*, vol. 230, pp. 932-933; March 6, 1950.) Capacitance/temperature curves for quartz-plate capacitors exhibit kinks or discontinuities at the transformation point near 570°C.
- 621.315.61 1708
 Fluid Dielectrics for the Decimetre and Centimetre Wave Band—W. Endres and H. Kohler. (*Frequenz*, vol. 4, pp. 57-63; March, 1950.) Discussion of composite dielectrics, which are of importance as offering a continuous range of values of dielectric constant. Measurements of the dielectric constant for different combinations of powdered ceramic materials with air or transformer oil confirm Lichtenecker and Rother's logarithmic law of mixtures.
- 621.315.612.4 1709
 Properties of Calcium-Barium Titanate Dielectrics—E. N. Bunting, G. R. Shelton, and A. S. Creamer. (*Bur. Stand. Jour. Res.*, vol. 43, pp. 237-244; September, 1949.) Properties measured were shrinkage, water absorption, linear expansion, dielectric constant and power factor. The electrical properties were measured at 0.05, 1, 20, and 3,000 Mc, and the highest values of dielectric constant were found to be associated with high baria content. The properties of some specimens changed with time. The expansion coefficient of all specimens was relatively high and of the order of 10×10^{-6} per °C for the temperature range 25°-700°C.
- 778.3:621.396.9 1710
 Single-Pulse Recording of Radar Displays—L. C. Mansur. (*Tele-Tech.*, vol. 9, pp. 30-33, 54; January, 1950.) Techniques are described which were originally developed for investigating fluctuations of fixed targets and their effect on the operation of moving-target indicators. Typical records are reproduced and various applications of the method are suggested.
- 535.37 1711
 Fluorescence and Phosphorescence [Book Review]—P. Pringsheim. Publishers: Interscience Publishers, New York and London, 1949, 794 pp., 120s. (*Nature (London)*, vol. 165, pp. 659-660; April 29, 1950.) "Provides a clear, balanced, fair, and complete account of present knowledge. . . an indispensable reference book for the student who requires either an over-all picture of the subject or detailed information on any particular part."
- MATHEMATICS
- 517.912.2 1712
 A Note on the Numerical Integration of Differential Equations—W. E. Milne. (*Bur. Stand. Jour. Res.*, vol. 43, pp. 537-542; December, 1949.) An integration method for ordinary differential equations is developed, in which the approximation formulas contain derivatives of higher order than those contained in the differential equation itself. The method is particularly useful for linear differential equations. Numerical examples are given for Bessel's differential equation.
- 519.283:621.39.001.11 1713
 A Simplified Derivation of Linear Least-Square Smoothing and Prediction Theory—II. W. Bode and C. E. Shannon. (*Proc. I.R.E.*, vol. 38, pp. 417-425; April, 1950.) The principal results of the Wiener-Kolmogoroff smoothing and prediction theory for stationary time series are developed by a new method. The mathematical procedure has, for the most part, a direct physical interpretation based on electric circuit theory and does not involve integral equations or the autocorrelation function. The cases treated are the "infinite lag" smoothing problem, pure prediction in the absence of noise, and the general smoothing prediction problem with noise present. The basic assumptions of the theory are discussed in order to clarify the question as to when the theory will be appropriate and to avoid possible misapplication.
- 681.142:621-526 1714
 Electronics and Experimental Mathematics—In the journal reference of 919 of May please read vol. 30 for vol. 29.
- 681.142:621.396.645 1715
 Analog Computers for Servo Problems—D. McDonald. (*Rev. Sci. Instr.*, vol. 21, pp. 154-157; February, 1950.) Exact equations are derived for the operational amplifiers used in analogue computers. By making certain approximations, simpler equations are obtained which indicate that in the case of servomechanisms the operational amplifiers may be of simpler type, with lower gain, than for more general problems.
- 501 1716
 Applied Mathematics for Engineers and Scientists [Book Review]—S. A. Schelkunoff. Publishers: D. van Nostrand, 1948, 472 pp., 36s. (*Phil. Mag.*, vol. 41, p. 108; January, 1950.) "The first half treats the general mathematical methods and the second half introduces the frequently occurring transcendental func-
- tions. The portion dealing with differential equations is particularly well written. The introductions to the use of Green's function and the Laplace transform method are two of the most valuable features of the book. The principles involved have been illustrated by concrete examples as far as possible. A chapter on tensors and matrices would perhaps have increased the general usefulness of the book."
- MEASUREMENTS AND TEST GEAR
- 621.317.3:[621.385.2:621.315.59 1717
 Applications of Germanium Crystal Diodes in Precision-Measurement Technique—A. Perlstein. (*Bull. Schweiz. Elektrotech. Ver.*, vol. 40, pp. 337-354; May 28, 1949. In German.) Basic circuits and the development of bridge and star modulator systems and their variants are considered. Detailed descriptions are given of (a) arrangements for the measurement of frequencies, voltage mean values, and capacitance, (b) a method for point-to-point curve plotting, (c) equipment for vector measurements, and (d) a method for harmonic analysis of voltage curves. Auxiliary apparatus includes a circuit for producing square waves without using tubes. Accuracy of measurement is indicated in each case and temperature effects are discussed. The indicator generally used is a dc galvanometer in a compensation circuit. The methods described can be used up to 200 kc.
- 621.317.329:537.291 1718
 An Automatic Plotter for Electron Trajectories—D. B. Langmuir. (*RCA Rev.*, vol. 11, pp. 143-154; March, 1950.) A scale model of the es field is produced in an electrolyte trough. The voltages picked up by a pair of wire probes determine the radius of curvature of the trajectory simulating that of an electron. Arrangements are provided so that when started from a selected point in a given initial direction the radius of curvature of the path of the probes is automatically adjusted so that they trace a simulated trajectory. Mechanical design, electrical circuits, and performance are discussed.
- 621.317.33 1719
 Methods for Obtaining the Voltage Standing-Wave Ratio on Transmission Lines Independently of the Detector Characteristics—A. M. Winzemer. (*Proc. I.R.E.*, vol. 38, pp. 275-279; March, 1950.) By means of the basic transmission line equations and the general law of detection, expressions are derived which give the voltage SWR as a function of measurable electrical angles, the expressions being independent of the response law of the detector. Special cases of the general equations are discussed covering applications where high or low SWR values are to be determined, with or without the use of the voltage maxima or minima. The extension of the methods to the case of attenuating transmission lines is considered.
- 621.317.336.029.64 1720
 Directional Coupler for Impedance Measurement at U.H.F.—R. Musson-Genon and P. Brissonneau. (*Compt. Rend. Acad. Sci. (Paris)*, vol. 230, pp. 1258-1259; March 27, 1950.) The impedance to be measured terminates a waveguide to which is coupled, by means of a directional coupler of attenuation about 20 db, a section of waveguide terminated at one end by a sliding piston and at the other by an accurately matched crystal detector, the current in which varies with the position of the piston. The unknown impedance is readily found from measurements of the maximum and minimum currents. Accuracy is of the same order as when using a movable probe, but the construction of the apparatus is much simpler.

- 621.317.373.029.64 1721
Experimental Determination of Phase Characteristics of Centimetric Waveband Circuits—M. Denis and P. Palluel. (*Microtecnica* Lausanne), vols. 3 and 4, pp. 218-224, 289-294 and 3-9; September, 1949-February, 1950.) English version of 682 of April.
- 621.317.74.029.64:621.396.67 1722
A New Type of Slotted Line Section—W. B. Wholey and W. N. Eldred. (Proc. I.R.E., vol. 38, pp. 244-248; March, 1950.) Full paper. Summary abstracted in 2716 of 1949.
- 621.317.755:621.396.645 1723
A Wide-Band Amplifier for Oscilloscopes—*Radio and Electronics* (Wellington, N.Z.), vol. 5, pp. 18-19; March 1, 1950.) A simple 5-tube circuit giving a balanced output from an unbalanced input and having a response useful up to 4.5 Mc. It is suitable for examination of square or irregular waveforms and will fill the screen of a 5-inch cr tube from an input of 1 v rms.
- 621.317.772 1724
Wide-Band Audio Phasemeter—J. R. Ragazzini and L. A. Zadeh. (*Rev. Sci. Instr.*, vol. 21, pp. 145-149; February, 1950.) A stabilized feedback amplifier is arranged to produce a 90° phase shift and its input is added to a variable fraction of its output to give a resultant emf of variable phase. This calibrated phase shift is matched to the unknown phase difference, using a cro as indicator. The error of measurement is <0.5° for frequencies from 20 cps to 100 kc.
- 621.317.772 1725
A New Measuring Instrument for Time-Delay Measurements—W. Dillenburger. (*Frequenz*, vol. 4, pp. 10-13; January, 1950.) Circuit details and description of a phase meter for the frequency range 100 kc to 20 Mc. Calibration is simple. Indication is direct and single-valued between 0° and 360° and within reasonable limits is independent of the intermediate frequency used in the meter and of the amplitude of the input signals.
- 621.317.784 1726
Dynamometer Type Wattmeter for Audio Frequencies—D. Alvey. (*Electronic Eng.*, vol. 22, pp. 146-148; April, 1950.) The basic principles of operation at af are summarized and expressions for frequency errors when used as a voltmeter, ammeter, or wattmeter are derived. A range of instruments covers measurements of voltage to 300 v, current to 3 a and power to 500 w. Various applications are noted.
- 621.317.794 1727
Measurement of Small Powers at Centimetre Wavelengths—J. Broc. (*Onde Élec.*, vol. 30, pp. 108-120; March, 1950.) Detailed account of methods and apparatus noted in 2860 of 1949.
- 621.317.794:621.317.733 1728
Analysis of the Direct-Current Bolometer Bridge—D. M. Kerns. (*Bur. Stand. Jour. Res.*, vol. 43, pp. 581-589; December, 1949.) "The behavior of a direct-current Wheatstone bridge with a nonlinear element (bolometer) in one arm, as used in the measurement of microwave power, is analyzed. Results of rather general applicability are obtained by ascribing arbitrary values to the resistances making up the bridge-network and by employing a resistance law of a general form for the bolometer element. Emphasis is placed upon the development of first-order theory in convenient form. General characteristics of the behavior of the type of network (and nonlinear element) under consideration are indicated. Results obtained include expressions for the derivatives of galvanometer current with respect to radio-frequency power, ambient temperature, source-voltage, and source-resistance."
- 621.319.4 1729
The Temperature Coefficient of Standard Air Capacitors—G. Zickner. (*Elektrotechnik* (Berlin), vol. 2, pp. 147-152; May, 1948.) The factors which determine the coefficient are analyzed and methods of reducing it are discussed. Descriptions are given of different designs of fixed and variable capacitors in which the temperature coefficient is much reduced by use of materials with different expansion coefficients in a "grid-iron" type of construction. Physical constants of different conducting and insulating materials are tabulated.
- 621.397.6.001.4:621.397.6 1730
The Video-Frequency Stage—Gondry. (See 1782.)
- OTHER APPLICATIONS OF RADIO AND ELECTRONICS**
- 534.232:534.321.9:621.3.087.6 1731
Pin-Pointing Ultrasonic Energy—Dana and van Meter. (See 1561.)
- 539.16.08 1732
Small Probing Geiger-Müller Counters—C. V. Robinson. (*Rev. Sci. Instr.*, vol. 21, pp. 82-84; January, 1950.) Experiments with mixtures of argon and ethyl acetate in small counters are described. Construction details are given for two brain-probing counters of diameter 3 mm and 2 mm respectively.
- 621.3.083.7:621.396 1733
High-Accuracy Radio-Telemetry—I. Podliasky and J. Zakheim. (*Compt. Rend. Acad. Sci.* (Paris), vol. 230, pp. 1260-1262; March 27, 1950.) In a system for measuring the velocity of a moving object such as an aircraft, in which differently phased beats are produced at a series of ground stations receiving signals from both the moving object and a ground transmitter, it is important to keep the difference between the two signal frequencies constant. Servomechanisms are provided at the ground transmitter for this purpose. Instrumental accuracy to within about 1 part in 10⁶ is possible, the over-all accuracy being limited only by variation of propagation velocity in the vicinity of the ground.
- 621.317.39 1734
Electrical Device for the Calculation of Product Integrals—O. Schäfer and G. Lander. (*Arch. Elek.* (Übertragung), vol. 4, pp. 59-64; February, 1950.) Curves representing the two functions concerned are scanned simultaneously by oscillating light beams. The resulting outputs from the two photocells used are applied, after amplification, to an integrator. The time for a complete scan is about 2 minutes.
- 621.365.54† 1735
H.F. Heating speeds Steel Forging—(*Filec. Times*, vol. 117, pp. 355-362; March 9, 1950.) Description of press-forge plant at Bromsgrove, Worcestershire. For another account see 420 of March.
- 621.38:629.13 1736
Electronics in Aircraft Design—A. L. Whitwell. (*Jour. Brit. I.R.E.*, vol. 10, pp. 79-95; March, 1950.) A survey of electronic methods used in measurements on aircraft structures, both on the ground and in flight; strain, displacement, velocity, acceleration, and pressure are dealt with, and multichannel apparatus developed for recording high-frequency vibrations is described.
- 621.384.6 1737
The Cyclosynchrotron—M. L. Oliphant. (*Nature* (London), vol. 165, pp. 466-468; March 25, 1950.) A first model is under construction for installation in the School of Physical Sciences in the Australian National University, Canberra. Protons are accelerated in a synchrocyclotron and a synchrotron guiding field is produced about the final orbit in such a way that the passage from one type of acceleration to the other is smooth. Final particle energies of the order of 2-3 kMeV should be obtained.
- 621.384.611.2† 1738
Design Study for a 3,000-MeV Proton Accelerator—M. S. Livingston, J. P. Blewett, G. K. Green, and L. J. Haworth. (*Rev. Sci. Instr.*, vol. 21, pp. 7-22; January, 1950.) Discussion of a proton synchrotron, to be called a cosmotron, now under construction at Brookhaven National Laboratory, Upton, L.I., N.Y.
- 621.384.611.2† 1739
Betatron-Starting in Electron Synchrotrons—J. J. Wilkins. (*Phil. Mag.*, vol. 41, pp. 34-53; January, 1950.)
- 621.385.15.001.8 1740
Recent Applications of Electron Multiplier Tubes—Allen. (See 1815.)
- 621.385.833 1741
The Practice of Electron Microscopy—(*Jour. R. Micr. Soc.*, vol. 70, pp. 1-141; March, 1950.) A comprehensive treatise compiled by the Electron Microscopy Group of the Institute of Physics and edited by D. G. Drummond. General optical considerations and basic techniques are discussed and methods are described for the examination of small particles, thin-film specimens, surface replicas, micro-organisms, and biological tissues. Special techniques, the calibration of magnification and resolving power, and photographic technique are also considered. Illustrative photographs and an extensive bibliography are included.
- 621.385.833 1742
A Three-Stage Electron Microscope with Stereographic Dark Field, and Electron Diffraction Capabilities—M. E. Haine, R. S. Page, and R. G. Garfitt. (*Jour. Appl. Phys.*, vol. 21, pp. 173-182; February, 1950.) A continuous range from -1,000 to X100,000 is covered by use of an intermediate projector lens.
- 621.385.833 1743
Principal Rays for a Family of Electron Lenses and Mirrors—E. Regenstreif. (*Compt. Rend. Acad. Sci.* (Paris), vol. 230, pp. 1262-1264; March 27, 1950.)
- 621.398 1744
Mains Control Installations: Report on the S.E.V. (Schweizerischer Elektrotechnischer Verein) Conference in Berne, December, 1949—(*Bull. Schweiz. Elektrotech. Ver.*, vol. 41, pp. 153-200; March 4, 1950.) Introductory papers by E. Erb (in German), reviewing possible methods of control, and by M. Roegen (in French), outlining the requirements of centralized remote control systems, are followed by: Research and New Productions of the Compagnie des Compteurs, by J. Pelpel (in French); description of different relays for carrier current control systems and consideration of optimum frequency; Principal Features of the Landis and Gyr Centralized Control System, by W. Koenig (in German); discussion of factors determining the choice of frequency for the pulse-width method; Mains Control Installations of the Zellweger

A. G., Uster, by O. Grob (in German): description of a system using stored energy for the control signals; The Sauter Remote Control System, by E. Spahn (in German): pulse system operating on 2 kc and using a triode rectifier and synchronous selector at the receiving end. The concluding discussion (in German) includes descriptions of other systems and equipment.

629.13.055.6:621.317.733.011.4 1745

Airplane Fuel Gage—C. R. Schafer. (*Electronics*, vol. 23, pp. 77-79; April, 1950.) The liquid fuel in the aircraft tank forms the dielectric in a tubular capacitor in one arm of a bridge, the unbalance voltage operating a servo-motor which restores the bridge balance and indicates fuel level mechanically. Advantages of the equipment are ruggedness, freedom from slosh effects, good accuracy, and indication of weight rather than volume of fuel.

621.317.083.7:621.396 1746

Principles and Methods of Telemetering [Book Review]—P. A. Burden and G. M. Thynell. Publishers: Chapman and Hall, London, 1948, 230 pp., 27s. (*Beama Jour.*, vol. 56, p. 349; October, 1949.) "A work which presents a technically analytical and descriptive treatment of a large variety of telemetering devices. . . . It is an informative record of U. S. practice in telemetering."

621.38 1747

Elements of Electronics [Book Review]—G. Windred. Publishers: Chapman and Hall, London, 1949, 185 pp., 15s. (*Beama Jour.*, vol. 57, pp. 46-47; February, 1950.) An elementary, nonmathematical introduction to the subject, giving a survey of principles and applications.

PROPAGATION OF WAVES

538.56 1748

Vectorial Space of Regular Waves outside a Closed Surface—J. Brodin. (*Compt. Rend. Acad. Sci.* (Paris), vol. 230, pp. 1388-1390; April 12, 1950.) The general expression of; Huyghens principle for a regular monochromatic wave outside a closed surface S and at infinity, is given in the form of a series of waves produced by the basic layers of electric and magnetic dipoles tangential to S . The development involves arbitrary coefficients permitting its application to particular problems. See also 523 and 712 of April.

538.56 1749

Particular Case of Huyghens Principle—J. Brodin. (*Compt. Rend. Acad. Sci.* (Paris), vol. 230, pp. 1345-1347; April 3, 1950.) Extension of 712 of April to the case in which the solutions of the integral equation are not zero. See also 1218 of June.

538.566.2 1750

The Geometric Locus of the Coefficient of Reflection of Electromagnetic Waves due to a Discontinuity in the Gradient of the Dielectric Constant, in the case of Small Gradient—G. Eckart. (*Compt. Rend. Acad. Sci.* (Paris), vol. 230, pp. 1044-1045; March 13, 1950.)

621.396.11 1751

Velocity of Light and of Radio Waves—L. Essen. (*Nature* (London), vol. 165, pp. 582-583; April 15, 1950.) Recent measurements of the velocity of light and radio waves are discussed. The value of 299, 776 \pm 4 km/sec quoted by Birge (1941) for light has been generally accepted, but the measurements described suggest that this figure is too low. Careful measurements with the Shoran radio system in America give a value of 299, 792 \pm 2.4 km/sec after making a refractive-index cor-

rection. Essen Gordon-Smith have obtained a value of 299, 792 km/sec, with an estimated maximum error of ± 9 km/sec, by measurements in vacuo of the resonance frequency of a metallic cavity of known dimensions. A later figure given by Essen is 299, 792.5 \pm 3 km/sec. Recent optical determinations by Bergstrand in Sweden using a Kerr cell and photocell give a value of 299, 792.7 \pm 0.25 km/sec.

621.396.11 1752

Some Remarks on the Ionospheric Double Refraction: Part 2—H. Bremmer. (*Philips Res. Rep.*, vol. 4, pp. 189-205; June, 1949.) Maxwell's equations for plane wave propagation through a stratified anisotropic medium are reduced to a set of four simultaneous first-order equations. A general method is indicated for deriving W. K. B. approximations from these equations and details are given for the simplified case of an isotropic medium. The intensities of the waves reflected by the stratified anisotropic medium are discussed and results combined with the saddle-point method of evaluating exponential integrals to find the geometric-optical approximation for the field strength after one ionospheric reflection. Part 1: 3519 of 1949.

621.396.11 1753

Ionosphere Data Deduced from Direct Tests on Radiotelegraphic Links in the [Italian] Army Network—S. Silleni. (*Ann. Geofis.*, vol. 2, pp. 388-399; July, 1949.) Results for the first three months of a year's survey of communications on 7.695 Mc. Values of the critical frequencies and their distribution were deduced from the data collected. Comparison with results obtained from ionosphere soundings showed fairly good agreement for mean values; distribution about the mean was more scattered in the case of the links, by a factor which remained almost constant over the period considered.

621.396.11:551.510.535 1754

Ionospheric Predictions and Radiocommunication—M. Nicolet. (*HF* (Brussels), no. 5, pp. 125-142; 1950.) General discussion of the factors influencing the propagation of short waves in the ionosphere. Methods for predicting usable frequencies and ionospheric conditions are explained. The theories underlying prediction calculations are outlined.

621.396.11:551.510.535 1755

Ionospheric Recordings—Bolte, Silleni, and Tiberio. (See 1684.)

621.396.11.029.6 1756

Reflection of Radio Waves from a Rough Sea—L. V. Blake. (*Proc. I.R.E.*, vol. 38, pp. 301-304; March, 1950.) "At microwave frequencies, the sea cannot always be assumed to be a smooth, or mirror-like, reflecting surface. It is shown that when the sea is rough the reflected field will be a randomly fluctuating one, or will at least have a fluctuating component, even though the radiated signal is of constant amplitude and frequency. The central limit theorem of mathematical probability theory is used to derive the probability-density functions for the amplitude of the reflected signal, and for the amplitude of the combined reflected and direct-path signals. The possible practical significance of these results is discussed."

621.396.11.029.64 1757

A Theory of Radio Scattering in the Troposphere—H. G. Booker and W. E. Gordon. (*Proc. I.R.E.*, vol. 38, pp. 401-412; April, 1950.) "The theory of scattering by a turbulent medium is applied to scattering of radio waves in the troposphere. In the region

below the horizon of the transmitter, energy is received (a) by diffraction round the curved surface of the earth (modified as appropriate by atmospheric refraction), and (b) by scattering from turbulence in the region of high field strength above the horizon. At distances beyond the horizon that are not too great, we may think of (a) as giving the mean signal received, and (b) as giving the fading. However, contribution (b) usually decreases with distance more slowly than contribution (a). Beyond a certain distance, therefore, contribution (b) becomes predominant and the mean signal is no longer given by (a)." A graphical comparison of field strength according to the scattering theory (using expected values of atmospheric turbulence and departure of the refractive index from its mean value) with experimental results obtained over sea at a wavelength of 9 cm, shows that the theory is fully adequate to explain the high field strengths observed at great distances.

621.396.81 1758

Approximate Formula for the Night Field-Intensity Curves established by the C.C.I.R.—C. Glinz. (*Tech. Mitt. Schweiz. Telegr.-Teleph. Verw.*, vol. 28, pp. 147-151; April 1, 1950. In French.) The Committee's work in producing these curves is reviewed. Weyrich's theory (1928 Abstracts, p. 516) on radiation from a finite antenna between two perfectly conducting planes is applied to the propagation of waves of wavelength 200-2,000 m between earth and the ionosphere. Neglecting distance attenuation, the result of the effects of interference and superposition is a cylindrical wave with field varying as $1/\sqrt{r}$, where r is the transmission distance. The inclusion of damping according to Sommerfeld's function $f(\rho)$ leads to formulas which for large values of r serve as an approximation for the field intensity curves.

RECEPTION

621.396.621 1759

Frequency Conversion by Phase Variation—G. Diener and K. S. Knol. (*Philips Res. Rep.*, vol. 4, pp. 161-167; June, 1949.) The highest theoretical conversion transconductance g_{en} is obtained when the tube transconductance has its optimum positive value and the phase angle decreases linearly by $2\pi n$ radians during one cycle of the oscillator voltage. With these conditions g_{en} equals the maximum hf transconductance and improves by a factor $\pi/2$ on the value of g_{en} given by Herold's phase-reversal method. Experimentally the electron beam is modulated using for each voltage two systems giving deflections at right angles to each other and in phase quadrature, the intermediate frequency current being taken in balance from two concentric annuluses.

621.396.621:621.395.623.7 1760

High-Efficiency Loudspeakers for Personal Radio Receivers—H. F. Olson, J. C. Bleazey, J. Preston, and R. A. Hackley. (*CA Rev.*, vol. 11, pp. 80-98; March, 1950.) The direct radiator, combination direct radiator and acoustical phase inverter, horn, and combination horn and phase inverter types of loudspeaker are discussed. The measured response frequency characteristic of each type is compared with the theoretical response. An efficiency of 25 per cent has been obtained with a combination of horn and phase inverter; this system has been incorporated in a complete 4-tube receiver of total volume only 25 cubic inches.

621.396.621.5 1761

Dual-Diversity Frequency-Shift Reception—D. G. Lindsay. (*Proc. I.R.E.* (Australia),

vol. 11, pp. 29-42; February, 1950.) A survey of frequency-shift systems and their advantages is followed by a general description of a receiver for 1.5-30 Mc teleprinter service, using the audio-filter method of separating mark and space signals (2125 and 2975 cps respectively). Practical filter and limiter characteristics and typical performance figures for the receiver, limiter-detector, relay, frequency-deviation indicator, and voice-frequency keying unit are given.

621.396.662:621.397.62 1762
Continuous Tuning for TV Sets—B. K. V. French. (*FM-TV*, vol. 10, pp. 9-11, 33; March, 1950.) Illustrated details and performance data of an input tuning system covering the range 54-216 Mc and permitting reception of FM broadcasts on 88-108 Mc without the addition of any other components. Another advantage of continuous as compared with step-by-step tuning is that necessary adjustments to compensate for aging do not require a serviceman. Variable-inductance tuning is used because of the wide range to be covered; a new inductuner developed for this purpose is described.

621.396.828 1763
Radio Interference Suppression—S. F. Philpott. (*Electrician*, vol. 144, pp. 1025-1029; March 31, 1950.) Interference caused by small motors is the main form considered, and means of reducing the interference voltages to <0.5 mv at the equipment terminals are discussed, various arrangements of capacitors and chokes being shown. The interference voltages remaining after applying different methods of suppression to a small universal motor are tabulated. A set designed by the Radio Branch of the British Post Office for the measurement of asymmetric rf voltages between the terminals of a machine and earth is briefly described.

STATIONS AND COMMUNICATION SYSTEMS

621.39.001.11 1764
Recent Developments in Communication Theory—C. E. Shannon. (*Electronics*, vol. 23, pp. 80-83; April, 1950.) A nonmathematical treatment of communication systems, discussing methods of coding information, its measurement, and the capacity of a channel in relation to bandwidth, noise, and power. Ideal and practical systems are briefly considered, a speech-transmission method being suggested which requires a bandwidth of only 2.3 cps on a channel with a signal-to-noise ratio of 20 db.

621.39.001.11:519.283 1765
A Simplified Derivation of Linear Least Square Smoothing and Prediction Theory—Bode and Shannon. (*See* 1713.)

621.395.5:621.395.661.2 1766
Note on Matching the Impedance of Terminal Equipment to that of Modern Long-Distance Telephone Lines—R. Sueur. (*Ann. Telecommun.*, vol. 3, pp. 105-108; March, 1948.) Matching defects produce additional crosstalk on the symmetrical lines used for multichannel carrier-current telephony. Equipment for long-distance coaxial cables should be matched to the lines for the lowest frequencies transmitted. C.C.I.F. recommendations for long-distance lines are mentioned and considered with reference to the transmission of television signals.

621.396.41:621.39.001.11 1767
Theoretical Aspects of Asynchronous Multiplexing—W. D. White. (*Proc. I.R.E.*, vol. 38, pp. 270-275; March, 1950.) 1949 IRE National Convention paper. Recent work in

communication theory by Shannon (1361 and 1649 of 1949) makes it possible to deduce the information capacity of a communication system in which isolated pulse transmitters share a common channel without synchronization. Under these conditions it is possible to add redundant information at the output of each transmitter and to separate the signals at the receiver in much the same manner as a wanted signal is separated from random noise. Some simple systems are discussed and specimen numerical data for a 6-station multiplex system are tabulated. Applications of such a system, especially to mobile communication, are suggested.

621.396.5:621.396.619.16 1768
Pulse Multiplex Equipment for 24-Channel Telephony—In the journal reference of 998 of May please read vol. 30 for vol. 29.

621.396.619.16 1769
Pulse Modulation—E. Prokott. (*Arch. Elek. (Übertragung)*, vol. 4, pp. 1-10; January, 1950.) Description of the basic methods: PAM, PHM, PFM, and PWM. The latter is considered as higher-order amplitude modulation. The sideband theory of the different systems is developed, with particular reference to the structure of the pulse train and to application possibilities.

621.396.619.16 1770
Interference Characteristics of Pulse-Time Modulation—E. R. Kretzmer. (*Proc. I.R.E.*, vol. 38, pp. 252-255; March, 1950.) 1949 IRE National Convention paper. Mathematical and experimental analysis, with particular reference to pulse-duration and pulse-position modulation. Both 2-station and 2-path interference are considered. In 2-station interference the stronger signal is completely predominant and the noise has a random character. For single-channel pulse-duration modulation, 2-path interference generally permits fairly good reception of speech and music signals.

621.396.619.16 1771
On Distortion in Pulse-Width Modulation—J. Müller. (*Arch. Elek. (Übertragung)*, vol. 4, pp. 51-58; February, 1950.) An investigation of the deformation of rectangular pulses due to the limited receiver bandwidth, as dependent on the ratio n of pulse period to pulse duration, and also of the distortion caused by subsequent amplitude limiting. Fourier analysis is used and, in an alternative method, the transfer functions of Kùpfmüller. The bandwidth necessary for PWM is determined and the relation of bandwidth to pulse ratio n is considered. Experiments confirm the theory.

621.396.65 1772
Problems of Decimetre-Wave Directional Links—G. Megla. (*Elektrotechnik* (Berlin), vol. 2, pp. 103-109; April, 1948.) Discussion of fundamental considerations in the technique, including choice of wavelength, antenna systems and bandwidth, height of stations, signal level, sensitivity, and antenna gain.

621.396.712+621.397.7 1773
WTCN A.M. F.M. TV—J. M. Sherman. (*Broadcast News*, no. 57, pp. 32-39; January and February, 1950.) Illustrated description of studio and transmitter facilities. The antennas and microwave relay receivers are installed at the top of the Foshay tower, the tallest building in the Minneapolis-St. Paul area.

621.396.712 1774
KENI, Anchorage, Alaska—A. G. Hiebert. (*Broadcast News*, no. 57, pp. 40-44; January and February, 1950.) Illustrated description of studio and transmitter equipment.

621.396.712 1775
Radio Istanbul Covers Near East with 150-kW Transmitter—P. C. Brown. (*Broadcast News*, no. 57, pp. 28-31; January and February, 1950.) Illustrations and a few details of equipment and studio facilities. The RCA Type BTA-150A transmitter operates on 704 kc with a 725-ft antenna tower.

621.396.712 1776
Voice of Americas 150-kW Transmitter—E. L. Schacht. (*Broadcast News*, no. 57, pp. 24-27; January and February, 1950.) Brief details, with illustrations, of a new RCA Type BTA-150A AM transmitter equipment installed in Munich, Germany, to relay on 1195 kc the Voice-of-America programs as they originate in the United States. The antenna system consists of a 4-element array of half-wave towers, giving three different beam patterns which can be selected by switching. The forward power gain on the main lobes is >6.

621.396.931:621.396.826 1777
Echoes in Transmission at 450 Mc/s from Land-to-Car-Radio Units—W. R. Young, Jr. and L. Y. Lacy. (*Proc. I.R.E.*, vol. 38, pp. 255-258; March, 1950.) 1949 IRE National Convention paper. Examples of multipath echoes observed in a moving car in New York City are shown and discussed.

SUBSIDIARY APPARATUS

621-526:621.3.016.35 1778
Contribution to the Study of the Stability of Regulating Circuits and of Servomechanisms—P. L. Dubois-Violette. (*Compt. Rend. Acad. Sci. (Paris)*, vol. 230, pp. 1380-1383; April 12, 1950.)

621.396.682:621.316.722 1779
Cathode Heater Compensation as Applied to Degenerative Voltage-Stabilized Direct-Current Power Supplies—R. C. Ellenwood and H. E. Sorrows. (*Bur. Stand. Jour. Res.*, vol. 43, pp. 251-255; September, 1949.) Full description of the method noted in 468 of March.

TELEVISION AND PHOTO-TELEGRAPHY

621.397.331.2 1780
TV Camera-Tube Design—A. Lytel. (*TV Eng.*, vol. 1, pp. 28-29, 22-25, and 24-26; January-March, 1950.) Mechanical, electronic, and optical characteristics of nine types of pickup tube developed during the past twenty years.

621.397.6:621.385 1781
Encyclopaedia of and Available New Components for Television Equipment—M. Alexant. (*Télev. (Franc)*, no. 57, pp. 9-12; April, 1950.) The first of a series of reviews. American and European cr tubes: receiving, rectifying, and transmitting tubes are tabulated with their characteristics.

621.397.62+621.397.6.001.4 1782
The Video-Frequency Stage—R. Gondry. (*Télev. (Franc)*, nos. 53 and 54, pp. 6-9 and 13-17; November and December, 1949.) Possible circuit arrangements and adjustments for near-linear frequency response are discussed. Circuits of two useful test instruments are given: (a) a square-wave generator; and (b) a tuned amplifier.

621.397.62 1783
Characteristics of High-Efficiency Deflection and High-Voltage Supply Systems for Kinescopes—O. H. Schade. (*RCA Rev.*, vol. 11, pp. 5-37; March, 1950.) The losses in the separate components of reactive deflection

systems are examined individually and in relation to each other. By reducing tube and circuit losses, combined hv and deflection systems can be produced having high efficiency and low cost.

621.397.62 1784
Simplified Inter-carrier Sound—W. J. Stroh. (*Electronics*, vol. 23, pp. 106-109; April, 1950.) By using the new Type-6BN6 tube (1292 of June) as the limiter detector of an inter-carrier sound system, a considerable reduction can be effected in the number of tubes and tuned circuits of a television receiver. Such equipment compares favorably with other FM detectors as regards suppression of ignition interference and of the AM which usually accompanies FM.

621.397.62 1785
TV Applications of the 6BN6—R. O. Gray and W. J. Stroh. (*FM-TV*, vol. 10, pp. 14-15, 30; March, 1950.) When used as an audio limiter-discriminator this tube replaces 3 conventional types. As a synchronization separator it also economizes in components, space, and wiring time. See also 1292 of June (Adler).

621.397.62 1786
A New Method of Synchronization for Long-Range TV Reception—T. B. Tomlinson. (*Electronic Eng.*, vol. 22, pp. 149-151; April, 1950.) The most objectionable feature of long-distance television reception is irregular triggering of the line timebase by noise in the synchronizing pulses. To overcome this a selective amplifier is used which extracts the fundamental component from the synchronizing pulse, which is then squared, differentiated, and applied to the timebase. This system has been used outside the normal service area and consistently provides pictures with good entertainment value.

621.397.62 1787
Permanent-Magnet Lenses for Television Tubes—D. Hadfield. (*Electronic Eng.*, vol. 22, pp. 132-138; April, 1950.) Permanent-magnet focusing systems are becoming increasingly popular for economic reasons. Methods of investigating the field and electron-optical characteristics are described. Magnet design, choice of materials and methods of varying the field, and of magnetizing are considered.

621.397.62 1788
Technique and Developments of High-Definition Television Receivers—In the journal reference of 1018 of May please read vol. 30 for vol. 29.

621.397.62 1789
A.V.C. System for Positive-Modulation Television—E. G. Beard. (*Philips Tech. Commun.* (Australia), no. 6, pp. 9-14; 1949.)

621.397.62 1790
Murphy V150 Television Set—(*Wireless World*, vol. 56, pp. 133-136; April, 1950.) Test report of a table model with unusual features and using a 12-in cr tube.

621.397.62:621.385.2:621.315.59 1791
Use of Germanium Diodes at High Frequencies—J. H. Sweeney. (*Elec. Eng.*, vol. 69, pp. 217-220; March, 1950.) AIEE Winter Meeting paper, 1950. Ge diodes may be substituted for vacuum tubes in detector, dc-restorer and mixer circuits if due allowance is made for the different characteristics of the two types of diode. Compared with the vacuum diode, the Ge unit has a greater forward conductance, though it has a finite back resistance. It has less shunt capacitance and has

zero current flow at zero voltage. Its resistance in either direction varies with temperature.

621.397.62:621.396.662 1792
An Experimental Ultra-High-Frequency Television Tuner—T. Murakami. (*RCA Rev.*, vol. 11, pp. 68-79; March, 1950.) Circuits and detailed description of an experimental 500-700-Mc tuner to enable field tests to be made by standard television receivers on television transmission from the NBC uhf station, Bridgeport (see 1795 below). Each tuning element consists of two strips of copper foil on a cylindrical former, tuned by means of a copper or brass core. A double-heterodyne system converts the uhf signals to the 21-27-Mc intermediate frequency of the standard television receiver. Performance figures are given.

621.397.62:621.396.662 1793
Continuous Tuning for TV Sets—French. (See 1762.)

621.397.7+621.396.712 1794
WTCN A.M. F.M. TV—Sherman. (See 1773.)

621.397.7 1795
Experimental Ultra-High-Frequency Television Station in the Bridgeport, Connecticut Area—R. F. Guy, J. L. Seibert, and F. W. Smith. (*RCA Rev.*, vol. 11, pp. 55-67; March, 1950.) The first of a series of reports on the NBC transmitter KC2XAK. Visual and aural signals from station WNBT, distant 54 miles, are received by a parabolic antenna and re-transmitted on carrier frequencies of 530.25 and 534.75 Mc respectively, using a pylon slot antenna 330 ft above average ground level. Each transmitter will give power outputs of 0.5 kw aural and 1.0 kw peak visual. With an antenna gain of 17, the effective radiated power of the system is approximately 13.9 kw peak visual, the overall efficiency being approximately 80 per cent.

621.397.7 1796
WHIO-TV, Dayton—(*Broadcast News*, no. 57, pp. 48-57; January and February, 1950.) A fully illustrated description of the lay-out and equipment of the studios of the Miami Valley Broadcasting Corporation.

621.397.7:621.397.81 1797
U.H.F. Television Field Test—R. F. Guy. (*Electronics*, vol. 23, pp. 70-76; April, 1950.) A description of experimental equipment for obtaining data on range, field strength and interference effects in uhf television reception. A 500-w commercial vhf unit operating at 176.75 Mc is followed by a tripler and amplifier. A vestigial sideband filter is provided, picture and sound signals being combined in a notch filter and fed to the antenna through a single coaxial line. A unidirectional slot antenna gives a vertical beam-width of about 2° for the main lobe at half-power points, and a power gain >17. Conventional tube technique is satisfactorily employed in the receiving equipment, which includes a special tuner and converter covering the range 500-700 Mc. See also 1792 and 1795 above.

621.397.828 1798
A Study of Co-Channel and Adjacent-Channel Interference of Television Signals—RCA Laboratories Division. (*RCA Rev.*, vol. 11, pp. 99-120; March, 1950.) Television carrier synchronization has been found extremely advantageous in reducing co-channel interference. Offset-carrier operation gives even better results and is more economical to apply. Moreover, it is equally applicable to standard monochrome transmissions and to the dot-sequential and the field-sequential color sys-

tems. For either monochrome or color transmissions it is recommended that the carrier offset shall be 10.5 kc, in a 3-station combination one being above and another below the assigned frequency.

621.397.6 1799
Television for Radiomen [Book Review]—E. M. Noll. Publishers: Macmillan and Co. London, 595 pp., 52s. 6d. (*Wireless Eng.*, vol. 27, p. 134; April, 1950.) "It covers all aspects of television receivers in an elementary manner and includes transmitting material only in just enough detail to give the reader a picture of the complete system. . . . The book should prove extremely valuable to those for whom it is intended, that is, those who have to maintain and repair American television receivers. There is a good deal of material in it useful to those who handle British receivers."

TUBES AND THERMIONICS

621.383.032.217 1800
Optical and Photoelectric Properties of Antimony-Caesium Cathodes—H. D. Morgulis, P. G. Borzyak, and B. I. Dyatlovitskaya. (*Compt. Rend. Acad. Sci. (URSS)*, vol. 56, pp. 925-928; June 21, 1947.)

621.385 1801
Ribbon-Beam Valves—J. L. H. Jonker. (*Tijdschr. ned. Radiogenoot.*, vol. 15, pp. 37-52; March, 1950. In Dutch, with English summary.) Results are presented of laboratory work on the development of special-purpose beam-deflection tubes using ribbon beams, particularly for rapid switching, as in telephony. The replacement of the more common pencil beam by the ribbon beam permits designs having dimensions and anode voltages comparable with those of ordinary receiving tubes.

621.385 1802
Miniature Valves in the French Radio Industry—L. Thibieroz and H. Saucet. (*Tech. Mod. (Paris)*, vol. 42, pp. 65-73; March 1 and 15, 1950.) Illustrated account of the development, manufacture, and testing of 7-pin miniature tubes in the works of the Société Française Radio-Électrique.

621.385:621.396.621 1803
New One-Tube Limiter-Discriminator for F.M.—A. P. Hasse. (*Tele-Tech.*, vol. 9, pp. 21-23, 49 and 32-33, 61; January and February, 1950.) Construction, characteristics, and applications of the Type-6BN6 gated-beam tube. For another account see 1292 of June (Adler).

621.385 (083.72) 1804
Standards on Electron Tubes: Definitions of Terms, 1950—(*Proc. I.R.E.*, vol. 38, pp. 426-438; April, 1950.) A comprehensive list prepared by a committee of The Institute of Radio Engineers. Definitions of tube parameters have been generalized to apply to all tube types at any frequency, and definitions pertaining to beam tubes are included.

621.385.012:621.3.032.213.2 1805
The Influence of the Heating on Valve Cathode Current—G. Kessler. (*Arch. Electrotech.*, vol. 39, pp. 601-619; 1950.) The relation between filament power and emitter temperature is established, and the effect of temperature change on cathode current is determined and expressed as an equivalent grid-voltage variation. The derived relations are confirmed by measurements, evaluated numerically, and applied to discussion of the design of amplifiers of improved performance at very low frequencies, e.g., <10 cps.

- 621.385.015.3 1806
Some Calculations of Transients in an Electronic Valve—D. R. Hartree. (*Appl. Sci. Res.*, vol. B1, pp. 379-390; 1950.) "The integro-differential equation for the non-steady behavior of a beam of electrons injected into the space between two plane parallel electrodes at given potentials is obtained. When the anode and grid are kept at the same potential V_0 , the leading electrons reach the anode with energies greater than eV_0 . If the front of the beam is sharp and the injected beam current is constant, then for the period until some electrons reach the anode and while the spatial order of electrons in the inter-electrode space remains the same as the time-order in which they passed through the grid, the integro-differential equation has an exact solution in terms of Airy functions. An example is given of results calculated from this solution, where applicable, and continued by numerical integration of the integro-differential equation."
- 621.385.029.6+621.396.615.14 1807
On the Physics and Technics of Modern Transmitting Valves for Ultra High Frequencies—K. W. Ruesse. (*Electrotechnik* (Berlin), vol. 4, pp. 33-42 and 81-90; February and March, 1950.)
- 621.385.029.63/.64+621.396.615.14 1808
The Amplification of Centimetre Waves: Travelling-Wave Valves—In the journal reference of 1294 of June please read vol. 30 for vol. 29.
- 621.385.029.63/.64 1809
Study of the Different Waves that Can Be Propagated along a Line in Interaction with an Electron Beam. Application to the Theory of the Travelling-Wave Amplifier—P. Lapostolle. (*Ann. Télécommun.*, vol. 3, pp. 57-71 and 85-104; February and March, 1948.) Detailed discussion of the possible waves in such systems and, in particular, of the wave whose amplitude increases along the line for certain values of the beam velocity. The study of particular models is generalized to apply to any type of delay line. The theory is applicable to beams of any diameter, intensity, and velocity, and line losses are taken into account. Curves are provided which facilitate the solution of many problems associated with the specially important case of very intense beams.
- 621.385.029.63/.64 1810
Traveling-Wave Tubes—J. R. Pierce. (*Bell Sys. Tech. Jour.*, vol. 29, pp. 1-59; January, 1950.) Part 1 of a four-part presentation of the contents of a forthcoming book. Chapter 1 is a brief introduction which stresses the great practical advantage of very broad bandwidth offered by the traveling-wave amplifier. Chapter 2 presents a simple theory of the gain for small signals on the assumption that all the electrons are acted on by the same ac field and are displaced by the field in the axial direction only; the gain is derived from the propagation constant of the forward wave with increasing amplitude. Chapter 3 discusses the helix, a high-impedance circuit capable of propagating slow waves with a phase velocity which is substantially constant over a wide frequency range. An approximation to the properties of a helix is obtained by considering a helically conducting cylindrical sheet of the same radius and pitch. Curves are given which enable the propagation constant, wave velocity, gain parameter and impedance parameter to be determined. The properties of a wire helix are discussed by "developing" the helix into a flat sheet and considering the special cases of two turns or four turns per

wavelength. Optimum design of the helix is treated in terms of the ratios of the beam radius to helix radius and of the wire diameter to pitch. The chapter concludes with a consideration of the transmission-line equivalent to a helix and of losses. Appendix 1 summarizes the field equations and the properties of the Bessel functions I and K and gives curves showing various series approximations to I_0 , I_1 , K_0 , and K_1 . Appendix 2 discusses propagation on a helically conducting cylinder.

- 621.385.029.64/.65 1811
Helix Parameters Used in Traveling-Wave-Tube Theory—R. C. Fletcher. (*Proc. I.R.E.*, vol. 38, pp. 413-417; April, 1950.) Helix parameters used in the normal-mode solution for the traveling-wave tube are determined by considering the field equations for a thin electron beam, the two methods of treatment being found equivalent. Corresponding parameters for a thick electron beam are found by considering an equivalent thin beam with approximately the same rf admittance.
- 621.385.032.213.2:621.317.336.1 1812
Change of Mutual Conductance with Frequency—A. Eisenstein. (*Wireless Eng.*, vol. 27, pp. 100-101; March, 1950.) Comment on 1301 of June (Raudorf). Experiments in which square voltage pulses were applied to the grid of a pentode are discussed. The results obtained support the view that an increase of cathode-interface thickness with tube life offers an explanation both of the observed frequency dependence of the mutual conductance g_m and of the reduction in capacitance with increasing resistance reported by Raudorf. See also 490 of March.
- 621.385.032.216 1813
Vacuum Factor of the Oxide-Cathode Valve—G. H. Metson. (*Brit. Jour. Appl. Phys.*, vol. 1, pp. 73-77; March, 1950.) Measurements on a variety of new tubes showed wide variations of vacuum factor k , but these values fell after a period of operation to an approximately constant value k_0 in the range 300-900 $\mu\text{a}/\text{ma}$. The variations of k_0 were examined with respect to anode voltage, anode current, and to cathode and envelope temperatures. A theory is proposed to explain the anomalous form of variation with anode voltage, which has a bearing on the interpretation of ionization-gauge measurements for pressures $<10^{-6}$ mm Hg.
- 621.385.15 1814
Receiving Tubes Employing Secondary Electron Emitting Surfaces Exposed to the Evaporation from Oxide Cathodes—C. W. Mueller. (*Proc. I.R.E.*, vol. 38, pp. 159-164; February, 1950.) The poisoning of the secondary emitting surface due to cathode evaporation is reduced by careful control of cathode materials and temperature, so that the surface can be exposed directly to the cathode evaporation. This evaporation, if not excessive, may even enhance the secondary emission. The construction and characteristics are described of a tube with a transconductance of 24ma/V, a wide-band figure-of-merit two to three times that of conventional tubes such as Types 6AG5 and 6AK5, and a life of at least 2000 hours.
- 621.385.15.001.8 1815
Recent Applications of Electron Multiplier Tubes—J. S. Allen. (*Proc. I.R.E.*, vol. 38, pp. 346-358; April, 1950.) Applications to the measurement of very small currents or the counting of single ions or electrons are considered. The characteristics of secondary-electron emitting surfaces suitable for use in multiplier tubes are discussed and recently

developed tubes with one or more stages of electron multiplication are described. The statistical treatment of the size distribution of pulses from multiplier tubes is also discussed.

- 621.385.2 1816
The Current Build-Up in a Planar Diode—E. H. Gamble. (*Jour. Appl. Phys.*, vol. 21, pp. 108-112; February, 1950.) An analytical study of the development of the space-charge cloud of electrons and its motion across the interelectrode space, and of the growth of current in the external circuit. Under space-charge-limited conditions the initial build-up is a function of higher powers of time than under temperature-limited conditions. The build-up may be considerably delayed or hastened by application of sine-wave signals of suitable amplitude.
- 621.385.2/.3:621.315.59 1817
Observations of the Rapid Withdrawal of Stored Holes from Germanium Transistors and Varistors—L. A. Meacham and S. E. Michaels. (*Phys. Rev.*, vol. 78, pp. 175-176; April 15, 1950.) Investigations of transistor response to square pulses of applied voltage have shown bursts of collector current provoked by preceding emitter current in units employing N-type germanium. These are thought to be due to the rapid withdrawal of stored holes produced by the forward emitter current and existing in the germanium at the time of application of the collector potential.
- 621.385.2:621.315.59 1818
On the Surface Conductance of Germanium—P. Aigrain. (*Compt. Rend. Acad. Sci. (Paris)*, vol. 230, pp. 732-733; February 20, 1950.) The surface conductance of a diode of 20-k Ω back resistance was demonstrated by measuring voltage variations at two beryllium-bronze contact points equidistant from the input point but on opposite faces of the Ge disk; except at very low input currents the variation on the input face was much the greater; since this variation depends only on input current, the transistor effect must be due to a modulation of the surface conductance. See also 1305 of June.
- 621.385.2:621.315.59]:621.397.62 1819
Use of Germanium Diodes at High Frequencies—Sweeney. (See 1791.)
- 621.385.3:621.396.615.14 1820
Electron Transit Time—S. K. Chatterjee and B. V. Sreekantan. (*Wireless Eng.*, vol. 27, pp. 59-63; February, 1950.) Transit-time effects on the efficiency and limiting oscillation frequency were studied for Type 833A, 834, 304B, 316A, and 955 tubes, using Gavin's expression for transit time (4358 of 1939), modified to take account of the negative grid bias and the alternating voltages on the anode and grid. The limiting frequency is reached for the first three of the above tubes when the oscillation period is nearly four times the electron transit time from cathode to anode, and for the other two tubes when the period is nearly three times the transit time.
- 621.385.4/.5 1821
Aligned-Grid Valves—D. C. Rogers. (*Wireless Eng.*, vol. 27, pp. 39-46; February, 1950.) An experimental investigation was made of the distribution of current density in the plane of the screen grid. In order to check the validity of existing assumptions about aligned-grid tubes, and to determine the optimum distance between the control and screen grids, a demountable planar tube was used in which the screen grid was replaced by a plate with a 0.1-mm slot parallel to the grid wires. The current flowing to a collector electrode behind

the slot was measured. Electrode distances were adjustable by means of micrometer screws and the slotted plate had similar adjustment in its plane at right angles to the slot. The control-grid pitch and total anode current were kept constant and the collector current was measured across the beam from the center grid aperture at intervals of 0.1 mm, the grid being at cathode potential. The process was repeated for various electrode distances. The results indicate that for minimum screen current, the screen should be as close as possible to the control grid and not, as is often assumed, in the plane of focus of the electron beam.

621.385.83:621.396.619.23 1822

The Electron Coupler: a Spiral-Beam U.H.F. Modulator—C. L. Cuccia and J. S. Donal, Jr. (*Electronics*, vol. 23, pp. 80-85; March, 1950.) A description based on that given in a 1949 IRE National Convention paper. See 2975 of 1949.

621.385.832 1823

A Method of Reducing Deflection Defocusing in Cathode-Ray Tubes—R. G. E. Hutter and S. W. Harrison. (*Jour. Appl. Phys.*, vol. 21, pp. 84-89; February, 1950.) The causes of spot distortion are explained and an electron gun is described in which beam predistortion is used for spot correction. The method can be used for both es and em focusing and deflecting systems.

621.396.615.14 1824

Observations on Some Electronic Fundamentals of Microwave Valves—W. Sigrist. (*Bull. Schweiz. Elektrotech. Ver.*, vol. 41, pp. 35-42; January 21, 1950. In German.) A graphical method of integration is described by which the electron paths may be exactly traced after the fields at the electrodes have been determined by the use of an electrolyte tank.

621.396.615.14 1825

The Linear Theory of Transit-Time Valves—F. W. Gundlach. (*Fernmeldelech. Z.*, vol. 2, pp. 319-328; October, 1949.) The operation of almost all transit-time tubes can be referred to the fundamental problem of electron motion in a plane capacitor. Under the assumption of small alternating voltages and currents, analytical relations are derived for the electron motion and for the currents thereby produced in the capacitor. The results are applied to the diode oscillator, the retarding-field tube, the klystron, and its reflex type, and to the Heil generator.

621.396.615.141.2 1826

The Flow of Standing Current in a Cylindrical Whole-Anode Magnetron—W. M. Glagolev. (*Zh. Tekh. Fiz.*, vol. 19, pp. 943-951; August, 1949. In Russian.)

621.396.615.141.2 1827

Phase Focusing in a Magnetron with Plane Electrodes—B. M. Zamorozkov. (*Zh. Tekh. Fiz.*, vol. 19, pp. 1321-1328; November, 1949. In Russian.) The idea of phase focusing was used by Golubkov in 1939 (*Bull. Acad. Sci.*

(*URSS*), vol. 4, p. 524; 1940) for providing a general theory which would be applicable to various types of uhf oscillators. This theory is applied to a study of the magnetron. It is fully adequate for interpreting the operation of the magnetron and equation (11) is derived determining the critical conditions. The relation between the generated wavelength and the intensity of the magnetic field is determined from the general equation (13) of Okabe (*Radio Res. Rep.* (Japan), vol. 5, p. 69; 1935). The possibility is also suggested of the appearance of second-order foci and of oscillations due to interaction between these foci and the electrodes. The theoretical results have been confirmed experimentally.

621.396.615.141.2 1828

The Planar Magnetron under Static Conditions of Space Charge—J. L. Delcroix and G. A. Boutry. (*Compt. Rend. Acad. Sci.* (Paris), vol. 230, pp. 1046-1048; March 13, 1950.) The equations are stated for space-charge conditions when the anode potential is higher than the cut-off potential. When cut-off occurs, the space-charge conditions can be deduced from those for the preceding case. The electron paths in the two cases are arcs of one and the same geometric curve.

621.396.615.141.2:621.396.645 1829

A New Type of Magnetron Amplifier—P. Marié. (*Onde Elec.*, vol. 30, pp. 13-22, 79-90, and 209-202; January, February, and April, 1950.) The variation of a negative resistance as a function of voltage is studied, the internal mechanism of the magnetron is discussed the threshold resistance calculated, and the relative amplitudes of the reflected and incident waves are determined. The threshold resistance decreases with frequency and in a wide band centered on the mean frequency can be considered as the reciprocal of the characteristic impedance of a waveguide with a given cut-off frequency. Separation of the reflected and incident waves requires the generation of polyphase waves. Their theory and the construction of 3-phase directional couplers are discussed. The constructional details of the magnetron itself are described. It is of the split-anode type, with 12 anode segments strapped in interleaved groups of 4. Using this system of overlapping anodes, the directional coupling may be incorporated in the tube itself. Experimental results will be given later.

621.396.615.142.2 1830

On the Theory of the Klystron—V. N. Shevchik. (*Zh. Tekh. Fiz.*, vol. 19, pp. 1271-1275; November, 1949. In Russian.)

621.396.822 1831

Spontaneous Fluctuations in Double-Cathode Valves—R. Fürth. (*Wireless Eng.*, vol. 27, p. 129; April, 1950.) Corrections to paper abstracted in 1035 of May.

621.396.822 1832

Are Transit-Angle Functions Fourier Transforms?—W. E. Benham. (*Wireless Eng.*, vol.

27, pp. 131-132; April, 1950.) Further discussion. See 2981 of 1949.

621.396.822 1833

Induced Grid Noise—R. L. Bell. (*Wireless Eng.*, vol. 27, pp. 86-94; March, 1950.) Under favorable conditions there is an exact relationship between mean-square noise currents induced at the grid of a triode tube and the "space-charge" component of input capacitance measurable at that point. In practice this provides an approximate relation useful for estimating the total mean-square induced noise from other measurements. Techniques of grid-noise measurement are discussed and attention is drawn to the occurrence of various inherent errors. Results are presented of measurements of induced grid noise in microwave triodes at 200 Mc. Available three-halves power-law treatments are inadequate to explain the induction of shot noise at a control grid, but values of space-charge admittance measured on the tube together with other low-frequency measurements may be made to yield much closer estimates of induced grid noise in any structure, for moderate transit angles.

621.396.822 1834

Fluctuation Process as Oscillations with Random Amplitude and Phase—V. I. Bunimovich. (*Zh. Tekh. Fiz.*, vol. 19, pp. 1231-1259; November, 1949. In Russian.) It is known that fluctuations at the output of an oscillatory system have the form of sinusoidal oscillations with amplitude and phase varying more or less slowly. In many cases it is convenient to represent fluctuations in the form $E \cos \phi$ where E and ϕ have definite and statistically independent random values. An investigation is presented of the statistical properties of the amplitude and phase of a fluctuation process. The investigation is divided into the following sections: (a) envelope; (b) fundamental relations; envelope and phase of a random process; (c) laws governing the probability distribution; and (d) probability distribution for the phase of fluctuations.

621.385 1835

Rundfunkröhren, Eigenschaften und Anwendung (Properties and Applications of Broadcasting Valves) [Book Review]—L. Ratheiser, revised and enlarged by H. Hönger and G. Hinke. Publisher: Regeliens Verlag. Berlin Gruenwald, 1949, 440 pp., 27DM. (*Arch. Elek.*, (Übertragung), vol. 4, p. 32; January, 1950.) "Helpful for all concerned with broadcast reception."



































MISCELLANEOUS

621.396.6.001.2:621.396.9:629.13.052 1836

Mechanical Development of a Radio Altimeter—R. T. Croft. (*Jour. Brit. I.R.E.*, vol. 10, pp. 62-71; February, 1950.) Discussion of the problems involved in converting a laboratory model into an engineered instrument suitable for production in quantity. The general principles are illustrated by considering the detailed construction of a radio altimeter designed by the research staff of the Telecommunications Research Establishment.

ADVENTURES IN ELECTRONIC DESIGN

Centralab's Printed Electronic Circuits May Solve a Problem for You

In a busy Washington  office during the past war  hung a sign  which said — “We do the miraculous every day — the impossible takes just a little longer.” Today, that sign  could hang in the offices of  Centralab. For example, someone wanted a *small* speech amplifier  Centralab's answer —  Ampec, a full 3 stage unit, two of which can fit inside of a regular pack of cigarettes!  A radio manufacturer  wanted a *small* audio-detection unit. Centralab's answer  Audet, a unit one-third size of an ordinary soda-cracker!  How were these things done? With Centralab's  Printed Electronic Circuits — a pioneered  development of  Centralab. Yes, and here are some of the benefits that many manufacturers of radio  TV sets  and other electronic gear  have reaped from using PEC's. They've eliminated numerous individual parts  their handling, inventory  and assembly. They've gotten more consistent and better performance results.  They've reduced finished product size and weight. They've eliminated wiring errors  and cut down on the number of  soldered connections. What's more, they've been able to stretch  their resistor supplies . . . an important factor in meeting current volume demands  for TV and radio production. Look over your own situation.  Want to cut costs?  Speed up assembly?  Then on the next two pages you may see a Centralab Printed Electronic Circuit unit    that will help you do just that! If you don't see what you want — contact us.  Tell us your problems. Maybe we can do the miraculous or take a little longer and accomplish the impossible!    

Centralab — DEVELOPMENTS THAT CAN HELP YOU 

Division of GLOBE-UNION INC., Milwaukee

CUT ASSEMBLY COSTS

Conserve Resistors

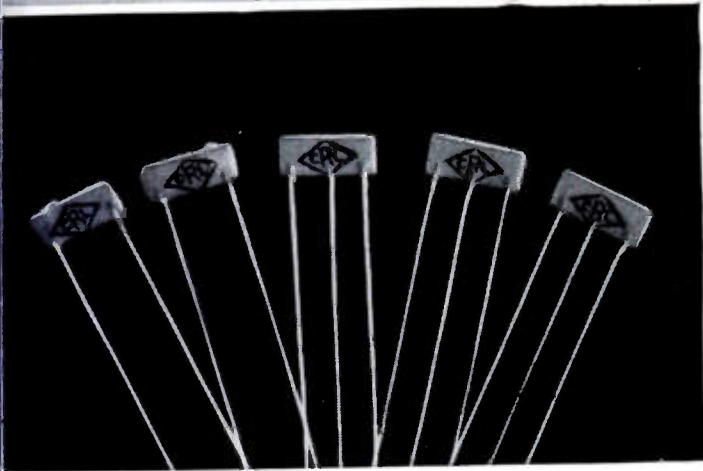

Actual size photograph of a group of plate capacitor, resistor, and resistor-capacitor units. Because of size and ease of installation, they readily fit all types of miniature and portable electronic equipment and overcome crowded conditions in TV, AM, FM and record-player chassis.

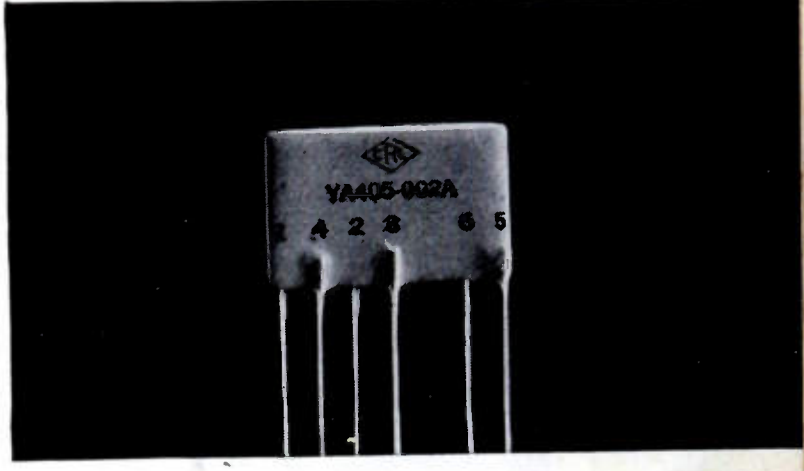

Pentode couplates are complete interstage coupling circuits consisting of 3 capacitors and 3 resistors on a small 6 lead ceramic plate. Compared with old-style audio circuits, they actually reduce soldered connections 50% — wiring errors accordingly. Saving in space and weight is obvious.

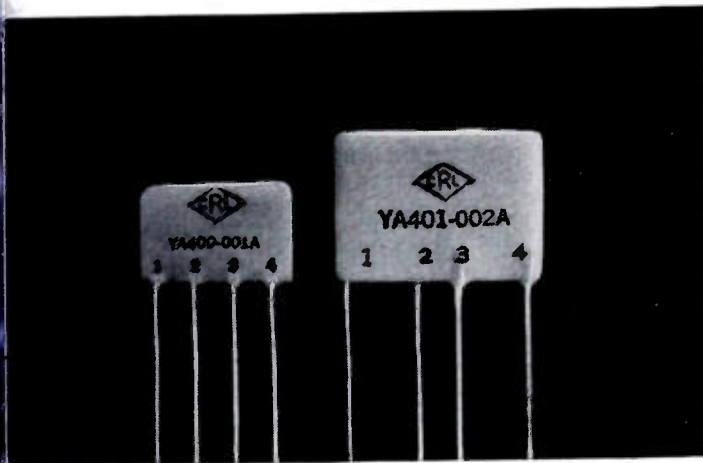

Centralab Triode Couplates save space and weight. They actually replace 5 components normally used in audio circuits. Triode Couplates are complete assemblies of 3 capacitors and 2 resistors bonded to a dielectric ceramic plate. Available in a variety of resistor and capacitor values.

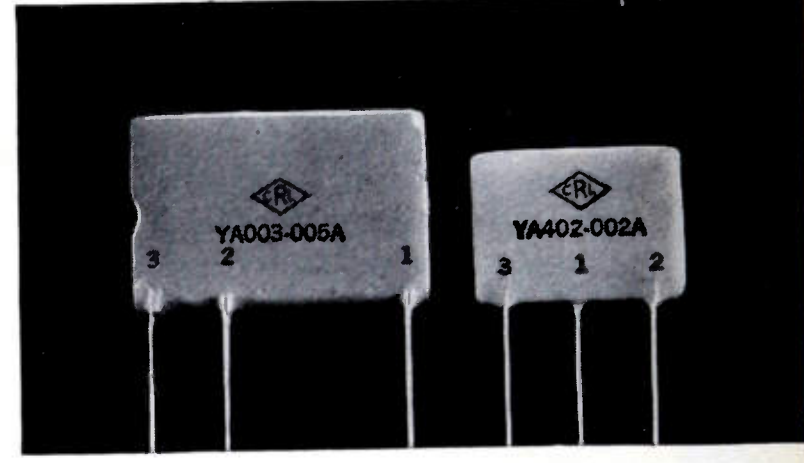

Centralab Vertical Integrators give you big savings in assembly costs, particularly in TV vertical integrator networks. One type consists of 4 resistors and 4 capacitors brought out to 3 leads . . . reducing the formerly required 16 soldered connections to only 3! There's a big saving in the number of parts handled, too!

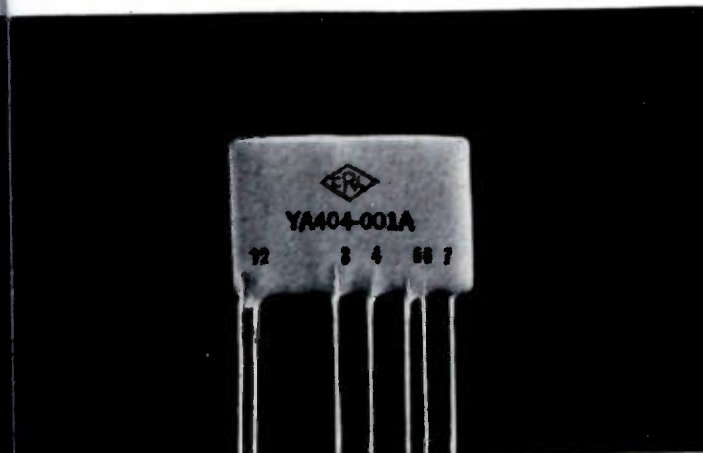

Audet P. E. C. units furnish all values of all components generally comprising the output stage of AC-DC radio receivers. They give you 4 capacitors and 3 resistors on a small plate with only 7 leads. Using Audet for output stage eliminates 50% of your usual soldered connections.

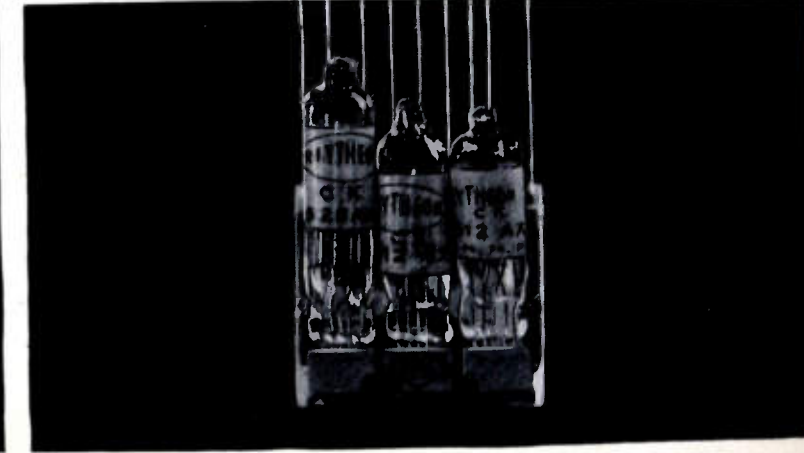

Ampec is a full 3-stage, 3-tube speech amplifier. Gives you truly highly efficient reliable performance. Size: 1/4" x 1 1/8" x .340" over tube sockets! Widely used in hearing aids, mike preamps and other amplifier applications where small size and outstanding performance counts.

IMPORTANT BULLETINS FOR YOUR TECHNICAL LIBRARY!

They're factual!



THEY'RE FREE!

Choose From This List!

Centralab Printed Electronic Circuits

- 973 — AMPEC — three-tube P. E. C. amplifier.
- 42-6 — COUPLATE — P. E. C. interstage coupling plate.
- 42-22 — VERTICAL INTEGRATOR — for TV application.
- 42-24 — CERAMIC PLATE COMPONENTS — for use in low-power miniature electronic equipment.
- 42-27 — MODEL 2 COUPLATE — for small or portable set applications.
- 999 — PENTODE COUPLATE — specialized P. E. C. coupling plate.
- 42-9 — FILPEC — Printed Electronic Circuit filter.

Centralab Capacitors

- 42-3 — BC TUBULAR HI-KAPS — capacitors for use where temperature compensation is unimportant.
- 42-4R — BC DISC HI-KAPS — miniature ceramic BC capacitors.
- 42-10 — HI-VO-KAPS — high voltage capacitors for TV application.
- 42-59 — CERAMIC TUBULAR TRIMMERS — designed for TV and VHF application.
- 695 — CERAMIC TRIMMERS — CRL trimmer catalog.

- 981 — HI-VO-KAPS — capacitors for TV application. For jobbers.
- 42-18 — TC CAPACITORS — temperature compensating capacitors.
- 814 — CAPACITORS — high-voltage capacitors.
- 975 — FT HI-KAPS — feed-thru capacitors.

Centralab Switches

- 953 — SLIDE SWITCH — applies to AM and FM switching circuits.
- 970 — LEVER SWITCH — shows indexing combinations.
- 995 — ROTARY SWITCH — schematic application diagrams.
- 722 — SWITCH CATALOG — facts on CRL'S complete line of switches.

Centralab Controls

- 42-19 — MODEL "1" RADIOHM — world's smallest commercially produced control.
- 42-85 — MODEL 2 RADIOHM — CRL's new line of 1/16" diam. controls for TV — AM — FM.

Centralab Ceramics

- 967 — CERAMIC CAPACITOR DIELECTRIC MATERIALS.
- 720 — CERAMIC CATALOG — CRL steatite, ceramic products.

Look to CENTRALAB in 1950! First in component research that means lower costs for the electronic industry. If you're planning new equipment, let Centralab's sales and engineering service work with you. For complete information on all CRL products, get in touch with your Centralab Representative. Or write direct.

CENTRALAB

Division of Globe-Union Inc.
900 East Keefe Avenue, Milwaukee, Wisconsin

Yes—I would like to have the CRL bulletins, checked below, for my technical library!

- | | | | | | | |
|--------------------------------|--------------------------------|--------------------------------|--------------------------------|--------------------------------|------------------------------|--------------------------------|
| <input type="checkbox"/> 973 | <input type="checkbox"/> 42-24 | <input type="checkbox"/> 42-9 | <input type="checkbox"/> 42-10 | <input type="checkbox"/> 981 | <input type="checkbox"/> 953 | <input type="checkbox"/> 42-19 |
| <input type="checkbox"/> 42-6 | <input type="checkbox"/> 42-27 | <input type="checkbox"/> 42-3 | <input type="checkbox"/> 42-59 | <input type="checkbox"/> 42-18 | <input type="checkbox"/> 970 | <input type="checkbox"/> 42-85 |
| <input type="checkbox"/> 42-22 | <input type="checkbox"/> 999 | <input type="checkbox"/> 42-4R | <input type="checkbox"/> 695 | <input type="checkbox"/> 814 | <input type="checkbox"/> 995 | <input type="checkbox"/> 967 |
| | | | | <input type="checkbox"/> 975 | <input type="checkbox"/> 722 | <input type="checkbox"/> 720 |

Name.....

Address.....

City..... State.....

TEAR OUT COUPON

← for the Bulletins you want →

Centralab

Division of GLOBE-UNION INC. • Milwaukee



ATLANTA

"The Brain and Electronics," by L. H. Montgomery, Chief Transmitter Engineer, WSM; May 26, 1950.

BEAUMONT-PORT ARTHUR

"Some Problems in Miniaturization of Component Parts," by Leon Podolsky, Sprague Electric Company; May 17, 1950.

"Electrons at Work and Play," by R. L. Nichols, Magnolia Petroleum Co.; May 30, 1950.

"TV Capacitors," by John Leedom, Sprague Electric Co.; June 5, 1950.

BOSTON

"Television—Why the Deep Freeze?" by S. L. Bailey, Jansky and Bailey; January 26, 1950.

"A 3,000-Mc Bandwidth Amplifier Triode," by L. F. Moose, Bell Telephone Laboratories; February 23, 1950.

"The RCA-NBC UHF Television Project at Bridgeport, Conn.," by R. F. Guy, National Broadcasting Company; "1-KW UHF Television Transmitter," by T. M. Gluyas, RCA Victor; "UHF Television Antenna System," by O. O. Fiet, RCA Victor; Election of Officers; May 25, 1950.

BUFFALO-NIAGARA

"Industrial Television System," N. S. Bean, RCA Victor; Election of Officers; May 17, 1950.

CEDAR RAPIDS

"An Industrial Television System," by R. C. Webb, Faculty, Iowa State College; May 24, 1950.

CHICAGO

"The Properties and Characteristics of Color Television Systems Proposed to F.C.C.," by Frank McIntosh, Consulting Engineer; "Phonevision Progress," by J. R. Howland, Zenith Radio Corporation; April 24, 1950.

"A Circuit Theory of Neuroses," by W. S. McCulloch, University of Illinois; Election of Officers; May 19, 1950.

CINCINNATI

"Serendipity, Cybernetics, and Electronics," by W. C. White, General Electric Research Laboratory; April 18, 1950.

Spring Technical Conference; April 29, 1950.

"The Human Side of Engineering," by W. L. Webb, Bendix Aviation Corp.; May 16, 1950.

CONNECTICUT VALLEY

"Electronics in Measurement," by T. W. Wall, General Electric Co.; "The Mechanization of Sound Measurements with Electronic Aids," by W. B. Conover, General Electric Co.; "Stabilization of Testing Power," by H. F. Parker, General Electric Co.; Inspection Trip to General Electric's High Voltage Laboratory; May 18, 1950.

DAYTON

"The Engineer and His Professional Society," by D. B. Sinclair, General Radio Co.; Election of Officers; May 18, 1950.

DENVER

"RCA Industrial Television System," by R. C. Webb, Iowa State College; Election of Officers; May 26, 1950.

EMPORIUM

"High-Quality Loud Speakers," by R. F. Bozak, R. F. Bozak Co.; May 31, 1950.

EVANSVILLE-OWENSBORO

"Transient Response and Square Wave Testing," by J. E. Everett, Tektronic, Inc.; Tour of Electronic Tube Manufacturing Facilities at the Owensboro Plant of the General Electric Co.; May 17, 1950.

(Continued on page 38A)

Specify BREEZE "Monobloc" Waterproof and Pressure Sealed CONNECTORS



The only APPROVED Monobloc System for Advanced Radar, Communications, and Electronic Equipment

Breeze "Monoblocs", with single piece plastic inserts, offer outstanding advantages in assembly, wiring, mounting and service in the field.

Single piece inserts make a tighter unit, eliminate the air spaces within conventional multiple-piece inserts, greatly reduce the opportunity for moisture shorts.

Removable contact pins make possible bench soldering of leads, quick, error free assembly of Breeze Waterproof Connectors and panel-type "Monobloc Miniatures."

Single-Hole Panel Mounting is all that is required for either Waterproof or Pressure Sealed types.

Pressure Sealed types are available for values up to and including 75 psi, or they can be specially engineered for greater pressures. They meet specified requirements of shock, vibration, salt spray, humidity and temperature cycling from -65° to $+185^{\circ}$ F.

Breeze "Monobloc" Waterproof and Pressure Sealed Connectors are engineered to your requirements in aluminum, brass or steel—in all sizes and capacities. They are fully tested and approved... cost no more than ordinary types.

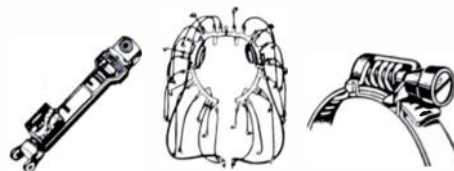

Other Breeze Precision Products

ACTUATORS: All types, sizes. Complete control systems engineered to requirements. Above: Lending gear actuator Fairchild Packet.

RADIO SHIELDING: For any type of high or low tension system. New type "unit leads" or re-wirable leads. Flexible shielded conduit.

"AERO-SEAL" Worm-Drive Hose Clamps. Vibration proof, uniform clamping, use again and again. All clamps have stainless steel bands.

Write for Details

If you have a tough connector problem, ask BREEZE for the answer!

BREEZE

CORPORATIONS, INC.

41-G South Sixth Street, Newark 7, N.J.

NEW!

THE HIGHEST GAIN COMMUNICATIONS ANTENNA EVER BUILT!

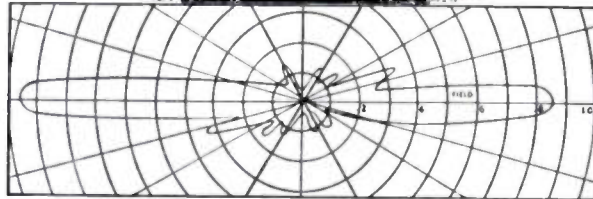

VERTICAL RADIATION PATTERN OF TYPE 3000 ANTENNA

Actually delivers 6 db increases your power 4 times!

Now, for the first time, you can operate in areas previously far out of your reach. This vast extra service area is yours at no additional operating cost because the 6 db actually delivered by this new ANDREW antenna is equivalent to increasing your power 4 TIMES! Think of the economy! This tremendous extra power also fills in any dead spots.

It's another pace-setting ANDREW "first".

Uniformity of performance is assured regardless of supporting structure height through a NEW EXCLUSIVE ANDREW METHOD of electrically isolating the radiating elements from the support structure.

Lightning protection and quieter reception during electrical storms are achieved by a DC path which conducts static charges from the elements to ground.

SPECIFICATIONS 148-174 MC

TYPE NO.	3000	3001	3002
Gain	6 db	6 db	3 db
Height above top of tower	27½ ft.	27½ ft.	13½ ft.
Length of support mast extending into tower	5 ft.	5 ft.	5 ft.
Weight	625 lbs.	375 lbs.	175 lbs.
Moment at tower top*	9300 ft. lb.	6150 ft. lb.	1600 ft. lb.

*Based on 100 mph wind loading and ½" radial ice. Moments include loading added by 300 mm beacon for Type 3000 and double obstruction light for Type 3001.

Type 3000 is designed to support a 300 mm code beacon, and includes a suitable mounting plate. Type 3001 is designed to support a double obstruction light.

All models are designed for connection to ANDREW Type 737 transmission line, and are provided with climbing steps.

All orders filled chronologically. Deliveries begin September 1. Write, wire or phone (ask for Mr. Bickel) today.

Andrew CORPORATION

363 EAST 75th STREET - CHICAGO 19



WORLD'S LARGEST ANTENNA EQUIPMENT SPECIALISTS

TRANSMISSION LINES FOR AM-FM-TV • ANTENNAS • DIRECTIONAL ANTENNA EQUIPMENT
ANTENNA TUNING UNITS • TOWER LIGHTING EQUIPMENT • CONSULTING ENGINEERING SERVICES



(Continued from page 37A)

HAWAII

"Loran. Principles, Problems and Applications," by Paul Burhorst, 14th District Coast Guard Office; Election of Officers; May 16, 1950

INDIANAPOLIS

"Baldwin Electronic Organ," by D. W. Martin, Baldwin Piano Co.; May 19, 1950.
"Atomic Power in War and Peace," by R. J. Kryter, Eaterline-Angus Co.; June 2, 1950

LOS ANGELES

"Methods of Nuclear Radiation Measurement," by H. K. Ticho, University of California; Film: "Atomic Physics"; June 6, 1950

NEW MEXICO

"A Multiple Sealar for Laboratory Use," by G. C. Lagomassini and E. M. Hodges, Students, University of New Mexico; "The Fixed Probes, Method of Impedance Measurement," by R. D. Ewing, Student, New Mexico College of Agriculture and Mechanic Arts; May 12, 1950

NORTH CAROLINA-VIRGINIA

"The Engineer in Electronics," by R. F. Guy, National Broadcasting Co.; May 12-13, 1950.

OMAHA-LINCOLN

"Miniature Condenser Microphone," by J. K. Hilliard, Altec-Lansing; April 20, 1950.
"The Reproduction of Music," by John Goodell, Minnesota Electronics Corporation; May 23, 1950

PITTSBURGH

"Automatic Control in Telephone Switching," by William Keister, Bell Telephone Labs., Inc.; June 12, 1950

PORTLAND

"Direct Reading Radio-Frequency Wattmeter" by W. S. Burdic, Oregon State College; "Plate Load Impedance Characteristics of an Audio-Frequency Power Amplifier," by L. B. Craine, Oregon State College; "Signal Distortion by Directional Broadcast Antennas," by C. H. Moulton, Oregon State College; April 1, 1950. "New Aircraft Landing System and Associated Equipment," by Ward Cutting, C.A.A.; April 27, 1950

ROCHESTER

"Television Transmission," by K. J. Gardner and A. W. Balling, Radio Station WHAM-FM and TV; Election of Officers; May 25, 1950

SAN ANTONIO

"The Effect of Scattering on the Reception of Radio Signals," by A. W. Straiton, Faculty, The University of Texas; May 25, 1950

SCHENECTADY

"Highways of Speech," by M. S. Paige, New York Telephone Co.; May 15, 1950.
Inspection of WRGB Television Station; June 19, 1950

SEATTLE

"Modern Transmission Methods in Electrical Communications," by Ralph Bown, Bell Telephone Laboratory; May 18, 1950.
"Metal Plate Lenses for Microwaves," by J. W. Brady, Faculty, Oregon State College; Tour of the Crown-Willamette Paper Mill; May 20, 1950

ST. LOUIS

"Pulses in Circuits and Lines," by D. L. Waidleich, Faculty, University of Missouri; May 25, 1950

TOLEDO

"Operations and Problems Involved in Regional Affairs," by H. E. Kranz, IRE Regional Director; Film; Election of Officers; May 15, 1950

(Continued on page 40A)

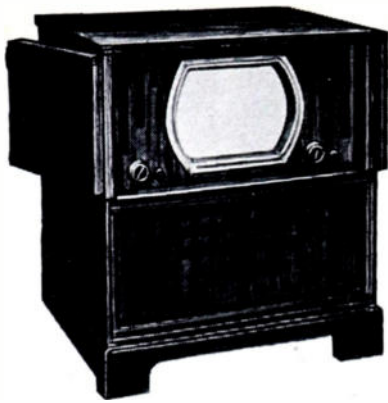

**YOU CAN HAVE
THE FINEST T-V CABINET
IN THE WORLD . . . BUT**

YOU AIN'T GOT NOTHIN'!

**YOU CAN HAVE
THE FINEST T-V CHASSIS
IN THE WORLD . . .**

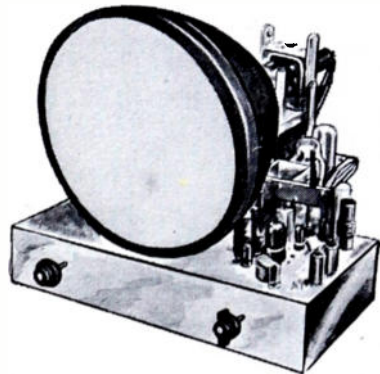

YOU STILL AIN'T GOT NOTHIN'!

BUT WHEN YOU ADD A

**Sheldon
PICTURE TUBE,**

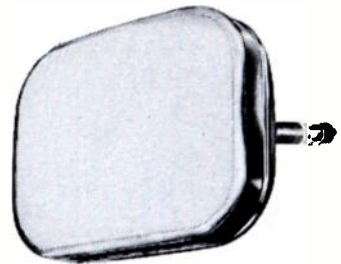
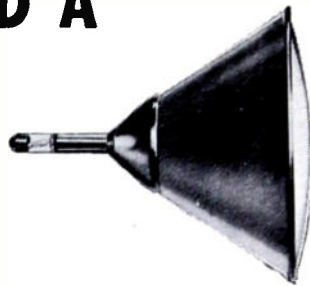

THE FINEST IN THE WORLD . . .

YOU REALLY HAVE SUMPTHIN'!

**Sheldon
NATURAL IMAGE**



**SOFT GLOW
Picture Tube**

SHELDON ELECTRIC CO.

Division of Allied Electric Products Inc.

68-98 Coit Street, Irvington 11, N. J.

Branch Offices & Warehouses: CHICAGO 7, ILL., 426 S. Clinton St.

LOS ANGELES 26, CAL., 1755 Glendale Blvd.

**SHELDON TELEVISION PICTURE TUBES • SHELDON CATHODE RAY TUBES • SPRING ACTION PLUGS
TAPMASTER EXTENSION CORD SETS & CUBE TAPS • SHELDON REFLECTOR AND INFRA-RED LAMPS
PHOTOFLOOD & PHOTOSPOT LAMPS • FLUORESCENT STARTERS & LAMPHOLDERS • RECTIFIER BULBS**

A Complete Line of PRODUCTION TEST EQUIPMENT for TV Manufacturers

Tel-Instrument has designed and provided the production test equipment for many of the major TV manufacturers. A complete line of instruments designed to be unusually critical in the testing of TV receivers is available. They are the result of the wide practical experience of Tel-Instrument engineers plus a complete understanding of the production problems of TV manufacturing.

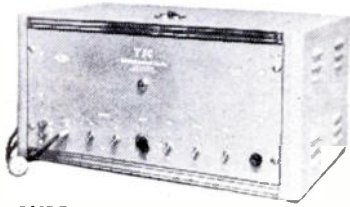

TYPE 2120
R.F. PICTURE SIGNAL GENERATOR

Provides picture and sound carrier. Modulated by standard R.M.A. composite picture signal. Sound carrier stability suitable for testing Inter Carrier type receivers. Internal 400 cycle FM and External audio with 75 microsecond pre-emphasis. Output max. 0.1v p-p across 75 ohm line. Available channels 2-13.

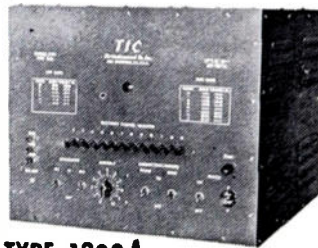

TYPE 1200A
12 CHANNEL
R.F. SWEEP GENERATOR

Intended for precise adjustment of R.F. head oscillator coils and R.F. bond pass circuits. Pulse type markers of picture and sound carrier frequencies extend to zero signal reference base line. Accuracy of markers 0.02% of carrier frequency. 12 to 15 MC. sweep on all channels. Max. 1.V peak output across a 75 ohm line. Provisions for balanced input receivers. Instant selection by push button.



TYPE 1900
CRYSTAL CONTROLLED
MULTI-FREQUENCY GENERATOR

A 10 frequency, 400 cps. modulated crystal controlled oscillator, ideal for production line adjustment of stagger tuned I.F. amplifiers. Available with crystals ranging from 4.5 to 40 M.C. Output frequency accurate to 0.02%. Immediate push button selection of frequency. Output attenuator range .5V to 500 microvolts. Self contained regulated power supply.



TYPE 1500A
I.F. WOBULATOR

A two band sweeping generator covering the range of 4.5 to 50 M.C. Capable of a band width of approximately $\pm 25\%$ on either band. Five pulse type crystal generated markers to specified frequencies available for each band. Accuracy of markers .05%. Zero signal reference base line, with markers extending to base line. 1.V output max. into 75 ohms. A saw sweep available for "X" axis of scope.

Write for Detailed Engineering Data Sheets.

Tel-Instrument Co. Inc.

54 PATERSON AVENUE • EAST RUTHERFORD, N. J.



(Continued from page 38A)

WASHINGTON

"Analysis of Performance of the Omni-Bearing-Distance Navigation System," by J. W. Leas, Air Navigation Development Board; May 8, 1950.

WILLIAMSPORT

"Microwave Transmission Characteristics," by E. H. Boden, Faculty, Bucknell University; May 16, 1950.

Election of Officers; May 16, 1950.

SUBSECTIONS

LONG ISLAND

Field Trip; Brookhaven National Laboratories; May 20, 1950.

NORTHERN NEW JERSEY

"The Columbia Long-Playing Microgroove Recording System," by Rene Sneyvanger, Columbia Broadcasting System; Election of Officers; May 24, 1950.

MONMOUTH COUNTY

"Experimental Radiotelephone Service for Train Passengers," by Newton Monk, Bell Telephone Laboratories; May 17, 1950.

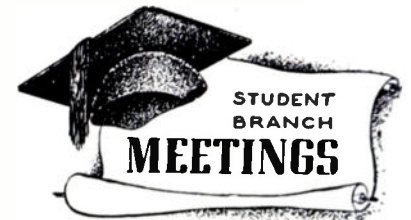

ALABAMA POLYTECHNIC INSTITUTE, IRE BRANCH
Film; Election of Officers; May 22, 1950.

CALIFORNIA INSTITUTE OF TECHNOLOGY,
IRE BRANCH

"Problems in the Design and Production of Television Receivers," by John A. Rankin, Hoffman Radio Company; May 22, 1950.

UNIVERSITY OF COLORADO, IRE-AIEE BRANCH
Films; "Theory of Flight," "Problems of Flight"; Election of Officers; May 3, 1950.

"The Network Analyzer," by W. Morgan, Reclamation Bureau at Denver; May 17, 1950.

UNIVERSITY OF DENVER, IRE-AIEE BRANCH
Business Meeting; May 25, 1950.

FENN COLLEGE, IRE BRANCH
Election of Officers; May 15, 1950.

JOHN CARROLL UNIVERSITY, IRE BRANCH
"The Spectrograph," by Clifford Poutney, Graduate Student and Faculty, John Carroll University; Business Meeting; May 11, 1950.

"The Basic Questions in Television," by Joseph Epperson, Scripps Howard Television Stations; May 25, 1950.

UNIVERSITY OF KENTUCKY, IRE BRANCH
Tour of the Long Lines Department of the American Telephone and Telegraph Co., by A. F. Gleaves, American Telephone and Telegraph Co.; May 12, 1950.

"Silicone Insulation in the Electrical Industry," by Mr. Noegle, Dow Corning Corporation; May 16, 1950.

"Electronics in the Electrical Power Industry," by E. W. Brown, Jr., Kentucky Utilities Company; May 23, 1950.

UNIVERSITY OF MAINE, IRE BRANCH
"Institute Affairs," by R. E. Frank; "Process Control," by Richard Schlotterbeck; Business Meeting; May 24, 1950.

(Continued on page 42A)



WILCOX...

First Choice of SOUTHERN AIRWAYS

Southern Airways Selects Wilcox Type 428
FACTORY PACKAGED VHF STATION
For All Ground Stations

A WILCOX FACTORY PACKAGED STATION OFFERS YOU:

1. OPERATING CONVENIENCE

All controls are within easy reach of the operator. Conveniently grouped telephone handset, typewriter, filing cabinet, and writing desk assure efficient operation.

2. INSTALLATION ECONOMY

All wiring inside the 72-inch-high standard relay rack is completed at the factory. No costly on-the-job wiring needs to be done. Just install the antenna, plug the station into any standard electrical outlet, and it is ready for operation.

3. MAINTENANCE EFFICIENCY

Simple, conventional circuits minimize the number and types of tubes, require no special training, techniques, or test equipment. All adjustments can be made from the front of the panels. All components are easily removable by means of plug and receptacle connections. This means low-cost maintenance.

Write Today for complete information on the Wilcox Type 428 Packaged VHF Ground Station

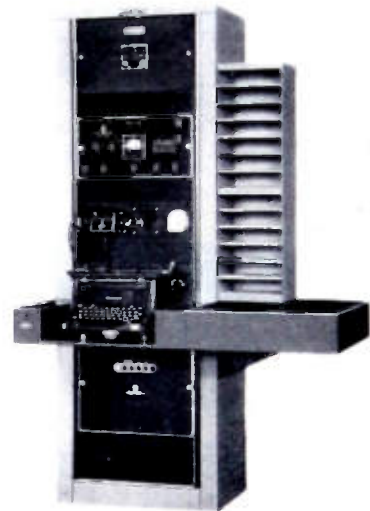

Type 428 Packaged VHF Station includes:
—406A fixed frequency 50 watt transmitter
—305A fixed frequency receiver
—407A power supply
—614A VHF antenna

WILCOX
ELECTRIC COMPANY

KANSAS CITY 1, MISSOURI, U. S. A.



There's a **TIC** Potentiometer for every application

TIC for top electrical and mechanical precision

Type RV2 High Precision Potentiometer
One of a series of semi-standardized types of metal-base potentiometers with exceptionally high electrical accuracy and mechanical precision. For both linear and non-linear functions. Designed for precision instrument, computer and military applications. Accurate phasing of individual units possible with exclusive clamping method of ganging.

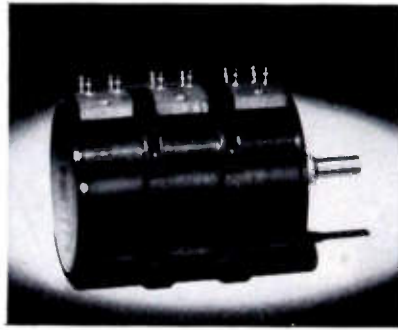

TIC for precision and economy

- Tapped mounting inserts
- Bronze bushing
- Totally enclosed with cover
- "Constrict-O-Grip" clamping to shaft
(no set screws)
- Precious metal contacts
- Silver overlay on rotor take-off slip ring

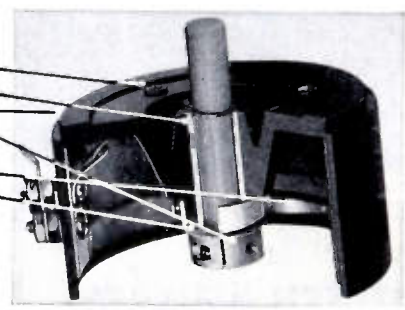

Type RV3 Precision Potentiometers
... available in models for either linear or non-linear functions with stock resistance values ranging from 100Ω to 200,000Ω and power ratings of 8 and 12 watts. 360° mechanical rotation or limited by stops as desired. Models with 5% total resistance accuracy — \$6.00
... 1% accuracy — \$8.00. Special models available for high humidity applications.

TIC for special use . . .

Type RVT Translatory Potentiometer
Actuated by longitudinal instead of rotating motion providing linear electrical output proportional to shaft displacement. Used as a position indicator, high amplitude displacement type pickup and for studying low frequency motion or vibration. Features exceptionally high linearity and resolution. Available in various lengths depending on amplitude being studied.

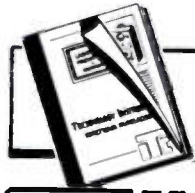
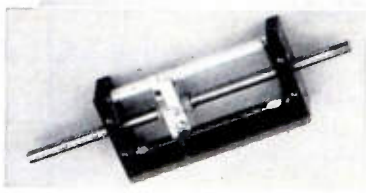
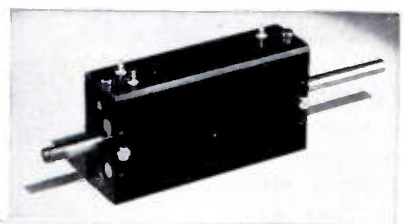

Valuable catalog — yours for the asking. Contains detailed information on all TIC Instruments, Potentiometers and other equipment. Get your copy without obligation — write today.

TIC TECHNOLOGY INSTRUMENT CORP.
1058 Main Street, Waltham 54, Massachusetts
Engineering Representatives
Chicago, Ill.-Uptown 8-1141 Boonton, N.J.-Boonton 8-3097 Cleveland, Ohio — PROspect 6171
Cambridge, Mass.-ELiot 4-1751 Canaan, Conn.-Canaan 649 Hollywood, Cal.-HOLlywood 9-6305
Manhasset, N.Y.-Manhasset 7-3424

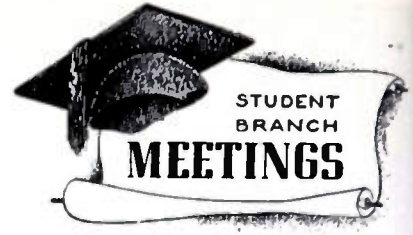

(Continued from page 40A)

MARQUETTE UNIVERSITY, IRE-AIEE BRANCH
Field Trip through the West Allis Works of the Allis-Chalmers Manufacturing Company; May 24, 1950.

UNIVERSITY OF MIAMI, IRE BRANCH
Business Meeting; April 26, 1950.

MICHIGAN STATE COLLEGE, IRE-AIEE BRANCH
"Fundamentals of Co-ordination of Power and Communication Systems," by W. Smith, Michigan Bell Telephone; May 3, 1950.
"Motor Control," by Mr. Beck, Graybar Electric; May 10, 1950.
Annual Picnic; May 17, 1950.
Films: "The Banshee," and "What Price Motors"; May 24, 1950.

UNIVERSITY OF MINNESOTA, IRE-AIEE BRANCH
Business Meeting; October 27, 1949.
Business Meeting; November 22, 1949.
"Electronic Wizards," by C. N. Hoyler, RCA Laboratories; Business Meeting; February 27, 1950.
Student Talks; April 24, 1950.
Election of officers; April 28, 1950.

NEW MEXICO COLLEGE OF AGRICULTURE AND MECHANIC ARTS, IRE-AIEE BRANCH
"The General Electric Training Program," by Max Lane, formerly with General Electric Company; "Opportunities for an Electrical Engineer with Phillips Petroleum Company," by F. E. Cockrell, El Paso Electric Company; Election of Officers; April 27, 1950.
Business Meeting; May 11, 1950.

OHIO STATE UNIVERSITY, IRE-AIEE BRANCH
Election of Officers; May 11, 1950.

OREGON STATE COLLEGE, IRE BRANCH
"Television," by R. J. Newman, Product Sales Engineer, R.C.A.; April 27, 1950.
"Some Problems of Material Procurement," by Carl Bjorquist, Chief, Materials Section, B.P.A.; Election of Officers; May 10, 1950.

RENSSELAER POLYTECHNIC INSTITUTE, IRE-AIEE BRANCH
Election of Officers; May 10, 1950.

SAN DIEGO STATE COLLEGE, IRE BRANCH
"The Closed Loop Television System for San Diego State College," by Richard Silberman, Student, San Diego State College; May 16, 1950.

SAN JOSE STATE COLLEGE, IRE BRANCH
"Ionosphere," by R. A. Helliwell, Faculty, Stanford University; May 24, 1950.

SOUTHERN METHODIST UNIVERSITY, IRE-AIEE BRANCH
Film: "Jet Propulsion"; Election of Officers; June 16, 1950.

ST. LOUIS UNIVERSITY, IRE BRANCH
"One to Sixty Million," by Myron Wagoner, Southwestern Bell Telephone Co.; May 4, 1950.
Election of Officers; May 11, 1950.
Picnic; June 4, 1950.

TULANE UNIVERSITY, IRE-AIEE BRANCH
Business Meeting; May 1, 1950.

UNIVERSITY OF WYOMING, IRE-AIEE BRANCH
"Microwaves," by Mr. Striely, American Telephone and Telegraph Co.; May 18, 1950.
Films: "Thunderbolt Hunters," and "This Is Resistance Welding"; Business Meeting; May 19, 1950.

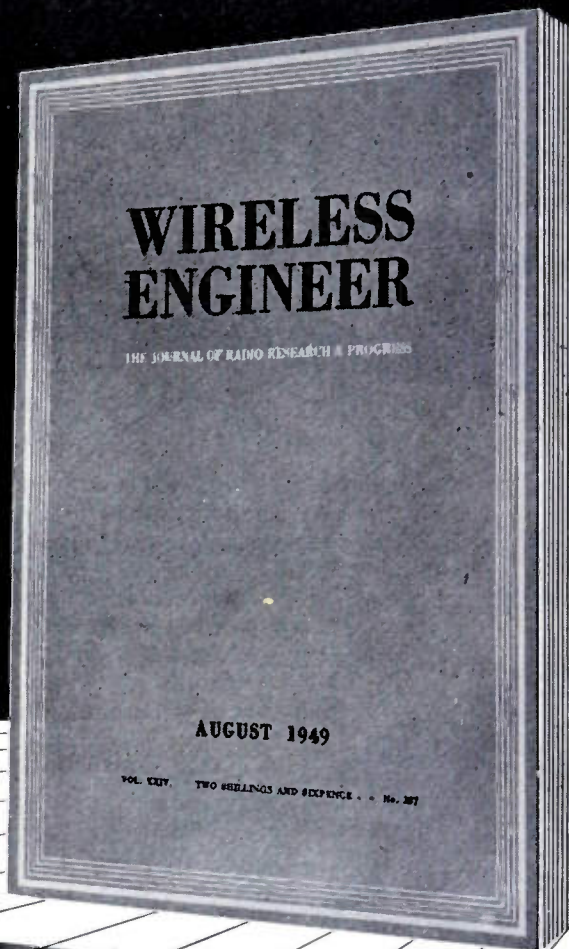
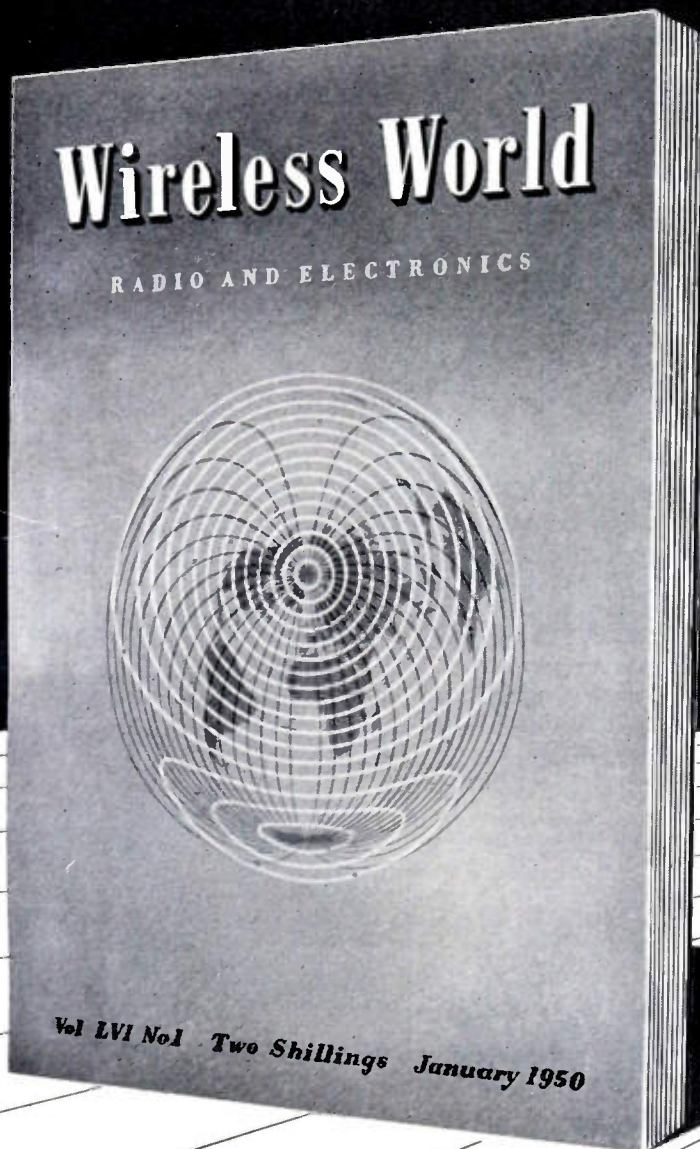

For accurate and up-to-date news of every British development in Radio, Television and Electronics

WIRELESS WORLD. Britain's leading technical magazine in the general field of radio, television and electronics. Founded nearly 40 years ago, it provides a complete and accurate survey of the newest British technique in design and manufacture. Critical reviews of the latest equipment, broadcast receivers and components of all types are regularly included. Theoretical articles deal with design data and circuits for every application. Each issue is profusely illustrated and news from all parts of the world is fully reported. Monthly, 2s. Annual Subscription - - £1 6s. (\$4.50).



WIRELESS ENGINEER. The journal of radio research and progress. Produced for research engineers, designers and students in radio, television and electronics, it is accepted internationally as a source of information for advanced workers and wireless engineers. Editorial policy is to publish only original work, selected by an Editorial Advisory Board representative of the foremost technical bodies in British radio engineering and electronics. Monthly, 2s. 6d. Annual Subscription, £1 12s. (\$5.50).

ASSOCIATED TECHNICAL BOOKS. "Wireless Direction Finding" (4th Edition) by R. Keen, B. Eng. (Hons.), A.M.I.E.E. An up-to-date and comprehensive work on the subject. 45s. (\$7.50). "Radio Laboratory Handbook" by M. G. Scroggie, B.Sc., M.I.E.E. 430 pages (4th Edition). 13s. (\$2.00)

Subscriptions can be placed with British Publications Inc.: 150 East 37th Street, New York, 16, N.Y., or sent direct by International Money Order to Dorset House, Stamford Street, London, S.E.1, England. Cables: "Iliffe Press, Sedist, London"

Gentlemen: IT'S A KNOCKOUT!

it's the new **CP**
MODEL 55 SWITCH
FOR RF AND
POWER SERVICE

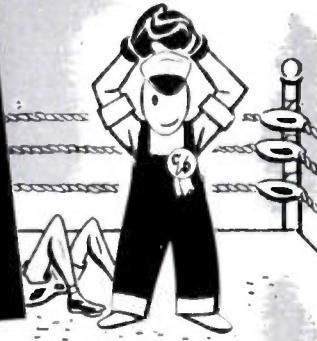

**NO BIGGER'N A WRISTWATCH
BUT PACKED WITH PERFORMANCE!**

The new model 55 shorting type switch reflects, in miniature, many design features of large CP switches. With a maximum of 18 contact positions in the single pole style, it's also available in two or three pole styles. Of course several sections may be "ganged". Silver path from terminal to terminal is provided. Flash-over voltage at 60 cycles is 1000 volts peak. Current rating is 2 amperes. Model 55 is only one of seven standard stock model switches of our manufacture. A catalog describing them all will be sent upon request.

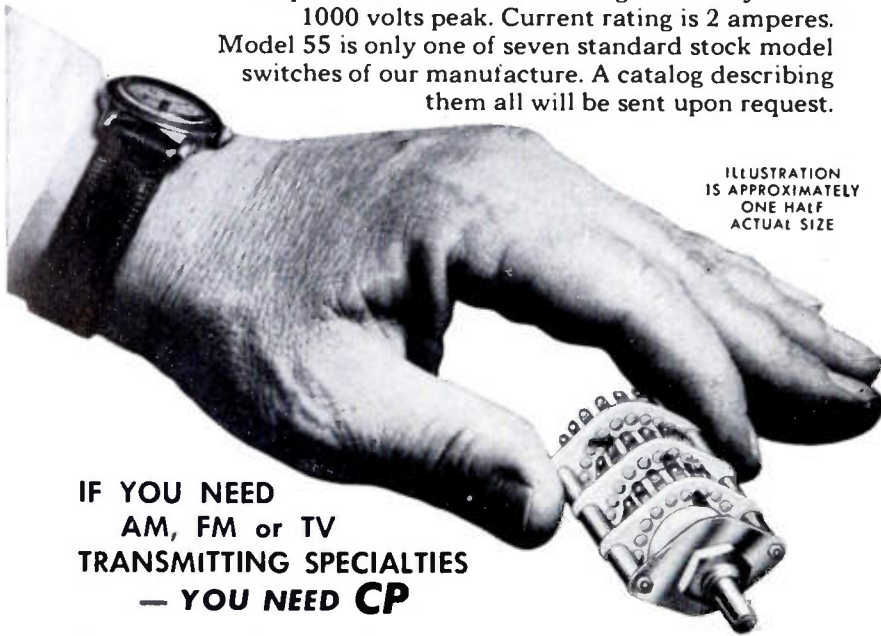

ILLUSTRATION
IS APPROXIMATELY
ONE HALF
ACTUAL SIZE

**IF YOU NEED
AM, FM or TV
TRANSMITTING SPECIALTIES
— YOU NEED CP**

Because CP Transmission Equipment has proven outstanding in service and performance in hundreds of major installations throughout the nation. If you have a specific problem pertaining to any of the products listed, our engineers will be happy to help you solve it. Consultation can be arranged to suit your convenience—without obligation.

- SEAL-O-FLANGE TRANSMISSION LINE
- TOWER HARDWARE
- AUTO-DRY-AIRE DEHYDRATORS
- LO-LOSS SWITCHES
- COAXIAL DIPOLE ANTENNAS

Communication Products Company, Inc.

KEYPORT  NEW JERSEY



The following transfers and admissions were approved and will be effective as of August 1, 1950:

Transfer to Senior Member

- Curtis, T. P., 104 Bruce St., Scotia 2, N. Y.
Fiet, O. O., 113 W. Park Ave., Oaklyn, N. J.
Fong, A., 1328 Parkinson Ave., Palo Alto, Calif.
Good, W. E., Westinghouse Research Laboratory, East Pittsburgh, Pa.
Helliwell, R. A., Electronics Bldg., Stanford, Calif.
Jamieson, H. W., 2121 Overland Ave., Los Angeles, Calif.
Kearney, J. W., 160 Old Country Rd., Mineola, L. I., N. Y.
Kingan, J. J., 4008 Wilson Ave., Montreal, Que., Canada
Klayton, M. H., 12 Wardell Pl., Wanamassa, N. J.
Knauss, H. C., 35 Harding Rd., Lexington 73, Mass.
Lonsdale, E. M., 226 McLean St., Iowa City, Iowa
Minor, M. J., Rt. 3, Charlotte 3, N. C.
Ogle, H. M., 1951 Clement Rd., Schenectady 10, N. Y.
Palter, N. H., 40-16-247 St., Little Neck, L. I., N. Y.
Pappenfus, E. W., 1101-30 Dr., S. E., Cedar Rapids, Iowa
Reed, R. I., 617 McClellan St., Schenectady, N. Y.
Reitz, N. J., Sylvania Electric Products Inc., Emporium, Pa.
Scott, M. C., Jr., Station WIOD, Miami 30, Fla.
Singleton, H. E., Research Laboratory of Electronics, Massachusetts Institute of Technology, Cambridge 39, Mass.
Steidley, J. W., U. S. Navy Electronics Laboratory, San Diego, Calif.
Stephenson, J. G., Airborne Instruments Laboratory, 160 Old Country Rd., Mineola, L. I., N. Y.
Talpey, R. G., Special Development Group, RCA Victor, Lancaster, Pa.
Vogele, C. E., Jr., 211 West St., Pittsburgh 21, Pa.
Weissman, S., 321 W. Norman Ave., Dayton 5, Ohio

Admission to Senior Member

- Bradley, J. K., 326 Hamilton Ave., Hasbrouck Heights, N. J.
Branch, G. E., 49 Woodmont Rd., Belle Haven, Alexandria, Va.
George, R. H., 703 N. Chauncey Ave., W. Lafayette, Ind.
Goudet, G., 24 Rue Morere, Paris 14, France
Johnson, R. E., American Telephone and Telegraph Co., 195 Broadway, New York, N. Y.
Manty, W. A., Nestor Engineering Co., 764 Palisade Ave., Teaneck, N. J.
Matthews, R. P., Federal Electric Manufacturing Co., Ltd., 9600 St. Lawrence Blvd., Montreal 14, Que., Canada
Miller, L., 140 Atlantic Ave., Long Branch, N. J.
Ortusi, J. A., 23 Rue du Maroc, Paris 19, France
Pintell, R. H., 1749 Grand Concourse, New York 53, N. Y.
Schmidt, F. W., 10 Garret St., Cedar Grove, N. J.
Sloan, D. H., Rm. 120 T-11, University of California, Berkeley, Calif.
Vollum, H., 1115 S. E. Lambert St., Portland 2, Ore.
Woodson, R. A., 6923 N. Kolmar Ave., Lincolnwood, Chicago, Ill.

Transfer to Member

- Cahn, S. L., 341 E. Ohio St., Chicago 11, Ill.
Ellis, A. R., 1244 Sevier Ave., Menlo Park, Calif.
Faltin, J. W., 482 N. Windsor Ave., Brightwaters, N. Y.
Farnsworth, N. B., Box 134, Ellet Sta., Akron 12, Ohio
Hamm, N. G., 5449 Charles St., Philadelphia 24, Pa.
Lephakis, A. J., Box 69, Cambridge 39, Mass.

(Continued on page 46A)

Announcing

the **H-14**
SIGNAL GENERATOR
108-118 megacycles

Newest in ARC's Line of Signal Generators



Checks on...

- 24 Omni courses
- Left-center-right on Phase-localizer
- Left-center-right on Amplitude-localizer
- Omni course sensitivity
- To-From and Flag-alarm operation
- All necessary quantitative bench tests

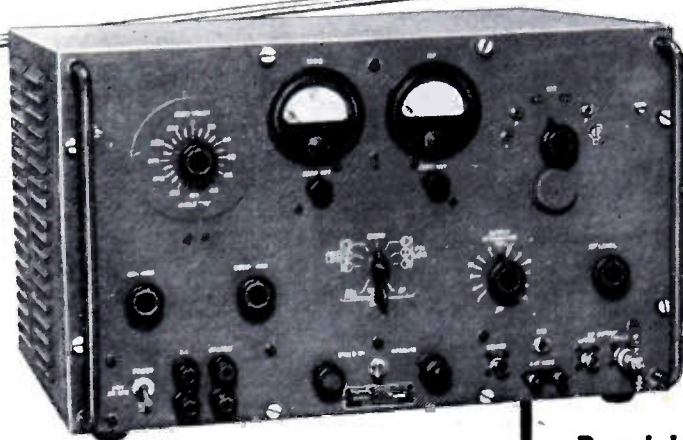

Use the H-14
for Testing Omni
Receiving Units in Aircraft
..... or on the Bench.

MICROWAVE TEST SET . . . TYPE

H-10
23,500-24,500
MEGACYCLES

Provides source of cw or pulse frequency-modulated RF, power level -37 to -90 dbm. RF power meter measures levels from +7 to +30 dbm. Frequency meter for measuring output or input RF accurate to better than 20 mic. Primary purpose of the H-10 is to measure receiver sensitivity, bandwidth, frequency, recovery time, and overload characteristics, plus transmitter power and frequency. Recommended as a standard source of RF for research or production testing. Equal to military TS-223/AP.

PRICE: \$1692.00 net, f.o.b. Boonton, N. J.



UHF SIGNAL GENERATOR . . . TYPE

H-12
900-2100
MEGACYCLES

Provides source of cw or pulse amplitude-modulated RF, power level 0 to -120 dbm. Internal pulse circuits with controls for width, delay, and rate, and provision for external pulsing. Single dial tuning, frequency calibration accurate to better than 1%. Built to Navy specifications for research and production testing. Equal to military TS-419/U.

PRICE: \$1950.00 net, f.o.b. Boonton, N. J.



ARC COMMUNICATION AND NAVIGATION EQUIPMENT

Aircraft Radio Corporation also manufactures LF and VHF airborne communication and navigation equipments - all CAA-Type-Certificated for scheduled air-carrier use or for those whose type of flying requires a high degree of reliability and performance. Equipment consists

of light, small units which can be combined to provide the required operation, whether it be the 1 Receiver/1 Transmitter (15-pound) installation in a 2-place helicopter, or a 3 Receiver/2 Transmitter/VHF Omni installation (70 pounds) in larger 2-engine aircraft.

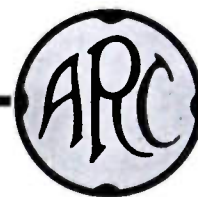

**Aircraft
Radio
Corporation**

Boonton, N. J.

Dependable Electronic Equipment Since 1928

WRITE TODAY for descriptive bulletins on any of these instruments

MORE GEO. STEVENS COIL WINDING EQUIPMENT IS IN USE THAN ALL OTHER MAKES COMBINED!

• **MORE OUTPUT . . . LOWER COSTS . . .** from **EXCLUSIVE SPEED FEATURE.** Universal motors permit variable speeds without changing belts and pulleys. Coil design permitting, speeds as high as 7500 RPM are not uncommon.

• **PORTABILITY.** Conveniently carried from place to place. Machines come mounted on bases to constitute one complete unit.

• **MUCH LOWER ORIGINAL COST.** The same investment buys more GEO. STEVENS machines than any other coil winding machines.

• **LONG LIFE.** Most of the original

GEO. STEVENS machines bought 14 years ago are still operating daily at full capacity.

• **MUCH FASTER CHANGING OF SET-UPS** than any other general purpose coil winding machine. Quickly changed gears and cams save time between jobs.

• **VERY LOW MAINTENANCE.** Replacement parts are inexpensive, can be replaced in minutes, and are stocked for "same day" shipment, thus saving valuable production time.

• **EASIEST TO OPERATE.** In one hour, any girl can learn to operate a GEO. STEVENS machine.

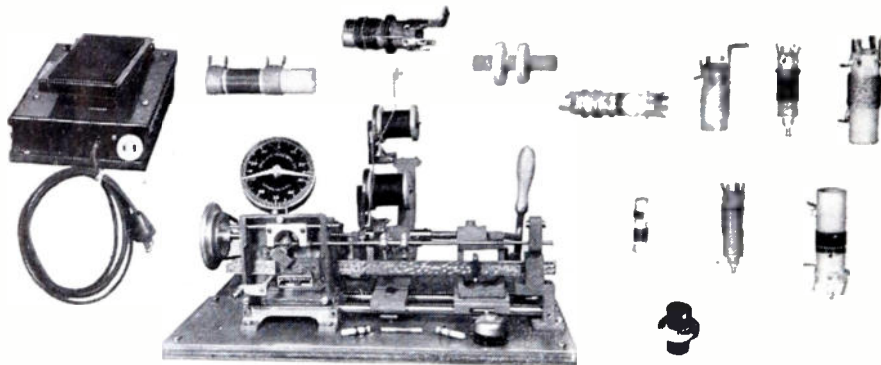

Progressive universal winding machine, Model 125, handles space wound coils and solenoids up to 8" in length, progressive universal coils up to 4" in length and 3" in diameter, universal coils up to 3/4" in width, and I.F. coils. Winds wire from 20 to 44 gauge. Cams are stocked from 3/4" to 1/16" in decrements of 1/64". Sizes larger than 3/4" or less than 1/64" are made upon request.

Cam, gears and idler forming the pattern are enclosed in front. Traverse rack is driven by change gears and idler enclosed in back of the head. The traverse rack has an adjustable stop to insure return to identical starting position. Large ball bearings on head stock spindle give long life and easy running. Ball bearing tailstock with spring tension lever permits quick change of coil forms.

Standard equipment: 1/4 H.P. universal motor, foot operated speed controller, V belt drive, and double spool carrier with two adjustable oilite bearing tensions to control wire during winding.

Dial Counter (Model 50 or 51) with 6" full vision clock dial, accurately registers all turns.

There is a GEO. STEVENS machine for every coil winding need. Machines that wind ANY kind of coil are available for laboratory or production line. . . . Send in a sample of your coil or a print to determine which model best fits your needs. Special designs can be made for special applications. Write for further information today.

World's Largest Manufacturer of Coil Winding Machines

REPRESENTATIVES

Frank Tatro
6022 No. Rogers Ave., Chicago 30, Illinois
Ralph K. Reid
1911 W. 9th St., Los Angeles 6, California
R. F. Staff & Co.
1213 W. 3rd St., Cleveland 13, Ohio

GEO. STEVENS
MFG. CO., INC.
Pulaski Road at Peterson
Chicago 30, Illinois



(Continued from page 44A)

- Love, E. J., 9264 Boleyn, Detroit 24, Mich.
Luhra, C. H., 115 Great Oak Lane, Pleasantville, N. Y.
McGowan, M. L., 3521 N. 58 St., Omaha 4, Neb.
McMasters, P. A., c/o Electronics Officer, Box 1042, Key West Naval Sta., Key West, Fla.
Moore, R. K., 215 Fall Creek Dr., Ithaca, N. Y.
Ohlinger, P. M., Portsmouth, Iowa
Parr, J. O., Jr., Box 2061, San Antonio 6, Tex.
Purnell, L. S., 25 Tanager Lane, Levittown, L. I., N. Y.
Raleigh, J. H., Box 232, Point Loma Sta., San Diego 6, Calif.
Roberts, E. A., 6024 W. Eddy St., Chicago 34, Ill.
Russell, G. M., American Telephone and Telegraph Co., 195 Broadway, New York 7, N. Y.
Sandberg, H. L., 838 Camburn Ct., S. E., Cedar Rapids, Iowa
Schachat, T., 5067 Parkgren Ave., Los Angeles 43, Calif.
Shaw, G. J., 701 Belmont St., Belmont 79, Mass.
Tepper, H. H., 135-04 Elder Ave., Flushing, L. I., N. Y.
Thompson, R. D., 39 Chestnut St., Wallington R.F.D. 1, East Rutherford, N. J.
Toomin, H., 362 Forrest, Beaumont, Tex.
Van Weele, J. C., Connetquot Dr., Oakdale, N. Y.
Wiese, A. H., 1123 Bellevue Ave., St. Louis 17, Mo.

Admission to Member

- Abouchanab, M. T., Engineer-in-Charge, Hashimite Broadcasting House, Ramallah via Amman, Trans-Jordan
Anderson, A. E., Pinewood Lane, Mansfield Center, Conn.
Ashby, G. L., 109 Sunrise Lane, Levittown, L. I., N. Y.
Clark, A. H., c/o Directorate of Communications, Hq. Continental Air Command, Mitchel Air Force Base, Hempstead, L. I., N. Y.
Clark, R. G., 10629 Wilton Pl., Los Angeles 47, Calif.
Field, R. W., 808 Frederica St., Owensboro, Ky.
Glancy, D. R., 584 Cosie Dr., St. Louis 15, Mo.
Hata, F. T., S-42, Ft. Belvoir, Va.
Keonjan, E., 225 E. 69 St., New York 21, N. Y.
Lyon, W. T., 224 South St., Hingham, Mass.
Margolick, F. H., 4662 Mariette Ave., Montreal, Que., Canada
Metten, W. H., 25 Walnut Park, Roxbury 19, Mass.
Michaelis, H. P., Box 322, Watertown, Mass.
O'Connor, G. J., Gilfillan Brothers, Inc., 1815 Venice Blvd., Los Angeles 6, Calif.
Owen, E. R., 1611 Central St., House 7, Evanston, Ill.
Purinton, H. G., 600 Walker Ave., Apt. F, Baltimore 12, Md.
Rao, S. S., Shettye Bldg., 49, Fourth Fl., Elphinstone Rd., Parel, Bombay 12, India
Rogers, T. F., 44 Kendall Park, Waltham, Mass.
Rotolo, N. V., 176 Hind Dr., Honolulu 16, T. H.
Shoulders, K. R., Route 2, Box 539B, Irving, Tex.
Wohl, R. J., 1149 E. 17 St., Brooklyn 30, N. Y.

The following elections to Associate grade were approved, and are effective as of July 1, 1950:

- Aiello, W. P., 1305 Iris St., Los Alamos, N. Mex.
Beal, E., 45 W. 97 St., New York 25, N. Y.
Becker, F. M., 5208 S. Natoma, Chicago, Ill.
Bernard, N., 1104 Carroll Pl., New York, N. Y.
Bonwit, S. E., 2800-31, S. E., Washington, D. C.
Brazdionis, J., 20-11 Bleecker St., Brooklyn 27, N. Y.
Brendle, T. A., 12 Old Perry Hgwy., R.D. 1, Wexford, Pa.
Burns, R. E., 4035 N. Sheridan Rd., Chicago, Ill.
Chang, S. Y., Electrical Engineering Department, University of Massachusetts, Amherst, Mass.

(Continued on page 47A)



(Continued from page 46A)

- Clark, C. E., 728 Fifth St., Marietta, Ohio
 Cobbs, E. R., R.F.D. 2, Beloit, Ohio
 Cockrell, J. H., Route 2, Box 6-A, Plant City, Fla.
 Delong, W. A., 501 S. Fourth St., Effingham, Ill.
 Dickensheets, L., 930 Wayne St., Topeka, Kan.
 Dolce, S. L., 20 Shute Path, Newton, Mass.
 Eakins, J. R., 38 Lankin Blvd., Toronto, Ont.,
 Canada
 Eggers, P., 57 Pleasant St., West Newton 65, Mass.
 Eicher, W. F., 4415-1-2 Woodman Ave., Sherman
 Oaks, Calif.
 Eldridge, D. F., 1520 Alki Ave., Seattle 6, Wash.
 Evenson, R. C., 4041 Berryman Ave., Culver City,
 Calif.
 Feehrer, M. R., 1510 Scott St., Williamsport 22, Pa.
 Ferro, J. A., 2500-72 Ct., Elmwood Park 35, Ill.
 Ford, W. W., 2 Woodside Rd., Madison, N. J.
 Frye, F. X., 556 Windsor Rd., New Milford, N. J.
 Galluppi, A. J., 233 W. Menomonee St., Chicago 14,
 Ill.
 Gardiner, K. W., 340 W. Latham, Phoenix, Ariz.
 Genco, F., 6407-11 Ave., Los Angeles 37, Calif.
 Greiger, G., 21-68-29 St., Astoria, L. I., N. Y.
 Haas, R. S., Rhode Island State College, Kingston,
 R. I.
 Haimowitz, S., 1185 Grand Concourse, New York
 52, N. Y.
 Harmer, H. S., Pacific Telephone and Telegraph
 Co., 509 S. W. Oak St., Portland 4, Ore.
 Harris, H. F., 6102 Eastridge Dr., Indianapolis,
 Ind.
 Harting, D. R., Route 3, Box R-32, Auburn, Wash.
 Hawkins, R. L., 4117 Illinois Ave., N. W., Wash-
 ington 11, D. C.
 Hollen, F. M., U.S.S. Markab Adzi, Orange, Tex.
 Holmes, W. R., 701 E. Broad St., Angola, Ind.
 Huston, P. D., 2616 Dayton St., Chicago 14, Ill.
 Hyland, R. C., 286 Essex St., Weymouth 88, Mass.
 Jacobs, V. J., 19 E. St. Joseph, Apt. 2, Indianapolis,
 Ind.
 Kalin, T., 39 Hartwell St., Fitchburg, Mass.
 Kelly, I. E., 4153 Kenmore Ave., Chicago 13, Ill.
 Klane, C. H., 148 Maple St., Malden 48, Mass.
 Klinko, E. H., 27 Linden St., Binghamton, N. Y.
 Lacey, H. F., 612 Van Buren St., N. W., Washing-
 ton 12, D. C.
 Lannary, J., 28 Riverside St., Watertown 72, Mass.
 Lawson, R. G., Port Arthur College, Box 511, Port
 Arthur, Tex.
 Leffler, J. M., General Delivery, China Lake, Calif.
 LoGatto, S. J., 2nd Radio Squadron, Mobile, A.P.O.
 175, c/o PM, New York, N. Y.
 Martin, J. O., O.I.C. Clear Creek Radio, Range
 Sta., R.R. 2, Port Rowan, Ont., Canada
 McDonald, J. J., 9236 S. Aberdeen St., Chicago, Ill.
 McGuyer, C. C., 1321 S. Governor St., Evansville
 13, Ind.
 McPherson, J. R., 1519 Olympia Way, S. W., At-
 lanta, Ga.
 Meisling, T. H., 4256 Gilbert St., Oakland 11, Calif.
 Moran, T. G., 1173 Nelson Ave., New York, N. Y.
 Morris, W. J., 6215 Linwood Ave., Cleveland 3,
 Ohio
 Oliver, J. J., 30 Brainerd Rd., Allston, Mass.
 Oujevolk, G. B., 92 Liberty St., New York 6, N. Y.
 Peto, C. J., Jr., 6239 S. Kilpatrick, Chicago 29, Ill.
 P'dhayny, D. D., 3613 W. Washington Blvd., Los
 Angeles, Calif.
 Rao, C. V., Madira, Hyderabad State, India
 Reitlinger, N. E., 101-80 Rd., Kew Gardens, L. I.,
 N. Y.
 Rizzo, S. J., 1215 Niagara St., Buffalo 13, N. Y.
 Robinson, R. D., YMCA, 13 State St., Schenectady,
 N. Y.
 Rose, A. B., Jr., 331A Harvard St., Cambridge,
 Mass.
 Sable, R. L., 217 W. Fifth St., Emporium, Pa.
 Show, O. C., 311 N. E. 103 Ave., Portland 16, Ore.

(Continued on page 48A)

PRESTO...most carefully made recording discs in the world



step 2-lacquer coating the disc

Through 15 years of experience in manufacturing fine recording discs, Presto has learned that the choice of lacquer, how it is stored, tested and maintained, how it is applied to the aluminum base are among the most important considerations.

Specifications for recording lacquer have been carefully worked out after many laboratory and turntable tests. Compounded from a well-guarded formula, Presto lacquer is stored in constantly agitated tanks to insure even flowing.

In the Presto coating room, polished aluminum blanks are fed into the processing "tunnel" where liquid lacquer is automatically flowed on their surfaces to just the right thickness. After completing their 1½ hour trip through this 550 foot tunnel, the coated discs are carefully placed in racks for "curing."

Whenever you see the Presto label on a disc, it is your assurance of the most carefully manufactured, best performing and most permanent disc anywhere.



The famous PRESTO "Green Label"
... world's finest recording disc.

PRESTO
RECORDING CORPORATION
 Poromus, New Jersey
 Mailing Address:
 Box 500, Hackensack, New Jersey

In Canada:
 Walter P. Downs, Ltd.
 Dominion Sq. Bldg.
 Montreal, Canada

Overseas:
 The M. Simons & Son Co., Inc.
 25 Warren Street
 New York, N. Y.

what's the REAL PROBLEM?

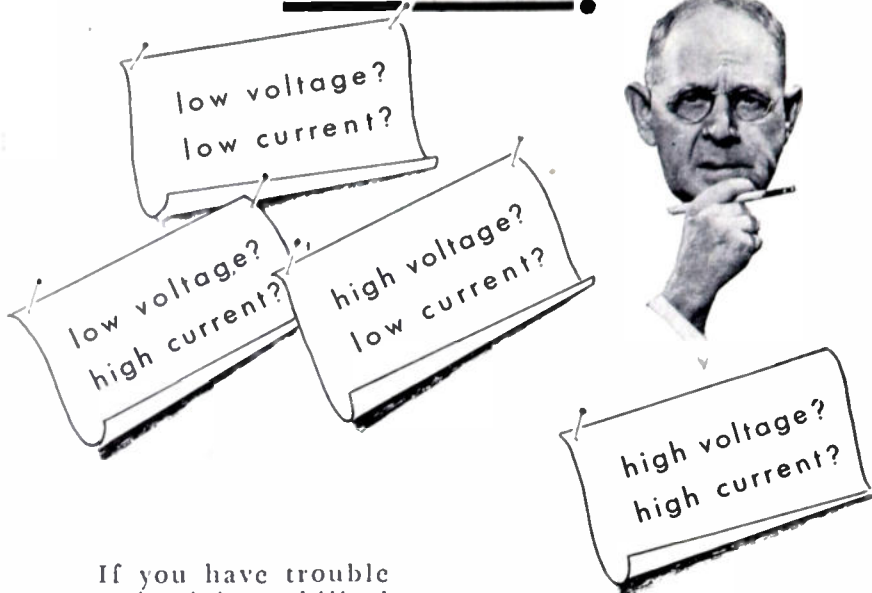

If you have trouble maintaining stabilized DC Voltage under changing Load conditions, it's time to investigate the Sorensen line of Nobatrons.

● Common Nobatron Specifications:

Regulation Accuracy 0.2% from 0.1 load to full load; Ripple Voltage 1%; Recovery time 0.2 seconds under most severe load or input conditions; 95-130 VAC single phase 50-60 cycles; Adapter available for 230 VAC operation.

● Ratings

Nobatron — 6, 12, 28, 48, 125 volts from 5—350 amperes

B-Nobatron — 325, 500, 1000 volts — 125 ma.; 300 ma. & 500 ma.

DC Standards — 2, 6, 15, 25, 50, 75, 150, 300 volts — 15, 30 and 50 ma.

● Problems? Sorensen Engineers are always at your service to help solve unusual applications.

● Sorensen manufactures:

AC line regulators 60 and 400 cycles; Regulated DC Power Sources, Electronic Inverters; Voltage Reference Standards; Custom Built Transformers; Saturable Core Reactors.

WRITE TODAY For Catalog B1049 For The Complete Line And Prices.

TYPICAL DC SOURCES

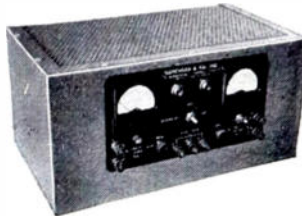

MODEL 325B
0-325 volts; 125 ma.



MODEL VS-50-50
50 volts @ 50 ma.

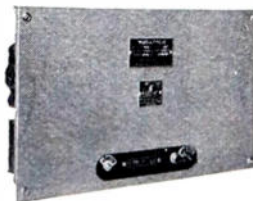

MODEL E-6-15
6 volts; 1.5-15 amperes

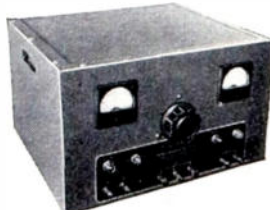

MODEL 500 B
0-500 volts; 300 ma.



(Continued from page 47A)

- Tait, J. S. R., Radio Section W.E.E., R.C.A.F., Edmonton, Alta., Canada
 Tanner, W. E., Gotthelfstrasse 16, Aarau, Switzerland
 Tutwiler, C. E., Jr., c/o C.A.A., 84 Marietta St., Atlanta, Ga.
 Uribe, E., 1254 Guerrero St., San Francisco, Calif.
 Uyeda, M. M., 4135 S. Berkeley, Chicago 15, Ill.
 Voss, R. G. P., University of Pretoria, Pretoria, Transvaal, South Africa
 Whiting, R. F., 1416 Jackson Blvd., Chicago 7, Ill.
 Wolak, S., Box 272, Seneca Falls, N. Y.
 Wood, L. E., 4342 Burns Ave., Los Angeles 27, Calif.

News—New Products

These manufacturers have invited PROCEEDINGS readers to write for literature and further technical information. Please mention your I.R.E. affiliation.

(Continued from page 30A)

Adjusting Isolation Transformer

A new voltage adjusting isolation transformer, a service tool, has been announced by the **Haldorson Co.**, 4500 Ravenswood Ave., Chicago, Ill.

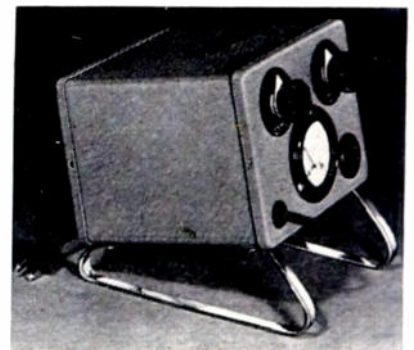

The new unit, Model N-202, was first introduced at the Parts Show in Chicago. According to the manufacturer, Model N-202 gives the operator close control over the line voltage on his bench, yet isolates it from his work.

Included in the many features is the provision for varying the voltage in approximately 1½-volt steps by means of two switch knobs on the panel. If the line voltage at the input is the standard rated 117 volts, it can be varied through a wide range of from about 95- to 145-volts. If the voltage drops to around 90, it can be varied from 75- to 115-volts. The rated capacity at 117-volt input is 500 watts. A volt meter with accuracy to 2½ per cent registers the output voltage.

(Continued on page 49A)



Sorensen and company, inc.
375 FAIRFIELD AVE. • STAMFORD, CONN.

MANUFACTURERS OF AC LINE REGULATORS, 60 AND 400 CYCLES, REGULATED DC POWER SOURCES; ELECTRONIC INVERTERS, VOLTAGE REFERENCE STANDARD, CUSTOM BUILT TRANSFORMERS; SATURABLE CORE REACTORS

News—New Products

These manufacturers have invited PROCEEDINGS readers to write for literature and further technical information. Please mention your I.R.E. affiliation.

(Continued from page 48A)

Audible Signal Timer

The Haydon Manufacturing Co., Inc., Torrington, Conn., has introduced a new, low-cost timing device with an audible signal for large volume applications. The timer, known as the Series 8010, is available in a wide range of timing intervals made possible because of the many motor speeds available. At the end of the preset interval the signal, a buzzer, sounds continuously until manually turned off, demanding whatever action is required.

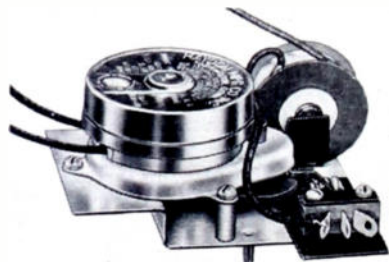

The 8010 is a compact unit, measuring $4\frac{1}{2}$ inches by $2\frac{1}{2}$ inches by $1\frac{1}{2}$ inches. It can be mounted and operated in any position; rotates clockwise or counter-clockwise and may be set in either direction to start, or when in operation. The unit features a snap action for quick break; is rated for 16 amperes 250 volts, $\frac{1}{2}$ horsepower 250 volts ac. The basic motor operating the device features a 450-rpm rotor speed for quiet operation and long life. The motor is totally enclosed, with a dual system of controlled lubrication.

Electronic Tuning Fork

American Time Products, Inc., 500 Fifth Ave., New York 19, N. Y. announces a new frequency standard tuning fork, Type 2001-2.

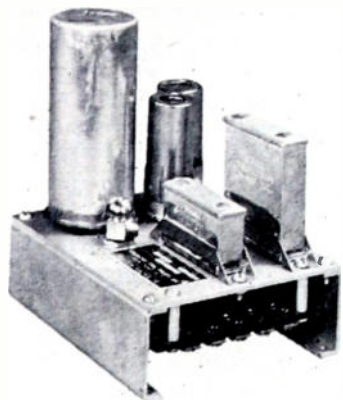

The manufacturer claims it will deliver an accurate, stable source of any frequency between 200 and 1,500 cps. Dividers and multipliers available for other frequencies.

The Type 2001-2 is of compact, miniature construction that permits ready integration into basic equipment.

It is suitable for navigational aids, controlling gyros, firing electronic inverters,

(Continued on page 56A)

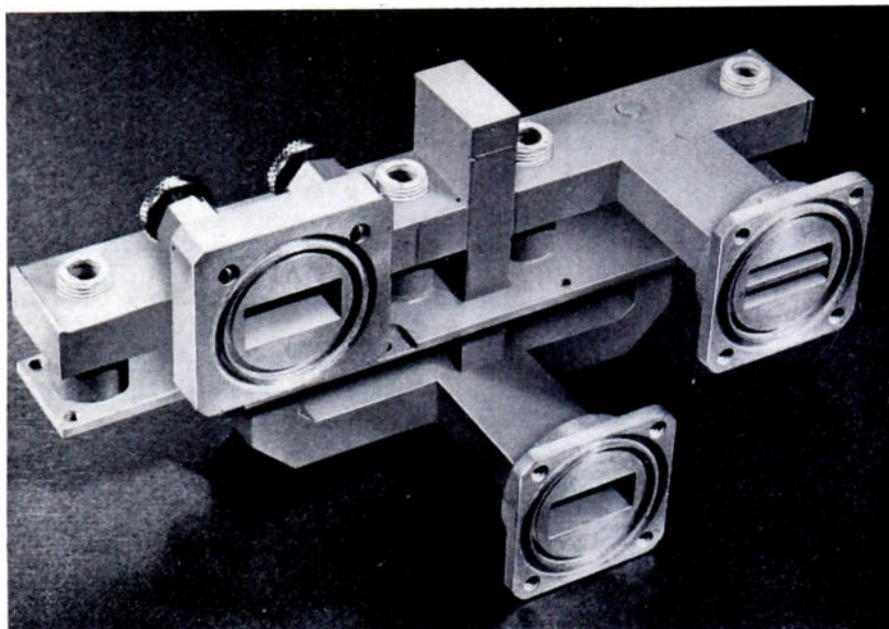

Need help with microwave transmission lines?...call TERPENING

The microwave mixer shown above was designed and produced on special order, in quantity, in our plant. Though made up from a number of different sections brazed together, special jigs, fixtures, and skilled techniques made it possible to hold tolerances between the outer flange center lines to $\pm .001''$.

Whether it's a special component, such as the mixer shown, or complete microwave transmission systems, we're set up to produce them with a high degree of precision from blueprints or performance specs. Although our engineering staff, laboratories, and fully equipped shop are usually busy on government contracts, our unusual facilities may permit us to work with you on special components for military or other microwave systems. We shall be happy to talk with you about your present and/or future needs.



L. H. TERPENING COMPANY

DESIGN • RESEARCH • PRODUCTION

Microwave Transmission Lines and Associated Components

16 West 61st St. • New York 23, N. Y. • Circle 6-4760

SCIENTISTS AND ENGINEERS

for
challenging research and advanced
development in fields of

RADAR
GYROSCOPES
SERVOMECHANISMS
MECHANICAL SYSTEMS
ELECTRONICS CIRCUITS
APPLIED PHYSICS AND MATH
PRECISION MECHANICAL DEVICES
ELECTRICAL SYSTEM DESIGN
GENERAL ELECTRONICS
INSTRUMENTATION
MICROWAVES
COMPUTORS
AUTOPILOTS

*Scientific or engineering
degree and extensive technical
experience required.*

WRITE:

Manager, ENGINEERING PERSONNEL

BELL AIRCRAFT CORPORATION

P.O. Box 1, Buffalo 5, N.Y.

POSITIONS OPEN FOR MEN HOLDING Ph.D OR M.S. DEGREE

Openings for men holding the Ph.D. or M.S. Degree in the fields of photo-surfaces, secondary emission, solid state, both light and electron optics, mechanics, electronic circuits, analog computers and servo-mechanisms.

Salary commensurate with experience and ability—Excellent opportunity for suitably qualified personnel.

Please furnish complete résumé of education, experience and salary required to:

CAPEHART-FARNSWORTH CORPORATION, INDUSTRIAL RELATIONS & PERSONNEL DEPARTMENT, FORT WAYNE 1, INDIANA



The following positions of interest to I.R.E. members have been reported as open. Apply in writing, addressing reply to company mentioned or to Box No. ...

The Institute reserves the right to refuse any announcement without giving a reason for the refusal.

PROCEEDINGS of the I.R.E.
1 East 79th St., New York 21, N.Y.

ASSISTANT TO CHIEF ENGINEER

Large speciality transformer manufacturer wants man experienced in small transformer work. Excellent opportunity for qualified man. Please state education and experience, also salary on last or present position. Southern Ohio location. All replies held strictly confidential. Suitable arrangements will be made to interview qualified applicants. Box 606.

PROFESSOR

Ph.D. or D.Sc. required. Age 40-45 with good teaching experience. Some industrial experience helpful. Large midwestern school, undergraduate and graduate program. State salary expected and qualifications. Box 609.

ELECTRONICS ENGINEER

Electronics engineer about 33 years old who preferably has had some graduate training and who is experienced in electronic circuit and apparatus design and development work. Wanted by a small but expanding and well known company specializing in precision electronic instruments. Located in New Jersey about 30 miles from New York City. Salary up to \$7,000 plus bonus. Our employees know of this ad. Box 611.

ENGINEERS

Engineers and assistants needed at new Motorola laboratory in Phoenix, Arizona. Engineers are required to be graduates of accredited engineering school, specialists in VHF and UHF receiver design, microwave communication pulse circuits, VHF, UHF and microwave antenna design, etc. Assistants must be engineering graduates with electronic experience. Replies should be sent to Daniel E. Noble, 4545 Augusta Blvd., Chicago 51, Ill., stating education, experience and past salary schedules.

TELEVISION ENGINEERS

Television engineers with at least 3 years design experience, preferably electrical engineering, as production engineer for nationally known radio and TV manufacturer located in upper New York state. Box 612.

ANTENNA ENGINEER

Long Island laboratory has an opening that is unusually suitable for an engineer who prefers a small company, is interested in specializing in VHF and microwave antennas and who has carried real responsibility in this or closely related field. Box 614.

ACOUSTIC ENGINEER

For research and design on loudspeakers and microphones. Must have a thorough background in acoustics, audio

(Continued on page 51A)

PHYSICISTS AND ENGINEERS

You can find plenty of positions where you will work on minor improvements on radar, telemetering systems, and other conventional devices. However, you will find very few positions where you can break ground in new fields having tremendous significance. This you can do at the JACOBS INSTRUMENT COMPANY, whose entire effort is devoted to pioneering activities in new fields that it has opened up itself. One of these fields, for example, is that of ultra-high speed, ultra-compact digital computers and controllers. This company's JAINCOMP family of computers dominates this field. Other equally important fields are being developed. Engineers and physicists with sound backgrounds and experience in the design of advanced electronic circuits or precision mechanical instruments may qualify, also individuals with good backgrounds in applied physics. A few openings exist for outstanding junior E. E.'s and physicists, also experienced technicians; applicants for these positions must apply in person.

**JACOBS
INSTRUMENT CO.**

4718 Bethesda Ave.
Bethesda 14, Maryland

ENGINEERS RESEARCH AND DEVELOPMENT

Career Positions
for

Top Engineers and Analysts

**SENIOR ELECTRONICS AND
ELECTRONICS ENGINEERS**—
B.S. or M.S. degree; 2 to 7 years
experience in radar, television, pulse,
video or display circuit design.

**DIGITAL COMPUTER DESIGN
ENGINEERS**

**AUTOMATIC TELEPHONE
SWITCHBOARD DESIGN EN-
GINEER**

**SENIOR ELECTRO-MECHANICAL
ENGINEERS**—Degree and at
least 4 years experience in servo-
mechanism analogue computers, spe-
cial weapons or system design.

Submit detailed resume. Personal
interview will be arranged.

THE GLENN L. MARTIN COMPANY
Employment Department
Baltimore 3, Maryland



(Continued from page 50A)

and measuring techniques, with a minimum of 5 years laboratory or practical design experience on loudspeakers or transducers. Progressive manufacturer in New York suburban area. Send complete resume and state salary requirements. Box 415.

RADIO ENGINEER

Electrical or radio engineer, must have development experience in audio frequency circuit design. Acoustical experience also helpful. State experience, age, salary desired. Box 616.

ELECTRONIC ENGINEER

At least 5 years post-college experience in development DC amplifier, digital computers, pulse and servo design. Established company. Classified work. New York City. Box 617.

PROFESSOR

Professor of communications engineering needed for fall 1950 by southeastern university. Will be in charge of graduate work and research activities. \$6,500.00 for nine months with extra income for summer teaching, or sponsored research. Must have Ph.D. or D.Sc. degree. Write Box 618.

JUNIOR ELECTRICAL ENGINEER

Attractive opportunity for Junior Electrical Engineer with manufacturer of UHF equipment. Preferably a man with one or two years experience. Reply to Box 619.

PROJECT RADIO ENGINEER

To take responsible charge of design of radio communications systems between Hawaiian Islands. Experience in VHF and microwave links design desirable. College training or equivalent necessary. Live in Honolulu. Contact Mutual Telephone Co. Box 2200, Honolulu, T.H.

INSTRUCTOR

Southern private vocational school desires and additional full time instructor in radio or television. Teaching experience preferred. Salary about \$250.00 per month depending on qualifications. Please send complete resume in first letter to: Mr. J. D. Muse, Box 505, Atlanta, Georgia.

ENGINEER

Chief systems test engineer with practical experience in electro-mechanical and hydraulic systems to direct systems testing on guided missiles. Familiarity with production testing techniques and test equipment in above fields is desirable. Excellent opportunity for someone who can organize a rapidly expanding facility. Direct inquiries to Manager, Engineering Personnel, Bell Aircraft Corp., P.O. Box 1, Buffalo, N.Y.

SPECIFICATION WRITERS

Specification writers capable of clear, concise technical description of the design, construction and testing of missile and electronic equipment. Knowledge of military specifications and familiarity

(Continued on page 52A)

RCA VICTOR Camden, N. J.

Requires Experienced Electronics Engineers

RCA's steady growth in the field of electronics results in attractive opportunities for electrical and mechanical engineers and physicists. Experienced engineers are finding the "right position" in the wide scope of RCA's activities. Equipment is being developed for the following applications: communications and navigational equipment for the aviation industry, mobile transmitters, microwave relay links, radar systems and components, and ultra high frequency test equipment.

These requirements represent permanent expansion in RCA Victor's Engineering Division at Camden, which will provide excellent opportunities for men of high caliber with appropriate training and experience.

If you meet these specifications, and if you are looking for a career which will open wide the door to the complete expression of your talents in the fields of electronics, write, giving full details to:

National Recruiting Division
Box 850, RCA Victor Division
Radio Corporation of America
Camden, New Jersey

PHYSICISTS AND SENIOR RESEARCH ENGINEERS

POSITIONS NOW OPEN

Senior Engineers and Physicists having outstanding academic background and experience in the fields of:

- Microwave Techniques
- Moving Target Indication
- Servomechanisms
- Applied Physics
- Gyroscopic Equipment
- Optical Equipment
- Computers
- Pulse Techniques
- Radar
- Fire Control
- Circuit Analysis
- Autopilot Design
- Applied Mathematics
- Electronic Subminiaturization
- Instrument Design
- Automatic Production Equipment
- Test Equipment
- Electronic Design
- Flight Test Instrumentation

are offered excellent working conditions and opportunities for advancement in our Aero-physics Laboratory. Salaries are commensurate with ability, experience and background. Send information as to age, education, experience and work preference to:

NORTH AMERICAN AVIATION, INC.
Aero-physics Laboratory
Box No. N-4, 12214 South Lakewood Blvd.
Downey, California

Pioneer in Radio Engineering Instruction Since 1927

CAPITOL RADIO ENGINEERING INSTITUTE

An Accredited Technical Institute

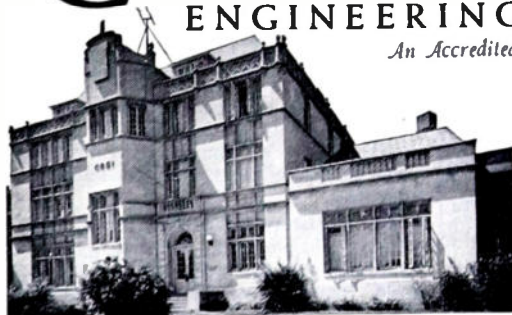

ADVANCED HOME STUDY
AND RESIDENCE COURSES IN
PRACTICAL RADIO-ELECTRONICS
AND TELEVISION ENGINEERING

Request your free home study or
resident school catalog by writing to:

DEPT. 268B
16th and PARK ROAD, N.W.,
WASHINGTON 10, D.C.

Approved for Veteran Training

Engineers Physicists

- What do you want in a position?
- What are your aims and ambitions?

SENIORS

Realizing that each of us has personal job requirements, the W. L. Maxson Corporation offers special opportunities if you are heavily experienced in research and development on radar, computers and associated equipment.

Please address your job requirements and résumé to A. Hoffsommer for individual attention.

THE W. L. MAXSON CORPORATION
460 W. 34th Street
New York 1, N.Y.



FOR BETTER PERFORMANCE BETTER BUY

Acme ACME Electric TRANSFORMERS

Acme Electric has been identified with the electronic industry since the crystal set days. The vast store of experience that Acme engineers have accumulated over these many years can be of considerable value in helping you solve your electronic transformer problems. We offer transformer engineering cooperation and facilities to build quality transformers in quantity production.

ACME ELECTRIC CORP.

448 Water Street Cuba, N. Y., U. S. A.



POSITIONS OPEN

(Continued from page 51A)

with aircraft and electronic components is essential. Direct inquiries to Manager, Engineering Personnel, Bell Aircraft Corp., P.O. Box 1, Buffalo 5, N.Y.

ENGINEER

Engineer, electrolytic capacitor, at least 5 years experience in design and development. Write resume of experience and salary expected. Box 620.

RADIO ENGINEER

Radio engineer wanted by prominent Chicago electronic manufacturer to design and supervise manufacture of full line of commercial amplifiers. Must have engineering degree or equivalent and minimum of 2 years design experience in commercial P.A. systems. Give details including age, education, experience, reference, availability and salary expected. Box 621.

ENGINEER

Excellent opportunity for engineer to apply microwave measurements and techniques to development and manufacture of magnetrons and klystrons. Pulse circuit knowledge also valuable. B.S. degree and experience or advanced degree with heavy concentration on above required. State salary expected and qualifications. Location New York City. Box 622.



Positions Wanted By Armed Forces Veterans

In order to give a reasonably equal opportunity to all applicants, and to avoid overcrowding of the corresponding column, the following rules have been adopted:

The Institute publishes free of charge notices of positions wanted by I.R.E. members who are now in the Service or have received an honorable discharge. Such notices should not have more than five lines. They may be inserted only after a lapse of one month or more following a previous insertion and the maximum number of insertions is three per year. The Institute necessarily reserves the right to decline any announcement without assignment of reason.

ENGINEER

M.S. in E.E. communications option, June 1949 B.E.F. Cum Laude June 1948. Tau Beta Pi, Eta Kappa Nu. Age 24, single. Navy electronic technician program 2 years and some radio and television experience. Desires electronic design, development or research position New York-Long Island area. Box 387 W.

ELECTRONIC ENGINEER

M.S.E.E., B.S.E.E., communications, Oklahoma A. and M. College. 2 years oil

(Continued on page 53A)

PROJECT ENGINEERS

Real opportunities exist for Graduate Engineers with design and development experience in any of the following: Servo-mechanisms, radar, microwave techniques, microwave antenna design, communications equipment, electron optics, pulse transformers, fractional h.p. motors.

SEND COMPLETE RESUME TO EMPLOYMENT OFFICE.

SPERRY GYROSCOPE CO.

DIVISION OF THE SPERRY CORP. GREAT NECK, LONG ISLAND

HIGHEST QUALITY ELECTRONIC COMPONENTS

Large Quantities in Stock for Immediate Delivery

- RELAYS
- TUBES
- TRANSFORMERS
- CHOKES
- VOLUME CONTROLS
- RECTIFIERS
- WIRE & CABLE
- TUBE SOCKETS
- RESISTORS (WIRE WOUND, CARBON, etc.)
- CONDENSERS (MOLDED, CERAMIC, OIL FILLED, etc.)
- SWITCHES (TOGGLE, MINIATURE, WAFER, etc.)

All standard brands, inspected and guaranteed by Wells Sales.

Manufacturers: Write for complete Electronic Catalog and prices. Dept. P



320 N. LA SALLE ST. CHICAGO 10, ILL.

Webster Electric Model "A" Cartridge

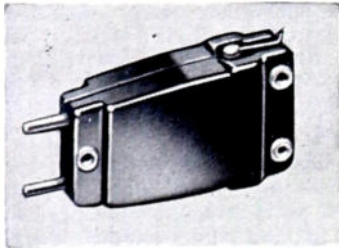

with Twist Mechanism

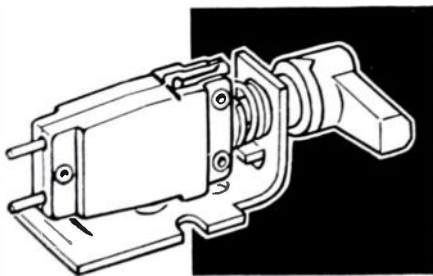

A complete unit with top performance and absolute minimum of service and installation problems.

The twist mechanism is factory assembled with Model A7 cartridge in place, ready for installation in tone arms without adjustment or modification. This completely assembled unit gives positive tracking at all playing speeds. High vertical and lateral compliance eliminate "skating". The simple, foolproof twist mechanism gives positive indexing, eliminating the possibility of twisting and damaging the leads in the tone arm.

There are no delicate parts to break or get out of order. The Model A7 with twist mechanism reverses through a 180 degree arc for playing either 33 $\frac{1}{2}$ - 45 or 78 R.P.M. records.

Send for a sample assembly today... try it... then note first hand the advanced improvement.

WEBSTER ELECTRIC

Webster Electric Company, Racine, Wis. • Established 1909

"Where Quality is a Responsibility and Fair Dealing an Obligation"

Positions Wanted

(Continued from page 52A)

company research lab. 2 years military Airborne radio maintenance. Thesis work parasitic antenna array impedance. 1st radio telephone, Amateur Class A, DXCC. Married, age 24. Desires design, development, research anywhere. Box 429 W.

RADIO ELECTRONICS TECHNICIAN

American, age 27, single. Desires long term position anywhere in Philippines. Amiable disposition. Speaks some Tagalog and Visayan. 10 years military, amateur and commercial radio experience. Box 431 W.

ELECTRONICS ENGINEER

B.E.E. September 1949, Georgia Institute of Technology, communications option. Age 27, single. Former Navy ETM. Limited production experience. Desires position with a future in electronics or communications. Salary secondary. Location immaterial. Box 432 W.

PHYSICIST

B.S. physics, University of Washington 1949, age 26. 6 years sub-professional radio and radar experience. FCC licensed radio telephone, 1st class. Primary interest: electronic instrumentation anywhere in U.S. Box 433 W.

ENGINEER

B.S.E. June 1949, University of Nebraska. Communications option. Single, age 26. Eta Kappa Nu, Pi Mu Epsilon. Desires position offering prospects of research or of work toward advanced degree. Salary and location secondary. Box 434 W.

ENGINEER

B.E.E. January 1950. Communications option. Rensselaer Polytechnic Institute. First quarter of class. 2 years Army experience as Chief Carrier Repeaterman. Age 31, single. Neat appearance. Salary and location secondary. Interested in communications, electronics and UHF. Box 435 W.

COMMUNICATIONS ENGINEER

7 years training in electronics. B.S.E.E. Graduate Navy electronics school and National Radio Institute. 1st class phone FCC license. Age 23, single. Technician experience. Interested in TV or other communications engineering. Box 436 W.

ENGINEER-EXECUTIVE

B.S. Iowa State, M.S. Purdue, M.B.A. Stanford, Graduate School of Business. E.E. Stanford, Graduate School of Engineering. 3 years Naval engineering officer; Bowdoin M.I.T. radar schools, radar material sea duty. Experience in research, engineering, production, business and industrial economics. Tau Beta Pi, Eta Kappa Nu, Sigma Xi. Interested in operation of a small business manufacturing and technical electronic product, or in a responsible position with a larger company in electronics industry. Box 437 W.

ELECTRONIC ENGINEER

B.S.E.E. and three-quarters toward M.S. Specialist in electronics, radio and control. 1 $\frac{1}{2}$ years as B-29 wing hq. staff

(Continued on page 54A)

New Miniature Insulated Terminals to help your miniaturization program

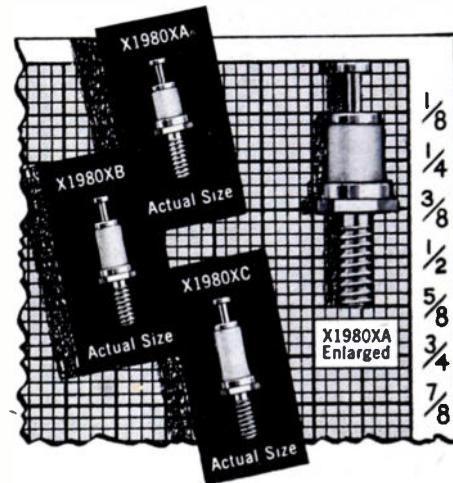

Featuring extremely small size combined with excellent dielectric properties, three new miniature insulated terminals are now available from CTC.

Designed to meet the requirements of the miniaturization programs now being carried out by manufacturers of electrical and electronic equipment, the terminals come in three lengths of dielectric and with voltage breakdown ratings up to 5800 volts. In addition, they have an extremely low capacitance to ground.

The X1980XA is the smallest terminal, having an over-all height of only three-eighths of an inch including lug. Insulators are grade L-5 ceramic, silicone impregnated for maximum resistance to moisture and fungi.

All terminals have hex-type mounting studs with 3/48 thread or .141" OD rivet style mounting. Mounting studs are cadmium plated, terminals are of bright-alloy plated brass.

Write for additional data.

custom or standard the
guaranteed components

CAMBRIDGE THERMIONIC CORP.
456 Concord Ave., Cambridge 38, Mass.
West Coast Stock Maintained By: E. V. Roberts,
5014 Venice Blvd., Los Angeles, California

THERE'S A JOHNSON INDUCTOR TO FIT EVERY NEED

IN YEARS of serving the manufacturers of transmitting and RF heating equipment, JOHNSON has evolved an extremely diverse line of inductors. From a comparatively few basic designs and with standardized parts it is possible to "tailor" an inductor for virtually any RF power application. This technique results in reasonable manufacturing costs and surprisingly good delivery on special as well as standard inductors. Examples of JOHNSON inductors are shown below.

224 Series

Standard 224 inductors capable of carrying current up to 50 amperes are available with $\frac{1}{2}$ " copper tubing windings to 50 microhenries. With $\frac{3}{8}$ " tubing, current may be 30 amperes, inductance to 110 microhenries. Insulation is glass bound mica, end frames cast aluminum, roller contact is silver plated beryllium copper. A special 224 inductor is also available with dual windings and two contacts for push-pull balanced circuits.

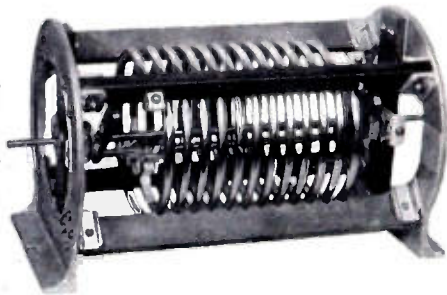

222 Series

JOHNSON 222 inductors are edgewound with $\frac{1}{2}$ " x .090 plated copper strip, are rated at currents up to 20 amperes depending upon frequency. Insulation is glass bound mica. Inductance is determined by the specific application.

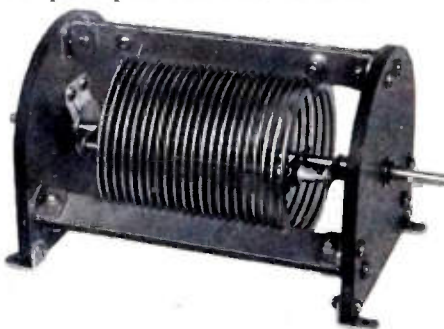

226 Series

This 226 variable inductor features a rotating coil with optional variable pitch for extended frequency coverage. The winding's conductor is $\frac{1}{4}$ " x .125" silver plated edgewise wound copper strip. Use of silver contacts assures low contact resistance. Depending upon winding pitch, frequency and allowable temperature rise, maximum current is 12 amperes. Inductor is wound to the specific requirements of the application: insulation glass bound mica.

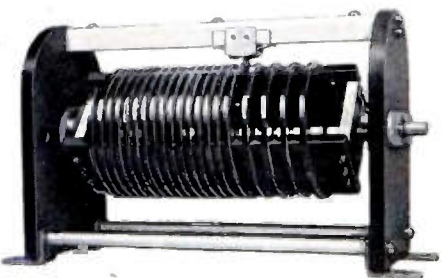

OTHER INDUCTORS

In addition to these sample types, the JOHNSON line includes many other variable and fixed inductors for low, medium and high power applications. Fixed inductors are available with single or multiple windings, fixed or variable coupling windings and with electrostatic shields if desired.

There is a JOHNSON inductor to fit your needs. In large quantities or small, we will be glad to quote on your requirements.



JOHNSON • • • a famous name in Radio!
E. F. JOHNSON CO., WASECA, MINNESOTA

Positions Wanted

(Continued from page 53A)

radar and radio officer; 2 years as E.E. instructor at prominent university. Age 30, married, 1 child. Conscientious, alert, congenial, excellent references. Primary interest: electronic or control development. Box 438 W.

ENGINEER-PHYSICIST

B.E.E. January 1949; M.A. in physics, May 1950, Columbia University; Experience in teaching, design and construction of highly specialized electronic instrumentation involving research and technical paper publication. I.I.A.M. experience 10 years on UHF to SHF. Member Tau Beta Pi, Eta Kappa Nu. State P.E. in training. Age 27, single. Prefer New York City vicinity but not exclusively. Box 440 W.

ELECTRONIC ENGINEER

Electronic engineer. Age 41. 7 years college; 15 years responsible practical experience in electronic operation, design and research. Now employed as consultant on job which will be completed this fall. Desires responsible position, credentials forwarded upon request. Salary open. Address: American, 72 Mococa, Sao Paulo, Brazil.

SALES, FIELD, OR APPLICATION ENGINEER

B.S.E.E. June 1950, Newark College of Engineering. Age 24. Single. Interested in position which combines engineering and "people." Navy 3 years, Electronic Technician 1/c. Some teaching, writing and industrial experience. Member Omicron Delta Kappa. Resume on request. Box 441 W.

ENGINEER

Engineering Aide, Graduate RCA Institute, 2 years advanced technology course, 2½ years experience as a laboratory electronic mechanic. Age 29, married. College background. Prefer work in eastern U.S. Box 439 W.

ELECTRICAL ENGINEER

Electrical engineer. Graduate of Iowa State College, June 1950, communication option. 6 months acetylene and electric welding experience, 14 months machinist apprentice training. Class A Amateur Radio Operator's license. Age 24, married. Location immaterial. Box 452 W.

ENGINEER

Position desired testing, design, research on electronic instruments (particularly interested in pulse and timing networks) or teaching electronic fundamentals, transients, and a.c. theory. Education: B.S.E.E., B.S. mathematics, graduate work in mathematics and physics. Experience: 2 years teaching mathematics and electrical engineering. Box 453 W.

ENGINEER

B.E.E. Pratt Institute, June 1950, top fifth of class. Desires start in electronic control and/or servomechanism. 2 years experience in testing. Salary secondary. Box 454 W.

ELECTRONIC ENGINEER

Electronic engineer, B.S.E.E., M.S.E.E. Age 28. Tau Beta Pi, Eta Kappa Nu. Experience: 1 year part time teaching; 2

(Continued on page 55A)

Positions Wanted

(Continued from page 54A)

years Navy Airborne electronics officer; 4 years development of digital computers, magnetic recording systems, and electromechanical devices. Box 455 W.

ENGINEER

B.E.E. Cornell, June 1950. Tau Beta Pi, Eta Kappa Nu. Some experience as laboratory assistant and in radio manufacture. Seeking position in communications or electronics development, design or research. Age 25. New York City or eastern U.S. location preferred. Starting salary secondary. Resume on request. Box 456 W.

ELECTRONICS ENGINEER

B.E.E. City College of New York, June 1950. Age 25, married. 1 year assistant in development of new oscilloscope. 1 year as electronic equipment specialist with Navy catalog office. 1 year as radio serviceman. AETM 1/c in Navy. Desires work in electronics or communications. Will relocate if necessary. Box 457 W.

ELECTRICAL ENGINEER

Electrical Engineer, age 43, single. B.S.E.E. 1 1/4 years design and development of transformers and coils for electronic equipment through manufacture. 2 1/2 years electrical design; 1 1/2 years Chief Electrical Engineer; 2 years

(Continued on page 56A)

Positions available for

SENIOR ELECTRONIC ENGINEERS

with

Development & Design
Experience

in

MICROWAVE RECEIVERS
PULSED CIRCUITS
SONAR EQUIPMENTS
MICROWAVE
COMMUNICATIONS
SYSTEMS

Opportunity For Advancement
Limited only by Individual
Ability

Send complete Resume to:
Personnel Department

MELPAR, INC.
452 Swann Ave.
Alexandria, Virginia



The Berkeley MODEL 410 INDUSTRIAL COUNTER

★ HIGH SPEED COUNTING—

Any mechanical, electrical or optical events that can be converted to changing electrical voltages can be counted at rates up to 10,000 per second.

★ **DIRECT READING**—no interpolation necessary; capacity of 1,000,000,000 counts.

★ **VERSATILE**—easily adapted for precise revolution counting,

linear measurements, frequency measurement, RF interpolation, nuclear counting, as well as virtually all laboratory and industrial high speed counting applications.

★

Complete description and specifications are yours for the asking.

Please request Bulletin PI-410.

Berkeley Scientific Company

SIXTH & NEVIN AVENUE • RICHMOND, CALIFORNIA

SMALL

PARTS

Cost less when made by

MULTI-SWAGE

The economy way to get

a million small parts

similar to these —

Examine the tubular and solid metal parts shown here twice size. If you use anything similar . . . in quantities of over a million . . . important savings can be yours. Send us the part and specs. Our quotation will show why the Bead Chain Company's MULTI-SWAGE Process has long been known as the most economical method of making electronic tube contact pins, terminals, jacks and sleeves. And, why more and more users of mechanical

parts (up to 1/4" dia. and to 2" length) employ our facilities. WRITE for Data Bulletin.
THE BEAD CHAIN MANUFACTURING CO.,
Tr. Mark 88 MOUNTAIN GROVE ST., BRIDGEPORT 5, CONN.

Let's talk Price



If your own sheet metal fabricating department is overloaded or if you are looking for a new source of supply, it will pay you to investigate the production facilities of Bud Radio.

Every month we produce thousands of sheet metal products for our own use and for industries throughout the country. Our specialized facilities enable us to turn out quality products at prices that will surprise you.

YOUR SPECIAL may be our STOCK ITEM

Regardless of your need for sheet metal products, we probably have a stock item that will fulfill your requirements. Often a slight change in one of our standard models will eliminate the necessity of special tools and dies and thereby cut your cost.

We make over 400 different sheet metal products as standard items, any one of which may be just what you need.

Our own large demand for steel and aluminum enable you to take advantage of large scale purchasing power. The engineering department is available for consultation on cost saving methods.

Let's talk about price. Whether your requirements are small or large, you will save time and money by consulting us first. Send us your blue prints for estimates or our representative will call at your convenience.

Write for Special Sheet Metal Catalog



THESE ARE SOME OF THE 1274 ITEMS AVAILABLE FROM BUD RADIO, INC.

BUD RADIO, INC.



2110 E. 55th ST. • CLEVELAND 3, OHIO

For Stability ... CONTINENTAL "NOBLELOY" RESISTORS



- Engineered Performance
- Metal Film
- Range $\frac{1}{2}$ ohm to 30 megohm
- Ratings, $\frac{1}{2}$, 1, 2 and 5 Watt
- Tolerance $\frac{1}{2}\%$, 1% and 5%

The "Nobleloy" type X resistors assure dependable operating characteristics for many critical applications at economical savings.

Write for further details

CONTINENTAL CARBON, INC. CLEVELAND 11, OHIO

Positions Wanted

(Continued from page 55A)

engineer-draftsman; 1 year construction and inspection—power and light engineering and telephone conduit installation. Desires responsible position with electronic transformer manufacturer or research. Wish to locate southwest. Box 463 W.

ELECTRONIC ENGINEER

B.S.E.E. Oklahoma Institute of Technology 1950. Communications major. 9 hours towards Master's degree. 3 years Naval Airborne radio and radar maintenance. $5\frac{1}{2}$ years 1st class machinist with Sperry. Age 31, single. Desires position with future in research, development, medical electronics, communications or electronic work. Anywhere in U.S. Box 464 W.

ELECTRONIC ENGINEER

B.S.E.E. communications, Oklahoma A. and M. College, June 1950. Eta Kappa Nu. 18 hours advanced graduate work. Age 24, single. Infantry 2 years. Informal varied experience in field of electronics. Desires position in research, design or development in any phase of electronics, preferably microwaves. Location immaterial. Box 465 W.

News—New Products

These manufacturers have invited PROCEEDINGS readers to write for literature and further technical information. Please mention your I.R.E. affiliation.

(Continued from page 49A)

time bases, telemetering, and chronometry. This tuning fork requires 6, 12, or 28 volts, 3.6 watts, and 100 to 350 volts 0.008 ampere. Accuracy is 1 part in 100,000; temperature coefficient, better than 1 part per million per degree Centigrade from 0 to 85° C or better.

Copper Oxide Rectifier

A new copper oxide rectifier of Bradley Laboratories, Inc., 82 Meadow St., New Haven, Conn., is designed to obtain a high reverse resistance of over 1 megohm per plate. The unit is intended for circuits in which very low leakage and maximum stability are essential.



Featuring vacuum processed gold contacts the new rectifier has $2\frac{1}{2}$ -inch leads. The rectifier barrel is only $\frac{3}{8}$ inch long and $\frac{1}{4}$ inch in diameter. Model number is CX18. Rated up to 5 ma dc.

(Continued on page 57A)

News—New Products

These manufacturers have invited PROCEEDINGS readers to write for literature and further technical information. Please mention your I.R.E. affiliation.

(Continued from page 56A)

Electrostatic Voltmeters

New electrostatic voltmeters, developed by Cole Instrument Co., 1320 S. Grand Ave., Los Angeles 15, Calif., are offered in portable and panel types. They operate on the attraction or repulsion between two electrical surfaces, and are used to measure high voltage outputs where no current can be drawn.



They are useful in many plants for measuring static voltages, and to check the charge of capacitors, potential of cathode-ray tubes, circuits of television, radar, ionization chambers, radiation instruments, and similar equipment.

These instruments have double pivoted movements with strong springs. The mirrored scale is 5 inches long with hand-drawn divisions. The aluminum pointer has a knife-edge for close reading. The accuracy as stated, is 1 per cent of full scale value. The movement is shielded to avoid errors due to stray external fields.

The portable type shown is furnished in single ranges, full scale from 120 volts to 12,000 volts and multi-ranges from 120/240 to 1,000/3,000/7,500 volts.

TV-FM Sweep Generator

A new television-FM sweep generator and marker combined in one instrument is the latest addition to the "Tee Vee" line of test equipment made by Radio City Products Co., 152 W. 25 St., New York 1, N. Y.



(Continued on page 58A)

LOW FREQUENCY PULSE PHENOMENA

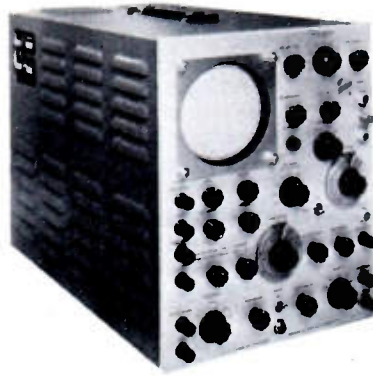

Type 512 Oscilloscope

- Band Pass—DC-2mc
- Sensitivity—5mv/cm maximum
- Sweeps—.3 sec/cm to 3 μ sec/cm

Accurate observation and measurement of slowly recurring phenomena is difficult, if not impossible, by conventional oscilloscopic techniques. The Tektronix Type 512 Cathode Ray Oscilloscope, combining as it does direct-coupled amplifiers, slow sweeps and high accuracy, is recognized by a constantly increasing number of researchers as being an indispensable laboratory tool. New and fruitful approaches to the problems encountered in research are permitted by these features. \$950.00 f.o.b. Portland, Oregon.

SUPPLEMENTARY SENSITIVITY

- Gain—1000
- Band Pass—1/6cps-40kc
- Noise Level—10 μ v peak-to-peak, max.



Type 122 Pre-Amplifier

The Tektronix Type 122 Pre-Amplifier has been designed as an accessory to the Type 512 Oscilloscope, for use in the biophysical, geophysical and other fields requiring additional sensitivity below 40 kc. At maximum gain, a 5 μ v signal will produce a 1 cm deflection on the oscilloscope. Use of the differential input gives a rejection ratio of 90 db for unwanted signals. A maximum of 20 v (peak-to-peak) is available at the cathode follower output. Multi-position switches permit separate control of both ends of the pass band. Battery operated for minimum noise level. \$85.00 f.o.b. Portland, Oregon.

Write today for detailed specification of Type 512, Type 122, and other Tektronix instruments.



TEKTRONIX, INC.

712 S. E. Hawthorne Blvd. Portland 14, Ore.

IT'S KINGS FOR CONNECTORS

News—New Products

These manufacturers have invited PROCEEDINGS readers to write for literature and further technical information. Please mention your I.R.E. affiliation.

(Continued from page 57A)

Pictured here are some of the more widely used R. F. co-axial, U. H. F. and Pulse connectors. They are all Precision-made and Pressurized when required. Over 300 types available, most of them in stock.



Backed by the name **KINGS**—the leader in the manufacture of co-axial connectors. Write for illustrated catalogs. Department "T"



Manufacturers of Radar, Whip, and Aircraft antennas
Microphone Plugs and Jacks.
Radar Assemblies, Cable Assemblies, Microwave and
Special Electronic Equipment

Adjustable AC Supply

A new voltage supply, called the "Solavolt," Type "CVL," is being manufactured by Sola Electric Co., 4633 W. 16 St., Chicago 50, Ill.



Solavolts are designed for use with equipment that requires an adjustable source of constant ac voltage (from 0 to 130 volts) of undistorted wave shape. They provide all of the voltage stabilizing characteristics of the standard Sola constant voltage transformer... ± 1 per cent regulation for line input changes from 95 to 125 volts, with less than 3 per cent harmonic distortion of the input voltage wave.

These Solavolt units may be used for exacting applications as well as general laboratory work, instrument calibration, testing, or other operations involving elements which are sensitive to power frequencies harmonically related to the fundamental.

As in other Sola constant voltage transformers, the voltage regulation is automatic and substantially instantaneous (maximum response time 1.5 cps). Except for the rotor of the autotransformer there are no moving parts, no manual adjustments, and no tubes or other expendable parts. Every unit is self-protecting against short circuit.

(Continued on page 59A)

ONE OF OUR
PRECISION PRODUCTS
FACSIMILE LEAD SCREW
28" LONG

12 $\frac{5}{8}$ " OF 96 PITCH THREAD
SHAFT DIAMETER 0.6250" \pm .0002"
CONCENTRICITY THROUGHOUT .0003"

MANUFACTURERS THREAD GRINDING, INC.

P. O. Box 66

EATONTOWN, N. J.

ASBURY PARK 1-1019

News—New Products

These manufacturers have invited PROCEEDINGS readers to write for literature and further technical information. Please mention your I.R.E. affiliation.

(Continued from page 58A)

50,000-Volt Power Supply

Condenser Products Co., 1375 N. Branch St., Chicago 22, Ill., has recently developed a 60-cps power supply to the following specifications: input voltage—117 volts ac, output voltage—50 kv; output current—1 ma (at 50 kv); output ripple—less than 1 per cent; output regulation—4,000 volts per ma.



The distinguishing feature of the PS-50 is the ease by which the three 5825 rectifiers can be replaced. In other oil-filled supplies, the entire cover must ordinarily be removed to replace the tubes, or the carefully processed oil becomes contaminated. In the PS-50, the rectifier tubes are set in bakelite tube-wells. The oil in these tube-wells does not mix with the oil in the transformer-capacitor compartment. The spacings around the tubes are great enough so that they can be filled with unprocessed oil without danger of corona or flashover. The gasket-sealed covers on the tube-wells are easily removed.

There are separate connections for the filament and plate transformers so that an input variac may be used to change output voltage.

New Transformer Material

A new oriented silicon lamination which permits reduced transformer stacks with resultant savings in materials and weight is announced by the Thomas and Skinner Steel Products Co., Indianapolis 7, Ind.

Main characteristic of the new lamination is higher permeability, with lower core loss. As a result, the oriented silicon material offers transformer designers greater efficiency with the normal number of E's and I's, or equal efficiency with fewer laminations.

Performance curves indicate that stacks may be reduced as much as 50 per cent in some cases, with resultant savings on copper and weight.

The new oriented silicon laminations are available in standard E and I designs and sizes, as well as for special applications.

(Continued on page 60A)

FAST STOPS

MAGNETIC DAMPING

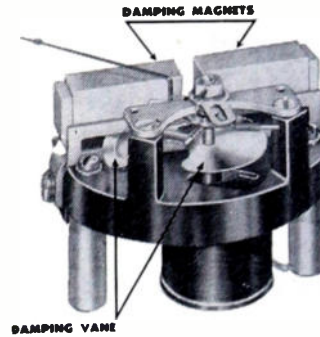

A NEW

Burlington

A. C. METER

These new A.C. instruments are *Magnetically Damped* by use of *Alnico Magnets* and are of the *Repulsion Vane Type* using carefully aged and impregnated field coils and multipliers. All standard ranges available in round, rectangular or square case styles and are guaranteed for one year against defects in workmanship or materials. Refer inquiries to Dept. I 80.

Burlington Instrument Co., Burlington, Iowa

ELECTRO-MECHANICAL RESEARCH, INC.

Specialists in High Quality, Sensitive
Electronic Instruments

NOW AVAILABLE:

MODEL 33—Supersensitive, narrow band, ten-cycle Amplifier. Maximum voltage gain 175 db. Also MODEL 35A Optical Chopper.

MODEL 27A—Subcarrier Discriminator. A high precision instrument for use in FM/FM telemetering systems. Linearity of output vs. subcarrier frequency $\pm \frac{1}{2}\%$ of full scale.

Manufacturing Consultants in the Fields of Infrared Devices, Metal Location, Vibration and Shock Measurement

Inquiries are invited on standard products and special services.

MODEL 36B—Broadband D-C Amplifier and sensitive voltmeter for use with oscilloscopes and recorders in a wide variety of physical and biological measurements.

MODEL 40A—Frequency Calibrator for rapid calibration of multi-channel FM system records.

Electro-Mechanical Research, Inc.

RIDGEFIELD, CONNECTICUT

Test Equipment FOR RADAR and PULSE APPLICATIONS

News—New Products

These manufacturers have invited PROCEEDINGS readers to write for literature and further technical information. Please mention your I.R.E. affiliation.

(Continued from page 59A)

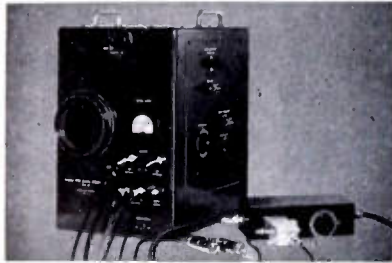

MODEL 708 SPECTRUM ANALYZER

Frequency range—8500 mc to 9600 mc.
Receiver—Double conversion superheterodyne.
IF bandwidth—approximately 10 kc.
Sweep frequency—10 cps to 25 cps.
Minimum frequency dispersion—1 mc/inch.
Maximum frequency dispersion—10 mc/inch.
Signal input attenuator—100 db linear.
Power—115V or 230V, 50 cps to 800 cps.

MODEL 705 WOBBULATOR

Swept signal output with center frequency adjustable from 2 to 500 mc.
Continuous swept output adjustable from 0 to 100 mc./sec. with 0.1 volt output at 50 ohms.
Internally synchronized scope with detectors and amplifiers.
High and low impedance shielded traveling wave detectors.
Output designed for making response measurements at 3000 mc., IF frequencies, and Video.

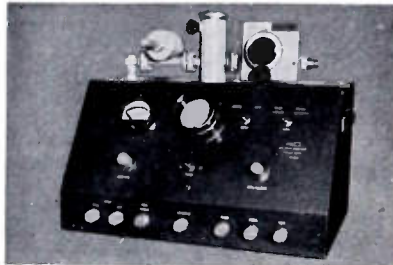

New Oscillo-Tracer

Robert A. Waters, Inc., 4 Gordon St., Waltham 54, Mass., announces the development of the Oscillo-Tracer, an optical super-positioning device that permits tracing of cathode-ray patterns of a repetitive nature directly on graph paper. The use of the Oscillo-Tracer for viewing oscillograms increases accuracy by the elimination of parallax caused by curved-face cathode-ray tubes and flat calibrated scales. The "projected" pattern is exactly the size of the original trace. For complete data, write to J. A. Macri, Robert A Waters, Inc.



Write for complete technical data

Canoga Corporation

14315 Bessemer St., Van Nuys, Calif. » Box 361

Only with **CO-AX**
air-spaced articulated
R.F. CABLES
4mmf/ft

Patents Regd Trade Mark

THE LOWEST EVER CAPACITANCE OR ATTENUATION

We are specially organized to give SPOT DELIVERIES TO U.S.A Cable your rush order for shipment by air freight. Settlement by your own \$ check

TRANSRADIO LTD

CONTRACTORS TO H.M. GOVERNMENT
13 BA CROMWELL ROAD LONDON SW7 ENGLAND
CABLES: TRANSRAD LONDON.

LOW ATTEN TYPES	IMPED OHMS	ATTEN db/100ft at 100 Mc/s	LOADING Att 100/100 Mc/s	OD"
A 1	74	1.7	0.11	0.36
A 2	74	1.3	0.24	0.44
A 34	73	0.6	1.5	0.88
LOW CAPAC TYPES	CAPAC mmf/ft	IMPED OHMS	ATTEN db/100ft 100 Mc/s	OD"
C 1	7.3	150	2.5	0.36
PC 1	10.2	132	3.1	0.36
C 11	6.3	173	3.2	0.36
C 2	6.3	171	2.15	0.44
C 22	5.5	184	2.8	0.44
C 3	5.4	197	1.9	0.64
C 33	4.8	220	2.4	0.64
C 44	4.1	252	2.1	1.03

HIGH POWER FLEXIBLE

PHOTOCELL CABLE

V. L. C. ★

★ Very Low Capacitance cable.

440-Volt Rectifier Cartridge

A new line of high-voltage selenium rectifier cartridges has been developed by the International Rectifier Corp., 6809 S. Victoria Ave., Los Angeles 43, Calif. The rectifier illustrated is rated at 440 volts dc and 10 ma dc, with a peak current rating of 1,500, volts. The 440-volt rectifier is of the half-wave type and is 9/16 inch outside diameter with an over-all length of 1 1/8 inches. Its voltage drop at rated load is about 25 volts, and its weight is 1/2 ounce.



These rectifier cartridges are available in either phenolic, glass, or hermetically sealed assemblies from 1/4 to 1 1/4 inches outside diameter, or they can be built to individual specifications utilizing either the half wave, or voltage doubler circuit. High-voltage rectifier cartridges are finding wide applications for radar, sonar, oscilloscope, photoflash, and all types of high-voltage power supplies.

(Continued on page 61A)

News—New Products

These manufacturers have invited PROCEEDINGS readers to write for literature and further technical information. Please mention your I.R.E. affiliation.

(Continued from page 60A)

Control Track Generator

It is now possible to use many of the non-synchronous $\frac{1}{4}$ -inch magnetic tape recorders for picture-synchronous sound-track recording by employing a control track generator, manufactured by the Fairchild Recording Equipment Corp., 154 St. and Seventh Ave., Whitestone, N. Y.



This generator superimposes a high-frequency signal on the magnetic tape simultaneously with the sound track. The hf signal becomes the tape speed control during playback. When played back on a "Fairchild Pic-Sync Recorder" this control track compensates for tape stretch and shrink, maintaining lip-sync between sound-track-on-tape and the picture-on-film. No extra heads or modifications to presently owned tape recorders are required. This compact unit is supplied in a small carrying case and may be removed for rack mounting. Cannon plug receptacles at the rear of the $19\frac{1}{2} \times 9\frac{1}{2} \times 7\frac{1}{2}$ -inch unit are for the two audio connections: one from the signal source, and one to the tape recorder's audio input terminal.

New Gamma-Ray Detector

The Model 939 Scintillometer (gamma-ray detector) has been announced by the Halross Instruments Corp., Ltd., 171 Garry St., Winnipeg, Canada.



(Continued on page 61A)



HERMETIC SEALING COMPONENTS

NEW! OCTAL PLUG-IN WAFERS



Now available in production quantities, E-I Series OBS Plug-in Wafers feature several important new developments. Hollow keys are form fitting and a new hermetic sealing technique makes the seal practically indestructible, even when the pins are bent. The entire assembly is extremely rigid. For complete data, call or write for the E-I illustrated brochure.

STANDARD SIZES	
MODEL	OUTSIDE DIA.
OBS 146	1.460
OBS 125	1.250
OBS 106	1.060

ELECTRICAL INDUSTRIES
 INCORPORATED
 44 SUMMER AVENUE • NEWARK 4, N. J.



200 MC BAND WIDTH AMPLIFIERS

Model 202P Wide-Band Chain Amplifier with Regulated Power Supply.

Band Width: 100 KC to 200 MC. Gain: 20 db.
 Impedance: 200 ohms. Rise Time: Less than .003 usec.
 With the Model 202P: very fast pulses, transients and other high frequency voltages can now be amplified.
 With the Model 202P: vacuum tube voltmeters and oscilloscopes are ten times more sensitive.
 With the Model 202P: the output voltage of signal, sweep and pulse generators is ten times greater.

Other Wide-Band Chain Amplifiers available:
 Model 200A — 10 db Gain. Model 204 — 40 db Gain.

Makers of chain amplifiers, temperature controls, variable electronic filters and power supplies.
 Write for Bulletin 202P-1-E

SKL SPENCER-KENNEDY LABORATORIES, INC.

186 MASSACHUSETTS AVE., CAMBRIDGE 39, MASS.

PULSE EQUIPMENT

- G.E.K.—2745 \$39.50
- G.E.K.—2744-A, 11.5 KV High Voltage, 3.2 KV Low Voltage @ 200 KW oper. (270 KW max.) 1 microsec. or ¼ microsec. @ 600 PPS \$39.50
- W.E. 2D160173 111-Volt input transformer. W.E. impedance ratio 50 ohms to 900 ohms. Freq. range: 10 kc to 3 mc. 2 sections parallel connected, potted in oil \$36.00
- W.E. KB 18000 Input transformer. Winding ratio between terminals 3-5 and 1-2 is 1:1.1, and between terminals 0-7 and 1-2 is 2:1. Frequency range: 380-520 c.p.s. Permalloy core \$6.00
- G.E. K2450A. Will receive 13 KV. 4 micro-second pulse on pri. secondary delivers 14KV. Peak power out 100KW G.E. \$34.50
- TP510 Modulator X Band \$350.00
- 80-4 Modulator Y Band \$425.00
- SCR-268 Keyer units \$95.00
- 715B Tubes \$12.00
- 705A Tubes \$2.80
- 705 Sockets \$7.00

Complete line of high voltage pulse transformers, networks and dual lines.

**23,000 TO 27,000 MC. BENCH TEST PLUMBING
1/2" x 1/4" WAVEGUIDE**

- PRECISION SLOTTED LINE. DeMornay Budd type 337, complete with adjustable probe and crystal output, Square flanges. \$400.00
- PRECISION SLOTTED LINE. Adjustable probe. Humble Oil type. CPK-2111U \$200.00
- DIRECTIONAL COUPLER-WAVEMETER MOUNT. 12DB \$60.00
- PRECISION VARIABLE ATTENUATOR. n.f.e. Bernard Rice \$90.00
- TUNABLE CRYSTAL MOUNT. DB423 less tuning plunger \$30.00
- FLAT ATTENUATOR. DB405 10DB attenuation \$25.00
- LOW POWER LOAD \$20.00
- SLEEVE TUNER \$25.00
- SHUNT TEE \$35.00
- WAVEGUIDE LENGTHS. 2" to 6" long, gold-plated with circular flanges and coupling nuts \$2.25 per inch
- APS-34 Rotating Joint \$49.50
- Right Angle Bend E or H Plane, specify combination of couplings desired \$12.00
- 45° Bend E or H Plane, Choke to cover \$12.00
- Directional coupler CU-103/APS32 \$49.50
- Mitered Elbow, cover to cover \$4.00
- TR-ATIR Section, choke to cover \$4.00
- Flexible Section 1" choke to choke \$5.00
- "S" Curve Choke to cover \$4.50
- Adaptor, round to square cover \$5.00
- Feedback to Parabola Horn with pressurized window \$27.50
- Low Power Load, less cards \$18.50
- K Band Mixer Block \$45.00
- Waveguide 1/2 x 1/4" \$1.00 per ft.
- Circular Flanges \$5.00
- Flange Coupling Nuts \$5.00
- Slotted line, DeMornay Budd 2397, new \$450.00
- 90° Twist \$10.00
- "K" Band Directional Coupler CU104/APS 34 20 DB \$49.50 ea.
- K BAND 2K33 w/cav \$115.00
- 3J31 Magnetrons \$55.00

**8500 Mc. to 9600 Mc. Bench Test Plumbing
1" x 1 1/2" WAVEGUIDE**

- SLOTTED LINE. Complete with adjustable probe, crystal output, precision vernier adjust. Humble oil type \$220.00
- KLYSTRON MOUNTS. DeMornay Budd type DB380 for 2K25 etc. Includes tunable termination \$70.00
- VARIABLE ATTENUATOR. DeMornay Budd type DB383. Maximum attenuation 35DB. \$120.00
- VARIABLE STUB TUNER. DB536. 180 degree phase shifting capability \$70.00
- FLAT ATTENUATOR. DB385. Maximum Attenuation 10DB \$25.00
- MAGIC TEE. DB539. \$42.00
- WAVE GUIDE TO TYPE "N" ADAPTOR. DB377 \$15.00
- LOW POWER TERMINATION. DB381. \$18.50
- UNI-DIRECTIONAL COUPLER. DB390. 25DB type "N" output \$18.50
- PICK UP HORN. Type "N" output \$4.50
- WAVEMETER. 8500 to 9400 mcs. with calibration. Micrometer adjust head. Reaction type \$85.00
- WAVEGUIDE LENGTHS. Plated and fitted with couplings available in 6", 12", 24", 30", 60" sections \$2.00 per ft.
- 90 DEGREE ELBOWS. E or H plane 2 1/2" radius \$12.50
- MITERED ELBOWS. E or H plane \$10.00
- 45 DEGREE OFFSET ELBOWS. E or H plane \$10.00
- 90 DEGREE TWIST. 6" long \$8.00
- BULKHEAD FEED-THRU ASSEMBLY \$15.00
- PRESSURE GAUGE SECTION. 15lb. gauge and press. nipple \$10.00
- PRESSURE GAUGE. 15 lbs. \$2.50
- CRYSTAL MOUNT. IN23 type crystal holder \$17.50
- DUAL OSCILLATOR-BEACON MOUNT. P/O APS16 Radar for mounting two 723A/B kly-

- strons with crystal mats, matching slugs, shields \$42.50
- DUAL OSCILLATOR MOUNTS. (Back to back) with crystal mount, tunable termination, at tenuating slugs \$18.50
- KLYSTRONS 723AB \$12.00
- Directional Coupler, UG-40/E Take off 20 DB \$17.50
- Directional coupler. APS-6 type "N" take off 20 DB calibrated \$17.50
- Broad Band Directional coupler, type "N" take off choke to cover, 23 DB calibrated \$12.00
- Flexible Section 18" long \$10.00
- Rotary Joint Choke to Choke \$10.00
- 2K25/723 AB Receiver local oscillator Klystron Mount, complete with crystal mount, iris coupling and choke coupling to TR \$22.50
- TR-ATR Duplexer section for above \$8.50
- 723AB Mixer Beacon Dual Oscillator Mount Matching slugs and tunable termination, new \$24.50

1 1/4" x 5/8" WAVEGUIDE

- SLOTTED LINE. Complete with adjustable probe, crystal output, precision vernier adjust. Humble Oil type \$225.00
- TUNABLE TERMINATION. Precision adjust \$65.00
- LOW POWER TERMINATION \$25.00
- MAGIC TEE \$45.00
- TRANSITION. 1 1/4" x 5/8" to 1" x 1/2" \$19.50
- OSCILLATOR MOUNT. for four 723AB klystron \$38.50
- 90 DEGREE ELBOWS. E or H plane \$12.50
- WAVEGUIDE LENGTHS. Cut to size and supplied with 1 choke. 1 cover, per length \$2.00 per ft.
- WAVEMETER: Absorption type. Precision micrometer adjust. Very high Q \$150.00

**6000 Mc. to 8500 Mc. Bench Test Plumbing
1 1/2" x 3/4" WAVEGUIDE**

- KLYSTRON MOUNT. DB356 complete with shield and tunable termination \$125.00
- FLAT ATTENUATOR. DB361 \$45.00
- PRECISION WAVEMETER. DB358. Micrometer adjust head \$190.00
- VARIABLE STUB TUNER \$90.00
- WAVEGUIDE TO TYPE "N" ADAPTER \$18.50
- WAVEMETER TEE. DB352 \$32.50
- SLOTTED LINE. DB34 Precision vernier adjust. less probe \$320.00
- MAGIC TEE \$80.00
- DIRECTIONAL COUPLER. Two hole 25DB coup-

- ling, type "N" output \$25.00
- PRECISION CRYSTAL MOUNT. Equipped with tuning slugs and tunable termination \$125.00
- TUNABLE TERMINATION. Precision adjust \$70.00
- LOW POWER LOAD \$35.00

**4000 to 6000 mcs. Bench Test Plumbing
2" x 1" WAVEGUIDE**

- SLOTTED LINE. DeMornay type 332 complete with probe, etc. \$600.00
- FLAT ATTENUATOR \$48.00
- VARIABLE STUB TUNER AND LOW POWER TERMINATION \$48.00
- WAVEMETER TEE \$48.00

3000 MC BENCH TEST PLUMBING

TEST EQUIPMENT

- 10 CM Wavemeter WE type B435490 Transmission type. Type N Fittings, Vender Root Micrometer dial. Gold Plated W/Calib. Chart P/O. Freq. Meter X66404A. New \$99.50
- AS14A/AP-10 CM Pick up Dipole with "N" Cables \$4.50

R. F. EQUIPMENT

- LHTR. LIGHTHOUSE ASSEMBLY. Part of RT-39 APG 5 & APG 16 Receiver and Frans Cavities w/assoc. Tr. Cavity and Type N CPLG. To Rev. Uses 2C40, 2C43, 1B27, Tunable APX 2400-2700 MCS, Silver Plated \$49.50
- Beacon Lighthouse cavity 10 cm with miniature 28 volt DC FM motor. Mfg. Bernard Rice \$47.50 ea.

S. BAND

- 90° Twist, circular cover to circular cover. \$25.00
- Magnetron to Waveguide Coupler with 721A Duplexer Cavity, gold-plated \$45.00
- 721A TR Box complete with tube and tuning plungers \$12.50
- McNally Klystron Cavities for 707B or 2K28. Three types available \$4.00
- F-20/Split-2 Filters, Type "N", input and output \$12.50

ARMY-NAVY TEST SETS

- TS-226A/AP Power Meter.
- TS67/AP 3 centimeter precision echo box.
- TS36/AP 3 centimeter Thermistor Bridge—Power Meter.
- TS89/AP Voltage divider.
- TS268/U Crystal checker for IN23 type crystals etc.
- CW-60ABM 10 Centimeter Wavemeter. Coaxial type micrometer adjust cavity. Resonance indicating meter, carrying case (similar to TS117/GP).
- TS235/UP High Power Load. "L" band (1000 mcs.).
- LU-1 Freq. Meter and Test OSC. Type CRV-60ACL.

- 726 Klystron Mount. Tunable output, to type "N" complete, with socket and mounting bracket \$12.50
- WAVEGUIDE TO 3/4" RIGID COAX "DOOR-NOB" ADAPTER, CHOKE FLANGE, SILVER PLATED BROAD BAND \$32.50
- WAVEGUIDE DIRECTIONAL COUPLER. 27 db. Navy type CABW-47AAN, with 4 in. slotted section \$32.50
- SQ. FLANGE to rd choke adapter. 18 in. long OA 1 1/2 in. x 3 in. guide, type "N" output and sampling probe \$27.50
- AN/AP15A 10 cm antenna equipment consisting of two 10 cm waveguide sections, each polarized, 45 degrees \$75.00 per set
- POWER SPLITTER. 726 Klystron input dual "N" output \$5.00
- 10 CM FEEDBACK DIPOLE ANTENNA. In lucite ball, for use with parabola 7/8" Rigid Coax Input \$8.00
- 721A TR cavities, heavy silver plated \$2.00 ea.
- 7/8" RIGID COAX
- Magnetron Coupling with TR Loop, gold-plated \$7.50
- Sperry Rotating Bend, pressurized \$22.50
- 5 Ft. Lengths Stub Supported, gold-plated, per length \$7.50
- Short Right Angle Bends (for above) \$2.50

- TVN-9HU Power Supply. M.I.T. Rad. Lab.
- TVN-BSE Klystron Power Supply. M.I.T. Rad. Lab.
- CS60ABW WAM Meter-Wavemeter, 3 centimeter.
- APR5 Receiver—1000 to 6000 mcs.
- AN/CPN-8—10 centimeter 40 kw. output RF package. Includes magnetron oscillator, complete modulator, complete receiver, complete signal and power analyzer with 5" scope. 115V AC input.

TEST EQUIPMENT

- Dehydrator Unit CPD 10137 Automatic cycling. Compressor to 50 lbs. Compl. for Radar XSMN. Line New \$425.00

MAGNETRONS

2127	2162	723A	2K42
2131	3131	707B	W/Cavity
2121-A	5130	417A	2K22
2126	7144Y	2K41	2G6B
2132	7180Y	2K26	2K55 726C
2137	720BY		
2138	720CY		
2139	725-A	QK 62	3150-3375 mc.
2140	730-A	QK 59	2075-2900 mc.
2149	728	QK 61	2975-3200 mc.
2134	700	QK 60	2800-3025 mc.
2161	706	QK 915	

KLYSTRONS

MAGNETRON MAGNETS

Gauss	Pole Diam.	Spacing	Price
4850	3/4 in.	3/4 in.	\$ 8.90
5200	2 1/2 in.	3/4 in.	\$12.50
1300	1 1/2 in.	1 5/16 in.	\$17.80
1860	1 1/2 in.	1 1/2 in.	\$14.50

Electromagnets for magnetrons \$24.50 ea.
GE Magnets type M705115, GI Distance Between pole faces variable, 2 1/16" (1300 Gauss) to 1 1/2" (2200 Gauss) Pole Dia. 1 1/2" New Part of SCR 584 \$34.50

THERMISTORS

D-167332 (tube)	\$.95	D-168687	\$.95
D-170396 (bead)	\$.95	D-171812	\$.95
D-167613 (button)	\$.95	D-171528	\$.95
D-164699 for MTG in "X" band Guide	\$.95	D-168549	\$.95
		D-168442	\$3.00
		D-165593	\$1.25
		D-98836	\$2.00
		D-161871A	\$2.85
		D-171121	\$.95
		D-162356(308A)	\$1.50
		D-163357	\$2.00
		D-99916	\$2.95

VARIATORS

ADAPTERS: Choke to choke \$18.00

- Cover to cover \$14.00
- Choke to cover \$16.00
- WAVEGUIDE TO TYPE "N" ADAPTER \$45.00
- DIRECTIONAL COUPLER, Two hole type, type "N" output \$48.00
- KLYSTRON MOUNT. Equipped with tunable termination and micrometer adjust. klystron antenna tuning \$110.00
- CRYSTAL MOUNT. Equipped with tunable termination and micrometer adjust crystal tuning \$125.00
- TUNABLE TERMINATION. Precision adjust \$90.00

GENERAL TEST EQUIPMENT

- Multi Frequency Generator. American Time Product type SC-16, Frequency 10 to 190. Precision Standard Watch-Master \$48.00
- UHF Signal Generator. J.C.A. type 710A 370 to 560 mcs. \$50.00
- Wheatstone Bridge. Industrial Instruments type RN-1
- FM Signal Generator. Boonton Radio type 155A. Freq. range 1 to 10 mcs. 38 to 50 mcs. Condenser Weld Power. Cap. 56 mfd. max., max. chg. 1500 Volts
- Frequency Meter. Lavole Model 105-300 to 600 mcs.
- Megohm Bridge. Industrial Instruments type MB. Visual Alignment Signal Generator. General Electric—0 to 60 mcs.

NEW TEST EQUIPMENT IN STOCK

- 1-185A Oscillator
- 1-158 Range Calibrator
- 1-223 Range Calibrator
- BC 438 Freq. Meter
- RF Preamp.
- G. R. Capacity Brdg. #216
- G. R. Uni Galvo Shunt #229
- G. R. 100 SL Aud. Osc. #213
- TS226A/AP Pwr. Mtr. O-1000 W.
- Sig. Gen. 2804 8-330 MC
- 183J Dynamotor Test set

- SO-3 Receiver. 30 mc. IF. 6 stages 6AC7. 10 MC. Band width input. 5.1 mc H.W. per stg. 9.6 volt gain per stage as desc in ch. 13 vol. 23 M.I.T. Rad. Lab. Series \$99.50
- APS-2 10 CM RF HEAD COMPLETE WITH HARD TUBE (715B) Pulsar. 714 magnetron 417A Mixer all 7/8" rigid coax, incl. revr. front end \$210.00
- 10 cm cavity type wavemeters 6" deep, 6 1/2" in diameter Coax. Output Silver Plated \$64.50 ea.
- 10 cm. echo box. Part of SFI Radar W111 volt DC Tuning motor Sub Sig. 1118AO \$47.50

All merch. guar. Mail orders promptly filled. All prices, F.O.B., N.Y.C. Send Money Order or Check. Only shipping charges sent C.O.D. Rated Concerns send P.O.

COMMUNICATIONS EQUIPMENT COMPANY

131 LIBERTY STREET, NEW YORK, N.Y. DEPT 18 P. J. PLSHNER PHONE DIGBY—9-4124

QCQ2 SONAR

ECHO RANGING AND LISTENING EQUIPMENT

Use: Medium ASW ships.
Keying interval, 1,000, 2,000, 4,000, 8,000 yards, and manual.
Projector, Magnetostrictive, permanent magnet polarization, resonant frequency about 25 kc.
Transmitting system, The electron tube driver oscillator and two amplifier stages are contained in the receiver chassis; the variable tuning condenser being ganged with the receiver tuning condensers in order to give uni-control of receiver and driver tuning. In another chassis are located the output tubes and the high voltage rectifier. Sweep frequency modulation is provided, giving a shift from 400 cycles below to 600 cycles above the operating frequency during the transmission.

Receiving system, The receiver is of the tuned-radio-frequency type. It includes time varied gain, to reduce the volume of reverberations immediately following the transmission, and has a "Flat-Peak" audio filter, and an adjustable BFO to give an audible note above or below 800 cycles.

Keying and indicating system, Keying is mechanical; cams in the indicator unit determine the pulse length and keying interval. Ranges are indicated by the flash of a neon lamp.
Complete sets available less hoist. Also stacks alone.

QBF and QJA SONAR

ECHO RANGING AND LISTENING EQUIPMENT

Use: Large ASW ships.
ABF may be converted by field modifications, to QJA available.
Keying interval, 1,000, 2,000, 3,000, 4,000, 5,000, 10,000 yards and manual.

The electrical train system consists of a handwheel on the stack which selects, by commutation, three voltages from the secondary of a transformer-like device called a Commutator Transmitter.

Projector, The projector is of the Rochelle salt crystal type with a single element used for both listening and ranging. The frequency is 22 to 28 kc.

Transmitting system, The receiver-driver oscillator unit contains two electron tube oscillators, one fixed at about 150 kc and one tunable over the range from 160 to 180 kc. The outputs of the two are mixed, producing a difference frequency, which is then fed to the driver-amplifier unit and thus to the projector.

Receiving system, The receiver is a superheterodyne type covering the range from 10 to 60 kc.

Keying and indicating system, Ranges are indicated by the flash of a neon lamp which revolves at a constant speed, driven by a synchronous motor.

QCU, QCU-1 SONAR

ECHO RANGING AND LISTENING EQUIPMENT

Use: Small ASW Ships.
Intended to be used as a replacement for the obsolete WEA-1 equipment the old hoist.

Keying interval, 1,000, 2,000, 4,000, 8,000 yards and manual.
Trainmg is electrical, controlled by a hand crank at the remote station.

Projector, Magnetostrictive, permanent magnet polarization, resonant frequency about 25 kc, split for BDI.

Transmitting system, The electron tube driver oscillator and two amplifier stages are contained in the receiver chassis; the variable tuning condenser being ganged with the receiver tuning condensers in order to give uni-control of receiver and driver tuning. In another chassis are located two type 811 output tubes and two type 836 high voltage rectifier tubes. Sweep frequency modulation is provided, giving a shift from 400 cycles below to 600 cycles above the operating frequency during the transmission.

Receiving system, The receiver is of the tuned radio frequency type. It includes time varied gain, to reduce the volume of reverberations immediately following the transmission, and has a "Flat-Peak" audio filter, and an adjustable BFO to give an audible note, above or below 800 cycles.

QCS, QCS-1, QCT-1 SONAR

ECHO RANGING AND LISTENING EQUIPMENT

Use: ASW ships.
Keying interval (original)—1,000, 2,000, 5,000, 10,000 yards and manual, (field modification added 3,000 and 4,000 yards)

Transmitting system, The driver-rectifier unit contains an electron-tube oscillator tunable over the range of 37 to 25.5 kc, and electron-tube amplifier and a rectifier power supply.

Receiving system, The superheterodyne receiver covers the range from 13 to 37 kc and may be connected by a selector switch to either the "QCQ" or the "JK" face of the projector. It has separate audio amplifiers for the range indicator lamp and for the loudspeaker. The audible note may be adjusted over the range from 0 to 1600 cycles. Three degrees of 1-f selectivity and two of audio are provided by selector switches connected to filters.

Keying and indicating system, Keying is mechanical; cams driven by the range indicator disc shaft determine the pulse strength and keying interval.

Complete 3 CM Radar System Equipment

40 KW peak transmitter, pulse modulator, receiver, using 723AB, power supply operating from 115V 800 Cycle, antenna system. Complete radar set neatly packaged in less than 16 cubic feet, all tubes, in used but excellent condition—\$350.00. This price for laboratories, schools, and experimental purposes only.

High Voltage Power Supply

15 KV at 30 Ma DC, Bridge Rectifier, Western Electric . . \$125.00

RADIO SYSTEMS

TAJ 500 Watt Low Frequency Transmitter 150-550KC CW-MCW.

TBK 500 Watt High Frequency Transmitter 2-18 MC. A1, A2, A3.

Emission Mfg. by RCA.

White Radio Telephone Model 2WRM88—ship to ship—ship to shore—small airports—mines—plantations—inter island—

10 channel fx tuned rec. & xmitter. Xmitter, pwr. output in excess of 100W unmodulated into antenna of 18Ω & 100 MMF. Freq. Range 2-12 MC. Can be modified to increase range. Xtal controlled, 110V 60 cy or 220V 60 or 25 cy. Meas. 24" H x 16" WX 14" D. 125 lbs. Write or phone for data.

FM STATION

Kilowatt Amplifier Model 4BT2A1 Type BT2A Serial RC25

250 Watt Exciter Model 4BT1A1 Type 3T1A Serial CC833

Station Monitor Model 4BM1A1 Type BM1A Serial WC268

Power Supply Model BP241 Type BP2A Serial WC517

Transmitter Console Model 4BC3A1 Type BC3A Serial WC5

Type BX-2A Two Bay Circular Antenna with Mast, Transmission Line, Elevators and Meters.

100 Feet of 1% coax, transmission line including 90° elbows.

Dehydrator for transmission line.

Desk and Chair for transmitter console.

Write or Phone for Data and Price

APS-2 10 cm. airborne radar set designed for navigation and high altitude bombing. The antenna rotates through 360 degrees. Presentation is PPI and A Scope. The following units of the set are supplied: Antenna, transmitter-receiver, modulator, indicator, 24VDC input power unit. New with all tubes, incl. 714AY magnetron, 417A klystron.

APS-3 3 cm. airborne radar set designed for intercept of enemy aircraft and nominal navigation. Antenna is sector scan. Remote as well as master indicator is supplied. 725A magnetron operates the set at 45kw. Complete sets available with all tubes incl. magnetron and 723AB klystrons. Both new and used condition.

APS-4 cm. airborne radar set designed for sector scan surface search, mapping and navigation, weather forecasting intercept of enemy aircraft. Entirely enclosed in a streamlined housing for optional mounting on aircraft bomb rack, or on nose of large bombers. Complete sets with indicator equipment, and power unit ready for installation.

APS-6 3 cm. Night Fighter radar with pencil beam antenna. Transmitter-receiver packages and antennas available in equal to new condition.

APS-6A 3 cm. airborne radar RF package, 45kw, using 725A magnetron, IF strip using 6AK5's, 723AB beacon and local oscillator.

APS-10 3 cm. airborne radar using 2J42 magnetron. Modulator decks and low voltage power supply, only, available, less tubes. Beacon—local oscillator klystron mounts are available.

APQ-13 3 cm. airborne radar complete RF package in excellent condition including all tubes.

APS-15 3 cm. airborne radar designed for high altitude bombing, navigation, intercept of enemy aircraft, weather forecasting. Antenna rotates 360 degrees. Presentation is PPI and A Scope. The following units are supplied: Antenna, transmitter-receiver, modulator, indicator, slant-range computer, 24VDC input power unit. New with all tubes including 45kw 725A magnetron, 723AB local oscillator-beacon.

CPN-8 10 cm Navigation Beacon ground station. Complete and partial installations available. High power beacon of long range capability. Complete power, frequency, operation analyzer (5" scope) included.

CXBR 10 cm, M.I.T. navigation beacon equipment, complete, in excellent condition.

FD MARK IV 800 mc. gunlaying radar mfg. and designed by Western Electric for battleships. Complete consoles available with all tubes including 700A magnetron and modulator thyratron.

MARK 10 10 cm. gunlaying radar, complete, for automatic firing of guns as antenna tracks target. 250 KW.

SA 200 cm. Air Search radar especially designed for shipboard of mobile installation. Ideal for ground intercept and control of aircraft. PPI 7" indicator. Long range.

SD 200 cm. radar similar to SA but designed for installation on submarines. New.

SE 10 cm. shipboard Surface Search radar, using thyratron modulator. Complete installation available including spare parts. "A" scope presentation. 250 KW.

SF-1 10 cm. shipboard Surface Search radar with PPI and A scope. Used for navigation and target range information on naval vessels. 250 KW.

SG 10 cm. shipboard Surface Search radar with PPI and A scope. Heavy, rugged equipment designed for large naval and merchant vessels. 250 KW.

SJ-1 10 cm. radar designed for installation of Submarines. Equipped with PPI and A scope. Complete installations.

SL 10 cm. radar designed for Surface Search on shipboard. PPI indicator console.

SN 10 cm. portable radar. Lightweight, easily transportable complete radar installation using lighthouse tubes with a 25 mile maximum range. 115 V AC operation.

SO-1 10 cm. shipboard radar for navigation of all types of vessels, 4, 20, and 80 miles range. PPI indicator. Large antenna. 115 V DC input.

SO-8 Same as SO-1 but with a lightweight antenna.

SO-13 Same as SO-1 but with a lightweight antenna, 28 V DC input. Designed for PT boat installation.

SCR-518 Radar altimeter using pulse-echo-time principle, 400 mc, 28 V DC input, CRT tube altitude indication.

SCR-520 Airborne radar RF package, 10 cm., complete with pulser, 714AY magnetron.

SCR-533 IFF/Air Search trailer, complete, 500mc operation, A scope.

SCR-663 Sperry searchlight training, aircraft tracking ground installation. Used condition.

TPS-2 1000 mc. portable early warning system. Bed spring antenna. Complete with portable gasoline generator.

UPN-2 10 cm. portable beacon equipment.

SQ 10 cm. portable radar designed for use on landing barges and beach heads. PPI, B, A indication on 3" scope. 115V AC operation.

MORE TEST EQUIPMENT

TM 36, 110A1' 35, 62, 108, 102, 111, 34, 104, 45, 102, 33, 107, '16

COMMUNICATIONS EQUIPMENT CO.

131 Liberty Street, New York, N.Y.

Dept. 13

P. J. Plishner

Phone Dlgby—D-4124

**RADAR
RADAR
RADAR
RADAR**

R

A

D

A

R

**RADAR
RADAR
RADAR
RADAR**

News—New Products

These manufacturers have invited PROCEEDINGS readers to write for literature and further technical information. Please mention your I.R.E. affiliation.

(Continued from page 61A)

The new instrument employs the scintillation principle, and provides a detection sensitivity over 100 times that obtainable by conventional portable Geiger counters; the actual count rate, the manufacturer claims, being approximately 290 times that of three popular Geiger counters tested under identical conditions.

Through the use of a gamma-ray spectrometer feature, the Scintillometer may be used to distinguish the difference between thorium and uranium ore deposits, and will indicate the uranium concentration in an ore containing both radioactive minerals.

The Scintillometer employs high vacuum tubes in conservatively designed circuits; is protected against vibration, shock, temperature, and humidity; and will operate continuously between -20° F and $+110^{\circ}$ F with a relative humidity of 95 per cent.

A removable probe is contained in the lower section of the case proper.

Pocket-Size Sound Level Meter

Indoor and outdoor acoustics, machinery noise, and hearing requirements are quickly and accurately measured with the new Type 410-A miniature sound level meter, which has been developed by, **Hermon Hosmer Scott, Inc.**, 385 Putnam Ave., Cambridge 39, Mass.



Subminiature tubes and hearing-aid batteries permit a rugged compact design meeting all specifications of the American Standards Association for sound level meters.

This type 410-A, sound level meter, weighing slightly over 2 pounds, covers the range from 34 to 140 db above the standard ASA weighting characteristics which duplicate the ear response at various loudness levels. Readily available batteries have a normal operating life of 50 hours. Optional accessories include carrying case, extension cable with input adaptor, and mounting tripod. Vibration pickups and integrators are available for measurement of displacements, velocities, and accelerations in the audio-frequency range.

(Continued on page 65A)

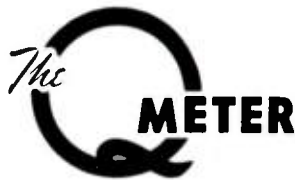

TYPE 160-A

ACCURATE • DEPENDABLE • VERSATILE

For the measurement of Q, inductance, and capacitance, the 160-A Q-Meter is the universal choice of radio and electronics engineers. Its wide frequency coverage from 50 kc. to 75 mc. is an outstanding feature which makes possible the accurate and rapid evaluation of components and insulating materials at the actual operating frequency.

SPECIFICATIONS

OSCILLATOR FREQUENCY RANGE: 50 kc. to 75 mc. 8 self contained ranges.

OSCILLATOR FREQUENCY ACCURACY: $\pm 1\%$, 50 kc.-50 mc. $\pm 3\%$, 50 mc.-75 mc.

Q-MEASUREMENT RANGE: Directly calibrated in Q, 20-250. "Multiply-Q-By" Meter calibrated at intervals from x1 to x2, and also at x2.5, extending Q-range to 625.

Q-MEASUREMENT ACCURACY: Approximately 5% for direct reading measurement, far frequencies up to 30 mc. Accuracy less at higher frequencies.

CAPACITANCE CALIBRATION RANGE: Main capacitor section 30-450 mmf, accuracy 1% or 1 mmf, whichever is greater. Vernier capacitor section $+3$ mmf., zero, -3 mmf. calibrated in 0.1 mmf. steps. Accuracy ± 0.1 mmf.

Write for literature containing further details

BOONTON RADIO

BOONTON - N.J. - U.S.A.



S.S. White MOLDED RESISTORS

ARE USED IN HIGH VOLTAGE "HIPOT" COUPLERS

S.S. White resistors are connected in series to permit a current flow to ground, when the "Hipot" Coupler is used to measure or to synchronize voltage of high voltage lines.

Canadian Line Materials, Ltd.—maker of "Hipot" Couplers and other transmission, distribution and lighting equipment—says—"We have always found S.S. White resistors of the highest quality". This checks with the experience of the many other producers of electrical and electronic equipment who use S.S. White resistors.

WRITE FOR BULLETIN 4906

It gives details of S.S. White Resistors including construction, characteristics, dimensions, etc. Copy with price list on request.



S.S. WHITE RESISTORS

are of particular interest to all who need resistors with low noise level and good stability in all climates.

HIGH VALUE RANGE

10 to 10,000,000 Megohms

STANDARD RANGE

1000 Ohms to 9 Megohms

S.S. WHITE INDUSTRIAL DIVISION

THE S.S. WHITE DENTAL MFG. CO. DEPT. GR 10 EAST 40th ST., NEW YORK 16, N. Y.



FLEXIBLE SHAFTS AND ACCESSORIES
MOLDED PLASTICS PRODUCTS—MOLDED RESISTORS

One of America's AAAA Industrial Enterprises

COSSOR for QUALITY

TWIN BEAMS

THE RIGHT ANSWER . . .

for simple, accurate and convenient measurements. Simultaneous error-free comparison of voltages, currents, phases, frequencies, wave-shapes.

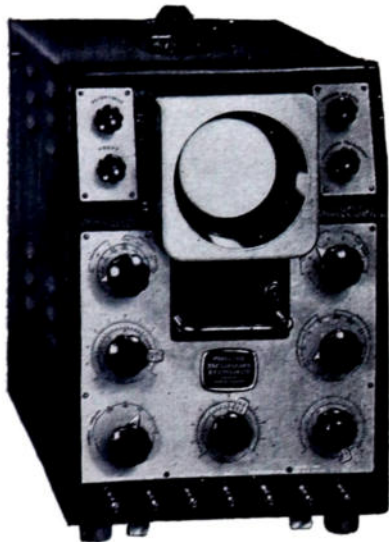

THE COSSOR MODEL 1035

Twin Beam Oscilloscope
\$650 f.o.b. New York
\$465 f.o.b. Halifax

DIRECT READING calibrated time and voltage measurement controls. Continuously variable driven and re-current sweeps from 150 millisc. to 5 microsec., blanked flyback.

Independent Y axis AC amplifiers for each beam + or - sync.

Flat face 4" twin beam CRT, green, blue or long afterglow screens all available from stock.

* Write for complete specifications and data on Model 1049 DC amplifier scope, Model 1428 Camera and film drives.

AGENTS THROUGHOUT U. S. & CANADA

COSSOR (CANADA) LIMITED

Windsor St., Halifax, Nova Scotia



BEAM INSTRUMENTS CORP.

Room 208, 55 W. 42nd Street,
New York 18, N. Y.

News—New Products

These manufacturers have invited PROCEEDINGS readers to write for literature and further technical information. Please mention your I.R.E. affiliation.

(Continued from page 64A)

Incremental Inductance Bridge and Associated Accessories

The Freed Transformer Co., Inc., 1718-36 Weirfield St., Brooklyn 27, N. Y., has introduced a new Incremental Inductance Bridge No. 1110.



This bridge is an instrument for accurate testing of communication and television components under load conditions. It has an impedance range of 1 millihenry to 1,000 henries in five ranges. The inductance values are read directly from a 4-dial decade and multiplier switch. The range of this instrument can be extended to 10,000 henries through the use of an external resistance.

The inductance accuracy of this bridge is within ± 1 per cent through the frequency range from 60 to 1,000 cps. For the largest multiplier at 1,000 cps, the accuracy of the bridge is decreased to 2 per cent. A 50- or 60-cps line frequency is generally used with this bridge.

The controls are two 4-dial decades, one for inductance, and one for ac resistance, and a 5-position multiplier.

Additional recommended accessories are ac supply No. 1180, dc supply No. 1170 null detector No. 1140, or vacuum-tube voltmeter and null detector No. 1210.

For further information, catalog, and price lists, write directly to the manufacturer.

Improved Coaxial Tube

Precision Tube Co., 3824 Terrace St., Philadelphia 28, Pa., announces a new and improved coaxial tube known as "Coaxitube."

The Coaxitube consists of an inner conductor, dielectric, and a seamless tube forming a coaxial pair of conductors. Since the dielectric is continuous and the outer conductor is seamless, conductor and shield remain coaxial even when formed into intricate shapes. This feature is a great advantage for many circuit components, such as closely-coupled tank coils and grid feedback circuits, shielded grid leads, and high-frequency transmission lines. The dielectric can be polyethylene, DuPont Teflon, fibreglas, or any other material commercially available to give the required electrical performance.

(Continued on page 66A)

Dependable
PERFORMANCE
at
LOWER COST



TOWER LIGHTING EQUIPMENT

H & P lighting equipment, consistently specified by outstanding radio engineers, is furnished as standard equipment by most leading tower manufacturers.

300 MM CODE BEACON

Patented ventilator dome circulates the air, assures cooler operation, longer lamp life. Concave base with drainage port at lowest point. Glass-to-glass color screen supports virtually eliminate color screen breakage. Neoprene gaskets throughout. CAA approved

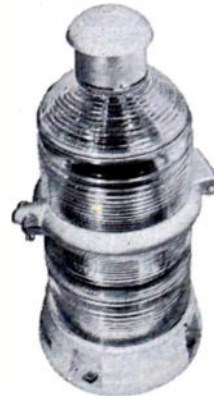

MERCURY CODE FLASHER

Lifetime-lubricated ball bearings. No contact points to wear out. Highest quality bronze gears. Adjustable, 14 to 52 flashes per minute

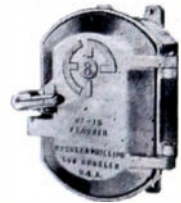

SINGLE and DOUBLE OBSTRUCTION LIGHTS

Designed for standard A-21 traffic signal lamps. Prismatic globes meet CAA specifications.



"PECA" SERIES PHOTO-ELECTRIC CONTROL

Turns lights on at 35 f.c.; off at 58 f.c., as recommended by CAA. High-wattage industrial type resistors. Low-loss circuit insulation.



ALSO COMPLETE LIGHT KITS FOR A-2, A-3, A-4 and A-5 TOWERS

PROMPT SERVICE and DELIVERY

First-day shipments out of stock. Immediate attention to specifications and unusual requirements.

WRITE OR WIRE FOR CATALOG AND DETAILED INFORMATION

HUGHEY & PHILLIPS

TOWER LIGHTING DIVISION

326 N. LA CIENEGA BLVD.
LOS ANGELES 48, CALIF.

60 E. 42ND ST. NEW YORK 17, N. Y.

Bolometer Amplifier . . .

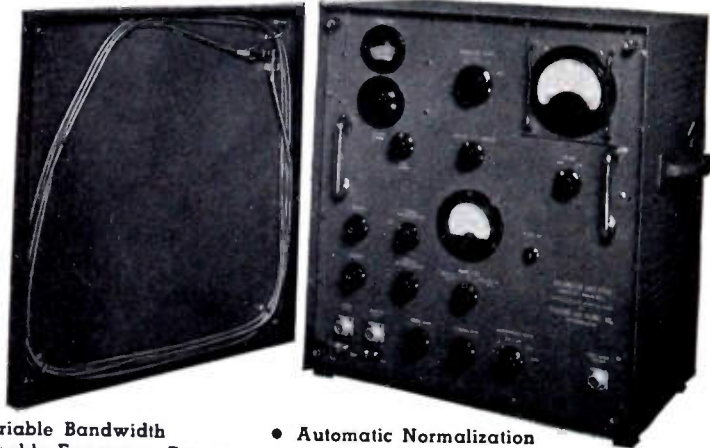

- Variable Bandwidth
- Tunable Frequency Range
- Voltage Ratio Expander
- Automatic Normalization
- Self Contained Metering
- Recorder Output

USES

The P & B Bolometer Amplifier Model 100 is a quality amplifier designed for use in connection with making electrical measurements of antennas and associated radio-frequency systems. Standing wave ratios may be quickly determined on either a linear or expanded indicating scale.

The tunable, variable bandwidth, band-pass characteristics of the amplifier makes it useful where conditions might render other test equipment useless.

Built to Navy Specifications for research and production testing.

Ask for Bulletin L-100

CHARACTERISTICS

Frequency range—400 cycles—5000 cycles (\pm 3% calibration accuracy)
 Bandwidth—(1/2 voltage) 6, 12, 22, 50, 100 and 300 cycles
 Input Voltage Range
 Signal Channel—10⁻²—10⁻⁷ volt.
 Monitor Channel—10⁻²—10⁻⁵ volt.
 Expander Operation—10⁻²—10⁻⁵ volt.
 Input Impedance—250-350 ohms.
 Meter—logarithmic scale with 100 db decade.
 Recorder Output—.01—100 volts @ .01 w. max. (undecaded)
 Normalization—output voltage holds within 1/4 db for input changes of 5 db to both channels.
 Bolometer Bias—adjusted in steps of 5% current change over range of 2.1.
 Voltage Ratio Expander—8th power expansion.

PICKARD & BURNS, INC.

240 Highland Avenue

Needham 94, Massachusetts

News—New Products

These manufacturers have invited PROCEEDINGS readers to write for literature and further technical information. Please mention your I.R.E. affiliation.

(Continued from page 65A)

Television Oscilloscope

A new high-gain, wide-band cathode-ray oscilloscope designed particularly for television circuit applications has been announced by the Radio Tube Div., Sylvania Electric Products Inc., 1740 Broadway, New York 19, N. Y.



The new Type 400 oscilloscope, which is supplied with 7-inch Type 7JP1 green screen cathode-ray tube, provides vertical sensitivity of ten millivolts per inch, and vertical response useful up to 4 Mc.

The Type 400 provides linear sweeps ranging from 10 cps to 50 kc, 5-megohm, 26- μ f input impedance for negligible circuit loading which is suitable for any crystal, direct or special probe or with supplied lead; cathode follower input circuit; switching for direct connection to deflection plates; panel connection for intensity or Z-axis modulation; built-in 60-cps voltage source; and low-parallax cross-lined screen.

Air Flow Switch

A new improved vane-type air flow switch for use in forced air cooling of electronic equipment has been announced by Coral Designs, Div. Henry G. Dietz Co., P. O. Box 248, Forest Hills, N. Y.

The quantity of air required for forced-air-cooled tubes is specified for various types of service and often for various power levels. The 103-A, vane-type air flow switch, is designed to operate a control relay to guard against tube failure in the event of blower failure or air-passage obstruction.

It guards against air flow failure due to: dust precipitation blocking the air ducts caused by the tube radiators operating at high voltage, unclean air filter or obstructions blocking louvers in cabinet, stalling of the blower motor, etc. It will operate on a minimum velocity of 500 feet per minute. Electrical ratings of 5 amperes at 250 volts ac are Underwriters' Laboratories approved.

(Continued on page 67A)



STANDARD SIGNAL GENERATOR

MODEL 84—300-1000 Megacycles

OUTPUT VOLTAGE: Continuously variable from 0.1 to 100,000 microvolts. Output impedance, 50 ohms.

MODULATION: Sine Wave: 0-30%, 400, 1000 or 2500 cycles.
 Pulse: Frequency, 60 to 100,000 cycles. Width, 1 to 50 microseconds. Delay, 0 to 50 microseconds. Sync. output, up to 50 volts, either polarity.

POWER SUPPLY: 117 volts, 60 cycles. (Also available for 117 volts, 50 cycles; 220 volts, 60 cycles; 220 volts, 50 cycles.)

DIMENSIONS: 12" high x 26" wide x 10" deep, overall.

WEIGHT: Approximately 135 pounds, including external line voltage regulator.

MEASUREMENTS CORPORATION

BOONTON · NEW JERSEY



Laboratory Standards

Standard Signal Generators
 Pulse Generators
 FM Signal Generators
 Square Wave Generators
 Vacuum Tube Voltmeters
 UHF Radio Noise & Field Strength Meters
 Capacity Bridges
 Megohm Meters
 Grid-Dip Meters
 Television and FM Test Equipment

News—New Products

These manufacturers have invited PROCEEDINGS readers to write for literature and further technical information. Please mention your I.R.E. affiliation.

(Continued from page 66A)

High-Frequency Step Attenuator

A step attenuator, designed to cover the frequency range from dc to 1,000 Mc, is available from Weinschel Engineering Co., 123 William St., New York 7, N. Y.

This attenuator contains coaxial pads. The resistance elements of each pad consist of stable, aged metal alloy films on pyrex glass.

A set of pads is mounted on a drum which is rotated to align any pad with a pair of matched, coaxial switches. Three drums are mounted on one panel. Each drum through its switches and associated cables connects to a separate pair of female-type "N" connectors located on the front panel.

The calibration is unaffected by operation at relative humidities as high as 95 per cent.

At 60 Mc, the attenuation departs less than +0/2-per cent from dc attenuation. At 1,000 Mc, the range is 5 to 60 db, and attenuation departs less than +5/10 per cent from dc attenuation.

Zero insertion loss of each drum is less than 1/2 db.

(Continued on page 68A)

Butterfly POWER...



● MICROTORQUE Variable Resistors and Potentiometers require as little as .003 in. oz. torque to operate. This unique feature makes the MICROTORQUE invaluable for applications where the position of instrument pointers, gyroscopes, and delicate instruments in general must be recorded, transmitted or indicated at a distance, and Giannini are the sole makers of MICROTORQUE Potentiometers. A variety of resistance values and circuits available.



Write for booklet.
G. M. Giannini & Co., Inc.
Pasadena 1, California



Manufacturer's tests confirm superiority of PALINEY* #7 for brushes on new Rectilinear Potentiometer . . .

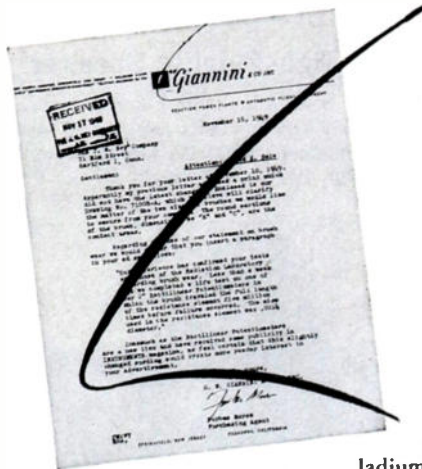

"Our experience has confirmed your tests and those of the Radiation Laboratory regarding brush wear. Less than a week ago we completed a life test on one of our 2" Rectilinear Potentiometers in which the brush traveled the full length of the resistance element five million times before failure occurred. The wire used in the resistance element was .0014 diameter."

PALINEY* #7 . . . a precious metal alloy containing gold, platinum and palladium . . . is giving outstanding service as the sliding contact in many types of potentiometers where long life, low noise and maintained linearity are essential. This and other Tested NEY Precious Metal Alloys are also being used successfully in numerous precision contact and slip ring applications requiring controlled wear resistance, high conductivity and freedom from tarnish and corrosion. Write or call our Research Department for additional technical data, outlining your problem if possible.

THE J. M. NEY COMPANY 171 ELM ST., HARTFORD, CONN.
SPECIALISTS IN PRECIOUS METAL METALLURGY SINCE 1812

G. M. GIANNINI & CO., INC.
697 Morris Turnpike
Springfield, New Jersey

* Reg. T.M. J. M. Ney Co.

SNY50

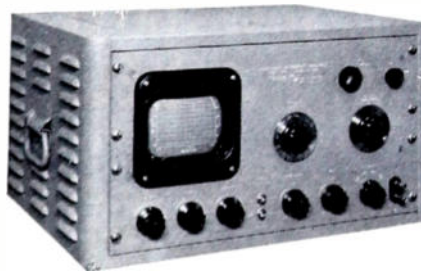

USES

- Ultrasonic Vibration Measurements
- Harmonic Analysis
- Cross Modulation Studies
- Noise Investigations
- Determining Transmission Characteristics of Lines and Filters
- Monitoring Communications Carrier Systems
- Checking Interference, Spurious Modulation, Parasitics, Effects of load changes, shock, humidity, component variations, etc. upon frequency stability
- Telemetry

SPECIFICATIONS

Frequency Range: 2KC—300KC stabilized linear scale
Scanning Width: Continuously variable from 200KC to zero
Four Input Voltage Ranges: 0.05V. to 50V. Full scale readings from 1 millivolt to 50 volts
Amplitude Scale: Linear and two decade log
Amplitude Accuracy: Within 1db. Residual harmonics suppressed by at least 50db.
Resolution: Continuously variable. 2KC at maximum scanning width, 500c.p.s. for scanning widths below 8KC

WRITE NOW For Complete Information,
Price and Delivery

Available Now!
Easy, Fast
Ultrasonic Spectrum Analysis
WITH
MODEL SB-7

PANORAMIC ULTRASONIC ANALYZER

An invaluable new direct reading instrument for simplifying ultrasonic investigations, the SB-7 provides continuous high speed panoramic displays of the frequency, amplitude and characteristics of signals between 2KC and 300KC. The SB-7 allows simultaneous observation of many signals within a band up to 200KC wide. Special control features enable selection and highly detailed examination of narrower bands which may contain signals separated by less than 500c.p.s. The instrument is unique in that it provides rapid indications of random changes in energy distribution.



6 CONNECTOR TYPE SERIES for LOW LEVEL SOUND

Cannon Plug

UA



XL



P



O

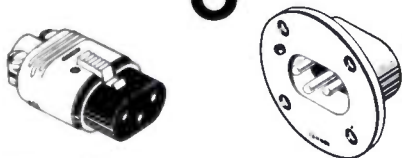

X

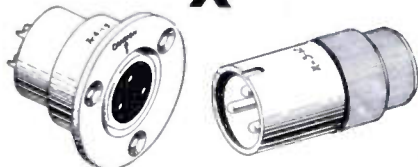

XK



Address Cannon Electric Development Co., Division of Cannon Manufacturing Corporation, 3209 Humboldt Street, Los Angeles 31, Calif. Canadian office and plant: Toronto, Ontario. World export: Frazer & Hansen, San Francisco.

SINCE 1915
CANNON ELECTRIC

News—New Products

These manufacturers have invited PROCEEDINGS readers to write for literature and further technical information. Please mention your I.R.E. affiliation.

(Continued from page 67A)

High-Fidelity Speaker

A new 8-inch high-fidelity speaker, Type 8T8-1, has been announced by Permoflux Corp., 4900 W. Grand Ave., Chicago 39, Ill.



This new blue cone is claimed to have ideal response, and if properly baffled compares favorably with 12-inch speakers on the market today.

(Continued on page 69A)

The New STAVER MINI-SHIELD

TRADE MARK REG. AND PAT. PEND.

The shield
that fits all
Miniature
Tubes



A flexible shield that snugly fits all miniature tubes because it compensates for all variations in tube dimensions. Mini-Shields are made for both T5½ and T6½ bulb tubes. Send for catalog sheet.

THE Staver COMPANY
INCORPORATED
91 PEARL ST. • BROOKLYN 1, N. Y.
ULSTER 5-6303

Gold Plated
TUNGSTEN
and
MOLYBDENUM
GRID WIRE



Made to meet your specifications... for gold content, diameter and other requirements.

Write for details and list of products

SINCE  1901

SIGMUND COHN CORP.
44 GOLD ST. NEW YORK

HF and UHF power leakage positively and economically controlled by new gasket material

The unique combination of controlled resiliency, stability and conductivity found in Metex "Electronic Weather Stripping" makes it particularly effective as a shielding material for such electronic applications as radar equipment, high frequency heating, television broadcasting and high frequency communication.

It is available in strips or in die-formed gaskets of the shape, size and volume required by the particular application. Economical in cost, the use of this material permits further savings in assembly time and eliminates much costly machining of closure surfaces that would normally be required.

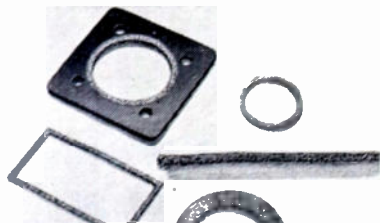

Metex "Electronic Weather Stripping"

The base material is a knitted—not woven—wire mesh which is made from any metal that can be drawn into wire. Knitting produces a mesh consisting of a multiplicity of interlaced loops which increase the normal resiliency of the wire and, by their hinge-like action, permit freedom of motion without loss of stability.

These characteristics are retained even when multiple layers of this mesh are compressed to form gaskets or strips. The result is a compressible, resilient, cohesive, conducting material with a large internal surface area. Where hermetic sealing is also required, these gaskets are made in combination with neoprene or similar materials.

Applications

Among the varied applications where Metex "Electronic Weather Stripping" has already proved its effectiveness and economy are: Air craft pulse modulator shields, wave-guide choke-flange gaskets, shielding metal housings, replacing beryllium-copper fingers and springs on TR or ATR tubes, and ignition shielding to prevent radio noise interference.

The facilities of our engineering department are available at any time to assist you in determining the possible adaptability of "Electronic Weather Stripping" to your specific requirements. A letter, addressed to Mr. R. L. Hartwell, Executive Vice President, and outlining briefly your particular problem, will receive immediate attention. No obligation, of course.

METAL TEXTILE CORP.

637 East First Ave., Roselle, N.J.

News—New Products

These manufacturers have invited PROCEEDINGS readers to write for literature and further technical information. Please mention your I.R.E. affiliation.

(Continued from page 68A)

Vacuum-Tube Voltmeter

The new type 1803-A vacuum-tube voltmeter, manufactured by General Radio Co., 275 Massachusetts Ave., Cambridge 39, Mass., meets the majority of the ac voltage measurement requirements of the electronics laboratory, and is priced within the budget requirements of the small laboratory.



Voltage range is from 0.1 to 150 volts, covered in 5 steps (1.5-, 5-, 15-, 50-, and 150-volts, full scale). Accuracy is ± 3 per cent. Frequency error is 10 per cent at 120 Mc, and correction curves are supplied, by means of which rated accuracy can be obtained up to 200 Mc.

Meter is peak indicating and is calibrated in rms values of sinusoidal voltage. Circuit is designed for high stability, and mechanical assembly is simple and rugged.

Voltage is measured at the terminals of a probe. Where fixed terminals are desired, probe is attached to side of cabinet and wire can be connected to it through an adaptor plug.

Anti-Static Agent for Polystyrene

A new and different anti-static agent for polystyrene plastic, trade-marked D-STAT B, is now available from Roxbury Chemical Works, Inc., 2072 Smith St., Centredale 11, R. I.

The manufacturer claims that D-STAT B is a material which will entirely eliminate unsightly dust collection due to static attraction. It is unique among destaticizers in that it will preserve the brilliance of polystyrene items, such as: radio cabinets, fluorescent lighting fixtures, television lenses, and frames.

Laboratory tests by a leading molding powder manufacturer indicate that polystyrene objects treated with D-STAT B remain static-free even after repeated wipings. D-STAT B is odorless, colorless, and nonflammable, and is applied readily by dipping, spraying, or brushing.

JUST PUBLISHED!

A Complete, Up-to-date Treatment of Waveguide Transmission, Covering Both Mathematical Theory and Practical Applications

HERE at last is a comprehensive, thorough-going study of waveguide techniques that covers not only such practical applications as television and radar, but explores the scientific investigation of electromagnetic phenomena, of the sun's spectrum, of the earth's atmosphere, of the absorptive properties of gases for microwaves, and in measurements of the dielectric properties of insulators and conductors.

PRINCIPLES AND APPLICATIONS OF WAVEGUIDE TRANSMISSION

By GEORGE C. SOUTHWORTH, Ph.D.
Member of the Technical Staff,
Bell Telephone Laboratories
Investigator of Waveguide Transmission
Phenomena for Approximately
Fifteen Years

IN THIS brand-new book, Dr. Southworth has based his study on the remarkable range of source material prepared at the Bell Telephone Laboratories, where much of the evolution of waveguide technique has taken place. Consequently this work reflects the broadest background and the most recent developments in this important, expanding field.

The early chapters of this work provide a broad treatment of the mathematical theory of waveguide transmission. This is immediately followed by a physical interpretation of the phenomena most frequently observed—a two-fold approach that is particularly valuable to students of electrical engineering and applied physics, both in lecture room and laboratory. Professionals chiefly interested in the practical aspects of the subject can proceed directly from the physical interpretation to the remaining chapters, constituting about two-thirds of the book, and dealing with current experimental research and concrete applications.

EXAMINE THIS BOOK FREE

Use the convenient order form below to obtain a copy of this important new work.

-----PLEASE CUT OUT AND MAIL-----
Proc. of IRE—850
D. VAN NOSTRAND COMPANY, INC.
250 Fourth Avenue, New York 3, New York
Please send me a copy of PRINCIPLES AND APPLICATIONS OF WAVEGUIDE TRANSMISSION. Within ten days I will either return the book without obligation or send you \$9.50.
Name
Address
City Zone State

don't fail
to see the

AMPEREX TUBE

advertisement
next month
(September issue)
on the inside
front cover

AMPEREX ELECTRONIC CORP.
25 WASHINGTON STREET, BROOKLYN 1, N. Y.
In Canada and Newfoundland: Rogers Majestic Limited
11-19 Brentcliffe Road, Leaside, Toronto, Ontario, Canada



FOR RECORDING TELEMETERING SIGNALS (up to 40 kc.)



Almost overnight Ampex Magnetic Tape Recorders revolutionized radio network broadcasting. Ampex succeeded in this most critical service because of simple and dependable operation, plus a tone quality that is unequalled. Ampex is now available in several models for a wide range of requirements. Inquiries for special instrumentation and industrial control application promptly answered.

- MODEL 300-C \$1575
- VU METER PANEL (EXTRA) \$105 (F.O.B. San Carlos)



IMPORTANT NEW TOOL FOR INDUSTRY AND SCIENCE

AMPEX

MAGNETIC TAPE RECORDER

"STANDARD OF THE GREAT RADIO SHOWS"

Standard units have dual-speed recording: 7 1/2-15 or 15-30 i.p.s.



Get FREE BOOKLET today!

AMPEX ELECTRIC CORP., San Carlos, California
Without obligation please send 16-page illustrated booklet containing technical specifications of Ampex Magnetic Tape Recorders.

NAME _____
ADDRESS _____
CITY _____ STATE _____

Our need is for:

- Laboratory Research
- Multi-Channel Recording
- Recording-Broadcasting
- Telemetering
- Industrial Recording
- Aerophysical Research

Distributed by . . .

BING CROSBY ENTERPRISES (Hollywood)
AUDIO & VIDEO PRODUCTS CORP. (New York City)
GRAYBAR ELECTRIC COMPANY (Everywhere)
EXPORT: WESTREX (New York City)

INDEX AND DISPLAY ADVERTISERS

Section Meetings	37A
Student Branch Meetings	40A
Membership	42A
Positions Open	50A
Positions Wanted	52A
News—New Products	30A

DISPLAY ADVERTISERS

Acme Electric Corp.	52A
Aircraft Radio Corp.	45A
Allen-Bradley Co.	20A
American Lava Corp.	17A
Amperex Electronic Corp.	70A
Ampex Electric Corp.	70A
Andrew Corp.	38A
Arnold Engineering Co.	18A
Lester W. Bailey	71A
Bead Chain Mfg. Co.	55A
Bell Aircraft	50A
Bell Telephone Labs.	2A
Berkeley Scientific Co.	55A
Blaw-Knox Co.	26A
Boonton Radio Corp.	64A
Breeze Corp.	37A
W. J. Brown	71A
Bud Radio, Inc.	56A
Burlington Instrument Co.	59A

Cambridge Thermionic Corp.	53A
Cannon Electric Development Co.	68A
Canoga Corp.	60A
Capehart-Farnsworth	50A
Capitol Radio Engineering Inst.	51A
Centralab	33A, 34A, 35A, 36A
C. P. Clare & Co.	27A
Cleveland Container Co.	15A
Sigmund Cohn Corp.	68A
Communication Products Co.	44A
Communications Equipment Co.	62A & 63A
E. J. Content	71A
Continental Carbon, Inc.	56A
Cornell-Dubilier Electric Corp.	Cover III
Cossor Ltd.	65A
Crosby Labs.	71A

Daven Co.	13A
Allen B. DuMont Laboratories, Inc.	70A

Eitel-McCullough, Inc.	6A
Electrical Industries	61A
Electrical Reactance Corp.	7A
Electro-Mechanical Research	59A
Electro-Motive Mfg. Co.	11A
Electro-Search	71A
Erie Resistor Corp.	23A

W. L. Foss	71A
----------------------	-----

General Electric Co.	5A
General Radio Co.	Cover IV

IT'S DU MONT FOR OSCILLOGRAPHY

Du Mont offers a complete line of cathode-ray oscillographs and associated equipment. For complete information and literature write to

**ALLEN B. DU MONT
LABORATORIES, INC.
INSTRUMENT DIVISION**

1000 Main Ave., Clifton, N.J.

ELECTRONICALLY REGULATED LABORATORY POWER SUPPLIES



- STABLE
- DEPENDABLE
- MODERATELY PRICED

MODEL 28
STANDARD
RACK
MOUNTING

PANEL SIZE
5 1/2" x 19"
WEIGHT 16 LBS.

- INPUT: 105 to 125 VAC, 50-60 cy
- OUTPUT #1: 200 to 325 Volts DC at 100 ma regulated
- OUTPUT #2: 6.3 Volts AC CT at 3A unregulated
- RIPPLE OUTPUT: Less than 10 millivolts rms

For complete information write for Bulletin G8



LAMBDA ELECTRONICS
CORPORATION
CORONA NEW YORK

DISPLAY ADVERTISERS

G. M. Giannini & Co.	67A
Paul Godley	71A
H. L. Gordon	71A
Helipot Corp.	22A
Hewlett-Packard Co.	3A
Hughey & Phillips	65A
Iliffe & Sons	43A
International Resistance Co.	8A, 9A
Jacobs Instrument Co.	50A
E. F. Johnson Co.	54A
Kings Electronics Co.	58A
Kollman Instrument Div.	24A
Lambda Electronics	70A
Lavoie Laboratories	31A
P. R. Mallory & Co., Inc.	14A
Manufacturers Thread Grinding Inc.	58A
Glenn L. Martin	50A
W. L. Maxson	51A
Measurements Corp.	66A, 71A
Melpar Inc.	55A
Mycalex Corp. of America	28A
J. M. Ney Co.	67A
North American Aviation	51A
Ohmite Mfg. Co.	29A
Panoramic Radio Products Inc.	67A
Pickard & Burns	66A, 71A
Presto Recording Corp.	47A
Radio Corp. of America	32A, 51A, 72A
Rauland Corp.	21A
Revere Copper & Brass Inc.	16A
Paul Rosenberg Assoc.	71A
Servo Corp. of America	71A
Sheldon Electric Co.	39A
Sola Electric Co.	25A
Sorensen & Co.	48A
Spencer-Kennedy Labs.	61A
Sperry Gyroscope Co.	19A, 52A
Sprague Electric Co.	12A
Staver Co.	68A
Stevens Mfg. Co.	46A
Stoddart Aircraft Radio Co.	10A
Technical Materiel Corp.	71A
Technology Instrument Corp.	42A
Tektronix Inc.	57A
Tel-Instrument Co.	40A
L. H. Terpening Co.	49A
Transradio Ltd.	60A
Truscon Steel Co.	4A
United Transformer Co.	Cover II
D. Van Nostrand Co.	69A
Webster Electric Co.	53A
Wells Sales, Inc.	52A
Wheeler Labs.	71A
S. S. White Dental Mfg. Co.	64A
Wilcox Electric Co.	41A

PROFESSIONAL CARDS

LESTER W. BAILEY
Registered Patent Agent
Senior Member IRE
PATENT OFFICE PRACTICE specializing in
ELECTRONICS MECHANICS
RADIO
LINCOLN-LIBERTY BUILDING
PHILADELPHIA 7
Broad & Chestnut Streets Rittenhouse 6-3267

ALFRED W. BARBER
LABORATORIES
Specializing in the Communications Field and
in Laboratory Equipment
Offices, Laboratory and Model Shop at:
32-44 Francis Lewis Blvd., Flushing, L.I., N.Y.
Telephone: Independence 3-3306

W. J. BROWN
International Electronics Consultant
AT PRESENT IN GREAT BRITAIN
Will undertake assignments for American or
British Clients. Please address inquiries to 11
Public Square, Cleveland 13, Ohio.
TO 1-6498 FA-1-0030

EDWARD J. CONTENT
Acoustical Consultant
Functional Studio-Theater Design
FM — Television — AM
Audio Systems Engineering
Roxbury Road Stamford 3-7459
Stamford, Conn.

CROSBY LABORATORIES, INC.
Murray G. Crosby & Staff
Radio-Electronic Engineering,
Research & Development
FM, Communications, TV
Test Equipment
Offices, Laboratory & Model Shop at:
126 Herricks Rd., Mineola, N.Y.
Garden City 7-0284

Richard B. Schulz
Electro-Search
Radio-Interference Reduction;
Development of
Interference-Free Equipment,
Filters, Shielded Rooms
515 W. Wyoming Ave., Philadelphia 40, Pa.
Gladstone 5-5353

ELK ELECTRONIC LABORATORIES
Jack Rosenbaum
Specializing in the design and
development of
Test Equipment for the communications,
radar and allied fields.
333 West 52nd St. Telephone:
New York 19, N.Y. PLAZA 7-0520

WILLIAM L. FOSS, INC.
927 15th St., N.W. REpublic 3883
WASHINGTON, D.C.

PAUL GODLEY CO.

Consulting Radio Engineers
P.O. Box J. Upper Montclair, N.J.
Offs & Lab.: Great Notch, N.J.
Phone: Montclair 3-3000
Established 1926

HERMAN LEWIS GORDON

Registered Patent Attorney
Patent Investigations and Opinions
Warner Building 100 Normandy Drive
Washington 4, D.C. Silver Spring, Md.
National 2497 Shepherd 2433

MEASUREMENTS CORP.

RESEARCH & MANUFACTURING
ENGINEERS
Harry W. Houck Jerry B. Minter
John M. van Beuren
Specialists in the Design and
Development of Electronic Test Instruments
BOONTON, N.J.

PICKARD AND BURNS, INC.

Consulting
Electronic Engineers
240 HIGHLAND AVE.
NEEDHAM, MASS.

PAUL ROSENBERG ASSOCIATES

Consulting Physicists
Main office: Woolworth Building,
New York 7, N.Y.
Cable Address Telephone
PHYSICIST WOrth 2-1939
Laboratory: 21 Park Place, New York 7, N.Y.

SERVO CORPORATION OF AMERICA

Henry Blackstone, President
Consultants on
Electronic Control Problems
for Industry
New Hyde Park Long Island, N.Y.

TECHNICAL MATERIEL CORPORATION

COMMUNICATIONS CONSULTANTS
RADIOTELETYPE - FREQUENCY SHIFT
INK SLIP RECORDING - TELETYPE NETWORKS
121 Spencer Place, Mamaroneck, N.Y.

WHEELER LABORATORIES, INC.

Radio and Electronics
Consulting — Research — Development
R-F Circuits — Lines — Antennas
Microwave Components — Test Equipment
Harold A. Wheeler and Engineering Staff
Great Neck, N.Y. Great Neck 2-78D6

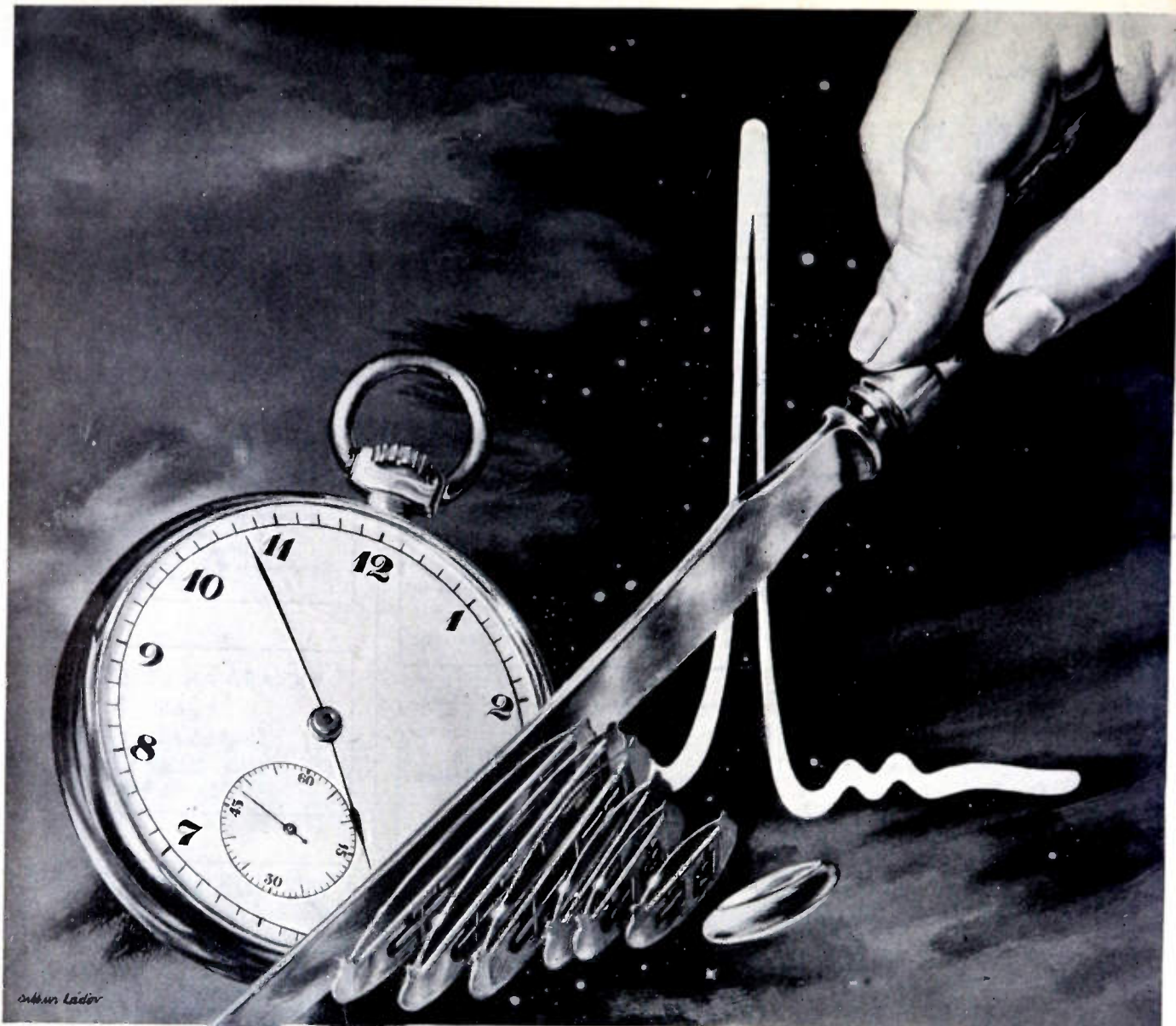

New RCA electron tube "freezes" movements that occur, and are ended, in millionths of a second!

How to "see" a super fine slice of time!

Now scientists at RCA Laboratories work with slivers of time too infinitesimal for most of us to imagine. Their new electron tube, the Graphechon, makes it possible.

For instance, in atomic research, a burst of nuclear energy may flare up and vanish in a *hundred-millionth* of a second. The Graphechon tube oscillograph takes the pattern of this burst from an electronic circuit, recreates it in a slow motion image. Scientists may then ob-

serve the pattern of the burst . . . measure its energy and duration.

With Graphechon we can watch fleeting phenomena which occur outside our control. It is not only applied to nuclear research, but also to studies of electrical current . . . or in new uses of radar and television. Like so many products of RCA research Graphechon widens man's horizons.

See the latest wonders of radio, television, and electronics at RCA Exhibition Hall, 36 West 49th St., N. Y. Admission is free. Radio Corporation of America, Radio City, N. Y. 20.



Research like that which gave us the Graphechon tube accounts for the superiority of RCA Victor's new 1950 home television receivers.



RADIO CORPORATION of AMERICA
World Leader in Radio — First in Television

they

may

look

alike,

but:

there

is

only

one

A C-D FILTER FOR EVERY APPLICATION!



In a wide range of sizes and container shapes to meet every known interference filtering application. A few typical types are listed below. Thousands of other types on request. Our engineers will be glad to consult with you on your specific noise problems. Engineering bulletin on request. CORNELL-DUBILIER ELECTRIC CORPORATION, Dept. M80 South Plainfield, New Jersey. Other plants in New Bedford, Brookline and Worcester, Mass.; Providence, R. I.; Indianapolis, Ind., and subsidiary, the Radiart Corp., Cleveland, Ohio.



Capacitive inductive filters — single and multiple section pi circuits in hermetically sealed containers for aircraft, marine, and heavy-duty application requiring filters with high insertion loss over temperature range from -55 to $+85^{\circ}\text{C}$.



Feed-through capacitive TV and radia noise filters — Compact! Lightweight! Numerous insertion-loss patterns available. Hermetically sealed! Dykanol impregnation!



Electrical appliance filters — for fluorescent lamps, food mixers, vacuum cleaners, business machines, and a wide variety of other electrical equipment available in many styles with both flexible lead and solder lug electrical connections.

FOR EFFECTIVE NOISE ELIMINATION . . . FOR DEPENDABLE RESULTS
... FOR PREMIUM QUALITY PERFORMANCE . . . ALWAYS SPECIFY C-D!

C-D



CONSISTENTLY DEPENDABLE

CORNELL-DUBILIER

CAPACITORS • VIBRATORS • ANTENNAS • CONVERTERS



For Impedance Measurements Between 70 and 1,000 Mc

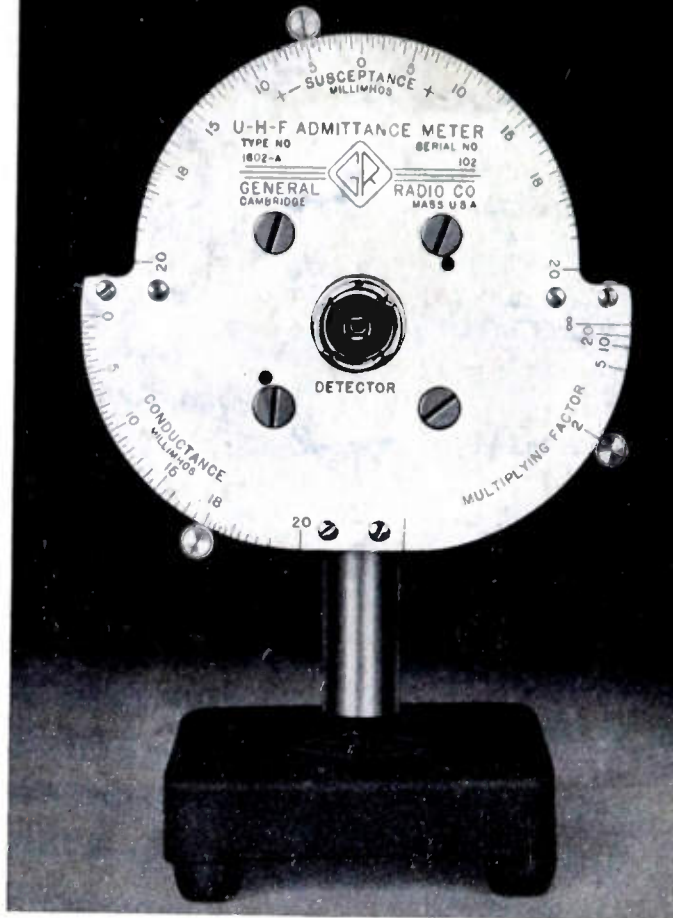

Spencer
Leventhal
Radio
60 West St.
6035
60 Pine Drive
60 Belmont St.
Nov. 6:30.

17821

A NEW G-R Null-Type ADMITTANCE METER

AS A NULL INSTRUMENT MEASURES Conductances and Susceptances, of either sign, from 1 millimho to 400 millimhos (1,000 ohms to 2.5 ohms).

AS A DIRECT-READING DEVICE DETERMINES Magnitude of Reflection Coefficient of coaxial systems and Magnitude of unknown Impedance and Admittance.

AS A COMPARATOR INDICATES Equality of one Admittance to another and the degree of departure of one from the other.

REPRESENTING an entirely new and unique technique in instrumentation, the new G-R Type 1602-A U-H-F Admittance Meter makes possible rapid, simple and accurate measurements of impedance in the range between the upper limit of conventional bridge circuits and the lower limit of practical slotted lines—70 to 1,000 Mc. (With an accessory Type 874-L30 Air Line, range can be extended to 50 Mc.)

Operating and design features include:

- PRACTICAL OPERATING RANGE of 200 micromhos to 1,000 millimhos
- DIALS CALIBRATED in Conductive and Susceptive components of the unknown Admittance
- DIALS DIRECT-READING at the operating frequency when the stub (supplied with the instrument) is set to that frequency
- CALIBRATION independent of frequency
- BUILT-IN ACCURACY independent of the calibration of an external detector or generator
- VERY SIMPLE TO MATCH the unknown to 50 ohms
- METER INDICATION shows approach toward matching
- HIGH ACCURACY for both Conductance and Susceptance: from 0 to 20 millimhos $\pm (5\% + 0.2 \text{ millimho})$; 20 to ∞ millimhos $\pm 5 \sqrt{\text{SCALE MULTIPLYING FACTOR}}\%$; an unknown can be compared to an arbitrary standard with still higher accuracy
- A SMALL, LIGHTWEIGHT, PORTABLE and COMPACT UNIT, ideal for field use
- ACCESSORIES SUPPLIED: Type 874-WM 50-ohm Termination for use as Conductance standard; one Type 1602-P2 Adjustable Stub (70 to 500 Mc) and one Type 1602-P1 Adjustable Stub (150 to 1,000 Mc) for Susceptance standards; two Type 874-R20 Patch Cords for connections to generator and detector.

TYPE 1602-A U-H-F ADMITTANCE METER . . . \$295.00



GENERAL RADIO COMPANY

Cambridge 39, Massachusetts

90 West St., New York 6 920 S. Michigan Ave., Chicago 5 1000 N. Seward St., Los Angeles 38