

# Proceedings



of the

I·R·E

**A Journal of Communications and Electronic Engineering**  
(Including the WAVES AND ELECTRONS Section)

**July, 1948**

Volume 36

Number 7



Westinghouse Electric Corporation

## RAILROADING VIA RADIO

Yardmaster and engineer, miles apart, are instantaneously linked by this new agency of "space radio" communication.

## PROCEEDINGS OF THE I.R.E.

Frequency Counting for F.M. Detection  
Duplex Microwave Communications System  
Application of Matrices to Vacuum-Tube Circuits  
Field Theory of Traveling-Wave Tubes  
A Contribution to the Approximation Problem  
Time Response of an  $N$  Identical Stage Amplifier  
Field of a Dipole with a Tuned Parasite

## Waves and Electrons Section

1948 Convention Banquet Speeches  
Avenues of Improvement in Present-Day Television  
Electronic Instrumentation for Underwater Ordnance  
Adjustment Speed of A.V.C. Systems  
Horizontal Microwave Angle-of-Arrival Measurements  
Interference Between V.H.F. Communication Circuits  
RMA Standards  
Abstracts and References

TABLE OF CONTENTS FOLLOWS PAGE 32A

# The Institute of Radio Engineers

# NEW ANTI-CORONA HIGH VOLTAGE TUBE OPERATES IN OPEN TO 12-MILE ALTITUDES

## AMPEREX RESEARCH TACKLED LONG PRESSING PROBLEM AND CAME THROUGH

As jet planes and guided missiles speed through diverse pressure and temperature changes into the thin air twelve miles above sea level, conventional high voltage tube performance drops far below minimum standards and becomes extremely erratic.

The importance of the problem can be seen in the fact that the dielectric strength of air at such altitudes permits standard tube designs to operate at less than one-fifth of their ratings.

Two years ago Amperex research teams tackled the problem of designing tubes that would insure sea-level performance, and the associated problem of developing the manufacturing techniques that would put them on a production basis.

The "specs" called for tubes to operate at full rating in the open at altitudes up to 60,000 feet where the barometer drops to the troposphere's 2" of mercury and the thermometer sinks to  $-55^{\circ}\text{C}$ .

Not only would the tubes have to stand temperatures between the upper air's  $-55^{\circ}\text{C}$ . and  $+250^{\circ}\text{C}$ . but would have to stand up under a rate of change as high as  $1^{\circ}\text{C}$ . per second.

New standards of mechanical ruggedness were called for by hitherto unmet stresses of shock and vibration imposed by the tremendous rates of jet and rocket acceleration. Inevitable moisture and ice formation presented formidable hazards. Cosmic ray showers and other particles were additional challenges.

The first theoretical survey two years ago made it apparent that only a radically different approach could be successful. Amperex is proud to announce that all research and design problems have been surmounted and that the new tube combinations, after prolonged and rigorous testing, are now in production.

## AMPEREX RECTIFIER HAR-3 GIVES UNVARYING SEA-LEVEL PERFORMANCE IN OPEN AT ALL PRESSURE, DUST, RADIATION, ICING AND TEMPERATURE EXTREMES TO 60,000 FOOT ALTITUDE

Challenging implications of the new Amperex application to equipment designers and engineers confronted with the necessity for utmost safety and reliability under extreme conditions of pressure, dust, cosmic ray bombardment, icing and temperature are illustrated in the Amperex HAR-3 now in production.

Characteristics apply to operation in the open at any altitude from sea level to 60,000 feet and to any rate of change in altitude.

The tube, a high vacuum, half-wave rectifier rated at 14,000 volts peak inverse, is fully able to handle voltages as high as 35,000 peak.

Average plate current delivery is 125 ma. Tube voltage drop at 100 ma. is 200 volts.



HAR-3 is only 4 1/2" long and 2" in diameter. Of the total tube length approximately 3/4" protrudes above the top plane of the socket. An existing conventional type tube having approximately the same electrical rating—but at sea level conditions only—is over 8" long and is 2-5/16" in diameter.

The molybdenum anode, coated with zirconium to provide substantial and continuous additional gettering, dissipates an average of 75 watts. The "hard" glass envelope is able to operate continuously at  $204^{\circ}\text{C}$ .

In excess of 2.0 amperes of useful peak emission is supplied by the thoriated tungsten filament when pulsed at 4,000 volts peak. It is rated at 5.0 volts and 10.0 amps.

Dimensions and other information are given under the photograph.

### READY FOR YOU:

General technical bulletin on this new Amperex advance, technical rating and data sheets or individually prepared reports on specific industrial sea-level applications.

## "SEALED" CONSTRUCTION SETS NEW STANDARDS FOR ALL EXTREME CONDITIONS

Problems presented by reliable and efficient operation of high voltage tubes in the open at full rating under extreme conditions of pressure, temperature and stress have been solved by a new Amperex development. Tubes incorporating the development are already in production.

Cumbersome containers, pressurized housings, oil baths and other devices which added heavily to weight, size, cost and operating complication are now eliminated. Tube replacement, often a major operation under old conditions, is now simple and speedy.

Basic to the advance is the conception of an all-in-one tube and socket combination and the use of the combination as a single operating unit with the complete exclusion of air. This, for the first time in practical fashion, eliminates the uncertainties of air as a dielectric and substitutes the advantage of solid dielectrics. The units are thus totally independent of outside influences which caused previous open designs to fail.

After the theoretical solution of the many problems involved and the making of scores of one-at-a-time prototypes for thorough testing, several novel manufacturing techniques were developed to place the new tube units on a production basis to insure extremely reasonable costs and fast delivery. These shop practices are a natural outgrowth of a quarter century of Amperex experience in electronic tube manufacture and the manipulation of materials to close tolerances.

## IMMEDIATE USE SEEN IN INDUSTRIAL FIELDS

Industrial equipment designers and manufacturers are expressing "down-to-earth" interest in the new Amperex application developed for use at high altitudes.

Most frequently asked question is: "How about the general run of 'standard' tube types? Can they be produced with the advantages of this development?"

The answer is "Yes!"

And it is being done. The development can be applied to the major number of the 340 Amperex tubes now made and catalogued. Included are practically all wanted industrial types.

Many sea-level conditions such as dust, moisture, temperature and pressure limit full, safe and efficient tube operation. They shorten tube life and increase operating costs. The new Amperex application which makes the tube unit entirely independent of all significant external atmospheric and pressure conditions fills a broad need and furnishes the answer to many problems facing designing engineers. Inquiries on specific problems are solicited.

APPLICATION ENGINEERING DEPARTMENT

AMPEREX ELECTRONIC CORP.

25 WASHINGTON STREET, BROOKLYN 1, N. Y.

In Canada and Newfoundland: Rogers Majestic Limited  
11-19 Brentcliffe Road, Leaside, Toronto, Ontario, Canada



HERE'S FLAT RESPONSE UP TO 700 MC

# hp 410A VACUUM TUBE VOLTMETER

with its new *-hp-* low-capacity diode probe, measures all the important radio voltages without disturbing circuits under test.

## CHECK THESE FACTS ABOUT THE NEW *-hp-* PROBE\*:

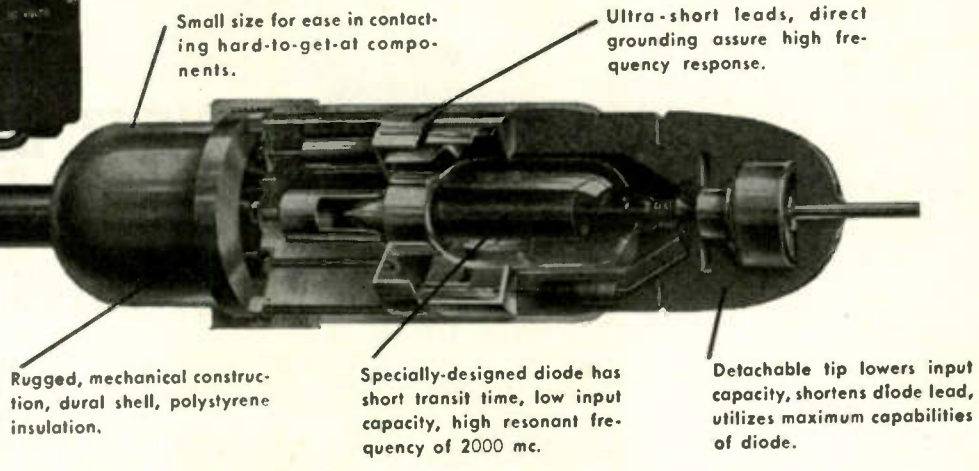

Rugged, mechanical construction, dural shell, polystyrene insulation.

Specially-designed diode has short transit time, low input capacity, high resonant frequency of 2000 mc.

Detachable tip lowers input capacity, shortens diode lead, utilizes maximum capabilities of diode.

\*Reproduced actual size

The specially-designed diode, in combination with the *-hp-* probe design, makes possible the exceedingly flat frequency response shown graphically in Figure 1.

With this flat frequency response are combined the factors of low input capacity and high input resistance. The variation of these factors with

frequency is shown in Figure 2. The input resistance and reactance are high throughout the entire range of the instrument, and thus measurements are made without appreciable detuning or loading of circuit. Maximum measuring accuracy is assured.

In addition to swiftly, easily, accurately making uhf radio measure-

ments, this *-hp-* 410A is a convenient voltage indicator up to 3000 mc. And it serves equally well as an audio or d-c voltmeter, or an ohmmeter. A-c measurements are made in 6 ranges ...full scale readings 1 to 300 v. D-c full scale readings from 1 to 1000 v in 7 ranges. Input resistance all ranges -100 megohms. As an ohmmeter, the *-hp-* 410A measures resistances from 0.2 ohms to 500 megohms in 7 ranges.

In short, this *-hp-* 410A Vacuum Tube Voltmeter is ideal for obtaining most important parameters in radio design, manufacture, or servicing. Write today for full details. Hewlett-Packard Company, 1407D Page Mill Road, Palo Alto, California.

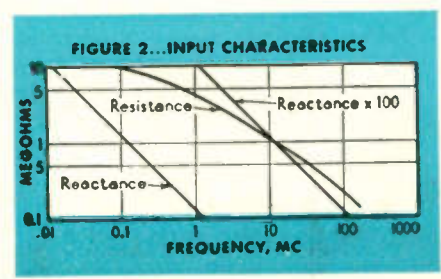
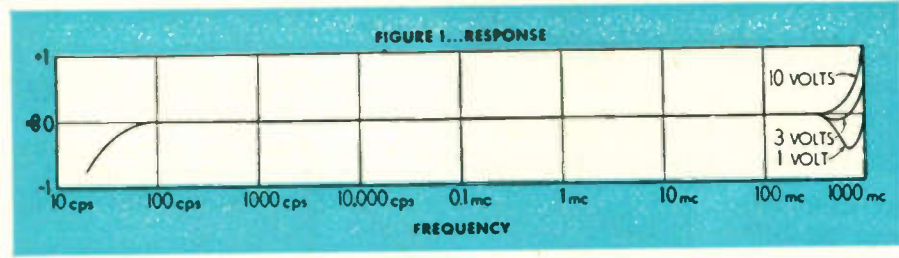

# hp laboratory instruments

FOR SPEED AND ACCURACY

- Noise and Distortion Analyzers
- Wave Analyzers
- Frequency Meters
- Audio Frequency Oscillators
- Audio Signal Generators
- Vacuum Tube Voltmeters
- Amplifiers
- Power Supplies
- UHF Signal Generators
- Attenuators
- Square Wave Generators
- Frequency Standards
- Electronic Tachometers

PROCEEDINGS OF THE I.R.E., July, 1948, Vol. 36, No. 7. Published monthly in two sections by The Institute of Radio Engineers, Inc., at 1 East 79 Street, New York 21, N.Y. Price \$2.25 per copy. Subscriptions: United States and Canada, \$18.00 a year; foreign countries \$19.00 a year. Entered as second class matter, October 26, 1927, at the post office at Menasha, Wisconsin, under the act of March 3, 1879. Acceptance for mailing at a special rate of postage is provided for in the act of February 28, 1925, embodied in Paragraph 4, Section 412, P. L. and R., authorized October 26, 1927.

# Western Electric

## 1304 TYPE REPRODUCER SET



Makes your finest discs  
sound better!

### ALSO AVAILABLE WITHOUT CABINET— OR WITHOUT REPRODUCER GROUP

If you have your own cabinet or table, the 304 Type Reproducer Panel is for you. Identical with the 1304 Set, but without the cabinet, it is supplied as a completely assembled unit, with all operating mechanism attached to the panel. Or, if you already own a 109 Type Reproducer Group, order the 305A Reproducer Panel (without 109 Type Group).



## LOWEST DISTORTION

You get your high frequencies *without introducing fuzz.*

## MINIMUM FLUTTER

You get piano notes *without introducing wow.*

## NEGLIGIBLE NOISE

You can boost bass response *without introducing rumble.*

### Plus...

Features that make the 1304 tops in operating utility! Accurate playing time—less than 2 seconds' variation in 15 minutes. Fast pickup to stable speed, rapid slowdown. Quick, easy electrical speed change. Easy reproducer handling — *positive* protection against reproducer damage.

### **A NATURAL FOR FM!**

If you're using FM, make the most of its possibilities! Start with well-cut recordings—then give them the finest in reproduction...with the 1304!

For early delivery, place your order now. Call your local Graybar Broadcast Representative for full details, or write Graybar Electric Company, 420 Lexington Avenue, New York 17, N. Y.

— QUALITY COUNTS —

DISTRIBUTORS: IN THE U. S. A.— Graybar Electric Company. IN CANADA AND NEW FOUNDLAND—Northern Electric Company, Ltd.

PROCEEDINGS OF THE I.R.E. July, 1948

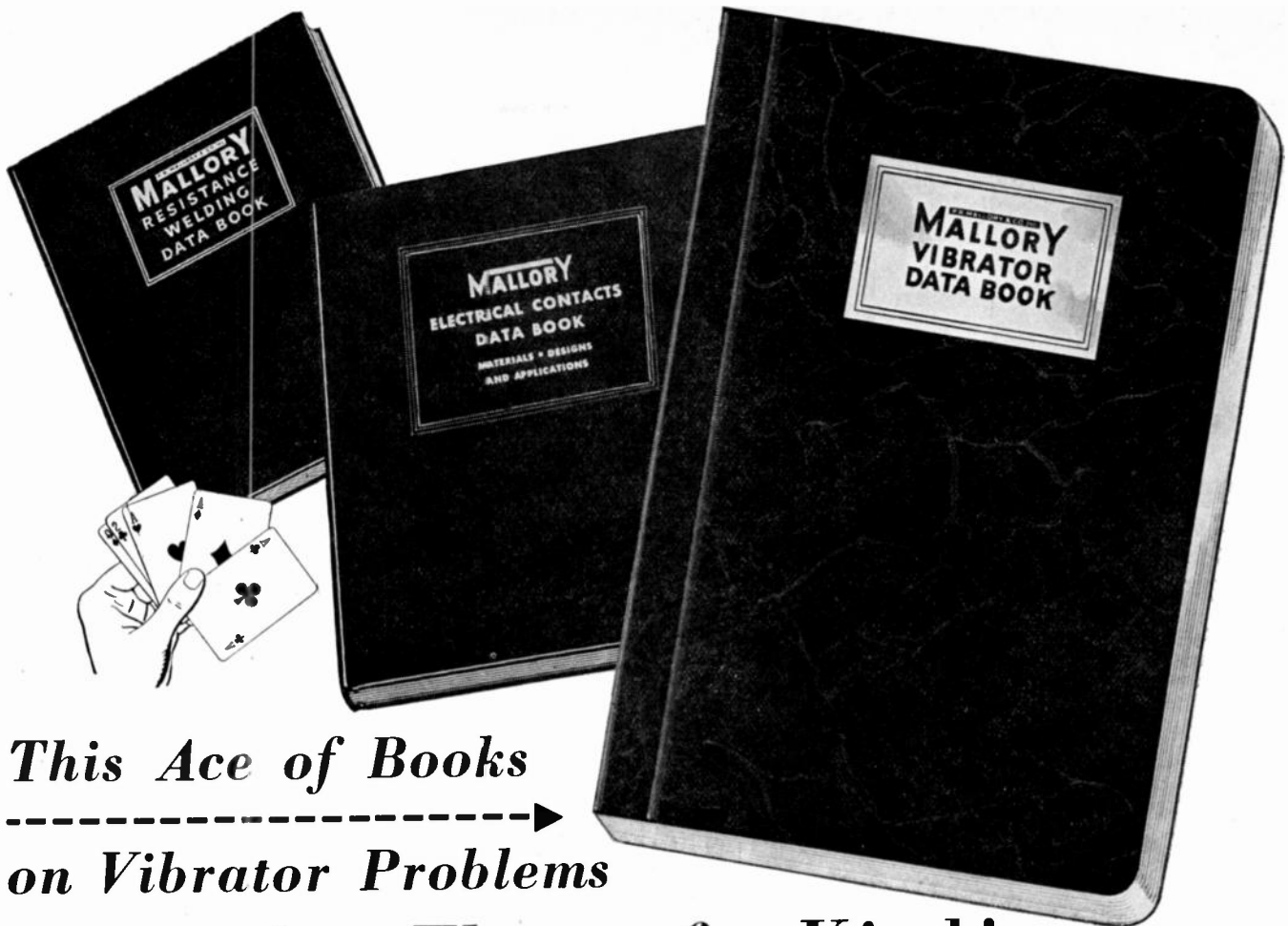

*This Ace of Books*  
 ----->  
*on Vibrator Problems*  
 now makes **Three of a Kind!**

First it was the Resistance Welding Data Book, then the Electrical Contacts Data Book, now the comprehensive, new Vibrator Data Book. Each is the product of years of Mallory research . . . each is unique in its field.

If your engineers design or use vibrator power supplies, this latest volume is a "must" for your library. Here are all the fundamentals they need to know . . . all the discoveries that 16 years of intensive experience and research have brought to light . . . all the "do's" and "don'ts" of a highly complicated and specialized field.

Put this ace of books to work before the first edition runs out. The price is only \$1.00. Free to recognized engineers and teachers when requested on your letterhead.

➡ **MORE MALLORY VIBRATORS ARE IN USE TODAY THAN ALL OTHER MAKES COMBINED**

**LIST OF CONTENTS**

- Basic Vibrator Structures
- Mallory Standard Vibrators
- Preliminary Design Considerations
- The Choice of a Vibrator
- Basic Power Transformer Characteristics
- Tables, Charts, Graphs and Formulas
- Development of Basic Transformer Formula with Design Examples
- Timing Capacitor Considerations
- Vibrator Power Supply Construction and Interference Elimination
- Vibrator Power Supply Circuits
- Inspection of Vibrators

P. R. MALLORY & CO. Inc.

# MALLORY VIBRATORS

## AND VIBRATOR POWER SUPPLIES

P. R. MALLORY & CO., Inc., INDIANAPOLIS 6, INDIANA



### 3-Phase Regulation

MODEL	LOAD RANGE VOLT-AMPERES	*REGULATION ACCURACY
3P15,000	1500-15,000	0.5%
3P30,000	3000-30,000	0.5%
3P45,000	4500-45,000	0.5%

• Harmonic Distortion on above models 3%.  
Lower capacities also available.

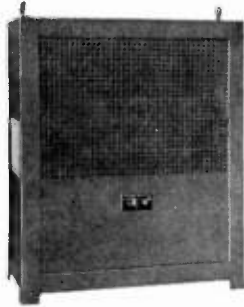

### Extra Heavy Loads

MODEL	LOAD RANGE VOLT-AMPERES	*REGULATION ACCURACY
5,000*	500 - 5,000	0.5%
10,000*	1000-10,000	0.5%
15,000*	1500-15,000	0.5%



### General Application

MODEL	LOAD RANGE VOLT-AMPERES	*REGULATION ACCURACY
150	25 - 150	0.5%
250	25 - 250	0.2%
500	50 - 500	0.5%
1000	100-1000	0.2%
2000	200-2000	0.2%



### 400-800 Cycle Line INVERTER AND GENERATOR REGULATORS FOR AIRCRAFT.

Single Phase and Three Phase

MODEL	LOAD RANGE VOLT-AMPERES	*REGULATION ACCURACY
D500	50 - 500	0.5%
D1200	120-1200	0.5%
3PD250	25 - 250	0.5%
3PD750	75 - 750	0.5%

Other capacities also available

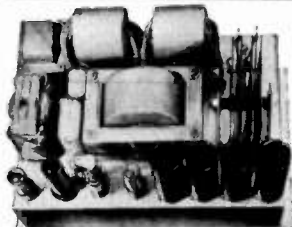

### The NOBATRON Line

Output Voltage DC	Load Range Amps.
6 volts	15-40-100
12 "	15
28 "	10-30
48 "	15
125 "	5-10

• Regulation Accuracy 0.25% from 1/4 to full load.

# SORENSEN

*The First Line* of standard electronic  
AC Voltage Regulators and Nobatrons

#### GENERAL SPECIFICATIONS:

- Harmonic distortion max. 5% basic, 2% "S" models
- Input voltage range 95-125: 220-240 volts (-2 models)
- Output adjustable bet. 110-120: 220-240 (-2 models)
- Recovery time: 6 cycles: \* (9 cycles)
- Input frequency range: 50 to 65 cycles
- Power factor range: down to 0.7 P.F.
- Ambient temperature range: -50°C to +50°C

All AC Regulators & Nobatrons may be used with no load.

\*Models available with increased regulation accuracy.

Special Models designed to meet your unusual applications.

Write for the new Sorensen catalog. It contains complete specifications on standard Voltage Regulators, Nobatrons, Incevolts, Transformers, DC Power Supplies, Saturable Core Reactors and Meter Calibrators.

SORENSEN & CO., INC.  
STAMFORD CONNECTICUT

Represented in all principal cities.

**PROGRESS REPORT  
ON  
P.E.C.\***

**How Stewart-Warner uses  
two "Couplates", one "Filpec" plus  
other Centralab components  
in compact chassis design.**

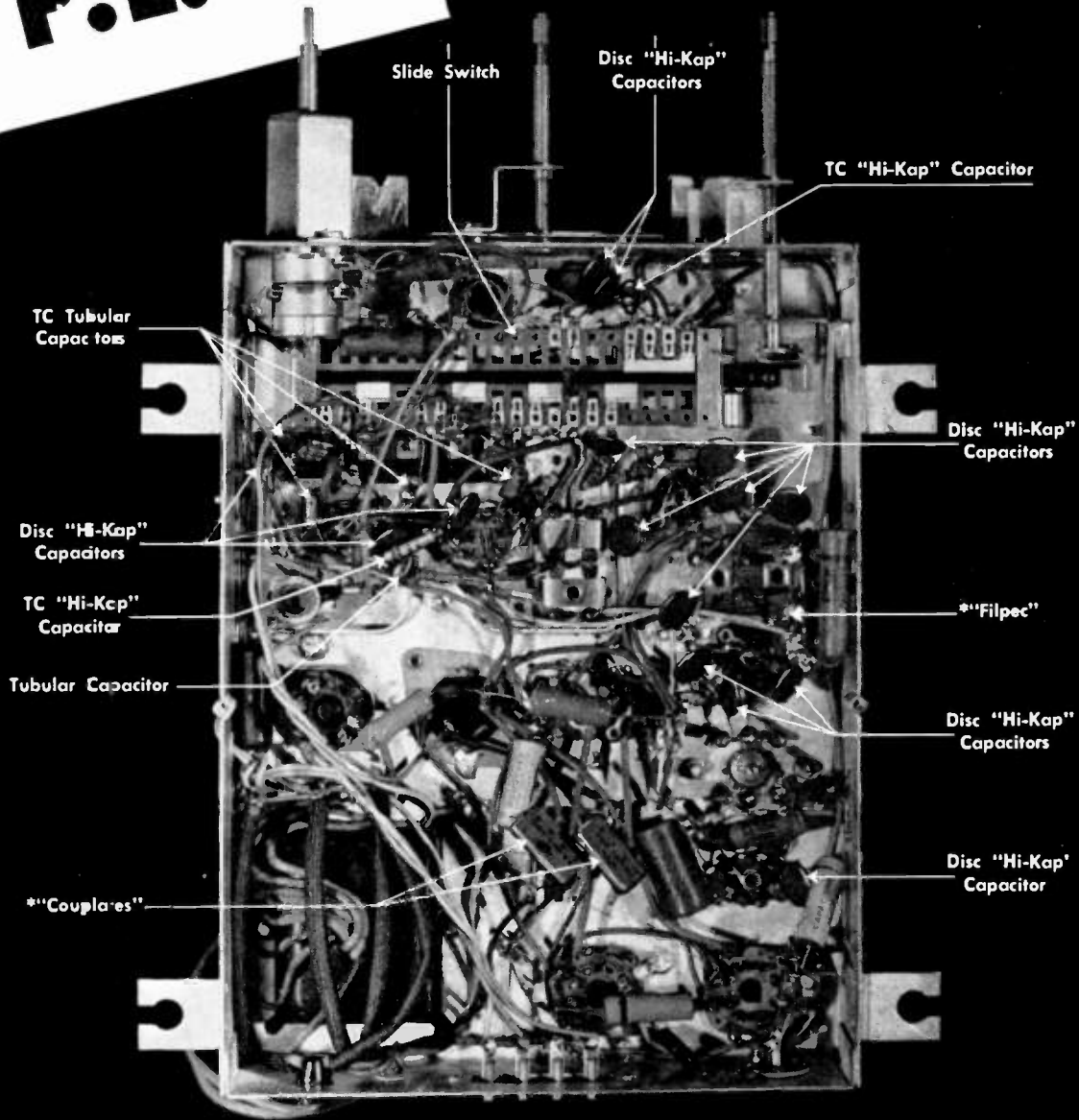

*Chassis Courtesy Stewart-Warner Corp.*

**\*Centralab's "Printed Electronic Circuit"  
— Industry's newest method for  
improving design and manufacturing efficiency!**

**S**IMPLIFIED wiring and assembly... fewer individual components... fewer leads to be soldered—these are just a few of the advantages you get when you use CRL's *Printed Electronic Circuits*. That's why Stewart-Warner has turned to CRL's *Couplate* (printed interstage coupling plate) and *Filpec* (printed electronic circuit filter). And that's why you will want to see and test this amazing new elec-

tronic development. But that's not all! For quality performance, dependability and long life, Stewart-Warner uses Centralab's *Slide Switch*, Ceramic Disc and Tubular *Hi-Kap* Capacitors. For all the facts about Centralab's advanced line of components, see your nearest CRL Representative, or write direct.

LOOK TO **Centralab** IN 1948

Division of GLOBE-UNION, INC., Milwaukee

# PERSONALLY CONDUCTED THROUGH THE REVERE MILLS



**B**ECAUSE OFHC Copper looks like any other copper, Revere takes great pains to identify it throughout processing, to see it is not lost track of or mixed up with other types. The obvious thing is to mark each piece, which is done, but markings are obliterated by operations such as rolling, and so Revere goes to the length of assigning special personnel to follow each lot of OFHC Copper from one operation to another, watching carefully to be sure each load is kept intact.

In addition, Revere takes full cognizance of the fact that OFHC Copper for radio purposes must have special qualities. In making anodes, it must be deep drawn, and for the feather-edge seal, it must be capable of being rolled or machined down to .002"/.010". By carefully controlling mill processing, grain size is kept at or below permissible limits. Freedom from oxygen, and from voids, is guaranteed by the method of casting the bars from which we roll the forms required. In addition, there is an operation which results in Revere OFHC Copper being not just commercially free but *nearly absolutely free* of internal and external defects. This great care in producing copper for radio and radar purposes probably accounts for the fact that Revere is a preferred source of supply.

## REVERE PRODUCTS AND SERVICES

All Revere Metals are processed with the care and attention required to assure that they meet all metallurgical and physical specifications. Revere supplies mill products in non-ferrous metals and alloys, and also electric welded and lockseam steel tube. An important part of our service to industry is the Revere Technical Advisory Service, which will gladly collaborate with you on specifications and fabrication methods.

# REVERE

## COPPER AND BRASS INCORPORATED

Founded by Paul Revere in 1801

230 Park Avenue, New York 17, New York

Mills: Baltimore, Md.; Chicago, Ill.; Detroit, Mich.;  
New Bedford, Mass.; Rome, N. Y.

Sales Offices in Principal Cities, Distributors Everywhere

PROCEEDINGS OF THE I.R.E. July, 1948



# RUBBER RECIPE

Rubber compounds to the tune of some 35 million pounds a year go into Bell System plant. Each compound must meet many requirements for resistance to humidity, oxygen, ozone, light and abrasion. The right properties depend on skillful selection and compounding of ingredients; this is one of the jobs of Bell Laboratories.

Sulphur, one essential ingredient of rubber, can also be corrosive. That seemed to rule out rubber on telephone cords. But Bell chemists found that if they held sulphur to the bare minimum, corrosion ceased. Now your handset cord has long life, is less susceptible to moisture as, for example, from a wet umbrella.

Connecting your home to the telephone wire on the street is a "drop" — one hundred feet or more of rubber-insulated wire. Once this wire was protected from ozone, light and abrasion by an impregnated cotton braid; but water leached the impregnant, and the braid rotted. Bell chemists tested scores of synthetics, and selected neoprene as an exterior covering with many times the life of braid.

Rubber is only one of many types of insulation developed by the Laboratories for the Bell System; insulation is only one of the Laboratories' problems in providing a quick, economical path for your voice.

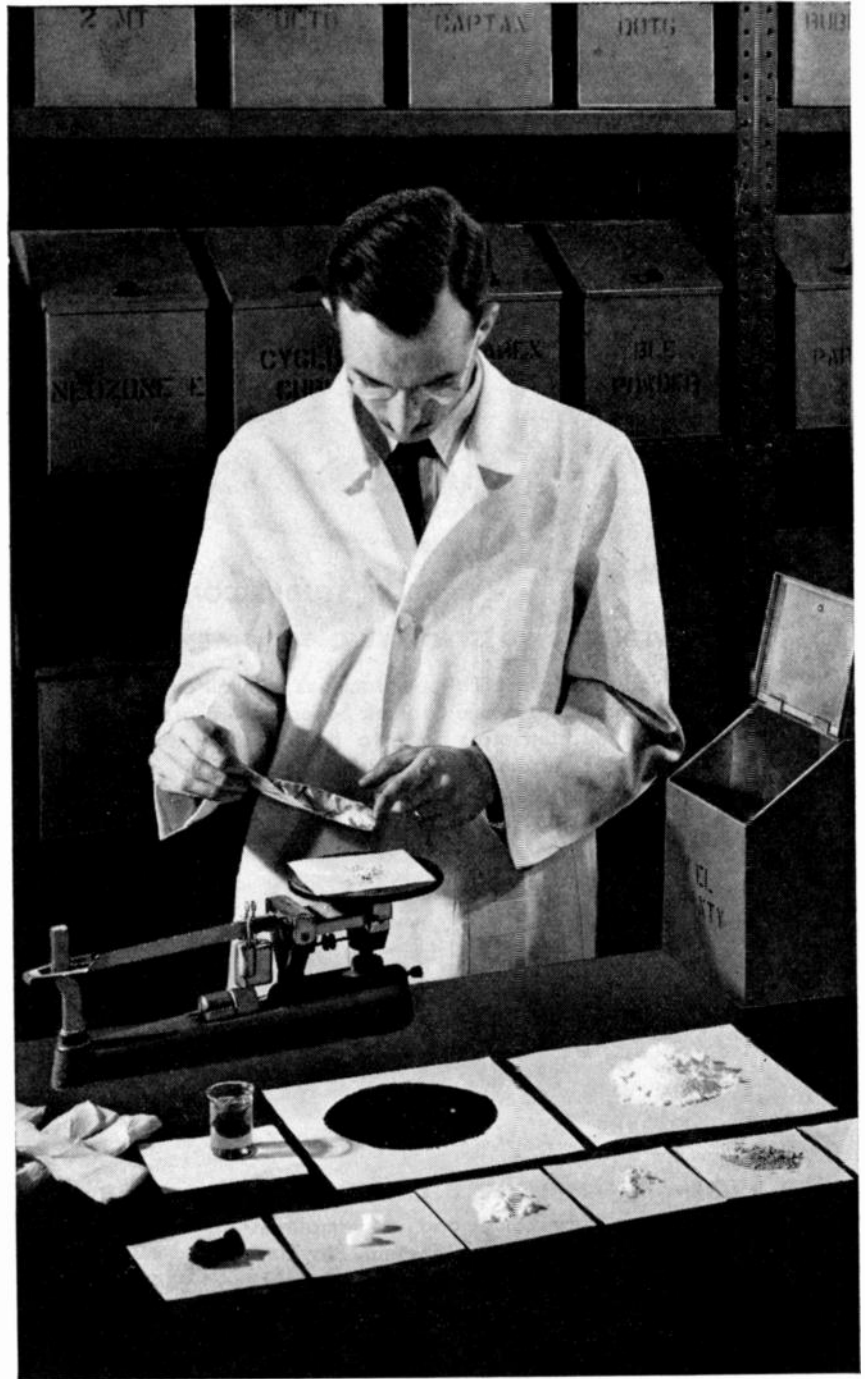

## BELL TELEPHONE LABORATORIES

EXPLORING AND INVENTING, DEVSING AND PERFECTING FOR CONTINUED IMPROVEMENTS AND ECONOMIES IN TELEPHONE SERVICE.



# AM · FM · TV RAYTHEON SPEECH EQUIPMENT

For the last word in complete, up-to-the-minute facilities . . . or simple, low-cost equipment to suit your limited requirements . . .

## Look to RAYTHEON for All Your Needs



**RC-11 STUDIO CONSOLE**

**NOW WITH CUE POTS FOR TWO TURNTABLES**

Provides complete high-fidelity speech input facilities with all control, amplifying and monitoring equipment in one cabinet. Seven built-in pre-amplifiers, nine mixer positions, cue attenuators for two turntables. Simple, positive controls reduce operational errors. Frequency response—2 DB from 30 to 15,000 cycles; Distortion—less than 1% from 50 to 10,000 cycles; Noise Level—minus 65 DB's or better. Meets all FCC requirements for FM.

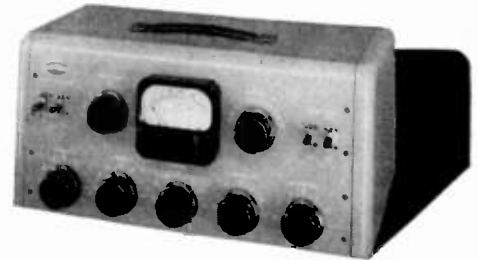

**RPC-40 PORTABLE CONSOLE**

Ideal for remote pickups yet complete enough to serve as a studio console. Four input channels for microphones or turntables, high level mixing, two output lines. Two RPC-40's interconnected provide 8-channel mixing—a feature of special interest to new TV stations planning future expansion.



**RR-30 REMOTE AMPLIFIER 3 CHANNEL**

A lightweight, easy-to-carry combination of amplifier and power supply—simple and quick to set up. Provides three high-fidelity channels, excellent frequency response, high over-all gain.

**RR-10 REMOTE AMPLIFIER  
SINGLE CHANNEL**

A complete, self-contained unit with built-in power supply. An excellent low-cost amplifier for remote pickups requiring only one high-fidelity channel.



**RL-10 VOLUME LIMITER**

Engineered for high-fidelity AM, FM or TV speech input. Increases average percentage modulation without distortion.

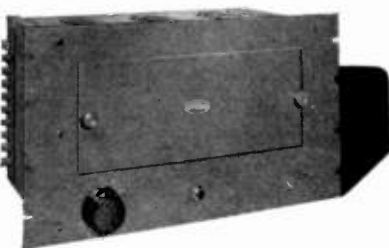
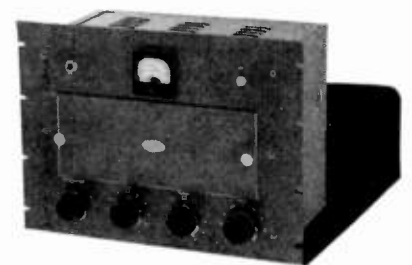

**RP-10 PROGRAM AMPLIFIER**

High gain, low distortion, excellent frequency characteristics. For rack or cabinet mounting.

### RAYTHEON MANUFACTURING COMPANY WALTHAM 54, MASSACHUSETTS

Industrial and Commercial Electronic Equipment, FM, AM and TV  
Broadcast Equipment, Tubes and Accessories

**BOSTON  
CHATTANOOGA**

**CHICAGO  
DALLAS**

**LOS ANGELES  
NEW YORK**

**SEATTLE  
WASHINGTON**

**EXPORT SALES AND SERVICE IN FOREIGN COUNTRIES**

Raytheon Manufacturing Company, 50 Broadway, New York 4, N. Y., WH. 3-4980

# 15 WATTS AT 940.5 - Mc. with the EIMAC 4X150A TETRODES

**K S B R**  
STL Transmitter

**FREQUENCY UP 6X, (156.75-Mc. to 940.5-Mc.)**  
**POWER UP 7X (2 watts to 15 watts)**

Here's a STL transmitter that's in operation on the new 950-Mc. band, fulfilling all the FCC requirements and powered by Eimac 4X150A tetrodes. It's a part of the studio-transmitter-link between the San Bruno studios and the 250 Kw FM transmitter of station KSBR high atop 3849-foot Mt. Diablo some 33 miles away.

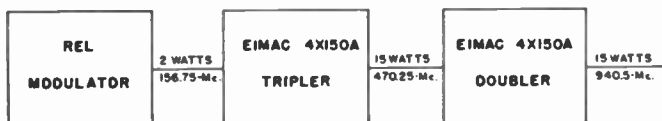

The R-F amplifier was specifically designed for the KSBR application by Eimac engineers. It is driven by an REL modulator delivering 2 watts output at 156.7-Mc. to one Eimac 4X150A in a tripler stage, which in turn drives a single 4X150A in a doubler stage, providing 15 watts useful output at 940.5-Mc.

The Eimac 4X150A is ideally suited for this application because of its high power gain at relatively low plate voltages, ability as a frequency multiplier without loss of amplification, low grid drive requirements, and a high ratio of transconductance to capacitance. It also has the advantage of being physically small and functionally designed for simple installation.

Complete data on the Eimac 4X150A for STL and other UHF applications is available by writing direct.

**EITEL-McCULLOUGH, INC.**  
197 San Mateo Avenue, San Bruno, California  
EXPORT AGENTS: Fraxar & Hansen—301 Clay St.—San Francisco, Calif.



*Eimac*  
**4X150A**

ESSENTIAL DATA KSBR STL TRANSMITTER	
REL MODULATOR, MODEL 694 EIMAC 4X150A, R-F AMPLIFIER	
Useful Output Power - - - - -	15 watts
Frequency - - - - -	940.5 Mc.
Frequency Stability - - - - -	.002%
Audio Frequency Response.	
Substantially flat - - - - -	50 to 15,000 cycles
Distortion - - - - -	.5% Max.
Noise Level - - - - -	70 db below 100% modulation
- - - - -	± 100 Kc. deviation

Eimac 4X150A General Characteristics	
Heater voltage - - - - -	6.0 volts
Heater current - - - - -	2.8 amps.
Minimum heating time - - - - -	30 secs.
Grid Screen amplification factor - - - - -	4.5
Direct interelectrode capacitance (Average)	
Grid-Plate - - - - -	0.02 μmf
Input - - - - -	14.1 μmf
Output - - - - -	4.7 μmf
Maximum Ratings	
D-C Plate voltage - - - - -	1000 volts
D-C Plate current - - - - -	250 ma.
Plate dissipation - - - - -	150 watts
D-C Screen voltage - - - - -	300 volts

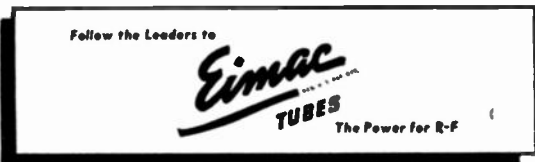



# Memo to...**DESIGN ENGINEERS**

## about...**MYCALEX 410 - MOLDED**

In the design of components or complete equipment for industrial controls or communications — where insulation qualities are of critical importance — where mechanical precision must be a fixed factor — where strength is essential — where electrical characteristics must accurately meet high frequency circuit needs . . . then remember MYCALEX 410 as the insulation that designs-in with your most exacting requirements.

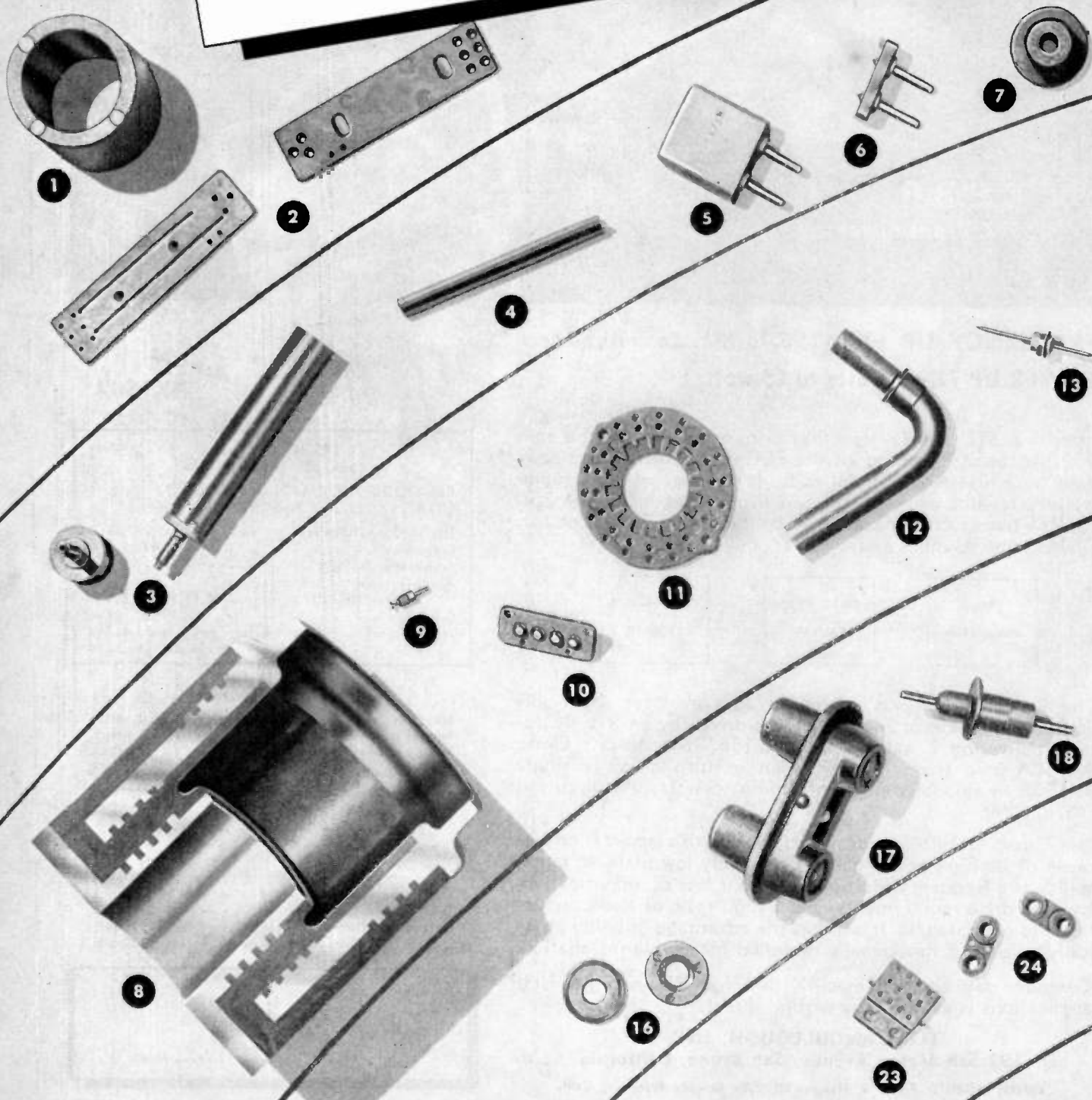

**M**YCALEX is today's improved insulation — designed to meet the exacting demands of all types of high-frequency circuits. MYCALEX is unusual in that it possesses a combination of peculiar characteristics that make it ideally suited for insulation in all types of electronic circuits. In tomorrow's designs for communications and industrial control equipment, MYCALEX 410 will be specified more than ever

before because of its... Low dielectric loss • High dielectric strength • High arc resistance • Dimensional stability over wide humidity and temperature changes • Resistance to high temperatures • Mechanical precision • Mechanical strength • Ability to mold metal inserts in place. If you have any insulation problems, our engineers will be glad to help you in their solutions.

## MYCALEX CORP. OF AMERICA

"Owners of 'MYCALEX' Patents"

Plant and General Offices: Clifton, N. J. Executive Offices: 30 Rockefeller Plaza, New York 20, N. Y.

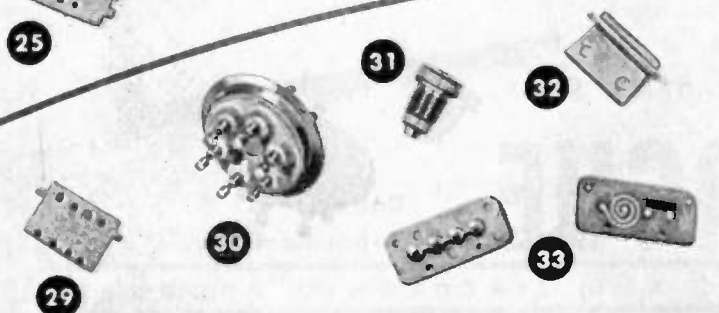
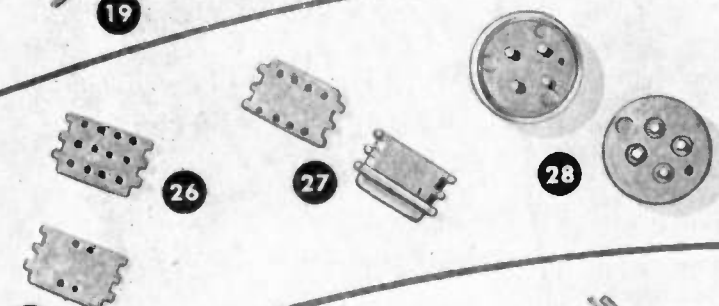
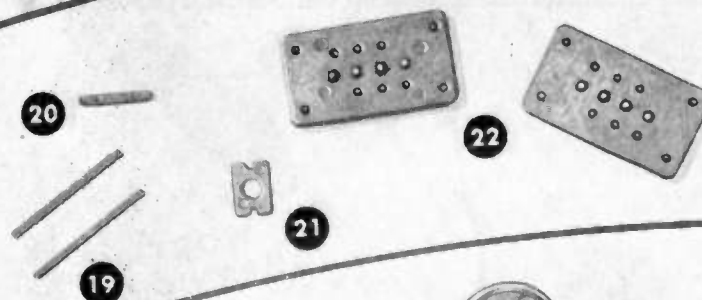
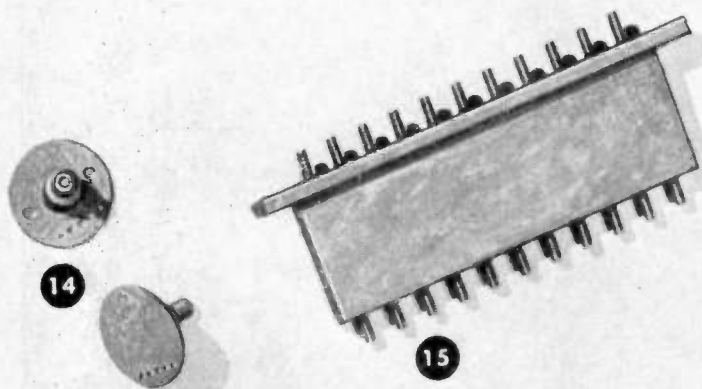

PART NAME	APPLICATION	INSERTS	MAX. DIMEN.
1 Bushing	Motor Generator	None	1.75"
2 Insulator	Electrical Instrument	None	3.18
3 End Seal	Thermostat Shell	Stainless Steel	3.75
4 Insulator	Electrical Instrument	None	3.00
5 Hermetic Seal	Crystal housing	Nickel and Copper	0.88
6 Hermetic Seal	Crystal housing	Copper	1.09
7 Insulator	Automobile Antenna	None	1.06
8 Bushing	Ignitron	Steel	4.50
9 Stand-Off Insulator	Electronics circuit	Brass	0.56
10 Panel	Television Selector Switch	Silver	1.38
11 Switch Wafer	Television Selector Switch	None	2.31
12 Elbow	Aircraft ignition	Steel and Brass	2.75
13 Lead	Transformer	Monel	1.75
14 Insulator	Polarizing relay	None	1.09
15 Lead through block	Oscillator	Brass	4.69
16 Insulator	Telephone Transmitter	None	0.88
17 Dual Bushing	Oil Burner Transformer	None	3.00
18 Lead	Transformer	Monel	2.50
19 Actuating Bar	Telephone relay	None	1.44
20 Actuating Bar	Telephone relay	None	0.78
21 Spacer	Radio vibrator	None	0.56
22 Panel	Television Selector Switch	None	1.75
23 Spacer	Telephone relay	None	1.00
24 Spacer	Relay	None	0.91
25 Spacer	Telephone relay	None	1.00
26 Spacer	Telephone relay	None	1.00
27 Clamping Plate	Telephone relay	None	1.00
28 Electrode Mounting	Level Indicator	Brass	1.13
29 Spacer	Telephone relay	None	1.00
30 Six Terminal Header	Transformer	Monel	1.42
31 Test jack body	High Frequency Circuits	Monel	0.75
32 Clamping Plate	Telephone relay	None	1.00
33 Printed Circuit Base	Experimental	Silver	1.38

# *Announcing* A NEW LINE OF **SPRAGUE ELECTROLYTIC CAPACITORS**



## **Designed For Television Use** (for operation up to 450 volts at 85° C.)

With some 7 times as many components in a television receiver as in the average radio, the possibility of service calls is greatly increased. The new SPRAGUE ELECTROLYTIC line offers the first practical solution to this problem.

Designed for dependable operation up to 450 volts at 85° C. these new units are ideally suited for television's severest electrolytic assignments. Every care has been taken to make these new capacitors the finest electrolytics available today. Stable operation is assured even after extended shelf life, because of a new processing technique developed by Sprague research and development engineers, and involving new and substantially increased manufacturing facilities. More than ever before your judgment is confirmed when you **SPECIFY SPRAGUE ELECTROLYTICS FOR TELEVISION AND ALL OTHER EXACTING ELECTROLYTIC APPLICATIONS!** Sprague Electric Company invites your inquiry concerning these new units.

**SPRAGUE ELECTRIC COMPANY · NORTH ADAMS, MASS.**

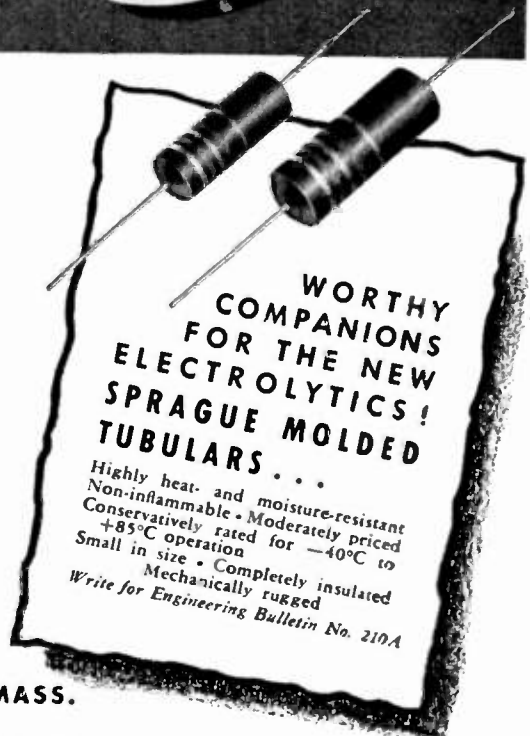

**WORTHY  
COMPANIONS  
FOR THE NEW  
ELECTROLYTICS!  
SPRAGUE MOLDED  
TUBULARS . . .**

Highly heat- and moisture-resistant  
Non-inflammable • Moderately priced  
Conservatively rated for -40°C to  
+85°C operation  
Small in size • Completely insulated  
Mechanically rugged  
*Write for Engineering Bulletin No. 210A*

# **SPRAGUE**

Capacitors

\* Koolohm Resistors

P I O N E E R S O F

E L E C T R I C A N D E L E C T R O N I C P R O G R E S S

• Trademarks reg. U. S. Pat. Office

To the  
engineer  
who wants  
high quality  
at low cost

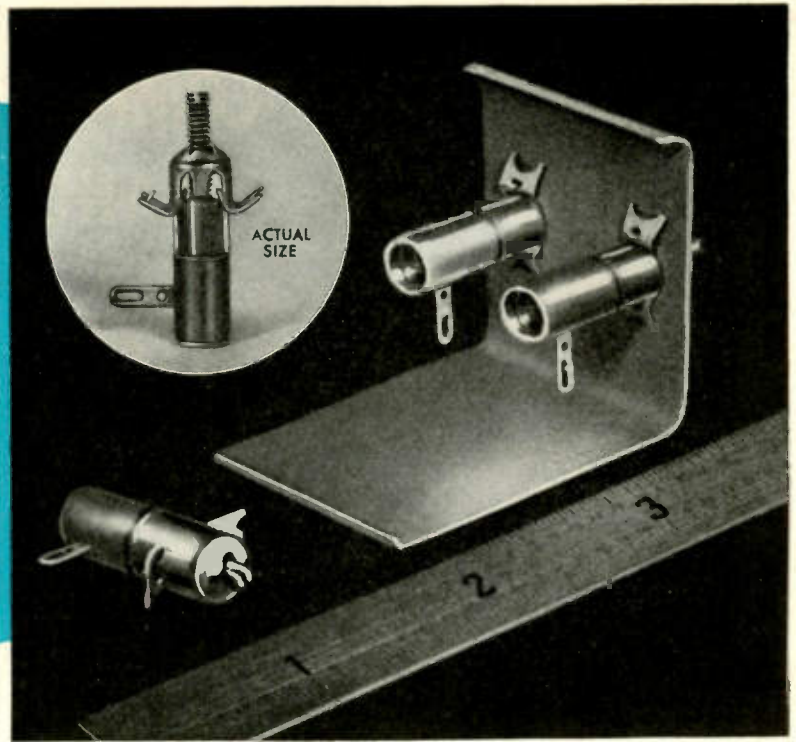

## The NEW ERIE Styles 531 and 532 TUBULAR TRIMMERS

THIS new trimmer condenser was released to production only after prolonged months of engineering development in quest of stable plastic materials and reliable manufacturing techniques. It is the most recent among a series of new ERIE RESISTOR capacitor designs, both fixed and variable.

Every characteristic desired in a trimmer is found in the Styles 531 and 532 Erie Tubular Trimmers. The capacity range of 1-8 MMF provides a low minimum with high ratio of maximum to minimum. Capacity stability is assured by the use of high temperature thermoplastic dielectric and simple but efficient mechanical design.

The change from maximum to minimum setting occurs in practically a straight line, without peaks or valleys, permitting accurate trimming over the entire range. Style 531 is designed for installation on panels from .015" to .039" thick, Style 532 from .040" to .065".

These miniature trimmers are built right and priced right. It will pay you to write for additional information.

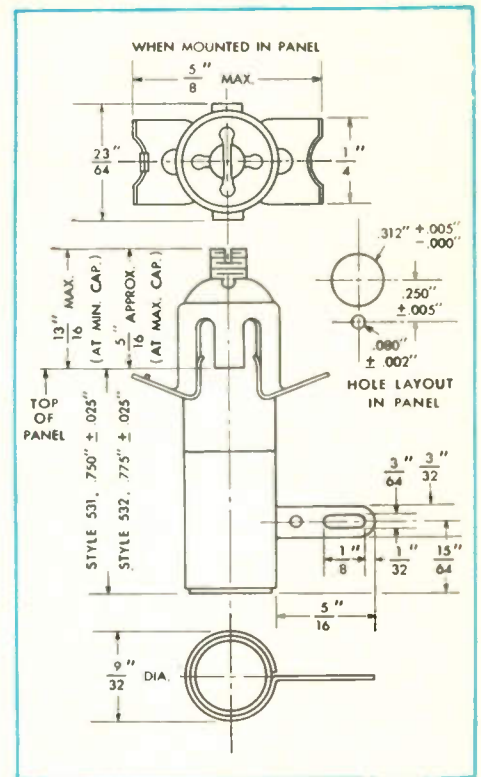

Electronics Division  
**ERIE RESISTOR CORP., ERIE, PA.**  
LONDON, ENGLAND • • TORONTO, CANADA

*Over 10,000  
different*

# COMPONENTS FOR RADIO AND ELECTRONICS

The quality and performance of Amphenol components have set standards for the radio and electronic industry for years. Specify Amphenol and be sure you get the best.



Reduce "down-time" . . . lower wiring costs . . . safeguard personnel with Amphenol Industrial Electron Tube Socket. A wide variety to fit your needs. Write for descriptive literature.



Low-loss Amphenol Coaxial Cable and Twin-Lead remain flexible indefinitely. Low-loss properties make Amphenol Twin-Lead ideal for television and FM lead-ins and amateur antennas.



Compact, custom-wired Amphenol Television Tube Sockets are easy to wire and space-saving. They provide the quality short cut to mass production of television receivers.

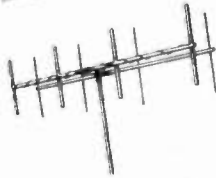

Antennas for many applications . . . railroads, police broadcast stations, truck dispatching, taxicabs, and home reception of TV and FM. Big features are beam control and virtual elimination of noise and interference thru complete scientific insulation.



Amphenol RF Connectors provide a low-loss connecting link between coaxial cables. In each type, design and materials are carefully selected to meet your service requirements. All are rugged, compact and provide unsurpassed performance, convenience and dependability.



Amphenol Cable Assemblies, completely wired and assembled ready for installation are available from Amphenol. Enormous stocks of components at Amphenol insure quick delivery of your made-to-order cable assembly.



Amphenol makes thousands of different "AN" Connectors for the aircraft and electronics industries. They provide efficient and economical detachable connections in electrical circuits, insure easy servicing, installation, etc. Write for catalog.



Low-loss Amphenol Radio Sockets have been the standard in the radio industry for years. Manufactured to closest tolerances, they are easy to solder and grip tube pins firmly.



Write today for complete catalog covering your requirements . . .

- D-1—RF Cables and Components
- G-1—Plastics in Sheets, Rods, Tubes, Film
- A-1—"AN" Connectors
- 73—Radio Components

## AMPHENOL

**AMERICAN PHENOLIC CORPORATION**

1830 South 54th Street, Chicago 50, Illinois

Coaxial Cable and Connectors • Industrial Connectors, Fittings and Conduit • Antennas • Radio Components • Plastics for Electronics



**TINY... BUT *so* SENSITIVE... *so* TOUGH!**



*This* **WESTON** [ MODEL 813 ] \* *Sensitrol Relay*

- provides positive control on 2 microamperes
- handles up to 50 milliamperes at 120 volts AC or DC
- resists extreme shock and vibration

Here is a sensitive relay whose unique characteristics stir the imagination... suggesting to design engineers vast possibilities for *new* product development, and for simplification and improvement

of existing products. To assist in their proper application, consult our representatives, or write... WESTON Electrical Instrument Corporation, 589 Frelinghuysen Ave., Newark 5, New Jersey.

\* SENSITROL—A registered trade-mark designating the contact-making instruments and relays, as manufactured exclusively by the Weston Electrical Instrument Corporation.

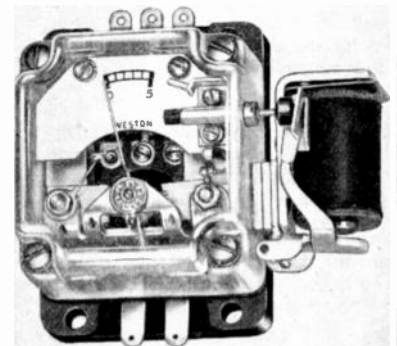

**Solenoid reset type (illustrated directly above) or manual reset types available.**

**WESTON** *Instruments*

ALBANY • ATLANTA • BOSTON • BUFFALO • CHARLOTTE • CHICAGO • CINCINNATI • CLEVELAND • DALLAS • DENVER • DETROIT • JACKSONVILLE • KNOXVILLE • LITTLE ROCK • LOS ANGELES • MERIDEN • MINNEAPOLIS • NEWARK  
NEW ORLEANS • NEW YORK • PHILADELPHIA • PHOENIX • PITTSBURGH • ROCHESTER • SAN FRANCISCO • SEATTLE • ST. LOUIS • SYRACUSE • IN CANADA, NORTHERN ELECTRIC CO., LTD., POWERLITE DEVICES, LTD.

# Mica

## TRANSMITTING CAPACITORS



An outstanding choice of bakelite-molded receiving and transmitting capacitors for widest range of requirements.

Bakelite-cased potted transmitting capacitors for greater load-carrying capacity. Aerovox current ratings insure the most satisfactory selection.

Stack-mounting heavy-duty capacitors for transmitting and other high-voltage applications.

Ultra-high-frequency molded-in-bakelite capacitors featuring high-voltage minimum-inductance characteristics.

Water-cooled oil-filled mica capacitors for higher KVA ratings and greatly reduced capacitor size for given power ratings.

• Be it tiny "postage-stamp" mica capacitor or large stack-mounting unit—regardless, it's a precision product when it bears the Aerovox name.

Only the finest ruby mica is used. Each piece is *individually gauged and inspected*. Uniform thickness means meeting still closer capacitance tolerances. Also, sections are of exceptionally uniform capacitance, vitally essential for those high-voltage series-stack capacitors. Meanwhile, the selection of perfect mica sheets accounts for that extra-generous safety factor so characteristic of ALL Aerovox capacitors.

### Send us your capacitance problems . . .

Aerovox application engineering service is yours for the asking. Let us quote on your mica, paper, oil electrolytic, ultra-high-frequency, power-factor and other capacitor needs.

## FOR RADIO-ELECTRONIC AND INDUSTRIAL APPLICATIONS



AEROVOX CORPORATION, NEW BEDFORD, MASS., U.S.A.

SALES OFFICES IN ALL PRINCIPAL CITIES • Export: 13 E. 40th ST., NEW YORK 16, N. Y.

Cable: 'ARLAB' • In Canada: AEROVOX CANADA LTD., HAMILTON, ONT.



# COMPONENTS FOR EVERY APPLICATION



**LINEAR STANDARD**  
High Fidelity Ideal

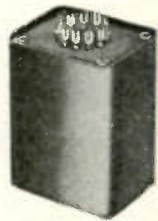

**HIPERM ALLOY**  
High Fidelity . . . Compact



**ULTRA COMPACT**  
Portable . . . High Fidelity



**OUNCER**  
Wide Range . . . 1 ounce

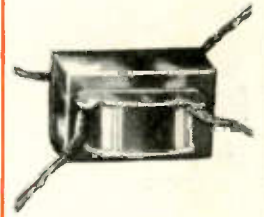

**SUB OUNCER**  
Weight 1/3 ounce



**COMMERCIAL GRADE**  
Industrial Dependability



**SPECIAL SERIES**  
Quality for the "Ham"



**POWER COMPONENTS**  
Rugged . . . Dependable



**VARITRAN**  
Voltage Adjustors



**MODULATION UNITS**  
One watt to 100KW



**VARIABLE INDUCTOR**  
Adjust like a Trimmer



**TOROID HIGH Q COILS**  
Accuracy . . . Stability



**TOROID FILTERS**  
Any type to 300KC



**MU-CORE FILTERS**  
Any type 1/2 - 10,000 cyc.

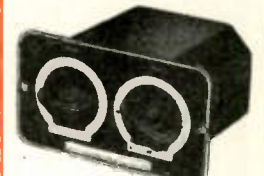

**EQUALIZERS**  
Broadcast & Sound



**PULSE TRANSFORMERS**  
For all Services



**SATURABLE REACTORS**  
Power or Phase Control



**LARGE UNITS**  
To 100KW Broadcast



**PLUG-IN TYPE**  
Quick change service



**CABLE TYPE**  
For mike cable line

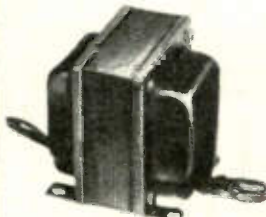

**VERTICAL SHELLS**  
Husky . . . Inexpensive

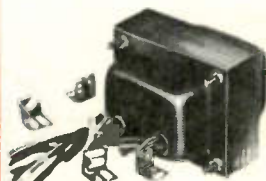

**REPLACEMENT**  
Universal Mounting

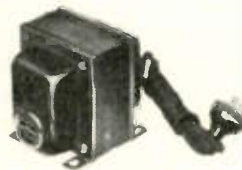

**STEP-DOWN**  
Up to 2500W . . . Stock



**LINE ADJLSTORS**  
Match any lire voltage

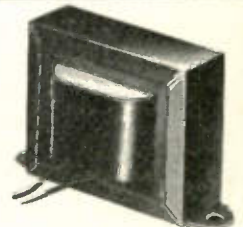

**CHANNEL FRAME**  
Simple . . . Low cost

*United Transformer Co.*  
150 VARICK STREET NEW YORK 13, N. Y.

EXPORT DIVISION: 13 EAST 40th STREET, NEW YORK 16, N. Y., CABLES: "ARLAB"

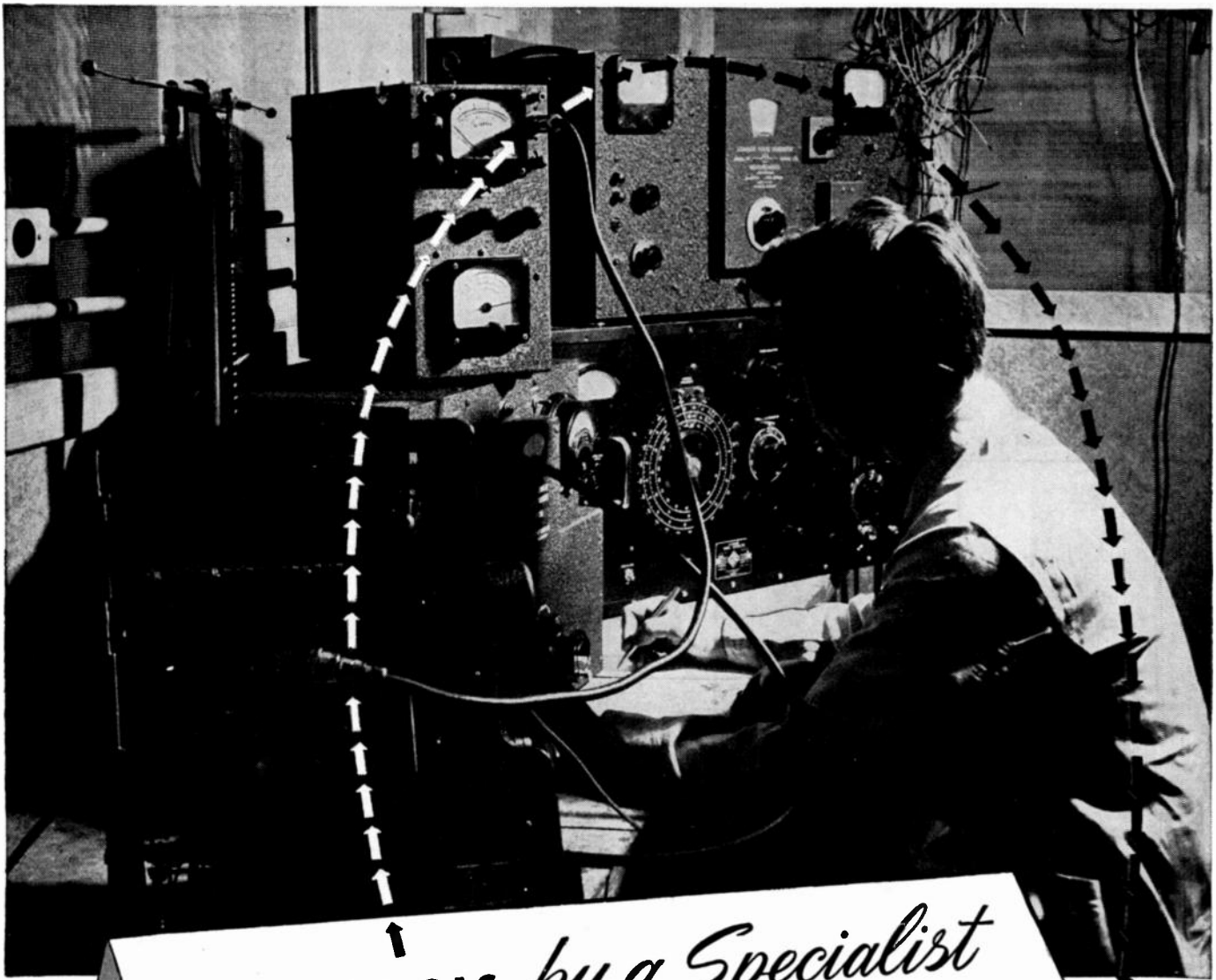

## DIAGNOSIS *by a Specialist*

**THE CURE OF RADIO NOISE** is a highly specialized task that involves much more than simply "hooking a condenser across the line". It requires exact knowledge of the proper size and type of capacitor to use . . . of the correct place to add it to the noise-making circuit . . . of the necessary length or positioning of connecting leads . . . and of many other seemingly trivial, but actually vital, bits of information that cannot rightfully be expected of the electrical design engineer.

This exact knowledge is available to you when you must provide radio silence for electrical apparatus. Just send us the offending equipment and we will measure its radio noise output according to standard specifications, will design the most efficient Filterette to cure the noise, will specify the proper means of installing it, and, upon your adoption of our recommendations, will authorize your use of the FILTERIZED label that tells buyers your apparatus will not interfere with radio reception. This service is free to users of Tobe Filterettes . . . write for details.



**TOBE DEUTSCHMANN CORPORATION NORWOOD, MASSACHUSETTS**  
**ORIGINATORS OF FILTERETTES . . . THE ACCEPTED CURE FOR RADIO NOISE**

# RADIO COMPONENT HANDBOOK

The handbook that every radio engineer and technician has been waiting for — written by engineers for engineers — the “know how” of over 20 years’ experience in the design, application and specification of radio components.

Tables, charts, curves, together with practical information never before published, makes the handbook indispensable to the experienced engineer as a reference, and to the radio technician as a guide. Complete — yet concise — it fills a long-felt need.

- **Design**
- **Application**
- **Specification**



## CONTENTS

General Design  
Transformers—*a-f*, power  
Transformers—*r-f*  
Capacitors—electrolytic  
Capacitors—variable  
Capacitors—fixed  
Resistors—variable  
Resistors—fixed  
Insulating Materials  
& Components  
Speakers  
Switches  
Tubes and Metallic  
Rectifiers

Through the sponsorship of the following manufacturers the handbook is made available at a cost within the reach of all. Editorial content contains no direct advertising. Names of sponsors and products are listed on title pages.

### THE MAGNAVOX COMPANY

Fort Wayne 4 — Indiana

### WARD LEONARD ELECTRIC COMPANY

Mount Vernon — New York

### THE FOSTER TRANSFORMER COMPANY

Cincinnati 23 — Ohio

Use This Coupon — Order Now

200 pages 6 x 9, cloth bound

**\$1.50** Postpaid

**TECHNICAL ADVERTISING  
ASSOCIATES**  
CHELTENHAM, PENNA.

**TECHNICAL ADVERTISING ASSOCIATES**  
CHELTENHAM, PENNSYLVANIA.

I enclose \_\_\_\_\_ dollars, for which send me \_\_\_\_\_ copies  
of the RADIO COMPONENT HANDBOOK at \$1.50 per copy.\*

NAME \_\_\_\_\_

ADDRESS \_\_\_\_\_

CITY \_\_\_\_\_ ZONE \_\_\_\_\_ STATE \_\_\_\_\_

\*10 or more to one address \$1.35 per copy.

capacitors

can be  
both

mighty

and

small

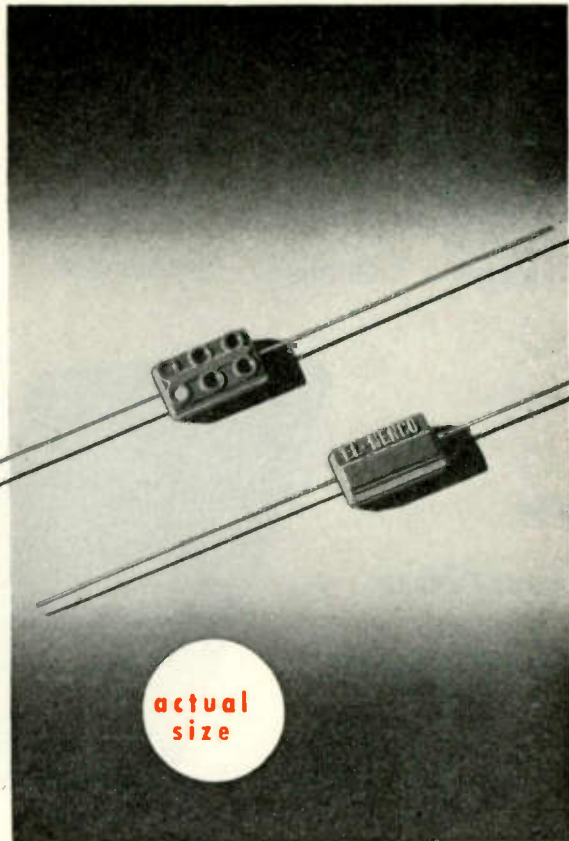

**EL-MENCO'S NEW CM15** for Television, Radio and other Electronic Applications... possesses the might of powerful performance, endurance, and accuracy, yet it measures only  $\frac{9}{32}$ " x  $\frac{1}{2}$ " x  $\frac{3}{16}$ ".

We're now ready to fill your CM15 orders promptly... in any quantity.

- 500 D.C. working voltage.
- 2 to 500 mmf. capacity.
- Temperature Coefficient  $0 \pm 100$  Parts per million per degree C.
- $\pm 20\%$  to  $1\%$  tolerance.
- 6-dot color coded to Joint Army-Navy Standard Specifications JAN-C-5.

**ARCO ELECTRONICS**

Sole Distributor for Jobbers and Retailers in U. S. and Canada.  
135 Liberty St., New York, N. Y.

THE ELECTRO MOTIVE MFG. CO., Inc.  
WILLIMANTIC, CONNECTICUT



Foreign Radio and Electronic Manufacturers communicate direct with our Export Department at Willimantic, Conn., for information.

Write, on firm letterhead, for samples and catalog.

MOLDED MICA

**EL-Menco**  
CAPACITORS

MICA TRIMMER

# These proved tubes are "money in the bank" for medium- size AM broadcast stations



- **Plenty of power . . .** Either tube in push-pull will handle the final output of a 10-kw transmitter.
- **Dependable . . .** Already GL-892's and GL-892-R's are on the job in scores of stations where a 24-hour day and 7-day week make exacting demands.
- **Long-lived . . .** General Electric superior design and workmanship pay valuable dividends in extra hours of tube service.
- **Versatile . . .** Applications include broadcast and communications work as amplifiers and modulators—also industrial electronic-heating use as oscillators. A plus-feature: the special 2-unit filament will take 2-phase or single-phase a-c current, or d-c.

YOUR tube investment is soundest when backed by proved quality, a proved record of performance. In key radio stations—in factories where electronic heating speeds production—GL-892's and GL-892-R's are respected because their performance is well known, their reliability demonstrated many times over. G-E tubes are a standard by which others may be judged . . . Builders of equipment, by specifying General Electric tubes, take an important step toward buyer acceptance. Your G-E electronics office gladly will help you choose the correct types for new circuits in the development stage . . . On tubes for replacement, station operators and manufacturers will obtain the fastest, most efficient service from their nearby G-E tube distributor or dealer, with same-day delivery a customary feature! General Electric Company, Electronics Department, Schenectady 5, N. Y.



TYPE GL-892  
Water-cooled



TYPE GL-892-R  
Forced-air-cooled

	GL-892		GL-892-R	
	Class C Telegraphy	Class C Plate- modulated	Class C Telegraphy	Class C Plate- modulated
Filament voltage	11 v	11 v	11 v	11 v
Filament current	60 amp	60 amp	60 amp	60 amp
Max plate voltage	15,000 v	10,000 v	12,500 v	10,000 v
current	2 amp	1 amp	2 amp	1 amp
input	30 kw	10 kw	18 kw	10 kw
dissipation	10 kw	6.6 kw	4 kw	2.5 kw
Power output (approx), typical operation	14 kw	6 kw	10 kw	5 kw

NOTES: (1) Filament voltage and current are per unit of 2-unit filament. (2) Max frequency for both tubes is 1.6 mc at top plate input; up to 20 mc at reduced ratings.

# GENERAL ELECTRIC

161-GS-8859

FIRST AND GREATEST NAME IN ELECTRONICS

This is the **NEW Astatic**



# MAGNETO INDUCTION PICKUP

they're talking about...

... And small wonder, indeed, that such a radical departure from established engineering precedent is causing universal comment in the field. The Astatic Magneto-Induction Pickup Cartridge, contrary to operating principles of previous magnetic type units, eliminates the need for "air gaps." Revolutionary? Yes, in construction and equally so in terms of performance. Absence of delicately spaced air gaps means no more trouble or diminishing quality of reproduction due to lint and dust collection. No more need for delicate handling. No more costly, troublesome armature balancing problems. Free of such limitations, the Magneto-Induction cartridge provides peak, unchanging fidelity of reproduction, under consistent service or adverse climatic conditions. It is another major contribution to greater listening pleasure by Astatic.

Write for Complete Technical Data, Prices.

## TWO MODELS NOW AVAILABLE

MODEL MI-1,  
Standard Housing

MODEL MI-2,  
Mumetal Housing\*

\*Provides increased shielding effect  
for maximum reduction of hum.

## Two Equalizer-Amplifier Models Available

Model EA-1, compact unit designed for radio sets and audio amplifiers having insufficient gain for operation of Astatic Magneto-Induction Pickup Cartridges. Provides "bass-boost."

Model EA-2 Equalizer-Amplifier, self-powered, provides adjustable "bass-boost" with adjustable treble "roll-off" and selection of "turnover frequency."

Manufactured under Massa Laboratories License

**THE Astatic CORPORATION**  
CONNEAUT, OHIO  
IN CANADA, CANADIAN ASTATIC LTD., TORONTO, ONTARIO

## News—New Products

These manufacturers have invited PROCEEDINGS readers to write for literature and further technical information. Please mention your I.R.E. affiliation.

### Multimeter for Electrolysis and Cathodic Protection Testing

A multicomination meter designed specifically for electrolysis and corrosion investigations and cathode protection testing has been developed by **M. C. Miller**, 1142 Emerson Ave., W. Englewood, N. J.

With a circuit selector switch, a high-sensitivity, 300 ohms-per-volt millivolt voltmeter covering ranges of 2 millivolts to 100 volts, full scale and high sensitivity, and a 62,500 ohms-per-volt voltmeter with ranges of 100 millivolts to 20 volts full scale, are provided. They may be used separately or simultaneously.

Also provided are: a potentiometer-voltmeter with a high-resistance galvanometer, a battery-operated vacuum-tube voltmeter with ranges from 100 millivolts to 10 volts with 500,000 ohms input resistance, a milliammeter and ammeter with ranges of 1 milliampere to 20 amperes, and a zero-resistance-type ammeter with range up to 2 amperes from self-contained batteries and controls. The ammeters may be used independently or simultaneously with the voltmeters.

### Miniature Selenium Rectifier

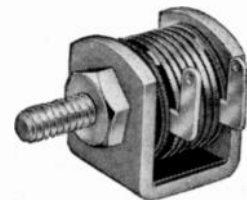

A miniature selenium rectifier, model number SE 14P 6H, has been designed by **Bradley Labs., Inc.**, 82 Meadow St., New Haven, Conn., for use on all low-current applications where small size and dependability are factors, such as in television preselectors, preamplifiers, and relays.

Rated 110-125 volts a.c. rms, 20 milliamperes d.c. continuous, the tiny rectifier is  $\frac{1}{2}'' \times \frac{1}{4}'' \times \frac{1}{4}''$ .

### Television Antenna To Increase Reception in "Fringe Areas"

A new-type long-range, high-gain television antenna is being manufactured by **Cole-Warner Corp.**, Dayton, Ohio. It was primarily developed for increased reception in outlying areas and will bring proper reception to localities which heretofore have been unable to pick up a strong enough signal for transmission.

This antenna, the "Telebeam," may be used as a two-stack array, and also as single element, thus making it either a 4, 2, or 1 antenna, depending upon the particular installation requirements.

The manufacturer claims that the product is of unusually rugged construction, having tested it under such adverse conditions as winds up to 70 m.p.h.

(Continued on page 24A)



# Kollsman now offers a line of special purpose AC units for servomechanisms

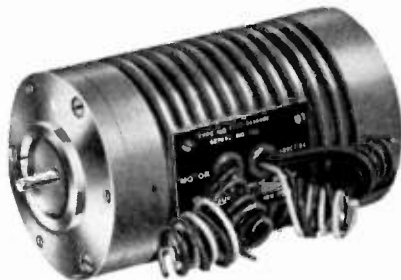

**MOTOR DRIVEN INDUCTION GENERATORS** — combination of a 2-phase, high-torque, low-inertia induction motor and an induction generator. Used as a fast reversing servo motor. Available with maximum stall torques of .7 (unit shown) to 6.7 (other units) oz/in.



**PERMANENT MAGNET GENERATORS** — for applications requiring a nearly perfect AC power or potential wave form having a harmonic content under 3% in the unit shown and less than 2% in several other units.

**DRAG CUP MOTORS** — miniature two-phase motors with extremely fast stopping, starting and reversal characteristics and high torque/inertia ratio, plus the ability to be held continuously at stall condition without overheating. Suitable for many special applications requiring torque of 1 oz/in. or less.



**INDUCTION MOTORS** — miniature two-phase motors with fast starting, stopping and reversing characteristics and maximum torque at zero r.p.m. Available with maximum torques of .57 (types shown) to 4.6 oz/in. (other units).

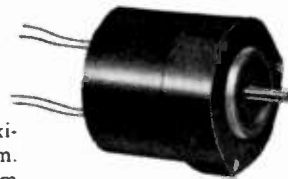

**INDUCTION GENERATORS** — when fed from an AC source produce a voltage output proportional to the speed of rotation of the shaft and having the same frequency as the source. Used in circuits as velocity control components.

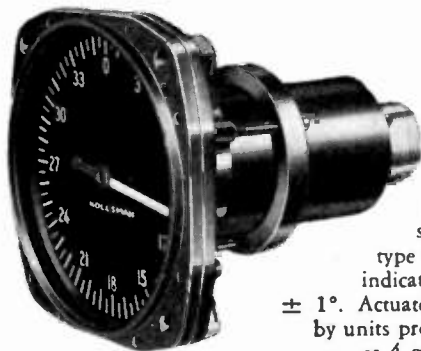
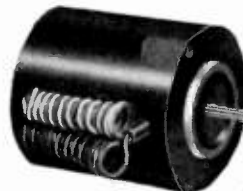

**TELETORQUE UNITS** — precision built selsyn-type units for remote indication. Accurate to  $\pm 1^\circ$ . Actuated satisfactorily by units producing as little as 4 gr/cm of torque.

**CIRCUITROL UNITS** — rotary electro-magnetic devices designed for use as control components in electronic circuits and related equipment. Useful as a phase shifter, resolver, rotatable and control transformer or phase indicator.



For the translation of linear or rotary motion of an actuating mechanism into an electrical impulse signal or indication, the Kollsman line of Special Purpose Motors offers the instrumentation or control engineer a wide variety of devices. Each of the units shown is representative of a comprehensive line of similar type units. They are available in many voltages and frequencies to meet various requirements.

All are high-performance precision devices, light in weight and compact in size. They have been developed by the same engineering staff which has made the Kollsman name synonymous with quality in aircraft instrumentation and control.

Further information on any or all of these units may be had upon request. Write to the Kollsman Instrument Division of Square D Company, 80-66 45th Avenue, Elmhurst, New York.

## KOLLSMAN INSTRUMENT DIVISION

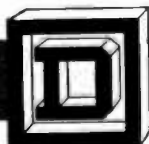

**SQUARE D COMPANY**

ELMHURST, NEW YORK

GLENDALE, CALIFORNIA

**New, Lighter, More Compact . . .  
Easier to Build Into Your Product**

## **RAYTHEON VOLTAGE STABILIZERS**



**VOLTAGE STABILIZER  
HEADQUARTERS**  
Since 1927

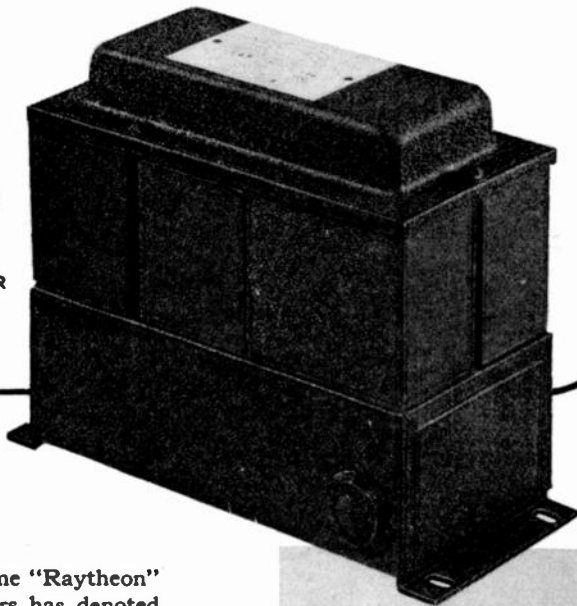

For years the name "Raytheon" on voltage stabilizers has denoted advanced design, precision manufacture, rugged construction, reliable and accurate performance . . . in a word — "Excellence in Electronics."

Now, to these highly desirable characteristics, have been added important space and weight saving features . . . features that make it easier and more economical to build dependable, accurate control of fluctuating line voltage right into your product. This entirely new line has been performance-engineered to provide a wide choice of models in service-tested, standard types . . . or you may have special models custom-engineered to suit your special needs.

Get the complete story on this important development at "Voltage Stabilizer Headquarters." Send for it today.

### **BUILD THESE ADVANTAGES INTO YOUR EQUIPMENT**

- Positive control of output voltage to within  $\pm 1/2\%$ .
- Stabilization at any load within rated capacity.
- Quick response. Stabilizes varying input voltage within 1/20 second.
- Entirely automatic. No adjustments. No moving parts. No maintenance.
- Many designs available with very low harmonic distortion of the output voltage wave at any load.
- Models can be supplied with frequency compensation.
- Single or multiple output voltages.
- Wide range of designs including hermetically-sealed types.

**RAYTHEON MANUFACTURING COMPANY**  
Waltham 54, Massachusetts

Gentlemen: Please send me copy of your new Voltage Stabilizer Bulletin DL-V-304F.

Name .....

Position .....

Street Address .....

City..... Zone No..... State.....

## **News—New Products**

(Continued from page 22A)

### **Cavity Meters for Precise Microwave Frequency Measurements**

Designed and manufactured by Sperry Gyroscope Co., Div. of Sperry Corp., Great Neck, N. Y., these instruments are high-Q tunable cavities that measure microwave frequencies to absolute accuracies between 1/10,000 and 1/20,000. Designed for applications which require high accuracy and resolution, these frequency meters can be used either as transmission or absorption cavities that provide continuous frequency coverage from 2575 to 3750 and 4500 to 10,500 Mc. Calibration is made against a frequency standard accurate to one part in 100,000.

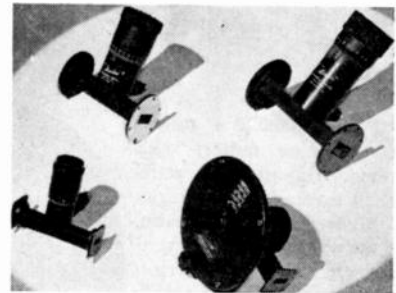

The cavities are electroformed to obtain minute tolerances, stress-free metal, and a true circular shape. Loaded Q's range from 5000 to 16,000. The tuning plungers use a double wavetrap instead of sliding contact fingers to develop an efficient and stable short circuit. The short coupling distance used between the cavity and the main line reduces reaction of frequency upon coupling.

Four models are available. (1) 291A for 2570 to 3750 Mc, (2) 28A for 4500 to 5600 Mc, (3) 208 for 5350 to 8100 Mc, (4) 901B for 8100 to 10,500 Mc. Delivery information on Model 138 for 8430 to 9660 Mc (not shown) will be sent on request.

### **Wider Television Program- ming Facilitated by New Projector**

Listed as Type TP-35A, a variation of the basic Brenkert 35-mm. sound-motion-picture projector which will permit projection of standard 35-mm. film directly on to the pickup tube for conversion to video signals has been developed by the Television Equipment Section, RCA Engineering Products Dept., Camden, N. J.

The use of film made for projection at the motion-picture standard of 24 frames per second in a television system requiring 60 interlaced fields or 30 complete frames per second is made possible by employing a sprocket which holds every alternate frame for two scannings and the remaining frames for three.

The "gap-lamp," a pulsed-light source, electronically triggered to provide 60 high intensity flashes per second, eliminates the necessity of a shutter, and is virtually free from heat.

A separate cabinet with a 10" picture monitor houses the remote-control switches, exciter lamp, and pulsed-light power supply.

(Continued on page 36A)

**HIGH GRADE**

*Electronics Experience*

**For HIGH ENERGY**

*Physics*

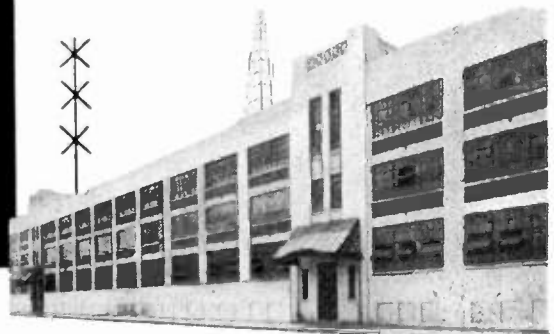

Work involving the controls for accelerators and electronic instruments for nuclear research is in the field of Sherron's activities. We can develop and manufacture equipment for the following purposes:

- 1** CONTROL
- 2** MEASUREMENT
- 3** POWER SOURCES

Seasoned physicists and electronic engineers are available for consultation in any auxiliary capacity—prototype through completed instrument . . . . Inquiries are invited.

## **S H E R R O N**

CAN SERVE IN  
THE DESIGN, DEVELOPMENT  
AND MANUFACTURE OF:

- Counters, computers, servo mechanisms
- Amplifiers, oscillators
- Power supplies, power regulators
- Process control, generator control
- Parameter measurement, control, production
- Temperature, flow, radiation
- Controls and accessories for synchrotrons
- Betatron, Cyclotron



# **SHERRON ELECTRONICS CO.**

*Division of Sherron Metallic Corporation*

1201 FLUSHING AVENUE • BROOKLYN 6, N.Y.

presenting the NEW

# "NOFLAME-COR"

the TELEVISION hookup wire

by



approved by  
Underwriters' Laboratories at

**90°** CENTIGRADE **600** VOLTS

This is IT! Tops in hookup wire for television, F-M, quality radio and all exacting electronic applications. Available for immediate delivery in all sizes, solid and stranded, in over 200 color combinations . . . ready to demonstrate anew the Efficiency and Economy of CORNISH WIRES AT WORK

- Flame Resistant
- Heat Resistant
- High Insulation Resistance
- High Dielectric
- Easy Stripping
- Facilitates Positive Soldering

COMPLETE ENGINEERING DATA AND SAMPLES ON REQUEST

RUBBER	75°
PLASTIC	80°
<b>"NOFLAME-COR"</b>	<b>90°</b>

*"made by engineers for engineers"*



## CORNISH WIRE COMPANY, Inc.

605 North Michigan Avenue,  
Chicago 11

15 Park Row, New York 7, N. Y.

1237 Public Ledger Bldg.,  
Philadelphia 6

MANUFACTURERS OF QUALITY WIRES AND CABLES FOR THE ELECTRICAL AND ELECTRONIC INDUSTRIES

# "For Unfailing Dependability Give Me OHMITE"

You can be sure the resistors, rheostats, and tap switches you buy will provide accurate, dependable service if they're made by Ohmite. Every Ohmite product is designed and constructed to stand up under severe operating conditions . . . to give extra performance . . . to withstand the effects of shock, vibration, temperature extremes, altitude, and humidity. This *extra* performance is the reason thousands of particular parts buyers are regular Ohmite customers.

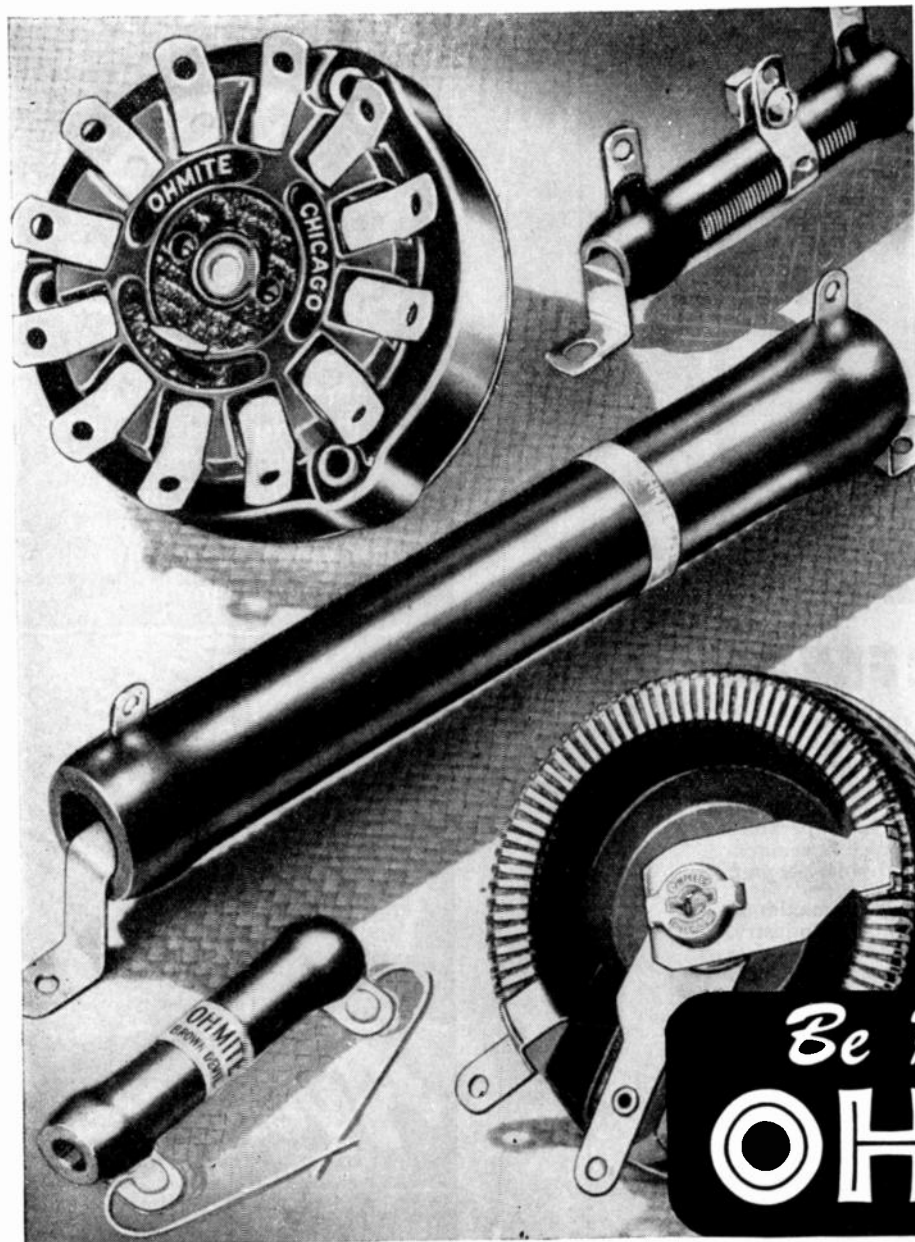

## ● Close Control RHEOSTATS

All ceramic and metal. Winding is permanently locked in vitreous enamel. Metal-graphite contact brush insures perfect contact with negligible wear on the wire. Available in 10 sizes from 25 to 1000 watts.

## ● Vitreous-Enameled RESISTORS

Vitreous enamel permanently locks and insulates each turn of wire on ceramic core. Prevents shorts, conducts generated heat away. All types and resistance values from 5 to 1500 watts.

## ● High Current TAP SWITCHES

Compact, dependable, and convenient to operate. Heavy, one-piece ceramic body is unaffected by arcing. Five models, A.C. ratings 10 to 100 amperes.

Write on Company  
Letterhead for  
Catalog and Engineering  
Manual No. 40



**OHMITE  
MANUFACTURING COMPANY**  
4860 Flournoy St., Chicago 44, Ill.

*Be Right with*  
**OHMITE**

**RHEOSTATS • RESISTORS • TAP SWITCHES • CHOKES • ATTENUATORS**

# BENDIX-SCINTILLA

the finest ELECTRICAL CONNECTORS  
money can build or buy!

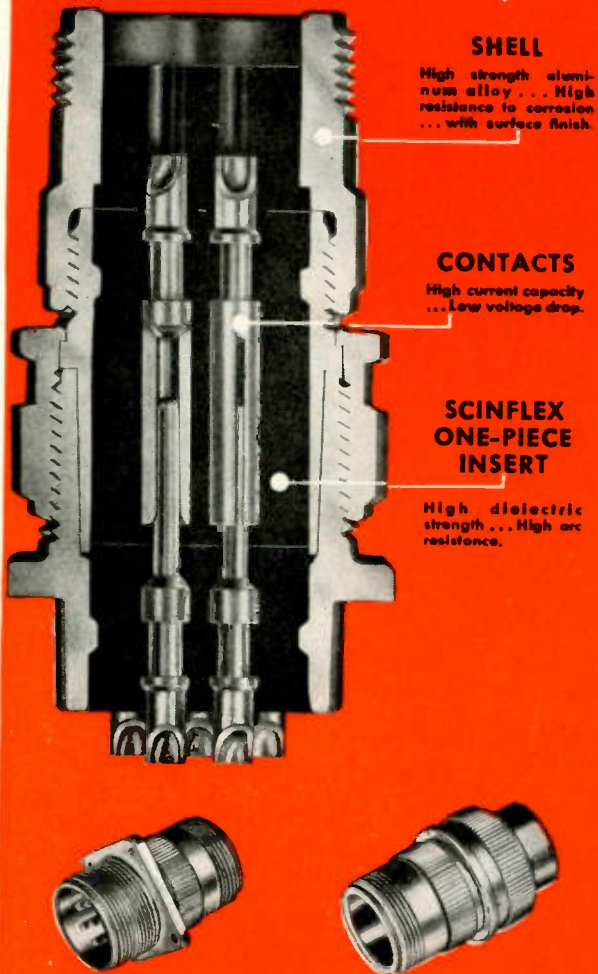

### SHELL

High strength aluminum alloy... High resistance to corrosion... with surface finish.

### CONTACTS

High current capacity... Low voltage drop.

### SCINFLEX ONE-PIECE INSERT

High dielectric strength... High arc resistance.

## AND THE SECRET IS SCINFLEX!

Bendix-Scintilla\* Electrical Connectors are precision-built to render peak efficiency day-in and day-out even under difficult operating conditions. The use of "Scinflex" dielectric material, a new Bendix-Scintilla development of outstanding stability, makes them vibration-proof, moisture-proof, pressure-tight, and increases flashover and creepage distances. In temperature extremes, from  $-67^{\circ}$  F. to  $+300^{\circ}$  F., performance is remarkable. Dielectric strength is never less than 300 volts per mil.

The contacts, made of the finest materials, carry maximum currents with the lowest voltage drop known to the industry. Bendix-Scintilla Connectors have fewer parts than any other connector on the market—an exclusive feature that means lower maintenance cost and better performance.

\*REG. U.S. PAT. OFF.

Write our Sales Department for detailed information.

- Moisture-proof, Pressure-tight • Radio Quiet • Single-piece Inserts
- Vibration-proof • Light Weight • High Arc Resistance • Easy Assembly and Disassembly • Less parts than any other Connector

Available in all Standard A.N. Contact Configurations

**BENDIX  
SCINTILLA**

**SCINTILLA MAGNETO**  
SIDNEY, N. Y.  
DIVISION OF



AVIATION CORPORATION

*Airtron*

**FLEXAGUIDE**

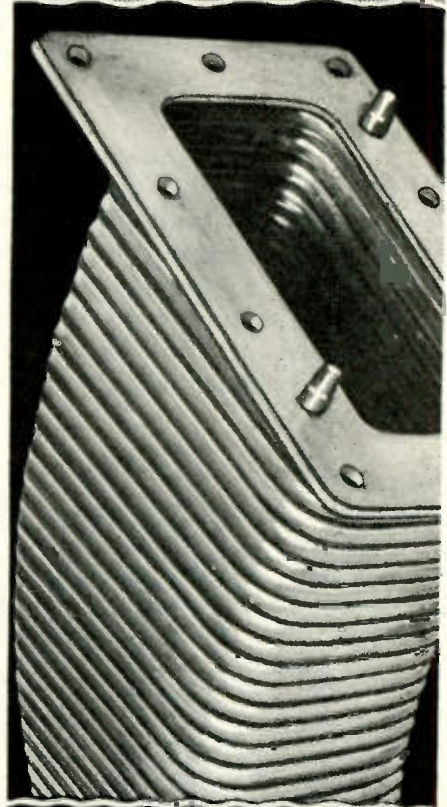

From the tiniest aircraft  
to the largest shipboard  
radar transmitter...  
a COMPLETE line  
of Army-Navy approved  
**FLEXIBLE MICRO-WAVE PLUMBING**  
Inquiries invited

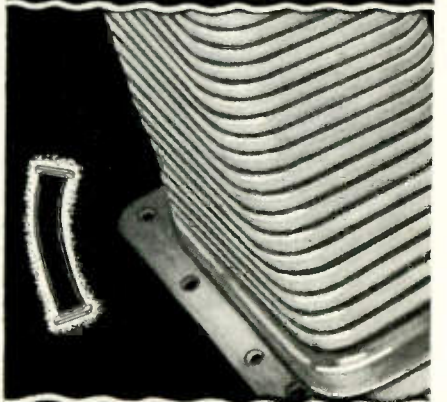

*Airtron*

DESIGNS and PRODUCES  
Electronic and Aircraft Components

650 Bloomingdale Road, Pleasant Plains  
Staten Island 9 New York

BRANCH OFFICES

Baltimore

Detroit

Los Angeles

You can use a sledge hammer to make it fit...



## ... **BUT** it's simpler to design the radio around the battery!

THE LOGICAL starting point in designing a new portable receiver is its batteries. You have to get them in sooner or later, and it's simpler to design them into the set at the start.

There's an "Eveready" battery to fit

virtually *any conceivable* radio design. Build maximum efficiency and utility into your radios by designing them around standard "Eveready" brand batteries. Our Battery Engineering Department will gladly provide you with complete technical data.



← "Eveready" No. 950 "A" batteries and the No. 467 "B" battery make an ideal combination for small portable receivers.

**EVEREADY**  
TRADE-MARK  
**RADIO BATTERIES**

The registered trade-marks "Eveready" and "Mini-Max" distinguish products of  
**NATIONAL CARBON COMPANY, INC.**  
Unit of Union Carbide and Carbon Corporation



30 East 42nd Street, New York 17, N. Y.

Division Sales Offices: Atlanta, Chicago, Dallas, Kansas City, New York, Pittsburgh, San Francisco

# "Communications"

**5J30** THE NEWEST THING IN UHF. 10-350 MC. MAGNETRON IN GLASS ENVELOPE. 200 W.C.W. OUTPUT. NEW, COMPLETE WITH DATA SHEET .....\$39.50

TUNABLE PKG'D "CW" MAGNETRONS			
QK59	2875-2900 mc	QK61	2975-3200
QK60	2900-3025 mc	QK62	3150-3375
New \$45—each		New \$55—each	

MAGNETRONS				
TUBE	FRQ. RANGE	PK. PWR.	OUT.	PRICE
2131	2830-2860 mc.	265 KW.		\$15.00
2121A	9345-9405 mc.	50 KW.		\$25.00
2122	3267-3333 mc.	285 KW.		\$15.00
2126	2992-3019 mc.	275 KW.		\$15.00
2127	2965-2992 mc.	275 KW.		\$15.00
2132	2780-2820 mc.	285 KW.		\$15.00
2139	Pkg. 3249-3263 mc.	5 KW.		\$25.00
2139	Pkg. 3267-3338 mc.	3.7 KW.		\$25.00
2139	Pkg. 9345-9405 mc.	50 KW.		\$25.00
3J31	24,000 mc.	35 KW.		\$17.50
W.E. 700A	680-710 mc.	100 KW.		\$35.00
W.E. 720BY	2800 mc.	1000 KW.		\$25.00
<b>KLYSTRONS: 723A/B \$7.75 707B with cavity \$20.00</b>				

**MAGNETS**  
For 2J21, 2J22, 2J26, 2J27, 2J21, 2J32, and 3J1 725A.  
Each .....\$8.00  
4850 Gauss, 1/2" bet. pole faces, 3/4" pole diam. \$8.00  
1500 Gauss, 1 1/2" bet. pole faces, 1 1/2" pole diam. \$8.00  
1000 Gauss, electromagnet, adjustable 2 1/2" to 3" bet. pole faces, 2 1/2" pole diam. ....\$12.00

**400-2400 CYCLE TRANSFORMERS**

Plate Xfmr: Pri. 115v, 400 cy SEC 9800 v or 8600 v @ 32 ma DC .....\$12.50  
1153457-3, Plate Xfmr: Pri: 115 v, 400 cy. Sec: 1150-0-1150 v. 40 ma. GE 68G631 .....\$1.75  
121239, Plate Xfmr: Pri: 115 v, 800 cy. Sec: 4540 vct. 250 ma. ....\$4.50  
121239, Fil. Xfmr: Pri: 115 v, 800-2400 cy. Sec: 5 v. 3 amp. 6.3 v. 2 amp. ....\$1.75  
K8 9445, Pwr. Xfmr. Pri: 115 v, 400-2400 cy. Sec: 592 vct, 120 ma; 6.3 v, 8 amp; 5 v, 2 amp. ....\$3.50  
1 plate Xfmr: Pri: 115 v, 400-2400 cy. Sec: 4500 v. 6 ma. ....\$6.50  
1 plate Xfmr: Pri: 115 v, 400 cy. Sec: 6.3 v, 7 amp. 8.3 v. 8.8 amp. 6.3 v, 1.3 amp. ....\$2.50  
Plate Xfmr. Pri: 115v, 400 cy .012 KVA. SEC: 600 vct. .036 amp GE 70G300G1 .....\$1.15  
Fil. Xfmr. Pri: 115 v, 400 cy. Sec: 3.3 v, 9 amps; 6.3 vct. .65 amp; 2.5 v, 3.5 amp; 2.5 v, 6.3 amp. ....\$3.25

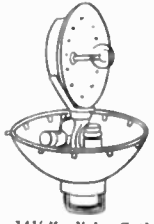

**ANTENNAS**

**AN MPG-1 Antenna.** Rotary feed type high speed scanner antenna assembly, including horn parabolic reflector. Less internal mechanisms, 10 deg. sector scan. Approx. 12" L x 4" W x 3" H. Unused. (Gov't Cost—\$4500.00) .....\$250.00

**AS 125/APR** Cone type receiving antenna, 1000 to 3200 megacycles. New .....\$4.50

**APS-4 3 cm. antenna.** Complete. 14 1/2" dish. Cutler feed dipole directional coupler, all standard 1" x 1/2" waveguide. Drive motor and gear mechanisms for horizontal and vertical scan. New, complete .....\$65.00

**AN/TPS-3, Parabolic dish type reflector.** approx. 10' diam. Extremely lightweight construction. New, in 3 carrying cases .....\$49.00

**RELAY SYSTEM PARABOLIC REFLECTORS:** approx. range: 2000 to 6000 mc. Dimensions: 4 1/2" x 3 1/2" rectangular, new .....\$85.00

**TDY "JAM" RADAR ROTATING ANTENNA.** 10 cm. 30 deg. beam, 115 v.a.c. drive. New .....\$100.00

**140-600 MC. CDNE TYPE ANTENNA,** complete with 25' sectional steel mast, guys, cables, carrying case, etc. New .....\$49.50

**SD-13 ANTENNA,** 24" dish with feedback dipole 360 deg. rotation, complete with drive motor and relay. New .....\$75.00 Used .....\$45.00

**AS 69/APT. TRANSMITTER JAMMING ANTENNA.** Consists of 4 radiators, polarized for hor. and vert. radiation. Type "N" input .....\$18.50

**DBM ANTENNA.** Dual, back-to-back parabolas with dipoles. Freq. coverage 1,000-4,500 mc. No drive mechanism .....\$65.00

**MICROWAVE TEST EQUIPMENT**

W. E. 1138 A. Signal generator, 2700-2900 Mc range. Lighthouse tube oscillator with attenuator & output meter. 115 VAC input, reg. Pwr. supply. With circuit diagram .....\$50.00

**TS-238 GP,** 10 cm. Echo box with resonance indicator and micrometer adjust cavity .....\$85.00

**3 cm. wavemeter:** 9200 to 11,000 mc transmission type with square flanges. ....\$15.00

**3 cm. stabilizer cavity, transmission type** .....\$20.00

**Direct reading VSWR meter.** Complete with amplifier, bolometer input—AC crystal—DC crystal connections .....\$45.00

**3 cm. Wavemeter.** Micrometer head mounted on X-Band guide. Freq. range approx. 7900 to 10,800 Mc. \$75.00

**THERMISTORS**  
(\$ .95 ea.)  
Western Electric  
D-167332 (Bead)  
D-170396 (Bead)  
D-168392 (Button)  
D-168391 (Bead)

**PULSE MODULATORS**

APQ-13 Pulse modulator. Pulse width, .5 to 1.1 micro sec, repetition rate 624 to 1348 PPS, pk pwr. out 35 KW Energy 0.018 Joules .....\$49.90

**TPS-3 PULSE MODULATOR.** Pk power 50 amp. 34 KV (1200 KW pk.); pulse rate 200 PPS, 1.5 micro sec; pulse line impedance 50 ohms. Circuit—series charging version of DC resonance type. Uses two 705-A's as rectifiers. 115 v, 400 cycle input. New, with all tubes .....\$49.00

**PULSE TRANSFORMERS**

GE K2731	.....\$19.50	WE D169271	.....\$ 9.95
K2450A	.....\$15.00	D166173	.....\$12.50
K2748A	.....\$12.00	K89948	.....\$ 8.50
		KS9800	.....\$ 2.00
UTAH 9318 or 9280			.....\$ 8.50
115B, with socket			.....\$ 2.50
705A, with socket			.....\$ 2.50

**PULSE NETWORK**

G.E. #25E5-1-350-50P2T, 25 KV, 5 sections, "E" circuit, 1 microsecond pulse length, 350 PPS, 50 ohms impedance .....\$46.00

G.E. #6E3-5-2000-50P2T, 6KV, "E" circuit, 3 sections, .5 microsecond, 2000 PPS, 50 ohms impedance .....\$6.50

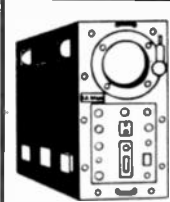

**MICROWAVE SPECIALS**

**SA-2 RADAR "PPI" INDICATOR.** 7" scope complete, 115V 60 cycle—like new .....\$185.00

**"X" BAND AN/APS—15A:** Compl. RF head & modulator, incl.: 725-A 2 magnetron, & magnet, two 723/AB klystrons (local osc. & beacon), 1B24 TR, rcvr.-ampl., duplexer. ....\$210.00

**"X" BAND APS—15B:** Compl. RF head, incl. 725-A magnetron & magnet, two 723/AB klystrons (local osc. & beacon), 1B24 TR, rcvr.-ampl., duplexer. ....\$210.00

**KW peak input, 707-B receiver-mixer** .....\$150.00

**Modulator-motor-alternator unit** for switching 1 Receiver rectifier power unit for above .....\$25.00

**Rotating antenna with parabolic reflector.** New .....\$75.00

**"PPI" rotating yoke type, complete with all necessary oscillator circuits, CR tube 5B1P7, complete with tubes. Used with 80 radar** .....\$100.00

**10 CM. WAVEGUIDE SWITCH** for switching 1 input to any of 3 outputs. Std. 1 1/2" x 1 1/2" sq. Flanges. Complete with 115 V.A.C. or D.C. Arranged switching motor. New, complete .....\$260.00

**BC 701-A RADAR RECEIVER.** Part of SCR 521 and ASE eqpt. 176 mc operation, receives bilobed search and homing patterns. Complete with tubes and antenna switching motor. ....\$37.00

**BC 704-A SCOPE,** part of SCR 521 and ASE equipment. "L" scope. With all tubes, including 5B1P1 .....\$17.50

**POWER EQUIPMENT**

Step down transformer: Pri: 440/220/110 volts a.c. 60 cycles, 3 KVA. Sec. 115 v. 2500 volt insulation. Size 12" x12" x7" .....\$40.00

**PLATE TRANSFORMER.** Pri: 117 v. 80 cy. Sec. 17,000 v. @ 144 ma, with choke, Oil immersed. Size: 26" x 29" x 13". Amertran .....\$65.00

**PLATE TRANSFORMER.** Pri: 220 v. 60 cy. 3 phase, 30 KVA. Sec: 6150, 5620, 5050, 4500 volts, Oil filled. 89 gal. Size: 54" x32" x23". Amertran. Approx. wt. 1500 lbs. ....\$250.00

**Fil. Transformer:** Pri: 220 v.a.c., 60 cy; .05KVA. sec: 5 v.c.t., 34,000 v. test .....\$24.50

**Fil. Trans. UX6899.** Pri: 115v 60 cy. Sec: Two 5V 5.5A windings 29 KV Test .....\$24.50

**Plate Transformer:** Pri: 115/230 v.a.c., 50-60 cy. sec: 21,000 v. 100 ma. ....\$145.00

**LINE VOLTAGE REG 2 KW** Saturable reactor type Pri 95-130 v 60 cy Sec 115 v 60 cy. 17.4 A 2 Kw 100% PF .....\$160.00

**LINE VOLTAGE REG** Pri 92-138v 57/63 cy 1ph15A Sec 115v 7.15A .82 Kw 96% PF .....\$135.00

**Voltage Reg. Transtat "Amertran" type** PH 2KVA load. Input 90/130 v. 50/60 cycle output 115 v. \$40.00

.1 mfd @ 10,000 KVDC, 14F191	.....\$15.00
.0016 mfd @ 15 KVDC, 25P7700	.....\$8.45
.015 mfd @ 16 KVDC, 25P7835	.....\$7.50
.005-005-01 mfd @ 10 KVDC, 25P7344	.....\$6.95
.08 mfd @ 15 KVDC, 25P585-G2	.....\$8.70
2X.1 mfd @ 7,000 vdc, 25P774	.....\$3.95
Precision condenser: D-166602, 16 mfd @ 400 vdc. temp comp—50 to 85 deg. C. ....\$7.50	
Precision condenser: D-161270, 1 mfd @ 200 vdc. temp comp—40 to plus 65 deg. C. ....\$5.00	
.08 mf @ 1500 VDC, MX60	.....\$11.50
.03 mf @ 2000 VDC, G1-50	.....12.75
.045 mf @ 2000 VDC, G1-50	.....12.75
.00015 mf @ 20 KV, 1970-404	.....25.00
.0001 mf @ 20 KV, G3	.....25.00
.0051 mf @ 15 KV, G4	.....25.00
.006 mf @ 10 KV, G3	.....17.50
166/110 mmf @ 10 KV AC (peak) Each	.....3.50

**MICROWAVE PLUMBING—10 Centimeter**

Waveguide to flexible coax coupler (RG 18/U), with flange Gold plated, App. 10" high .....\$17.50

**Magnetron to waveguide** coupler with 721-A duplexer cavity, gold plated .....\$45.00

**721-A TR cavity with tube.** Complete with tuning plungers .....\$5.50

**Line stretcher** complete with remote control cable in standard guide with square flanges .....\$50.00

**Waveguide section, MC 445A, rt. angle bend, 3/4" I.D., 8" slotted section** .....\$15.00

**3/4" RIGID COAX—3/4" I.C.**

Right angle bend, with flexible coax output pickup loop .....\$3.00

Short right angle bend, with pressurizing nipple .....\$2.00

30 ft. flexible section, 3/4" rigid to 1/2" rigid .....\$7.50

Rigid coax to Flex Coax Adapter .....\$2.50

Stub-supported rigid coax, gold plated, 5' lengths. For length .....\$5.00

**Rt. Angle for above** .....\$5.00

**3/4" coax, rotary joint** .....\$8.00

**3/4" coax, rt. angle bend 15" L, OA** .....\$2.00

**Slotted section, 10" long** .....\$5.50

**Flexible section, 15" L, Male to female, Pressurized** .....\$3.25

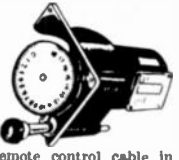

**3 CM. PLUMBING**

(Standard 1" x 1/2" guide unless otherwise specified)

**Waveguide section, CG 251/AP8-15A, 26" long** choke to cover, with 180 deg. bend of 2 1/2" rad. at one end .....\$4.00

**Rotary joint with slotted section and type "N" output pickup** .....\$8.50

**Waveguide section, 12" long** choke to cover, 45 deg. twist or H plane, 90 deg. bend .....\$4.50

**Stabilizer cavity feeding waveguide section, with filtered output and attenuating slugs** .....\$20.00

**Slug Tuner/attenuator, W.E. guide gold plated** .....\$3.75

**TR/ATR Duplexer section with wavemeter iris flange** .....\$4.00

**Right angle elbow, 5 1/2" choke to cover, 2 1/2" radius, F or H plane** .....\$5.00

**Twist, 90 deg., 8" choke to cover** .....\$5.00

**Waveguide sections 2 1/2" long, silver plated, with choke flange** .....\$3.50

**Waveguide, 90 deg. bend E plane, 18" long** .....\$4.00

**Rotary Joint, choke to choke** .....\$6.00

**Rotary Joint, choke to choke, with deck mounting** .....\$6.00

**S-curve waveguide, 8" long** cover to choke .....\$2.50

**Duplexer section for 1B24** .....\$10.00

**3 cm. waveguide, 1" x 1/2" I.D., 1/16" wall per ft.** .....\$1.50

**Circular Choke flanges, solid brass** .....\$.65

**"T" section (TR-ATR) choke to choke, supplied with direct output flanges** .....\$3.50

**Directional coupler CG 124 AP8-15A on 16" section** cover to cover 15 deg. bend .....\$5.00

**Feedback dipole with 90 deg. twist, 7 1/2"** .....\$3.50

**Waveguide to Type "N" Coax Adapter** .....\$6.50

**2K25/723AB, X band local oscillator mount** with (1) choke coupling to beacon reference cavity; (2) choke coupling to TR and receiver; (3) iris coupling with AFC attenuator to antenna waveguide; (4) Radar AFC crystal mount; (5) Receiver crystal mount; (6) Attenuating slugs. Mfg. DeMornay Budd .....\$22.50

**TR/ATR Duplexer section for above** .....\$4.00

**2 1/2" Flexible section, cover to cover** .....\$4.00

**Short Arm "T" section, with additional choke output on vertical section** .....\$4.00

**LABORATORY ACCESSORIES**

Sperry klystron tuner, model 12 .....\$2.00

Sine potentiometers, GE2251 x 96 or W.E. 2KS 15138 .....\$3.50

LOI .....\$3.50

CG 27, "N" cable ass'y, 3' long, male to female, \$2.50

Phase-Shifting Cap. 180 deg. W.E. 21-150734 .....\$2.50

Klystron sockets for 723 A.B. and similar types, 2 .....\$1.00

10 cm. mechanically cavity type SG. Pa .....\$3.00

**Crystal mixer "N" band.** Complete with type "N" fitting and IN22 crystal .....\$3.85

**Line insertion attenuator, type OAX-1, 20 Db.** attenuation, with 3-contact plug and socket (amphenol 168-5) .....\$2.25

**Delay Line, 5.0 micro sec max, 500 ohms impedance, 12 taps** .....\$4.00

**Trihedral Radar Reflector, MK 1** .....\$4.00

**Lighthouse Cavity for GI. 446.** Cavity dim: 3" x 2 1/2" diam. ....\$5.50

**TS 115/AP8-2F 10 cm antenna** in lucite ball, with type "N" fitting .....\$4.50

**DAJ Navy type CPT6ADL, antenna** in lucite ball, with Sperry fitting .....\$4.50

**10 cm. feedback dipole antenna, in lucite ball, for use with parabola** .....\$8.00

**"K" Band 1.25 cm. Rotary Joint** .....\$45.00

**PE 206-A, Input: 2R VDC @ 38 amp. Output: 80 volts @ 500 volt-amp, 800 cy. Leland Electric.** New complete with instruction book, relays, filters, etc. ....\$12.50

**CATHODE RAY TUBES**

3B1P	.....\$1.25	3GP1	.....\$3.35
3FP7	.....\$1.20	5FP7	.....\$1.75
5B1P	.....\$1.20	3DP1	.....\$2.25
3EP1	.....\$2.95	5JP2	.....\$4.00
		12G1P	.....\$10.95

**COAX CABLE CONNECTORS**

RG 18/U, Armored, 52 ohm imp ..... Per ft. \$ .51

RG 24/U, Twin Coax, 125 ohm imp. Armored ..... Per ft. \$ .51

RG 28/U, 48 ohm imp. .... Per ft. \$ .75

UG 254/U, Adapts UG 254/U to Amphenol low loss series .....\$ .85

UG 21/U, type "N" male connector .....\$ .85

UG 86/U, chassis receptacle, gold plated .....\$ .95

UG 146/U, male type "N" to female 83 series .....\$ .85

**VARISTORS**  
(\$ .95 ea.)

Western Electric  
D-167176  
D-170225  
D-168887  
D-171121

All merchandise guaranteed. Mail orders promptly filled. All prices, F.O.B., New York City. Send Money Order or Check. Shipping charges sent C.O.D.

## COMMUNICATIONS EQUIPMENT CO.

131-R Liberty St., New York City 7, N.Y. Mr. Rosen Digby 9-4124



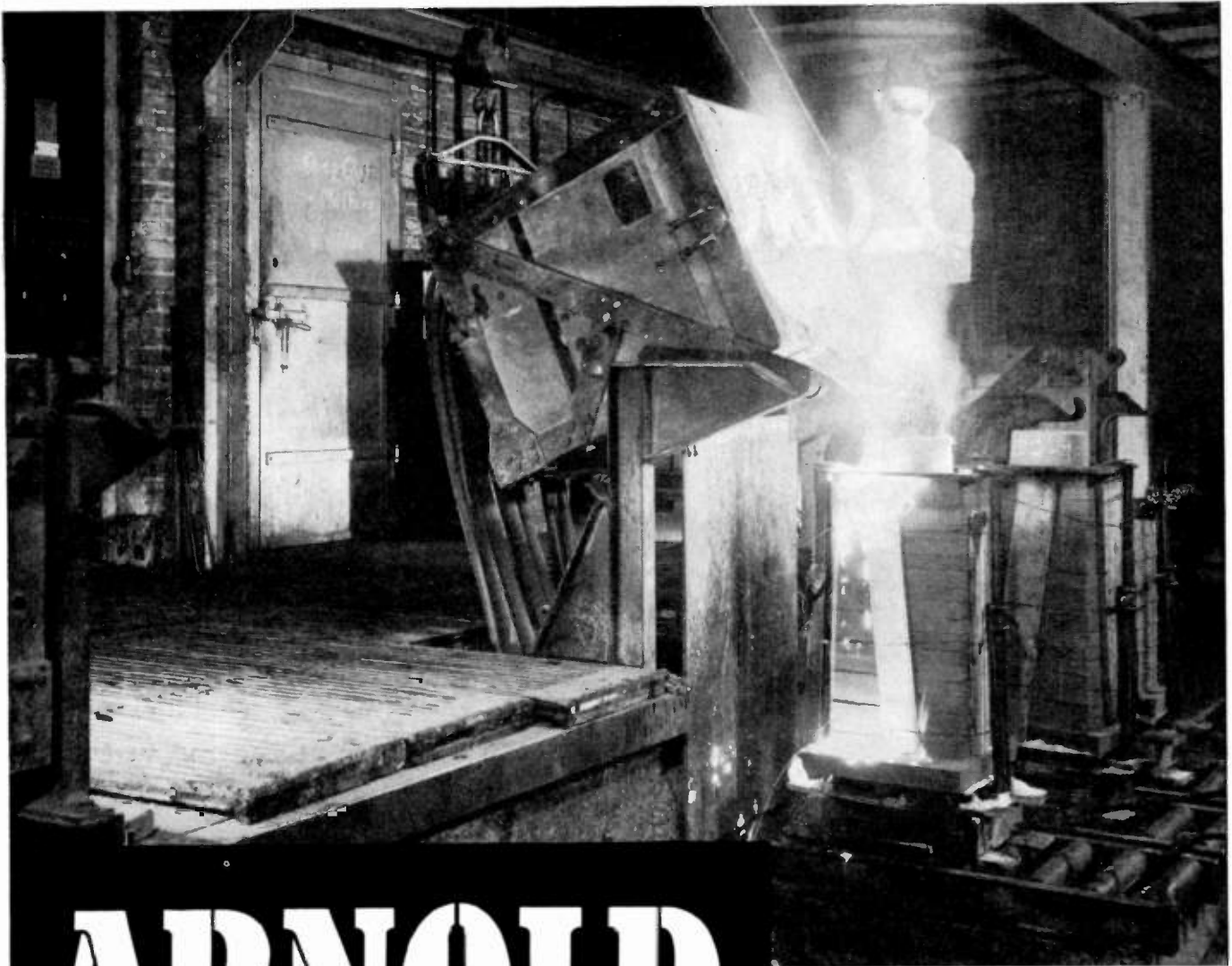

# ARNOLD

## PERMANENT MAGNETS

*100% quality-controlled  
at every step from  
the design board  
to final assembly*

The increased efficiency and economy you'll realize in the use of Arnold Permanent Magnets are *constant* factors. The thousandth unit is exactly like the first—because they're produced under controlled conditions at every step of manufacture, to bring you complete uniformity in every magnetic and physical characteristic. Count on Arnold Products to do your magnet job *best*—and they're available in any grade of material, size, shape, or degree of finish you require. Write us direct, or check with any Allegheny Ludlum field representative.

### **THE ARNOLD ENGINEERING CO.**



Subsidiary of  
**ALLEGHENY LUDLUM STEEL  
CORPORATION**

147 East Ontario Street, Chicago 11, Illinois

*Specialists and Leaders in the Design, Engineering and Manufacture of  
PERMANENT MAGNETS*

W&D 1297

# The Lancaster Story



## RCA — Lancaster, Pa. — the world's most modern television, communications, and industrial tube plant

THE STORY OF LANCASTER is a story of inspired planning, foresight, and achievement. In this plant, with 7½ acres of floor space under one roof, RCA has developed and is manufacturing a remarkably large quantity and variety of electron tubes to meet the unprecedented demands of television, communications, and industry. In addition to television tubes—which alone require eight tons of glass daily, and are turned out at the rate of one-a-minute—"RCA, Lancaster" produces image orthicons, cathode-ray tubes, phototubes, large rectifiers, power tubes, and types for special applications.

Complete engineering development facilities are located at Lancaster for tubes manufactured in the plant. In modern, well-equipped laboratories a large staff of engineers, technicians, machinists, and glassworking specialists are developing new tubes . . . and improving existing ones.

In the future, as in the past, the resources of RCA—its manufacturing experience and skill—its specialized technical staffs—are dedicated to the development and production of progressively better electron tubes at lower cost to meet your requirements.

**THE FOUNTAINHEAD OF MODERN TUBE DEVELOPMENT IS RCA**

A few of the many tube types produced at RCA, Lancaster

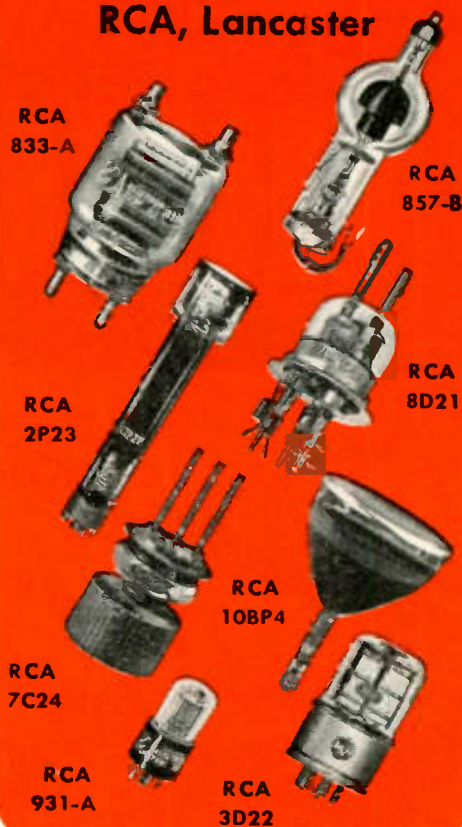

**TUBE DEPARTMENT**

**RADIO CORPORATION of AMERICA**

**HARRISON, N. J.**

BOARD OF DIRECTORS, 1948

- Benjamin E. Shackelford  
*President*
- R. L. Smith-Rose  
*Vice-President*
- S. L. Bailey  
*Treasurer*
- Haraden Pratt  
*Secretary*
- Alfred N. Goldsmith  
*Editor*
- Frederick B. Llewellyn  
*Senior Past President*
- W. R. G. Baker  
*Junior Past President*

1948-1949

- J. B. Coleman  
Murray G. Crosby  
Raymond A. Heising  
T. A. Hunter  
H. J. Reich  
F. E. Terman

1948-1950

- J. E. Shepherd  
J. A. Stratton

1948

- A. E. Cullum, Jr.  
Virgil M. Graham  
Raymond F. Guy  
Keith Henney  
J. V. L. Hogan  
F. S. Howes  
J. A. Hutcheson  
I. J. Kaar  
D. B. Sinclair

- Harold R. Zeamans  
*General Counsel*

- George W. Bailey  
*Executive Secretary*

- Laurence G. Cumming  
*Technical Secretary*

- E. K. Gannett  
*Assistant Secretary*

BOARD OF EDITORS

- Alfred N. Goldsmith  
*Chairman*

PAPERS REVIEW COMMITTEE

- Murray G. Crosby  
*Chairman*

PAPERS PROCUREMENT COMMITTEE

- John D. Reid  
*General Chairman*

# PROCEEDINGS OF THE I.R.E.

(Including the WAVES AND ELECTRONS Section)

Published Monthly by

The Institute of Radio Engineers, Inc.

VOLUME 36

July, 1948

NUMBER 7

## PROCEEDINGS OF THE I.R.E.

William Wilson	826
The End Is in Sight	827
3098. Theory of Frequency Counting and Its Application to the Detection of Frequency-Modulated Waves	828
3099. A Duplex System of Communications for Microwaves	840
3100. The Application of Matrices to Vacuum-Tube Circuits	844
3101. Field Theory of Traveling-Wave Tubes	853
3102. A Contribution to the Approximation Problem	863
3103. Time Response of an Amplifier of <i>N</i> Identical Stages	870
3104. The Field of a Dipole with a Tuned Parasite at Constant Power	872
Contributors to the PROCEEDINGS OF THE I.R.E.	876
Correspondence:	
3056. Note on Practical Limitations in the Directivity of Antennas	878
3105. Upper-Atmosphere Circulation as Indicated by Drifting and Dissipation of Intense Sporadic-E Clouds	879
3106. Standardization of Nomenclature for Pulse Modulation	880
2991. Correction	880

## INSTITUTE NEWS AND RADIO NOTES SECTION

Chicago I.R.E. Conference	882
Industrial Engineering Notes	882
Books:	
3107. "Photofact Folders 1, 2, and 3," by Howard W. Sams	884
3108. "Directory of Engineering Sources," published by Southeastern Research Institute	884
3109. "Practical Amplifier Diagrams," by Jack Robin and Chester E. Lipman	884
3110. "Über Synchronisierung von Röhrengeneratoren durch modulierte Signale," by Fritz Diemer	884
3111. "Radio Receiver Tube Placement Guide," by Howard W. Sams	884
3112. "Most-Often-Needed F.M. and Television Servicing Information," by M. N. Beltman	884
3113. "Elements of Radio Servicing," by William Marcus and Alex Levy	886
Sections:	
I.R.E. People	887
Long Island Subsection	890

## WAVES AND ELECTRONS SECTION

Westinghouse Electric Corporation	891
3114. Greetings from England and the I.E.E.	892
3115. The Radio Manufacturers Association Greets The Institute of Radio Engineers	892
3116. Speech of Acceptance for 1948 Fellows of the I.R.E.	893
3117. Radio and Electronic Frontiers	893
3118. The I.R.E. in 1948	894
3119. Avenues of Improvement in Present-Day Television	896
3120. Electronic Instrumentation for Underwater Ordnance Development and Evaluation	906
3121. Adjustment Speed of Automatic-Volume-Control Systems	911
3122. Results of Horizontal Microwave Angle-of-Arrival Measurements by the Phase-Difference Method	916
3123. Interference Between Very-High-Frequency Radio Communication Circuits	923
Contributors to Waves and Electrons Section	930
3124. RMA Standards	932
3125. Abstracts and References	939
News—New Products	22A
Section Meetings	34A
Membership	37A
Student Branches	35A
Positions Open	40A
Positions Wanted	44A
Advertising Index	50A

## EDITORIAL DEPARTMENT

Alfred N. Goldsmith  
*Editor*

Clinton B. DeSoto  
*Technical Editor*

Mary L. Potter  
*Assistant Editor*

William C. Copp  
*Advertising Manager*

Lillian Petranek  
*Assistant Advertising Manager*

Responsibility for the contents of papers published in the PROCEEDINGS OF THE I.R.E. rests upon the authors. Statements made in papers are not binding on the Institute or its members.

Changes of address (with advance notice of fifteen days) and communications regarding subscriptions and payments should be mailed to the Secretary of the Institute, at 450 Ahaip St., Menasha, Wisconsin, or 1 East 79 Street, New York 21, N. Y. All rights of republication, including translation into foreign languages, are reserved by the Institute. Abstracts of papers, with mention of their source, may be printed. Requests for republication privileges should be addressed to The Institute of Radio Engineers.





## William Wilson

William Wilson, formerly assistant vice-president of the Bell Telephone Laboratories, an important contributor to the development of the vacuum tube, and the recipient of the I.R.E.'s Medal of Honor in 1943 "for his achievements in the development of modern electronics . . . and for his contributions to the welfare and work of the Institute," died recently at his home in Raleigh, N. C.

Dr. Wilson was born in Preston, Lancashire, England, on March 29, 1887. He was graduated from the University of Manchester in 1907 with the B.Sc. degree, and received the M.Sc. degree from the same institution the following year for his studies of radioactivity. In 1912 he was given the B.A. degree from Cambridge University, where he had studied under Sir J. J. Thompson, pioneer in electronic investigations. The subsequent year he received the D.Sc. degree from Manchester University. He also did research work at the University of Giessen in Germany.

From 1912 until 1914 Dr. Wilson had been lecturing in physics at the University of Toronto, and in the latter year he joined the research department of the Western Electric Company in the United States, where he conducted investigations on high-vacuum thermionic tubes. In 1918 he was placed in charge of the research, development, and manufacture of vacuum tubes, and, in 1925, when the engineering department of Western Electric became the Bell Telephone Labo-

ratories, he headed the division of radio research, which included the development and design of the transatlantic radiotelephone equipment. He was appointed assistant director of research in 1927, and held that position until 1936, when he was appointed assistant vice-president in charge of personnel and publications.

In 1942 Dr. Wilson retired from the Bell System because of poor health. Two years later, however, his health had improved sufficiently to allow him to join the science department of Philips Exeter Academy at Exeter, N. H., as an instructor. In 1946 he became a professor of physics at the University of North Carolina, and he held that position until his death.

Dr. Wilson was elected a Member of the I.R.E. in 1926, and was transferred to Fellow Grade in 1928. He was a member of the Institute's Board of Directors from 1932 to 1936, and served as a member or chairman of numerous committees—Awards, Bibliography, Convention, Nominations, Sections, Papers, Standards—as well as being on the Board of Editors of the PROCEEDINGS. A member of the American Institute of Electrical Engineers, of Sigma Xi, and of the International Scientific Radio Union's executive committee, Dr. Wilson was also a fellow of the American Physical Society and was a past president of the E. J. Hall Chapter of the Telephone Pioneers of America.

The attention of all members of The Institute of Radio Engineers is particularly directed to the basically important notice given in the following guest editorial, written by an outstanding analyst and worker in the field of electromagnetic-wave control and propagation. The units of measurement used in the communications and electronics field are obviously of utmost importance and significance to all workers in that field. A correct choice of units contributes substantially to convenience of use, simplicity of application, and, indirectly, even to the accuracy of computation in that field. Accordingly, all PROCEEDINGS readers are urged to consider and accept the recommendations given in the following analysis.—*The Editor.*

## The End Is in Sight

S. A. SCHELKUNOFF

The end is in sight for the age of diverse scientific units—of cgs electromagnetic units, of mixed electrostatic and electromagnetic units, of rationalized and unrationalized varieties of each. At a meeting of the I.R.E. Technical Committee on Wave Propagation held on March 4, 1947, a resolution was adopted to the effect that the rationalized mks system of units be recommended by The Institute of Radio Engineers as the preferred system of units. This action was prompted by the rapid and unmistakable trend toward universal adoption of this system, both in experimental and theoretical investigations, and by a desire to shorten the transition period.

Although the rationalized mks system of units was first suggested in the middle of the last century, it remained almost unknown until about 15 years ago. In the last 15 years, however, it has made astonishingly rapid conquests. The reasons for this are many. In the mks system the electrical units are those already in common use in laboratory measurements: the volt, the ampere, the ohm, etc. If the system is of the rationalized variety, Maxwell's equations assume a form which is merely a generalization of the one-dimensional transmission-line equations. In recent years, the gap between circuit and transmission-line theories on the one hand and field theory on the other hand has been closed by waveguides and microwave circuits in general. This made it essential that there be no clash between the ideas, terminology, and units employed in these theories. Since the rationalized mks system fulfills this requirement, it is only natural that it should enjoy rapidly increasing popularity. An added factor in this popularity is that the rationalized mks system is equally well adapted to electromechanical theories. It has begun to appeal to many physicists as well as to engineers—which is particularly fortunate, since the engineer of today must be somewhat of a physicist, and the physicist somewhat of an engineer.

At a meeting held on January 8, 1948, the Standards Committee of The Institute of Radio Engineers approved the position held by the Wave Propagation Committee, and on March 2, 1948, the Executive Committee ratified this action. We can now look forward to universal use of these units.

# Theory of Frequency Counting and Its Application to the Detection of Frequency-Modulated Waves\*

EDOUARD LABIN†, SENIOR MEMBER, I.R.E.

**Summary**—Electronic circuits of the “frequency-counting” type furnish, in response to a sinusoidal signal of frequency  $\omega/2\pi$ , a continuous signal proportional to  $\omega$ .

It may then be expected that, within certain limits, if the frequency  $\omega$  is modulated, this “continuous” signal output will reproduce the modulation.

In this paper are studied, first, the validity of this principle of detection of frequency-modulated waves, with observations on the subject of detection in general, and second, the methods employed for carrying into effect the electronic counting.

## I. GENERAL PRINCIPLES OF THE DETECTION OF F.M. WAVES BY COUNTING

LET US CONSIDER a nonsinusoidal, but periodic, current or voltage of period

$$T = \frac{1}{F} = \frac{2\pi}{\Omega} \tag{1}$$

Its expression in Fourier series would be:

$$u = U_0 + \sum_n U_n \cos(n\Omega t + \phi_n) \tag{2}$$

with the following value for the mean term:

$$U_0 = \frac{1}{T} \int_0^T u(t) dt = Fb = \frac{\Omega b}{2\pi} \tag{3}$$

where  $b$  is the area covered by one period of the curve  $u(t)$ . See Fig. 1.

We may consider that the coefficients  $U_0, U_n, \phi_n$  of the Fourier series are functions of the fundamental frequency  $\Omega/2\pi$  and of other parameters which define the particular shape of the curve (for example, the crest  $A$ , or the slope of a wave front, etc.). Let us now formulate the following question:

What happens to the magnitude  $u(t)$  if we modulate the fundamental frequency, that is, if we make

$$\Omega = \Omega_0 + \Omega_v(t) \tag{4}$$

where the variable part  $\Omega_v$  reproduces some intelligence, and the constant  $\Omega_0$  represents a central or carrier frequency? The simplest and most tempting answer would be to carry the new expression of  $\Omega$  as a function of  $t$  into the expression of  $u$  as function of  $\Omega$ . *Supposing that the parameters of form do not vary due to the modulation*, the following would be obtained:

$$u = U_0[\Omega(t)] + \sum_n U_n[\Omega(t)] \cos \left\{ n \int_0^t \Omega(t) dt + \phi_n[\Omega(t)] \right\} \tag{5}$$

\* Decimal classification: R148.2×621.375.2. Original manuscript received by the Institute, August 28, 1946; revised manuscript received, July 11, 1947.

† Laboratoire d'Electronique et de Recherches Scientifiques Appliquées (LERSA) of the Philips Organization, Paris.

In the oscillatory terms, we have not replaced  $\Omega$  by  $\Omega(t)$ , but  $\Omega t$  by  $\int_0^t \Omega dt$ , for well-known reasons which relate to the physical signification of the frequency.

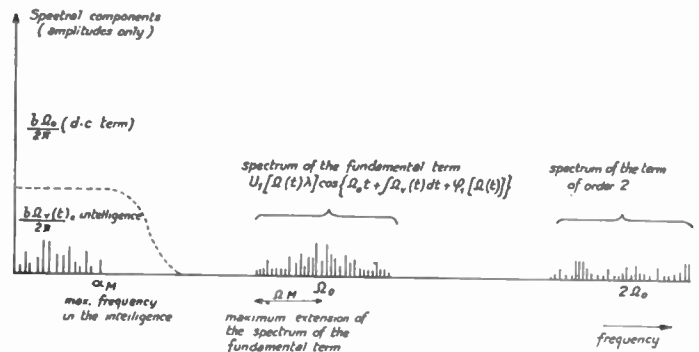
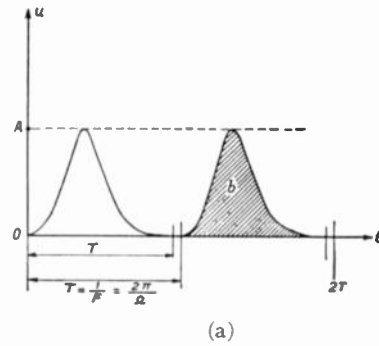

Fig. 1

Let us suppose, first, that this operation of simple substitution of  $\Omega$  by  $\Omega(t)$  is legitimate; we shall come back to this point in a moment. It will be seen at once that, if the mean term  $U_0$  is *linear in  $\Omega$* , a circumstance which, by (3), means that *the area  $b$  is a constant independent of  $\Omega$* , then the mean term, in the presence of the modulation, becomes

$$U_0[\Omega(t)] = \frac{C\Omega(t)}{2\pi} = \frac{b\Omega_0}{2\pi} + \frac{C\Omega_v(t)}{2\pi} \tag{6}$$

and contains, in consequence, in its variable part, the intelligence completely separated.

More exactly, it is “separated” in the full sense of the word if its spectrum does not mix with that of one of the other terms of the whole wave modulated.

In Fig. 1 is shown, schematically, the spectral constitution of the signal  $u(t)$  modulated. From the viewpoint of the separation of the intelligence, the most dangerous oscillations are evidently the most extended ones, towards the beginning, of the spectrum of the fundamental term. Let  $\Omega_{vM}$  be the maximum distance,

in frequency/ $2\pi$ , up to which said spectrum actually extends from  $\Omega_0$ , its center position. On the other hand, let  $\alpha_M$  be the maximum frequency contained in the intelligence. For this intelligence to appear separated, the following must hold:

$$\alpha_M \ll \Omega_0 - \Omega_{vM}. \quad (7)$$

If this condition is satisfied, it will be sufficient, to recover the intelligence, to *filter* it out from the other components of Fig. 1 by means of a linear circuit. Of course, for said circuit to operate at ease, a sufficiently large interval must be arranged between  $\alpha_M$  and  $\Omega_0 - \Omega_{vM}$ .

Now, it will appear clearly how the preceding facts can be used to solve the problem of detecting the intelligence in an ordinary frequency-modulated wave. First, as such a wave is sinusoidal (or very nearly so), it is *deformed* in a special step which is able to derive from it another wave such as the  $u(t)$  we considered above, and which presents an average value *not zero* and the same  $\Omega$  as the incoming f.m. wave; more exactly, an average value which, in the case of the unmodulated incoming wave, is proportional to its frequency,  $U_0 = b\Omega/2\pi$ , where  $b$  is the area covered by one cycle of the deformed wave. If this coefficient remains constant in the presence of the modulation, and condition (7) is fulfilled, then said average value takes a variable part which reproduces the intelligence completely separated and, in addition, *without any distortion!*

If, on the other hand, the coefficient of area  $b$  is rendered independent of the amplitude of the received wave, a requisite which, as will be seen, is easily fulfilled, a system of detection of f.m. waves has been obtained, endowed with all the advantages which result from the classical "limitation of amplitude."

The production of a "continuous" magnitude directly proportional to the frequency of an incident oscillation is precisely the work done by the well-known direct-reading frequency meters based on the "counting" principle. Therefore, our f.m. detector is constituted by a frequency counter (self-"limited") followed by a low-pass filter.

We must now return to the hypothesis which we have made, according to which it is legitimate to consider that, if the distorted signal corresponding to the unmodulated wave of fixed frequency  $\Omega$  is  $u(t, \Omega)$ , the signal corresponding to that "same" wave but modulated is obtained by replacing  $\Omega$  by  $\Omega(t)$  in the *unchanged* expression of  $u: u[t, \Omega(t)]$ . In other words, the question is to insure that the operation which we have described is quasi-stationary.

For it to be so, it is evidently necessary that the time required to establish the distorted signal be small compared to the duration of the most rapid variation contained in the modulation; i.e.,  $2\pi/\alpha_M$ .

This condition will be amply satisfied by arranging matters so that the distorted signal consists of impulses whose *full* duration (of existence)  $\tau$  is inferior to

the smallest period of the purely sinusoidal incoming wave which may appear, a period for whose value we may certainly adopt the expression  $2\pi/\Omega_0 + \Omega_{vM}$ . In fact, this last quantity is certainly inferior to  $2\pi/\Omega_0 - \Omega_{vM}$ , and this is greatly inferior to  $2\pi/\alpha_M$  according to condition (7).

We will impose, therefore, the following condition (amply sufficient for the legitimacy of the quasi-stationary treatment):

$$\left. \begin{array}{l} \text{Each period of the distorted signal is an} \\ \text{impulse terminated at the end of } \tau \text{ seconds,} \end{array} \right\} \quad (8)$$

$$\tau \leq \frac{2\pi}{\Omega_0 + \Omega_{vM}}.$$

The two conditions (7) and (8) suffice to guarantee the correctness of the system.

It is to be noted that, as a consequence of (8), the coefficient of area  $b$  can be written:

$$b = \int_0^\tau u(t)dt, \quad \text{or, as well,} \quad \int_0^p u(t)dt \quad (9)$$

with the upper limit  $\tau$ , or  $\infty$ , in place of  $T$ , when it is understood that for  $u(t)$  we take the expression of *one single impulse*.

## II. GENERALIZATION

It will be instructive to consider the common detection of amplitude-modulated waves, from the same viewpoint as the preceding principle for f.m. detection.

In a.m., the beginning of the process is exactly the same: the wave to be handled is distorted so as to establish a mean value not zero.

The distorter is none other than the common diode, which (ideally) splits the wave along the axis, and only permits the subsistence of the semiwaves of the same polarity. As in the case of f.m., it is found that, when the wave handled is modulated, the intelligence appears in the mean value thus created.

Only, in the product  $bT$  which represents said mean value in the presence of a pure wave, it is now  $T$  which is constant and it is the factor of area  $b$  which is left proportional to the modulated parameter; i.e., the amplitude  $A$  of the incident wave. Condition (7) remains necessary, as well as (8), which is reduced to  $\tau \leq T$ , and which is verified by the fact that here  $\tau$  is  $T/2$ .

This observation seems to indicate that we are in the presence of a general principle which could be formulated as follows: to modulate a carrier wave is to vary one of its parameters without creating an average value; to detect said modulation is to distort the wave so as to create an average value not zero, a value in which the modulation is completely separated.

Both processes must be quasi-stationary, which presupposes, among other things, that the characteristic

variations of the intelligence are slow compared with the carrier oscillations.

### III. GENERAL OUTLINES OF THE COUNTING CIRCUITS

The classical idea for executing electronic counting consists in utilizing the wave, the frequency of which is to be measured, for commanding the electronic equivalent of an interrupter, so that the latter excites the transitory regime of a reactive circuit each time the wave being handled passes, for example, through zero in the "increasing" sense.

The transient thus provoked, which displays the role of what was called the "distorted signal"  $u(t)$ , is, or rather should be, *proper to the reactive circuit* and independent of any parameter of the incident wave, except of its frequency; it must be terminated in a time delay shorter by a certain "reserve" than the period  $T$  (reserve for accommodating the smaller values which  $T$  may take as a consequence of the modulation). In other words, the incident wave is used only for "marking the cadence" of the distorted signal. This latter is then sent

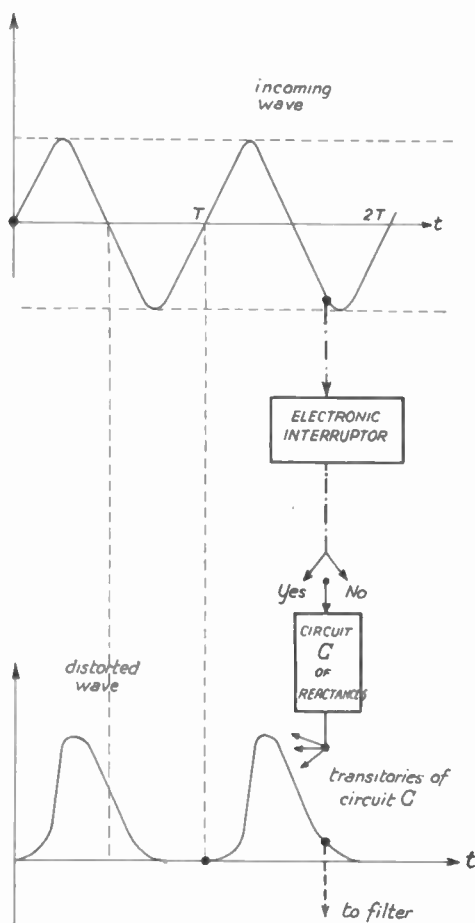

Fig. 2

to a filter which, when the incident wave is modulated, passes all the spectrum of the intelligence and eliminates the "high" frequencies, or, as is sometimes said in view of the impulsive character of the signal, the "peaks." See Fig. 2.

The electronic interrupter consists of a tube on the grid of which is applied the incident wave and which is adjusted so that the anode current varies from zero to maximum according to whether the grid is negative or positive. A little reasoning shows that, to realize a very cyclic regime, which means that the system returns to zero in all its parts (discharging again all that was discharged, and conversely) two interrupters are in general required, as shown in Fig. 3. One tube,  $L_1$ , operated by the incoming wave, opens and closes  $I_1$  on one side of circuit  $C$ . The "charge" (transient) of  $C$  when  $I_1$  is opened is such that automatically tube  $L_2$ , which flanks  $C$  on the other side, closes  $I_2$ . When  $L_1$ , under the influence of the incoming wave, closes  $I_1$ ,  $C$  "discharges," in the opposite sense, this automatically causing  $I_2$  to be opened by  $L_2$ . The utilization branch may be situated, for instance, on the side of  $L_2$ , in such a way that the unilateral impulse used is the *discharge* of  $C$  through  $I_2$ - $L_2$ , the charge being made through  $L_1$ . Practical circuits will soon illustrate these ideas.

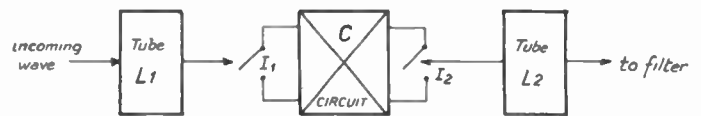

Fig. 3

The use of *two* tubes naturally permits other methods for creating the unilateral impulses; for example, push-pull circuits. We will concern ourselves with systems of two tubes opening alternatively, of the type shown in Fig. 3, from which other systems may also be derived.

As circuit  $C$ , one may think of securing the simplest possible combinations with the minimum possible number of the elements "capacitor," "resistor," and "inductor." On low frequencies, it is, in fact, easy to find combinations of  $R$  and  $C$  alone which work well. On "high" frequencies—"high," for counters, is above 100 kc., for example—these combinations suffer from defects more and more inhibitory, and it becomes necessary to introduce the three elements  $R$ ,  $C$ , and  $L$  at the same time.

Apart from the unilateral characteristics of the transient used, and of condition (8), we will impose the condition that *said transient is not of an oscillatory character*; it is then evident that it will embrace the maximum area  $b$  with the elements  $R$ ,  $C$ ,  $L$  given, and it is always interesting to make the factor  $b$  as large as possible (see (6)). Later, we will see a much more important reason for imposing this condition.

In the detailed study of practical counting circuits, we will consider as incident waves only the pure sinusoidal oscillations, for if, with such a wave, one has realized the preceding conditions, one is sure in advance that the detection will be correctly made on the modulated wave. On the other hand, to simplify, we will not show in our circuits the filter required for extracting the modulation. In this way, the reasoning is affected by an error which we will keep within acceptable limits



by agreeing once and for all to construct the filter on the model of Fig. 4, with  $R_1 \geq Z$ . This is the simplest model of audio-pass filter and the most efficient one (if it is desired to refine it, a trap may be interposed to specifically eliminate the frequencies near the fundamental  $\Omega_0$  of the "peaks").

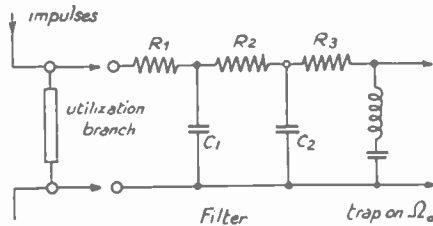
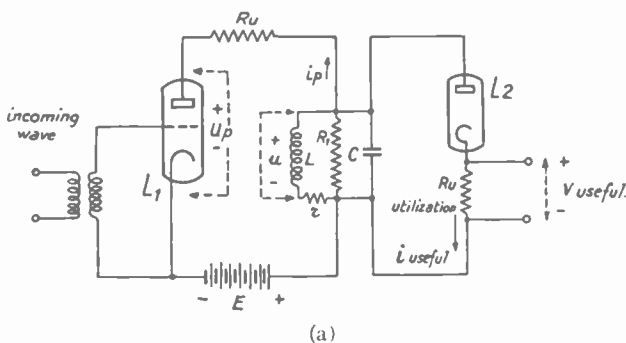

Fig. 4

IV. FIRST CIRCUIT

The most simple circuit is shown in Fig. 5(a). Fig. 5(b) represents the characteristics ( $i_p - v_p$ ) of the pentode  $L_1$ . Tube  $L_2$  is a simple diode. We beg the reader not to concern himself for the moment with the particular mode of connection (low point of  $R_u$  not grounded).



(a)

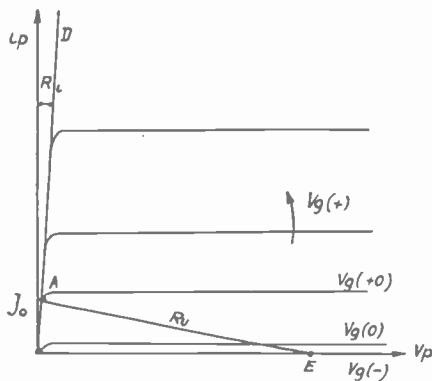

(b)

Fig. 5

When the incident wave is zero, the grid voltage,  $v_g(0)$ , is such that tube  $L_1$  is just at the cutoff point, without current. The full supply voltage  $+E$  is on the anode, the voltage  $u$  on the circuit is zero. During the positive half-period, the grid voltage increases to values under which the current  $i_p$  flows. At first, capacitor  $C$  being neutral, it appears as a short circuit; that is, the current in the coil is initially zero and the tube current appears at first through the capacitive branch,

without encountering any appreciable impedance other than resistance  $R_u$ . In other words, the tube begins to operate on the load line of Fig. 5(b). Let  $v_g(+0)$  be the grid voltage for which said line cuts the characteristic ( $i_p - v_p$ ) at the elbow  $A$  situated on the "limit characteristic"  $OD$ . If  $v_g(+0)$  is small compared with the final voltage assumed by the grid of  $L_1$ , this value  $v_g(+0)$  will be reached in so small a fraction of the positive half-period that we may continue to suppose  $C$  as discharged, and consequently equivalent to a short circuit, up to that moment. We will then have placed the operating point of the tube from  $E$  to  $A$  by what is called in mechanics a "percussion." From this moment on, all the characteristics ( $i_p - v_p$ ) with  $v_g \geq v_g(+0)$  will have the line  $OD$  in common, the operation point will remain on said line, whereof the equation is  $v_p = R_u i_p$ , with  $R_u$  of the order of 100 ohms in good pentodes. Let us call  $j_0$  the current value which corresponds to point  $A$ .

In fact, the percussion may be defined as a sudden short-circuiting of the space  $L_1$ , so as to cancel the voltage  $+E$  which existed at its terminals; the small residual voltage which remains in the tube along the limit characteristic is negligible compared with  $E$ , and in any case it is possible to take account of it by incorporation of resistance  $R_i$  in  $R_u$ . After the short circuit is established, the current will gradually migrate from the capacitive branch, where it will pass from  $j_0$  to 0, to the inductive branch, where it will pass from 0 to  $j_0$ , while in the branch  $R_1$  and in the tube  $L_p$  there will be an evolution which can be deduced from the preceding and of which it is possible to guess that, in  $R_1$ , it will pass from zero to zero, and, in  $L_1$ , from  $j_0$  to  $j_0$ .

If the circuit is adjusted so that the charge of the coil occurs in a regular manner, with the current  $i_L$  always increasing, the high point of the circuit will take a potential smaller than the low point; in other words, the voltage in the circuit, estimated in the sense indicated in Fig. 5(a), will be negative, and the diode  $L_2$  will remain nonconductive and the branch in which it is placed will not intervene in the phenomenon. This shows, in passing, that the condition of a nonoscillating transient is not only favorable to sensitivity, but also necessary for the correct operation of closure and opening of the two complementary interrupters according to the model of Fig. 3.

In addition, we suppose that the circuit is adjusted in such a way that said unilateral charge is practically completed before the end of the semiperiod. Very close to said end, at the moment when the grid voltage of  $L_1$  passes back through the value  $v_g(+0)$ , one will find the circuit in the following new "initial" state: current through the tube  $j_0$  constant, circulating through  $R_u$  and coil  $L$ ; branches  $C$  and  $R_1$  neutral, in particular no voltage at the terminals of  $C$ ;  $L_2$  open. When  $v_g$  decreases below that value, the operating point of  $L_1$  must leave the limit characteristic, and by reasoning of the same class as the preceding, it will be seen that it goes back from  $A$  to  $E$  by a "percussion" which cancels the current

$j_0$ , and this quick annulment performs along the path constituted by the resistance  $R_u$  and the short circuit represented by the capacitor  $C$  in its discharge state. In other words, the interrupter  $L_1$  reopens itself, re-establishing instantaneously a nonzero voltage at the terminals of the tube. This time, the voltage  $u$  on the circuit becomes *positive*, the diode  $L_2$  closes, and the discharge of the coil takes place through the system of branches  $R_1$ ,  $C$ , and  $R_u$  (the  $R_u$  on the right of Fig. 5(a)). *This is the useful period.* Let us note that the tube  $L_1$  is working along its limiting characteristics; i.e., practically in short circuit, a circumstance which is very convenient indeed for the power dissipation, which practically ceases to be a limiting factor.

Calculations will now make precise this qualitative analysis. We will write down the equations which govern the circuit in the hypothesis of unilateral charge and discharge without overlapping, and *afterwards* we shall get from them the necessary conditions to fulfill this hypothesis. In accordance with our preceding physical inquiry, the charging process consists of closing interrupter  $A, B$  of Fig. 6(a), canceling an initial voltage of  $+E$ . Therefore, the voltage can be calculated as the voltage which would exist permanently under voltage  $+E$  in  $(A, B)$  *minus* that other voltage which is provoked by a step-function impulse of height  $-E$  applied in  $(A, B)$ .

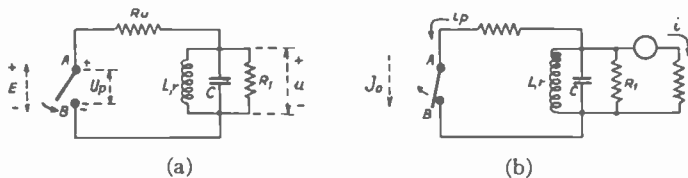

Fig. 6

Now, the first contribution to  $u$ , that of the permanent voltage  $+E$ , is obviously nil in our circuit, disregarding the d.c. voltage which could remain on the coil. The second contribution is obtained in operational form by using the operational transference between  $\mathcal{U}_p$  and  $\mathcal{U}$  (the script letters mean operational forms, or Laplacian transforms, of the magnitudes labelled by the corresponding common letters); i.e.,

$$\mathcal{U} = \mathcal{K}(p)\mathcal{U}_p \quad (10)$$

and making, then:

$$\mathcal{U}_p = -\frac{E}{p} \quad (11)$$

which is the well-known operational form of the step-impulse mentioned above.

The generalized transference  $\mathcal{K}(p)$  can be taken from the ordinary symbolic calculus of the sinusoidal strata in which  $i\omega$  is replaced by  $p$ . It will be found easily in our circuit:

$$\mathcal{K}(p) = \frac{1}{R_u C} \frac{p + \frac{r}{L}}{p^2 + p \left[ \frac{r}{L} + \frac{1}{RC} \right] + \frac{1 + r/R}{LC}} \quad (12)$$

where we put:

$$R = \frac{R_1 R_u}{R_1 + R_u} = \text{value of } R_1 \text{ and } R_u \text{ in parallel.} \quad (13)$$

Concerning the discharge period, the same is the outcome of a process which reduces itself to annul a constant current  $i_p = j_0$  flowing in  $(A, B)$  by opening the interrupter. The current  $i$  which appears in the useful branch, as a consequence of this (see Fig. (6b)) is again the sum of the current—here 0—which corresponds to  $i_p = \text{constant} = j_0$  supposed to flow permanently and that other current which corresponds to the application in  $(A, B)$  of a current-impulse of step-function form and of height  $-j_0$ . So, if we compute the operational transference of the currents:

$$\mathcal{K}'(p) = \frac{\mathcal{I}}{\mathcal{I}_p}$$

we will have, in a completely analogic manner as before:

$$\mathcal{I} = -\frac{j_0}{p} \mathcal{K}'(p)$$

It is easily shown that both transfer functions  $\mathcal{K}$  and  $\mathcal{K}'$ , of voltages and currents, are identical (apart from the sign) if the two resistances  $R_u$  in series with the tubes  $L_1$  and  $L_2$  are identical, a condition we will satisfy.

Therefore, it will be sufficient to study the  $\mathcal{K}(p)$  of (12): the conditions which insure the correctness of the charge are identically the same as those which insure the correctness of the discharge. This symmetry between the two behaviors, obviously desirable, completely identifies the whole operation with the ideal of the two interrupters as represented by Fig. 3.

The formula for  $\mathcal{K}(p)$  conduces to an unilateral non-oscillating time curve for the generating function of  $-E/p \cdot \mathcal{K}$  only if the denominator has two real roots, which will be negative. From this we extract the following condition:

$$\left( \frac{r}{L} + \frac{1}{RC} \right)^2 \geq \frac{4 \left( 1 + \frac{r}{R} \right)}{LC} \quad (14)$$

We know that the most rapid transitory response is obtained when this condition is fulfilled with the = sign (critical damping). We have then

$$p_0 = \frac{1}{2} \left[ \frac{r}{L} + \frac{1}{RC} \right] = \frac{\sqrt{1 + \frac{r}{R}}}{LC} \quad (\text{or } >, \text{ but just}) \quad (15)$$

and the denominator of  $\mathcal{K}(p)$  in (12) has this  $-p_0$  as a double root. The generating function of  $-E/p(\mathcal{K}(p))$  can then be written:

$$u = -\frac{E}{R_u C} \left[ \frac{rC}{1 + \frac{r}{R}} + \left\{ \frac{1}{2} \left( \frac{1}{RC} - \frac{r}{L} \right) \sqrt{LC} t - \frac{rC}{1 + \frac{r}{R}} \right\} e^{-p_0 t} \right] \quad (16)$$

(these results can be found, in what concerns their mathematical aspects, in any of the current operational calculations treatises).

At  $t=0$ , we have in fact  $u=0$ . At  $t=\infty$ , the right-hand member tends towards

$$u_\infty = -\frac{Er}{R_u \left( 1 + \frac{r}{R} \right)}$$

which is obviously the d.c. voltage reigning at the terminals of the circuit owing to the ohmic loss in the resistance  $r$  of the coil. If this resistance is sufficiently small with respect to  $R_u$  (and  $R$ ), this residual voltage is practically zero. If its final value plays any part whatsoever, it is only to delay the closing of the diode for the discharge a little, but some little delay is not disagreeable to us, as in the qualitative theory, where we had disregarded this effect, it appeared that the beginning of the discharge was the moment where the signal passed a definite, yet positive, value ( $v_\theta = v_\theta(+0)$  and not  $v_{\theta 0}$ ); i.e., a moment slightly in advance with respect to the very end of the half-period. This observation shows that it is important *not* to exaggerate the value of  $r$  (in other words, to work with coils of reasonably good quality) but once this condition is fulfilled, it can be dismissed from our thoughts, the  $r$ -dependent terms can be disregarded, and the impedance of the coil can be written simply  $Lp$ .

If we keep in mind this convention, to neglect terms in  $r$  which we are going to accept throughout the whole paper, our solution gets the following aspect:

$$p_0 = \frac{1}{2} \frac{1}{RC} = \frac{1}{\sqrt{LC}}; \quad \frac{1}{R} \sqrt{\frac{L}{C}} = 2 \quad (17)$$

$$u = -\frac{Et}{R_u C} e^{-p_0 t}. \quad (18)$$

It is easy to get a universal drawing for the  $u(t)$  by introducing dimensionless relative variables:

$$p_0 t = \frac{t}{2RC} = \frac{t}{\theta} = x \quad \left( \theta = 2RC = \frac{1}{2} \frac{L}{R} \right). \quad (19)$$

$$\frac{R_1}{R_u} = \nu \quad (20)$$

$$\frac{u}{E} = y. \quad (21)$$

With these parameters, we have

$$y = -\frac{2\nu}{1 + \nu} x e^{-x}. \quad (22)$$

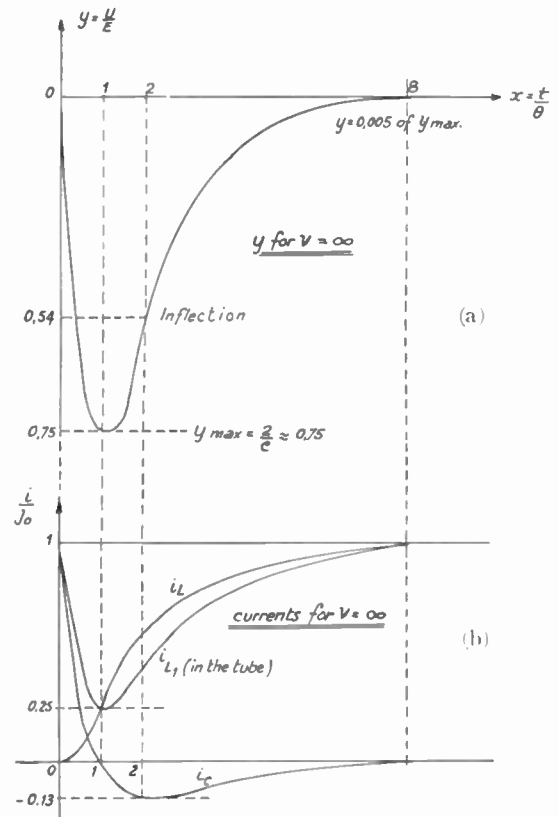

Fig. 7

This function  $y(x)$  is drawn in Fig. 7 for  $\nu = \infty$ . As we wished, it is negative and nonoscillating. In  $x=1$ , i.e.,  $t=\theta$ , it presents a maximum  $y_{max} = -2/e \approx -0.75$ , which means that the voltage on the circuit, in this case of  $\nu = \infty$ , rises (negatively) up to the three-quarter parts of the feeding voltage  $E$  at our disposal. In  $x=8$ ,  $y$  has fallen down to a few thousandths of its maximum value, so we will be generous if we take for "the duration"  $\tau$  of the impulse (we consider the whole function as "an impulse"), the value

$$\tau = 8\theta = 16RC = 4 \frac{L}{R}. \quad (23)$$

As the integral  $\int_0^\infty x e^{-x} dx$  is equal to 1, and we have  $dt = \theta dx$ , the area under the impulse is equal, in absolute value, to

$$b = 2E\theta = Lj_0. \quad (24)$$

We remain here in the case  $\nu = \infty$ ; i.e.,  $R_1 = \infty$ , so that  $R$  is the same as  $R_u$ ; and accordingly  $\theta = (L/2R_u)$  and  $j_0 = (E/R_u)$ .

The result (24) can also be derived directly by noting that, in the branch  $L$ , we have

$$-u = L \frac{di}{dt};$$

therefore,

$$\int_0^\infty -u dt = L [i_{\text{final}} - i_{\text{initial}}]$$

and, as  $i$  (final) in the coil  $L$  is  $j_0$  (end of the charge), and  $i$  (initial)  $\equiv 0$ , we find (24) again. This reasoning has the virtue of making the result (24) a very intuitive one. From  $u(t)$ , the values of  $i_L = -(1/L) \int^t u dt$ ,  $i_c = -C(du/dt)$ ,  $i_{R_1} = (u/R_1)$ , and  $i_{L_1}$  (in the tube  $= i_L + i_c + i_{R_1}$ ) are easily deduced; they are represented in Fig. 7(b). If  $\nu$  is not  $\infty$ , meaning  $R_1$  not infinite, all the values of  $u$  are reduced in the factor  $\nu/1+\nu$ . Let us note by the way, that according to a former remark, the ratio  $u/E$  of the charge period is exactly equal, apart from the sign, to the ratio  $i(\text{useful})/j_0$  of the discharge period. As the utilization resistance in series with  $L_2$  is the same as the one which determines the operating point in series with  $L_1$ , we have

$$i_{\text{useful}} = (\text{useful voltage})/R_u = \frac{v}{R_u} \quad (25)$$

and on the other hand  $j_0 = (E/R_u)$ ; so we will have, during the discharge,

$$\frac{v}{E} \equiv \left| \frac{u}{E} \right|_{\text{of charge}} = \text{function } y(x) \text{ of (24) and Fig. 8.} \quad (26)$$

This shows that in order to get the best possible sensitivity, it is recommended to make  $\nu = \infty$ ; i.e.,  $R_1 = \infty$ . Nevertheless, it is still convenient to load the circuit, for instance, by  $R_1 = 10 R_u$ , in order to avoid the possibility that the internal resistance of the diode, which reaches very high values while the diode is closing, may extend the transitory period unduly. In the case when sensitivity is a less important factor than some other quality (see below), we will be able to make  $\nu$  finite and eventually use its value to take care of special requirements.

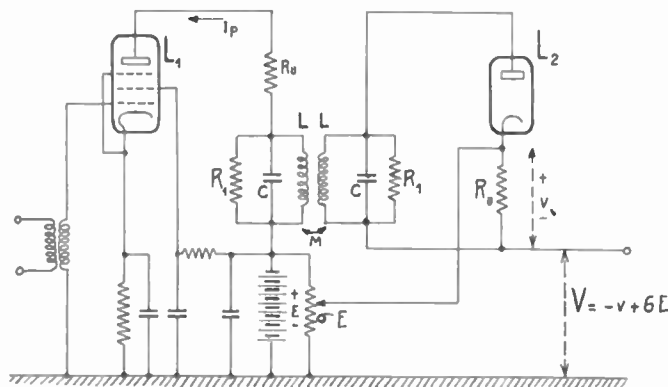

Fig. 8

The design of a circuit intended to operate a wave of a maximum frequency  $\Omega_M$  (this is the  $\Omega_0 + \Omega_{\nu, M}$  of the general theory of §3); i.e., of a minimum half-period of  $\pi/\Omega_M$ , is readily accomplished by writing the condition (8) of the quasi-stationary regime, which contains in itself the condition of correctness (unilaterality) of the transitory:

$$\frac{\pi}{\Omega_M} = 4 \frac{L}{R} = 16RC$$

or, making conspicuous the  $R_u$  as a term of comparison:

$$\frac{L\Omega_M}{R_u} = 0.75 \frac{\nu}{1+\nu} \quad (27)$$

$$\frac{1/C\Omega_M}{R_u} = 5 \frac{\nu}{1+\nu} \quad (28)$$

To this we add the formula giving the sensitivity, or still better, the full equation of the output voltage  $v$  as a function of the current frequency  $\omega$ :

$$v = \frac{Lj_0\omega}{2\pi} = \frac{EL\omega}{2\pi R_u} = \frac{E}{2\pi} \frac{L\Omega_M}{R_u} \frac{\omega}{\Omega_M} \approx \frac{0.12\nu}{1+\nu} E \frac{\omega}{\Omega_M} \quad (\text{for } \omega \leq \Omega_M). \quad (29)$$

With a given tube  $L_1$  and a given feeding d.c. voltage  $E$ ,  $R_u$  is imposed by the characteristic curves of the tube, and from there, all the design comes out in a very convenient form by rendering  $C$  in (28) equal to the smallest possible value; i.e., the parasitic capacitance of the tube output and connections. For instance, with the EL3 as tube  $L_1$ , and  $E = 320$  volts, it results  $R_u \approx 3200$  ohms and if we adopt (generously)  $C_{\text{min}} = 20 \mu\text{mfd.}$  we have, with the choice  $\nu = \infty$ ; i.e.,  $R_1 \gg R_u$  (practically,  $R_1$  of the order of 50,000 ohms), a limiting frequency of 500 kc. The grid voltages  $v_{g_0}$  for cutoff and  $v_{g_0(+)}$  for the bending point  $A$  (see Fig. 5) are then of more or less  $-12$  and  $0$  volts, so that the incident signal has to be at least 40 volts. The residual voltage in  $A$  on the anode is no more than 3 to 5 volts.

If the problem reduces itself to the construction of a simple frequency meter for pure sinusoidal waves up to 500 kc., such a design is perfectly convenient. Then it is sufficient to connect, in series with  $R_u$  and  $L_1$ , a common d.c. ammeter of maximum sensitivity equal to  $6.12j_0$  (in the preceding example, 12 ma.), which corresponds to the maximum incident frequency  $\Omega_M$ , and according to (29) the deflection  $\delta$  of the ammeter pointer for the frequency  $\omega$  will be given by

$$\frac{\delta}{\delta_M} = \frac{\omega}{\Omega_M}, \quad (30)$$

which means we have a perfect linear scale.

If the pursued aim is a detector of frequency-modulated waves, the situation is not quite so comfortable. As a matter of fact, it will then be necessary to send the useful voltage  $u$  which appears at the terminals of the circuit to the grid of another tube, and Fig. 5 shows that none of said terminals are grounded.

Should one be exclusively concerned with the sole task of detecting an ordinary modulation, the difficulty could be overcome by the use of a simple (but big) separating capacitor, which cuts the d.c. only and transmits

everything else unchanged down to the lowest frequency contained in the intelligence. We have then, in (29),

$$\omega = \Omega_0 + \Omega_v(t),$$

and the useful voltage becomes,

$$v = v_{00} + v_{0u} \begin{cases} v_{00} = 0.12 \frac{\nu}{1 + \nu} E \frac{\Omega_0}{\Omega_M} \\ = 0.12 \frac{\nu}{1 + \nu} E \frac{\Omega_0}{\Omega_0 + \Omega_{vM}} \\ v_{0u} = 0.12 \frac{\nu}{1 + \nu} E \frac{\Omega_v}{\Omega_M} \\ = 0.12 \frac{\nu}{1 + \nu} E \frac{\Omega_v(t)}{\Omega_0 + \Omega_{vM}} \end{cases} \quad (31)$$

The part  $v_{00}$ , of d.c., does not interest us. The very useful part,  $v_{0u}$ , which reproduces the intelligence, can be applied to a grid. As, in this case, we will try to use a receiving tube as  $L_1$ , we will find an important value of  $R_u$  which, by (28) would conduce, for  $\nu = \infty$ , to a much too low capacitance at  $\Omega_M \approx 500$  kc. So we shall manipulate  $\nu$ . For instance, with an EF9 tube,  $E = 150$  volts,  $j_0 = 5$  ma.  $R_u = 30,000$  ohms,  $\Omega_0 = 465$  kc. (second intermediate frequency of normal receivers),  $\Omega_{vM} = 75$  kc.,  $\Omega_M = 540$  kc., one gets an acceptable value of  $20 \mu\text{mfd}$ . for  $C$  by choosing  $\nu = 0, 1$ ; i.e.,  $R_1 = 3.000$  and, by (31),  $v_{0u}$ , for the maximum excursion  $\Omega_v(t) = \Omega_{vM}$ , happens to be:

$$v_{0uM} = \text{max. useful voltage} = 0.0014E \approx 0.21 \text{ volt.}$$

### V. SECOND CIRCUIT

But the preceding solution of the connection problem is impossible when we wish to transmit the d.c. term  $v_{00}$  as well, or at least very slow (infra-audio) variations of it. This case occurs in those f.m. transmitting systems where the frequency modulation is performed by controlling directly the parameters of the circuit of an auto oscillator. It is well known that, in this case, the necessary stability of the central frequency cannot be achieved, but by the use of an automatic-controlling link we are able to supply an "infra-audio" voltage  $v_{00}$  which reproduces the slow variations of said central frequency and applying it back to the system which controls the auto-oscillating circuit, in order to counteract said slow variations. Therefore, it is clear that the f.m. detector placed in the heart of this control link must be able to transmit an infra-audio output.

One means to secure this is to separate the discharge circuit or utilization circuit  $L_2$  from the charge circuit or excitation circuit, by a transformer. This solution was suggested and experimentally studied by Ziegler, whose name should be given to the novel circuit.

The complete layout is represented by Fig. 8, including a connection derived from the battery and whose role is to define a "zero," as will be explained below.

The qualitative theory is very much the same as for

the preceding circuit. It is necessary to give the coils of the transformer such a sense that, during the charge, when the current from low to high in the primary is increasing, the voltage from high to low in the secondary is negative. Then, we have a charge again through the primary coil suddenly short-circuited in the presence of the secondary, but with the branch  $L_2$  passive, lasting until the value of current  $j_0$  of point A of Fig. 5(b) is reached; and thereafter, a discharge of the primary through the secondary, from  $j_0$  to 0, the branch  $L_1$  being suddenly opened, and the branch  $L_2$  closed, being now active in the secondary. In the same way as before, the voltage  $u$  during the charge is obtained operationally by

$$U = - \frac{E}{p} \mathfrak{C}(p) \quad (32)$$

where  $\mathfrak{C}(p)$  is the voltage-transfer function ( $U/U_p$ ) of the circuit in Fig. 9(a), being  $-E/p$ , the operational form of the step impulse of voltage of value  $E$  equivalent

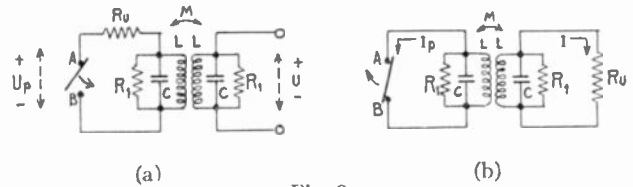

Fig. 9

to closing the interrupter ( $A, B$ ) through  $u_p$ . Analogously, the current  $i$  during the charge is obtained by

$$i = - \frac{j_0}{p} \mathfrak{C}'(p) \quad (33)$$

where  $\mathfrak{C}'$  is the current's transfer function ( $i/i_p$ ) of the circuit of Fig. 9(b), being  $-j_0/p$ , the operational form of the step-impulse of current of height  $j_0$  which is equivalent to opening the interrupter ( $A, B$ ) through  $i_p$ .

The following theorem can be demonstrated: Given a quadripole terminated by a definite branch, on the terminals of which the voltage is  $u$ , let us excite it by a voltage  $u_p$  from a constant-voltage source through a resistance  $R_u$ ; and let  $\mathfrak{C}(p)$  be the generalized sinusoidal voltage transfer function  $U/U_p$ . At the terminals of said branch, let us now connect a resistance  $R_{u'}$ , and let  $i$  be the current which flows through  $R_{u'}$  when the quadripole is excited by a source of constant current  $i_p$ . Let us call, under this circumstance,  $\mathfrak{C}'(p)$  the generalized current-transfer-function  $i/i_p$ . *Theorem:*  $\mathfrak{C}'$  is identical with  $\mathfrak{C}$  if the two following conditions are fulfilled: (a) quadripole symmetrical; (b)  $R_{u'} = R_u$ . (The preceding case of a single antiresonant circuit is a particular one of this theorem.)

This result obliges us to make the transformer symmetrical, which means equalizing all the elements of a same nature on both sides, a desirable feature from the constructional point of view. Once this has been done (it was supposed so in Figs. 8 and 9), we are sure that the

discharge will be exactly symmetrical to the charge (in our case, we do not have  $\mathcal{C}' \equiv \mathcal{C}$ , but  $\mathcal{C}' = -\mathcal{C}$ , because of our sense conventions), and it is sufficient, as in the precedent case, to study the voltage  $u$  during the charge.

The generalized sinusoidal transference function  $\mathcal{C}$  of voltages in Fig. 9 is calculated in Appendix A, from which the following formula is obtained:

$$\mathcal{C} = \frac{kg_u L p}{[1 + (1 - k)Lp(g_1 + Cp)][1 + (1 + k)Lp(g_1 + Cp)] + g_u L p [1 + (1 - k^2)Lp(g + Cp)]}. \quad (34)$$

where we put:

$$M = kL. \quad (35)$$

The operational quantity whose generating function is the voltage  $u(t)$  looked for, being  $E - \mathcal{C}/p$ , or, here  $-Eg_u L/D(p)$ , it is obvious that, in order that  $u(t)$  should not be oscillatory, it is necessary that the denominator  $D(p)$  has only real roots, which evidently will be negative.

The discussion of the 4th-degree polynomial  $D(p)$  can be made completely, with some graphic aid, a feature which is worth while to stress in order to sustain the confidence in operational methods. But as this discussion is too lengthy to be reproducible in the frame of a normal paper, we must content ourselves with giving a short outline of the method in Appendix B, and picking out, here, the following end results.

An over-abundant condition that the transitory will be unilateral is:

$$\frac{1}{R_1^2} \frac{L}{C} = \frac{4}{1 - k}. \quad (36)$$

Once this is fulfilled, the time of duration of the transitory is of the order of magnitude of the inverse of that (negative real) root of  $D(p)$  which is located nearest to the origin. A little consideration shows that this time delay can be taken as:

$$\tau = 6(2 + \nu) \frac{L}{R_1} \quad \left( \nu = \frac{R_1}{R_u} = \frac{g_u}{g_1} \right). \quad (37)$$

If we use this value to write down condition (8), and introduce, as before, resistance  $R_u$  as a comparison term, we find, grasping also (36), the following two equations:

$$\frac{L\Omega_M}{R_u} = \frac{\pi}{6} \frac{\nu}{2 + \nu} \leq \frac{0.5\nu}{2 + \nu} \quad (38)$$

$$\frac{1/C\Omega_M}{R_u} = \frac{24}{\pi} \frac{\nu(2 + \nu)}{1 - k} \leq \frac{6\nu(2 + \nu)}{1 - k}. \quad (39)$$

These are the resulting design equations of our problem. In order to obtain a practical discussion from these, let us add to them the sensitivity equation. For this, we observe that the *mean value* of the function  $i(t)$  = generating function of the operational  $j_0 \mathcal{C}(p)/p = j_0 kg_u L/D(p)$  (see (34)), which is what we need to put in (6), can be gained without writing down  $i(t)$ . In fact,

by a well-known result, the quantity  $\int_0^\infty i(t)dt$  is equal to the operational form of  $i(t)$  taken at  $p=0$ , which by (32(b)) and (34) amounts to  $Mg_u j_0$ . As the voltage  $v$  on the useful resistance  $R_u$  is  $R_u$  times this multiplied by  $\Omega/2\pi$  (see (6)), and  $j_0$  is  $E/R_u$ ; and if finally we take into account the special connection of Fig. 9 which combines  $-v$  with a fraction  $\sigma$  of the feeding voltage  $E$ , we have as net result:

$$\text{output} = \sigma E - v, \quad v = Mj_0 \frac{\Omega}{2\pi} = \frac{EM\Omega}{2\pi R_u}, \quad \text{or, too, by (48):}$$

$$v = \frac{E}{12} \frac{\kappa\nu}{1 + \nu} \frac{\Omega}{\Omega_M}. \quad (40)$$

As in the preceding case, the particular result  $v = M\Omega j_0/2\pi$  could have been obtained by integrating directly the equation of the current in the coil, and taking into account the hypothesis that the discharge begins and ends at the two limits of the integral.

As has been stated,  $v$  is proportional to  $E$ , so that the whole arrangement can be "compensated" by making, for a predetermined value  $\Omega_0$  on which it is desired to have output zero,  $\sigma = M\Omega_0/2\pi R_u$ . It is to be noted that the two parameters  $M$  and  $R_u$  which define this value can be made stable much more easily than the tuned circuits of common discriminators. In this fact lies an important advantage of frequency-counting detectors in frequency-stabilizing links.

Equations (38), (39), and (40) allow discussing and designing any planned circuit under all circumstances, whatever the imposed data may be: tube (i.e.,  $R_u$ ), coupling factor  $k$ , minimum parasitic capacitance (i.e.,  $(1/C)$  max), maximum frequency  $\Omega_M$ , and so on. The explicit calculus of any design is so easy that it would be redundant to insist upon the matter. Orders of magnitude are a little smaller than in the case of one tube but can be illustrated roughly by the same figures.

A drastic feature of the preceding results is that the parameter  $\nu = R_1/R_u$  plays an important part as a limiting factor, whereas in the case of a single circuit its value could well be infinite. Here, the value of  $\nu$  only can be  $\infty$  if, simultaneously,  $k=1$ , and then all will degenerate into the preceding case (the mathematical verification of this statement is left to the reader). As soon as  $k < 1$ , the transformer presents, by its leakage inductances, *parasitic reactances* which must be *especially damped*, if it is desired to avoid oscillations. As a matter of fact, it can be verified that the condition (36), if written:

$$\frac{(1 - k)L}{R_1} = 4R_1C,$$

represent the condition of critical damping, by the

resistance  $R_1$ , of the resonant parasitic circuit formed by the total leakage inductance of the transformer  $(1-k)L$  and the capacitors  $C$  (see Fig. 10). Therefore, in the present case, it is necessary to anchor down the resistances  $R_1$  immediately at the terminals of the coils, and the values of said parallel resistances  $R_1$  become very rapidly small as soon as the coupling coefficient has those values which are common even in the most refined high-frequency transformers.

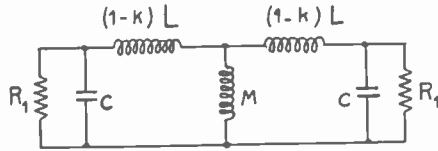

Fig. 10

It is, moreover, obvious that the part played by this new factor makes it so that it is not always desirable to have the  $k$  as near to 1 as possible. See especially equation (39) which conduces to  $C$  nil when  $k \rightarrow 1$ . Here lies an important trap of which one cannot be aware until having completed the exact theory of the circuit.

VI. COMPLETE CHARACTERISTICS

It is interesting to consider in their full extension the family of curves which, in a simple frequency counter, not compensated, give the d.c. output voltage as a function of the frequency of the applied signal for various values of this signal's level.

For a sufficiently high level  $e_1$  of the applied signal, and a circuit adjusted upon the maximum frequency  $\Omega_M$ , we comply exactly with the foregoing theory; i.e., we have first, for  $\Omega < \Omega_M$ , a characteristic  $v(\Omega)$  strictly straight,  $OA$ , whose slope depends only from the circuit and not from  $e_1$ . So we have, in this zone, an ideal f.m. detector; i.e., linear and auto-limited at the time. If, under a constant input level, we push the frequency beyond  $\Omega_M$ , the condition for the complete fading out of the impulses before the end of the half-periods, is fulfilled worse and worse. The mean value of the areas of impulses, cut prematurely by the applied wave going back to zero, cannot increase any more and finally begins to decrease very fast, as soon as the areas happen to be cut in the initial zone of the impulses, where the major part of their value is concentrated. Thus we will get a curve such as the one labelled  $e_1$  on Fig. 11.

For a level  $e_2 < e_1$ , but yet greater than the threshold, we have a similar curve, but the separation from the straight line  $OA$  occurs before, because the duration of the initial percussion which closes the interrupters equivalent to the tubes is becoming significant as the time taken by the grid voltage to go from one level,  $v_{\theta 0}$ , to another,  $v_{\theta(+0)}$ , is a fraction of the half-period so much the greater as the final height to which the signal raises within the half-period is lower. This is the same as saying that the independence of the area with respect to the period of the signal does not extend up to periods as short as before.

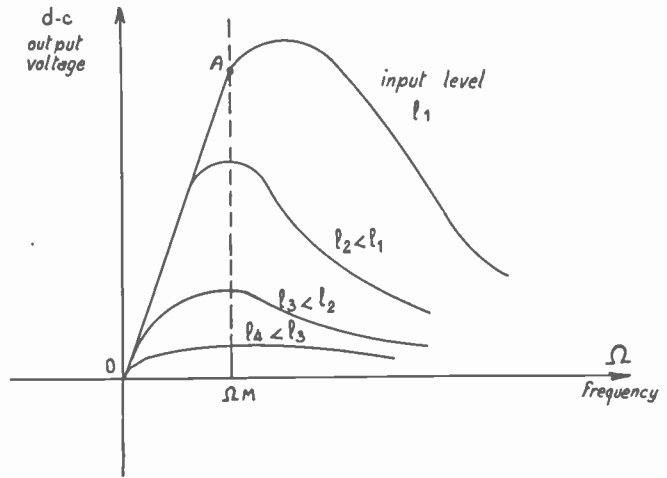

Fig. 11

For a level  $e_3$  still smaller, this independence ceases practically to exist for any frequency whatsoever, and the circuit ceases to behave as a counter. Finally, for levels such as  $e_4$  so small that the plate current does not limit itself at all, there does not remain any vestige of the impulses, the plate current reproduces the grid voltage with its smooth sinusoidal form, as in ordinary amplifier; i.e., the circuit becomes linear and the characteristic  $v(\Omega)$  tends simply toward the ordinary "selectivity" curve, or "frequency-response" characteristic of the plate circuit, with exact proportionality of the levels,  $v = Ae$ . If the plate circuit is heavily damped, as it is in our case for the convenience of the frequency counting under higher levels, then said selectivity curve does not present the ordinary resonant peak. But this circumstance does not prevent the whole of the Ziegler circuit from transmitting without modification, and further rectifying by the diode in the ordinary form, oscillations of a level  $e \leq e_4$ ; the only difference is that it does it without appreciable frequency discrimination. This fact inspired in M. Ciancaglini (of the same Laboratory) the idea of using a counter as an *unique* step for detection in an universal a.m. and f.m. receiver. In that arrangement, we pass from the position f.m. to the position a.m. simply by dividing the input level to the detector stage by, say, 20 or 30, which is a very easy matter to achieve by an ordinary knob or push-button. In the simplicity with which the service of a receiver can so be changed lies a useful advantage indeed of f.m. detection by counting.

Over-All Study

(1) The preceding analysis is a schematic one only, owing to the fact that the two tubes were treated as mere interrupters. In a more complete study, it would become necessary to introduce the real curved characteristics of the tubes in the zones where they are working; i.e., the vicinity of the "limiting" straight portion in what concerns  $L_1$ , and of the cutoff in what concerns  $L_2$ .

This will raise, of course, a nonlinear problem. But

experience shows that the results of the schematic analysis are not so far from reality as to make us worry about such a refinement. The difference between the measured facts and those predicted by the preceding schematic analysis comes much more from the difficulty of constructing elements  $L$ ,  $C$ ,  $M$  with exactly pre-established values, than from the residue of non-linearity. If one decides first to construct a symmetrical transformer, measuring afterwards the values of its parameters  $L$ ,  $M$ ,  $C$ , and then adjust the working frequency and the load  $g_1$  in order to fulfill the conditions of the preceding theory, one obtains an agreement between experiment and theory up to 10 per cent. This will be shown with more details in a further paper dealing with the practical side of the question, in which our results will be applied specially to the case of a link of automatic control of central frequency.

(2) The frequency counter is intrinsically a detector of low over-all sensitivity. If we wish to illustrate sensitivity by the following figure, with a common receiver tube as  $L_1$  and 75 kc. useful deviation, we have a few tenths of a volt of useful output for several ten volts of input. But we have already seen that the 0.2 volt of useful output is more than sufficient for the following audio steps, and that the several tens of volts of input are unavoidable in all detection systems which claim limiting action. As a matter of fact, in the detection of f.m. the incoming voltage displays much more the role of the local oscillation in a mixer than that of a signal to be reproduced. So the ratio of audio level to applied signal level is not a significant figure.

(3) As the tube is used merely as an interrupter, it could well be replaced by a thyatron if the working frequency would fall to the 100-kc. zone where the modern gas tubes are still able to oscillate. Then the  $j_0$  of the preceding theory can rise to more than ten times higher values than stated before,  $R_u$  becomes more than ten times lower, and the damping resistor  $R_1$  can be a much higher fraction thereof. So, the irrelevant "sensitivity figure" (ratio of levels) rises up to values equal or greater than those encountered with discriminator detectors. This solution can be used specially in frequency stabilizing links, but requires some further circuit techniques which can not be dealt with in the present paper.

(4) A very important point is the following: the common discriminator with resonant circuits is a very delicate device because it adds to the ordinary worries of double tuning, those much more ticklish which are presented, as it is well known, by all *differential* sets. Its tolerances lay at the extreme limit of actual mass production, and in particular, it is completely out of question to avoid the post-fabrication adjusting of the discriminator in the receivers, one by one. On the contrary, the frequency counter is a very strong structure, demanding but the easiest tolerance and no adjusting whatsoever is necessary once put in a receiver. This is an important feature from the economical standpoint.

APPENDIX I.

To derive the voltage transfer function of the circuit of Fig. 9 of the paper, it is convenient to reason systematically with the admittances. See Fig. 12(a), (b), and (c).

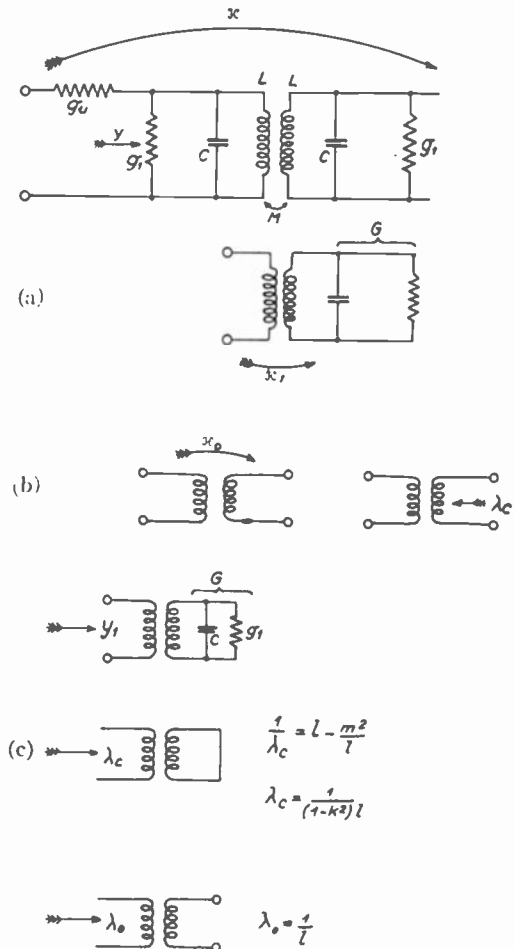

Fig. 12

If we call  $y$  the admittance seen in Fig. 12(a), and  $\mathcal{C}_1$  the transference shown there, we have first:

$$\mathcal{C} = \mathcal{C}_1 \frac{g_u}{g_u + Y} \tag{41}$$

Let us begin to study  $\mathcal{C}_1$ . If we call  $G$ , provisionally, the total conductance  $g_1 + \gamma$  which loads the secondary ( $\gamma = Cp$ , as  $\lambda = 1/Lp$ ), we can decompose  $\mathcal{C}_1$  in the product of the transference  $\mathcal{C}_0$  by  $\lambda_c / \lambda_c + G$ , where  $\lambda_c$  is the admittance seen from the secondary backwards with source passivated; i.e., here by short-circuiting the primary. We have immediately:

$$\mathcal{C}_0 = \frac{m}{l} = k \tag{42}$$

( $m$  and  $l$  are impedances  $Mp$  and  $Lp$ ) so that:

$$\mathcal{C}_1 = \mathcal{C}_0 \frac{\lambda_c}{\lambda_c + G} = \frac{k \lambda_c}{g_1 + \gamma + \lambda_c} \tag{43}$$

and, putting in (41)

$$\mathcal{C} = \frac{g_u}{g_u + Y} \cdot \frac{k \lambda_c}{g_1 + \gamma + \lambda_c} \tag{44}$$



Let us now calculate  $Y$ . We have, in Fig. 12(a) and 12(c):

$$Y = g + \gamma + Y_1 \tag{45}$$

and  $Y_1$  can be written in function of the "load"  $G$  and the admittances  $\lambda_c$  and  $\lambda_0$  at short-circuit and open-circuit, by a general formula of the theory of quadri-poles:

$$Y_1 = \lambda_c + \frac{\lambda_c(\lambda_0 - \lambda_c)}{G + \lambda_c} \quad (G, \text{ we recall, } = g + \gamma)$$

from where, in  $Y$ :

$$Y = g_1 + \gamma + \lambda_c + \frac{\lambda_c(\lambda_0 - \lambda_c)}{g_1 + \gamma + \lambda_c} \tag{46}$$

and putting this value in (44):

$$\mathfrak{C} = k \frac{\lambda_c}{g_1 + \gamma + \lambda_c} \frac{g_u}{g_u + g_1 + \gamma + \lambda_c + \frac{\lambda_c(\lambda_0 - \lambda_c)}{g_1 + \gamma + \lambda_c}}$$

Rearranging and substituting  $\lambda_c$  and  $\lambda_0$  by their values, (see Fig. 12(c) we have:

$$\mathfrak{C} = \frac{k g_u l}{1 + l(g_u + 2g_1 + 2\gamma) + (1 - k^2)l^2(g_1 + \gamma)(g_u + g_1 + \gamma)}$$

We can rearrange the denominator and finally get:

$$\mathfrak{C} = \frac{k g_u l}{[1 + (1 - k)l(g_1 + \gamma)][1 + (1 + k)l(g_1 + \gamma)] + g_u l [1 + (1 - k^2)l(g_1 + \gamma)]}$$

If, in this formula, we make  $l = Lp$ ,  $\gamma = Cp$ , we obtain the formula of the paper.

APPENDIX II

By using the dimensionless parameters.

$$x = p\sqrt{LC}$$

$$2\delta = g_1 \sqrt{\frac{L}{C}}$$

$$\frac{g_u}{g_1} = \frac{R_1}{R_u} = \nu,$$

the polynomial to be studied takes the form:

$$D(x) = N_1 N_2 + 2\nu\delta x \Delta$$

with:

$$N_1 = 1 + (1 - k)x(x + 2\delta)$$

$$N_2 = 1 + (1 + k)x(x + 2\delta)$$

$$\Delta = 1 + (1 + k^2)x(x + 2\delta).$$

The roots of  $D(x) = 0$  are discussed by investigating the cutting of the curve  $y(x) = \frac{N_1(x)N_2(x)}{\Delta(x)}$  by the straight

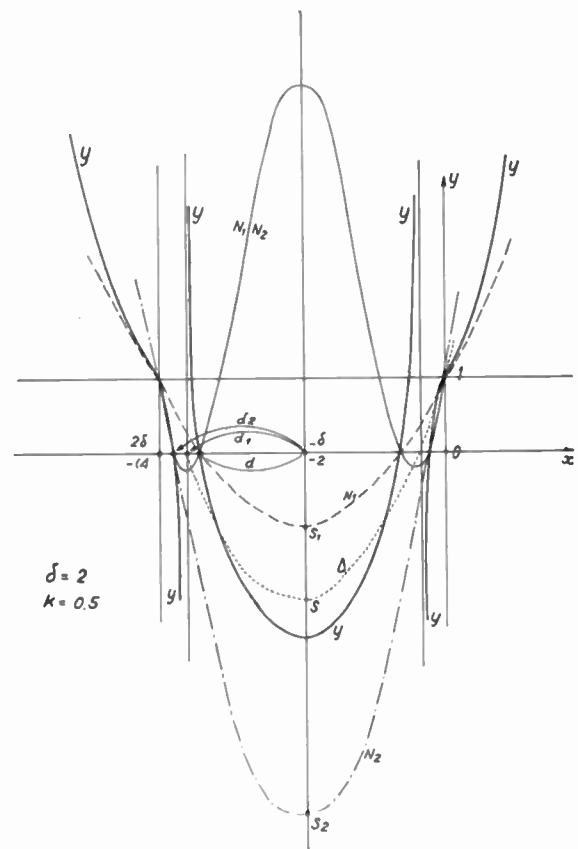

Fig. 13

line  $-2\nu\delta x$ . The curve  $y$  can be constructed and discussed for all values of the two parameters  $k$  and  $\delta$ . A typical example is given by Fig. 13, where we inscribe successively the three parabolas,  $N_1(x)$ ,  $N_2(x)$ , and  $\Delta(x)$ , the product curve,  $N_1 \cdot N_2$  and, finally, the gradient  $y = N_1 N_2 / \Delta$ . All the curves which serve as steps to construct  $y(x)$  are very easy to locate with the aid of their peaks  $S_1, S_2, S$ , and their cutting points with the axis. All the curves have the vertical  $(-\delta)$  as axis of symmetry. In the case represented, ( $k = 0, 5, \delta = 2$ ), we have obviously four cutting points with any straight line  $(-2\nu\delta)x$ . By keeping  $\delta$  constant and raising  $k$  up to its limiting value 1, one sees that the evolution of the curve is such that for  $1 - k > 1/\delta^2$ , the central branch is above the  $-0x$  axis, so it is no more sure that the straight lines cut it in four points, and the over-abundant-condition of no oscillation becomes  $1 - k = 1/\delta^2$ , which is (36) of the paper. Once this is insured, an approximative value of the root which is located nearest the origin can be derived by reducing  $D(x)$  to its linear term, from which we get  $x_0 = -1/2\delta(2 + \nu)$ . Going back to  $p$  by  $x = p\sqrt{LC}$ , and taking as duration of the transitory  $6/p_0$ , we obtain the value (37) of the paper.

# A Duplex System of Communications for Microwaves\*

R. V. POUND†

**Summary**—This paper discusses the properties of a communication system obtained by the use of a single microwave oscillator as both transmitter and beating oscillator of a superheterodyne receiver. The oscillator is stabilized in frequency by an electronic circuit at the frequency of a high- $Q$  cavity and frequency-modulated about this stabilization frequency. The resultant communication sets are capable of very simple duplex communication in pairs, and evidence that he is being received at the other station is given to the operator initiating communication. An application to communication from ground to aircraft, utilizing the very large number of channels available in the microwave region, is discussed. A booster station for a relay link, based on the same principles, is suggested, and an experimental version of the duplex microwave communication set is described.

## INTRODUCTION

IN A PREVIOUS PAPER,<sup>1</sup> two systems of frequency stabilization were described. It was shown that it is possible to obtain signals having very little inherent random frequency modulation, and that these stable signals can be frequency-modulated at audio and higher frequencies. The availability of such signal generators suggests their use as carriers for voice communication, and the purpose of this paper is to discuss some of the properties of a special duplex system of communication which has been tried in elementary form at the M.I.T. Radiation Laboratory in the early part of 1945.

Instead of a conventional transmitting oscillator and separate superheterodyne receiver, a special system which takes advantage of the properties peculiar to the microwave region was used. It is well known that transmission and reception with omnidirectional antennas at both ends is not well suited to microwaves because the power required to cover a given line-of-sight range varies inversely with the wavelength. Directional communication, where the directivities of the antennas are limited by the areas available for them, requires a power proportional to the wavelength, but such communication is limited to stations in fixed or prearranged relative locations. The systems to be described are particularly suited to applications requiring a master station with a steerable, highly directional antenna, and a large number of dependent stations with omnidirectional antennas. Such a situation, if the directional-antenna gain

is limited by the area available for it, requires a transmitted power independent of wavelength.

The systems to be described make use of the very large range of frequencies available in a region of a given fractional width in the microwave region, to provide a very large number of narrow channels. Thus the transmitter power requirement is kept low, but the frequency stability of the oscillators must be high. Crystal-controlled oscillators, multiplied into the microwave region, could be used, but the single-knob tuning and the ease of producing frequency modulation of the previously mentioned stabilized oscillators make them particularly suited to systems of this kind. Precision cavities having low temperature coefficients of frequency would be a prerequisite engineering accomplishment to the extensive use of such systems.

## THE BASIC SYSTEM

A block diagram of the components and their relations to the systems to be described is shown in Fig. 1. A large part of this diagram is the d.c. frequency stabilizer discussed in the previous paper. The i.f. stabilization system, which is capable of producing greater stability, may be substituted readily.

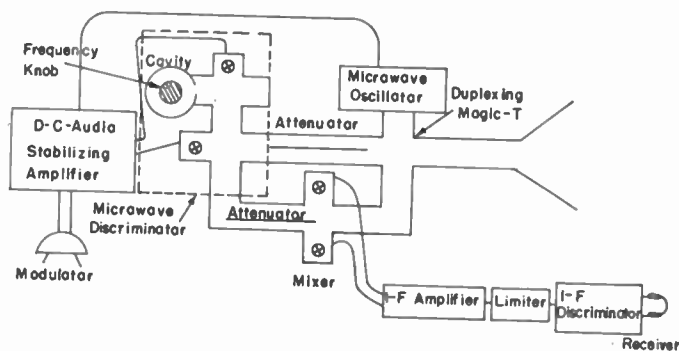

Fig. 1—Block diagram of the duplex communication station.

The components additional to the stabilization system are an antenna, a duplexing magic tee, a magic-tee balanced mixer, and the i.f. components and discriminator of an f.m. receiver. The magic tee used as a duplexer allows the transmission of one-half the oscillator power to the antenna with little direct coupling to the mixer and of one-half the power received by the same antenna into the mixer. A part of the oscillator power is fed through the discriminator into the local-oscillator input arm of the balanced mixer. Thus, a common stabilized oscillator is used as the transmitter and as the beating oscillator of the receiver.

\* Decimal classification: R460×R310. Original manuscript received by the Institute, June 24, 1946; revised manuscript received, December 15, 1947. This paper is based on work done for the Office of Scientific Research and Development under Contract OEMsr-262 with the Massachusetts Institute of Technology.

† Formerly, Radiation Laboratory, Massachusetts Institute of Technology, Cambridge, Mass.; now, Society of Fellows, Harvard University, Cambridge, Mass.

<sup>1</sup> R. V. Pound, "Frequency stabilization of microwave oscillators," *Proc. I.R.E.*, vol. 35, pp. 1405-1415; December, 1947.

If the cavity of the discriminator is set at a frequency  $f_A$ , this is the frequency of the oscillator and, therefore, the transmitted frequency. The receiver, on the other hand, is sensitive at  $f_A$  plus and minus the intermediate frequency  $f_I$ . Thus f.m. signals at  $f_{A'} = f_A + f_I$  or at  $f_{A''} = f_A - f_I$  could be received. If a signal were present at either of these frequencies, a meter measuring the d.c. voltage at the i.f. discriminator would act as a tuning indicator allowing the oscillator frequency to be set to receive this signal properly by tuning of the cavity of the r.f. discriminator. In fact, the presence of a carrier would be apparent from the fact that the operator would hear his own modulation in his receiver, since it makes no difference to the i.f. signal whether the local-oscillator wave or the incoming signal is frequency-modulated. Thus the operator could set his frequency properly to receive modulation when it appeared on a quiescent carrier, simply by setting his frequency to reproduce his own modulation properly.

Suppose that the incoming carrier is that of an identical communication set and that it is at the frequency  $f_{A'} = f_B$ . That set must receive at  $f_B \pm f_I$ . These two frequencies are  $f_A$  and  $f_A + 2f_I$ . But the signal transmitted by the first station was at  $f_A$ , and therefore the second must receive the first when the first is set to receive the second. Communication can be initiated by the operator of one station with the operator of the other by proper setting of the relative frequencies of the two oscillators. Each operator may be certain that he is being heard by the other simply because he can hear himself. A large number of identical stations could be assigned different quiescent frequencies, and any one could establish communication with any other by setting his cavity frequency to the assigned receiving frequency of the other.

Since a band as wide as 10 per cent can be covered with the single-knob tuning of the cavity, a region of 1000 Mc. might be used for systems of a given type operating in the vicinity of 10,000 Mc. If the frequency stability were sufficient, channels 10 kc. in width could be used for voice communication and  $10^5$  such channels would be available. Considerable development would be required before such stability could be achieved in practice, but it would not be very difficult to get sufficient stability for, perhaps, two or more channels per Mc. Thus, two thousand or more channels would result in the 10-per cent band. It is not necessary that the receiver bandwidth or the transmitter bandwidth be as large as the distance between channels, since the exact setting within a given channel can be made by the operator initiating the communication. Knowledge of the identity of the station contacted is derived from the frequency interval in which the signal is found. If necessary, the d.c. component of the output voltage of the i.f. discriminator at one station could be used as an automatic-frequency-control voltage, fed into the frequency stabilizer at the modulation terminals, to keep the two stations in exact tune.

The well-known arguments relative to the 6-db loss encountered with the duplexer versus the use of separate antennas apply here. The decision must depend on the particular conditions to be met.

The features of the system so far discussed show that it is a basic system that allows duplex communication between any two of a large number of stations within line-of-sight range of one another. If any station is not operating, is out of range, or is off frequency, this is immediately apparent at the station attempting to initiate communication. A system analogous to the dial telephone could be visualized, with the frequency-control knob of the cavity corresponding to the dial and the absence of a signal corresponding to a busy signal.

#### A POSSIBLE APPLICATION

The fact that higher power or greater receiver sensitivity is required at microwave frequencies to accomplish the omnidirectional communication done at ultra-high frequencies disfavors application of this sort. Of more direct interest would be applications where the sharp antenna beams available with small antennas at microwaves are utilized. Fixed point-to-point communication could utilize such antennas, but, if both stations of a communicating pair possessed highly directive antennas, only scheduled communication, with correct aiming of the antennas at both stations, would be possible. Such applications might be of interest, but the present systems would not be utilized to their full advantage.

The remaining combination is one in which one station of a communicating pair has a highly directive antenna and the other has an omnidirectional one. The station having a directive antenna could establish communication with any station having a nondirectional antenna, provided that the operator knew the direction of the desired station relative to his own. The reverse process would not always be possible, but short-range communication between a pair of stations with nondirectional antennas could be achieved. Such a combination suggests ground control of aircraft, with the highly directive antenna at the ground station and a relatively nondirectional one in each airplane. The operator at the ground station would direct his antenna toward one of a group of incoming airplanes, not too nearly in the same relative direction, and search with his frequency-control knob for the signal from the airplane. When found, he would be in communication with the airplane in that direction, without confusion, even if a large number of aircraft were within line-of-sight range.

The aircraft could be spotted and the alignment of the communication antenna accomplished with radar, at night or through overcast. Once properly directed, the communication set itself could be made to maintain, automatically, the proper antenna pointing. Since a signal is received continuously from the aircraft, a conical scan, such as is used in automatically tracking

radar, could also be used on the communication system to derive a control signal for antenna alignment. This would be taken from the i.f. amplifier of the receiver before the limiter, and the phase of the amplitude modulation relative to the phase of the scanning of the antenna used to correct the pointing of the antenna, through servo mechanisms. Thus, the radar set could be returned to the maintenance of its search.

Unlike ordinary communication systems, the present one allows correlation of the frequency and position of the airplane through the directivity of the ground antenna. With the large number of channels available, the frequency allocations can be such that the airplane can be identified through its quiescent frequency. A code signal on the carrier can further increase the ability to identify the airplane.

With the automatic tracking feature incorporated, the communication set is endowed with the ability to give accurate bearing information about the airplane. If the airborne set is altered so that the audio output voltage is fed back to its frequency-modulation terminals, it can be made to repeat modulation originating at the ground station and thus to allow the determination of the range of the airplane from the time delay in the signal received at the ground station. For accurate determination of short ranges a wide-band system might be necessary, however, and then the feedback system of the airborne set might be difficult to make stable, and the number of communication channels available would be reduced.

#### FREQUENCY ALLOCATIONS

The best method of utilization of a frequency band depends on the type of service being contemplated. If only twenty or thirty channels are needed, they could be adjacent to one another and separated only enough

communication range of one another. In addition, the receiving frequency on one side of any carrier frequency cannot coincide with the receiving frequency on the other side of any other carrier frequency, without resulting in confusion.

One of the sensitive frequencies of the receiver could be removed by a rejection filter tracking the stabilizing cavity of the system. This would necessitate systems of two kinds, each kind having the opposite sideband suppressed. Only communication between systems of the opposite kinds would be possible, because the duplex communication utilizes the opposite sideband in each set of a communicating pair. It might be possible to switch the suppression device from one sideband to the other in a set initiating communication to allow communication between any pair.

Fig. 2 illustrates a possible method of frequency allocation for communication between any pair of a large number of stations. The horizontal axis represents a linear scale of frequency, and it is divided into regions less than the intermediate frequency in width, by blocks representing gaps having centers separated by the intermediate frequency. It has been chosen to term the low-frequency sideband of each quiescent station, the receiver frequency, and the high-frequency sideband, the image frequency. Each of the solid lines represents a carrier frequency, and a broken line below each of these, by the intermediate frequency, represents the quiescent receiving frequency. The dotted line, the same distance above the carrier frequency, represents the image frequency of that station. One of the carriers from the group on the right is missing. This is a station originating communication with one in the center group, and it is shown above the main diagram. It can be seen that only one station can be contacted at each frequency setting at a station initiating communication,

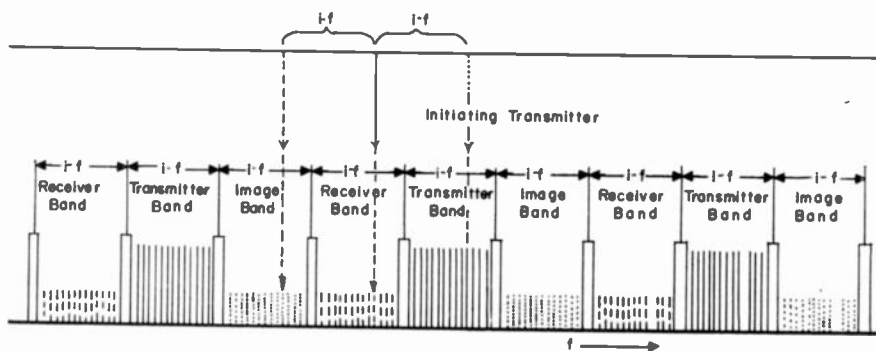

Fig. 2—A possible method of frequency allocation.

to allow them to be identified unambiguously with the available degree of absolute frequency stabilization. For a number of channels covering a band of frequencies wider than the intermediate frequency, the image response must be taken into account. No two stations may be assigned to frequencies different by the intermediate frequency if they are likely ever to be within com-

and any number of pairs of stations may be in communication if the carriers of the initiating stations are set to channels in the receiver bands. A scheme using systems of two types, each having an image-response suppressor, could be devised, making it possible to utilize one-half of the full number of channels available in the region. Without image suppression, only one-third of the

total number can be assigned. The increase of 50 per cent in the number of available channels seems hardly worth the complication involved, however. More channels might be more easily obtained through higher absolute frequency stability.

#### A BOOSTER STATION FOR A RELAY LINK

In connection with the adaptation of the system to range measurement, the possibility of connecting the audio output voltage to the modulation terminals was suggested. In this way, the oscillator is made to repeat frequency modulation in the received signal. Such a scheme could be used for a high-fidelity booster in a chain of relay stations. The repeated signal would have the level of the local transmitter, independently of the level of the received signal. Tracking would result so long as the received signal was strong enough to properly actuate the system. No problem of feedback between the transmitter and receiver would exist, although the transmitted frequency would differ from the received frequency by the intermediate frequency. The frequencies of each of a chain of boosters could alternate from one channel to another and so use two channels separated by the intermediate frequency.

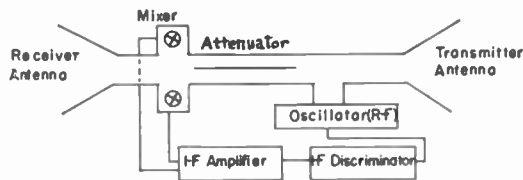

Fig. 3—A relay booster station.

The fidelity of such a booster could be very high because the device is completely degenerative. The principal problem in such a device would be the tendency of the feedback loop to become unstable. To accommodate signals requiring a wide pass band, this feature of the design problem would require considerable attention.

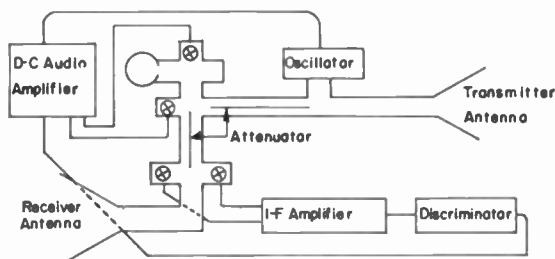

Fig. 4—A booster station having absolute frequency stabilization.

Block diagrams of two boosters of this type are shown in Figs. 3 and 4. These differ in that, in the first, no

stabilization system for the oscillator, except that provided by the i.f. channel, is used. If the carrier frequency of the received signal were always present, the oscillator of the booster would be stabilized directly to that, but if the incoming carrier were shut off, the booster oscillator could drift. Locking of the frequency-control circuit could not be assured when the incoming carrier was restored.

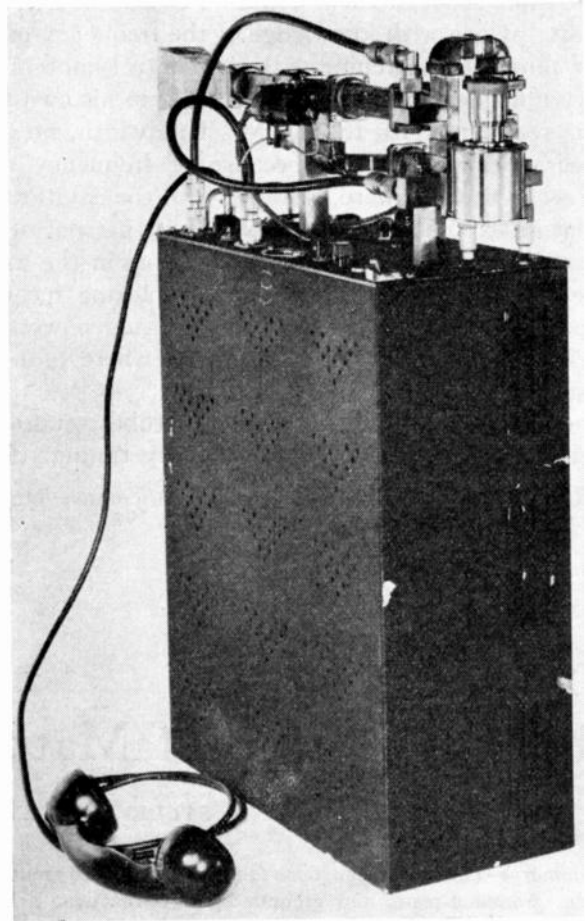

Fig. 5—A duplex communication set for the 3-centimeter band.

The system of Fig. 4 is almost identical to the duplex communication set except that the receiving and transmitting antennas are separated. The absolute stability of the oscillator frequency obtained with the stabilization circuit would maintain the correct receiving frequency, and tracking of an incoming signal would result as soon as such a signal was incident. Neither diagram shows a limiter in the i.f. part of the device. Very effective limiting is obtained by the feedback, since the stronger the incoming signal the more accurately does the booster track frequency modulation. A very strong signal might make the gain encompassed by the feedback loop large enough to cause instability, and, as a precaution against this, a limiter might be used.

## EXPERIMENTAL SYSTEMS

A pair of duplex communication sets have been constructed and operated experimentally. These used 2K25 tubes as oscillators, the d.c. system of frequency stabilization, and i.f. amplifiers at 30 Mc. with bandwidths of about 0.5 Mc. Balanced mixers were used as indicated in Fig. 1.<sup>2</sup> A photograph of one of these sets is shown in Fig. 5.

These sets operated as expected in all ways. Communication between them could be established by the operator at one with knowledge of the frequency of the other simply by searching with the control knob of the cavity until he could hear himself talk, in his own telephone receiver. With the 0.5-Mc. bandwidth, no difficulties were encountered because of frequency drift even when the sets were operated with the cavities and oscillators exposed to gusts of wind on the roof of the laboratory. Range tests using attenuators in the waveguide path between antenna and duplexing tee confirmed that only 10 milliwatts of radiated power was sufficient for a range of several miles where both antennas had gains of about 100.

Another pair of sets, using 2K45 tubes, stabilized through the reflector and the thermally tuning triode,

<sup>2</sup> Radiation Laboratory Series, vol. 16, "Microwave Mixers," McGraw-Hill Publishing Co., New York, N. Y., 1948.

has been constructed. In these an additional magic tee was used to provide independent adjustments of the oscillator power incident in the discriminator and in the balanced mixer. With these sets, single-knob control over about 1000 Mc. in the 3-centimeter band could be obtained. These systems utilized a standard f.m. communication receiver, with a preamplifier to improve the noise figure, as the i.f. part of the system. The bandwidth used was, therefore, only that used in ordinary f.m. broadcast. The greatest difficulty encountered was the tendency of the stabilization circuit to break into oscillation at certain frequency settings. This occurs because the effect of the high- $Q$  cavity on the oscillator is such that the gain in the feedback loop changes as the effective electrical length of the line between the cavity and the oscillator varies with frequency. An oscillator with a pulling figure no greater and a power output an order of magnitude or more greater would completely eliminate this trouble. Such an oscillator would also give a power level entirely adequate for line-of-sight ranges with a 10-kc. receiver bandwidth and a highly directive antenna at one end. For practical systems, much work is needed to obtain the requisite stability against changes of frequency with changes in temperature and pressure in the high- $Q$  cavities used for frequency control.

# The Application of Matrices to Vacuum-Tube Circuits\*

J. S. BROWN†, STUDENT, I.R.E., AND F. D. BENNETT‡, MEMBER, I.R.E.

**Summary**—The matrix equations for the triode in the grounded-cathode, grounded-plate, and grounded-grid connections are derived for linear operation. The nonbilateral characteristics of the networks are pointed out, and a table relating matrix elements is calculated on this basis. The formula for the gain of an amplifier is derived for one stage and then for  $m$  identical stages. Two examples are given which illustrate the advantages of the matrix method.

## I. INTRODUCTION

THE FIRST APPLICATION of matrix algebra to the study of four-terminal passive networks, operating under steady-state conditions, was made by Strecker and Feldtkeller in 1929.<sup>1</sup> Since then, many

others have contributed to the subject,<sup>2-9</sup> and recently a unifying treatment of four-terminal networks based on the bilinear transformation and drawing on matrix theory has appeared.<sup>10</sup>

All of the previously mentioned works were concerned only with passive networks. In 1930, Strecker and Feldtkeller, preceded slightly by A. C. Bartlett, applied the matrix method to vacuum-tube ampli-

<sup>2</sup> H. G. Baerwald, "Quadripoles and their applications," *Preuss. Akad. Wiss.*, Berlin, Ber., vol. 33, pp. 784-829; 1931.

<sup>3</sup> H. G. Baerwald, "Strecker-Feldtkeller Quadripole Equations," *Elec. Nach. Tech.*, vol. 9, pp. 31-38; June, 1932.

<sup>4</sup> L. Brillouin, "Electric filters and theory of matrices," *Revue Generale de l'Electricite*, vol. 39, pp. 3-16; January 4, 1936.

<sup>5</sup> E. A. Guillemin, "Communication Networks," vol. 2, John Wiley and Sons, Inc., New York, N. Y., 1935.

<sup>6</sup> L. A. Pipes, "Matrices in engineering," *Elec. Eng.*, vol. 56, pp. 1177-1190; September, 1937.

<sup>7</sup> L. A. Pipes, "The matrix theory of four terminal networks," *Phil. Mag.*, Ser. 7-33, pp. 370-395; November, 1940.

<sup>8</sup> G. Kron, "Application of Tensor Analysis to Networks," John Wiley and Sons, Inc., New York, N. Y. 1942.

<sup>9</sup> P. Richards, "Application of matrix algebra to filter theory," *Proc. I.R.E.*, vol. 34, pp. 145-150; March, 1946.

<sup>10</sup> S. Gorn, "Mathematical Tools in the Theory of Four Terminal Networks," Air Technical Service Command, TSELPS-29; January, 1946.

\* Decimal classification: R139.1. Original manuscript received by the Institute, June 10, 1947; revised manuscript received, November 17, 1947. A portion of a thesis by J. S. Brown submitted to the Graduate School of the University of Illinois in partial fulfillment of the requirements for the degree of master of science in electrical engineering.

† Argonne National Laboratory, Chicago, Ill.

‡ Electrical Engineering Laboratories, University of Illinois, Urbana, Ill.

<sup>1</sup> F. Strecker and R. Feldtkeller, "Theory of the generalized quadripole," *Elec. Nach. Tech.*, vol. 6, pp. 93-112; March, 1929.

fiers.<sup>11,12</sup> Both of these early papers considered an infinite chain of identical amplifier stages. The work of Strecker and Feldtkeller was, however, much more extensive, going on to a study of the amplifier frequency response and cutoff frequencies. Kron also studied vacuum-tube circuits by the use of matrices, but not as four-terminal networks.<sup>13</sup> He considered the general Kirchhoff laws circuit equations and took advantage of the concise notation of the tensor analysis. In a recent paper by Abbott, the methods recorded in Guillemin's text were applied to obtain the elements of a vacuum-tube matrix.<sup>14</sup> Only the grounded-cathode circuit was considered. The equation for the voltage gain was derived and an example of a single-stage amplifier with inverse feedback was discussed.

The application of matrix algebra to vacuum-tube amplifier circuits is advocated because it reduces the amount of work necessary when analyzing the circuits in detail. It has the additional advantage of organizing previously developed results so that they can be drawn upon in attacking problems. The purposes of this paper are, therefore, to develop the matrices for the three possible triode connections, and then indicate how these matrices can be used and what results can be obtained. The nonbilateral characteristics of the resultant matrix of the vacuum tube and its capacitive circuits will be studied, and the gain equation will then be investigated with regard to the portions of the equation indicating any feedback paths.

II. DEVELOPMENT OF THE GENERAL THEORY

Before starting the theory development, it would be well to define the directions of voltage and current at the terminals of a four-terminal network. In Fig. 1,

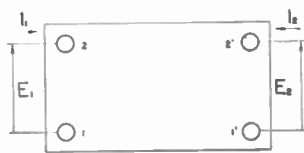

Fig. 1—Four-terminal network.

the positive directions of current are indicated. It is necessary to adopt a convention for the positive direction of current, and we will, therefore, consider that our current is positive if it flows through an impedance from the positive terminal of a source and returns from the other end of the impedance to the negative terminal of

the source. Therefore,  $I_1$  will be positive if terminal 2 is at a positive potential with respect to terminal 1,  $E_1$  being the source. When alternating currents are being considered, the same reasoning is applied to the instantaneous values of voltage and current. For example, in Fig. 1, if  $E_1$  is an alternating voltage, then at any instant when the potential of  $E_1$  is a potential rise as indicated by the arrow,  $I_1$  will be defined as positive if it is flowing in the direction indicated by its arrow.

A knowledge on the part of the reader of elementary matrix algebra will be assumed.<sup>5-7</sup> Before going ahead, it would be well to list the forms in which the four-terminal equations can be written. The voltages and currents will be those indicated in Fig. 1.

$$\begin{aligned}
 \text{(a)} \quad & \begin{pmatrix} E_1 \\ I_1 \end{pmatrix} = \begin{pmatrix} A & B \\ C & D \end{pmatrix} \begin{pmatrix} E_2 \\ -I_2 \end{pmatrix} \\
 \text{(b)} \quad & \begin{pmatrix} E_2 \\ -I_2 \end{pmatrix} = \begin{pmatrix} D & -B \\ -C & A \\ \eta & \eta \end{pmatrix} \begin{pmatrix} E_1 \\ I_1 \end{pmatrix} = \begin{pmatrix} \alpha & \beta \\ \gamma & \delta \end{pmatrix} \begin{pmatrix} E_1 \\ I_1 \end{pmatrix} \\
 & \text{where } \eta = AD - DC \\
 \text{(c)} \quad & \begin{pmatrix} I_1 \\ I_2 \end{pmatrix} = \begin{pmatrix} D & -\eta \\ B & B \\ -1 & A \\ B & B \end{pmatrix} \begin{pmatrix} E_1 \\ E_2 \end{pmatrix} = \begin{pmatrix} y_{11} & y_{12} \\ y_{21} & y_{22} \end{pmatrix} \begin{pmatrix} E_1 \\ E_2 \end{pmatrix} \\
 \text{(d)} \quad & \begin{pmatrix} E_1 \\ E_2 \end{pmatrix} = \begin{pmatrix} A & \eta \\ C & C \\ 1 & D \\ C & C \end{pmatrix} \begin{pmatrix} I_1 \\ I_2 \end{pmatrix} = \begin{pmatrix} z_{11} & z_{12} \\ z_{21} & z_{22} \end{pmatrix} \begin{pmatrix} I_1 \\ I_2 \end{pmatrix} \quad (1) \\
 \text{(e)} \quad & \begin{pmatrix} I_1 \\ E_2 \end{pmatrix} = \begin{pmatrix} C & -\eta \\ A & A \\ 1 & B \\ A & A \end{pmatrix} \begin{pmatrix} E_1 \\ I_2 \end{pmatrix} = \begin{pmatrix} g_{11} & g_{12} \\ g_{21} & g_{22} \end{pmatrix} \begin{pmatrix} E_1 \\ I_2 \end{pmatrix} \\
 \text{(f)} \quad & \begin{pmatrix} E_1 \\ I_2 \end{pmatrix} = \begin{pmatrix} B & \eta \\ D & D \\ -1 & C \\ D & D \end{pmatrix} \begin{pmatrix} I_1 \\ E_2 \end{pmatrix} = \begin{pmatrix} h_{11} & h_{12} \\ h_{21} & h_{22} \end{pmatrix} \begin{pmatrix} I_1 \\ E_2 \end{pmatrix}
 \end{aligned}$$

Equation (1) was taken from footnote reference 5 and altered to include nonbilateral networks by specifying the condition that  $AD - BC = \eta$ . These matrices can be used in treating cascaded circuits by matrix multiplication (1a) and (1b); parallel circuits (1c), series circuits (1d), parallel input and series output circuits (1e), and series input and parallel output circuits (1f) by addition. An extensive treatment of these connections with bilateral circuits can be found in footnote references 5 and 7.

As a start in the development of the vacuum-tube

<sup>11</sup> A. C. Bartlett, "Multi-stage valve amplifier," *Phil. Mag.*, Ser. 7-10, pp. 734-738; October, 1930.

<sup>12</sup> F. Strecker and R. Feldtkeller, "Theory of low frequency amplifier chains," *Arch. für Electrotech.*, vol. 24, pp. 425-468; November 7, 1930.

<sup>13</sup> G. Kron, "Application of Tensor Analysis to Networks," John Wiley and Sons, Inc., New York, N. Y., 1942.

<sup>14</sup> W. R. Abbott, "Analysis of four-terminal networks containing vacuum tubes," A.I.E.E. Miscellaneous Paper 46-204, recommended by the A.I.E.E. Great Lakes District meeting Committee for presentation at the A.I.E.E. Great Lakes District Meeting, Indianapolis, Ind., October 9-11, 1946.

matrices, let us introduce the equivalent-plate-circuit theorem<sup>15</sup>

$$i_p = \frac{1}{r_p} (\mu e_g + e_p), \quad i_g = 0, \quad (2)$$

which assumes operation on the linear portion of the vacuum-tube operating characteristic. The voltages  $e_g$  and  $e_p$  are the alternating voltages of the grid and plate, respectively, referred to the cathode, and  $e_p$  will be interpreted as the alternating voltage across the load. Although it does not appear in (2), the load impedance is implicit in the term  $e_p$ . The alternating plate current is  $i_p$  and the alternating plate resistance is  $r_p$ . It should also be specifically stated that in (2)  $i_p$  is the dependent and  $e_g$  and  $e_p$  are the independent variables. This distinction is important in handling the various matrix forms in which the role of independent and dependent variables may appear to be reversed. Physically, one must always choose  $e_g$  and  $e_p$  in order to determine  $i_p$  for the tube. It appears that no physical meaning attaches to the choice of  $i_p$  and  $e_p$  as independent variables in order to determine  $e_p$ , or to the choice of  $e_g$  and  $i_p$  to determine  $e_p$ . Where the forms imply this choice, one must keep in mind the first physical situation and regard the mathematics as a convenient tool in manipulation.

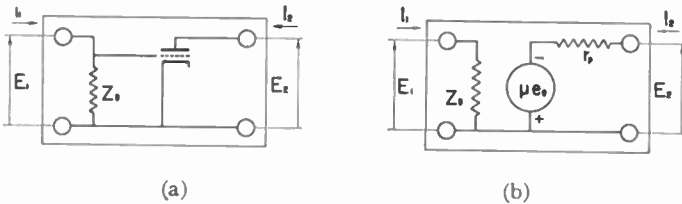

Fig. 2—Grounded-cathode connection as a four-terminal network.

Consider the circuit shown in Fig. 2. Inspection reveals that

$$E_1 = e_g, \quad E_2 = e_p, \quad I_1 = \frac{E_1}{z_g}, \quad I_2 = i_p. \quad (3)$$

From (2) and (3) we can obtain

$$I_1 = \frac{1}{z_g} \cdot E_1$$

$$I_2 = g_m E_1 + \frac{1}{r_p} \cdot E_2$$

where  $g_m$  is the grid-plate transconductance and equals  $\mu/r_p$ . From the current equations we can write the matrix equation

$$\begin{bmatrix} I_1 \\ I_2 \end{bmatrix} = \begin{bmatrix} \frac{1}{z_g} & 0 \\ g_m & \frac{1}{r_p} \end{bmatrix} \begin{bmatrix} E_1 \\ E_2 \end{bmatrix} \quad (4a)$$

where the subscript  $k$  indicates that the matrix refers to a grounded-cathode circuit.

From (4a) we can obtain

$$\begin{bmatrix} E_1 \\ E_2 \end{bmatrix} = \begin{bmatrix} z_g & 0 \\ -\mu z_g & r_p \end{bmatrix} \begin{bmatrix} I_1 \\ I_2 \end{bmatrix} \quad (4b)$$

and

$$\begin{bmatrix} E_1 \\ I_1 \end{bmatrix} = \begin{bmatrix} -1 & -1 \\ \mu & g_m \end{bmatrix} \begin{bmatrix} E_2 \\ -I_2 \end{bmatrix} \quad (4c)$$

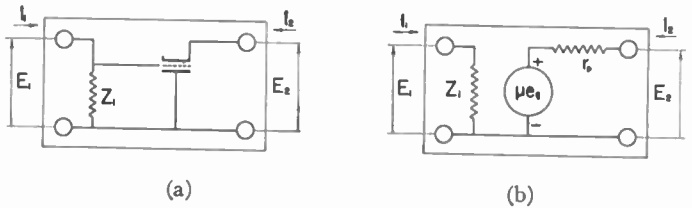

Fig. 3—Grounded-plate connection as a four-terminal network.

Consider the circuit of Fig. 3(a), from which

$$e_g = E_1 - E_2, \quad E_1 = I_1 z_i$$

$$i_p = -I_2, \quad e_p = -E_2. \quad (6)$$

Substituting (6) into (2), we obtain

$$I_1 = \frac{1}{z_i} \cdot E_1$$

$$I_2 = -g_m E_1 + \frac{1 + \mu}{r_p} \cdot E_2.$$

From which we can write

$$\begin{bmatrix} I_1 \\ I_2 \end{bmatrix} = \begin{bmatrix} \frac{1}{z_i} & 0 \\ -g_m & \frac{1 + \mu}{r_p} \end{bmatrix} \begin{bmatrix} E_1 \\ E_2 \end{bmatrix} \quad (7a)$$

$$\begin{bmatrix} E_1 \\ E_2 \end{bmatrix} = \begin{bmatrix} z_i & 0 \\ \frac{\mu z_i}{1 + \mu} & \frac{r_p}{1 + \mu} \end{bmatrix} \begin{bmatrix} I_1 \\ I_2 \end{bmatrix} \quad (7b)$$

$$\begin{bmatrix} E_1 \\ I_1 \end{bmatrix} = \begin{bmatrix} \frac{1 + \mu}{\mu z_i} & \frac{1}{g_m z_i} \\ \mu & 1 \end{bmatrix} \begin{bmatrix} E_2 \\ -I_2 \end{bmatrix} \quad (7c)$$

where the subscript  $p$  indicates that the matrix refers to a grounded-plate circuit.

The third possible connection of a triode vacuum tube, the grounded-grid connection, is shown in Fig. 4. From Fig. 4(a) we can see that

$$e_g = -E_1, \quad e_p = -E_1 + E_2, \quad i_p = I_2, \quad (8)$$

$$E_1 = (I_1 + I_2) z_k,$$

<sup>15</sup> H. J. Reich, "Theory and Application of Vacuum Tubes," 1st ed., McGraw-Hill Publishing Co., New York, N. Y., 1939.



which, substituted into (2), gives

$$I_1 = \frac{r_p + (1 + \mu)z_k}{r_p z_k} E_1 - \frac{1}{r_p} E_2$$

$$I_2 = -\frac{1 + \mu}{r_p} E_1 + \frac{1}{r_p} E_2.$$

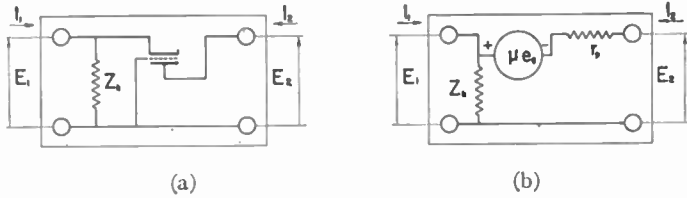

Fig. 4—Grounded-grid connection as a four-terminal network.

From which can be written

$$\begin{Bmatrix} I_1 \\ I_2 \end{Bmatrix} = \begin{bmatrix} \frac{r_p + (1 + \mu)z_k}{r_p z_k} & -\frac{1}{r_p} \\ \frac{1 + \mu}{r_p} & \frac{1}{r_p} \end{bmatrix} \begin{Bmatrix} E_1 \\ E_2 \end{Bmatrix} \quad (9a)$$

$$\begin{Bmatrix} E_1 \\ E_2 \end{Bmatrix} = \begin{bmatrix} z_k & z_k \\ (1 + \mu)z_k & r_p + (1 + \mu)z_k \end{bmatrix} \begin{Bmatrix} I_1 \\ I_2 \end{Bmatrix} \quad (9b)$$

$$\begin{Bmatrix} E_1 \\ I_1 \end{Bmatrix} = \begin{bmatrix} \frac{1}{1 + \mu} & \frac{r_p}{1 + \mu} \\ \frac{1}{(1 + \mu)z_k} & \frac{r_p + (1 + \mu)z_k}{(1 + \mu)z_k} \end{bmatrix} \begin{Bmatrix} E_2 \\ -I_2 \end{Bmatrix} \quad (9c)$$

where the subscript *g* indicates that the matrix refers to a grounded-grid circuit.

Comparison of (4), (7), and (9) with the equations describing passive bilateral networks reveals a difference in the case of all the vacuum-tube circuit equations. That is, for the vacuum tubes in general,

$$(a) \quad y_{12} \neq y_{21} \quad (10)$$

$$(b) \quad z_{12} \neq z_{21}.$$

In fact, when operating the vacuum tube with plate or cathode grounded,

$$z_{12} = y_{12} = 0 \quad (11)$$

when the interelectrode capacitances are not considered. This makes necessary definitions of unilateral and bilateral networks which had been assumed up to the present time.

A unilateral impedance is one which provides coupling in one direction only between two networks.<sup>16</sup> A bilateral impedance is one which provides coupling equally in either direction between two networks. The above definitions, it should be noted, apply to coupling or transfer impedances. On this basis we can define a unilateral

network as a network in which the coupling impedance is unilateral. This leads to the conclusion that a network can transmit in one direction only or in either direction equally well, depending on whether the network is unilateral or bilateral respectively.

Since, by definition,  $z_{12}$ ,  $z_{21}$ ,  $y_{12}$ , and  $y_{21}$  are the terms which describe the ability of a network to transmit energy, (10) would indicate that the network described is not bilateral. Going further, (11) may be taken as the definition of a unilateral network.<sup>17</sup> The  $z$  and  $y$  matrices show the functional dependence previously pointed out in (2). When  $z_{12}$ , and therefore  $y_{12}$ , are zero, it can be shown that the (1b) type of matrix does not exist.

Let us now look more closely into the above conditions to see what they mean with reference to some of the matrix elements. For this purpose, consider equation (1c), from which

$$y_{12} = -\frac{\eta}{B},$$

$$y_{21} = -\frac{1}{B},$$

or

$$\frac{y_{12}}{y_{21}} = \eta = AD - BC. \quad (12a)$$

From equation (1d) it can also be shown that

$$\frac{z_{12}}{z_{21}} = \eta = AD - BC. \quad (12b)$$

The relationships between the elements of all the matrices in the set of equations (1) have been developed on the basis of (12a) and (12b) and tabulated in Appendix I for convenient reference.

From equations (1a) and (1b) we obtain

$$\begin{Bmatrix} E_2 \\ -I_2 \end{Bmatrix} = \begin{bmatrix} A & B \\ C & D \end{bmatrix}^{-1} \begin{Bmatrix} E_1 \\ I_1 \end{Bmatrix}$$

$$= \begin{bmatrix} \frac{D}{\eta} & -\frac{B}{\eta} \\ -\frac{C}{\eta} & \frac{A}{\eta} \end{bmatrix} \begin{Bmatrix} E_1 \\ I_1 \end{Bmatrix}$$

from which we can see that the inverse matrix exists if (11) does not hold. If  $\eta = 0$ , that is,  $z_{12} = 0$  ( $z_{21} = \infty$  is not considered physically realizable), then there can be transmission in only one direction; and, speaking mathematically,  $E_1$  and  $I_1$  are functions of  $E_2$  and  $I_2$ , considered as independent variables, but the reverse is not so. The cause of this phenomenon may be found in the functional dependence of  $i_p$  on  $e_p$  and  $e_g$ , as pointed out in the discussion of (2). Equations (4c) and (7c) also

<sup>16</sup> W. L. Everitt, "Communication Engineering," p. 344, par. 2, 2nd ed., McGraw-Hill Book Co., New York, N. Y., 1937.

<sup>17</sup> It is of interest to note that the bilateral condition is equivalent to reciprocity.

exhibit the characteristic that  $\eta=0$ , but this is not so for (9c) wherein  $\eta=1/1+\mu$ . In the connection represented by (9c) the coupling between circuits is provided by the conduction path through the tube; whereas, in the examples of (4c) and (7c) the independence of the grid and plate circuits is responsible for the unilateral characteristic.

We then see that  $\eta$  can take on values such that  $0 \leq \eta \leq 1$ , the lower extreme representing the grounded-cathode or grounded-plate type of vacuum-tube networks, the upper extreme representing the bilateral passive network, and intermediate values being given by the grounded-grid circuit. When a passive bilateral quadripole is combined with a vacuum-tube quadripole (for example, a  $\pi$  network representing interelectrode admittances with a grounded-cathode vacuum-tube quadripole), complex values of  $\eta$  are obtained and  $|\eta|$  can take on values greater than one. Strecker and Feldtkeller<sup>12</sup> considered one stage of an infinite chain of identical amplifiers (where the  $z_L$  was the  $z_{11}$  of the following stage and  $z_o$  was the  $z_{22}$  of the previous stage), and found that

$$\frac{E_1'}{E_2'} = \eta \frac{E_2}{E_1} \quad (14)$$

where  $E_1'/E_2'$  represents the gain in the reverse direction, and  $E_2/E_1$  the gain in the forward direction.

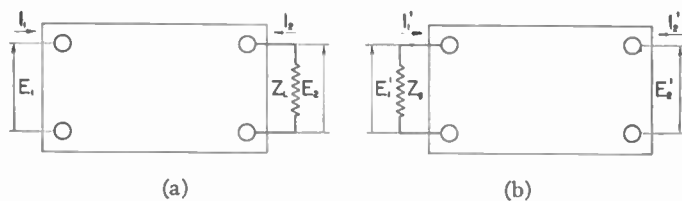

Fig. 5—Generalized amplifier.

If a single stage is considered, no such simple relationship can be found. For example, consider Fig. 5(a).

$$E_2 = -I_2 z_L. \quad (15)$$

From equation (1a) we can obtain

$$E_1 = A E_2 - B I_2. \quad (16)$$

Substituting (15) into (16) results in

$$\frac{E_2}{E_1} = \frac{z_L}{A z_L + B}, \quad (17)$$

which we will define as the voltage amplification in the forward direction, and designate it by

$$G = \frac{z_L}{A z_L + B}. \quad (18)$$

If  $\eta \neq 0$ , we can obtain in a similar way for the circuit of Fig. 5(b)

$$\frac{E_1'}{E_2'} = \frac{\eta z_o}{D z_o + B}. \quad (19)$$

Let us define (19) as the voltage amplification in the reverse direction and denote it by

$$G' = \frac{\eta z_o}{D z_o + B}. \quad (20)$$

Comparison of (18) and (20) reveals that, if

$$(a) \quad A = D \quad (21)$$

and

$$(b) \quad z_o = z_L, \quad G' = \eta G, \quad (22)$$

which is the same as (14) except the  $G$  or  $G'$  refer to a single-stage amplifier.

Returning now to (18), let us rewrite it in terms of impedance matrix elements. We obtain

$$G = \frac{z_L \cdot z_{21}}{z_{11}(z_L + z_{22}) - \eta z_{21}^2}$$

and

$$G' = \frac{\frac{z_L z_{21}}{z_{11}(z_L + z_{22})}}{1 - \eta \frac{z_{21}}{z_L} \frac{z_L \cdot z_{21}}{z_{11}(z_L + z_{22})}}. \quad (23)$$

If  $\eta = 0$ , (23) becomes

$$G'_{\eta=0} = \frac{z_L \cdot z_{21}}{z_{11}(z_L + z_{22})}, \quad (24)$$

which is the gain when there is no passive coupling impedance between the output and input circuit. Substitution of (24) into (23) gives

$$G = \frac{G'_{\eta=0}}{1 - \eta \frac{z_{21}}{z_L} \cdot G'_{\eta=0}}, \quad (25)$$

which is identical with equation for the gain of an amplifier with a single controlled feedback path.<sup>18-20</sup>

Let us now develop the corresponding equation for the gain of an  $m$ -stage amplifier in which all the stages are identical except the last stage, which has a load impedance of  $z_L$ . The first step in this process is to find

$$\left\| \begin{matrix} A & B \\ C & D \end{matrix} \right\|^m = \left\| \begin{matrix} A_m & B_m \\ C_m & D_m \end{matrix} \right\|$$

where the superscript indicates the number of times the matrix is multiplied by itself.

This is done in the Appendix II, and gives us

<sup>18</sup> H. S. Black, "Stabilized Feedback Amplifiers," *Elec. Eng.*, vol. 53, p. 114, January, 1934.

<sup>19</sup> U. S. Patent 2,102,671, December 21, 1937, to H. S. Black.

<sup>20</sup> H. W. Bode, "Network Analysis and Feedback Amplifier Design," D. Van Nostrand Co., Inc., New York, N. Y., 1945.

$$\begin{vmatrix} A & B \\ C & D \end{vmatrix}^m = \frac{1}{s_2 - s_1} \begin{vmatrix} -s_1 & s_2 \\ -1 & 1 \end{vmatrix} \begin{vmatrix} \lambda_1^m & 0 \\ 0 & \lambda_2^m \end{vmatrix} \begin{vmatrix} 1 & -s_2 \\ 1 & -s_1 \end{vmatrix} \quad (26a)$$

$$s_1 = \frac{(A - D) + \sqrt{(A + D)^2 - 4\eta}}{2C}$$

$$s_2 = \frac{(A - D) - \sqrt{(A + D)^2 - 4\eta}}{2C}$$

$$s_1 + s_2 = \frac{A - D}{C}, \quad s_1 s_2 = -\frac{B}{C}$$

$$s_1 - s_2 = \frac{\sqrt{(A + D)^2 - 4\eta}}{C}$$

where

$$\lambda_1 = \frac{(A + D) + \sqrt{(A + D)^2 - 4\eta}}{2}$$

$$\lambda_2 = \frac{(A + D) - \sqrt{(A + D)^2 - 4\eta}}{2}$$

$$\lambda_1 + \lambda_2 = A + D, \quad \lambda_1 \lambda_2 = \eta$$

Expanding (26a), we obtain

$$\begin{vmatrix} A_m & B_m \\ C_m & D_m \end{vmatrix} = \frac{1}{s_2 - s_1} \begin{vmatrix} (s_2 \lambda_2^m - s_1 \lambda_1^m) & \{s_1 s_2 (\lambda_1^m - \lambda_2^m)\} \\ (\lambda_2^m - \lambda_1^m) & (s_2 \lambda_1^m - s_1 \lambda_2^m) \end{vmatrix} \quad (26b)$$

Considering the  $m$  cascaded four-terminal networks as a single quadripole described by (26b), we can write for the gain of this network

$$G_m = \frac{z_L}{A_m z_L + B_m} \quad (27a)$$

$$G_m = \frac{z_L (s_2 - s_1)}{(s_2 \lambda_2^m - s_1 \lambda_1^m) z_L + (\lambda_1^m - \lambda_2^m) s_1 s_2} \quad (27b)$$

From  $\lambda_2 = \eta/\lambda_1$ , (27b) can be written

$$G_m = \frac{z_L \lambda_1^m (s_2 - s_1)}{(s_2 \eta^m - s_1 \lambda_1^{2m}) z_L + (\lambda_1^{2m} - \eta^m) s_1 s_2} \quad (27c)$$

If we let  $\eta = 0$ , then

$$\begin{vmatrix} -\frac{1}{\mu'} & -\frac{1}{g_m'} \\ \frac{1}{z_0 \mu'} & \frac{1}{z_0 g_m'} \end{vmatrix} = \begin{vmatrix} \frac{1 + \mu_1}{\mu_1} & \frac{1}{g_{m1}} \\ \frac{1 + \mu_1}{z_1 \mu_1} & \frac{1}{z_1 g_{m1}} \end{vmatrix} \begin{vmatrix} \frac{1}{1 + \mu_2} & \frac{r_{p2}}{1 + \mu_2} \\ \frac{1}{(1 + \mu_2) z_k} & \frac{r_{p2} + (1 + \mu_2) z_k}{(1 + \mu_2) z_k} \end{vmatrix}$$

$$\begin{vmatrix} -\frac{1}{\mu'} & -\frac{1}{g_m'} \\ \frac{1}{z_0 \mu'} & \frac{1}{z_0 g_m'} \end{vmatrix} = \begin{vmatrix} \frac{1 + \mu_1}{\mu_1(1 + \mu_2)} + \frac{r_{p1}}{\mu_1(1 + \mu_2) z_k} & \frac{r_{p2}(1 + \mu_1)}{\mu_1(1 + \mu_2)} + \frac{r_{p1} r_{p2} + (1 + \mu_2) r_{p1} z_k}{\mu_1(1 + \mu_2) z_k} \\ \frac{1 + \mu_1}{\mu_1(1 + \mu_2) z_1} + \frac{r_{p1}}{\mu_1(1 + \mu_2) z_1 z_k} & \frac{r_{p2}(1 + \mu_1)}{\mu_1(1 + \mu_2) z_1} + \frac{r_{p1} r_{p2} + (1 + \mu_2) r_{p1} z_k}{\mu_1(1 + \mu_2) z_k z_1} \end{vmatrix}$$

$$G_{m,\eta=0} = \frac{z_L \lambda_1^m (s_2 - s_1)}{s_1 s_2 \lambda_1^{2m} - s_1 z_L \lambda_1^{2m}} = \frac{z_L (s_2 - s_1)}{s_1 \lambda_1^m (s_2 - z_L)} \quad (28)$$

If the elements from the impedance matrix are substituted into (28) we obtain

$$G_{m,\eta=0} = \left\{ \frac{(z_{11} \cdot z_{21})}{z_{11}(z_{11} + z_{22})} \right\}^{m-1} \cdot \frac{z_L z_{21}}{z_{11}(z_{22} + z_L)} \quad (29)$$

which corresponds to (24) for a single-stage amplifier. As a matter of fact, the last quantity in (29) is identical to (24). The first part of (29),

$$G_{m-1,\eta=0} = \left\{ \frac{z_{11} z_{21}}{z_{11}(z_{11} + z_{22})} \right\}^{m-1}$$

is the gain of  $m-1$  identical amplifier stages, each loaded by  $z_{11}$  of the succeeding stage and followed by a last stage loaded with  $z_L$ .

Considering again (27c), it can be written

$$G_m = \frac{\frac{z_L (s_2 - s_1)}{s_1 \lambda_1^m (s_2 - z_L)}}{1 - \frac{s_2 \eta^m (s_1 - z_L)}{s_1 \lambda_1^{2m} (s_2 - z_L)}}$$

which, from (28), becomes

$$G_m = \frac{G_{m,\eta=0}}{1 - \frac{\eta^m s_2 (s_1 - z_L)}{z_L \lambda_1^m (s_2 - s_1)} G_{m,\eta=0}} \quad (30)$$

If  $m = 1$ , we obtain (25) from (30), after substituting the elements of the impedance matrix.

### III. EXAMPLES

Let us now consider several examples illustrating the use of matrices to solve vacuum-tube circuit problems. Consider the circuit in Fig. 6.

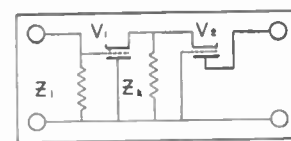

Fig. 6—Cathode-coupled triode amplifier represented as a four-terminal network.

If the interelectrode capacitances are neglected and we wish to find the equivalent  $\mu$ ,  $r_p$ , and  $g_m$ , let us write the matrix product of (7c) and (9c). This gives

If  $V_1$  and  $V_2$  are the same type, operating so that  $\mu_1 = \mu_2 = \mu$ ,  $r_{p1} = r_{p2} = r_p$ , and  $g_{m1} = g_{m2} = g_m$ ,

then the above reduces to

$$\begin{vmatrix} -\frac{1}{\mu_1'} & -\frac{1}{g_m'} \\ \frac{1}{z_g \mu'} & -\frac{1}{z_g g_m'} \end{vmatrix} = \begin{vmatrix} \frac{(1 + \mu)z_k + r_p}{\mu(1 + \mu)z_k} & \frac{2r_p(1 + \mu)z_k + r_p^2}{\mu(1 + \mu)z_k} \\ \frac{(1 + \mu)z_k + r_p}{\mu(1 + \mu)z_k z_1} & \frac{2r_p(1 + \mu)z_k + r_p^2}{\mu(1 + \mu)z_k z_i} \end{vmatrix}$$

Equating elements in the above two matrices, we obtain, after letting  $z_g = z_1$ ,

$$\mu' = -\frac{\mu(1 + \mu)z_k}{r_p + (1 + \mu)z_k} = -\mu \frac{(1 + \mu)z_k}{(1 + \mu)z_k + r_p}$$

$$g_m' = -\frac{\mu(1 + \mu)z_k}{2(1 + \mu)z_k r_p + r_p^2}$$

$$= -g_m \frac{(1 + \mu)z_k}{2(1 + \mu)z_k + r_p}$$

From which,

$$r_p' = r_p \frac{2(1 + \mu)z_k + r_p}{(1 + \mu)z_k + r_p}$$

The same results could, of course, have been obtained by the fundamental application of Kirchhoff's laws to the circuit shown. This was done by Korman, and required the writing of more than twelve equations and their solutions to obtain the results.<sup>21</sup>

As another example, consider the input impedance of a triode vacuum tube as a function of interelectrode capacitance. The circuit for only the interelectrode capacitances is given in Fig. 7. We know that

$$\begin{vmatrix} A_c & B_c \\ C_c & D_c \end{vmatrix} = \begin{vmatrix} 1 & 0 \\ j\omega C_{ok} & 1 \end{vmatrix} \begin{vmatrix} 1 & \frac{1}{j\omega C_{op}} \\ 0 & 1 \end{vmatrix} \begin{vmatrix} 1 & 0 \\ j\omega C_{pk} & 1 \end{vmatrix}$$

$$= \begin{vmatrix} \frac{C_{op} + C_{pk}}{C_{op}} & \frac{1}{j\omega C_{op}} \\ j\omega \left\{ \frac{C_{ok}(C_{op} + C_{pk})}{C_{op}} + C_{pk} \right\} & \frac{C_{ok} + C_{op}}{C_{op}} \end{vmatrix}$$

From Appendix I we obtain

$$\begin{vmatrix} y_{11} & y_{12} \\ y_{21} & y_{22} \end{vmatrix} = \begin{vmatrix} j\omega(C_{op} + C_{ok}) & -j\omega C_{op} \\ -j\omega C_{op} & j\omega(C_{op} + C_{pk}) \end{vmatrix} \quad (31)$$

From the inspection we can write the matrix for  $z_L$  as

$$\|Y_{z_L}\| = \begin{vmatrix} 0 & 0 \\ 0 & \frac{1}{z_L} \end{vmatrix} \quad (32)$$

The matrix for the circuit of Fig. 9 is then the sum of (31), (32), and (4a), neglecting the  $1/z_g$  from (4a).

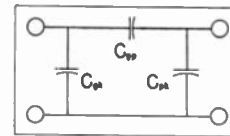

Fig. 7—Grounded-cathode-connection interelectrode capacitance of a vacuum tube represented as a four-terminal network.

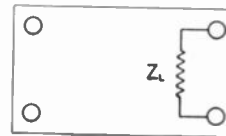

Fig. 8—Amplifier load impedance represented as a four-terminal network.

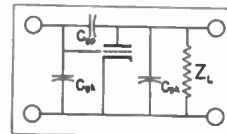

Fig. 9—Grounded-cathode connection of vacuum tube including interelectrode capacitance and load impedance, represented as a four-terminal network.

$$\|Y_{TC}\| = \begin{vmatrix} j\omega(C_{op} + C_{ok}) & -j\omega C_{op} \\ (g_m - j\omega C_{op}) & j\omega(C_{op} + C_{pk}) + \frac{1}{r_p} + \frac{1}{z_L} \end{vmatrix}$$

<sup>21</sup> N. Korman, "Cathode-coupled triode amplifiers," Proc. I.R.E., vol. 35, p. 48; January, 1947.

Using the identities of Appendix I,

$$z_{11} = \frac{\frac{z_L + r_p}{z_L r_p} + j\omega(C_{op} + C_{pk})}{\{j\omega(C_{op} + C_{ok})\} \left\{ \frac{z_L + r_p}{z_L r_p} + j\omega(C_{op} + C_{pk}) \right\} + \omega^2 C_{op}^2 + j\omega C_{op} g_m}$$

$$z_{11} = \frac{\frac{r_p + z_L}{r_p z_L} + j\omega(C_{op} + C_{pk})}{-\omega^2(C_{ok}C_{pk} + C_{op}C_{ok} + C_{op}C_{pk}) + j\omega \left\{ C_{op} \frac{r_p + (1 + \mu)z_L}{r_p z_L} + \frac{r_p + z_L}{r_p z_L} C_{ok} \right\}}$$

$$z_{11} = \frac{r_p(C_{op} + C_{pk}) - j \frac{1}{\omega} \left( \frac{r_p}{z_L} + 1 \right)}{\mu C_{op} + \left( \frac{r_p}{z_L} + 1 \right) (C_{op} + C_{ok}) + j\omega(C_{ok}C_{pk} + C_{op}C_{ok} + C_{op}C_{pk})r_p}$$

This result could also have been obtained by the direct application of Kirchhoff's laws, but would have required the solution of seven loop equations.<sup>22</sup>

IV. CONCLUSIONS

From the preceding work the following conclusions may be drawn:

(1) The triode vacuum tube under conditions of linear operation in its three fundamental connections can be described as a four-terminal network. The admittance matrix can be made to have a nonvanishing determinant by including either the interelectrode capacitances or an input admittance, thereby allowing us to write any of the other quadripole matrices.

(2) The resultant quadripole is not bilateral. It therefore becomes necessary to develop a new set of relationships between the elements of the matrices describing the different types of connections (Appendix I).

(3) The gain of an amplifier can be written in terms of any of the quadripole matrix elements. Of particular interest is this equation in terms of the impedance matrix elements which can be rewritten as the gain of an amplifier with a simple feedback loop.

(4) The gain of an amplifier consisting of an integral number of identical stages is derived simply and written concisely by taking advantage of matrix algebra.

(5) Two examples are given to illustrate the organizational and mechanical advantages of the matrix method.

In general, the attempt has been made in the preceding work to develop the necessary tools for the application of matrix methods to vacuum-tube problems. In addition, examples have been presented that show the advantages of the matrix method in handling the more complex problems. These advantages lie in the organization and clear procedure offered by matrix methods, and not necessarily in any great reduction in the labor involved.

APPENDIX I

$A =$	$A =$	$\frac{z_{11}}{z_{21}} =$	$-\frac{y_{22}}{y_{21}} =$	$\frac{1}{g_{21}} =$	$-\frac{ h }{h_{21}}$
$B =$	$B =$	$\frac{ z }{z_{21}} =$	$-\frac{1}{y_{21}} =$	$\frac{g_{22}}{g_{21}} =$	$-\frac{h_{11}}{h_{21}}$
$C =$	$C =$	$\frac{1}{z_{21}} =$	$-\frac{ y }{y_{21}} =$	$\frac{g_{11}}{g_{21}} =$	$-\frac{h_{22}}{h_{21}}$
$D =$	$D =$	$\frac{z_{22}}{z_{21}} =$	$-\frac{y_{11}}{y_{21}} =$	$\frac{ g }{g_{21}} =$	$-\frac{1}{h_{21}}$
$z_{11} =$	$\frac{A}{C} =$	$z_{11} =$	$\frac{y_{22}}{ y } =$	$\frac{1}{g_{11}} =$	$\frac{ h }{h_{22}}$
$z_{12} =$	$\frac{\eta}{C} =$	$\eta z_{21} =$	$-\frac{\eta y_{21}}{ y } =$	$\frac{\eta g_{21}}{g_{11}} =$	$-\frac{\eta h_{21}}{h_{22}}$
$z_{21} =$	$\frac{1}{C} =$	$z_{21} =$	$-\frac{y_{21}}{ y } =$	$\frac{g_{21}}{g_{11}} =$	$-\frac{h_{21}}{h_{22}}$
$z_{22} =$	$\frac{D}{C} =$	$z_{22} =$	$\frac{y_{11}}{ y } =$	$\frac{ g }{g_{11}} =$	$\frac{1}{h_{22}}$
$y_{11} =$	$\frac{D}{B} =$	$\frac{z_{22}}{ z } =$	$y_{11} =$	$\frac{ g }{g_{22}} =$	$\frac{1}{h_{11}}$
$y_{12} =$	$-\frac{\eta}{B} =$	$-\frac{\eta z_{21}}{ z } =$	$\eta y_{21} =$	$-\frac{\eta g_{21}}{g_{22}} =$	$\frac{\eta h_{21}}{h_{11}}$
$y_{21} =$	$-\frac{1}{B} =$	$-\frac{z_{21}}{ z } =$	$y_{21} =$	$-\frac{g_{21}}{g_{22}} =$	$\frac{h_{21}}{h_{11}}$
$y_{22} =$	$\frac{A}{B} =$	$\frac{z_{11}}{ z } =$	$y_{22} =$	$\frac{1}{g_{22}} =$	$\frac{ h }{h_{11}}$
$g_{11} =$	$\frac{C}{A} =$	$\frac{1}{z_{11}} =$	$\frac{ y }{y_{22}} =$	$g_{11} =$	$\frac{h_{22}}{ h }$
$g_{12} =$	$-\frac{\eta}{A} =$	$-\frac{\eta z_{21}}{z_{11}} =$	$\frac{\eta y_{21}}{y_{22}} =$	$-\eta g_{21} =$	$\frac{\eta h_{21}}{ h }$
$g_{21} =$	$\frac{1}{A} =$	$\frac{z_{21}}{z_{11}} =$	$-\frac{y_{21}}{y_{22}} =$	$g_{21} =$	$-\frac{h_{21}}{ h }$

<sup>22</sup> R. S. Glasgow, "Principles of Radio Engineering," p. 228, 1st McGraw-Hill Book Co., New York, N. Y., 1936.

$$\begin{aligned}
g_{22} &= \frac{B}{A} = \frac{|z|}{z_{11}} = \frac{1}{y_{22}} = \frac{g_{22}}{|h|} \quad \therefore s_1 = \frac{(A-D) + \sqrt{(A+D)^2 - 4\eta}}{2C} = \frac{(A-D) + R}{2C} \\
h_{11} &= \frac{B}{D} = \frac{|z|}{z_{22}} = \frac{1}{y_{11}} = \frac{g_{22}}{|g|} = h_{11} \quad s_2 = \frac{(A-D) - \sqrt{(A+D)^2 - 4\eta}}{2C} = \frac{(A-D) - R}{2C} \\
h_{12} &= \frac{\eta}{D} = \frac{\eta z_{21}}{z_{22}} = -\frac{\eta y_{21}}{y_{11}} = \frac{\eta g_{21}}{|g|} = -\eta h_{21} \quad \lambda_1 = \frac{(A+D) + \sqrt{(A+D)^2 - 4\eta}}{2} = \frac{(A+D) + R}{2} \\
h_{21} &= -\frac{1}{D} = -\frac{z_{21}}{z_{22}} = \frac{y_{21}}{y_{11}} = -\frac{g_{21}}{|g|} = h_{21} \quad \lambda_2 = \frac{(A+D) - \sqrt{(A+D)^2 - 4\eta}}{2} = \frac{(A+D) - R}{2} \\
h_{22} &= \frac{C}{D} = \frac{1}{z_{22}} = \frac{|y|}{y_{11}} = \frac{g_{11}}{|g|} = h_{22} \\
\alpha &= \frac{D}{\eta} = \frac{z_{22}}{\eta z_{21}} = -\frac{y_{11}}{\eta y_{21}} = \frac{|g|}{\eta g_{21}} = -\frac{1}{\eta h_{21}} \\
\beta &= -\frac{B}{\eta} = -\frac{|z|}{\eta z_{21}} = \frac{1}{\eta y_{21}} = -\frac{g_{22}}{\eta g_{21}} = \frac{h_{11}}{\eta h_{21}} \\
\gamma &= -\frac{C}{\eta} = -\frac{1}{\eta z_{21}} = \frac{|y|}{\eta y_{21}} = -\frac{g_{11}}{\eta g_{21}} = \frac{h_{22}}{\eta h_{21}} \\
\delta &= \frac{A}{\eta} = \frac{z_{11}}{\eta z_{21}} = -\frac{y_{22}}{\eta y_{21}} = \frac{1}{\eta g_{21}} = -\frac{|h|}{\eta h_{21}}
\end{aligned}$$

where

$$\begin{aligned}
|z| &= z_{11}z_{22} - \eta(z_{21})^2 \\
|y| &= y_{11}y_{22} - \eta(y_{21})^2 \\
|g| &= g_{11}g_{22} + \eta(g_{21})^2 \\
|h| &= h_{11}h_{22} + \eta(h_{21})^2 \\
|z| &= |y|^{-1} \\
|h| &= |g|^{-1} \\
\eta &= AD - BC.
\end{aligned}$$

## APPENDIX II

Derivation of

$$\left\| \begin{array}{cc} A & B \\ C & D \end{array} \right\|^m.$$

Consider (a)

$$\left\| \begin{array}{cc} M & N \\ O & P \end{array} \right\| \left\| \begin{array}{cc} A & B \\ C & D \end{array} \right\| = \left\| \begin{array}{cc} \lambda_1 & 0 \\ 0 & \lambda_2 \end{array} \right\| \left\| \begin{array}{cc} M & N \\ O & P \end{array} \right\|,$$

where  $\lambda_1$  and  $\lambda_2$  are distinct solutions of

$$\left| \begin{array}{cc} A - \lambda & B \\ C & D - \lambda \end{array} \right| = 0 \quad \text{and} \quad \lambda_1 + \lambda_2 = A + D \\
\lambda_1 \lambda_2 = \eta = AD - BC.$$

Also,  $s_1$  and  $s_2$  are solutions of

$$Z = \frac{AZ + B}{CZ + D} \quad \text{or} \quad C \cdot Z^2 + (D - A) \cdot Z - B = 0$$

From (a),

$$\begin{aligned}
M(A - \lambda_1) + NC &= 0, & \frac{M}{N} &= \frac{C}{\lambda_1 - A} \\
MB + N(D - \lambda_1) &= 0, & \frac{M}{N} &= \frac{\lambda_1 - D}{B} \\
O(A - \lambda_2) + PC &= 0, & \frac{O}{P} &= \frac{C}{\lambda_2 - A} \\
OB + P(D - \lambda_2) &= 0, & \frac{O}{P} &= \frac{\lambda_2 - D}{B}.
\end{aligned}$$

Let  $M=1$ . Then

$$\begin{aligned}
N &= \frac{\lambda_1 - A}{C} \\
N &= \frac{A + D + R - 2A}{2C} = -\frac{A - D - R}{2C} \\
&= -s_2.
\end{aligned}$$

Let  $O=1$ . Then

$$\begin{aligned}
P &= \frac{\lambda_2 - A}{C} \\
&= \frac{A + D - R - 2A}{2C} \\
&= -\frac{A - D + R}{2C} \\
&= -s_1
\end{aligned}$$

$$\begin{aligned}
\left\| \begin{array}{cc} A & B \\ C & D \end{array} \right\|^m &= \left\| \begin{array}{cc} M & N \\ O & P \end{array} \right\|^{-1} \left\| \begin{array}{cc} \lambda_1 & 0 \\ 0 & \lambda_2 \end{array} \right\| \left\| \begin{array}{cc} M & N \\ O & P \end{array} \right\| \\
&= \frac{1}{s_2 - s_1} \left\| \begin{array}{cc} -s_1 & s_2 \\ -1 & 1 \end{array} \right\| \left\| \begin{array}{cc} \lambda_1 & 0 \\ 0 & \lambda_2 \end{array} \right\| \\
&\quad \cdot \left\| \begin{array}{cc} 1 & -s_2 \\ 1 & -s_1 \end{array} \right\|
\end{aligned}$$

and

$$\begin{aligned}
\left\| \begin{array}{cc} A & B \\ C & D \end{array} \right\|^m &= \frac{1}{s_2 - s_1} \left\| \begin{array}{cc} -s_1 & s_2 \\ -1 & 1 \end{array} \right\| \left\| \begin{array}{cc} \lambda_1^m & 0 \\ 0 & \lambda_2^m \end{array} \right\| \\
&\quad \cdot \left\| \begin{array}{cc} 1 & -s_2 \\ 1 & -s_1 \end{array} \right\|.
\end{aligned}$$

# Field Theory of Traveling-Wave Tubes\*

L. J. CHU†, ASSOCIATE, I.R.E., AND J. D. JACKSON†, STUDENT, I.R.E.

**Summary**—The problem of a helix-type traveling-wave amplifier tube, under certain simplifying assumptions, is solved as a boundary-value problem. The results indicate that the presence of the beam in the helix causes the normal mode to break up into three modes with different propagation characteristics. Over a finite range of electron velocities one of the three waves has a negative attenuation, and is thus amplified as it travels along the helix. If the electron velocity is too high or too low for net energy interaction, all three waves have purely imaginary propagation constants; no amplification occurs. Consideration of the beam admittance functions shows that, during amplification, the electron beam behaves like a generator with negative conductance, supplying power to the fields through a net loss of kinetic energy by the electrons. Curves are shown for a typical tube, and the effects of beam current and beam radius are indicated. The initial conditions are investigated, as are the conditions of signal level and limiting efficiency. In the Appendix a simple procedure for computing the attenuation constant is given.

## I. INTRODUCTION

THE ANALYSIS of traveling-wave tubes as amplifiers has been carried out by Pierce<sup>1,2</sup> of Bell Telephone Laboratories and Kompfner<sup>3</sup> of the Clarendon Laboratory. In Pierce's paper,<sup>2</sup> the action of the field on the electron beam and the reaction of the beam back on the field were formulated. A cubic equation was obtained which yielded three distinct propagation constants corresponding to the three dominant modes of propagation. Kompfner followed a different line of attack and arrived at essentially the same results.

The present analysis follows the procedure which Hahn<sup>4,5</sup> and Ramo<sup>6,7</sup> used in dealing with velocity-modulated tubes. The problem of the traveling-wave tube is idealized, and such approximations are introduced that the field theory can be used throughout to correlate the important factors in the problem. Numerical examples are given for a specific tube to illustrate the effects of various parameters upon the characteristics of the tube.

\* Decimal classification: R339.2. Original manuscript received by the Institute, July 30, 1947; revised manuscript received, December 29, 1947. Presented, I.R.E. Electron Tube Conference, Syracuse, N. Y., June, 1947. This work has been supported in part by the U. S. Army Signal Corps, the Air Matériel Command, and the Office of Naval Research, and appeared originally as Technical Report No. 38, April 28, 1947, of the Research Laboratory of Electronics, M.I.T.

† Massachusetts Institute of Technology, Cambridge 39, Mass.

<sup>1</sup> J. R. Pierce and Lester M. Field, "Traveling-wave tubes," *Proc. I.R.E.*, vol. 35, pp. 108-111; February, 1947.

<sup>2</sup> J. R. Pierce, "Theory of the beam-type traveling-wave tube," *Proc. I.R.E.*, vol. 35, pp. 111-123; February, 1947.

<sup>3</sup> Rudolf Kompfner, "The traveling-wave tube as amplifier at microwaves," *Proc. I.R.E.*, vol. 35, pp. 124-128; February, 1947.

<sup>4</sup> W. C. Hahn, "Small signal theory of velocity-modulated electron beams," *Gen. Elec. Rev.*, vol. 42, pp. 258-270; June, 1939.

<sup>5</sup> W. C. Hahn, "Wave energy and transconductance of velocity-modulated electron beams," *Gen. Elec. Rev.*, vol. 42, pp. 497-520; November, 1939.

<sup>6</sup> Simon Ramo, "Space charge and field waves in an electron beam," *Phys. Rev.*, vol. 56, pp. 276-283; August, 1939.

<sup>7</sup> Simon Ramo, "The electron-wave theory of velocity-modulated tubes," *Proc. I.R.E.*, vol. 27, pp. 757-763; December, 1939.

In this paper, only the helix-type of traveling-wave tube will be considered. It consists of a cylindrical helical coil which, in the absence of an electron beam, is capable of supporting a wave along the axis of the helix with a phase velocity substantially less than the light velocity. When an electron beam is shot through the helix, the electrons are accelerated or decelerated by the field of the wave, especially the longitudinal electric field. As a result, the electrons will be bunched. The bunched beam travels substantially with the initial velocity of electrons, which is usually different from the phase velocity of the wave. Because of the bunching action, there will be, in time, more electrons decelerated than those accelerated over any cross section of the helix or vice versa. As a result, there will be a net transfer of energy from the electron beam to the wave or from the wave to the beam. The bunching of the electrons produces an alternating space-charge force or field which modifies the field structure of the wave, and consequently its phase velocity. The average energy of the electron beam must change as it moves along, on account of the energy transfer. The process is continuous, and a rigorous solution to the problem is probably impossible. The procedure of analysis is, therefore, to find the modes of propagation which can have exponential variation along the tube in the presence of the electron beam. We are interested in those modes which will either disappear or degenerate into the dominant mode when the beam is removed. By studying the properties of these modes and combining them properly, we hope to present a picture of some of the physical aspects of the helix-type traveling-wave tube.

## II. SOLUTION OF THE PROBLEM

### A. Formulation

In order to obtain some theoretical understanding about the behavior of the traveling-wave tube, we have to simplify the problem by making numerous assumptions. Instead of a physical helix, we shall use a lossless helical sheath of radius  $a$  and of infinitesimal thickness. The current flow along the sheath is constrained to a direction which makes a constant angle ( $90^\circ - \theta$ ) with the axis of the helix. The tangential component of the electric field is zero along the direction of current flow, and finite and continuous through the sheath along the direction perpendicular to the current flow. The force acting on the electrons is restricted to that associated with the longitudinal electric field only; and the electrons are assumed to have no initial transverse motion. We shall further assume that the electrons are confined within a cylinder of radius  $b$  concentric with the helical sheath. The time-average beam-current density is assumed constant over the cross section, the

problem is further simplified by considering small signals only, which will be discussed in Section D.

To find the natural modes of propagation along the tube, it is convenient to divide the space into three physical regions with well-defined boundaries. First, we have the region occupied by the electrons. As shown in Fig. 1, this region is cylindrical in shape and extends

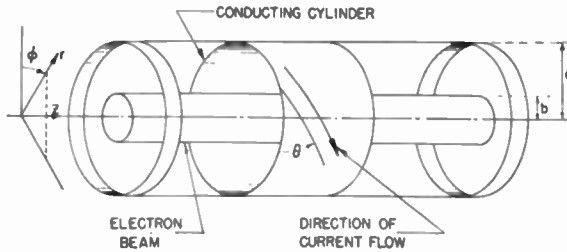

Fig. 1—Idealized representation of a section of a helix-type traveling-wave tube.

from  $r=0$  to  $r=b$ . Then, there is the region between the electron beam and the helical sheath (from  $r=b$  to  $r=a$ ). Lastly, the space outside the helix forms the third region. These three regions are separated by two well-defined boundaries. In the following we shall find the expressions of the field appropriate for the three regions and satisfying the conditions at the boundaries, and an investigation of the properties of the field will follow. Further approximations will be made in (28) and (29) to simplify the calculation.

### B. General Field and Wave Equations

If the fields are circularly symmetric about the coordinate axis, and assumed to vary with  $e^{j\omega t - \gamma z}$ , then the field equations can be written in the form:

$$\left. \begin{aligned} \gamma E_\phi + j\omega\mu H_r &= 0 \\ \frac{1}{r} \frac{\partial}{\partial r} (rE_\phi) + j\omega\mu H_z &= 0 \\ \frac{\partial H_z}{\partial r} + \gamma H_r + j\omega\epsilon E_\phi &= -J_\phi \end{aligned} \right\} TE \text{ wave} \quad (1)$$

$$\left. \begin{aligned} \gamma H_\phi - j\omega\epsilon E_r &= J_r \\ \frac{1}{r} \frac{\partial}{\partial r} (rH_\phi) - j\omega\epsilon E_z &= J_z \\ \frac{\partial E_z}{\partial r} + \gamma E_r - j\omega\mu H_\phi &= 0 \end{aligned} \right\} TM \text{ wave} \quad (2)$$

where  $(z, r, \phi)$  are the cylindrical co-ordinates  
 $\gamma = \alpha + j\beta$  is the propagation constant along the  $z$  direction

$E_z, E_r, E_\phi$  are the electric field components  
 $H_z, H_r, H_\phi$  are the magnetic field components  
 $J_z, J_r, J_\phi$  are the components of the vector current density.

Unless otherwise specified, the rationalized mks unit system is used.

The grouping of field components into  $TE$  and  $TM$  waves is for mathematical convenience only. All six components are required to satisfy the boundary conditions on the helical sheath. From the field equations the following inhomogeneous wave equations for  $H_z$  and  $E_z$  can be deduced:

$$\frac{1}{r} \frac{\partial}{\partial r} \left( r \frac{\partial H_z}{\partial r} \right) + (\gamma^2 + k^2) H_z = -\frac{1}{r} \frac{\partial}{\partial r} (rJ_\phi) \quad (3)$$

$$\begin{aligned} \frac{1}{r} \frac{\partial}{\partial r} \left( r \frac{\partial E_z}{\partial r} \right) + (\gamma^2 + k^2) E_z \\ = -\frac{(\gamma^2 + k^2)}{i\omega\epsilon} J_z + \frac{\gamma}{j\omega\epsilon} \frac{1}{r} \frac{\partial}{\partial r} (rJ_r) \end{aligned} \quad (4)$$

where  $k^2 = \omega^2 \mu \epsilon$ .

### C. TE Wave within the Electron Beam

Since the electrons are assumed to have no transverse motion, the a.c. current density  $J$  has only one component, namely,  $J_z$ . Thus, (3) for  $H_z$  reduces to the form of a homogeneous wave equation since the right-hand side of the equation vanishes. Let

$$p^2 = -(\gamma^2 + k^2), \quad (5)$$

and  $I_\nu(x)$  be the modified Bessel function of the  $\nu$ th order, related to the more familiar Bessel function through the equation

$$I_\nu(x) = j^{-\nu} J_\nu(jx). \quad (6)$$

From (1) and (3), the solutions for the components of the  $TE$  wave within the electron beam are

$$\left. \begin{aligned} H_z &= A_1 I_0(pr) e^{j\omega t - \gamma z} \\ H_r &= A_1 \frac{\gamma}{p} I_1(pr) e^{j\omega t - \gamma z} \\ E_\phi &= -A_1 \frac{j\omega\mu}{p} I_1(pr) e^{j\omega t - \gamma z} \end{aligned} \right\} \quad (7)$$

### D. Dynamics of the Electron Beam

It will be seen from (4) that a knowledge of  $J_z$  as a function of  $E_z$  is necessary in order to obtain the solution of the  $TM$  wave within the electron beam. To find such a relationship, the behavior of the electrons under the action of electric and magnetic fields must be considered.

As was indicated earlier, the motion of the electrons is assumed to be confined to the axial direction. This implies that  $J_r = J_\phi = 0$ . In practice, this assumption is very nearly realized by means of the focusing action of a strong d.c. magnetic field applied parallel to the helix axis. It is also assumed that the a.c. components of charge, current, and electron velocity vary exponen-



tially with the same propagation constant as the wave traveling in the helix, while the average electron velocity is substantially constant over a finite section of the helix. This last assumption depends on the tacit supposition that the phenomena can be described by a small-signal analysis.

The notation used will be the following:

- $\rho$  = a.c. component of charge density
- $\rho_0$  = average value of charge density
- $v$  = a.c. component of electron velocity
- $v_0$  = average value of electron velocity
- $J_z$  = a.c. component of current density
- $J_0$  = average value of current density
- $e/m$  = ratio of charge to mass of the electron.

Continuity of charge demands that

$$\frac{\partial J_z}{\partial z} = -\frac{\partial \rho}{\partial t}$$

or

$$J_z = \frac{j\omega}{\gamma} \rho. \tag{8}$$

The force equation for the charges due to the longitudinal electric field is

$$\frac{d}{dt}(v_0 + v) = -\frac{e}{m} E_z. \tag{9}$$

Now,

$$\frac{d}{dt}(v_0 + v) = \frac{dv}{dt} = \frac{\partial v}{\partial t} + v_0 \frac{\partial v}{\partial z} = v_0 \left( j \frac{\omega}{v_0} - \gamma \right) v. \tag{10}$$

Then (9) can be written:

$$v = \frac{\left( -\frac{e}{m} \right) E_z}{v_0 \left( j \frac{\omega}{v_0} - \gamma \right)}. \tag{11}$$

To a first approximation, the current density is

$$J = J_0 + J_z = (v_0 + v)(\rho_0 + \rho) \cong v_0 \rho_0 + \rho v_0 + \rho_0 v. \tag{12}$$

Since

$$J_0 = v_0 \rho_0,$$

the a.c. current density can be put in the form, after eliminating  $\rho$  and  $v$  from (12) by (8) and (11),

$$J_z = \left[ \frac{-j\omega \frac{e}{m} J_0}{v_0^3 \left( j \frac{\omega}{v_0} - \gamma \right)^2} \right] E_z. \tag{13}$$

*E. TM Wave Within the Electron Beam*

The necessary relation between  $J_z$  and  $E_z$  having been obtained, it is now possible to solve (4). In view of

(13) and the fact that  $J_r = 0$ , (4) becomes

$$\frac{1}{r} \frac{\partial}{\partial r} \left( r \frac{\partial E_z}{\partial r} \right) + (\gamma^2 + k^2) \left[ 1 - \frac{\frac{e}{m} J_0}{\epsilon v_0^3 \left( j \frac{\omega}{v_0} - \gamma \right)^2} \right] E_z = 0. \tag{14}$$

Let

$$\eta^2 = p^2 \left[ 1 + \frac{\frac{e}{m} I}{\pi b^2 \epsilon v_0^3 \left( j \frac{\omega}{v_0} - \gamma \right)^2} \right] \tag{15}$$

where

$$p^2 = -(\gamma^2 + k^2) \tag{5}$$

and

$$I = -\pi b^2 J_0 = \text{d.c. beam current.}$$

Then the solutions for the three components of field are

$$\left. \begin{aligned} E_z &= B_1 I_0(\eta r) e^{i\omega t - \gamma z} \\ E_r &= B_1 \frac{\gamma \eta}{p^2} I_1(\eta r) e^{i\omega t - \gamma z} \\ H_\phi &= B_1 \frac{j\omega \epsilon \eta}{p^2} I_1(\eta r) e^{i\omega t - \gamma z} \end{aligned} \right\} \tag{16}$$

*F. Admittance Functions*

The fields within the electron beam will have to be matched to the fields outside the beam at the boundary  $r = b$ . One method of matching the fields is equating corresponding radial impedance or admittance functions<sup>8</sup> at the boundary. Normalized radial admittances for both *TE* and *TM* waves can be defined by

$$Y_r^{(1)} = -\sqrt{\frac{\mu}{\epsilon}} \frac{H_z}{E_\phi} \tag{17}$$

$$Y_r^{(2)} = \sqrt{\frac{\mu}{\epsilon}} \frac{H_\phi}{E_z} \tag{18}$$

Thus defined, the admittances are to be measured in the direction of decreasing  $r$ .

Therefore, the two admittances within the beam are:

$$Y_r^{(1)} = \frac{p}{jk} \frac{I_0(pr)}{I_1(pr)} \text{ for } TE \text{ wave} \tag{19}$$

$$Y_r^{(2)} = \frac{jk}{p} \frac{\eta}{p} \frac{I_1(\eta r)}{I_0(\eta r)} \text{ for } TM \text{ wave.} \tag{20}$$

<sup>8</sup> J. A. Stratton, "Electromagnetic Theory," McGraw-Hill Book Co., New York, N. Y., 1941, p. 354.

G. TE Wave in Charge-Free Regions

Outside the electron beam,  $J=0$ . Thus, (3) for  $H_z$  again reduces to a homogeneous wave equation. It is clear, therefore, that in the whole region  $0 < r < a$  the solution for  $H_z$  and the other TE components is independent of the presence of charge and current in the region  $0 < r < b$ . Thus the TE-wave components both inside and outside the electron beam are given by (7). The equating of corresponding admittance functions (17) at  $r=b$  merely results in an identity. To obtain the TE-field components outside the helix, we must use the modified Bessel function of the second kind,  $K_r(pr)$ , since the field must vanish at  $r = \infty$ . Thus the field components for the TE wave outside the helix are

$$\left. \begin{aligned} H_z &= A_2 K_0(pr) e^{j\omega t - \gamma z} \\ H_r &= -A_2 \frac{\gamma}{p} K_1(pr) e^{j\omega t - \gamma z} \\ E_\phi &= A_2 \frac{j\omega\mu}{p} K_1(pr) e^{j\omega t - \gamma z} \end{aligned} \right\} r > a \quad (21)$$

$K_\nu(x)$  is related to the Hankel function by the following

$$K_\nu(x) = \frac{\pi}{2} j^{\nu+1} H_\nu^{(1)}(jx). \quad (22)$$

H. TM Wave in Charge-Free Regions

Outside the helix the TM-field component are, from (2) and (4),

$$\left. \begin{aligned} E_z &= C_1 K_0(pr) e^{j\omega t - \gamma z} \\ E_r &= -C_1 \frac{\gamma}{p} K_1(pr) e^{j\omega t - \gamma z} \\ H_\phi &= -C_1 \frac{j\omega\epsilon}{p} K_1(pr) e^{j\omega t - \gamma z} \end{aligned} \right\} r > a. \quad (23)$$

In the charge-free region within the helix ( $b < r < a$ ), we must use both types of the modified Bessel function for completeness:

$$\left. \begin{aligned} E_z &= [C_3 I_0(pr) + C_4 K_0(pr)] e^{j\omega t - \gamma z} \\ E_r &= \frac{\gamma}{p} [C_3 I_1(pr) - C_4 K_1(pr)] e^{j\omega t - \gamma z} \\ H_\phi &= \frac{j\omega\epsilon}{p} [C_3 I_1(pr) - C_4 K_1(pr)] e^{j\omega t - \gamma z} \end{aligned} \right\} b < r < a. \quad (24)$$

Since the TM wave is mainly responsible for the interactions between the waves and electrons, we shall discuss briefly here the nature of the field structure. If the phase velocity of the wave is radically less than the velocity of light, from (5)  $p$  will essentially be a real quantity. Fig. 2 is a sketch of the electric field of the TM wave associated with the  $I_0(pr)$  function. The electric lines start and terminate at  $r$  equals infinity. Clearly, this type of field structure cannot exist outside the helical

sheath. In the charge-free region within the helix, all the electric lines start and terminate on charges on the conducting helical sheath. The field intensity increases with the radius. This type of field will exist even in the absence of any electron beam. Consider now a continuous stream of electrons of uniform density passing through the tube at a constant velocity approximately the same as the phase velocity of the wave. Half of the electrons will stay with an accelerating field for a while, and the rest will be decelerated at the same time. The result is a slow change of velocity and density as the electrons move on—a bunching process.

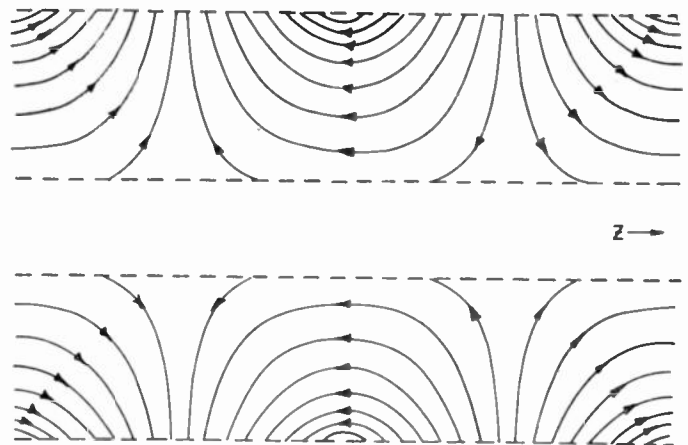

Fig. 2—Instantaneous configuration of the electric field associated with the  $I_0(pr)$  function (longitudinal section).

As soon as the electron beam is bunched, the field expressions associated with the  $I_0$  functions only are no longer adequate to describe the electromagnetic phenomena inside the tube. Fig. 3 illustrates the field dis-

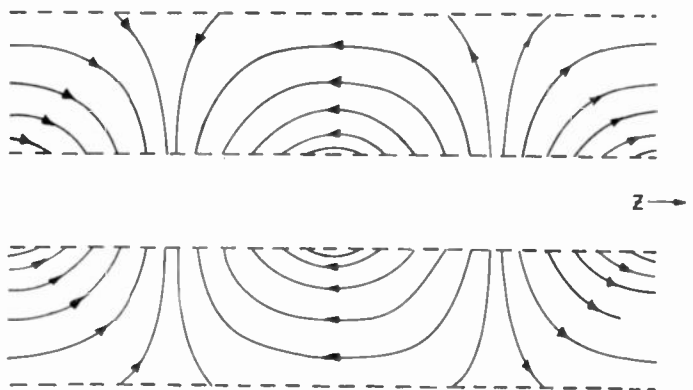

Fig. 3—Instantaneous configuration of the electric field associated with the  $K_0(pr)$  function (longitudinal section).

tribution associated with the  $K_0(pr)$  function. Here the electric lines start and terminate substantially on the electron beam. There is, of course, the electric field associated with the average or d.c. charge distribution superposed on the fluctuation or the a.c. charge distribution. Clearly, a field of this type is closely related to the

space charges, and its presence is responsible for the debunching force which will tend to smooth out the fluctuations of the charge distribution.

I. Boundary Conditions on the Helix

At the helix wall ( $r=a$ ) the boundary condition is that the current flow be restricted to a direction making a constant angle ( $90^\circ-\theta$ ) with the axis of the helix,  $\theta$  being the pitch angle of the helix. Also, the electric field directed along the winding shall vanish at  $r=a$ , the electric field normal to that direction shall be continuous at  $r=a$ , and the magnetic field parallel to the windings shall be continuous at  $r=a$ . Employing these conditions, one can solve for any four of the constants,  $A_1, A_2, C_1, C_3,$  and  $C_4$ , in terms of the fifth. These constants relate the six field components on both sides of the helix. There remains then the matching of the  $TM$  wave at  $r=b$ .

The normalized admittance (18) for the  $TM$  wave outside the beam is as follows:

dimensions, it can be solved, in principle at least, for  $p$  and thus the propagation constant  $\gamma$ . Once  $\gamma$  or  $p$  is found, the whole behavior of the fields both inside and outside the helix is known.

K. Charge-Free Helix Waveguide

It is of interest to investigate the special case in which the charge and current densities are zero everywhere within the helix. It is clear from (15) that in such circumstances  $\eta=p$ , so that the equating of the admittance yields<sup>2</sup>

$$\frac{I_1(pa)K_1(pa)}{I_0(pa)K_0(pa)} \left(\frac{ka}{pa}\right)^2 \cot^2 \theta = 1. \tag{26}$$

From (26) a relationship can be obtained between the phase velocity  $v_p(=\omega/\beta_0)$  of the wave in the helix and the parameter  $ka(=2\pi a/\lambda)$  where  $\beta_0$  is the phase constant associated with the charge-free helix and  $\lambda$  is the free-space wavelength. Curves indicating this relationship for various angles of pitch are shown in Fig. 4. For

$$Y_r^{(2)} = j \frac{ka}{pa} \left[ \frac{I_1(pr) - K_1(pr) \left\{ \frac{\left(\frac{ka}{pa}\right)^2 \cot^2 \theta I_1(pa)K_1(pa) - I_0(pa)K_0(pa)}{K_0^2(pa)} \right\}}{I_0(pr) + K_0(pr) \left\{ \frac{\left(\frac{ka}{pa}\right)^2 \cot^2 \theta I_1(pa)K_1(pa) - I_0(pa)K_0(pa)}{K_0^2(pa)} \right\}} \right]. \tag{25}$$

J. Matching

At the boundary of the electron beam ( $r=b$ ), the admittance given in (25) must be equal to that given in (20).

The equation obtained represents the formal solution of the problem, since, for prescribed conditions of initial current, initial electron velocity, frequency, and physical

large values of  $ka$ , (26) approaches the asymptotic form

$$\left(\frac{pa}{ka}\right)^2 \tan^2 \theta = 1,$$

which gives

$$\frac{v_p}{c} = \sin \theta.$$

This is the value to be expected from elementary considerations of Fig. 1, neglecting the proximity effects due to a small ratio of diameter to wavelength.

L. Discussion of the Admittance Functions

In order to facilitate calculation of results, it would be desirable to replace the admittance functions (20) and (25) by reasonably simple algebraic forms which approximate as closely as possible the actual admittances as functions of  $p$  or  $\eta$ . With this purpose in mind the behavior of the radial admittance (25) (evaluated at  $r=b$ ) as a function of  $p$  must be examined. For real values of  $p$  (no energy interaction between the electrons and the field),  $Y_r^{(2)}$  as given by (25) has the form shown in Fig. 5. Since there is no radial flow of energy, the ad-

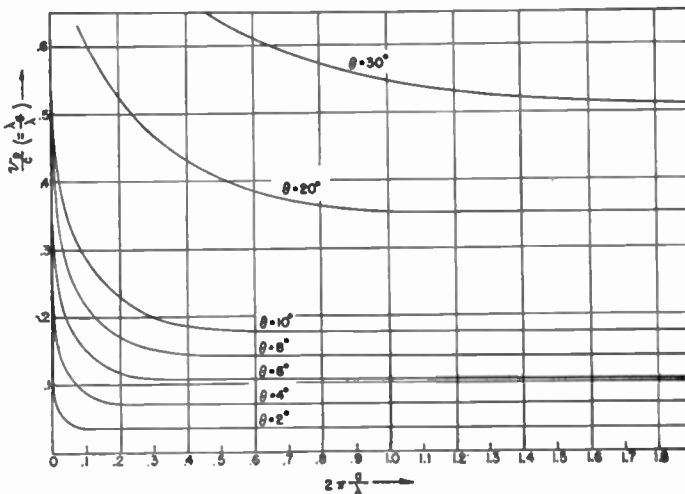

Fig. 4—Phase velocity  $v_p(=\omega/\beta_0)$  in the charge-free helix as a function of  $ka(=2\pi a/\lambda)$  for various pitch angles ( $\theta$ ).

mittance is purely imaginary for all real values of  $p$ . The exact shape of the curve is governed by the choice of  $b/a$ ,  $ka$ , and  $\theta$ ; but the general features are the same, irrespective of the values of these parameters. Along the real axis of  $p$  the function has a zero at  $p=p'$ , and an infinite value at  $p=0$ , and  $p=p''$ . Investigation of the function shows that these three points are the only poles and zero of the function in the complex  $p$  plane.<sup>9</sup>

Consideration of the form of the function, as shown in Fig. 5, indicates that (25) can be, in view of the Weierstrass factor theorem, approximated by an expression of the following type:

$$Y_r^{(2)} = jkaC \left( \frac{p - p'}{p - p''} \right) \quad (27)$$

where

$$jkaC = - (p'' - p') \left. \frac{\partial Y_r^{(2)}}{\partial p} \right|_{p=p'}$$

The singularity of (25) at  $p=0$  is overlooked, because we are interested in the function only in the neighborhood of  $p'$  and  $p''$ , and, as can be seen from Fig. 5, (27) approximates the exact admittance very closely in

this region. Furthermore, since the phase velocities of the waves are very much less than that of light, it is evident from (5) that  $jp \cong \gamma$ . Upon making this substitution, (27) becomes:

$$Y_r^{(2)} = jkaC \left( \frac{\gamma - j\beta'}{\gamma - j\beta''} \right) \quad (28)$$

where  $\beta'$ ,  $\beta''$  correspond to  $p'$  and  $p''$ .

The admittance (20) derived from the fields within the electron beam will be approximated by

$$Y_r^{(2)} = j \frac{ka}{a} \frac{\eta^2}{p^2} \frac{b}{2} \quad (29)$$

This approximation means, physically, that  $E_z$  is assumed to be constant over the cross section of the electron beam, while  $H_\phi$  increases linearly with  $r$  in the same region.

### M. Approximate Matching Equation

Equating the approximate expressions (28) and (29) yields the matching equation

$$\frac{\eta^2}{2p^2} \left( \frac{b}{a} \right) = C \left( \frac{\gamma - j\beta'}{\gamma - j\beta''} \right),$$

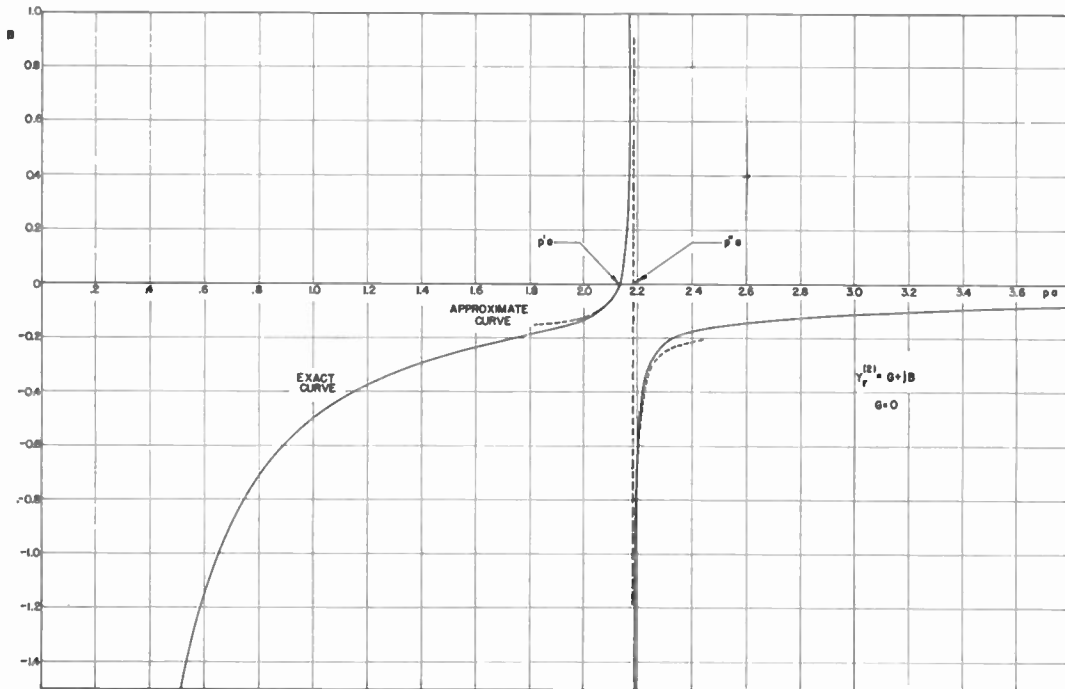

Fig. 5—Radial admittance  $Y_r^{(2)} (=G + jB)$  at  $r=b$  as a function of  $pa$  for real values of  $pa$ .  $ka=0.2$ ,  $\theta=5^\circ$ ,  $b/a=0.2$ .

<sup>9</sup> When the imaginary part of  $p$  is not zero, there will be a radial flow of energy from or to the cylindrical surface  $r=b$ , on account of the modified Hankel functions associated with the field outside the helix ((21) and (23)). The radial flow of energy requires the components of the electric and magnetic field tangential to the cylindrical surface  $r=b$  to differ from zero. As a consequence, the admittance  $Y_r^{(2)}$  has no zeros or poles except along the real axis of the complex  $p$  plane. The logarithmic singularity at  $p=0$  is neglected in the approximate formula (27). For  $\theta=0$  or  $\theta=\pi/2$ , solutions which have zero field for  $r>a$  are permissible. The admittance function (25) will then have poles and zeros off the real axis of the  $p$  plane.

or, substituting for  $\eta^2$  from (15),

$$\left( \frac{b}{a} \right) \left[ 1 + \frac{\frac{e}{m} I}{\pi b^2 \epsilon v_0^3 \left( j \frac{\omega}{v_0} - \gamma \right)^2} \right] = 2C \left( \frac{\gamma - j\beta'}{\gamma - j\beta''} \right) \quad (30)$$

Equation (30) is a cubic equation in  $\gamma$ , and thus for a fixed set of parameters yields three values of the propagation constant. These three values of  $\gamma$ , since they determine different field configurations as well as different propagation characteristics, can be thought of as indicating three different modes co-existing in the guide. The three modes represent an approximation to the infinite series of modes and other waves necessary to describe exactly the fields in the helix.

### III. DISCUSSION OF A SPECIFIC EXAMPLE

After various simplifications, we finally arrived at (30), which is a cubic equation for the longitudinal propagation constant involving many parameters. Physically, the normal mode of propagation in a helical waveguide splits into three independent modes in the presence of the electron beam, as characterized by the three independent roots of the cubic equation. Within the limitations of the approximations, these three modes can exist simultaneously within the waveguide, depending upon the initial conditions at the input terminal (to be discussed later). We shall now study the behavior of the three modes of propagation for a specific waveguide at a specific wavelength.

- Helix diameter = 1.0 cm.
- Angle of pitch = 5°
- Wavelength (free space) = 16 cm.
- Electron beam diameter = 0.2 cm.
- Beam current  $I = 10^{-3}$  amp.

#### A. Characteristics of the Three Modes

With the conventional notation  $\gamma = \alpha + j\beta$ , the real and imaginary parts of the three propagation constants are plotted in Fig. 6 as solid lines. In addition, the "phase constant" ( $\beta_0$ ) of the d.c. electron beam, defined as  $\omega/v_0$ , is also plotted. The phase constants  $\beta_0$ ,  $\beta'$ , and  $\beta''$  are indicated on the curve as horizontal lines. The independent variable in Fig. 6 is the ratio of the d.c. electron velocity to the velocity of light.

The cubic equation has alternately real and imaginary coefficients. We expect to have three independent imaginary roots, or a pair of complex roots and one independent one. When the d.c. electron velocity is too high or too low, we have three independent waves neither amplified nor attenuated. Over a finite range of the electron velocity, two of the waves have the same phase constant and the same absolute value of the attenuation. The third wave has an imaginary propagation constant.

Over the ranges at which the electron velocity is either too high or too low for a net transfer of energy to or from the electron beam, the three waves seem to follow a pattern. Over each range, one of the waves has a phase constant approximately equal to the phase constant  $\beta_0$  of the electron-free helical guide. The other two waves seem to travel at a velocity close to that of the electron beam. Over the range of amplification or

attenuation, the distinction between these types of waves becomes less marked. This is reasonable, since the electron velocity is fairly close to the phase velocity of the unperturbed wave.

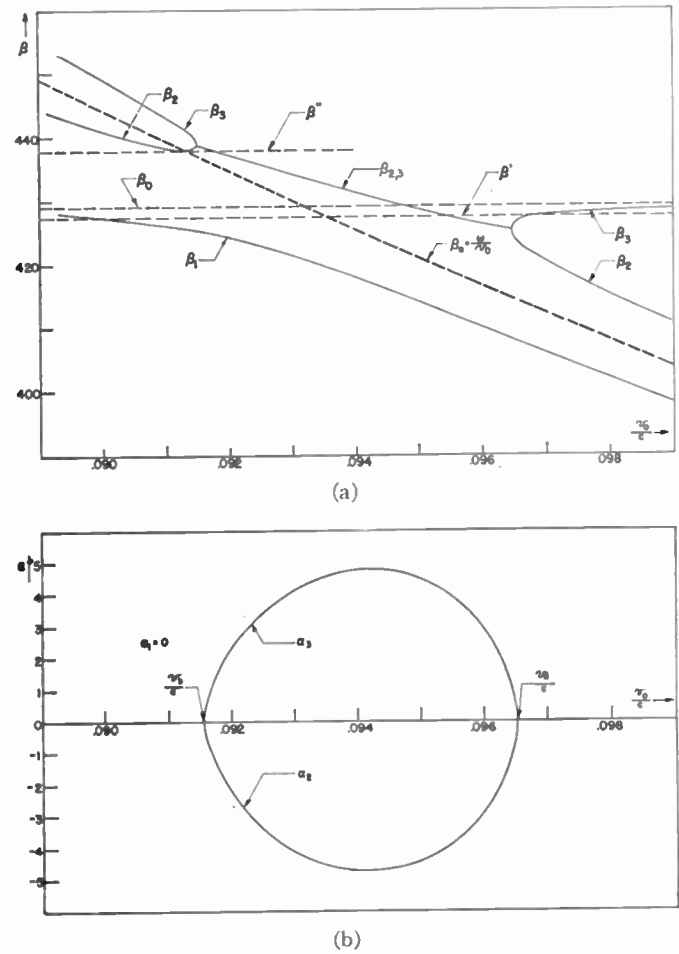

Fig. 6—Attenuation and phase constants for the three component waves as functions of the average electron velocity ( $v_0$ ).  $I = 10^{-3}$  amp. (a) Attenuation constants; (b) phase constants.

#### B. Admittance Function

The normalized admittance  $Y_r^{(2)}$  as defined in (18) is one looking into the electron beam at the boundary of the beam. A positive conductance indicates a transfer of power from the field to the beam, and vice versa. The admittance functions for the three waves are plotted in Fig. 7 for the above case. The first wave, which has  $\alpha = 0$  for all velocities, possesses a susceptance varying slowly with the electron velocity. The susceptance is zero at a certain low velocity point at which the phase constant corresponds to  $\beta'$ . At this point the total a.c. current (sum of the displacement current and the a.c. electronic current) produced by that wave is zero within the beam. The conductance curve for the other two waves increases in amplitude with the decrease of the electron velocity. It finally drops down to zero at a point where the electron velocity is too low for amplification. The magnetic field at the surface of the electron beam is due to the displacement current, as well as the

electron current within the beam. Since  $p$  is essentially a real quantity, the displacement current is  $90^\circ$  out of phase with the electric field. The conductance is contributed solely by the a.c. electron current. From Fig. 7, we can draw the following conclusion. Over the amplifying range, the amplified or attenuated wave has a relatively strong a.c. electron current for a low d.c. electron velocity  $v_0$ , and a weak a.c. electron current for a high  $v_0$ . The phenomenon of the high a.c. electron current is closely connected with the infinity  $\beta''$  of the admittance function as plotted in Fig. 5. The  $\beta''$  line in Fig 6. intercepts the curve for the phase constant  $\beta_2$  or  $\beta_3$ , where we have high current density.

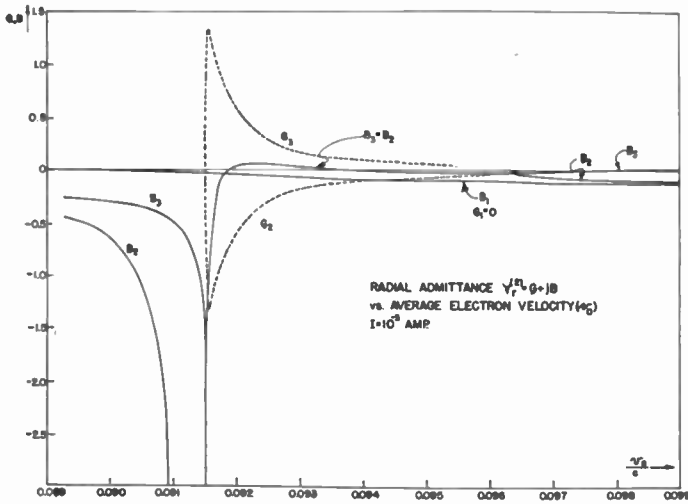

Fig. 7—Radial admittances  $Y_r^{(2)} (=G+jB)$  for the three component waves as functions of the average electron velocity ( $v_0$ ).  $I=10^{-3}$  amp.

C. Effect of the Beam Current

Fig. 8 indicates the behavior to be expected for various values of beam current  $I$ . As the beam current is increased the velocity range over which amplification can occur increases, as well as the maximum amplification attainable. It should be noted that both  $\alpha$  and  $\beta$  curves for the amplified wave shift toward the right as the beam current increases. High beam current calls for a higher electron velocity to take advantage of the higher amplification. However, with currents ranging up to 10 ma., the shift of optimum electron velocity is not appreciable.

If we plot the maximum value of  $\alpha$  against the d.c. beam current, it seems that  $\alpha_{max}$  is proportional to the fourth root of the d.c. beam current.

D. Effect of Beam Radius on Amplification

Equation (30) has been investigated for various values of  $b/a$  in order to obtain information about the effect of the beam radius on the amplification for a fixed

beam current. The calculations indicate that the maximum value of  $\alpha$  increases approximately as the cube root of the ratio  $b/a$ . This is to be expected, since the strength of all the field components is weakest on the axis and increases as we approach the boundary of the helix. For

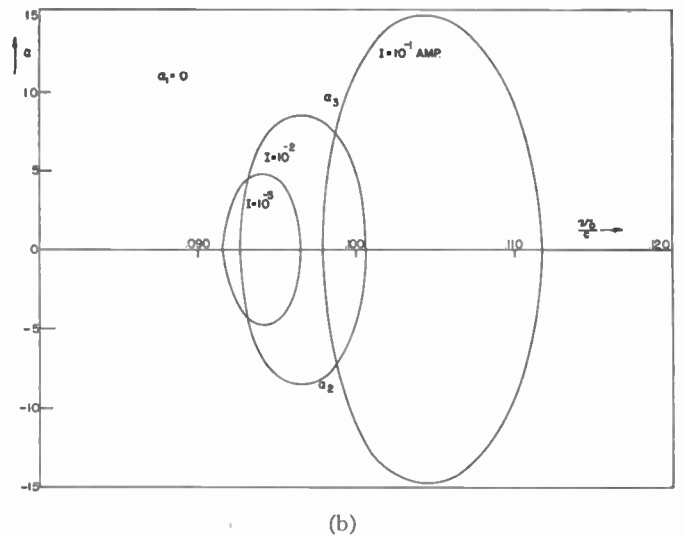
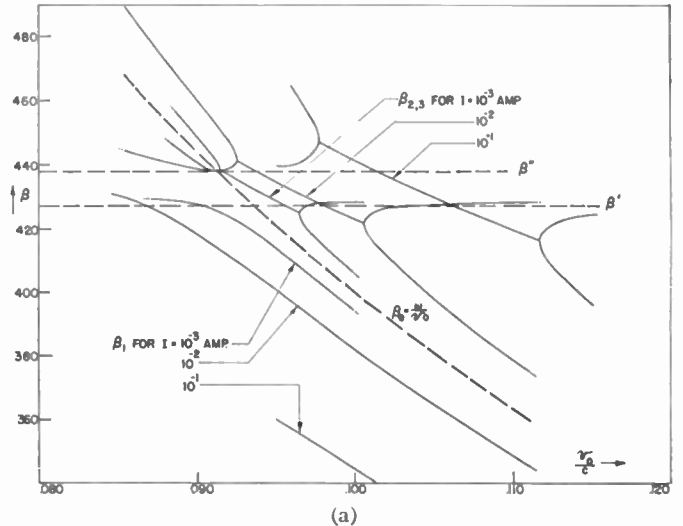

Fig. 8—Attenuation and phase constants of the three component waves as functions of the average electron velocity ( $v_0$ ) for beam currents  $I=10^{-3}$ ,  $I=10^{-2}$ ,  $I=10^{-1}$  amp. (a) Phase constants, (b) attenuation constants.

a given total beam current, more electrons travel in regions of higher electric fields as the beam radius is increased. Therefore, we expect greater interaction and energy exchange, and therefore more amplification, than when the beam is constrained to a small region near the axis.

The cube-root dependence of  $\alpha$  on beam radius should not be taken as exact, since it was derived from (30) which has inherent in it the assumption that  $E_z$  is constant throughout the beam, while  $H_\phi$  increases linearly with  $r$ . However, it does give a qualitative indication of the behavior to be expected.

IV. INITIAL CONDITIONS AND LIMITING EFFICIENCY

A. Initial Conditions

We have so far discussed in general terms the existence of three waves along electron-filled tubes. Their amplitudes depend not only upon the relative amplification, but also upon the initial conditions at the input end. Physically there will be other modes of propagation, which must exist at least at the beginning of the tube. Consideration of these other modes would make the problem of initial conditions complicated. We shall neglect all the higher modes in the present treatment.

We shall deal with the type of initial conditions associated with an unmodulated electron beam and an r.f. signal at the input  $z=0$ . The electron beam can be idealized as a uniform stream of electrons flowing into the tube at  $z=0$  with uniform density and velocity. It takes time for the electrons to change their velocity and it takes more time for the electron beam to change its density. Consequently, the resultant r.f. wave will travel for a short while undisturbed by the electron beam. The phase velocity and the field structure will essentially be the same as those of the charge-free wave along the tube. The proper procedure of solving this problem would be to match the field components of the three perturbed waves to those of the unperturbed wave for a short length of the tube. This is equivalent to using the initial condition of zero a.c. current and charge density (or a.c. electron velocity).

Let  $E_{z1}$ ,  $E_{z2}$ , and  $E_{z3}$  be the longitudinal electric field components of the three waves at the input. They are normalized so that the sum of the three is unity. Then, from (11) and (13) and the above conditions, we have

$$\left. \begin{aligned} E_{z1} &= \frac{\left(\gamma_1 - j \frac{\omega}{v_0}\right)^2 (\gamma_2 - \gamma_3)}{D} \\ E_{z2} &= \frac{\left(\gamma_2 - j \frac{\omega}{v_0}\right)^2 (\gamma_3 - \gamma_1)}{D} \\ E_{z3} &= \frac{\left(\gamma_3 - j \frac{\omega}{v_0}\right)^2 (\gamma_1 - \gamma_2)}{D} \end{aligned} \right\} \quad (31)$$

where

$$D = \left(\gamma_1 - j \frac{\omega}{v_0}\right)^2 (\gamma_2 - \gamma_3) + \left(\gamma_2 - j \frac{\omega}{v_0}\right)^2 (\gamma_3 - \gamma_1) + \left(\gamma_3 - j \frac{\omega}{v_0}\right)^2 (\gamma_1 - \gamma_2).$$

Within the range of amplification, the voltage gain along a tube of length  $l$  is evidently

$$\text{voltage gain} = |E_{z2}| e^{-\alpha l} \quad (32)$$

since the longitudinal electric field at the input is taken as a unity.

The normalized amplitudes and phases of the  $E_{z1}$ ,  $E_{z2}$ , and  $E_{z3}$  at the input are shown in Figs. 9 and 10. Over the amplifying range,  $E_{z2}$  and  $E_{z3}$  are conjugate quantities. At the high-velocity end, the amplitudes of  $E_{z2}$  and  $E_{z3}$  exceed unity. It should be remembered that here the amplification constant is rather small. At the

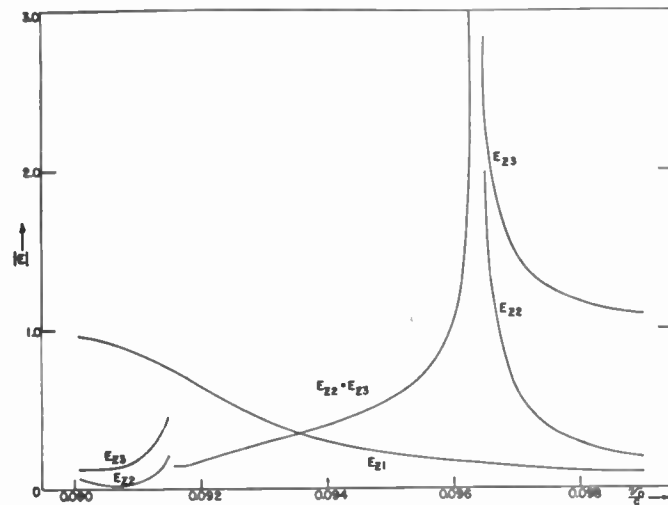

Fig. 9—Initial relative magnitudes of the three component axial electric fields as functions of the average electron velocity ( $v_0$ ).  $I=10^{-3}$  amp.

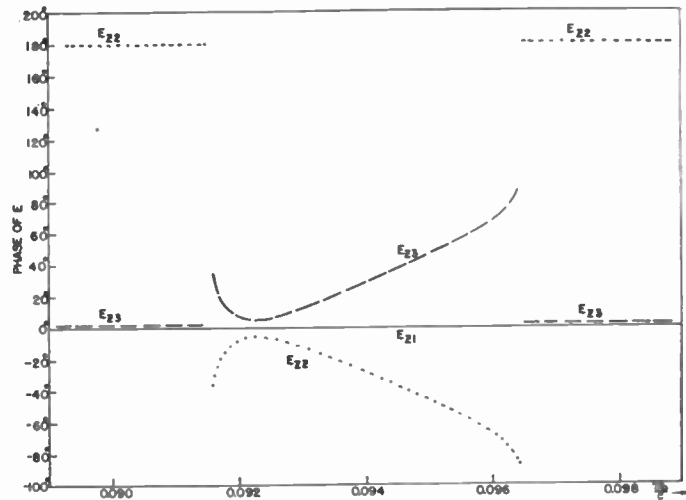

Fig. 10—Initial relative phases of the three component axial electric fields as functions of the average electron velocity ( $v_0$ ).  $I=10^{-3}$  amp.

low-velocity end, the amplitude of  $E_{z2}$  is rather small. However, this is compensated by the high a.c. current over this portion of the curve.

B. Signal Level and Limiting Efficiency

So long as we limit our discussion to a low level of r.f. power all through the tube, the assumption of a constant electron velocity  $v_0$  is valid, since the energy transferred from the electron beam to the r.f. field will

be a negligible fraction of the total kinetic energy of the electrons. We observe from the above theory that, within the amplification range, the electron beam moves at a higher velocity than the interacting wave. Each individual electron must consequently undergo periods of acceleration and deceleration along the tube. It must also lose more energy during the deceleration than the energy gained during the acceleration. On the time average all the electrons must lose energy gradually, and probably at the same average rate. If the last statement is correct, we can apply the above theory, with modification, to a tube with a high signal level. We can consider the theory valid for a very short section of the tube. As the wave and electrons move along the tube the d.c. electron velocity is reduced because of the net decrease in kinetic energy of the electrons. The phase velocity of the wave is slowed down accordingly, with a corresponding change of the field structure. We can imagine that the point of operation in Fig. 6 shifts gradually to the left. The amplification constant is continuously changing. The decrease of the average electron velocity will be slow at the beginning. Because of the exponential increase of the r.f. power level, the average electron velocity must decrease rapidly at the end.

On the assumption that a sufficiently long lossless helix is used, the maximum energy exchange would take place if the electrons enter the helical guide with a velocity  $v_a$  corresponding to the upper end of the amplification range, and leave with a velocity  $v_b$  corresponding to the lower end of the range. Therefore, the maximum limit of the efficiency of energy conversion  $\epsilon$  can be given by

$$\epsilon = \frac{v_a^2 - v_b^2}{v_a^2}$$

For the typical tube discussed here, the upper limit of maximum efficiency possible is of the order of 10 to 25 per cent, depending upon the beam current and beam radius.

Practically, the efficiency of a practical device would be limited to a value much less than that given above by the relatively short length of helix employed, terminating conditions, and other factors.

The ratio of the a.c. electron current to the longitudinal electric field increases as the d.c. velocity of the electrons slows down. This is obvious from the conductance curve in Fig. 7. At the output of a helix-type traveling-wave tube, we shall find that the beam is highly bunched, more so than is expected from an exponential increase of the a.c. current. It is interesting to note that it might be possible to extract the r.f. power from the beam at the output by some klystron-type cavity.

APPENDIX

Calculation of Attenuation Constants Using Power Transfer Considerations

Fig. 6 suggests a functional relationship between  $\alpha$  and the difference of the phase constants  $\beta_2$  and  $\omega/v_0$ . A relatively simple calculation which employs the concept of power transfer from the beam to the traveling wave affords an easy method of evaluating the attenuation constants of the component waves in an explicit manner.

Within the electron beam the following relation between the a.c. convection current and the axial electric field can be obtained from (13):

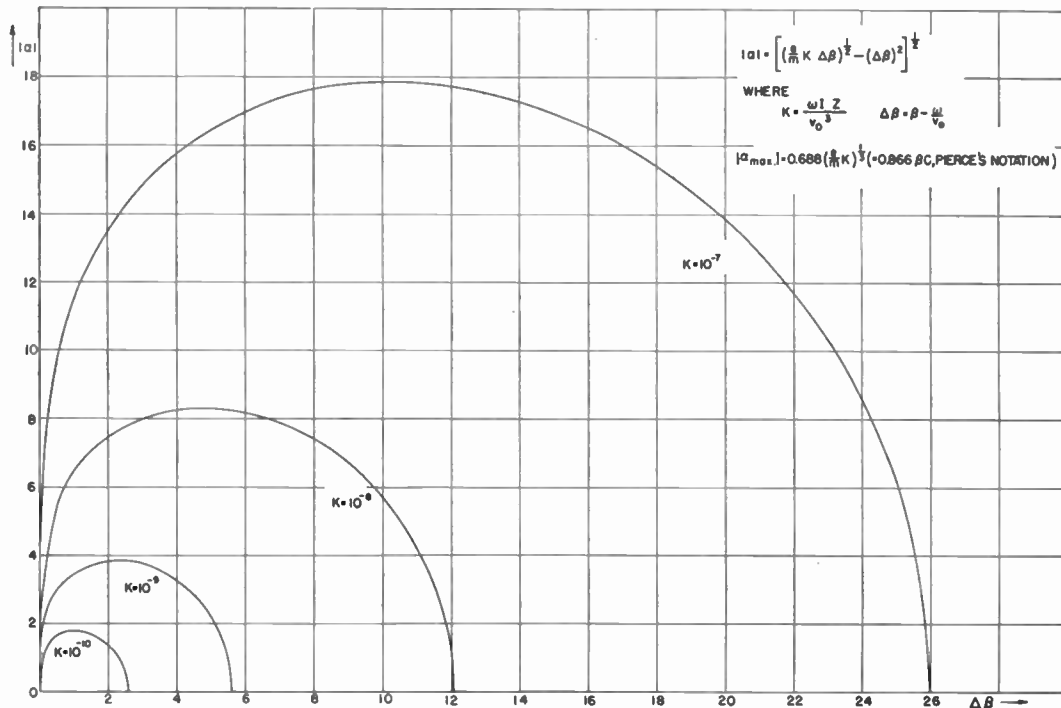

Fig. 11—Functional relationship between the amplification constant  $|\alpha|$  and the difference of phase constants ( $\Delta\beta = \beta - (\omega/v_0)$ ).



$$I_z = \left[ \frac{j\omega \frac{e}{m} I}{v_0^3 \left( j \frac{\omega}{v_0} - \gamma \right)^2} \right] E_z \quad (33)$$

where  $I$  is the d.c. beam current and is equal to  $-\pi b^2 J_0$ .

Since the displacement current is in quadrature with the axial electric field, we can write the rate of increase of power transferred along a lossless waveguide structure as

$$\begin{aligned} \frac{dP}{dz} &= \frac{\omega}{2\pi} \int_t^{t+2\pi/\omega} -E_z I_z^* dt \\ &= -\frac{e\omega I}{mv_0^3} \frac{\alpha \Delta\beta}{(\alpha^2 + \Delta\beta^2)^2} E_z E_z^* \end{aligned} \quad (34)$$

where  $\Delta\beta = \beta - \omega/v_0$ .

We can define the power transmitted in a waveguide as

$$P = \frac{E_z E_z^*}{2Z} \quad (35)$$

where  $Z$  is an impedance dependent upon the guide field configuration which in turn depends upon  $I$ ,  $\Delta\beta$ , etc. The rate of increase of power can then be written

$$\frac{dP}{dz} = -\frac{\alpha}{Z} E_z E_z^* \quad (36)$$

Equating (34) and (36) gives

$$\alpha \left[ \frac{e\omega I Z}{mv_0^3} \times \frac{\Delta\beta}{(\alpha^2 + \Delta\beta^2)^2} - 1 \right] = 0. \quad (37)$$

This is a cubic equation yielding the three roots:

$$\begin{aligned} \alpha_1 &= 0 \\ \alpha_2 &= -\alpha_3 = - \left[ \left( \frac{e\omega I Z}{mv_0^3} \Delta\beta \right)^{1/2} - (\Delta\beta)^2 \right]^{1/2}. \end{aligned} \quad (38)$$

The absolute values of these three attenuation constants are plotted in Fig. 11 as functions of  $\Delta\beta$  for various values of the parameter  $K = \omega I Z / v_0^3$ . The three attenuation constants calculated in this way are identical with those derived in the more elaborate field theory, provided the dependence of  $Z$  upon the operating conditions is taken into account.

Under the assumption that  $\Delta\beta$  varies rapidly with a small variation in  $v_0$  while  $Z$  is constant, the maximum absolute value of  $\alpha_2$  can be calculated by differentiating (38) with respect to  $\Delta\beta$ .

$$|\alpha_{\max}| = 0.688 \left( \frac{e\omega I Z}{mv_0^3} \right)^{1/3}. \quad (39)$$

This can be readily shown to agree with Pierce's<sup>2</sup> corresponding result by a simple change in notation, provided  $Z$  is interpreted as  $1/\psi_0^*$  as defined by Pierce, this being rigorously true only if  $I=0$ .

## A Contribution to the Approximation Problem\*

RICHARD F. BAUM†, ASSOCIATE, I.R.E.

**Summary**—A method is outlined whereby a given attenuation curve is approximated by the addition of a finite number of semi-infinite slopes, each of which in turn is closely approximated by the attenuation curve of a Butterworth function. These functions therefore constitute a set of approximation functions for impedance functions.

The set is extended by the addition of Tschebyscheff functions, which seem more appropriate for the approximation of curves with filter properties.

The method avoids most of the labor normally involved in the numerical solution of approximation problems and the calculation of impedance zeros and poles. It seems especially suited for cases of rather smooth attenuation curves extending over a wide range of frequency.

A short indication is given of how to apply the same method to the approximation of resistance, reactance, and phase functions.

### I. INTRODUCTION

NETWORK SYNTHESIS makes it its purpose to find a suitable combination of resistances, capacitances, and inductances in order to realize a

prescribed impedance function<sup>1</sup>

$$Z(\lambda) = \frac{a_0 + a_1\lambda + \cdots + a_n\lambda^n}{b_0 + b_1\lambda + \cdots + b_m\lambda^m} \quad (1)$$

where  $\lambda$  is the complex frequency.

It is known that, if  $Z(\lambda)$  is restricted to minimum reactance and minimum phase type, it is completely determined by either one of its components. For instance, if its absolute value is prescribed by an expression of the form

$$|Z(j\omega)|^2 = \frac{A_0 + A_2\lambda^2 + \cdots + A_{2n}\lambda^{2n}}{B_0 + B_2\lambda^2 + \cdots + B_{2m}\lambda^{2m}}, \quad (2)$$

there are means available by which one may calculate the complex impedance expression (1). Similar procedures are at hand or are being worked out for the cases where either the phase, or the real part, or the imaginary part of  $Z(\lambda)$  are prescribed instead. In the present paper we shall confine ourselves mainly to the

\* Decimal classification: 510. Original manuscript received by the Institute, February 4, 1948; revised manuscript received, April 7, 1948.

† Raytheon Manufacturing Company, Waltham, Mass.

<sup>1</sup> In this paper, the general term "impedance function" includes impedance or admittance, of both driving-point or transfer type.

most frequent case where the absolute value is prescribed, but in the concluding paragraph a short outline will be given showing how the proposed methods may be applied to the remaining cases.

According to (2), the most general expression for the squared magnitude of  $Z(j\omega)$  is a ratio of two polynomials in  $\lambda^2$  with real coefficients  $A_r$  and  $B_r$ . The calculation of these coefficients from an empirically or theoretically given curve precedes the network synthesis proper, and is called the *approximation problem*. It forms the subject of this paper.

Assume that the parameters  $A_r$  and  $B_r$  were known. Let us recall how to proceed in order to obtain the impedance expression from its squared magnitude. The first step is to calculate the zeros and poles of  $|Z(j\omega)|^2$ , which are the roots of the two polynomials appearing in (2). These roots, expressed in terms of  $\lambda$ , then are split into two groups. One group with negative real parts forms the zeros and poles of the impedance function  $Z(\lambda)$ , whereas the other group, comprising the same zeros and poles but with negative sign, forms the conjugate complex impedance function.<sup>2</sup>

From this it is evident that the knowledge of the roots of the two polynomials in (2) is of fundamental importance. As the roots are complex and the polynomials may be of rather high order, the numerical extraction of the roots is a rather laborious undertaking which one would like to avoid. It is one of the advantages of the proposed method that the squared magnitude of  $Z(j\omega)$  is approximated by a finite product of functions the roots of which are known.

After this brief digression, a short review of some methods used in the solution of the approximation problem is called for.

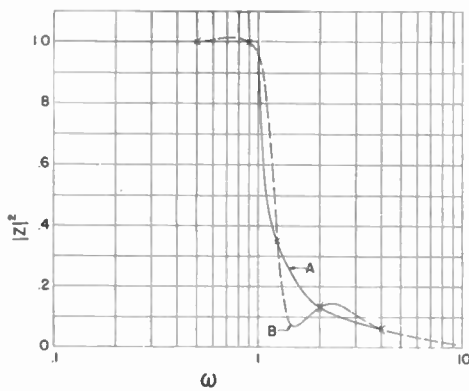

Fig. 1

Assume, for instance, that  $|Z(j\omega)|^2$  be given graphically as curve  $A$  in Fig. 1. We may try to represent this curve by the expression

$$|Z(j\omega)|^2 = \frac{A_0 + A_2\omega^2 + A_4\omega^4}{B_0 + B_2\omega^2 + B_4\omega^4 + B_6\omega^6} \quad (3)$$

or by the equivalent equation

$$(A_0 + A_2\omega^2 + A_4\omega^4) - |Z(j\omega)|^2(B_0 + B_2\omega^2 + B_4\omega^4 + B_6\omega^6) = 0. \quad (4)$$

By choosing particular points on the curve  $A$  for a series of special values of  $\omega$  and substituting in (4), a set of simultaneous linear equations for the coefficients  $A_r$  and  $B_r$  is obtained, which must be solved numerically.

Fig. 1 shows a particular result of this operation. It was assumed that, besides  $A_0=B_0=1$ , five more coefficients would be sufficient. Accordingly, five points (marked with crosses) were chosen on  $A$ . The result is shown by the dashed curve  $B$ . The departure from curve  $A$  is rather marked. The example is given mainly to show the shortcomings of this method of approach: it is difficult to foretell the behavior of the approximation curve between the prescribed points. Slight changes in their respective position often cause large variations in the shape of  $B$ , such as inadmissible overshoot or negative portions. Before realizing these effects, the whole system of equations has to be calculated.

Another method of approach has been advanced by Norbert Wiener.<sup>3</sup> Briefly, it consists in plotting the given curve  $|Z|^2$  on a new scale, by replacing the abscissa  $\omega$  by a new variable  $\phi$  related to  $\omega$  by

$$\omega = \tan(\phi/2). \quad (5)$$

This transforms  $|Z|^2$  into a periodic function of  $\phi$  to which the well-known method of expansion into a Fourier series is applied. This results in

$$|Z(\phi)|^2 = a_0 + a_1 \cos \phi + a_2 \cos 2\phi + \dots \quad (6)$$

The series is stopped when a sufficiently close approximation is attained. Equation (6) is now transformed into a polynomial in  $x$  by a further substitution

$$x = \cos \phi \quad (7)$$

which makes

$$|Z(x)|^2 = b_0 + b_1x + b_2x^2 + \dots \quad (8)$$

Equations (7) and (5) furnish the relation

$$x = \frac{1 - \omega^2}{1 + \omega^2}. \quad (9)$$

When this is introduced into (8)  $|Z|^2$  emerges as

$$|Z(j\omega)|^2 = \frac{A_0 + A_2\omega^2 + A_4\omega^4 + \dots}{(1 + \omega^2)^{2n}} \quad (10)$$

which has the required aspect of (3), although the denominator has a rather special form.

<sup>2</sup> H. W. Bode, "Network Analysis and Feedback Amplifier Design," D. Van Nostrand Company, Inc., New York, N. Y., 1945; p. 261.

<sup>3</sup> Lectures on Network Synthesis, E. A. Guillemin, given at the Raytheon Manufacturing Company during 1946.

This method reduces the approximation problem to the more familiar Fourier expansion. From the practical standpoint, it is somewhat lengthy because of the required triple change of variable. Furthermore, the roots of the numerator of (10) still must be evaluated.

### II. PROPOSED METHOD OF APPROXIMATION

The approximation problem may be solved in two steps by a semigraphical method. First, the attenuation curve (in db versus a logarithmic frequency scale) is graphically approximated by a succession of straight lines. Next, the corresponding mathematical expression is set up.

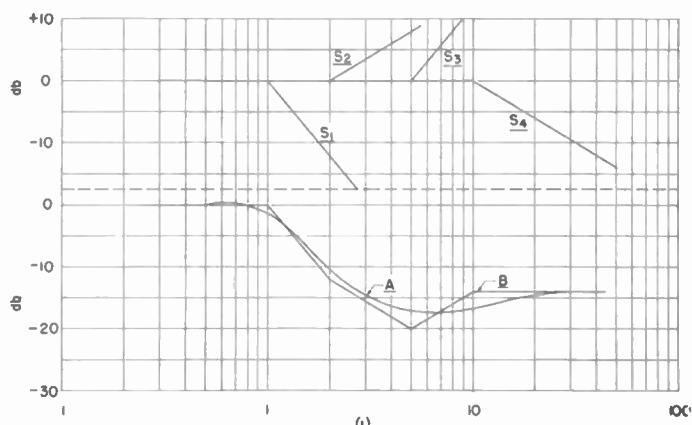

Fig. 2

Consider, in Fig. 2, the succession of semi-infinite slopes  $S_1, S_2, S_3, \dots$ . (In conformity with Bode's nomenclature, we call a "semi-infinite slope" an attenuation curve which is constant for all values of frequency below a certain "cutoff frequency" and rises or falls beyond this frequency at a constant rate, on a logarithmic frequency scale.) It is evident that, by simple addition of these slopes, the broken line  $B$  of Fig. 2 is obtained, which may be considered as an approximation of the given attenuation curve  $A$ . It seems that, by the use of a sufficiently high number of semi-infinite slopes, the approximation could be made as close as required.

Still there is an important restriction on the choice of the slopes. It follows from examination of (2) that the asymptotic behavior of any physically realizable impedance (that is, its behavior for  $\omega \rightarrow \infty$ ) is characterized by an even power of frequency, or

$$|Z(j\omega)|^2 \rightarrow \text{const.} \times \omega^{2n}$$

as

$$\omega \rightarrow \infty \tag{11a}$$

where  $n$  is a positive or negative integral number. To this corresponds an attenuation

$$A = 10 \log_{10} |Z(j\omega)|^2 = \text{const.} + 20n \log \omega. \tag{11b}$$

Now, if  $\omega$  increases to  $2\omega$  (or increases by one octave), the attenuation  $A$  increases by  $20n \log 2 = 6n$ , or an integer times 6 db. Any other slope cannot be approximated by an expression of the type of (2) with a finite number of terms, or realized by a network with a finite number of components. This also applies to the inverse function  $1/|Z(j\omega)|^2$ . This consideration therefore limits the available semi-infinite slopes to those including an angle of  $6n$  db per octave with the horizontal axis.

The next step is to find convenient mathematical expressions for the semi-infinite slopes. The choice of Butterworth functions seems indicated for ample reasons: They are familiar from the theory of filter design, their roots are known, they may be reproduced graphically with extreme ease, and, last but not least, they actually very smoothly fit semi-infinite slopes by a margin of not more than 3 db. A recapitulation of their properties, therefore, is given in Part III.

If, in Fig. 2, the function corresponding to a slope  $S_r$  has been found to be  $B_r(\omega^2)$ , then the expression for the broken line  $B$  obviously becomes

$$B = 10 \log B_2 + 10 \log B_3 - 10 \log B_1 - 10 \log B_4 \tag{12}$$

$$\cong 10 \log |Z(j\omega)|^2$$

from which

$$|Z(j\omega)|^2 = \frac{B_2(\omega^2) \times B_3(\omega^2)}{B_1(\omega^2) \times B_4(\omega^2)}. \tag{13}$$

If the roots of the functions  $B_r(\omega^2)$  are known, it is evident that the zeros and poles of (12) are known also, and no further calculation is necessary.

### III. APPROXIMATION BY BUTTERWORTH FUNCTIONS

The Butterworth function of order  $2n$  is given by

$$B_{2n}(\omega^2) = 1 + \omega^{2n} \tag{14}$$

where  $n$  is a positive integer. In Fig. 3, corresponding attenuation curves are drawn for  $n=1, 2, \text{ and } 3$ ; their expression is

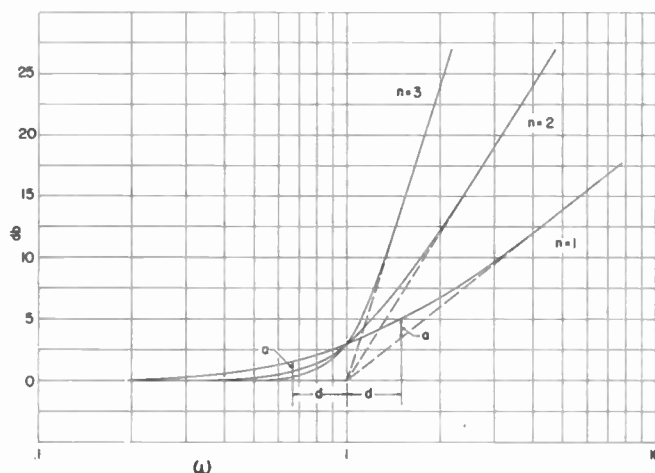

Fig. 3

$$S_{2n} = 10 \log_{10} (1 + \omega^{2n}). \quad (15)$$

It is apparent that these curves can be regarded as approximations to the semi-infinite slopes through the cut-off point  $\omega_0 = 1$  with an inclination of  $6n$  db per octave, respectively. They connect these slopes with the horizontal by a gentle arc, which extends (with 0.26 db margin) over about  $2/n$  octaves. All of them intersect at the 3-db point, where their departure from the semi-infinite slope is maximum, and where their slope is half of the asymptotic slope. They show a symmetrical behavior insofar as, at equidistant points from  $\omega_0 = 1$ , their distances above the horizontal and above the asymptote are equal, as shown for the curve  $n = 3$ .

The fact that the corner of the semi-infinite slope is replaced by an arc often is convenient. For instance, if we replace the semi-infinite slopes in Fig. 2 by Butterworth functions, it is easily seen that the resulting curve fits the prescribed curve *A* much better than the broken line *B*. Any discrepancy between the original curve *A* and its approximation will show up immediately, and adjustments in the position of the slopes can be made at once.

A semi-infinite slope of  $6n$  db per octave, but with a cutoff frequency different from 1, obviously is approximated by

$$B_{2n} = 1 + \left(\frac{\omega}{\omega_0}\right)^{2n}. \quad (16)$$

In accordance with (12), the equation for the squared magnitude  $|Z(j\omega)|^2$  can now be written down immediately. The four slopes of Fig. 2, for instance, have an angle of  $-12, 6, 12,$  and  $-6$  db, and a cutoff point of 1, 2, 5, and 10 radians, respectively. The corresponding impedance function is

$$|Z(j\omega)|^2 = \frac{\left[1 + \left(\frac{\omega}{2}\right)^2\right] \left[1 + \left(\frac{\omega}{5}\right)^4\right]}{[1 + \omega^4] \left[1 + \left(\frac{\omega}{10}\right)^2\right]}. \quad (17)$$

The roots of the Butterworth functions of (14) are the  $2n$  roots of  $(-1)$ . They form a symmetric star inscribed into a circle of unity radius, as shown in Fig. 4 for  $n = 2$

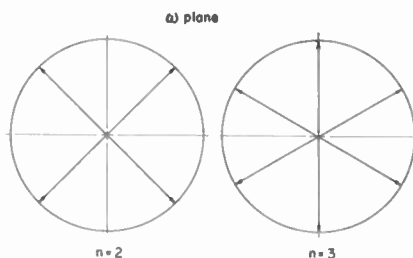

Fig. 4

(even) and  $n = 3$  (odd). If  $n$  is odd, one pair of roots coincides with the imaginary axis. If the cutoff frequency is

$\omega_0$  instead of one, as in (16), the radius of the circle equals  $\omega_0$ .

The roots in terms of  $\lambda = j\omega$  are obtained by simply rotating the root star counterclockwise by 90 degrees. Calling  $\lambda_1, \lambda_2, \dots, \lambda_n$  the roots now lying in the left-hand plane, the polynomial  $P(\lambda)$  having these roots is, but for a constant factor,

$$P(\lambda) = (\lambda - \lambda_1)(\lambda - \lambda_2) \cdots (\lambda - \lambda_n) \left. \begin{aligned} & \\ & = 1 + a_1\lambda + a_2\lambda^2 + \cdots + a_n\lambda^n \end{aligned} \right\}. \quad (18)$$

This result, for a cutoff frequency equal to 1, is summarized in Table I, which tabulates all coefficients  $a$ ,

TABLE I

$n =$	$a_1$	$a_2$	$a_3$	$a_4$	$a_5$	$a_6$	$a_7$	$a_8$
1	1							
2	$\sqrt{2}$	1						
3	2	2	1					
4	2.613	3.414	2.613	1				
5	3.236	5.236	5.236	3.236	1			
6	3.864	7.464	9.141	7.464	3.864	1		
7	4.494	10.103	14.606	14.606	10.103	4.494	1	
8	5.126	13.138	21.848	25.691	21.848	13.138	5.126	1

for Butterworth functions up to the eighth order. For many synthesis problems it is more convenient to group only conjugate complex roots together, and  $P(\lambda)$  then appears as in Table II. If the cutoff frequency is  $\omega_0 \neq 1$ , then in (18)  $\lambda$  has to be replaced by  $\lambda/\omega_0$ .

TABLE II

$n =$	$P_n(\lambda)$
1	$(1 + \lambda)$
2	$(1 + 1.4142\lambda + \lambda^2)$
3	$(1 + \lambda)(1 + \lambda + \lambda^2)$
4	$(1 + 0.7653\lambda + \lambda^2)(1 + 1.8477\lambda + \lambda^2)$
5	$(1 + \lambda)(1 + 0.6180\lambda + \lambda^2)(1 + 1.6180\lambda + \lambda^2)$
6	$(1 + 0.5176\lambda + \lambda^2)(1 + 1.4142\lambda + \lambda^2)(1 + 1.9318\lambda + \lambda^2)$
7	$(1 + \lambda)(1 + 0.4449\lambda + \lambda^2)(1 + 1.2465\lambda + \lambda^2)(1 + 1.8022\lambda + \lambda^2)$
8	$(1 + 0.3896\lambda + \lambda^2)(1 + 1.1110\lambda + \lambda^2)(1 + 1.6630\lambda + \lambda^2)(1 + 1.9622\lambda + \lambda^2)$

Using Table I, the impedance  $Z(\lambda)$  corresponding to  $|Z(j\omega)|^2$  of our example (equation (17)), can be written as

$$Z(\lambda) = \frac{\left[1 + \left(\frac{\lambda}{2}\right)\right] \left[1 + \sqrt{2}\left(\frac{\lambda}{5}\right) + \left(\frac{\lambda}{5}\right)^2\right]}{[1 + \sqrt{2}\lambda + \lambda^2] \left[1 + \left(\frac{\lambda}{10}\right)\right]}. \quad (19)$$

In many applications the phase  $\phi_n$  of  $Z(\lambda)$  is of importance. It can be obtained by simple addition of phase curves corresponding to the individual Butterworth function  $B_{2n}$  of the same parameter  $n$ . Such phase curves  $\phi_n/n$  are shown in Fig. 5 for  $n = 1, 2,$  and 3. The bottom curve corresponds to the phase of the semi-infinite slope itself, which forms the limit as  $n$  approaches  $\infty$ . All curves are skew-symmetric with respect to the point

$\omega = 1, \phi_n/n = 45^\circ$  as center of symmetry, where they intersect. Therefore, they are not continued beyond this point.

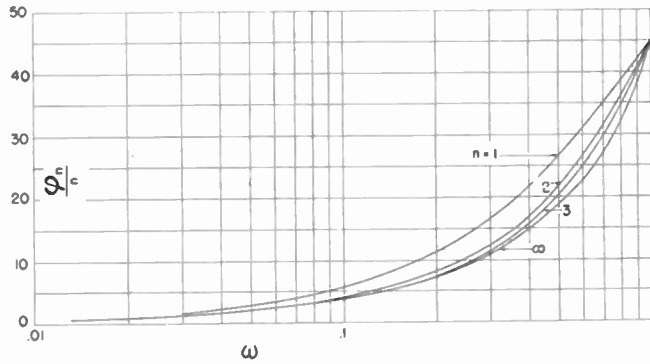

Fig. 5

This concludes the explanation of the proposed method of approximation and its application to a practical example. An additional improvement shall be pointed out.

Consider the ratio of two Butterworth functions with the same cutoff frequency:

$$r = \frac{B_{2n}(\omega^2)}{B_{2(n+k)}(\omega^2)} \quad (20)$$

where  $n$  and  $k$  are integers. This ratio has an asymptotic slope of  $-6k$  db per octave, independently of the value of  $n$ . In Fig. 6 a number of curves are shown for  $k = 1, 2, 3,$  and  $4$  and of  $n = 1, 2,$  and  $3$ . They are easily obtained by subtraction of any two attenuation curves of Fig. 3. When doing this, it becomes clear that  $r(\omega^2)$  becomes the better an approximation to a semi-infinite slope the higher one chooses the parameter  $n$ . The curves run in geometric symmetry above the horizontal axis and the

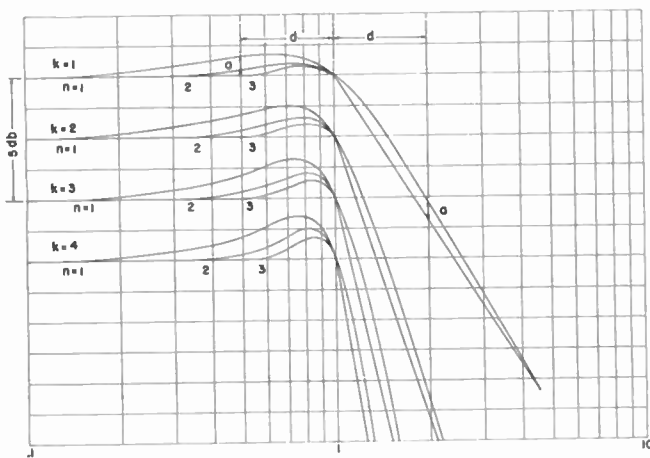

Fig. 6

asymptotes, as indicated for the curve  $n = 1, k = 1,$  and all intersect at the cutoff point  $\omega_0 = 1$ . Some of the curves therefore are not continued beyond this point. The semi-infinite slope then appears as the limiting case for  $n \rightarrow \infty$ .

Fig. 7 shows the phase curve  $\phi_s$  of a semi-infinite slope

of 6 db per octave and the phase curve of a simple Butterworth function  $B_2(\omega^2)$ . The crossed and circled points correspond to improved approximations  $r(\omega^2)$  equal to  $B_2/B_4$  and  $B_6/B_8$ , respectively. The latter almost coincides with  $\phi_s$ .

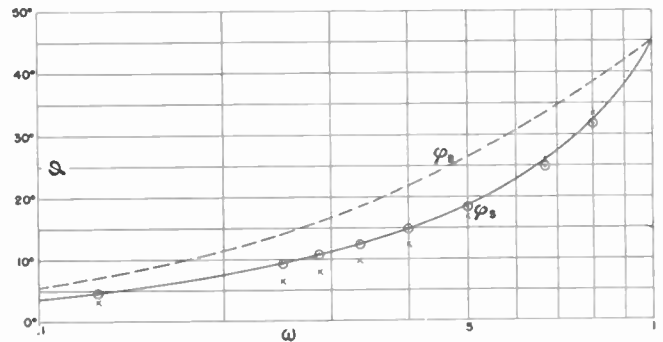

Fig. 7

Also of interest is the question of how to approximate a semi-infinite slope of a nonintegral number of 6 db per octave, like curve  $A$  in Fig. 8, which has 10 db per octave. This can be done by approximating  $A$  with the broken line, which has alternately 6 and 12 db per octave; the cutoff points  $P_1, P_2, P_3 \dots$  being chosen to lie alternately 3 db above and below  $A$ . This procedure has to be continued until a region of  $A$  is reached where the 10-db requirement can be relaxed, and either a 6-db or 12-db slope can be admitted.

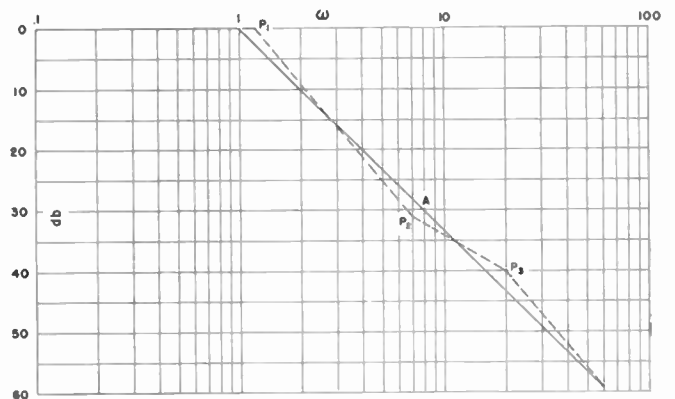

Fig. 8

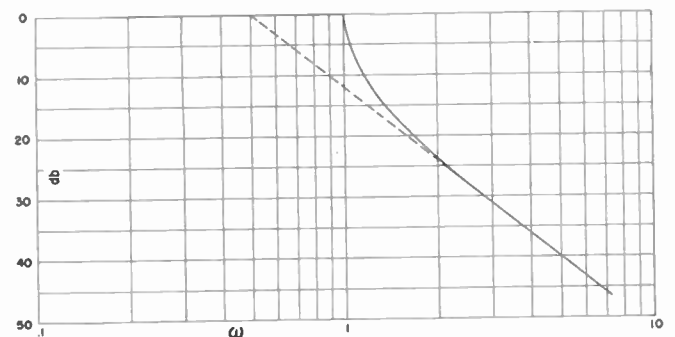

Fig. 9

IV. APPROXIMATION BY TSCHEBYSCHIEFF FUNCTIONS

Approximation of the prescribed attenuation curve by Butterworth functions would lead to very high powers of the polynomials  $B_{2n}(\omega^2)$  (and therefore to a high number of network components) when the prescribed curve shows filter properties with a very sharp cutoff, as shown in Fig. 9.

As is known from the theory of filter design, the use of Tschebyscheff functions is appropriate in these cases because they require the minimum power of  $\omega$  in any polynomial for a given attenuation margin in the pass band and steepness of cutoff.

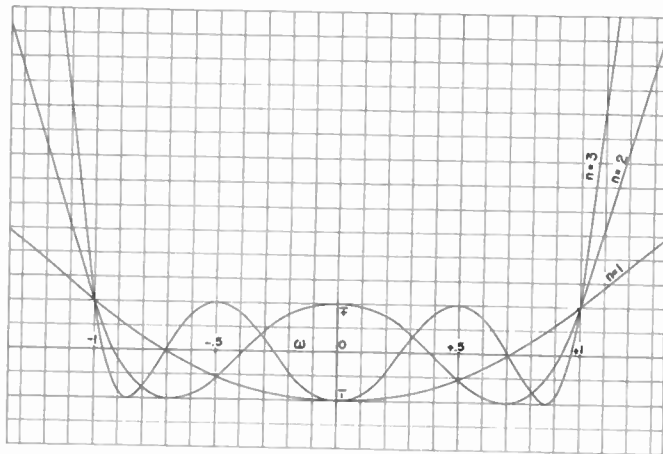

Fig. 10

The Tschebyscheff function  $T_{2n}(\omega^2)$  of order  $2n$  is a polynomial in  $\omega^2$  of highest power  $2n$  in which the coefficients are chosen in a definite way; namely, to make the function oscillate between plus and minus one within the interval  $-1 < \omega < +1$ , as shown in Fig. 10. For  $|\omega| > 1$  the function assumes rapidly increasing values. The function

$$T_{2n}'(\omega^2) = 1 + \epsilon T_{2n}(\omega^2), \tag{21}$$

where  $n$  is a positive integer and  $\epsilon$  is a positive real parameter small compared to one, obviously oscillates between  $1 + \epsilon$  and  $1 - \epsilon$  within the same interval  $-1 < \omega < +1$ . The cutoff of functions of this type (for  $n > 1$ ) is much steeper than that of Butterworth functions of the same order, as is apparent from Figs. 11(a), (b), and (c). These figures show the corresponding attenuation curves for  $n$  up to 5 and  $\epsilon = 0.1, 0.2,$  and  $\frac{1}{3}$ , respectively, for values of  $\omega > 1$ . It is seen that their asymptotic slopes again are  $6n$  db per octave, and meet at the point of abscissa  $\omega = 0.5$  and ordinate  $-10 \log(2/\epsilon)$ , or 13, 10, and 7 db, respectively.

If, by analogy to (20), the ratio of two such functions is formed by setting

$$r_T = \frac{1 + \epsilon T_{2n}(\omega^2)}{1 + \epsilon T_{2(n+k)}(\omega^2)}, \tag{22}$$

the set of attenuation curves of Fig. 12 is obtained. Their filter behavior is pronounced. Their asymptotes are confluent in the point  $\omega = 0.5$  on the  $\omega$  axis, and again have a slope of  $6k$  db per octave independent of

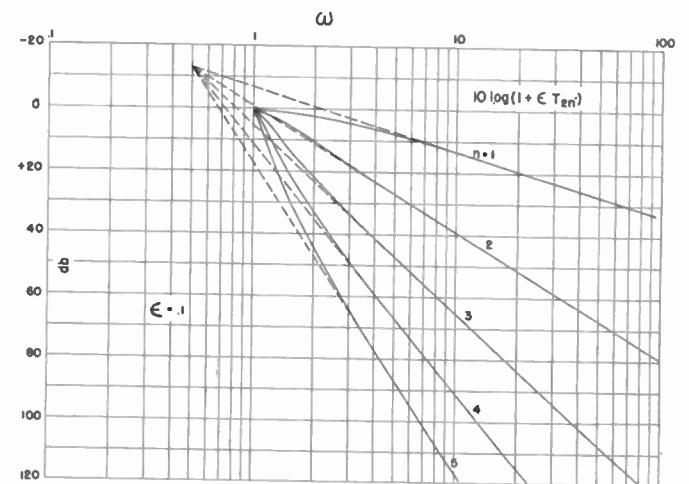

(a)

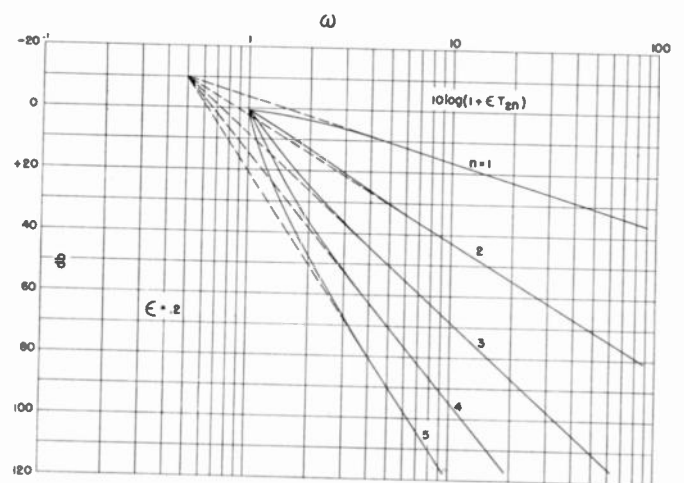

(b)

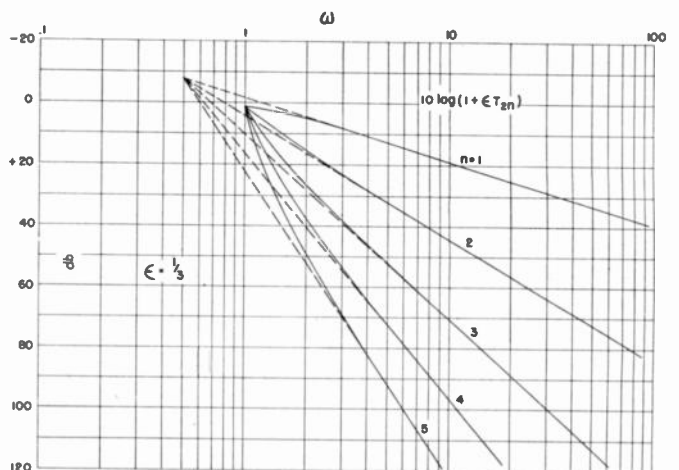

(c)

Fig. 11

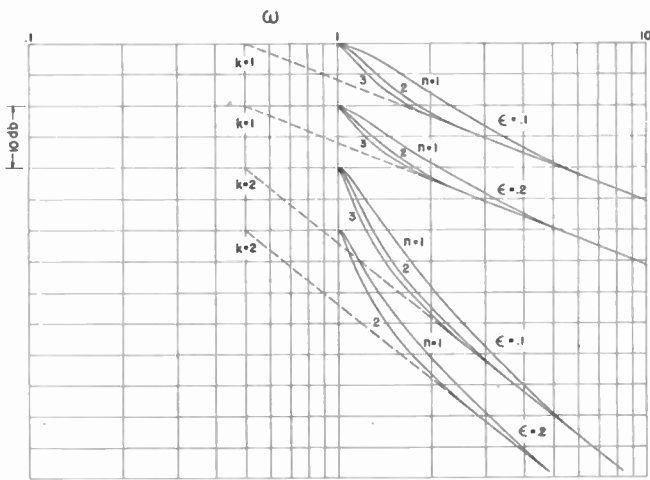

Fig. 12

the value of  $n$  and  $\epsilon$ . It should be pointed out that, as the numerator and denominator of (22) oscillate between  $1 + \epsilon$  and  $1 - \epsilon$  independently, the value of  $r_T$  may oscillate as much as  $1 \pm 2\epsilon$  within the pass band. Curves of the type shown in Figs. 11 and 12 are of practical interest in the design of interstage and feedback networks.

The roots of the functions (21), derived from Tscheybyscheff functions, are known, and may be obtained graphically from the root star of a Butterworth function of the same order, as shown in Fig. 13. Each root vector

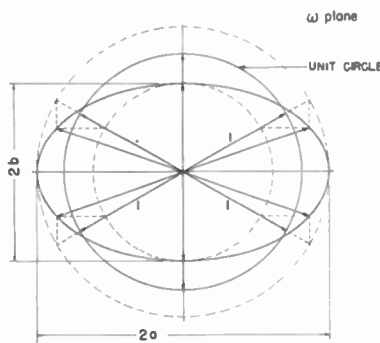

Fig. 13

is prolonged to its intersection with circles of radii  $a$  and  $b$ , and the points of intersection are projected horizontally and vertically onto the ellipse with the long axis  $2a$ , and the short axis  $2b$ , where

$$\begin{aligned} a &= \cosh \left[ \frac{\cosh^{-1}(1/\epsilon)}{2n} \right] \\ b &= \sinh \left[ \frac{\cosh^{-1}(1/\epsilon)}{2n} \right]. \end{aligned} \quad (23)$$

The approximation method outlined in the previous two paragraphs may be applied to high-pass and band-pass cases by making the proper low-pass-high-pass or low-pass-band-pass transformation.

### V. USE OF THE METHOD FOR THE APPROXIMATION OF RESISTANCE, REACTANCE, AND PHASE CURVES

The resistance characteristic  $R$  of a network may be represented by the ratio of two polynomials in  $\omega^2$  or  $\lambda^2$ , just as in the case of  $|Z(j\omega)|^2$  in (2). The same methods of approximation, therefore, may be used as described, by plotting  $10 \log R$  on a  $\log \omega$  scale. This can be done because  $R$  is always positive. The reconstruction of  $Z(\lambda)$  from  $R(\lambda^2)$  follows lines very similar to the reconstruction of  $Z(\omega)$  from  $|Z(\lambda)|^2$ , and here again the knowledge of the roots of the polynomials is helpful.

Reactance curves are odd functions of frequency, and must be approximated by expressions of the form

$$X(\omega) = \omega \frac{A(\omega^2)}{B(\omega^2)} \quad (24)$$

where  $A$  and  $B$  are polynomials in  $\omega^2$ . As  $X(\omega)$  is negative within certain frequency ranges, its logarithm there is not real. Still, the previously given approximations may be applied after some changes have been made. Equation 24 shows that  $X(\omega)$  has a zero at  $\omega=0$ , where a change of sign occurs. Further changes of sign can occur only at other zeros or poles, which obviously are real, occur in positive and negative pairs, and may be read off directly from the given curve. We may put them in evidence by writing

$$X(\omega) = \omega \frac{(\omega^2 - \omega_0^2)(\omega^2 - \omega_2^2) \cdots A'(\omega^2)}{(\omega^2 - \omega_1^2)(\omega^2 - \omega_2^2) \cdots B'(\omega^2)} \quad (25)$$

where the remaining polynomials  $A'$  and  $B'$  have only complex roots, and their quotient remains positive for all values of  $\omega$ . This suggests transposing the root factors to the left side of (21):

$$\frac{X(\omega)(\omega^2 - \omega_1^2)(\omega^2 - \omega_2^2) \cdots}{\omega(\omega^2 - \omega_0^2)(\omega^2 - \omega_2^2) \cdots} = \frac{A'(\omega^2)}{B'(\omega^2)}. \quad (26)$$

The left side now does not change sign with frequency; the logarithm of its absolute value can be plotted and the previous method of approximation applied. It is easy to show that the left side of (22) remains finite even for  $\omega$  approaching zero or  $\omega_0, \omega_2, \dots$ .

The same considerations are applicable to the approximation of phase curves, as the tangent of the phase is expressed by functions of exactly the same type as reactance functions, equation (20).

# Time Response of an Amplifier of $N$ Identical Stages\*

EUGENE F. GRANT†, ASSOCIATE, I.R.E.

**Summary**—The response of a many-stage amplifier to a unit step of voltage is to be calculated. From this, the response to rectangular pulses may be inferred. In order to simplify the calculations, it is assumed that the pass band is narrow compared to the center frequency so that a low-pass equivalent circuit may be analyzed, and its behavior will describe sufficiently accurately the behavior of the amplifier.

## I. ANALYSIS

THE FREQUENCY RESPONSE of a single-tuned amplifier is known to be

$$Y_1(p) = \frac{1}{1 + Q\left(\frac{p}{\omega_0} + \frac{\omega_0}{p}\right)} \quad (1)$$

The low-pass equivalent of this circuit is a simple  $RC$  circuit with a bandwidth of  $\Delta f_1$  where the bandwidth is defined as the frequency between the 3-db points.

$$Y_1'(p) = \frac{1}{1 + \frac{p}{\pi\Delta f_1}} \quad (2)$$

The time response of  $Y_1(p)$  to a voltage of center frequency  $f_0$  has an envelope which is approximately equal to the response of  $Y_1'(p)$  to the envelope of the input. Then the envelope of the response of an  $n$ -stage amplifier to an application of a unit step of voltage of frequency  $f_0$  may be determined by

$$E_n(t) = \frac{1}{2\pi j} \int_{Br} \frac{e^{p't} dp}{p \left(1 + \frac{p}{\pi\Delta f_1}\right)^n} \quad (3)$$

This integral may be evaluated by the method of residues or by a recourse to the literature.<sup>1</sup>

$$E_n(t) = 1 - e^{-\pi\Delta f_1 t} \sum_{k=0}^{n-1} \frac{(\pi\Delta f_1 t)^k}{k!} \quad (4)$$

$E_n(t)$  as a function of  $(\Delta f_1 t)$  has been plotted in Fig. 1 for values of  $n$  up to 9.

It is of interest to plot the behavior of  $E_n(t)$  in terms of  $\Delta f_n t$  instead of  $\Delta f_1 t$  where  $\Delta f_n$  is the 3-db bandwidth of the  $n$  stages.

$$\Delta f_n = \Delta f_1 \sqrt{2^{1/n} - 1} \quad (5)$$

$$\cong \sqrt{\frac{\log 2}{n}} \Delta f_1 \text{ for large } n. \quad (6)$$

\* Decimal classification: R363.12. Original manuscript received by the Institute, July 17, 1947; revised manuscript received, January 5, 1948.

† Electronic Research Laboratories, Air Matériel Command, Cambridge 39, Mass.

<sup>1</sup> G. A. Campbell and R. M. Foster, "Fourier Integrals for Practical Applications," Pair No. 581.7, p. 64, Bell System Technical Monograph, Bell Telephone Laboratories, New York, N. Y.

Substituting (5) in (4),

$$E_n(t) = 1 - e^{-(\pi\Delta f_n t / \sqrt{2^{1/n} - 1})} \sum_{k=0}^{n-1} \frac{1}{k!} \left[ \frac{\pi\Delta f_n t}{\sqrt{2^{1/n} - 1}} \right]^k \quad (7)$$

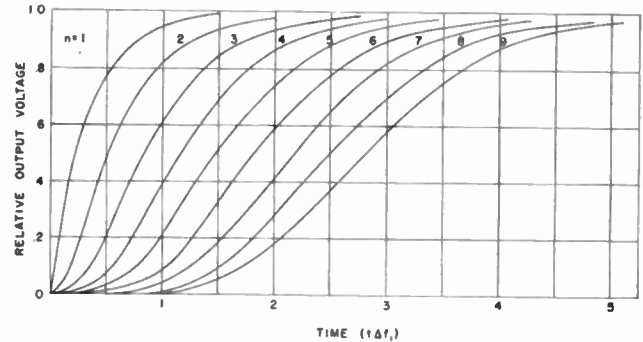

Fig. 1—Response of an amplifier to a unit step of voltage.

$E_n(t)$  is plotted in Fig. 2.

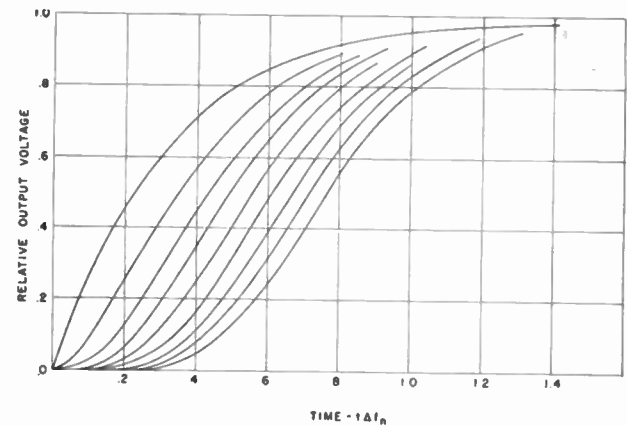

Fig. 2—Response of an amplifier to a unit step of voltage.

## II. ASYMPTOTIC EXPRESSION FOR THE RESPONSE

It is interesting to note in the curve of Fig. 2 that the responses for large  $n$  have nearly the same shape and slope. It would be suspected from this that there may be a response to which the responses, as  $n \rightarrow \infty$ , are asymptotic. Going back to (2) and substituting for  $\Delta f_1$  the asymptotic expression for  $\Delta f_n$ , (6),

$$Y_n'(p) = \frac{1}{\left[1 + \frac{p}{\pi\Delta f_n} \sqrt{\frac{\log 2}{n}}\right]^n} \quad (8)$$

Expanding  $\log Y_n'(p)$  in a Taylor series about  $p=0$ , it is seen that

$$\begin{aligned} \log Y_n'(p) &= \frac{p^2 \log 2}{2\pi^2 \Delta f_n^2} + \frac{p^4 (\log 2)^2}{n\pi^4 \Delta f_n^4} + \dots \\ &\quad - \frac{\sqrt{n \log 2} p}{\pi \Delta f_n} - \frac{1}{3\sqrt{n}} \left( \frac{p \sqrt{\log 2}}{\pi \Delta f_n} \right)^3 + \dots \end{aligned} \quad (9)$$



Then, for large  $n$ ,  $Y_n'(p)$  may be represented approximately, but simply, by

$$Y_n'(p) \sim e^{(p^2 \log 2 / 2 \pi^2 \Delta f_n^2)} e^{-(p \sqrt{n \log 2} / \pi \Delta f_n)} \quad (10)$$

The response to the unit step is then represented by

$$E_n(\Delta f_n t) \sim \frac{1}{2\pi j} \int_{Br} \frac{e^{(p^2 \log 2 / 2 \pi^2 \Delta f_n^2)} e^{p[t - (\sqrt{n \log 2} / \pi \Delta f_n) t]}}{p} dp \quad (11)$$

Again referring to the tables by Campbell and Foster,<sup>2</sup> it follows that:

$$E_n(t) \sim \frac{1}{2} \left\{ 1 + \operatorname{erf} \left[ \frac{\pi}{\sqrt{2 \log 2}} \left( \Delta f_n t - \frac{\sqrt{n \log 2}}{\pi} \right) \right] \right\} \quad (12)$$

It is seen from this expression that, for large  $n$ , the shape of the response is independent of  $n$ , but is delayed in time inversely proportional to the bandwidth and proportionally to the square root of the number of stages.  $E_n(t)$  is plotted in Fig. 3. The time delay from the

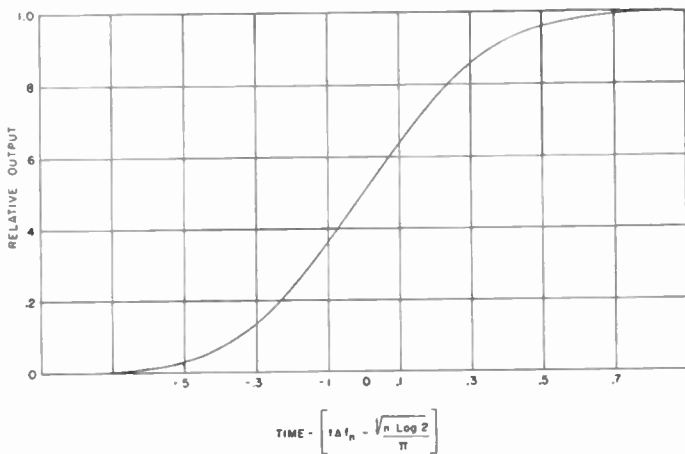

Fig. 3—Response of an amplifier with a large number of stages.

application of the unit step for the response to rise to one-half its final value is

$$t = \frac{\sqrt{n} \sqrt{\log 2}}{\pi \Delta f_n} \quad (13)$$

$$t \cong \frac{\sqrt{n}}{\Delta f_n} 0.26. \quad (14)$$

From Fig. 3 it is easy to calculate the time for a pulse to rise from 0.1 to 0.9 its final value:

$$t = \frac{0.7}{\Delta f_n} \quad (15)$$

<sup>2</sup> See pp. 43 and 86, pairs 408.1 and 727, of footnote reference 1.

This figure may be termed the equivalent time constant of the amplifier, if the time constant be defined as the time for the response to rise from zero to the final value at its maximum rate. (For one stage the maximum slope occurs at zero amplitude, but for large  $n$  the maximum slope occurs at a relative amplitude of 1/2.)

### III. CONCLUSIONS

The shape of the response of an identical-stage amplifier is asymptotic to an error-function curve for a large number of stages, but the delay (to the 1/2 relative amplitude point) varies as the square root of the number of stages and inversely with the 3-db bandwidth. The expression for the delay,

$$t_d = \frac{\sqrt{n}}{\Delta f_n} 0.26,$$

gives a result which is accurate within 20 per cent for  $n=1$ , 5 per cent for  $n=2$ , and about 1 per cent for  $n=9$ .

An equivalent time constant, which is dependent only on the 3-db bandwidth for a large number of stages, may be defined as

$$t = \frac{0.7}{\Delta f_n},$$

where  $t$  is the time to rise from 0.1 to 0.9 the final value, or the time to rise from zero to final amplitude at its maximum rate.

### IV. GLOSSARY

- $n$  = the number of stages of an amplifier
- $E_n(t)$  = the normalized envelope of the response of an amplifier of  $n$  stages to a unit step of voltage
- $f$  = frequency
- $\omega = 2\pi f$
- $p = j\omega$
- $j^2 = -1$
- $f_0$  = resonant frequency
- $t$  = time
- $\Delta f_n$  = the 3-db bandwidth of  $n$  stages
- $Q = f_0 / \Delta f_n$ , the  $Q$  of one stage
- $Y_1(p)$  = the normalized frequency response of one stage
- $Y_1'(p)$  = the low-pass equivalent of the stage
- $Y_n(p) = [Y_1(p)]^n$ , the response of  $n$  stages
- $\operatorname{erf} Z = 2 / \sqrt{\pi} \int_0^Z e^{-x^2} dx$
- $Br$  = the Bromwich contour, which is a path in the  $p$  plane extending from  $-j\infty$  to  $+j\infty$  but passing the poles of the integrand on the right.

# The Field of a Dipole with a Tuned Parasite at Constant Power\*

RONOLD KING†, SENIOR MEMBER, I.R.E.

**Summary**—Theoretical curves are shown of the electric field in the forward direction and in the backward direction for a center-driven half-wave dipole in the presence of a parallel center-tuned parasite of the same length and radius. The ratio of the electric field of the two-antenna array to the field of the driven unit alone at constant power is given as a function of the distance  $b$  between the antennas in the range from  $b=0$  to  $b=\lambda_0$ , for both the forward direction (the parasite is a reflector) and the backward direction (the parasite is a director). The total reactance of the parasitic antenna is used as a parameter in the form  $X_{22} = X_{s2} + X_2$  where  $X_{s2} = X_{s1}$  is the self-reactance of the parasite in the presence of the identical, driven dipole and  $X_2$  is the tuning reactance at the center of the parasite. Values for which curves are shown are  $X_{22} = 20, 10, 0, -10, -20$  ohms and  $X_{22} = X_{s2}$  or  $X_2 = 0$ . Reactances and resistances used are those of the first-order King-Middleton-Tai theory.

## REVIEW OF THE THEORY OF COUPLED ANTENNAS

THE CIRCUIT equations for two parallel antennas (Fig. 1), of which number 1 is driven and number 2 is parasitic, are:

$$V_1 = I_{01}Z_{11} + I_{02}Z_{12} \quad (1a)$$

$$0 = I_{01}Z_{21} + I_{02}Z_{22}. \quad (1b)$$

The driving voltage and the current at the center of antenna 1 are  $V_1$  and  $I_{01}$ ; the self-impedance of antenna 1 in the presence of antenna 2 is  $Z_{s1}$ ; the impedance in series with  $Z_{s1}$  is  $Z_1$ ; by definition,  $Z_{11} = Z_{s1} + Z_1$ . The current in the load at the center of antenna 2 is  $I_{02}$ , the

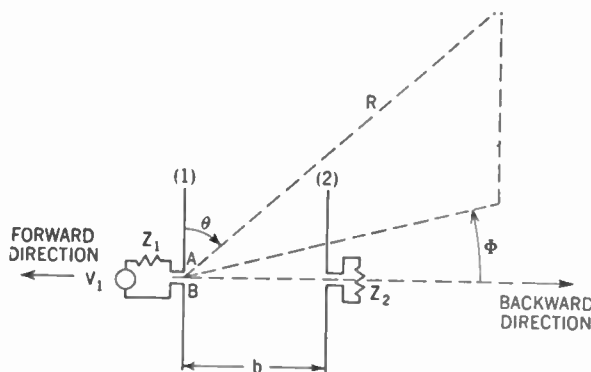

Fig. 1—Schematic diagram of a driven antenna with a tunable parasite.

self-impedance of antenna 2 in the presence of antenna 1 is  $Z_{s2}$ , the load or tuning impedance in series with  $Z_{s2}$  is  $Z_2$ ; by definition,  $Z_{22} = Z_{s2} + Z_2$ .  $Z_{s1}$  is, by definition, the coefficient of  $I_{01}$  in (1a) if  $Z_1 = 0$ ; similarly,  $Z_{s2}$  is the

\* Decimal classification: R125.1. Original manuscript received by the Institute, December 12, 1947. The research in this document was made possible through support extended Cruft Laboratory, Harvard University, jointly by the Navy Department, Office of Naval Research, and the Signal Corps, U. S. Army, under ONR contract N5ori-76, T.O.1.

† Cruft Laboratory, Harvard University, Cambridge, Mass.

coefficient of  $I_{02}$  in (1b) if  $Z_2 = 0$ . Both  $Z_{s1}$  and  $Z_{s2}$  depend upon the distributions of current in both antennas and, since this is a function of the distance  $b$  between the antennas, the self-impedances of the two antennas in each other's presence are functions of  $b$ . As  $b$  is increased to large values,  $Z_{s1}$  and  $Z_{s2}$  approach the self-impedances of isolated antennas. The mutual impedances  $Z_{12}$  and  $Z_{21}$  are, by definition, the coefficients, respectively, of  $I_{02}$  in (1a) and  $I_{01}$  in (1b). In general,  $Z_{21} = Z_{12}$ .

Recently, new formulas for  $Z_{s1}$  and  $Z_{12}$  have been derived by C. T. Tai<sup>1,2</sup> and curves computed for the range  $0 \leq b/\lambda_0 \leq 1$  for the important special case of two geometrically identical antennas for which  $Z_{s2} = Z_{s1}$ . The new derivation is an improvement on the earlier King-Harrison<sup>3</sup> theory for coupled antennas, which was not a good approximation for antennas very close together. The Tai theory introduces a new kernel for the integral equation, and obtains a solution using the expansion method of King and Middleton<sup>4</sup> instead of that of Hallén.<sup>5</sup>

Since the distribution of current in a center-driven or center-loaded antenna of half-length  $h = \lambda_0/4$  when isolated or close to another antenna is always essentially sinusoidal,<sup>1</sup> the conventional method of calculating the radiation field by assuming a sinusoidally distributed current in each antenna is a good approximation for antennas of this length. The well-known formula for the electric field is<sup>6</sup>

$$E_\theta = j \frac{60I_{01}}{R_0} F(\theta) e^{-i\beta_0 R_0} \quad (2)$$

where  $\beta_0 = 2\pi/\lambda_0$  and  $R_0$  is the distance from the center of the dipole to the point where  $E_\theta$  is evaluated.  $F(\theta)$  is the field factor<sup>7</sup> for a half-wave dipole; namely,

$$F(\theta) = \frac{\cos\left(\frac{\pi}{2} \cos \theta\right)}{\sin \theta}. \quad (3)$$

The far-zone field of a two-antenna array referred to the current in the driven unit involves  $I_{02}$  from (1b) and

<sup>1</sup> C. T. Tai, "Coupled antennas," Proc. I.R.E., vol. 36, pp. 487-500; April, 1948.

<sup>2</sup> R. King, "Graphical Representation of the Characteristics of Cylindrical Antennas," Cruft Laboratory Technical Report No. 20, October 1, 1947.

<sup>3</sup> R. King and C. W. Harrison, Jr., "Mutual and self-impedance for coupled antennas," Jour. Appl. Phys., vol. 15, pp. 481-495; June, 1944.

<sup>4</sup> R. King and D. Middleton, "The cylindrical antenna; current and impedance," Quart. Appl. Math., vol. 3, pp. 302-335; January, 1946.

<sup>5</sup> E. Hallén, *Nova Acta* (Upsala), November, 1938.

<sup>6</sup> R. W. P. King, H. R. Mimno, and A. H. Wing, "Transmission Lines, Antennas, and Wave Guides," McGraw-Hill Book Company, Inc., New York, N. Y., p. 185, eq. (37.10); 1945.

<sup>7</sup> See p. 183, eq. (37.7), of footnote reference 6.

$$\frac{Z_{21}}{Z_{22}} = \frac{Z_{12}}{Z_{22}} = - \left| \frac{Z_{12}}{Z_{22}} \right| e^{j(\theta_{22} - \theta_{12})}. \tag{4}$$

This field is given by<sup>8</sup>

$$E_{\theta} = j \frac{60I_{01}}{R_0} I'(\theta) e^{-i\beta_0 R_0} \left[ 1 - \left| \frac{Z_{12}}{Z_{22}} \right| e^{-j(\theta_{22} - \theta_{12} - \beta_0 b \sin\theta \cos\Phi)} \right]. \tag{5}$$

The field in the forward direction, i.e., the direction from parasite to driven unit, is defined by (5) with  $\theta = \pi/2$ ,  $\Phi = \pi$ ; the field in the backward direction, i.e., in the direction from driven unit to parasite, by  $\theta = \pi/2$ ,  $\Phi = 0$ . The corresponding formulas are

$$E_{\theta} = \frac{j60I_{01}}{R_0} e^{-i\beta_0 R_0} \left[ 1 - \left| \frac{Z_{12}}{Z_{22}} \right| e^{-j(\theta_{22} - \theta_{12} \pm \beta_0 b)} \right] \tag{6}$$

where the upper sign applies to the forward field, the lower sign to the backward field.

Since the input impedance of the driven antenna is a function of the distance  $b$  between antennas, so that the input current varies with  $b$ , the behavior of the array is best studied by requiring constant power input.

If the power to antenna 1, and hence to the array, is constant at

$$P_1 = \frac{1}{2} |I_{01}|^2 R_{AB}, \tag{7}$$

where  $R_{AB}$ , the input resistance of the driven antenna in the presence of the parasite, and the magnitude of the current  $|I_{01}|$  both vary with  $b$ , then the magnitude of (6) is

$$\left| E_{\theta} \right| = \frac{60}{R_0} \left\{ \frac{2P_1}{R_{AB}} \left[ 1 + \left| \frac{Z_{12}}{Z_{22}} \right|^2 - 2 \left| \frac{Z_{12}}{Z_{22}} \right| \cos(\theta_{22} - \theta_{12} \pm \beta_0 b) \right] \right\}^{1/2}. \tag{8}$$

The field of the driven antenna alone in the directions  $\theta = \pi/2$ ,  $\Phi = \pi$ , 0, when supplied with the same power  $P_1$ , is

$$\left| E_{\theta} \right| (1 \text{ unit}) = \frac{60}{R_0} \sqrt{\frac{2P_1}{R_0}} \tag{9}$$

where  $R_0$  is the input resistance of an *isolated* dipole, a quantity that differs from  $R_{AB}$  for the array. The final formula for the magnitude of the electric field in the forward direction (upper sign) and backward direction (lower sign) divided by the field of the driven unit alone at constant input power is<sup>9</sup>

$$\left| \frac{E_{\theta}(\text{array})}{E_{\theta}(1 \text{ unit})} \right| = \left\{ \frac{R_0}{R_{AB}} \left[ 1 + \left| \frac{Z_{12}}{Z_{22}} \right|^2 - 2 \left| \frac{Z_{12}}{Z_{22}} \right| \cos(\theta_{22} - \theta_{12} \pm \beta_0 b) \right] \right\}^{1/2}. \tag{10}$$

GRAPHICAL REPRESENTATION

The ratios defined by (10) with its two signs have been computed under the following conditions:

(a) Antenna 2 is geometrically identical with antenna

<sup>8</sup> See p. 207, eq. (42.7) of footnote reference 6.

<sup>9</sup> See p. 210, eq. (42.13), of footnote reference 6.

1, i.e., the half-lengths are the same, so that  $h_2 = h_1 = h$ ; and the radii are the same, so that  $a_2 = a_1 = a$ . Values chosen for computation are  $h = \lambda_0/4$ ;  $\Omega = 2ln(2h/a) = 10$  and 20, so that  $h/a = 75$  and  $1.1 \times 10^4$ . Also,  $Z_{e2} = Z_{e1}$ .

(b)  $Z_2 = jX_2$ ;  $R_2 = 0$ ; so that  $Z_{22} = Z_{e2} + jX_2 = Z_{e1} + jX_2$ . Values chosen for computation are  $X_{22} = 20, 10, 0, -10, -20, X_{e1}$ , so that  $X_2 = 20 - X_{e1}, 10 - X_{e1}, -X_{e1}, -10 - X_{e1}, -20 - X_{e1}, 0$ .

Note that in all cases, except that for which  $X_2 = 0$ , the tuning reactance  $X_2$  is continuously varied as the distance  $b$  between the antennas is changed.

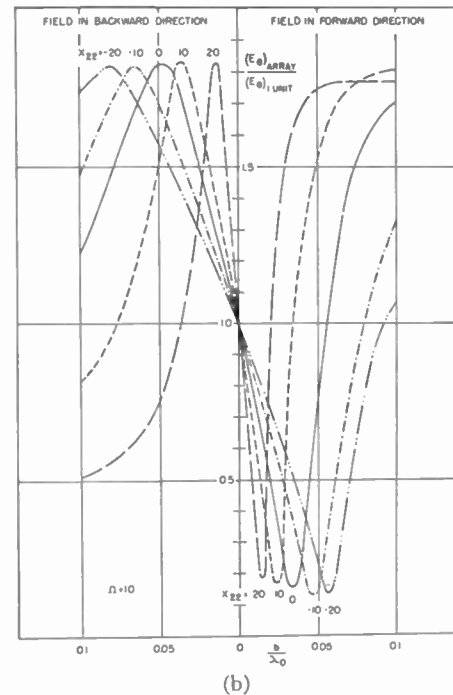
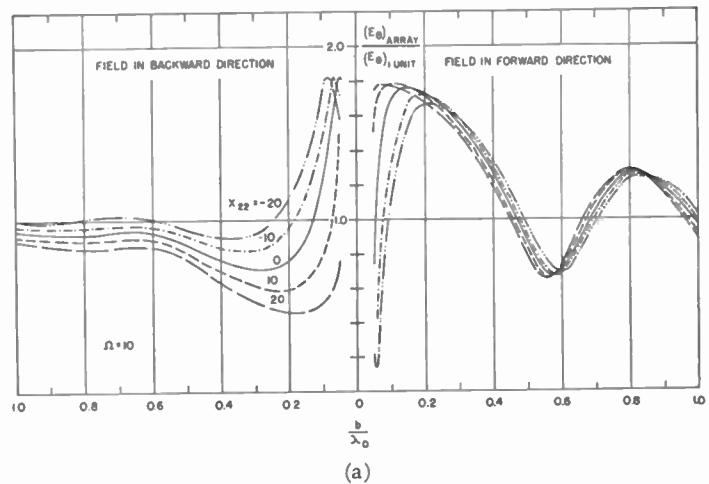

Fig. 2 (a)—Normalized electric field of an antenna with a parasite in forward and backward directions, with the total reactance in the circuit of the parasite as the parameter.  $\Omega = 2ln(2h/a) = 10$ . (b)—Same as Fig. 2 (a) for very close spacing.

In Fig. 2(a) are shown curves of (10) for  $\Omega = 10$ ;  $X_{22} = 20, 10, 0, -10, -20$ ; in the range  $0.05 \leq (b/\lambda_0) \leq 1$ ; in Fig. 2(b) is an enlarged representation of the range  $0 \leq (b/\lambda_0) \leq 0.1$ . Figs. 3(a) and 3(b) are like Figs. 2(a) and 2(b) but for the thinner antenna,  $\Omega = 20$ . Fig. 4 is like Figs. 1 and 2 for the one case,  $X_{22} = X_{e2}$ ;  $X_2 = 0$ .

In Fig. 5(a) are curves of the ratio of forward-to-backward field for  $\Omega=10$ ;  $X_{22}=20, 10, 0, -10, -20$ ; in the range  $0.07 \leq b/\lambda_0 \leq 1$ ; in Fig. 5(b) is an enlarged representation of the range  $0 \leq b/\lambda_0 \leq 0.1$ . Figs. 6(a) and

6(b) are like Figs. 5(a) and 5(b) for  $\Omega=20$ . Fig. 7 is like Figs. 4 and 5 for  $X_{22}=X_{21}$ ;  $X_2=0$ .

In Figs. 2(b), 3(b), 5(b), and 6(b) the curves have been extrapolated through  $b/\lambda_0=0$ . Actually,  $b/\lambda_0$  must always exceed  $2a/\lambda_0$  so that the extrapolated curves are meaningless for values equal to or smaller than

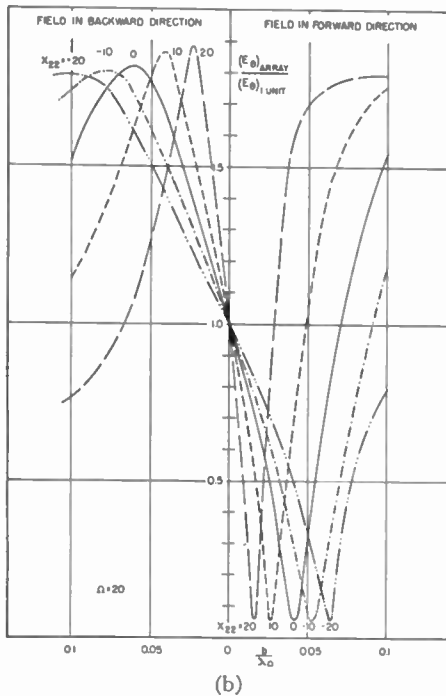
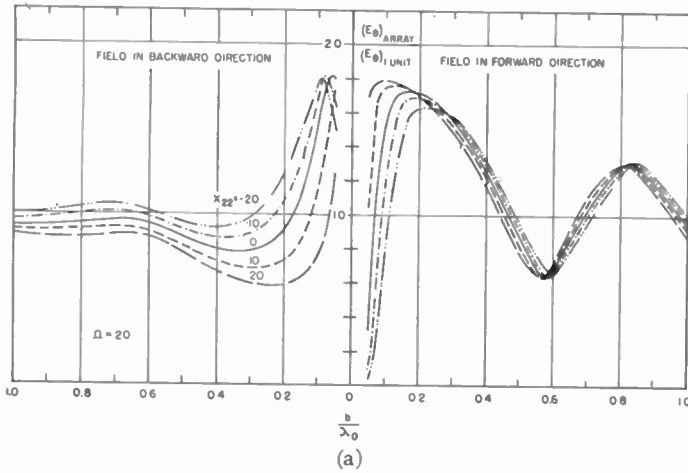

Fig. 3 (a)—Same as Fig. 2 (a), but for  $\Omega=ln2h/a=20$ . (b)—Same as Fig. 3 (a), but for very close spacing.

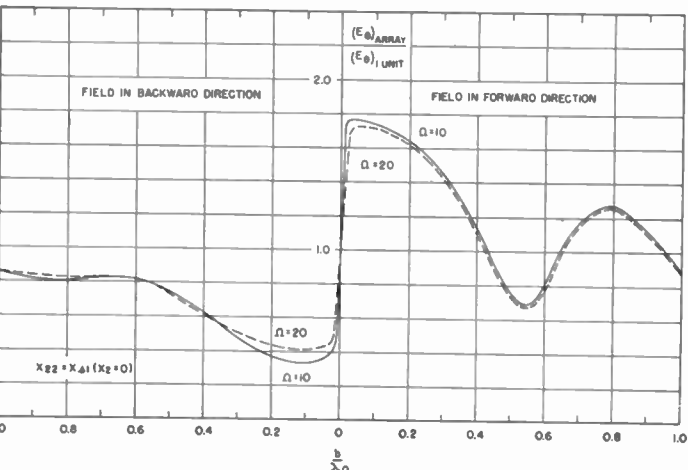

Fig. 4—Like Figs. 2 (a) and 3 (a), but with zero tuning reactance.

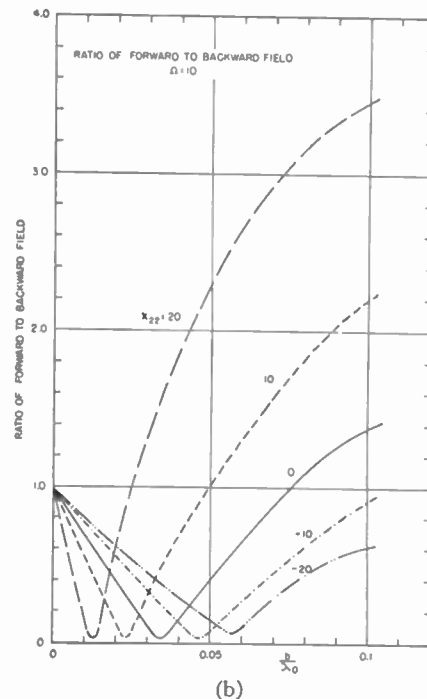
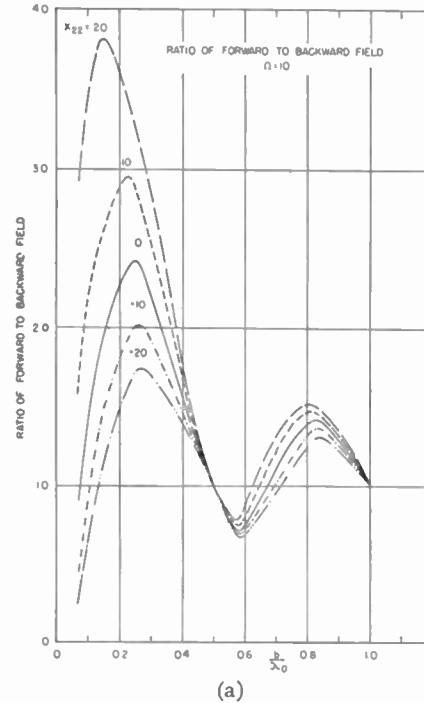
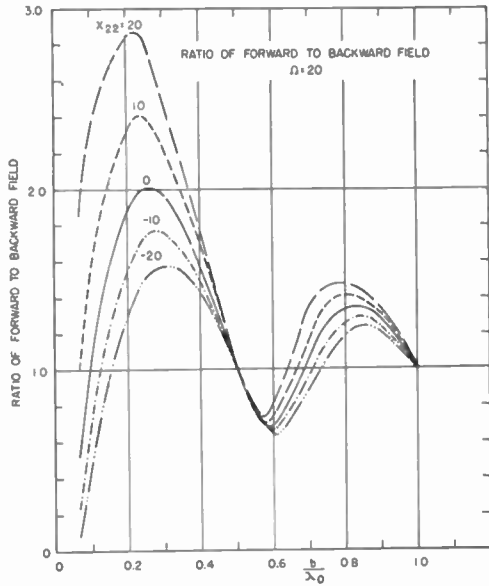

Fig. 5 (a)—Ratio of forward to backward field as obtained from Fig. 2 (a). (b)—Ratio of forward to backward field as obtained from Fig. 2 (b).

$b/\lambda_0=2a/\lambda_0$ . For relatively thin antennas the value  $b/\lambda_0=2a/\lambda_0$  is very small. Specifically, for  $h=\lambda_0/4$ ,  $\Omega=10$ ,  $a/\lambda_0=a/4h=1/300$ , so that  $b/\lambda_0 \geq 1/150 \approx 0.0067$ ; for  $\Omega=20$ ,  $a/\lambda_0=a/4h=1/4.4 \times 10^4$ , so that  $b/\lambda_0 \geq 1/2.2 \times 10^4 \approx 5 \times 10^{-5}$ .

Note that the curves in Figs. 2-7 correspond to similar curves in footnote references 3 and 6, but that the new curves are based upon the more accurate first-order King-Middleton-Tai theory instead of the first-order Hallén-King-Harrison theory. Moreover, the ranges of  $b/\lambda_0$  and of  $X_{22}$  are much greater in the new calculations.

Although numerical data for a driven antenna with a coupled parasite have been computed only for identical antennas with  $h = \lambda_0/4$  and with tuning reactances at the center of the parasite, these results may be applied



(a)

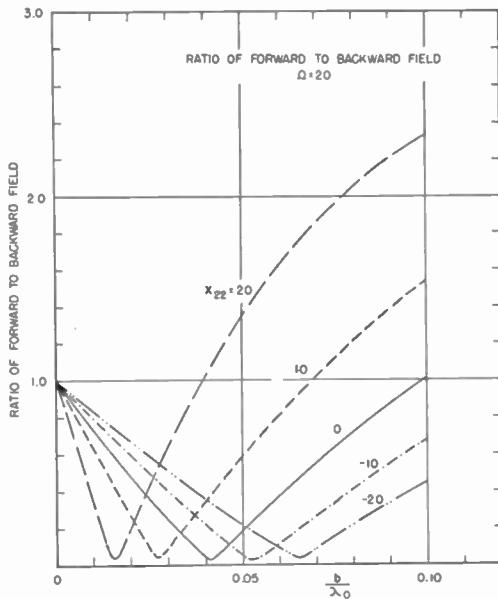

(b)

Fig. 6 (a)—Ratio of forward to backward field as obtained from Fig. 3 (a). (b)—Ratio of forward to backward field as obtained from Fig. 3 (b).

qualitatively to parasites that are slightly shorter or longer than  $\lambda_0/4$ . Since the distributions of current in coupled antennas differ very little except in phase if the parasite is somewhat longer or shorter than  $\lambda_0/4$ , the behavior of all parasites with a given value of  $X_{22} = X_{e2} + X_2$  will be essentially the same for half-lengths near  $h = \lambda_0/4$ . If  $X_{22}$  is varied by changing  $X_{e2}$ , as by varying

the length of the antenna with  $X_2 = 0$ , the effect is not greatly different from the variation of  $X_{22}$  by adjusting  $X_2$ . The variation of  $X_{e2}$  with length above or below the value at  $h = \lambda_0/4$  may be assumed to be approximately the same as the variation of the reactance  $X_0$  with

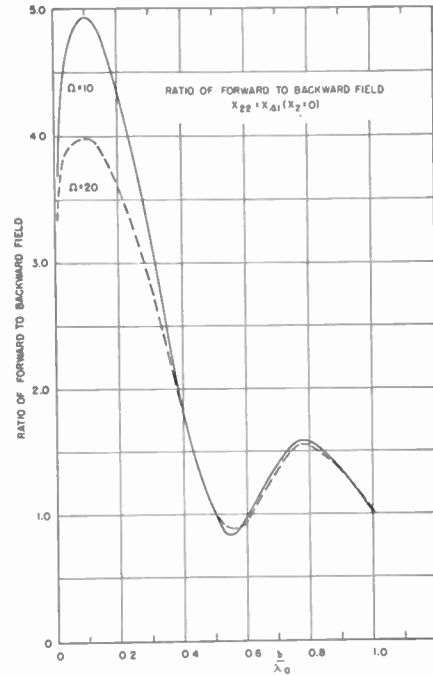

Fig. 7—Ratio of forward to backward field as obtained from Fig. 4.

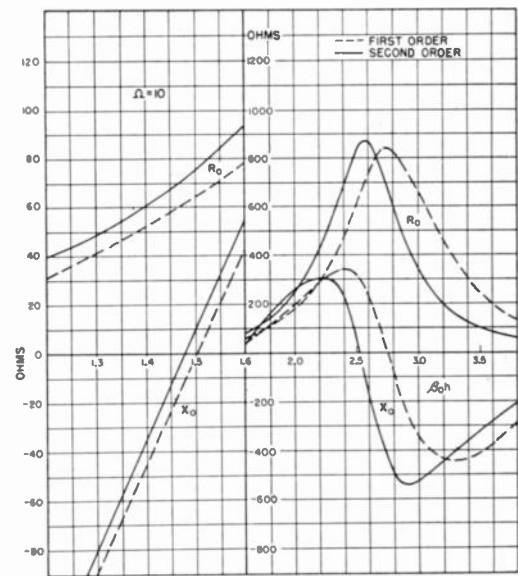

Fig. 8—First- and second-order impedances of an isolated center-driven antenna of half-length  $h$  and ratio  $a$  for  $\Omega = 2\pi 2h/a = 10$ .

length above or below the value at  $h = \lambda_0/4$  for an isolated antenna. Note that all data on coupled antennas are based on a first-order theory, so that the *first-order* and not second-order self-reactances of the King-Middleton theory must be used for this purpose. These are given in footnote reference 2 and reproduced here as Figs. 8 and 9.

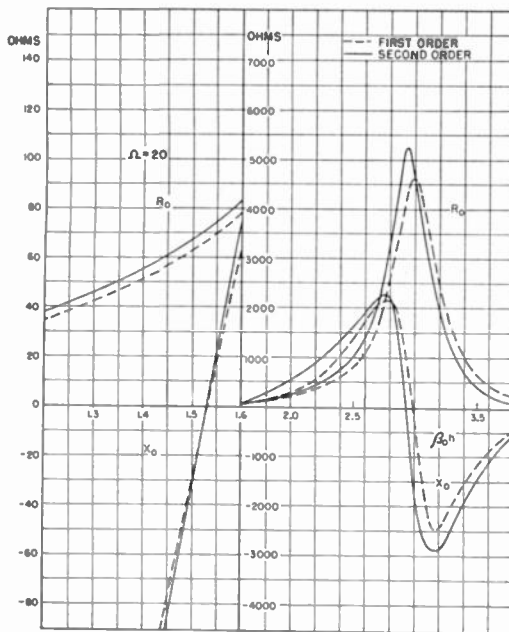

Fig. 9—Like Fig. 8, but for  $\Omega = 20$ .

#### APPLICATIONS

The first-order input impedance of an array consisting of a driven antenna in the presence of a coupled parasitic antenna is readily determined using the self- and mutual-impedance curves of the King-Middleton-Tai theory.<sup>1</sup> For convenience, these are reproduced in Fig. 10. The data provided in this paper permit determination of the electromagnetic field of such an array under a variety of conditions, including especially (1) the use of a parasitic antenna as a reflector with maximum field in the forward direction ( $\Phi = \pi$ ) (i.e., from parasite to driven unit), and a reduced or minimum field in the backward direction ( $\Phi = 0$ ); or (2) the use of

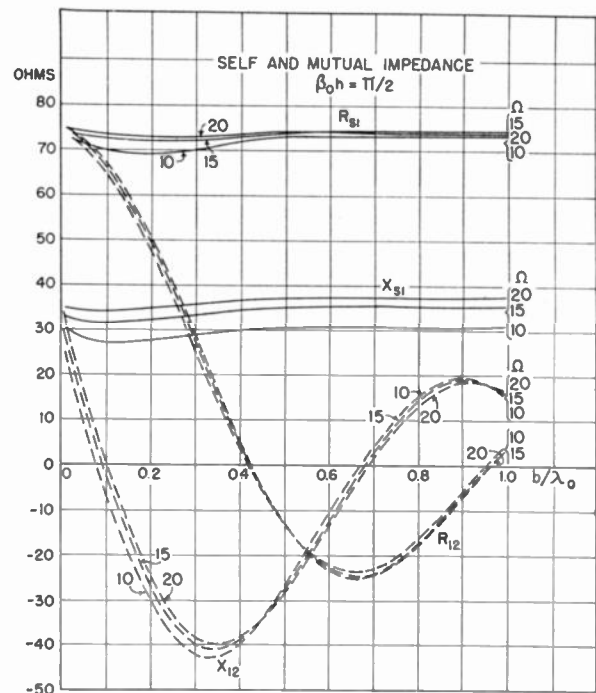

Fig. 10—Self and mutual impedances (first order) for identical, parallel, nonstaggered antennas of half-length  $h$  which are center-driven or center-tuned.

a parasitic antenna as a director with maximum field in the backward direction ( $\Phi = 0$ ) (i.e., from driven unit to parasite), and a reduced or minimum field in the forward direction. The distances between antennas for maximum or minimum field in either direction are readily obtained or interpolated from Figs. 2(a), 2(b); 3(a), 3(b), or 4 for a range of values of total reactance  $X_{22}$  of the parasitic antenna and its tuning circuit and different values of  $a/h$ . Similarly, from Figs. 5(a), 5(b), 6(a), 6(b), or 7 the spacing for maximum forward or backward field may be obtained.

## Contributors to the Proceedings of the I.R.E.

Richard F. Baum (A'42) was born on August 18, 1911, at Most, Czechoslovakia. He received the E.E. degree in 1935 from the Technische Hochschule in Prague, and a radio engineer's diploma in 1939 from the Ecole Superieure d'Electricité in Paris.

He worked for several years in the field of power applications. From 1940 to 1941 he was a radio operator in the United States Signal Corps. Subsequently he worked as development engineer with Industrial Instruments, Inc., Jersey City, N. J., on the suppression of radio interference in army vehicles. From 1942 to 1945, he was employed as senior engineer at the Federal Telephone and Radio Research Laboratories in New York, N. Y., being engaged in the development of direction-finding systems. Since July, 1945, he has been a member of the microwave communication department at the Raytheon Manufacturing Company, Waltham, Mass.



RICHARD F. BAUM

Frederick D. Bennett, (M'45) was born in Miles City, Mont., on June 2, 1917. After receiving the B.A. degree from Oberlin College in 1937, he went to the Pennsylvania State College where he received the M.Sc. degree in 1939 and Ph.D. degree in physics in 1941. From 1941 to 1943 he taught in the physics department at the University of New Hampshire. During the summer of 1942, he was associated with the engineering staff of Pratt and Whitney Aircraft Company engaged in the investigation of engine-cooling problems. From 1943 to 1946, he was engaged in aircraft-antenna research and design at Special Projects Laboratory, Wright Field, Dayton, Ohio. Since March, 1946, he has been a member of the staff of the electrical engineering department of the University of Illinois.

He is a member of the American Physical Society, Sigma Xi, Society for General Semantics, and Phi Beta Kappa.



FREDERICK D. BENNETT



Jacob S. Brown (J'37-S'38-A'44-S'46) was born in Philadelphia, Pa., on November 2, 1917. He received the B.S. degree in electrical engineering in 1942 from the Drexel Institute of Technology, and the M.S. in electrical engineering from the University of Illinois in 1947. From 1942 to 1946, he was with the Johns Hopkins University at the Radiation Laboratory in Baltimore, and then at the Applied Physics Laboratory at Silver Spring, Md. At the present time, he is at Argonne National Laboratory, Chicago, Ill.



Lan Jen Chu (A'39) was born on August 24, 1913, in Hweiyung, Kiangsu, China. He was graduated from Chiao Tung University, Shanghai, China, with the B.S. degree in electrical power in 1934; he received the S.M. degree in electrical engineering in 1935; and the Sc.D. degree in electrical engineering in 1938 from the Massachusetts Institute of Technology.



JACOB S. BROWN

Dr. Chu served as consultant to the Radiation Laboratory and the Radio Research Laboratory on various problems of jamming, antenna, and propagation problems. He joined the staff of the Radiation Laboratory of M.I.T. in 1942, and during the last years of the war supervised research and design of many special antennas for radar and communication applications. In 1945 he served as expert consultant to the Secretary of War, and in this capacity was sent to China to head the Advisory Specialist Group of Lt. General A. C. Wedemeyer, commanding general of the U. S. Armed Forces in China. Since his return to this country a year ago, he has supervised a group in the Research Laboratory of Electronics at M.I.T., on problems dealing with traveling-wave tubes, transient phenomena in waveguides, air-to-air collision systems, and the like, and is now a senior member of the staff.

Dr. Chu is associate professor of electrical engineering at the Massachusetts Institute of Technology and is a member of Sigma Xi. He is also a Fellow of the American Physical Society.



LAN JEN CHU



J. David Jackson (S'45) was born on January 19, 1925, in London, Ontario, Canada. He received the B.Sc. degree in physics and mathematics from the University of Western Ontario in 1946. Since June, 1946, he has held the position of research assistant on the physics staff of the Massachusetts Institute of Technology, doing theoretical research in the fields of electromagnetic theory and, at present, of nuclear physics, while pursuing postgraduate studies.

Mr. Jackson is a student member of the Canadian Association of Physicists.



For a photograph and biography of RONOLD KING, see page 244 of the February, 1948, issue of the PROCEEDINGS OF THE I.R.E.



EUGENE F. GRANT

Eugene F. Grant (A'44) was born in Baker, Ore., on June 15, 1917. He received the B.S. degree in electrical engineering from Oregon State College in 1941, and was awarded a graduate assistantship from Oregon State College, receiving the M.S. degree in electrical engineering in 1942. He was then employed by the Westinghouse Research Laboratories at East Pittsburgh in the electronics department. A large part of his work there consisted of the design of automatic-frequency-control systems for microwave oscillators. In 1945 he accepted a position as project engineer in the Sperry Gyroscope Company at Garden City, N. Y. Since late 1946 he has been with the Air Forces Electronic Research Laboratories (formerly Cambridge Field Station of the Watson Laboratories), Cambridge, Mass., in the Mathematical Research Branch of the Special Studies Laboratory.

Mr. Grant is a member of Phi Kappa Phi, Eta Kappa Nu, Sigma Pi Sigma, Pi Mu Epsilon, Sigma Tau, and Sigma Xi.



For a biography and photograph of R. V. POUND, see page 1516 of the December, 1947, issue of the PROCEEDINGS OF THE I.R.E.



J. DAVID JACKSON

Edouard Labin (A'42-SM'46), a French radio engineer, was born in Bucharest, on March 11, 1910. He received the degree of bachelor of science and philosophy in Paris in 1928, was graduated as *Licencié es Sciences Physiques* from the Sorbonne, Paris, in 1933, and as radio-engineer from the *École Supérieure d'Electricité*, Paris, in 1935. He then became associated with advance research in the field of radio, electronics, and radio aids to navigation.

From 1936 to 1937, Mr. Labin was engaged as research engineer in the radio laboratory of the *Lignes Télégraphique et Téléphoniques* company near Paris, and from 1938 to 1939 he headed a development department of the *Laboratoires Radioélectriques Co.* in Paris. With the beginning of war in September, 1939, he served with the French Air Force, and after the French Armistice, worked for nine months with the Lyon



EDOUARD LABIN

group of the Company L.M.T

From 1941 to 1946, Mr. Labin was on the staff of the Buenos Aires branch of the *Société Anonyme Philips* as assistant chief and, later, chief engineer of the Radio Research Laboratory. In the Argentine University in Buenos Aires, he was professor of general radioelectricity and assistant professor of mathematical theories applied to radio.

In 1947 Mr. Labin returned to France where he became chief of the Laboratory for Electronics and Applied Scientific Research of the Philips organization in Paris. His main work in radio pertains to radio aids to navigation, transmission, general theory of circuits, and frequency modulation; and, in electronics, to production, maintenance, and special uses of electron beams.

Mr. Labin is the author of numerous studies, papers, and patents in various branches of radio, and allied fields.

## Correspondence

### Note on Practical Limitations in the Directivity of Antennas\*

Mr. Riblet's paper<sup>1</sup> indicates the possibility of increasing the directivity by properly controlling the current distribution of an antenna. He has presented an analytical theory which indicates that directivity can be increased almost indefinitely, even though the antenna is limited in dimensions.

In 1930, I studied that particular problem without using the integral equations that are involved, but by considering discrete antenna elements and adding elements which, by trial and error, I found increased the directivity. After a comparatively short experience, the selection of the discrete elements to increase directivity became a comparatively simple matter, so that the amount of work involved was not nearly so burdensome as appeared necessary at the first attempt. I was able to design an antenna within 1 wavelength that had a directivity comparable to an antenna of some 10 wavelengths long. This result clearly appeared impractical. I therefore began to study the effective radiation resistance of these antennas, and found, to my distress, that the radiation resistance fell off very rapidly. In the case of one of the antennas that I had designed in this way, I calculated an effective radiation resistance of the order of  $10^{-6}$  ohms. Clearly, such an antenna would have high directivity, but would radiate practically no power. All the power would be dissipated in ohmic resistance. Continuing this study, I discovered that if the directivity is increased beyond that which would be obtained by a simple design with individual radiators in phase, the radiation resistance at first remains fairly steady, but when the directivity is increased beyond a certain

point it begins to fall off extremely rapidly. It is only by reducing the ohmic resistance that such increased directivity can be effectively used, and in practice it is not possible to increase the directivity without soon reaching the stage where the radiation resistance is too low for practical purposes.

In the case of certain broadcast antennas, I have presented evidence during the 1930's at hearings before the Federal Communications Commission showing that certain directional antennas were likely to have a much lower efficiency than expected because their directivity was too great for the space in which they were laid. That general result has been found by designers of directional antennas. The physical explanation of this phenomenon is to be found in the increase of circulating currents as the directivity is increased, thereby increasing the ohmic loss and the effective ohmic resistance.

An obvious and well-known case of a directional antenna contained in a small space is the loop antenna. This antenna consists effectively of two radiators spaced a small fraction of a wavelength apart with their currents almost exactly out of phase. It is well known that such an antenna for the space that it takes has a comparatively high directivity, its directional pattern being a figure of eight. The reason that such a system is practicable is because, although it carries a large circulating current, the ohmic resistance in the path of the circulating current is very low, so that the small radiation resistance of the system is still adequate to produce, in some cases, a reasonable degree of efficiency.

In an effort to improve the efficiency and characteristics of broadcast antennas by controlling the current distribution along a radiator, I developed a radiator<sup>2</sup> which was effectively excited at both its ends. In a vertical radiator the top-end excitation was ob-

tained by means of an insulated top loading. By adjusting the ratio of the excitation at the two ends of the radiator, it is possible to control to any reasonable extent the current distribution along the radiator. By this means the directivity in the plane of the radiator can be controlled. If the coupling circuit is adjusted so that the directivity is increased and the radiation resistance reduced, a point is reached at which the efficiency, or rather the effective field in the horizontal plane, is a maximum for a given power input. That condition is one that is commonly desired by broadcast stations. This maximum value depends on the ohmic loss of the antenna and coupling circuits. The lower the ohmic loss, the greater the directivity obtainable without excessive loss of radiation efficiency. An interesting point is that, quite frequently, increasing directivity reduces the ohmic loss by reducing the ground currents, as will occur in a vertical antenna when the required excitation decreases the current at the base.

Another possible practical use of this doubly excited vertical antenna is to adjust the directivity so that the minimum radiation occurs at such an angle that the sky wave at that angle corresponds with the normal beginning of the rapid-fading zone. The rapid-fading zone can therefore be pushed back so that the effective primary service of a regular broadcast station can thereby be increased.

It appears that the control of directivity which Mr. Riblet suggests as being possible in his paper has some practical applications, but there are strict limitations to the degree to which increased directivity can be obtained without building up the losses of the system beyond values which make the operation impracticable.

RAYMOND M. WILMOTTE  
1469 Church St., N.W.,  
Washington 5, D. C.

\* Received by the Institute, May 14, 1948.  
<sup>1</sup> H. J. Riblet, "Note on the maximum directivity of an antenna," *Proc. I.R.E.*, vol. 36, pp. 620-624, May, 1948.

<sup>2</sup> U. S. Patent Nos. 2,283,617, 2,283,618, and 2,283,619.



### Upper-Atmosphere Circulation as Indicated by Drifting and Dissipation of Intense Sporadic-E Clouds\*

Knowledge of upper-atmosphere circulation in the region 80-120 km. in altitude has been limited to the meager data obtained from observations of meteor trains<sup>1-3</sup> and luminous night clouds.<sup>4-8</sup> Mimno<sup>7</sup> and Eyfrig<sup>8</sup> have observed measurable time differences in the appearance overhead of sporadic-E clouds of very high ionized densities between geographic locations separated from one to fifty miles. The limited size of these clouds which appear to be immersed in the E-region of the ionosphere is known.<sup>7-10</sup> The writer<sup>11</sup> has proposed that an analysis of a large number of medium-duration radio transmissions in the frequency band 50-60 Mc. may provide additional information on the apparent drift of sporadic-E clouds.

A co-operative research program was initiated by the writer in 1947 to study the effects of sporadic-E reflections in the radio amateur band 50-54 Mc. Normally, radio wave transmissions at these frequencies are limited by the curvature of the earth. Occasionally, the appearance of highly ionized sporadic-E clouds will propagate radio signals at these frequencies to distances of 400 to 1400 miles. The random distribution and operating hours of radio amateurs throughout the United States and Canada has permitted the frequency of occurrence of sporadic-E clouds to be determined with a fair degree of accuracy.

The times, dates, and duration of reception or two-way communication when 50-Mc. signals were propagated beyond skip-distance ranges of 400 miles were tabulated. Arbitrary periods of approximately 30 minutes duration were then established. The equivalent free-electron density to reflect a mean radio frequency of 50.25 Mc. back to earth is then calculated from the path length between radio stations. Assuming great-circle transmission with no horizontal deviation, the midpoint will represent the point of reflection overhead in the E-region. Plotting a large number of paths within the prescribed period enables the size and horizontal ionization gradient of the sporadic-E cloud to be determined.

Fig. 1 illustrates the area overhead and

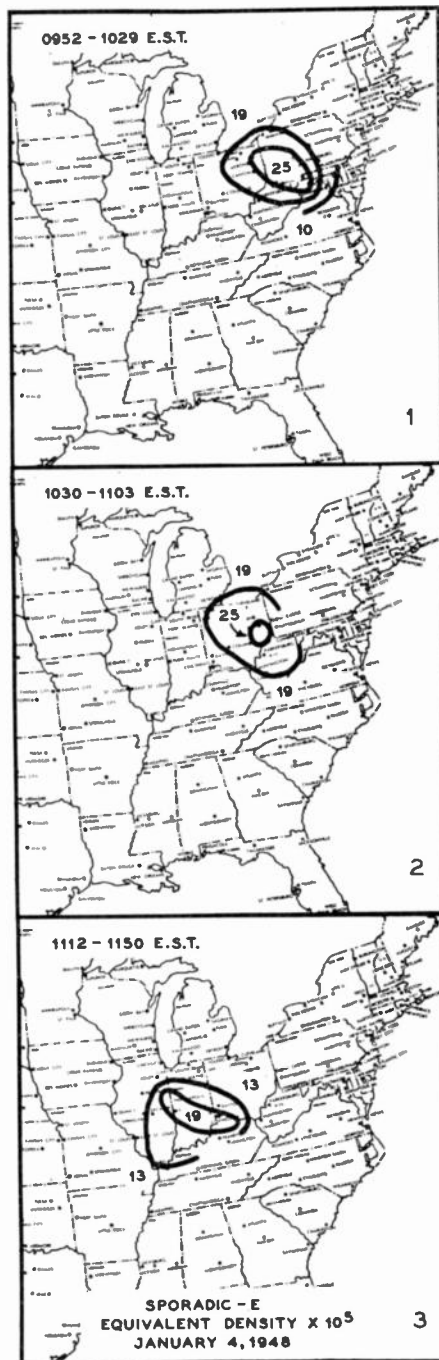
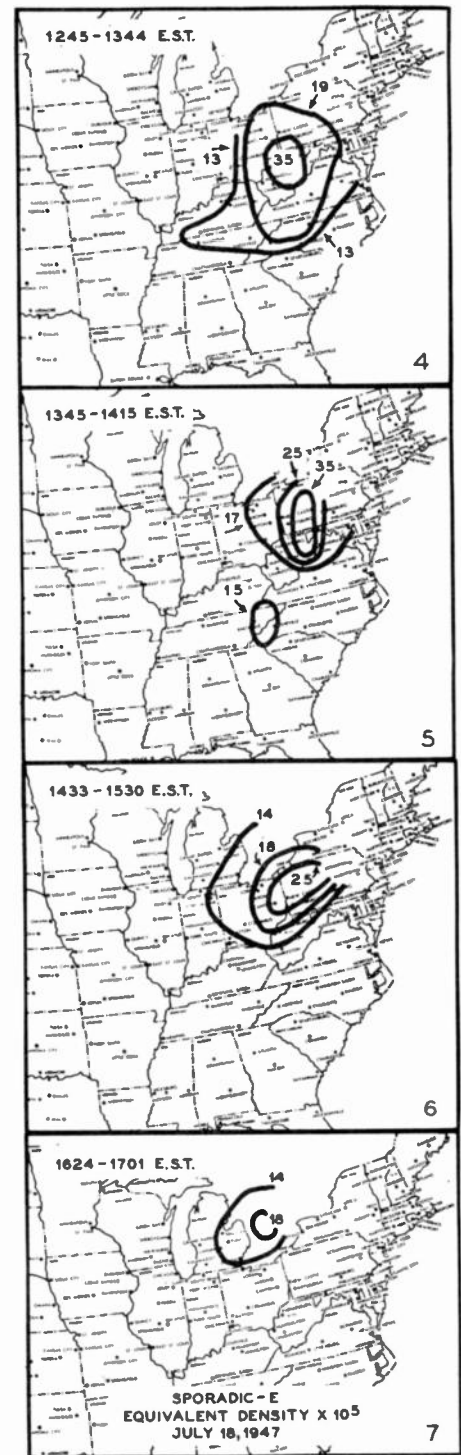

Fig. 1-3



Figs. 4-7

the approximate density of the sporadic-E cloud occurring the morning of January 4, 1948. The method described does not permit a fine-structure analysis of the cloud. However, the equivalent density at the center of the cloud probably exceeded  $40 \times 10^6$  free electrons/cm<sup>3</sup>. This was derived from path lengths of the order of 440 to 480 miles at a frequency of 50.25 Mc. Contours of equal density are drawn to encompass scattered points of reflection. The density contour  $10 \times 10^5$  is based upon the vertical-incidence measurements of the sporadic-E cloud made at Washington, D. C.<sup>12</sup>

Fig. 2 shows the position and relative density approximately 30 minutes later than

Fig. 1. It will be immediately noted that a drift of the sporadic-E cloud has occurred. During the 1030-1103 E.S.T. period the highest required equivalent density did not exceed  $26 \times 10^6$  free electrons/cm<sup>3</sup>. Fig. 3 shows the position and relative density approximately 45 minutes later than Fig. 2. The highest required density during the period 1112-1150 E.S.T. did not exceed  $23 \times 10^6$  free electrons/cm<sup>3</sup>.

The mean values show that, during a period of 75 minutes, the center density of the sporadic-E cloud decreased over  $20 \times 10^6$  free electrons/cm<sup>3</sup>. The drift was observed

\* Received by the Institute, April 30, 1948.  
<sup>1</sup> C. Trowbridge, "High altitude air circulation," *Astrophys. J.*, vol. 26, pp. 95-116; September, 1907.  
<sup>2</sup> C. P. Olivier, "Long enduring meteor trains," *Proc. Amer. Phil. Soc.*, vol. 85, pp. 93-131; December, 1942.  
<sup>3</sup> C. P. Olivier, "Long enduring meteor trains," *Proc. Amer. Phil. Soc.*, vol. 91, pp. 315-342; June, 1947.  
<sup>4</sup> V. Malzev, "Luminous night clouds," *Nature*, vol. 118, pp. 14-15; September, 1926.  
<sup>5</sup> E. H. Vestine, "Noctilucent clouds," *Jour. Roy. Astr. Soc. Can.*, vol. 28, pp. 249-272; July-August, 1934.  
<sup>6</sup> C. Stormer, "Luminous night clouds," *Nature*, vol. 135, pp. 103; November, 1935.  
<sup>7</sup> H. R. Mimno, "Physics of the ionosphere," *Rev. Mod. Phys.*, vol. 9, pp. 1-43; January, 1937.  
<sup>8</sup> R. Eyfrig, "Echo measurements in long distance transmission," *Hochfrequenz und Elektroakustik*, vol. 56, pp. 161-190, December, 1940.  
<sup>9</sup> J. E. Best, F. T. Farmer, and J. A. Radcliffe, "Studies of the region-E of the ionosphere," *Proc. Roy. Soc. A.*, vol. 164, pp. 96-116; January, 1938.  
<sup>10</sup> E. H. Conklin, "56-megacycle reception via sporadic-E layer reflections," *Proc. I.R.E.*, vol. 27, pp. 36-41, January, 1939.  
<sup>11</sup> O. P. Ferrell, "Radio investigation of air movement in the upper atmosphere," *Science and Culture* (Calcutta), vol. 9, pp. 555; June, 1944.

<sup>12</sup> CRPL-F42.

to be about 600 km., corresponding to a velocity of 130 meters. The direction of the drift was due west.

An analysis using the same methods was also made to determine the sporadic-*E* extent and density during the afternoon of July 18, 1947. The plotted contours are shown for four intervals in Figs. 4, 5, 6, and 7. The first period from 1245 to 1344 E.S.T. shows a large sporadic-*E* formation of irregular dimensions. The highest value of contour is  $35 \times 10^6$  free electrons or equivalents/cm<sup>3</sup>. Five instances of radio transmission requiring a density of  $39 \times 10^6$  free electrons/cm<sup>3</sup> were computed during this interval. In Fig. 5 there is a noticeable change in the position and extent of the sporadic-*E* cloud. Fig. 6, during the period 1433 to 1530 E.S.T., shows a northwestward drift and a diminution of the highest density area. The last interval, Fig. 7, was plotted from observations between 1624 and 1701 E.S.T. A great decrease in the density of the cloud and a further northwest movement are evident. Calculated path length required reflection densities, and observations by the automatic equipment at Washington, D. C.,<sup>12</sup> are in good agreement.

The drift is mostly in the northwest-north direction and was approximately 400 kilometers, corresponding to a velocity of about 40 meters. No attempt has been made to correlate this phenomenon with synoptic weather conditions. It is also to be noted that the sporadic-*E* clouds, when plotted by this method, will be somewhat greater in extent than the actual physical measurements at any given instant.

Extension of this study through a cooperative program combining the analytical facilities of the Geophysical Research Division of the Watson Laboratories and the observations of diligent radio amateurs is contemplated. A description of the methods employed is being prepared and will be published shortly. The author wishes to express his thanks to the numerous radio amateurs for supplying the data employed, and for making this study possible.

OLIVER P. FERRELL  
CQ Magazine  
342 Madison Ave.  
New York 17, N.Y.

<sup>12</sup> CRPL-F36

### Standardization of Nomenclature for Pulse Modulation\*

At present there is no general agreement on the names of the various types of pulse modulation. Latterly, different names have been used, leading to confusion.<sup>1,2</sup>

The desirability of standardization has already been expressed.<sup>3,4</sup> Cooke<sup>5</sup> states this

\* Received by the Institute, March 25, 1948.

<sup>1</sup> F. Rockett, "Modulation types and characteristics," *Electronics*, vol. 20, pp. 124-125; June, 1947.

<sup>2</sup> R. R. Batcher, "Pulse code modulation method for multi-channel telephony," *Tele-tech*, vol. 6, pp. 28-33; July, 1947.

<sup>3</sup> D. Cooke, "Pulse modulation," *Wireless Eng.*, vol. 23, p. 29; January, 1946.

<sup>4</sup> F. F. Roberts and J. C. Simmonds, "Pulse modulation," *Wireless Eng.*, vol. 23, p. 93; March, 1946.

<sup>5</sup> D. Cooke, "Pulse communication, part I," *Jour. I.E.E.*, vol. 94, part IIIA, p. 84; 1947.

very clearly: "Independent investigators have not always arrived at the same nomenclature, and it is felt strongly that an effective and early standardization of terminology, both in this country and abroad, will contribute greatly to clarity of discussion and hence to progress in the art."

As a member of the section 1-60 of the Netherlands Electrotechnical Committee, it appears to me that it is desirable to inform you of what the above-mentioned Committee will propose as recommended terms for pulse modulation in the Netherlands. It is the intention to make an international suggestion of this, that will eventually reach the I.E.C.

With pulse modulation, a pulse train, consisting of a series of fundamentally congruent and equidistant d.c. pulses or groups of d.c. pulses, is modulated. As a rule, the repeating frequency of the pulses will be at least twice the highest frequency of the modulating quantity, simply called "the signal."

A pulse train can be modulated in different ways, of which the more important are: the modulation in pulse rate, in pulse width, in pulse position, and in pulse height. Also conceivable is modulation in pulse slope.

With pulse-rate modulation, the rate of the pulses is a function of the signal. The term "pulse-frequency modulation" is considered undesirable.

With pulse-width modulation, the width of the pulses is a function of the signal. This width can be changed in different ways; for instance, the center of the pulse may remain stationary, in which case one speaks of symmetrical pulse-width modulation. However, there are also symmetrical pulse-width modulations, in which are distinguished, among others, asymmetrical pulse-width modulations with fixed leading edge (the front of the pulse remaining stationary), and with fixed trailing edge (the rear of the pulse remaining stationary).

The names "pulse-length modulation" (causes confusion with height) and "pulse-time modulation" are considered undesirable; the latter term is, at present, mostly used for pulse-position modulation.

With double-pulse modulation, only the beginning and the end of a pulse of a pulse-width modulation are indicated by means of a short pulse; meanwhile, the center collapses.

With pulse-position modulation, the position of the pulses, with respect to a reference point, is a function of the signal.

The terms "pulse-phase modulation," "pulse-displacement modulation," "pulse-time modulation," and "pulse-delay modulation" are considered undesirable.

With pulse-height modulation, the height of the pulses is a function of the signal. The term "pulse-amplitude modulation" is considered undesirable.

With pulse-slope modulation, the slope of one or both sides of the pulses would be a function of the signal.

A form of pulse-modulation, not yet mentioned, is pulse-code modulation. With this method, a characteristic quantity of the signal is transmitted by means of a code of

pulse-shaped character. As this code is in principle not restricted by a number or a counting, we deem the term "pulse-count modulation" too limited.

The above-mentioned modulated pulse trains will be able to modulate an alternating-current carrier as an intermediate carrier. At the moment there is no need to create short description terms for the different ways in which these further modulations can take place. However, consideration has been given to the possibility that eventually this need may arise. Herein resides the reason why frequency, phase, and amplitude modulation are deemed undesirable terms for pulse modulation. Should it, for example, be necessary to distinguish briefly the different ways by which a pulse modulation can modulate, as intermediate carrier, an alternating-current carrier, then it is possible to make contractions such as pulse-position-amplitude modulation, pulse-position-phase modulation, etc.

We understand by the phrase, "to pulse a current," the taking out of pulse-shaped samples with constant time duration of a current at equal intervals. This expression is an expedient for the indication of the way in which certain modulation processes take place.

The above-proposed nomenclature has the great advantage that the terms are not confusing, and there is sufficient flexibility to cover future requirements. In this, multiplex transmission has been especially borne in mind.

H. H. HEEROMA  
Willem Witsenplein 6,  
The Hague, Holland

### Correction\*

With reference to the paper by Brunetti and Curtis,<sup>1</sup> my attention has been drawn to the reference no. 8 in the Bibliography on page 161, where you attribute "New Methods of Radio Production" by J. A. Sargrove to the *Journal of the Institution of Electrical Engineers*.

May I respectfully point out that Mr. Sargrove is a member of the British Institution of Radio Engineers, and it was before this body that his paper was first read in February, 1947. The paper was subsequently published in the January/February, 1947, issue of the Institution's *Journal*; i.e., in no. 1, vol. 7 (new series). I would be grateful if you would correct this in your next issue.

C. WILSON  
Publications Officer  
The British Institution of  
Radio Engineers  
London, England

\* Received by the Institute, February 6, 1948.

<sup>1</sup> C. Brunetti and R. W. Curtis, "Printed-circuit techniques," *Proc. I.R.E.*, vol. 36, pp. 121-162; January, 1948.

# Institute News and Radio Notes

## Executive Committee

April 6, 1948

*Joint Technical Advisory Committee.* Dr. Baker moved that Philip F. Siling be appointed Chairman of the Joint Technical Advisory Committee for I.R.E., and that the chairmanship of the committee change each year, the chairman one year to be an I.R.E. representative and the next year an RMA representative, with the understanding that the first year the I.R.E. representative will be chairman. (Unanimously approved.)

Mr. Graham moved that RMA be requested to appoint an RMA representative, and that the two representatives be requested to recommend the number and names of committee members for the approval of the Executive Committee. (Unanimously approved.)

*Report of Convention Policy Committee.* The Committee discussed two letters, dated April 1, 1948, received from J. E. Shepherd, Chairman of the Convention Policy Committee, concerning a possible summer or fall convention in Chicago in 1950. After discussion by the Committee, Dr. Sinclair moved that the Executive Committee recommend to the Board of Directors the general policy that Institute Headquarters sponsor only one National Convention a year, that convention to be held in New York City, and that Regions be encouraged to hold Regional Conventions during other times of the year. (Unanimously approved.)

Dr. Goldsmith moved that the Executive Committee refer to the Finance Committee the method of financing Regional Conventions in such fashion that there shall be no conflict between the financing of Regional Conventions and the conduct of Institute National Conventions, nor the financial aspects thereof, including considerations of policy as to exhibits and advertising at Regional Conventions, and their effects upon the corresponding items at National Conventions, and upon general Institute advertising returns. (Unanimously approved.)

*New Section Petitions.* The Executive Committee considered the following two petitions for new sections.

a. *New Mexico Section.* Mr. Graham moved that the petition of the New Mexico Section be accepted. (Unanimously approved.)

b. *Toledo Section.* Mr. Graham moved that the petition of the Toledo Section be accepted. (Unanimously approved.)

*Student Branch Petitions.* The Executive Committee considered the following two petitions for Student Branches.

a. *University of Notre Dame.* Mr. S. L. Bailey moved that the petition for a Joint I.R.E.-AIEE Branch at the University of Notre Dame be approved. (Unanimously approved.)

b. *St. Louis University.* Mr. Graham moved that the petition for an I.R.E. Student Branch at St. Louis University be approved. (Unanimously approved.)

### NOMINATIONS—1949

At its May 5, 1948 meeting, the Board of Directors received the recommendations of the Nominations Committee, and the reports of the Regional Committees, for officers and directors for 1949. They are as follows:

For President:  
S. L. Bailey  
For Vice-President:  
A. S. McDonald

Two Directors-at-Large, 1949-1951:

W. L. Everitt                      R. F. Guy  
D. G. Fink                         D. B. Sinclair

Regional Director (1 per Region),  
1949-1950:

Region 2, the North Central Atlantic Region  
J. V. L. Hogan

Region 4, the East Central Region:

H. E. Kranz  
F. A. Lidbury  
G. R. Town

Region 6, the Southern Region:

Ben Akerman

Region 8, the Canadian Region:

F. H. R. Pounsett

According to Article VI, Section 1, of the Constitution, nominations by petition for any of the above offices may be made by letter to the Board of Directors, setting forth the name of the proposed candidate and the office for which it is desired he be nominated. For acceptance, a letter of petition must reach the executive office before twelve o'clock noon, on August 13, 1948, and shall be signed by at least 100 voting members qualified to vote for the office of the candidate nominated.

## Calendar of COMING EVENTS

1948 West Coast Convention of the  
I.R.E., Los Angeles, Calif.  
September 30-October 2, 1948

National Electronics Conference, Chi-  
cago, Ill.  
November 4-6, 1948

Rochester Fall Meeting, Rochester,  
N. Y.  
November 8-10, 1948

1949 I.R.E. National Convention, New  
York, N. Y.  
March 7-10, 1949

## N.E.C. PROCEEDINGS FOR 1947 NOW AVAILABLE

The Proceedings of the 1947 National Electronics Conference has been printed and is now available at \$4.00 per copy from R. R. Buss, Secretary of the Conference, who should be addressed in care of the Electrical Engineering Department, Northwestern Technological Institute, Evanston, Ill.

Copies of the 1946 and 1944 N.E.C. Proceedings are also available at \$3.50 and \$3.00 per copy, respectively.

The 1948 National Electronics Conference will be held at the Edgewater Beach Hotel on November 4, 5, and 6.

## I.R.E. WEST COAST CONVENTION

The theme of this year's I.R.E. West Coast Convention, to be held from September 29 to October 2, will be "Electronics in the Progressive West."

Convention headquarters and location of the I.R.E. exhibits, as well as those of the West Coast Electronic Manufacturers Convention and Exhibits, will be at the Biltmore Hotel. There has, however, been so much prospective interest shown that the committees have decided that the Biltmore will be unable to handle the expected attendance; provisions have been made, therefore, to hold the technical meetings in the near-by Embassy Auditorium.

Many interesting activities are planned for attending members, including a trip to the top of Mount Wilson to tour the Observatories and the television and f.m. transmitting stations. The program for the ladies will feature a "get-together" tea, a special breakfast at Tom Breneman's Hollywood Restaurant, and tickets for outstanding radio broadcasts.

## WCEMA BOARD HOLDS ANNUAL MEETING

The annual meeting of the board of directors of the West Coast Electronic Manufacturers' Association was held in San Francisco at the St. Francis hotel in April. Two I.R.E. members were elected to office: William Hewlett (S'35-A'38-SM'47-F'48), of the Packard-Hewlett Company, Palo Alto, was chosen vice-president, and Noel Eldred (S'32-A'35-SM'45), sales manager of Packard-Hewlett Company, continued as secretary.

The WCEMA's fourth annual Pacific Electronic Exhibit will be held at the Biltmore Hotel in Los Angeles on September 30, October 1 and 2, co-sponsored by the I.R.E.'s West Coast Convention. The product index and membership roster of the WCEMA will be distributed without charge. Inquiries should be addressed to E. Grigsby, 1161 N. Vine Street, Hollywood 28, Calif.



CHICAGO I.R.E. CONFERENCE COMMITTEE

Rear row, left to right: Jean Brand, E. O. Ross, Leo G. Killian, G. F. Levey, W. P. Keller, R. M. Krueger, K. W. Jarvis, Alois W. Graf, and J. A. Myers, Jr.  
Front row, left to right: W. R. Brock, Cal Sloan, Don Haines, Harold Renne, E. H. Schulz, Arch Brolley, and O. D. Westerberg.



GENERAL SESSION SPEAKERS AT THE CHICAGO I.R.E. CONFERENCE

Left to right: Karl Kramer, Chairman, Chicago Section; W. A. Lewis, Dean of the Illinois Institute of Technology; B. E. Shackelford, President, I.R.E.; K. W. Jarvis, Vice-Chairman, Chicago Section.

## CHICAGO I.R.E. CONFERENCE ATTRACTS 400

The Chicago Section of the I.R.E. held its third annual one-day conference at the Illinois Institute of Technology's new Chemical and Metallurgical buildings on April 17, 1948. Approximately 400 members and guests attended morning and afternoon sessions. Karl Kramer, Chairman of the I.R.E.'s Chicago section, presided at the general meeting. The welcoming address was delivered by Dean W. A. Lewis of the Illinois Institute of Technology, and B. E. Shackelford, President of the I.R.E., gave the keynote address.

In addition to the standard panels on Management and Research, Quality Control, and Magnetic Recording, presided over by Alois W. Graf, Donald G. Haines, and Benjamin Bauer, respectively, there were also three panels on Sales Engineering, headed by Kenneth W. Jarvis, and made up of short engineering sales presentations and demonstrations by well-known engineers on components, products, and processes. These short sessions, an innovation on the standard procedures, were well attended and well received.

A number of significant papers were offered as part of the regular panel proceedings, including "Management of a Research Laboratory," by A. L. Samuel; "The Evaluation of Coated Magnetic Recording Media," by H. A. Howell; "Co-ordination of Research and Development with Production," by Waldo H. Kliever; "Personnel Management in Research and Development," by Christopher E. Barthel, Jr.; "An

Introduction to Modern Quality Control," by Warren E. Jones; "Computing Methods and Presentation of Data," by Harvey S. Pardee; "Testing Magnetic Recording, Tapes," by Robert Herr; "Stereophonic Magnetic Recorder," by Marvin Camras; "Practical Techniques in the Measurement and Evaluation of Magnetic Heads," by Lee Gunter; and "The Problem of Equalization and Pre-Emphasis," by R. B. Vaile, Jr.

Twenty-five manufacturers featured exhibits of new electronic instruments and components throughout the day.

## Industrial Engineering Notes<sup>1</sup>

### NEW WEATHER DEVICE

Weather data formerly not readily available to modern science is now obtainable over the ocean and in remote regions of the Arctic through a new radiosonde device developed at the Signal Corps Engineering Laboratories at Fort Monmouth, N. J. The instrument used, which weighs less than ten pounds, including two batteries and attached parachute, is launched from aircraft, and transmits Morse code signals representing measurements of temperature, barometric pressure, and relative humidity, back to the plane.

<sup>1</sup> The data on which these NOTES are based were selected, by permission, from "Industry Reports," issues of April 6, 23, and 30, and May 7, 1948, published by the Radio Manufacturers' Association, whose helpful attitude in this matter is hereby gladly acknowledged.

### ARMY DEVELOPING NEW RUBBER COMPOUNDS

New types of rubber compounds aimed at correcting the effects of subzero weather on conventional rubber used in military equipment, including radios and supporting springs for electronic equipment, are under development by the Signal Corps. Making rubber flexible at  $-67^{\circ}\text{F}$  is the goal of Signal Corps engineers, whose research has been supplemented through several contracts with industry.

Cracking of vital rubber parts in military equipment in certain subzero areas prompted this research two years ago, according to the Signal Corps. Through techniques of plasticizing, corrective results are seen possible for producing synthetic rubbers which would be nonbrittle even in Arctic areas. They would be used in such military necessities as cables, radios, push-button covers, shock-proof containers, and rubber supporting springs for electronic equipment.

### F.C.C. ENDS TELEVISION CHANNEL SHARING AND ORDERS HIGH-BAND INQUIRY

The F.C.C. recently issued a far-reaching order affecting television and f.m. broadcasting and the mobile communications service and their equipment in reaching a decision in the long pending and controversial Television Channel No. 1 case.

The Commission's order in this matter (Mimeograph No. 21363), copies of which may be obtained from the Secretary of the F.C.C., Washington 25, D. C., became effective on June 14. It abolished the sharing of television channels by non-broadcast services, because of interference problems; deleted television channel Number 1 (44-50 Mc) and assigned it to non-government fixed and mobile services which have been sharing television channels; allocated the 72-76-Mc. band, now a source of television interference, to the fixed services, on condition that no interference will be caused to the television; and revised the table of allocations of the 12 remaining television channels to service areas throughout the nation. A hearing on the last proposal was held on June 14. Furthermore, the new order calls for an F.C.C. hearing on September 20, 1948, in the matter of utilizing frequencies in the 475-890-Mc. band for monochrome or color television broadcasting, or both.

The Commission also proposed rules (Docket 8965) to provide for new station and service classifications in the 25-30-Mc band, grouping the geophysical, power, petroleum, provisional, relay press, and motion-picture stations under the broad heading of "Industrial Radio Services"; deleting certain channels allocated to flight test and flying school stations now provided for in the 118-132-Mc. band; shifting the amateur service 200 kc. lower in the band; replacing the former 27.320 Mc. frequency for the industrial, scientific, and medical services by the new worldwide frequency, 27.120 Mc; providing for certain public and aeronautical fixed services; and realigning channels for the land mobile service with 20-kc. widths in lieu of the previous 25.

At the same time, the F.C.C. proposed rules respecting the suballocation of the mo-

bile bands 44-50 and 152-162 Mc. (Docket 8972), the 72-76-Mc. band to the fixed services (Docket 8973), and the 450-460-Mc. band to the nongovernment land mobile service (Docket 8974). The Commission believes that, in general, common carrier facilities will be used for network programming, and it is proposing a modification of its rule (Docket 8977) to permit intercity relaying of f.m. programs on frequencies allocated for f.m. studio-to-transmitter-link purposes (940-952 Mc). It pointed out that there is nothing in its rules to prevent f.m. stations in the 88-108-Mc. band from rebroadcasting the programs of other f.m. stations.

#### AMATEUR FREQUENCY-ALLOCATION RULE CHANGE

The F.C.C. has taken two actions affecting amateur radio operations. In one order (mimeograph No. 19588), the Commission made available to amateurs until January 1, 1952, the 235-240-Mc. band for allocation in areas near the Canadian border where interference is caused to British or Canadian radar distance indicators by amateur transmissions in the 220-225-Mc. band. The F.C.C. also noted that British radar indicators may use the 220-231-Mc. band at U. S. gateways of International Air Routes until January 1, 1952.

Another action by the F.C.C. (mimeograph No. 19543) amends rules of the amateur service concerning the operation of mobile equipment, and designates special provisions for the operation of amateur stations aboard ships or aircraft.

#### TYPE-APPROVAL CERTIFICATE ISSUED FOR "MISCELLANEOUS EQUIPMENT"

The F.C.C. recently issued the first certificate of type approval under its rules and regulations governing miscellaneous equipment for an interchangeable neon sign which is activated by radio-frequency energy. The Commission rules (Part 18) require that all such equipment manufactured after April 30, 1946, be operated under a certificate of type approval, or that a competent engineer certify that its operation is in compliance with F.C.C. regulations relating to the radiation of radio-frequency energy. Equipment manufactured prior to that date may be operated for five years without type approval or certification, if it does not create interference.

#### F.C.C. LISTS STATIONS IN NONBROADCAST SERVICES

Following is an F.C.C.-compiled list of nonbroadcast radio stations authorized as of March 31:

Aeronautical Services	
Carrier Aircraft	1,377
Private Aircraft	17,125
Public Service Aircraft	369
Aeronautical and Fixed	1,424
Airdrome Control	50
Aeronautical Navigation	43
Flight Test	89
Flying School	22
Aeronautical Public Service	0
Aeronautical Public Utility	47

Public Safety Services	
Police	4,000
Fire	71
Forestry	432
Highway Maintenance	0
Special Emergency	125
Industrial Services	
Utility	1,409
Petroleum	83
Lumber	16
Other	963
Experimental	
Experimental	387
Miscellaneous	29
Marine Services	
Ships	13,539
Coastal and Marine Relay	139
Alaskan Coastal	248
Alaskan Fixed Public	423
Other Marine	392
Land Transportation	
Railroad	198
Transit Utility	72
Intercity Busses and Trucks	37
Taxicabs	2,775
Amateur	68,449
Citizens	39
Experimental Services	
Experimental	115
General Mobile	649
Fixed Public Telephone	23
Fixed Public Telegraph	54

#### RADIO LICENSE CHANGE FOR CIVIL AIR PATROL

The F.C.C. has modified all outstanding licenses of the Civil Air Patrol authorized to operate on the frequency 148,140 kc. with A3 emission (telephony) to include A2 emission (telegraph). This was done at the request of the Civil Air Patrol with the concurrence of the Chief Signal Officer of the Department of the Army, in order to facilitate various phases of training.

#### TELEVISION NETWORK FACILITIES AUTHORIZED BY F.C.C.

The American Telephone and Telegraph Company has obtained F.C.C. approval to construct two experimental microwave relay chains—from Chicago to Milwaukee, and from Detroit to Toledo—at a cost of \$1,400,000, to provide common carrier service, including television transmission. At the same time, the F.C.C. granted applications of the AT&T and certain Bell System companies for television facilities to connect Detroit, Toledo, and Buffalo with proposed microwave networks. It authorized two coaxial units in the Cleveland-to-Buffalo cable, and television terminals at Buffalo, Toledo, South Bend, Ind., and Danville, Ill. The new authorizations will permit the televising of programs, including football, originating at Notre Dame and Illinois universities.

#### AUTHORIZED TELEVISION STATIONS NUMBER MORE THAN 100

More than one hundred television stations have been authorized by the F.C.C. and 21 stations are operating commercially, according to an F.C.C. tabulation. The number of applications pending is 218.

#### F.M. STATIONS INCREASE PHENOMENALLY

Commercial f.m. broadcasting stations on the air now number 514, as compared with 356 at the end of 1947, and there are 20 noncommercial f.m. educational outlets, according to FCC records. New and scheduled f.m. stations in the various states are:

*California:* Eureka, KRED; Los Angeles, KVUN (July 15); Oakland, KLX-FM; San Diego, KDSO and KSOR-FM; Sausalito, KDFC (August 1). *Delaware:* Wilmington, WAMS-FM. *Florida:* Gainesville, WRUF-FM; Orlando, WHOO-FM. *Georgia:* Atlanta, WAGA-FM. *Illinois:* Chicago, WOAK and WFME; Hamsburg, WEBQ-FM; Springfield, WTAX-FM. *Indiana:* Elkhart, WTRC-FM; Kokomo, WKMO. *Kansas:* Wichita, KFH-FM (late summer or fall). *Kentucky:* Lexington, WLAP-FM (late summer). *Louisiana:* Baton Rouge, WAFB-FM (June 15) and WLCS (July 1 or before). *Maryland:* Baltimore, WFBR-FM (July 1); Silver Spring, WHIP. *Massachusetts:* Fitchburg, WEIM-FM; Pittsfield, WBEF-FM; Springfield, WSFL; West Yarmouth, WOCB-FM. *Michigan:* Flint, WFDF-FM (summer); Owosso, WOAP-FM. *Minnesota:* Winona, KWNO-FM. *Mississippi:* Jackson, WTDX-FM. *Missouri:* Jefferson City, KWOS-FM; Kenneth, KBOA-FM; St. Joseph, KFEQ-FM. *New York:* Cherry Valley, WVCV; De Ruyter, WVCN; Elmira, WENY-FM (August 15), Endicott, WENE-FM (mid-summer); Highmarket, WVBV; Ithaca, WVFC; New York City: WJZ-FM, South Bristol, WVBN, *North Carolina:* Fayetteville, WFLV-FM (late summer or early fall); Raleigh, WNAO-FM. *Ohio:* Ashtabula, WICA-FM (August); Columbus, WVKO (August or September); Findlay, WFNF-FM; Lima, WNXC. *Oklahoma:* Ardmore, KVSO-FM; Stillwater, KSPI-FM. *Pennsylvania:* Butler, WISR-FM; New Castle, WKST-FM; Philadelphia, WFLN (July); Warren, WNAE-FM. *Rhode Island:* Providence, WPRO-FM, WJAR-FM, and WPJB (June 1). *South Carolina:* Charleston, WCSC-FM. *Tennessee:* Clarksville, WCLC; Memphis, WHHM-FM. *Texas:* Brownsville, KURO-FM (August 1); San Antonio, KTSa-FM (July 1).

#### TELEVISION SETS PASS 300,000 MARK, F.M. GAINS IN QUARTERLY REPORT

RMA member-companies reported production of 118,027 television receivers during the first quarter of 1948, bringing the total output by RMA companies since the war to more than 300,000. The quarterly production was almost three times the output of RMA companies during the first quarter of 1947, and 66 per cent of the entire year's production. Radio set production remained at a high level, and f.m.-a.m. sets for the first quarter totalled 437,829, or two and one-half times the number manufactured in the first quarter of 1947. The first 1948 quarter production of f.m.-a.m. sets brought the total output of RMA companies since the war to 1,794,418. All set production, including television, aggregated 4,352,296 during the first quarter, as compared with 4,321,406 in the corresponding period of 1947. Fewer a.m. radios, especially table models, were reported, however, for the 1948 quarter.

#### EXCISE COLLECTIONS SHOW DECREASED SALES

March collections of the 10 per cent excise tax on radios and phonographs and their component parts dropped below collections in February of this year and of March, 1947, according to statistics released by the Bureau of Internal Revenue. Collections during March totalled \$5,211,350.84, as compared with \$6,173,908.34 in February and \$6,905,675.30 in March, 1947.

#### RMA COMMITTEE APPOINTED ON INDUSTRY MOBILIZATION PROBLEMS

A preliminary RMA committee on problems of industry mobilization and military production, authorized by the RMA Board of Directors, was appointed by President Max F. Balcolm, and immediate conferences are planned in Washington with several government agencies.

F. R. Lack, vice-president of the Western Electric Company, was named chairman of the new RMA government liaison committee. Other members are Frank M. Folsom, executive vice president of the RCA Victor Division, and W. A. MacDonald, president of the Hazeltine Electronics Corporation. All are directors of RMA with wide experience on similar problems during the last war period.

The new RMA committee will secure information on the government industry mobilization and military production plans from the National Security Resources Board, the Munitions Board, the Army and Navy, and other agencies, as they affect the radio-electronic industry, and will provide for future co-ordinated action between the government and manufacturers of the industry. Later, an expanded RMA committee, or subcommittees, may be appointed to consider various industry interests and problems involved, particularly in connection with the greatly enlarged armament program for the Army and Navy being planned by Congress and its appropriations for the armed services.

#### RETAILERS AND DISTRIBUTORS INVITED TO JOIN RADIO WEEK

All organizations and groups concerned either with radio or television broadcasting or the merchandising of radio and television receivers will be invited to participate, both nationally and in local communities, in the observance of National Radio Week, November 14 to 20, a joint sponsoring committee representing the Radio Manufacturers Association and the National Association of Broadcasters, announced.

#### RMA MEETINGS

The following RMA engineering meetings were held:

- April 22—Subcommittee on Transformers and Reactors
- April 26—Committee on Packing
- May 11—Committee on Television Transmitters
- May 12—Subcommittee on Gas-Filled Microwave Transmission Lines

## Books

### Photofact Folders 1, 2, and 3, by Howard W. Sams.

Published (1947) by Howard W. Sams and Company, Inc., 2924 E. Washington St., Indianapolis 6, Ind. 8½×11. Price, \$1.50. (Note: These are folders containing schematic diagrams of competitive models of the radio industry.)

The Photofact Folders, Volumes 1, 2 and 3 published by Howard W. Sams and Co., Inc., of Indianapolis, Ind. are written to present accurate and complete information on most radio models produced by most of the manufacturers, large and small, for the use of the service men. It is the purpose of the author to collect factual information based on laboratory analysis and a study of the actual receivers, and to present the findings in a clear, concise, and uniform manner.

Each volume includes a number of Photofact sets identified by a number which includes a number of folders giving information on several manufacturers' radio receiver models.

The information is presented in a uniform format for easy reference and in order to save time in the location of specific data.

Each sheet covers the trade name and model number on the upper righthand corner and on the righthand margin for ease of identification and filing. A cumulative index is provided so that the data on any manufacturer's model can be readily found. The models are listed under the manufacturer's name and indexed according to the Photofact set number and the folder number on which the information is filed.

The author has met his planned objectives very well, in that complete, accurate, and conveniently-filed material is provided for the service man's use. While the books more than meet the requirements of the service man, they have been found invaluable for the product design engineer in providing accurate and factual information on the many models produced by many manufacturers.

The books are well written and presented in a clear, concise, and uniform manner; they are timely and accurate and of real value to service man and engineer alike.

LEWIS M. CLEMENT  
Crosley Manufacturing Corporation  
Cincinnati 25, Ohio

### Directory of Engineering Sources

Published (1948) by the Southeastern Research Institute, Inc., 5009 Peachtree Road, Atlanta, Ga. 63 pp. 5½×8½. Price, \$2.50.

Subtitled "a Guide to American Literature in Engineering and Related Sciences," this useful and informative pamphlet represents an attempt to bring to the attention of the individual engineer the great number of information sources available in order to

keep him abreast of scientific developments. It is divided into five sections, covering the government printing office and federal agencies; universities, colleges, and state agencies; scientific, technical, and trade associations, societies, and organizations; commercial publishers of periodicals and books; and a general classified section.

### Practical Amplifier Diagrams, by Jack Robin and Chester E. Lipman.

Published (1948) by Os-tronic Publications, Los Angeles, Calif. 55 pages. 45 figures. 8½×10½ inches. Price, \$2.00.

This volume is a description of a series of amplifiers designed to cover the audio frequencies, frequencies that affect the human ear, and those that cover the entire range of sound. Only standard parts are specified.

### Über Synchronisierung von Röhrengeneratoren durch modulierte Signale, by Fritz Diemer.

Published (1947) by Gebr. Leemann and Company, Stockerstrasse 64, Zürich 2, Switzerland. 98 pages. 34 figures. 6½×8½ inches. Price, 10.80 Swiss francs.

This is a treatise on the synchronization of generator tubes through modulated signals.

### Radio Receiver Tube Placement Guide, by Howard W. Sams.

Published (1948) by Howard W. Sams and Company, Inc., 2924 East Washington Street, Indianapolis 7, Ind. 190 pages. 1,880 figures. 5½×8½ inches. Price, \$1.25.

The purpose of this book is to show exactly where to replace tubes in almost 5400 radio receivers, covering 1938 to 1947 models.

### Most-Often-Needed F.M. and Television Servicing Information, by M. N. Beitman.

Published (1948) by Supreme Publications, 9 South Kedzie Avenue, Chicago 12, Ill. 191 pages+1 page index. 382 figures. 8½×10½ inches. Price, \$2.00.

This manual is intended to aid radio servicemen in learning how to repair modern f.m. and television receivers, and also presents specific factory instructions on adjustment and repair of many popular sets.

# Sections

Chairman		Secretary	Chairman		Secretary
W. A. Edson Georgia School of Tech. Atlanta, Ga.	ATLANTA	M. S. Alexander 2289 Memorial Dr., S.E. Atlanta, Ga.	O. W. Towner Radio Station WHAS Third & Liberty Louisville, Ky.	LOUISVILLE	D. C. Summerford Radio Station WHAS Third & Liberty Louisville, Ky.
F. W. Fischer 714 Beechfield Ave. Baltimore 29, Md.	BALTIMORE	E. W. Chapin 2805 Shirley Ave. Baltimore 14, Md.	E. T. Sherwood Globe-Union Inc. Milwaukee 1, Wis.	MILWAUKEE	J. J. Kircher 2450 S. 35th St. Milwaukee 7, Wis.
John Petkovsek 565 Walnut Beaumont, Texas	BEAUMONT— PORT ARTHUR	C. E. Laughlin 1292 Liberty Beaumont, Texas	R. R. Desaulniers Canadian Marconi Co. 211 St. Sacrement St. Montreal, P.Q., Canada	MONTREAL, QUEBEC	R. P. Matthews Federal Electric Mfg. Co. 9600 St. Lawrence Blvd. Montreal 14, P.Q., Canada
W. H. Radford Massachusetts Institute of Technology Cambridge, Mass.	BOSTON	A. G. Bousquet General Radio Co. 275 Massachusetts Ave. Cambridge 39, Mass.	L. A. Hopkins, Jr. 629 Permanent Quarters Sandia Base Branch Albuquerque, N. M.	NEW MEXICO	T. S. Church 637 La Vega Rd. Albuquerque, N. M.
A. T. Consentino San Martin 379 Buenos Aires, Argentina	BUENOS AIRES	N. C. Cutler San Martin 379 Buenos Aires, Argentina	J. E. Shepherd 111 Courtenay Rd. Hempstead, L. I., N. Y.	NEW YORK	I. G. Easton General Radio Co. 90 West Street New York 6, N. Y.
R. G. Rowe 8237 Witkop Avenue Niagara Falls, N. Y.	BUFFALO-NIAGARA	R. F. Blinzler 558 Crescent Ave. Buffalo 14, N. Y.	C. G. Brennecke Dept. of Electrical Eng. North Carolina State Col- lege Raleigh, N. C.	NORTH CAROLINA- VIRGINIA	C. M. Smith Radio Station WMIT Winston-Salem, N. C.
G. P. Hixenbaugh Radio Station WMT Cedar Rapids, Iowa	CEDAR RAPIDS	W. W. Farley Collins Radio Co. Cedar Rapids, Iowa	W. L. Haney 117 Bourque St. Hull, P. Q.	OTTAWA, ONTARIO	G. A. Davis 78 Holland Ave. Ottawa, Canada
Karl Kramer Jensen Radio Mfg. Co. 6601 S. Laramie St. Chicago 38, Ill.	CHICAGO	D. G. Haines Hytron Radio and Elec- tronics Corp. 4000 W. North Ave. Chicago 39, Ill.	P. M. Craig 342 Hewitt Rd. Wyncote, Pa.	PHILADELPHIA	J. T. Brothers Philco Radio and Tele- vision Tioga and C Sts. Philadelphia 34, Pa.
J. F. Jordan Baldwin Piano Co. 1801 Gilbert Ave. Cincinnati, Ohio	CINCINNATI	F. Wissel Crosley Corporation 1329 Arlington St. Cincinnati, Ohio	E. M. Williams Electrical Engineering Dept. Carnegie Institute of Tech. Pittsburgh 13, Pa.	PITTSBURGH	E. W. Marlowe 560 S. Trenton Ave. Wilkinburgh PO Pittsburgh 21, Pa.
W. G. Hutton R.R. 3 Brecksville, Ohio	CLEVELAND	H. D. Seielstad 1678 Chesterland Ave. Lakewood 7, Ohio	O. A. Steele 1506 S.W. Montgomery St. Portland 1, Ore.	PORTLAND	F. E. Miller 3122 S.E. 73 Ave. Portland 6, Ore.
C. J. Emmons 158 E. Como Ave. Columbus 2, Ohio	COLUMBUS August 13	L. B. Lamp 846 Berkeley Rd. Columbus 5, Ohio	N. W. Mather Dept. of Elec. Engineering Princeton University Princeton, N. J.	PRINCETON	A. E. Harrison Dept. of Elec. Engineering Princeton University Princeton, N. J.
L. A. Reilly 989 Roosevelt Ave. Springfield, Mass.	CONNECTICUT VALLEY	H. L. Krauss Dunham Laboratory Yale University New Haven, Conn.	A. E. Newlon Stromberg-Carlson Co. Rochester 3, N. Y.	ROCHESTER	J. A. Rodgers Huntington Hills Rochester, N. Y.
J. G. Rountree 4333 South Western Blvd. Dallas 5, Texas	DALLAS-FT. WORTH	J. H. Homsy Box 5238 Dallas, Texas	E. S. Naschke 1073-57 St. Sacramento 16, Calif.	SACRAMENTO	
George Rappaport 132 East Court Harshman Homes Dayton 3, Ohio	DAYTON	C. J. Marshall 1 Twain Place Dayton 10, Ohio	G. M. Cummings 7200 Delta Ave. Richmond Height 17, Mo.	ST. LOUIS	N. J. Zehr Radio Station KWK Hotel Chase St. Louis 8, Mo.
C. F. Quentin Radio Station KRNT Des Moines 4, Iowa	DES MOINES- AMES	F. E. Bartlett Radio Station KSO Old Colony Bldg. Des Moines 9, Iowa	C. L. Jeffers Radio Station WOAI 514 W. Lynwood San Antonio, Texas	SAN ANTONIO	H. G. Campbell 233 Lotus Ave. San Antonio 3, Texas
A. Friedenthal 5396 Oregon Detroit 4, Mich.	DETROIT	N. C. Fisk 3005 W. Chicago Ave. Detroit 6, Mich.	C. N. Tirrell U. S. Navy Electronics Lab. San Diego 52, Calif.	SAN DIEGO August 3	S. H. Sessions U. S. Navy Electronics Lab. San Diego 52, Calif.
E. F. Kahl Sylvania Electric Prod- ucts Emporium, Pa.	EMPORIUM	R. W. Slinkman Sylvania Electric Prod- ucts Emporium, Pa.	L. E. Reukema Elec. Eng. Department University of California Berkeley, Calif.	SAN FRANCISCO	W. R. Hewlett 395 Page Mill Rd. Palo Alto, Calif.
F. M. Austin 3103 Amherst St. Houston, Texas	HOUSTON	C. V. Clarke, Jr. Box 907 Pasadena, Texas	W. R. Hill University of Washington Seattle 5, Wash.	SEATTLE August 12	W. R. Triplett 3840—44 Ave. S.W. Seattle 6, Wash.
R. E. McCormick 3466 Carrollton Ave. Indianapolis, Ind.	INDIANAPOLIS	Eugene Pulliam 931 N. Parker Ave. Indianapolis, Ind.	F. M. Deelhake 600 Oakwood St. Fayetteville, N. Y.	SYRACUSE	S. E. Clements Dept. of Electrical Eng. Syracuse University Syracuse 10, N. Y.
C. L. Omer Midwest Eng. Devel. Co. Inc. 3543 Broadway Kansas City 2, Mo.	KANSAS CITY	Mrs. G. L. Curtis 6003 El Monte Mission, Kansas	W. M. Stringfellow Radio Station WSPD 136 Huron St. Toledo 4, Ohio	TOLEDO	M. W. Keck 2231 Oak Grove Pla. Toledo 12, Ohio
R. C. Dearle Dept. of Physics University of Western Ontario London, Ont., Canada	LONDON, ONTARIO	E. H. Tull 14 Erie Ave. London, Ont., Canada			
Walter Kenworth 1427 Lafayette St. San Gabriel, Calif.	LOS ANGELES July 20	R. A. Monfort L. A. Times 202 W. First St. Los Angeles 12, Calif.			

# Sections

Chairman		Secretary		Chairman		Secretary
C. A. Norris J. R. Longstaffe Ltd. 11 King St., W. Toronto, Ont., Canada	TORONTO, ONTARIO	C. G. Lloyd 212 King St., W. Toronto, Ont., Canada		G. P. Adair 1833 "M" St. N.W. Washington, D. C.	WASHINGTON	H. W. Wells Dept. of Terrestrial Magnetism Carnegie Inst. of Washington Washington, D. C.
O. H. Schuck 4711 Dupont Ave. S. Minneapolis 9, Minn.	TWIN CITIES	B. E. Montgomery Engineering Department Northwest Airlines Saint Paul, Minn.		J. C. Starks Box 307 Sunbury, Pa.	WILLIAMSPORT	R. G. Petts Sylvania Electric Products, Inc. 1004 Cherry St. Montoursville, Pa.

## SUBSECTIONS

Chairman		Secretary		Chairman		Secretary
P. C. Smith 179 Ido Avenue Akron, Ohio	AKRON (Cleveland Sub-section)	J. S. Hill 51 W. State St. Akron, Ohio		L. E. Hunt Bell Telephone Laboratories Deal, N. J.	MONMOUTH (New York Subsection)	G. E. Reynolds, Jr. Electronics Associates, Inc. Long Beach, N. J.
S. C. Ferguson Farnsworth Television & Radio Co. 3700 E. Pontiac St. Fort Wayne, Ind.	FORT WAYNE (Chicago Sub-section)	S. J. Harris Farnsworth Television and Radio Co. 3702 E. Pontiac Fort Wayne 1, Ind.		J. B. Minter Box 1 Boonton, N. J.	NORTHERN N. J. (New York Subsection)	A. W. Parkes, Jr. 47 Cobb Rd. Mountain Lakes, N. J.
F. A. O. Banks 81 Troy St. Kitchener, Ont., Canada	HAMILTON (Toronto Sub-section)	E. Ruse 195 Ferguson Ave., S. Hamilton, Ont., Canada		A. R. Kahn Electro-Voice, Inc. Buchanan, Mich.	SOUTH BEND (Chicago Subsection) June 17	A. M. Wiggins Electro-Voice, Inc. Buchanan, Mich.
A. M. Glover RCA Victor Div. Lancaster, Pa.	LANCASTER (Philadelphia Subsection)	C. E. Burnett RCA Victor Div. Lancaster, Pa.		R. M. Wainwright Elec. Eng. Department University of Illinois Urbana, Illinois	URBANA (Chicago Subsection)	M. H. Crothers Elec. Eng. Department University of Illinois Urbana, Illinois
H. A. Wheeler Wheeler Laboratories 259-09 Northern Blvd. Great Neck, L. I., N. Y.	LONG ISLAND (New York Subsection)	M. Lebenbaum† Airborne Inst. Lab. 160 Old Country Rd. Box 111 Mineola, L. I., N. Y.		W. A. Cole 323 Broadway Ave. Winnipeg, Manit., Canada	WINNIPEG (Toronto Subsection)	C. E. Trembley Canadian Marconi Co. Main Street Winnipeg, Manit., Canada

# Books

## Elements of Radio Servicing, by William Marcus and Alex Levy.

Published (1947) by McGraw-Hill Book Co., 330 W. 42 St., New York 18, N. Y. 475 pages + 14-page index + x pages. 364 figures, 6×9 inches. Price, \$4.50.

The authors state a dual purpose in presenting their book—to furnish the basic information, and the type of approach required for successful servicing. An elementary background of radio theory is assumed, and no design theory is included in the book. The expressed desire is to develop a background of information for the service man so that he can utilize this knowledge to solve his servicing problems even if the factory information is not available.

Several chapters are devoted to a general description of the superheterodyne receiver, the servicing process, meters, to signal generators and their set-up and use. A typical receiver is used throughout the book for illustrating service problems and examples, although many variations of circuits are also covered. This receiver is then broken down into "stages," beginning typically with the

output stage. Chapters are devoted to the a.c. power supply, to speakers, the output stage, and so through to antennas. Additional chapters appear on a.c./d.c. power supplies, automobile power supplies and installation, and conclude with general chapters on alignment and the service bench and its set-up.

No attempt is made to cover f.m. or television circuits. It contains neither specific servicing instructions nor describes specific receivers.

The book is generally applicable as a text for radio service schools and will be found a valuable reference for the experienced service man.

Numerous minor criticisms will be made by technical critics, as the language and viewpoint are obviously that of the technician rather than the engineer. A number of practical criticisms will also be readily found; for example, in all of the several pages on "speaker rattle," mention is not made of one of the most frequent causes of this complaint—a defective power output tube or circuit. "Rumble" in phonograph operation has been confused with microphonics, and no adequate remedies for these most prevalent conditions are described.

There is no information on triode converters or circuits. The theory and description of outside antennas is rather archaic, and some of the information on noise pickup reduction for outside antennas is positively wrong. Rather unusual emphasis is given to the "hot chassis" in a.c./d.c. receivers, which will amaze the underwriters.

The automobile receiver installation information is not believed to be the best modern practice.

In the chapter on a.c. power supply, no mention is made of resistance-type filters, but some information is found in the chapter on a.c./d.c. power supplies.

Sections on push buttons, on multi-band receivers, and permeability-tuned circuits are found tucked away in the chapter on "Further Notes on the Converter-Variations."

Obviously such criticisms are minor or technical, and do not detract from the great help and assistance that this book can give to the beginner or the experienced service man.

H. C. FORBES  
Colonial Radio Corporation  
1280 Main Street  
Buffalo 9, N. Y.



# I.R.E. People

## DOUGLAS H. EWING

Douglas H. Ewing, former manager of Teleran engineering, has been appointed manager of advanced development engineering for the Radio Corporation of America's engineering products department. The development of Teleran, the new air-navigation and traffic-control system, which derives its name from a contraction of Television-Radar-Air-Navigation, will continue under the RCA aegis.

Born in Indiana, Dr. Ewing served on the Smith College physics faculty before becoming assistant to the director of the radiation laboratory at the Massachusetts Institute of Technology during the war, and also chairman of the Laboratory's activities in overseas war theaters. Dr. Ewing is a fellow of the American Physical Society, and a member of Phi Kappa Phi and Sigma Xi.



EDWIN W. HAMLIN

## EDWIN W. HAMLIN

Edwin W. Hamlin (A'40), professor of electrical engineering and director of the Cornell University microwave astronomy project, died suddenly at his home in Ithaca, N. Y., on April 27, 1948.

Born in New York City in 1905, Dr. Hamlin received the B.S. degree in 1926, the M.S. degree in 1928, and the Ph.D. degree in 1932 from Union College, where he taught from 1932 until 1935. After serving as professor at the University of Kansas for four years, he became professor of electrical engineering and director of the electrical engineering research laboratory at the University of Texas, where his work bore directly upon the design of gun-laying radar. In 1947 he joined the faculty of Cornell University.

Dr. Hamlin was a member of the American Institute of Electrical Engineers, the American Association of University Professors, Kappa Eta Kappa, Delta Chi, Eta Kappa Nu, Tau Beta Pi, and Sigma Xi.

## ROBERT B. ROBINSON

Robert B. Robinson (S'48), is one of five young engineers who have been selected by Tau Beta Pi for fellowship awards of a year's graduate study in 1948-49. Mr. Robinson was graduated in electrical engineering from the University of Washington in June of this year, and will take advanced work at the Massachusetts Institute of Technology.



N. F. SHOFSTALL

## N. F. SHOFSTALL

N. F. Shofstall (A'41), formerly designing engineer for the General Electric Company, was recently appointed assistant division engineer with this company's receiver division.

Mr. Shofstall was born in Houston, Tex., and obtained the B.S. and M.S. degrees in electrical engineering in 1928 and 1929, respectively. He has been associated with General Electric in various engineering capacities since 1929. During 1939 Mr. Shofstall visited Argentina, Brazil, Uruguay, and Chile as a consultant on the receiver-manufacturing requirements of these countries.

## CHARLES WILLIAM TAUSSIG

Charles William Taussig (A'22), president and chairman of the board of the American Molasses Company, died unexpectedly on May 9, 1948.

Although Mr. Taussig joined the Molasses Company in 1914, and remained there until his death, his principal avocation was radio, and during the first World War he served with the United States Navy as a radio electrician. Moreover, he wrote *The Book of Radio*, which was published in 1924.

Mr. Taussig was one of the six original members of President Roosevelt's "Brain Trust," and served as adviser to a number of government commissions. At the time of his death, he was chairman of the United States Section of the Caribbean Commission.



## JETEC COMMITTEE ON SAMPLING PROCEDURE

The Joint Electron Tube Engineering Council's Committee on Sampling Procedure: Front row, left to right, N. P. Gowell, Raytheon Manufacturing Company; T. H. Nelson, Air Matériel Command, a guest of the committee; J. R. Steen (A'40), chairman, Sylvania Electric Products Inc.; and W. P. Koechel (A'22),

Tungsol Lamp Works. Rear row, left to right, H. G. Romig, Bell Telephone Laboratories; S. J. Cherry (A'40), Westinghouse Electric Corporation; A. J. Heitner (A'42), Sylvania Electric Products Inc.; G. E. Hackley (A'47), Sperry Gyroscope Company; and W. B. Rupp, Radio Corporation of America.

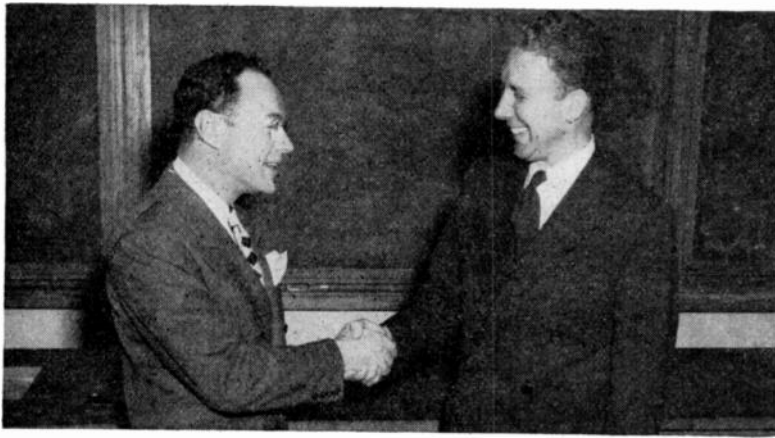

JESSE E. HOBSON AND HALDON A. LEEDY

## JESSE E. HOBSON

Jesse Edward Hobson (M'45), former director of the Armour Research Foundation, has resigned to become executive director of Stanford University's Research Institute at Palo Alto, Calif.

Dr. Hobson received the B.S. and M.S. degrees in electrical engineering from Purdue University in 1932 and 1933, respectively. After receiving the Ph.D. degree from the California Institute of Technology in 1935, he became assistant professor of mathematics at Earlham College, and subsequently an instructor of electrical engineering at the Armour Institute. In 1937 he was appointed central station engineer by the Westinghouse Electric Company, but he continued his academic interests by lecturing at the University of Pittsburgh. He left both positions in 1941 to assume the directorship of the Illinois Institute of Technology's department of electrical engineering, and he held that post until the Armour Research Foundation named him director in 1944.

Dr. Hobson is a member of the Illinois State Board of Examiners for the Registration of Professional Engineers, the National Research Council, the National Electronics Conference, the Western Society of Engineers, and the American Institute of Electrical Engineers.



## DAVID T. FERRIER

David T. Ferrier (A'42-SM'46) has been named assistant to the president of the Servo Corporation of America.

A graduate of the U. S. Naval Academy, Mr. Ferrier completed post-graduate work in radio engineering and communications at the U. S. Naval Post Graduate School and Harvard University with an M.S. degree. From 1929 to 1946 Mr. Ferrier was on active duty in the U. S. Navy, his latest service assignment having been as Navy liaison officer for the National Defense Research Council, Divisions 13, 14, and 15, in the Radiation Laboratory at M.I.T. He was associated with the Radio Research Laboratory and Central Communications Research Laboratory, Harvard University, from 1941 to 1946. Previous to this time Mr. Ferrier served for two years as Battle Force Radio Officer, U. S. Fleet.

## HALDON A. LEEDY

Haldon A. Leedy (SM'46) has been named acting director of the Armour Research Foundation of the Illinois Institute of Technology, succeeding Dr. Jesse E. Hobson.

Born in 1910 in Fremont, Ohio, Dr. Leedy received the B.A. degree in physics from North Central College, Naperville, Ill., in 1933. Upon receiving the Ph.D. degree in 1938 from the University of Illinois, Dr. Leedy accepted the post of physicist in acoustics at the Armour Research Foundation, becoming chairman of physics research in 1944. During the war he was active in the Foundation's research program on magnetic-wire sound recording, and he was also in charge of several projects for the U. S. Navy's Office of Scientific Research and Development.

Dr. Leedy is a member of the American Physical Society, the Acoustical Society of America, Sigma Xi, the American Institute of Electrical Engineers, and the Illinois State Academy of Science. He is director of the Physics Club of Chicago, and program chairman of the 1948 National Electronics Conference.



## MALCOLM R. EASTERDAY

Malcolm R. Easterday (A'45) recently joined the electronics section of the Midwest Research Institute's engineering mechanics



DAVID T. FERRIER

department. Mr. Easterday received his education at the Kansas State College in Manhattan, Kan., and has previously been employed in the Railway Radiotelephone Company's electronics development laboratories and with the Kenmar Engineering and the Aeron Manufacturing Companies, all of Kansas City.



## MURRAY G. CROSBY

Murray G. Crosby (A'25-M'38-SM'43-F'43), formerly a member of the firm of Paul Godley Company, consulting engineers, will conduct a radio-electronic consulting practice under the firm name of Crosby Laboratories at 126 Old Country Road, Mineola, L.I., N. Y.

Born in Elroy, Wis., on September 17, 1903, Mr. Crosby studied electrical engineering at the University of Wisconsin, receiving the B.S. degree in 1927 and an electrical engineering degree in 1943. From 1925 to 1944 he was research engineer in the communications division of the Radio Corporation of America's laboratories, where he specialized in frequency and phase modulation, and point-to-point reception. He has written a number of technical articles in those fields, and has been issued approximately 150 patents.

Mr. Crosby received the Modern Pioneer Award from the National Association of Manufacturers in 1940 for contributions toward the improvement of the American standard of living. In 1943 and 1944 he served as technical consultant to the Secretary of War, receiving official commendation for his work. He also served on Panel Number 1 of the Radio Technical Planning Board.

He was awarded his I.R.E. Fellowship for his "contributions to the development of high-frequency radio communications, including a careful study of frequency modulation." He was Vice-Chairman of the New York Section of the I.R.E. in 1943. In 1944 and 1945 he served on the Papers Procurement Committee, and in 1945 and 1946 on the Admissions Committee. At present he is a member of the Board of Directors, chairman of the Papers Review Committee, member of the Standards and Modulations Systems Committees, member of the Board of Editors, and member of the Editorial Administrative Committee. He is a Fellow of the Radio Club of America, and a member of the American Institute of Electrical Engineers.



MURRAY G. CROSBY



J. HOWARD DELLINGER

### J. HOWARD DELLINGER

J. Howard Dellinger (F'23) retired recently as chief of the Central Radio Propagation Laboratory of the National Bureau of Standards, after forty years of service.

Dr. Dellinger was born in Cleveland, Ohio, 1886. Although he received the B.A. degree from George Washington University in 1908, he had joined the Bureau of Standards in 1907, working initially to determine the conductivity of copper. All standards subsequently adopted were based upon his work. In 1911 he initiated radio research at the Bureau, and, upon the establishment of the Radio Section in 1919, was appointed chief. On loan from the Bureau, Dr. Dellinger was chief engineer of the Federal Radio Commission in 1928 and 1929. At the outset of World War II he was chosen to direct the Bureau's Interservice Radio Propagation Laboratory, which became the Central Radio Propagation Laboratory in 1946.

Dr. Dellinger received the Ph.D. from Princeton in 1913 and the Doctorate of Science from George Washington University in 1932. The author of more than 200 scientific and technical papers dealing with radio and allied subjects, as well as radio editor for Webster's dictionary, Dr. Dellinger was Vice-President in 1924 and President in 1925 of the I.R.E., and received its Medal of Honor in 1938. He is also a member of the Washington Academy of Sciences, the American Geophysical Union, the Associazione Italiana di Aerotecnica (honorary), and Phi Beta Kappa. He is vice-president of the International Scientific Radio Union and chairman of both the Radio Technical Commission for Aeronautics and the Radio Technical Commission for Marine Services.



### A. B. CHAMBERLAIN

A. B. Chamberlain (A'27-M'30-F'41) was recently appointed a member of the Standards Council of the American Standards Association by the I.R.E.

Mr. Chamberlain, chief engineer of the General Engineering Department of Columbia Broadcasting System, was Director of the Institute from 1941-1944. He received the Fellow Award in 1941 for "engineering leadership in broadcast transmission and operation."

### ILLINOIS FELLOWSHIPS AWARDED ENGINEERING STUDENTS

The Graduate College of the University of Illinois has awarded several fellowships in electrical engineering to young members of the I.R.E. The E. I. Du Pont de Nemours Fellowship was given to Clarence E. Bergman (S'48), who received the B.S. degree from the University of Oklahoma in 1947, and the M.S. degree from the University of Illinois the following year. Israel A. Lesk received the Jansky and Bailey Fellowship. Mr. Lesk got his B.S. degree in engineering physics from the University of Alberta in 1948. The Westinghouse Educational Foundation Fellowship was granted to John H. Bryant, who received the B.S. degree from the A. and M. College of Texas in 1942, and the M.S. degree from the University of Illinois in 1947. Chi-Yung Lin was awarded a University of Illinois Fellowship. He received the B.S. degree from National Central University in 1942, and the M.S. degree from Oregon State College in 1948.



W. J. MORLOCK

### W. J. MORLOCK

The appointment of William J. Morlock (A'43-SM'46) was announced recently as division engineer of the Specialty Division of the General Electric Company at Electronics Park, Syracuse, N. Y.

Mr. Morlock was born in McKeesport, Pa., and obtained a B.E.E. degree from Ohio State University in 1930. He has been connected with the electronics industry since 1926. For over ten years he was engaged in the development and design of interior communication and sound equipment for the U. S. Navy and government agencies. For several years he was responsible for the RCA development and design of photophone equipment, microphones, special loudspeakers, 16-mm. sound-motion-picture projectors, broadcast studio equipment, and related equipment.

He is a member of the Society of Motion Picture Engineers, Pi Tau Pi Sigma, Theta Kappa Phi, and the Radio Oldtimers Association. He has served as a member of various RMA committees dealing with intercommunication and sound equipment.

### C. RONALD SMITH

C. Ronald Smith (S'37-A'43) has recently been appointed chief of the missile flight-test unit at the Boeing Aircraft Company, in which capacity he has the responsibility for all guided-missile flight-testing operations at the field-testing grounds, for the reduction of flight-data test, for the development and co-ordination of test range instrumentation, and for the design and supply of the auxiliary servicing and test equipment required for launching missiles.

Mr. Smith won the B.S. degree in electrical engineering from the University of Washington at Seattle in 1936. Two years later he received the M.S. degree from the Massachusetts Institute of Technology. In 1940 and 1941 he pursued additional advanced studies at the University of Pennsylvania.

Mr. Smith began his career as a student engineer at the General Electric Company from 1937 until 1939, when he left to become instructor in electrical engineering at the University of Pennsylvania's Moore School. He was appointed to the staff of the U. S. Naval Ordnance Laboratory in 1941; then transferred to the Bureau of Aeronautics in 1943, where he headed the systems section of the pilotless aircraft guidance branch until he joined Boeing Aircraft in 1947. He is a member of Tau Beta Pi and Sigma Xi.



### MELVIN C. SPRINKLE

Melvin C. Sprinkle (A'42) has joined the sales engineering staff of Altec Lansing Corporation in New York. He was formerly manager of radio sales and service of the Jordan Piano Company, Washington, D. C.

Mr. Sprinkle is a graduate of Shepherd College, Shepherdstown, W. Va., and the New York School of the RCA Institutes in radio engineering. He was factory field representative for Radiomarine Corporation on the Great Lakes, and previously senior radio engineer, Bureau of Ships, United States Navy, where he planned the installation of radio equipment in noncombatant ships. He taught radio engineering at the Capitol Radio Engineering Institute, in Washington, and acted as Washington representative for Scott Radio Laboratories. Mr. Sprinkle has written extensively for technical journals.



MELVIN C. SPRINKLE

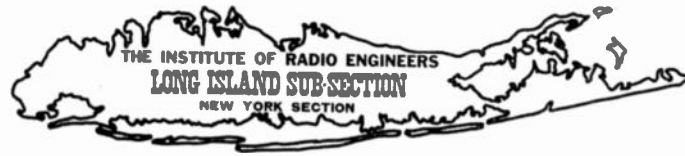

## Long Island Subsection

UNDER the able guidance of James E. Shepherd Chairman of the New York Section of the I.R.E., the Long Island Subsection was formed this year in order better to serve the needs of approximately one thousand Institute members who live on the Island.

Six technical meetings held in the Garden City High School were the high points of an eminently successful first year. Engineers from the local industries headed discussions of numerous subjects in the field of radio and electronics. In addition to presenting topics of fresh and varied interest, the Subsection's meetings had the additional function of acquainting the various groups of engineers working on Long Island with one another, especially since the comparatively small attendance at each meeting—only about one hundred persons—

presented greater social opportunities than the very large meetings of the main New York Section.

Besides the technical meetings, the Subsection organized an inspection trip to the RCA Communication Company's facilities on Long Island on the first of May, which was attended by over two hundred members. The RCA installations on the Island are of unusual interest, providing almost a complete history of the radio art, beginning with 20-kc. Alexanderson alternators to modern ultra-high-frequency equipment.

When the Subsection was formed, Mr. Shepherd appointed a committee, headed by Eric J. Isbister, to handle its affairs. Harold A. Wheeler, present vice-chairman, is chairman-elect for the coming year.

Eric J. Isbister was born in Brooklyn, N. Y., on June 11, 1912. After receiving the B.S. degree in electrical engineering from the Massachusetts Institute of Technology in 1934, he joined the Sperry Gyroscope Company, where he is now employed, continuing his studies at night at the Brooklyn Polytechnic Institute, from which he received the M.E.E. degree in 1940.

During his early years with Sperry, Mr. Isbister was engaged in a variety of projects, which included gyro compasses, searchlights, radio direction finders, aircraft flight in-

he was appointed head of the department of radar engineering in 1942, and his achievements in the field were of such high quality that the United States Navy's Bureau of Ships awarded him a Certificate of Commendation for his outstanding work as a research engineer at the Sperry Gyroscope Company, and for his skill and ability in basic research and development of display circuits, airborne interception beacons, airborne search radar, and loran equipment.

Mr. Isbister is a Senior Member of the I.R.E., and is also a member of the American Institute of Electrical Engineers and the Institute of Navigation. He has served on a number of committees for the AIEE and RMA, and on the Radio Technical Committees for Marine and Aeronautical Services.

Harold Alden Wheeler was born in St. Paul, Minn., in 1903. After his graduation in 1925 from George Washington University with the degree of B.S. in physics, he did postgraduate work in the electrical field at Johns Hopkins University, where his research won him election to Sigma Xi and Gamma Alpha.

In 1922 Mr. Wheeler met Professor Alan Hazeltine, with whom he found a common interest in neutralized amplification. When the Hazeltine Company, now the Hazeltine Electronics Corporation, was formed two years later, Mr. Wheeler was one of its founders, becoming head of the Bayside Laboratory in 1930, and finally vice-president of the company. In 1946 he left to open his own consulting office in Great Neck, N. Y.

Mr. Wheeler's scientific contributions have been numerous and varied. He has developed special testing equipment, a simple inductance formula for solenoid coils, studies of frequency modulation, and studies of distortion and wide-band amplifiers which won him the Morris Liebmann Memorial Prize in 1940. In 1948 he was awarded a Certificate of Commendation by the United States Navy for his wartime achievements in the development of radar identification and beacon equipment, as well as for other contributions.



ERIC J. ISBISTER  
CHAIRMAN



HAROLD A. WHEELER  
CHAIRMAN-ELECT

struments, instrument landing systems, and a number of military projects which increased in number with the advent of World War II. After intensive work on radar and loran,

Mr. Wheeler, a former director of the I.R.E., is active in Institute affairs, and has served and is serving on a number of Institute Committees.



WESTINGHOUSE RESEARCH LABORATORIES

*Westinghouse Electric Corporation*

On a hillside cluster the buildings of the research laboratories of the Westinghouse Electric Corporation at East Pittsburgh, Pa.

# Greetings from England and the I.E.E.\*

WILLIS JACKSON†

I FEEL IT a great privilege to be allowed to speak on this auspicious occasion, and I should like you to know how much I have appreciated your kindness and hospitality throughout this Convention. I have been told many times of the spontaneous and warm-hearted welcome which you in the United States extend to your visitors, and now I know this by personal experience. Many of my friends in Britain are extremely grateful for the kind and generous way in which you have received them in the past, and if they were aware that I am speaking here tonight I am sure they would wish me to tell you so. I was, in fact, asked, should the opportunity occur, to express greetings on behalf of C. E. Strong, chairman of the Radio Section of the Institution of Electrical Engineers, and of the members of the Radio Section Committee; of R. L. Smith-Rose, to whom you paid the great honor of making him your Vice-President; and of one who is

\* Decimal classification: 4060. Original manuscript received by the Institute, March 31, 1948. An editorial revision based on an address delivered at the Annual Banquet, 1948 I.R.E. National Convention, New York, N. Y., March 24, 1948.  
† Imperial College of Science and Technology, London, England.

known well by so many here tonight, and whose knowledge of America is a very important asset in Britain, F. S. Barton. With them, I should like to wish The Institute of Radio Engineers continued and expanding prosperity.

Our I.E.E. conventions are necessarily on a much smaller scale than your own, but it has been interesting for me to note that, as with us, perhaps the most valuable part of your proceedings has been the opportunity afforded for informal gatherings and discussions, through which men who do not meet often are enabled to get to know each other better. The process of getting to know each other better, both nationally and internationally, is of supreme importance, and in my opinion occasions such as this Convention are justified on this basis alone.

Your technical program and your magnificent exhibitions are indicative of the immense present-day scope of the subjects of radio and electronics. This has raised with us, as no doubt with you, some complex problems in the fields of scientific and technical education and of industrial training, to which we have not yet found wholly satisfactory solutions, but to which we are de-

voting considerable attention. One of the main purposes of my visit is to discuss the ways in which you are tackling these problems, and it already evident that I am going to have a most interesting and profitable time.

This is my first visit to the United States and it is too early yet for me to have formed any reliable impressions, but I might perhaps mention the most vivid of my responses so far. It was the thrill I experienced when, as the boat approached New York, the Statue of Liberty emerged slowly through the morning mist and was later bathed in a glow of warm sunshine. I felt deeply that here was your symbol in metal and stone of the cause to which our two countries have dedicated themselves, and for which, during the past few years, we have both paid such a high price in men and resources. This is not the occasion to speak of international relations, but it is perhaps appropriate to remark that in the field of radio we have a very great part to play together, and I hope and trust that in it we shall lose no opportunity of co-operating to the full.

May I, in conclusion, thank you most sincerely for your kind hospitality.

# The Radio Manufacturers Association Greets The Institute of Radio Engineers\*

MAX F. BALCOM†

AS PRESIDENT of the Radio Manufacturers Association, I appreciate this opportunity to extend the greetings of the Radio Manufacturers Association, its directors and its members, to the officers and members of The Institute of Radio Engineers on the occasion of your annual Convention.

RMA and I.R.E. are old friends in the radio industry. Both organizations have had important roles in implementing the growth of our industry and in bringing into being the Electronic Era, on the threshold of which we stand today. The RMA, including its varied activities and the functions of its engineering department, represents principally the management phase of our industrial organization, while the I.R.E. comprises the radio engineers both in and out of the industry. Both are essential, and one complements the other.

RMA and I.R.E. have worked harmoniously together to promote the best interests of the radio industry, and are now sponsor-

ing joint technical conferences such as the Spring Meeting to be held in Syracuse on April 26 through 28.

The radio engineer was never so important to the society in which he lives as he is today. The radio industry attained maturity during World War II and now is embarked upon a period of expanding markets and services that may well make it one of the greatest in this nation of giant industries.

I need not call your attention to the potentialities of television and f.m. broadcasting services in whose development the radio engineer has played such a vital part. The availability of these services is an excellent illustration of the co-ordination of engineering and production talent. The key to American industrial leadership can be found in this ability to turn the results of engineering research into a mass-produced product which a maximum number of persons can afford and enjoy.

The one thing, perhaps, that keeps the United States ahead of all other countries industrially, and which unquestionably turned the tide in the recent war, is our industrial "know-how." It was this talent for converting scientific theory into practical use that enabled our country to produce the first atom bomb.

Similarly, the teamwork of radio engineers and industry management has maintained American leadership in the radio and electronic fields. We can feel justly proud of our wartime record for both developing and producing some of the most effective weapons of our armed services. But we can be equally proud of the speed with which our industry has reconverted to peacetime production, and has made available to the public new products of *your* engineering research.

Despite the thoroughness with which the radio industry has supplied the American public with radio receivers, radio's greatest years are still ahead. Our industry will be kept busy for years building up television and f.m. audiences, even to the present level of a.m. or standard radio listeners. Moreover, since radio has become so much a part of our daily life, and since program tastes within a family are so varied, one radio set in a home is no longer adequate. Out of this realization emerged the RMA "Radio-in-Every-Room" program about which you have no doubt heard.

Radio and television broadcasting is only one, although the most important, aspect of this adaptation of laboratory research to civilian use. Radio's possibilities in the

\* Decimal classification: 4060. Original manuscript received by the Institute, March 31, 1948. An editorial revision based on an address delivered at the Annual Banquet, 1948 I.R.E. National Convention, March 24, 1948, New York, N. Y.

† Radio Manufacturers Association, Washington 4, D. C.; Sylvania Electric Products Inc., Emporium, Pa.

fields of communications, navigation, and detection are just beginning to be realized, while industrial adaptations, such as electronic heating, have scarcely scratched the surface of possible development.

Yet already the list of stations and services licensed by the Federal Communications Commission indicates the wide variety of these opportunities. As of the first of this year, the F.C.C. had licensed 3551 broadcasting stations of all types—a.m., f.m., television—and 112,137 nonbroadcasting stations, of which 75,000 were amateurs.

These nonbroadcasting services range from aviation and maritime aids to the mobile communications services of taxicabs, buses, and trains, and include a miscellaneous assortment of public services and industrial uses.

Many of these new radio services are still in the experimental or developmental stage. Others are on the way. The Citizens Radio Communications Service, to which the F.C.C. will shortly give the green light, may someday even challenge radio broadcasting in the number of persons served.

The radio industry, greatly expanded beyond its prewar capacity, is a billion-dollar industry today. Tomorrow, as television and f.m. stations increase along with set ownership and as radio nonbroadcast services grow, it may well be a five-billion-dollar industry, or even greater.

As I said before, this progress has been made possible by the teamwork of engineers and management. It will continue so long as these segments of our industry continue to function within the framework of our free-enterprise system.

## Speech of Acceptance for 1948 Fellows of the I.R.E.\*

JAMES E. SHEPHERD†, FELLOW, I.R.E.

IN ACCEPTING the award of Fellow grade in this Institute, on behalf of all the newly elected Fellows, there is one thing I wish to emphasize. That is that membership of *any* grade in The Institute of Radio Engineers is enough to inspire a sense of deep pride and great responsibility. For *this* is the Institute which champions and advances that art which underlies so much of our modern civilization.

For example:

Ours is the art which makes possible the rapid and far-flung communications which form the very foundation of modern business, statesmanship, and military operations.

Ours is the art which forms the basis for new and precise industrial processes and controls, for all sorts of unusual measurements, for detonating shells high in the air, and for performing mathematical computations with incredible speed.

Ours is the art on which are based the greatest advances toward precise navigation since the invention of the compass and the astrolabe.

Ours is the art on which so much dependence is placed for safety of lives and property—on land, at sea, and in the air.

Ours is the art whose new radar eyes of many facets have revolutionized all manner of concepts of both commercial and military operations.

Ours is the art which adds accuracy and range to weather predictions and surveying.

Ours is the art which aids the delving into the mysteries of the atom, which contributes to advances in the medical sciences, and which compensates for deficiencies in hearing.

Ours is the art on which is based the greatest extension in the distribution of culture and entertainment since the invention of the printing press.

Ours is the art by which emotional influences are felt on a nationwide (and often worldwide) scale, with such reality that the personal problems of a fictitious Lum and Abner are transmuted into very *real* concern in the minds of many millions of persons each day (and, in fact, I have it on good

authority that one mother keeps her kiddies away from their living-room loudspeaker whenever the announcer has a bad cold).

This is a miraculous art indeed!

Now comes the hard part: What does the Institute expect of us as Fellows? There are no definitive specifications, no performance specifications, in these diplomas we have just received. If we take for our calibration point the 250 engineers whose privilege it has been to serve as Fellows of this Institute since its founding 35 years ago, the going gets really tough! To name only a few, we find such fabulous names, familiar to every student of radio and electronics, as Hartley, Colpitts, Pupin, Stone, Van der Bijl, Armstrong, DeForest, Alexanderson, Espenschied, Beverage, Doherty, Heising, Hazeltine, Morecroft, Pierce, Chaffee, Terman, Everitt, Llewellyn, Barrow, Stratton, and scores of other well-known I.R.E. people—many of whom are right here in this banquet hall with us tonight.

To enjoy the same grade of membership as men like *these*, in such an organization as The Institute of Radio Engineers, is a grave responsibility indeed, Mr. President, and one which we, the newly elected Fellows, accept with the deepest humility.

\* Decimal classification: 4060. Original manuscript received by the Institute, March 31, 1948. An editorial revision based on an address delivered at the Annual Banquet, 1948 I.R.E. National Convention, New York, N. Y., March 24, 1948.  
† Sperry Gyroscope Company, Great Neck, L. I., N. Y.

## Radio and Electronic Frontiers\*

W. R. G. BAKER†, FELLOW, I.R.E.

IT HAS BEEN a real privilege and pleasure to have served as President of such an outstanding organization as The Institute of Radio Engineers, and I want to take this opportunity to thank the Board of Directors, the Executive Secretary, and his competent staff for their excellent support and co-operation.

This is an opportune time to consider the subject, "Radio and Electronic Frontiers."

Reference to a dictionary will disclose several definitions of the word "Frontier." Perhaps the most suitable definition is, "The Border or Advance Region of Settlement and Civilization."

If you were asked to describe your *mental* picture of the word *frontier*, I am certain you would say something about a great and dense forest, a rugged mountain range, an endless prairie, or a log cabin on the shore of a lake with—perhaps for scenery—an Indian or two peering out from behind the trees.

If you were asked for a *word* picture of *frontier* you would probably say: endurance, hardship, privation, strength, and, perhaps, curiosity—which, without doubt, is one of

the great motivating forces that establishes frontiers.

The process of establishing a frontier in an unexplored country is of interest, since there is a close analogy between such a frontier and the mechanism of establishing a scientific frontier.

First, we may assume that one or more men, with a driving determination, go forward into the unexplored territory. Presumably they have no idea of where they are going, what they will find—being supported only by intuition, and a suspicion that new and greater opportunities lie ahead. That their efforts will be rewarded is certainly not assured. We may assume that they are looking for a place to settle and

\* Decimal classification: 4060. Original manuscript received by the Institute, March 31, 1948. An editorial revision based on an address delivered at the Annual Banquet, 1948 I.R.E. National Convention, New York, N. Y., March 24, 1948.  
† General Electric Company, Electronics Park, Syracuse, N. Y.

bring their families. Hence, they will be interested in the land, the location of water, and ease of travel.

These men find a suitable location, clear the ground, and build log cabins, to which they bring their families. Word of their findings soon spreads through the settled part of the country, and more and more families follow the narrow trail. The trail becomes a path, and the path a road. The few cabins become a village. The village requires more facilities to care for the people. There is required protection from fire, and a police force. The town meeting changes to the more conventional form of government. Merchants find a profitable market. Better travel and communication means are needed and provided, so that we finally have a small city with its residential and commercial sections. Our frontier has disappeared. Now the process is repeated. Again, a few men—motivated by the desire for a better standard of living for their families, or by a curiosity to learn what lies beyond—strike out in the unknown, and once more a new frontier is to be established.

The frontier process, if we may call it that, is not unique to opening up new lands. It applies to all fields of science—to all business, and to all individuals. It is, fundamentally, a process of growth.

We know that in the field of research men are advancing into the unknown with perhaps even less knowledge of where they are going than the pioneer striking out into unexplored lands. The pioneering scientist uncovers a new phenomenon, a new truth, a new fact, or just a hint of a new idea. As soon as news of the phenomenon is known, additional scientists establish scientific cabins, and almost at once the new land is under cultivation. The scientific trail becomes a path, and the path a road.

Now the development engineers settle in the little clearing in the great forest of ignorance. The design engineers follow, and the small scientific clearing begins to take on the aspect of a village. Finally, the commercial people are attracted to the scientific village, and it becomes a city.

The frontier process as applied to the exploration of the unknown in the field of science is practically a duplication—step by step—of the process as applied to unexplored

lands. The time factors may vary considerably, but certainly the motivated forces of a better standard of life and the inherent curiosity of man are the same. For example, in the last ten years at least three major frontiers have been established, and from these frontiers a multiplicity of trails already are leading into the scientific unknown.

1. One of the major frontiers has been the great work represented by the use of microwaves. Perhaps the most important product resulting from this frontier is radar. That this frontier is in its final stages is evidenced by the commercial application of radar principles to ships and aircraft. Already trails are leading into the higher frequencies, and surely these trails will result in the establishment of new frontiers. Other examples of frontiers which are in the process of commercialization are television and frequency modulation.

2. Undoubtedly one of the most important and perhaps the major frontier which has been established in the last ten years is that of nuclear science. Unfortunately, the major product of this frontier has been a weapon of destruction; but those of you who heard our distinguished speakers on the nuclear science symposium know that the efforts in establishing this frontier can be directed along constructive lines.

From this frontier many paths are being established, one leading towards improved and perhaps revolutionary means of generating power which may turn deserts into fertile valleys, and another which may provide new and revolutionary means of transportation on land, sea, and in the air.

3. A third frontier—while, in a sense, a branch of atomic power research—is the pathway of nuclear radiation. We already know in a small way the beneficial effects of this radiation in relieving human suffering, in increasing the productivity of our farms, and in its applications to industrial processes. I want to stress the point that, if new scientific frontiers are to be a benefit to mankind, full and complete utilization of the advances are made possible *only* by making this knowledge and the benefits of these advances available to everyone.

The scientist is an explorer in the field of nature. He seeks new facts and new principles which others—such as the engineer,

the industrialist, the physician, or the educator—may use for the good of mankind. He supplies, as it were, the raw materials for technological processes, for elevating our standards of living, and for the betterment of mankind.

The pioneer process is an inherent characteristic of growth. In the pioneering of land, the limit of the pioneer process is established presumably by the extent to which the land can support the population. In the field of science, the limit is established only by the intellectual curiosity of the men engaged in work in the scientific field under consideration. In new lands and in new fields of science, the tempo of the pioneer process may be high as compared with lands which have become well-populated and sciences which have been under intensive investigation for a considerable period. Our knowledge of the road along which a particular branch of science is traveling is confined to that which lies behind. We cannot say how much further, if at all, the road extends in front, or what the far end of it is like; at best, we can only guess.

Up to the present, the field of radio and electronics has been one frontier after another. We might almost say that we have had an inventory of frontiers. Certainly in the field of electronics and its sister science of nucleonics there are a vast number of frontiers, representing every step in the frontier process from the pioneer, striking into the unknown, to full commercialization and utilization.

In the pioneering of new lands, the cabins were located close together for purposes of exchange of information, mutual assistance, and community strength. As the frontier communities developed, transportation and communication facilities were provided between these communities and from the frontier communities to the older sections and the settled portions of the countries. The tempo of the development of our frontiers depends to a large extent upon the dissemination of knowledge which establishes a unity of purpose.

This, then, is a simple analogy of the responsibility of The Institute of Radio Engineers, to its 21,000 members. Such responsibility will be adequately discharged by our Officers and Board of Directors.

## The I.R.E. in 1948\*

ALFRED N. GOLDSMITH†, FELLOW, I.R.E.

ANY DESCRIPTION of the I.R.E. might appropriately be preceded by some brief comments on societies and institutes in general. There are already a number of types of what are termed engineering societies, and the distinctions between them are becoming of increasing interest to engineers.

Some engineering societies are more

nearly groups of amateur enthusiasts. Such organizations insufficiently stress the professional attainments of their membership and the achievement of high standards of professional procedure. These societies of enthusiasts, pure and simple, can usually be recognized by their somewhat disorganized treatment of technical problems and professional matters. Yet the vigorous and genuine interest of their membership and the stimulus which they give to individual effort fully justify their existence and activities. They are, however, not what may be termed "professional engineering societies."

Societies of another type in the engineering field are not far removed in principle and practice from trade associations. Such organizations are primarily interested in commercial questions, and occasionally, and regrettably, in the personal advancement of their more prominent members. Societies of this more nearly commercial or personal type can usually be distinguished by a comparative lack of interest in the wishes and welfare of the majority of the membership, and a concentration of effort on commercial, political, and personal developments for a minority. Trade associations, in themselves,

\* Decimal classification: 4060. Original manuscript received by the Institute, March 31, 1948. An editorial revision based on an address delivered at the Annual Banquet, 1948 I.R.E. National Convention, March 24, 1948, New York, N.Y.

† Consulting Engineer, New York, N. Y.



are valuable assets of modern civilization, and offer industries an effective means for self-expression, for protection against unwise procedures or measures, and for the interchange of mutually helpful ideas. Oddly enough, they are more generally free from domination by personal considerations than are the type of "engineering societies" which, in a sense, imitate them.

Fully admitting the value of the society of scientific or technical enthusiasts, and also of the well-conducted trade associations, it must be pointed out that The Institute of Radio Engineers does not fall into either of these classes. It is inherently a definitely professional engineering organization and maintains very rigorous standards for its membership. In fact, the I.R.E. Admissions Committee is so conscientious, analytic, and even critical that occasionally objections have been raised to its lofty ideals and unswervingly severe interpretations of the Institute's demanding regulations for each grade of membership. Yet such adherence to its duties ensures the integrity and standing of the Institute through the decades.

Again, the Board of Editors and the Papers Review Committee have set such exigent standards for the quality of papers to be accepted and published in the PROCEEDINGS that there are necessarily some disappointed authors. Occasionally, some of the membership have even suggested that the rules and regulations be somewhat relaxed. However, this has not been done nor is it planned that it be done. The membership of the Institute are entitled to receive a journal the contents of which have been subjected to rigorous scrutiny as to accuracy and intrinsic value.

To summarize, the I.R.E. can be fairly accused only of having and maintaining the highest standards of professional and scientific attainment for its membership and publications, regardless of the occasional discomfort which results to individuals.

And despite these facts—or perhaps because of them—the I.R.E. does receive the welcome loyalty of its tens of thousands of members. It is truly a fraternity of communications and electronic engineers bound together by mutuality of interest. And many of its members obviously are proud of their hard-won connection with the Institute, and their achievements and participation in its activities. They are firmly resolved to assist its continuous upbuilding.

The officers of the Institute naturally receive many welcome communications from the membership criticizing one or another feature or procedure, or suggesting this or that new or altered step. The language of some of these communications is vigorous, to put it mildly. Sometimes, it is true, a group of communications from capable members of the Institute, received almost simultaneously, will differ markedly in viewpoint and recommendations. But this adds

to their interest.

One point which should be stressed is that the officers who receive these letters are glad to get them. So far from objecting to such communications, as may be elsewhere in the case, the I.R.E. officers consistently regard letters of sincere comment and criticism as constructively helpful, and indeed as conclusive evidence of the interest and loyalty of the membership. This statement should be interpreted as an invitation to the entire membership to continue to send as many such communications to the officers as it may desire.

The loyalty of the I.R.E. membership has in fact been proven in many other ways. For example, in 1947 the membership gave nearly 100,000 man-hours of time to the Technical Committee activities of the I.R.E.! This does not include time devoted to the work of the Standing Committees which also received substantial assistance from the membership, even though their hours of labor are more difficult to estimate. When it is considered that many of the members participating in I.R.E. committee activities are in important positions of trust, the time and expense involved in their contributions is indeed substantial. Accordingly, even on this crude quantitative basis, it is clear that the Institute membership greatly values its own society.

The results of the work of the Committees, in the form of standards, tests, definitions, and data on new fields, will be of great importance in the postwar engineering and industrial development of its field. It should benefit the numerous organizations with whom the membership of the Institute is affiliated. It should be helpful in this regard, as well, to the Radio Manufacturers Association, with which the I.R.E. has most friendly and mutually helpful relationships.

The work of the I.R.E. is never done nor yet crystallized into a set pattern. Its membership and authors have seen to that. In fact, the activities of the Institute have recently been fundamentally broadened and kept thoroughly up-to-date by the formation of the new Audio-Video Engineering Group, and of the committees dealing respectively with electronic computers and with nuclear studies.

The Institute is the beneficiary not only of the collaboration of its membership, but also of the efforts of its administrative staff. It would be less than justice to point out that the daily administration of the Institute by its employed officers and other workers is also a difficult, time-consuming, and tiring job. The I.R.E. members well know of the numerous activities of their Executive Secretary. His many hours of work at Headquarters, and his numerous trips on Institute business to the Sections of the Institute and to other meeting places and organizations, both industrial and governmental, are directed toward the upbuilding of the Insti-

tute. He is ably assisted by the Assistant Secretary, Mr. Gannett, and the Technical Secretary, Mr. Cumming.

In the Editorial Department, the devotion to duty of the Technical Editor, Mr. DeSoto, and of the Assistant Editor, Miss Potter, are well known to those who have contact with that Department. All other members of the secretarial and editorial staffs have been found to be an unusually capable and willing group of intelligent and effective workers.

To offer some concrete examples of the magnitude of the task of administering the Institute, it may be mentioned that during 1947 over five hundred envelopes left Headquarters each working day, or approximately 150,000 individual pieces of mail during the year. More than one thousand work orders, reaching about one-quarter of a million sheets of paper, were processed in the multilith department. And some seven thousand orders for supplies, such as copies of standards, membership pins, and so on, were serviced for the membership. These figures are quite understandable when it is considered that the I.R.E. membership *doubled* in the decade 1927-1937, but actually *quadrupled* in the decade 1937-1947.

As to the PROCEEDINGS OF THE I.R.E., the members well know that the recent issues have exceeded in size any in the past history of the Institute, and have enabled reducing an embarrassingly large backlog of unpublished papers to manageable and acceptable dimensions.

And so I.R.E. Headquarters certainly does not operate automatically. It happens that I pass Headquarters on my way home from work in the late afternoon or early evening. And often times, long past dusk, I have seen the lights still on in many rooms of the Institute building where members of the staff are carrying on their work in a fashion which can justly be described as "beyond the call of duty."

It is good to be present at this meeting with my fellow Director, John V. L. Hogan. He and I have the inestimable privilege of having been present with our good colleague, Robert H. Marriott, when the Institute was founded, and of still being granted the opportunity of actively serving its membership and, through them, the entire communications and electronic engineering field. When he and I see how amazingly the Institute has grown from humble beginnings to its present position of unquestionable leadership in its field, and how rapidly it is going forward toward the accomplishment of further appropriate and valuable tasks, we can summarize its history and its future, speaking for the membership, in "modest" phraseology, somewhat as follows:

"We have accomplished the merely remarkable; we are naturally dissatisfied; we look forward to achieving the almost miraculous."



# Avenues of Improvement in Present-Day Television\*

DONALD G. FINK†, FELLOW, I.R.E.

THE HISTORY OF the technical arts shows clearly that the extent of their application to the common good, and the prosperity of those who develop and promote them, depend on a continuing stream of improved techniques. It is, therefore, not too early to consider necessary improvements in the present-day television system, despite the fact that its introduction to the public on a large scale began only a year ago.

The prosperity of television depends on the number of man-hours devoted by the public to the viewing of programs. To increase the audience, and its devotion to the medium, the quality and variety of programs must improve. Good programs will attract an audience in spite of the high cost of receivers, and in spite of poor picture quality.

Reduction in the price of receivers is next in importance. The experience of the movies and sound broadcasting has shown that it is impossible to offer excellent programs during every hour of the exhibition schedule. But even mediocre programs will attract an audience if the means of attending them are convenient and inexpensive.

The third factor is the technical excellence of the medium. A poor medium restricts the range of program material, and poor quality, if long continued, has a stultifying effect on the audience. Many a television enthusiast has found a 7-inch picture, with 200-line horizontal resolution, satisfactory for a few weeks. But his first view of a 15×20-inch projected image, with 340-line horizontal resolution,<sup>1</sup> deals a blow from which he never fully recovers. Thereafter, if the programs continue to interest him, he buys a better receiver as soon as he can afford it.

While the program material is, for the most part, outside the sphere of influence of the engineer, the cost of receivers and the technical excellence of the medium are wholly within his purview. The avenues of improvement open to the engineer are, unfortunately, in fundamental conflict. Nearly all the possible improvements we shall discuss here can be introduced using available techniques, but many of them will increase the cost to the public. Exceptions occur in the techniques used at the transmitter, since their cost is confined to one unit serving tens or hundreds of thousands of receivers, and the cost is small in proportion to program costs in any event.

To resolve the conflict between improved quality and cost, the attention of engineers must be directed to the matters urgently requiring action, and their activity supported by the necessary appropriation of time, equipment, and funds. Cost reduction without impairing quality requires a high degree of inventiveness. Improving quality, while at the same time reducing costs, requires inspiration. The invention and the inspiration are needed, imperatively, if television is to prosper. They will be forthcoming, as in the past, if the right problems are attacked by the right men in the right environment.

What, then, are the necessary improvements in present-day television? In attempting to answer this question, we have elected to compare the 525-line television system with another very similar medium, having approximately the same ultimate limitations, but enjoying a higher degree of development. This medium is the 16-mm. motion-picture system, as exemplified by professional-grade cameras and film (corresponding to professional television pickup equipment), and the amateur type of projector (corresponding to the mass-produced receiver). Using such 16-mm. equipment, the writer has produced films of subjects similar to those currently televised, and studied the differences between the end results of the two systems.

In so doing we find that, while the two media are beset by many similar difficulties, the motion-picture system suffers least. The superior quality of the motion picture is in part explained by the intrinsic simplicity of the photographic process, compared to television transmission, and in part by its longer period of development, during which the shortcomings of the motion picture have been overcome. Whatever the cause, a 16-mm. image, even when projected on amateur equipment, is far superior to the television images reproduced by commercial television receivers of the present day.

Ultimately, the two media should be equally excellent. The 6-Mc. television channel, with 4 Mc. devoted to picture information, permits resolution of picture detail equal to that of a 16-mm. movie system using commercial-grade positive prints and an amateur-type projector. Evidence of this is the fact that, even today, the television system permits an experienced viewer to distinguish between 16-mm. and 35-mm. film programs, especially since many of the 16-mm. prints available are below standard. In other respects, such as picture brightness, background lighting, flicker, tonal gradation, geometric distortion, jitter, and displacement, the television system can ultimately do as well, or better, than the 16-mm. system.

Not so today. Only in picture brightness and freedom from flicker can television receivers today equal or sur-

\* Decimal classification: R583. Original manuscript received by the Institute, January 14, 1948. Presented, 1947 Rochester Fall Meeting, November 18, 1947, Rochester, N. Y.; and New York Section, I.R.E., May 5, 1948.

† *Electronics*, McGraw-Hill Publishing Co., New York 18, N. Y.

<sup>1</sup> A 525-line, 30-frame image, transmitted over the standard 6-Mc. channel, displays a maximum resolution of about 340 lines horizontally. See p. 225-235, "Television Standards and Practice," (N.T.S.C.) McGraw-Hill Book Co., New York, N.Y., 1943.

pass the 16-mm. system. In resolution of detail, in tonal gradation, particularly in the delineation of low-key scenes, and in the multitude of geometric and tonal distortions produced by scanning irregularities, noise, transients, and poor synchronization, the television system comes off a very poor second. In only two respects must the television system inevitably remain poorer than the 16-mm. system, and these are the minor defects introduced by interlaced scanning (virtual pairing of lines accompanying vertical motion, and jagged edges accompanying horizontal motion). In all other respects, present-day television has the opportunity to match 16-mm. performance.

To make more concrete the degree of improvement possible, the motion-picture films illustrated were prepared. A camera and lenses of professional quality (Kodak Ciné Special, with Kodak Anastigmat  $f/1.9$ , 1-inch general-purpose lens, and an  $f/2.7$ ,  $2\frac{1}{2}$ -inch telephoto lens) were used to expose the film. Super-X film (average speed and graininess) was used where light was plentiful, Super-XX (high speed and graininess) where light was limited. Reversal film was used to preserve the ultimate resolution of the system. The camera was defocused to introduce lower resolution in the study of the test chart. The projector used in the study is a typical amateur product (Keystone Model A-82, with Wollensak 2-inch  $f/1.6$  projection lens and 750-watt lamp).

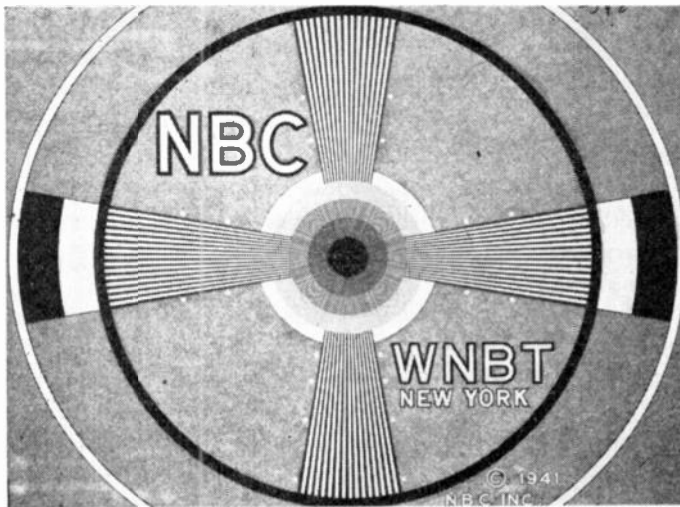

Reproduced by the permission of the National Broadcasting Co., Inc.  
 Fig. 1—Original copy of the NBC test chart, from which the filmed images (Figs. 2 and 3) were taken.

The subjects are the standard NBC test pattern (Fig. 1) and two sporting events, football and ice hockey. The first portion (Figs. 2 and 3) shows the test chart in the normal manner, as customarily shown prior to programs to permit adjustment of receivers. When viewed on the projection screen all four resolution wedges are resolved clearly to the center of the pattern, and the detail otherwise is much more crisp than that visible on a television

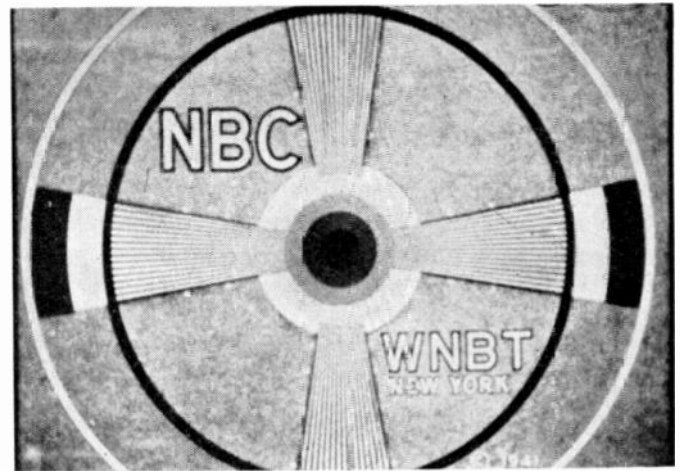

(a)

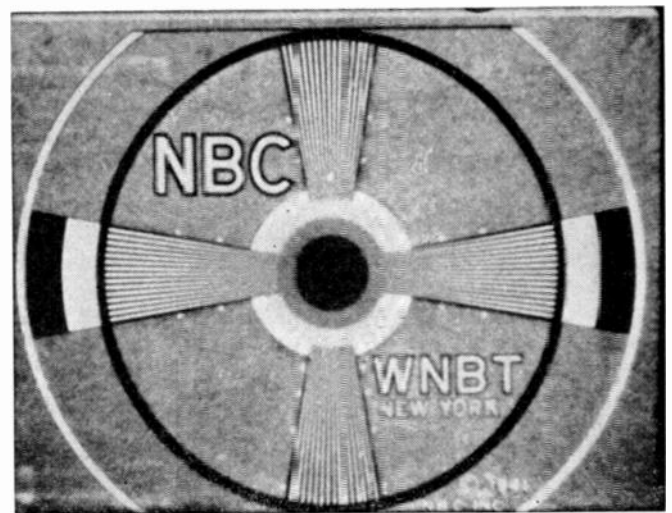

(b)

Fig. 2—Single frames of 16-mm. film, showing the NBC test chart as reproduced on Plus-X reversal film ( $f/1.9$ ,  $1/30$ -second exposure, two No. 2 photofloods at 5 feet). (a) Normal focus. (b) Defocused to simulate televised reproduction. The detail visible in these half-tone engravings is considerably less than that visible in the direct projection of the reversal film.

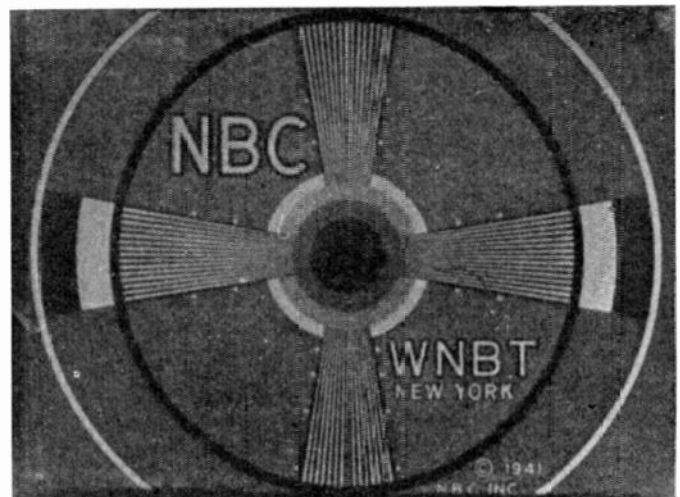

Fig. 3—Same as Fig. 2, but exposed at  $f/8$ . Note the uniformity of steps in scale of grays, despite underexposure.

screen of the same subject, even on the monitor at the transmitter.<sup>2</sup>

The tonal gradations at the center of the chart are uniformly delineated. The background illumination is uniform over the entire area of the pattern. *And there is no observable geometric distortion of any kind.* The circles are circles, the letters evenly spaced. "Noise," in the form of grain and dirt specks, is visible, particularly when the exposure is reduced to emphasize this effect.

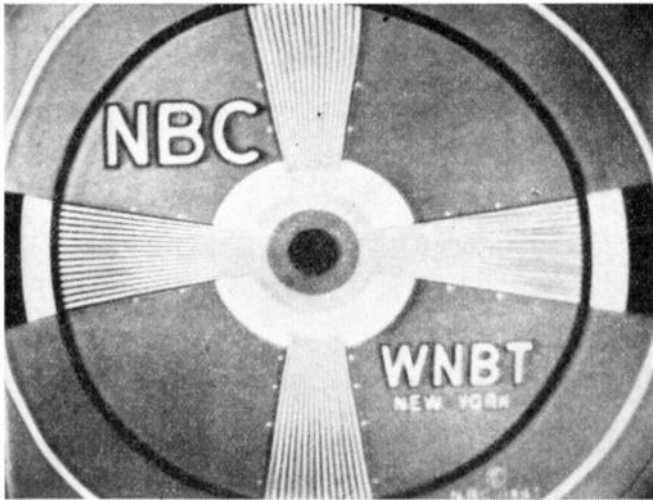

Fig. 4—Televised reproduction of the test chart, as received 13 miles from the transmitter. The receiver, constructed by the writer, uses a 12-inch tube, 4-Mc. i.f. bandwidth.

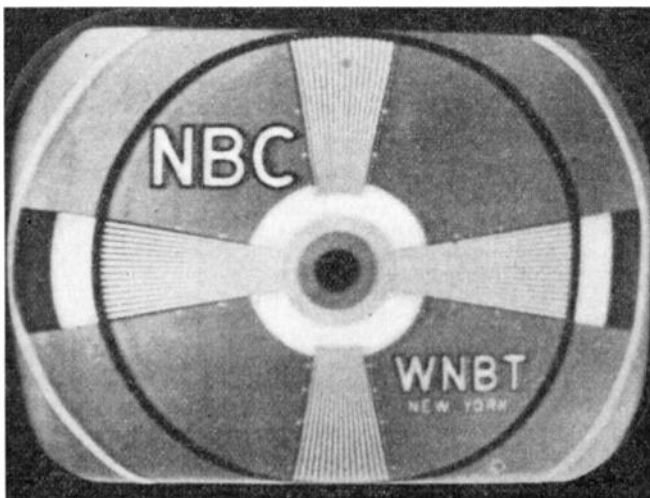

Fig. 5—Same as Fig. 4, except as reproduced on a postwar commercial receiver, using a 7-inch tube and 3-Mc. i.f. bandwidth. Note the lack of interlace, as revealed in the wedges to left and right and incomplete resolution of the top and bottom wedges.

Figs. 4 and 5 show the test pattern as reproduced on typical domestic receivers. It is evident that television

<sup>2</sup> In the discussion at the oral presentation of this paper, it was pointed out that the projected film images showed a degree of resolution, particularly in the sharp edges of the wedge lines at the center of the pattern, which the 4-Mc. bandwidth of commercial television could not hope to reproduce. This represents the 16-mm. film system at its best, i.e., with reversal film exposed and projected in professional equipment. Positive prints projected in amateur equipment display considerably poorer resolution. It is on the latter basis that the comparisons here described are intended.

of the present day *does not* perform nearly so well. But the fact remains that television, on which sufficient effort, inventiveness, and inspiration have been lavished, *can* perform as well without any change in the present standards of operation.

The second portion of the film (a Harvard-Yale football game) was taken entirely with a 1-inch general purpose lens. These amateur shots, not edited in any way, are intended to show that football can be enjoyed without telephoto lenses. They also indicate that a television system which utilizes the present standards does not have to depend on telephoto lenses. The whole area of play, not merely the backfield of one team, is shown, and the play can be followed (Fig. 6).

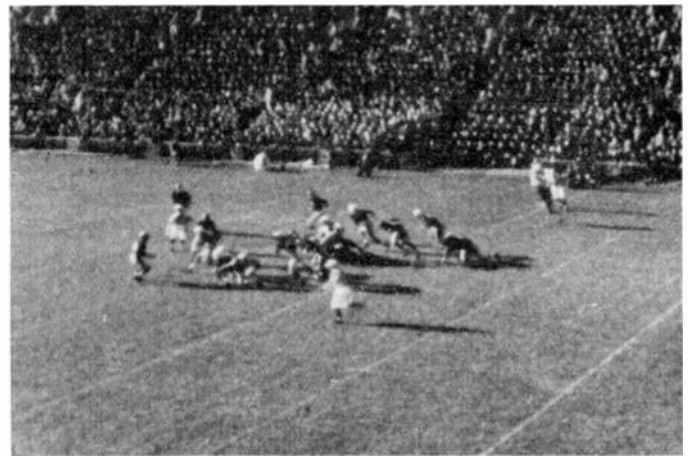

Fig. 6—Football game as reproduced by the 16-mm. system (Plus-X reversal film, 1/30-second exposure at  $f/12$ ).

This is, we believe, clear evidence of the restrictive effect of the present poor quality of outdoor pickups. The viewer of baseball or football on television today is boxed in by the limiting angle of a telephoto lens, because wide-angle shots do not have sufficient detail to pass muster.

Here, again, the conclusion is clear: the 6-Mc. channel will permit a television view of at least half of a football field, in sufficient detail to satisfy the most ardent roter, if the defects of the present-day system are removed as carefully as they have been from the 16-mm. motion-picture system.

The third portion of the film shows a more difficult subject: the fast motion of an ice-hockey game played under artificial illumination (Uline Arena, Washington, D. C., 1944). To cope with the paucity of light, fast film (Super-XX) was used. Its coarse grain is evident in Figs. 7 and 8. Both the general-purpose and telephoto lenses were used, although the crowded condition of the stands prevented the use of a tripod, and the camera action leaves much to be desired.

These views exhibit a degree of detail which, while less than that of the football scenes, exceeds that of the usual image-orthicon television pickup of the present day. The need of the telephoto lens is evident in the

shots of the far end of the arena. The fact that the 1-inch general-purpose lens covers the whole area of the rink as seen from one end, while depicting adequate detail for following the gross aspects of the play, is to the credit of the 16-mm. system.



Fig. 7—Ice hockey as reproduced by the 16-mm. system (Super-XX reversal film, 1-inch lens, 1/30-second,  $f/1.9$ ).



Fig. 8—Same as Fig. 7, except that it is a telephoto shot through a  $2\frac{1}{4}$ -inch lens, at  $f/2.7$ .

In other respects the motion pictures show some of the limitations of present-day television. The available light is marginal in the movie shots. The same light would have produced a longer scale of grays, in all probability, when picked up by an image orthicon. This camera, imperfect as it is in other respects, exceeds Super-XX film in sensitivity to light.

This portion of the film shows, perhaps more clearly than the previous shots, that the 16-mm. system and the television system are not too far apart when fast action must be picked up under artificial light.

The figures, being static, give but a partial indication of the relative quality of the two media. The film must be seen in motion to permit a full comparison. The film, moreover, comprises entirely undistinguished amateur

shots, taken with an excellent camera but otherwise not calculated to excite any particular comment when projected in a living room. But, when we view the film as representing the attainable performance of the present-day monochrome television system, it assumes special significance. The writer urges those readers who have 16-mm. film libraries to review them from this special point of view. A good time to do this is immediately after the evening television program. The urgency of improving the present-day television system is then most evident.

Critical examination of the film reveals three strong points of superiority of the 16-mm. system over comparable television images. These are: (1) superior resolution of detail, (2) freedom from geometric distortions, and (3) superior rendition of tonal values. We shall proceed to trace the causes of television's shortcomings in these respects. We shall discuss first the shortcomings of the pickup and transmitting equipment, since they can be remedied with but trifling cost to the viewing public.

#### RESOLUTION OF PICTURE DETAIL

First, then, is the ability of the transmitter to resolve the fine structure of the image it transmits.<sup>3,4</sup> Here the principal bottleneck is clearly the television camera tube, the iconoscope, and its progeny, the orthicon and image orthicon.

A television transmitter which possesses adequate linearity of phase and uniformity of amplitude response over a bandwidth of 4 Mc. can transmit an image having the pictorial detail of images typical of the 16-mm. amateur motion-picture system, but only if the signal source is a static-image tube, such as the monoscope.

The studio iconoscope, with adequate lighting, does nearly as well in this respect, but the detail of the image, when viewed on a high-performance monitor, is noticeably poorer than the monoscope image. The studio image orthicon is next, and the conventional image orthicon, as used in outside pickups, is a poor third.

That the manufacture of the image orthicon is not under control is all too evident from the variability in performance from one camera to the next in a given outdoor pickup. Certainly the greatest effort must be expended to improve the resolution and uniformity of all classes of camera tubes. It is perhaps unfortunate that only two organizations (or at most three) in the radio industry have sufficient "know-how" to be able to produce this type of tube. Television will be richer when other organizations take up the task of assisting in the improvement of these devices.

Even when a crisp, clear monoscope pattern is used, too many television transmitters now on the air fail to transmit the detail initially present in the video signal

<sup>3</sup> P. C. Goldmark and J. N. Dyer, "Quality in television pictures," *Proc. I.R.E.*, vol. 28, pp. 343-351; August, 1940.

<sup>4</sup> M. W. Baldwin, Jr., "Subjective sharpness of simulated television images," *Proc. I.R.E.*, vol. 28, pp. 458-468; October, 1940.

because of faulty phase or amplitude responses, or because of picture-element displacements caused by noise, hum, or jitter in the synchronizing signals. There is little excuse for this except, perhaps, shortage of trained man power, because the methods of producing adequate circuit responses and stable synchronization are now fully understood. In some quarters of the industry, in fact, the subject of circuit responses has advanced to the point of predistorting the signal to compensate for receiver characteristics purposely made less than ideal for reasons of economy. But the word on these developments has not been carried to all segments of the industry. Nearly all of the television stations now on the air, and more particularly those which have been broadcasting for some years, can profit from a serious study of phase response, amplitude response, and sync stability.

Even if the transmitter offers a signal of excellent inherent detail (Figs. 4 and 9), the detail of the image as reproduced at the fringe of the service area is bound to be degraded because of the inevitable effects of noise. Noise obscures fine detail even in the presence of excellent sync performance (Fig. 10), and at greater distances ultimately destroys the synchronization. Here, also, the remedy is to be found at the transmitter, at least in part. It is certain that 5 kw. of peak power, the value typical of commercial equipment recently installed, will not long continue to meet the needs of the industry. At the risk of offending station owners already overburdened with expense, the writer is impelled to state the case for the 50-kw. transmitter. Such a 10-db increase in power may not greatly increase the service range of the transmitter, particularly in heavily populated areas where

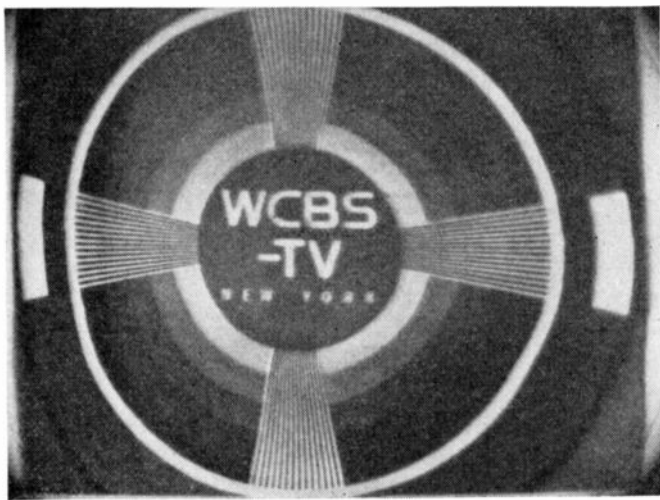

Fig. 9—Test shot to determine the limiting resolution broadcast by station WCBS-TV. The chart has a maximum horizontal resolution of 350 lines, somewhat greater than could be resolved by the 4-Mc. band of the receiver. Detuning was introduced to bring the upper transmitter sideband well within the receiver pass band, thus permitting full 350-line resolution (lower wedge). This indicates that transmitter sidebands extend to about 4.2 Mc. Detuning removed the low frequencies and reversed the tonal values of the image, as in a photographic negative.

mutual interference between stations marks the limit of service, but it will vastly improve the performance of receivers, by reducing the effects of noise, within the existing service areas. Moreover, in competitive areas it is not sufficient for one station to have higher power. *All* must have it. Otherwise, the interference contours will shift to the detriment of the laggards.

#### GEOMETRIC DISTORTION

Second in importance after the poor resolution of the television system is the universal geometric distortion of the images, to which transmitter operators and receiver designers contribute with equal blame. So bad is this condition that television has been termed the "science of the invariant transformation of circles into oblate ovals." The cause of this gross geometric distortion is a lack of linearity in scanning.

This condition, so far as it arises in the transmitter, has little justification on economic grounds. But its elimination requires unremitting care, since every camera has its own deflection system which can introduce geometric distortion incapable of compensation elsewhere in the transmitter. One would image that the test pattern transmitted prior to each program would be picked up by a camera to whose scanning linearity particular attention had been paid. But not so. Today, in New York, after years of competitive broadcasting, if a receiver is adjusted to show a circle on the test pattern of one station, the patterns of the other two stations are found to be egg-shaped (Fig. 11). The nonlinear scanning introduced by outside pickup equipment, so far as can be judged by the distortions observed during panning, is worse than that of the studio and film cameras.

One of the causes of this defect is the tendency of the station engineer to trust a particular monitor equipment as the final judge of such matters. But monitors may introduce compensating geometric distortions of their own. To cure this evil, a technique must be used to examine camera scanning independently of the performance of the monitor. Such a technique was worked out and described six years ago by Duke.<sup>5</sup> But none of the New York stations applies this method as a regular maintenance tool to all cameras in use. Sooner or later, it must be universally adopted. For television cameras are not like microphones. They need steady and careful maintenance, not only in the preamplifier (which is taken seriously) but in the scanning system (which is not).

The broadcasters may well feel that there is little value in spending effort on this problem so long as the scanning linearity of receivers is as poor as it is (Figs. 11 and 12). But this is retrograde thinking. Television receivers of different design and manufacture cannot be compared, competitively, so long as the images, as

<sup>5</sup> V. J. Duke, "A method and equipment for checking television scanning linearity," *RCA Rev.*, vol. 2, pp. 190-202; October, 1941.

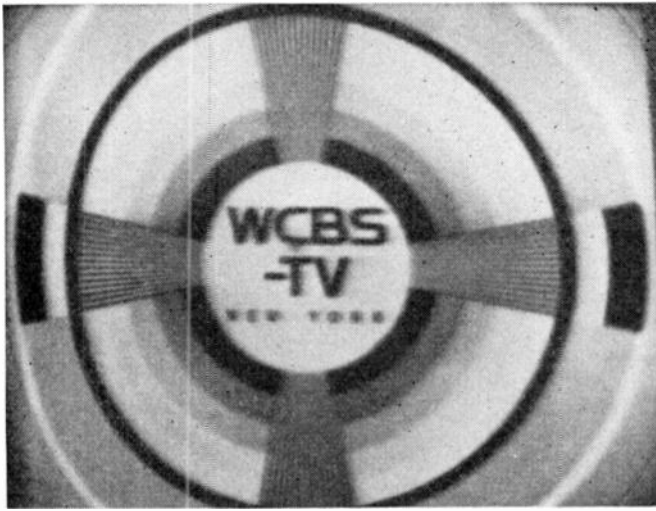

(a)

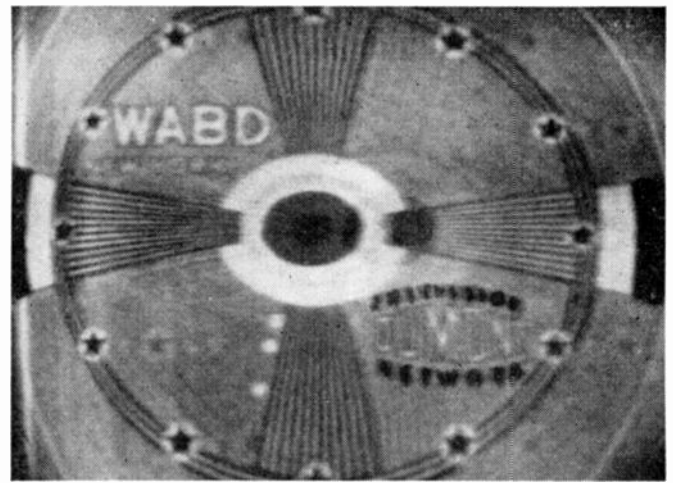

(c)



(b)

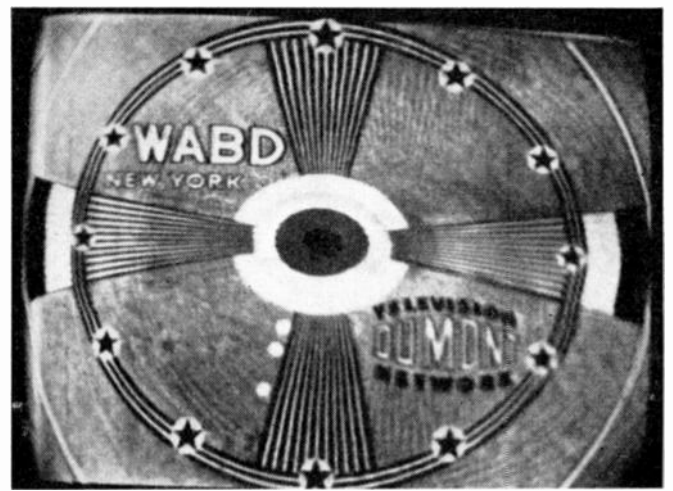

(d)

Fig. 10—Loss of detail caused by noise. To produce this effect, 10 db attenuation was introduced at the antenna terminals and the i.f. gain advanced to compensate for the lower signal level ((a) and (c)). Synchronization remained excellent, but the horizontal resolution was reduced to less than 250 lines. The same patterns without attenuation are shown for comparison. The marked difference in quality is indicative of the improvement to be expected from a 50-kw. transmitter, at marginal receiver locations, relative to the 5-kw. service now rendered ((b) and (d)).

broadcast, exhibit inherent and variable geometric distortion. When every test pattern shows circles as round as those shown on the motion-picture film, and when all cameras, including those used in outside pickups, meet this standard of performance—then, and only then, will the true shapes of chorus girls become a part of the competitive sales talk of the receiver manufacturers. Rumor has it that new techniques are available which will permit this high degree of scanning performance to be achieved in circuits using less tubes, not more tubes, than the number presently required. If this is true, the technique should be widely disseminated and adopted, and at once.

#### RENDITION OF TONAL VALUES

Great progress has been made during recent months in the matter of proper rendition of the tonal range; that is, the scale of grays from black to white. The im-

provement is most evident in the increased contrast range available from the cathode-ray phosphors, particularly those with aluminum backing. A gross contrast range (between large areas of the image) of 100-to-1 (maximum white 100 times as bright as maximum black) has been achieved in production c.r. tubes. This is comparable to the performance of the 16-mm. film and projector demonstrated. Moreover, the maximum brightness of a 750-watt 16-mm. projector, on a picture whose diagonal is 10 inches, is of the order of 40 foot-lamberts, which is about the same as the peak brightness of modern 10-inch television picture tubes. In maximum brightness and gross contrast range, the two systems have roughly the same performance.

But the 16-mm. system has the advantage in two other important respects: the fine-structure contrast, and the rendition of intermediate grays, particularly dark grays in the vicinity of the black level. Further



(a)

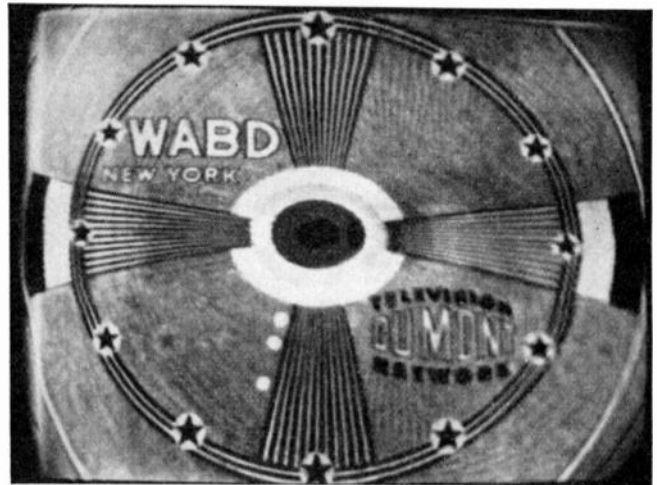

(c)

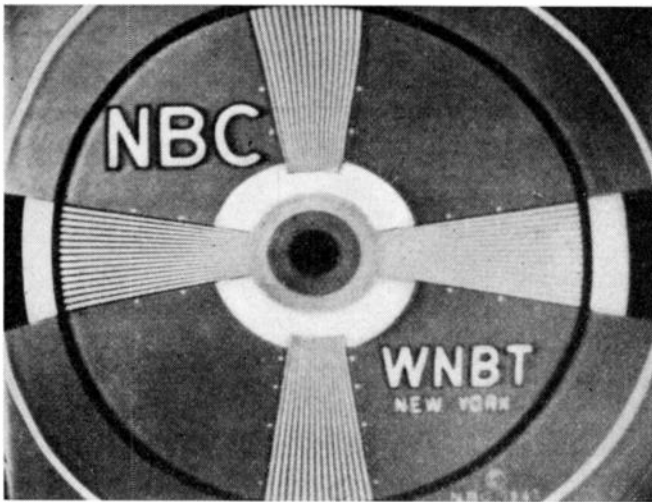

(b)



(d)

Fig. 11—Geometric distortion arising at the transmitter. Patterns of the three New York stations, photographed in rapid succession without adjustment of the receiver scanning circuits, show wide variations in the shape of the outer circle. Variations in the shape of the center circles are also evident. The triple exposure (d) shows the patterns superimposed. Taken from the 12-inch 4-Mc. receiver.

development of cathode-ray tubes is necessary to improve the available contrast between adjacent small areas of the image. This is a matter of primary concern to the receiver designer. The rendition of intermediate grays, particularly in low-key scenes, is a matter requiring attention at the transmitter.

During the projection of the movies of the test pattern the scale of grays at the center of the pattern is evenly delineated, even when the exposure is reduced far below the level required for satisfactory brightness. No television engineer can make that statement about the television images of the present day. The television transfer characteristic (the relation between the brightnesses of portions of the televised subject to the brightnesses of the same portions of the reproduced image, plotted to logarithmic scales) is far from linear in commercial television systems. A good part of the non-linearity arises at the transmitter, and is of a type which

cannot readily be compensated in the receiver.

An important example is the very poor reproduction of low-key scenes in motion pictures. The emotional response evoked by a dramatic performance depends, at critical junctures, on action occurring at night or in semidarkness. On such occasions the television system falls down so badly as to remind the viewer that he is, after all, looking at a television picture, and a poor one at that. A number of shortcomings of the transmitter contribute to this effect. First, the characteristic shading flare of the iconoscope (due to redistribution of secondary electrons) is then most evident, and difficult to remove by shading-correction methods. Second, the black level of the video signal is likely to shift in the direction of white when the scene approaches the black level, and this brings the retrace lines into view. While this effect can be removed by adjustment of the receiver brightness control, this is hardly a function to be trans-



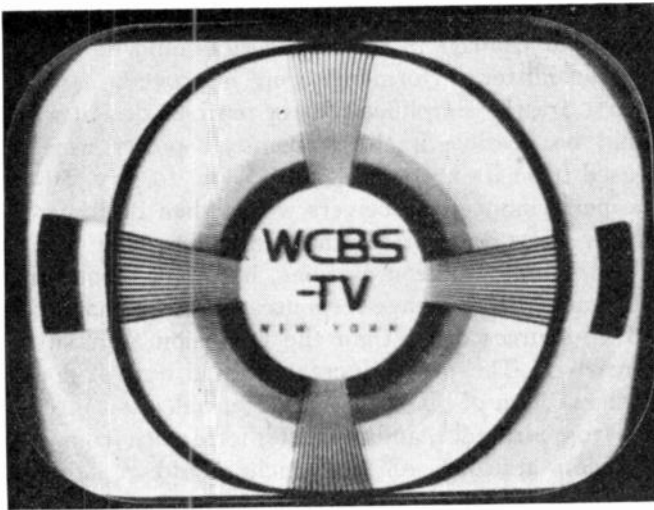

(a)

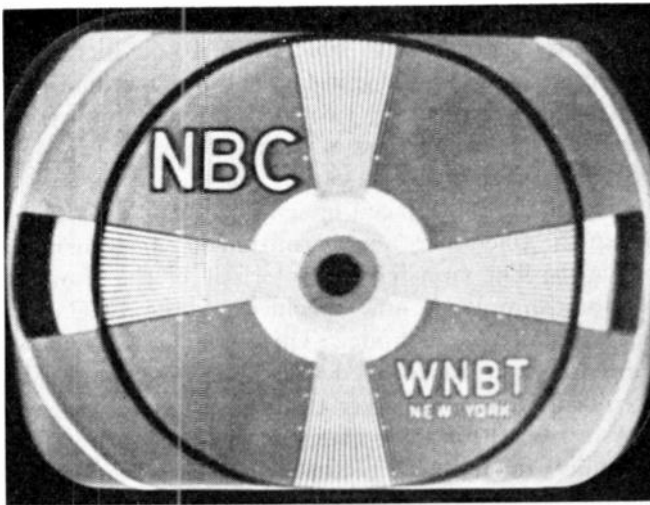

(b)

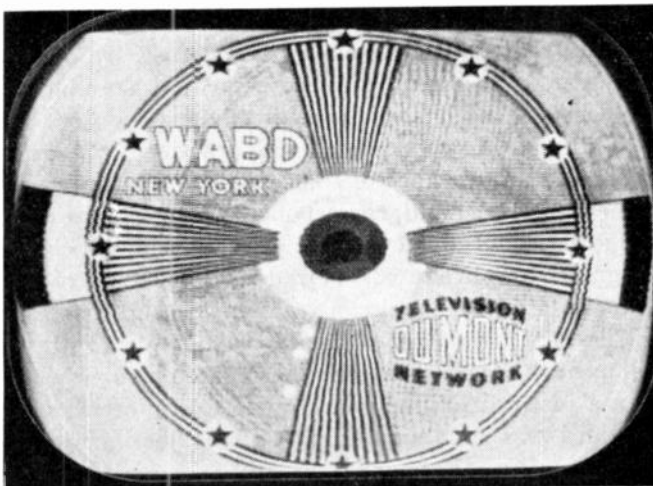

(c)

Fig. 12—Same as Fig. 11, but taken from the 7-inch, 3-Mc. receiver. The difference in scanning linearity between the two receivers is clearly evident. All of the exposures in Figs. 11 and 12 were taken within a 15-minute period on the afternoon of March 8, 1948.

ferred to the viewer. Third, the compression of the near-black tones is often so severe that essential detail of low-key scenes, which would be clearly visible if shown by a movie projector, are entirely absent in the televised reproduction.

The avenues of improvement in these directions are clear. Wider employment of the linear type of picture tube (orthicon or image dissector) will remove the shading difficulties and secure even reproduction of the near-black gray scale. The image dissector deserves wider use than it has enjoyed for motion-picture work. Granted, it requires a great deal of light. But the necessary light can be found for projecting films and slides.

The televising of motion-picture film can be improved in other ways related to the manufacture and processing of the film itself. First, the print stock should have a transfer characteristic (gamma, in photographic parlance) chosen with respect to the transfer characteristic of the television system. Here the photographic industry can be of assistance. Second, the printing and processing of positive stock should be done with great care, particularly if 16-mm. film is used.

The appearance of retrace lines in low-key scenes has even less justification. The RTPB-FCC standards specify a constant black level independent of picture content. For the most part this standard is met, but not in low-key scenes. The reason is that all television transmitters reserve the primary portion of their power capability for transmitting the gray scale, and economize by overdriving the tubes during the short duration of each sync pulse. This is a worth-while procedure, but it permits variable compression of the sync pulse-amplitude in any stage of the transmitter following the final reinsertion of the d.c. component. Hence, when the scene content approaches the black level, the relative amplitude of the sync pulses may change. At the receiver, the d.c. component is reinserted by reference to the peak value of the sync pulses, so the black level must shift when the sync amplitude shifts. The remedy is to radiate a rock-steady black level with respect to the peak of the sync pulses. Of considerable assistance in maintaining constant black level is the use of d.c. reinsertion by clamping the sync pedestal ("back porch" of the video wave form), rather than the peak of the sync pulses. This requires a two-tube clamping circuit and a pulse transformer, the cost of which is negligibly greater than the diode restorers widely used today. Only five of the fifteen transmitters now in operation (November, 1947) employ the back-porch clamper, simple and inexpensive as it is. These five stations produce a superior result, in this respect, in every receiver tuned to them. The way is open to the other ten stations and to the many other stations now preparing to take the air.

The transfer characteristic, throughout its range from black to white, deserves attention at the transmitter. Transfer-characteristic control amplifiers (capable of compressing or extending the tonal range) have been

brought to a high stage of perfection in color-television research. The techniques are available, but they are not applied to any extent to commercial monochrome transmission.

#### CONTINUITY OF SYNCHRONIZATION

One final aspect of transmitter operation deserving attention is the continuity of the vertical and horizontal synchronization signals. At present, on many, if not all, stations, when the program is switched from the local studio to a pickup at a remote point, the synchronization signals are interrupted during the instant of switching, since the two sync generators, one at the studio and the other at the remote pickup, are not in step. To avoid the adverse effects of this discontinuity on the image at the receiver, the scene is dimmed down to black several seconds prior to the switch and brightened several seconds later.

This interruption to the program is a source of annoyance to sponsors of sports programs and other outside pickups who do not want a blank screen to precede the commercial announcement of their product. Another objection to the practice is the fact that such interruptions to the sync signals have an inhibiting effect on the receiver designer. The automatic-frequency-control type of synchronization circuit used in receivers is presently applied only to the horizontal synchronization system. It could be applied, admittedly at extra cost, to the vertical system, as well, but the effect would be to prolong excessively the out-of-sync condition whenever a discontinuity occurred in the transmitted sync signal. For this, among other reasons, the vertical sync system of receivers has remained without benefit of the virtues of the a.f.c. circuit.

Techniques are already available to cure this trouble at the transmitter. The sync generator at the remote pickup is established as the master sync control for the whole duration of the program originating at that point, and the sync generator at the studio is brought into step, in exact phase at each line and field pulse, with the remote generator by rotating a continuously variable phase shifter in the sine-wave source of the studio generator. This process may be carried out continuously and automatically, or it may be accomplished manually prior to each scheduled local-remote switch.

The foregoing discussion treats several of the more important problems at the television transmitter, imperfectly solved as of the present, but capable of solution in the not-too-distant future. The solutions are not always inexpensive. But in view of the public investment in receivers (about 100 million dollars at present), money spent on them is the soundest possible economy.

#### IMPROVEMENTS IN RECEIVERS

We turn now to the improvement of receivers, and consider what changes are advisable to reduce their

cost and improve their performance. First, let us consider what changes in receiver design could be made if the transmitter performance were improved.

First are the simplifications in receiver design which would be possible if the transmitter power were increased from its present level of 5 kw. to, say, 50 kw. The performance of receivers would then be improved against noise and interference, including that created by automobile ignition systems, harmonics from amateur transmitters, image responses to f.m. transmitters, and all sources other than the television transmitters themselves. The power increase would not, of course, rid the system of ghost interference, reflection interference from airplanes, and mutual interference from other television stations, all of which would remain unchanged.

Higher field strengths would reduce the cost of the i.f. amplifiers of receivers, or permit wider bandwidth to be used without increasing the present costs. Higher field strengths would also permit simpler synchronizing circuits to be used with success. A 10-db increase in transmitter power would, in fact, permit a reduction of the tube complement by two to six tubes in many current designs, without loss of quality.

Second, receiver design can be made simpler, and the quality of the reproduced image improved, by tightening up the tolerances now permitted in the transmitter standards. The transfer characteristic of the transmitter, for example, is now specified by the FCC to be "substantially logarithmic." This standard is so loosely worded that it has proved difficult, if not impossible, to co-ordinate the receiver transfer characteristic with it. As a result, too little attention has been paid to the dynamic properties of picture-tube electron guns and phosphors, second detectors, and video amplifiers. If this transmitter standard were tightened, at least to the extent of specifying a region within which the logarithmic characteristic would be found, a worth-while improvement in receiver performance would become possible and practical, without increased cost.

Similarly, the amplitude transmission standard of television transmitters is now too loosely worded. The FCC standard of good engineering practice now permits an amplitude tolerance of some 12 db at the upper end of the upper sideband, corresponding to the finest detail of the reproduced picture. It is obviously difficult to design the amplitude versus frequency response of a receiver to produce equal contrast for fine and coarse detail, if the transmitter response may droop 12 db and still meet the requirements for a license. There may have been a justification for such a wide tolerance when the standard was first written. If so, the justification no longer applies. There are too many expensive receivers in the hands of the public to justify any other than the best signal of which the art is capable. If permitted at all, the amplitude droop should be *uniform* in all transmitters.

Narrower tolerances in the blanking (retrace) times of the standard scanning pattern are also in order. At present the FCC standards allow a variation in vertical blanking time of the transmitted image of approximately 3 per cent. The receiver designer must arrange to complete the retrace in his receiver in time to accommodate the fastest retrace among the available transmissions. If the transmitter operator chooses to adjust his equipment to the opposite end of the tolerance range, the vertical dimension of the received image is 3 per cent too small. The geometric distortion thus introduced can be removed if the receiver operator adjusts the vertical scanning amplitude, but this is adjustable, in commercial sets, only by a screw-driver adjustment at the rear of the cabinet. A similar situation exists in the horizontal blanking time. Although the FCC tolerance is reasonably narrow in this respect, many stations are not too strict in their observance of it.

If the blanking tolerances were tightened, and enforced, the reproduced picture would just fill the screen, horizontally and vertically, on all pickups from all stations. Moreover, such narrowing of the tolerances would improve the linearity of scanning, which could be more easily adjusted to optimum at the fixed value of scanning amplitude which would then suffice.

Still another matter requiring stricter co-ordination between transmitter and receiver is the d.c. restoration problem. Receivers differ widely in the rigidity with which their d.c. restorers hold to the sync-peak level. There appears to be a tendency among transmitter operators to adjust brightness levels to compensate for the shortcomings of the receiver types in widest circulation among the public. This may be a good procedure, but it should not be haphazardly applied. A standard level-compensation characteristic might be drawn up in accordance with the joint recommendations of the transmitter and receiver specialists, and widely published, so that receiver designers will know what to expect.

A closely related problem is that of high-frequency and low-frequency predistortion at the transmitter to compensate for shortcomings of the receiver amplitude and phase characteristics. Predistortion requires careful study to determine the best compromise, and the adopted form should receive the status of an industry standard, promulgated by joint agreement of transmitter and receiver designers.

There are several improvements which might be considered by receiver designers which are independent of transmitter performance. One is the use of higher intermediate frequencies for picture and sound signals. Sufficient difficulty has been experienced with the standard values of 21.25 Mc. for the sound and 25.75 Mc. for the picture, with respect to image responses and local-oscillator radiation, to justify serious consideration of values above 30 Mc., which would improve per-

formance in both respects without increase in cost.

Scanning linearity should also be improved. Tests of a large number of receivers have shown that nearly all of them *can* be adjusted to have nonlinearity not greater than 5 per cent (in any 10 per cent area of the reproduced image, not more than 5 per cent deviation from the average). This is excellent performance. But few receivers maintain this degree of linearity over extended periods of time, as tubes and other components age. Compensation, perhaps of the feedback type, might well be introduced, at moderate cost.

Finally, there are a number of changes in receivers which can be introduced without increased cost only if considerable ingenuity is brought to bear. Among these are:

1. Larger picture size with adequate brightness.
2. More-stable synchronization circuits, especially to give greater freedom from tearout due to ignition interference.
3. Higher gain and lower input noise in the picture channel.
4. Lower radiation from the local oscillator (by methods in addition to the use of higher intermediate frequencies).
5. More stable tuning; elimination of the fine tuning control.
6. Greater stability in all aspects of receiver performance now adjusted by screw-driver controls. These adjustments cannot be made by the untutored owner of the receiver. Unless trained service technicians are available (and they are not sufficient even to keep up with installations at present), the picture is apt to undergo a steady deterioration from this cause.
7. The widest possible bandwidth in the picture i.f. channel consistent with necessary selectivity. This means a sharp cutoff at 4 Mc., with accompanying phase distortion, but this can be compensated by standardized predistortion at the transmitter.

#### CONCLUSION

In conclusion, the writer wishes to correct any impression this paper may give that television engineers have failed to provide a service adequate for public consumption. On the contrary, an adequate and creditable job has been done in nearly every quarter of the industry, sufficient to support the service in its initial period of use. The extraordinary public acceptance is full proof of this. In no other quarter of the industry, in fact, has so good a job been done of co-ordinating the work of standardization. But television is, and perhaps always must remain, a technical tour de force. As such, it requires sustained effort to improve its performance. It is hoped that this outline of the possibilities of improvement will assist in channeling future technical work along constructive lines.

# Electronic Instrumentation for Underwater Ordnance Development and Evaluation\*

RALPH D. BENNETT†, SENIOR MEMBER, I.R.E.

*Summary*—An important difference between the underwater weapons of World War II and their predecessors was the use of electronic devices both in the weapons and in the techniques for their development and evaluation. Some of these techniques have now been made available, of which four are described; namely: (1) a recording accelerometer which gives the time-acceleration curve for a missile dropped at high speed into the water; (2) acoustic instrumentation used in the ranging of torpedoes; (3) a system for recording very low-frequency acoustic waves; and (4) a system for telemetering back information from a free weapon operating under water.

## INTRODUCTION

THE USE OF ORDNANCE under water is an art almost as old as gun powder itself. Torpedoes, in the form of charges brought near the hull of a ship and fired by simple mechanical or electrical means, have long been a serious threat to shipping in time of war. Advancing technology made possible the automobile torpedo, a device to which the term "torpedo" is almost universally applied today. This weapon has proved to be ideal for the submarine, and has been very dangerous to surface ships in both World Wars. The nonautomobile "torpedo," now called a mine, has also played an important role in both wars. Further, the success of the submarine led to the development of various antisubmarine weapons; generally called "depth charges" because the "pistol" with which they were originally equipped fired at preset depth. This device has been the principal anti-submarine weapon, although toward the end of World War II it began to be displaced by other more versatile devices.

An examination of the differences between the World War I and World War II models of underwater weapons shows that the most striking and perhaps the most important advance lies in the application of electronic devices. The use of the electron-tube amplifier has made it possible enormously to increase the delicacy of the signal by which these weapons can be fired. It has, in fact, made possible their actuation at a distance from the target by the use of influence fields. We now have mines which fire whenever a ship approaches within the range of lethal damage. These mines can also be made selective to the extent of firing only under large ships, or only under small ships, or under special kinds of ships such as minesweepers. They can be made to fire only after a certain date, and before another date, and, if necessary, only in the dark of the moon. Thanks to electronics, we also have both torpedoes and depth charges which will fire at the point of closest approach to their targets.

\* Decimal classification: R565. Original manuscript received by the Institute, December 29, 1947. Presented, I.R.E. West Coast Convention, San Francisco, Calif., September, 1947.  
† Naval Ordnance Laboratory, White Oak, Md.

The use of influence fields in underwater weapons has made it necessary to measure many properties of the weapons themselves, the targets which they are designed to attack, and the sea which serves as the medium in which they operate. These measurements, up to the present, have involved the determination of the magnetic properties of ships in the earth's field under many conditions of latitude, heading, and depth; the acoustic field radiated by ships under different conditions of loading and speed; and even the electric fields generated by the dissimilar underwater metal parts of ships. Almost all of these measurements have involved the use of electronic devices. There follow descriptions of four which were developed by the Naval Ordnance Laboratory for the measurement of these fields or for use in the development of weapons.

## THE LOW-FREQUENCY ACOUSTIC SYSTEM

When we began to measure the acoustic fields of ships we found very substantial sound outputs over a frequency range from zero to at least 2 Mc., and probably well beyond. Equipment was available for measuring this output in much of the range from 100 to about 25,000 c.p.s., but for frequencies outside this region it was necessary to develop our own gear. The Low-Frequency Acoustic System was designed to measure sound waves in the 0- to 100-c.p.s. range. While we were able to construct a hydrophone which would cover this range for purposes of recording it was necessary to break the range into two parts; namely, from 0 to 1 c.p.s., and from 1 to 100 c.p.s.

The principle of operation of the hydrophone is shown in Fig. 1. The armature is coupled to the sea by means of

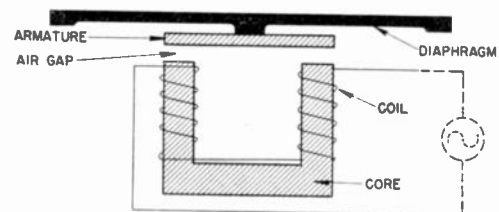

Fig. 1—Diagram showing the principle of operation of the low-frequency hydrophone.

a diaphragm which must be rigid enough to withstand the hydrostatic pressures encountered down to about 120 feet, and yet must be flexible enough to yield appreciably to the impact of underwater sound waves. The diaphragm carries an armature made up of permalloy strips which is held opposite a C-shaped core, on each leg of which is a coil. The apparent inductance of the coil varies as the air-gap is varied by the motion of the armature resulting from the sound waves impinging on

the diaphragm. The hydrophone, as it was eventually constructed, was provided with a heavy bronze case equipped with suitable handling eyes, waterproof cable glands, and other necessary accessories. It is approximately 10 inches in diameter.

The inductance of the hydrophone is measured by means of a bridge. The hydrophone coils can be wound to an impedance which matches the connecting cable, and the cable can in turn be coupled into the measuring bridge by a suitable transformer. In operation, the bridge is excited by a 1000-c.p.s. source and the apparent inductance of the hydrophone and cable assembly is nearly, but not quite, balanced by an adjustable capacitor. Exact reactance balance is avoided, since this would yield a double-frequency output from the bridge. Off-resonance operation reproduces the input frequency faithfully in the modulated output of the bridge. The operation of the system may be considered under the impact of a sound wave containing components at  $\frac{1}{2}$  and at 10 c.p.s. The bridge output wave with such an input is a 1000-c.p.s. carrier modulated by both  $\frac{1}{2}$ - and 10-c.p.s. components. Fig. 2 is a block diagram of the

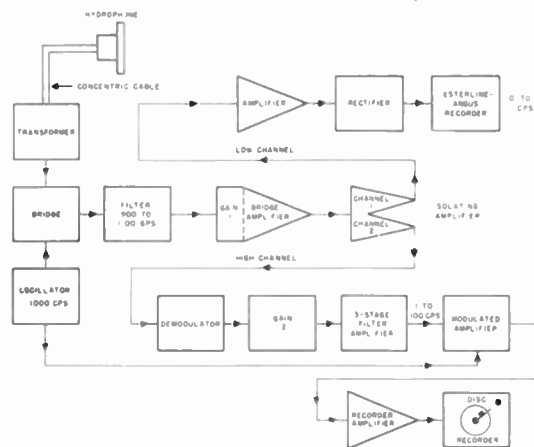

Fig. 2—Block diagram of the low-frequency system.

whole system, the bridge output going initially through a band-pass filter which eliminates frequencies below 900 and above 1100 c.p.s. The output is then amplified and feeds two channels, the upper in Fig. 2 arranged to record the frequencies below 1 c.p.s., and the lower to record the frequencies between 1 and 100 c.p.s. In the 0- to 1-c.p.s. channel the signal is amplified to a suitable level, rectified, and fed directly into an Esterline-Angus recorder of such characteristics that it filters out everything above 2 c.p.s. The recorder traces directly a curve of the output in the low-frequency band.

The high-frequency channel receives the same output from the bridge, which it first demodulates, removing the 1000-c.p.s. component. The demodulated signal is fed through a three-stage filter amplifier, which by means of *R-C* coupling removes everything below 1 c.p.s., leaving only the 10-c.p.s. wave. This is fed to a modulated amplifier, modulated by the original 1000-c.p.s. oscillator. The output of this amplifier contains

the 1000-c.p.s. carrier modulated at 10 c.p.s., which, in this particular example, yields two frequencies of 990 and 1010 c.p.s. This output can be recorded on ordinary disks.

By these two channels the system can measure and record underwater sound over the whole range from 0 to 100 c.p.s. Measurements made with it demonstrated very early in World War II that, from the point of view of localization about a ship and difficulty of reproduction for purposes of sweeping, frequencies below 1 c.p.s. were more useful offensively than any other part of the whole acoustic band. Mines developed on this basis proved baffling to the enemy, and made possible the thorough-going mine blockade of Japan. The system has been used in many other applications, particularly in seismological and microbarographic measurements.

### UNDERWATER RADIO TELEMETERING

The use of complicated electronic gear in depth charges made it essential that some means be provided for indicating the performance of the various internal circuits at different stages of the depth-charge trajectory. Cables attached to the charge under measurement

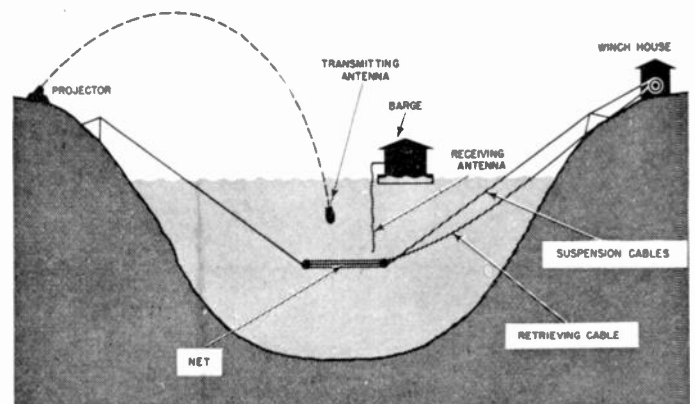

Fig. 3—Arrangement for testing depth charges.

for bringing out this information could not be used, because any cable arrangement that could be devised interfered with the free fall of the charge. Fig. 3 shows, diagrammatically, the arrangement for testing certain types of depth charges. The projector is mounted on the bank of a deep lake, which is provided with a recovery net for retrieving the charges. The charge under test is equipped with a suitable radio transmitter, and a receiving antenna is hung into the water from a barge located adjacent to the target. The transmitter is of the frequency-modulated type, powered by batteries, and placed in space ordinarily occupied by explosive components. It is arranged so that it can be started just before the charge is launched, and is connected into various circuits of the depth-charge firing mechanism so that its output frequency will indicate such things as the moment of arming, effect of water impact, firing time, or other property which may be under investigation. The transmitter is of a conventional type operating at 2 Mc.

The receiving equipment located on the barge consists of an a.m. receiver, converted for narrow-band f.m. reception.

Fig. 4 is a reproduction of a record of the response of a firing circuit in a typical test. Starting at the upper left is shown, first, the three calibration steps; next, the firing indications induced manually in the mechanism under test before launching; then, the launching, the disturbance when the charge strikes the water, the closing of the filament circuits, the closing of the plate circuit, the "noise" background as the charge falls through the water, and finally the signal when and after the charge strikes the recovery net. This system was developed some time ago, and while more elaborate systems, having many channels, are now common, those of the radio type operating under water are not frequently encountered. In a fresh-water lake there was no difficulty in getting ranges up to 300 feet with a transmitter output of less than 1 watt. The system would not operate so well in salt water, where the conductivity is about a thousand times higher.

#### RECORDING ACCELEROMETER

World War II saw the introduction of aircraft-laid ground mines of the influence type. The influence feature made it necessary to include in the firing device electronic gear which was sometimes delicate and complex. Nevertheless, this equipment had to stand the shock of aircraft laying. Fig. 5 shows an aircraft-laid in-

fluence mine being dropped into the sea from an airplane flying at low altitude.

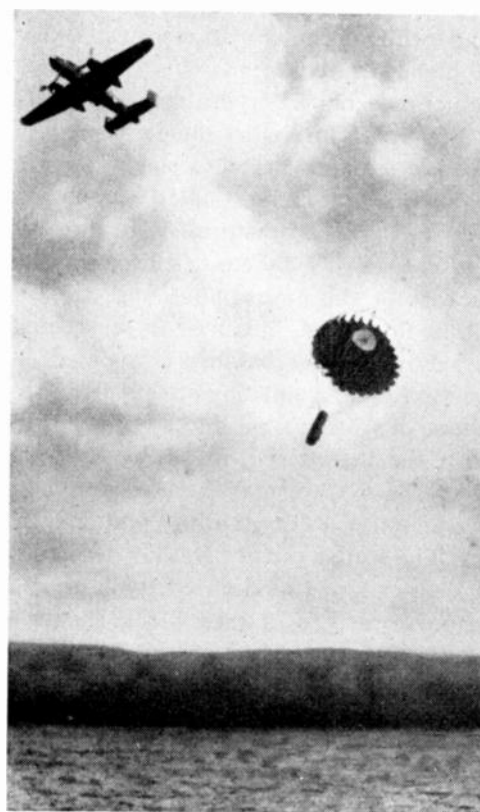

Fig. 5—Influence mine being laid by aircraft.

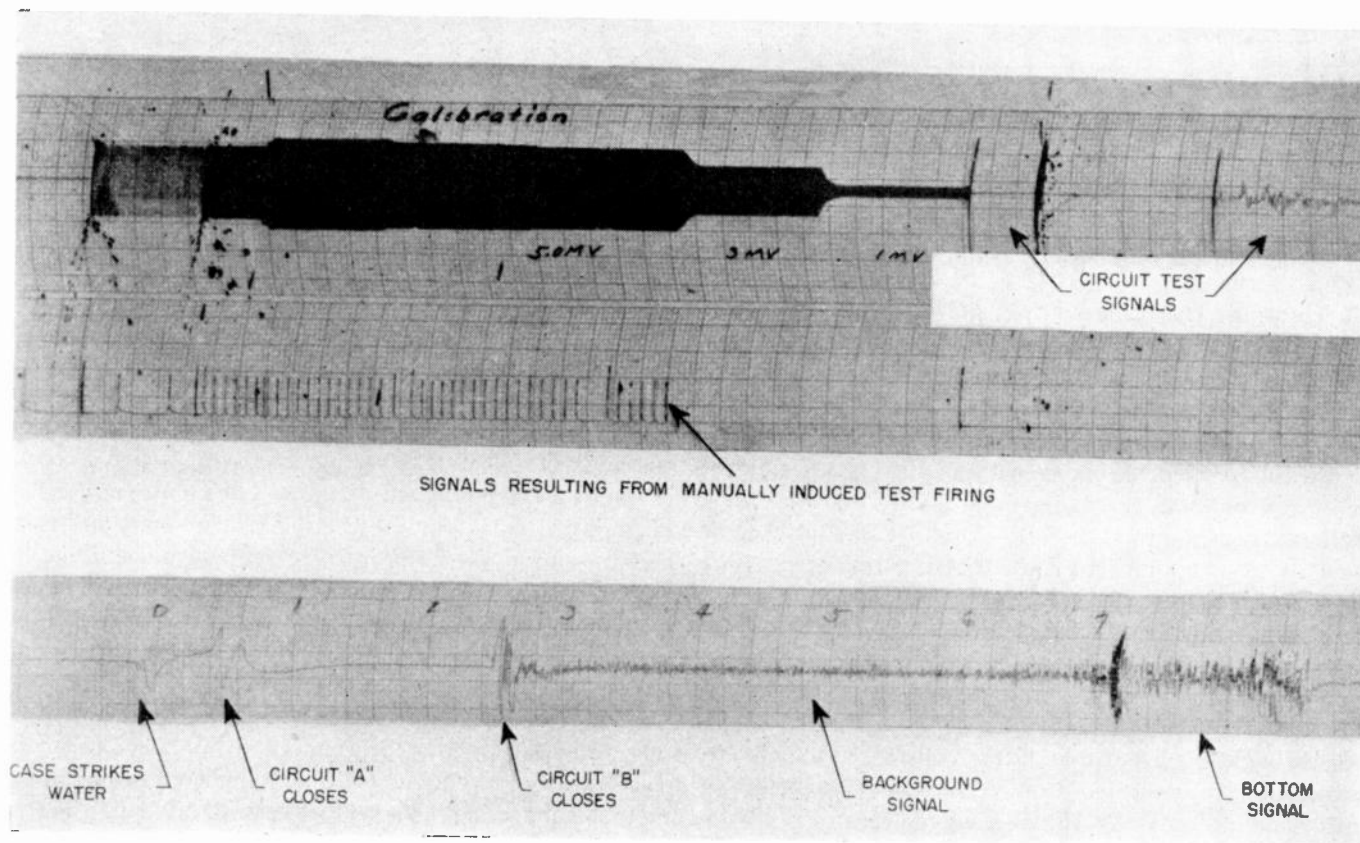

Fig. 4—Underwater radio telemetering record of a depth-charge launching test.

It soon became evident in the development of these electronic firing devices that to test each of many models by actual dropping would be a far-too-expensive and time-consuming process. Therefore, equipment was developed to measure the mechanical shock encountered by the gear when installed in a typical mine. Once these measurements were available, the shock could be duplicated in the laboratory and the development and test procedure greatly expedited.

In order to measure these shocks, the piezoelectric accelerometer shown in Fig. 6 was developed, together

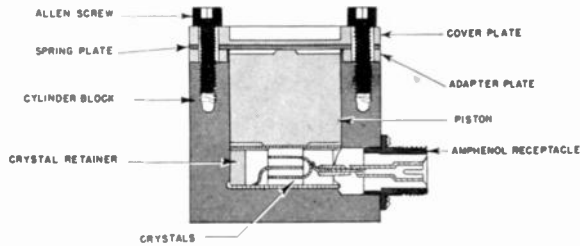

Fig. 6—Cross section of a piezoelectric accelerometer.

with suitable cathode-ray recording equipment. The accelerometer consists of a stack of quartz plates provided with terminals and placed under a spring-loaded piston in a substantial steel frame. This accelerometer could be bolted into the mine at the point where it was desired to measure the acceleration, and gave accurate response over a fairly wide range of accelerations. A record of the acceleration was made by means of a cathode-ray tube, whose deflecting plates were excited directly from the crystal. The trace was photographed on a moving film driven by an electric motor, the image being focused by an arrangement of mirrors and lenses. This equipment was made up both in single-channel units and in three-channel units, the latter for measuring simultaneously accelerations in three mutually perpendicular directions.

The various parts of the accelerometer were mounted in the mechanism chamber of the mine case, as shown in Fig. 7. This assembly, in several units, simplifies the

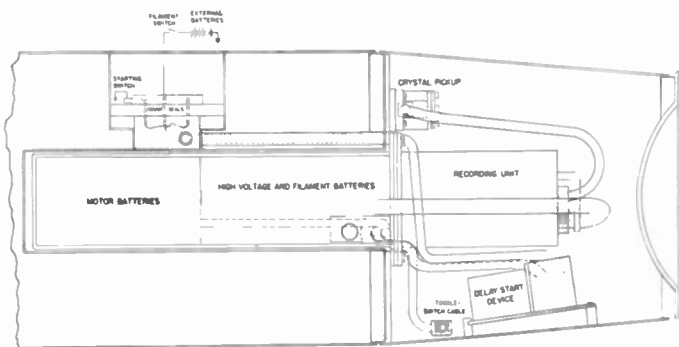

Fig. 7—Diagram showing mounting of an accelerometer in a mine case.

placing of the equipment in the limited space available in the case. The recording accelerometer proved serviceable for accelerations up to about 150g, and it was necessary to build all the components very substantially to

make sure that the measurements were not vitiated by deflections of various members or parts.

ACOUSTIC TORPEDO RANGE

Torpedoes are proofed by trials runs over a test range. Steam torpedoes leave a substantial wake, and their depth at any point on the range can be determined approximately from the time of rise of bubbles in the wake. Speed can be measured by the difference in time of appearance of these bubbles at two points on the range. The advent of electrically driven torpedoes which leave no wake created an urgent need for a new method of measuring torpedo speed, depth, and course. The problem was put to the Naval Ordnance Laboratory, which, with the help of a number of industrial contractors, reached a satisfactory solution.

Torpedo propellers are small for the amount of power they absorb, and they cavitate and produce tremendously large outputs of sound over a very wide frequency range. The use of this sound for actuating directional hydrophones supplies the principle on which the new type of range is based. The primary instrument is a long, thin hydrophone comprising a row of twenty-four 1-inch-square Rochelle-salt crystals, arranged with their electrodes connected in parallel and all oriented in the same plane. The crystals are enclosed in a rubber tube filled with castor oil, with the whole suitably supported for mounting on piles driven into the sea bottom. This long, thin hydrophone has a rather sharply defined sensitivity pattern, whose maximum lies in a plane perpendicular to the axis of the hydrophone, and covers a rather narrow angle as indicated in Fig. 8. This sensi-

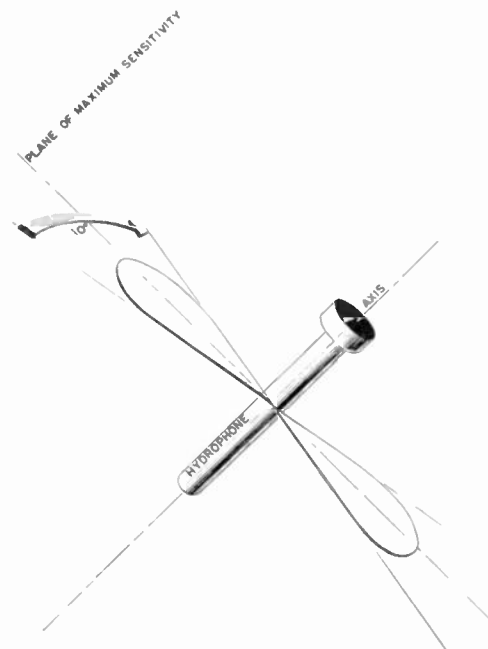

Fig. 8—Field pattern of the directional hydrophone.

tivity pattern makes it possible to determine, with considerable accuracy, when a propeller passes through its plane of maximum response.

Fig. 9 is a plan view of the arrangement of these hydrophones for measuring speed and course of a torpedo. Two sets of hydrophones are mounted in pairs on piles, the axis of one set being parallel to the line of fire of the torpedo, and those of the other having their axis shifted 45° to the line of fire. The members of each set are paralleled and connected to amplifiers and a recorder. One set deflects the recorder pen to the right whenever a member of the set receives a signal, and the other set causes left deflections. Thus, the passage of a torpedo down the range produces a record shown schematically at the bottom of Fig. 9. The displacement between two successive opposite signals gives a measure of the distance of the torpedo course from the line of hydrophones, and the displacement between any two successive similar signals

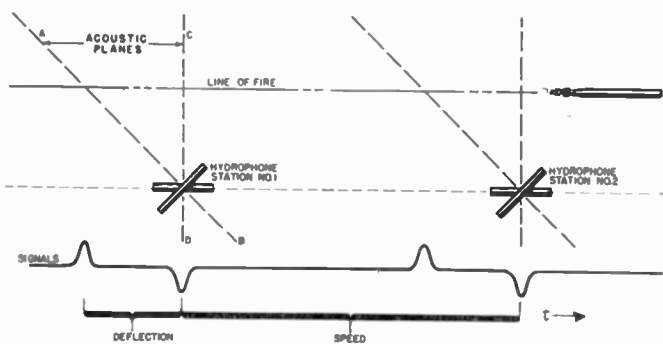

Fig. 9—Plan of arrangement of directional hydrophones for measuring the speed of a torpedo and the lateral position of its course.

gives a measure of the time between the passage of two marker piles. If the distance between the piles is accurately known, the speed of the torpedo can be accurately calculated. Fig. 10 shows an actual record made on the range. A similar geometrical arrangement can be

used for measuring the height of the course of a torpedo above a pair of hydrophones.

Fig. 11 is a schematic diagram of the range at the Naval Torpedo Station, Newport. Starting from the

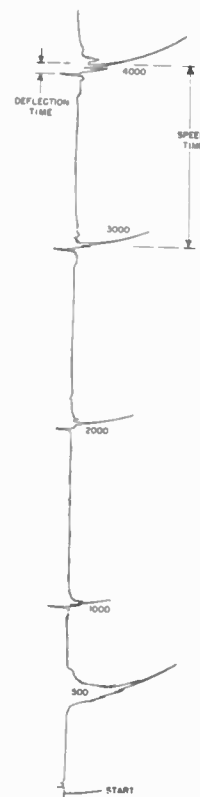

Fig. 10—Record of torpedo passage down the range.

launching pier, the range extends 10,000 yards up Narragansett Bay, and piles carrying hydrophones were located at each 1000-yard mark. In addition, there is a "zero" hydrophone for indicating the instant the tor-

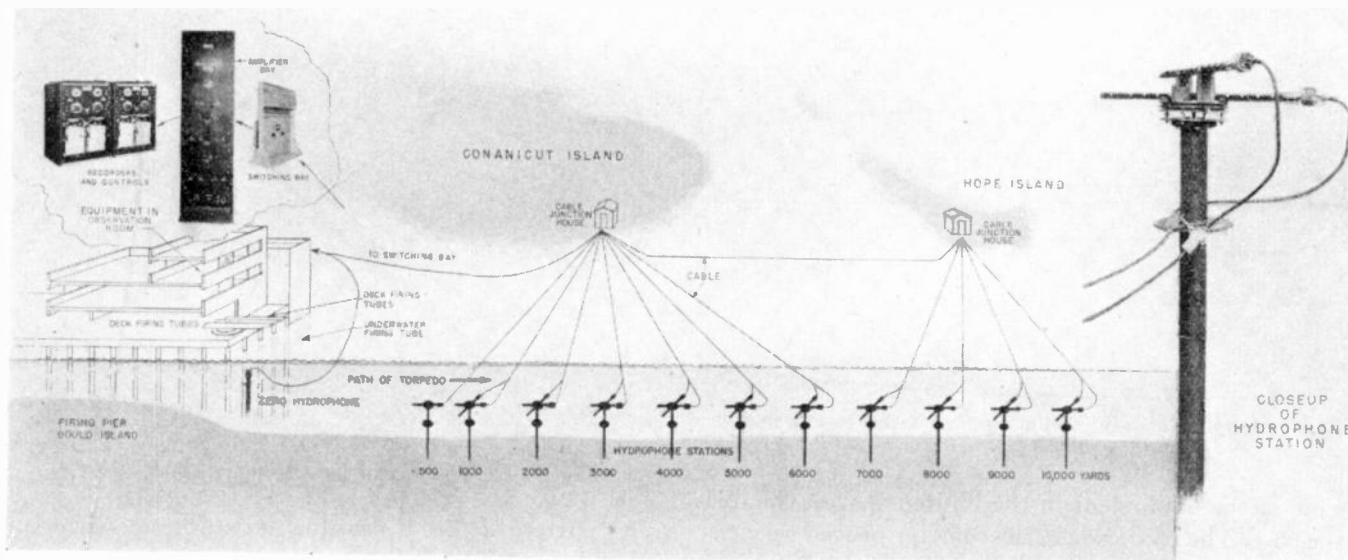

Fig. 11—Schematic diagram of hydrophone layout on a torpedo range.



pedo hits the water, and a 500-yard hydrophone arranged only to detect the passage of the torpedo under test. The hydrophones are connected by a rather elaborate cable system through suitable junction houses to the electronic and recording equipment on the firing pier. The diagram at the right of Fig. 11 shows a typical pile with the flange to locate it with respect to the bottom, clamps to relieve the hydrophones of cable strain, and the various leveling and orienting screws necessary to give accurate direction to the hydrophones. This range is also equipped with a depth-measuring pair of hydrophones at the 1000-yard marker (not shown in Fig. 11). With experienced operators, four or five torpedoes may be ranged simultaneously. The range serves equally well for steam torpedoes, and has displaced the older and less accurate bubble method.

The introduction of electronic devices in the field of underwater ordnance has presented many problems to the designer. At the same time it has provided the means of solution of many of these problems, as indicated in the four examples cited above. But beyond this, the availability of electronic devices has revolutionized the art and practice of underwater ordnance. The modern mine, torpedo, and depth charge are many times more effective than their predecessors, which lacked the versatility and sensitiveness provided by electronic devices. Developments in this direction are continuing, and the possibilities of underwater ordnance which takes full advantage of electronic devices now available are sufficiently great to cause grave concern to any nation which hopes to retain control of the sea during war-time.

## Adjustment Speed of Automatic-Volume-Control Systems\*

A. W. NOLLE†

**Summary**—The behavior of an a.v.c. amplifier, following a sudden change of input level, is analyzed on the basis of the following assumptions, which are justified in the case of many practical a.v.c. amplifiers: (1) the open-circuit voltage developed by the rectifier is a linear function of the decibel output level of the amplifier; (2) the decibel gain reduction in the controlled stages is a linear function of the gain-control voltage; (3) only one resistance-capacitance filter section is important in delaying delivery of the rectifier output voltage to the gain-control points. It is shown that the last condition is desirable from the standpoint of stability. The analysis shows that, following a sudden change of input level, the fraction  $(1 - 1/e)$  of the decibel gain change required to reach a new equilibrium occurs in  $(RC)/M$

seconds.  $RC$  is the time constant of the filter section specified in assumption (3), while  $M$ , a dimensionless "flatness factor," is defined as the decibel change of input level required to produce a 1-db change of output level, under equilibrium conditions. Further,  $M = 1 + K_1 K_2$ , where  $K_1$  is the rectifier voltage increase per db increase of amplifier output, and  $K_2$  is the db gain reduction per volt of control. If the change of input level is sufficient in magnitude to cause amplifier overload (or "underload"—stoppage of rectifier action), the control voltage changes with the time constant  $RC$  until the overload disappears. Overload may greatly increase the time required for gain readjustment. Equations for the overload case are developed and their application to a particular amplifier is illustrated.

### INTRODUCTION

AN AMPLIFIER with automatic volume control is frequently used under circumstances demanding a knowledge of the rate at which the gain-control system will adjust itself to changes of input level. This knowledge is of some concern in the design of radio receivers and is of particular interest in certain other applications of a.v.c. circuits. For example, an a.v.c. amplifier is sometimes used as an approximate logarithmic indicator, an application which is made possible because the grid cutoff characteristics of amplifier tubes give rise in the a.v.c. system to an approximate logarithmic relation between a.v.c. and input voltages. But practical limitations of design require that filtering

be present in the control circuits, with the result that the gain-control system can not reach equilibrium immediately when the input level is changed. It is then important that the speed with which the control system approaches equilibrium be known, in order that misleading results will not be obtained in an attempt to read signal fluctuations which are too rapid for the amplifier to follow. It is the purpose of this paper to derive and illustrate the use of relations which permit calculation of the speed of adjustment of a.v.c. systems.

### BASIC CIRCUIT AND ASSUMPTIONS

The circuit of the a.v.c. amplifier is easily analyzed from a mathematical standpoint when one considers the simplified block circuit diagram shown in Fig. 1.

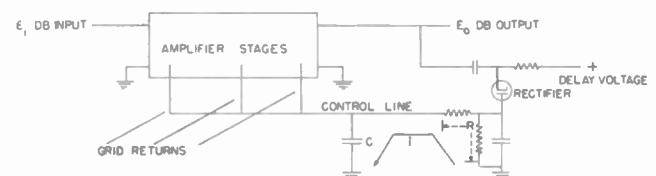

Fig. 1—Simplified a.v.c. circuit for analysis.

\* Decimal classification: R361.201. Original manuscript received by the Institute, November 20, 1947. This paper is based on work performed by the author when at the Harvard University Underwater Sound Laboratory, operated under contract with the Office of Scientific Research and Development, and at the Pennsylvania State College Ordnance Research Laboratory, operated under the auspices of the Bureau of Ordnance, Navy Department.

† Formerly, Acoustics Laboratory, Massachusetts Institute of Technology, Cambridge, Mass.; now, University of Texas, Austin, Texas.

Fortunately, a.v.c. amplifiers which are designed for stiff control (good "flatness") over a wide range of input level usually do not differ from this simplified circuit in any respect which seriously affects the analysis. The actual analysis will be given at the end of this article, but the following assumptions which are fundamental to the analysis are of immediate interest:

1. The open-circuit d.c. output voltage of the rectifier bears a straight-line relation to the a.c. output voltage of the amplifier, measured in decibels<sup>1</sup> from some arbitrary level.

The justification for this assumption lies in the presence of a delay, or bias, voltage on the rectifier. The peak value of the a.c. output voltage exceeds the delay voltage by an amount which is small compared to the delay voltage itself. This fact, with the fact that  $\log(1+x) \doteq x$  when  $x$  is much smaller than unity, makes the assumption permissible. For example, the delay voltage may be 14 volts, and at a particular level the peak output voltage may be 16 volts. Then the rectifier output, which is 2 volts if a peak rectifier is used, is

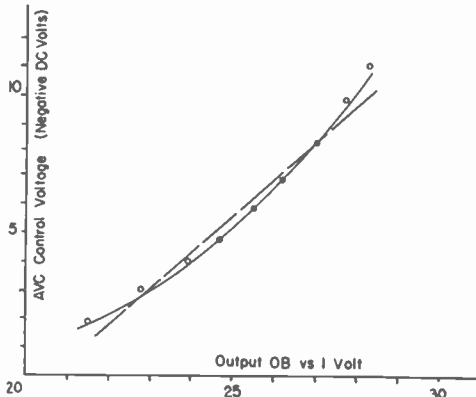

Fig. 2—Experimental data for a.v.c. control voltage as a function of a.c. output level in a specimen a.v.c. amplifier.

small compared to the delay voltage. Experimental justification for assumption 1 is offered in Fig. 2, which shows d.c. rectifier output plotted against output voltage in db for a particular a.v.c. amplifier.

2. The gain reduction in the controlled stages, measured in decibels, bears a straight-line relation to the d.c. gain-control voltage.

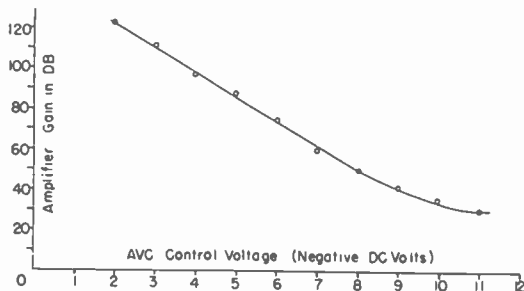

Fig. 3—Gain in db as a function of control voltage. The same amplifier furnished the data for Figs. 2 and 3.

<sup>1</sup> For convenience of analysis, a.c. voltages are expressed in decibels throughout this paper. For definiteness, the reader may think of the voltages as measured in dbv (db versus 1 volt, or  $20 \log_{10} E$ ). There is no occasion in this paper to emphasize the fact that the decibel is fundamentally a measure of power level, but nothing is done which is contrary to this concept.

Assumption 2 is based upon the well-known logarithmic relation between bias voltage and gain in remote-cutoff ("variable- $\mu$ ") tubes. The nature of the relationship may be seen from Fig. 3, in which measured gain is plotted against control voltage for the same a.v.c. amplifier which furnished the data for Fig. 2.

3. Only one resistance-capacitance filter section contributes materially to the delay in delivery of control voltage from the rectifier to the grid returns.

In many a.v.c. amplifiers, the time constant of the RC section<sup>2</sup> which follows the rectifier is much longer than the time constants of the filter sections which separate the individual grid returns, or the time constant of the rectifier circuit itself. Such an arrangement is frequently desirable, in fact, to minimize the tendency toward instability in the a.v.c. system. (This point is discussed more fully later.) Assumption 3 is justified in the case just discussed. For amplifiers in which the assumption is not justified, it is possible to gain an order-of-magnitude notion of a.v.c. speed if the longest time constant which exists for any path through the filter system is used in the relations which are to be developed.

#### DESCRIPTION OF A.V.C. TRANSIENTS

In the following paragraphs, the transient behavior of the a.v.c. system in an amplifier which meets the above conditions is discussed. The mathematical derivation of the results will be given in the latter part of the article. The mathematical results may be summarized for present purposes by the statement that, following a step-function change of input level, the gain in db of the amplifier proceeds to its new equilibrium value either as an exponential function of time, or as a sequence of two exponential functions. The nature of the boundary conditions for various cases will appear in the discussion.

First, it will be useful to introduce the concept of the "flatness factor" of an a.v.c. system. Flatness factor, which will be denoted by  $M$ , is defined by

$$M = \frac{\text{Change of input level, in db}}{\text{Change of output level, in db}}$$

where the quantities are measured under equilibrium conditions. That is, if the output level of a particular a.v.c. amplifier changes by 4 db when the input level is changed by 48 db, the flatness factor is  $M = 48/4 = 12$ . It is shown later, in (7), that

$$M = 1 + K_1 K_2$$

where

$K_1$  = volts of increase of d.c. rectifier output per db of increase in amplifier a.c. output

<sup>2</sup> The resistance  $R$  in the filter section following the rectifier includes the parallel combination of the rectifier load resistance and the effective source resistance of the rectifier circuit. This source resistance is infinite when signal is absent and the capacitor  $C$  is discharging, but in general its value must be found for a particular amplifier. In the amplifier which furnished the illustrative data for this paper, the rectifier load resistance is only 2 per cent of  $R$  and is neglected in calculations.

$K_2$  = gain reduction of controlled stages, in db, per volt of control.

When the input level to the amplifier is suddenly and permanently increased by a small amount  $\Delta E_i$  (measured in db), the output likewise increases suddenly by the same amount; but with increasing time the output decreases exponentially and approaches a value which is higher than the original output level of  $\Delta E_i/M$  db. As shown in the development of (8) in the final section of this paper, the time constant associated with the decrease of output level from its temporary high value to its final value is not  $RC$ , but is  $(RC)/M$ . (As before,  $RC$  denotes the nominal time constant of the dominant

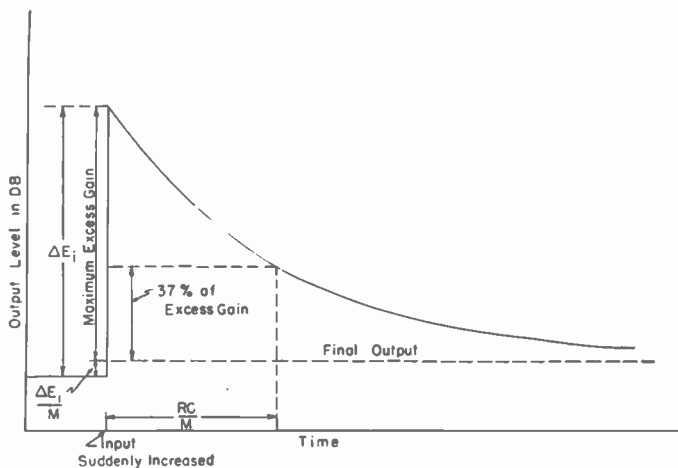

Fig. 4—Output level of an a.v.c. amplifier as a function of time, following a small sudden increase of input level.

resistance-capacitance filter section between the rectifier and the controlled stages.) This behavior is illustrated by the curve of Fig. 4, which is similar in character to one side of the output-signal envelope which appears on an oscilloscope screen when the input level is suddenly increased. Actually, the plot of Fig. 4 is in logarithmic units (db), but the corresponding linear plot for a small increase of signal level is similar in appearance.

The performance which has just been discussed, for the case of sudden small increases of input level, is realized only if none of the amplifier stages overloads even momentarily when the level is increased. When no overload occurs, the voltage delivered to the rectifier reaches a value much higher than is required for eventual equilibrium; it is this excess voltage which enables the readjustment of amplifier gain to occur more rapidly than the apparent time constant  $RC$  would indicate. Therefore, it is to be expected that when the increase of input level is accompanied by overload, the rate of readjustment will be retarded.

Suppose that there is a rigorous upper limit to the output level of the amplifier. That is, if the volume-control circuit be held at constant voltage, the output level increases in proportion to input level until a certain output level is reached, but further increase of input level produces no change in output level. (This behavior

is fairly well realized in the case of a tuned amplifier.) For an a.v.c. amplifier which has this property, analysis shows that the performance following an increase of input level sufficient to produce overload is that shown in Fig. 5. This figure illustrates the significance of (11), developed in the final section of this paper. The voltage delivered to the rectifier remains constant until sufficient charge has flowed into the gain-control circuit to remove the overload. During the time when overload exists, the voltage of the control circuit tends toward the maximum output voltage of the rectifier with the time constant  $RC$ , while the gain of the amplifier tends toward a value much smaller than that required for equilibrium. As soon as the output level becomes less than the overload value, the situation is identical with that which was described for the case of no overload; the effective time constant of the a.v.c. system is  $(RC)/M$ , and the gain of the amplifier decays exponentially to the equilibrium value. The "virtual output" shown in Fig. 5 indicates the manner in which gain reduction proceeds, although the actual output is constant during overload.<sup>3</sup> It should not be supposed, however, that the change of gain as a function of time becomes more rapid when overload disappears and the

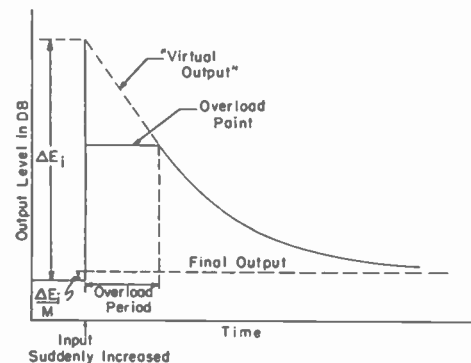

Fig. 5—Output level of an a.v.c. amplifier as a function of time, following a sudden increase of input level sufficient to produce overload.

time constant changes from  $RC$  to  $(RC)/M$ . There is no discontinuity in the rate of change of gain, because, although the time constants are different for the two parts of the transient, the boundary conditions are also different, with the result that there is no discontinuity in the current flow from the rectifier to the gain control circuit. It is evident that the occurrence of overload always increases the time required for gain readjustment.

The case of suddenly decreased input level presents similar features. If the decrease in level is small enough that the peak signal delivered to the rectifier does not become less than the rectifier delay voltage, the gain readjustment proceeds with a time constant  $(RC)/M$ .

<sup>3</sup> In some a.v.c. amplifiers the output is taken from the input to the stage which drives the rectifier ("amplified a.v.c."). In this case the overload condition which may occur in the rectifier driver stage does not affect the output circuit, and the observed output follows the curve labelled "virtual output" in Fig. 5. It is not difficult to decide which case applies to a given a.v.c. amplifier.

If, on the other hand, the peak signal becomes less than the delay voltage, there is an interval during which the rectifier output is constant at the value zero. This is comparable to the overload case. The gain varies with the time constant  $RC$ , tending toward the maximum gain of the amplifier. If the input is of sufficient magnitude the operation of the rectifier may be restored, after which the time constant is  $(RC)/M$ , as before. (In this discussion it is assumed that the effective delay, or bias, voltage on the rectifier is constant. Thus the biasing of the rectifier due to the discharge of the capacitor  $C$ , an effect which is usually negligible in practical circuits, is not considered.) In an a.v.c. amplifier with high flatness factor a decrease in level of less than 6 db will generally cause the rectifier to cease functioning. Consequently, nonoperation of the rectifier following a decrease of level is likely to be a more common phenomenon than is overload of the amplifier following an increase of level. It is the most conservative practice to assume that the time constant associated with a decrease of level is  $RC$  unless, for a special reason, only very small decreases in level are of interest.

An important difference between the case of no overload and that of overload must be stressed. When there is no overload, the absolute rate of gain adjustment is proportional to the magnitude of the input level change, so that the excess gain, no matter what its magnitude, is reduced to 37 per cent in the time  $(RC)/M$ . When overload (or "underload"—rectifier cutoff) occurs, the actual rate of gain change depends upon the voltage existing across the a.v.c. capacitor at the time of overload, and thus bears no relation to the magnitude of the change of input level. Therefore useful information for the overload (or "underload") case can only be obtained by making calculations, as in the following section, for specific operating conditions which may be of interest.

#### AN ILLUSTRATIVE EXAMPLE

The data for the following numerical example are taken from the same a.v.c. amplifier to which the curves of Figs. 2 and 3 apply. The static output-input characteristics of this amplifier are plotted in Fig. 6. The necessary constants are

$K_1 = 1.3$  volts d.c. rectifier potential per db increase of a.c. output

$K_2 = 11.5$  db gain reduction per volt of control

$M = 1 + K_1 K_2 = 16$  (flatness factor)

$RC = 2$  megohms  $\times 0.1$   $\mu$ fd. = 0.2 second.

For signal levels in the middle of the useful range, the output level of this amplifier is 10 db below the overload point. Suppose that the input is suddenly increased by 18 db. Following the sudden increase of level, the gain decreases exponentially, with a time constant  $RC$ , in such fashion that it would eventually approach a low value corresponding to the presence at the grid returns of a voltage equal to the maximum d.c. rectifier output. This process continuous only until the overload condition is removed by an 8-db reduction of gain. The time

required for removal of the overload is found from

$$8 \text{ db} = K_1 K_2 \times 10 \text{ db} \times (1 - e^{-t/RC}),$$

or

$$1 - e^{-t/0.2} = 8/150,$$

from which

$$t = 0.11 \text{ second.}$$

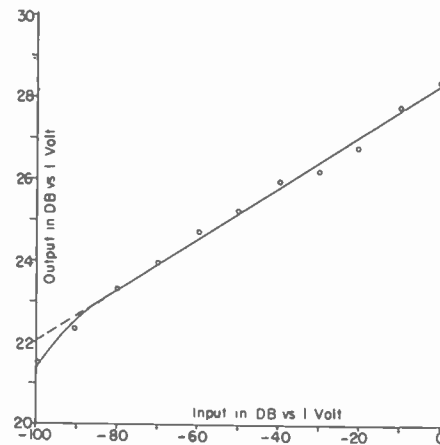

Fig. 6—Equilibrium output-input characteristic for the a.v.c. amplifier which furnished the data for Figs. 2 and 3.

(For a justification of this procedure, consult the derivation of (11) in the latter part of the paper.) For large values of  $t$ , the remaining excess gain diminishes with a time constant  $(RC)/M = 0.2/16 = 0.0125$  second, since overload is no longer present. Since the output level will ultimately approach a value which is higher than the original level by  $18/M = 18/16 = 1.1$  db, the excess gain at the instant when overload disappears is 8.9 db. This excess gain of 8.9 db is reduced to the fraction  $1/e$ , or 37 per cent, in 0.0125 second. Thus the gain (and the output) exceeds its ultimate value by  $0.37 \times 8.9 = 3.3$  db, at a time  $0.0125$  second after the disappearance of overload. The output is 3.3 db above its final value at a time  $0.11 + 0.0125 = 0.12$  second after the sudden increase of input level.

Now suppose that the amplifier does not overload on the 18-db increase of input. In this case the excess gain diminishes from the outset as  $\exp(-t/0.0125)$ . The time required for the gain (or the output) to reach a value 3.3 db above its final value is given by

$$e^{-t/0.0125} = 3.3/16.9,$$

from which

$$t = 0.020 \text{ second.}$$

(The figure 16.9 is the db decrease of gain which will ultimately occur.) In this case, the occurrence of overload has caused a gain reduction which otherwise would take place in 0.020 second to require 0.11 second.

#### STABILITY AND INSTABILITY

The a.v.c. system may be considered as a feedback amplifier in which the signal consists of a voltage equal

to the magnitude in db of the output signal of the actual a.v.c. amplifier. (The fact that the decibel scale is arbitrary offers no difficulty, as only changes of level are of interest.) The normal gain of the equivalent amplifier is unity; that is, in the absence of "feedback," the output envelope of the real (a.v.c.) amplifier follows the input envelope. The "fraction"  $K_1K_2$  of the output signal is fed back degeneratively to the input. Hence, the gain of the equivalent amplifier with feedback is

$$1/(1 + K_1K_2),$$

by the familiar formula for feedback amplifiers. Thus, in the actual a.v.c. amplifier the variation of output level is obtained by dividing the variation of input level by  $(1 + K_1K_2)$ .

In the preceding paragraph the possibility of phase shift in the "feedback" (a.v.c.) network is not considered. If phase shift in this network exists it is possible for the system to execute spontaneous oscillation, for, according to the work of Nyquist,<sup>4</sup> oscillation may occur in the event that the path traced in the complex plane by  $K_1K_2$ , with varying frequency, encloses or intersects the point  $(-1, 0)$ . The quantity  $K_2$  now is a complex number and has a more general significance than in the remainder of this paper; it represents the magnitude and phase of alternating grid control voltage existing for an output envelope which varies sinusoidally, at a particular frequency, with unit amplitude. If the phase of the alternating grid control voltage approaches a delay of  $180^\circ$  with respect to the phase of the sinusoidally varying output envelope; at some frequency for which the filter networks do not offer too much attenuation, the system may oscillate steadily. The oscillation in question appears as an amplitude modulation of the high-frequency signal which is being passed by the amplifier. In order for this oscillation of the control circuit to exist, it is necessary that high-frequency signal be furnished from an external source at a level sufficient to activate the a.v.c. system. If the filter system between the a.v.c. rectifier and the grid returns involves one  $RC$  time constant which is much longer than all others, it will not be possible for the control-voltage phase shift to approach  $180^\circ$ , except at frequencies of output variation which are sufficiently high that the attenuation of the filter network is large. Under this condition, in which one time constant is dominant, the control system will not be subject to steady oscillation, but only to the exponential time variation of gain following a sudden change in signal level, which is the subject of this paper.

#### MATHEMATICAL ANALYSIS

The following symbols will be used in the analysis:

$E_i$  = input voltage level in decibels (see footnote 1)

$E_o$  = output voltage level in decibels

$i$  = current in the loop indicated in Fig. 1

$V_1$  = open-circuit output voltage of the rectifier

$V_2$  = voltage of the control circuit (grid returns)

( $V_1$  and  $V_2$  are inherently negative d.c. voltages with respect to the amplifier common terminal, but are treated as positive for simplicity.)

$K_1$  = change in  $V_1$  divided by change in  $E_o$

$K_2$  = change of amplifier gain (db) per volt in the control circuit

$G$  = gain of the amplifier in db

$M$  = flatness factor of the a.v.c. system

Subscript  $I$  = value of a quantity before sudden change of input level occurs

Subscript  $M$  = maximum value of a quantity, attained only at overload

$\Delta$  denotes finite increments.

In the current loop indicated by the arrow in Fig. 1, the potential equation is

$$V_1 = iR + \left( \int idt \right) / C$$

or

$$dV_1/dt - Rdi/dt - i/C = 0. \quad (1)$$

According to the assumptions which were listed earlier,

$$dV_1/dE_o = K_1$$

or

$$dV_1/dt = K_1dE_o/dt. \quad (2)$$

The relation between output level and  $V_2$ , for constant input, is

$$dE_o/dV_2 = -K_2,$$

or

$$dE_o/dt = -K_2i/C \quad (3)$$

since

$$dV_2/dt = i/C.$$

Equations (1), (2), (3) combine to give

$$K_1K_2i/C + Rdi/dt + i/C = 0$$

or

$$Rdi/dt + (1 + K_1K_2)(i/C) = 0. \quad (4)$$

In terms of the more useful variable  $E_o$ , (4) becomes

$$Rt^2E_o/dt^2 + (1/C)(1 + K_1K_2)dE_o/dt = 0. \quad (4a)$$

The solution of (4a) is

$$E_o = A + Be^{-(1+K_1K_2)t/RC}.$$

It is now necessary to examine the boundary conditions in order that the unspecified constants  $A$  and  $B$  may be replaced by quantities suitable to the problem. Suppose that, for  $t=0$ , the input has just been increased by  $\Delta E_i$  db above a previous value  $E_{i_1}$ , for which the amplifier was in equilibrium, and that the input remains constant at  $\Delta E_i + E_{i_1}$  after  $t=0$ . Let  $\Delta V_2$ ,  $\Delta E_o$  be the amounts by which  $V_2$  and  $E_o$  vary between the original condition at

<sup>4</sup> S. H. Nyquist, "Regeneration theory," *Bell Sys. Tech. Jour.*, vol. 11, pp. 126-147; January, 1932.

$t=0$  and the final equilibrium when  $t$  becomes indefinitely large. For a new condition of equilibrium,

$$\Delta V_2 = K_1(\Delta E_i - K_2\Delta V_2) \quad (5)$$

since the gain of the amplifier is ultimately reduced by  $K_2\Delta V_2$ . From (5),

$$\Delta V_2 = (K_1\Delta E_i)/(1 + K_1K_2)$$

and since

$$\Delta F_0 = \Delta E_i - K_2\Delta V_2$$

there follows

$$\Delta E_0 = \Delta E_i/(1 + K_1K_2). \quad (6)$$

Thus the flatness factor for the a.v.c. system is

$$M = 1 + K_1K_2. \quad (7)$$

Finally, the equation for the output level  $E_0$ , obtained by modifying the solution of (4a) to include the above boundary conditions, is

$$E_0 = E_{0i} + \Delta E_i/M + (K_1K_2/M)\Delta E_i e^{-M t/RC} \quad (8)$$

This equation is represented in Fig. 4.

Similarly, the control voltage is

$$V_2 = V_{2i} + (K_1\Delta E_i/M)(1 - e^{-M t/RC}). \quad (9)$$

The case in which the amplifier is overloaded for an interval following a sudden increase of level is only slightly different. In this case the exponential increase of  $V_2$  begins as though to approach ultimately the value

$K_1E_{0M}$ , the rectifier voltage corresponding to maximum output. Accordingly,  $V_2$  obeys the relation

$$V_2 = K_1E_{0M} - K_1(E_{0M} - E_{0i})e^{-t/RC}. \quad (10)$$

Consequently, the gain decreases according to the relation

$$G = G_I - K_2(V_2 - V_{2i}) \\ = G_I - K_1K_2(E_{0M} - E_{0i})(1 - e^{-t/RC}). \quad (11)$$

Reduction of gain signifies only that progress is made toward the removal of overload; the actual output is constant at the overload value. For consistency with the original assumptions, (10) and (11) have been written for the case  $V_1 = K_1E_0$ . At high levels this linear relation is a rough approximation, but the equations may be replaced by the more nearly exact overload equations

$$V_2 = V_{1M} - (V_{1M} - V_{1i})e^{-t/RC} \quad (12)$$

$$G = G_I - K_2(V_{1M} - V_{1i})(1 - e^{-t/RC}). \quad (13)$$

Equations (10), (11) or (12), (13) apply only until overload disappears. After disappearance of overload, the output level behaves according to the following modification of (8):

$$E_0 = E_{0i} + \Delta E_i/M + (E_{0M} - E_{0i} - \Delta E_i/M)e^{-M t/RC}. \quad (14)$$

Here  $t$  is measured from the instant of disappearance of overload. Evidently the remaining excess gain is reduced by the factor  $1/e$ , or 0.37, in  $(RC)/M$  second.

## Results of Horizontal Microwave Angle-of-Arrival Measurements by the Phase-Difference Method\*

A. W. STRAITON†, MEMBER, I.R.E., AND J. R. GERHARDT†

**Summary**—This paper gives the results of horizontal microwave angle-of-arrival measurements made at a location on the King Ranch, a few miles south of the Naval Air Station at Corpus Christi, Texas. Small deviations of the angle of arrival in a landward direction from the geometric path were noticed at nearly all times. Sixty per cent of the measurements showed angular deviations less than  $0.015^\circ$ , and 90 per cent showed deviation less than  $0.03^\circ$ . The angular deviation is directly proportional to path length if constant gradient persists over the path. Under this condition, deviations greater than  $0.10^\circ$  will be expected, 10 per cent of the time, on a path 23 miles long. The measured angular deviations show a general correlation with the measured horizontal gradient of index of refraction. Meteorological soundings showed overwater ducts present nearly all of

the time, with a maximum difference of approximately 50  $M$  units between the surface of the water and the 38-foot level.

### I. INTRODUCTION

THIS PAPER describes equipment for the measurement of the angle of arrival of microwaves using the phase difference method.<sup>1</sup> The application of this method to the vertical-angle measurements is described elsewhere.<sup>2,3</sup> Vertical angle-of-arrival measurements have been made by Sharpless<sup>4</sup> using the method of pointing for maximum signal strength.

<sup>1</sup> F. E. Brooks, Jr. and C. W. Tolbert, "Equipment for measuring angle-of-arrival by the phase difference method," The University of Texas, Electrical Engineering Research Laboratory, Report No. 2, May, 1946.

<sup>2</sup> A. W. Straiton, W. E. Gordon, and A. H. LaGrone, "A method of determining angle-of-arrival," *Jour. Appl. Phys.*, vol. 19, pp. 524-533; June, 1948.

<sup>3</sup> A. W. Straiton and E. W. Hamlin, "Phase difference between two vertically spaced antennas," to be published in *PROC. I.R.E.*

<sup>4</sup> W. M. Sharpless, "Measurement of the angle-of-arrival of microwaves," *PROC. I.R.E.*, vol. 34, pp. 837-845; November, 1946.

\* Decimal classification: R115.3×R221. Original manuscript received by the Institute, June 2, 1947; revised manuscript received, February 27, 1948. Presented, Joint Meeting of International Scientific Radio Union, American Section, and The Institute of Radio Engineers, Washington, D. C., May 7, 1947. The research in this paper was performed at the Electrical Engineering Research Laboratory of The University of Texas under Contract No. NSori 136 with the Office of Naval Research.

† University of Texas, Austin, Texas.

This paper is concerned only with the measurement of horizontal angle of arrival for a wavelength of 3.2 cm.

## II. DESCRIPTION OF SITE

### Location

The radio path was along the shore line of Laguna Madre in Nueces and Kleberg Counties in Texas. The general location is shown by the rectangle on the map of the Texas coast line, Fig. 1. This particular location was chosen because of the relative straightness of the

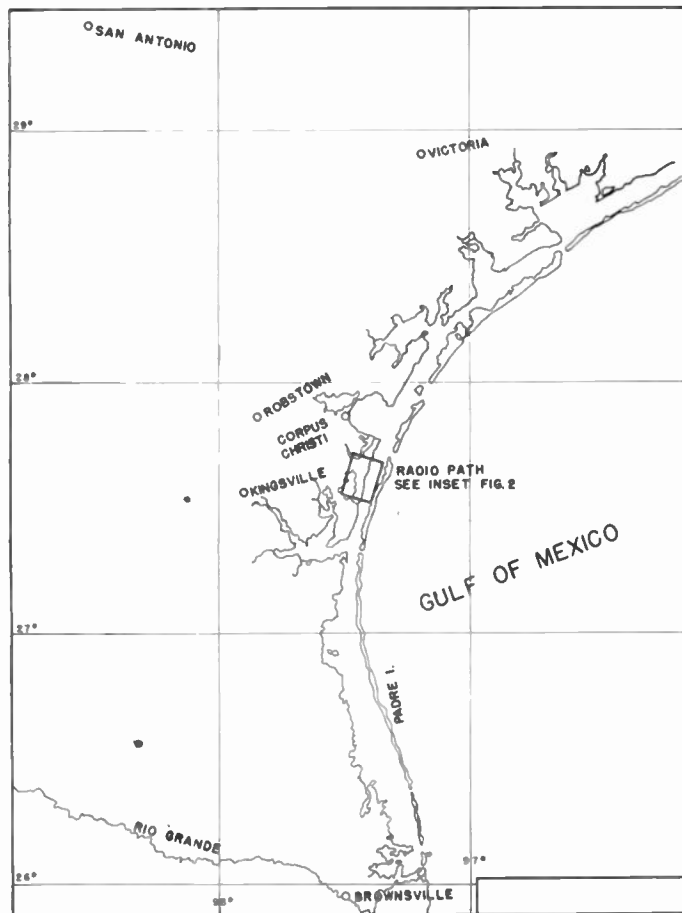

Fig. 1—South Texas coast line showing location of radio site.

shore line, the absence of swampy land, and the relatively small rainfall during the summer months. With respect to Padre Island, the location was not ideal; however, it offered the best available contrast between land and sea. An enlarged map of the area is shown in Fig. 2.

### Physical Dimensions

The transmitting tower was located at *A* and the receiving tower at *B*, 6.89 miles from *A*. The north meteorological sounding site was at *C*, 0.5 miles south of

the receiving site, and the south meteorological sounding site was at *D*, 1.5 miles north of the transmitting site. A survey of the path between *A* and *B* was made and the profile of this path is shown in Fig. 3. The water

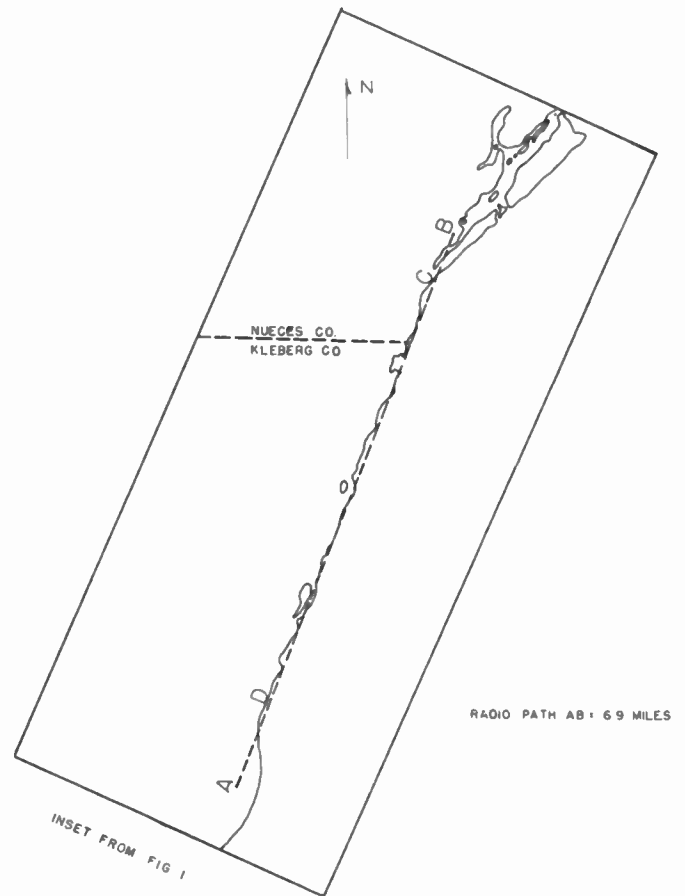

Fig. 2—Enlarged map of radio path.

level taken as reference is the mean sea level. The daily variations in water level are only a few inches. The seasonal variations in level are in the neighborhood of one foot. The inland lakes shown in the maps nearly dried up in August, but were partly refilled by rains around the first of September.

## III. RADIO MEASUREMENTS

### Theory of Measurements

The method used in the angle-of-arrival measurements was that of determining the phase difference between the signals received at two horns spaced horizontally 10 feet apart. This method is illustrated by Fig. 4. A plane wave traveling in a direction making a horizontal angle  $\theta$  with the geometric path will have a longer path to horn *B* than to horn *A*. This extra distance is given by  $D \sin \theta$ , and the phase delay  $\phi$  at the horn *B* is given very approximately by

$$\phi = D\theta 2\pi/\lambda \quad (1)$$

where  $D$  is the spacing of the horns, and  $\lambda$  is the wavelength. For a spacing of 10 feet and a wavelength of 3.2 cm., this becomes  $\phi = 600\theta$ . The angle of arrival is then obtained by dividing the phase difference by 600.

The combination of the direct and reflected rays will cause the wave front to be irregular in a vertical direction, but will cause comparatively little disturbance in a horizontal direction.

*Receiving Equipment*

The receiving equipment measured the difference in phase of two antennas spaced horizontally 10 feet apart. This was accomplished by heterodyning the microwave signals down to 12 Mc. and applying them to a cathode-ray tube. The signal from one channel was applied to the deflection plates in such a way as to form a circle. This

signal is referred to as the circle-axis signal. The other signal, referred to as the Z-axis signal, was applied to

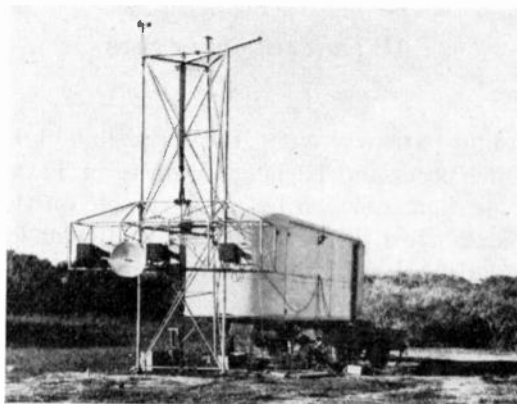

Fig. 5—Receiving tower with horns at 8-foot level.

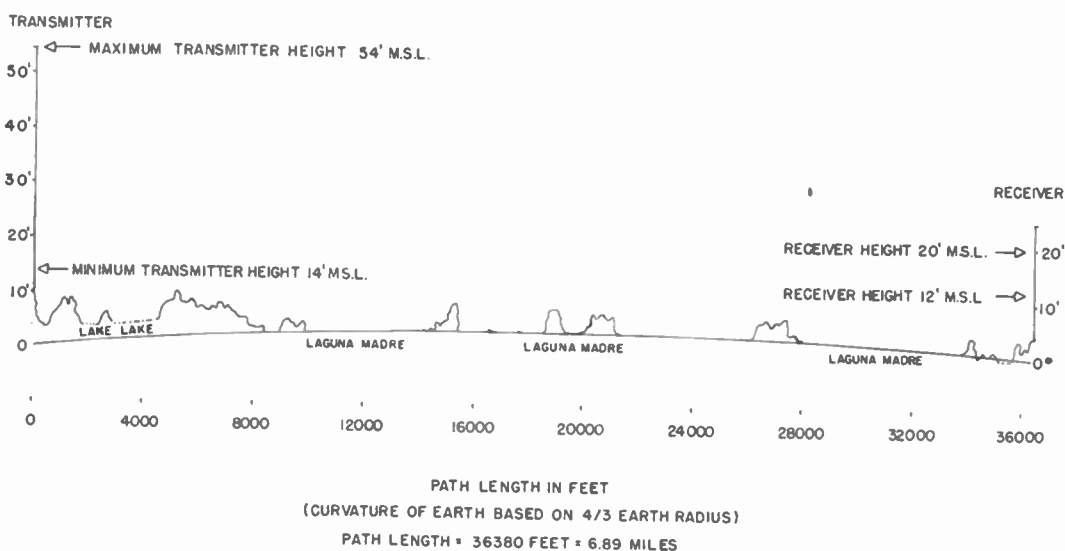

Fig. 3—Profile of path.

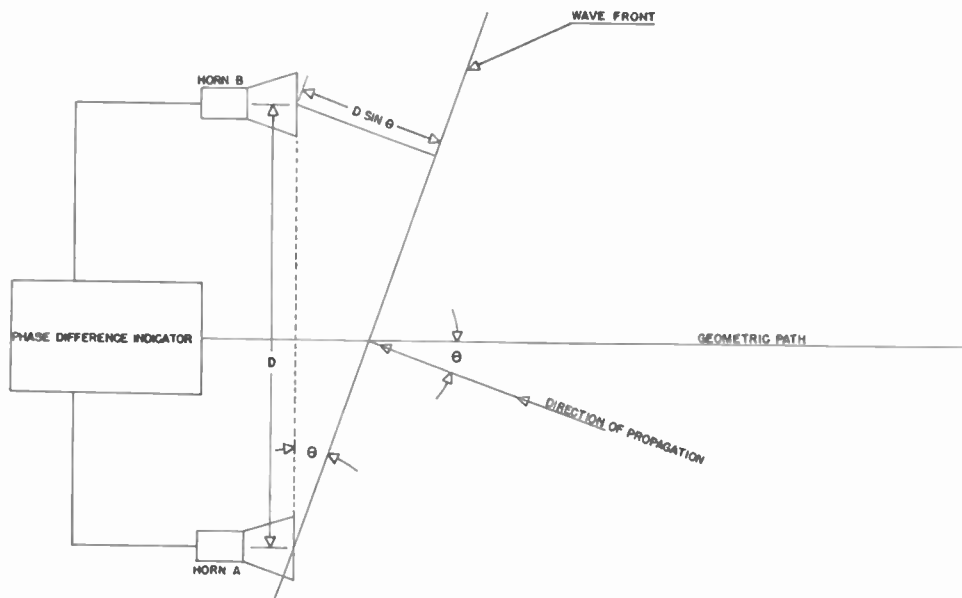

Fig. 4—Principle of measurements.



the control grid to produce amplitude modulation of the beam intensity so that an arc of the circle appeared on the tube screen. The phase delay  $\phi$  was determined from the position of this arc.

All angles were measured with respect to a reference signal located on the geometric path. The receiving horns were mounted on a 20-foot tower, as shown in Fig. 5. Elevations of 12 and 20 feet above mean sea level were used for the tests.

#### Transmitting Equipment

The transmitter, using a 2K39 reflex klystron, was mounted on the movable platform of a 50-foot tower. The transmitter is shown in Fig. 6. Elevations ranging from 14 feet to 54 feet above mean sea level were used, and curves of angle of arrival and signal strength at the two horns were obtained for this range of heights.

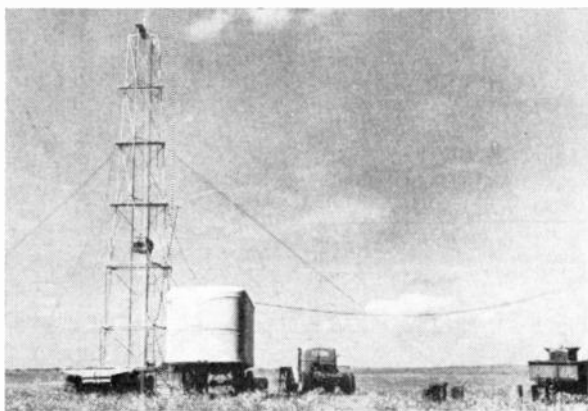

Fig. 6—Transmitting equipment.

#### IV. METEOROLOGICAL EQUIPMENT

The measurement of the variations in the horizontal and vertical gradients of refractive index was accomplished by the use of two sets of pole-mounted instruments. A set consisted of three poles spaced 200 feet apart in a line perpendicular to the path with the center pole on the path and on the shore line. Each pole supported housings containing wet- and dry-bulb ceramic elements at three levels, 2½, 11, and 38 feet. Through a suitable switching arrangement the necessary data were recorded for the three levels in 40 seconds, the measurements at a level on each set of three poles being simultaneous. Thus, by referring the temperature and moisture values to a standard nomogram, the horizontal gradient of the modified refractive index at two locations on the path and at three elevations was measured together with several overland and overwater vertical gradients. This equipment used the Radiation Laboratory Psychograph as the basic unit and was produced in the Meteorology Section of the Electrical Engineering Research Laboratory.

#### V. HORIZONTAL-ANGLE MEASUREMENT (HEIGHT RUNS)

##### General Discussion

Horizontal angle as a function of the height of the transmitter was studied with the receiving horns at elevations of 20 and 12 feet above mean sea level. One hundred and four curves, taken point by point with angle variations plotted as a function of the height of the transmitter, were made with the receiving horns at a height of 20 feet, and 45 curves were made with the receiving horns at a height of 12 feet. The average time required for making a run of this type was fifteen minutes.

##### Typical Curves of Angle and Signal Strength With Height

The curves for angle of arrival and signal strength as functions of height of the transmitter were classified into three groups. The characteristics of the curves in each group are described in this section.

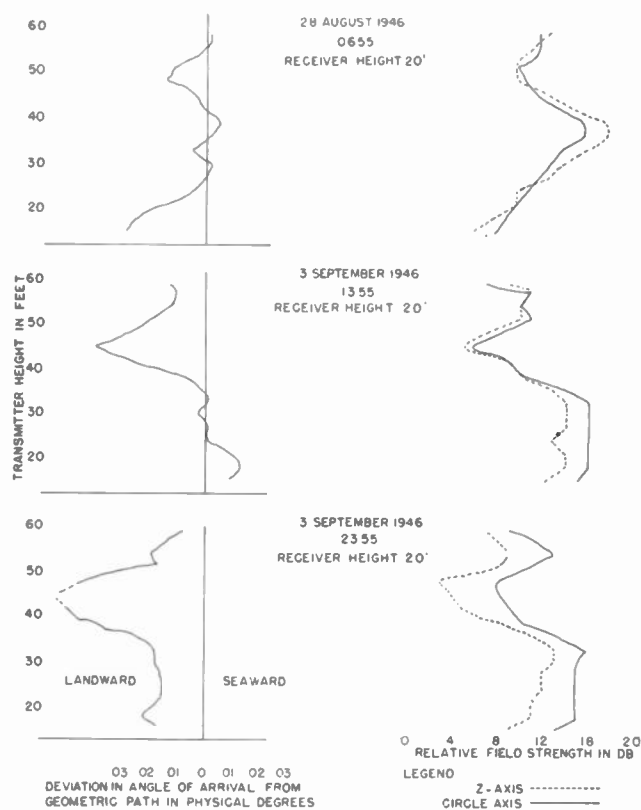

Fig. 7—Typical angle and field-strength curves. Group I.

*Group I.* The type of curve most commonly found is illustrated by the three sets shown in Fig. 7. One hundred and seventeen sets of curves were classified in this group. The signal-strength curve marked Z axis is for the horn on the seaward side, and the curve marked circle axis is for the horn on the landward side. The difference in magnitude of the two signal-strength

curves merely indicates that the gain control of one was increased relative to the other for proper operation of the receiver. The scale divisions for signal strength are approximately linear in decibels. The characteristic features of this group of curves are:

(1) The break in the angle curve was in a landward direction, accompanied by low signal strengths. (For an example of this break, see the lower-angle curve of Fig. 7 between 32 and 50 feet.)

(2) The signal strength increased with height to a maximum between 34 and 40 feet, had a minimum between 40 and 50 feet, and increased again.

(3) The break in the angle in a landward direction is considered as being due to a reduction in the strength of the direct ray for certain heights of the transmitter. The reflected ray, traveling closer to the ground, will be subject to the stronger horizontal gradients which existed in that region. If the strength of the direct ray is reduced, the resulting angle will be more nearly that of the reflected ray. Vertical-angle measurements made over an adjacent path indicate a similar reduction of the strength of the direct ray for increasing transmitter heights. These vertical-angle measurements are described elsewhere.<sup>5</sup>

The maximum deviation of the angle from its average value correlated roughly with the difference of the low-level ( $2\frac{1}{2}$  feet) gradient from the average gradient.

(4) With rare exceptions, the horizontal gradient of the modified index of refraction ranged from 0 to  $+4M$  units per hundred feet across the geometric path, with the larger gradients being nearer the surface and positive gradients being measured seaward. Under such conditions, a ray traveling near the surface would be refracted in a landward direction, and the degree of such refraction would increase as the ray approached the surface.

(5) Minima in the signal strength for the two horns occurred at approximately the same height as the maximum deviation of the angle. The minima for the horns at the 12-foot level occurred at an average height of transmitter 5 feet lower than for the horns at the 20-foot level. This is opposite to the interference patterns in a standard atmosphere, where the signal-strength minimum for the horns at the 12-foot level would require a greater transmitter height than would the horns at the 20-foot level.

*Group II.* A second type of curve is illustrated by the three sets shown in Fig. 8. Thirteen curves were classified in this group. The characteristic features of this group are:

- (1) The angle of arrival showed comparatively little change as the height of the transmitter was increased.
- (2) The signal strength increased consistently from a

low value at the ground to a maximum for the highest position of the transmitter.

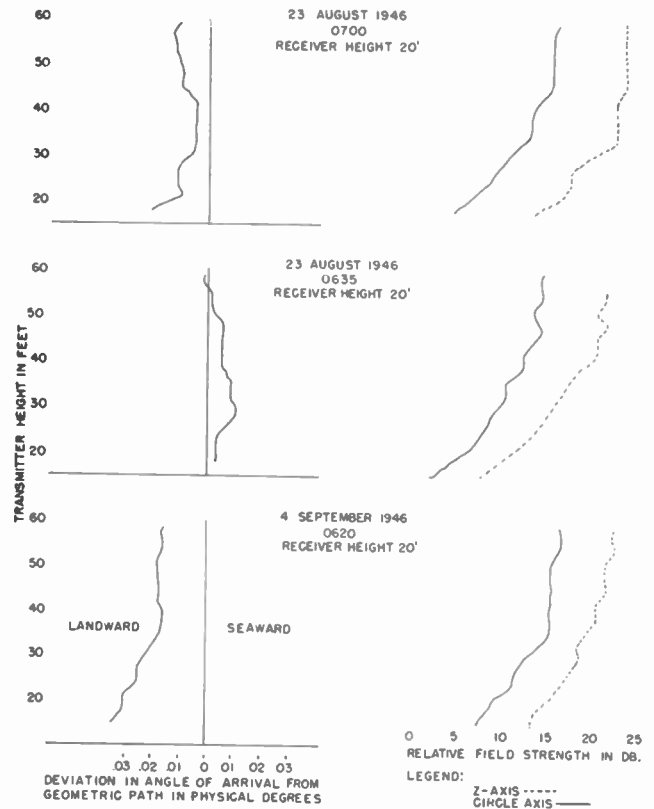

Fig. 8—Typical angle and field-strength curves. Group II.

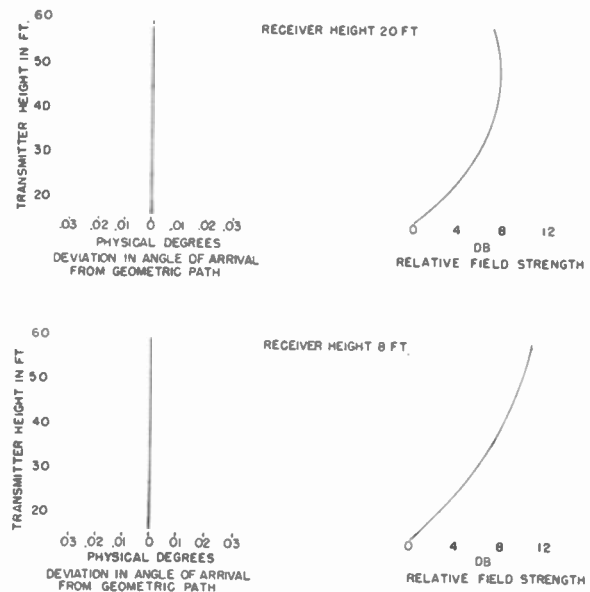

Fig. 9—Theoretical angle-of-arrival and signal-strength curves for standing conditions.

<sup>5</sup> A. W. Straiton, "Vertical Phase Front Measurements for Microwave Transmission Over Water, Near Corpus Christi, Texas," Electrical Engineering Research Laboratory, Memorandum No. 4, January, 1947.

For standard conditions, the theoretical angle-of-arrival and signal-strength curves for the Corpus Christi path are as shown in Fig. 9. The maximum transmitter

height used was not enough to approach the height necessary to produce a signal-strength minimum. A transmitter height of 95 feet would be required for the first signal-strength minimum with the receiving horns at the 20-foot level, and a height of 159 feet would be required with the horns at the 12-foot level.

The nearest approach to standard-condition curves are those shown in Fig. 8. The angle variations with height in these cases are relatively small, and the signal strength increases consistently as the transmitter was raised. Thirteen occurrences of this type were found, and all of them were between 0600 and 0700. The meteorological soundings show that at these times the wind shifted from seaward to landward, and the strength and height of the duct, which existed nearly all of the time, were diminished. The atmospheric conditions resulting were nearer standard than at any other time.

*Group III.* The third group of curves, consisting of nineteen sets, includes those which could not be classified under Groups I or II. These curves cover a range of characteristics.

This group included the five cases in which the break in the angle-of-arrival curve was in the seaward direction, as illustrated in Fig. 10. These cases are associated with the few exceptional negative horizontal  $M$  gradients en-

countered near the surface. In all such cases, positive gradients were measured at higher levels. The "break" is interpreted as being caused by a reduction in the strength of the direct ray in this height range permitting the angle of arrival to take on the characteristics of the reflected ray, which would then be refracted in a seaward direction due to the low-level negative horizontal  $M$  gradients.

### Superrefraction Conditions

The overwater duct varied in height and strength over an average 24-hour period, being strongest ( $M_{afc} - M_{40'} = 50$ ) during midafternoon conditions with the strongest sea surface to air moisture lapse, but rising to a maximum height of about 80 feet during early morning hours (0200-0500) due to the greater degree of temperature stability over water at that time. The minimum duct strength and height (about  $M$  units and 10 feet) occurred simultaneously about 0600, when the restricted land-to-sea breeze circulation usually came into existence. This was due to the decrease in overwater temperature stability resulting from the replacement of the warmer air overlying the sea surface with the cooler air brought in by the land breeze.

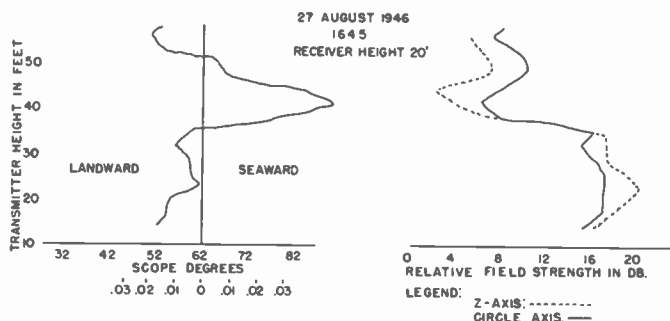

Fig. 10—Typical angle and field-strength curves.

countered near the surface. In all such cases, positive gradients were measured at higher levels. The "break" is interpreted as being caused by a reduction in the strength of the direct ray in this height range permitting the angle of arrival to take on the characteristics of the reflected ray, which would then be refracted in a seaward direction due to the low-level negative horizontal  $M$  gradients.

## VI. SUMMARY OF METEOROLOGICAL MEASUREMENTS

### Average Temperature, Moisture, and Wind

The air temperature at all measured levels throughout the entire observation period was within  $\pm 2^\circ\text{C}$ . of a mean value of  $28^\circ\text{--}29^\circ\text{C}$ . The corresponding high wet-bulb temperatures gave rise to a near-constant 80 per cent relative humidity. Onshore winds with an apprecia-

## VII. CORRELATION OF HORIZONTAL ANGLE AND METEOROLOGICAL MEASUREMENTS

### Angle of Arrival as a Function of Average Horizontal Gradient of Index of Refraction

In this section, the horizontal angle of arrival as a function of the average horizontal index of refraction gradient per 100 feet is considered. The angle and gradient measurements were made simultaneously. A comparison of the measured angles and gradients with the receiving horns at the 12-foot level is shown in Fig. 11.

The angle of arrival plotted is the average of all heights of the transmitter, and the index-of-refraction gradient is the average of the gradients at the three heights at which the meteorological soundings were taken ( $2\frac{1}{2}$ , 11, and 38 feet).

The straight line plotted on each graph represents the theoretical relationship for angle of arrival as a function of the horizontal index-of-refraction gradient and the length of the path. This relationship is given by

$$\alpha = 0.175l\gamma \quad (2)$$

where

$\alpha$  = deviation of angle of arrival from geometric path in hundredths of degrees

$\gamma$  = horizontal index-of-refraction gradient per 100 feet  
 $l$  = path length in miles.

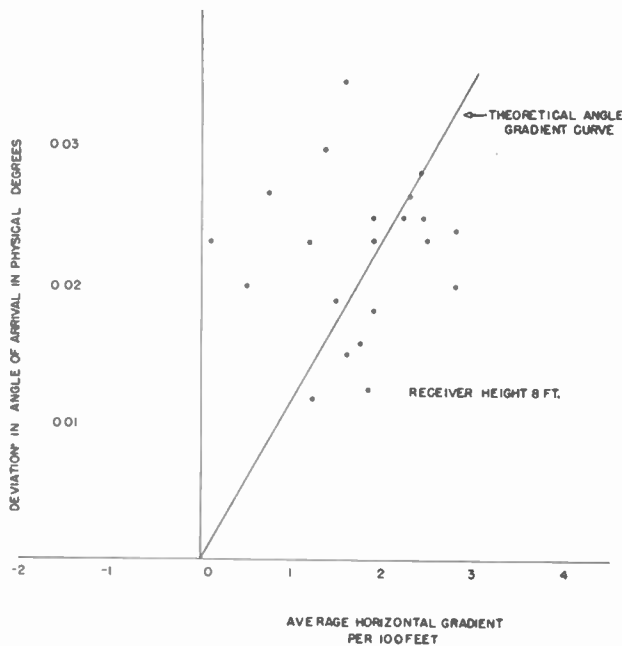

Fig. 11—Angle-of-arrival versus index-of-refraction gradients.

*Deviation of Angle of Arrival From Geometric Path*

This section presents a statistical analysis of the deviation of the angle of arrival from the geometric path.

(a) In determining the deviations of the angle of arrival from the geometric path, the following procedure

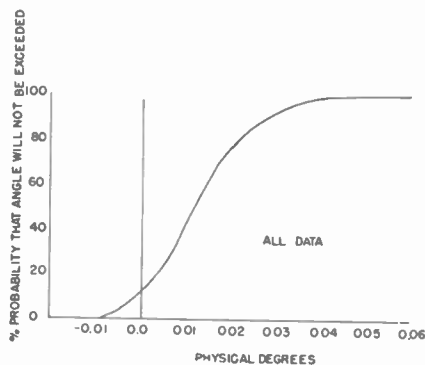

Fig. 12—Deviation of angle of arrival from geometric path.

was used. The oscilloscope readings for all heights of a given curve were averaged, and this average was sub-

tracted from the reference signal angle. This difference was divided by 600 to convert degrees on the face of the oscilloscope to physical degrees. A positive value indicates a landward angle of arrival and a negative value indicates seaward. The number of occurrences of the various angles of arrival is shown in Table I. The probability curve for all data taken is shown in Fig. 12.

TABLE I  
 ANGLE-OF-ARRIVAL STATISTICS

Number of occurrences Receiver heights	Receiver heights		Probability in per cent that angle will not be exceeded Receiver heights	Receiver heights		Physical degrees
	Feet	Feet		Feet	Feet	
Total	16	8	Total	16	8	-0.005
1	1	0	1	1	0	-0.01
14	14	0	10	14	0	0.00
45	39	6	40	52	13	0.01
53	29	24	76	80	67	0.02
23	10	13	91	89	96	0.03
11	9	2	98	98	100	0.04
1	1	0	99	99	0	0.05
1	1	0	100	100	0	0.06

VIII. EXTENSION OF RESULTS

*Angle-of-Arrival Deviations Related to Path Length*

From (2) it can be seen that the angular deviation is proportional to the path length. By increasing the angular-deviation scale of the probability curve, in proportion to the path lengths, the relationships of Table II are obtained. This relationship depends on the assumption that the gradient is constant over the entire radio path. Caution should be used in applying these results to longer paths, as the curvature of the ray may cause it to bend out of the region of strong horizontal gradient. In addition, the linear relationship between angular deviation and path length will be disturbed by irregularities in the coast line.

TABLE II  
 ANGULAR ERROR—PATH LENGTH DATA

Path length in miles	Angular deviation in degrees	Probability that angular deviation will not be exceeded
7	0.015	Per cent 60
7	0.03	90
14	0.03	60
14	0.06	90
23	0.05	60
23	0.10	90

# Interference Between Very-High-Frequency Radio Communication Circuits\*

W. RAE YOUNG, JR.†, ASSOCIATE, I.R.E.

*Summary*—Interference between different radio circuits is an old problem, one which in the past generally has been solved by trial and error and by hand tailoring (special filters, etc.). With the general increase in the usage of radio communication, however, the amount of potential interference is greatly increased. This paper will be concerned principally with the v.h.f. problem.

There is generally a large difference between transmitting and receiving power levels. As a result, spurious radiations, spurious responses, and lack of sufficient receiver selectivity may in many instances cause interference. Situations are described in which such interferences are likely.

In mobile systems interference can occur if the interfering station is close enough to "capture" it from the desired signal. This, in turn, depends upon the selectivity and spurious response of the receiver and the amount of spurious radiation from the transmitter. The problem can be approached in a statistical manner.

The types of spurious radio behavior which are common causes of interference are discussed. Sample measurements are given to illustrate the relative magnitude of the various modes of behavior. Formulas are given which permit computation of the frequency of the disturbances. A method is described for making charts suitable for a given type of equipment from which the spurious frequencies can be read directly as a function of the operating frequency.

## INTRODUCTION

INTERFERENCE between radio systems is the major factor in determining how many and which of the assignable channels can be usefully employed. The intent of the present paper is, firstly, to analyze the important situations giving rise to interference, and, secondly, to describe the characteristics of equipment which make such interference possible.

The discussion is limited primarily to very-high-frequency communications, with special emphasis on mobile systems. On this basis no mention will be made of long-distance (sky-wave) interference, except to say here that it precludes use of the same channels in different areas between which sky-wave propagation is probable.

## THE NATURE AND MAGNITUDE OF THE PROBLEM

When the large difference in power levels between the transmitting and receiving ends of typical radio communications circuits in the v.h.f. range are viewed in the light of the spurious output and spurious response characteristics of present-day equipment, it is apparent that there exist a great many possibilities for interference. When the geographical disposition and frequency assignment of the equipment are made specific, some of these possibilities are likely to become actualities. They are,

that is, unless the situation has been analyzed beforehand, and preventive measures applied.

A brief inquiry into the transmitting and receiving power levels will show why spurious transmitter outputs which are ordinarily regarded as well-suppressed, and a receiver characteristic which is regarded as highly selective by the usual standards, may be the source of interference.

A signal strength of 1 microvolt (across a 70-ohm receiver input) may be taken as typical of the weakest which will give satisfactory communication. It is true, of course, that a signal which is several db weaker may suffice in electrically quiet locations, whereas 15 to 30 db more may be required in noisy ones. One microvolt at this point represents a power level of 138 db below 1 watt.

The power radiated from transmitters in present-day communication circuits is generally between 25 and 250 watts, in round numbers. These are power levels of +14 to +24 db above 1 watt.

## Types of Interference

Suppose a 25-watt transmitter radiates some spurious power at the frequency to which a closely adjacent receiver is tuned, and that the amount of this power is 152 db below the carrier. Then  $14 - 152 = -138$  db from 1 watt is the power of the spurious signal. If the minimum usable level of desired signal, mentioned above, is being received at this same time, the spurious signal will prevent reception because the two signals are at the same level. The interfering signal must be at least 6 to 10 db lower in order that the desired signal may be understood. It will be seen then that spurious outputs down as much as 160 db from the main output of a 25-watt transmitter may cause interference to a receiver whose antenna is very close to the transmitting antenna.

A moderate separation between these antennas reduces this value by only a discouragingly small amount. At 150 Mc., for example, separation between these two antennas puts a loss between them in the following approximate amounts ( $\pm 6$  db):

5 ft.—16 db  
50 ft.—36 db  
500 ft.—56 db.

Evidently a physical separation between the antennas of sources and receivers of interference reduces the requirements placed on the equipment. In general, however, there are not enough antenna sites, all separated sufficiently to eliminate any chance of interfer-

\* Decimal classification: R170X R430. Original manuscript received by the Institute, October 29, 1946; revised manuscript received, March 1, 1948. Presented, October 3, 1946, National Electronics Conference, Chicago, Ill.

† Bell Telephone Laboratories, Inc., New York, N. Y.

ence, to take care of the needs for individual channels in a given city. Frequencies to be assigned therefore need to be chosen or grouped so that either the interfering assignments are not used, or the needed additional suppression is feasible to obtain, or a combination of both measures.

The frequency selectivity of ordinary antennas is not a large factor in eliminating spurious outputs. It has been estimated that perhaps 10 db may be gained at this point, but no more, unless the frequency of the spurious output is outside of the range from one-half to two times that of the carrier. Most antennas are not sharply tuned. Frequencies within a few per cent of the center are all radiated with nearly top efficiency.

By a similar analysis, it will be apparent that interference may result if the response of a receiver at the frequency of a 25-watt transmitter which is very close by is 152 db below (that is, less sensitive than) the response at its operating frequency. The amount of power which finds its way from the near-by transmitter to the frequency-modulation limiter or amplitude-modulation detector will be equal to that caused at this point by the distant signal. Evidently, then, interference may occur at frequencies for which receiver sensitivity is not as much as 160 db below the operating frequency.

Interference may also result from a spurious output, if the response of the receiver at that frequency is not sufficiently far down from its main response. Following the examples given above, if a spurious output is down 70 db from the carrier power, and if the response of a near-by receiver at that frequency is down 82 db ( $70 + 82 = 152$  db), reception of a marginal distant signal will be lost.

A false signal from any source may, of course, cause interference. The heterodyning oscillator from one receiver may be the source of such a signal for another near-by receiver. The local oscillator often induces as much as 60 or 80 db above 1 microvolt across its r.f. input. This may travel by way of the antennas to a near-by receiver. Thus interference of this type may easily be present when several receivers are operated from the same or closely grouped antennas.

Interference may also result even when the receiver has no perceptible response to the interfering signal in the sense that "response" is used above. The modulation on the interfering signal cannot be heard in the output of the receiver in an f.m. system, and in an a.m. receiver only when the intended signal is also present. In this type of interference, the unwanted signal is so powerful that it causes overloading of the vacuum tubes in the early stages of the receiver, before selectivity has had a chance to attenuate it. Overloading, in effect, reduces the gain of the receiver with respect to the desired as well as the unwanted signal.

Frequency modulation of the unwanted signal does not change the amount of overloading, nor does it cause the frequency of the desired signal to vary. It is, therefore, not heard, and the desired signal is left

virtually undisturbed. The reduction in gain due to the undesired signal may, however, disturb the operation of "codan" or "squell" circuits.

In a.m. systems, on the other hand, the amount of overloading changes with modulation. The corresponding gain changes modulate the amplitude of the distant signal as it passes through the receiver. The local signal will, therefore, be heard along with the distant signal.

With present common design practice, and where the interfering frequency is 10 per cent or more removed from the receiving frequency, it is estimated that about 1 volt applied to the ordinary receiver will cause overloading in the first stage. It may take more, if there is high selectivity in the tuned stage preceding the first tube. If the interfering frequency is closer than 10 per cent, overloading will probably begin in the second stage with a receiver input as low as 0.1 volt. In this case the selectivity of the circuits associated with the first stage is so little that the incoming signal is amplified and sent along to the next stage, where, because of the high level, overloading occurs.

A spurious signal of interfering proportions may sometimes result from the action of two signals in a nonlinear circuit or medium. An imperfect metal joint in the structure of a building, car, or ship, having these two signals applied to it at high level, will generate sum and difference products, etc. If one of these coincides with the operating frequency of a near-by receiver, or with a high point in its spurious response characteristic, interference may result—but only when both of the original signals are present at the same time.

Of more practical importance, however, these spurious frequency products can be generated as a result of nonlinear action in the output stage of one of the transmitters or the input stage of a receiver.

Interference due to this cause is unlikely when the numbers of systems operating in the same general frequency range and locality is small. This is due simply to the fact that the assigned frequencies are not likely to bear the necessary relationships. However, as the number of channels in use increases, the chance of one system encountering interference from a pair combination from among the remaining channels increases rapidly.

Where two transmitters are located so that a moderate amount of power from the second reaches the final plate circuit of the first, in spite of antenna tuning and tank-circuit selectivity of the first, a series of spurious products is formed there. Generally, the most significant of these, in point of its magnitude and frequency, is the  $2f_1 - f_2$  product, where  $f_1$  is the carrier frequency of the first, and  $f_2$  is the frequency of the power introduced by the second (or interfering) transmitter. The magnitudes of all of these products depend upon the amount of voltage at  $f_2$  which is induced by the interfering transmitter across the tank circuit of the first transmitter, as compared with the voltage at  $f_1$

which is normally found there. In the case of the  $2f_1 - f_2$  product, the ratio of current entering the tank circuit at this frequency to that which enters at  $f_1$  is nearly the same as the above voltage ratio. Thus, for example, if a transmitter receives 1 watt of power from an interfering source, it may be expected to radiate perhaps 0.1 to 0.25 watt at  $2f_1 - f_2$ , unless the frequencies are such that tank-circuit and antenna selectivities are effective. On the other hand, if  $f_1$  and  $f_2$  are widely separated,  $2f_1 - f_2$  often will be attenuated a great deal by these selectivities.

It may, therefore, be inadvisable in many cases to locate several transmitting antennas close together, when they are operating in the same general range of frequencies. For the same reason, special precautions will be needed where a communications transmitting antenna is to be located near (for example, on the same roof with) the antenna of a high-power v.h.f. broadcast transmitter.

The intermodulation of two interfering signals in a receiver is also a problem of serious proportions. To avoid interference, the components of a receiver must be so linear that a weak signal is readable, even though a pair of strong signals at particular frequencies is also present. The requirement is so severe in the general case that even the best of present receiver designs falls far short of it. It is thus necessary to choose frequencies carefully for assignment, or to use supplementary filters where practical.

*Statistical Approach for Mobile Systems*

In mobile systems, where the positions of the cars are more or less random in position and time, it is impractical to defend the various systems against all interference. However, a satisfactory engineering solution involving moderate equipment requirements can be achieved on the basis that interference to any given channel can be tolerated a small random portion of the time.

An idea as to whether or not the interference picture is satisfactory may be gained by considering the probability that interference will occur. The probability referred to below is defined as the fraction of channel-busy time during which interference may be expected. It is also the probability that interference will be present at any given time.

The first case to be considered is shown in Fig. 1.  $T_1$  and  $T_2$  are mobile transmitters operating on dif-

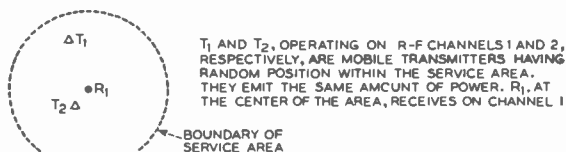

$T_1$  AND  $T_2$ , OPERATING ON R-F CHANNELS 1 AND 2, RESPECTIVELY, ARE MOBILE TRANSMITTERS HAVING RANDOM POSITION WITHIN THE SERVICE AREA. THEY EMIT THE SAME AMOUNT OF POWER.  $R_1$ , AT THE CENTER OF THE AREA, RECEIVES ON CHANNEL 1

Fig. 1—Simple layout of vehicular system to illustrate interference at the land receiver.

ferent frequencies and located at random within the circular service area.  $R_1$  is a fixed-position receiver in-

tended to receive  $T_1$ .  $R_2$  is not shown because it does not enter the immediate computations. The problem is to determine the probability that  $T_2$  will be so close to  $R_1$  that the signal from  $T_1$  will be obscured. The two transmitters are assumed to have equal power, and for simplicity the field strength expressed in volts per meter is assumed proportional to inverse-distance squared.

If the characteristics of these transmitters and the receiver are such that the interfering carrier may be  $I/S$  (a voltage ratio) stronger than the desired signal carrier, as measured at the input of the receiver, without interference resulting, the probability of interference resulting from an unfavorable distance relationship of the units can be shown to be

$$P = \frac{1}{2I/S} \tag{1}$$

Space does not permit giving the derivation of this formula here.

From this formula, for example, it may be seen that, if an adverse carrier ratio of 60 db (equals a voltage ratio of 1000) may exist at the carrier input before interference begins, then the probability of interference, that is, the fraction of time during which interference occurs, is

$$\frac{1}{2 \times 1000} = 0.0005 = 0.05 \text{ per cent.}$$

This probability formula also applies to the case shown in Fig. 2. In this figure, transmitter 1 is fixed in position (a land transmitter), while  $T_2$  and  $R_1$  are mounted on mobile units which are located at random within the service area. The formula then gives the



$R_1$  AND  $T_2$  ARE MOBILE AND RANDOM IN POSITION.  $T_1$  IS FIXED.  $T_1$  AND  $T_2$  ARE ASSUMED TO PRODUCE THE SAME FIELD STRENGTH AT A GIVEN DISTANCE.

Fig. 2—Simple layout of vehicular system to illustrate interference at the mobile receiver.

probability that  $T_2$  will be so close to  $R_1$  that  $T_1$  cannot be heard. In deriving the above formula for this case, however, it was assumed that  $T_1$  and  $T_2$  are of equal power, and work into antennas which are the same height above ground.

In practical application, however,  $T_1$  is usually about 10 db stronger than  $T_2$ , and, in addition, its antenna is placed higher above ground. For example, the antenna for  $T_1$  might be 500 feet above ground, while that for  $T_2$ , on a car, is effectively 6 feet above ground. This height difference amounts to roughly 25 db difference in field strength at 30 Mc., or about 35 db at 150 Mc. Thus, for operation around 30 Mc.,  $T_1$  might have  $25 + 10 = 35$  db advantage over  $T_2$ . This operates in the

direction of reducing interference exactly as if the  $I/S$  required for interference were increased by the field-strength advantage; in this instance, 35 db. Hence, if the equipment can tolerate an  $I/S$  of 45 db, the probability of interference is computed in the above formula on the basis of  $45 + 35 = 80$  db (equals voltage ratio of 10,000). Then

$$P = \frac{1}{2 \times 10,000} = 0.00005 = 0.005 \text{ per cent.}$$

The probability of interference to a given transmission may be increased over that given in the formula by the fact that propagation is not smooth, as was assumed by the inverse-distance-squared rule. Instead, the field intensity which strikes an antenna rises and falls over a range of 15 to 30 db as the position of the antenna is changed by relatively short distances.

If neither the car in question nor the interfering mobile transmitter is moving, then the chances that the receiver is located in a low-intensity spot with regard to the desired signal, while at the same time in a high-intensity spot for the interfering signal, are about balanced by the chances of the situation being reversed. The net chance of interference is then the same as computed on the basis of smooth propagation. On the other hand, when both mobile units are moving, both signals fluctuate moderately rapidly, perhaps 1 to 10 times per second. When interference is present it may be expected to come and go at this rate. The effect of a swing toward a favorable signal-to-interference ratio does not balance the effect of a reverse swing, because the transmission of the complete message is disturbed by the intermittent interference. Thus, in order to guarantee a certain small probability of interference, the effective suppression of interfering products by the receiver must be greater than that indicated by the simple formula (1). It is thought that about 15 db more suppression will take care of these fluctuations.

In the case shown in Fig. 3,  $T_1$  and  $T_2$  are land transmitters which are fixed in position and separated

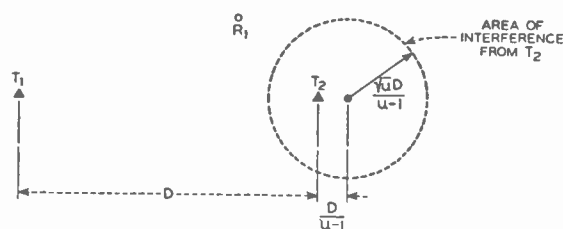

$T_1$  AND  $T_2$  ARE LAND-STATION TRANSMITTERS  
 $R_1$  IS A MOBILE RECEIVER  
 INTERFERENCE AREA IS THAT IN WHICH  $\frac{\text{FIELD (VOLTAGE) FROM } T_2}{\text{FIELD FROM } T_1}$  IS  
 GREATER THAN A SPECIFIED VALUE OF  $u$ , WHERE  $u$  IS THE ADVERSE  
 RATIO WHICH  $R_1$  CAN TOLERATE WITHOUT INTERFERENCE.

Fig. 3—Interference by one land transmitter to transmission from another land transmitter.

by the distance  $D$ .  $R_1$  is a mobile unit designed to receive from  $T_1$ . It can be shown that, if  $R_1$  is located

within the interference circle shown on the diagram, the amount of voltage the receiver picks up from  $T_2$  will be more than  $u$  times as much as from  $T_1$ . If  $u$  is the just-tolerable voltage ratio of interfering to desired carriers, then interference will result whenever  $R_1$  lies within the interference circle. The probability of this occurring is, of course, simply the probability of  $R_1$  being located within the small circle. Where the position  $R_1$  is completely random, the probability is, therefore, the ratio of the area of the interference circle to the service area.

It is interesting to note in Fig. 3 that, for a given value of  $u$ , the interference circle diminishes as the distance between the two transmitters decreases. Theoretically, then, the interference circle is infinitesimally small if the two transmitters are located very close together.

The above probabilities were computed on the basis that the interfering channel was in use all of the time. If the interfered-with channel is in use only part of the time, the probability figure indicates the fraction of that time in which interference may be expected. On the other hand, where the interfering channel is in use only a fraction of the time, the probability of interference is less, and may be obtained by multiplying the value obtained from the formula by this fraction.

The amount of suppression of outputs and responses in the equipment which is required in order that interference shall not be too frequent depends, therefore, upon a specification of a permissible probability of interference. So far, there does not appear to be any standard of good engineering practice which specifies an acceptable value for this probability. An acceptable value needs to be determined by field experience. In lieu of this, however, it may be estimated tentatively that a value somewhere between 0.01 and 0.1 per cent might be considered acceptable for the present.

#### SPURIOUS PRODUCTS AND RESPONSES IN RADIO EQUIPMENT

Up to this point the discussion has centered around the power levels encountered in communications systems and, as related to them, the amounts of spurious outputs and responses which may be important from the interference standpoint. In the following paragraphs the characteristics of these responses and outputs are illustrated by sample measurements which show their general magnitude. A brief discussion as to their cause is also given. Formulas are included which can be used to predict the frequencies at which spurious outputs and responses will occur.

##### *Spurious Outputs of One Transmitter*

While transmitters may emit power at frequencies just outside of their allotted transmission channel because of improper modulation, emphasis is placed here upon another type of spurious output which is present regardless of modulation.



Due to the methods employed in producing the frequency which it is desired to radiate, spurious radiations are almost always formed in such quantity that they can not be ignored in the type of service now contemplated. An example of spurious r.f. power as measured out of one type of transmitter is shown in Fig. 4. While this example happens to be an a.m. transmitter, it serves to illustrate both a.m. and f.m. equipment.

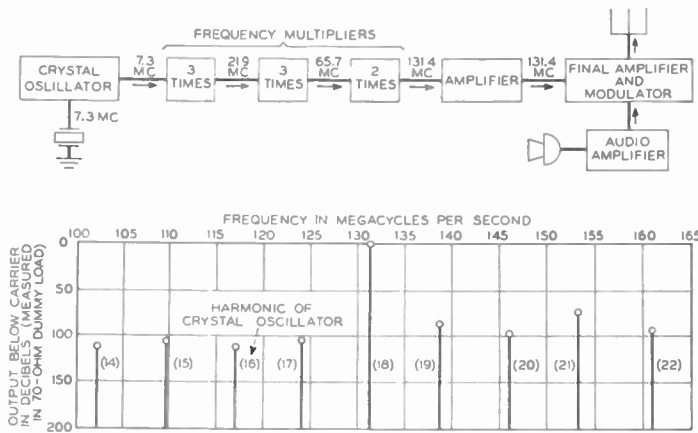

Fig. 4—Block schematic and spurious outputs of a 131.4-Mc. radio transmitter.

The method by which these spurious components arise suggests the frequencies at which they will occur. In f.m. transmitters it is common to start with an oscillator of relatively low frequency, which is a submultiple of the desired signal frequency, modulate this signal, and then pass the signal through a series of frequency-multiplying stages (harmonic producers). Unfortunately, other harmonics of the base-frequency oscillator “leak” through. It is not unusual, for example, to start with a 1-Mc. crystal to control a transmitter of 96 Mc. In such a case, spurious outputs occur at 1-Mc. intervals throughout a large part of the spectrum.

If straight frequency multiplication is employed between the master oscillator and the final output, and if  $f_{opr}$  = operating frequency,  $f_{mo}$  = master-oscillator frequency,  $f_{opr} = Nf_{mo}$ , and  $n$  = any integer, then r.f. outputs will occur at frequencies given by  $f_{out}$  in the following equation:

$$f_{out} = nf_{mo} = \frac{n}{N} f_{opr}. \tag{2}$$

In choosing operating frequencies so as to avoid interference from spurious outputs, it is sometimes desirable to be able to read the spurious output frequencies which result for any given operating frequency of a particular type of equipment. For this purpose, a chart which graphs the various possibilities is useful. A sample chart applying to the transmitter of Fig. 4 is shown in Fig. 5.

In another type of transmitter the final signal is obtained by mixing together (heterodyning) an unmodulated signal, generated in the same manner as described for the above case, with another signal which has been

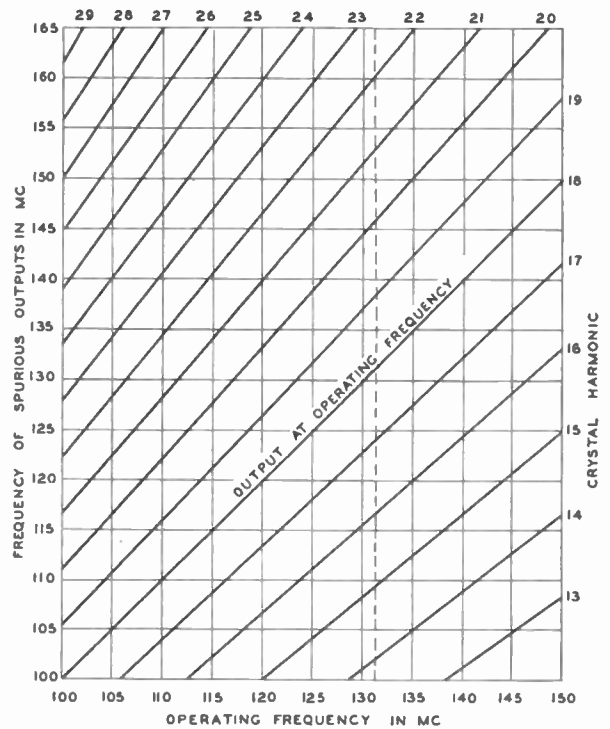

Fig. 5—Spurious output frequencies for the transmitter of Fig. 4.

frequency-modulated. In the mixing process, the sum and difference of these two frequencies are generated. One or the other of these is the operating frequency. This is selected for amplification by means of tuned circuits. The other product, however, is never completely eliminated by this selection. Other products arise also because of higher-order nonlinearity. If  $f_1$  and  $f_2$  are the frequencies which are mixed together, the frequencies at which outputs may be expected are:

$$f_{out} = n_1f_1 \pm n_2f_2. \tag{3}$$

The most important of these outputs may be expected at frequencies computed in (3) by assuming values of 0 or 1 for  $n_1$  and  $n_2$ .

#### Spurious Outputs Resulting from Two Coupled Transmitters

A description was given previously of the manner in which energy received in the tank circuit of one transmitter from another transmitter could cause the generation of new spurious outputs. If  $f_1$  is the frequency of the first transmitter and  $f_2$  the frequency of the second, the output of transmitter 1 may be expected to contain energy at

$$f_{out} = n_1f_1 \pm n_2(f_2 - f_1). \tag{4}$$

One of the values computed from this equation will, of course, equal  $f_2$  itself.

By way of illustrating this type of action, a brief test has been made using two transmitters wherein part of the output of one of these transmitters operating at 71.8 Mc. ( $f_2$ ) was loosely coupled by means of a loop of wire

to the tank circuit of another transmitter operating at 71.6 Mc. ( $f_1$ ). The load connected to the latter transmitter was found to contain the frequency components and relative amounts of power shown in Table I.

TABLE I

Frequency in Mc.	$f_{out}$	Relative level in db
71.0	$f_1 - 3 \times (f_2 - f_1)$	-76
71.2	$f_1 - 2 \times (f_2 - f_1)$	-47
71.4	$f_1 - 1 \times (f_2 - f_1)$	-22
71.6	$f_1 \pm 0 \times (f_2 - f_1)$	0 (reference)
71.8	$f_1 + 1 \times (f_2 - f_1)$	-17
72.0	$f_1 + 2 \times (f_2 - f_1)$	-46
72.2	$f_1 + 3 \times (f_2 - f_1)$	-60

This type of performance is distinct from a possible phenomenon in which modulation from one becomes incorporated as modulation on the other signal. There is no experimental evidence at hand, but theoretical study indicates that, if the latter phenomenon occurs at all, it will be a minor effect.

*Spurious Outputs from Receivers*

In a superheterodyne receiver (essentially all receivers in the v.h.f. range are of this type), the fundamental or harmonics of its local oscillator may be present in the input circuit of that receiver. As mentioned previously, this constitutes spurious energy which may be radiated and cause interference to near-by receivers.

In some receivers the heterodyning frequency is obtained as a harmonic of an oscillator generating a lower frequency. Quite often this is a crystal-controlled oscillator. Spurious radiation may be expected at all of its harmonics.

The spurious outputs at the antenna jack of the receiver pictured in the block diagram of Fig. 6 measure as shown in Table II. In some receivers, the magnitude

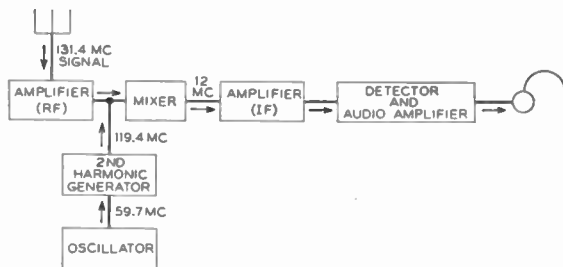

Fig. 6—Block schematic of a 131.4-Mc. radio receiver.

has been measured as high as 80 or even 100 db above 1 microvolt. In addition, the receiver cited above is not typical in that the oscillator frequency is high as compared with the heterodyning frequency. A more

TABLE II

Frequency in Mc.	Output in db above 1 $\mu$ v.
59.7	59
119.4	67

typical receiver would show spurious outputs of the same approximate magnitude, but many more of them scattered through the frequency spectrum (because of a lower base frequency).

The spurious outputs may be expected at  $f_{out} = n_{het} f_{het}$  where  $n_{het}$  is any integer and  $f_{het}$  is the frequency used in the mixer stage. If  $f_{het}$  is derived by frequency multiplication,  $f_{het} = N_{osc} \times$  a master-oscillator frequency  $f_{osc}$ , spurious outputs may be expected at any harmonic,  $n_{osc}$ , of  $f_{osc}$ . Thus,

$$f_{out} = n_{osc} f_{osc} = \frac{n_{osc}}{N_{osc}} f_{het}. \tag{5}$$

Since  $f_{het}$  is known in terms of the operating frequency for a particular equipment, it is possible to make a graph of the output frequencies plotted against the operating frequency. This has been done in Fig. 7 for the receiver of Fig. 6.

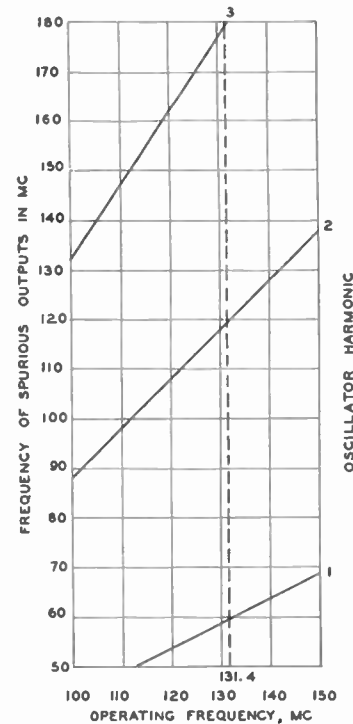

Fig. 7—Spurious output frequencies for the receiver of Fig. 6.

*Spurious Responses of Receivers*

Everyone is familiar, of course, with the fact that a receiver will show some response to signals which are near the edge of its pass band. The selectivity gradually increases at frequencies further removed from the pass band. An example of this selectivity is given in Fig. 8(a).

Most receivers are of the superheterodyne type illustrated by Fig. 6. This converts the signal to one of lower (intermediate) frequency at which better band-pass and gain characteristics are possible. It is not practicable to build frequency converters in which one band of frequencies and one only is converted to the intermediate frequency. Instead, there are many frequencies which

may be translated to this same intermediate frequency. Therefore, the over-all frequency-pass characteristic of a receiver shows many bands of frequencies for which the attenuation is much lower than might be expected from adding the selectivities of the r.f. and i.f. amplifier stages. These are called spurious response frequencies, of which "image" response is the most familiar example. This class of response is manifest as the specific high points in the characteristic shown in Figs. 8(a) and 8(b). The significance of the associated numbers is explained later.

circuits preceding the mixer. In some sets this selectivity may be only 40 db, while sets which show upward of 80-db selectivity in this respect are considered good at the present time.

A receiver designed so that  $f_{opr} = f_{het} + f_{if}$  will have an image response at

$$f_{resp} = f_{opr} - 2f_{if} \tag{9}$$

For a receiver in which  $f_{opr} = f_{het} - f_{if}$ ,

$$f_{resp} = f_{opr} + 2f_{if} \tag{10}$$

*Responses at Submultiples of the Operating Frequency:* A series of spurious responses can also occur at

$$f_{resp} = \frac{f_{opr}}{n_{rf}}$$

where  $n_{rf} = 1, 2, 3$ , etc. When such frequencies are applied to the receiver input, the nonlinear characteristics of the r.f. and mixer stages cause the appearance of harmonics in the mixer stage. In each case, one of these harmonics,  $n_{rf} f_{resp}$ , will equal  $f_{opr}$  to which the receiver is sensitive.

*Responses Due to Harmonics of the Heterodyning Frequency:* The heterodyning frequency is not usually a pure frequency,  $f_{het}$ , but includes harmonics such as  $2f_{het}, 3f_{het}, \dots, n_{het} f_{het}$ . Such harmonics will beat with certain incoming frequencies  $f_{resp}$  to produce  $f_{if}$  in the output of the mixer. This occurs when

$$n_{het} f_{het} - f_{resp} = f_{if} \tag{11}$$

or

$$f_{resp} - n_{het} f_{het} = f_{if} \tag{12}$$

That is, when

$$f_{resp} = n_{het} f_{het} \pm f_{if} \tag{13}$$

*Responses Due to Harmonics of Base Frequency  $f_{osc}$ :* If the desired heterodyning frequency is obtained by using a particular harmonic of a master oscillator of lower frequency (for example, from a crystal oscillator) as is common in v.h.f. receivers,  $f_{het}$  may be defined as  $N_{osc} f_{osc}$  where  $N_{osc}$  is the particular harmonic of  $f_{osc}$  chosen for amplification before application to the mixer grid. Other harmonics of  $f_{osc}$  also reach the mixer grid in varying strengths. Any harmonic of  $f_{osc}$  is here designated  $n_{osc}$ , whereas  $N_{osc}$  refers to the one used in the normal response. But each of these harmonics causes the receiver to respond at related frequencies, as follows:

$$f_{resp} = n_{osc} f_{osc} \pm f_{if} \tag{14}$$

This is similar to (13), but brings in new responses due to harmonics of the base-frequency oscillator.

*Responses Due to R.F. Harmonics in Combination with Harmonics of the Heterodyning Frequency or of the Base Frequency:* Harmonics of an incoming signal  $n_{rf} f_{resp}$  may combine in the mixer with  $n_{het} f_{het}$  or  $n_{osc} f_{osc}$  to produce  $f_{if}$ . Numerous responses are so formed. The most important of these are those for which  $f_{resp}$  is within  $\pm 5$  or

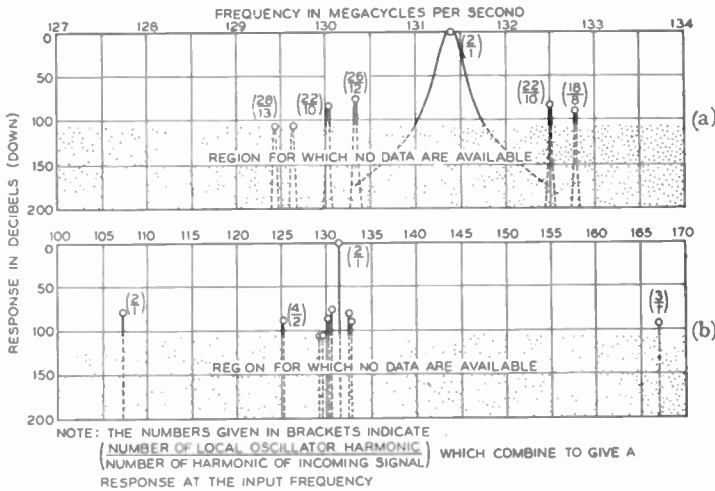

Fig. 8—R.f. response measured on the radio receiver shown in Fig. 6. (a) Near the operating frequency. (b) Over a wide frequency range.

*Normal Response:* If  $f_{if}$  is the intermediate frequency (or small band of frequencies) of the receiver,

$$f_{opr} = f_{he} + f_{if} \tag{6}$$

in some receivers, by design, and

$$f_{opr} = f_{het} - f_{if} \tag{7}$$

in others.

In the formulas to follow,  $f_{resp}$  will be used to indicate any input frequency which will produce a response, particularly spurious response.

*Intermediate-Frequency Response:* Signals within the intermediate-frequency pass band will cause the receiver to respond if there is insufficient shielding or selectivity between the r.f. input and the i.f. amplifier. Thus, for this case,

$$f_{resp} = f_{if} \tag{8}$$

*Image Response:* The image response exists because when a signal of this frequency is applied to the mixer of the receiver along with the heterodyning oscillator signal, the difference frequency which is formed is the intermediate frequency. When this occurs, the i.f. amplifier cannot distinguish this false signal from the true one. The fact that the image response is not as great as the main response is due solely to the selectivity of the

$\pm 10$  per cent of  $f_{opr}$ . The frequencies at which these responses occur are

$$f_{resp} = \frac{n_{het}}{n_{rf}} f_{het} \pm \frac{f_{if}}{n_{rf}} \quad (15)$$

or

$$f_{resp} = \frac{n_{osc}}{n_{rf} N_{osc}} (N_{osc} f_{osc}) \pm \frac{f_{if}}{n_{rf}} \quad (16)$$

The resulting values of  $f_{resp}$  will be formed near  $f_{opr}$  when

$$\frac{n_{het}}{n_{rf}} \quad \text{or} \quad \frac{n_{osc}}{n_{rf} N_{osc}}$$

takes on values equal to  $2/2$  and  $3/3$ ; also values near unity such as  $\frac{2}{3}$ ,  $\frac{3}{4}$ ,  $\frac{4}{5}$  up to, say,  $19/20$ , or values  $3/2$ ,  $4/3$ ,  $5/4$  up to, say,  $20/19$ .

It will be noted that (15) and (16) are general in the sense that all of the equations pertaining to receivers in the preceding paragraphs can be derived from them by assigning appropriate values to the various  $n$  quantities.

Figs. 8(a) and (b) show the spurious response characteristic as measured for the receiver of Fig. 6. The various responses are labeled in a fashion which describes how their frequencies can be derived from (16).

As in the case of spurious outputs from transmitters and receivers, the response frequencies of a given design of receiver can be plotted as a function of the operating frequency. This is illustrated by Fig. 9, which applies to the receiver of Fig. 6. The lines shown are for responses which have been observed through measurement of a receiver tuned for 131.4 Mc.

Regarding the magnitude of spurious responses computed from (15) or (16), it has been found by experience that the responses which are measurable within 5 or 10 per cent of the operating frequency tend to be down from the main response by a flat number of db plus the amount of selectivity in the r.f. stages. This, of course, is merely an empirical rule which follows the observation of typical receiver characteristics. The "flat" number of db differs from one receiver to another between about 60 and 100 db, depending on the quality of r.f. amplifier and mixer. If it were not for r.f. selectivity, many more responses of this class (that is, involving high integers

for  $n_{rf}$ ,  $n_{osc}$ , or  $n_{het}$ ) would be high enough to be causes of interference over a much wider range of frequencies.

*Location of Responses in a Superheterodyne Receiver Having Two Mixers:* The location of spurious response frequencies in a receiver which has two heterodyning stages (many v.h.f. receivers are of this class) can be obtained by applying the formulas given in (15) or (16) in two steps.

In the first step, that portion of the receiver following the first mixer is assumed to contribute no spurious responses. In the second step, that portion of the receiver ahead of the second mixer is assumed to perform as an amplifier (equivalent to the r.f. amplifier of a receiver having only one mixer).

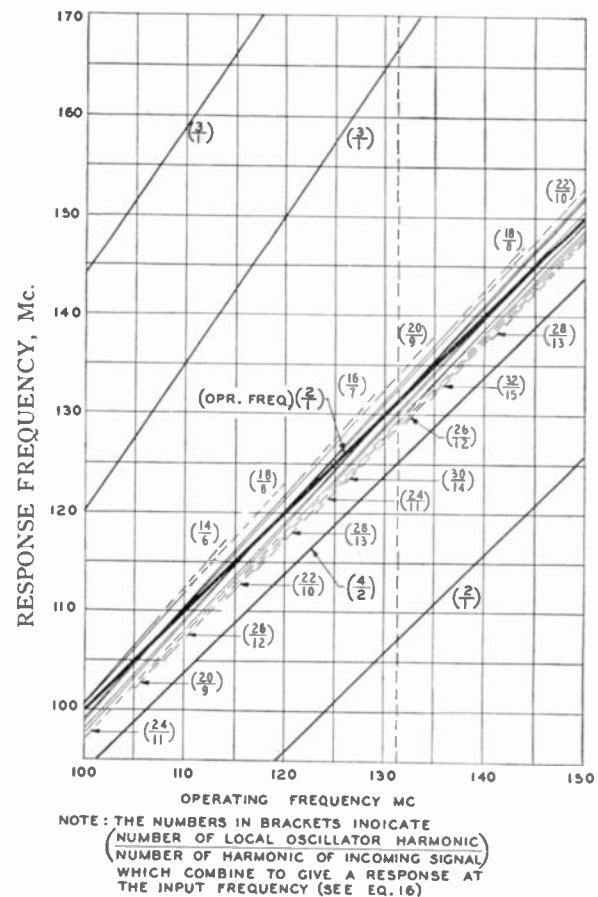

Fig. 9—Some of the response frequencies for the receiver of Fig. 6.

## Contributors to Waves and Electrons Section

Ralph D. Bennett (SM'44) was born in Williamson, N. Y., on June 30, 1900. He holds the degrees of B.S. and M.S. in electrical engineering, Sc.D. (Hon.) from Union College, and Ph.D. from the University of Chicago.

After teaching for three years at Union College he was awarded a National Research Fellowship at Princeton during 1926-1927, and at the California Institute of Technology during 1927-1928. He spent three years as Research Associate at the University of

Chicago, after which he joined the electrical engineering staff of the Massachusetts Institute of Technology as associate professor of electrical measurements. He was made professor in 1937.

In 1940, Dr. Bennett went on active duty in the Naval Reserve, rising to the rank of captain in 1943, and remaining in that capacity until 1947 at the Naval Ordnance Laboratory. Since 1944 he has been technical director of the Laboratory, the position he now holds in a civilian status.

Dr. Bennett is a member of Sigma Xi, the American Institute of Physics, the Washington Philosophical Society, and the American Society for Engineering Education. He is also a Trustee of Union College, a Fellow of the American Physical Society, and a Fellow of the American Institute of Electrical Engineers. He is the author of many papers on X rays, cosmic rays, ionization measurements, and electrical measurements.



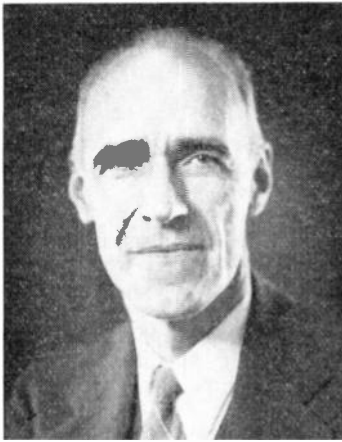

RALPH D. BENNETT



Donald G. Fink (A'35-SM'45-F'47) was born on November 8, 1911, in Englewood, N. J. He received the B.Sc. degree in 1933 from the Massachusetts Institute of Technology, and the M.Sc. degree in 1942 from Columbia University. Mr. Fink is the editor-in-chief of the journal *Electronics*. He has served on the following I.R.E. committees: Membership, Radio Aids of Navigation, Handbook, Papers, Board of Editors, Television, Annual Review, Standards, Research, Awards, and Papers Review.

Mr. Fink was the recipient of the Medal of Freedom from the War Department in 1946. The I.R.E. Fellow Award was conferred "in recognition of his espousal of high standards of technical publishing and for his wartime contributions in the field of electronic aids to navigation."



J. R. Gerhardt was born in Omaha, Neb., on April 29, 1918. He received the B.S. in engineering science in 1940 from the Illinois Institute of Technology. He entered the Air Corps in 1941 and graduated from the New York University meteorology course for weather officers in 1943. In 1944 he was given training in radar and radio propagation, leading to assignments from 1944 to 1946 with Radiation Laboratories at M.I.T., the A.A.F. Board at Orlando, Fla., and with the



DONALD G. FINK



J. R. GERHARDT

OCSigO on their radio relay projects in California and Florida.

Since 1946 Mr. Gerhardt has been associated with the Electrical Engineering Research Laboratory of the University of Texas as chief meteorologist. He is a member of Phi Lambda Upsilon, The American Meteorological Society, The American Geophysical Union, and The New York Academy of Sciences.



A. W. Nolle was born on July 28, 1919, in Columbia, Mo. He received the B.A. degree from the Southwest Texas State College in 1938 with a major in chemistry. From 1938 until 1941 he did graduate study in physics at the University of Texas, from which he received the M.A. degree in 1939. During the war years he engaged in research in underwater sound and ordnance problems at the Underwater Sound Laboratory, Harvard University, and at the Ordnance Research Laboratory, Pennsylvania State College.

From 1945 until 1947 Dr. Nolle was a research associate in physics at the Massachusetts Institute of Technology, where he conducted research on the dynamic mechanical properties of rubber-like materials under the auspices of the Acoustics Laboratory. In 1947 he received the Ph.D. degree from the Massachusetts Institute of Technology. At the present time he is assistant professor of physics at the University of Texas, Austin, Tex. His research interests have included electronics, musical and physical acoustics, and the macroscopic properties of matter.



A. W. NOLLE

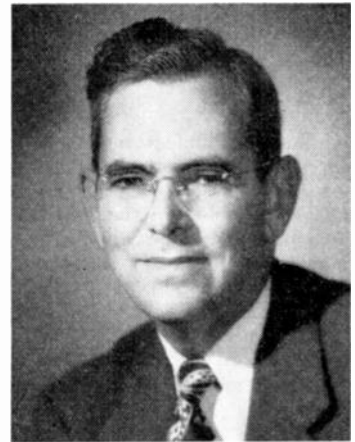

A. W. STRAITON

A. W. Straiton (M'47) was born in Tarrant County, Tex. on August 27, 1907. He received the B.S. degree in electrical engineering in 1929, the M.A. in 1931, and the Ph.D. in 1939 from The University of Texas.

Dr. Straiton spent one year at Bell Telephone Laboratories, after which he taught at Texas College of Arts and Industries as assistant professor, associate professor, and professor of electrical engineering. From 1941 to 1943, he was head of the Department of Engineering, Institutional Representative of E.S.M.W.T., and director of the Pre-Radar Training courses.

Since 1943, he has been associate professor of electrical engineering at The University of Texas. He was recently made director of the Electrical Engineering Research Laboratory.

Dr. Straiton is a member of Sigma Xi, Tau Beta Pi, Eta Kappa Nu, the American Institute of Electrical Engineers, and the American Society for Engineering Education.



W. Rae Young, Jr., (A'42) was born in Michigan in 1915. He received the B.S. degree in electrical engineering from the University of Michigan in 1937. Upon graduation he joined the technical staff of the Bell Telephone Laboratories, Inc., where, until the beginning of the war, he worked on teletypewriter circuit problems. During the war he was assigned to do development work on radar systems for the Armed Forces, and later to problems on radio systems for the National Defense Research Committee. Since the war he has been working on the development of mobile radio systems.

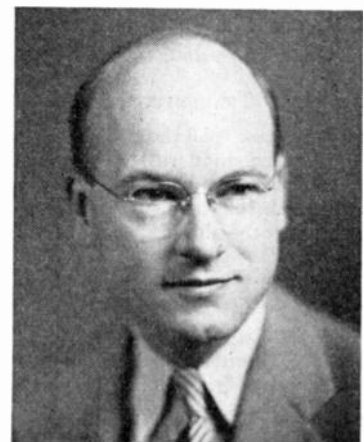

W. RAE YOUNG, JR.

# RMA Standards

The Radio Manufacturers Association, through its Engineering Department, has granted The Institute of Radio Engineers permission to publish in the PROCEEDINGS the following RMA standards which are believed to be of particular interest to the readers of the PROCEEDINGS. The granting of this permission is gratefully acknowledged.

The Radio Manufacturers Association specifically states in connection with these standards that:

"The adoption of recommended standards and practices by the Association does not insure users of them against liability for infringement of patents or proprietary rights and does not constitute a recommendation of patented commodities. It has been established as a policy of the Association that patents do not necessarily influence the adoption of standards which might relate to patented articles, materials, or processes."

In the case of standards adopted and issued jointly by the Radio Manufacturers Association and the National Electrical Manufacturers Association, these standards were formulated by the Joint Electron Tube Engineering Council. JETEC is sponsored by both RMA and NEMA to develop standards, proposals, and data dealing with electron tubes and allied sealed devices.

RMA-NEMA standards are adopted in the public interest and are designed to eliminate misunderstandings between the manufacturer and the purchaser and to assist the purchaser in selecting and obtaining, without delay, the proper product for its particular need. Existence of such standards does not in any respect preclude any member or nonmember of RMA or NEMA from manufacturing or selling products not conforming to the standard.

## TR—104\*

### ELECTRICAL PERFORMANCE STANDARDS FOR TELEVISION BROADCAST TRANSMITTERS, CHANNELS 1 TO 13 (44 TO 216 Mc.)

#### SECTION A—TELEVISION TRANSMITTER

Standards recommended in this section apply to the complete station or to both aural and visual transmitters.

#### 1. TELEVISION TRANSMITTER

(a) *Definition*—All the equipment necessary to take the standard RMA transmitter input signals and convert them to standard output signals as defined by RMA and applied to both aural and visual transmitters.

#### 2. POWER RATING

(a) *Definition*—The power rating of a television transmitter shall be the same as that of the visual transmitter portion.

\* Published by RMA, December, 1947.

#### 3. CARRIER-FREQUENCY RANGE

(a) *Definition*—The continuous range of carrier frequencies to any one of which the transmitter may be adjusted for normal operation meeting all the RMA performance standards.

(b) *Minimum Standard*—The minimum carrier-frequency range shall be such as to assure that the transmitter will perform in accordance with these RMA standards at any one frequency assignment as selected by the purchaser.

(c) *Method of Measurement*—The carrier-frequency range of the transmitter is determined by measuring the minimum and maximum carrier frequency to which the transmitter can be adjusted to meet the RMA performance standards. Any suitable frequency meter may be used.

#### 4. MAGNITUDE OF RADIO-FREQUENCY HARMONICS

(a) *Definition*—A sinusoidal component of a periodic wave having a frequency which is an integral multiple of the fundamental or carrier frequency. For example, a component, the frequency of which is twice the carrier frequency, is called the second harmonic.

(b) *Minimum Standard*—Radio-frequency harmonics radiated by a transmitter shall be maintained at as low a level as the state of the art permits.

(c) *Method of Measurement*—Field-intensity measurements may be made after a transmitter is installed and working into its normal antenna system. For methods of measurement, refer to I.R.E. Standards of Transmitter and Antennas, 1938, Section III, Methods of Testing Transmitters.

#### 5. RATED POWER SUPPLY

(a) *Definition*—The rated power supply of the transmitter is described by specifying the voltage, the number of phases, and the frequency of the supply with which the transmitter shall be required to meet all applicable RMA standards of performance for such apparatus.

(b) *Standard*—The rated power supply for each of the standard outputs shall be as follows:

Rated Output	Voltage	Phases	Frequency
0.5 kw.	208/230	1	60 <sup>2</sup>
5 kw.	208/230	3	60 <sup>2</sup>
50 kw.	1	3	60 <sup>2</sup>

(c) *Method of Measurement*—Standard power-measurement practice shall be followed.

#### 6. POWER-SUPPLY VARIATION

(a) *Definition*—The term "power-supply variation" includes all differences between the standard rated voltage and frequency of

<sup>1</sup> The power-supply voltage for a 50 kw. rated output transmitter is considered special and can be arranged with the purchaser.

<sup>2</sup> It is recommended that 50/60-cycle components be used wherever economically feasible.

the power supply (shown in the above table) and the corresponding characteristics of the actual power supply.

(b) *Minimum Standard*—The transmitter shall be capable of meeting all applicable RMA standards of performance for such apparatus under the following power-supply variations.

1. For single-phase power supplies, the voltage shall at all times under normal conditions be within 5 per cent of the rated voltage.

2. For 3-phase power supplies, the voltage from phase to phase shall at all times under normal conditions be within 2 per cent of the average for the three phases and within 5 per cent of the standard rated voltage.

3. The regulation from no load to full load shall not exceed 3 per cent.

4. The frequency of the power supply shall be within 2 per cent of the transmitter power-supply rated frequency.

(c) *Method of Measurement*—Standard power-measurement practice shall be followed.

#### 7. CROSS TALK BETWEEN VISUAL AND AURAL TRANSMISSIONS

(a) *Definition*—The video modulation of the aural transmission, or audio modulation of the visual transmission.

(b) *Minimum Standard*

(1) Cross talk from aural into the visual transmission (amplitude modulation) in the band from 0 to 4.5 Mc. shall be at least X db below the level represented by synchronizing peaks.

(2) Cross talk from the visual into the aural transmission (frequency modulation) in the band from 50 to 15,000 c.p.s. shall be at least Y db below the audio-frequency level representing a frequency swing of  $\pm 25$  kc.

(3) Cross talk from the visual into the aural transmission (amplitude modulation) in the band from 50 to 15,000 c.p.s. shall be at least Z db below the level representing 100 per cent amplitude modulation.

(The values of X, Y, and Z cannot be specified at this time.)

(c) *Method of Measurement*—The measurements shall be made on the radiated signal since the presence of an unwanted signal on the transmission line is not necessarily an indication of remodulation.

(1 and 2) A method of measurement of cross talk when the unwanted modulation is of the same type as the transmitter under consideration consists of applying low-frequency (1000 c.p.s.) modulation at full level alternately to one transmitter and then the other. The carrier level chosen for the unmodulated condition of the visual transmitter shall be black level. A listening test is made with an f.m.-a.m. receiver with an accurately calibrated output meter located near the antenna, but not near enough to permit any likelihood of saturation or direct pickup within the receiver. The receiver is tuned to one transmission, and the modulation level determined when that transmitter

is modulated. The reduction in level is then measured while the other transmitter is modulated but the first transmitter is unmodulated.

(3) A method of measurement of cross talk of amplitude modulation into the aural transmission consists of measuring the d.c. and r.m.s. a.c. output of a linear second detector of an a.m. receiver tuned to the aural transmitter with the visual transmitter tuned off. The visual transmitter is then turned on and modulated with a 1000 c.p.s. tone at full level and the r.m.s. a.c. detector output reread. The cross talk is then the ratio of the square root of the difference of squares of the two r.m.s. a.c. outputs to 0.707 times the d.c. voltage.

**CAUTION 1:** Care should be exercised that extraneous noise is not causing a reading or that cross talk is not caused by other factors than the system being tested.

**CAUTION 2:** In the measurement of the f.m. cross talk into the aural transmitter, an f.m. receiver with proper limiting and de-emphasis should be employed.

**CAUTION 3:** The f.m. receiver should have a minimum r.f. bandwidth of 50 kc. and minimum audio bandwidth of 15 kc. The a.m. receiver should have a minimum r.f. bandwidth of 30 kc. and minimum audio bandwidth of 15 kc.

**CAUTION 4:** No a.v.c. should be employed in the receiver.

## 8. INTERFERENCE INTO OTHER SERVICES

(a) *Definition*—Radiation outside of the assigned channel great enough to disturb other services. These may be caused by a beat between the visual and aural carriers within either or both transmitters.

(b) *Minimum Standard*—Radiation outside the assigned channel shall be as low as practicable and in any case shall not disturb other services.

(c) *Method of Measurement*—The interference level can be measured by a field-strength meter. **NOTE:** The meter must be near enough to the transmitting antenna to pick up the out-of-channel sidebands if they exist, but must not be near enough to have a likelihood of direct pickup or saturation within the field-strength meter. The test should be made at several locations to avoid null conditions.

## SECTION B—VISUAL TRANSMITTER

Standards recommended in this section apply to the visual transmitter only.

### 1. VISUAL TRANSMITTER

(a) *Definition*—The radio-frequency circuits and modulation equipment required to deliver the standard output signal as defined by RMA (see Appendix A for synchronizing wave form) into a nonreactive load when a standard visual transmitter input signal is applied at the input.

### 2. POWER OUTPUT RATING

(a) *Definition*—It shall be standard to rate the visual transmitter in terms of its peak power output when transmitting a standard visual transmitter output signal. Peak power shall be defined as the power averaged over an r.f. cycle corresponding to peak amplitude.

(b) *Standard*—The standard ratings of peak power output for visual transmitters shall be 0.5, 5, and 50 kw.

(c) *Method of Measurement*—The average power output shall be measured while operating into a dummy load of substantially zero reactance and a resistance equal to the surge impedance of the transmission line terminating the transmitter while transmitting the standard black television picture. The peak power shall be the reading obtained above multiplied by the factor 1.68.

In the event that suitable impedance- and voltage- or current-measuring instruments become available, direct measurements of peak power may be used instead of the method outlined above.

### 3. VARIATION OF OUTPUT

(a) *Definition*—The change in peak amplitude during a period not exceeding one frame in length. Variation of output results from such things as: hum, noise, and incorrect low-frequency response.

(b) *Minimum Standard*—The variation of output shall not exceed 5 per cent of the average of the peak signal amplitude.

(c) *Method of Measurement*—The wave form measurement established under "pedestal level," Section B-14(c), may be used. The height of the highest and lowest sync peaks shall be measured. Their difference shall not exceed 4.5 per cent of the highest sync peak. This will assure less than 5 per cent variation of the average peak-signal amplitude. The over-all accuracy of the measuring equipment shall be sufficient that it shall be possible to measure variation of amplitude with an accuracy of  $\pm 1$  per cent of the total peak amplitude.

### 4. PEAK POWER OUTPUT ADJUSTMENT

(a) *Definition*—The control either manual or automatic to maintain the transmitter output power within definite limits over long time intervals.

(b) *Minimum Standard*—Adjustment shall be provided such that the peak power output can be adjusted to any given value for all probable normal changes in line voltage, tube aging, antenna icing, or other conditions which would change the peak power output.

(c) *Method of Measurement*—The power output shall be measured by a calibrated device responding to peak voltage or current in the antenna transmission line while working into either the actual antenna or suitable dummy load. The device shall be calibrated by means of measurements described under Method of Measurements: "Power Output Rating."

In the event that suitable impedance- and voltage- or current-measuring instruments become available, direct measurements of peak power may be used instead of the method outlined above.

### 5. REGULATION OF OUTPUT

(a) *Definition*—The change in peak signal amplitude with change in average brightness of the transmitted picture.

(b) *Minimum Standard*—The change in peak signal amplitude from an all-black to all-white picture shall not exceed 10 per cent of the signal amplitude with an all-black picture.

(c) *Method of Measurement*—The regulation of output shall be measured by a device whose indication is proportional to peak voltage or current in the antenna transmission line while working into either the actual antenna or a suitable dummy load.

## 6. CARRIER FREQUENCY STABILITY

(a) *Definition*—A measure of the ability of the transmitter to maintain an assigned average frequency.

(b) *Minimum Standard*—The frequency control of a visual transmitter shall be such as to maintain the operating carrier frequency within  $\pm 0.002$  per cent of the assigned value.

(c) *Method of Measurement*—The frequency of a visual transmitter shall be measured by extracting a sample of unmodulated carrier, or of the modulated carrier if suitable frequency monitors are made available, and measuring its frequency by equipment having a degree of accuracy of  $\pm 0.001$  per cent, or better.

## 7. LOWER-SIDEBAND ATTENUATION

(a) *Definition*—The amplitude versus frequency characteristic of modulation products lower than the frequency of the visual transmitter carrier.

(b) *Minimum Standard*—The voltage of the lower sideband shall not be greater than minus 20 db, using the 200-kc. sideband voltage as a reference, for a modulating frequency of 1.25 Mc. or greater.

(c) *Method of Measurement*—It is recommended that the sideband attenuation characteristics of a visual transmitter be measured by the application of a modulating signal to the transmitter input terminals in place of the normal composite television video signal. The signal applied shall be a composite signal consisting of the normal television synchronizing impulses (to aid in maintaining the transmitter operating levels at normal values) plus a variable-frequency sine wave occupying the intervals between pulses. The axis of the sine wave observed in the output monitor shall be maintained at an amplitude of 0.5, the voltage of the synchronizing pulse peaks. The amplitude of the applied sine wave shall be maintained at a constant value. This value shall be such that at no modulation frequency does the maximum value of the signal at the peak of the sine wave, as observed in the output signal monitor, exceed 0.75 of the peak output voltage. The amplitude of the lower-sideband energy of the 200-kc. sidebands when the modulating frequency is 200 kc. shall be measured by means of a field-intensity meter or equivalent and used as reference level. The modulating frequency shall then be varied over the range from 200 kc. to 5 Mc. and the amplitude of the corresponding lower sideband measured. This measurement shall be made with the transmitter operating into a resistive load of the value specified by the transmitter manufacturer.

As an alternate method of measuring in those cases in which automatic d.c. insertion can be replaced by manual control, the above characteristics may be taken by the use of a signal generator and without the use of pedestals and synchronizing pulses. The d.c. level shall be set for mid-characteristic operation.

### 8. PHASE VERSUS FREQUENCY-RESPONSE CHARACTERISTIC

(a) *Definition*—The curve describing the phase of the visual transmitter output envelope with respect to the signal at the input terminals, as the video input frequency is changed.

(b) *Minimum Standard*—Insufficient knowledge regarding the frequency and phase requirements of the program transmitter facility is available to set minimum standards. However, the following general recommendations are considered advisable at this time.

(1) There shall be no intentional pre-emphasis.

(2) It is believed that pulse testing technique should be used.

(3) Recognizing the importance of cumulative degradation, it is recommended that the program transmitter facility shall not appreciably discriminate either as to amplitude or phase against any frequency in the band from 60 c.p.s. to 4.5 Mc. There shall be no appreciable increase in the peak-to-peak amplitude due to frequency or phase characteristics outside of the band specified.

(c) *Method of Measurement*—Final methods of measurement cannot be specified at this time, but experimentation with new transmitters giving satisfactory service should provide information leading to more complete specifications. The most desirable known method of measuring this characteristic consists of applying to the transmitter video input a flat-topped pulse of rapid rise time. A monitor having characteristics as close as practical to that of the idealized receiver should be used to monitor the r.f. emission. The rise time and per cent overshoot of the output of the monitor should be measured.

### 9. TRANSFER CHARACTERISTIC

(a) *Definition*—That function which, when multiplied by an input magnitude, will give a resulting output magnitude.

(b) *Minimum Standard*—Insufficient knowledge regarding transfer characteristic is available to set a minimum standard. However, it is believed that this characteristic should be essentially constant.

(c) *Method of Measurement*—A standard picture signal of uniform shade of gray or a simulated signal from a pulse generator shall be used as a source. The peak-to-peak level of this signal shall be varied from that corresponding to white to that corresponding to black. The r.f. envelope output shall be detected with a linear detector and displayed on an oscilloscope. The peak-to-peak voltages so detected corresponding to black and white shall be taken as the ordinates of a straight line with the respective input peak-to-peak voltage as the abscissa. The deviation from this line for intermediate input should be measured to determine the conformance with the standard. This should be expressed as the ratio of the deviation to the difference of the black and white ordinates.

An alternate method would be to measure average power output at each point, correct for the pulse energy, and take the square root of the results to obtain the ordinate.

### 10. AMPLITUDE VERSUS FREQUENCY CHARACTERISTIC

(a) *Definition*—A description by means of a graph of the ratio of sine-wave output voltage to input voltage applied to a four-terminal network. In the case of a transmitter, this characteristic is taken between the transmitter input terminals and the output terminals of an assumed ideal linear detector.

(b) *Minimum Standard*—The output attenuation characteristic of the transmitter measured in the antenna transmission line after the vestigial sideband filters shall not be greater than:

2 db	at 0.5 Mc.
2 db	at 1.25 Mc.
3 db	at 2 Mc.
4 db	at 3 Mc.
6 db	at 4 Mc.

below the ideal curve shown below. The curve shall be substantially smooth between these specified points exclusive of the region from 0.75 Mc. to 1.25 Mc.

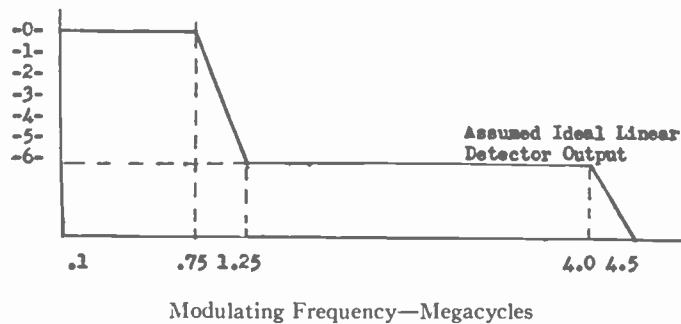

(c) *Method of Measurement*—The output measurements shall be made with the transmitter operating into a dummy load of pure resistance and the demodulated voltage measured across this load. A modulating signal shall be applied to the transmitter input terminals in place of the nominal composite television video signals. The signal applied shall be a composite signal composed of a synchronizing signal to establish peak output voltage plus a variable-frequency sine-wave voltage occupying the interval between synchronizing pulses. The axis of the sine wave in the composite signal observed in the output monitor shall be maintained at an amplitude 0.5 of the voltage at synchronizing peaks. The amplitude of the sine-wave input shall be held at a constant value. This constant value should be such that at no modulation frequency does the maximum excursion of the sine wave observed in the composite output signal monitor exceed the value of 0.75 of peak output voltage. With a 100-kc. modulating signal applied to the transmitter, the amplitude of the detected signal should be measured and designated zero db as a basis for comparison. The modulating-signal frequency shall then be varied over the desired range and the detected signal voltage measured. As an alternate method of measuring, in those cases in which the automatic d.c. insertion can be replaced by manual control, the above characteristic may be taken by the use of a signal generator and without the use of pedestal and synchronizing pulses. The

d.c. level shall be set for mid-characteristic operation.

### 11. TRANSMITTER INPUT LEVEL FOR RATED MODULATION

(a) *Definition*—The peak-to-peak voltage required at the input terminals to modulate the transmitter in accordance with RMA standards when modulating from sync peaks to white level.

(b) *Standard*—A standard composite picture signal input to the transmitter across its standard input impedance shall be a minimum of 1 volt and a maximum of 2.5 volts peak-to-peak when the signal contains reference white.

(c) *Method of Measurement*—The input voltage shall be measured by means of an oscilloscope, having known deflection sensitivity and at least 1 Mc. bandwidth, connected across the input terminals.

The transmitter shall be adjusted to deliver rated peak power into a standard load and shall be modulated so that reference

white-level output occurs at some time during the modulation cycle.

The input voltage shall be determined by measuring the peak-to-peak deflection on the oscilloscope.

### 12. TRANSMITTER INPUT POLARITY

(a) *Definition*—The polarity of a picture signal is determined by the potential of a portion of the signal representing a dark area of a scene relative to the potential of a portion of the signal representing a light area. For convenience, polarity will be given in terms of the black direction of the signal, such as "black negative," or its opposite, "black positive."

(b) *Standard*—The polarity of the transmitter input signal shall be black negative.

(c) *Method of Measurement*—Polarity shall be measured by a cathode-ray oscilloscope having a known deflection polarity.

### 13. TRANSMITTER INPUT IMPEDANCE

(a) *Definition*—Impedance is the complex ratio of voltage to current in a two-terminal network, expressed in ohms.

(b) *Minimum Standard*—The standard video input resistance of a television transmitter shall be 75 ohms single-ended and variable over a range of  $\pm 5$  ohms. At any set value in this range, the resistance component shall be constant within  $\pm 2$  ohms over a frequency range of 0 to 4.5 Mc., and over a range of input d.c. voltage level from 0 to 15 volts. The equivalent series reactance at 4.5 Mc. shall not exceed 10 ohms.



(c) *Method of Measurement*—Standard impedance-measuring technique is suitable.

#### 14. PEDESTAL LEVEL

(a) *Definition*—The level of the r.f. carrier envelope that divides the picture signal amplitudes from the sync signal amplitudes.

(b) *Minimum Standard*—Means shall be provided for setting the pedestal level of the transmitter carrier at  $(75 \pm 1)$  per cent of peak amplitude for any fixed picture content. With variation of picture content, the pedestal level shall not vary from the set level by more than  $\pm x$  per cent of the peak amplitude. (The value of  $x$  cannot be determined at this time.)

(c) *Method of Measurement*. It is believed that the same equipment would be used for this measurement as for measurement of Variation of Output, Section B-3(c).

There are several methods of measuring these phenomena. The following oscillographic means are suggested with a desirable procedure: A sample of the transmitter output signal shall be rectified and the resulting video signal viewed on a cathode-ray oscilloscope. Means for interrupting the r.f. signal ahead of the rectifier to establish a zero level must be provided. D.c. insertion based on synchronizing level or other means must be provided ahead of a cathode-ray tube to prevent change of display with picture content. The synchronizing amplitude should be calibrated by means of a peak-power measuring device. The scope deflection must then be calibrated by other means to establish the tolerance limits of the pedestal and reference white levels.

#### CAUTION:

(1) All a.c. coupled stages should be essentially linear.

(2) The calibration should include the diode characteristic.

(3) A video bandwidth of at least 1 Mc. should be provided.

(4) The vertical resolution of the display tube should be at least 100 lines.

(5) The time constant of the d.c. insertion system shall be such as not to destroy the accuracy of the instrument for measurement of "variation of output."

(6) The interruption of the signal to the rectifier should be less than 10 per cent of the total time. The over-all accuracy of the equipment shall be such that measurements may be made with an accuracy of better than  $\pm 1$  per cent of the total peak amplitude.

#### 15. CARRIER REFERENCE WHITE LEVEL

(a) *Definition*—The carrier amplitude corresponding to reference white level.

(b) *Minimum Standard*—The carrier reference white level amplitude shall not exceed 15 per cent of the peak carrier amplitude.

(c) *Method of Measurement*—The same procedure shall be used as in the Method of Measurement of "Pedestal Level" B-14(c).

#### 16. OUTPUT POLARITY AND VOLTAGE FOR COMPOSITE PICTURE SIGNAL MONITOR CONNECTIONS

(a) *Definition*—Standard acceptable definitions apply.

(b) *Standard*—The standard composite picture signal monitor output connections shall provide a signal, black negative with an amplitude of 0.5 to 2.5 volts peak-to-peak across a resistive impedance of 75 ohms, when transmitting the standard composite picture signal containing reference white.

(c) *Method of Measurement*—Polarity and voltage shall be measured by connecting an oscilloscope having a known deflection polarity and sensitivity across the monitor terminals when operating into a 75-ohm resistive impedance. The oscilloscope input resistance shall not be less than 10,000 ohms shunted by not more than 40  $\mu$ fd. The frequency response shall be essentially flat from 30 c.p.s. to at least 1 Mc., with good transient response.

Polarity shall be determined by observing the direction of deflection of the synchronizing pulse and voltage by measuring the magnitude of deflection.

#### 17. OUTPUT VOLTAGE FOR R.F. MONITOR CONNECTIONS

(a) *Definition*—Standard acceptable definitions apply.

(b) *Standard*—The output terminal for the monitor will deliver r.f. voltage of 1.0 to 2.5 volts r.m.s., during the sync pulse, into a resistive load of 50 ohms.

(c) *Method of Measurement*—The r.f. monitor voltage at the transmitter terminals shall be measured with a peak-reading vacuum-tube voltmeter across the standard monitor impedance.

### SECTION C—AURAL TRANSMITTER

Standards recommended in this section apply to the aural transmitter only.

#### 1. AURAL TRANSMITTER

(a) *Definition*—The aural transmitter is frequency-modulated and is the radio-frequency circuits and modulation equipment required to deliver the standard output signal as defined by RMA standards into a non-reactive load when a standard aural transmitter input signal is applied.

#### 2. CARRIER POWER OUTPUT RATING

(a) *Definition*—The power available at the output terminals of the transmitter when the output terminals are connected to the normal load circuit or to a circuit equivalent thereto.

(b) *Minimum Standard*—The output power of the aural transmitter shall be not less than the rated output at the specified frequency. The standard aural transmitter power ratings shall be as follows:

Television (Visual) Transmitter Ratings	Aural Transmitter Ratings
0.5 kw.	0.25 kw.
5.0 kw.	2.5 kw.
50.0 kw.	25.0 kw.

(c) *Method of Measurement*—There are several methods of measuring the radio-frequency power delivered by a transmitter. The following are typical methods of measurement.

(1) *Voltage-Resistance Method*—In this method, the voltage across the parallel-resistance component of a known impedance is measured. A vacuum-tube voltmeter or a milliammeter in series with a variable air

capacitor calibrated in terms of voltage may be used to measure power.

(2) *Photometric Method*—In this method, a lamp filament heated to incandescence provides the resistive load. The d.c. or a.c. power required to heat the same or a similar lamp to the same brilliance is a measure of the radio frequency dissipated in the load. This comparison should be made by means of a calibrated photoelectric cell. (This method is applicable only when spot heating of the load lamp is avoided.)

(3) *Calorimeter Method*—In this method of measurement, a resistor carrying the radio-frequency power is cooled by water or other liquid surrounding and passing over it. The power dissipated is then calculated from the temperature rise, rate of flow measured in mass per unit time, and specified heat of the cooling fluid, or by a power substitute method.

(4) *Anode-Dissipation Method*—In this method, the total power delivered to the filament, grid, and plate circuits is measured. The power dissipated by the cooling medium is observed, and the difference between this and the total power delivered to the tubes of the output stage gives the radio-frequency power delivered by the transmitter into the output circuit and load. The loss in the output circuit may be measured and subtracted, thus giving the power delivered to the load. (This method is not applicable where power from the driver stage is fed through the output tube and circuit to the load.)

#### 3. CENTER-FREQUENCY STABILITY

(a) *Definition*—The ability of the transmitter to maintain an assigned center frequency in the absence of modulation. The center-frequency stability is expressed as the maximum number of cycles deviation from the assigned frequency, within the limits of normal operation conditions.

(b) *Minimum Standard*—The center frequency shall remain within  $\pm 0.002$  per cent of the assigned frequency.

(c) *Method of Measurement*—The frequency of an aural transmitter shall be measured by extracting a sample of carrier and measuring its center frequency by equipment having a degree of accuracy equal to, or better than,  $\pm 0.001$  per cent.

#### 4. FREQUENCY-MODULATION NOISE LEVEL ON CARRIER

(a) *Definition*—The residual frequency modulation resulting from disturbances produced in the transmitter itself within the band of 50 to 15,000 c.p.s. The level shall be expressed as the ratio of the residual frequency swing in the absence of modulation to the full frequency swing with modulation, as weighted by the effect of a standard 75-microsecond de-emphasis circuit. The standard 75-microsecond pre-emphasis shall be employed in the transmitter.

(b) *Minimum Standard*—The ratio shall be at least 55 db below 100 per cent modulation ( $\pm 25$  kc. swing) within the band of 50 to 15,000 c.p.s.

(c) *Method of Measurement*—The frequency-modulation noise level may be obtained by demodulating a sample of r.f. output of the transmitter and comparing the r.m.s. voltage developed by the demodulator in the absence of modulation voltage to the

r.m.s. voltage obtained with 100 per cent 400 c.p.s. modulation. The audio input terminals of the transmitter shall be shunted by a resistance equal to the transmitter input resistance. The frequency-response characteristic of the demodulator shall be within  $\pm 1$  db of the standard 75-microsecond de-emphasis curve from 50 to 15,000 c.p.s.

##### 5. AMPLITUDE-MODULATION NOISE LEVEL ON CARRIER

(a) *Definition*—The ratio of the r.m.s. value of the amplitude-modulation component (50 to 15,000 c.p.s.) of the carrier envelope to the r.m.s. carrier value in the absence of applied modulating voltage.

(b) *Minimum Standard*—The amplitude-modulation noise level on the aural transmitter carrier shall not exceed  $-50$  db within the band of 50 to 15,000 c.p.s.

(c) *Method of Measurement*—Measurement of the carrier amplitude-modulation noise level may be accomplished by the use of a linear peak-carrier-responsive a.m. detector coupled to the output of a transmitter. Readings are made of the d.c. voltage and the r.m.s. value of the a.c. component across the detector load resistor. The d.c. voltage must be multiplied by 0.707. These measurements shall be made in the absence of modulating voltage. The audio input terminals of the transmitter shall be shunted by a resistance equal to the transmitter input impedance.

##### 6. OUTPUT VOLTAGE AND IMPEDANCE FOR AUDIO AND R.F. MONITOR CONNECTIONS

(a) *Definition*—Standard acceptable definitions apply.

(b) *Minimum Standard*—

*Audio*—If aural monitor connections are provided, the audio output from such connections shall be at least 1 mw. at 100 per cent modulation into an impedance of 600/150 ohms. A 75-microsecond de-emphasis circuit shall be provided for this circuit in the transmitter.

*R.F.*—The radio-frequency output voltage for operating a frequency monitor and/or a modulation monitor shall be at least 10 volts r.m.s. into a resistance of 50 ohms.

(c) *Method of Measurement*—

*Audio*—The audio-frequency voltage for monitoring shall be measured directly across the aural monitoring connections of the transmitter, using a standard vu meter and 400-cycle tone modulation, with the transmitter adjusted to give a frequency swing representing 100 per cent modulation.

*R.F.*—The r.f. monitoring voltage at the transmitter terminals shall be measured with a vacuum-tube voltmeter across a resistance of 50 ohms.

##### 7. MODULATION CAPABILITIES

(a) *Definition*—The maximum frequency swing of which it is capable without objectionable distortion.

(b) *Minimum Standard*—The maximum modulation capability of an aural transmitter shall not be less than  $\pm 50$  kc. At this swing, the distortion shall not exceed 5 per cent at any frequency from 50 c.p.s. to 15 kc.

(c) *Method of Measurement*—An absolute method commonly employed also utilizes

the fact that, for a given modulating frequency, the carrier frequency disappears at a series of different ratios of carrier frequency swing to audio frequency. The carrier first vanishes for a ratio of frequency swing to audio frequency of 2.405. It also disappears at a series of ratios of frequency swing to audio frequency corresponding to the zero points of the zero'th order of the Bessel function.

##### 8. AUDIO-INPUT IMPEDANCE AND INPUT LEVEL FOR 100 PER CENT MODULATION

(a) *Definition*—The audio input expressed in dbm necessary to obtain 100 per cent modulation. 100 per cent modulation is represented by  $\pm 25$  kc. swing. The term dbm is defined as db referred to 1 milliwatt, single frequency, sine wave.

(b) *Standard*—The standard audio input level for 100 per cent modulation swing shall be  $+10$  dbm  $\pm 2$  db. The standard input impedance shall be 600/150 ohms. The transmitter shall be capable, by adjustment, of delivering  $\pm 40$  kc. swing at an input level of  $+10$  dbm  $\pm 2$  db.

(c) *Method of Measurement*—The audio input level shall be measured directly across the input terminals of the transmitter using a standard vu meter and 400-cycle tone modulation, adjusted to give 100 per cent modulation.

CAUTION: Meter reading must be corrected if input impedance is 150 ohms.

##### 9. AUDIO-FREQUENCY RESPONSE

(a) *Definition*—A description by means of a graph or a specification of the ratio of input voltages (expressed in db) required to obtain a constant frequency swing at all audio frequencies between 50 and 15,000 c.p.s., referred to a 1000-cycle standard.

(b) *Minimum Standard*—The maximum departure of the audio-frequency response from either a flat or a 75-microsecond pre-emphasis curve (whichever is specified) shall not exceed 1 db at  $\pm 10$  kc.,  $\pm 20$  kc.,  $\pm 30$  kc., and  $\pm 40$  kc. swing. If a pre-emphasis network is used, the graph shall be drawn to show the deviation from the standard 75-microsecond pre-emphasis curve.

(c) *Method of Measurement*—Standard instruments shall be used to measure the audio-frequency input voltage and the frequency swing of the modulated carrier frequency. A resistor equal to the transmitter input impedance shall be connected between the audio oscillator and the transmitter input terminals, or a 10-db pad having an output impedance equal to the transmitter input impedance shall be used between these two units. The audio-frequency-level meter shall be connected across the output of the oscillator.

##### 10. AUDIO-FREQUENCY HARMONIC DISTORTION

(a) *Definition*—The change in harmonic content of the input signal as a result of passing through the transmitter. The standard 75-microsecond pre-emphasis shall be employed in the transmitter.

(b) *Minimum Standard*—The audio-frequency distortion including all harmonics up to 30 kc. shall not exceed the values given in the following table at  $\pm 10$  kc.,  $\pm 20$  kc., and  $\pm 40$  kc. swing.

Distortion in per cent	Frequency Range in Cycles
1.5	50 to 100
1.0	100 to 7500
1.5	7500 to 15000

( $\pm 40$  kc. swing only)

(c) *Method of Measurement*—The audio-frequency harmonic distortion shall be measured by demodulating a sample of the r.f. output of the transmitter through a device having less than 0.25 per cent inherent r.m.s. distortion. The audio input shall be supplied from a source having less than 0.1 per cent r.m.s. distortion. A 75 microsecond de-emphasis circuit shall be incorporated in the demodulator.

##### 11. INTERMODULATION DISTORTION

(a) *Definition*—That distortion which is due to the modulation of the components of a complex wave by each other, as a result of which waves are produced which have frequencies equal to the sums and differences of integral multiples of the components of the original complex wave.

(b) *Minimum Standard*—No minimum standard has been established.

(c) *Method of Measurement*—No method of measurement can be specified at present.

##### 12. R.F. OUTPUT-COUPLING IMPEDANCE RANGE

(a) *Definition*—The range of load-impedance values for which the adjustment facilities provided in the transmitter will permit loading the transmitter to its rated output.

(b) *Minimum Standard*—The transmitter r.f. output-coupling circuit shall be designed to enable the transmitter to deliver its rated output in accordance with the RMA standards into a load whose electrical characteristics are those of a transmission line of 50 to 70 ohms surge impedance single-ended, or 100 to 140 ohms surge impedance double-ended, in which the voltage-standing-wave ratio is not more than 1.5/1 at the aural carrier frequency.

#### SECTION D—ANTENNAS AND TRANSMISSION LINES

Standards recommended in this section apply to television antennas and transmission lines only.

##### 1. OVER-ALL SYSTEM PERFORMANCE WITH RESPECT TO IMPEDANCE OF TRANSMISSION LINE AND ANTENNA

(a) *Definition*—The conformance of the impedance of the antenna system to an established standard, over the television channel viewed from the transmitter terminals.

(b) *Minimum Standard*—It is not believed that sufficient data is available at the present time to properly set this standard. While some data is available indicating performance at carrier (voltage-standing-wave ratio of 1.1 or better), no data is available on sideband performance.

(c) *Method of Measurement*—Measurement of impedance shall be made by means of an accurate slotted measuring line at least three-quarter wavelength long connected to the transmission line, with the antenna terminating the transmission line.

**CAUTION:** In employing this method, care must be exercised that the slotted line itself does not introduce a voltage-standing-wave ratio greater than 1.03; also, that the oscillator stays exactly on frequency and that its power output does not vary with loading.

## 2. INPUT TERMINALS OF AN ANTENNA

(a) *Definition*—The terminals at the last place on the RMA standard transmission line through which the power passes at the characteristic impedance of the line.

## 3. POLARIZATION

(a) *Definition*—The direction of the electric vector of the radiated signal.

(b) *Standard*—The polarization of the radiated signal shall be horizontal.

## 4. PATTERNS—GENERAL, INCLUDING DIRECTIONAL ANTENNAS

(a) *Definition*—The pattern of a television broadcast antenna is a plot of angle, versus free-space radiation field intensity at a fixed distance, in the horizontal plane passing through the center of the antenna.

(b) *Standard*—The patterns shall fit the intended application.

(c) *Method of Measurement*—The pattern of an antenna may be measured by rotating the antenna through 360° at a test location, and measuring the received field with a receiving antenna and suitable calibrated receiver at a fixed location.

**CAUTION 1:** It is essential that no reflecting objects be near enough to cause interfering reflections.

**CAUTION 2:** The distance between antennas must be great enough to avoid proximity effects. A practical guide is to have the following relation between  $D$ , the distance between antennas, and  $W$ , the largest dimension of the antenna:

$$D > 10W.$$

## 5. PATTERN VARIATIONS WITHIN THE CHANNEL

(a) *Definition*—Changes in horizontal patterns as the frequency is changed within the television channel.

(b) *Minimum Standard*—Insufficient data exist to set a standard at this time.

(c) *Method of Measurement*—The measurement is to be made through the range of frequencies for which the antenna is intended, by the method outlined in Section D-4(c).

## 6. PHASE VARIATION WITHIN THE CHANNEL

To be determined.

## 7. GAIN OF ANTENNAS

(a) *Definition*—The ratio of power radiated by the antenna in question, compared with the power radiated in the direction of maximum radiation by a half-wave dipole with the same input power. For a nondirectional antenna, the power radiated by the antenna is taken as the average of the power over 360° in the horizontal plane. For a directional antenna, the gain is the average of the power radiated through the half-power angle of the antenna over the power radiated in the direction of maximum radiation by a half-wave dipole.

(b) *Standard*—The antenna shall fit the intended application.

(c) *Method of Measurement*—A calibrated receiving device is located in the field of the antenna at a sufficient distance to avoid proximity effects (see Section D-4(c)). Relative readings of output are obtained by rotating the antenna. The average power reading is then determined as defined in section D-7(a). A dipole located in the same center position using the same polarization and input power with its maximum radiation toward the receiving device is then substituted. The gain is the power ratio of these two values. Caution must be exercised in avoiding interfering reflections from other objects including the ground.

**NOTE:** This measurement is usually difficult to make because errors tend to creep in from the causes mentioned. Gain can also be calculated. If this is done, the loss in feed lines, stubs, etc., must be carefully taken into account.

## 8. ANTENNA INPUT IMPEDANCE FOR SINGLE-ENDED INPUT

(a) *Definition*—The complex impedance looking into the antenna terminals throughout the band for which the antenna is intended.

(b) *Minimum Standard*—The antenna at its input terminals should terminate the transmission line so as to cause a minimum of reflections over the frequency band for which the antenna is to be used.

*Visual Standard*—It is not believed that sufficient data are available at the present time to set a tolerance on this termination; while some data are available indicating satisfactory performance at carrier for the whole system including the transmission line (voltage-standing-wave ratio of 1.1 or better), no data is available on sideband performance.

*Aural Standard*—The reflections caused by the antenna shall not cause the voltage-standing-wave ratio on the line feeding the antenna to exceed a value of 1.5.

(c) *Method of Measurement*—Measurement of impedance shall be made by means of an accurate slotted measuring line at least three-quarter wavelength long connected to the transmission line, with the antenna terminating the transmission line.

**CAUTION:** In employing this method, care must be exercised that the slotted line itself does not introduce a voltage-standing-wave ratio greater than 1.03; also, that the oscillator stays exactly on frequency and that its power output does not vary with loading.

## 9. ANTENNA INPUT CHARACTERISTICS FOR DOUBLE-ENDED INPUT

(a) *Definition*—The complex impedance looking into antenna terminals throughout the band for which the antenna is intended.

(b) *Minimum Standard*—The antenna at its input terminals should terminate the transmission line so as to cause a minimum of reflections over the frequency band for which the antenna is to be used.

*Visual Standard*—It is not believed that sufficient data is available at the present time to set a tolerance on this termination; while some data is available indicating satisfactory performance at carrier for the whole system, including the transmission line (voltage-standing-wave ratio of 1.1 or bet-

ter), no data are available on sideband performance.

*Aural Standard*—The reflections caused by the antenna shall not cause the voltage-standing-wave ratio on the line feeding the antenna to exceed a value of 1.5.

(c) *Method of Measurement*—Measurement of impedance shall be made with a pair of slotted measuring lines at least three-quarter wavelength long connected to the transmission line, with the antenna terminating the transmission line.

**CAUTION:** In employing this method, care must be exercised that the slotted line itself does not introduce a voltage-standing-wave ratio greater than 1.03; also, that the oscillator stays exactly on frequency and that its power output does not vary with loading.

## 10. ELECTRICAL PERFORMANCE CHANGES DUE TO MECHANICALLY IMPOSED CONDITIONS (ICE OR WIND LOAD)

(a) *Definition*—Changes in complex impedance at the antenna terminals due to mechanically imposed conditions such as bending of members due to wind load or changing impedance due to the presence of ice, glaze, or sleet.

(b) *Minimum Standard*—The change in impedance due to these conditions shall not exceed the conditions imposed by Sections D-8(b) or D-9(b). In climates where ice formation may be expected, it shall be standard to adequately protect the antenna against impedance changes due to the formation of ice, by inherent design or through the use of suitable heaters.

(c) *Method of Measurement*—This shall be measured as described in Sections D-8(c) or D-9(c) with simulated conditions to represent the ice or wind load.

## 11. SIZES OF COAXIAL RIGID AIR-DIELECTRIC TRANSMISSION LINES

(a) *Definition*—The outside diameter of the line measured in inches.

(b) *Standard*—The recommended sizes of air-dielectric coaxial transmission lines shall be:  $\frac{7}{8}$ , 1 $\frac{1}{8}$ , 3 $\frac{1}{8}$ , and 6 $\frac{1}{8}$  inches.

(c) *Method of Measurement*—Linear measurements are to be made by the application of micrometers, calipers, or any other suitable precision devices.

## 12. SURGE IMPEDANCE OF COAXIAL TRANSMISSION LINES

(a) *Definition*—The impedance looking into an infinite length of line. In the event of a line having recurrent discontinuities (such as beads, stub support constructions, etc.) the impedance is defined at a position midpoint between these discontinuities.

(b) *Standard*—The surge impedance of the line, not including the fittings, shall be as indicated in the following table:

Line Size	Z <sub>0</sub> 50 to 100 Mc.	Z <sub>0</sub> 200 Mc.
$\frac{7}{8}$ -in. dia.	51.5 ± 1 $\frac{1}{2}$ ohm	51.1 ± 1 $\frac{1}{2}$ ohm
1 $\frac{1}{8}$ -in. dia.	51.5 ± 1 ohm	50.9 ± 1 ohm
3 $\frac{1}{8}$ -in. dia.	51.5 ± 1 ohm	50.5 ± 1 ohm
6 $\frac{1}{8}$ -in. dia.	51.5 ± 1 ohm	51.5 ± 1 ohm

(c) *Method of Measurement*—No method of measurement that is accurate enough for these measurements is readily applicable. However, until suitable methods are available, the impedance can be calculated quite accurately by a graphical method, such as Smith charts, or by consideration of con-

ventional transmission-line theory. These calculations should be based on measurements made on the insular material taken at the frequency in question.

13. SURGE IMPEDANCE OF TRANSMISSION-LINE FITTINGS

(a) *Definition*—The surge impedance of a fitting is equal to the impedance of an infinite line which suffers no significant discontinuity due to the insertion of the fitting.

(b) *Standard*—When measured in accordance with Section D-13(c), the voltage-standing-wave ratio shall not change by more than plus/minus 3 per cent.

(c) *Method of Measurement*—Four fittings are to be inserted along a terminated line, electrically one-half wavelength or multiples thereof apart at the operating frequency. The input impedance is to be measured by means of a slotted line or the equivalent. The frequency is to be changed within the range ±20 per cent. The change of impedance measured shall then fall within the standard.

14. POWER RATINGS OF TRANSMISSION LINES

(a) *Definition*—The ratings for average power are those values which can be carried at any point on the line with heating to a given temperature rise on the outer conductor, and without arc-over.

(b) *Standard*—The ratings for average power shall be:

	50 Mc.	100 Mc.	200 Mc.
1/4-in. dia.	4.5	3.0	2.0 kw.
1/2-in. dia.	16.0	10.0	7.0 kw.
3/4-in. dia.	64.0	42.0	27.0 kw.
6/8-in. dia.	235.0	166.0	118.0 kw.

If the above values are used for "black level" power, there is sufficient safety factor in the line to withstand "synchronizing peaks."

(c) *Method of Measurement*—The power rating of the recommended transmission lines shall be one-half the transmitted power required to raise the outer conductor temperature 40°C, for a horizontal run in still air.

15. LINE LOSS OF STANDARD SIZES, PER UNIT LENGTH

(a) *Definition*—The loss in db per 100 feet at 25°C.

(b) *Minimum Standard*—Maximum losses to be in accordance with the following table:

	db per 100 ft.		
	50 Mc.	100 Mc.	200 Mc.
1/4-in. dia.	0.273	0.386	0.548
Copper loss	0.016	0.032	0.064
Insulation loss	0.289	0.418	0.612
Total	0.318	0.460	0.673
Total +10 per cent derating			
1/2-in. dia.	0.137	0.195	0.279
Copper loss	0.009	0.018	0.036
Insulation loss	0.146	0.213	0.315
Total	0.161	0.234	0.346
Total +10 per cent derating			
3/4-in. dia.	0.071	0.100	0.145
Copper loss	0.016	0.032	0.064
Insulation loss	0.087	0.132	0.209
Total	0.096	0.145	0.230
Total +10 per cent derating			

6 1/4-in. dia.			
Copper loss	0.0343	0.0485	0.0685
Insulation loss	0.0013	0.0026	0.0051
Total	0.0356	0.0511	0.0736
Total +10 per cent derating	0.039	0.056	0.081

(c) *Method of Measurement*—The method of measurement is to be by calculation in accordance with the factors outlined in the following table:

$$\text{Copper loss is: db/100 feet} = \frac{0.443(a+b)\sqrt{f_{mc}}}{abZ_0}$$

where *a* and *b* are conducting surface diameters in inches.

A conductivity of 95 per cent IACS is assumed. Insulation loss is:

$$\text{db/100 feet} = \frac{2.77L_f f_{mc}}{\sqrt{k}} \frac{k-1}{K-1}$$

where *L<sub>f</sub>* is loss factor (assumed to be 0.044, *K* = 6.0 and *k* is average dielectric constant).

Line Size	Z <sub>0</sub> 50 to 100 Mc.	Z <sub>0</sub> 200 Mc.	Z <sub>0</sub> Without Insulators	Outer Conductor	Inner Conductor (Min. Cond. = 95 per cent)	Insulators (Steatite K = 6.0 ± 0.5 Loss Factor = 0.004 Max.)
1/4-in. dia.	51.5 ± 1.5	51.1 ± 1.5	55.2	OD 0.875 in. ± 0.002 in. ID 0.785 in. ± 0.002 in.	OD 0.3125 in. ± 0.002 in. ID 0.2625 in. ± 0.002 in.	Beads 0.1875 in. effective thickness by 6 in. spacing
1/2-in. dia.	51.5 ± 1	50.9 ± 1	53.5	OD 1.625 in. ± 0.002 in. ID 1.572 in. ± 0.002 in.	OD 0.625 in. ± 0.002 in. ID 0.569 in. ± 0.002 in.	Beads 0.193 in. effective thickness by 12 in. spacing
3/4-in. dia.	51.5 ± 1	50.5 ± 1	55.6	OD 3.125 in. ± 0.003 in. ID 3.027 in. ± 0.003 in.	OD 1.200 in. ± 0.002 in. ID 1.136 in. ± 0.002 in.	Beads 0.375 in. effective thickness by 12 in. spacing
6/8-in. dia.	51.5 ± 1	51.5 ± 1	52.3	OD 6.125 in. ± 0.003 in. ID 5.981 in. ± 0.003 in.	OD 2.500 in. ± 0.003 in. ID 2.435 in. ± 0.003 in.	Pin-type construction 12 in. spacing

NOTE 1: A derating factor of 10 per cent is to be applied to allow for aging and joints.

NOTE 2: These attenuation values will increase when the temperature rises above 25°C.

16. PRESSURIZATION

(a) *Definition*—The application of a positive pressure of dry gas to the inside of a coaxial line to prevent the entrance of moisture or other foreign material.

(b) *Minimum Standard*—A pressure of clean, dry gas greater than the atmospheric pressure shall be maintained at all times.

(c) *Method of Measurement*—The pressure shall be measured in psi over the maximum atmospheric pressure.

17. DESIGN RECOMMENDATION

The physical characteristics given in the following table are design recommendations for immediate construction of lines.

VISUAL TRANSMITTER OUTPUT SIGNAL WAVE FORM

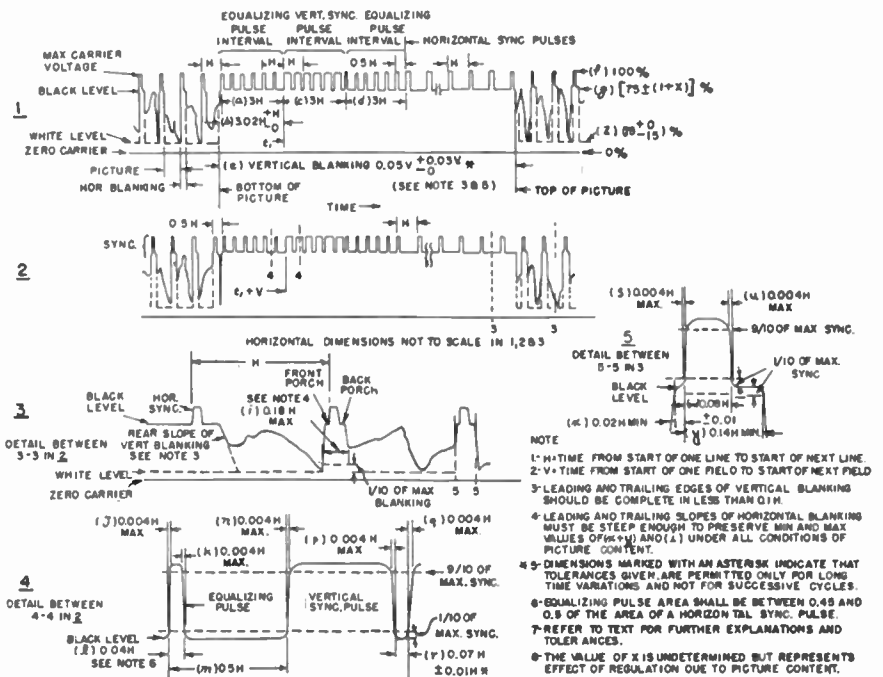

# Abstracts and References

Prepared by the National Physical Laboratory, Teddington, England, Published by Arrangement with the Department of Scientific and Industrial Research, England, and *Wireless Engineer*, London, England

NOTE: The Institute of Radio Engineers does not have available copies of the publications mentioned in these pages, nor does it have reprints of the articles abstracted. Correspondence regarding these articles and requests for their procurement should be addressed to the individual publications and not to the IRE.

Acoustics and Audio Frequencies . . . . .	939
Antennas and Transmission Lines . . . . .	940
Circuits and Circuit Elements . . . . .	940
General Physics . . . . .	942
Geophysical and Extraterrestrial Phenomena . . . . .	943
Location and Aids to Navigation . . . . .	944
Materials and Subsidiary Techniques . . . . .	944
Mathematics . . . . .	945
Measurements and Test Gear . . . . .	945
Other Applications of Radio and Electronics . . . . .	947
Propagation of Waves . . . . .	947
Reception . . . . .	948
Stations and Communication Systems . . . . .	948
Subsidiary Apparatus . . . . .	949
Television and Phototelegraphy . . . . .	949
Vacuum Tubes and Thermionics . . . . .	951
Miscellaneous . . . . .	952

The number in heavy type at the upper left of each Abstract is its Universal Decimal Classification number and is not to be confused with the Decimal Classification used by the United States National Bureau of Standards. The number in heavy type at the top right is the serial number of the Abstract. UDC numbers marked with a dagger (†) must be regarded as provisional.

## ACOUSTICS AND AUDIO FREQUENCIES

**016:534** 1531  
References to Contemporary Papers on Acoustics—A. Taber Jones. (*Jour. Acous. Soc. Amer.*, vol. 20, pp. 72-78; January, 1948.) Continuation of 908 of May.

**534.321.9** 1532  
Absorption of Ultrasonic Waves in Liquids—(*Nature* (London), vol. 160, pp. 913-914; December 27, 1947.) Short account of a Physical Society discussion.

**534.422:534.7** 1533  
Some Biological Effects of Intense High Frequency Airborne Sound—C. H. Allen, H. Frings, and I. Rudnick. (*Jour. Acous. Soc. Amer.*, vol. 20, pp. 62-65; January, 1948.) A 20-kc. siren provided a sound intensity of about 160 db above  $10^{-16}$ w/cm<sup>2</sup>, which was sufficient to kill mice and insects by the heating produced by sound absorption. Effects on the observers, such as dizziness and fatigue, are described. See also 922 of May (White).

**534.6** 1534  
A Mobile Laboratory for Acoustical Work—W. C. Copeland. (*Jour. Sci. Instr.*, vol. 25, pp. 82-85; March, 1948.) A detailed description of equipment designed by the Acoustics Section of the National Physical Laboratory for field work. Power is normally obtained from local mains, but a battery supply is available. Special methods of mounting are used to minimize damage by vibration; the necessary long cables (100 yards) are carried on eight drums located at the rear of the outfit.

**534.75/76** 1535  
Monaural and Binaural Threshold Sensitivity for Tones and for White Noise—I. Pollack. (*Jour. Acous. Soc. Amer.*, vol. 20, pp. 52-57; January, 1948.) The binaural threshold was found to be significantly lower than the

monaural threshold only when the difference in sensitivity of the two ears was artificially cancelled. The difference between the thresholds was significantly greater for a pure tone than for noise.

**534.75** 1536  
The Effect of Noise in One Ear upon the Loudness of Speech in the Other Ear—J. P. Egan. (*Jour. Acous. Soc. Amer.*, vol. 20, pp. 58-62; January, 1948.)

**534.78** 1537  
Effects of Differentiation, Integration, and Infinite Peak Clipping upon the Intelligibility of Speech—J. C. R. Licklider and I. Pollack. (*Jour. Acous. Soc. Amer.*, vol. 20, pp. 42-51; January, 1948.) Subjective articulation tests showed that intelligibility was reduced very little by differentiation or integration of the speech waves. Infinite clipping (reduction of speech to a succession of rectangular waves of uniform amplitude in which the discontinuities corresponded to the crossings of the time-axis in the original signal) and combinations of clipping, differentiating, and/or integrating reduced intelligibility, but in all the cases considered intelligible conversation was possible.

**534.851:621.395.625.2** 1538  
Noise Modulation in Recording—E. G. Cook. (*Audio Eng.*, vol. 31, pp. 8-11; December, 1947.) Causes are discussed, with particular reference to the effects due to inclination between the normal to the stylus face and the direction of the groove. Methods of measuring noise modulation are outlined and an arbitrary stylus factor-of-merit is suggested.

**534.861.1/2** 1539  
Broadcasting Studio Pickup Technique—H. M. Guin. (*Audio Eng.*, vol. 32, pp. 9-14; 48; February, 1948.) Discussion of the factors influencing the selection of positions for microphones and for performers in broadcasting studios.

**534.861.1:621.395.623.8** 1540  
Broadcasting Studio Sound Reinforcement—H. A. Chinn and R. B. Monroe. (*Audio Eng.*, vol. 31, pp. 5-7, 38; December, 1947.) Systems used in the CBS studios.

**534.862** 1541  
Cinema Photoelectric [sound] Reproduction—H. Sapiens. (*Toute la Radio*, vol. 15, pp. 39-42; January, 1948.) A short account of general principles, with descriptions of the optical systems of a few commercial types.

**534.87** 1542  
Underwater Sound Transducers—H. F. Olson, R. A. Hackley, A. R. Morgan, and J.

Preston. (*RCA Rev.*, vol. 8, pp. 698-718; December, 1947.) An account of various types of transmitters and receivers for underwater sounds.

**621.395.61:534.43:621.385.1** 1543  
A Vacuum-Tube-Type Transducer for Use in the Reproduction of Lateral Phonograph Recordings—Gordon. (See 1821.)

**621.395.623.8** 1544  
Sound Reinforcement in the Hollywood Bowl—M. Rettinger and S. M. Stevens. (*Audio Eng.*, vol. 32, pp. 15-17, 43; February, 1948.) Mechanical and acoustical features of the RCA two-way loudspeaker system installed in 1947.

**621.395.625** 1545  
The Recording and Reproduction of Sound: Parts 8-10—O. Read. (*Radio News*, vol. 38, pp. 51-53, 156, 48-50, 163, and 48-50, 115; October to December, 1947.) Part 8: Discussion of crystal cartridges and coupling methods. Part 9: Magnetic reproducers of various types. Part 10: Discussion of two representative tuners. For earlier parts, see 3771 and 3772 of January. To be continued.

**621.395.625.2** 1546  
Sound Recording by Engraving on Film—M. Adam. (*Tech. Mod.* (Paris), vol. 40, pp. 21-23; January 1 and 15, 1948.) Recording is effected on a celluloid film covered with a layer of transparent gelatine of thickness  $60\mu$ , on which is deposited a thin opaque layer of thickness about  $3\mu$ . A chisel stylus with a  $174^\circ$  V-edge cuts a groove of varying width in the gelatine film. Reproduction is exactly the same as with films obtained by optical processes. A great advantage of the system is that records can be reproduced immediately, as no developing, drying, etc., is required.

**621.395.813:534.75** 1547  
Sensitivity of the Ear to Phase Distortion Experimental Demonstration—G. Zananini. (*Radio Franc.*, pp. 30-32; February, 1948.) Translation from an article in *Electronica*, August, 1947. Tests were carried out with apparatus in which a network producing a rapid phase variation, while maintaining a constant output voltage, could be inserted at will between a receiver and a loudspeaker amplifier. The results showed that in the electroacoustic reproduction of sound, phase displacement is perceptible when it reaches a sufficiently high value and when the sounds have a transient character. With the type of circuit normally used, the phase distortion is too small to be perceptible, but certain types of

correction network may produce perceptible effects.

**534** **1548**  
**Elements of Acoustical Engineering** [Book Review] H. F. Olson. D. Van Nostrand, New York, N. Y., 2nd ed. 1947, 539 pp., \$7.50. (*Electronics*, vol. 21, pp. 252, 254; February, 1948.) Each chapter of the first edition (noted in 124 of 1941) is brought up to date and amplified. "An outstanding book in this field."

#### ANTENNAS AND TRANSMISSION LINES

**621.315.09** **1549**  
**Note on the Propagation of Electricity along a Non-Uniform Cable**—M. Parodi. (*Rev. Gén. Élec.*, vol. 57, pp. 37–38; January, 1948.) By using an invariant of the wave-propagation equation, a family of nonuniform lines can be found for which the propagation conditions can at once be deduced from those of a given non-uniform Thomson cable.

**621.315.2** **1550**  
**High-Frequency Cable Design**—K. H. Zimmermann. (*Electronics*, vol. 21, pp. 112–115; February, 1948.) Practical design equations and two abacs for calculation of characteristic impedance, inductance, time delay, and power rating for solid-dielectric, coaxial, and two-conductor hf and vhf balanced lines. A typical polyethylene cable design problem is worked out.

**621.315.21:621.317.74** **1551**  
**The Measurement of the Propagation Constants of Screened Twin Cables**—Essen. (*See* 1689.)

**621.392:[621.317.336+621.317.341]** **1552**  
**Method of measuring Feeder Parameters**—Kaganovich. (*See* 1677.)

**621.392.029.64:621.3.09** **1553**  
**On the Propagation of Plane Waves in a Straight Metal Guide of Any Cross-Section**—R. Rigal and J. Voge. (*Compt. Rend. Acad. Sci.* (Paris), vol. 226, pp. 326–328; January 26, 1948.) Formulas are derived from which the propagation characteristics, including phase and group velocities, cutoff frequency, reflections at discontinuities, etc., can easily be deduced.

**621.392.029.64:621.3.09** **1554**  
**Wave Propagation in Metal Tubes**—P. G. Violet. (*Funk und Ton*, pp. 38–46 and 88–94; January and February, 1948.) Formulas are derived for  $E_0$  and  $H_0$  waves; the limiting conditions at the tube walls, the propagation characteristics, and the shape of the field for these waves are discussed. Formulas for the attenuation in tubes of finite conductivity are given and harmonics of the  $E_0$  and  $H_0$  waves, and waves of higher order, are considered briefly.

**621.392.029.64:621.3.09** **1555**  
**Slow Propagation of TM Waves in Cylindrical Waveguides**—G. G. Bruck and E. R. Wicher. (*Onde Élec.*, vol. 27, pp. 470–472; December, 1947.) The physical basis of the action of linear electron accelerators and of traveling-wave tubes is the reduction of the phase velocity of TM waves to a fraction of that of light. The complex forms of the waveguide walls normally used for this velocity reduction make exact calculation impossible. The phase-velocity can also be reduced by coating the wall of the waveguide with dielectric. Calculation in this case is both easier and more exact. Diagrams are given of field and energy distributions for three cases of practical interest.

**621.392.091** **1556**  
**Attenuation in Compound Lines**—P. Marmet. (*Compt. Rend. Acad. Sci.* (Paris), vol. 225, pp. 1132–1133; December 10, 1947.) The term

"compound line" is applied to a series  $AB$  of  $n$  homogeneous lines terminated by impedances  $Z_A, Z_B$  and fed by an emf  $E$ , of zero impedance, in series either with  $Z_A$  or  $Z_B$ . Theoretical treatment shows that for such a line the attenuation of emf in one direction is equal to the current attenuation in the opposite direction. Formulas are derived for the parameters at any point of the line.

**621.392.43:518.4** **1557**  
**Mismatch Loss Chart for Transmission Lines**—J. M. Hollywood. (*Electronics*, vol. 21, p. 130; January, 1948.) Loss due to mismatch between load and line impedance is given in terms of total rated loss of line and swr at loaded end.

**621.396.67** **1558**  
**Current Distribution in Aerials**—R. Gans. (*Rev. Sci.* (Paris), vol. 85, pp. 643–648; July 1, 1947.) A method of calculation is described which is based on the theory of Hallén. The discussion is restricted to the case of a rectilinear antenna extending from  $z = -l$  to  $z = +l$ , although the theory can also be applied to curved antennas.

**621.396.67:621.317.336** **1559**  
**Measurement of the Impedance of an Aerial**—Mourmant. (*See* 1678.)

**621.396.67:621.396.933** **1560**  
**Circularly Polarized Antennas for Aircraft Communication**—J. P. Shanklin. (*Tele-Tech*, vol. 6, pp. 36–40, 90; December, 1947.) Discussion of the design of a 3-dipole antenna system for 120 Mc giving approximately circular polarization. The problems involved and the method of analyzing the experimental data are considered and various polar diagrams are given.

**621.396.67.029.64** **1561**  
**Systems of Slots in the Wall of a Circular Waveguide giving a Spindle-Shaped Radiation Diagram**—Z. Szepeši. (*Compt. Rend. Acad. Sci.* (Paris), vol. 226, pp. 883–885; March 15, 1948.) A continuation of the work of Benoit (957 of May). To obtain a narrow radiation diagram in the horizontal plane, a multislotted system is used, with suitable phase differences for the successive slots, the differences being obtained by displacing the slots parallel to the axis of the waveguide. A phase difference of  $180^\circ$  can be obtained by reversing the slope of the slot without axial displacement. Axial displacement can be avoided by changing the length of the slots; parasitic lobes are reduced by giving the middle slots a greater slope than the outer ones. Addition of a second series of slots at a distance of  $\lambda_0/2$  from the first, with the slope of the slots reversed, gives a narrow beam in the vertical plane. A combination of short and long longitudinal slots with interposed inclined slots gives the equivalent of two Yagi arrays with a third driven antenna, the long slots acting as reflectors and the short as directors.

**621.396.671:538.566** **1562**  
**On the Application of the Kirchhoff-Huyghens Principle to Electromagnetic Radiation Fields, with Examples**—Zuhrt. (*See* 1624.)

**621.396.672:621.396.621** **1563**  
**Capacity Aerials for Mains Receivers**—(*Philips Tech. Commun.* (Australia), pp. 24–26; March, 1947.) Experiments show that when a metal-plate or wire-grid antenna is used, the power mains actually function as the antenna while the plate acts as a counterpoise. Methods of connecting plate antennas are discussed briefly and a circuit diagram is given of an arrangement suitable for testing receivers fitted with plate antennas.

**621.392.029.64** **1564**  
**Micro-Waves and Wave Guides** [Book Review]—H. M. Barlow. Constable, London, 122

pp., 15s. (*Electronic Eng.* (London), vol. 20, pp. 66–67; February, 1948.) A simple and compact introduction to the study of microwaves, adapted to the needs of those readers who possess little previous knowledge of the subject.

#### CIRCUITS AND CIRCUIT ELEMENTS

**621.314.2.015.33** **1565**  
**Pulse Transformers**—F. V. Lukin. (*Radio-tekhnika* (Moscow), vol. 2, pp. 46–61; April, 1947. In Russian, with English summary.) Discusses the equivalent circuit reduced to unity turn ratio and gives a graphical-analytical method of design.

**621.314.3†** **1566**  
**Magnetic Amplifiers: Parts 1 and 2**—S. E. Tweedy. (*Electronic Eng.* (London), vol. 20, pp. 38–43 and 84–88; February and March, 1948.) In part 1, basic circuit arrangements known as "transducers" (saturable twin-core reactors) are discussed. In part 2, the methods whereby these devices become magnetic amplifiers with high amplifications are considered. The advantages, construction, and properties of magnetic amplifiers in various circuit connections are discussed, with particular reference to the magnetic photometer Type MAP 1.

**621.314.3†** **1567**  
**Electromagnetic Amplifiers**—(*Electronics*, vol. 21, pp. 190, 195; January, 1948.) A brief discussion of general principles, with a bibliography of 35 items. See also 960 of May, and 664 of April.

**621.316.078.3** **1568**  
**Study of the Stability of Systems Capable of Mathematical Representation**—Y. Rocard. (*Rev. Sci.* (Paris), vol. 85, pp. 519–531; May 15, 1947.) A discussion of linear systems for which the law may not be known. Curves representing impedance and phase paths are described and their use explained. Applications are considered to Nyquist curves for feedback amplifiers, to regulators and telecontrol apparatus, and to systems governed by functional equations. See also 2022 of 1947 (Frey) and back references.

**621.316.726.078.3:621.396.615.142.2** **1569**  
**Stabilizing Frequency of Reflex Oscillators**—G. G. Bruck. (*Electronics*, vol. 21, pp. 170, 176; February, 1948.) An electronic duplex-heterodyne method for microwave generators which is simple and uses relatively few components. The frequency of a 10,000-Mc oscillator can be maintained within one part in  $10^8$ .

**621.317.733** **1570**  
**The D. C. Bridge with Nonlinear Resistances**—W. Schaaffs. (*Frequenz*, vol. 1, pp. 48–56; November, 1947.) The special features are discussed of many types in which tubes, glow tubes, photo cells, etc., are used as circuit elements. The voltage developed across the measurement diagonal is proportional to the variation of the supply voltage. The proportionality factor is equal to the ratio of the difference to the sum of the slopes of the current versus voltage characteristics of the resistances in the bridge arms. The use of negative resistances is discussed and applications of bridges of this type are outlined. Voltage control to 1 part in 1000 is easily obtained.

**621.318.572** **1571**  
**A High Speed Coincidence Circuit**—R. H. Dicke. (*Rev. Sci. Instr.*, vol. 18, pp. 907–914; December, 1947.) Resolving time is of the order  $10^{-9}$  to  $10^{-10}$  seconds. Experimental results are given.

**621.318.572** **1572**  
**Phototube-Operated Trigger Circuit**—J. Degelman. (*Electronics*, vol. 21, pp. 134, 150; January, 1948.) A circuit for use when only a slight voltage variation is obtainable from a photo cell; it acts as a sensitive dc amplifier.

- 621.318.572** 1573  
**Relay Control Circuits for Stepping Switches**—C. J. Dorr and H. M. West. (*Electronics*, vol. 21, pp. 158, 176; January, 1948.) A stepping magnet operates a pawl-and-ratchet mechanism so that 1, 2, or 3 wipers are moved one step forward over a bank of ten contacts at each current pulse.
- 621.392:621.385.832:518.5** 1574  
**Numeroscope for Cathode-Ray Printing**—H. W. Fuller. (*Electronics*, vol. 21, pp. 98-102; February, 1948.) Circuit details of equipment generating wave forms which will display Arabic numerals on a cr screen. Photographic recording with exposures down to 0.002 second is practicable. The device was developed for use with high-speed electronic calculators, where results are produced so quickly that conventional printing devices cannot keep up with the output of the machines.
- 621.392.4** 1575  
**Stability Conditions for Nonlinear 2-Terminal Networks**—S. Malatesta. (*Alta Frequenza*, vol. 17, pp. 3-19; February, 1948. In Italian, with English, French, and German summaries.) From the phase relations between current and voltage in a circuit comprising a nonlinear 2-terminal network (bipole), a resistor, and a generator, general stability conditions are derived.
- 621.392.4** 1576  
**Properties and Some Applications of Twin-T and Bridged-T Circuits**—I. Barta. (*Elekrotechnika* (Budapest), vol. 39, pp. 231-238; December, 1947. With English, French, and German summaries.) General formulas are established for output voltage and for input and output impedances. Twin-T circuits with only resistors and capacitors, and bridged-T circuits using inductors, are discussed and applications to the measurement of distortion, frequency, and inductance are considered.
- 621.392.5** 1577  
**Simplified Method for Calculating the Operational Properties of Chains of Quadripoles**—F. Streckler. (*Frequenz*, vol. 1, pp. 41-48 and 77-85; November and December, 1947.) The wave theory of Hoেকে is simplified and extended to the generalized quadripole. A general theory of quadripole chains is developed from which calculations of input resistance can be made without the use of tables for the reflection factor or for the arguments of complex hyperbolic functions.
- 621.392.5:534.321.9** 1578  
**Ultrasonic Solid Delay Lines**—D. L. Arenberg. (*Jour. Acous. Soc. Amer.*, vol. 20, pp. 1-26; January, 1948.) Expressions based on electrical transmission-line formulas are used for determining delay, bandwidth, and attenuation of sound-waves in solids. The relationship between Poisson's ratio and angles of incidence for complete conversion of transverse to compressional mode, and vice-versa, is obtained for various solids with a view to using multiple reflections to increase the delay obtainable in solids of small dimensions. Nicol prism and piezoelectric transducers are considered. Fused quartz is found to be the best substance to use, and the development of a delay line for the distortionless transmission of 1- $\mu$ s pulses at ultrasonic frequencies of the order to 20 Mc, with a delay up to 2 ms, is discussed.
- 621.392.52:621.396.611.21** 1579  
**Crystal Filters**—In 2701 of 1947, cancel the author's name as given, and substitute E. Istvánffy.
- 621.396.611** 1580  
**Optimum Conditions for an RC Oscillator**—H. A. Whale. (*Electronics*, vol. 21, pp. 178, 186; February, 1948.) Relations between the values of components for optimum frequency stability of a particular RC network used in feedback oscillators of the Wien bridge type.
- 621.396.611.1** 1581  
**Temperature Coefficients in Electronic Circuits**—C. I. Soucy. (*Electronics*, vol. 21, pp. 117-121; January, 1948.) The principal causes of frequency drift in tuned circuits are temperature effects in coils and coil formers, in fixed and variable capacitors, tubes and wiring, and in resistors. With proper choice of components, the frequency changes can be reduced very materially.
- 621.396.611.3** 1582  
**An Experimental Investigation of the Mutual Synchronization of Two Coupled Thomson's Oscillators: Part 1—Loose Coupling**—N. I. Esafov. (*Zh. Tekh. Fiz.*, vol. 17, no. 7, pp. 803-808; 1947. In Russian.) A system of equations (6) is derived from which the stationary amplitudes, and the frequency of the oscillations in the system can be determined. A report is also presented on experiments with two Hartley oscillators with power supplies in parallel (Fig. 2). Both oscillators are tuned to a frequency of 500 kc and the necessary detuning of one oscillator by an amount up to 56 kc was obtained by means of a variable capacitor. Experimental curves are plotted showing the variation of the amplitudes in the oscillating circuits, and the relative phase displacements for loose and tight couplings (Figs. 3 and 4 respectively). The case of tight coupling will be investigated more fully in a later paper.
- 621.396.615** 1583  
**Harmonics in Oscillators**—A. S. Gladwin. (*Wireless Eng.*, vol. 25, pp. 33-34; January, 1948.) Comment on 976 of May (Tillman). The "energy balance" explanation of the frequency change produced by harmonics in an oscillator is critically discussed. It is suggested that Groszkowski gave an incorrect physical explanation of an accurate analytical formula. Correction, *ibid.*, vol. 25, p. 98; March, 1948.
- 621.396.615.029.5** 1584  
**H.F. Beat-Frequency Oscillator**—R. Aschen and J. Goutelle. (*Télev. Franç.*, Supplement *Électronique*, pp. 35-39; January, 1948.) Description of the latest type, with suggested applications. See also 3827 of January (Aschen and Lafargue) and back references.
- 621.396.615.14** 1585  
**Some Notes on Oscillating Valve Circuits**—E. G. Beard. (*Philips Tech. Commun.* (Australia), pp. 6-18; October, 1947.) A comparison of Colpitts, Hartley, and Meissner oscillators for use at 100 Mc is made and reasons given for the choice of the Colpitts type for very high frequencies. Experiences with the type 6BE6 tube at 92 Mc are described. The circuit of a "freak" oscillator is given. The difference between grid and anode limitation of oscillation amplitude is explained and some general problems in connection with oscillators are discussed. Circuits for an amplifier with gain stabilized by self-oscillation and for a double-frequency oscillator are developed.
- 621.396.615.14** 1586  
**Push-Pull Resonant Line Oscillator for the 166-170 Mc/s V.H.F. Band**—G. Thompson. (*Philips Tech. Commun.* (Australia), pp. 7-11; November, 1946.) The construction of an experimental uhf transmitter using resonant lines as tuned circuits in combination with a Type 800 tube is described. Technical data relating to this tube are included.
- 621.396.615.17** 1587  
**Basic Design Principles for Sawtooth Current Generator**—V. F. Samoilov. (*Radio-tekhnika* (Moscow), vol. 2, pp. 63-77; March, 1947. In Russian, with English summary.) An approximate nonlinear treatment is presented of the phenomena in an oscillator with strong feedback, used to generate sawtooth currents. Graphs and formulas are derived for approximate calculation of the frequency and shape of the current pulses in deflection coils; these can assist in the choice of circuit parameters.
- 621.396.615.17:621.317.755:621.397.6** 1588  
**Television Timebase**—Chauvierre. (See 1791.)
- 621.396.619.23** 1589  
**Reactance Modulator Theory**—F. Butler. (*Wireless Eng.*, vol. 25, pp. 69-74; March, 1948.) In the simplified analysis of reactance modulators, the loading effect of the phase-shifting circuit is commonly neglected. By considering the impedance of this circuit in parallel with that of the modulator tube it is possible to select the component values of the circuit so that the complete two-terminal network is purely reactive. The analysis covers both the conventional reactance modulator and the cathode-driven modulator. A simple bridge circuit is described, which may be used to determine the exact point of resistance neutralization.
- 621.396.619.23** 1590  
**A 50-Watt Modulator with Peak Limiting**—R. Lewis. (*Radio News*, vol. 38, pp. 42-43, 150; November, 1947.) For a 75-w amateur transmitter. A remote cutoff 6K7 pentode is used to eliminate blocking at unusually high signal levels, by using two tubes in push-pull in the limiter stage and removing all filtering from the avc line, delay in limiter action is prevented.
- 621.396.621.54.001.8** 1591  
**Superregenerative Circuit Applications**—H. Stockman. (*Electronics*, vol. 21, pp. 81-83; February, 1948.) Applications discussed include IFF (identification), telemetering systems, radar beacons, remote-control devices, and FM receivers. Empirical design considerations are discussed; basic circuit analysis is difficult.
- 621.396.645** 1592  
**Reduction of Noise at U.H.F. in Triode Valves and Grounded Grid Amplifiers**—E. G. Beard. (*Philips Tech. Commun.* (Australia), pp. 20-23; March, 1947.) Simplified summary of the principal conclusions of 3474 of 1947 (van der Ziel).
- 621.396.645** 1593  
**The Cathode Follower: Parts 1-4**—E. Parker. (*Electronic Eng.* (London) vol. 20, pp. 12-16, 55-58, 92-95, and 126-129, 131; January to April, 1948.) A logical and comprehensive development of the subject, including a number of new theorems and constructions. Parts 1 and 2 and the six appendixes in part 4 cover linear theory; part 3 covers general theory and methods of constructing exact cathode-follower characteristics.
- 621.396.645** 1594  
**Differential Input Circuits**—E. E. Suckling. (*Electronics*, vol. 21, pp. 186, 190; February, 1948.) An improved version of the Toennies circuit (2096 of 1938).
- 621.396.645:621.317.755** 1595  
**A High-Quality Amplifier for Application in Cathode-Ray Oscilloscopes**—C. J. Boers. (*Philips Tech. Commun.* (Australia), pp. 11-15, 20-24, and 12-15; April to July, 1947.) Design of an amplifier with distortion-free performance at vhf and suitable for modulating a cr tube with a screen 16 cm in diameter. The three parts deal respectively with a wide-range amplifier, an attenuator, and a stabilized power supply. The design methods have other applications.

- 621.396.645:621.385.4 1596  
Operating Conditions and Circuits for Valve Type 807—Thompson. (See 1833.)
- 621.396.645.015.3 1597  
Transients in a Multi-Stage Resonant Amplifier—R. D. Leites. (*Radiotekhnika* (Moscow), vol. 2, pp. 32-46; March, 1947. In Russian, with English summary.) Equations are derived for the envelopes of the output voltages of an  $n$ -stage resonant amplifier when pulse signals of various shapes are applied to the input terminals. It is shown that if  $n > 3$  or 4 and the over-all frequency band is kept unchanged, the addition of extra stages has very little effect on the shape of the transient curve, which tends to a limiting curve; only the delay time is affected.  
Equations are obtained for the limiting transient curves for input signals of various forms; these curves are used in an analysis of output distortion.
- 621.396.645.029.4 1598  
Low-Frequency Amplifier with Variable Selectivity—E. Gatti. (*Alla Frequenza*, vol. 17, pp. 20-31; February, 1948. In Italian, with English, French, and German summaries.) Theory and experimental results are given for an amplifier with gain independent of frequency. A selective feedback network of the Scott type (1802 of 1938) is used. An equivalent  $Q$  of about 2000 is obtained in the low af range.
- 621.396.645.029.6+621.396.621.54.029.6 1599  
Properties of Gain and Noise Figures at V.H.F. and U.H.F.—M. J. O. Strutt. (*Philips Tech. Commun.* (Australia), no. 3, pp. 3-16, 19; March, 1947.) Optimum stage gain of amplifiers and of mixers at vhf and uhf is derived for narrow-band and wide-band conditions. Five useful properties of noise figures relating to amplifiers and mixers are applied to obtain considerable noise reduction, in some cases amounting to 15 db at vhf in mixer stages. A long summary of Strutt's lecture to the Swiss Federal Institute of Technology at Zürich dealing with the same subject is given in *Wireless Eng.*, vol. 25, pp. 21-32; January, 1948. See also 3067 of 1947.
- 621.396.645.029.6+621.396.621.54.029.6 1600  
Reduction of Noise in Amplifiers and Frequency Changers—E. G. Beard. (*Philips Tech. Commun.* (Australia), pp. 17-19; March, 1947.) Simplified summary of the principal conclusions of 1599 above.
- 621.396.645.2.029.4 1601  
Low Frequency Compensation for Amplifiers—K. Schlesinger. (*Electronics*, vol. 21, pp. 103-105; February, 1948.) Two interstage coupling networks for lf amplifiers are discussed and their design requirements analyzed. One has a grounded load resistor, thus providing a low impedance output; the other requires very little capacitance.
- 621.396.645.35 1602  
D.C. Amplifiers with Automatic Zero Adjustment and Input Current Compensation—D. G. Prinz. (*Jour. Sci. Instr.*, vol. 24, pp. 328-331; December, 1947.) A negative-feedback system is used to charge a capacitor which is inserted in the input circuit of the amplifier to reduce the zero error.
- 621.396.645.36 1603  
A New High Gain Phase Splitting Circuit—E. G. Beard. (*Philips Tech. Commun.* (Australia), pp. 10-15; September, 1947.) Based on the use of a heptode mixing tube, such as ECH21; the heptode is used as a combined phase splitter and amplifier, while the triode unit is applied in automatic gain reduction.
- 621.396.645.371 1604  
On Negative Feedback—F. Benz. (*Radio Tech.* (Vienna), vol. 24, pp. 53-58; February and March, 1948.) A detailed discussion, including the effect on nonlinear distortion, improvement of the frequency curve for radio receivers and for sound reproduction, automatic loudspeaker control, increase of cutoff sharpness for lf filters, reduction of tube noise, etc.
- 621.396.645.371 1605  
Counter-Reaction in Amplifiers—L. Thourel. (*Radio Franc.*, pp. 3-6, 12-16, and 24-27; December, 1947; January and February, 1948.) Elementary theory is presented and a general formula given. Improvement of the amplitude-frequency curve, different types of counter-reaction, input and output impedances of an amplifier with counter-reaction, and the cathode-follower circuit are discussed. De-phasing in lf and in hf amplifiers is considered and the use of the counter-reaction polar diagram is explained. Correction circuits and amplifier bandwidth are also discussed briefly.
- 621.396.645.371 1606  
Some Curious Counter-Reaction Circuits—E. Aisberg. (*Toute la Radio*, vol. 15, pp. 34-38; January, 1948.) A simple explanation of the principle of counter-reaction, with practical circuits for volume expansion or compression, automatic tone control, so-called silent control, correction of loudspeaker resonances, and attenuation of background noise and needle scratch.
- 621.396.645.371 1607  
Evocation of a Virtual Triode—L. Chrétien. (*Toute la Radio*, vol. 15, pp. 56-59; January, 1948.) A discussion of the application of counter-reaction in the final stage of amplifiers. When properly used, counter-reaction reduces amplitude, frequency, and intermodulation distortion. If applied to an output pentode, the effect is to transform it into a virtual triode, which will have a set of virtual characteristics. These can be used in the usual way for calculating the stage gain, output power, and relative distortion of the various harmonics.
- 621.396.645.371:534.43:621.395.61 1608  
Feedback Preamplicator for Magnetic Pick-ups—R. S. Burwen. (*Audio Eng.*, vol. 32, pp. 18-20; February, 1948.) A simple design with low output impedance permitting the use of shielded coupling cable without causing severe attenuation of high frequencies. Negative feedback reduces harmonic distortion and also noise and hum originating in the preamplicator.
- 621.396.662:621.396.615 1609  
Increasing the Efficiency of a High-Power H.F. Valve Oscillator by Tuning to the Third Harmonic—Z. I. Model, B. I. Ivanov, S. V. Person, and G. F. Soloviev. (*Radiotekhnika* (Moscow), vol. 2, pp. 15-23; April, 1947. In Russian, with English summary.) In many tube oscillators the hf anode voltage contains a pronounced third harmonic. With additional anode-circuit tuning for this harmonic, an increased efficiency is obtained. A theoretical explanation is given.
- 621.396.662.21 1610  
Temperature Coefficient Effects of R. F. Coil Finishes—C. I. Soucy. (*Tele-Tech.*, vol. 6, pp. 52-55, 93; December, 1947; vol. 7, pp. 42-44, 79; January, 1948.) Frequency shift is plotted against temperature for various coil constructions and finishes. The optimum finish for stability and a fairly low temperature coefficient was obtained by applying a liquid polystyrene dope after baking, followed by a flash dip in Zophar wax No. 1436 at 250°F, the coil being preheated to 200°F.
- 621.396.662.3.015.3 1611  
Transient Response of Symmetrical 4-Terminal Networks—A. W. Glazier. (*Wireless Eng.*, vol. 25, pp. 11-20; January, 1948.) The input and output currents  $I_s$  and  $I_r$  of a symmetrical 4-terminal network of transfer constant  $\theta$  and image impedance  $Z_0$ , terminated with an impedance  $R_0$  and connected to a generator of emf  $E$  and internal resistance  $R_0$  can be written
- $$I_s, I_r = \frac{E}{2} \left[ \frac{1}{R_0 + Z_0 \tan h\phi/2} \pm \frac{1}{R_0 + Z_0 \cot h\phi/2} \right]$$
- where the doubtful sign is + for  $I_s$  and - for  $I_r$ . These equations apply to steady-state or transient problems. An equivalent lattice network is deduced from the equations and discussed with particular reference to  $T$ ,  $\Pi$ , and bridged-T networks.  
The equations are also applied to the transient response of low-pass and high-pass filters, and that of 6-element band-pass and band-stop filters, all these filters being connected between resistive terminations; the responses are thus easily calculated. A 4-terminal network which, when short-circuited at the output and energized by receiving unit-step voltage input, has the same transient response as a transmission line with given distributed constants is also considered. See also 48 of 1947 (Eaglesfield) and back references.
- 621.396.662.3.029.621.63 1612  
Ultra-High Frequency Filters—C. W. Oatley and C. M. Burrell. (*Jour. IEE* (London), part IIIA, vol. 93, pp. 1338-1342; 1946.) An account of the measurement in the frequency range 200 to 800 Mc of the variation of attenuation with frequency for concentric-line filters. The results are in rough agreement with formulas derived from transmission-line theory, which is given in an appendix by R. F. Proctor and R. W. Sloane. It is shown that, for most practical purposes, the cutoff frequency can be calculated from simple lumped-circuit theory. Construction details for a number of low-pass and high-pass filters are given.
- 621.396.662.32.029.63 1613  
An Ultra-High-Frequency Low-Pass Filter of Coaxial Construction—C. L. Cuccia and H. R. Hegbar. (*RCA Rev.*, vol. 8, pp. 743-750; December, 1947.) Metal disks placed at equal intervals along the inner conductor of a coaxial line provide lumped capacitances which produce a multisection constant- $K$  T-type low-pass filter. Design equations are derived and applied to two coaxial filters whose cutoff frequencies are 800 and 1800 Mc respectively.
- 621.396.69 1614  
Present Status of Printed Circuit Technics—A. F. Murray. (*Tele-Tech*, vol. 6, pp. 29-33; December, 1947.) Summaries of the following papers at a Washington symposium, October 15, 1947. Printed Circuit Technics, by A. S. Khouri. Status, Applications and Limitations of PC [printed circuits], by C. Brunetti. Printed Vitreous Dielectric Units, by C. I. Bradford. Metal Films and Their Applications to Resistors and Printed Circuits, by J. W. Jira. Printed Resistors, by J. Marsten and A. L. Pugh, Jr. Printing Conductors on Glass, by H. S. Cramer. Physical Aspects of PC Conductors, by L. I. Marton. Conductor Paints, by W. V. Patton. Spraying Technic, by G. W. Johnson. Military Program Needs, by B. Blom. PC in Radio Receivers, by A. Gross. See also 1913 of 1947 (Sargrove).

## GENERAL PHYSICS

- 530.145 1615  
Report of a Series of Lectures given by P. A. M. Dirac on the Second Quantification—M. Baranger and F. Netter. (*Rev. Sci.* (Paris), vol. 85, pp. 623-632; June 1 and 15, 1947.)
- 535.1:530.12 1616  
Notes on the New Theory of Light—L. Bloch. (*Jour. Phys. Radium*, vol. 6, pp. 196-202; July, 1945. In French.) The new theory of L. de Broglie is interpreted in a geometrical manner suggested by the principle of relativity,



and applied to representations leading to an electromagnetism purely Maxwellian, with spin 1, and an electromagnetism purely non-Maxwellian, with spin 0. See "Nouvelle théorie de la lumière." by L. de Broglie (T. I. Herrmann et Cie, Paris, 1940).

535.12 1617

On the Diffusion of Spherical Waves in a Dispersive Medium—M. Lévy. (*Compt. Rend. Acad. Sci.* (Paris), vol. 226, pp. 330-332; January 26, 1948.) Formulas for the partial and global damping factors are derived and discussed briefly.

535.42 1618

Huyghens' Principle and Diffraction—J. P. Vasseur. (*Compt. Rend. Acad. Sci.* (Paris), vol. 226, pp. 885-886; March 15, 1948.)

536.48+537.312.62 1619

Low-Temperature Physics in North America—J. F. Allen. (*Nature* (London), vol. 160, pp. 736-737; November 29, 1947.) A general account of a visit to low temperature laboratories in North America. A compact liquefier is described, suitable for any gas including helium, in which all the cooling is obtained by the principle of external work. Rf phenomena under examination are the properties of superconducting cavities for  $\lambda 1.25$  cm, and the "anomalous skin resistance" of metals at low temperatures. The rectifying properties of niobium carbide in the transition region near 15°K are being examined.

537.221 1620

On Frictional Electricity—E. Darmon. (*Compt. Rend. Acad. Sci.* (Paris), vol. 226, pp. 882-883; March 15, 1948.) A short discussion of various theories and experimental results.

537.226.1:621.317.3.011.5 1621

On the Interpretation of Pulse Measurements of the Dielectric Constant—Letienne. (See 1671.)

537.291:621.385:621.317.329 1622

Electrolyte-Tank Study of Electron Beams, taking Account of Space Charge—Goudet and Musson-Genon. (See 1811.)

537.56:621.385 1623

Production of H.F. Energy by Ionized Gases in a Magnetic Field—J. L. Steinberg. (*Rev. Sci.* (Paris), vol. 85, pp. 601-606; June 1 and 15, 1947.) Results of observations on meter wavelengths. The noise is only produced when the magnetic field is present. At constant gas pressure, the noise reaches a maximum value for a certain field and discharge current. Probe measurements show the noise to be greatest when the probe assumes the local potential. The effects seem to exhibit characteristics very different from those observed for longer waves. See also 715 of 1947 (Thonemann and King).

538.566:621.396.671 1624

On the Application of the Kirchhoff-Huyghens Principle to Electromagnetic Radiation Fields, with Examples—H. Zuhrt. (*Frequenz*, vol. 1, pp. 33-37 and 63-70; November and December, 1947; and vol. 2, pp. 6-12; January, 1948.) The use of simple formulas which are valid for scalar wave functions but not for em field vectors leads to false results when calculating radiation fields. General formulas are derived for the cases of refraction and reflection; these are applied to determine the radiation from the open end of a rectangular waveguide and to calculate the horizontal and vertical polar diagrams of a paraboloid antenna.

621.39 1625

Bandwidth vs Noise in Communication Systems—D. G. F. (See 1745.)

## GEOPHYSICAL AND EXTRATERRESTRIAL PHENOMENA

523.7+523.854]:621.396.822 1626

Recent Researches on Extra-Terrestrial Emission of Metre Waves—J. Denisse. (*Rev. Sci.* (Paris), vol. 85, pp. 483-488; May 1, 1947.) Discussion of the results obtained by various investigators of radiations from the sun and from the galaxy, and suggested explanations. See also 402 of 1947 (Appleton) and back references.

523.72:621.396.822 1627

Observation of Electromagnetic Radiation from the Sun—Y. Rocard. (*Rev. Sci.* (Paris), vol. 85, p. 422; April 15, 1947.) Direct reception on a radar receiver was effected in April, 1947, on board a French naval vessel. The wavelength used cannot be disclosed. The received radiation was at first little above the background noise in the receiver, but increased very considerably in less than an hour. It appeared to consist of a succession of discharges analogous to those of lightning. The ppi was quite confused by the parasitic signal over a considerably angular sector corresponding to the relatively low directivity of the antenna. The results are the first of their kind obtained in France.

523.72.029.3:621.396.822 1628

Audio-Frequency Radio Waves from the Sun—D. H. Menzel and W. W. Salisbury. (*Nature* (London), vol. 161, p. 91; January 17, 1948.) The existence of solar radiation in the frequency range 1 to 500 cps could explain various observed effects in both the sun and the ionosphere. Using a large loop antenna and a tunable amplifier, variations of the right order of magnitude and of frequency up to about 400 cps have been observed. Experiments to determine whether these variations are of solar or terrestrial origin are in progress.

523.74/.75:551.510.535 1629

On the Relations between Ionosphere, Sunspots and Solar Corona—K. O. Kiepenheuer. (*Mon. Not. R. Astr. Soc.*, vol. 106, no. 6, pp. 515-524; 1946.)

523.745:550.385 1630

Solar Streams of Corpuscles and Their Relation to Geomagnetic Storms—S. K. Chakrabarty. (*Mon. Not. R. Astr. Soc.*, vol. 106, no. 6, pp. 491-499; 1946.) The equation of the stream curves of such particles has been obtained as a function of the velocity of emission and the co-ordinates of the point of emission, generating the two-dimensional motion considered by Chapman. The results obtained show that a very narrow beam of corpuscles emitted from a point on the Sun's surface can produce a magnetic storm of given duration, provided the velocity of the emitted particles has a continuous distribution, the width of the velocity spectrum determining the duration of the storm. The velocity of emission of the corpuscles which are possibly responsible for the commencement of some "very great" geomagnetic storms that have occurred in recent years has been calculated.

523.745"1946.07.25" 1631

Visual and Spectrographic Observations of a Great Solar Flare, 1946 July 25—M. A. Ellison. (*Mon. Not. R. Astr. Soc.*, vol. 106, no. 6, pp. 500-508; 1946.)

523.78"1947.05.20":621.396.11:551.510.535 1632

Provisional Results obtained by the French Mission to Brazil during the Total Solar Eclipse, 20th May 1947—Y. Rocard. (*Rev. Sci.* (Paris), vol. 85, p. 618; June 1 and 15, 1947.) The critical frequencies of the E, F<sub>1</sub>, and F<sub>2</sub> layers show a partial return to night conditions during the eclipse. The absence of time lag indicates that ionization changes in these

layers are not due to corpuscular rays, but solely to radiation effects. Calculated falls in ionization, relative to normal values, are: E layer, 64 per cent; F<sub>1</sub> layer, 75 per cent; F<sub>2</sub> layer, 30 per cent. Propagation conditions for a frequency of 4 Mc show a return to night conditions at the center of the eclipse. The D-layer absorption curve follows the eclipse with no phase lag and without asymmetry. See also 1640 below.

538.12:521.15 1633

Universal Constants in Blackett's Formula—H. Y. Tzu. (*Nature* (London), vol. 160, pp. 746-747; November 29, 1947.) "If we assume that the equations of the new theory can be derived from a Lagrangian, and that the magnetic moment of a rotating body is originated through some cross-terms between the gravitational and the electromagnetic field quantities in the Lagrangian, then it would be found that there must be other universal constants than G and c in the theory." Blackett's theory was noted in 3112 of 1947.

538.12:521.15:538.71(24.084) 1634

On the Mechano-Magnetic Effect inside Rotating Spherical Masses. Application to the Terrestrial Magnetic Field—A. Gão. (*Compt. Rend. Acad. Sci.* (Paris), vol. 226, pp. 645-647; February 23, 1948.) Formulas derived from the author's unitary theory of geoinagnetism (1023 of May and back references) are used to calculate the earth's field at a depth of 1463 m. The result is in good agreement with measurements by Hales and Gough at this depth in a mine in the Transvaal (1635 below).

538.12:521.15:538.711(24.084) 1635

Blackett's Fundamental Theory of the Earth's Magnetic Field—A. L. Hales and D. I. Gough. (*Nature* (London), vol. 160, p. 746; November 29, 1947.) An account of a series of measurements made with a horizontal magnetometer (Schmidt type) at a mean depth of 4800 ft below the surface in the Witwatersrand mines. The field underground was less than that at the surface. Errors in the observations due to geological and other causes are discussed. Comparisons are made with theoretical predictions. Blackett's theory was noted in 3112 of 1947; see also 1634 above.

550.385 1636

Magnetic Storms—S. Chapman. (*Rev. Sci.* (Paris), vol. 85, pp. 387-400; April 15, 1947.) A lecture at the Henri Poincaré Institute, March 24, 1947, giving an account of the various phenomena observed and a detailed discussion of systems of earth currents which could explain these effects.

551.508.94:621.317.32 1637

Radiosonde Potential Gradient Measurements—Belin. (See 1674.)

551.51 1638

On the Problem of Atmosphere Models Where the Absorption Coefficient Is an Arbitrary Function of Frequency—V. Kourganoff. (*Compt. Rend. Acad. Sci.* (Paris), vol. 225, pp. 1124-1126; December 10, 1947.) An extension of the variational method is used to obtain a general solution for an atmosphere for which g, T<sub>e</sub>, and the chemical composition are known.

551.510.535 1639

Ionosphere Recorder—(*Tele-Tech*, vol. 6, pp. 79-81; December, 1947.) The entire frequency range from 1 to 25 Mc is covered continuously without bandswitching by beating a fixed-frequency pulsed oscillator (30 Mc) and a variable frequency oscillator (31 to 55 Mc) in a low-level mixer. The difference frequency is amplified by a wide-band of amplifier delivering several kw peak power to a wide-band antenna. The receiver consists of a 30-Mc amplifier preceded by an untuned balanced mixer. Voltages from the transmitter variable oscil-

lator are mixed with the received variable-frequency echoes to produce pulses of constant frequency. Presentation is similar to that of a normal radar—"A" scan, and is photographed continuously on 35-mm film. Continuous records on 16-mm film are also obtained of a derived radar—"B" scan having both frequency and height co-ordinates. See also 3518 of 1947 (Wells).

551.510.535:523.78"1947.05.20" 1640

**Results of Ionosphere Observations during the Total Eclipse of the Sun 20th May 1947**—J. F. Denisse, P. Seligmann, and R. Gallet. (*Compt. Rend. Acad. Sci. (Paris)*, vol. 225, pp. 1169–1171; December 10, 1947.) The observations were made at Bêbédouro, Brazil. The critical frequencies and virtual heights of the  $E$ ,  $E_s$ ,  $F_1$ , and  $F_2$  layers were determined every 4 minutes by automatic apparatus with a frequency sweep from 1.4 to 18 Mc.  $D$ -layer absorption was measured on fixed frequencies. Curves are given showing the results obtained. A full discussion will be given later.

$E$  layer: normal variation, leading to a value for the recombination coefficient of the order of  $\alpha_R = 0.5 \times 10^{-8}$ .

$F_1$  layer: hardly distinguishable from the  $F_2$  layer. The sudden ionization drop in  $F_2$  about 0900 affected the variation of  $F_1$ . Recombination coefficient, about  $\alpha_{F_1} = 2 \times 10^{-9}$ .

$F_2$  layer: sudden drop in ionization occurred about 50 minutes after the commencement of the optical eclipse. This time lag was not observed for the other layers; it may be connected with occultation of a group of sunspots. Minimum value of recombination coefficient,  $\alpha_{F_2} \times 10^{-10}$ .

$D$  layer: measurements on 4 Mc showed an ionization variation in synchronism with the eclipse, leading at totality to night propagation conditions, with  $\alpha_D > 10^{-7}$ .

No particular variation was observed either of the  $E_s$  layer or of the apparent heights of the different layers. See also 1632 above.

551.557:621.396.11.018.41 1641

**Influence of Wind on the Frequency of Radio Waves**—Jouaust. (See 1726.)

551.593.9 1642

**The Origin of the Night Sky Light**—D. R. Bates. (*Mon. Not. R. Astr. Soc.*, vol. 106, no. 6, pp. 509–514; 1946.) Experimental evidence indicates that the light may be due partly to incident charged particles which, at low latitudes, are enabled by the action of the Störmer current to approach the earth.

551.593.9:523.72 1643

**The Luminescence of the Night Sky and Corpuscular Solar Radiation**—A. I. Ol. (*Priroda*, no. 7, pp. 3–11; 1947. In Russian.) The role of the corpuscular radiation from the sun in the excitation of the night sky luminescence is discussed under the following headings: (a) methods for studying the night sky luminescence; (b) spectral analysis of luminescence; (c) excitation mechanism of luminescence; (d) regular variations of the night sky brightness, and (e) irregular variations of brightness. It is concluded that this phenomenon consists of a background luminescence on which irregular variations of brightness are superimposed. The background luminescence is due to the ultraviolet radiation from the sun while the irregular variations are caused by streams of charged particles emitted by the sun.

551.593.9:535.61-15 1644

**Concerning Very Intense Infra-Red Radiation in the Light of the Night Sky**—R. Herman L. Herman, and J. Gauzit. (*Jour. Phys. Radium*, vol. 6, pp. 182–183; June, 1945. In French.) Photographic records show the existence of an infrared band of mean wavelength 1.04  $\mu$ .

550.384.3 1645

**Description of the Earth's Main Magnetic Field and Its Secular Change, 1905–1945** [Book Review]—E. H. Vestine, L. Laporte, C. Cooper, I. Lange, and W. C. Hendrix. Carnegie Institution, Washington, 532 pp. \$2.50. (*Nature (London)*, vol. 161, pp. 160–161; January 31, 1948.) "This volume is unique in geomagnetic literature not only for the extent of the underlying data and the fullness of the reduction and representation of the data; it is the first to describe at all adequately the nature of the processes of reduction and representation, with examples of the actual working sheets of computations for a typical observing station. . . . The volume is a worthy embodiment and memorial of the first quarter-century of the observing work of the Department of Terrestrial Magnetism."

#### LOCATION AND AIDS TO NAVIGATION

621.396.933 1646

**The Decca Navigator**—A. V. J. Martin. (*Toute la Radio*, vol. 15, pp. 100–105; March and April, 1948.) Basic principles and mode of operation.

621.396.933 1647

**Teleran: Part 2—First Experimental Installation**—D. H. Ewing, H. J. Schrader, and R. W. K. Smith. (*RCA Rev.*, vol. 8, pp. 612–632; December, 1947.) Describes demonstration equipment and discusses the choice of television parameters, synchronizing equipment, the television transmitter, altitude coding, cameras and mixing, the landing display, the airborne transponder beacon, and the airborne television receiver. Part 1: 3138 of 1947.

621.396.933:621.397.331.2 1648

**The Storage Orthicon and Its Application to Teleran**—Fargue. (See 1780.)

#### MATERIALS AND SUBSIDIARY TECHNIQUES

535.37 1649

**Luminescent Materials**—In 2795 of 1947, cancel the author's name as given, and substitute G. Szigeti.

535.37 1650

**On the Growth of Photoluminescence of ZnS under Constant Excitation**—J. Saddy. (*Compt. Rend. Acad. Sci. (Paris)*, vol. 226, pp. 896–898; March 15, 1948.) Experimental results conform to an exponential law.

535.37 1651

**The Influence of Infra-Red Rays on the Excitation of Luminescence of CaS-Pb Phosphors**—S. A. Popok and F. D. Klement. (*Zh. Eksp. Teor. Fiz.*, vol. 17, pp. 915–923; October, 1947. In Russian.)

535.371.07:621.385.832 1652

**Testing Long-Persistence Screens**—J. C. Tellier and J. F. Fisher. (*Electronics*, vol. 21, pp. 126–130; February, 1948.) Description of a test set for measuring under various conditions the build-up, persistence, and steady values of light output from long-persistence screens for a wide variety of cr tubes. All static voltage and current characteristics can also be determined. See also 3921 of January (Johnson and Hardy) and 1653 below.

535.371.07:621.385.832 1653

**Performance Characteristics of Long-Persistence Cathode-Ray Tube Screens; Their Measurement and Control**—R. E. Johnson and A. E. Hardy. (*RCA Rev.*, vol. 8, pp. 660–681; December, 1947.) The requirements and characteristics of phosphor coatings are discussed. A laboratory system is described for pulse excitation of cascade-type coatings with blue light, evaluating their characteristics in finished tubes, and correlating the values with

field performance. Averaged curves show the effect of layer thickness and exhaust-bake temperatures on screen characteristics. See also 3921 of January (Johnson and Hardy) and 1652 above.

546.42/.431].246 1654

**Study of the Structure and of the Thermal Decomposition of Mixed Carbonates of Strontium and Barium**—R. Faivre and G. Chaudron. (*Compt. Rend. Acad. Sci. (Paris)*, vol. 226, pp. 249–251; January 19, 1948.) X-ray diffraction studies show that these carbonates are miscible in all proportions. Dissociation isotherms at 800°C are given for various mixtures.

546.78+546.84]:621.385.1.032.3 1655

**Designing Thoriated Tungsten Filaments**—H. J. Dailey. (*Electronics*, vol. 21, pp. 107–109; January, 1948.) Thoriated tungsten filaments have a higher resistance after carburization, when they have greater thermal-power emissivity than either pure tungsten filaments or uncarburized thoriated filaments. These properties can be balanced with proper control of thoriation and carburization, so that a carburized thoriated tungsten filament can be found with electrical characteristics similar to those of a given pure tungsten filament. Formulas derived for pure tungsten filaments can thus be extended to yield design data for carburized thoriated tungsten filaments.

546.815.221:537.311.3 1656

**Physical Properties of Lead Sulphide**—Yu. A. Dunaev and Yu. P. Maslakovets. (*Zh. Eksp. Teor. Fiz.*, vol. 17, pp. 901–910; October, 1947. In Russian.) An experimental investigation. The main conclusions reached are: (a) PbS has a constant number of carriers from 2.15°K to 800 to 900°K. In this interval, PbS behaves as a typical metal and variations of conductivity with temperature are due entirely to variations of mobility. (b) When the temperature is raised above 800°K, the concentration of carriers grows exponentially and PbS behaves like a semiconductor. (c) The carriers transferred into the upper zone are apparently not taken from the lower filled zone, since a comparison of the Hall effect data with measurements of conductivity does not indicate the appearance of a mixed conductivity.

Changes in physical dimensions of PbS samples with temperature were also investigated.

549.514.51 1657

**Recent Progress in the Technique of Piezoelectric Substances**—M. Tourmier. (*Onde Élec.*, vol. 27, pp. 447–459; December, 1947.) For growing quartz crystals at École de Physique et de Chimie Industrielle 3, autoclaves of stainless steel, with a capacity of 500 cm<sup>3</sup>, are used. The critical temperature is about 374°C and critical pressure 216 kg/cm<sup>2</sup>. The increase of length of the crystals, which are started from seed crystals previously etched in HF, is about 2 mm in 5 days. Methods are also described for growing crystals of the Rochelle-salt type. Agitation of the mother liquor is necessary to avoid occlusions of liquid. Periodical reversal of the rotation of the crystals tends to avoid cloudiness. A rate of growth of 6 mm per day may be obtained. The possibility of producing large crystals by fusion is discussed. See also 1825 of 1947.

621.3(54) 1658

**Electrical Engineering Problems in the Tropics: Part 2**—R. Allan. (*Beama Jour.*, vol. 55, pp. 16–20; January, 1948.) Conclusion of 1378 of June. Difficulties due to salt-laden air, dust, rodents, and insects are discussed and typical wiring systems used in India are described briefly. Recommendations are made regarding general design of plant and treatment of materials. Manufacturers' tests can only be

regarded as satisfactory if carried out under extreme temperature and humidity conditions.

**621.315.59** **1659**  
**Sintered Semiconductors**—H. H. Hausner. (*Electronics*, vol. 21, pp. 138, 184; January, 1948.) Resistivity and temperature coefficient are dependent on particle size and sintering temperature. Mixtures of coarse copper and fine graphite particles have similar resistivity characteristics to those of fine copper and coarse graphite mixtures, so that particle contact resistance appears to be more important than particle resistance. Mixtures of 10- $\mu$  crystalline graphite and  $ZrO_2$  show a wide divergence of resistivity and temperature coefficient, the latter being zero in the 100  $\Omega$ -cm region when the mixture contains 72 per cent  $ZrO_2$ . Mixtures of fine and coarse crystalline graphite show some correlation between resistivity and temperature coefficient. A graph illustrates the dependence of resistivity on sintering temperature.

**621.315.612.4.011.5:546.431.82** **1660**  
**The Dielectric Properties of Barium Titanate at High Frequencies**—H. S. Novosil'tsev and A. L. Khodakov. (*Zh. Tekh. Fiz.*, vol. 17, no. 6, pp. 651-656; 1947. In Russian.) Experiments were conducted at frequencies from 1.5 to 66 Mc. The temperature coefficient of the dielectric constant is independent of frequency and the Curie point remains at 80°C. Ceramic dielectrics made up of mixtures of different titanates were also investigated. Some theoretical conclusions are given.

**621.315.316** **1661**  
**Resin Bonded Insulation**—(*Elec. Rev.* (London), vol. 142, pp. 533-536; April 9, 1948.) A detailed account of the manufacture of paper and fabric insulating boards with synthetic-resin bonding, and some particulars of the preliminary testing of the component materials to ensure satisfactory electrical properties of the finished product.

**621.318.2** **1662**  
**Magnetic Materials**—J. L. Salpeter. (*Philips Tech. Commun.* (Australia) pp. 3-10, 3-11, and 3-11; April to July, 1947.) Essentially similar to a paper abstracted in 3935 of January.

**621.318.22** **1663**  
**Permanent Magnet Alloys**—E. M. Underhill. (*Electronics*, vol. 21, pp. 122-123; January, 1948.) Magnetic, physical, and mechanical data tabulated for over 40 different alloys, with brief remarks on methods of manufacture.

**669.3** **1664**  
**Copper and Copper Alloys**—E. Voce. (*Metallurgia* (Manchester), vol. 37, pp. 80-84 and 141-145; December, 1947, and January, 1948.) A survey of technical developments during 1947, with a bibliography of 115 papers.

**679.5** **1665**  
**The British International Plastics Annual, 1947. [Book Review]**—Croome Hill International, London, 460 pp., 63s. (*Beama Jour.*, vol. 55, pp. 33-34; January, 1948.) A new annual covering the whole field of "laboratory synthesized resins and products made therefrom." An outstanding feature is the mass of data under the heading "the properties of commercial plastics," giving fifty-four items of technical information and interest in relation to several hundred grades, each listed under its trade name.

#### MATHEMATICS

**517.514** **1666**  
**Stationary Aleatory Functions of Many Variables**—A. Blanc-Lapierre and R. Fortet. (*Rev. Sci.* (Paris), vol. 85, pp. 419-422; April 15, 1947.) The principal properties of such func-

tions are established, using the method of linear filters previously applied to functions of a single variable (3505 of 1947). For simplification functions of two variables are considered, the results obtained being valid for any finite number of variables.

**518.5** **1667**  
**Automatic Integration of Linear Sixth-Order Differential Equations by Means of Punched-Card Machines**—L. F. Hausman and M. Schwarzschild. (*Rev. Sci. Instr.*, vol. 18, pp. 877-883; December, 1947.) Differential equations are converted to difference equations which are solved automatically in steps by punched-card machines operated by relay networks. The final solution is obtained by repeated integration, the truncation error being computed each time and applied as a correction to the subsequent integration.

**518.5:621.392:621.385.832** **1668**  
**Numeroscope for Cathode-Ray Printing**—(See 1574.)

#### MEASUREMENTS AND TEST GEAR

**531.76:681.11** **1669**  
**Watch Timer**—R. S. Mackay, Jr., and R. R. Soule. (*Electronics*, vol. 21, pp. 160, 168; February, 1948.) A stroboscopic method for indicating in a few minutes whether a watch is running fast or slow. Most watches tick 5 times per second, and each tick operates a strobtron flash tube which illuminates a disk revolved by a synchronous motor at exactly five revolutions per second. Alternatively, the strobtron flash tube may be triggered by the ticks from a chronometer, in which case two images of the disk will be seen, apparently revolving at slightly different speeds. The exact speed of revolution of the disk is not then important.

**621.317.3** **1670**  
**Measurement of Electrical Quantities by Means of Phase Displacements in A.C. Circuits**—W. Schaaffs. (*Frequenz*, vol. 2, pp. 22-27; January, 1948.) The method depends on the phase difference between current and applied voltage, and can be used for measuring changes of resistance, inductance or capacitance, as well as the sum, difference, or mean of quantities which can be represented by these electrical quantities. Many different types of phase-shift circuits are discussed. A polar c.r.o. is used as indicator. A measurement accuracy of 1 part in 1000 can be obtained.

**621.317.3.011.5:537.226.1** **1671**  
**On the Interpretation of Pulse Measurements of the Dielectric Constant**—R. Letienne. (*Compt. Rend. Acad. Sci.* (Paris), vol. 226, pp. 399-400; February 2, 1948.) Pulse measurements give a much lower value of the dielectric constant  $\epsilon$  than that obtained when using a sinusoidal voltage.  $\epsilon$  has practically the same value for pulse repetition frequencies of 120 and 1100. The results are discussed in relation to Debye's theory.

**621.317.31:621.383** **1672**  
**Measurement of Small Photoelectric Currents by a Pulse Method**—J. Baurand and R. Lambert. (*Jour. Phys. Radium*, vol. 6, pp. 206-208; July, 1945. In French.) A galvanometer in series with a large capacitance is shunted on the load resistance of an electrometer tube, whose grid receives a pulse each time the galvanometer coil passes the equilibrium position. Theory of the method is given and the choice of suitable components is discussed. With the most sensitive galvanometer used, a voltage of about 20  $\mu$ v could be measured.

**621.317.31:621.385.5** **1673**  
**Measurement of Small Currents: Characteristics of Types 38, 954, and 959 as Reduced Grid Current Tubes**—C. E. Nielsen. (*Rev.*

*Sci. Instr.*, vol. 18, pp. 18-31; January, 1947.) A detailed study of the three types and of their use for small-current measurement. Results are given showing the dependence of grid and anode currents on the applied potentials. Grid currents less than  $10^{-16}$ a in the 959 tube were obtained, with stability comparable with that of special electrometer tubes.

**621.317.32:551.508.94** **1674**  
**Radiosonde Potential Gradient Measurements**—R. E. Belin. (*Electronics*, vol. 21, pp. 184, 190; January, 1948.) Potential gradient inside and near cumulo-nimbus clouds is measured by obtaining a point discharge from two collectors, oriented in opposition, and using the resulting current to control the squeezing frequency of a modified radiosonde. The frequency received by the ground station thus gives a measure of the electrostatic field. Atmospheric pressure is also measured by the sonde so that the potential gradient can be determined during flight.

**621.317.32:621.396.81.029.63** **1675**  
**Field Tests for Citizens Band**—Samuelson. (See 1728.)

**621.317.333:621.315.3** **1676**  
**New Testing Apparatus for Enamelled Wire**—R. Friza. (*Elektrotech und Maschinenb.*, vol. 65, pp. 14-17; January and February, 1948.) For wire diameters of 0.03 to 0.8 mm. The wire is drawn off the reel at 20 centimeters per second through a bath containing a 5 per cent solution of common salt. Faults in the insulation with a leakage resistance below 10 k $\Omega$  operate a relay and indicator lamp. Wire length is measured by the revolutions of one of the guide pulleys, which has a circumference of 10 centimeters.

**621.317.336+621.317.341]:621.392** **1677**  
**Method of measuring Feeder Parameters**—V. M. Kaganovich. (*Radiotekhnika* (Moscow), vol. 2, pp. 62-67; April, 1947. In Russian, with English summary.) Describes measurement of attenuation with a standing-wave indicator and discusses briefly methods for measuring feeder impedance.

**621.317.336:621.396.67** **1678**  
**Measurement of the Impedance of an Aerial**—P. Mourmant. (*Radio Franc.*, pp. 4-8; February, 1948.) Methods described include (a) series or parallel resonance, (b) Q-meter, (c) simple bridge and (d) double-T bridge. Graphical presentation of the results is discussed.

**621.317.34:621.396.822** **1679**  
**An Absolute Method of Measurement of Receiver Noise Factor**—Ullrich and Rogers. (See 1743.)

**621.317.361+621.317.372** **1680**  
**New U.H.F. Methods for Measurement of Frequency and of Q**—R. Musson-Genon. (*Onde Élec.*, vol. 27, pp. 461-469; December, 1947.) A cavity-resonator, a wavemeter, a FM oscillator, and a c.r.o. are used for accurate comparison and measurement of frequencies. The period of the horizontal sweep of the sawtooth wave is suitably related to the modulation frequency. Accuracy is of the order of 1 part in  $10^7$ . The method described can also be used for measurements of Q, from a few hundreds up to about 10,000, with an accuracy of a few per cent. It can also be used to determine the bandwidth of a FM oscillator.

**621.317.361** **1681**  
**Measuring Instantaneous Frequency of an F.M. Oscillator**—L. E. Hunt. (*Tele-Tech.*, vol. 6, pp. 34-35; December, 1947.) The frequency is compared with a calibrated c.w. signal by switching the two signals alternately into a FM detector and observing the oscilloscope pattern produced.

- 621.317.361:621.396.11:551.510.535 1682  
The Effect of Doppler's Principle on the Comparison of Standard Frequencies over a Transatlantic Radio Path—Booth & Gregory. (See 1723.)
- 621.317.373 1683  
Standard Lag Line for Phase Measurement—O. H. Schuck. (*Jour. Acous. Soc. Amer.*, vol. 20, pp. 26–39; January, 1948.) The available methods for electrical phase measurement are reviewed; a method using a standard delay line as a reference is recommended. Such lines can be used for various types of measurements. The construction of two particular lines is described for measurements in the range 10 to 80 kc and a method of calibration is outlined. Accuracy within  $\frac{1}{2}^\circ$  can be attained.
- 621.317.72:621.396.81 1684  
A Pulse Field-Strength Measuring Set for Very High Frequencies—B. G. Pressey and G. E. Ashwell. (*Jour. IEE* (London), part IIIA, vol. 93, no. 8, pp. 1359–1366; 1946.) Portable equipment for use on pulse or c.w. signals in the frequency bands 20 to 30 Mc and 40 to 650 Mc. It consists essentially of a receiver, including calibrated signal- and intermediate-frequency attenuators and output meter, and a c.r. output-indicator unit. The field strength is measured by adjustment of the attenuators for a standard output, which for pulse signals is read on the c.r. tube and for c.w. signals on the meter. A  $\lambda/2$  dipole antenna is used, and the initial calibration of the standard output in terms of the field strength at the antenna is carried out by a radiation method. The minimum measurable field strength varies with frequency between 3 and 500  $\mu\text{V}/\text{m}$  on short-pulse signals ( $<2\mu\text{s}$ ), and between 1.5 and 250  $\mu\text{V}/\text{m}$  on long-pulse and c.w. signals. The accuracy of relative measurements on any one frequency is within  $\pm 0.5$  db, and that of absolute measurements is within  $\pm 2$  db. Within these limits of accuracy, the measurements are independent of pulse width when this is greater than 0.5  $\mu\text{s}$ . Various types of measurement which have been made with the equipment are described, and they illustrate its wide range of application. Summary in *Jour. IEE* (London), part IIIA, vol. 93, pp. 228–229; 1946.
- 621.317.72.029.63/.64:621.396.81 1685  
A Radio Field-Strength Measuring Set for use in the Frequency Range 400 to 4000 Mc/s—A. C. Grace. (*Jour. IEE* (London), part IIIA, vol. 93, no. 8, pp. 1325–1326; 1946.) The mixing unit, with its local oscillator of range 400 to 800 Mc, is used with a wide-band if amplifier covering the range 0.5 to 3.5 Mc. Signals on frequencies above 800 Mc can be received with the aid of harmonics of the local oscillator. The equipment is normally supplied by batteries and can be used with several types of antenna.
- 621.317.725+621.317.734 1686  
New Voltohmmeter—F. Haas. (*Toute la Radio*, vol. 15, pp. 44–47; January, 1948.) The design is given of an instrument, with diode probe, which uses only components easily obtainable in France. Six ranges for both volts and ohms, with linear voltage scale and maxima of 1 v to 300 v. Maximum resistance range 3 M $\Omega$ .
- 621.317.725 1687  
A Pocket V.T.V.M. [vacuum-tube voltmeter]—R. P. Turner. (*Radio News*, vol. 38, pp. 64–66, 114; November, 1947.) For measuring dc voltages in four ranges, 0–0.8–8–80–800 v. Input resistance on all ranges is 10 M $\Omega$ .
- 621.317.726 1688  
The Measurement of Large Pulse Voltages a 200 Mc/s—A. L. Cullen. (*Jour. IEE* (London), part IIIA, vol. 93, no. 8, pp. 1311–1314; 1946.)
- For pulse voltages up to 10 kv rms. Accuracy is about 5 per cent. A calculable fraction of the peak voltage is derived from the standing wave on a short-circuited line and measured with a tube peak-voltmeter. Possible sources of error are discussed and their magnitude is estimated.
- 621.317.74:621.315.21 1689  
The Measurement of the Propagation Constants of Screened Twin Cables—L. Essen. (*Jour. IEE* (London), part IIIA, vol. 93, no. 8, pp. 1319–1324; 1946.) Balanced-line measurements of propagation constants, at frequencies of 200 Mc and above, are discussed. In these measurements, errors due to unbalance of the cable can be eliminated, but the unbalance cannot be measured quantitatively. A method of measuring unbalance treats the cable as three unbalanced systems, which are measured separately on an unbalanced coaxial-line measuring equipment. Propagation constants of a number of commercial cables obtained by this method are tabulated; they show good agreement with theoretical values and with balanced measuring-line results. A test procedure for examination of the balance of twin cables is described.
- 621.317.755 1690  
The Design of High-Speed Oscillographs—J. G. Bartlett and G. T. Davies. (*Jour. IEE* (London), part IIIA, vol. 93, no. 8, pp. 1304–1310; 1946.) Design difficulties are considered. The characteristics required in the timebase generator, the c.r. tube and the signal input circuits are discussed. "The limitations of present instruments at the very highest writing speeds are enumerated, and possible remedies are suggested."
- 621.317.763.029.62/.63 1691  
An Absorption Wavemeter for 250–850 Mc/s—R. G. Hibberd. (*Jour. IEE* (London), part IIIA, vol. 93, no. 8, p. 1303; 1946.) A wavemeter, using a butterfly tuning circuit and a crystal rectifier, is described and illustrated. Performance figures are given. Accuracy is between 1 and 2 per cent.
- 621.317.763.029.62/.63 1692  
Note on an Absorption Wavemeter to Cover the Frequency Range 120–500 Mc/s—M. C. Crowley-Milling. (*Jour. IEE* (London), part IIIA, vol. 93, no. 8, p. 1327; 1946.) "A sensitive, wide-range wavemeter, using a capacitance-loaded coaxial line as the resonator. The concentric line has a sliding central conductor, which serves to vary simultaneously the length of the line and the capacitance loading. The electrodes of the capacitor are so shaped as to produce an almost linear relationship between the position of the central conductor and the resonant frequency of the wavemeter. A crystal detector and galvanometer are used to indicate resonance."
- 621.317.79:621.385.2:621.396.822 1693  
A Diode Noise Generator—J. Moffatt. (*Jour. IEE* (London), part IIIA, vol. 93, no. 8, pp. 1335–1337; 1946.) The generator was designed as a standard source for the measurement of the noise factor of if amplifiers of centimeter-wave receivers; it has special output arrangements. The determination of the noise factor involves only the measurement of the dc diode current for specified output conditions. Summary in *Jour. IEE* (London), part IIIA, vol. 93, no. 1, p. 228; 1946.
- 621.317.79:621.396:61 1694  
F.M. Transmitter Performance Measurements—H. P. Thomas and L. M. Leeds. (*Electronics*, vol. 21, pp. 84–87; February, 1948.) Discussion of the use of standard test equipment to ensure that frequency response, harmonic distortion and AM and FM noise are within the limits specified by the FCC.
- 621.317.79:621.396.615 1695  
An alignment Signal Generator for 5–35 Mc/s and 38–82 Mc/s, incorporating a Display System—C. M. Burrell, W. R. Savery, and P. B. F. Evans. (*Jour. IEE* (London), part IIIA, vol. 93, no. 8, pp. 1352–1358; 1946.) An account of the design and performance of an instrument for showing on a c.r.o. the frequency-response curve of an amplifier. The accuracy of representation is  $\pm 0.2$  to  $\pm 0.3$  db in amplitude and  $\pm 200$  kc in frequency. Any bandwidth between 1 Mc and the full extent of either band can be displayed. Summary in *Jour. IEE* (London), part IIIA, vol. 93, no. 1, pp. 219–220; 1946.
- 621.317.79:621.396.615 1696  
Universal Generator with Fixed Carrier Frequencies—G. Nissen. (*Toute la Radio*, vol. 15, pp. 116–119; March and April, 1948.) A generator suitable for receiver testing. It includes three h.f. oscillators  $f_1, f_2, f_3$ , an af oscillator giving frequencies of 150, 400, 800, or 3000 cps, and various capacitive attenuators. The circuit arrangements are such that for each of five h.f. ranges, three signals can be obtained simultaneously, modulated or not, and with voltages between 50 mv and 5 v for each of the 15 frequencies available. The main attenuator, of the capacitive type, is of unique design and produces no frequency shift. A small variable capacitor enables the frequency of  $f_2$  to be varied by 2 per cent.
- 621.317.79:621.396:615:14 1697  
A Pulse-Modulated Signal Generator for 260–800 Mc/s—R. G. Hibberd, J. H. Shankland, and A. Bruce. (*Jour. IEE* (London), part IIIA, vol. 93, no. 8, pp. 1331–1334; 1946.) The design of a signal generator consisting of independent rf oscillator and pulse generator units is discussed in detail with circuit diagrams. Pulse lengths from  $\frac{1}{2}$  to 8  $\mu\text{s}$  are available at repetition rates from 25 cps to 25 kc. The oscillator frequency can be adjusted within  $\pm 1$  per cent. The output attenuation range is 130 db. Summary in *Jour. IEE* (London), part IIIA, vol. 93, no. 1, pp. 222–223; 1946.
- 621.317.79:621.396.615.14 1698  
A Wide-Band Visual-Alignment Signal Generator for 10–100 Mc/s—R. G. Hibberd. (*Jour. IEE* (London), part IIIA, vol. 93, no. 8, pp. 1328–1330; 1946.) Details of a signal generator with FM to a maximum of  $\pm 20$  Mc. It is used with an oscillograph to display the frequency response and sensitivity of amplifiers with bandwidths to about 30 Mc. Summary in *Jour. IEE* (London), part IIIA, vol. 93, no. 1, p. 221; 1946.
- 621.317.79:621.396.615.14:621.396.619.16 1699  
Methods of Pulse Modulation of Signal Generators Covering 5–300 Mc/s—E. D. Hart. (*Jour. IEE* (London), part IIIA, vol. 93, no. 8, pp. 1315–1318; 1946.) An account of wartime methods of applying pulses of duration of 1 to 10  $\mu\text{s}$  to wide-frequency-range signal generators, with a critical examination of defects. An improved gating method, using a grounded-grid triode, is described, giving a possible modulation depth of 99.5 per cent with 0.25- $\mu\text{s}$  delay. Suggestions for further improvements are outlined. Summary in *Jour. IEE* (London), part IIIA, vol. 93, no. 1, pp. 220–221; 1946.
- 621.317.79:621.396.001.4 1700  
Pocket Stethoscope—R. L. Farnsworth. (*Radio News*, vol. 38, pp. 62–63; November, 1947.) A mains-operated unit, consisting of a probe and amplifier with aural and visual outputs, designed for tracing faults in radio and electronic equipment.
- 621.317.79:621.396.82 1701  
Interference Measurement—G. L. Ham-burger. (*Wireless Eng.*, vol. 25, pp. 44–54 and

89-97; February and March, 1948.) An examination of the effects of bandwidth on various types of interference, such as fluctuation noise, single and repeated impulses, and noise generated by dc motors. A special amplifier was constructed for operation at a fixed mid-band frequency of 5 Mc. Variation of bandwidth was effected by interchangeable filter sets. Circuit details are given. Measurements of fluctuation noise show that the effect of bandwidth follows the expected square-root law and that the diode rectifier does indicate the rms value of this type of noise. The amplifier response to transients was investigated by an oscillographic method. The response of four coupled band-pass filters differs in some respects from that of an idealized filter but agrees fairly well with theory. The relative shape of the transient envelope is independent of bandwidth and the crest values of the actual transients agree with those of the ideal transients within  $\pm 3$  db. In the case of repeated impulses, the narrower the bandwidth and the higher the recurrence frequency, the closer does the reading of the output meter approach the crest values of the transients. Motor noise follows the square-root law within the range investigated.

#### OTHER APPLICATIONS OF RADIO AND ELECTRONICS

531.717.1:534.321.9 1702  
**Portable Ultrasonic Thickness Gage**—N. G. Branson. (*Electronics*, vol. 21, pp. 88-91; January, 1948.) Circuit and operation details are given. The physical and electronic principles are discussed. Accuracy within 1 per cent is claimed for uniform thicknesses while accuracy within 2 to 5 per cent may be expected for corroded materials.

531.767:629:135 1703  
**Precise Measurement of Aircraft Speed**—C. S. Franklin. (*Electronics*, vol. 21, pp. 72-77; February, 1948.) An American Army Air Force system for measuring true air-speed. Two modified instrument-landing-system beams are produced in parallel vertical planes ten miles apart. The airplane flies at right angles to these planes at any altitude; an airborne transmitter automatically sends a signal to a ground receiver and electronic chronograph as the aircraft passes through each beam. Great care is taken in setting up the antenna arrays to ensure that the beams are in vertical and parallel planes. A monitor receiver is located in each of these planes 400 ft. from the transmitter; small errors of course are thus automatically allowed for. The beams are aligned and maintained to within  $\pm 50$  ft. so that the maximum error for a speed of 600 m.p.h. is about  $\frac{1}{2}$  per cent.

534.321.9:[616.314+669 1704  
**Ultrasonics in Solids**—S. Y. White. (*Audion Eng.*, vol. 31, pp. 22-24, 42; October, 1947.) Discusses the application of ultrasonics to dentistry and metallurgy.

539.16.08 1705  
**A New Scale-of-Ten Recorder**—R. D. Lowde. (*Jour. Sci. Instr.*, vol. 24, pp. 322-324; December, 1947.) The instrument is compact and inexpensive. "Its operation is best described as that of scaling by  $2(2^2+1)$ , pentode flip-flop scale-of-two pairs being used throughout." Provision is made in the output stage for a recorder resolving time of 0.05 second; the statistical loss for random counting is then 1 per cent at an average rate of 4000 counts per minute. The model will function satisfactorily with a regular pulse input up to 100 kc.

539.16.08 1706  
**A One-Shot Multivibrator Anticoincidence and Recording Circuit**—S. J. du Toit. (*Rev. Sci. Instr.*, vol. 18, pp. 31-35; January, 1947.) A circuit using two one-shot multivibrators, for

experiments where large numbers of counter tubes are to be used in anticoincidence. 539.16.08 1707

**Some Photoelectric Thresholds for Geiger-Müller Counters with Evaporated Cathodes**—C. A. Ramm. (*Jour. Sci. Instr.*, vol. 24, pp. 320-321; December, 1947.) The thresholds were measured for several cathode metals, of which gold appears to be the best.

539.16.08 1708  
**Analysis of the Impulses from Geiger-Müller Tubes**—S. C. Curran and E. R. Rae. (*Rev. Sci. Instr.*, vol. 18, pp. 871-876; December, 1947.) The method of analysis described is suitable for finding the effective dead-time of high-resolving-power counters. Spurious pulses from positive ions incident on the cathode are revealed and the drift time of the ions can be measured. Results are given for tubes containing various diatomic gases and methane, mixed with alcohol. Tubes containing such mixtures are inefficient for  $\beta$ -ray detection.

615.83:534.321.9 1709  
**Ultrasonic Treatment, a New Branch of Physical Therapy**—G. Fiedler. (*Frequenz*, vol. 1, pp. 56-59; November, 1947.) A short review of the first technical and biological applications, with a discussion of therapeutic effects, especially in cases of sciatica, neuralgia, and cancer. The Siemens-Reiniger equipment, with an output in water of 40 w at 800 kc, is briefly described.

621.383.001.8:535.61-15 1710  
**An Infra-Red Image-Converter Tube**—T. H. Pratt. (*Jour. Sci. Instr.*, vol. 24, pp. 312-314; December, 1947.) The basic design consists of an Ag-Cs<sub>2</sub>O photocathode deposited on a plane glass surface with an anode in the form of a willemite screen parallel to it. Infrared radiation falling on the cathode releases electrons, which are accelerated to the anode, where they form a fluorescent image corresponding to the initial infrared image. Possible applications are indicated. See also 2861 of 1947 (Morton and Flory).

621.384.6 1711  
**The Path towards Billiards of Electron-Volts**—B. Kwal. (*Toute la Radio*, vol. 15, pp. 48-53; January, 1948.) A discussion of the principles and special features of various types of electron accelerators, including electrostatic generators of the Van de Graaff type, the betatron, cyclotron, synchrotron, and linear accelerators.

621.384.6 1712  
**R.F. System for Frequency Modulated Cyclotron**—K. R. MacKenzie and V. B. Waithman. (*Rev. Sci. Instr.*, vol. 18, pp. 900-907; December, 1947.) A grounded-grid FM oscillator and single-dee resonator system are described and coupling constants, phase correction AM, and discharge phenomena are discussed.

621.385.833 1713  
**Progress in Electron Microscopy**—R. Reed. (*Nature* (London), vol. 160, pp. 762-763; November 29, 1947.) An account of a conference of the Electron Microscopy Group of the Institute of Physics, held at Leeds in September, 1947.

621.385.833:523.821.5 1714  
**Use of Electronic Telescope in Stellar Photometry**—A. Lallemand and F. Lenouvel. (*Compt. Rend. Acad. Sci.* (Paris), vol. 225, pp. 1129-1130; December 10, 1947.) The apparatus used consists of a semitransparent photocathode whose spectral sensitivity extends to 1.2 $\mu$ ; an electrostatic lens reproduces the electronic image of the photocathode on a fluorescent screen. The image of an artificial star is projected on to the photocathode beside

that of the star under observation and adjusted to obtain intensity equality on the fluorescent screen.

621.386 1715  
**One-Millionth Second Radiography and Its Development**—C. M. Slack and L. F. Ehrke. (*ASTM Bull.*, pp. 59-68; January, 1948.) An account of the development of X-ray tubes with electron currents of 1000 to 2000 amp; also of surge generators capable of giving such currents under pulse conditions. Typical applications are described.

621.396.621.54.001.8 1716  
**Superegenerative Circuit Applications**—Stockman. (See 1591.)

621.397.331.2:551.462 1717  
**Underwater Television**—Engleman. (See 1779.)

621.398+621.317.083.7]:627.8 1718  
**Radio Control for Water Works**—(*Electronics*, vol. 21, pp. 152, 158; January, 1948.) A radio system of telephony, telemetry, and telecontrol providing intercommunication between the pump station, the reservoir, and the water company's office.

#### PROPAGATION OF WAVES

538.566+621.396.11 1719  
**Guided Propagation in Metal Tubes and in the Atmosphere**—J. Vogt. (*Onde Elec.*, vol. 28, pp. 29-38; January, 1948.) A ray method is described for the study of guided waves; it is applicable to homogeneous dielectrics or to those whose heterogeneities are small compared with  $\lambda$ . Both phase and amplitude of the waves can easily be found. The method is applied to metal waveguides and to the anomalous propagation of very short waves in atmospheric ducts. In both cases, a certain number of proper waves can be guided. The cutoff wavelength, the group and phase velocities, and the vertical distribution of the field are calculated. In the case of the atmospheric duct, the method fails in the neighborhood of the caustic and in the diffraction zone, but here the optical methods developed by Fresnel and Airy and based on Huyghens' principle can be applied. It is found that only the rays of very small inclination to the horizon can be guided in the actual atmosphere. Consequently the maximum wavelength which can be so guided is very much less than the height of the duct, and the phase and group velocities approximate to that of light in vacuo.

538.566 1720  
**Some Theorems on Group Velocities of Electromagnetic Waves**—S. M. Rytov. (*Zh. Eksp. Teor. Fiz.*, vol. 17, pp. 930-936; October, 1947. In Russian.)

621.396.11 1721  
**Russian Radiophysics and the Theory of Radio Wave Propagation over the Surface of the Earth**—E. L. Feinberg. (*Radiotekhnika* (Moscow), vol. 2, pp. 5-14; April, 1947. In Russian, with English summary.) The researches of Russian investigators are outlined.

621.396.11:523.78"1947.05.20":551.510.535 1722  
**Provisional Results Obtained by the French Mission to Brazil during the Total Solar Eclipse, 20th May, 1947**—Rocard. (See 1632.)

621.396.11:621.317.361:551.510.535 1723  
**The Effect of Doppler's Principle on the Comparison of Standard Frequencies over a Transatlantic Radio Path**—C. F. Booth and G. Gregory. (*PO Elec. Eng. Jour.*, vol. 40, part 4, pp. 153-158; January, 1948.) An account of the calibration of an oscillator incorporated in the Post Office standard of frequency at Dollis Hill, and of its use for frequency comparisons

with the National Bureau of Standards' standard frequency transmissions from Washington on 10 Mc and 15 Mc. Apparent frequency changes of up to approximately  $\pm 25$  parts in  $10^8$ , due to the Doppler effect, were found in the received signals. See also 3254 of 1947 and 1725 below.

621.396.11:621.396.5 1724  
Transoceanic Radiotelephony—Guld-  
mann. (See 1750.)

621.396.11.018.41 1725  
Modification of the Frequency of Radio  
Waves during Propagation—B. Decaux.  
(*Compt. Rend. Acad. Sci. (Paris)*, vol. 226,  
pp. 328–329; January 26, 1948.) Measure-  
ments of the frequency of the standard trans-  
missions from Washington were made with  
special apparatus permitting observation of  
frequency differences of 0.02 cps. The results  
show that the phase instability is more pro-  
nounced for the lower transmission frequen-  
cies. A diurnal variation of the received frequency  
has been observed, the morning value being,  
with few exceptions, higher than the evening  
value. The frequency variation is of the order of  
 $6 \times 10^{-8}$  and in certain cases may exceed  
 $20 \times 10^{-8}$ . Differences are also found between  
the measurements on the various transmission  
frequencies; such differences may be as much as  
 $25 \times 10^{-8}$ , though the same frequency reference  
standard is used for all measurements. In gen-  
eral, the relative frequency variation of the  
morning transmission on 5 Mc is distinctly  
higher than for the other transmissions, the  
average difference from December 22 to Janu-  
ary 15, being  $8 \times 10^{-8}$ . Measurements every  
hour between 0630 and 2230 on any frequency  
show a fairly sharp maximum towards 0800  
and a flat minimum between 1330 and 2100,  
the difference between maximum and mini-  
mum being about  $15 \times 10^{-8}$ . See also 1723 above  
and 1726 below.

621.396.11.018.41:551.557 1726  
Influence of Wind on the Frequency of  
Radio Waves—R. Jouaust. (*Compt. Rend.  
Acad. Sci. (Paris)*, vol. 226, pp. 329–330;  
January 26, 1948.) It is suggested that the re-  
sults obtained by Decaux (1725 above) may be  
due to ionospheric winds which give rise to a  
Doppler effect. See also 3254 of 1947 (Griffiths).

621.396.11.029.6 1727  
Propagation of Very Short Waves—D. E.  
Kerr. (*Electronics*, vol. 21, pp. 124–128 and  
118–123; January and February, 1948.) A  
simplified presentation of the immense mass of  
new theory and data dealing with factors  
governing propagation at frequencies between  
100 and 30,000 Mc. Both one-way and two-  
way transmission are considered, and the effects  
of earth curvature, surface reflections, and at-  
mospheric refraction are discussed in detail.

621.396.81.029.63:621.317.32 1728  
Field Tests for Citizens Band—R. E.  
Samuelson. (*Electronics*, vol. 21, pp. 92–96;  
January, 1948.) An explanation of an empirical  
equation which indicates the coverage to be  
expected for two-way systems in the 465-Mc  
band. Some details are given of the test equip-  
ment used and of its capabilities. See also 802  
of April (Bullington) and 855 of April (Hollis).

#### RECEPTION

621.396/.397.62 1729  
A Complete Television Receiver—*Télev.  
Franç.*, pp. 20–23; January, 1948.) Full circuit  
and coil winding details of a receiver with pro-  
vision for radio reception on long and medium  
waves and on 6 short-wave bands.

621.396.621 1730  
Concerning an Invention—R. Aschen.  
(*Télev. Franç.*, Supplement *Electronique*, pp.  
30–31; January, 1948.) Discusses various ap-

plications of a system of reception in which the  
frequency of a local oscillator is varied periodi-  
cally about a mean frequency equal to the  
signal frequency. Such a system introduces a  
certain amount of distortion, but has the ad-  
vantage of simplifying receiver design and re-  
ducing the number of stages required. Applica-  
tions to the reception of c.w., radio telephone,  
and television transmissions, and to a l.f. har-  
monic analyzer, are mentioned.

621.396.621 1731  
Hazeltine FreModyne F.M. Circuit—  
(*Tele-Tech*, vol. 6, pp. 41, 86; December, 1947.)  
Combines superheterodyne and superregenera-  
tive principles and gives good selectivity and  
af output.

621.396.621:621.314.2 1732  
Intermediate Frequency Transformers for  
A.M.-F.M. Receivers—E. G. Beard. (*Philips  
Tech. Commun. (Australia)*, pp. 12–15; Novem-  
ber, 1946.) Circuit arrangements are discussed  
and simple AM/FM switching arrangements  
described.

621.396.621:621.396.619.11 1733  
The Synchrodyne: Refinements and Exten-  
sions—D. G. Tucker and J. Garlick. (*Elec-  
tronic Eng. (London)*, vol. 20, pp. 49–54; Febru-  
ary, 1948.) A method is suggested for stabiliz-  
ing the phase difference between the output and  
input signal of the synchronized oscillator. The  
synchronizing signal can thus be substantially  
reduced in level, so that interfering signals in  
the output of the synchronized oscillator be-  
come very small.

The synchrodyne can also be used as a re-  
jector instead of as an acceptor by arranging  
that the phase angle between the local oscilla-  
tor output and the carrier of the signal fed to  
the demodulator is  $90^\circ$  instead of zero. By using  
an additional synchrodyne circuit, tuned to  
reject the unwanted signal, it would therefore  
be possible to receive a weak station adjacent to  
a strong one, even when the sidebands overlap.

Other suggestions include the application of  
the synchrodyne circuit to short-wave receivers,  
to the reception of i.c.w. signals, and to single-  
span frequency coverage. See also 1139 of  
May and back references.

621.396.621:621.396.619.13 1734  
A Narrow-Band FM Adapter—B. DuHart.  
(*Radio News*, Vol. 38, pp. 46, 128; November,  
1947.) A simple limiter and discriminator unit  
which can be used to adapt any type of com-  
munications receiver to detect narrow-band  
FM signals. An ordinary untapped if trans-  
former is used in the discriminator circuit.

621.396.621:621.396.672 1735  
Capacity Aerials for Mains Receivers—(See  
1563.)

621.396.621.53.029.62 1736  
28–54 Mc/s Converter, incorporating RL37  
Grounded Grid R.F. Amplifier with ECH35  
Mixer—D. B. Knock. (*Philips Tech. Commun.  
(Australia)*, pp. 3–5; October, 1947.) Circuit  
details of a converter for amateur vhf commu-  
nication.

621.396.621.54 1737  
Superregenerative Reception of Pulse Sig-  
nals—M. K. Belkin. (*Radiotekhnika (Moscow)*,  
vol. 2, pp. 47–62; March, 1947. In Russian,  
with English summary.) The conditions for  
maximum amplification are found by solving  
linear differential equations derived for all pos-  
sible phase relations.

621.396.621.54:621.396.82 1738  
Effect of Interference on a Superregenera-  
tor: Part 2—Effect of Fluctuation Interference  
—L. S. Gutkin. (*Radiotekhnika (Moscow)*,  
vol. 2, pp. 24–45; April, 1947. In Russian, with  
English summary.) The effective noise voltages

at the output of the superregenerative circuit  
and at that of the narrow-band filter in series  
with the detector are determined. The signal-  
to-noise ratio for a superregenerative receiver  
is shown to be higher than for an ordinary re-  
ceiver by a factor which increases with the de-  
gree of superregeneration and may reach a  
value of about 2. Part 1: *ibid.*, vol. 1, no. 9,  
1946.

621.396.81:621.396.96 1739  
Signal-Noise Ratio in Radar—S. de Wal-  
den. (*Wireless Eng.*, vol. 25 pp. 97–98; March,  
1948.) Criticism of 1146 of May (Levy).

621.396.82:621.317.79 1740  
Interference Measurement—Hamburger.  
(See 1701.)

621.396.822 1741  
Survey of Radio Noise—(*Nature (London)*,  
vol. 161, p. 107; January 17, 1948.) See 534  
of March.

621.396.822:538.523 1742  
Electromagnetic Background Noise Due to  
Sea Waves—Y. Rocard. (*Rev. Sci. (Paris)*,  
vol. 85, p. 481; May 1, 1947.) See 251 of  
February.

621.396.822:621.317.34 1743  
An Absolute Method of Measurement of  
Receiver Noise Factor—E. H. Ullrich and D. C.  
Rogers. (*Jour. IEE (London)*, part IIIA, vol.  
93, no. 8, pp. 1347–1351; 1946.) This factor is  
the ratio of the signal-to-noise ratio in a re-  
sistive source at room temperature before con-  
nection to the receiver, to that existing in the  
receiver output. It is assumed that the noise in  
the source is thermal, i.e., that no extraneous  
noise pick-up is present.

The measurement is made by using a dum-  
my antenna as a source, and raising its tempera-  
ture until a measurable increase in noise output  
is obtained. The noise factor can then be de-  
duced from the increase in noise output and  
the temperature of the dummy antenna. The  
method has been used at frequencies up to  
1200 Mc. The paper includes some practical  
details of measurement, and experimental re-  
sults obtained at frequencies of 45, 200, and 600  
Mc. Summary in *Jour. IEE*, part IIIA, vol.  
93, no. 1, pp. 233–234; 1946.

621.396.823 1744  
Radio Interference Tests on an Electrified  
Railway—S. F. Pearce. (*Beama Jour.*, vol. 55,  
pp. 13–14; January, 1948.) Tests at various  
distances from the track show that interference  
falls off approximately as (distance)<sup>-2</sup> and is  
unlikely to disturb broadcasting reception.

#### STATIONS AND COMMUNICATION SYSTEMS

621.39 1745  
Bandwidth vs Noise in Communication  
Systems—D. G. F. (*Electronics*, vol. 21, pp.  
72–75; January, 1948.) A report on an IRE sym-  
posium at which the law

$$C = W \log_2 [1 + (P/N)]$$

was proposed, where  $C$  is the capacitance of the  
channel, or number of binary digits which can  
be transmitted in unit time,  $W$  is the bandwidth  
of the channel and  $P/N$  is the signal-to-noise  
ratio in power units. This equation extends the  
Hartley law, which states that  $C/W$  is constant.

Using mathematical-physical concepts of  
quantum mechanics, the derivation of the pro-  
posed law is discussed for an ideal system. Pulse  
code modulation, unlike earlier systems of  
modulation, takes full advantage of the theo-  
retical possibilities. See also 1057 of 1947  
(Gabor) and 1491 of June.

621.39.015.3:621.317.35 1746  
Telecommunication System in Transient  
State—D. C. Espley. (*Onde Élec.*, vol. 27,

- pp. 437-446; December, 1947.) A discussion with special reference to the wave form of the signals during passage through the system. The point of view is physical rather than mathematical; by reference to the relation between frequency and time it is found possible to design practical circuits, including time equalizers and phase compensators, without recourse to frequency/attenuation and frequency/dephasing characteristics.
- 621.396.1** 1747  
**Frequency Allocations**—P. F. Siling. (*RCA Rev.*, vol. 8, pp. 737-742; December, 1947.) A general review, with particular reference to the Atlantic City conference and to the RCA charts now being distributed.
- 621.396.1** 1748  
**Radiocommunication Conference at Atlantic City**—B. de Clejoulx. (*Onde Élec.*, vol. 28, pp. 13-28; January, 1948.) An account of the principal results of the conference, including definitions, classification and quality of transmissions, frequency allocations, conditions for mobile stations, International Frequency Registration Board (IFRB), new list of frequencies, marine and aeronautical services, and reorganization of the CCIR.
- 621.396.1** 1749  
**International Telecommunications Conferences, Atlantic City, 1947**—A.H.M. (*PO Elec. Eng. Jour.*, vol. 40, part 4, pp. 175-178; January, 1948.) A critical discussion of the principal results.
- 621.396.5:621.396.11** 1750  
**Transoceanic Radiotelephony**—A. Guldinmann. (*Tech. Mitt. Schweiz. Telegr.-Teleph. Verw.*, vol. 25, pp. 239-245; December 1, 1947. In French and German.) A general discussion of terminal equipment and of the conditions affecting the reception of long-distance signals, including fading, noise, and magnetic storms.
- 621.396.619:621.397.5** 1751  
**An Important Advance in Television Modulation**—(See 1788.)
- 621.396.619.11/13** 1752  
**Comparison of A.M.-F.M.**—D. R. Parsons. (*Wireless Eng.*, vol. 25, p. 33; January, 1948.) Comment on 1160 of May (Scroggie and Macdiarmid).
- 621.396.65:621.397.6** 1753  
**2000-Mc Television Program Chain**—Deerhake. (See 1792.)
- 621.396.65.029.64** 1754  
**A Preview of Radio Relaying**—G. N. Thayer. (*Bell Lab. Rec.*, vol. 25, pp. 397-401; November, 1947.) Discussion of a wide-band FM microwave system using directive antennas for a 21-mile optical path. A similar system now operates between New York and Boston (1755 and 1756 below). Loss varies between 55 and 80 db according to weather; it is normally about 60 db. Television signals have been sent round the system twice without suffering appreciable degradation. Tests have also been made using pulse-code modulation.
- 621.396.65.029.64** 1755  
**Microwave Relay System between New York and Boston**—A. L. Durkee. (*Bell Lab. Rec.*, vol. 25, pp. 437-441; December, 1947.) The system operates at frequencies near 4000 Mc and uses eight repeater stations with an average spacing of 27.5 miles. Two 2-way communication channels are provided, each covering a signal band extending from 30 cps to 4.5 Mc, and with noise and distortion characteristics satisfactory either for television signals or for a considerable number of telephone channels. Time-division or frequency-division multiplex methods are used.
- 621.396.65:621.397.743** 1756  
**NY [New York]-Boston Microwave Television Relay**—J.M. (*Electronics*, vol. 21, pp. 114-116; January, 1948.) Seven repeater stations are used to provide line-of-sight transmission in each direction over a total effective range of 220 miles, at four frequencies in the 3700 to 4200-Mc band. Each repeater station uses broad-band horn antennas with beam width 2°; metal focusing lenses give a gain of 40 db. Operation is reliable in all weathers with a transmitter power less than 1 w. Two channels are available in each direction. Each frequency is separated at the repeater by filter sections in the waveguides from the receiver horns. Provision is made for frequency control and for the elimination of picture distortion due to time delay differences for the different transmitted frequencies.
- 621.396.73** 1757  
**WOR's Field Pick-Up Studio for Spot Broadcasts**—(*Tele-Tech*, vol. 6, pp. 32-33; November, 1947.) Four transmitters, supplied with power from a bank of storage batteries, are used for a completely self-contained mobile service on frequencies ranging from 150 to 1.5 Mc.
- 621.396.931.029.62+621.396.65.029.62** 1758  
**Limited Common Carrier Radio Service**—A. A. McK. (*Electronics*, vol. 21, pp. 97-99; January, 1948.) A conventional 160-Mc system enabling business men to maintain two-way communication, from a car or a fixed position, with a telephone operator who receives messages on behalf of the clients of the telephone answering service when their offices are closed.
- 621.396.97 (45):621.396.619.13** 1759  
**F.M. and Broadcasting Problems in Italy**—P. L. Bargellini. (*Tecn. Elettronica*, vol. 2, pp. 37-48; July, 1947. In Italian.) A concise account of FM, its advantages and requirements in bandwidth and frequency, with a plea for its development on a large scale in Italy.
- 621.396.97(94)** 1760  
**Engineering Aspects of the National Broadcasting Service**—R. J. Boyle. (*PROC. IRE (Australia)*, vol. 8, pp. 5-19; November, 1947. Discussion, pp. 19-22.) Australian broadcasting facilities are discussed with particular reference to New South Wales. Broadcast coverage for the m.f. and h.f. bands is considered, and details are given of the technique used for determining locations for new transmitters. The antenna systems and transmitting equipment are described and the studio switching arrangements, recording, and broadcast relaying facilities are outlined.
- 621.398+621.317.083.7]:627.8** 1761  
**Radio Control for Water Works**—(*Electronics*, vol. 21, pp. 152, 158; January, 1948.) A radio system of telephony, telemetry, and telecontrol providing intercommunication between the pump station, the reservoir, and the water company's office.

## SUBSIDIARY APPARATUS

**621.526** 1762  
**The Inverse Nyquist Plane in Servomechanism Theory**—G. B. Criss. (*PROC. IRE*, vol. 35, pp. 1503-1504; December, 1947.)

**621.316.57** 1763  
**A Sensitive Circuit Breaker for Instrument Protection**—A. Borup. (*Electronic Eng.* (London), vol. 20, pp. 26-27; January, 1948.)

**621.316.722.1** 1764  
**Electronic Voltage Regulator**—(*Bell Lab. Rec.*, vol. 25, pp. 452-453; December, 1947.) Needing only a small tube and a few resistors, this regulator made practicable the use of wind-driven generators as power supplies for early

airborne radio apparatus. The relationship between anode and heater currents in the diode was used to give continuous control of the generator voltage. This method replaced the intermittent control effected by the relay type of regulator which gave a sawtooth voltage output having harmonic frequencies which interfered with reception.

**621.316.722.1** 1765  
**Voltage Stabilization**—L. Liot. (*Télev. Franc.*, pp. 25-28, 44; November, 1947.) Describes and compares methods using (a) Fe resistors in H, (b) carbon disks, (c) Ne tubes, and (d) triodes.

**621.316.722.1:621.397.6** 1766  
**Electron Stabilizers for Television Apparatus**—S. P. Pivovarov. (*Zh. Tekh. Fiz.*, vol. 17, no. 6, pp. 737-742; 1947. In Russian.) The anode voltage of wide-band amplifiers and scanning devices in modern television apparatus is kept constant by means of special rectifying circuits (electron stabilizers). The theory of two such circuits is discussed.

**621.316.726:534.321.71** 1767  
**Use of Rectifier with Tuning-Fork Control as Frequency-Constant A.C. Source**—H. Herwig. (*Funk und Ton*, no. 2, pp. 93-99; 1947.) A 100-cps tuning fork is used for accurate frequency control of a power amplifier with neon-tube stabilization of the anode supply. Various applications are suggested.

**621.318.572** 1768  
**Transmitter-Blocker Cells**—R. H. Kay and M. Surdin. (*Wireless Eng.*, vol. 25, pp. 55-61 and 75-87; February and March, 1948.) This type of cells has also been termed the a.t.r. (anti-transmitter-reception) switch and the transmitter disconnect switch. In centimeter-wave technique, it consists of a resonant-waveguide device, between the receiver branch and the magnetron, which on reception presents a high impedance in series with the magnetron branch of the main guide and so prevents undue reception loss. Theory of the design of fixed-tuned transmitter-blocker cells is given, with an outline of experimental methods for investigating these cells. Methods are also discussed for assessing quantitatively the reception loss in a system using a cell of given edge-band impedance when operating with magnetrons of given "cold-impedance" characteristics.

**621.352** 1769  
**Recent Progress in the Study and the Manufacture of Dry Batteries**—G. Génin. (*Rev. Gén. Élec.*, vol. 57, pp. 27-33; January, 1948.) Description of elements using (a) HClO<sub>4</sub>, (b) AgCl and Mg, (c) Hg, and an account of the special features of each type. See also 3295 of 1947 (Mullen and Howard) and 1171 of May.

**621.396.622.63** 1770  
**An Investigation into the Use of Crystal Rectifiers for Measuring and Monitoring Purposes**—R. C. Robbins and F. W. Black. (*Jour. IEE (London)*, part IIIA, vol. 93, no. 8, pp. 1343-1346; 1946.) Measurements of the rectification law and sensitivity of silicon-tungsten crystals of the type used for centimeter  $\lambda$  are described. The effects of the rf circuit impedance, of the dc meter resistance and of temperature changes were investigated at 50 cps and 200 Mc. Temperature changes were found to have a very marked effect. High-resistance meters are preferable.

## TELEVISION AND PHOTOTELEGRAPHY

**621.396/.397].62** 1771  
**A Complete Television Receiver**—(*Télev. Franc.*, pp. 20-23; January, 1948.) Full circuit and coil winding details of a receiver with provision for radio reception on long and medium waves and on 6 short-wave bands.

- 621.397(083.74) 1772  
**Radiophoto Standards**—S. H. Simpson, Jr., and R. E. Hammond. (*RCA Rev.*, vol. 8, pp. 682-697; December, 1947.) A short review of the development of the art and discussion of proposed standards for cylinder dimensions and speed, transmission frequency, etc.
- 621.397.3 1773  
**Interlocked Scanning for Network Television**—J. R. De Baun. (*RCA Rev.*, vol. 8, pp. 651-659; December, 1947.) The advantages of interlocking the scanning systems of several cameras to permit instantaneous switching-over or mixing are discussed. Possible methods are outlined.
- 621.397.3 1774  
**Horizontal Scanning Generator and H.V. Supply**—J. F. Bigelow. (*Tele-Tech.*, vol. 6, pp. 56-57; December, 1947.) Oscillator and h.v. generator are combined in one tube. Operation is described.
- 621.397.331.2 1775  
**The New Television Camera—The C. P. S. Emitron**—(*Electronic Eng.* (London), vol. 20, p. 59; February, 1948.) A photoelectric mosaic of greatly increased sensitivity is used and a method known as cathode potential stabilization is applied to eliminate undesirable shading effects and spurious signals. Advantages claimed include the possibility of a considerable reduction of studio lighting intensities, improved fidelity of color reproduction and great depth of focus with quite moderate lighting. See also *Wireless World*, vol. 54, pp. 60-61; February, 1948.
- 621.397.331.2 1776  
**The Eriscopes**—(*Radio Franc.*, p. 24; December, 1947.) A French pickup tube similar in some respects to the iconoscope, but in which the photosensitive mosaic is replaced by a surface giving rise to secondary emission. The image on this surface is produced by a system of electromotive or electrostatic lenses and is analyzed by a cathode beam. The surface is continuous, but its electrical resistivity is great enough for the charges accumulated at each point by the secondary emission to remain localized, so that subdivision is unnecessary. The optical image on the photosensitive surface is very small, about 9 mm $\times$ 12 mm. This is enlarged 6 to 8 times by the electron-optical system. The short-focus, wide-aperture lenses used give a considerable depth of focus. This new tube gives very high definition: scanning with 800 lines or more is practicable.
- 621.397.331.2 1777  
**Study of Thin Slightly-Conducting Targets**—R. Barthélemy. (*Compt. Rend. Acad. Sci.* (Paris), vol. 226, pp. 292-294; January 26, 1948.) A theoretical discussion of the properties of thin targets similar to those used in the image-orthicon. See also 1778 below.
- 621.397.331.2 1778  
**Impact of a Scanning Beam on a Thin Target with Two Faces**—R. Barthélemy. (*Compt. Rend. Acad. Sci.* (Paris), vol. 226, pp. 532-533; February 16, 1948.) Further theoretical discussion, continuing 1777 above.
- 621.397.331.2:551.462 1779  
**Underwater Television**—C. L. Engleman. (*Electronics*, vol. 21, pp. 78-80; February, 1948.) A multiplier-orthicon camera, enclosed in a watertight cylinder, with remote focusing and target control. It has been used in Bikini lagoon down to a depth of 180 ft.
- 621.397.331.2:621.396.933 1780  
**The Storage Orthicon and Its Application to Teleran**—S. V. Forgue. (*RCA Rev.*, vol. 8, pp. 633-650; December, 1947.) The storage orthicon pickup tube has a very high capacity mosaic target and operates with a very low scanning beam current. Charges induced on the mosaic by successive instantaneous pictures, such as would be produced by a p.p.i. for teleran, are stored and may be retransmitted as a composite television picture corresponding to the normal p.p.i. display obtained on a long-delay c.r. tube. Theory and construction details are given.
- 621.397.335 1781  
**Design of Simple Sync Generator**—E.M. Noll. (*Tele-Tech.*, vol. 6, pp. 34-37; November, 1947.) Details of a 60-frame 260-line system without interlacing, intended for use as a basic pulse timing and shaping unit and for checking both standard and nonstandard television receivers. See also 3489 of 1947 (Schoenfeld, Brown, and Milwitt.)
- 621.397.5 1782  
**Television and Colour**—J. L. Salpeter. (*Philips Tech. Commun.* (Australia) pp. 3-16; September, 1946.) Discussion of the Leverenz theory of the optimum screen efficiency in kinescopes and of the relation between color television and colorimetry.
- 621.397.5 1783  
**Technical Aspects of Television Studio Operation**—R. W. Clark and H. C. Gronberg. (*RCA Rev.*, vol. 8, pp. 719-736; December, 1947.)
- 621.397.5 1784  
**TV Pick-Up from Moving Location**—(*Tele-Tech.*, vol. 6, pp. 48, 91; December, 1947.) Short account of methods used for television transmission from a ship approaching New York and for retransmission from New York and Washington.
- 621.397.5:535.317.25 1785  
**The Resolving Power of a Television System**—Ya. A. Ryftin. (*Zh. Tekh. Fiz.*, vol. 17, no. 4, pp. 401-424; 1947. In Russian.) Discussion of an equivalent over-all schematic for a television system, from the objective of the transmitter to the screen of the receiver. Various generalized parameters are introduced. Quantitative relationships between these parameters are established. By a suitable choice of these parameters, any given conditions can be satisfied and the optimum quality for a given frequency band ensured. A number of practical conclusions are enumerated. See also 1179 of May.
- 621.397.5:535.88 1786  
**Television Projection**—M. Chauvierre. (*Radio Franc.*, pp. 17-20; December, 1947.) A short account of the basic principles and of the use of (a) plastic lenses for correction of spherical aberration, and (b) magnets for correction of trapezoidal distortion.
- 621.397.5:535.88 1787  
**The Projection of Images on a Screen: Parts 5 and 6**—R. Aschen. (*Télev. Franc.*, pp. 12-14 and 10-11; October and November, 1947.) Continuation of 4053 of January. Discusses supply circuits for projection c.r. tubes and direct vision tubes.
- 621.397.5:621.396.619 1788  
**An Important Advance in Television Modulation**—(*Télev. Franc.*, p. 24; January, 1948.) A short account of a method due to Gutton and Ortusi. The modulation is effected in a section of waveguide coupled to a resonant circuit. The variable capacitance of this circuit is that between the anode of a magnetron and the outer layer of the ring of electrons forming the space charge surrounding the cathode. This capacitance is small, but its variation is a maximum when the wave frequency coincides with that of the space charge. 100 per cent modulation of several hundred w requires no more than 1 w. The bandwidth can reach a value of 22 mc on a wavelength of 23 centimeters. The method appears to be applicable to both AM and FM though tests for FM are still in progress.
- Other possible applications of the method are mentioned.
- 621.397.5:621.396.97 1789  
**The RCA Type TJ-50A Television Mobile Unit**—W. J. Poch and H. C. Shepard. (*Broadcast News*, pp. 44-48; September, 1947.) Description of a van which can be used as a mobile control room as well as a means of transport. Power supplies and transmission of picture and sound signals to the headquarters studio are discussed. See also 3685 of January and 841 of April (Bridgewater).
- 621.397.6:621.316.722.1 1790  
**Electron Stabilizers for Television Apparatus**—Pivovarov. (*See* 1766.)
- 621.397.6:621.396.615.17:621.317.755 1791  
**Television Timebase**—M. Chauvierre. (*Radio Franc.*, pp. 44-47; February, 1948.) Circuit details of a system in which the flyback is used to obtain the high voltage required for the c.r. tube.
- 621.397.6:621.396.65 1792  
**2000-Mc Television Program Chain**—F. M. Deerhake. (*Electronics*, vol. 21, pp. 94-97; February, 1948.) Circuit details of the 143-mile New York/Schenectady relay using three unattended intermediate repeater stations. Two staggered rf channels, each 25 Mc wide, at present provide one-way transmission. Klystrons are used in transmitters and receivers, and a FM signal with 14-Mc swing is obtained. During the first two months of operation, it was found that the frequency control of transmitter and receiver klystron obtained by temperature controlled cabinets was quite satisfactory. The frequency drift from the instant of switching on up to normal operating temperatures, was of the order of 0.1 per cent; about four-fifths of this occurred in the first five minutes.
- 621.397.61 1793  
**Design Trends in Television Transmitters**—D. G. F. (*Electronics*, vol. 21, pp. 76-82; January, 1948.) Description, and discussion of the relative merits, of three commercial video transmitters with basically different methods of modulation, sideband suppression, and output tube cooling.
- 621.397.61:621.396.619.13:621.396.65 1794  
**F.M. in Television**—J. S. Cordovés. (*Rev. Telecomunicación* (Madrid), vol. 3, pp. 43-47; September, 1947.) Description of a 20-w transmitter, using a carrier frequency of 1350 Mc, and the associated receiver, designed as a link between a studio or outside broadcast vehicle and the main transmitter. Maximum range is about 40 km, with 72.5 db signal-to-noise ratio.
- 621.397.62 1795  
**Study and Construction of a Television Receiver**—R. Gosmand. (*Télev. Franc.*, pp. 12-17; November, 1947.) A discussion of the various stages, with circuit and construction details of a receiver using a Philips MW 31-6 c.r. tube; direct amplification and high-impedance deflection coils reduce the number of tubes and result in an economical design.
- 621.397.62 1796  
**The Telesvisor**—(*Electronic Eng.* (London), vol. 20, p. 25; January, 1948.) Discussion on the booklet mentioned in 577 of March. See also *ibid.*, vol. 19, p. 352; November, 1947.
- 621.397.62:535.88 1797  
**Large-Screen Projection Television Receiver of the Compagnie des Compteurs**—(*Radio Franc.*, pp. 23-25; January, 1948.) The general arrangement of the receiver follows normal practice, with h.f. amplification, detection, and a stage of video-frequency amplification. The amplifier chain is corrected to be perfectly linear up to 4 Mc. The control deck includes a direct-vision tube. The projector comprises the



optical system, timebase, and h.v. supply. The screen used is a multicellular structure 3 m X 2 and one quarter m. A special h.f. transformer, designed for voltages up to 90 kv between primary and secondary, is used to feed the final h.f. stage. The cathode of the projection tube, with its Wehnelt cylinder, is maintained at about -80 kv. The current in the projection tube is of the order of 500  $\mu$  amp. The screen is formed of a very large number of small ribbon reflectors whose dimensions are of the same order as the image elements. These reflectors give a beam concentrated in an angle of about 20° in the vertical and 45° in the horizontal plane. The image obtained using a wide-angle projection lens is of the same order of brightness as that of the normal cinema projection. See also 838 of April (Hémaradinquer).

621.397.62(443):621.396.82 1798

**Television Reception Problems**—Giloteau and Raymond. (*Télev. Franç.*, pp. 15-19; January, 1948.) Tests with a Pathé Marconi 47 receiver were carried out at 15 points each within 12 km of the transmitter and at one point about 30 km distant. In the latter case, the receiver sensitivity was increased by decreasing the bandwidth, and with a dipole antenna and  $\lambda/4$  reflector at a height of 12 m reception was satisfactory, but there was little reserve of sensitivity. At the shorter distances some trouble was experienced with ghost images, but this could usually be overcome by using a good antenna system with correct feeder matching.

621.397.645 1799

**Correction of Video Amplifiers towards the High Frequencies**—R. Charbonnier and J. Royer. (*Télev. Franç.*, pp. 10-14; January, 1948.) With the present 455-line standard, the video frequency to be transmitted is only slightly above 3 Mc, but for a 1000-line standard, a much wider pass band will be required. Various circuits are discussed, and curves are given showing the improvement in h.f. response resulting from the use of each. Correction by means of two inductances is much better than that using a single inductance.

621.397.743:621.396.65.029.64 1800  
N. Y. [New York]-Boston Microwave Television Relay—(See 1755 and 1756.)

621.396.61 1801

**A Chicago Kilowatt**—R. J. Higgins. (*CQ*, vol. 3, pp. 36-39, 62; December, 1947.) A general description with circuit diagram and photographs of a home-made 1-kw transmitter using four 4-250 amp power tetrodes and fitted with safety switches.

621.396.61 1802

**Medium-Power Table-Top Transmitter**—T. Smith. (*CQ*, vol. 3, pp. 41-43, 86; November, 1947.) 75-w radio telephone and c.w. complete in one compact cabinet. Full circuit and component details.

621.396.61 1803

**Transmitter for All [amateur] Bands, with 40-W Input**—R. Pera. (*Tecn. Elettronica*, vol. 2, pp. 71-76; July, 1947. In Italian.) Construction and circuit details for crystal-controlled equipment.

621.396.61:621.396.3 1804

**Recent Developments in Radiotelegraph Transmitters for Shore Stations**—J. F. McDonald. (*RCA Rev.*, vol. 8, pp. 751-764; December, 1947.) A description of three new keyed telegraph transmitters (15, 20, and 50 kw), for shore-to-ship communication, incorporating push-button frequency changing. Frequency ranges are 2 to 18 Mc and 350 to 500 kc.

621.396.61.029.58 1805

**A Single-Sideband Transmitter for Amateur Operation**—A. H. Nichols. (*QST*, vol. 32, pp. 19-24, 128, 130; January, 1948.) The de-

sign, construction, and operation of a single-sideband suppressed-carrier transmitter are described. Intermediate frequencies of 9 kc. and 550 kc are used and the transmitted frequency is 14.2 Mc. The two higher oscillator frequencies are crystal-controlled and each frequency stage has a balanced modulator and filter.

621.396.615:621.396.712 1806

**B.B.C. Variable-Frequency Drive Equipment for Transmitters**—W. E. C. Varley. (*BBC Quart.*, vol. 2, pp. 244-256; January, 1948.) Details of design and construction of the latest equipment which uses a single, continuously variable oscillator covering the frequency range 700 to 1400 kc. All the frequencies required for long-, medium- and short-wave bands are obtained from this by frequency multipliers, dividers, and harmonic generator multipliers. The frequency can be set to the prescribed tolerance by direct dial observation, although a frequency monitor is included in the equipment to give even higher accuracy. Long-term frequency stability is obtained by proper choice of components in the frequency-determining network and their maintenance at a constant temperature. The specified rf output power is achieved by a wide-band amplifier in the long- and medium-wave bands and by the final stage of the harmonic generator multiplier in the short-wave band.

621.396.619 1807

**Signal-to-Noise Ratio in Different Methods of Radio Transmission. Spectrum of Pulse Modulation**—L. J. Libois. (*Onde Élec.*, vol. 27, pp. 411-425; November, 1947.) Known results for AM and for FM are reviewed briefly. The various forms of pulse modulation are then considered in detail, including pulse amplitude modulation, pulse width modulation, pulse position modulation, and frequency modulation by pulses. Formulas are derived for the signal-to-noise ratio appropriate to each case. In order to determine correctly the spectrum of a pulse-modulated wave, precise assumptions must be made concerning the modulation process. Calculations for certain particular cases are discussed.

621.396.619 1808

**Some Design Problems of a Modern High-Level Modulation System**—A. I. Lebedev-Karmanov and A. M. Pisarevski. (*Radiotekhnika* (Moscow), vol. 2, pp. 3-17; March, 1947. In Russian, with English summary.) Discussion of methods for: (a) the suppression of dynatron oscillations, (b) the reduction of the input power for the submodulator, and (c) the application of phase compensation in the submodulator transformer circuit, with practical design details.

621.396.619.23 1809

**Wide-Band Correction of Distortion by Reaction in High-Level Class-B Modulators**—S. V. Person. (*Radiotekhnika* (Moscow), vol. 2, pp. 18-31; March, 1947. In Russian, with English summary.) Methods of providing for a wide frequency coverage and for the effective correction of distortion are surveyed and instructions are given for selecting the parameters of phase compensators. A method is proposed for widening the compensated frequency band by use of a modulation transformer in the circuit of the i.f. II-network filter. Means are suggested for increasing the transformer leakage inductance.

621.397.61 1810

**Design of Television Transmitters for Low Level Modulation**—J. W. Downie, L. M. Ewing, H. B. Fancher, and J. E. Keister. (*Tele-Tech*, vol. 6, pp. 44-47, 89; December, 1947.) Study of available methods led to the adoption of low-level modulation; the required power was obtained by linear amplifiers. Grounded-grid triodes operating in push-pull are used in the four power-amplifier stages. A sweep gen-

erator is incorporated for alignment of the different stages. Details are given of the method of tuning.

#### VACUUM TUBES AND THERMIONICS

537.291:621.385:621.317.329 1811

**Electrolyte-Tank Study of Electron Beams, taking account of Space Charge**—G. Goudet and R. Musson-Genon. (*Jour. Phys. Radium*, vol. 6, pp. 185-195; July, 1945. In French.) A method of successive approximations enables the electrolyte tank to be used to obtain the potential distribution in a tube. The method is also applicable to other problems involving an equation of the Poisson type. A generalization of Langmuir's law is given in an appendix.

537.291:621.385.1 1812

**Space-Charge Spreading of a Cylindrical Electron Beam near a Cathode**—G. Goudet and A. M. Gratzmuller. (*Jour. Phys. Radium*, vol. 6, pp. 153-162; June, 1945. In French.) Discussion of the electron beam emitted by a plane circular cathode surrounded by a guard ring and accelerated by an infinite plane anode parallel to the cathode. The trajectory of a peripheral electron is calculated, with certain simplifying assumptions, by applying the theorem of electrical images and representing all unknown quantities by Fourier series. The beam divergence depends only on the ratio  $\alpha$  of the distance between anode and cathode to the radius of the beam. A curve is given showing the relative increase of the radius of the beam, at the level of the anode, as a function of  $\alpha$ .

621.383 1813

**The Preparation of Thallium Sulphite Photocells**—B. T. Kolomiets. (*Zh. Tekh. Fiz.*, vol. 17, no. 2, pp. 195-202; 1947. In Russian.) Detailed description of the manufacturing process as developed at the Leningrad Technical Physics Institute. The main difference between this method and those of other authors is that the photosensitive semiconducting layer is obtained by evaporating previously prepared thallium sulphide.

621.383 1814

**Local Variations of the Sensitivity of Photocells**—J. Terrien, C. Anglade, and G. Touvat. (*Compt. Rend. Acad. Sci.* (Paris), vol. 225, pp. 1142-1144; December 10, 1947.) The sensitivity distribution was studied for two types of cell; (a) Cs cells with cylindrical anode and plane cathode (C.S.F., Paris); (b) KMV6 and RMV6 cells with gride anode and rectangular plate cathode (Osram, London). Wide variations, of the order of 2 to 1, were found for both types, and the equisensitive contours were very irregular.

621.383 1815

**Lead Selenide Cells for Infra-Red Spectroscopy**—D. E. Blackwell, O. Simpson, and G. B. M. Sutherland. (*Nature* (London), vol. 160, p. 793; December 6, 1947.) Photo cells made by Simpson's method (1376 of June) have two maxima, near 1.6 $\mu$  and near 3.3 $\mu$ . With a quartz envelope instead of pyrex, the effective range is extended beyond 3.4 $\mu$  and, with a suitable window, it may be possible to extend the useful range to 4 $\mu$  and beyond.

621.383:621.316.722.1 1816

**Improvement of the Characteristics of Photo-Voltaic and Photo-Conductive Cells by Feedback Circuits**—E. S. Rittner. (*Rev. Sci. Instr.*, vol. 18, pp. 36-38; January, 1947.) The decrease of current sensitivity of these cells with increasing load resistance can be avoided by maintaining constant voltage across the cell. Two stable electronic circuits for this purpose are described.

621.383.032.216 1817

**Hot-Cathode Photocell**—J. Debiessé and R. Champeix. (*Compt. Rend. Acad. Sci.* (Paris),

vol. 226, pp. 234-236; January 19, 1948.) The cell has a cathode coated with a mixture of the oxides of Ba and Sr. Results of tests are given with either a resistance of several MΩ or a microammeter in the anode circuit. The sensitivity depends on the state of activation of the cathode.

**621.385.1 1818**

**Two New V-Valves**—O. P. Herrnkind. (*Funk und Ton*, pp. 26-37; January, 1948.) Full electrical data and characteristics of triode-hexode VCH11 and pentode VF14.

**621.385.1 1819**

**Oscillation Frequency Limits for Grid-Controlled Valves**—L. Ratheiser. (*Radio Tech. (Vienna)*, vol. 23, nos. 11 and 12, pp. 501-505; 1947.) A general discussion of the maximum frequencies obtainable with various circuits using normal tubes, with a short reference to special tubes designed for u.h.f. operation.

**621.385.1:621.395.61:534.43 1820**

**A Vacuum-Tube-Type Transducer for Use in the Reproduction of Lateral Phonograph Recordings**—J. F. Gordon. (*Proc. IRE*, vol. 35, pp. 1571-1575; December, 1947.) A plane-parallel triode with the grid structure pivoted at one end and connected directly to a stylus through a 0.002-inch Kovar diaphragm. The over-all height of the tube is 2.3 cm and it may be mounted in a standard arm. Characteristic curves show that the harmonic distortion is very low. A conventional RC coupling in the anode circuit will give an output of 1 v from a standard shellac record.

**621.385.1:621.396.621.53 1821**

**International Frequency Changer Equivalents**—L. Ratheiser. (*Radio Tech. (Vienna)*, vol. 23, nos. 8 and 9, pp. 429-434; 1947.) Tables of the principal characteristics of the international series of triode-hexodes, triode-heptodes, heptodes (pentagrid converters), and octodes.

**621.385.1(44) 1822**

**Development of Valve Technique**—M. Descarsin. (*Onde Élec.*, vol. 27, pp. 399-410; November, 1947.) A historical review of developments in France since August, 1914, when bright-emitter tubes began to be used for the French and allied armies. Particular attention is paid to construction methods adapted to mass production and which can be used with little or no variation throughout a whole series of tubes with outputs ranging from a few w to several kw.

**621.385.1.032.21:621.315.591†537.533.8 1823**

**On the Autoelectronic Emission from Complex Semiconducting Cathodes**—N. D. Morgulias. (*Zh. Tekh. Fiz.*, vol. 17, no. 9, pp. 983-986; 1947. In Russian.) Equations (5) and (6) are derived determining the auto electron current for comparatively weak external fields ( $E \leq 5 \times 10^4$  V/cm). These equations differ considerably from the Fowler-Nordheim equation for metals.

**621.385.1.032.216 1824**

**Cathode Problems**—L. Ratheiser. (*Radio Tech. (Vienna)*, vol. 23, nos. 8 and 9, pp. 385-388; 1947.) Discusses briefly the theory and properties of oxide cathodes, and the development of special types for modern tubes.

**621.385.1.032.216:537.533.1:537.583 1825**

**Tangential Electron Emission**—(*Tele-Tech.*, vol. 7, pp. 45, 88; January, 1948.) Summary of 872 of April (Klemperer).

**621.385.1.032.216:537.533.8 1826**

**Emission from an Oxide Cathode**—S. V. Ptitsyn. (*Zh. Tekh. Fiz.*, vol. 17, no. 9, pp. 965-982; 1947. In Russian.) Attempts to study the operation of oxide cathodes under pulse conditions have revealed the inadequacy of our knowledge of those physical processes in the

cathodes which govern the emission of electrons.

Accordingly, a detailed investigation of such cathodes was undertaken under the following headings: (a) structure, (b) core, (c) semiconducting layer, (d) barrier layer, (e) emission properties, (f) operation under pulse conditions, (g) causes limiting emission under pulse conditions, and (h) poisoning of the cathode by current emission.

**621.385.1.032.3:[546.78+546.84 1827**

**Designing Thoriated Tungsten Filaments**—Dailey. (*See* 1655.)

**621.385.2:621.317.79:621.396.822 1828**

**A Diode Noise Generator**—Moffatt. (*See* 1693.)

**621.385.2:621.396.822 1829**

**The Reduction of the Shot Effect in Cylindrical Diodes**—L. A. Weinstein. (*Zh. Tekh. Fiz.*, vol. 17, no. 9, pp. 1035-1044; 1947. In Russian.) A theory is developed for the case in which the current is reduced by the space charge. The results obtained show that the shot effect in a cylindrical diode may be less than in a plane diode.

**621.385.3.011.4.032.2 1830**

**Inter-Electrode Capacitances of Triode Valves at Ultra-High Frequency and Their Dependence on the Operating Conditions**—D. K. Ganguli and S. R. Khastgir. (*Indian Jour. Phys.*, vol. 21, pp. 153-167; August, 1947.) Six triodes were examined at 66.76 Mc by connecting the capacitance to be determined across a Lecher system and measuring the length of line required to produce resonance. The variations of the interelectrode capacitances with increase of anode current are described and the reasons for the variations are discussed.

**621.385.4:621.396.645 1831**

**Operating Conditions and Circuits for Valve Type 807**—G. M. Thompson. (*Philips Tech. Commun. (Australia)*, pp. 14-23; August, 1947.) Complete data and characteristics for the Philips 807 beam tetrode and circuit details for a 60-w power amplifier and modulator, a rf amplifier or doubler, a series-tuned doubler, and a push-pull rf amplifier.

**621.385.5 1832**

**A Study of the Operation of Pentodes with Variable Screen Voltage**—F. Job. (*Cables and Trans. (Paris)*, vol. 1, pp. 245-253; October, 1947. With English summary.) The gain of a pentode with variable screen voltage can be calculated from a knowledge of the internal resistance as a triode, the ratio of anode current to screen current and the corresponding parameters (slope and internal resistance as a pentode) when operating with a fixed screen voltage. Application is made to the case of a pentode with screen connected to the anode battery through an impedance. It is also shown that by suitable decoupling of cathode, anode, and screen, the gain of a pentode can be made absolutely independent of frequency.

**621.385.5:621.317.31 1833**

**Measurement of Small Currents: Characteristics of Types 38, 954, and 959 as Reduced Grid Current Tubes**—Nielsen. (*See* 1673.)

**621.385.831.029.64 1834**

**Wide-Band Amplifier Valves for Centimetre Waves**—Touraton, Zwobada, and Dumousseau. (*Onde Élec.*, vol. 27, pp. 361-370; October, 1947.) For high-definition television and also for multiplex telephony with a large number of channels, wide frequency bands must be covered and special high-power tubes are essential. Relatively simple modification of the klystron have resulted in the production of tubes operating on a mean frequency of 3000 Mc, with a power gain of the order of 40 in a frequency band of 50 Mc and an output of about 10 w. The principles used in the con-

struction of these tubes are described fully and experimental results are given for the first sealed model produced.

**621.385.832 1835**

**Cathode-Ray Tube Data**—D. W. Thomasson. (*Wireless World*, vol. 53, pp. 484-485; December, 1947.) Characteristics of some ex-Service surplus types.

**621.385.832:535.371.07 1836**

**Performance Characteristics of Long-Persistence Cathode-Ray Tube Screens; Their Measurement and Control**—Johnson and Hardy. (*See* 1653.)

**621.385.832:621.396.662 1837**

**A Useful Tube**—E. Leslie. (*Radio Craft*, vol. 19, p. 23; October, 1947.) Description and applications of a new c.r. tuning indicator, 6AL7-GT.

**621.385.832:621.396.96 1838**

**The Skiatron or Dark Trace Tube**—G. Wikkenhauser. (*Electronic Eng. (London)*, vol. 20, pp. 20-22; January, 1948.) For other accounts see 2404 of 1946 (King and Watson) and 888 of April (King and Gittins).

**621.396.615.141.2 1839**

**The Mechanism for exciting Oscillations in a Multi-Segment Magnetron**—A. A. Slutskin. (*Zh. Tekh. Fiz.*, vol. 17, no. 4, pp. 425-434; 1947. In Russian.) In magnetrons with many anode segments, oscillations can occur which are practically independent of the magnetic field intensity. The period of these oscillations is smaller than the electron transit time. A theoretical analysis of these oscillations is given, based on the consideration of the energy exchange between the electrons leaving the cathode and the oscillatory circuits between the segments of the anode. For small oscillation amplitudes and small distances between the adjacent segments, conditions for the occurrence of the oscillations are established and an equation (17) determining the oscillatory power is derived.

**621.396.615.141.2 1840**

**The Multiple Cavity Magnetron**—P. Lombardini. (*Tecn. Elettronica*, vol. 2, pp. 25-36; July, 1947. In Italian.) Principles of operation are considered, with particular attention to oscillation modes and mode separation. Reference is made to British and American work. See 293 of 1947 (Fisk, Hagstrum, and Hartman).

**MISCELLANEOUS**

**53 Planck 1841**

**Max Planck**—L. de Broglie. (*Rev. Gén. Élec.*, vol. 56, pp. 475-477; December, 1947.) A short biography, with an account of some of Planck's contributions to modern theoretical physics.

**621.396 Popov 1842**

**Alexander S. Popov**—G. W. O. H. (*Wireless Eng.*, vol. 25, pp. 1-5; January, 1948.) A review of his life and work, with special reference to the rival claims of Popov and Marconi to be the inventor of radio communication. See also 1218 and 1219 of May and 4100 of January.

**6(43):017.4 1843**

**Technical Index of Reports on German Industry: Part 4. [Book Notice]**—H. M. Stationery Office, London, 43 pp., 2s. Deals with reports published between December 31, 1946, and March 27, 1947.

**017.4:621.38/39 1844**

**RCA Technical Papers Index: Vol. I [1919-1945] Vol. Ila [1946]. [Book Notice]**—Radio Corporation of America, Princeton, N. J., 143 + 21 pp., gratis. (*Wireless Eng.*, vol. 24, p. 167; June, 1947.) A list of papers published in English on radio, electronics, and related subjects, the author or co-author of which was associated with RCA vol. I Ib [1947], 24 pp., gratis, has also appeared.

# GREATEST ADVANCE IN V.O.M. HISTORY

**Beautiful Streamlined Instrument.**

**Large 5 1/2 Inch Meter** in special molded case under panel.

**Resistance Scale Markings** From .2 Ohm To 100 Megohms... Zero Ohms Control Flush With Panel.

**Only one switch**... Has Extra Large Knob 2 1/2" Long... Easy To Turn... Flush With Panel Surface.

**New Molded Selector Switch**... Contacts Are Fully Enclosed... will retain lubrication without dust contamination.

**Batteries Easily Replaced**... New Double Suspended Contacts.

**All Resistors Are Precision Film Or Wire Wound Types...** Sealed For Permanent Accuracy.

**Unit Construction**... Resistors, Shunts, Rectifier, Batteries All Are Housed In A Molded Base Built Right Over The Switch... Provides Direct Connections Without Cabling... No Chance For Shorts.



Inside view cover removed...inverted

## TECH DATA

D.C. VOLTS: 0-3-12-60-300-1200-6000, at 20,000 Ohms/Volt  
 A.C. VOLTS: 0-3-12-60-300-1200-6000, at 5,000 Ohms/Volts  
 D.C. MICROAMPERES: 0-60, at 250 Millivolts  
 D.C. MILLIAMPERES: 0-1.2-12-120, at 250 Millivolts  
 D.C. AMPERES: 0-12, at 250 Millivolts  
 OHMS: 0-1000-10,000; 4.4 Ohms at center scale on 1000 scale;  
 44 Ohms center scale on 10,000 range.  
 MEGOHMS: 0-1-100  
 DECIBELS: -30 to +4, +16, +30, +44, +56, +70  
 OUTPUT: Condenser in series with A.C. Volt ranges

**TRIPLETT ELECTRICAL INSTRUMENT CO. • BLUFFTON, OHIO**

In Canada: Triplett Instruments of Canada, Georgetown, Ontario



## NOTE the Sensational Improvements Model 630

**\$37.50** U.S.A. Dealer Net

**Leather Carrying Case \$5.75**  
**ADAPTER PROBE FOR TV**  
**HIGH VOLTAGE TESTS EXTRA**

A completely new Volt-Ohm-Mil-Ammeter that does more... has proved components... and will give a lifetime of satisfaction.

*Precision first... to Last*

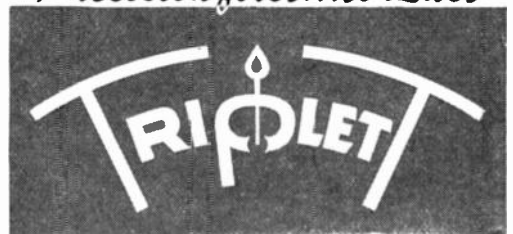

# TECHNICAL MANUALS

CUSTOM DESIGNED TO  
YOUR SPECIFICATIONS

Planned, written and illustrated by a select staff . . . experts in creating radio and electronic manuals for civilian and military use.

When you call upon Boland & Boyce to create your manuals you are relieved of every detail in their preparation. The entire operation is taken over and completed by a specialized staff with years of experience in publishing books and manuals.

First the requirements for your manual are completely surveyed. The working conditions to which they will be put are studied and the operations or equipment described in the manual are thoroughly analyzed. A complete outline is then prepared and submitted for your approval, along with a dummy of the manual as it will appear when finished. Upon your approval the job is completed and delivered with your satisfaction guaranteed.

Boland & Boyce manuals incorporate only the most modern editorial and illustrative style. Each project is treated with individual attention in technique of presentation and editorial approach. The Boland & Boyce military and civilian manuals now in use throughout the world are our best recommendations.

U. S. Navy  
U. S. Signal Corps  
Sylvania Electric Products, Inc.  
The National Company  
Western Electric Co.  
Bell Telephone Laboratories  
Maguire Industries, Inc.  
Allen B. Dumont Laboratories, Inc.  
General Electric Co.  
Mine Safety Appliances Co.

Write or wire Boland & Boyce  
today for more information

Radio Maintenance      Radio Data Book  
Technical Manuals      Video Handbook

**BOLAND & BOYCE INC., PUBLISHERS**

MANUAL DIVISION M-2 MONTCLAIR, N.J.



## ATLANTA

"What is New in Science and Engineering," by E. S. Lee, General Electric Company; March 16, 1948.

## BOSTON

"An Analyzing Oscillograph for Television," by E. G. Nichols and R. P. Abbenhouse, Allen B. DuMont Laboratories, Inc.; April 22, 1948.

## CEDAR RAPIDS

"History of Development of KCRG/KCRK," by W. L. Babcock, Radio Station KCRG/KCRK; April 14, 1948.

"FM Transmitter for KCRK," by L. K. Findley, Collins Radio Company; April 14, 1948.

"AM Transmitter for KCRG," by J. W. Smith, Collins Radio Company; April 14, 1948.

"Studio Facilities of KCRG/KCRK," by C. H. Stratemeyer, Collins Radio Company; April 14, 1948.

## CHICAGO

"Psychoacoustic Factors in Loudspeaker Selection," by H. S. Knowles, Jensen Manufacturing Company; March 19, 1948.

"Tone Poem with Color Slides," by F. Bemm; March 19, 1948.

"A New Look at the Audio Response Curve," by R. P. Glover, Consulting Engineer; March 19, 1948.

"Chicago IRE Conference; April 17, 1948."

## CINCINNATI

"Television Conference," April 24, 1948.

"Preparedness During Peacetime," by J. L. Sullivan, United States Navy; April 26, 1948.

## CLEVELAND

"Television Operation," by J. B. Epperson, Scripps-Howard Radio, Inc.; April 20, 1948.

## COLUMBUS

"Cold Cathode Glow Discharge Tubes and their Circuit Applications," by W. Depp and W. H. T. Holden, Bell Telephone Laboratories; February 20, 1948.

"Electro Neurology," by M. M. Parker, College of Medicine, Ohio State University; March 12, 1948.

"F.M. Transmitter and Receiver Engineering Problems," by G. B. Saviers, Westinghouse Electric Manufacturing Company; April 9, 1948.

## CONNECTICUT VALLEY

"Printed Circuits and Miniature Electronics," by C. Brunetti, National Bureau of Standards; May 13, 1948.

## DALLAS-FORT WORTH

"Acoustical Considerations in Radio Broadcasting," by W. Rudmose, Southern Methodist University; April 29, 1948.

## EMPORIUM

"A Thermionic Device with a Sense of Smell," by W. C. White, General Electric Company; May 6, 1948.

## HOUSTON

"Microwave Radio Relay Systems," by M. G. Steton, Radio Corporation of America; April 21, 1948.

## INDIANAPOLIS

"A Few Special Developments," by E. D. Cook, General Electric Company; April 23, 1948.

## LOS ANGELES

"The Navy Electronics Laboratory," by R. Bennett, United States Navy; April 20, 1948.

"A Short Survey of Sonar Equipment and its Development," by R. O. Burns, United States Navy Electronics Laboratory; April 20, 1948.

"Model Studies of Communication Antennas and Facilities for Microwave Antenna Investigations," by V. C. Smith, United States Navy Electronics Laboratory; April 20, 1948.

## LOUISVILLE

"152-162 Mc Urban Radio Telephone System," by S. H. Gates, Southern Bell Telephone and Telegraph Company; April 16, 1948.

## MONTREAL

"Affairs and Aims of the I.R.E.," by B. E. Schackelford, President, The Institute of Radio Engineers; February 18, 1948.

## NEW YORK

"Avenues of Improvement in Present-Day Television," by D. G. Fink, *Electronics*; May 5, 1948.

## NORTH CAROLINA-VIRGINIA

"Measuring Devices for U.H.F. Transmission Lines," by W. M. Breazeale, University of Virginia; February 27, 1948.

"I.R.E. Affairs," by B. E. Schackelford, President, The Institute of Radio Engineers; April 9, 1948.

## OTTAWA

"Some Engineering Problems Investigated by the Canadian Broadcasting Corporation Transmission and Development Department," by J. E. Hayes, Canadian Broadcasting Corporation; April 22, 1948.

Election of Officers; April 22, 1948.

## PORTLAND

"Problems in Radar Indicators," by M. A. Starr, University of Portland; May 4, 1948.

## SACRAMENTO

"The Institute of Radio Engineers," by F. E. Terman, Stanford University; April 20, 1948.

"A Zero to 200 Mc Amplifier Using Conventional Tubes," by J. Noe, Hewlett-Packard Company; April 20, 1948.

## ST. LOUIS

"The Cyclotron," by F. N. D. Kurie, Washington University; April 22, 1948.

## SAN DIEGO

"Future Electrical Applications of Structural Plastics," by G. G. Havens, Narmco Incorporated; April 6, 1948.

## SAN FRANCISCO

"Radar and Microwaves," by J. O. Perrine, American Telephone and Telegraph Company; March 26, 1948.

## SEATTLE

"A New Method of Analyzing Complex Waves," by W. E. Rogers, University of Washington; April 16, 1948.

## SYRACUSE

Air Navigation and Traffic Control," by R. C. Jensen, H. F. Mayer, O. H. Winn, and J. W. Nelson, General Electric Company; May 6, 1948.

Election of Officers; May 6, 1948.

## TOLEDO

"High-Quality Radio Program Links," by H. A. French, Federal Telecommunication Laboratories, Inc.; April 26, 1948.

## TWIN CITIES

"Principles and Applications of Magnetic Recording," by R. Marchant, Minnesota Mining and Manufacturing Company; April 1, 1948.

## WASHINGTON

"Communications Theory," by W. G. Tuller, Melpar, Inc.; April 12, 1948.

## SUB-SECTIONS

## FORT WAYNE

"Modern Recording Mechanism and Equipment," by B. Ratts, Radio Station WOWO; April 30, 1948.

Election of Officers; April 30, 1948.

(Continued on page 35A)



(Continued from page 34A)

LANCASTER

"Technical and Economical Aspects of Industrial H.F. Heating," by G. W. Scott, Jr., Armstrong Cork Company; April 14, 1948.

MOUNMOUTH

"Field Coverage Considerations of New York Television Stations and Interference Problems of Shared Channel Stations," by T. T. Goldsmith and R. Wakeman, Allen B. Dumont Laboratories; January 21, 1948.

"Basic Considerations in Design of Digital Computer and their Application of the Edvac," by S. Lubkin, Reeves Instrument Corporation; February 18, 1948.

"Solar and Cosmic Noise," by C. R. Burrows, Cornell University; April 21, 1948.

NORTHERN NEW JERSEY

"Pulse Code Modulation and the Electron Beam Coding Tube," by L. A. Meacham and R. W. Sears, Bell Telephone Laboratories; May 12, 1948.  
Election of Officers; May 12, 1948.

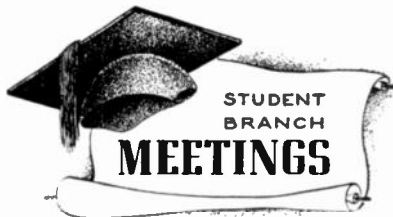

ALABAMA POLYTECHNIC INSTITUTE,  
I.R.E. BRANCH

"Uses of the Oscilloscope," by J. Montgomery, Alabama Polytechnic Institute; April 19, 1948.

"Demonstration in Short Radio Waves and Microwaves," by F. Allison, Alabama Polytechnic Institute; May 3, 1948.

UNIVERSITY OF ARKANSAS, I.R.E. BRANCH

"The Synchrony Receiver," by H. Cooke, Student, University of Arkansas; April 28, 1948.

UNIVERSITY OF CALIFORNIA, I.R.E.—  
A.I.E.E. BRANCH

"Applying Apparatus in Industry," by F. M. Roberts, General Electric Company; April 16, 1948.

UNIVERSITY OF ILLINOIS, I.R.E.—  
A.I.E.E. BRANCH

"The Part of the Engineer in Bettering Community Understanding," by F. A. Faville, Faville-Le Valley Corporation and Lincoln Engineering Company of Illinois; April 12, 1948.

KANSAS STATE COLLEGE, I.R.E. BRANCH  
Election of Officers; April 22, 1948.

UNIVERSITY OF MICHIGAN, I.R.E.—  
A.I.E.E. BRANCH

"The Delray Plant," by G. A. Porter, Detroit Edison Company; April 15, 1948.

"Outlook for Engineers," by Mr. Le Clair, A.I.E.E.; April 15, 1948.

UNIVERSITY OF MINNESOTA, I.R.E.—  
A.I.E.E. BRANCH

"Licensing Engineers," by S. L. Stalte, Minnesota Association of Professional Engineers; March 16, 1948

COLLEGE OF THE CITY OF NEW YORK,  
I.R.E. BRANCH

"The Design and Construction of an F.M. Receiver," by C. Fruchter, Student; April 13, 1948.

(Continued on page 36A)

# PRECISION



## SQUARE WAVE GENERATOR TYPE YGL-1

**D**ESIGNED to produce a square wave of excellent form, this equipment meets the rigid requirements of research and developmental laboratories, industry and educational institutions.

It has a wide fundamental frequency range, is highly stable and may be mounted either in a cabinet or rack.

**PULSE CHARACTERISTIC:** Rectangular wave output, with a 25% negative pulse.

**RISE TIME:** Approximately .3 microsecond.

**FUNDAMENTAL FREQUENCY RANGE:** Six overlapping ranges, to give continuous coverage from 5 to 125,000 cycles.

**OUTPUT VOLTAGE:** Variable from 0-5 volts; fixed outputs at 5, 10, 15, 25, 50 and 75 volts.

**OUTPUT IMPEDANCE:** 100 ohms at 5 volts, approximately 20 ohms/volts at all outputs.

**SYNCHRONIZATION:** A "sync" input level control is provided.

For complete information on this unit and other G-E Precision Equipments write: *General Electric Company, Electronics Park, Syracuse, New York.*

# GENERAL ELECTRIC

165-04

# A New 1-MC CRYSTAL

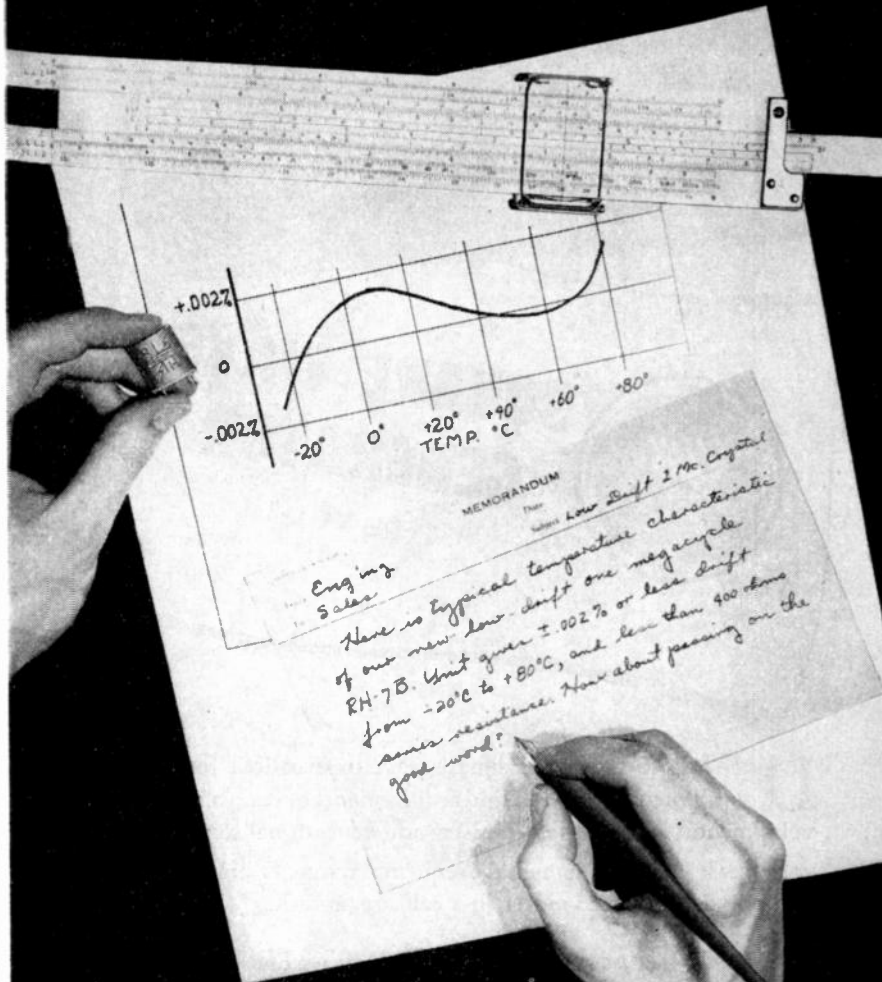

Companion to the  $\pm 0.005\%$  wide range 1-mc crystal, the newest RH-7B can be produced at series resonance, 32 uufd, or to your specifications. Reeves-Hoffman engineers are equipped to work with you in planning your circuits.

For detailed specification write for Bulletin RHC-x

**REEVES  HOFFMAN**  
**CORPORATION**  
 CHERRY AND NORTH STREETS • CARLISLE, PA.

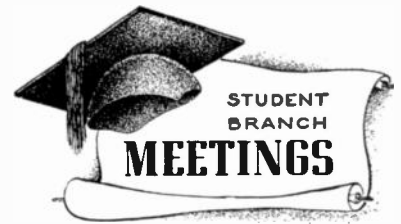

(Continued from page 35A)

"Trends in Television Receiver Design," by I. E. Lempert, Allen B. Dumont Laboratories; April 20, 1948.

"Facsimile," by L. R. Philippott, Finch Telecommunications; April 27, 1948.

"Vacuum Tubes," by F. W. Tietsworth, General Electric Company; April 29, 1948.

"Pulse Time Modulation," by S. Moskowitz, Federal Telecommunications Laboratories; May 4, 1948.

NORTH CAROLINA STATE COLLEGE, I.R.E. BRANCH

"Directional Antennas for Broadcasting," by B. E. Porter, Radio Station WNAO; April 14, 1948. Election of Officers; April 28, 1948.

RUTGERS UNIVERSITY, I.R.E.—A.I.E.E. BRANCH  
 Election of Officers; May 5, 1948.

STANFORD UNIVERSITY, I.R.E.—A.I.E.E. BRANCH

"Demonstration of an Ampex Magnetic Tape Recorder," by H. W. Lindsay, Ampex Corporation; April 22, 1948.

SYRACUSE UNIVERSITY, I.R.E. BRANCH

"The Professional Engineer," by J. B. Foley, Jr., J. B. Foley Inc.; April 21, 1948.

## News—New Products

These manufacturers have invited PROCEEDINGS readers to write for literature and further technical information. Please mention your I.R.E. affiliation.

(Continued from page 24A)

### New Tube Checker Eliminates Time Waste

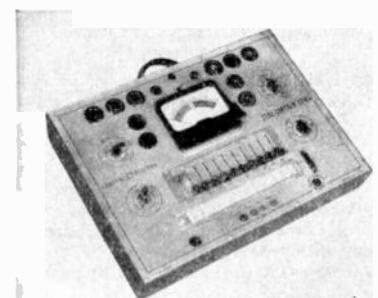

A receiving-tube checker with a circuit designed to immediately expose a tube with an open filament without the usual warm-up period is being marketed by G-E Specialty Div., Electronics Park, Syracuse, N. Y.

This checker, type YTW-1 completely portable and weighing only 15 lbs., has an individual circuit for each tube element. Operating from a standard a.c. power source, it tests 4-, 5-, 6-, 7-, and 8-pin standard, 5-pin small, 7- and 9-pin miniature and lock-in tubes, as well as pilot tubes and batteries.

(Continued on page 45A)



The following transfers and admissions were approved on June 2, 1948, to be effective July 1, 1948:

**Transfer to Senior Member**

- Allen, H. C., 15 Rollingmead, Princeton, N. J.
- Camras, M., 1313 S. Keeler Ave., Chicago 23, Ill.
- Freeland, E. C., 111 Kirkwood Ave., Fox Chase Manor, Philadelphia 11, Pa.
- Giacoletto, L. J., RCA Laboratories, Princeton, N. J.
- Heberlein, A. A., c/o Bell Telephone Laboratories, Inc., 180 Varick St., New York 14, N. Y.
- Jimenez-Michelena, L. G., 27 Ave., San Miguel, Caracas, Urbanizacion El Avila, Venezuela
- Lakatos, E., RIE 433, Bell Telephone Laboratories, Inc., Murray Hill, N. J.
- Mabe, W. S., 42 Collindale Ave., Sidcup, Kent, England
- Pote, A. J., 71 W. Squantum St., N. Quincy 71, Mass.
- Segerstrom, C. A., 2 Maple Rd., Winchester, Mass.
- Sink, R. L., 3119 Santa Anita, Altadena, Calif.
- Stagnaro, J. A., 2207 Fairfield Ave., Fort Wayne 6, Ind.
- Stokes, H. S., 425 N. Jackson St., Arlington, Va.
- Trifari, F. R., 30 Maplewood Ave., Dobbs Ferry, N. Y.
- Young, J. E., 114 Morris St., Merchantville, N. J.

**Admission to Senior Member**

- Apuli, J. A., 3100 Connecticut Ave., N.W., Washington, D. C.
- Craigie, S. M., Tropical Radio Telegraph Co., Managua, Nicaragua
- Dimock, P. V., 44 Beechwood Ave., Manhasset, N. Y.
- Ellett, A., Zenith Radio Corp., 6001 W. Dickens Ave., Chicago 39, Ill.
- Holden, W. H. T., 463 West St., New York 14, N. Y.
- Hupert, J. J., 943 Monroe Ave., River Forest, Ill.
- Ingles, H. C., 66 Broad St., New York 4, N. Y.
- Lacy, L. Y., 52 Maple Ave., Madison, N. J.
- Nash, P. E., 4865-A S. 28 St., Fairlington, Va.
- Sinnett, C. M., 103 Virginia Ave., Westmont, N. J.

**Transfer to Member Grade**

- Barbour, C. W., Jr., 52C Oak Grove Dr., Baltimore 20, Md.
- Buccicone, V. S., 580 Taney Place, Gary, Ind.
- Cacheris, J. C., 2701 14 St., N.W., Washington 9, D. C.
- Cheng, D. K., Rm. 515, 111 Broadway, New York 6, N. Y.
- Friedman, H., 35 Emmet St., Dayton, Ohio
- Gehres, F. A., 2232 E. Powell, Evansville 14, Ind.
- Gershon, J. J., 2475 Gunnison St., Chicago 25, Ill.
- Groetke, E. A., 4655 Elmbank, St. Louis 15, Mo.
- Hemman, R. J. E., 231 Westerly Pkwy., State College, Pa.
- Hornberger, J. E., Wertz Engineering Co., 30 N. Eighth St., Reading, Pa.
- Mandell, A., 202 Highland Ave., Somerville 43, Mass.
- Morgan, R. B., Sandia Base Branch, Albuquerque, N. Mex.
- Murray, D. A., F.C.C., 208 Uptown Post Office Bldg., St. Paul 2, Minn.
- Oberlé, E. J., 1805 Main St., Jacksonville, Fla.
- Richards, J. A. K., 1134 1/2 S. Doheny Dr., Los Angeles 35, Calif.
- Rohner, G. J., 10 Robley Evans Apt., Sampson College Fac., Sampson, N. Y.
- Schulz, H. R., 531 E. Lincoln Ave., Mount Vernon, N. Y.
- Silvester, D. D., 8 Carlos St., Godalming, Surrey, England
- Sullivan, J. R., Communication Dept. Panagra, Limatambo, Lima, Peru, S. A.
- Swanson, E. R., 5827 Madden Ave., Los Angeles 43, Calif.

(Continued on page 38A)

# WGN-TV SELECTS ANDREW TELEVISION TRANSMISSION LINE *and* ANDREW INSTALLATION SERVICE

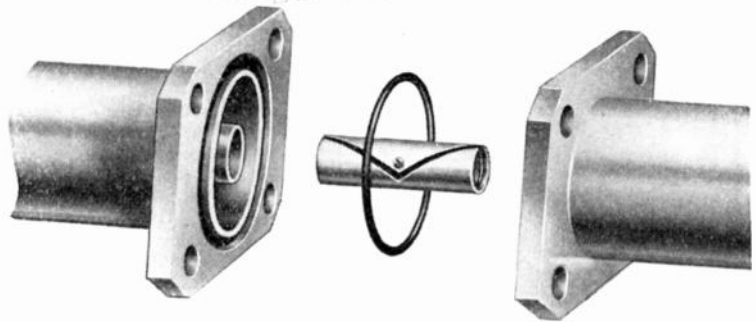

Many of America's new television stations are selecting Andrew equipment because of the efficiency of Andrew's flanged coaxial transmission line and the added advantage of having Andrew consulting engineers install it.

Because each television installation poses its own different, individual problem, those stations selecting Andrew have two big advantages: 1) they obtain transmission line and accessories *specially designed for television*, and 2) specialized Andrew consulting engineers are available to direct the installation. These engineers have both the special instruments and the experience to engineer all or any part of the construction of a television station. **NO OTHER TRANSMISSION LINE MANUFACTURER OFFERS YOU THIS COMPLETE INSTALLATION SERVICE!**

Andrew TV transmission line meets official RMA standards and is specially designed for television. Mechanically, it's held to close television tolerances assuring an essentially "flat" transmission line system.

Fabricated in twenty foot lengths with brass connector flanges silver brazed to the ends, sections can be easily bolted together with only a couple of small wrenches. Flanges are fitted with gaskets so that a completely solderless, gas-tight installation results. Markings on the outer conductor indicate where twenty foot sections may be cut to maintain the characteristic 51.5 ohm impedance.

**WANT A TELEVISION STATION DESIGNED AND BUILT—FROM THE GROUND UP? LET ANDREW DO IT!**

Write today for full details. Andrew will get you on the air.

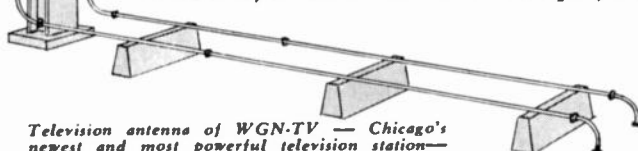

Television antenna of WGN-TV — Chicago's newest and most powerful television station—showing Andrew 1-5/8" flanged television transmission line.

**ANDREW CORPORATION**  
363 EAST 75th STREET · CHICAGO 19

TRANSMISSION LINES FOR AM, FM, TV · DIRECTIONAL ANTENNA EQUIPMENT · ANTENNA TUNING UNITS · TOWER LIGHTING EQUIPMENT · CONSULTING ENGINEERING SERVICE

# TELEVISION TRANSFORMERS



## for BETTER VIDEO REPRODUCTION

Acme Electric engineers will cooperate with your engineering department by providing specially designed transformers for power supply and other applications in an effort to improve the reception and reproduction qualities of your sets.

Acme Electric can produce transformers of special characteristics from standard parts which means that our enormous manufacturing facilities and quality controlled production results in buying economies for you.

Send us specifications and application outline.

**ACME ELECTRIC CORP.**  
447 WATER ST, CUBA, N.Y.

**Acme Electric**  
TRANSFORMERS



(Continued from page 37A)

Swingle, D. M., 70 Jarvis Ct., Cambridge 38, Mass.  
Torian, R. B., 430 S. Elm Dr., Beverly Hills, Calif.  
Trego, D. G., 949 Wye Dr., Akron 3, Ohio  
Turner, F. T., Box 114, Hampton Bays, N. Y.  
Wigington, L. M., 317 W. Third St., Morrestown, N. J.  
Wood, K. P., 104 Bramshot Ave., London, S.E.7, England

### Admission to Member Grade

Burke, A. C., 63 Yorkville Ave., Toronto, Ont., Canada  
Butterfield, F. E., Andrew Corp., 363 E. 75 St., Chicago, Ill.  
Chapel, I. J., 916 Southern Blvd., New York 59, N. Y.  
Cohen, J., 2420 14 St., N.E., Washington 18, D. C.  
Davis, C. W., Marine Sales Department, Sperry Gyroscope Co., Great Neck, L. I., N. Y.  
Fink, L., III, Rm. 210, 1401 Arch St., Philadelphia 2, Pa.  
Fraser, G. R., 118 Irvington St., S.W., Apt. 2A, Washington 20, D. C.  
Hall, I. A., Jr., 191 Duncan Dr., Assinippi, Mass.  
Hauran, P. N., Electronics Institute, Inc., 21 Henry St., Detroit 1, Mi h.  
Hauser, A. A., Jr., Sperry Gyroscope Co., Mail Station K-39, Great Neck, L. I., N. Y.  
Havelka, G., 284 Pod Klaudiankou, Praha-Podoli, Czechoslovakia  
Hotine, W., 10 Bromley Lane, Great Neck, L. I., N. Y.  
Huckabee, J. R., Box 1679, Houston 1, Tex.  
John, A. G., Indian Students Union and Hostel, 112 Gower St., London, W.C.1, England

Luddy, E. N., 311 E. 13 St., Amarillo, Tex.  
Marsh, G. E., 1109 E. Harvey, Fort Worth, Tex.  
Massey, M. M., 1124 Vermont Ave., N.W., Washington 5, D. C.  
McCauley, C., Jr., R.F.D. 1, Winston-Salem, N. C.  
Murtaugh, W. A., Providence College, Providence 8, R. I.  
Nolte, R. E., 263 Campus, Ames, Iowa  
Pakan, J. J., 238 N. Pine Ave., Chicago 44, Ill.  
Parlas, J. L., 218 N. Globe Rd., Arlington, Va.  
Perron, R. R., 35 Broadway, Beverly, Mass.  
Pierce, C. H., TWA, 400 E. Donovan Rd., Kansas City, Kan.  
Plummer, J. W., Tactical Test, NATC, Patuxent River, Md.  
Rosmovsky, P., 108 Second Ave., Bradley Beach, N. J.  
Sadler, J. T., 42 Huntington Rd., Garden City, N. Y.  
Schifino, A. G., 80 Thurston Rd., Rochester 11, N. Y.  
Schwennessen, A. B., 4235 Merrimac Ave., Dayton 5, Ohio  
Shaw, J. E., c/o Western Electric Co., 120 Broadway, New York 5, N. Y.  
Smith, G. B., 3806 N. Broadway, Knoxville 18, Tenn.  
Sronce, G. S., 3571 23 St., Sacramento, Calif.  
Stanton, J. S., 1804 Watervliet Ave., Dayton 10, Ohio  
Vazaca, C. S., 10 Berzei, Bucharest, Roumania  
Warren, J. E., 8 Ruby Place, Newark 4, N. J.

The following admissions to Associate Grade have been approved and will be effective as of June 1, 1948:

Acunto, V. S., 2430 Atlantic Ave., Brooklyn 33, N. Y.  
Auerbach, B., 340 Carteret St., Camden, N. J.  
Bartels, W. S., Electronics Test, NATC, Patuxent River, Md.  
Berger, Mrs. J. M., 1741 Andrews Ave., New York 53, N. Y.

(Continued on page 39A)

"A Well Known Name in Radio for Over 25 Years"

NO.  
**7**  
OF A SERIES

## Carter

### Preferred Power for HARVEY WELLS Marine Radio Telephone

Where life or death may depend on reliable communications, the Carter Genemotor is the logical power supply. That's why Harvey-Wells picks Carter to power the marine transmitter shown here. At the flick of a switch... in less than 3/10 of a second; the Carter Genemotor supplies full power... dependable power... designed to provide for thousands of service-free radio transmissions.

## Carter Motor Co.

Chicago, Illinois

2645 N. MAPLEWOOD AVENUE • CABLE: GENE MOTOR





(Continued from page 38A)

- Birchmeier, C. E., 7 Handley Ave., Bexley North, New South Wales, Australia
- Bramsen, E. A., 3737 14 Ave. S., Minneapolis 7, Minn.
- Bukofzer, R., 39-48—65 St., Woodside, L. I., N. Y.
- Ceccarini, R. E., 325 S. Bedford Dr., Beverly Hills, Calif.
- Chase, R. L., 2121 Beekman Place, Brooklyn 25, N. Y.
- Cipolla, A. H., 40-13—69 St., Woodside, L. I., N. Y.
- Cullen, J. G., 340 S. Third St., Baton, N. Mex.
- Deeken, J. W., 556 Telford Ave., Dayton 9, Ohio
- Docca, S. N., c/o Dr. G. Vinayake Rao, 4, Sri-puram II St., Royapettah, Madras, India
- Fernandez Acquier, A. H., Bme. Mitre 1961, Buenos Aires, Argentina
- Fisher, E. H., 6536 Aylesboro Ave., Pittsburgh 17, Pa.
- Geisler, H. J., Court H. Apt. 40-C, Stadium Ter., Champaign, Ill.
- Gopalakrishna, T. V., Tadinada Bldgs., Rajah-mundry, Madras, S. India
- Hare, J., 48, Cochrane Park Ave., Newcastle-on-Tyne, 7, England
- Hyland, F. G., 2125 Darwin Ave., Los Angeles 31, Calif.
- Johnson, A. H., 219 Milford Dr. W., Syracuse 6, N. Y.
- Jones, R. B., 4919 Behrwald Ave., Cleveland 9, Ohio
- Kenny, J. A., 43-17—220 Place, Bayside, L. I., N. Y.
- Klein, S., 4909 N. 17 St., Philadelphia 41, Pa.
- Komenko, J. W., 210 Schenck Ave., Brooklyn 7, N. Y.
- Lanciani, D. A., 22 Baxter Ter., West Medford 55, Mass.
- Levens, P. J., 1505 Ocean Ave., Brooklyn 30, N. Y.
- Lucas, F. P., 8796 Petoskey Ave., Detroit 4, Mich.
- Macropulos, G. S., 7306 S. Green St., Chicago 21, Ill.
- Matarazzo, T., Jr., 11 Marshfield St., Roxbury 19, Mass.
- McMurray, C. R., 2902 Jennings Rd. Kensington, Md.
- McQuiston, W. R., Box 312, Boeing Airplane Co., Alamogordo, N. Mex.
- Melton, D. P., 1023 Gardenia Dr., Houston 8, Tex.
- Mulgan, D. K., York Bay, Wellington, New Zealand
- Nagel, R. F., Cyclotron Laboratories, Washington University, St. Louis, Mo.
- Reeves, C. A., Sr., 1323 Schley Ave., San Antonio 3, Tex.
- Reisenweaver, W. B., General Delivery, Kernersville, N. C.
- Schnell, W. S., 3650 Rugby Dr., Toledo 9, Ohio
- Schuh, L., 1253 Loyola Ave., Chicago 26, Ill.
- Silson, R. G., The Schoolhouse, Fosdyke, Boston, Linca., England
- Stone, R. S., 6037 W. Addison St., Chicago 34, Ill.
- Striplin, J. E., 2713 W. 154 St., Gardena, Calif.
- Strobach, F., 106 Myrtle St., Suite 9, Boston 14, Mass.
- Swontek, W. J., 5917 Storer Ave., Cleveland 2, Ohio
- Taherzadeh, A., c/o Mr. Bridge, General Electric Company of England, Telephon Wks., Coventry, England
- Taschler, F., 527 E. 88 St., New York 28, N. Y.
- Velkers, G. D., Box 1365, AA & G.M. Branch, TAS, Fort Bliss, Tex.
- Wagner, F. C., 2116 Portland Ave. S., Minneapolis 4, Minn.
- Wagner, T. C. G., 4995 Newport Ave., Washington 16, D. C.
- Walker, G. A., Sr., 14560 Sherman Cir., Van Nuys, Calif.
- Whittenberg, H. H., 7115 Casa Loma, Dallas, Tex.
- Yu, Y. P., Electrical Engineering Department, North Dakota Agricultural College, Fargo, N. Dak.

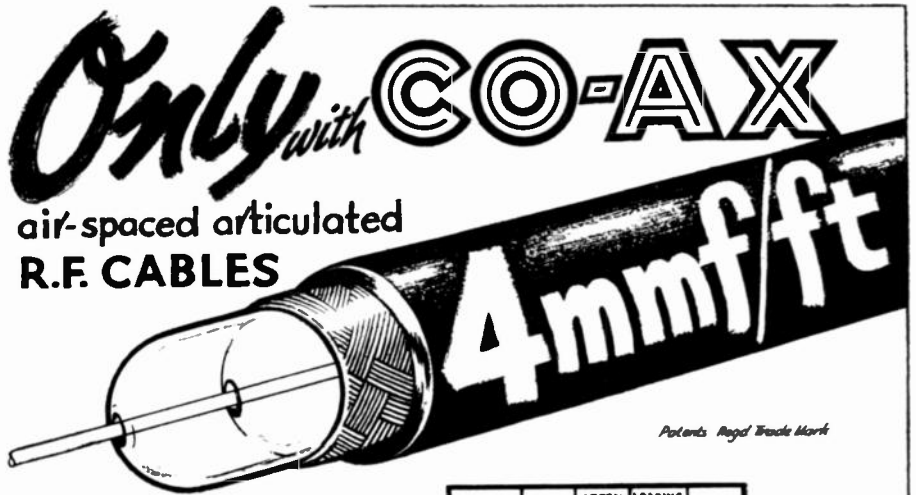

Patents Registered Trade Mark

**THE LOWEST EVER CAPACITANCE OR ATTENUATION**

We are specially organised to handle direct enquiries from overseas and can give

**IMMEDIATE DELIVERIES FOR EXPORT**

Write or cable for data sheets or deliveries to the Originators of flexible air-spaced R.F. Cables

**TRANSRADIO LTD**  
CONTRACTORS TO H.M. GOVERNMENT  
13 BA CROMWELL ROAD LONDON SW7 ENGLAND  
CABLES: TRANSRAD. LONDON.

LOW ATTER TYPES	IMPED OHMS	ATTEN db/100ft at 100 Mc/s.	LOADING $\mu$ W	O.D. "
A1	74	1.7	0.11	0.36
A2	74	1.3	0.24	0.44
A34	73	0.6	1.5	0.88

LOW CAPAC TYPES	CAPAC mm/ft.	IMPED OHMS	ATTEN db/100ft 100 Mc/s.	O.D. "
C1	7.3	150	2.5	0.36
PC1	10.2	132	3.1	0.36
C11	6.3	173	3.2	0.36
C2	6.3	171	2.15	0.44
C22	5.5	184	2.8	0.44
C3	5.4	197	1.9	0.64
C33	4.8	220	2.4	0.64
C44	4.1	252	2.1	1.03

**HIGH POWER FLEXIBLE**

**PHOTOCELL CABLE**

**V.L.C. ★**

★ Very Low Capacitance cable



Engineering Building, University of Notre Dame

**Student Laboratory Measurements at NOTRE DAME with Z-ANGLE METERS**

Dr. H. E. Ellithorn, Associate Professor of Electrical Engineering at the University of Notre Dame has this to say about the Z-Angle Meter:

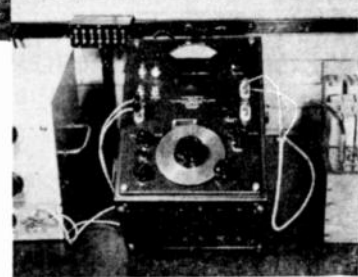

One of Notre Dame's Z-Angle Meters

"The Z-Angle Meters have been in use at Notre Dame for the past four months with great success. The meters have been used to find the open circuit and short circuit impedances of artificial lines and cables; clamped and unclamped impedances of telephone receivers; impedances of two terminal balancing networks as a function of frequency and other impedance tests."

"In the case of the artificial lines and cables, the time necessary to obtain the measurements was reduced to one-half that usually required by ordinary bridge methods."

Write today for Bulletins on the Z-Angle Meter, R-F Z-Angle Meter, R-F Oscillator and Precision Variable Resistors.

**TI TECHNOLOGY INSTRUMENT CORP.**  
1058 MAIN STREET, WALTHAM 54, MASS.

Midwest Office: Alfred Crossley & Associates, 549 W. Randolph St., Chicago 6, Illinois, State 7444

## WANTED ELECTRONIC ENGINEERS AND PHYSICISTS

Excellent opportunities for graduates with research, design, and/or development experience in Communications and aerial navigation systems including direction finders, radar, FM, television, micro-wave.

Write complete details regarding education, experience and salary desired.

To personnel manager  
Federal Telecommunication  
Laboratories  
500 Washington Ave.  
Nutley, New Jersey

### Positions Open for

#### PHYSICISTS

**SENIOR ELECTRONIC ENGINEERS**

**SENIOR MECHANICAL ENGINEER**

**CHEMIST FOR PROBLEMS ASSOCIATED WITH TUBE DEVELOPMENT**

Experienced in radar development, servomechanisms and computers to fulfill the requirements of an expanding airborne radar project, research in electron optics and tubes, and production engineering.

Salary commensurate with experience and ability—insurance plan—paid vacations—excellent opportunity for suitably qualified personnel.

Please furnish complete resume of education, experience and salary required to:

*Industrial Relations & Personnel Department, Farnsworth Television & Radio Corporation, Fort Wayne 1, Indiana*



The following positions of interest to I.R.E. members have been reported as open. Apply in writing, addressing reply to company mentioned or to Box No. . . .

The Institute reserves the right to refuse any announcement without giving a reason for the refusal.

**PROCEEDINGS of the I.R.E.**  
1 East 79th St., New York 21, N.Y.

#### ENGINEERS—PHYSICISTS

The Aeronautical Research Center of the University of Michigan at Willow Run, Michigan, has several openings for engineers and physicists with experience in the fields of servo-mechanisms, electronics and instrumentation. Interested applicants should furnish complete outline of experience with letter of application. University of Michigan, Personnel Office, 208 University Hall, Ann Arbor, Michigan.

#### TECHNICAL RADIO ENGINEER

Radio engineer, capable of adjusting (or learning) complex directional antennas, for positions with Washington consultant. State detailed qualifications, education and salary requirements. Box 514.

#### ELECTROLYTIC CAPACITOR ENGINEER

Exceptional opportunity for right man who can qualify for development engineering post with leading manufacturer. Please send complete particulars in first letter. Our men know of this advertisement. Reply Box 515.

#### TELEVISION ENGINEER

Chief engineer of television broadcast station located in midwest city. Please state fully experience and qualifications. Box 516.

#### RADIO RECEIVERS ENGINEER

Radio receiver engineers. Various types of qualifications. Please state experience and salary requirements in first letter. Box 517.

#### ENGINEERS

Allen B. DuMont Laboratories, Inc., have several openings in their Clifton plant for intermediate and senior engineers. Must have B.S. degree in physics of electrical engineering and experience in V.H.F., television deflection or general circuit development. Apply personnel

Dept., 1000 Main Ave., Clifton, New Jersey. 9:00 A.M. to 3:00 P.M.

#### ELECTRONIC DESIGN ENGINEER— PRODUCTION ENGINEER

(1) **ELECTRONIC DESIGN ENGINEER**—Boston firm developing electronic instruments for radioactivity detection and measurement. Offers excellent opportunity for high calibre design engineer. Write full details.

(2) **PRODUCTION ENGINEER**—Boston firm manufacturing electronic radioactivity instruments has opening for qualified man experienced in engineering production models from prototype designs. Position also entails responsibility for component and production quality control. Write full details. Box 518.

*(Continued on page 42A)*

## WANTED PHYSICISTS ENGINEERS

Engineering laboratory of precision instrument manufacturer has interesting opportunities for graduate engineers with research, design and/or development experience on radio communications systems, Servomechanisms (closed loop), electronic & mechanical aeronautical navigation instruments and ultra-high frequency & microwave technique.

WRITE FULL DETAILS  
TO  
EMPLOYMENT SECTION

**SPERRY  
GYROSCOPE  
COMPANY**

DIVISION OF SPERRY CORP.  
Marcus Ave. & Lakeville Rd.  
Lake Success, L.I.

## ENGINEERS – ELECTRONIC

Senior and Junior, outstanding opportunity, progressive company.  
Forward complete résumés giving education, experience and salary requirements to

*Personnel Department*  
**MELPAR, INC.**  
452 Swann Avenue  
Alexandria, Virginia



*RCA's new television camera has a super-sensitive "eye" that sees even in the dimmest light—indoors or outdoors.*

## **WANTED! Design and Development Engineers for**

- \_\_\_\_\_ **TELEVISION**
- \_\_\_\_\_ **AVIATION EQUIPMENT**
- \_\_\_\_\_ **RADAR**
- \_\_\_\_\_ **MOBILE COMMUNICATIONS**
- \_\_\_\_\_ **OTHER ELECTRONIC DEVICES**

*Write to:* Camden Personnel Division  
RCA Victor Division  
Camden, New Jersey

Wire drawn to .0004" diameter.



Ribbon rolled to .0001" thickness.



Alloys for Special requirements.

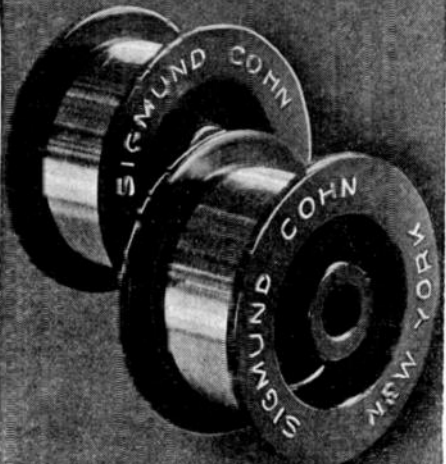

Write for list of stock alloys

**SIGMUND COHN CORP.**

44 GOLD ST., NEW YORK

SINCE 1901



(Continued from page 40A)

#### CATHODE RAY TUBE TEST ENGINEER

Test experimental models of television cathode ray tubes in cooperation with the design engineers and carry out the modification of test equipment for the testing of such special tubes. Experience in the design of television video and scanning circuits desirable. Position includes responsibilities with maintenance of cathode ray test tube equipment but not for its initial design or construction. Apply: Supervisor of Employment, Industrial Relations Dept., Sylvania Electric Products, Inc., 500 Fifth Ave., New York, N.Y.

#### GLASS ENGINEER

A progressive New England radio tube manufacturing company is in need of a glass engineer for development work. This man must have considerable industrial experience in general glass work. Must be familiar with modern practices of metal to glass seals. Box 524.

#### SCR—584 TECHNICIANS

Unusual opportunity for engineers and technicians familiar with the SCR—584 radar. Many advantages offered. For application forms write Route 1, Box 118, Oxnard, California.

#### ELECTRONICS RESEARCHER

Ph.D. in Electrical Engineering, with background in antenna theory, for research work at University of California, Berkeley, Calif. Possibility of part-time faculty appointment. Salary dependent on qualifications. Write to Professor T. C. McFarland, Chairman, Division of Electrical Engineering, giving full details regarding education and experience.

#### ELECTRONIC ENGINEER

Wanted by electronic laboratory in New York City, electronic engineer with practical experience VHF receiver design. Must also be well versed in mechanical design aspects. State experience and salary requirements in first letter. Box 526.

#### DRAFTSMAN

Wanted by electronic laboratory in New York City, draftsman with thorough experience in mechanical and electrical phases of radio drafting. State experience and salary requirements. Box 527

#### TELEVISION INSTRUCTOR

Television instructor wanted by a television training institution of long standing in Hollywood; must be well versed in the principles and practice underlying television transmitting and receiving. Minimum \$3,200. State particulars, including educational and experience background. Box 521.

#### MATHEMATICIANS, ENGINEERS, PHYSICISTS

Men to train in oil exploration for operation of seismograph instruments, computing seismic data, and seismic surveying. Beginning salary—open depending upon background; excellent opportunity for advancement determined on ingenuity and ability. Nature of work requires several changes of address each year; work in-

(Continued on page 43A)

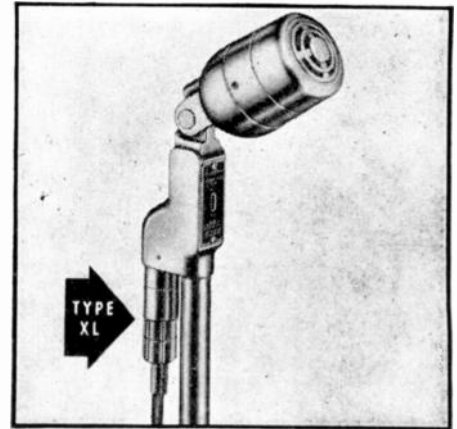

## HIGH FIDELITY EV-635 MICROPHONE USES "XL" PLUG

Electro-Voice has equipped the new EV-635 High Fidelity Dynamic Microphone for studio and remote broadcasting, with the Cannon Type XL-3-11 Plug—a quality plug for a quality microphone.

Shown at left is the new XL-3-36 Wall Receptacle (pin insert) engaged with an XL-3-11 Plug. XL-3-36 is priced at \$5.45 List; and XL-3-35 (socket insert) \$4.95 List.

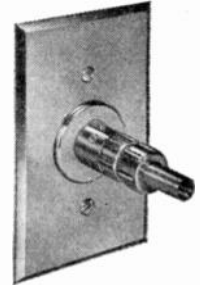

For a practical, low cost but high quality connector series having three 15-amp. contacts, choose the "XL". Four plug types and six receptacles with 3 adapter receptacles are available. Min. flashover voltage 1500 Volts.



Above are the two zinc plugs (Left) XL-3-12, List \$1.20 and (Right) XL-3-11, List \$1.25

No other small electric connector has all the features of the XL, including the safety latch lock.

XL Connectors are available from more than 250 radio supply houses throughout the U. S. A.

For complete information on the XL, write for Bulletins XL-347 and XL-PR1. Address Department G-377.

SINCE 1915

**CANNON ELECTRIC**

*Development Company*

3209 HUMBOLDT ST., LOS ANGELES 31, CALIF.

IN CANADA & BRITISH EMPIRE: CANNON ELECTRIC CO., LTD., TORONTO 13, ONT.

WORLD EXPORT (Excepting British Empire): FRAZAR & HANSEN, 301 CLAY ST., SAN FRANCISCO

**FASTER, SIMPLER**  
**AUDIO ANALYSIS**  
 with Model AP-1



**PANORAMIC SONIC ANALYZER**

Reduce time, complexity and cost of making audio measurements with the unusual advantages offered by the Panoramic Sonic Analyzer. By resolving a complex audio wave into a spectrograph showing the frequency distribution and voltage amplitude of the components, Model AP-1...

- Eliminates slow point-by-point frequency checks • Provides a quick overall view of the audio spectrum
- Enables determination of changes in waveform content while parameters are varied • Furnishes simple presentations for production line testing.

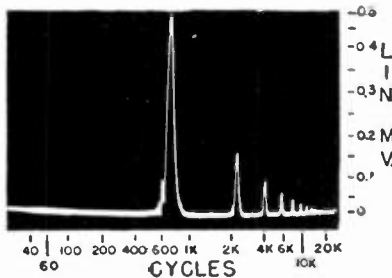

Panoramic Sonic Spectrograph of 750 cps square wave.

Use Model AP-1 for analyzing...  
 • Harmonics • Intermodulation • Vibration • Noise • Acoustics • Materials

Features... Continuous scanning from 40-20,000 cps in one second • Wide input voltage range • Linear and log voltage scale • Closely logarithmic frequency scale • Built-in voltage and frequency calibrator • Simple operation.

WRITE for detailed specs, price and delivery.

**PANORAMIC RADIO CORP.**

92 Gold St. Cable Address  
 New York 7, N. Y. PANORAMIC, NEW YORK  
 Exclusive Canadian Representative: Canadian Marconi, Ltd.

**POSITIONS OPEN**

(Continued from page 42A)

doors and out; general locations in oil producing states. To apply, write giving scholastic and employment background, age, nationality, marital status and include recent snapshot to National Geophysical Co. Inc., 8800 Lemmon Ave., Dallas 9, Texas.

**ELECTRONIC ENGINEERS**

Salaries \$3,021 and \$4,149 per annum. In charge of major field communication installation projects including electronic, radio, and teletype equipment system. Contact Civil Aeronautics Administration, 385 Madison Ave., New York 7, N.Y.

**ELECTRONIC ENGINEER**

Salary \$4,902 per annum. Responsible for the type of certification of radio and electronic equipment as well as for its installation in aircraft and for engineering approval of aircraft electrical systems. Contact Civil Aeronautics Administration, 383 Madison Ave., New York 7, N.Y.

**PROFESSOR OF COMMUNICATION ENGINEERING**

Professor of communications engineering needed for fall 1948 by southeastern university. Will be in charge of graduate work and research activities. \$6,000 for nine months with extra income for summer teaching. Must have Ph.D. or D.Sc. degree. Write Box 522.

**PROJECT ENGINEER**

Electronic engineer with practical background in television is required by small television manufacturer to act as project engineer on television distribution systems. Metropolitan New Jersey. Box 523.

**DEVELOPMENT ENGINEERS**

West coast organization has openings for creative electronic engineers with several years research and development experience. Work involves highly interesting, essential projects in fields of audio-video circuits; magnetic circuits; electronic, mechanical, and optical apparatus. An outstanding opportunity with a small, aggressive development and manufacturing concern in the San Francisco area. Reply in detail, giving education, experience, and salary requirements. Berkeley Scientific Company, Sixth and Nevin Ave., Richmond, California.



**BUY BONDS TODAY!**

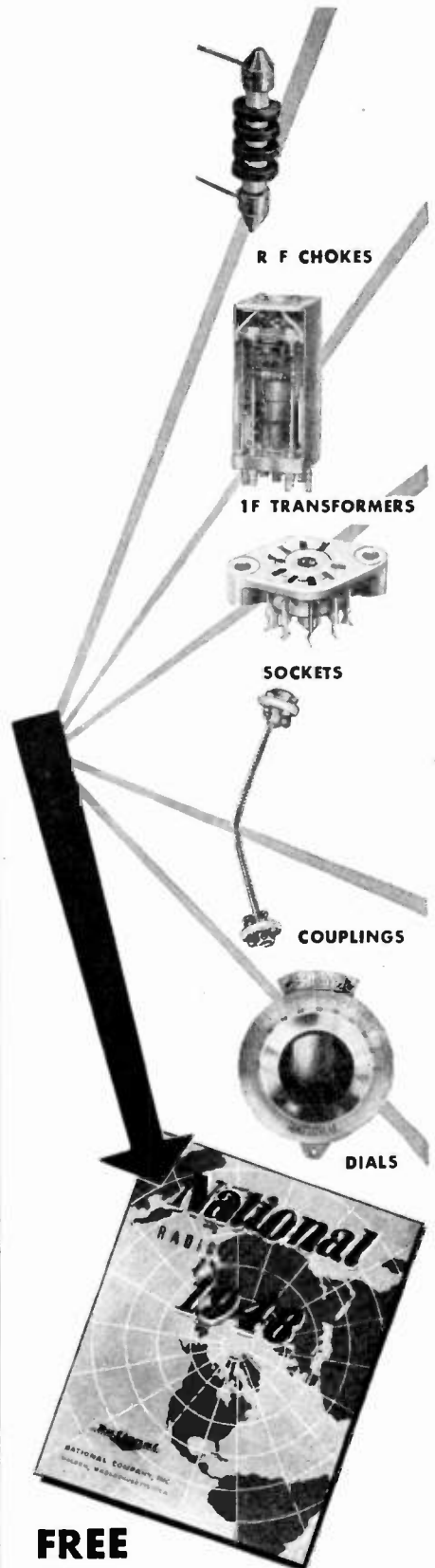

**FREE**

the new 1948 catalog of famous National precision components, parts, and communication receivers.

**WRITE TODAY TO**

**National**

EST. 1914

**NATIONAL COMPANY, Inc.**  
 61 Sherman St. Malden, Mass.

ONE OF A SERIES



## Ceramic Pointer Stops

**WHY BURLINGTON PANEL INSTRUMENTS PROVIDE UTMOST RELIABILITY . . .**

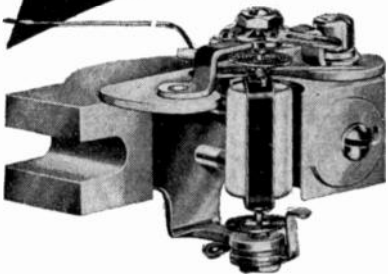

CERAMIC POINTER STOPS are used to prevent damage to the pointer due to accidental application of sudden overloads. All ranges AC and DC available in 2 1/2", 3 1/2", 4 1/2" rectangular or round case styles and are fully guaranteed for one year against defects in workmanship or material. Refer inquiries to Dept. 178.

**Burlington** INSTRUMENT COMPANY  
BURLINGTON, IOWA



## PILOT LIGHT ASSEMBLIES

**PLN SERIES—Designed for NE-51 Neon Lamp**



### Features

- THE MULTI-VUE CAP
- BUILT-IN RESISTOR
- 110 or 220 VOLTS
- EXTREME RUGGEDNESS
- VERY LOW CURRENT

*Write for descriptive booklet*

**The DIAL LIGHT CO. of AMERICA**

FOREMOST MANUFACTURER OF PILOT LIGHTS  
900 BROADWAY, NEW YORK 3, N. Y.  
Telephone—Spring 7-1300



## Positions Wanted By Armed Forces Veterans

In order to give a reasonably equal opportunity to all applicants, and to avoid overcrowding of the corresponding column, the following rules have been adopted:

The Institute publishes free of charge notices of positions wanted by I.R.E. members who are now in the Service or have received an honorable discharge. Such notices should not have more than five lines. They may be inserted only after a lapse of one month or more following a previous insertion and the maximum number of insertions is three per year. The Institute necessarily reserves the right to decline any announcement without assignment of reason.

### ELECTRICAL ENGINEER

Electrical engineer. Age 26. B.E.E., M.E.E. Capable research man, desires position in video, medical or physics instrumentation, or other circuit research. Tau Beta Pi, Eta Kappa Nu. Available August. Box 167W.

### ENGINEERING PHYSICIST

B.S. Engineering, physics 1941; advanced mathematics; 7 years research and development, electronic, mechanical, optical, hydraulic fire control material; extensive liaison experience; 3 1/2 years Ordnance Officer; employed. Desires shift to nuclear energy field. Box 168W.

### ENGINEER

B.E.E. December 1946, M.S.E.E. June 1948. Age 23. Class A amateur and 1st class radiotelephone licenses. Three months installation of FM equipment, six months microwave research, and one year of half-time teaching. Box 178W.

### JUNIOR ENGINEER

Graduating University of Michigan June 1948 with B.S.E.E. (in communication) and B.S.E. (mathematics). Also fluent knowledge of German. Interested in mathematical applications to electrical engineering (electronics), or in electronics applied to mathematics. Prefer New York City vicinity. Box 179W.

### ELECTRICAL ENGINEER

McGill University B.E.E. 1948. Desires television, radio or industrial electronics work in design production or research. Canadian Army radar training. Box 180W.

### SALES ENGINEER

Sales Engineer: Broadcast Engineer, past three years as Chief Engineer of local station. Interested in entering sales field as an engineer with an established manufacturer of broadcast equipment. Family man. 28 years old; prefer southwest territory. Box 144W.

*(Continued on page 46A)*

## News—New Products

These manufacturers have invited PROCEEDINGS readers to write for literature and further technical information. Please mention your I.R.E. affiliation.

(Continued from page 36A)

### Soldering Pencil for Difficult and Inaccessible Places

An improved pencil soldering iron that is said to assure tightness and guarantee contact by use of a spring-action rivet that takes up expansion has been announced by Ungar Electric Tool Co., Los Angeles 54, Calif.

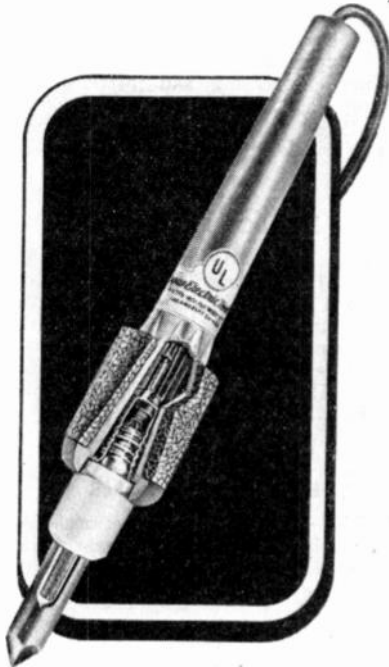

The element is rated at 20 watts and has been tested at 1000 hours operation. It operates on 110-120-volt a.c.-d.c.

The complete product has four interchangeable Tellurium tips:  $\frac{1}{8}$ " pencil,  $\frac{1}{8}$ " and  $\frac{1}{4}$ " chisel, and  $\frac{3}{8}$ " pyramid. Copper tip length beyond the heating coil is  $\frac{3}{8}$ " on the  $\frac{3}{8}$ " tips, and  $\frac{1}{4}$ " on the  $\frac{1}{8}$ " tips. Both heat to 500° in 90 seconds.

### 1000 Watt "Ham" Transmitter for the U.N. at Lake Success

The United Nations station, known as K2UN, will have two transmitters of 1000 watts each. One operates on the 80 and 40 meter bands, and covers a good part of the U. S. from the transmission point at Lake Success. The other broadcasts in the high ends of the 20 and 10 meter phone bands and is capable of making contact with amateur operators all over the world.

At the outset the frequency of broadcasts will be uncertain, but it is hoped ultimately to arrange daily contacts on a world wide basis from 4:00 PM to midnight.

The station was opened May 17, with George W. Bailey, W2KH, sending out the first call in his capacity as president of the International Amateur Radio Union.

(Continued on page 47A)

# New! All inclusive!



## STANDARD LINE OF TRANSMITTER COMPONENTS

FOR AM, FM AND TV—LABORATORY AND INDUSTRIAL APPLICATIONS

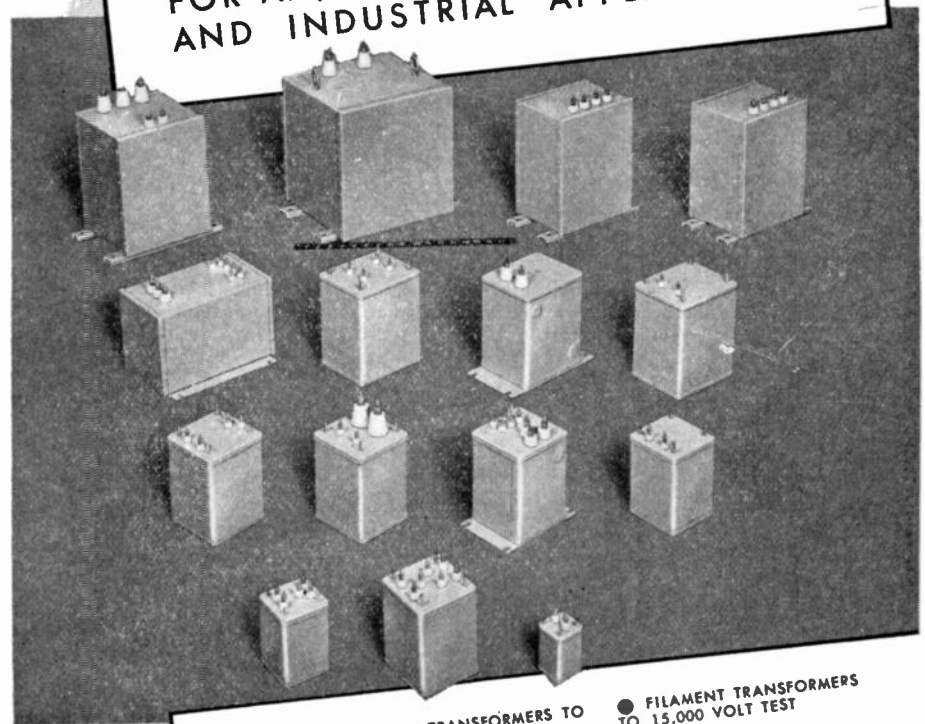

INCLUDING —

FEATURING —

- PLATE TRANSFORMERS TO 10 KVA
- FILTER REACTORS
- 115/230 VOLT, 50/60 CYCLE SUPPLY
- RUGGED INTERNAL CONSTRUCTION, SUPPORTED CORE STRUCTURE
- EYE BOLTS ON LARGE UNITS FOR EASY HANDLING
- FILAMENT TRANSFORMERS TO 15,000 VOLT TEST
- PLATE FILAMENT TRANSFORMERS LOW VOLTAGE
- AIEE SURGE TEST ON HIGH VOLTAGE UNITS
- EFFICIENT MAGNETIC AND ELECTRO-STATIC SHIELDING
- UNIFORM STREAMLINED APPEARANCE
- STURDY STEEL CASES

Here is one of the finest and most complete lines of standard transmitter components available today. Built to the same well-known high standards as N·Y·T custom-built units, they bring to the design engineer the full economy of standardized construction. Superbly constructed, inside and out, each unit fully reflects the years of experience that have made the name NEW YORK TRANSFORMER synonymous with quality, integrity and dependability wherever inductive components are used.

WRITE FOR CATALOG

**NEW YORK TRANSFORMER CO., INC.**  
ALPHA, NEW JERSEY

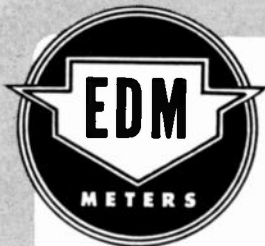

## HAVE YOU A METER PROBLEM?

Electric Design & Manufacturing Corporation takes pride in being able to produce at modest cost custom engineered meters to meet your specific needs.

We particularly specialize in instruments involving unusual resistance and damping requirements. Because of our precision methods, we are able to produce instruments with extremely high sensitivity and low resistance—without sacrificing durability or ruggedness.

Our craftsmen utilize the most modern production methods and machines to speed production yet keep costs at a minimum.

Only the finest of materials are used and all EDM Meters are subjected to rigid double inspection before being shipped.

If you have a meter problem, why not contact us? You'll be agreeably surprised to discover that we can give you what you want, when you want it and at very reasonable cost.



**ELECTRIC DESIGN & MFG. CORP.**  
BURLINGTON, IOWA

## 1500 VOLT POWER SUPPLY



Continuously Adjustable and Regulated 600-1500 V.D.C. at 0-1 Milliampere.

For Use With Geiger Counters, Photo multiplier Tubes, Cathode Ray Tubes and Other Applications Requiring High Voltage at Low Current.

Regulation: Output Voltage varies less than .01% of output voltage per volt change of line voltage and less than 1 Volt with variations of output current between 0-1 Milliampere. (Internal impedance less than 1000 Ohms)



**FURST ELECTRONICS**  
806 W. North Ave., Chicago 22, Illinois

### MODEL 710-5

Cabinet Mounted—\$160.00  
Net F.O.B. Chicago

### MODEL 710-SR

With Standard Rock Mounting—\$165.00  
Net F.O.B. Chicago

Also available in 2 or 3 independently regulated and independently adjustable outputs.

## Positions Wanted

(Continued from page 44A)

### ELECTRICAL ENGINEER

Electrical Engineer. Age 27. Single. B.E.E. 1949. 5 years experience in testing, development, drafting and maintenance of electrical equipment. Wants New York sales position with electrical or electronic equipment manufacturing company. Sales training must be part of long term program. Write Box 145W.

### ELECTRICAL ENGINEER

B.E.E. 1943 C.C.N.Y., M.S. 1948 Columbia University. Age 27. Married. Six years experience on electronic research, product engineering and instructing including one year AAF service. Available June 1948. Prefer Omaha, Nebraska, or New York. Box 146W.

### JUNIOR ENGINEER

School: RCA Institutes Inc., N.Y.C. 1948 Ex-Petty Officer Telegraphist (Royal Canadian Navy). Married. No children. Experience: Radio assembly. Operation, maintenance and installation of receivers, transmitters (LF, UHF), radar, RDF (LF, VHF) loran. Interested in engineering and sales. Box 147W.

### ELECTRICAL ENGINEER

B.E.E., R.P.I. (Communications). Age 26. Married. 1 child. Two years Navy maintenance of radio and radar equipment. One year Civil Service testing VHF-UHF transceivers. Current development of signal generators. Desires position as sales engineer. Box 148W.

### ADMINISTRATIVE ENGINEER

Registered electrical engineer (N.Y.) FCC licenses. Eight years experience in engineering, production, construction and administration; with power communications and aircraft organizations. Harvard Business School graduate. Navy radar trained veteran. West coast preferred. Box 149W.

### ELECTRICAL ENGINEER

B.S.E.E. Columbia June 1948. Age 29. Married. 2½ years Naval radar; 1 year Naval Research Lab., 1½ years instructor in theory and shop practice; 5 years experience in production planning and coordinator-metal and woodworking manufacturing. Tau Beta Pi. Desires position in design, development or production anywhere in the U.S.A. Box 150W.

### TELEVISION ENGINEER

B.E.E. Cooper Union. Age 25. Single. 3½ years experience in development and design of U. S. Navy Airborne I.F.F. and airborne television receivers, F.M. radar system, civilian television receivers. Also maintenance and operation of radar sets in Army Ground Forces. Desires position in design of electronic equipment; New York City vicinity or northeast. Box 160W.

(Continued on page 48A)



## News—New Products

These manufacturers have invited PROCEEDINGS readers to write for literature and further technical information. Please mention your I.R.E. affiliation.

(Continued from page 45A)

### New Enterprises and New Locations

•••On April 1, **Electrical Reactance Corp.**, of Franklinville, N. Y., announced the opening of a Canadian plant at Prescott, Ont., Canada.

Under the direction of T. G. Kincaid this division will manufacture capacitors, resistors, and choke coils, but orders will have to be placed through the N. Y. address.

•••On May 1, **Standard Arcturus Corp.** moved to its new address at 54 Clark St., Newark, N. J. Now located at this new plant are Arcturus Radio & Television Corp., Kotron Rectifier Corp., and Arcturus Electronics Inc., Tube Division.

•••On May 13, the War Assets Administration approved the purchase of the Wright Aeronautical Corporation plant at East Paterson, N. J., by **Allen B. DuMont Labs., Inc.**, for \$1,700,000.

•••On May 15, **Presto Recording Corp.** moved to its new consolidated plant at Paramus, N. J., located seven miles from New York City on Route 4, via George Washington Bridge. Address mail to P.O. Box 500, Hackensack, N. J.

### Three-Sequence Predetermined Electronic Counter



As an extension of the single and dual types, this product will predetermine three different counts that occur in sequence, each of which can be any number from 1 to 10,000.

Developed by the **Potter Instrument Co., Inc.**, 136-56 Roosevelt Ave., Flushing, N. Y. it uses four-tube counter decades which are completely electronic and have no moving parts. The input consists of three high-speed mercury-type relays, each of which is energized at the completion of its associated count.

Although the multiple-sequence counters are usually designed for counting speeds up to 15,000 per minute, higher rates will be supplied from this company on order.

(Continued on page 48A)

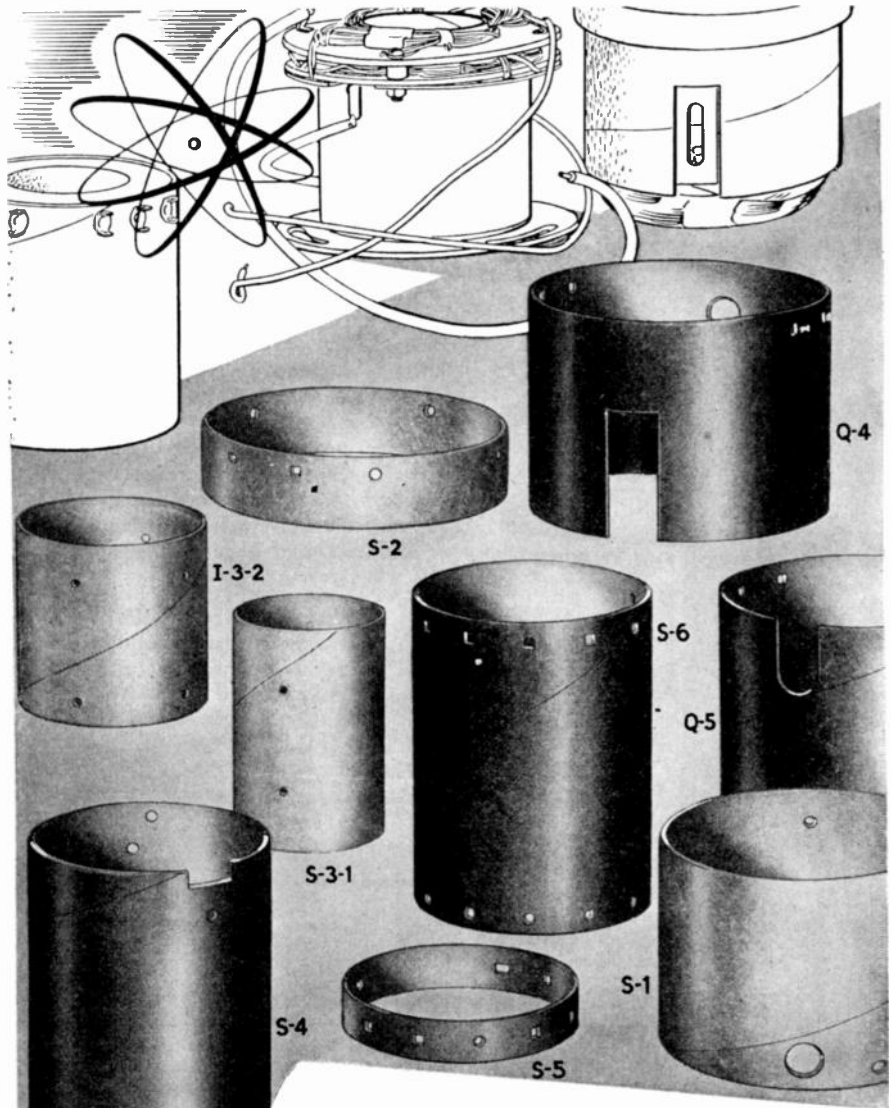

## COSMALITE\* TUBES

For Television deflection yokes

These spirally laminated paper base, phenolic tubes are obtainable in sizes and with punching and notching that meet each customer's individual needs.

Quality performance at prices that appeal.

OTHER COSMALITE TYPES INCLUDE . . .

#96 Cosmalite for coil forms in all standard broadcast receiving sets. SLF Cosmalite for Permeability Tuners. Spirally wound kraft and fish paper Coil Forms and Condenser Tubes.

Partial List of Radio & Television Receivers in which COSMALITE is used:

Admiral	Magnavox
Arvin	Motorola
Belmont	Sentinel
Bendix Radio	Stewart Warner
Colonial	Warwick
Farnsworth	Wells Gardner
General Electric	Zenith
Howard	

DEFLECTION YOKE SHELLS		
	Inside Diameter	Length
S-1	3"	2 <sup>5</sup> / <sub>16</sub> "
S-4	2 <sup>3</sup> / <sub>8</sub> "	3 <sup>7</sup> / <sub>16</sub> "
Q-3	3"	2 <sup>3</sup> / <sub>16</sub> "
Q-4	3"	2 <sup>1</sup> / <sub>16</sub> "
Q-5	3"	2 <sup>1</sup> / <sub>16</sub> "
S-6	2 <sup>3</sup> / <sub>8</sub> "	3 <sup>7</sup> / <sub>16</sub> "
DEFLECTION YOKE CORES		
S-3-1	1 <sup>3</sup> / <sub>32</sub> "	2 <sup>1</sup> / <sub>32</sub> "
S-3-2	1 <sup>3</sup> / <sub>32</sub> "	2 <sup>1</sup> / <sub>32</sub> "
S-3-3	1 <sup>3</sup> / <sub>32</sub> "	2 <sup>1</sup> / <sub>32</sub> "
I-3-1	1 <sup>17</sup> / <sub>32</sub> "	2 <sup>3</sup> / <sub>32</sub> "
I-3-2	1 <sup>7</sup> / <sub>8</sub> "	2"
DEFLECTION YOKE RINGS		
S-2	3"	3 <sup>3</sup> / <sub>4</sub> "
S-5	2 <sup>3</sup> / <sub>8</sub> "	1 <sup>9</sup> / <sub>32</sub> "

\* Trade Mark Registered

Inquiries given specialized attention.

## The CLEVELAND CONTAINER Co.

6201 BARBERTON AVE. CLEVELAND 2, OHIO

- All-Fibre Cans • Combination Metal and Paper Cans
- Spirally Wound Tubes and Cores for all Purposes
- Plastic and Combination Paper and Plastic Items

PRODUCTION PLANTS also at Plymouth, Wis., Ogdenburg, N.Y., Chicago, Ill., Detroit, Mich., Jamesburg, N.J.  
 PLASTICS DIVISION at Plymouth, Wis. • ABRASIVE DIVISION at Cleveland, Ohio  
 SALES OFFICES: Room 5632, Grand Central Term. Bldg., New York 17, N.Y., also 647 Main St., Hartford, Conn.  
 CANADIAN PLANT: The Cleveland Container Canada, Ltd., Prescott, Ontario



# Engineers... like to SHOP at 'NEWARK'

## for ALL Their Needs in RADIO and ELECTRONIC • EQUIPMENT • COMPONENTS • ACCESSORIES

RECORDERS



TUBES



TELEVISION SETS



F-M TUNERS



P.A. SYSTEMS



TRANSMITTING and  
RECEIVING EQUIPMENT

**NEWARK** CHICAGO  
ELECTRIC COMPANY, INC.  
323 W. Madison St.  
Chicago 6, Ill.

NEW YORK  
Offices & Warehouse  
242 W. 55th St., N.Y. 19

New York City Stores: 115-17 W. 45th St. & 212 Fulton St.

For all your personal or professional needs in Radio and Electronic equipment — save time, save MONEY, by shopping 'Newark' FIRST!

Engineers, who "live by the clock" have learned to depend on Newark's speedy, efficient service . . . our high geared organization of technically trained personnel know how important YOUR order is to YOU . . . mail and phone orders shipped same day! All standard makes of Tubes, Components, Receiving, Transmitting, Public Address, and Recording Equipment, in stock.

WIRE & TAPE RECORDERS — all makes now on demonstration at any of our THREE GREAT STORES, centrally located in New York and Chicago.

*Speedy, Efficient Service*  
AS NEAR AS YOUR PHONE!  
in NEW YORK  
Phone: CI. 6-4060  
in CHICAGO  
Phone: STAt 2950

## Positions Wanted

(Continued from page 46A)

### ENGINEER

B.E.E. (R.P.I., 1941) LL.B. (Brooklyn Law School, 1948). 5 years product and research engineering in electronic servo-control systems. Ex-engineering officer. Seeking position in patents, legal department or as junior executive, FCC radio telegraph, 1st class, 10 years. Write Box 161W.

### ENGINEER

Engineer B.S. in E.E., M.S. in Ae.E. 4½ years experience in development, test and manufacturing of automatic flight control systems for conventional aircraft and guided missiles. Desires position in New York City area. Available in June. Box 162W.

### ELECTRONIC ENGINEER

B.S.E.E. Northeastern University, Boston, 1947. Two years experience as Navy radio technician with Navy radar and communications equipment. Some experience in sonar equipment design at Naval Research Lab., Washington, D.C. Hold 1st class phone license. Member of Tau Beta Pi. Desire position in research, design or development in New York metropolitan area. Box 163W.

### ENGINEER

Graduate of McGill University. Age 30. Married. Desires work in radio, radar, television research or development. 4 years with National Research Council, Ottawa on radar development. 6 years of radio experience with other companies. Box 164W.

## BUILD BETTER ELECTRONIC EQUIPMENT

with STANDARDIZED



READY-TO-USE  
CABINETS  
•  
CHASSIS  
•  
PANELS  
•  
RACKS

for  
ALL  
P. A.  
NEEDS

Par-Metal Equipment is preferred by Service Men, Amateurs, and Manufacturers because they're adaptable, easy-to-assemble, economical. Beautifully designed, ruggedly constructed by specialists. Famous for quality and economy.

Write for Catalog.

**PAR-METAL**  
PRODUCTS CORPORATION

32-62-49th ST., LONG ISLAND CITY 3, N. Y.  
Export Dept.: Rocke International Corp.  
13 East 40 Street, New York 16

## News—New Products

These manufacturers have invited PROCEEDINGS readers to write for literature and further technical information. Please mention your I.R.E. affiliation.

(Continued from page 47A)

### New Versatile Amplifier

Plug-in channel adapters make the Type 122 8-watt amplifier, produced by Langevin Manufacturing Corp., 37 West 65 St., New York 23, N. Y., an audio unit with eight applications.

Three extra sockets are provided in each of the two input channels of the Type 122 so that various combinations of plug-in equalizers, transformers, voice filters, and vacuum tubes can adapt the amplifier for

crystal pickups, radio tuners, crystal microphones, low-impedance microphones, variable-reluctance pickups (i.e., G. E. or Pickering), low-impedance pickups, line-level transmission, and magnetic-wire recorders.

The Type 122 is a low-noise-level, low-distortion unit with wide-range frequency response (8 watts with less than 3% total harmonic distortion from 50 to 15,000 c.p.s.)

The new-type chassis-cabinet with snap-on cover and hinged back facilitates maintenance.

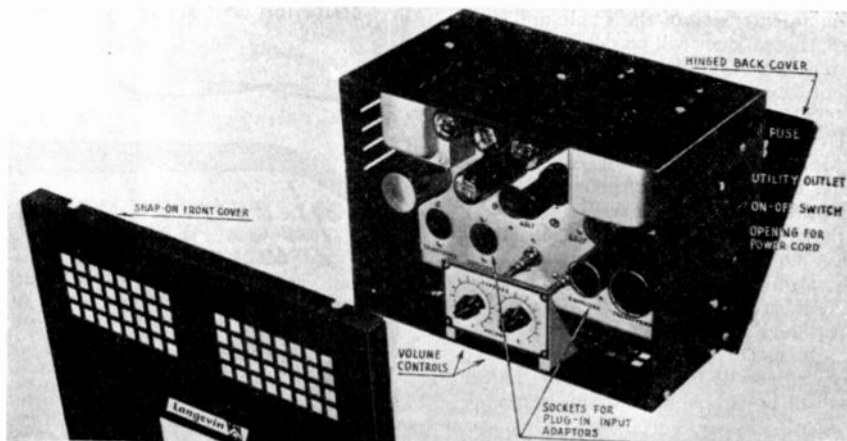

Now! Specify

# KENYON



**KENYON** one of the oldest names in transformers, offers high quality specification transformers custom-built to your requirements. For over 20 years the KENYON "K" has been a sign of skillful engineering, progressive design and sound construction.

**KENYON** now serves many leading companies including: Times Facsimile Corporation, Western Electric Co., General Electric Co., Schulmerich Electronics, Sperry Gyroscope Co., Inc. Yes, *electronification* of modern industrial machinery and methods has been achieved by KENYON'S engineered, efficient and conservatively rated transformers.

For all high quality sound applications, for small transmitters, broadcast units, radar equipment, amplifiers and power supplies — Specify KENYON! Inquire today for information about our JAN approved transformers.

Now — for the first time in any transformer catalog, KENYON'S new modified edition tells the full complete story about specific ratings on all transformers. Our standard line saves you time and expense. Send for the latest edition of our catalog now!



**KENYON TRANSFORMER CO., Inc.** 840 BARRY STREET NEW YORK 59, N. Y.



# NEW

For TV



## HI-LO 3-DIMENSION ANTENNA Gets All 13

- SIMPLE
- EASY TO ERECT
- RUGGED CONSTRUCTION
- COVERS ALL CHANNELS

Premax Hi-Lo Television Antenna is radically new and severely simplified in design for quick, easy assembly and erection and for rugged strength and service.

Two completely separate arrays, each consisting of dipole antenna and reflector, provide maximum signal pickup for all 13 channels, in both low and high frequency bands. Both are mounted on the same mast but thru a simple device each is adjustable in BOTH horizontal and vertical planes, entirely independent of each other. Spacing between arrays may be varied at will. They are interconnected into a single electrical system by a new circuit licensed under the A.A.&K. patents.

Get complete details on this revolutionary, low-cost, all-channel Antenna.

ASK YOUR JOBBER



4811 Highland  
NIAGARA FALLS, N. Y.

## MEASUREMENTS CORPORATION MODEL 80 STANDARD SIGNAL GENERATOR



### 2 to 400 MEGACYCLES

**MODULATION:** Amplitude modulation is continuously variable from 0 to 30%, indicated by a meter on the panel. An internal 400 or 1000 cycle audio oscillator is provided. Modulation may also be applied from an external source. Pulse modulation may be applied to the oscillator from an external source through a special connector. Pulses of 1 microsecond can be obtained at higher carrier frequencies.

**FREQUENCY ACCURACY** ±.5%

**OUTPUT VOLTAGE**  
0.1 to 100,000 microvolts

**OUTPUT IMPEDANCE**  
50 ohms

MANUFACTURERS OF  
Standard Signal Generators  
Pulse Generators  
FM Signal Generators  
Square Wave Generators  
Vacuum Tube Voltmeters  
UNF Radio Noise & Field Strength Meters  
Capacity Bridges  
Megohm Meters  
Phase Sequence Indicators  
Television and FM Test Equipment

**MEASUREMENTS CORPORATION**  
BOONTON NEW JERSEY

# INDEX AND DISPLAY ADVERTISERS

Section Meetings	34A
Student Branch Meetings	35A
Membership	37A
Positions Open	40A
Positions Wanted	44A
News—New Products	22A

## DISPLAY ADVERTISERS

Acme Electric Corporation	YB 38A
Aerovox Corp.	16A
Aircraft Radio Corp.	YB
Airtron, Inc.	YB 28A
Allied Radio Corporation	YB
American Electrical Heater Co.	YB
American Lava Corporation	YB
American Phenolic Corp.	14A
American Television & Radio Co.	YB
Amperex Electronic Corp.	Cover 11
Amperite Co.	YB
Andrew Corporation	YB 37A
Applied Science Corp. of Princeton	YB
Arlington Elec. Prod.	YB
Arnold Engineering Co.	31A
Astac Corp.	22A
Atlantic India Rubber Works	YB
Audio Devices, Inc.	YB

## Bourdon tube HIGH PRESSURE TRANSDUCER

2 1/2" high and 2 3/8" in diameter, the Giannini Bourdon Tube Pressure Transducer is designed for all ranges up to 6000 psi. Hysteresis is better than 1/2 of 1%. Linearity and accuracy are within 1%.

Deflection of the bourdon tube produces an electrical signal proportional to pressure. Even at low pressures, this instrument retains all of its accuracy and retains the large electrical outputs typical of Giannini instruments.

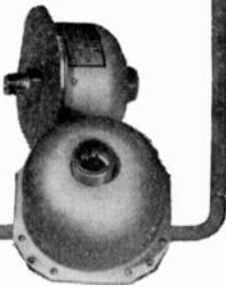

Write for engineering details.

**GM Giannini & Co. Inc.**

REACTION POWER PLANTS • AUTOMATIC FLIGHT EQUIPMENT  
285 WEST COLORADO STREET • PASADENA 1, CALIFORNIA

Those firms coded "YB" in the above index are providing additional product data in advertisements in the I.R.E. Yearbook coming out this summer. I.R.E. Members will find these ads provide working facts.

Ballantine Laboratories	YB
Alfred W. Barber Laboratories	YB
Barker & Williamson	YB
Barry Corporation	YB
Bead Chain Mfg. Co.	YB
Bell Telephone Laboratories	7A
Bendix Aviation Corp. (Pacific Div.)	YB
Bendix Aviation Corp. (Scintilla Div.)	28A
Beta Electronics	YB
Biwax Corporation	YB
Bliley Electric Co.	YB
Boland & Boyce, Inc.	34A
Boonton Radio Corp.	YB
W. H. Brady Co.	YB
W. J. Brown	51A
Burlington Instrument Co.	44A
Burnell & Co.	YB
Bussman Mfg. Co.	YB
Cambridge Thermionic Corp.	YB
Cannon Electric Development Co.	YB 42A
Capitol Radio Engineering Institute	50A
Carter Motor Co.	38A
Centralab	YB 5A
Chatham Electronics	YB
Chicago Transformer	YB
Clark Crystal Co.	YB
Clark-Reiss Distributors	YB
Clarostat Mfg. Co.	YB
Cleveland Container Co.	47A
Cohan-Epner Co.	YB
Sigmund Cohn Corp.	YB 42A
Collins Radio Co.	YB
Communications Equipment Co.	30A
Concord Radio Corp.	YB
Edward J. Content	51A
Cornell-Dubilier Electric Corp.	Cover III
Cornish Wire Company, Inc.	YB 26A
R. W. Cramer Co., Inc.	YB
Daven Co.	YB
DeJur Amsco Corp.	YB
Tobe Deutschmann Corp.	18A
Dial Light Co. of America	YB 44A
Drake Mfg. Co.	YB
Allen B. DuMont Laboratories	YB
Stanley D. Eilenberger	51A
Eitel-McCullough, Inc.	9A
Electric Design & Mfg. Corp.	46A
Electric Soldering Iron Co.	YB
Electrical Reactance Corp.	YB
Electro-Engineering Works	YB
Electro Motive Mfg. Co.	YB 20A
Electro-Seal Corp.	YB
Electro-Tech Equipment Co.	YB
Erie Resistor Corp.	YB 13A
Farnsworth Television & Radio	40A
Federal Telecommunications, Inc.	40A
Federal Telephone & Radio Corp.	YB
Ferranti Electric, Inc.	YB
Field Electrical Inst. Co.	YB
A. W. Franklin Mfg. Co.	YB
Frankel & Nelson	YB
Freed Transformer Co., Inc.	YB
Furst Electronics	YB 46A
General Aniline & Film Corp.	YB
General Electric Company	21A, 35A
General Radio Company	YB Cover IV
G. M. Giannini & Co., Inc.	50A

Paul Godley Company	YB 51A
Herman Lewis Gordon	51A
Samuel Gubin	51A
Alexander Hamilton Institute	YB
Harvey Radio Co.	YB
Hawley Products	YB
A. W. Haydon Co.	YB
Helipot Corp.	YB
Hewlett-Packard Co.	YB 1A
Hughey & Phillips	YB
Hunt Corporation	YB
Illinois Condenser Co.	YB
Indiana Steel Products Co.	YB
Inductive Equipment Co.	YB
Industrial Products Co.	YB
Industrial Television	YB
Insulation Manufacturers Corp.	YB
Insuline Corp. of America	YB
Jennings Radio Mfg. Co.	YB
Kay Electric Co.	YB
Kenyon Transformer Co., Inc.	YB 49A
Kollsman Instrument Division	YB
Lavoie Laboratories	YB
Lehigh Structural Steel Co.	YB
Lenz Electric Mfg. Co.	YB
Legri-S Company	YB
Linde Air Products Co.	YB
Machlett Laboratories	YB
Macmillan Company	YB
Magnetic Core Corp.	YB
George J. Maki	YB
P. R. Mallory & Co., Inc.	3A
Marion Electrical Inst. Co.	YB
McGraw-Hill Book Co.	YB
Measurements Corp.	YB 49A
Melpar, Inc.	40A
Mepeco, Inc.	YB
J. W. Miller Co.	YB
Eugene Mittelmann	51A
Mueller Electric Co.	YB
Mycalex Corp. of America	YB 10A & 11A
National Carbon Co.	YB 29A
National Co.	43A
Newark Electric Co., Inc.	YB 48A
New York Transformer Co.	45A
J. M. Ney Co.	YB
Northern Radio Co.	YB
J. P. O'Donnell & Sons	YB
Ohmite Mfg. Co.	YB 27A
Panoramic Radio Corp.	YB 43A
Par-Metal Products Corp.	YB 48A
Precision Paper Tube Co.	YB
Premax Products	YB 49A
Presto Recording Corp.	YB
Radio Corporation of America	YB 32A, 41A, 52A
RCA Review	YB
Radio Receptor Co.	YB
Raytheon Mfg. Co.	8A, 24A
Reeves Hoffman Corp.	YB 36A
Revere Copper & Brass, Inc.	6A
Irving Rubin	51A
Howard W. Sams & Co., Inc.	YB
A. J. Sanial	51A
Herman Hosmer Scott	YB
Shallcross Mfg. Co.	YB
Sherron Electronics Co.	YB 25A
Shure Brothers, Inc.	YB
Sorensen & Co., Inc.	4A
Sperry Gyroscope Co., Inc.	YB 40A
Sprague Electric Co.	YB 12A
Standard Piezo	YB
Stephens Mfg. Corp.	YB
Superior Electric Company	YB
Sylvania Electric Prod. Co., Inc.	YB
TAB	YB
Technical Advertising Associates	19A
Technology Instrument Corp.	39A
Times Facsimile Corp.	YB
Transradio, Ltd.	39A
Triplett Electrical Inst. Co.	YB 33A
Truscon Steel Co.	51A
Turner Company	YB
United Transformer Corp.	YB 17A
V-M Corporation	YB
Valpey Crystal Corp.	YB
Vitroscop Corp.	YB
Waterman Products	YB
W. M. Welch Mfg. Co.	YB
Western Electric Co.	YB 2A
Weston Electrical Inst. Corp.	15A
S.S. White Dental Mfg. Co.	YB
John Wiley & Sons	YB
C. K. Williams & Co.	YB
Zophar Mills, Inc.	YB

"Where  
Professional  
Radiomen  
Study"

## CAPITOL RADIO ENGINEERING INSTITUTE

An Accredited Technical Institute  
16th and Park Rd., N. W.  
Washington 10, D. C.

Advanced  
Home Study and Residence  
Courses in Practical Radio-  
Electronics and Television.  
Approved for Veteran Training.



## PROFESSIONAL CARDS

**W. J. BROWN**

*Consulting Engineer*  
**INDUSTRIAL ELECTRONICS**  
**RADIO AND TELEVISION**  
 25 years active electronic development  
 experience  
 P.O. Box 5106, Cleveland, Ohio  
 Telephone & Telegrams Yellowstone 7771  
 Office: 501 Marshall Building

**EDWARD J. CONTENT**

*Acoustical Consultant*  
**Functional Studio Design**

FM - Television - AM  
 Audio Systems Engineering  
 Roxbury Road Stamford 3-7459  
 Stamford, Conn.

**STANLEY D. EILENBERGER**

*Consulting Engineer*  
**INDUSTRIAL ELECTRONICS**

Design—Development—Models  
 Complete Laboratory and Shop Facilities  
 6309-13—27th Ave.  
 Kenosha, Wis. Telephone 2-4213

**PAUL GODLEY CO.**

*Consulting Radio Engineers*

P.O. Box J, Upper Montclair, N.J.  
 Offs. & Lab.: Great Notch, N.J.  
 Phone: Little Falls 4-1000  
 Established 1926

**HERMAN LEWIS GORDON**

*Engineering Consultant—Registered  
 Patent Attorney*

Product Development and Design  
 Electronics — Mechanical Devices — Optics  
 100 Normandy Drive 1416 F Street, N.W.  
 Silver Spring, Md. Washington 4, D.C.  
 Shepherd 2433 National 2497

Samuel Gubin, Electronics  
 G. F. Knowles, Mech. Eng.

**SPECTRUM ENGINEERS, Inc.**  
*Electronic & Mechanical Designers*

540 North 63rd Street  
 Philadelphia 31, Pa.  
 GRanite 2-2333; 2-3135

**EUGENE MITTELMANN, E.E., Ph.D.**

*Consulting Engineer & Physicist*  
**HIGH FREQUENCY HEATING**  
**INDUSTRIAL ELECTRONICS**  
**APPLIED PHYSICS &  
 MATHEMATICS**

549 W. Washington Blvd. Chicago 6, Ill.  
 Phone: State 8021

**IRVING RUBIN**

*Physicist*

Radio Interference and noise meters. Inter-  
 ference suppression methods for ignition sys-  
 tems and electrical devices. Laboratory facili-  
 ties.

P.O. Box 153, Shrewsbury, New Jersey  
 Telephone: REDBANK 6-4247

**ARTHUR J. SANIAL**

*Consulting Engineer*

Loudspeaker Design; Development; Mfg.  
 Processes. High Quality Audio Systems.  
 Announcing Systems. Test and Measuring  
 Equipment Design.

168-14 32 Ave. Flushing, N.Y.  
 FLushing 9-3574

# TRUSCON RADIO TOWERS

*are Modern to meet Modern Needs*

When the WSBA Broadcasting Company, York, Pennsylvania, planned its completely new and modern transmitter building, it also selected the very best in modern radio tower design. WSBA uses a 380 ft. high Truscon Self-Supporting Steel Radio Tower, to support a 2-bay RCA FM Pylon.

This splendid new tower is typical of the sturdy design, quality materials and skilled workmanship in hundreds of Truscon Radio Towers in America and foreign lands . . . each tower built to exactly meet specific requirements.

Truscon can engineer any type of tower you desire . . . guyed or self-supporting, either tapered or uniform cross-section . . . tall or small AM, FM or TV. Truscon engineering consultation is yours without obligation. Write or phone our home office at Youngstown, Ohio, or any of our numerous and conveniently located district sales offices.

**TRUSCON STEEL COMPANY**

YOUNGSTOWN 1, OHIO  
 Subsidiary of Republic Steel Corporation

Manufacturers of a Complete Line  
 of Self-Supporting Radio Towers . . .  
 Uniform Cross-Section Guyed Radio  
 Towers . . . Copper Mesh Ground  
 Screen . . . Steel Building Products.



Millions of Americans—with RCA television—will see history as it is made at the two National Political Conventions.

## ***Look before you vote — with Television***

This year, television joins press and radio as a "political reporter." in Philadelphia, at the Republican Convention, June 21, and the Democratic Convention, July 12. As political leaders step up to speak, you're right with them on the convention platform.

The Candidate will be televised as he looks into the camera—talks to the people, face to face. His appearance, smile, gestures, combine with the sound of his voice, and his message, to complete the transmission of his per-

sonality. You have a new opportunity to know your man!

Important as any in history, the 1948 conventions will be covered from start to finish by keen-eyed RCA Image Orthicon television cameras. Highlights and sidelights, all will be seen. And what the camera catches will be sharp and clear on the screens of RCA Victor home television receivers . . .

Today, 40,000,000 Americans are within reach of regularly scheduled daily television programs.

Television as an aid to good citizenship, through the formation of an informed public opinion, is one of the ways in which developments from RCA Laboratories serve the nation and its people. Advanced research is part of any instrument bearing the name RCA or RCA Victor.

When in Radio City, New York, be sure to see the radio, television and electronic wonders at RCA Exhibition Hall, 36 West 49th Street. Free admission. Radio Corporation of America, RCA Building, Radio City, N. Y. 20.



**RADIO CORPORATION of AMERICA**



*your*  
**product**

**IS MORE SALEABLE WITH**



*Quietones*  
Reg. U.S. Pat. Off.

You may build the best appliance of its kind on the market — but if it sets up local radio interference—you'll have tough sledding against today's keen competition. Your customers are *demanding* radio noise-free performance in the electrical equipment they buy.

The answer, of course, is to equip *your* products with C-D Quietones. Why Quietones? First, because they're the best-engineered noise filters — second, because they guard your product's reputation by

giving long trouble-free service — third, because they're designed and built to meet manufacturers' specific needs — efficiently and economically.

Speed up sales — build prestige — boost profits with C-D Quietones. Your inquiries are invited. Cornell-Dubilier Electric Corporation, Dept. K-7, South Plainfield, New Jersey. Other large plants in New Bedford, Brookline and Worcester, Mass., and Providence, Rhode Island.

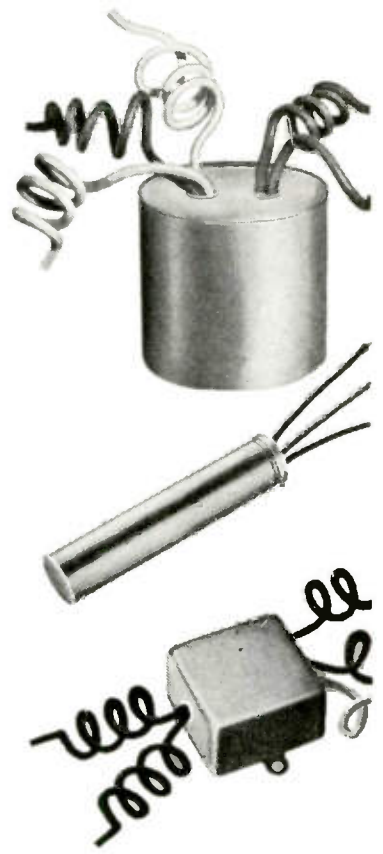

*Make Your Product More Saleable with C-D Quietone Radio Noise Filters and Spark Suppressors*

*An Invitation from C-D*  
WORLD'S MOST ADVANCED RADIO  
"NOISE-PROOFING" LABORATORY  
IS AT YOUR SERVICE  
*without obligation*

**CORNELL-DUBILIER**  
WORLD'S LARGEST MANUFACTURER OF  
**CAPACITORS**

MICA • DYKANOL • PAPER • ELECTROLYTIC

# for DISTORTION and BRIDGE MEASUREMENTS at 2 to 15,000 CYCLES

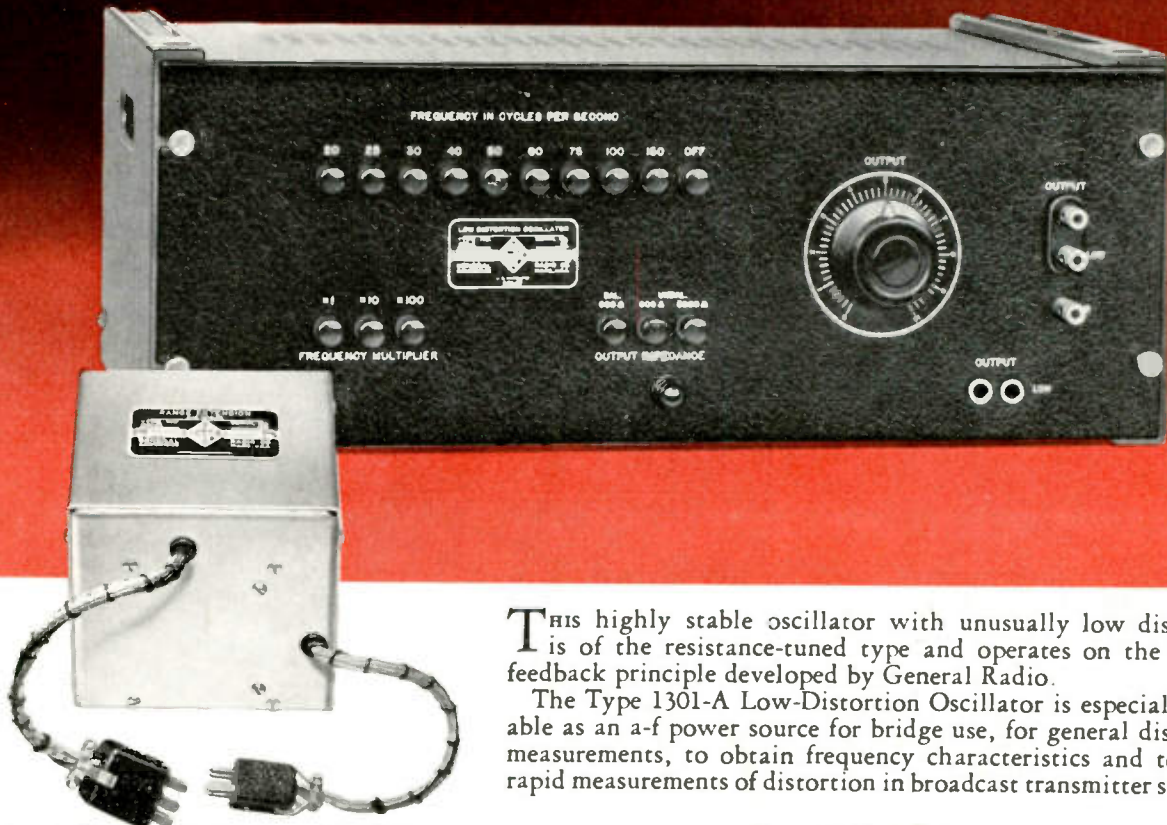

THIS highly stable oscillator with unusually low distortion is of the resistance-tuned type and operates on the inverse feedback principle developed by General Radio.

The Type 1301-A Low-Distortion Oscillator is especially suitable as an a-f power source for bridge use, for general distortion measurements, to obtain frequency characteristics and to make rapid measurements of distortion in broadcast transmitter systems.

## FEATURES

- **WIDE FREQUENCY RANGE** — 20 to 15,000 cycles (with Range Extension Unit, 2 to 15,000 cycles)
- **CONVENIENT TO USE** — 27 fixed frequencies, selected by two push-button switches in logarithmic steps — any desired frequency between steps obtained by plugging in external resistors
- **THREE OUTPUT IMPEDANCES** — 600-ohm balanced to ground; 600-ohm unbalanced; 5,000 ohm unbalanced
- **EXCEPTIONALLY PURE WAVEFORM** — Distortion not more than the following percentages: with 5,000-ohm output 0.1% from 40 to 7,500 cycles; 0.15% at other frequencies. With 600-ohm output 0.1% from 40 to 7,500 cycles; 0.25% from 20 to 40 cycles and 0.15% above 7,500 cycles
- **HIGH STABILITY** — Frequency is not affected by changes in load or plate supply voltage. Drift less than 0.02% per hour after a few minutes operation
- **ACCURATE FREQUENCY CALIBRATION** — Adjusted to within  $1\frac{1}{2}\% \pm 0.1$  cycle
- **NO TEMPERATURE OR HUMIDITY EFFECTS** — In ordinary climatic changes, operation is unaffected

TYPE 1301-A LOW-DISTORTION OSCILLATOR \$395.00

● The normal range of this oscillator is 20 to 15,000 cycles. The Range Extension Unit (above) lowers this range by a full decade to 2 to 15 cycles, greatly extending its usefulness to frequencies considerably below those heretofore practicable.

With its very high stability, unusually low distortion and many operating conveniences, the Type 1301-A Low-Distortion Oscillator fills a universal need in distortion and bridge measurements.

TYPE 1301-P1 RANGE EXTENSION UNIT . . . . . \$70.00

# GENERAL RADIO COMPANY

Cambridge 39,  
Massachusetts

90 West St., New York 6

920 S. Michigan Ave., Chicago 5

950 N. Highland Ave., Los Angeles 38